

ETSI TS 151 010-1 V4.3.0 (2001-04)

Technical Specification

**Digital cellular telecommunications system (Phase 2+);
Mobile Station (MS) conformance specification;
Part 1: Conformance specification
(3GPP TS 51.010-1 version 4.3.0 Release 4)**



Reference

DTS/TSGG-0451010-1Uv4

Keywords

GSM

ETSI

650 Route des Lucioles
F-06921 Sophia Antipolis Cedex - FRANCE

Tel.: +33 4 92 94 42 00 Fax: +33 4 93 65 47 16

Siret N° 348 623 562 00017 - NAF 742 C
Association à but non lucratif enregistrée à la
Sous-Préfecture de Grasse (06) N° 7803/88

Important notice

Individual copies of the present document can be downloaded from:

<http://www.etsi.org>

The present document may be made available in more than one electronic version or in print. In any case of existing or perceived difference in contents between such versions, the reference version is the Portable Document Format (PDF). In case of dispute, the reference shall be the printing on ETSI printers of the PDF version kept on a specific network drive within ETSI Secretariat.

Users of the present document should be aware that the document may be subject to revision or change of status. Information on the current status of this and other ETSI documents is available at

<http://portal.etsi.org/tb/status/status.htm>

If you find errors in the present document, send your comment to:
editor@etsi.fr

Copyright Notification

No part may be reproduced except as authorized by written permission.
The copyright and the foregoing restriction extend to reproduction in all media.

© European Telecommunications Standards Institute 2001.

All rights reserved.

Intellectual Property Rights

IPRs essential or potentially essential to the present document may have been declared to ETSI. The information pertaining to these essential IPRs, if any, is publicly available for **ETSI members and non-members**, and can be found in ETSI SR 000 314: "*Intellectual Property Rights (IPRs); Essential, or potentially Essential, IPRs notified to ETSI in respect of ETSI standards*", which is available from the ETSI Secretariat. Latest updates are available on the ETSI Web server (<http://www.etsi.org/legal/home.htm>).

Pursuant to the ETSI IPR Policy, no investigation, including IPR searches, has been carried out by ETSI. No guarantee can be given as to the existence of other IPRs not referenced in ETSI SR 000 314 (or the updates on the ETSI Web server) which are, or may be, or may become, essential to the present document.

Foreword

This Technical Specification (TS) has been produced by the ETSI 3rd Generation Partnership Project (3GPP).

The present document may refer to technical specifications or reports using their 3GPP identities, UMTS identities or GSM identities. These should be interpreted as being references to the corresponding ETSI deliverables.

The cross reference between GSM, UMTS, 3GPP and ETSI identities can be found under www.etsi.org/key.

Contents

Foreword	37
1 Scope.....	38
2 References.....	38
3 Definitions, conventions, and applicability	48
3.1 Mobile station definition and configurations.....	48
3.2 Applicability.....	49
3.2.1 Applicability of this specification.....	49
3.2.1.1 MS equipped with a connector	49
3.2.1.1.1 GPRS	49
3.2.2 Applicability of the individual tests.....	49
3.2.3 Applicability to terminal equipment	49
3.3 Definitions.....	49
3.4 Conventions for mathematical notations	50
3.4.1 Mathematical signs.....	50
3.4.2 Powers to the base 10	50
3.5 Conventions on electrical terms	50
3.5.1 Radio Frequency (RF) input signal level.....	50
3.5.2 Reference sensitivity level.....	51
3.5.3 Power level of fading signal	51
3.6 Terms on test conditions.....	51
3.6.1 Radio test conditions.....	51
4 Test Equipment.....	52
4.1 Terms used to describe test equipment in this EN.....	52
4.2 Functional requirements of test equipment.....	53
5 Testing methodology in general (layers 1, 2, and 3).....	53
5.1 Testing of optional functions and procedures.....	53
5.2 Test interfaces and facilities	53
5.3 Different protocol layers.....	53
5.4 Information to be provided by the apparatus supplier	54
5.5 Definitions of transmit and receive times.....	54
6 Reference test methods	54
6.1 General	54
6.2 Choice of frequencies in the frequency hopping mode	54
6.3 "Ideal" radio conditions.....	55
6.4 Standard test signals	55
6.5 Power (control) levels.....	55
7 Implicit testing	56
8 Measurement uncertainty.....	56
9 Format of tests	56
10 Generic call set up procedures	57
10.1 Generic call set-up procedure for mobile terminating speech calls	57
10.2 Generic call set-up procedure for mobile originating speech calls	62
10.3 Generic call set-up procedure for mobile terminating data calls.....	65
10.4 Generic call set-up procedure for mobile originating data calls	67
10.5 Generic call set-up procedure for mobile terminating multislot configuration, minimum number of timeslots allocated	70
10.6 Generic call set-up procedure for mobile originating multislot configuration, minimum number of timeslots allocated	73
10.7 Generic procedure for GPRS downlink data transfer	76
10.8 Generic procedure for GPRS uplink data transfer	77

11	General tests.....	80
11.1	Verification of support and non-support of services (multiple numbering scheme or ISDN)	80
11.1.1	Mobile Terminated (MT) calls	80
11.1.2	Mobile Originated (MO) calls	81
11.2	Verification of support of the single numbering scheme	82
11.3	Verification of non-support of services (Advice of Charge Charging (AoCC)).....	83
11.4	Verification of non-support of services (call hold).....	85
11.5	Verification of non-support of services (multiparty)	85
11.6	Verification of non-support of feature (Fixed Dialling Number (FDN)).....	86
11.7	IMEI Security	87
11.8	Coding of the Bearer Capability information element.....	88
11.8.1	Network to MS Direction	89
11.8.1.1	BS 21 to 26 - Asynchronous Service.....	89
11.8.1.1.1	BS 21 89	
11.8.1.1.2	BS 22 93	
11.8.1.1.3	BS 24 93	
11.8.1.1.4	BS 25 93	
11.8.1.1.5	BS 26 93	
11.8.1.1.6	BS 23 93	
11.8.1.2	BS 31 to 34 - Synchronous Service.....	94
11.8.1.2.1	BS 32 94	
11.8.1.2.2	BS 31 98	
11.8.1.2.3	BS 33 99	
11.8.1.2.4	BS 34 99	
11.8.1.3	BS 61 - Alternate Speech / Data.....	99
11.8.1.3.1	Speech/Asynchronous Data, Transparent.....	100
11.8.1.3.2	Speech/Asynchronous Data, Non Transparent.....	102
11.8.1.3.3	Speech/Synchronous Data.....	104
11.8.1.4	BS 81 - Speech followed by Data	105
11.8.1.4.1	Speech followed by Asynchronous Data.....	105
11.8.1.4.2	Speech followed by Synchronous Data.....	105
11.8.1.5	TS 61 - Alternate Speech / Facsimile group 3.....	105
11.8.1.5.1	TS 61 - Alternate Speech / Facsimile group 3, Transparent.....	106
11.8.1.5.2	TS 61 - Alternate Speech / Facsimile group 3, Non-Transparent.....	107
11.8.1.6	TS 62 - Automatic Facsimile group 3	108
11.8.2	MS to SS direction.....	108
11.8.2.1	BS 21 to 26 - Asynchronous Service.....	108
11.8.2.1.1	BS 21 109	
11.8.2.1.2	BS 22 112	
11.8.2.1.3	BS 24 113	
11.8.2.1.4	BS 25 113	
11.8.2.1.5	BS 26 113	
11.8.2.1.6	BS 23 113	
11.8.2.2	BS 31 to 34 - Synchronous Service.....	114
11.8.2.2.1	BS 32 114	
11.8.2.2.2	BS 31 118	
11.8.2.2.3	BS 33 119	
11.8.2.2.4	BS 34 119	
11.8.2.3	BS 41 to 46 - PAD Access Asynchronous	120
11.8.2.3.1	²⁾ BS 41.....	120
11.8.2.3.2	BS 42 121	
11.8.2.3.3	BS 44 122	
11.8.2.3.4	BS 45 122	
11.8.2.3.5	BS 46 122	
11.8.2.3.6	BS 43 122	
11.8.2.4	BS 51 to 53 - Packet Service Synchronous	123
11.8.2.4.1	²⁾ BS 51.....	123
11.8.2.4.2	BS 52 123	
11.8.2.4.3	BS 53 123	
11.8.2.5	BS 61 - Alternate Speech / Data.....	124
11.8.2.5.1	Speech/Asynchronous Data, Transparent.....	124
11.8.2.5.2	Speech/Asynchronous Data, Non Transparent.....	127

11.8.2.5.3	Speech/Synchronous Data.....	129
11.8.2.6	BS 81 - Speech followed by Data	130
11.8.2.6.1	Speech followed by Asynchronous Data.....	130
11.8.2.6.2	Speech followed by Synchronous Data.....	130
11.8.2.7	TS 61 - Alternate Speech / Facsimile group 3.....	130
11.8.2.7.1	TS 61 - Alternate Speech / Facsimile group 3, Transparent.....	131
11.8.2.7.2	TS 61 - Alternate Speech / Facsimile group 3, Non Transparent.....	132
11.8.2.8	TS 62 - Automatic Facsimile group 3	133
11.8.2.9	TS 11 and TS 12- Speech.....	133
11.8.2.9.1	Support of only full/half rate speech version 1	133
11.8.2.9.2	Support of speech full rate version 2 (Enhanced Full Rate).....	133
12	Transceiver	134
12.1	Conducted spurious emissions.....	134
12.1.1	MS allocated a channel.....	134
12.1.2	MS in idle mode.....	137
12.2	Radiated spurious emissions.....	139
12.2.1	MS allocated a channel.....	139
12.2.2	MS in idle mode.....	141
12.3	Conducted spurious emissions for MS supporting the R-GSM frequency band.....	143
12.3.1	MS allocated a channel.....	143
12.3.2	MS in idle mode.....	145
12.4	Radiated spurious emissions for MS supporting the R-GSM frequency band.....	146
12.4.1	MS allocated a channel.....	147
12.4.2	MS in idle mode.....	149
13	Transmitter.....	150
13.1	Frequency error and phase error	150
13.2	Frequency error under multipath and interference conditions	154
13.3	Transmitter output power and burst timing.....	156
13.4	Output RF spectrum.....	164
13.5	Intermodulation attenuation.....	171
13.6	Frequency error and phase error in HSCSD multislot configurations	172
13.7	Transmitter output power and burst timing in HSCSD configurations.....	176
13.8	Output RF spectrum in HSCSD multislot configuration	184
13.9	Output RF spectrum for MS supporting the R-GSM band	191
13.10	[Reserved for future GSM test].....	197
13.11	[Reserved for future GSM test].....	197
13.12	[Reserved for future GSM test].....	197
13.13	[Reserved for future GSM test].....	197
13.14	[Reserved for future GSM test].....	197
13.15	[Reserved for future GSM test].....	197
13.16	GPRS transmitter tests.....	197
13.16.1	Frequency error and phase error in GPRS multislot configuration.....	197
13.16.2	Transmitter output power in GPRS multislot configuration	200
13.16.3	Output RF spectrum in GPRS multislot configuration	208
13.17	EGPRS transmitter tests.....	216
13.17.1	Frequency error and Modulation accuracy in EGPRS Configuration.....	216
13.17.2	Frequency error under multipath and interference conditions.	221
13.17.3	EGPRS Transmitter output power	224
13.17.4	Output RF spectrum in EGPRS configuration	232
13.17.5	Intermodulation attenuation.....	239
14	Receiver	240
14.1	Bad frame indication.....	246
14.1.1	Bad frame indication - TCH/FS.....	246
14.1.1.1	Bad frame indication - TCH/FS - Random RF input.....	246
14.1.1.2	Bad frame indication - TCH/FS - Frequency hopping and downlink DTX	247
14.1.2	Bad frame indication - TCH/HS	248
14.1.2.1	Bad frame indication - TCH/HS - Random RF input.....	248
14.1.2.2	Bad frame indication - TCH/HS - Frequency hopping and downlink DTX.....	249
14.1.3	Bad frame indication - TCH/FS - Frequency hopping and downlink DTX - Phase 2 MS in a phase 1 network.....	250

14.1.4	Bad frame indication - TCH/HS - Frequency hopping and downlink DTX - Phase 2 MS in a phase 1 network.....	252
14.2	Reference sensitivity.....	254
14.2.1	Reference sensitivity - TCH/FS.....	254
14.2.2	Reference sensitivity - TCH/HS (Speech frames).....	256
14.2.3	Reference sensitivity - FACCH/F.....	259
14.2.4	Reference sensitivity - FACCH/H.....	260
14.2.5	Reference sensitivity - full rate data channels.....	261
14.2.6	Reference sensitivity - half rate data channels.....	262
14.2.7	Reference sensitivity - TCH/EFS.....	263
14.2.8	Reference sensitivity - full rate data channels in multislot configuration.....	265
14.2.9	Reference sensitivity - TCH/FS for MS supporting the R-GSM band.....	266
14.3	Usable receiver input level range.....	268
14.4	Co-channel rejection.....	270
14.4.1	Co-channel rejection - TCH/FS.....	270
14.4.2	Co-channel rejection - TCH/HS.....	272
14.4.3	Co-channel rejection - TCH/HS (SID frames).....	274
14.4.4	Co-channel rejection - FACCH/F.....	275
14.4.5	Co-channel rejection - FACCH/H.....	276
14.4.6	Co-channel rejection - TCH/EFS.....	277
14.4.7	Receiver performance in the case of frequency hopping and co-channel interference on one carrier.....	279
14.5	Adjacent channel rejection.....	280
14.5.1	Adjacent channel rejection - speech channels.....	280
14.5.2	Adjacent channel rejection - control channels.....	283
14.6	Intermodulation rejection.....	285
14.6.1	Intermodulation rejection - speech channels.....	285
14.6.2	Intermodulation rejection - control channels.....	286
14.7	Blocking and spurious response.....	288
14.7.1	Blocking and spurious response - speech channels.....	288
14.7.2	Blocking and spurious response - control channels.....	293
14.7.3	Blocking and spurious response - speech channels for MS supporting the R-GSM band.....	298
14.7.4	Blocking and spurious response - control channels for MS supporting the R-GSM band.....	301
14.8	AM suppression.....	304
14.8.1	AM suppression - speech channels.....	304
14.8.2	AM suppression - control channels.....	305
14.9	Paging performance at high input levels.....	307
14.10	[Reserved for future GSM test].....	308
14.11	[Reserved for future GSM test].....	308
14.12	[Reserved for future GSM test].....	308
14.13	[Reserved for future GSM test].....	308
14.14	[Reserved for future GSM test].....	308
14.15	[Reserved for future GSM test].....	308
14.16	GPRS receiver tests.....	308
14.16.1	Minimum Input level for Reference Performance.....	310
14.16.2	Co-channel rejection.....	314
14.16.2.1	Co-channel rejection for packet channels.....	314
14.18	EGPRS receiver tests.....	317
14.18.1	Minimum Input level for Reference Performance.....	319
14.18.2	Co-channel rejection.....	324
14.18.3	Adjacent channel rejection.....	328
14.18.4	Intermodulation rejection.....	332
14.18.5	Blocking and spurious response.....	335
14.18.6	EGPRS Usable receiver input level range.....	342
15	Timing advance and absolute delay.....	345
15.6	GPRS Timing advance and absolute delay.....	346
15.7	ECSD Timing advance and absolute delay.....	350
15.8	EGPRS timing advance and absolute delay.....	351

16	Reception time tracking speed	355
17	Access times during handover	358
17.1	Intra cell channel change	358
17.2	Inter cell handover	360
18	Temporary reception gaps	363
18.1	Temporary reception gaps, single slot	363
18.2	Temporary reception gaps in HSCSD multislot configurations.....	364
19	Channel release after unrecoverable errors.....	366
19.1	Channel release after unrecoverable errors -1.....	366
19.2	Channel release after unrecoverable errors - 2.....	367
19.3	Channel release after unrecoverable errors - 3.....	368
20	Cell selection and reselection	369
20.1	Cell selection	372
20.2	Cell selection with varying signal strength values.....	373
20.3	Basic cell reselection	375
20.4	Cell reselection using TEMPORARY_OFFSET, CELL_RESELECT_OFFSET, POWER_OFFSET and PENALTY_TIME parameters	377
20.5	Cell reselection using parameters transmitted in the System Information type 2bis, type 2ter, type 7 and type 8 messages	379
20.6	Cell reselection timings	381
20.7	Priority of cells	383
20.8	Cell reselection when C1 (serving cell) < 0 for 5 seconds.....	384
20.9	Running average of the surrounding cell BCCH carrier signal levels	386
20.10	Running average of the serving cell BCCH carrier signal level	387
20.11	Updating the list of six strongest neighbour carriers and decoding the BCCH information of a new carrier on the list	388
20.12	Decoding the BCCH information of the neighbour carriers on the list of six strongest neighbour carriers ..	389
20.13	Decoding the BSIC of the neighbour carriers on the list of six strongest neighbour carriers	390
20.14	Emergency calls.....	391
20.15	Cell reselection due to MS rejection "LA not allowed"	392
20.16	Downlink signalling failure	394
20.17	Cell selection if no suitable cell found in 10 s	395
20.18	Cell reselection due to MS rejection "Roaming not allowed in this LA"	396
20.19	Cell selection on release of SDCCH and TCH	397
20.20	Multiband cell selection and reselection.....	399
20.20.1	Multiband cell selection and reselection / Cell Selection	399
20.20.2	Multiband cell selection and reselection / Cell reselection.....	401
20.21	R-GSM cell selection and reselection.....	402
20.21.1	R-GSM cell selection.....	404
20.21.2	R-GSM cell selection with varying signal strength values	406
20.21.3	R-GSM basic cell reselection.....	408
20.21.4	R-GSM cell reselection using TEMPORARY_OFFSET, CELL_RESELECT_OFFSET, POWER_OFFSET and PENALTY_TIME parameters	410
20.21.5	R-GSM cell reselection using parameters transmitted in the System Information type 2bis, type 2ter, type 7 and type 8 messages	411
20.21.6	R-GSM cell reselection timings.....	413
20.21.7	R-GSM priority of cells	415
20.21.8	R-GSM cell reselection when C1 (serving cell) < 0 for 5 seconds.....	416
20.21.9	R-GSM running average of the surrounding cell BCCH carrier signal levels.....	417
20.21.10	R-GSM running average of the serving cell BCCH carrier signal level	418
20.21.11	Updating the list of six strongest neighbour carriers and decoding the BCCH information of a new carrier on the list.....	419
20.21.12	R-GSM decoding the BCCH information of the neighbour carriers on the list of six strongest neighbour carriers.....	420
20.21.13	R-GSM decoding the BSIC of the neighbour carriers on the list of six strongest neighbour carriers.....	421
20.21.14	R-GSM emergency calls	422
20.21.15	R-GSM cell reselection due to MS rejection "LA not allowed"	423
20.21.16	R-GSM downlink signalling failure	425
20.21.17	R-GSM cell selection if no suitable cell found in 10 s.....	426

20.21.18	R-GSM cell reselection due to MS rejection "Roaming not allowed in this LA"	427
20.21.19	R-GSM cell selection on release of SDCCH and TCH	429
20.22	GPRS Cell Selection and Reselection	430
20.22.1	Cell selection	432
20.22.2	Cell reselection in Packet Idle mode	433
20.22.3	Priority of cells	435
20.22.4	Cell re-selection with cells in different routing area	436
20.22.5	Network controlled Cell re-selection in Transfer Mode	438
20.22.6	Cell reselection timings	439
20.22.7	Downlink signalling failure	440
20.22.8	Cell selection when the best cell does not support GPRS	441
20.22.9	Cell reselection when the best cell does not support GPRS	443
20.23	COMPACT Cell Selection and Reselection	446
20.23.1	Cell selection	448
20.23.2	Cell reselection in Packet Idle mode	449
20.23.3	Priority of cells	451
20.23.4	Cell re-selection with cells in different routing area	452
20.23.5	Network controlled Cell re-selection in Transfer Mode	454
20.23.6	Cell reselection timings	455
20.23.7	Downlink signalling failure	456
20.23.8	COMPACT Cell re-selection when target cell is BCCH supporting EGPRS and different routing area	457
20.23.9	Cell re-selection when target cell is COMPACT CPBCCCH in different routing area	459
20.24	SoLSA Cell Selection and Reselection	460
20.24.1	SoLSA Cell Selection suitable cell	468
20.24.2	SoLSA Cell (Re)Selection Emergency Call	476
20.24.3	SoLSA Cell Reselection / idle mode support enabled	478
20.24.3.1	General conformance requirement	478
20.24.3.2	SoLSA Cell Reselection / idle mode support enabled / LSA Priority	480
20.24.3.3	SoLSA Cell Reselection / idle mode support enabled / LSA Priority / different location area	482
20.24.3.4	SoLSA Cell Reselection / idle mode support enabled / Priority Threshold	485
20.24.3.5	SoLSA Cell Reselection / idle mode support enabled / LSA Priority / LSA_OFFSET	489
20.24.3.6	SoLSA Cell Reselection / idle mode support enabled / LSA Priority / cell combinations	491
20.24.3.7	SoLSA Cell Reselection / roaming	495
20.24.4	SoLSA Cell Reselection / idle mode support / any value	496
20.24.5	SoLSA Cell Reselection / LSA indication for idle mode	499
20.24.5.1	General definition and applicability	499
20.24.5.2	General conformance requirement	499
20.24.5.3	SoLSA Cell Reselection / LSA indication for idle mode / idle mode support enabled	499
20.24.5.4	SoLSA Cell Reselection / LSA indication for idle mode / idle mode support disabled	501
21	Received signal measurements	504
21.1	Signal strength	504
21.2	Signal strength selectivity	508
21.3	Signal quality under static conditions	510
21.3.1	Signal quality under static conditions - TCH/FS	510
21.3.2	Signal quality under static conditions - TCH/HS	512
21.4	Signal quality under TUhigh propagation conditions	513
21.5	Received signal measurements in HSCSD multislot configuration	515
21.5.1	Signal strength	515
21.6	COMPACT Signal strength	519
21.7	COMPACT Signal strength selectivity	523
22	Transmit power control timing and confirmation	526
22.1	Transmit power control timing and confirmation, single slot	526
22.2	Transmit power control timing and confirmation in HSCSD multislot configurations	528
22.3	GPRS Uplink Power Control – Use of α and Γ_{CH} parameters	529
22.4	GPRS Uplink Power Control – Independence of TS Power Control	533
22.5	[Reserved for future GPRS test]	534
22.6	Normal transmit power control timing and confirmation in ECSD	534
22.7	ECSD Fast Power Control (FPC) timing and interworking with normal power control	536
22.8	EGPRS Uplink Power Control – Use of α and Γ_{CH} parameters	539
22.9	EGPRS Uplink Power Control – Independence of TS Power Control	543

22.10	[Reserved for future EGPRS test]	544
23	Single frequency reference	544
24	Tests of the layer 1 signalling functions	544
25	Tests of the layer 2 signalling functions	545
25.1	Introduction, objective and scope	545
25.1.1	General	545
25.1.2	Test configurations	545
25.1.3	Pre-conditions	545
25.1.4	Layer 2 test frames	546
25.1.5	Establishment of the dedicated physical resource	547
25.1.6	Release of the dedicated physical resource	547
25.2	Test sequences	547
25.2.1	Initialization	548
25.2.1.1	Initialization when contention resolution required	548
25.2.1.1.1	Normal initialization	548
25.2.1.1.2	Initialization failure	549
25.2.1.1.3	Initialization denial	552
25.2.1.1.4	Total initialization failure	553
25.2.1.2	Initialization, contention resolution not required	554
25.2.1.2.1	Normal initialization without contention resolution	554
25.2.1.2.2	Initialization failure	555
25.2.1.2.3	Initialization denial	556
25.2.1.2.4	Total initialization failure	557
25.2.2	Normal information transfer	558
25.2.2.1	Sequence counting and I frame acknowledgements	558
25.2.2.2	Receipt of an I frame in the timer recovery state	561
25.2.2.3	Segmentation and concatenation	563
25.2.3	Normal layer 2 disconnection	566
25.2.4	Test of link failure	566
25.2.4.1	I frame loss (MS to SS)	566
25.2.4.2	RR response frame loss (SS to MS)	568
25.2.4.3	RR response frame loss (MS to SS)	568
25.2.5	Test of frame transmission with incorrect C/R values	569
25.2.5.1	I frame with C bit set to zero	569
25.2.5.2	SABM frame with C bit set to zero	570
25.2.6	Test of errors in the control field	571
25.2.6.1	N(S) sequence error	571
25.2.6.2	N(R) sequence error	573
25.2.6.3	Improper F bit	573
25.2.7	Test on receipt of invalid frames	574
26	Testing of layer 3 functions	579
26.1	Default conditions and structured sequence of tests	579
26.1.1	Default test conditions during layer 3 tests	579
26.1.2	Structured sequence of the tests	582
26.1.3	General rules for message parameters	582
26.1.4	General rules for layer 3 testing	583
26.1.5	Format of layer 3 test descriptions	583
26.2	Initial tests	584
26.2.1	Channel request	584
26.2.1.1	Channel request / initial time	584
26.2.1.2	Channel request / repetition time	585
26.2.1.3	Channel request / random reference	587
26.2.2	IMSI detach and IMSI attach	588
26.2.3	Sequenced MM / CM message transfer	592
26.2.4	Establishment cause	593
26.3	Test of MS functions in idle mode	600
26.3.1	Initial conditions	600
26.3.2	MS indication of available PLMNs	605
26.3.3	MS will send only if BSS is "on air"	606

26.3.4	Manual mode of PLMN selection.....	606
26.4	Lower layer failures in layer 3 testing	608
26.4.1	Introduction.....	608
26.4.2	Layer 1 reception failures	608
26.4.3	Data link layer failures.....	608
26.4.4	Lower layer failures, used for the tests in clause 25	608
26.5	Handling of unknown, unforeseen, and erroneous protocol data, and of parallel transactions	608
26.5.1	Handling of unknown, unforeseen, and erroneous protocol data, and of parallel transactions / unknown protocol discriminator	608
26.5.2	Handling of unknown, unforeseen, and erroneous protocol data, and of parallel transactions / TI and skip indicator.....	610
26.5.2.1	TI and skip indicator / RR	610
26.5.2.1.1	TI and skip indicator / RR / Idle Mode	610
26.5.2.1.2	TI and skip indicator / RR / RR-Connection established	611
26.5.2.2	TI and skip indicator / MM	612
26.5.2.3	TI and skip indicator / CC	614
26.5.3	Handling of unknown, unforeseen, and erroneous protocol data, and of parallel transactions / undefined or unexpected message type.....	616
26.5.3.1	Undefined or unexpected message type / undefined message type / CC.....	616
26.5.3.2	Undefined or unexpected message type / undefined message type / MM.....	617
26.5.3.3	Undefined or unexpected message type / undefined message type / RR.....	618
26.5.3.4	Undefined or unexpected message type / unexpected message type / CC	619
26.5.4	Handling of unknown, unforeseen, and erroneous protocol data, and of parallel transactions / unforeseen information elements in the non-imperative message part.....	620
26.5.4.1	Unforeseen information elements in the non-imperative message part / duplicated information elements.....	620
26.5.5	Handling of unknown, unforeseen, and erroneous protocol data, and of parallel transactions / non-semantic mandatory IE errors.....	622
26.5.5.1	Non-semantic mandatory IE errors / RR	622
26.5.5.1.1	Non-semantic mandatory IE errors / RR / missing mandatory IE error	622
26.5.5.1.2	Non-semantic mandatory IE errors / RR / comprehension required.....	625
26.5.5.2	Non-semantic mandatory IE errors / MM	626
26.5.5.2.1	Non-semantic mandatory IE errors / MM / syntactically incorrect mandatory IE	626
26.5.5.2.2	Non-semantic mandatory IE errors / MM / syntactically incorrect mandatory IE	627
26.5.5.2.3	Non-semantic mandatory IE errors / MM / comprehension required.....	628
26.5.5.3	Non-semantic mandatory IE errors / CC	630
26.5.5.3.1	Non-semantic mandatory IE errors / CC / missing mandatory IE.....	630
26.5.5.3.2	Non-semantic mandatory IE errors / CC / comprehension required.....	632
26.5.6	Handling of unknown, unforeseen, and erroneous protocol data, and of parallel transactions / unknown IE, comprehension not required	634
26.5.6.1	Unknown information elements in the non-imperative message part / MM	634
26.5.6.1.1	Unknown IE, comprehension not required / MM / IE unknown in the protocol.....	634
26.5.6.1.2	Unknown IE, comprehension not required / MM / IE unknown in the message.....	635
26.5.6.2	Unknown information elements in the non-imperative message part / CC	636
26.5.6.2.1	Unknown information elements in the non-imperative message part / CC / Call establishment	636
26.5.6.2.2	Unknown information elements in the non-imperative message part / CC / disconnect.....	638
26.5.6.2.3	Unknown information elements in the non-imperative message part / CC / release.....	639
26.5.6.2.4	Unknown information elements in the non-imperative message part / CC / release complete	640
26.5.6.3	Unknown IE in the non-imperative message part, comprehension not required / RR.....	641
26.5.7	Handling of unknown, unforeseen, and erroneous protocol data, and of parallel transactions / spare bits....	643
26.5.7.1	Spare bits / RR	643
26.5.7.1.1	Spare bits / RR / paging channel	643
26.5.7.1.2	Spare bits / RR / BCCH.....	644
26.5.7.1.3	Spare bits / RR / AGCH	646
26.5.7.1.4	Spare bits / RR / Connected Mode	648
26.5.7.2	Spare bits / MM.....	650
26.5.7.3	Spare bits / CC	652
26.5.8	Default contents of messages.....	654
26.6	Test of the elementary procedures for radio resource management.....	656
26.6.1	Immediate assignment	656
26.6.1.1	Immediate assignment / SDCCH or TCH assignment	656
26.6.1.2	Immediate assignment / extended assignment	657

26.6.1.3	Immediate assignment / assignment rejection.....	659
26.6.1.4	Immediate assignment / ignore assignment.....	661
26.6.1.5	Immediate assignment after immediate assignment reject.....	663
26.6.2	Test of paging.....	664
26.6.2.1	Normal paging.....	664
26.6.2.1.1	Paging / normal / type 1.....	664
26.6.2.1.2	Paging / normal / type 2.....	667
26.6.2.1.3	Paging / normal / type 3.....	669
26.6.2.2	Paging / extended.....	670
26.6.2.3	Paging / reorganization.....	673
26.6.2.3.1	Paging / reorganization / procedure 1.....	673
26.6.2.3.2	Paging / reorganization / procedure 2.....	676
26.6.2.4	Paging / same as before.....	677
26.6.2.5	Paging / multislot CCCH.....	678
26.6.3	Test of measurement report.....	679
26.6.3.1	Measurement / no neighbours.....	679
26.6.3.2	Measurement / all neighbours present.....	685
26.6.3.3	Measurement / barred cells and non-permitted NCCs.....	693
26.6.3.4	Measurement / DTX.....	700
26.6.3.5	Measurement / Frequency Formats.....	708
26.6.3.6	Measurement / multiband environment.....	715
26.6.3.7	Measurement / new cell reporting.....	724
26.6.4	Test of the channel assignment procedure.....	736
26.6.4.1	Dedicated assignment / successful case.....	736
26.6.4.2	Dedicated assignment / failure.....	755
26.6.4.2.1	Dedicated assignment / failure / failure during active state.....	755
26.6.4.2.2	Dedicated assignment / failure / general case.....	757
26.6.5	Test of handover.....	758
26.6.5.1	Handover / successful / active call / non-synchronized.....	759
26.6.5.2	Handover / successful / call under establishment / non-synchronized.....	791
26.6.5.3	Handover / successful / active call / finely synchronized.....	833
26.6.5.4	Handover / successful / call under establishment / finely synchronized.....	844
26.6.5.5	Pre-synchronized handovers.....	867
26.6.5.5.1	Handover / successful / active call / pre-synchronized / Timing Advance IE not included.....	867
26.6.5.5.2	Handover / successful / call being established / pre-synchronized / timing advance IE is included / reporting of observed time difference requested.....	869
26.6.5.6	Handover / successful / active call / pseudo synchronized.....	871
26.6.5.7	Handover / successful / active call / non-synchronized / reporting of observed time difference requested.....	873
26.6.5.8	Handover / layer 3 failure.....	875
26.6.5.9	Handover / layer 1 failure.....	876
26.6.6	Test of frequency redefinition.....	877
26.6.6.1	Frequency redefinition.....	877
26.6.7	Test of the channel mode modify procedure.....	889
26.6.7.1	Test of the channel mode modify procedure / full rate.....	889
26.6.7.2	Test of the channel mode modify procedure / half rate.....	891
26.6.8	Test of ciphering mode setting.....	894
26.6.8.1	Ciphering mode / start ciphering.....	894
26.6.8.2	Ciphering mode / no ciphering.....	895
26.6.8.3	Ciphering mode / old cipher key.....	896
26.6.8.4	Ciphering mode / change of mode, algorithm and key.....	898
26.6.8.5	Ciphering mode / IMEISV request.....	908
26.6.9	Test of additional assignment.....	909
26.6.10	Test of partial release.....	910
26.6.11	Test of classmark.....	910
26.6.11.1	Classmark change.....	910
26.6.11.2	Classmark interrogation.....	911
26.6.12	Test of channel release.....	913
26.6.12.1	Channel release / SDCCH.....	913
26.6.12.2	Channel release / SDCCH - no L2 ACK.....	915
26.6.12.3	Channel release / TCH-F.....	916
26.6.12.4	Channel release / TCH-F - no L2 ACK.....	917

26.6.13	Test of starting time	919
26.6.13.1	Dedicated assignment with starting time / successful case / time not elapsed	921
26.6.13.2	Dedicated assignment with starting time / successful case / time elapsed	923
26.6.13.3	Dedicated assignment with starting time and frequency redefinition / failure case / time not elapsed	925
26.6.13.4	Dedicated assignment with starting time and frequency redefinition / failure case / time elapsed	928
26.6.13.5	Handover with starting time / successful case / time not elapsed.....	930
26.6.13.6	Handover with starting time / successful case / time elapsed.....	932
26.6.13.7	Handover with starting time and frequency redefinition / failure case / time not elapsed	934
26.6.13.8	Handover with starting time and frequency redefinition / failure case / time elapsed.....	937
26.6.13.9	Immediate assignment with starting time / successful case / time not elapsed	940
26.6.13.10	Immediate assignment with starting time / successful case / time elapsed	942
26.6.14	Default contents of GSM 900 layer 3 messages for RR tests	944
26.6.15	Default contents of DCS 1 800 layer 3 messages for RR tests	955
26.6.16	Default contents of GSM 450 layer 3 messages for RR tests	965
26.6.17	Default contents of GSM 480 layer 3 messages for RR tests	976
26.6.18	Default contents of PCS 1900 layer 3 messages for RR tests.....	987
26.7	Elementary procedures of mobility management	997
26.7.1	TMSI reallocation.....	998
26.7.2	Authentication.....	1000
26.7.2.1	Authentication accepted.....	1000
26.7.2.2	Authentication rejected	1001
26.7.3	Identification.....	1004
26.7.3.1	General Identification.....	1004
26.7.3.2	Handling of IMSI shorter than the maximum length	1006
26.7.4	Location updating	1009
26.7.4.1	Location updating / accepted.....	1009
26.7.4.2	Location updating / rejected.....	1014
26.7.4.2.1	Location updating / rejected / IMSI invalid	1014
26.7.4.2.2	Location updating / rejected / PLMN not allowed	1017
26.7.4.2.3	Location updating / rejected / location area not allowed.....	1021
26.7.4.2.4	Location updating / rejected / roaming not allowed in this location area.....	1024
26.7.4.3	Location updating / abnormal cases	1031
26.7.4.3.1	Location updating / abnormal cases / random access fails.....	1031
26.7.4.3.2	Location updating / abnormal cases / attempt counter less or equal to 4, LAI different	1033
26.7.4.3.3	Location updating / abnormal cases / attempt counter equal to 4.....	1039
26.7.4.3.4	Location updating / abnormal cases / attempt counter less or equal to 4, stored LAI equal to broadcast LAI	1046
26.7.4.4	Location updating / release / expiry of T3240.....	1052
26.7.4.5	Location updating / periodic	1053
26.7.4.5.1	Location updating / periodic spread	1053
26.7.4.5.2	Location updating / periodic normal / test 1.....	1055
26.7.4.5.3	Location updating / periodic normal / test 2.....	1057
26.7.4.5.4	Location updating / periodic HPLMN search	1060
26.7.4.6	Location updating / interworking of attach and periodic	1064
26.7.5	MM connection.....	1065
26.7.5.1	Introduction	1065
26.7.5.2	MM connection / establishment with cipher	1066
26.7.5.3	MM connection / establishment without cipher	1067
26.7.5.4	MM connection / establishment rejected.....	1068
26.7.5.5	MM connection / establishment rejected cause 4.....	1069
26.7.5.6	MM connection / expiry T3230	1071
26.7.5.7	MM connection / abortion by the network	1072
26.7.5.7.1	MM connection / abortion by the network / cause #6.....	1072
26.7.5.7.2	MM connection / abortion by the network / cause not equal to #6	1075
26.7.5.8	MM connection / follow-on request pending	1076
26.7.5.8.1	MM connection / follow-on request pending / test 1.....	1076
26.7.5.8.2	MM connection / follow-on request pending / test 2.....	1077
26.7.5.8.3	MM connection / follow-on request pending / test 3.....	1079
26.7.6	Default contents of messages.....	1080
26.8	Tests related to circuit switched call control.....	1083
26.8.1	Circuit switched Call Control (CC) state machine verification	1083
26.8.1.1	General on CC state machine verification.....	1083

26.8.1.2	Establishment of an outgoing call	1084
26.8.1.2.1	Outgoing call / U0 null state	1087
26.8.1.2.2	Outgoing call / U0.1 MM connection pending	1088
26.8.1.2.3	Outgoing call / U1 call initiated	1092
26.8.1.2.4	Outgoing call / U3 MS originating call proceeding	1101
26.8.1.2.5	Outgoing call / U4 call delivered	1117
26.8.1.2.6	U10 call active.....	1127
26.8.1.2.7	U11 disconnect request	1135
26.8.1.2.8	U12 disconnect indication.....	1141
26.8.1.2.9	Outgoing call / U19 release request	1146
26.8.1.3	Establishment of an incoming call / Initial conditions	1152
26.8.1.3.1	Incoming call / U0 null state	1155
26.8.1.3.2	Incoming call / U6 call present.....	1156
26.8.1.3.3	Incoming call / U9 mobile terminating call confirmed	1158
26.8.1.3.4	Incoming call / U7 call received.....	1167
26.8.1.3.5	Incoming call / U8 connect request.....	1177
26.8.1.4	In call functions.....	1188
26.8.1.4.1	In-call functions / DTMF information transfer	1188
26.8.1.4.2	In-call functions / user notification	1190
26.8.1.4.3	In-call functions / channel changes	1191
26.8.1.4.4	In-call functions / MS terminated in-call modification	1194
26.8.1.4.5	In-call functions / MS originated in-call modification	1196
26.8.2	Call Re-establishment	1211
26.8.2.1	Call Re-establishment/call present, re-establishment allowed	1211
26.8.2.2	Call Re-establishment/call present, re-establishment not allowed	1213
26.8.2.3	Call Re-establishment/call under establishment, transmission stopped	1214
26.8.3	User to user signalling	1216
26.8.4	Default contents of message	1218
26.9	Structured procedures	1224
26.9.1	Structured procedures / general	1224
26.9.2	Structured procedures / MS originated call / early assignment.....	1225
26.9.3	Structured procedures / MS originated call / late assignment.....	1228
26.9.4	Structured procedures / MS terminated call / early assignment.....	1230
26.9.5	Structured procedures / MS terminated call / late assignment.....	1233
26.9.6	Structured procedures / emergency call.....	1235
26.9.6.1	Structured procedures / emergency call / idle updated.....	1235
26.9.6.1.1	Structured procedures / emergency call / idle updated / preferred channel rate.....	1235
26.9.6.1.2	Structured procedures / emergency call / idle updated, non-preferred channel rate.....	1238
26.9.6.2	Structured procedures / emergency call / idle, no IMSI.....	1238
26.9.6.2.1	Structured procedures / emergency call / idle, no IMSI / accept case.....	1238
26.9.6.2.2	Structured procedures / emergency call / idle, no IMSI / reject case	1240
26.9.7	Directed Retry / Mobile Originated Call.....	1242
26.9.8	Directed Retry / Mobile Terminated Call	1253
26.9.9	Default contents of messages.....	1264
26.10	E-GSM or R-GSM signalling	1272
26.10.1	E-GSM or R-GSM signalling / general considerations.....	1272
26.10.2	E-GSM or R-GSM signalling / RR.....	1274
26.10.2.1	E-GSM or R-GSM signalling / RR / Measurement.....	1274
26.10.2.2	E-GSM or R-GSM signalling / RR / Immediate assignment	1281
26.10.2.3	E-GSM or R-GSM signalling / RR / channel assignment procedure	1283
26.10.2.4	E-GSM or R-GSM signalling / RR / Handover.....	1287
26.10.2.4.1	E-GSM or R-GSM signalling / RR / Handover / Successful handover	1287
26.10.2.4.2	E-GSM or R-GSM signalling / RR / Handover / layer 1 failure.....	1293
26.10.2.5	E-GSM or R-GSM signalling / RR / Frequency Redefinition.....	1295
26.10.3	E-GSM or R-GSM signalling / Structured procedure.....	1298
26.10.3.1	E-GSM or R-GSM signalling / Structured procedure / Mobile originated call.....	1299
26.10.3.2	E-GSM or R-GSM signalling / Structured procedures / emergency call	1301
26.10.3.3	Default contents of messages	1304
26.10.4	E-GSM or R-GSM signalling / Default message contents.....	1305
26.11	Multiband signalling	1309
26.11.1	General considerations.....	1309
26.11.2	Multiband signalling / RR.....	1309

26.11.2.1	Multiband signalling / RR / Immediate assignment procedure	1309
26.11.2.2	Multiband signalling / RR / Handover	1316
26.11.2.2.1	Multiband signalling / RR / Handover / successful / active call / non-synchronized	1316
26.11.2.2.2	Multiband signalling / RR / Handover / layer 1 failure	1331
26.11.2.2.3	Multiband signalling / RR / Handover / Multiband BCCH / successful / active call / non synchronized	1336
26.11.2.2.4	Multiband signalling / RR / Handover/ Multiband BCCH / Intracell Handover - Interband Assignment	1349
26.11.2.3	Multiband signalling / RR / Measurement reporting	1368
26.11.3	Multiband signalling / MM	1378
26.11.3.1	Multiband signalling / MM / Location updating	1378
26.11.3.1.1	Location updating / accepted	1378
26.11.3.1.2	Location updating / periodic	1381
26.11.4	Multiband signalling / CC	1384
26.11.5	Multiband signalling / Structured procedures	1384
26.11.5.1	Multiband signalling / Structured procedures / MS originated call / early assignment	1384
26.11.5.2	Structured procedures / MS terminated call / late assignment	1392
26.11.6	Multiband signalling / Default messages contents	1400
26.12	Enhanced Full Rate signalling	1420
26.12.1	EFR signalling/ test of the channel mode modify procedure	1420
26.12.2	EFR signalling/ tests of handover	1423
26.12.2.1	EFR signalling / Handover / active call / successful case	1424
26.12.3	EFR Signalling / Structured procedures / MS originated call / late assignment	1464
26.12.4	Structured procedures / MS terminated call / l early assignment	1467
26.12.5	Structured procedures / emergency call	1470
26.12.6	EFR Signalling / Directed Retry / Mobile Originated Call	1473
26.12.7	EFR Signalling / Directed Retry / Mobile Terminated Call	1481
26.12.8	Default contents of layer 3 messages for Enhanced Full rate speech tests	1491
26.13	Multislot signalling	1498
26.13.1	Multislot signalling / RR	1498
26.13.1.1	Multislot signalling / RR / Measurement	1498
26.13.1.1.1	Multislot signalling / RR / Measurement / symmetric	1498
26.13.1.1.2	Multislot signalling / RR / Measurement / asymmetric	1505
26.13.1.1.3	Multislot signaling / RR / Measurement / asymmetric / change of the reported subchannel	1512
26.13.1.2	Multislot signalling / RR / Dedicated assignment	1517
26.13.1.2.1	Multislot signalling / RR / Dedicated assignment / successful case	1517
26.13.1.2.2	Multislot signalling / RR / Dedicated assignment / failure / general case	1542
26.13.1.3	Test of handover	1567
26.13.1.3.1	Multislot signalling / RR / Handover / successful / active call / non-synchronized	1567
26.13.1.3.2	Multislot signalling / RR / Handover / successful / call under establishment / non synchronized / resource upgrading	1573
26.13.1.3.3	Multislot signalling / RR / Handover / successful / active call / finely synchronized / resource downgrading	1580
26.13.1.3.4	Multislot signalling / RR / Handover / successful / call under establishment / finely synchronized / relocation of channels	1586
26.13.1.3.5	Multislot signalling / RR / Handover / successful / call under establishment / pre-synchronized / resource upgrading	1596
26.13.1.4	Multislot signalling / RR / Test of the channel mode modify procedure	1602
26.13.1.5	Multislot signalling / RR / Early classmark sending	1605
26.13.1.6	Default contents of layer 3 messages for RR tests	1606
26.13.1.6.1	Default contents of GSM 900 layer 3 messages for RR tests	1606
26.13.1.6.2	Default contents of DCS 1 800 layer 3 messages for RR tests	1616
26.13.1.6.3	Default contents of GSM 450 layer 3 messages for RR tests	1627
26.13.1.6.4	Default contents of GSM 480 layer 3 messages for RR tests	1638
26.13.2	Multislot signalling / CC	1649
26.13.2.1	Multislot signalling / CC / In-call functions	1649
26.13.2.1.1	Multislot signalling / CC / In-call functions / User initiated service level upgrade / successful	1649
26.13.2.1.2	Multislot signalling / CC / In-call functions / User initiated service level downgrade / successful	1651
26.13.2.1.3	Multislot signalling / CC / In-call functions / User initiated service level upgrade / Time-out of timer T323	1653
26.13.2.1.4	Multislot signalling / CC / In-call functions / User initiated service level upgrade / modify reject	1655
26.13.2.1.5	Multislot signalling / CC / In call functions / contents of some of the messages	1656

26.13.3	Multislot signalling / Structured procedures	1657
26.13.3.1	Multislot signalling / Structured procedures / MS originated call / early assignment / HSCSD / non-transparent	1657
26.13.3.2	Multislot signalling / Structured procedures / MS originated call / late assignment / HSCSD / non-transparent	1660
26.13.3.3	Multislot signalling / Structured procedures / MS originated call / early assignment / HSCSD / Transparent	1663
26.13.3.4	Multislot signalling / Structured procedures / MS Terminated call / early assignment / HSCSD / non-transparent	1666
26.13.3.5	Multislot signalling / Structured procedures / MS Terminated call / early assignment / HSCSD / Transparent	1670
26.13.3.6	Default test conditions during layer 3 tests	1674
26.13.3.7	Default contents of messages	1676
26.14	VGCS and VBS Tests.....	1682
26.14.1	VGCS-VBS / Notification	1683
26.14.1.1	VGCS-VBS / Notification / notification indication	1683
26.14.1.2	VGCS-VBS / Notification / NCH position	1687
26.14.1.3	VGCS-VBS / Notification / Reduced NCH monitoring.....	1689
26.14.1.4	VGCS-VBS / Notification / Limited Service state.....	1695
26.14.2	VGCS-VBS / Paging	1697
26.14.2.1	VGCS-VBS / Paging / Paging indication.....	1697
26.14.2.2	VGCS-VBS / Paging / Notification.....	1700
26.14.3	VGCS-VBS / RR Procedures	1704
26.14.3.1	VGCS-VBS / RR Procedures / frequency redefinition	1704
26.14.3.2	VGCS-VBS / RR Procedures / assignment.....	1711
26.14.3.3	VGCS-VBS / RR Procedures / handover / successful in group transmit mode.....	1716
26.14.3.4	VGCS-VBS / RR Procedures / handover / successful at group call establishment	1730
26.14.3.5	VGCS-VBS / RR Procedures / handover / failure.....	1741
26.14.3.6	VGCS-VBS / RR / Measurement Report.....	1743
26.14.3.6.1	Measurement / all neighbours present	1743
26.14.4	VGCS-VBS / Uplink Access and Uplink Reply Procedures	1749
26.14.4.1	VGCS-VBS / Uplink Access / uplink investigation.....	1749
26.14.4.2	Uplink Access / uplink access procedure	1750
26.14.4.3	VGCS-VBS / Uplink Reply in VGCS receive mode	1754
26.14.5	VGCS-VBS / Leaving Group Receive or Group Transmit Mode	1755
26.14.5.1	VGCS-VBS / Leaving group receive mode	1755
26.14.5.2	VGCS-VBS / Leaving group transmit mode.....	1757
26.14.6	VGCS-VBS / GCC-BCC Procedures	1759
26.14.6.1	VGCS-VBS / GCC-BCC Procedures / MO call establishment.....	1759
26.14.6.2	VGCS-VBS / GCC-BCC Procedures / Transaction Identifier	1762
26.14.6.3	VGCS-VBS / GCC-BCC Procedures / Call Termination / originator / group transmit mode.....	1763
26.14.6.4	VGCS-VBS / GCC-BCC Procedures / Call Termination / originator in group receive mode	1765
26.14.6.5	VGCS-VBS / GCC-BCC Procedures / Call Termination / not originator.....	1767
26.14.6.6	VGCS-VBS / GCC-BCC Procedures / GCC states.....	1768
26.14.6.7	VGCS-VBS / GCC-BCC Procedures / BCC states	1771
26.14.7	VGCS-VBS / Error Handling	1772
26.14.7.1	VGCS-VBS / Error Handling / short message length, unknown message type and TI.....	1772
26.14.7.2	VGCS-VBS / Error Handling / incorrect information elements.....	1776
26.14.7.3	VGCS-VBS / Messages not addressing VGCS receive mode.....	1780
26.14.8	VGCS-VBS / Structured Procedures	1782
26.14.8.1	VGCS-VBS / Structured Procedures / Very early and early assignment	1782
26.14.9	VGCS-VBS / Cell change.....	1785
26.14.9.1	VGCS-VBS / Cell Change / Same LA	1785
26.14.9.2	VGCS-VBS / Cell Change / Different LA	1788
26.14.9.3	VGCS-VBS / Cell Change / Different PLMN	1791
26.14.10	VGCS-VBS / Default Message Contents.....	1794
26.14.11	VGCS-VBS / User-to-Dispatcher Information	1798
26.14.11.1	VGCS-VBS / User-to-Dispatcher Information / BCC MO call	1798
26.14.11.2	VGCS-VBS / User-to-Dispatcher information / GCC MO call	1800
26.14.11.3	VGCS-VBS / User-to-Dispatcher information / Compressed user information in VBS fast call set-up	1802
26.14.11.4	VGCS-VBS / User-to-Dispatcher information / Compressed User-to-Dispatcher information in VGCS fast call set-up	1804

26.15	SoLSA signalling	1806
26.15.1	General considerations.....	1806
26.15.1.1	Default message content.....	1806
26.15.1.2	General initial conditions for SIM card.....	1807
26.15.2	SoLSA signalling / RR	1807
26.15.2.1	SoLSA signalling / RR / classmark interrogation	1807
26.15.3	SoLSA signalling / MM.....	1810
26.15.3.1	SoLSA signalling / MM / location updating	1810
26.15.3.1.1	Location updating / accepted.....	1810
26.15.3.2	SoLSA signalling / MM / MM information	1815
26.15.4	SoLSA signalling / CC	1817
26.15.4.1	SoLSA signalling / CC / call re-establishment / call present.....	1817
26.15.5	SoLSA signalling / structured procedures	1820
26.15.5.1	SoLSA signalling / structured procedures / MS originated call / early assignment	1820
26.15.5.2	SoLSA signalling / structured procedures / MS originated call / late assignment.....	1823
26.15.5.3	SoLSA signalling / structured procedures / MS terminated call / early assignment.....	1826
26.15.5.4	SoLSA signalling / structured procedures / MS terminated call / late assignment.....	1829
26.15.5.5	SoLSA signalling / structured procedures / emergency call / idle updated	1832
26.15.5.6	SoLSA signalling / structured procedures / emergency call / idle, no IMSI	1835
26.16	Adaptive Multi Rate Signalling	1837
26.16.1	Inband Signalling, Downlink Codec Adaptation	1838
26.16.2	Inband Signalling, Uplink Codec Adaptation	1841
26.16.3	Structured procedures / MS terminated call / early assignment / no initial codec mode	1844
26.16.4	Structured procedures / MS originated call / late assignment / specified initial codec mode	1847
26.16.5	AMR signalling / Handover / active call / successful case	1849
26.16.6	Structured procedures / emergency call.....	1853
26.16.7	AMR Signalling / Directed Retry / Mobile Originated Call	1855
26.16.8	AMR Signalling / Directed Retry / Mobile Terminated Call.....	1861
26.16.9	Default contents of layer 3 messages for AMR signalling tests.....	1868
27	Testing of the SIM/ME interface	1869
27.1	MS identification by short IMSI.....	1874
27.1.1	MS identification by short IMSI - Normal case.....	1874
27.1.2	MS identification by short IMSI, Phase 1 DCS SIM.....	1874
27.2	MS identification by short TMSI.....	1875
27.3	MS identification by long TMSI.....	1877
27.4	MS identification by long IMSI, TMSI updating and cipher key sequence number assignment.....	1878
27.5	Forbidden PLMNs, location updating and undefined cipher key	1881
27.6	MS updating forbidden PLMNs.....	1885
27.7	MS deleting forbidden PLMNs.....	1887
27.8	MS updating the PLMN selector list	1890
27.9	MS recognizing the priority order of the PLMN selector list	1891
27.10	MS access control management.....	1893
27.11	Exchange protocol tests	1909
27.11.1	Character transmission.....	1909
27.11.1.1	Bit/character duration during the transmission from the ME to the SIM	1909
27.11.1.2	Bit/character duration during the transmission from the SIM simulator to the ME	1909
27.11.1.3	Inter-character delay.....	1910
27.11.1.4	Error handling during the transmission from the ME to the SIM.....	1911
27.11.1.5	Error handling during transmission from the SIM to the ME	1912
27.11.2	Answer to reset (RST)	1913
27.11.2.1	Acceptance of SIMs with internal RST.....	1913
27.11.2.2	Acceptance of SIMs with active low RST	1913
27.11.2.3	Characters of the answer to reset.....	1914
27.11.2.4	PTS procedure	1915
27.11.2.5	Reset repetition.....	1916
27.11.2.6	Speed Enhancement	1917
27.11.3	Command processing, procedure bytes	1918
27.12	Evaluation of directory characteristics.....	1919
27.12.1	Operating speed in authentication procedure.....	1919
27.12.2	Clock stop	1919
27.13	Mechanical tests.....	1921

27.13.1	Contact pressure.....	1921
27.13.2	Shape of contacts for IC card SIM card reader.....	1922
27.14	Secret code usage.....	1922
27.14.1	Entry of PIN.....	1922
27.14.2	Change of PIN.....	1923
27.14.3	Disabling the PIN.....	1924
27.14.4	PUK entry.....	1925
27.14.5	Entry of PIN2.....	1926
27.14.6	Change of PIN2.....	1927
27.14.7	PUK2 entry.....	1928
27.15	Abbreviated Dialling Numbers (ADN).....	1929
27.16	MMI reaction to SIM status encoding.....	1930
27.17	Electrical tests.....	1931
27.17.1	Test of the power transition phases.....	1932
27.17.1.1	Phase preceding ME power on.....	1932
27.17.1.2	Phase during SIM power on.....	1933
27.17.1.3	Phase during ME power off with clock stop forbidden.....	1935
27.17.1.4	Phase during ME power off with clock stop allowed.....	1936
27.17.1.5	SIM Type Recognition and Voltage Switching.....	1938
27.17.1.5.1	Reaction of 3V only MEs on SIM type recognition failure.....	1938
27.17.1.5.2	Reaction of 3V only MEs on type recognition of 5V only SIMs.....	1939
27.17.1.5.3	Reaction of 3V technology MEs on type recognition of 5V only SIMs.....	1940
27.17.1.5.4	Reaction of 3V technology MEs on type recognition of 3V technology SIMs.....	1941
27.17.2	Electrical tests on each ME contact.....	1942
27.17.2.1	Electrical tests on contact C1.....	1942
27.17.2.1.1	Test 1.....	1943
27.17.2.1.2	Test 2.....	1944
27.17.2.2	Electrical tests on contact C2.....	1946
27.17.2.3	Electrical tests on contact C3.....	1947
27.17.2.4	[Not used].....	1949
27.17.2.5	Electrical tests on contact C7.....	1949
27.18	Fixed Number Dialling (FND).....	1951
27.18.1	ME and SIM with FND activated.....	1951
27.18.1.1	EF _{ADN} invalidated and not readable or updatable.....	1951
27.18.2	ME and SIM with FND deactivated.....	1953
27.18.3	Enabling, disabling and updating of FND.....	1954
27.19	Phase identification.....	1955
27.20	SIM presence detection.....	1956
27.21	Advice of Charge (AoC).....	1957
27.21.1	AoC not supported by SIM.....	1957
27.21.2	Maximum frequency of ACM updating.....	1959
27.21.3	Call terminated when ACM greater than ACM _{max}	1961
27.21.4	Response codes of increase command.....	1963
28	Test of autocalling restrictions.....	1966
28.1	General.....	1966
28.2	Constraining the access to a single number (GSM 02.07 category 3).....	1966
28.3	Constraining the access to a single number (GSM 02.07 categories 1 and 2).....	1968
28.4	Behaviour of the MS when its list of blacklisted numbers is full.....	1970
29	Testing of bearer services.....	1973
29.1	General.....	1973
29.2	Testing of transparent data services.....	1973
29.2.1	Verification of synchronization.....	1973
29.2.2	Filtering of channel control information for transparent BCs.....	1976
29.2.3	Correct Terminal Compatibility Decision.....	1977
29.2.3.1	Negotiation of Radio Channel Requirement (RCR).....	1977
29.2.3.2	Negotiation of Connection Element (CE).....	1978
29.2.3.3	Negotiation of Number of Stop Bits, Number of Data bits, and Parity.....	1979
29.2.3.4	Negotiation of Modem Type.....	1979
29.2.3.5	Negotiation of Intermediate Rate.....	1980
29.2.3.6	Negotiation of User Information Layer 2 Protocol.....	1981

29.2.3.7	Negotiation between TS 61 and TS 62: Mobile Originated call	1981
29.2.3.8	Negotiation between TS 61 and TS 62: Mobile Terminated call	1982
29.2.4	Data Rate Adaptation for Synchronous Transparent Bearer Capabilities	1982
29.2.5	Network Independent Clocking	1983
29.2.6	Asynchronous Transparent Bearer Capabilities	1984
29.2.6.1	Data Rate Adaptation	1984
29.2.6.2	Passage of the Break Signal	1985
29.2.6.3	Overspeed/Underspeed Handling (Local Terminal).....	1986
29.2.6.4	Overspeed/Underspeed Handling (Remote Terminal)	1987
29.2.7	Interchange circuit mapping for transparent bearer capabilities	1988
29.3	Testing of non transparent data services (RLP tests)	1989
29.3.1	Initialization	1989
29.3.1.1	Normal initialization done by the MS	1989
29.3.1.2	Initialization failure	1991
29.3.1.2.1	Loss of UA frame	1991
29.3.1.2.2	Total loss of UA frame.....	1992
29.3.2	Data transfer.....	1993
29.3.2.1	Default conditions	1993
29.3.2.2	MS sends I+S frames	1994
29.3.2.2.1	N(S) sequence number	1994
29.3.2.2.2	Transmission window	1995
29.3.2.2.3	Busy condition	1997
29.3.2.3	SS sends I+S frames.....	1999
29.3.2.3.1	N(R) sequence number.....	1999
29.3.2.3.2	Busy condition	2000
29.3.2.4	SS rejects I+S frames	2002
29.3.2.4.1	REJ frame.....	2002
29.3.2.4.2	SREJ frame.....	2004
29.3.2.4.3	I+S reject frame.....	2007
29.3.2.5	MS rejects I+S frames	2010
29.3.2.5.1	Rejection with REJ or SREJ supervisory frames	2010
29.3.2.5.2	Retransmission of REJ or SREJ frames	2016
29.3.2.5.3	I+S reject frame.....	2020
29.3.2.6	Checkpoint recovery	2023
29.3.2.6.1	SS in checkpoint recovery mode.....	2023
29.3.2.6.2	End of the window	2027
29.3.2.6.3	End of a sequence.....	2030
29.3.2.6.4	Time-out of one frame.....	2032
29.3.2.6.5	No response to checkpointing	2034
29.3.2.6.6	Incorrect response to checkpointing	2036
29.3.2.6.7	Total loss of response to checkpointing	2039
29.3.2.6.8	Retransmission of a sequence.....	2042
29.3.2.6.9	N2 retransmission of a sequence.....	2046
29.3.3	Negotiation of the RLP parameters.....	2050
29.3.3.1	Negotiation initiated by the SS.....	2050
29.3.3.2	Negotiation initiated by the MS	2055
29.3.3.3	Collision of XID frames.....	2060
29.3.3.4	Loss of XID frames	2065
29.3.3.5	Total loss of XID frames.....	2067
29.4	Facsimile tests for the transparent network support.....	2069
29.4.1	General.....	2069
29.4.2	Mobile originated call.....	2070
29.4.2.1	Call establishment procedure	2070
29.4.2.1.1	Alternate speech / facsimile	2070
29.4.2.1.2	Automatic facsimile	2071
29.4.2.2	Pre-message procedure.....	2072
29.4.2.3	Message procedure.....	2074
29.4.2.4	Post-message procedure	2075
29.4.2.5	Call release procedure	2076
29.4.2.6	CTC processing - 4th PPR for the same block	2077
29.4.2.7	Transition from Facsimile to Speech - Procedure interrupt generated by receiving station.....	2079
29.4.2.8	Transition from Facsimile to Speech - Procedure interrupt generated by transmitting station	2081

29.4.2.9	Quality check	2082
29.4.3	Mobile terminated call	2083
29.4.3.1	Call Establishment Procedure	2083
29.4.3.1.1	Alternate Speech/Facsimile.....	2083
29.4.3.1.2	Automatic facsimile	2086
29.4.3.2	Pre-message procedure.....	2087
29.4.3.3	Message procedure.....	2088
29.4.3.4	Post-message procedure.....	2089
29.4.3.5	Call release procedure	2090
29.4.3.6	Speed conversion factor	2091
29.4.3.7	Quality Check.....	2094
29.4.4	Notes.....	2094
30	Speech teleservices	2095
30.1	Sending sensitivity/frequency response	2095
30.2	Sending loudness rating	2097
30.3	Receiving sensitivity/frequency response.....	2098
30.4	Receiving loudness rating.....	2099
30.5	Side tones.....	2100
30.5.1	Side Tone Masking Rating (STMR).....	2100
30.5.2	Listener Side Tone Rating (LSTR).....	2101
30.6	Telephone Acoustic coupling Loss (TAL).....	2102
30.6.1	Echo Loss (EL).....	2102
30.6.2	Stability margin	2103
30.7	Distortion.....	2104
30.7.1	Sending	2104
30.7.2	Receiving	2105
30.8	Sidetone distortion	2106
30.9	Out-of-band signals.....	2107
30.9.1	Sending	2107
30.9.2	Receiving	2108
30.10	Idle channel noise	2109
30.10.1	Sending	2109
30.10.2	Receiving.....	2110
30.11	Ambient Noise Rejection.....	2111
30.11.1	Definition and Applicability	2111
30.11.2	Conformance Requirement.....	2111
30.11.3	Test Purpose	2111
30.11.4	Method of Test.....	2111
31	Test of supplementary services.....	2112
31.1	Number identification supplementary services.....	2113
31.1.1	CLIP.....	2113
31.1.1.1	Normal operation	2113
31.1.1.2	Interrogation.....	2114
31.1.1.2.1	Interrogation accepted.....	2114
31.1.1.2.2	Interrogation rejected	2115
31.1.2	CLIR.....	2117
31.1.2.1	Normal operation - requesting presentation of CLI.....	2117
31.1.2.2	Normal operation - requesting restriction of CLI presentation	2118
31.1.2.3	Interrogation.....	2119
31.1.2.3.1	Interrogation accepted.....	2119
31.1.2.3.2	Interrogation rejected	2120
31.1.3	COLP.....	2122
31.1.3.1	Normal operation	2122
31.1.3.2	Interrogation.....	2123
31.1.3.2.1	Interrogation accepted.....	2123
31.1.3.2.2	Interrogation rejected.....	2125
31.1.4	COLR.....	2127
31.1.4.1	Interrogation.....	2127
31.1.4.1.1	Interrogation accepted.....	2127
31.1.4.1.2	Interrogation rejected	2128

31.1.4.2	Normal operation	2130
31.2	Call offering supplementary services.....	2131
31.2.1	Call forwarding supplementary services.....	2132
31.2.1.1	Registration	2132
31.2.1.1.1	Registration accepted	2132
31.2.1.1.2	Registration rejected.....	2135
31.2.1.2	Erasure by the subscriber	2138
31.2.1.2.1	Erasure accepted.....	2138
31.2.1.2.2	Erasure rejected.....	2141
31.2.1.3	Activation.....	2143
31.2.1.4	Deactivation	2145
31.2.1.5	Invocation.....	2148
31.2.1.6	Interrogation.....	2148
31.2.1.6.1	Interrogation accepted	2148
31.2.1.6.2	Interrogation rejected	2151
31.2.1.7	Normal operation	2153
31.2.1.7.1	Served mobile subscriber side.....	2153
31.2.1.7.2	Forwarded-to mobile subscriber side	2157
31.2.2	Call transfer and mobile access hunting supplementary services	2159
31.3	Call completion supplementary services.....	2159
31.3.1	Call Waiting.....	2159
31.3.1.1	Waiting call indication and confirmation.....	2159
31.3.1.2	Normal operation with successful outcome	2160
31.3.1.2.1	Waiting call accepted; existing call released.....	2160
31.3.1.2.2	Waiting call accepted; existing call on hold.....	2161
31.3.1.2.3	Existing call released by user A; waiting call accepted.....	2163
31.3.1.3	Normal operation with unsuccessful outcome	2164
31.3.1.3.1	Waiting call released by subscriber B	2164
31.3.1.3.2	Waiting call released by calling user C	2165
31.3.1.4	Activation.....	2166
31.3.1.5	Deactivation	2169
31.3.1.6	Interrogation.....	2172
31.3.1.6.1	Interrogation accepted.....	2172
31.3.1.6.2	Interrogation rejected	2174
31.3.2	Call Hold.....	2176
31.3.2.1	Hold invocation.....	2176
31.3.2.2	Retrieve procedure	2177
31.3.2.3	Alternate from one call to the other.....	2178
31.4	Multi-party supplementary services.....	2180
31.4.1	Beginning the MultiParty service	2180
31.4.1.1	Beginning the MultiParty service, successful case.....	2180
31.4.1.2	Beginning the MultiParty service, unsuccessful case.....	2182
31.4.1.3	Beginning the MultiParty service, expiry of timer T(BuildMPTY).....	2184
31.4.2	Managing an active MultiParty call.....	2185
31.4.2.1	Served mobile subscriber	2185
31.4.2.1.1	Put the MultiParty call on hold	2185
31.4.2.1.2	Create a private communication with one of the remote parties	2190
31.4.2.1.3	Terminate the entire MultiParty call	2194
31.4.2.1.4	Explicitly disconnect a remote party	2195
31.4.2.2	Remote parties.....	2196
31.4.2.2.1	Release from the MultiParty call.....	2196
31.4.3	Managing a held MultiParty call.....	2198
31.4.3.1	Retrieve the held MultiParty call.....	2198
31.4.3.1.1	Retrieve the held MultiParty call, successful case	2198
31.4.3.1.2	Retrieve the held MultiParty call, unsuccessful case	2199
31.4.3.1.3	Retrieve the held MultiParty call, expiry of timer T(RetrieveMPTY)	2201
31.4.3.2	Initiate a new call	2202
31.4.3.3	Process a call waiting request.....	2203
31.4.3.4	Terminate the held MultiParty call.....	2205
31.4.4	Managing a single call and a MultiParty call.....	2206
31.4.4.1	Served mobile subscriber	2206
31.4.4.1.1	Disconnect the single call.....	2206

31.4.4.1.2	Disconnect the MultiParty call	2209
31.4.4.2	Disconnect all calls	2212
31.4.4.3	Add the single call to the MPTY	2213
31.4.4.3.1	Add the single call to the MPTY, successful case	2213
31.4.4.3.2	Add the single call to the MPTY, maximum number of participants exceeded	2215
31.4.4.4	Alternate between the MPTY call and the single call	2216
31.4.5	Adding extra remote parties	2218
31.5	Community of interest supplementary services	2220
31.6	Charging supplementary services	2220
31.6.1	Advice of Charge Charging	2221
31.6.1.1	AoCC time related charging / MS originated call	2221
31.6.1.2	AoCC time related charging / MS terminated call	2224
31.6.1.3	AoCC volume related charging / MS originated call	2226
31.6.1.4	AoCC volume related charging / MS terminated call	2226
31.6.1.5	Change in charging information during a call	2226
31.6.1.6	Different formats of charging information	2229
31.6.1.7	AoCC on a Call Hold call	2232
31.6.1.8	AoCC on a Multi-party call	2235
31.6.2	Charge Storage	2239
31.6.2.1	Removal of SIM during an active call	2239
31.6.2.2	Interruption of power supply during an active call	2241
31.6.2.3	MS going out of coverage during an active AoCC call	2243
31.6.2.4	ACMmax operation / Mobile Originating	2245
31.6.2.5	ACMmax operation / Mobile Terminating	2248
31.6.3	Advice of Charge Information	2251
31.6.3.1	AoCI time related charging / MS originated call	2251
31.6.3.2	AoCI time related charging / MS terminated call	2254
31.6.3.3	AoCI volume related charging / MS originated call	2256
31.6.3.4	AoCI volume related charging / MS terminated call	2256
31.6.3.5	Change in charging information during a call	2256
31.6.3.6	Different formats of charging information	2259
31.6.3.7	AoCI on a Call Hold call	2262
31.6.3.8	AoCI on a Multi-party call	2265
31.6.4	Default contents of messages	2269
31.7	Additional information transfer supplementary services	2270
31.8	Call restriction supplementary services	2270
31.8.1	Registration of a password	2270
31.8.1.1	Registration accepted	2270
31.8.1.2	Registration rejected	2273
31.8.1.2.1	Rejection after invoke of the RegisterPassword operation	2273
31.8.1.2.2	Rejection after password check with negative result	2275
31.8.1.2.3	Rejection after new password mismatch	2277
31.8.2	Erasure	2280
31.8.3	Activation	2280
31.8.3.1	Activation accepted	2280
31.8.3.2	Activation rejected	2283
31.8.3.2.1	Rejection after invoke of ActivateSS operation	2283
31.8.3.2.2	Rejection after use of password procedure	2285
31.8.4	Deactivation	2287
31.8.4.1	Deactivation accepted	2287
31.8.4.2	Deactivation rejected	2291
31.8.4.2.1	Rejection after invoke of DeactivateSS operation	2291
31.8.4.2.2	Rejection after use of password procedure	2293
31.8.5	Invocation	2295
31.8.6	Interrogation	2295
31.8.6.1	Interrogation accepted	2295
31.8.6.2	Interrogation rejected	2298
31.8.7	Normal operation	2301
31.9	Handling of undefined (future) GSM supplementary services	2302
31.9.1	Mobile station initiated Unstructured supplementary service data operation	2302
31.9.1.1	ProcessUnstructuredSS-request/accepted	2302
31.9.1.2	ProcessUnstructuredSS-request/cross phase compatibility and error handling	2307

31.9.2	Network initiated unstructured supplementary service operations	2312
31.9.2.1	UnstructuredSS-Notify/accepted.....	2312
31.9.2.3	UnstructuredSS-Request/accepted	2317
31.10	MMI input for USSD.....	2322
31.11	Specific message contents and ASN.1 codings.....	2324
31.12	eMLPP Service	2371
31.12.1	eMLPP Service / priority level of MO call	2371
31.12.2	eMLPP Service / automatic answering point-to-point MT call	2375
31.12.3	eMLPP Service / automatic answering MT VGCS or VBS call.....	2379
31.12.4	eMLPP Service / registration	2381
31.12.5	eMLPP Service / interrogation.....	2383
31.13	Explicit Call Transfer (ECT)	2385
31.13.1	Explicit Call Transfer invocation.....	2385
31.13.1.1	Explicit Call Transfer invocation, successful case, both calls active, clearing using DISCONNECT ..	2385
31.13.1.2	Explicit Call Transfer invocation, successful case, both calls active, clearing using RELEASE.....	2387
31.13.1.3	Explicit Call Transfer invocation, successful case, both calls active, clearing using RELEASE COMPLETE.....	2388
31.13.1.4	Explicit Call Transfer invocation, successful case, second call alerting	2389
31.13.1.5	Explicit Call Transfer invocation, unsuccessful case	2390
31.13.1.6	Explicit Call Transfer invocation, expiry of T(ECT)	2392
31.14	User-to-User Signalling (UUS).....	2394
31.14.1	UUS / Implicit UUS1.....	2394
31.14.1.1	UUS / Implicit UUS1 / CC MO call.....	2394
31.14.1.2	UUS / Implicit UUS1 / CC MT call.....	2398
31.14.1.3	UUS / Implicit UUS1 / Interactions with Call Waiting and call HOLD supplementary services	2402
31.15	Follow Me (FM)	2407
31.15.1	Follow Me (FM) / Registration.....	2407
31.15.2	Follow Me (FM) / Interrogation	2413
31.15.3	Follow Me (FM) / Erasure	2416
32	Testing of speech transcoding functions.....	2421
32.1	Full Rate Downlink speech transcoding	2421
32.2	Full Rate Downlink receiver DTX functions.....	2422
32.3	Full Rate Uplink speech transcoding	2426
32.4	Full Rate Uplink transmitter DTX functions	2427
32.5	Full Rate Speech channel transmission delay	2428
32.5.4	Downlink processing delay.....	2428
32.5.5	Downlink coding delay.....	2429
32.5.6	Uplink processing delay.....	2430
32.5.7	Uplink coding delay.....	2430
32.6	Half Rate Downlink speech transcoding.....	2431
32.7	Half Rate Downlink receiver DTX functions	2432
32.8	Half Rate Uplink speech transcoding.....	2433
32.9	Half Rate Uplink transmitter DTX functions.....	2434
32.10	Half Rate Speech channel transmission delay	2436
32.10.4	Downlink processing delay.....	2436
32.10.5	Downlink coding delay.....	2437
32.10.6	Uplink processing delay.....	2437
32.10.7	Uplink coding delay.....	2438
32.11	Intra cell channel change from a TCH/HS to a TCH/FS.....	2439
32.12	Intra cell channel change from a TCH/FS to a TCH/HS.....	2441
33	Mobile station features.....	2443
33.1	Entry and display of called number	2443
33.2	Indication of call progress signals.....	2444
33.2.4	Ringing tone.....	2444
33.2.5	Busy tone	2445
33.2.6	Congestion tone	2445
33.2.7	Authentication failure tone	2446
33.2.8	Number unobtainable tone.....	2446
33.2.9	Call dropped tone.....	2447
33.3	Network selection / indication	2447

33.4	Invalid and blocked PIN indicators.....	2451
33.5	Service indicator	2452
33.6	Subscription identity management.....	2453
33.7	Barring of outgoing calls	2454
33.8	Prevention of unauthorized calls.....	2454
34	Short message service (SMS)	2455
34.1	General.....	2455
34.2	Short message service point to point	2455
34.2.1	SMS mobile terminated	2455
34.2.2	SMS mobile originated.....	2461
34.2.3	Test of memory full condition and memory available notification:.....	2465
34.2.4	Test of the status report capabilities and of SMS-COMMAND:	2469
34.2.5	Test of message class 0 to 3.....	2473
34.2.5.1	Short message class 0.....	2473
34.2.5.2	Test of class 1 short messages	2475
34.2.5.3	Test of class 2 short messages	2477
34.2.5.4	Test of class 3 short messages	2480
34.2.6	Test of short message type 0.....	2480
34.2.7	Test of the replace mechanism for SM type 1-7	2480
34.2.8	Test of the reply path scheme	2484
34.2.9	Multiple SMS mobile originated	2487
34.2.9.1	MS in idle mode	2487
34.2.9.2	MS in active mode	2490
34.3	Short message service cell broadcast.....	2492
34.4	Default message contents:	2494
35	Low battery voltage detection.....	2497
36	Individual equipment type requirements and interworking - special conformance testing functions	2498
37	Void	2498
38	Void	2498
39	Additional CTS-MS testcases	2499
39.1	General paragraph.....	2499
39.2	Tests for CTS-MS/PLMN interface.....	2499
39.2.1	CTS not allowed by GSM Network.....	2499
39.3	RF tests for CTS-MS/FP interface	2500
39.3.1	Transmit power control timing and confirmation	2500
39.3.2	CTS Fixed Part selection	2502
39.3.3	Monitoring of CTSBCH	2503
39.3.4	AFA measurement and reporting	2504
39.4	L2 tests for CTS-MS/FP interface	2506
39.5	L3 tests for CTS-MS/FP interface	2506
39.5.3.1	Elementary Procedures.....	2506
39.5.3.1.1	System Access.....	2506
39.5.3.1.2	Immediate Assignment.....	2510
39.5.3.1.2	Paging	2514
39.5.3.1.4	Reserved.....	2516
39.5.3.1.5	Reserved.....	2516
39.5.3.1.6	Reserved.....	2516
39.5.3.1.7	Reserved.....	2516
39.5.3.1.8	Reserved.....	2516
39.5.3.1.9	Channel Release	2516
39.5.3.1.10	Authentication	2519
39.5.3.1.11	Reserved	2521
39.5.3.1.12	Reserved	2521
39.5.3.1.13	Radio Link Management	2521
39.5.3.2	Structured Procedures	2524
39.5.3.2.1	Attachment	2524
39.5.3.2.2	Detachment	2526
39.5.3.2.3	Reserved.....	2528

39.5.3.2.4	Reserved.....	2528
39.5.3.2.5	Reserved.....	2528
39.5.3.2.6	Reserved.....	2528
39.5.3.2.7	Handover.....	2528
39.5.3.2.8	2529	
39.5.3.3	Initialisation.....	2530
39.5.3.3.1	Enrolment.....	2530
39.5.3.3.2	Reserved.....	2532
39.5.3.3.3	De-enrolment.....	2532
40	GPRS default conditions, message contents and macros.....	2535
40.1	Default test conditions.....	2535
40.1.1	Default settings for cell A:.....	2536
40.1.2	Default settings for cell B.....	2537
40.2	Default message contents.....	2538
40.2.1	System Information messages.....	2538
40.2.1.1	Cell A.....	2538
40.2.1.2	Cell B.....	2541
40.2.2	Packet System Information messages.....	2541
40.2.2.1	Cell A.....	2541
40.2.2.2	Cell B.....	2564
40.2.3	Default contents of Layer 2 messages.....	2566
40.2.4	Default contents of Layer 3 messages.....	2568
40.3	Default GPRS Conditions, Message Contents and Macros for the Higher Layer Test Cases.....	2577
40.3.1	Default Test Conditions for the Higher Layer Test Cases.....	2577
40.3.2	Default Message for the Higher Layer Test Cases.....	2577
40.3.2.1	Default Contents of System Information Messages for the Higher Layer Test Cases.....	2577
40.3.3	Contents Of Packet System Information Messages for the Higher Layer Test Cases.....	2578
40.3.4	Contents of Layer 2 Messages for the Higher Layer Test Cases.....	2579
40.3.5	Contents of Layer 3 Messages for the Higher Layer Test Cases.....	2579
40.4	Macros.....	2580
40.4.1	Overview.....	2580
40.4.1.1	Definition.....	2580
40.4.1.2	Syntax.....	2580
40.4.1.2.1	Message contents.....	2580
40.4.1.2.2	Message sequence.....	2580
40.4.2	Default message contents.....	2581
40.4.3	Macro message sequences.....	2582
40.4.3.1	Acknowledged downlink data.....	2582
40.4.3.2	Classmark and measurement.....	2582
40.4.3.3	Downlink data.....	2582
40.4.3.4	Downlink data transfer.....	2583
40.4.3.5	Measurement reporting.....	2583
40.4.3.6	Uplink data transfer.....	2583
40.4.3.7	Uplink dynamic allocation one phase access.....	2584
40.4.3.8	Uplink dynamic allocation one phase access with contention resolution.....	2585
40.4.3.9	Uplink dynamic allocation two phase access.....	2585
40.4.3.10	Completion of uplink RLC data block transfer.....	2586
40.4.3.11	Uplink fixed allocation one phase access.....	2587
40.4.3.12	Uplink fixed allocation one phase access with contention resolution.....	2587
40.4.3.13	Uplink fixed allocation two phase access.....	2588
40.4.3.14	Downlink TBF establishment.....	2588
40.4.3.15	PDP Context Activation.....	2588
40.4.3.16	PDP Context Deactivation.....	2589
40.4.3.17	Inter-SGSN Routing Area Update.....	2589
40.4.3.18	PDP Context Modification.....	2589
40.4.3.19	Location Update Procedure.....	2590
40.5	Test PDP contexts.....	2590
40.6	Appendix A.....	2592
40.6.1	ARFCNs in different SI messages.....	2592

41	GPRS Paging, TBF establishment/release and DCCH related procedures.....	2594
41.1	/ RR / Paging.....	2594
41.1.1	RR / Paging / on PCCCH for GPRS service successful.....	2594
41.1.1.1	RR / Paging / on PCCCH for GPRS service / normal paging with P-TMSI successful.....	2594
41.1.1.2	RR / Paging / on PCCCH for GPRS service / normal paging with IMSI successful.....	2596
41.1.1.3	RR / Paging / on PCCCH for GPRS service / extended paging with P-TMSI successful.....	2598
41.1.1.4	RR / Paging / on PCCCH for GPRS service / paging reorganisation successful.....	2601
41.1.2	RR / Paging / on PCCCH for circuit-switched services / paging successful.....	2603
41.1.3	RR / Paging / on PCCCH / paging ignored.....	2606
41.1.4	RR / Paging / on PACCH for circuit-switched services.....	2609
41.1.4.1	RR / Paging / on PACCH for circuit-switched services/ paging successful.....	2609
41.1.4.2	RR / Paging / on PACCH for circuit-switched services/ paging ignored.....	2611
41.1.5	RR / Paging / on CCCH for GPRS service.....	2612
41.1.5.1	RR / Paging / on CCCH for GPRS service / normal paging.....	2612
41.1.5.1.1	RR / Paging / on CCCH for GPRS service / normal paging with P-TMSI successful.....	2612
41.1.5.1.2	RR / Paging / on CCCH for GPRS service / normal paging with IMSI successful.....	2615
41.1.5.1.3	RR / Paging / on CCCH for GPRS service / normal paging with P-TMSI ignored.....	2619
41.1.5.2	RR / Paging / on CCCH for GPRS service / extended paging.....	2621
41.1.5.2.1	RR / Paging / on CCCH for GPRS service / extended paging with P-TMSI successful.....	2621
41.1.5.3	RR / Paging / on CCCH for GPRS service / paging reorganisation.....	2623
41.1.5.4	RR / Paging / on CCCH for GPRS service / default message contents.....	2626
41.1.6	RR / Paging / Before T3172 expiry.....	2626
41.2	RR procedures on CCCH related to temporary block flow establishment.....	2628
41.2.1	Permission to access the network.....	2628
41.2.1.1	Permission to access the network / priority classes.....	2628
41.2.2	Initiation of the packet access procedure.....	2631
41.2.2.1	Initiation of the packet access procedure / establishment causes.....	2631
41.2.2.2	Random references for single block packet access.....	2632
41.2.2.3	Random references for one phase packet access.....	2634
41.2.2.4	Initiation of the packet access procedure / timer T3146.....	2635
41.2.2.5	Initiation of the packet access procedure / Request Reference.....	2636
41.2.3	Packet immediate assignment / One phase packet access.....	2637
41.2.3.1	Two-message assignment / Successful case.....	2637
41.2.3.2	Two-message assignment / Failure cases.....	2639
41.2.3.3	Packet uplink assignment / Polling bit set.....	2642
41.2.3.4	One phase packet access / Contention resolution / Successful case.....	2643
41.2.3.5	One phase packet access / Contention resolution / TLLI mismatch.....	2644
41.2.3.6	One phase packet access / Contention resolution / Counter N3104.....	2645
41.2.3.7	One phase packet access / Contention resolution / Timer T3166.....	2646
41.2.3.8	One phase packet access / Contention resolution / 4 access repetition attempts.....	2648
41.2.3.9	One phase packet access / TBF starting time.....	2649
41.2.3.10	One phase packet access / Timing Advance Index present.....	2650
41.2.3.11	One phase packet access / Timing Advance Index not present.....	2652
41.2.4	Packet immediate assignment / Single block packet access.....	2653
41.2.4.1	Single block packet access / Packet Resource Request.....	2653
41.2.4.2	Single block packet access / Packet Measurement Report.....	2654
41.2.5	Packet immediate assignment / Packet access rejection.....	2655
41.2.5.1	Packet access rejection / wait indication.....	2655
41.2.5.2	Packet access rejection / assignment before T3142 expires.....	2656
41.2.6	Packet downlink assignment procedure using CCCH.....	2658
41.2.6.1	Initiation of packet downlink assignment procedure / MS listens to correct CCCH block.....	2658
41.2.6.2	Initiation of packet downlink assignment procedure / timer T3190.....	2659
41.2.6.3	Initiation of packet downlink assignment procedure / TBF starting time.....	2660
41.2.6.4	Initiation of packet downlink assignment procedure / incorrect TFI.....	2661
41.2.7	Single block packet downlink assignment.....	2662
41.2.7.1	Single block packet downlink assignment / TBF Starting Time.....	2662
41.2.7.2	Single block packet downlink assignment / MS returns to packet idle mode.....	2663
41.2.8	Macros and default message contents.....	2665
41.2.8.1	Macros.....	2665
41.2.8.1.1	GPRS attach procedure.....	2665
41.2.8.1.2	Uplink data transfer.....	2666
41.2.8.1.3	Downlink data transfer.....	2667

41.2.8.2	Default message contents	2668
41.3	MAC/RLC Release	2675
41.3.1	TBF Release / Uplink / Normal / MS initiated	2675
41.3.1.1	TBF Release / Uplink / Normal / MS initiated / Acknowledged mode.....	2675
41.3.1.2	TBF Release / Uplink / Normal / MS initiated / Unacknowledged mode	2679
41.3.1.3	TBF Release / Uplink / Normal / MS initiated / Channel coding change during countdown.....	2682
41.3.2	TBF Release / Uplink / Normal / Network initiated	2683
41.3.2.1	TBF Release / Uplink / Normal / Network initiated / Acknowledged mode.....	2683
41.3.2.2	TBF Release / Uplink / Normal / Network initiated / Unacknowledged mode	2685
41.3.3	TBF Release / Uplink / Network initiated / Abnormal release	2686
41.3.4	TBF Release / Downlink / Normal / Network initiated	2688
41.3.4.1	TBF Release / Downlink / Normal / Network initiated / Acknowledged mode.....	2688
41.3.4.2	TBF Release / Downlink / Normal / Network initiated / Unacknowledged mode	2691
41.3.5	PDCH Release	2694
41.3.5.1	Void.....	2694
41.3.5.2	PDCH Release / With TIMESLOTS_AVAILABLE	2694
41.3.6	Default message contents.....	2698
41.4	DCCH related RR procedures for TBF establishment.....	2698
41.4.1	Default conditions and message contents	2698
41.4.1.1	Default conditions	2698
41.4.1.2	Default message contents	2699
41.4.1.2.1	Default contents of system information messages	2699
41.4.1.2.2	Default contents of L3 messages.....	2699
41.4.2	Immediate Assignment of a DCCH	2699
41.4.2.1	Immediate Assignment / Contention resolution failure.....	2699
41.4.2.2	Immediate Assignment / Use of DCCH for Uplink TBF Establishment.....	2702
41.4.2.3	Immediate Assignment / Use of DCCH for Downlink TBF Establishment.....	2705
41.4.3	RR commands while on DCCH.....	2707
41.4.3.1	Assignment Command.....	2707
41.4.3.2	Handover.....	2710
41.4.3.3	PDCH Assignment Command	2713
41.4.3.3.1	Successful case.....	2713
41.4.3.3.2	Failure / T3132 expires	2716
41.4.3.4	Cell change order	2717
41.4.3.4.1	Successful case / Normal procedure.....	2717
41.4.3.4.2	Successful case / DCCH on the target cell	2722
41.4.3.4.3	Failure / Immediate Assignment Reject on CCCH of the target cell.....	2725
41.4.3.4.4	Failure / Packet Access Reject on PCCCH of the target cell	2727
41.4.3.4.5	Failure / T3134 expiry.....	2728
41.4.3.4.6	Contention resolution failure / GPRS supported using BCCH.....	2730
41.4.3.4.7	Contention resolution failure / GPRS supported using PBCCH / Timer or counter expiry	2732
41.4.3.4.8	Contention resolution failure / GPRS supported using PBCCH / TLLI mismatch	2735
41.4.3.5	Release	2738
41.4.3.6	Radio link failure.....	2740
42	Test of Medium Access Control (MAC) protocol	2743
42.1	Test of Medium Access Control (MAC) Procedures on PCCCH in idle mode	2743
42.1.1	Packet Channel Request.....	2743
42.1.1.1	Packet Channel Request / Message format	2743
42.1.1.2	Packet Channel Request / Response to Packet Paging.....	2744
42.1.1.3	Packet Channel Request / Access type.....	2747
42.1.1.4	Packet Channel Request / Access persistence control on PRACH.....	2748
42.1.1.4.1	Packet Channel Request / Access persistence control on PRACH / M+1 attempts	2748
42.1.1.4.2	Packet Channel Request / Access persistence control on PRACH / Persistence level	2749
42.1.1.4.3	Packet Channel Request / Access persistence control on PRACH / Successive Attempts.....	2751
42.1.2	Packet Uplink/Downlink Assignment.....	2753
42.1.2.1	Packet uplink assignment procedure	2753
42.1.2.1.1	Packet Uplink Assignment / Packet access queuing notification procedure	2753
42.1.2.1.1.1	Packet Uplink Assignment / Packet queuing notification / Stop sending Packet Channel Requests	2753
42.1.2.1.1.2	Packet Uplink Assignment / Packet queuing notification / Ignoring Packet Queuing Notification	2755
42.1.2.1.1.3	Packet Uplink Assignment / Packet queuing notification / Assigned PDCHs.....	2756
42.1.2.1.1.4	Packet Uplink Assignment / Packet queuing notification / Expiry of timer T3162.....	2757

42.1.2.1.2	Packet Uplink Assignment / Response to packet polling request.....	2758
42.1.2.1.3	Packet Uplink Assignment / Packet access reject procedure	2760
42.1.2.1.3.1	Packet Uplink Assignment / Packet access reject / Action during Wait_Indication.....	2760
42.1.2.1.3.2	Packet Uplink Assignment / Packet access reject / No respond	2761
42.1.2.1.3.3	Packet Uplink Assignment / Packet access reject / Trigger RR connection	2762
42.1.2.1.4	Packet Uplink Assignment / Packet Uplink Assignment handling.....	2764
42.1.2.1.5	Packet Uplink Assignment / One or two phase access	2765
42.1.2.1.6	Packet Uplink Assignment / Decoding of frequency parameters	2768
42.1.2.1.7	Packet Uplink Assignment / Most recently received Packet Uplink Assignment	2770
42.1.2.1.8	Packet Uplink Assignment / One phase access	2771
42.1.2.1.8.1	Packet Uplink Assignment / One phase access / Contention Resolution.....	2771
42.1.2.1.8.1.1	Packet Uplink Assignment / One phase access / Contention resolution / Inclusion of TLLI in RLC data blocks.....	2771
42.1.2.1.8.1.2	Packet Uplink Assignment / One phase access / Contention resolution / Counter N3104	2774
42.1.2.1.8.1.3	Packet Uplink Assignment / One phase access / Contention resolution / Timer T3166.....	2775
42.1.2.1.8.1.4	Packet Uplink Assignment / One phase access / Contention resolution / TLLI mismatch.....	2777
42.1.2.1.8.1.5	Packet Uplink Assignment / One phase access / Contention resolution / 4 access repetition attempts.....	2779
42.1.2.1.8.2	Packet Uplink Assignment / One phase access / Timing Advance.....	2780
42.1.2.1.8.2.1	Packet Uplink Assignment / One phase access / Timing Advance / TA Index present.....	2780
42.1.2.1.8.2.2	Packet Uplink Assignment / One phase access / Timing Advance / TA Index not present.....	2782
42.1.2.1.8.2.3	Packet Uplink Assignment / One phase access / Timing Advance / TA value field not provided ...	2783
42.1.2.1.9	Packet Uplink Assignment / Two phase access.....	2784
42.1.2.1.9.1	Packet Uplink Assignment / Two phase access / Packet Resource Request / RLC Octet Count.....	2784
42.1.2.1.9.2	Packet Uplink Assignment / Two phase access / Contention resolution	2785
42.1.2.1.9.2.1	Packet Uplink Assignment / Two phase access / Contention resolution / Expiry of timer T3168 ...	2785
42.1.2.1.9.2.2	Packet Uplink Assignment / Two phase access / Contention resolution / TLLI mismatch	2786
42.1.2.1.9.3	Packet Uplink Assignment / Two phase access / Packet Resource Request / No respond to Packet Downlink Assignment	2787
42.1.2.1.10	Packet Uplink Assignment / Abnormal cases.....	2789
42.1.2.1.10.1	Packet Uplink Assignment / Abnormal cases / Incorrect PDCH assignment	2789
42.1.2.1.10.2	Packet Uplink Assignment / Abnormal cases / Expiry of timer T3164.....	2790
42.1.2.2	Packet Downlink Assignment	2791
42.1.2.2.1	Packet Downlink Assignment / Response to poll bit	2791
42.1.2.2.2	Packet Downlink Assignment / PCCCH monitoring	2792
42.1.2.2.3	Packet Downlink Assignment / Frequency hopping	2794
42.1.2.2.4	Packet Downlink Assignment / Response to Packet Polling.....	2796
42.1.2.2.5	Packet Downlink Assignment / Abnormal cases.....	2797
42.1.2.2.5.1	Packet Downlink Assignment / Abnormal cases / Incorrect PDCH assignment	2797
42.1.2.2.5.2	Packet Downlink Assignment / Abnormal cases / Expiry of timer T3190.....	2799
42.1.3	Macro and default message contents	2800
42.1.3.1	Macro	2800
42.1.3.1.1	GPRS attach procedure	2800
42.1.3.1.2	Uplink data transfer, dynamic allocation.....	2801
42.1.3.2	Default Messages	2801
42.2	Fixed Allocation in Packet Transfer Mode	2807
42.2.1	Generic procedures to bring the MS into uplink transfer mode	2807
42.2.1.1	One phase access.....	2807
42.2.1.2	Two phase access	2808
42.2.2	Fixed Allocation / Uplink Transfer.....	2810
42.2.2.1	Fixed Allocation / Uplink Transfer / Normal operation	2810
42.2.2.1.1	Fixed Allocation / Uplink Transfer / Normal operation / Blocks	2810
42.2.2.1.2	Fixed Allocation / Uplink Transfer / Normal operation / Block Periods.....	2811
42.2.2.2	Fixed Allocation / Uplink Transfer / Operation with TS_OVERRIDE for single-slot TX	2814
42.2.2.3	Fixed Allocation / Uplink Transfer / Operation with TS_OVERRIDE for multi-slot TX	2815
42.2.2.4	Fixed Allocation / Uplink Transfer / T3184 Expiry	2817
42.2.2.5	Fixed Allocation / Uplink Transfer / T3188.....	2820
42.2.2.5.1	Fixed Allocation / Uplink Transfer / T3188/Expiry.....	2820
42.2.2.5.2	Fixed Allocation / Uplink Transfer / T3188/Stop with Packet Uplink Assignment.....	2821
42.2.2.5.3	Fixed Allocation / Uplink Transfer / T3188/Stop with Packet Uplink Ack/Nack with REPEAT_ALLOCATION.....	2823
42.2.2.5	Fixed Allocation / Uplink Transfer / MS requests new resources/ T3168	2824

42.2.2.6.1	Fixed Allocation / Uplink Transfer / MS requests new resources/ T3168/Expiry	2825
42.2.2.6.2	Fixed Allocation / Uplink Transfer / MS requests new resources/ T3168/Stop with Packet Uplink Assignment	2826
42.2.2.6.3	Fixed Allocation / Uplink Transfer / MS requests new resources/ T3168/Stop with Packet Uplink Ack/Nack with REPEAT_ALLOCATION.....	2828
42.2.2.6.4	Fixed Allocation / Uplink Transfer / MS requests new resources/ T3168/Stop with Packet Access Reject	2830
42.2.2.6.5	Fixed Allocation / Uplink Transfer / MS requests new resources/ T3168/Continue with Packet Uplink Ack/Nack without REPEAT_ALLOCATION and without ALLOCATION_BITMAP	2831
42.2.2.7	Fixed Allocation / Uplink Transfer / MS requests new resources/ Successful.....	2833
42.2.2.7.1	Fixed Allocation / Uplink Transfer / MS requests new resources/ Successful/Packet Uplink Assignment with ALLOCATION_BITMAP.....	2833
42.2.2.7.2	Fixed Allocation / Uplink Transfer / MS requests new resources/ Successful/Multiple Packet Uplink Assignments.....	2835
42.2.2.7.3	Fixed Allocation / Uplink Transfer / MS requests new resources/ Successful/Packet Uplink Ack/Nack with ALLOCATION_BITMAP.....	2837
42.2.2.7.4	Fixed Allocation / Uplink Transfer / MS requests new resources/ Successful/Multiple Packet Uplink Ack/Nack with ALLOCATION_BITMAP.....	2838
42.2.2.7.5	Fixed Allocation / Uplink Transfer / MS requests new resources/ Successful/Multiple Packet Uplink Ack/Nack with REPEAT_ALLOCATION.....	2841
42.2.2.8	Fixed Allocation / Uplink Transfer / MS requests new resources/ Failure	2843
42.2.2.8.1	Fixed Allocation / Uplink Transfer / MS requests new resources/ Failure/Packet Access Reject	2843
42.2.2.8.2	Fixed Allocation / Uplink Transfer / MS requests new resources/ Failure/Packet Access Reject with WAIT_INDICATION during allocation in progress	2844
42.2.2.9	Fixed Allocation / Uplink Transfer / Network initiates new resources	2846
42.2.2.10	Fixed Allocation / Uplink Transfer / PACCH operation.....	2847
42.2.2.10.1	Fixed Allocation / Uplink Transfer / PACCH operation/ Normal Operation	2847
42.2.2.10.2	Fixed Allocation / Uplink Transfer / PACCH operation/ PACCH message addressed to another MS.....	2849
42.2.2.10.3	Fixed Allocation/ Uplink Transfer / Abnormal cases / PACCH timeslot removed.....	2851
42.2.2.11	Fixed Allocation/ Uplink Transfer / Abnormal cases.....	2853
42.2.2.11.1	Fixed Allocation/ Uplink Transfer / Abnormal cases / Assignment without fixed allocation	2853
42.2.2.11.2	Fixed Allocation/ Uplink Transfer / Abnormal cases / Frequency not supported	2854
42.2.2.11.3	Fixed Allocation/ Uplink Transfer / Abnormal cases / Invalid MA_NUMBER	2856
42.2.3	Fixed Allocation / Uplink Transfer with Downlink TBF Establishment	2858
42.2.3.1	Fixed Allocation / Uplink Transfer with Downlink TBF Establishment/T3190.....	2858
42.2.3.1.1	Fixed Allocation / Uplink Transfer with Downlink TBF Establishment/ T3190/Half-Duplex.....	2858
42.2.3.1.2	Fixed Allocation / Uplink Transfer with Downlink TBF Establishment/ T3190/Non Half-Duplex	2860
42.2.3.2	Fixed Allocation / Uplink Transfer with Downlink TBF Establishment/ Ending uplink TBF.....	2862
42.2.3.2.1	Fixed Allocation / Uplink Transfer with Downlink TBF Establishment/ Ending uplink TBF/ Half-Duplex.....	2862
42.2.3.2.2	Fixed Allocation / Uplink Transfer with Downlink TBF Establishment/ Ending uplink TBF/ Non Half-Duplex	2865
42.2.3.3	Fixed Allocation/ Uplink Transfer with Downlink TBF Establishment/ Abnormal cases	2867
42.2.3.3.1	Fixed Allocation/ Uplink Transfer with Downlink TBF Establishment/ Abnormal cases / Violation of multi-slot capabilities	2867
42.2.3.3.2	Fixed Allocation/ Uplink Transfer with Downlink TBF Establishment/ Abnormal cases / No defined PDCH.....	2869
42.2.4	Fixed Allocation / Downlink Transfer with Uplink TBF Establishment	2870
42.2.4.1	Fixed Allocation/ Downlink Transfer with Uplink TBF Establishment/ T3168.....	2870
42.2.4.1.1	Fixed Allocation/ Downlink Transfer with Uplink TBF Establishment/ T3168/ Expiry	2870
42.2.4.1.2	Fixed Allocation/ Downlink Transfer with Uplink TBF Establishment/ T3168/ Stop with Packet Uplink Assignment	2872
42.2.4.2	Fixed Allocation/ Downlink Transfer with Uplink TBF Establishment/ Packet Uplink Assignment....	2874
42.2.4.2.1	Fixed Allocation/ Downlink Transfer with Uplink TBF Establishment/Packet Uplink Assignment/ Non half-duplex	2874
42.2.4.2.2	Fixed Allocation/ Downlink Transfer with Uplink TBF Establishment/Packet Uplink Assignment/ Half-duplex	2877
42.2.4.3	Fixed Allocation/ Downlink Transfer with Uplink TBF Establishment/Packet Timeslot Reconfigure .	2880
42.2.4.3.1	Fixed Allocation/ Downlink Transfer with Uplink TBF Establishment/Packet Timeslot Reconfigure/Starting time with AFN encoding	2880

42.2.4.3.2	Fixed Allocation/ Downlink Transfer with Uplink TBF Establishment/ Packet Timeslot Reconfigure/ Starting time with relative encoding	2883
42.2.4.4	Fixed Allocation/ Downlink Transfer with Uplink TBF Establishment/ Packet Access Reject	2886
42.2.4.4.1	Fixed Allocation/ Downlink Transfer with Uplink TBF Establishment/ Packet Access Reject/ With WAIT_INDICATION.....	2886
42.2.4.4.2	Fixed Allocation/ Downlink Transfer with Uplink TBF Establishment/ Packet Access Reject/ No WAIT_INDICATION.....	2888
42.2.4.4.3	Fixed Allocation/ Downlink Transfer with Uplink TBF Establishment/ Packet Access Reject/ With Polling.....	2890
42.2.5	Default message contents.....	2892
42.2.5.1	Default message contents	2892
42.3	Dynamic Allocation in Packet Transfer Mode	2897
42.3.1	Dynamic Allocation / Uplink Transfer	2897
42.3.1.1	Dynamic Allocation / Uplink Transfer / Normal.....	2897
42.3.1.1.1	Dynamic Allocation / Uplink Transfer / Normal / Successful	2897
42.3.1.1.2	Dynamic Allocation / Uplink Transfer / Normal / Request new resources	2900
42.3.1.1.3	Dynamic Allocation / Uplink Transfer / Normal / Starting frame number encoding	2901
42.3.1.1.4	Dynamic Allocation / Uplink Transfer / Normal / Starting time.....	2904
42.3.1.1.5	Dynamic Allocation / Uplink Transfer / Normal / Close-ended TBF	2908
42.3.1.1.6	Dynamic Allocation / Uplink Transfer / Normal / T3180 expiry	2911
42.3.1.1.7	Dynamic Allocation / Uplink Transfer / Normal / PACCH operation	2913
42.3.1.1.8	Dynamic Allocation / Uplink Transfer / Normal / Two uplink timeslots.....	2915
42.3.1.1.9	Dynamic Allocation / Uplink Transfer / Normal / Frequency parameters	2917
42.3.1.2	Dynamic Allocation / Uplink Transfer / Abnormal.....	2929
42.3.1.2.1	Void	2929
42.3.1.2.2	Dynamic Allocation / Uplink Transfer / Abnormal / with cell reselection in acknowledged mode.....	2929
42.3.1.2.3	Dynamic Allocation / Uplink Transfer / Abnormal / with cell reselection in unacknowledged mode...	2930
42.3.2	Dynamic Allocation / Uplink Transfer with Downlink TBF establishment (concurrent).....	2932
42.3.2.1	Dynamic Allocation / Uplink Transfer with Downlink TBF establishment / Normal.....	2932
42.3.2.1.1	Dynamic Allocation / Uplink Transfer with Downlink TBF establishment / Normal / Successful	2932
42.3.2.1.2	Dynamic Allocation / Uplink Transfer with Downlink TBF establishment / Normal / Multislot capabilities	2937
42.3.2.2	Dynamic Allocation / Uplink Transfer with Downlink TBF establishment / Abnormal.....	2945
42.3.2.2.1	Dynamic Allocation / Uplink Transfer with Downlink TBF establishment / Abnormal / with random access	2945
42.3.2.2.2	Dynamic Allocation / Uplink Transfer with Downlink TBF establishment / Abnormal / Continuation of normal operation.....	2949
42.3.3	Dynamic Allocation / Resource reallocation	2951
42.3.3.1	Dynamic Allocation / Resource reallocation / Successful.....	2951
42.3.3.1.1	Dynamic Allocation / Resource reallocation / Successful / Higher throughput class or higher radio priority	2952
42.3.3.1.2	Dynamic Allocation / Resource reallocation / Successful / Lower throughput class	2957
42.3.3.1.3	Dynamic Allocation / Resource reallocation / Successful / Different RLC mode and higher radio priority	2960
42.3.3.2	Dynamic Allocation / Resource reallocation / Abnormal.....	2963
42.3.3.2.1	Dynamic Allocation / Resource reallocation / Abnormal / T3168 expiry	2963
42.3.3.2.2	Dynamic Allocation / Resource reallocation / Abnormal / Invalid assignment	2966
42.3.3.3	Dynamic Allocation / Resource reallocation / Reject	2971
42.3.4	Default message contents.....	2975
42.4	Measurement reports and Cell change order procedures	2984
42.4.1	Measurement reports	2984
42.4.1.1	Network Control measurement reporting / Uplink / Normal case.....	2984
42.4.1.2	Network Control measurement reporting / Idle mode / New cell reselection	2987
42.4.1.3	Network Control measurement reporting / Downlink transfer / Normal case.....	2989
42.4.2	Cell change order procedures	2992
42.4.2.1	Cell change order procedure / Uplink transfer	2992
42.4.2.1.1	Cell change order procedure / Uplink transfer / Normal case	2992
42.4.2.1.2	Cell change order procedure / Uplink transfer / Failure cases / T3174 expiry	2993
42.4.2.1.3	Cell change order procedure / Uplink transfer / Failure cases / REJECT from the new cell.....	2995
42.4.2.1.4	Cell change order procedure / Uplink transfer / Failure cases / Contention resolution failure.....	2996
42.4.2.1.5	Cell change order procedure / Uplink transfer / Failure cases / REJECT from the new cell and T3176 expiry	2997

42.4.2.1.6	Cell change order procedure / Uplink transfer / Failure cases / Frequency not implemented	2999
42.4.2.2	Cell change order procedure / Downlink transfer	3000
42.4.2.2.1	Cell change order procedure / Downlink transfer / Normal case	3000
42.4.2.2.2	Cell change order procedure / Downlink transfer / Failure cases / REJECT from the new cell.....	3001
42.4.2.2.3	Cell change order procedure / Downlink transfer / Failure cases / Frequency not implemented	3003
42.4.2.3	Cell change order procedure / Simultaneous uplink and downlink transfer.....	3004
42.4.2.3.1	Cell change order procedure / Simultaneous uplink and downlink transfer / Normal case.....	3004
42.4.2.3.2	Cell change order procedure / Simultaneous uplink and downlink transfer / Failure case / T3174 expiry	3007
42.4.3	Macros and Default Message contents.....	3008
42.4.3.1	Macros.....	3008
42.4.3.1.1	Uplink packet transfer mode / Dynamic allocation	3008
42.4.3.1.2	Uplink packet transfer mode / Fixed allocation.....	3009
42.4.3.2	Default Messages	3009
42.4.3.2.1	PACKET CELL CHANGE ORDER message.....	3009
42.4.3.2.2	PACKET CELL CHANGE FAILURE message.....	3009
42.4.3.2.3	PACKET MEASUREMENT ORDER message	3010
42.4.4	Cell Change Order Procedures without PBCCH	3011
42.4.4.1	Network Controlled Cell Reselection – Packet Measurement Order Procedure	3011
42.4.4.2	Network Controlled Cell Reselection/validity of reselection parameters/MS enters standby state.....	3012
42.5	Downlink Transfer.....	3013
42.5.1	Downlink Transfer / Normal Operation.....	3013
42.5.1.1	Downlink Transfer/ Normal Operation / Relative Encoding TBF starting time	3013
42.5.1.2	Downlink Transfer/ Normal Operation / Without TBF starting time	3015
42.5.2	Downlink Transfer / Polling	3016
42.5.2.1	Downlink Transfer/ Polling/ Normal operation/RLC data block	3016
42.5.2.2	Downlink Transfer/ Polling/ Packet Polling Request/ Access Burst format	3018
42.5.2.3	Downlink Transfer/ Polling/ Packet Polling Request/ Control block format	3019
42.5.3	Downlink Transfer / T3190 Expiry / Initial allocation	3021
42.5.3.1	Downlink Transfer/ T3190 Expiry / Initial allocation / Restart with valid RLC data block	3021
42.5.4	Downlink Transfer / T3190 Expiry / Resource reallocation	3023
42.5.4.1	Downlink Transfer/ T3190 Expiry / Resource reallocation / Without TBF starting time	3023
42.5.4.2	Downlink Transfer/ T3190 Expiry / Resource reallocation / With TBF starting time	3024
42.5.4.3	Downlink Transfer/ T3190 Expiry / Resource reallocation / Restart with valid RLC data block	3026
42.5.5	Downlink Transfer / Reestablishment.....	3028
42.5.5.1	Downlink Transfer/ Reestablishment/ T3192 Expiry.....	3028
42.5.5.2	Downlink Transfer/ Reestablishment/ Packet Downlink Assignment	3031
42.5.5.3	Downlink Transfer/ Reestablishment/ Invalid Frequency Parameters IE	3033
43	RLC Test Cases	3036
43.1	Acknowledged Mode.....	3036
43.1.1	Acknowledged mode / Uplink TBF.....	3036
43.1.1.1	Acknowledged mode / Uplink TBF / Send state variable V(S).....	3036
43.1.1.2	Acknowledged mode / Uplink TBF / Transmit window size	3038
43.1.1.3	Acknowledged mode / Uplink TBF / Acknowledge state variable V(A).....	3039
43.1.1.4	Acknowledged mode / Uplink TBF / Negatively acknowledged RLC data blocks	3041
43.1.1.5	Acknowledged mode / Uplink TBF / Invalid Negative Acknowledgment.....	3043
43.1.1.6	Acknowledged mode / Uplink TBF / Decoding of Received Block Bitmap.....	3045
43.1.2	Acknowledged mode / Downlink TBF.....	3048
43.1.2.1	Acknowledged mode / Downlink TBF / Receive state variable V(R)	3048
43.1.2.2	Acknowledged mode / Downlink TBF / Receive window state variable V(Q)	3049
43.1.2.3	Acknowledged mode / Downlink TBF / Re-assembly of RLC data blocks	3050
43.1.2.4	Acknowledged mode / Downlink TBF / Re-assembly / Length Indicator	3051
43.2	Control Blocks	3052
43.2.1	Control Blocks Re-assembly.....	3052
43.3	Default Message Contents and Macros.....	3054
43.3.1	Message Contents	3054
43.3.1.1	Packet Uplink Assignment	3054
43.3.2	Macros	3055
43.3.2.1	Macro for uplink dynamic allocation two phase access (PBCCH not present).....	3055
43.3.2.2	Macro for downlink TBF establishment (PBCCH not present)	3055

44	Test case requirements for GPRS mobility management	3055
44.1	Applicability, default conditions and default messages	3055
44.2	Elementary procedures of GPRS mobility management.....	3056
44.2.1	GPRS attach procedure.....	3056
44.2.1.1	Normal GPRS attach	3056
44.2.1.1.1	GPRS attach / accepted	3056
44.2.1.1.2	GPRS attach / rejected / IMSI invalid / illegal MS	3059
44.2.1.1.3	GPRS attach / rejected / IMSI invalid / GPRS services not allowed.....	3062
44.2.1.1.4	GPRS attach / rejected / PLMN not allowed.....	3063
44.2.1.1.5	GPRS attach / rejected / roaming not allowed in this location area	3067
44.2.1.1.6	GPRS attach / abnormal cases / access barred due to access class control.....	3075
44.2.1.1.7	GPRS attach / abnormal cases / change of cell into new routing area.....	3077
44.2.1.1.8	GPRS attach / abnormal cases / power off	3079
44.2.1.1.9	GPRS attach / abnormal cases / GPRS detach procedure collision.....	3080
44.2.1.2	Combined GPRS attach.....	3082
44.2.1.2.1	Combined GPRS attach / GPRS and non-GPRS attach accepted	3082
44.2.1.2.2	Combined GPRS attach / GPRS only attach accepted	3086
44.2.1.2.3	Combined GPRS attach / GPRS attach while IMSI attach.....	3091
44.2.1.2.4	Combined GPRS attach / rejected / IMSI invalid / illegal ME.....	3093
44.2.1.2.5	Combined GPRS attach / rejected / GPRS services and non-GPRS services not allowed.....	3096
44.2.1.2.6	Combined GPRS attach / rejected / GPRS services not allowed.....	3099
44.2.1.2.7	Combined GPRS attach / rejected / location area not allowed.....	3102
44.2.1.2.8	Combined GPRS attach / abnormal cases / attempt counter check / miscellaneous reject causes	3105
44.2.1.2.9	Combined GPRS attach / abnormal cases / GPRS detach procedure collision	3109
44.2.2	GPRS detach procedure	3111
44.2.2.1	MS initiated GPRS detach procedure.....	3112
44.2.2.1.1	GPRS detach / power off / accepted.....	3112
44.2.2.1.2	GPRS detach / accepted	3113
44.2.2.1.3	GPRS detach / abnormal cases / attempt counter check / procedure timeout.....	3114
44.2.2.1.4	GPRS detach / abnormal cases / GMM common procedure collision	3117
44.2.2.1.5	GPRS detach / power off / accepted.....	3118
44.2.2.1.6	GPRS detach / accepted / GPRS/IMSI detach	3119
44.2.2.1.7	GPRS detach / accepted / IMSI detach	3121
44.2.2.1.8	GPRS detach / abnormal cases / change of cell into new routing area.....	3123
44.2.2.1.9	GPRS detach / abnormal cases / GPRS detach procedure collision.....	3124
44.2.2.2	Network initiated GPRS detach procedure.....	3126
44.2.2.2.1	GPRS detach / re-attach not required / accepted	3126
44.2.2.2.2	GPRS detach / rejected / IMSI invalid / GPRS services not allowed.....	3127
44.2.2.2.3	GPRS detach / IMSI detach / accepted	3129
44.2.2.2.4	GPRS detach / re-attach requested / accepted.....	3131
44.2.2.2.5	GPRS detach / rejected / location area not allowed.....	3133
44.2.3	Routing area updating procedure.....	3136
44.2.3.1	Normal routing area updating.....	3137
44.2.3.1.1	Routing area updating / accepted	3137
44.2.3.1.2	Routing area updating / rejected / IMSI invalid / illegal ME	3140
44.2.3.1.3	Routing area updating / rejected / MS identity cannot be derived by the network.....	3142
44.2.3.1.4	Routing area updating / rejected / location area not allowed.....	3144
44.2.3.1.5	Routing area updating / abnormal cases / attempt counter check / miscellaneous reject causes	3147
44.2.3.1.6	Routing area updating / abnormal cases / change of cell into new routing area.....	3150
44.2.3.1.7	Routing area updating / abnormal cases / change of cell during routing area updating procedure	3152
44.2.3.1.8	Routing area updating / abnormal cases / P-TMSI reallocation procedure collision	3153
44.2.3.2	Combined routing area updating	3155
44.2.3.2.1	Combined routing area updating / combined RA/LA accepted.....	3155
44.2.3.2.2	Combined routing area updating / MS in CS operation at change of RA	3158
44.2.3.2.3	Combined routing area updating / RA only accepted.....	3159
44.2.3.2.4	Combined routing area updating / rejected / PLMN not allowed.....	3164
44.2.3.2.5	Combined routing area updating / rejected / roaming not allowed in this location area	3167
44.2.3.2.6	Combined routing area updating / abnormal cases / access barred due to access class control	3172
44.2.3.2.7	Combined routing area updating / abnormal cases / attempt counter check / procedure timeout	3175
44.2.3.2.8	Combined routing area updating / abnormal cases / change of cell into new routing area	3179
44.2.3.2.9	Combined routing area updating / abnormal cases / change of cell during routing area updating procedure	3181

44.2.3.2.10	Combined routing area updating / abnormal cases / GPRS detach procedure collision	3183
44.2.3.3	Periodic routing area updating	3186
44.2.3.3.1	Periodic routing area updating / accepted	3186
44.2.3.3.2	Periodic routing area updating / accepted / T3312 default value	3188
44.2.3.3.3	Periodic routing area updating / no cell available / network mode I	3190
44.2.3.3.4	Combined periodic routing area updating / no cell available	3192
44.2.4	P-TMSI reallocation	3194
44.2.5	GPRS authentication and ciphering	3196
44.2.5.1	Test of authentication	3196
44.2.5.1.1	Authentication accepted	3197
44.2.5.1.2	Authentication rejected	3198
44.2.5.2	Test of ciphering mode setting	3200
44.2.5.2.1	Ciphering mode / start ciphering	3200
44.2.5.2.2	Ciphering mode / stop ciphering	3203
44.2.5.2.3	Ciphering mode / IMEISV request	3206
44.2.6	Identification procedure	3209
44.2.6.1	General Identification	3209
44.2.7	GMM READY timer handling	3210
45	Session Management Procedures	3216
45.1	Definition and applicability	3216
45.2	PDP context activation	3216
45.2.1	Initiated by the mobile station	3216
45.2.1.1	Attach initiated by context activation/QoS Offered by Network is the QoS Requested	3216
45.2.1.2	QoS Offered by Network is a lower QoS	3218
45.2.1.2.1	QoS Accepted by MS	3218
45.2.1.2.2	QoS Rejected by MS	3220
45.2.2	PDP context activation requested by the network, successful and unsuccessful	3222
45.2.4	Abnormal cases	3225
45.2.4.1	T3380 Expiry	3225
45.2.4.2	Collision of MS initiated and network requested PDP context activation	3227
45.3	PDP context modification procedure	3229
45.3.1	PDP context modification	3229
45.4	PDP context deactivation procedure	3232
45.4.1	PDP context deactivation initiated by the MS	3232
45.4.2	PDP context deactivation initiated by the network	3234
45.4.3	Abnormal cases	3236
45.4.3.1	T3390 Expiry	3236
45.4.3.2	Collision of MS and network initiated PDP context deactivation requests	3239
45.5	Unknown or Unforeseen Transaction Identifier/Non-semantical Mandatory Information Element Errors	3241
45.5.1	Error cases	3241
46	3246	
46.1	LLC Tests	3246
46.1.1	Default Conditions	3246
46.1.2	Test cases	3247
46.1.2.1	Unacknowledged data transfer	3247
46.1.2.1.1	Data transmission in protected mode	3247
46.1.2.1.2	Data transmission in unprotected mode	3248
46.1.2.1.3	Reception of I frame in ADM	3249
46.1.2.2	Acknowledged data transfer	3250
46.1.2.2.1	Link establishment	3250
46.1.2.2.1.1	Link establishment from MS to SS	3250
46.1.2.2.1.2	Link establishment from SS to MS	3251
46.1.2.2.1.3	Loss of UA frame	3252
46.1.2.2.1.4	Total loss of UA frame	3253
46.1.2.2.1.5	DM response	3254
46.1.2.2.2	MS sends I+S frames	3255
46.1.2.2.2.1	Checking N(S)	3255
46.1.2.2.2.2	Busy condition at the peer, with RR sent for resumption of transmission	3256
46.1.2.2.2.3	Busy condition at the peer, with ACK sent for resumption of transmission	3258
46.1.2.2.2.4	SACK frame	3260

46.1.2.2.3	Reception of I + S frames at the MS	3261
46.1.2.2.3.1	Checking N(R).....	3261
46.1.2.2.3.2	MS handling busy condition during bi-directional data transfer	3262
46.1.2.2.3.3	SACK frame	3264
46.1.2.2.3.4	ACK frame	3265
46.1.2.2.4	Link Reestablishment.....	3266
46.1.2.2.4.1	Reestablishment due to reception of SABM.....	3266
46.1.2.2.4.2	Reestablishment due to N200 failures	3268
46.1.2.2.4.3	Reestablishment due to reception of DM	3269
46.1.2.3	Collision of commands and responses	3270
46.1.2.3.1	Collision of SABM	3270
46.1.2.3.2	Collision of SABM and DISC.....	3271
46.1.2.3.3	Collision of SABM and XID commands.....	3272
46.1.2.4	Unsolicited response frames.....	3273
46.1.2.4.1	Unsolicited DM.....	3273
46.1.2.5	FRMR frames.....	3274
46.1.2.5.1	Sending FRMR due to undefined command control field.....	3274
46.1.2.5.2	Sending FRMR due to reception of an S frame with incorrect length	3275
46.1.2.5.3	Sending FRMR due to reception of an I frame information field exceeding the maximum length	3276
46.1.2.5.4	Frame reject condition during establishment of ABM	3278
46.1.2.6	Multiple Connections	3279
46.1.2.6.1	Simultaneous acknowledged and unacknowledged data transfer on the same SAPI	3279
46.1.2.6.2	Simultaneous acknowledged and unacknowledged data transfer on different SAPIs	3280
46.1.2.7	XID Negotiation.....	3282
46.1.2.7.1	Negotiation initiated by the SS during ABM, for T200 and N200.....	3282
46.1.2.7.2	Negotiation initiated by the SS during ADM, for N201-I.....	3283
46.1.2.7.3	Negotiation initiated by the SS (using SABM, for IOV-I).....	3284
46.1.2.7.4	Negotiation initiated by the SS (during ADM, for N201-U).....	3285
46.1.2.7.5	Negotiation initiated by the SS (during ADM, for IOV-UI)	3286
46.1.2.7.6	Negotiation initiated by the SS (during ABM, for Reset)	3288
46.1.2.7.7	XID command with unrecognised type field.....	3290
46.1.2.7.8	XID Response with out of range values.....	3291
46.2	SNDCP Tests	3292
46.2.1	Default Conditions.....	3292
46.2.2	Test cases.....	3293
46.2.2.1	Data transfer	3293
46.2.2.1.1	Mobile originated normal data transfer with LLC in acknowledged mode.....	3293
46.2.2.1.2	Mobile originated normal data transfer with LLC in unacknowledged mode.....	3294
46.2.2.1.3	Usage of acknowledged mode for data transmission before and after PDP Context modification, on different SAPIs	3296
46.2.2.1.4	Reset indication during unacknowledged mode.....	3297
46.2.2.1.5	Reset indication during acknowledged mode.....	3298
46.2.2.2	Segmentation.....	3300
46.2.2.2.1	LLC link re-establishment on reception of SN-DATA PDU with F=0 in ack mode in the Receive First Segment state.....	3300
46.2.2.2.2	LLC link re-establishment on receiving second segment with F=1 and with different PCOMP and DCOMP values in the acknowledged mode data transfer.....	3301
46.2.2.2.3	Single segment N-PDU from MS.....	3302
46.2.2.3	Link Release.....	3303
46.2.2.3.1	LLC link release on receiving DM from the SS during link establishment.....	3303
46.2.2.4	XID negotiation.....	3303
46.2.2.4.1	Response from MS on receiving XID request from the SS.....	3303
46.2.2.4.2	Response from MS on receiving an XID request from the SS with an unassigned entity number	3305
46.2.2.4.3	Response from MS on receiving an XID response from the SS with unrecognised type field	3306
46.2.2.5	LLC link release on receiving "Invalid XID response" from the network during link establishment procedure.....	3307

50	EGPRS Default Conditions	3309
51	EGPRS Paging, TBF establishment/release and DCCH related procedures	3309
52	EGPRS Test of Medium Access Control (MAC) protocol.....	3309
53	EGPRS RLC Test Cases	3309
60.	Inter-system hard handover from GSM to UTRAN	3310
60.1	Inter system handover to UTRAN/From GSM/Speech/Success.....	3311
60.2	Inter system handover to UTRAN/From GSM/Data/Same data rate/Success	3319
60.3	Inter system handover to UTRAN/From GSM/Data/Data rate upgrading/Success	3333
60.4	Inter system handover to UTRAN/From GSM/Speech/Establishment/Success	3335
60.5	Inter system handover to UTRAN/From GSM/Speech/Blind HO/Success	3337
60.6	Inter system handover to UTRAN/From GSM/Speech/Failure	3345
Annex 1 (Normative): Reference test methods		3347
A1.1	General Conditions (GC)	3347
A1.1.1	Outdoor test site and general arrangements for measurements involving the use of radiated fields (GC4).	3347
A1.1.2	Anechoic shielded chamber (GC5)	3347
A1.1.3	Temporary antenna connector (GC7)	3348
A1.1.4	Temporary antenna connector characteristics	3348
A1.1.5	Calibration of the temporary antenna connector	3349
A1.1.5.1	Antenna radiation pattern	3349
A1.1.5.2	Test range calibration	3351
A1.1.5.3	Temporary antenna connector coupling factor	3351
A1.2	Normal and extreme Test Conditions (TC)	3352
A1.2.1	Power sources and ambient temperatures (TC2)	3352
A1.2.2	Normal test conditions (TC2.1)	3352
A1.2.3	Extreme test conditions (TC2.2)	3353
A1.2.4	Vibration requirements (TC4)	3354
Annex 2: Not used		3354
Annex 3: Protocol implementation information.....		3354
A3.1	Protocol Implementation Conformance Statement (PICS)	3354
A3.1.1	LAPDm protocol (GSM 04.05 and 04.06).....	3355
A3.1.1.1	Simplified protocol - GSM 04.06 section 6	3355
A3.1.1.2	Management of SAPI = 3 - GSM 04.11 section 2.3	3355
A3.1.2	Mobility management.....	3355
A3.1.2.1	IMSI detach initiation by the MS - GSM 04.08 section 4.3.4.1	3355
A3.1.2.2	IMSI detach completion by the MS - GSM 04.08 section 4.3.4.3	3355
A3.1.2.3	MM specific procedures - GSM 04.08 section 4.4 and 4.5.1.1	3355
A3.1.2.4	Receiving an MM STATUS message - GSM 04.08 section 4.6	3355
A3.1.3	Call control	3355
A3.1.3.1	Status enquiry procedures - GSM 04.08 section 5.5.3.1	3355
A3.1.3.2	Receiving a STATUS message by a CC entity - GSM 04.08 section 5.5.3.2	3355
A3.1.3.3	Called side compatibility checking - GSM 04.08 annex B.3	3356
A3.1.3.4	Disconnect on incoming call	3356
A3.1.4	Layer 1	3356
A3.1.4.1	Optional storage of BCCH carrier information - GSM 05.08 section 6.3	3356
A3.1.5	Autocalling - (ref.: GSM 02.07, annex 1)	3356
A3.1.6	Transient states	3356
A3.2	Protocol Implementation Extra Information for Testing (PIXIT)	3357
A3.2.0	Introduction.....	3357
A3.2.1	Basic characteristics.....	3357
A3.2.1.1	Type of antenna.....	3357
A3.2.1.2	Power supply	3357
A3.2.1.3	Power class of the MS	3358
A3.2.1.4	Channel modes supported	3358
A3.2.1.5	Teleservices supported	3358

A3.2.1.6	Supplementary services supported	3358
A3.2.1.7	Bearer services supported.....	3358
A3.2.1.8	SIM removal.....	3359
A3.2.1.9	Classmark.....	3359
A3.2.1.10	Type of SIM/ME interface (ref. GSM 11.11 and GSM 11.12)	3359
A3.2.1.11	Multislot class	3360
A3.2.2	Man machine interface.....	3360
A3.2.2.1	Mobile station features	3360
A3.2.2.2	Short message service	3361
A3.2.2.3	Supplementary services.....	3361
A3.2.2.3.1	Call forwarding	3361
A3.2.2.3.2	Call restriction.....	3361
A3.2.2.3.3	Handling of (undefined) GSM supplementary services	3362
A3.2.3	Electrical Man Machine Interface (EMMI)	3362
A3.2.3.1	Methods supported for activation/deactivation of EMMI	3362
A3.2.3.2	Transmission rate supported by the ME on the EMMI	3362
A3.2.3.3	Layer 3 messages supported on the EMMI	3362
A3.2.3.4	Keystroke sequence messages.....	3362
A3.2.3.5	Internal malfunction detected messages.....	3362
A3.2.4	Digital Audio Interface (DAI)	3362
A3.2.5	Characteristics related to bearer services or teleservices	3363
A3.2.5.1	Access interface	3363
A3.2.5.2	Configuration of the MT	3363
A3.2.5.3	Capability information	3363
A3.2.5.4	Subaddress or DDI number	3363
A3.2.5.5	User to user signalling.....	3363
A3.2.5.6	Data call set-up and data call clearing.....	3363
A3.2.5.7	Characteristics of non-transparent data services	3364
A3.2.5.8	Possible ways of setting-up a call from either an external interface or internally	3364
A3.2.5.9	Application layer causing automatic call termination	3364
A3.2.5.10	Call re-establishment for MS not supporting speech.....	3364
A3.2.6	International mobile station equipment identity	3364
A3.2.7	Receiver intermediate frequencies	3364
A3.2.8	Artificial ear.....	3365
Annex 4: Test SIM Parameters.....		3368
A4.1	Introduction.....	3368
A4.1.1	Definitions	3368
A4.1.2	Definition of the test algorithm for authentication.....	3368
A4.2	Default Parameters for the test SIM.....	3368
A4.3	Default settings for the Elementary Files (EFs).....	3369
A4.3.1	EF _{ICCID} (ICC Identification).....	3369
A4.3.2	EF _{LP} (Language preference)	3369
A4.3.3	EF _{IMSI} (IMSI)	3369
A4.3.4	EF _{Kc} (Ciphering key Kc).....	3369
A4.3.5	EF _{PLMNsel} (PLMN selector)	3369
A4.3.6	EF _{HPLMN} (HPLMN search period).....	3370
A4.3.7	EF _{ACMmax} (ACM maximum value).....	3370
A4.3.8	EF _{SST} (SIM service table)	3370
A4.3.9	EF _{ACM} (Accumulated call meter)	3371
A4.3.10	EF _{PUCT} (Price per unit and currency table).....	3371
A4.3.11	EF _{CBMI} (Cell broadcast Message Identifier Selection)	3371
A4.3.12	EF _{BCC} (Broadcast control channels).....	3371
A4.3.13	EF _{ACC} (Access control class)	3371
A4.3.14	EF _{FPLMN} (Forbidden PLMNs)	3372
A4.3.15	EF _{LOCI} (Location information)	3372
A4.3.16	EF _{AD} (Administrative data).....	3372
A4.3.17	EF _{Phase} (Phase identification)	3373
A4.3.18	EF _{ADN} (Abbreviated dialling numbers).....	3373
A4.3.19	EF _{FDN} (Fixed dialling numbers).....	3373

A4.3.20	EF _{SMS} (Short messages)	3373
A4.3.21	EF _{CCP} (Capability configuration parameters).....	3373
A4.3.22	EF _{MSISDN} (MSISDN)	3373
A4.3.23	EF _{SMSP} (Short message service parameters).....	3373
A4.3.24	EF _{SMSS} (SMS status)	3373
A4.3.25	EF _{EXT1} (Extension 1).....	3374
A4.3.26	EF _{EXT2} (Extension 2).....	3374
A4.3.27	EF _{VGCS} (Voice Group Call Service).....	3375
A4.3.28	EF _{VGCS} (Voice Group Call Service Status)	3376
A4.3.29	EF _{VBS} (Voice Broadcast Service)	3377
A4.3.30	EF _{VBSS} (Voice Broadcast Service Status).....	3378
A4.3.31	EF _{eMLPP} (enhanced Multi Level Pre-emption and Priority)	3378
A4.3.32	EF _{AAeM} (Automatic Answer for eMLPP Service)	3378

Annex 5: Test equipment..... 3378

A5.1	Introduction.....	3378
A5.1.1	General.....	3378
A5.1.2	Test equipment terms.....	3378
A5.1.3	Confidence level	3379
A5.2	Standard test signals.....	3379
A5.3	SS functional requirements	3379
A5.3.1	Level setting range.....	3379
A5.3.2	Level Measurement / operation range.....	3379
A5.3.3	MS power supply interface	3380
A5.3.4	MS antenna interface	3380
A5.3.4.1	Uplink receiver error	3380
A5.3.4.2	Power and Power versus time measurements.....	3380
A5.3.4.3	Wideband selective power measurement	3383
A5.3.4.4	Inband selective power measurements	3383
A5.3.4.5	Modulation accuracy and frequency error measurements	3384
A5.3.4.6	RF delay measurements relative to nominal times.....	3384
A5.3.4.7	The wanted signal or traffic channel of serving cell	3384
A5.3.4.8	The first interfering signal or traffic channel of the first adjacent cell	3385
A5.3.4.9	The second interfering signal	3386
A5.3.4.10	BCCH carriers of serving and adjacent cells.....	3387
A5.3.4.11	The wide frequency range signal.....	3388
A5.3.4.12	The multipath fading function.....	3388
A5.3.5	MS audio interface and DAI.....	3388
A5.3.5.1	General uncertainties.....	3388
A5.3.5.2	Analogue single test tone	3388
A5.3.5.3	Delay measurement between Um and DAI.....	3388
A5.4	SIM simulator functional requirements	3389
A5.4.1	General.....	3389
A5.4.2	Contacts C1, C2, C6, C7.....	3389
A5.4.2.1	Default measurement / setting uncertainties.....	3389
A5.4.2.2	Contact C1.....	3389
A5.4.2.3	Contact C7.....	3390
A5.4.3	Contact C3	3390
A5.4.4	Definition of timing	3390

Annex B (informative): Change history..... 3391

Foreword

This Technical Specification has been produced by the 3GPP.

The contents of the present document are subject to continuing work within the TSG and may change following formal TSG approval. Should the TSG modify the contents of this TS, it will be re-released by the TSG with an identifying change of release date and an increase in version number as follows:

Version x.y.z

where:

- x the first digit:
 - ≥ 3 Indicates TSG approved document under change control (Release 2000).
- y the second digit is incremented for all changes of substance, i.e. technical enhancements, corrections, updates, etc.
- z the third digit is incremented when editorial only changes have been incorporated in the specification.

The present document describes the technical characteristics and methods of test for Mobile Stations (MSs), operating in the 400 MHz, 700 MHz, 850 MHz, 900 MHz, 1 800 MHz and/or 1900 MHz frequency band (GSM 400, GSM 700, GSM 850, GSM 900, DCS 1 800 and/or PCS 1900) within the digital cellular telecommunications system. Definition 'all types of mobiles' includes all systems listed above (GSM 400, GSM 700, GSM 850, GSM 900, DCS 1 800 and PCS 1900).

The present document is part 1 of a multi-part EN covering the Digital cellular telecommunications system (GSM Phase2 and Phase 2+ Releases 96, 97, 98, 99 and 3GPP Release 2000); Mobile Station (MS) conformance specification, as identified below:

- Part 1: Conformance specification**
Reference: 3G TS 51.010-1.
- Part 2: Protocol Implementation Conformance Statement (PICS) proforma specification.
Reference: 3G TS 51.010-2.
- Part 3: Layer 3 (L3) Abstract Test Suite (ATS).
Reference: 3G TS 51.010-3.

1 Scope

The present document describes the technical characteristics and methods of test for Mobile Stations (MS), for the Pan European digital cellular communications system and Personal Communication Systems (PCS) operating in the 400 MHz, 700 MHz, 850 MHz, 900 MHz, 1 800 MHz and 1900 MHz band (GSM 400, GSM 900, DCS 1 800 and PCS 1900), standardized by ETSI Special Mobile Group (SMG).

The present document is valid for MS implemented according to GSM Phase2 or Phase2+ R96, or R97, or R98, or R99 or 3GPP Release 2000.

A subset of the tests is referenced in the GSM Common Technical Regulations (CTRs) and is used for regulatory conformance testing according to the EEC procedures for Telecommunications Terminal Equipment (TTE) type approval (EC Directive 91/263/EEC; also known as the "Terminal Directive" or "Second Phase Directive"). The remaining tests can be used to verify conformance with the GSM core technical specifications for those requirements that are not considered "essential" in the sense of the EC Directive 91/263/EEC (Article 4).

The present document covers the minimum characteristics considered necessary in order to provide sufficient performance for mobile equipment and to prevent interference to other services or to other users, and to the PLMNs.

It does not necessarily include all the characteristics which may be required by a user or subscriber, nor does it necessarily represent the optimum performance achievable.

It applies to the public land mobile radio service in the GSM 400, 700 MHz, 850 MHz, GSM 900, DCS 1 800 and PCS 1900 systems, using constant envelope modulation and operating on radio frequencies in the 400, 700, 850, 900, 1 800 and 1900 MHz bands respectively with a channel separation of 200 kHz and carrying 8 full rate channels or 16 half rate channels per carrier according to the TDMA principle.

The present document is part of the GSM-series of technical specifications. This EN neither replaces any of the other GSM technical specifications or GSM related ETSs or ENs, nor is it created to provide full understanding of (or parts of) the GSM 400, GSM 700, GSM 850, GSM 900, DCS 1 800 and PCS 1900 systems. This EN lists the requirements, and provides the methods of test for testing a MS for conformance to the GSM standard.

For a full description of the system, reference should be made to all the GSM technical specifications or GSM related ETSs or ENs. Clause 2 provides a complete list of the GSM technical specifications, GSM related ETSs, ENs, and ETRs, on which this conformance test specifications is based.

The present document applies to the unit which includes the hardware to establish a connection across the radio interface.

If there is a difference between this conformance document, and any other GSM technical specification or GSM related ETS or EN, or 3GPP TS, then the other GSM technical specification or GSM related ETS or EN or 3GPP TS shall prevail.

2 References

The following documents contain provisions which, through reference in this text, constitute provisions of the present document.

- References are either specific (identified by date of publication, edition number, version number, etc.) or non-specific.
- For a specific reference, subsequent revisions do not apply.
- For a non-specific reference, the latest version applies. In the case of a reference to a 3GPP document (including a GSM document), a non-specific reference implicitly refers to the latest version of that document *in the same Release as the present document*.
 - For a Phase2+ Release 4 MS, references to GSM documents are to version 4.x.y, when available.
 - For a Phase2+ Release 1999 MS, references to GSM documents are to version 8.x.y, when available.

- For a Phase2+ Release 1998 MS, references to GSM documents are to version 7.x.y, when available.
 - For a Phase2+ Release 1997 MS, references to GSM documents are to version 6.x.y, when available.
 - For a Phase2+ Release 1996 MS, references to GSM documents are to version 5.x.y, when available.
 - For a Phase2 MS, references to GSM documents are to version 4.x.y.
- [1] GSM 01.04 (ETR 350): "Digital cellular telecommunications system (See note 1); Abbreviations and acronyms".
- [1a] 3G TS 41.004: "3rd Generation Partnership Project; Technical Specification Group GERAN (see Note 2); Abbreviations and acronyms".
- [2] GSM 02.02: "Digital cellular telecommunications system (See note 1); Bearer Services (BS) supported by a GSM Public Land Mobile Network (PLMN)".
- [2a] 3G TS 22.002: "3rd Generation Partnership Project; Technical Specification Group Services and system aspects; Circuit Bearer Services (BS) supported by a Public Land Mobile Network (PLMN) (see Note 2)".
- [3] GSM 02.03: "Digital cellular telecommunications system (See note 1); Teleservices supported by a GSM Public Land Mobile Network (PLMN)".
- [3a] 3G TS 22.003: "3rd Generation Partnership Project; Technical Specification Group Services and system aspects; Circuit Teleservices supported by a Public Land Mobile Network (PLMN) (see Note 2)".
- [4] GSM 02.04: "Digital cellular telecommunications system (See note 1); General on supplementary services".
- [4a] 3G TS 22.004: "3rd Generation Partnership Project; Technical Specification Group Services and system aspects; General on Supplementary Services (see Note 2)".
- [5] GSM 02.06: "Digital cellular telecommunications system (See note 1); Types of Mobile Stations (MS)".
- [5a] 3G TS 42.006: "3rd Generation Partnership Project; Technical Specification Group Services and system aspects; Types of Mobile Stations (MS) (see Note 2)".
- [6] GSM 02.07: "Digital cellular telecommunications system (See note 1); Mobile Station (MS) features".
- [6a] 3G TS 42.007: "3rd Generation Partnership Project; Technical Specification Group Services and system aspects; Mobile Station (MS) features (see Note 2)".
- [7] GSM 02.09: "Digital cellular telecommunications system (See note 1); Security aspects".
- [7a] 3G TS 42.009: "3rd Generation Partnership Project; Technical Specification Group Services and system aspects; Security aspects (see Note 2)".
- [8] GSM 02.11: "Digital cellular telecommunications system; Service accessibility".
- [8a] 3G TS 22.011: "3rd Generation Partnership Project; Technical Specification Group Services and system aspects; Service accessibility (see Note 2)".
- [8] GSM 02.11: "Digital cellular telecommunications system; Service accessibility".
- [9a] 3G TS 42.017: "3rd Generation Partnership Project; Technical Specification Group Terminals; Subscriber Identity Modules (SIM) Functional characteristics (see Note 2)".
- [10] GSM 02.24: "Digital cellular telecommunications system; Description of Charge Advice Information (CAI)".
- [10a] 3G TS 22.024: "3rd Generation Partnership Project; Technical Specification Group Services and system aspects; Description of Charge Advice Information (CAI) (see Note 2)".

- [11] GSM 02.30: "Digital cellular telecommunications system (See note 1); Man-Machine Interface (MMI) of the Mobile Station (MS)".
- [11a] 3G TS 22.030: "3rd Generation Partnership Project; Technical Specification Group Services and system aspects; Man-Machine Interface (MMI) of the User Equipment (UE) (see Note 2)".
- [12] GSM TS 02.81: "Digital cellular telecommunications system (See note 1); Line identification supplementary services - Stage 1".
- [12a] 3G TS 22.081: "3rd Generation Partnership Project; Technical Specification Group Services and system aspects; Line identification supplementary services - Stage 1 (see Note 2)".
- [13] GSM TS 02.83: "Digital cellular telecommunications system (See note 1); Call Waiting (CW) and Call Hold (HOLD) supplementary services - Stage 1".
- [13a] 3G TS 22.083: "3rd Generation Partnership Project; Technical Specification Group Services and system aspects; Call Waiting (CW) and Call Hold (HOLD) Supplementary Services; Stage 1 (see Note 2)".
- [14] GSM TS 02.84: "Digital cellular telecommunications system (See note 1); MultiParty (MPTY) supplementary services - Stage 1".
- [14a] 3G TS 22.084: "3rd Generation Partnership Project; Technical Specification Group Services and system aspects; MultiParty (MPTY) Supplementary Services; Stage 1 (see Note 2)".
- [15] GSM TS 02.86: "Digital cellular telecommunications system (See note 1); Advice of Charge (AoC) supplementary services - Stage 1".
- [15a] 3G TS 22.086: "3rd Generation Partnership Project; Technical Specification Group Services and system aspects; Advice of Charge (AoC) Supplementary Services; Stage 1 (see Note 2)".
- [16] GSM TS 02.88: "Digital cellular telecommunications system (See note 1); Call Barring (CB) supplementary services - Stage 1".
- [16a] 3G TS 22.088: "3rd Generation Partnership Project; Technical Specification Group Services and system aspects; Call Barring (CB) supplementary services; Stage 1 (see Note 2)".
- [17] GSM TS 02.90: "Digital cellular telecommunications system (See note 1); Unstructured Supplementary Service Data (USSD) - Stage 1".
- [17a] 3G TS 22.090: "3rd Generation Partnership Project; Technical Specification Group Services and system aspects; Unstructured Supplementary Service Data (USSD); Stage 1 (see Note 2)".
- [18] GSM 03.03: "Digital cellular telecommunications system (See note 1); Numbering, addressing and identification".
- [18a] 3G TS 23.003: "3rd Generation Partnership Project; Technical Specification Group Services and system aspects; Numbering, Addressing and Identification (see Note 2)".
- [19] GSM 03.11: "Digital cellular telecommunications system; Technical realization of supplementary services".
- [19a] 3G TS 23.011: "3rd Generation Partnership Project; Technical Specification Group Services and system aspects; Technical realization of Supplementary Services – General Aspects (see Note 2)".
- [20] GSM 03.20: "Digital cellular telecommunications system (See note 1); Security related network functions".
- [20a] 3G TS 43.020: "3rd Generation Partnership Project; Technical Specification Group Services and system aspects; Security related network functions (see Note 2)".
- [21] GSM 03.22: "Digital cellular telecommunications system; Functions related to Mobile Station (MS) in idle mode and group receive mode".
- [21a] 3G TS 43.022: "3rd Generation Partnership Project; Technical Specification Group GERAN; Functions related to Mobile Station (MS) in idle mode and group receive mode (see Note 2)".

- [22] GSM 03.38: "Digital cellular telecommunications system (See note 1); Alphabets and language-specific information".
- [22a] 3G TS 23.038: "3rd Generation Partnership Project; Technical Specification Group Terminals; Alphabets and Language (see Note 2)".
- [23] GSM 03.40: "Digital cellular telecommunications system (See note 1); Technical realization of the Short Message Service (SMS); Point-to-Point (PP)".
- [23a] 3G TS 23.040: "3rd Generation Partnership Project; Technical Specification Group Terminals; Technical realization of the Short Message Service (see Note 2)".
- [24] GSM 03.41: "Digital cellular telecommunications system (See note 1); Technical realization of Short Message Service Cell Broadcast (SMSCB)".
- [24a] 3G TS 23.041: "3rd Generation Partnership Project; Technical Specification Group Terminals; Technical Realization of Cell Broadcast Service (see Note 2)".
- [25] GSM 03.45: "Digital cellular telecommunications system (See note 1); Technical realization of facsimile group 3 transparent".
- [25a] 3G TS 43.045: "3rd Generation Partnership Project; Technical Specification Group Core Network; Technical realization of facsimile group 3 transparent (see Note 2)".
- [26] GSM 03.50: "Digital cellular telecommunications system (See note 1); Transmission planning aspects of the speech service in the GSM Public Land Mobile Network (PLMN) system".
- [26a] 3G TS 43.050: "3rd Generation Partnership Project; Technical Specification Group Services and system aspects; Transmission planning aspects of the speech service in the GSM Public Land Mobile Network (PLMN) system (see Note 2)".
- [27] GSM 03.86: "Digital cellular telecommunications system (See note 1); Advice of Charge (AoC) supplementary services - Stage 2".
- [27a] 3G TS 23.086: "3rd Generation Partnership Project; Technical Specification Group Core Network; Advice of Charge (AoC) supplementary services - Stage 2 (see Note 2)".
- [28] GSM 04.04: "Digital cellular telecommunications system (See note 1); Layer 1 General requirements".
- [28a] 3G TS 44.004: "3rd Generation Partnership Project; Technical Specification Group GERAN; Layer 1 General requirements (see Note 2)".
- [29] GSM 04.05: "Digital cellular telecommunications system (See note 1); Data Link (DL) layer General aspects".
- [29a] 3G TS 44.005: "3rd Generation Partnership Project; Technical Specification Group GERAN; Data Link (DL) layer General aspects (see Note 2)".
- [30] GSM 04.06: "Digital cellular telecommunications system (See note 1); Mobile Station - Base Station System (MS - BSS) interface Data Link (DL) layer specification".
- [30a] 3G TS 44.006: "3rd Generation Partnership Project; Technical Specification Group GERAN; Mobile Station - Base Station System (MS - BSS) interface Data Link (DL) layer specification (see Note 2)".
- [31] GSM 04.07: "Digital cellular telecommunications system (See note 1); Mobile radio interface signalling layer 3; General aspects".
- [31a] 3G TS 24.007: "3rd Generation Partnership Project; Technical Specification Group Core Network; Mobile Radio Interface Signalling Layer 3; General Aspects (see Note 2)".
- [32] GSM 04.08: "Digital cellular telecommunications system (See note 1); Mobile radio interface layer 3 specification".

- [32a] 3G TS 24.008: "3rd Generation Partnership Project; Technical Specification Group Core Network; Mobile radio interface layer 3 specification (see Note 2)".
- [33] GSM 04.10: "Digital cellular telecommunications system (See note 1); Mobile radio interface layer 3 Supplementary services specification; General aspects".
- [33a] 3G TS 24.010: "3rd Generation Partnership Project; Technical Specification Group Core Network; Mobile radio Interface Layer 3 – Supplementary Services Specification – General Aspects (see Note 2)".
- [34] GSM 04.11: "Digital cellular telecommunications system (See note 1); Point-to-Point (PP) Short Message Service (SMS) support on mobile radio interface".
- [34a] 3G TS 24.011: "3rd Generation Partnership Project; Technical Specification Group Core Network; Point-to-Point (PP) Short Message Service (SMS) Support on Mobile Radio Interface (see Note 2)".
- [35] GSM 04.12: "Digital cellular telecommunications system (See note 1); Short Message Service Cell Broadcast (SMSCB) support on the mobile radio interface".
- [35a] 3G TS 24.012: "3rd Generation Partnership Project; Technical Specification Group Core Network; Short Message Service Cell Broadcast (SMSCB) Support on the Mobile Radio interface (see Note 2)".
- [36] GSM 04.13: "Digital cellular telecommunications system (See note 1); Performance requirements on the mobile radio interface".
- [36a] 3G TS 44.013: "3rd Generation Partnership Project; Technical Specification Group Core Network; Performance requirements on the mobile radio interface (see Note 2)".
- [37] GSM 04.21: "Digital cellular telecommunications system (See note 1); Rate adaption on the Mobile Station - Base Station System (MS - BSS) Interface".
- [37a] 3G TS 44.021: "3rd Generation Partnership Project; Technical Specification Group Core Network; Rate adaption on the Mobile Station - Base Station System (MS - BSS) Interface (see Note 2)".
- [38] GSM 04.22: "Digital cellular telecommunications system (See note 1); Radio Link Protocol (RLP) for data and telematic services on the Mobile Station - Base Station System (MS - BSS) interface and the Base Station System - Mobile-services Switching Centre (BSS - MSC) interface".
- [38a] 3G TS 24.022: "3rd Generation Partnership Project; Technical Specification Group Core Network; Radio Link Protocol (RLP) for Data and Telematic Services on the Mobile Station - Base Station System (MS - BSS) interface and the Base Station System - Mobile-services Switching Centre (BSS - MSC) interface (see Note 2)".
- [39] GSM 04.80: "Digital cellular telecommunications system (See note 1; Mobile radio interface layer 3 supplementary services specification; Formats and coding".
- [39a] 3G TS 24.080: "3rd Generation Partnership Project; Technical Specification Group Core Network; Mobile Radio Layer 3 Supplementary Service specification – Formats and coding (see Note 2)".
- [40] GSM 04.81: "Digital cellular telecommunications system (See note 1); Line identification supplementary services - Stage 3".
- [40a] 3G TS 24.081: "3rd Generation Partnership Project; Technical Specification Group Core Network; Line identification Supplementary Service – Stage 3 (see Note 2)".
- [41] GSM 04.82: "Digital cellular telecommunications system (See note 1); Call Forwarding (CF) supplementary services - Stage 3".
- [41a] 3G TS 24.082: "3rd Generation Partnership Project; Technical Specification Group Core Network; Call Forwarding Supplementary Service – Stage 3 (see Note 2)".
- [42] GSM 04.83: "Digital cellular telecommunications system (See note 1); Call Waiting (CW) and Call Hold (HOLD) supplementary services - Stage 3".

- [42a] 3G TS 24.083: "3rd Generation Partnership Project; Technical Specification Group Core Network; Call Waiting (CW) and Call Hold (HOLD) Supplementary Service – Stage 3 (see Note 2)".
- [43] GSM 04.84: "Digital cellular telecommunications system (See note 1); MultiParty (MPTY) supplementary services - Stage 3".
- [43a] 3G TS 24.084: "3rd Generation Partnership Project; Technical Specification Group Core Network; Multiparty (MPTY) Supplementary Service – stage 3 (see Note 2)".
- [44] GSM 04.86: "Digital cellular telecommunications system (See note 1); Advice of Charge (AoC) supplementary services - Stage 3".
- [44a] 3G TS 24.086: "3rd Generation Partnership Project; Technical Specification Group Core Network; Advice of Charge (AoC) Supplementary Service – Stage 3 (see Note 2)".
- [45] GSM 04.88: "Digital cellular telecommunications system (See note 1); Call Barring (CB) supplementary services - Stage 3".
- [45a] 3G TS 24.088: "3rd Generation Partnership Project; Technical Specification Group Core Network; Call Barring (CB) Supplementary Service – Stage 3 (see Note 2)".
- [46] GSM 04.90: "Digital cellular telecommunications system (See note 1); Unstructured Supplementary Service Data (USSD) - Stage 3".
- [46a] 3G TS 24.090: "3rd Generation Partnership Project; Technical Specification Group Core Network; Unstructured Supplementary Service Data (USSD) – Stage 3 (see Note 2)".
- [47] GSM 05.02: "Digital cellular telecommunications system (See note 1); Multiplexing and multiple access on the radio path".
- [47a] 3G TS 45.002: "3rd Generation Partnership Project; Technical Specification Group GERAN; Multiplexing and multiple access on the radio path (see Note 2)".
- [48] GSM 05.03: "Digital cellular telecommunications system (See note 1); Channel coding".
- [48a] 3G TS 45.003: "3rd Generation Partnership Project; Technical Specification Group GERAN; Channel coding (see Note 2)".
- [49] GSM 05.04: "Digital cellular telecommunications system (See note 1); Modulation".
- [49a] 3G TS 45.004: "3rd Generation Partnership Project; Technical Specification Group GERAN; Modulation (see Note 2)".
- [50] GSM 05.05: "Digital cellular telecommunications system (See note 1); Radio transmission and reception".
- [50a] 3G TS 45.005: "3rd Generation Partnership Project; Technical Specification Group GERAN; Radio transmission and reception (see Note 2)".
- [51] GSM 05.08: "Digital cellular telecommunications system (See note 1); Radio subsystem link control".
- [51a] 3G TS 45.008: "3rd Generation Partnership Project; Technical Specification Group GERAN; Radio subsystem link control (see Note 2)".
- [52] GSM 05.09: "Digital cellular telecommunications system (See note 1); Link Adaptation".
- [52a] 3G TS 45.009: "3rd Generation Partnership Project; Technical Specification Group GERAN; Link Adaptation (see Note 2)".
- [53] GSM 05.10: "Digital cellular telecommunications system (See note 1); Radio subsystem synchronization".
- [53a] 3G TS 45.010: "3rd Generation Partnership Project; Technical Specification Group GERAN; Radio subsystem synchronization (see Note 2)".

- [54] GSM 06.01: "Digital cellular telecommunications system (See note 1); Full rate speech; Processing functions".
- [54a] 3G TS 46.001: "3rd Generation Partnership Project; Technical Specification Group Services and system aspects; Full rate speech; Processing functions (see Note 2)".
- [55] GSM 06.02: "Digital cellular telecommunications system (See note 1); Half rate speech; Half rate speech processing functions".
- [55a] 3G TS 46.002: "3rd Generation Partnership Project; Technical Specification Group Services and system aspects; Half rate speech; Half rate speech processing functions (see Note 2)".
- [56] GSM 06.07: Digital cellular telecommunications system (See note 1); Half rate speech; Test sequences for the GSM half rate speech codec".
- [56a] 3G TS 46.007: 3rd Generation Partnership Project; Technical Specification Group Services and system aspects; Half rate speech; Test sequences for the GSM half rate speech codec (see Note 2)".
- [57] GSM 06.10: "Digital cellular telecommunication system (See note 1); Full rate speech transcoding".
- [57a] 3G TS 46.010: "3rd Generation Partnership Project; Technical Specification Group Services and system aspects; Full rate speech transcoding (see Note 2)".
- [58] GSM 06.11: "Digital cellular telecommunications system (See note 1); Full rate speech; Substitution and muting of lost frames for full rate speech channels".
- [58a] 3G TS 46.011: "3rd Generation Partnership Project; Technical Specification Group Services and system aspects; Full rate speech; Substitution and muting of lost frames for full rate speech channels (see Note 2)".
- [59] GSM 06.12: "Digital cellular telecommunications system (See note 1); Comfort noise aspect for full rate speech traffic channels".
- [59a] 3G TS 46.012: "3rd Generation Partnership Project; Technical Specification Group Services and system aspects; Comfort noise aspect for full rate speech traffic channels (see Note 2)".
- [60] GSM 06.20: "Digital cellular telecommunications system (See note 1); Half rate speech; Half rate speech transcoding".
- [60a] 3G TS 46.020: "3rd Generation Partnership Project; Technical Specification Group Services and system aspects; Half rate speech; Half rate speech transcoding (see Note 2)".
- [61] GSM 06.21: "Digital cellular telecommunications system (See note 1); Half rate speech; Substitution and muting of lost frames for half rate speech traffic channels".
- [61a] 3G TS 46.021: "3rd Generation Partnership Project; Technical Specification Group Services and system aspects; Half rate speech; Substitution and muting of lost frames for half rate speech traffic channels (see Note 2)".
- [62] GSM 06.22: "Digital cellular telecommunications system (See note 1); Half rate speech; Comfort noise aspects for half rate speech traffic channels".
- [62a] 3G TS 46.022: "3rd Generation Partnership Project; Technical Specification Group Services and system aspects; Half rate speech; Comfort noise aspects for half rate speech traffic channels (see Note 2)".
- [63] GSM 06.31: "Digital cellular telecommunications system (See note 1); Full rate speech; Discontinuous Transmission (DTX) for full rate speech traffic channels".
- [63a] 3G TS 46.031: "3rd Generation Partnership Project; Technical Specification Group Services and system aspects; Full rate speech; Discontinuous Transmission (DTX) for full rate speech traffic channels (see Note 2)".

- [64] GSM 06.32: "Digital cellular telecommunications system (See note 1); Voice Activity Detector (VAD)".
- [64a] 3G TS 46.032: "3rd Generation Partnership Project; Technical Specification Group Services and system aspects; Voice Activity Detector (VAD) (see Note 2)".
- [65] GSM 06.41: "Digital cellular telecommunications system (See note 1); Discontinuous Transmission (DTX) for half rate speech traffic channels".
- [65a] 3G TS 46.041: "3rd Generation Partnership Project; Technical Specification Group Services and system aspects; Discontinuous Transmission (DTX) for half rate speech traffic channels (see Note 2)".
- [66] GSM 06.42: "Digital cellular telecommunications system (See note 1); Half rate speech; Voice Activity Detector (VAD) for half rate speech traffic channels".
- [66a] 3G TS 46.042: "3rd Generation Partnership Project; Technical Specification Group Services and system aspects; Half rate speech; Voice Activity Detector (VAD) for half rate speech traffic channels (see Note 2)".
- [67] GSM 07.01: "Digital cellular telecommunications system (See note 1); General on Terminal Adaptation Functions (TAF) for Mobile Stations (MS)".
- [67a] 3G TS 27.001: "3rd Generation Partnership Project; Technical Specification Group Core Network; General on Terminal Adaptation Functions (TAF) for Mobile stations (MS) (see Note 2)".
- [68] GSM 07.02: "Digital cellular telecommunications system (See note 1); Terminal Adaptation Functions (TAF) for services using asynchronous bearer capabilities".
- [68a] 3G TS 27.002: "3rd Generation Partnership Project; Technical Specification Group Core Network; Terminal Adaptation Functions (TAF) for services using Asynchronous bearer capabilities (see Note 2)".
- [69] GSM 07.03: "Digital cellular telecommunications system (See note 1); Terminal Adaptation Functions (TAF) for services using synchronous bearer capabilities".
- [69a] 3G TS 27.003: "3rd Generation Partnership Project; Technical Specification Group Core Network; Terminal Adaptation Functions (TAF) for services using Synchronous bearer capabilities (see Note 2)".
- [70] GSM 09.02: "Digital cellular telecommunications system (See note 1); Mobile Application Part (MAP) specification".
- [70a] 3G TS 29.002: "3rd Generation Partnership Project; Technical Specification Group Core Network; Mobile Application Part (MAP) (see Note 2)".
- [71a] 3G TS 29.007: "General requirements on interworking between the Public Land Mobile Network (PLMN) and the Integrated Services Digital Network (ISDN) or Public Switched Telephone Network (PSTN) (see Note 2)".
- [71a] 3G TS 29.006: "3rd Generation Partnership Project; Technical Specification Group Core Network; Interworking between a Public Land Mobile Network (PLMN) and a Packet Switched Public Data Network/Integrated Services Digital Network (PSPDN/ISDN) for the support of packet switched data transmission services (see Note 2)".
- [72] GSM 09.07: "Digital cellular telecommunication system (See note 1); General requirements on interworking between the Public Land Mobile Network (PLMN) and the Integrated Services Digital Network (ISDN) or Public Switched Telephone Network (PSTN)".
- [72a] 3G TS 29.007: "3rd Generation Partnership Project; Technical Specification Group Core Network; General requirements on interworking between the Public Land Mobile Network (PLMN) and the Integrated Services Digital Network (ISDN) or Public Switched Telephone Network (PSTN) (see Note 2)".
- [73] GSM 11.11: "Digital cellular telecommunication system (See note 1); Specification of the Subscriber Identity Module - Mobile Equipment (SIM - ME) interface".

- [73a] 3G TS 51.011: "3rd Generation Partnership Project; Technical Specification Group Terminals; Specification of the Subscriber Identity Module - Mobile Equipment (SIM - ME) interface (see Note 2)".
- [74] GSM 11.12: "Digital cellular telecommunications system (See note 1); Specification of the 3 Volt Subscriber Identity Module - Mobile Equipment (SIM - ME) interface".
- [74a] 3G TS 51.012: "3rd Generation Partnership Project; Technical Specification Group Terminals; Specification of the 3 Volt Subscriber Identity Module - Mobile Equipment (SIM - ME) interface (see Note 2)".
- [75] ITU-T Recommendation E.164: "Numbering plan for the ISDN era".
- [76] ITU-T Recommendation G.122: "Influence of national systems on stability talker echo in international connections".
- [77] ITU-T Recommendation G.223: "Assumptions for the calculation of noise on hypothetical reference circuits for telephony".
- [78] ITU-T Recommendation G.714: "Separate performance characteristics for the encoding and decoding sides of PCM channels applicable to 4-wire voice-frequency interfaces".
- [79] ITU-T Recommendation G.721: "32 kbit/s Adaptive Differential Pulse Code Modulation (ADPCM) - General Aspects of Digital Transmission Systems; Terminal Equipments".
- [80] ITU-T Recommendation O.131: "Quantizing distortion measuring equipment using a pseudo-random noise test signal".
- [81] ITU-T Recommendation O.132: "Quantizing distortion measuring equipment using a sinusoidal test signal".
- [82] ITU-T Recommendation O.153: "Basic parameters for the measurement of error performance at bit rates below the primary rate".
- [83] ITU-T Recommendation P.34: "Transmission characteristics of hands-free telephones".
- [84] ITU-T Recommendation P.35: "Handset telephones".
- [85] ITU-T Recommendation P.50: "Artificial voices".
- [86] ITU-T Recommendation P.51: "Artificial mouth".
- [87] ITU-T Recommendation P.64: "Determination of sensitivity/frequency characteristics of local telephone systems".
- [88] ITU-T Recommendation P.76: "Determination of loudness ratings fundamental principles".
- [89] ITU-T Recommendation P.79: "Calculation of loudness ratings for telephone sets"
- [90] ITU-T Recommendation T.4: "Standardization of group 3 facsimile apparatus for document transmission".
- [91] ITU-T Recommendation T.21: "Standardized tests charts for document facsimile transmission".
- [92] ITU-T Recommendation T.30: "Procedures for document facsimile transmission in the general switched telephone network".
- [93] ITU-T Recommendation V.1: "Equivalence between binary notation symbols and the significant conditions of a two-condition code".
- [94] ITU-T Recommendation V.14: "Transmission of start-stop characters over synchronous bearer channels".
- [95] ITU-T Recommendation V.24: "List of definitions for interchange circuits between data terminal equipment (DTE) and data circuit-terminating equipment (DCE)".

- [96] ITU-T Recommendation V.25bis: "Automatic calling and/or answering equipment on the general switched telephone network (GSTN) using the 100-series interchange circuits".
- [97] ITU-T Recommendation V.110: "Support of data terminal equipments with V-Series type interfaces by an integrated services digital network".
- [98] ITU-T Recommendation X.21: "Interface between data terminal equipment and data circuit-terminating equipment for synchronous operation on public data networks".
- [99] ITU-T Recommendation X.208: "Specification of Abstract Syntax Notation One (ASN.1)".
- [100] ITU-T Recommendation X.290: "OSI conformance testing methodology and framework for protocol Recommendations for ITU-T applications - General concepts".
- [101] ISO 3: "Preferred Numbers - Series of preferred Numbers".
- [102] ISO 2110: "Information Technology - Data Communication - 25-Pole DTE/DCE Interface Connector and Contact Number Assignments".
- [103] ISO 7816-3: "Identification cards - Integrated Circuit(s) Cards with Contacts - Part 3: Electronic Signals and Transmission Protocols".
- [104] IEC publication 68-2-1: "Environmental Testing Part 2: Tests - Tests A: Cold".
- [105] IEC publication 68-2-2: "Environmental Testing Part 2: Tests - Tests B: Dry Heat".
- [106] IEC publication 68-2-36: "Environmental Testing Part 2: Tests - Test Fdb: Random Vibration Wide Band - Reproducibility Medium".
- [107] ETSI ETR 028: "Uncertainties in the Measurement of Mobile Radio Equipment Characteristics".
- [108] ITU-T Recommendation P.57 (1993), "Artificial ears."
- [109] 3G TS 22.043: "3rd Generation Partnership Project; Technical Specification Group Services and system aspects; Support of Localised Service Area (SoLSA), Service description, Stage 1".
- [110] 3G TS 23.73: "3rd Generation Partnership Project; Technical Specification Group Core Network; Support of Localised Service Area (SoLSA), Stage 2".
- [111] 3G TS 44.018: "3rd Generation Partnership Project; Technical Specification Group GERAN; Radio Resource Control Protocol".
- [112] 3G TR 21.905: "3rd Generation Partnership Project; Technical Specification Group Services and system aspects; Vocabulary for 3GPP Specifications".
- [114] 3G TS 42.067: "3rd Generation Partnership Project; Technical Specification Group Services and system aspects; enhanced Multi-Level Precedence and Pre-emption service (eMLPP) – stage 1".
- [115] 3G TS 42.068: "3rd Generation Partnership Project; Technical Specification Group Services and system aspects; Voice Group Call Service – stage 1".
- [116] 3G TS 42.069: "3rd Generation Partnership Project; Technical Specification Group Services and system aspects; Voice Broadcast Service – stage 1".
- [117] 3G TS 22.087: "3rd Generation Partnership Project; Technical Specification Group Services and system aspects; User-to-User Signalling (UUS); Service description, Stage 1".
- [118] 3G TS 22.094: "3rd Generation Partnership Project; Technical Specification Group Services and system aspects; Follow Me Service description; Stage 1".
- [119] 3G TS 23.067: "3rd Generation Partnership Project; Technical Specification Group Core Network; enhanced Multi-Level Precedence and Pre-emption service (eMLPP); Stage 2".
- [120] 3G TS 43.068: "3rd Generation Partnership Project; Technical Specification Group Core Network; Voice Group Call Service (VGCS); Stage 2".

- [121] 3G TS 43.069: "3rd Generation Partnership Project; Technical Specification Group Core Network; Voice Broadcast Service (VBS); Stage 2 ".[116a] 3G TS: 23.087 " Digital cellular telecommunications system (Phase 2+); User-to-User Signalling (UUS) Supplementary Service; Stage 2".
- [122] 3G TS 23.094: "3rd Generation Partnership Project; Technical Specification Group Core Network; Follow-Me (FM) - Stage 2".
- [123] 3G TS 24.067: "3rd Generation Partnership Project; Technical Specification Group Core Network; enhanced Multi-Level Precedence and Pre-emption service (eMLPP); Stage 3".
- [124] 3G TS 44.068: "3rd Generation Partnership Project; Technical Specification Group Core Network; Group Call Control (GCC) protocol".
- [125] 3G TS 44.069: "3rd Generation Partnership Project; Technical Specification Group Core Network; Broadcast Call Control (BCC) protocol".
- [126] 3G TS 24.087 "3rd Generation Partnership Project; Technical Specification Group Core Network; User-to-User Signalling (UUS) Supplementary Service; Stage 3".
- [127] 3G TS 44.018: "3rd Generation Partnership Project; Technical Specification Group GERAN; Radio Resource Control Protocol".
- [128] 3G TS 25.331: "3rd Generation Partnership Project; Technical Specification Group Radio Access Network; RRC Protocol Specification" (see Note 2).
- [129] 3G TS 04.18: " Mobile radio interface layer 3 specification, Radio Resource Control Protocol"

Note 1: Read Phase 2 or Phase 2+ as necessary.

Note 2: Read Release 1999 or further as necessary.

3 Definitions, conventions, and applicability

For abbreviations and acronyms, see GSM 01.04.

3.1 Mobile station definition and configurations

In this EN, a MS can be:

- a vehicle mounted station;
- a portable station;
- a handheld station;
- a vehicle mounted/portable station;
- a vehicle mounted/handheld station.

A MS is the complete equipment configuration which may take part in a communication. However, this may not be the MS as it is offered to a test house for conformance testing.

In general, the MS, as it will be presented to a test house for conformance testing, is the station without all the additional Terminal Equipment (TE). Such a piece of hardware is also called a Mobile Termination (MT), but in this EN, the expression MS is used for any form of MS hardware as it is offered to the test house.

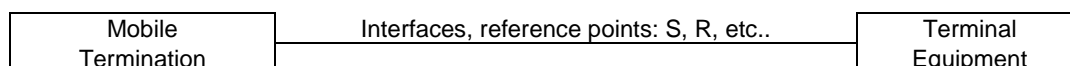

Figure 3-1

During the tests, the interfaces of the MT shall be connected to a System Simulator (SS), which will also emulate the TE. For some tests, it may be necessary to establish a pre-configured setup of the MS.

EXAMPLE: For reception of automatic fax group 3 to a fax machine on the R-interface, the MS needs configuration information about the presence of such a machine on that interface.

As an alternative, the TE may be physically integrated.

For a more detailed description of MS-configurations, see GSM 02.06.

3.2 Applicability

3.2.1 Applicability of this specification

3.2.1.1 MS equipped with a connector

If a MS is equipped with a connector, to connect terminal equipment on an S or R reference point as defined in GSM 04.02, then testing of the MS may include testing of appropriate functioning to and from this connector.

This EN does not apply to TE which is to be connected to that connector, even if it is delivered with the MS.

3.2.1.1 GPRS

Several important tests are missing in this EN for the following types of GPRS MS:

- Type 2 MS. [GSM 05.02]
- MS with 3 or more TX-slots. (Included in the test cases are multislot classes 1, 2, 3, 4, 5, 6, 8, 9, 10, 19 and 24) [GSM 05.02]
- GPRS only MS
- Mobiles that can operate in class A. [GSM 03.60]
- Mobiles that can operate in class B in Network mode III. [GSM 03.60]
- Optional GPRS features

3.2.2 Applicability of the individual tests

This information has been moved to 3GPP TS 51.010-2 Annex B.

3.2.3 Applicability to terminal equipment

If a MS is delivered for conformance testing, and it contains physically integrated TE, then this EN applies to the complete MS including that TE.

This EN also applies to separate TE that is delivered for conformance testing with the MS. The MS is then tested as an MT0. In that case, the specific TE with which the MS is tested is documented in the test report.

3.3 Definitions

The following definitions are used in this EN:

idle updated:

The MS is defined to be "idle updated" if the following three conditions are fulfilled:

- its update status is U1 UPDATED (cf. GSM 04.08);
- it is in the MM state MM-IDLE (cf. GSM 04.08);

- it is in the RR idle mode (cf. GSM 04.08).

idle not updated:

The MS is defined to be "idle not updated" if the following three conditions are fulfilled:

- its update status is U2 NOT UPDATED (cf. GSM 04.08);
- it is in the MM state MM-IDLE (cf. GSM 04.08);
- it is in the RR idle mode (cf. GSM 04.08).

arbitrary:

If for a test, a test purpose, a test group, or a test suite, which uses a certain parameter the value of that parameter has to be chosen arbitrarily in a certain set of values, this means that:

- for each value in the set the MS is required to fulfil the requirements of the test, test purpose, test group, or test suite, but that
- the test, test purpose, test group, or test suite is only performed for one value in the set, the selection of which is made by the test operator.

3.4 Conventions for mathematical notations

For the purpose of this EN mathematical terms used throughout this EN are given in this subclause.

3.4.1 Mathematical signs

The "plus or minus" sign is expressed by "±".

The sign "multiplied by" is expressed by "*".

The sign "divided by" is expressed by "/", or the common division bar.

The sign "greater than or equal to" is expressed by "≥".

The sign "less than or equal to" is expressed by "≤".

3.4.2 Powers to the base 10

Powers to the base 10 are expressed by "10Ex", where x is the exponent, e.g. 10E-5, 10E6.

3.5 Conventions on electrical terms

3.5.1 Radio Frequency (RF) input signal level

In general, the RF input signal level to the MS is expressed in terms of the received field strength E in dBμV/m (assuming a 0 dBi gain antenna). This is related to the power level P in dBm by the following formula (see GSM 05.05)

GSM 400: $E \text{ (dB}\mu\text{V/m)} = P \text{ (dBm)} + 130.5$ (calculated for a frequency of 460 MHz).

GSM 700: $E \text{ (dB}\mu\text{V/m)} = P \text{ (dBm)} + 134.9$ (calculated for a frequency of 770 MHz).

GSM 850: $E \text{ (dB}\mu\text{V/m)} = P \text{ (dBm)} + 135.9$ (calculated for a frequency of 859 MHz).

GSM 900: $E \text{ (dB}\mu\text{V/m)} = P \text{ (dBm)} + 136,5$ (calculated for a frequency of 925 MHz).

DCS 1 800: $E \text{ (dB}\mu\text{V/m)} = P \text{ (dBm)} + 142,3$ (calculated for a frequency of 1 795 MHz).

PCS 1900: $E \text{ (dB}\mu\text{V/m)} = P \text{ (dBm)} + 142,9$ (calculated for a frequency of 1 920 MHz).

According to annex 1 subclause A1.1.5.3, in all tests in which a handheld MS normally only equipped with integral antenna is the unit under test, the equivalent input signal level into a temporary test connector is determined from:

$$E_{in} = E_{req} + F$$

where: E_{in} = input signal level to a temporary antenna connector (dB μ V $_{emf}$);

E_{req} = signal level required by the test (dB μ V $_{emf}$);

F = coupling factor (dB) at the respective ARFCN.

Since F has to be determined by each test house individually, E_{in} cannot be given as a figure in test procedures.

If the case of integral antenna is applicable, the input signal level is then expressed in the test procedures as:

$$E_{req} \text{ dB}\mu\text{V}_{emf}(\quad),$$

where the empty parenthesis is to be read as E_{in} .

Alternatively, the input signal level to the MS at the antenna connector can be expressed in dB μ V $_{emf}$ (). This is related to the power level P in dBm by the following formula, assuming a 50 ohm antenna connector:

$$\text{Input signal level (dB}\mu\text{V}_{emf}(\quad)) = P(\text{dBm}) + 113$$

3.5.2 Reference sensitivity level

In this EN the term:

Reference Sensitivity level ()

is used to indicate that the SS establishes reference sensitivity level taking account of any losses associated with the RF connection to the MS.

3.5.3 Power level of fading signal

The power level of a fading signal is defined as the total signal level averaged over time.

3.6 Terms on test conditions

3.6.1 Radio test conditions

The radio propagation conditions refer to multipath propagation models of GSM 05.05.

They are expressed by typical profiles:

- static;
- rural area (RA);
- hilly terrain (HT);
- urban area (TU); or for
- equalization test (EQ).

The non-static profiles are also related to typical speeds of movement of the MS expressed in km/h, e.g. TU1,5, TU3, TU50, HT100, EQ50.

In this EN the following conventions are used:

Table 3.2

Term	for GSM 400 represents	for GSM 700 represents	For GSM 850 and GSM 900 represents	for DCS 1800 and PCS 1900 represents
RA	RA500	RA300	RA250	RA130
HT	HT200	HT120	HT100	HT100
TUhigh	TU100	TU60	TU50	TU50
TUlow	TU6	TU3.6	TU3	TU1,5
EQ	EQ100	EQ60	EQ50	EQ50

For tests using ARFCN ranges the following tables (3.3, 3.4) shall be used.

Table 3.3

Term	P-GSM 900	DCS 1 800	E-GSM 900	R-GSM 900
Low ARFCN range	1 to 5	513 to 523	975 to 980	955 to 960 (R-GSM) and 975 to 980 (E-GSM)
Mid ARFCN range	60 to 65	690 to 710	60 to 65	60 to 65
High ARFCN range	120 to 124	874 to 884	120 to 124	120 to 124

Table 3.4

Term	GSM 450	GSM 480	PCS 1900	GSM 750	GSM 850
Low ARFCN range	259 to 261	306 to 308	513 to 523	438 to 452	128 to 132
Mid ARFCN range	275 to 277	322 to 324	650 to 670	472 to 474	188 to 192
High ARFCN range	291 to 293	338 to 340	799 to 809	507 to 511	247 to 251

NOTE 1: For definitions of GSM 450, GSM 480, GSM 750, GSM 850, P-GSM 900, DCS 1 800, PCS 1900, E-GSM 900 and R-GSM 900 refer to GSM 05.05.

NOTE 2: In this EN the term "GSM 900" is used to cover the primary GSM band, the extended GSM band and the railway-GSM band.

NOTE3: For R-GSM two low ARFCN ranges are defined. Unless specified otherwise for a specific test the ARFCN range defined for E-GSM900 MS is used for the testing of MS supporting the R-GSM 900 frequency range.

4 Test Equipment

4.1 Terms used to describe test equipment in this EN

In order to perform MS conformity testing, the use of test equipment is necessary to provide the MS with stimulus signals and to analyse and record the resulting responses.

Throughout this EN the term "System Simulator" is used to describe the suite of test equipment required to interact with the following MS interfaces:

- antenna
- acoustic
- data port
- power supply
- DAI

The term "SIM simulator" is used to describe the test equipment required to interact with the SIM/ME interface.

A "test SIM" has the physical characteristics of a standard SIM card, (see 11.11) with specific parameters defined in annex 4.

4.2 Functional requirements of test equipment

This EN does not include a functional description of the test equipment required to perform the tests. These requirements should be deduced from the test descriptions and the information in annex 5.

Annex 5 describes the requirements for the test equipment which cannot be derived from, and which are assumed in, the conformance test descriptions described in this EN. Specifically, stimulus setting and measurement uncertainty requirements are defined in annex 5.

5 Testing methodology in general (layers 1, 2, and 3)

5.1 Testing of optional functions and procedures

Any function or procedure which is optional, as indicated in this EN, may be subject to a conformance test if it is implemented in the MS.

A declaration by the apparatus supplier (PICS/PIXIT) is used to determine whether an optional function/procedure has been implemented.

5.2 Test interfaces and facilities

The air interface (Um reference point) provides the main test interface for the purpose of performing conformance tests.

The SS layer 2 and layer 3 shall react with the MS on the air interface in accordance with the BSS requirements in the GSM 04.xx and 05.xx series recommendations, except where the description defines otherwise.

The provision of the following special conformance test facilities is mandatory where applicable:

- support of special conformance test functions, which are enabled by the insertion of a dedicated SIM for testing (test-SIM);
- provision of a Digital Audio Interface (only for MS which support speech services, or alternate speech/data services);
- for equipment which does not have a permanent external 50 ohm connector, a temporary 50 ohm antenna connector shall be provided in accordance with the requirements of annex 1 GC7;
- for MS supporting diversity, or for any other reason having more than one RF connector (or temporary connector in the case of integral antenna MS) the manufacturer shall supply coupling and / or terminating devices so that the tests can be performed via a single transmit / receive RF connection.

Furthermore, an optional Electrical Man Machine Interface (EMMI), is specified.

These special conformance test facilities, with the exception of the temporary antenna connector, are described in subclause 36.1.

Actions at the user side of the equipment under test (i.e. at the man-machine Interface, at the S- or R- interface, at the SIM-interface, execution of higher layer processes in the case of data services) are used to invoke actions at layers 1, 2 and 3 of the Dm-channel protocol within the equipment under test.

5.3 Different protocol layers

The conformance tests for each layer of the Dm-channel protocol are specified separately and the test configuration(s) to be used in testing each layer is specified in the subclause of this EN relating to the conformance tests for that layer.

5.4 Information to be provided by the apparatus supplier

The apparatus supplier shall provide two kinds of information:

- information with respect to the protocol: Protocol Implementation Conformance Statement (PICS);
- information with respect to the man machine interface: Protocol Implementation Extra Information required for Testing (PIXIT).

The complete list of the information to be provided by the apparatus supplier is a matter between the apparatus supplier and the test house but an example of the information to be supplied is given in informative annex 3 of this EN.

5.5 Definitions of transmit and receive times

The time a burst is received or transmitted is defined to be in the middle of the burst, i.e. transition from Bit Number BN74 to BN75 for all bursts except random access bursts, the middle of which is the transition from BN48 to BN49.

The reception/transmission time of speech or data blocks or a signalling frame (layer 2 and layer 3) is defined to be the reception/transmission time of the last burst containing part of the block or frame.

The start of a layer 2 or 3 frame is defined to be the time of the first burst containing part of the layer 2 or 3 frame. (The time of a burst is defined to be in the middle of the burst.)

The end of a layer 2 or 3 frame is defined to be the time of the last burst containing part of the layer 2 or 3 frame.

6 Reference test methods

6.1 General

Annex 1 gives reference test conditions to be used throughout this EN, unless otherwise specified. It consists of a part on general conditions, and a part on normal and extreme test conditions.

Unless otherwise specified, tests are run using the normal test conditions.

If a test is to be run using the extreme test conditions then this is identified in the test description.

For all tests, the MS is connected to the SS. This connection, unless otherwise specified, is to the permanent antenna connector for a MS which is equipped with one, or via the temporary antenna connector defined in annex 1, GC7, for a MS with an integral antenna, and not normally having a means of connecting an external antenna.

6.2 Choice of frequencies in the frequency hopping mode

For the tests using frequency hopping, 38 frequencies are used over

GSM 850:	a 21 MHz band
P-GSM 900:	a 21 MHz band
E-GSM 900:	a [21] MHz band
R-GSM 900:	a 23 MHz band
DCS 1 800:	a 75 MHz band
PCS 1900:	a 60 MHz band

For the tests using frequency hopping, 14 frequencies are used over

GSM 450:	a 6.4 MHz band
----------	----------------

GSM 480: a 6.4 MHz band

For the tests using frequency hopping, 24 frequencies are used over

GSM 750: a 12.4 MHz band

Table 6.1: Hopping frequencies

	ARFCN
GSM 450	260, 262, 265, 267, 269, 272, 274, 278, 280, 282, 285, 287, 290, 292
GSM 480	307, 309, 312, 314, 316, 319, 321, 325, 327, 329, 332, 334, 337, 339
GSM 750	444, 447, 450, 451, 455, 457, 459, 463, 464, 467, 471, 475, 479, 482, 483, 486, 489, 490, 494, 496, 498, 502, 503, 505
GSM 850	137, 141, 144, 145, 149, 151, 153, 157, 158, 161, 165, 169, 172, 173, 177, 179, 181, 185, 186, 189, 193, 197, 200, 201, 205, 207, 209, 213, 214, 217, 221, 225, 228, 229, 233, 235, 237, 241
P-GSM900	10, 14, 17, 18, 22, 24, 26, 30, 31, 34, 38, 42, 45, 46, 50, 52, 54, 58, 59, 62, 66, 70, 73, 74, 78, 80, 82, 86, 87, 90, 94, 98, 101, 102, 106, 108, 110, 114
E-GSM900	984, 988, 991, 992, 996, 998, 1000, 1004, 1005, 1008, 1012, 1016, 1019, 1020, 1022, 2, 6, 10, 14, 17, 18, 22, 24, 26, 30, 31, 34, 38, 42, 45, 46, 50, 52, 54, 58, 59, 62, 64
R-GSM 900	955, 963, 966, 967, 971, 974, 984, 988, 991, 992, 996, 998, 1000, 1004, 1005, 1008, 1012, 1016, 1019, 1020, 1022, 2, 6, 10, 14, 17, 18, 22, 24, 26, 30, 31, 34, 36, 38, 42, 43, 45
DCS 1 800	522, 539, 543, 556, 564, 573, 585, 590, 606, 607, 624, 627, 641, 648, 658, 669, 675, 690, 692, 709, 711, 726, 732, 743, 753, 760, 774, 777, 794, 795, 811, 816, 828, 837, 845, 858, 862, 879
PCS 1900	522, 539, 543, 547, 556, 564, 573, 585, 590, 596, 606, 607, 615, 624, 627, 633, 641, 648, 658, 669, 675, 684, 690, 692, 703, 709, 711, 726, 732, 743, 753, 760, 774, 777, 789, 794, 795, 803

NOTE: The range of frequencies available during tests under simulated fading conditions is restricted by the fading simulator bandwidth.

6.3 "Ideal" radio conditions

In this EN the following conditions are referenced by the term "ideal" radio conditions:

No multipath conditions

MS power control level:

GSM 400:	7
GSM 700:	7
GSM 850:	7
GSM 900:	7
DCS 1 800:	3
PCS 1900	3
RF level to MS: 63 dB μ Vemf()	(not tests in subclause 14.4, 14.5 or 18.1.4)
RF level to MS: 20 dB above reference sensitivity level ()	(subclause 14.4 and 14.5)
RF level to MS: 28 dB μ Vemf()	(tests in subclause 18.1.4)

6.4 Standard test signals

The standard test signals C0, C1, I0, I1 and I2 as used in this EN, are defined in annex 5.

6.5 Power (control) levels

In this EN, except where explicitly stated otherwise, if the MS is commanded to its minimum power (control) level, the SS is allowed to signal power control level 19 for GSM 400, GSM 700, GSM 850, GSM 900, and 15 for DCS 1 800 and PCS 1900. Furthermore, except where explicitly stated otherwise, if the MS is commanded to its maximum power (control) level, and if MS_TXPWR_MAX_CCH is set to the maximum output power of the MS, the SS is allowed to

signal the power control level corresponding to the maximum output power for the power class of the MS. For a GSM 400 or GSM 900 power class 2 MS, the SS is allowed to signal power control level 2.

7 Implicit testing

For some GSM features conformance is not verified explicitly in this EN. This does not imply that correct functioning of these features is not essential, but that these are implicitly tested to a sufficient degree in other tests. Examples for implicitly tested features are frequency hopping and encryption.

It should be noted that for these features some aspects have to be and are explicitly tested, e.g. the ability to switch to frequency hopping or non-hopping, and the ability to change the encryption mode setting.

8 Measurement uncertainty

The measured value relating to the corresponding limit shall be used to determine whether or not a terminal equipment meets the requirement. (ETR 028 annex B).

This process is often referred to as "shared risk".

9 Format of tests

In general the following basic format for tests is used:

..* Title

..*.1 Definition and applicability

This sections provides, if necessary, a definition of the feature/function being tested and the applicability of the test to different MS (e.g. speech only, data only etc.).

..*.2 Conformance requirement

This section details the core specification requirements being tested and includes any necessary core specification references.

..*.3 Test purpose

This section details the purpose of the test.

..*.4 Method of test

..*.4.1 Initial conditions

If present this section defines the initial conditions to be established before running the test.

..*.4.2 Procedure

This section details the test procedure.

..*.5 Test requirements

This section details the conditions to be met for successful completion of the test.

[However for the Layer 3 tests, in general, a slightly modified format, as described below, is used:

..* Title

..*.1 Conformance requirement

References

..*.2	Test purpose
..*.3	Method of test
	Initial conditions
	Related PICS/PIXIT statement
	Foreseen final state of the MS
	Test Procedure
	Maximum duration of the test
	Expected sequence]

10 Generic call set up procedures

10.1 Generic call set-up procedure for mobile terminating speech calls

In the test procedures described in this EN, unless otherwise stated in the test description, the Mobile Terminating Speech call set-up procedure shall be as described in this subclause.

NOTE: In test cases where a fading profile is required, a different and appropriate ARFCN may be selected, for instance if the fading simulator bandwidth does not allow use of the default ARFCN.

10.1.1 Initial conditions

System Simulator:

1 cell, default parameters.

Mobile Station:

- The MS shall be operated under normal test conditions (see annex 1 TC.2.1)
- The special Test-SIM (see annex 4) shall be inserted.
- The MS is "idle, updated", with a TMSI assigned and listening to the BCCH/CCCH of the active cell.

10.1.2 Definition of system information messages

The following parameters shall be coded into the system information messages. Parameters shall be coded according to GSM 04.08.

The RACH Control Parameters IE shall be the same in SYSTEM INFORMATION TYPE 1, TYPE 2, TYPE 3 and TYPE 4 messages.

The Location Area Identification IE, Cell Selection Parameters IE, and P1 bit shall be the same in SYSTEM INFORMATION TYPE 3 and TYPE 4 messages.

SYSTEM INFORMATION TYPE 1

Information Element	Value/remark
Cell channel description	Includes the hopping sequence ARFCNs, if hopping is used
RACH control parameters	
MAX RETRANS	Any Value
TX-INTEGER	Any Value
CELL BAR ACCESS	Not barred
CALL RE-ESTABLISHMENT	Not Allowed
EMERGENCY CALL	Allowed
ACCESS CONTROL CLASS (0...9, 11...15)	None Barred
SI1 rest octets	Spare Octets

SYSTEM INFORMATION TYPE 2

Information Element	Value/remark
BCCH Frequency list	Indicates seven surrounding cells on any ARFCN of the supported band, excluding ARFCNs in or immediately adjacent to those specified in subclause 6.2
NCC permitted	
NCC PERMITTED	e.g. all NCCs permitted
RACH control parameters	
MAX RETRANS	Any Value
TX-INTEGER	Any Value
CELL BAR ACCESS	Not barred
CALL RE-ESTABLISHMENT	Not Allowed
EMERGENCY CALL	Allowed
ACCESS CONTROL CLASS (0...9, 11...15)	None Barred

SYSTEM INFORMATION TYPE 3

Information Element	Value/remark
Cell identity	
CI VALUE	0001 hex (not relevant)
Location Area Identification	
MCC	001 decimal (not relevant)
MNC	01 decimal (not relevant)
LAC	011 decimal (not relevant) for PCS 1900
0001 hex (not relevant)	
Control Channel Description	
ATT (IMSI att/det)	MS shall not apply (not relevant)
BS-AG-BLKS-RES	0 blocks reserved (not relevant)
CCCH-CONF	Combined CCCH/SDCCH (not relevant)
BS-PA-MFRMS	5 multiframes (not relevant)
T3212	Infinite
Cell options	
PWRC	power control not set
DTX	MS must not use DTX
RADIO LINK TIME-OUT	8
Cell selection parameters	
CELL RESELECT HYSTERESIS	0 dB
MS-TXPWR-MAX-CCH	Max. output power of MS
RXLEV-ACCESS-MIN	-90 dBm
ACS	There are no additional cell parameters included in SI7 and SI8
NECI	New establishment cause not supported
RACH control parameters	
MAX RETRANS	Any Value
TX-INTEG	Any Value
CELL BAR ACCESS	Not barred
CALL RE-ESTABLISHMENT	Not Allowed
EMERGENCY CALL	Allowed
ACCESS CONTROL CLASS	None Barred
(0...9, 11...15)	
SI3 rest octets	
P1	C2 parameters not present

SYSTEM INFORMATION TYPE 4

Information Element	Value/remark
Location Area Identification	
MCC	001 decimal (not relevant)
MNC	01 decimal (not relevant)
LAC	011 decimal (not relevant) for PCS 1900
0001 hex (not relevant)	
Cell selection parameters	
CELL RESELECT HYSTERESIS	0 dB
MS-TXPWR-MAX-CCH	Max. output power of MS
RXLEV-ACCESS-MIN	-90 dBm
RACH control parameters	
MAX RETRANS	Any Value
TX-INTEG	Any Value
CELL BAR ACCESS	Not barred
CALL RE-ESTABLISHMENT	Not Allowed
EMERGENCY CALL	Allowed
ACCESS CONTROL CLASS	None Barred
(0...9, 11...15)	
CBCH Channel Description	Omitted
CBCH Mobile Allocation	Omitted
SI4 rest octets	
P1	C2 parameters not present

SYSTEM INFORMATION TYPE 5

Information Element	Value/remark
Neighbour cell description	As BCCH Frequency list in SI 2

SYSTEM INFORMATION TYPE 6

Information Element	Value/remark
Cell identity CI VALUE	0001 hex (not relevant)
Location Area Identification MCC	001 decimal (not relevant)
MNC	01 decimal (not relevant)
LAC	011 decimal (not relevant) for PCS 1900
Cell options PWRG	0001 hex (not relevant)
DTX	power control not set
RADIO LINK TIME-OUT	MS must not use DTX
NCC permitted	8
NCC PERMITTED	e.g. all NCCs permitted

10.1.3 Procedure

An MS terminating call on a TCH/FS shall be established under ideal radio conditions and with Timing advance set to 0, as follows:

Step	Direction	Message	Comments
1	SS -> MS	PAGING REQUEST TYPE 1	Sent on the correct paging subchannel
2	MS -> SS	CHANNEL REQUEST	Establishment cause indicates "answer to paging"
3	SS -> MS	IMMEDIATE ASSIGNMENT	
4	MS -> SS	PAGING RESPONSE	Message is contained in SABM
5	SS -> MS	AUTHENTICATION REQUEST	
6	MS -> SS	AUTHENTICATION RESPONSE	SRES specifies correct value
7	SS -> MS	CIPHERING MODE COMMAND	SS starts deciphering after sending the message
8	MS -> SS	CIPHERING MODE COMPLETE	Shall be sent enciphered. All following messages shall be sent enciphered
9	SS		SS starts ciphering
10	SS -> MS	SETUP	Message contains the signal IE
11	MS -> SS	CALL CONFIRMED	
A12	MS -> SS	CONNECT	
B12	MS -> SS	ALERTING	
B13	MS		An alerting indication as defined in a PICS/PIXIT statement given by the MS
B14	MS		The MS is made to accept the call in a way described in a PICS/PIXIT statement
B15	MS -> SS	CONNECT	
16	SS -> MS	ASSIGNMENT COMMAND	
17	MS -> SS	ASSIGNMENT COMPLETE	
18	MS		The TCH is through connected in both directions
19	SS -> MS	CONNECT ACKNOWLEDGE	

10.1.4 Specific message contents

PAGING REQUEST TYPE 1 (GSM 04.08, 9.1.22) to the MS

Information Element	Value/remark
Protocol Discriminator	RR
Skip Indicator	0000
Message Type	
Page Mode	Normal Paging
Channel Needed	spare, any channel
Mobile Identity 1	
Odd/even no of digits	As applicable for TMSI
Type of Identity	TMSI
Identity digits	As applicable
Mobile Identity 2	Omitted
P1 rest octets	Spare octets

IMMEDIATE ASSIGNMENT (GSM 04.08, 9.1.18) to the MS

Information Element	Value/remark
Protocol Discriminator	RR
Skip Indicator	0000
Message Type	
Page Mode	Normal
Channel Description	
Channel Type	SDCCH/SACCH 1(4)
Time slot number	zero
Training seq. code	same as BCCH
Hopping	No
ARFCN	ARFCN of the BCCH
Random Reference	
Random access info	As in CHAN REQ
N51, N32, N26	As applicable
Timing Advance	0
Mobile allocation	length 0 due to hopping
IA rest octets	Spare octets

AUTHENTICATION REQUEST (GSM 04.08, 9.2.2) to the MS

Information Element	Value/remark
Protocol Discriminator	MM
Skip Indicator	0000
Message Type	
Ciphering key seq. number	Arbitrary
Authent. parameter RAND	Arbitrary

CIPHERING MODE COMMAND (GSM 04.08, 9.1.9) to the MS

Information Element	Value/remark
Protocol Discriminator	RR
Skip Indicator	0000
Message Type	
Ciphering mode setting	Start ciphering
Algorithm Identifier	Supported by the MS
Cipher Response	IMEISV shall not be included

SETUP (GSM 04.08, 9.3.23) to the MS

Information Element	Value/remark
Protocol Discriminator	CC
Transaction Identifier	SS orig.
Message Type	
Signal	any non-reserved value
Bearer capability 1	Appropriate for the basic service selected for the test or omitted

ASSIGNMENT COMMAND (GSM 04.08, 9.1.2) to the MS

Information Element	Value/remark
Protocol Discriminator	RR
Skip Indicator	0000
Message Type	
Channel Description	
Channel type	Bm + ACCHs
Time slot number	Arbitrary
Training seq. code	Default
Hopping	No
ARFCN	Default
Power level	Power control level 7
Channel mode	Speech full rate

CONNECT ACKNOWLEDGE (GSM 04.08, 9.3.6) to the MS

Information Element	Value/remark
Protocol Discriminator	CC
Transaction Identifier	SS orig.
Message Type	

10.2 Generic call set-up procedure for mobile originating speech calls

In the test procedures described in this EN, unless otherwise stated in the test description, the Mobile Originating Speech (MOC) call set-up procedure shall be as described in this subclause.

NOTE: In test cases where a fading profile is required, a different and appropriate ARFCN may be selected, for instance if the fading simulator bandwidth does not allow use of the default ARFCN.

10.2.1 Initial conditions

System Simulator:

1 cell, default parameters.

Mobile Station:

- The MS shall be operated under normal test conditions (see [annex 1 TC.2.1])
- The special Test-SIM (see annex 4) shall be inserted.
- The MS is "idle, updated", with a TMSI assigned and listening to the BCCH/CCCH of the active cell.

10.2.2 Definition of system information messages

See subclause 10.1.2.

10.2.3 Procedure

An MS originating call on a TCH/FS shall be established under ideal radio conditions and with Timing advance set to 0, as follows:

Step	Direction	Message	Comments
1	MS		"called number" entered
2	MS -> SS	CHANNEL REQUEST	Establishment cause indicates "originating call, NECI <> 1"
3	SS -> MS	IMMEDIATE ASSIGNMENT	
4	MS -> SS	CM SERVICE REQUEST	Message is contained in SABM
5	SS -> MS	AUTHENTICATION REQUEST	
6	MS -> SS	AUTHENTICATION RESPONSE	SRES specifies correct value
7	SS -> MS	CIPHERING MODE COMMAND	SS starts deciphering after sending the message
8	MS -> SS	CIPHERING MODE COMPLETE	Shall be sent enciphered. All following messages shall be sent enciphered
9	SS		SS starts ciphering
10	MS -> SS	SETUP	
11	SS -> MS	CALL PROCEEDING	
12	SS -> MS	ALERTING	
13	MS		An alerting indication as defined in an PICS/PIXIT statement is given by the MS
14	SS -> MS	ASSIGNMENT COMMAND	
15	MS -> SS	ASSIGNMENT COMPLETE	
16	SS -> MS	CONNECT	
17	MS -> SS	CONNECT ACKNOWLEDGE	
18	MS		The TCH is through connected in both directions

10.2.4 Specific message contents

IMMEDIATE ASSIGNMENT (GSM 04.08, 9.1.18) to the MS

Information Element	Value/remark
Protocol Discriminator	RR
Skip Indicator	0000
Message Type	
Page Mode	Normal
Channel Description	
Channel Type	SDCCH/SACCH 1(4)
Time slot number	zero
Training seq. code	same as BCCH
Hopping	No
ARFCN	ARFCN of the BCCH
Random Reference	
Random access info	As in CHAN REQ
N51, N32, N26	As applicable
Timing Advance	0
Mobile allocation	length 0 due to hopping
IA rest octets	Spare octets

AUTHENTICATION REQUEST (GSM 04.08, 9.2.2) to the MS

Information Element	Value/remark
Protocol Discriminator	MM
Skip Indicator	0000
Message Type	
Ciphering key seq. number	Arbitrary
Authent. parameter RAND	Arbitrary

CIPHERING MODE COMMAND (GSM 04.08, 9.1.9) to the MS

Information Element	Value/remark
Protocol Discriminator	RR
Skip Indicator	0000
Message Type	
Ciphering mode setting	Start ciphering
Algorithm Identifier	Supported by the MS
Cipher Response	IMEISV shall not be included

CALL PROCEEDING (GSM 04.08, 9.3.3) to the MS

Information Element	Value/remark
Protocol Discriminator	CC
Transaction Identifier	As derived from SETUP
Message Type	
Repeat Indicator	Omitted
Bearer Capability 1	Omitted
Bearer Capability 2	Omitted
Facility	Omitted
Progress Indicator	Omitted

ALERTING (GSM 04.08, 9.3.1) to the MS

Information Element	Value/remark
Protocol Discriminator	CC
Transaction Identifier	As derived from SETUP
Message Type	
Facility	Omitted
Progress Indicator	Omitted
User-user	Omitted

ASSIGNMENT COMMAND (GSM 04.08, 9.1.2) to the MS

Information Element	Value/remark
Protocol Discriminator	RR
Skip Indicator	0000
Message Type	
Channel Description	
Channel type	Bm + ACCHs
Time slot number	Arbitrary
Training seq. code	Default
Hopping	No
ARFCN	Default
Power level	Power control level 7
Channel mode	Speech full rate

CONNECT (GSM 04.08, 9.3.5) to the MS

Information Element	Value/remark
Protocol Discriminator	CC
Transaction Identifier	As derived from SETUP
Message Type	
Facility	Omitted
Progress Indicator	Omitted
Connected number	Omitted
Connected Subaddress	Omitted
User-user	Omitted

10.3 Generic call set-up procedure for mobile terminating data calls

In the test procedures described in this EN, unless otherwise stated in the test description, the Mobile Terminating Data call set-up procedure shall be as described in this subclause.

NOTE: In test cases where a fading profile is required, a different and appropriate ARFCN may be selected, for instance if the fading simulator bandwidth does not allow use of the default ARFCN.

10.3.1 Initial conditions

System Simulator:

1 cell, default parameters.

Mobile Station:

- The MS shall be operated under normal test conditions (see annex 1 TC.2.1)
- The special Test-SIM (see annex 4) shall be inserted.
- The MS is "idle, updated", with a TMSI assigned and listening to the BCCH/CCCH of the active cell.

10.3.2 Definition of system information messages

See subclause 10.1.2.

10.3.3 Procedure

An MS terminating call on a TCH shall be established under ideal radio conditions and with Timing advance set to 0, as follows:

Step	Direction	Message	Comments
1	SS -> MS	PAGING REQUEST TYPE 1	Sent on the correct paging subchannel
2	MS -> SS	CHANNEL REQUEST	Establishment cause indicates "answer to paging"
3	SS -> MS	IMMEDIATE ASSIGNMENT	
4	MS -> SS	PAGING RESPONSE	Message is contained in SABM
5	SS -> MS	AUTHENTICATION REQUEST	
6	MS -> SS	AUTHENTICATION RESPONSE	SRES specifies correct value
7	SS -> MS	CIPHERING MODE COMMAND	SS starts deciphering after sending the message
8	MS -> SS	CIPHERING MODE COMPLETE	Shall be sent enciphered. All following messages shall be sent enciphered
9	SS		SS starts ciphering
10	SS -> MS	SETUP	A call is set up according to the required characteristics of the test procedure. Bearer Capability and Signal IEs included
11	MS -> SS	CALL CONFIRMED	Bearer Capability shall or shall not be included according to the rules given in GSM 04.08 and GSM 07.01
A12	MS -> SS	CONNECT	
B12	MS -> SS	ALERTING	An alerting indication as defined in a PICS/PIXIT statement given by the MS
B13	MS		The MS is made to accept the call in a way described in a PICS/PIXIT statement
B14	MS		
B15	MS -> SS	CONNECT	
16	SS -> MS	ASSIGNMENT COMMAND	
17	MS -> SS	ASSIGNMENT COMPLETE	
18	MS		The TCH is through connected in both directions
19	SS -> MS	CONNECT ACKNOWLEDGE	

10.3.4 Specific message contents

PAGING REQUEST TYPE 1 (GSM 04.08, 9.1.22) to the MS

Information Element	Value/remark
Protocol Discriminator	RR
Skip Indicator	0000
Message Type	
Page Mode	Normal Paging
Channel Needed	spare, any channel
Mobile Identity 1	
Odd/even no of digits	As applicable for TMSI
Type of Identity	TMSI
Identity digits	As applicable
Mobile Identity 2	Omitted
P1 rest octets	Spare octets

IMMEDIATE ASSIGNMENT (GSM 04.08, 9.1.18) to the MS

Information Element	Value/remark
Protocol Discriminator	RR
Skip Indicator	0000
Message Type	
Page Mode	Normal
Channel Description	
Channel Type	SDCCH/SACCH 1(4)
Time slot number	zero
Training seq. code	same as BCCH
Hopping	No
ARFCN	ARFCN of the BCCH
Random Reference	
Random access info	As in CHAN REQ
N51, N32, N26	As applicable
Timing Advance	0
Mobile allocation	length 0 due to hopping
IA rest octets	Spare octets

AUTHENTICATION REQUEST (GSM 04.08, 9.2.2) to the MS

Information Element	Value/remark
Protocol Discriminator	MM
Skip Indicator	0000
Message Type	
Ciphering key seq. number	Arbitrary
Authent. parameter RAND	Arbitrarily selected

CIPHERING MODE COMMAND (GSM 04.08, 9.1.9) to the MS

Information Element	Value/remark
Protocol Discriminator	RR
Skip Indicator	0000
Message Type	
Ciphering mode setting	Start ciphering
Algorithm Identifier	Supported by the MS
Cipher Response	IMEISV shall not be included

SETUP (GSM 04.08, 9.3.23) to the MS

Information Element	Value/remark
Protocol Discriminator	CC
Transaction Identifier	SS orig.
Message Type	
Bearer Capability	
Radio Channel Requirement	
Connection Element	T or NT and declared as supported by the MS (Not "Both ...")
NIRR	No meaning
Other parameters	Declared as supported by the MS
Signal	any non-reserved value

ASSIGNMENT COMMAND (GSM 04.08, 9.1.2) to the MS

Information Element	Value/remark
Protocol Discriminator	RR
Skip Indicator	0000
Message Type	
Channel Description	
Channel type	Bm + ACCHs
Time slot number	Arbitrary
Training seq. code	Default
Hopping	No
ARFCN	Default
Power level	Power control level 7
Channel mode	Proper data rate, according to BC-IE included in the Set-Up and to the following table

Table 10-1: Correspondence between User rate (UR) and Channel Mode (CM) for transparent (T) and non transparent (NT) connections

UR	9,6kbit/s	4,8kbit/s	2,4kbit/s	1,2kbit/s	1,2/0,075kbit/s	0,3kbit/s
CM T FR	12 FR	6 FR	3,6 FR	3,6 FR	3,6 FR	3,6 FR
CM T HR	n.a	6 HR	3,6 HR	3,6 HR	3,6 HR	3,6 HR
CM NT FR	12 FR	12 FR	12 FR	12 FR	12 FR	12 FR
CM NT HR	n.a	6 HR	6 HR	6 HR	6 HR	6 HR

CONNECT ACKNOWLEDGE (GSM 04.08, 9.3.6) to the MS

Information Element	Value/remark
Protocol Discriminator	CC
Transaction Identifier	SS orig.
Message Type	

10.4 Generic call set-up procedure for mobile originating data calls

In the test procedures described in this EN, unless otherwise stated in the test description, the Mobile Originating Data call set-up procedure shall be as described in this subclause.

NOTE: In test cases where a fading profile is required, a different and appropriate ARFCN may be selected, for instance if the fading simulator bandwidth does not allow use of the default ARFCN.

10.4.1 Initial conditions

System Simulator:

1 cell, default parameters.

Mobile Station:

- The MS shall be operated under normal test conditions (see [annex 1 TC.2.1])
- The special Test-SIM (see annex 4) shall be inserted.
- The MS is "idle, updated", with a TMSI assigned and listening to the BCCH/CCCH of the active cell.

10.4.2 Definition of system information messages

See subclause 10.1.2.

10.4.3 Procedure

An MS originating call on a TCH shall be established under ideal radio conditions and with Timing advance set to 0, as follows:

Step	Direction	Message	Comments
1	MS		"called number" entered
2	MS -> SS	CHANNEL REQUEST	Establishment cause indicates "originating call, NECI <> 1"
3	SS -> MS	IMMEDIATE ASSIGNMENT	
4	MS -> SS	CM SERVICE REQUEST	Message is contained in SABM
5	SS -> MS	AUTHENTICATION REQUEST	
6	MS -> SS	AUTHENTICATION RESPONSE	SRES specifies correct value
7	SS -> MS	CIPHERING MODE COMMAND	SS starts deciphering after sending the message
8	MS -> SS	CIPHERING MODE COMPLETE	Shall be sent enciphered. All following messages shall be sent enciphered
9	SS		SS starts ciphering
10	MS -> SS	SETUP	
11	SS -> MS	CALL PROCEEDING	
12	SS -> MS	ALERTING	
13	MS		An alerting indication as defined in an PICS/PIXIT statement is given by the MS
14	SS -> MS	ASSIGNMENT COMMAND	
15	MS -> SS	ASSIGNMENT COMPLETE	
16	SS -> MS	CONNECT	
17	MS -> SS	CONNECT ACKNOWLEDGE	
18	MS		The TCH is through connected in both directions

10.4.4 Specific message contents

IMMEDIATE ASSIGNMENT (GSM 04.08, 9.1.18) to the MS

Information Element	Value/remark
Protocol Discriminator	RR
Skip Indicator	0000
Message Type	
Page Mode	Normal
Channel Description	
Channel Type	SDCCH/SACCH 1(4)
Time slot number	zero
Training seq. code	same as BCCH
Hopping	No
ARFCN	ARFCN of the BCCH
Random Reference	
Random access info	As in CHAN REQ
N51, N32, N26	As applicable
Timing Advance	0
Mobile allocation	length 0 due to hopping
IA rest octets	Spare octets

AUTHENTICATION REQUEST (GSM 04.08, 9.2.2) to the MS

Information Element	Value/remark
Protocol Discriminator	MM
Skip Indicator	0000
Message Type	
Ciphering key seq. number	Arbitrary
Authent. parameter RAND	Arbitrarily selected

CIPHERING MODE COMMAND (GSM 04.08, 9.1.9) to the MS

Information Element	Value/remark
Protocol Discriminator	RR
Skip Indicator	0000
Message Type	
Ciphering mode setting	Start ciphering
Algorithm Identifier	Supported by the MS
Cipher Response	IMEISV shall not be included

CALL PROCEEDING (GSM 04.08, 9.3.3) to the MS

Information Element	Value/remark
Protocol Discriminator	CC
Transaction Identifier	As derived from SETUP
Message Type	
Repeat Indicator	Present if and only if Bearer Capability 1 and Bearer Capability 2 are present in this message
Bearer Capability 1	Present if negotiation of BC 1 or BC 2 necessary (e.g. reception of "Both" for CE parameter in SETUP), else omitted
Radio Channel Requirement	spare
Connection element	T (in case of "Both T (NT) preferred" received)
NIRR	No meaning
Other parameters	Same as sent by the MS in the SETUP, where applicable
Bearer Capability 2	Present if dual BC-IE received and negotiation of either BC 1 or BC 2 necessary, else omitted
Radio Channel Requirement	spare
Connection element	T in case of "Both, T (NT) preferred" in the SETUP message else same as in the SETUP message
NIRR	No meaning
Other parameters	Same as sent by the MS in the SETUP, where applicable
NOTE: If both BC 1 and BC 2 are present, then one and only one of them shall indicate speech.	
Facility	Omitted
Progress Indicator	Omitted

ALERTING (GSM 04.08, 9.3.1) to the MS

Information Element	Value/remark
Protocol Discriminator	CC
Transaction Identifier	As derived from SETUP
Message Type	
Facility	Omitted
Progress Indicator	Omitted
User-user	Omitted

ASSIGNMENT COMMAND (GSM 04.08, 9.1.2) to the MS

Information Element	Value/remark
Protocol Discriminator	RR
Transaction Identifier	Not used
Message Type	
Channel Description	
Channel type	Bm + ACCHs
Time slot number	Arbitrary
Training seq. code	Default
Hopping	No
FB no	Band no 0
ARFCN	Default
Power level	Power control level 7
Channel mode	If no negotiation took place: - Speech FR (resp. HR) if first BC IE in the SETUP indicated speech FR (resp. HR); - Set according to the table below if first BC - IE in the SETUP indicates data or fax If negotiation took place; - Speech FR (resp. HR) if first BC-IE in the CALL PROCEEDING indicates speech FR (resp. HR); - Set according to the table below if first BC - IE in the CALL PROCEEDING indicates data or fax

Table 10-2: Correspondence between User rate (UR) and Channel Mode (CM) for transparent (T) and non transparent (NT) connections

UR	9,6kbit/s	4,8kbit/s	2,4kbit/s	1,2kbit/s	1,2/0,075kbit/s	0,3kbit/s
CM T FR	12FR	6 FR	3,6 FR	3,6 FR	3,6 FR	3,6 FR
CM T HR	n.a	6 HR	3,6 HR	3,6 HR	3,6 HR	3,6 HR
CM NT FR	12 FR	12 FR	12 FR	12 FR	12 FR	12 FR
CM NT HR	n.a	6 HR	6 HR	6 HR	6 HR	6 HR

CONNECT (GSM 04.08, 9.3.5) to the MS

Information Element	Value/remark
Protocol Discriminator	CC
Transaction Identifier	As derived from SETUP
Message Type	
Facility	Omitted
Progress Indicator	Omitted
Connected number	Omitted
Connected Subaddress	Omitted
User-user	Omitted

10.5 Generic call set-up procedure for mobile terminating multislot configuration, minimum number of timeslots allocated

In the test procedures described in this EN, unless otherwise stated in the test description, the Mobile Terminating multislot connection set-up procedure shall be as described in this subclause.

NOTE: In test cases where a fading profile is required, a different and appropriate ARFCN may be selected, for instance if the fading simulator bandwidth does not allow use of the default ARFCN.

10.5.1 Initial conditions

System Simulator:

1 cell, default parameters.

Mobile Station:

- The MS shall be operated under normal test conditions (see annex 1 TC.2.1)
- The special Test-SIM (see annex 4) shall be inserted.
- The MS is "idle, updated", with a TMSI assigned and listening to the BCCH/CCCH of the active cell.

10.5.2 Definition of system information messages

See subclause 10.1.2.

10.5.3 Procedure

An MS terminating multislot connection shall be established under ideal radio conditions and with Timing advance set to 0, as follows:

Step	Direction	Message	Comments
1	SS -> MS	PAGING REQUEST TYPE 1	Sent on the correct paging subchannel
2	MS -> SS	CHANNEL REQUEST	Establishment cause indicates "answer to paging"
3	SS -> MS	IMMEDIATE ASSIGNMENT	
4	MS -> SS	PAGING RESPONSE	Message is contained in SABM
5	MS -> SS	CLASSMARK CHANGE	Multislot class
6	SS -> MS	AUTHENTICATION REQUEST	
7	MS -> SS	AUTHENTICATION RESPONSE	SRES specifies correct value
8	SS -> MS	CIPHERING MODE COMMAND	SS starts deciphering after sending the message
9	MS -> SS	CIPHERING MODE COMPLETE	Shall be sent enciphered. All following messages shall be sent enciphered
10	SS		SS starts ciphering
11	SS -> MS	SETUP	A multislot connection is set up according to the required characteristics of the test procedure. Bearer Capability and Signal IEs included
12	MS -> SS	CALL CONFIRMED	Bearer Capability shall or shall not be included according to the rules given in GSM 04.08 and GSM 07.01
A12	MS -> SS	CONNECT	
B13	MS -> SS	ALERTING	An alerting indication as defined in a PICS/PIXIT statement given by the MS
B14	MS		
B15	MS		The MS is made to accept the call in a way described in a PICS/PIXIT statement
B16	MS -> SS	CONNECT	
17	SS -> MS	ASSIGNMENT COMMAND	In multislot allocation only one timeslot is allocated.
18	MS -> SS	ASSIGNMENT COMPLETE	Sent on the TCH/Sm channel
19	MS		The TCH(s) is through connected in both directions
20	SS -> MS	CONNECT ACKNOWLEDGE	

10.5.4 Specific message contents

PAGING REQUEST TYPE 1 (GSM 04.08, 9.1.22) to the MS

Information Element	Value/remark
Protocol Discriminator	RR
Skip Indicator	0000
Message Type	
Page Mode	Normal Paging
Channel Needed	spare, any channel
Mobile Identity 1	
Odd/even no of digits	As applicable for TMSI
Type of Identity	TMSI
Identity digits	As applicable
Mobile Identity 2	Omitted
P1 rest octets	Spare octets

IMMEDIATE ASSIGNMENT (GSM 04.08, 9.1.18) to the MS

Information Element	Value/remark
Protocol Discriminator	RR
Skip Indicator	0000
Message Type	
Page Mode	Normal
Channel Description	
Channel Type	SDCCH/SACCH 1(4)
Time slot number	zero
Training seq. code	same as BCCH
Hopping	No
ARFCN	ARFCN of the BCCH
Random Reference	
Random access info	As in CHAN REQ
N51, N32, N26	As applicable
Timing Advance	0
Mobile allocation	length 0 due to hopping
IA rest octets	Spare octets

AUTHENTICATION REQUEST (GSM 04.08, 9.2.2) to the MS

Information Element	Value/remark
Protocol Discriminator	MM
Skip Indicator	0000
Message Type	
Ciphering key seq. number	Arbitrary
Authent. parameter RAND	Arbitrarily selected

CIPHERING MODE COMMAND (GSM 04.08, 9.1.9) to the MS

Information Element	Value/remark
Protocol Discriminator	RR
Skip Indicator	0000
Message Type	
Ciphering mode setting	Start ciphering
Algorithm Identifier	Supported by the MS
Cipher Response	IMEISV shall not be included

SETUP (GSM 04.08, 9.3.23) to the MS

Information Element	Value/remark
Protocol Discriminator	CC
Transaction Identifier	SS orig.
Message Type	
Bearer Capability	
Radio Channel Requirement	
Connection Element	T or NT and declared as supported by the MS (Not "Both ...")
NIRR	No meaning
Other parameters	Declared as supported by the MS
Signal	any non-reserved value

ASSIGNMENT COMMAND (GSM 04.08, 9.1.2) to the MS

Information Element	Value/remark
Protocol Discriminator	RR
Skip Indicator	0000
Message Type	
Channel Description 2	
Channel type	TCH/F + FACCH/F and SACCH/M
Time slot number	Arbitrary
Training seq. code	Default
Hopping	No
ARFCN	Default
Power level	Power control level 7
Multislot allocation	
- Downlink assignment	Only one timeslot is assigned in downlink direction.
- Uplink assignment	Only one timeslot is assigned in uplink direction.

CONNECT ACKNOWLEDGE (GSM 04.08, 9.3.6) to the MS

Information Element	Value/remark
Protocol Discriminator	CC
Transaction Identifier	SS orig.
Message Type	

10.6 Generic call set-up procedure for mobile originating multislot configuration, minimum number of timeslots allocated

In the test procedures described in this EN, unless otherwise stated in the test description, the Mobile Originating multislot connection set-up procedure shall be as described in this subclause.

NOTE: In test cases where a fading profile is required, a different and appropriate ARFCN may be selected, for instance if the fading simulator bandwidth does not allow use of the default ARFCN.

10.6.1 Initial conditions

System Simulator:

1 cell, default parameters.

Mobile Station:

- The MS shall be operated under normal test conditions (see [annex 1 TC.2.1])
- The special Test-SIM (see annex 4) shall be inserted.
- The MS is "idle, updated", with a TMSI assigned and listening to the BCCH/CCCH of the active cell.

10.6.2 Definition of system information messages

See subclause 10.1.2.

10.6.3 Procedure

An MS originating multislot connection shall be established under ideal radio conditions and with Timing advance set to 0, as follows:

Step	Direction	Message	Comments
1	MS		"called number" entered
2	MS -> SS	CHANNEL REQUEST	Establishment cause indicates "originating call, NECI <> 1"
3	SS -> MS	IMMEDIATE ASSIGNMENT	
4	MS -> SS	CM SERVICE REQUEST	Message is contained in SABM
5	MS -> SS	CLASSMARK CHANGE	Multislot class
6	SS -> MS	AUTHENTICATION REQUEST	
7	MS -> SS	AUTHENTICATION RESPONSE	SRES specifies correct value
8	SS -> MS	CIPHERING MODE COMMAND	SS starts deciphering after sending the message
9	MS -> SS	CIPHERING MODE COMPLETE	Shall be sent enciphered. All following messages shall be sent enciphered
10	SS		SS starts ciphering
11	MS -> SS	SETUP	A multislot connection is set up according to the required characteristics of the test procedure.
12	SS -> MS	CALL PROCEEDING	
13	SS -> MS	ALERTING	
14	MS		An alerting indication as defined in an PICS/PIXIT statement is given by the MS
15	SS -> MS	ASSIGNMENT COMMAND	In multislot allocation only one timeslot is allocated.
16	MS -> SS	ASSIGNMENT COMPLETE	Sent on TCH/Sm channel.
17	SS -> MS	CONNECT	
18	MS -> SS	CONNECT ACKNOWLEDGE	
19	MS		The TCH(s) is through connected in both directions

10.6.4 Specific message contents

IMMEDIATE ASSIGNMENT (GSM 04.08, 9.1.18) to the MS

Information Element	Value/remark
Protocol Discriminator	RR
Skip Indicator	0000
Message Type	
Page Mode	Normal
Channel Description	
Channel Type	SDCCH / SACCH 1(4)
Time slot number	zero
Training seq. code	same as BCCH
Hopping	No
ARFCN	ARFCN of the BCCH
Random Reference	
Random access info	As in CHAN REQ
N51, N32, N26	As applicable
Timing Advance	0
Mobile allocation	length 0 due to hopping
IA rest octets	Spare octets

AUTHENTICATION REQUEST (GSM 04.08, 9.2.2) to the MS

Information Element	Value/remark
Protocol Discriminator	MM
Skip Indicator	0000
Message Type	
Ciphering key seq. number	Arbitrary
Authent. parameter RAND	Arbitrarily selected

CIPHERING MODE COMMAND (GSM 04.08, 9.1.9) to the MS

Information Element	Value/remark
Protocol Discriminator	RR
Skip Indicator	0000
Message Type	
Ciphering mode setting	Start ciphering
Algorithm Identifier	Supported by the MS
Cipher Response	IMEISV shall not be included

CALL PROCEEDING (GSM 04.08, 9.3.3) to the MS

Information Element	Value/remark
Protocol Discriminator	CC
Transaction Identifier	As derived from SETUP
Message Type	
Repeat Indicator	Present if and only if Bearer Capability 1 and Bearer Capability 2 are present in this message
Bearer Capability 1	Present if negotiation of BC 1 necessary (e.g. reception of "Both" for CE parameter in SETUP), else omitted
Radio Channel Requirement	spare
Connection element	T (in case of "Both T (NT) preferred" received)
NIRR	No meaning
Other parameters	Same as sent by the MS in the SETUP, where applicable
Facility	Omitted
Progress Indicator	Omitted

ALERTING (GSM 04.08, 9.3.1) to the MS

Information Element	Value/remark
Protocol Discriminator	CC
Transaction Identifier	As derived from SETUP
Message Type	
Facility	Omitted
Progress Indicator	Omitted
User-user	Omitted

ASSIGNMENT COMMAND (GSM 04.08, 9.1.2) to the MS

Information Element	Value/remark
Protocol Discriminator	RR
Transaction Identifier	Not used
Message Type	
Channel Description 2	
Channel type	TCH/F + FACCH/F + SACCH/M
Time slot number	Arbitrary
Training seq. code	Default
Hopping	No
FB no	Band no 0
ARFCN	Default
Power level	Power control level 7
Multislot allocation	
- Downlink assignment	Only one timeslot is assigned in downlink direction.
- Uplink assignment	Only one timeslot is assigned in uplink direction.

CONNECT (GSM 04.08, 9.3.5) to the MS

Information Element	Value/remark
Protocol Discriminator	CC
Transaction Identifier	As derived from SETUP
Message Type	
Facility	Omitted
Progress Indicator	Omitted
Connected number	Omitted
Connected Subaddress	Omitted
User-user	Omitted

10.7 Generic procedure for GPRS downlink data transfer

In the test procedures described in this EN, unless otherwise stated in the test description, the Mobile Terminating Data transfer procedure shall be as described in this subclause.

NOTE: In test cases where a fading profile is required, a different and appropriate ARFCN may be selected, for instance if the fading simulator bandwidth does not allow use of the default ARFCN.

10.7.1 Initial conditions

System Simulator:

- 1 cell, default parameters as specified in section 40.
- Ideal radio conditions and Timing advance set to 0.

Mobile Station:

- The MS shall be operated under normal test conditions (see annex 1 TC.2.1)
- The special Test-SIM (see annex 4) shall be inserted.
- The MS is GPRS attached with a P-TMSI allocated and the test PDP context2 activated.

10.7.2 Definition of system information messages

See section 40.

10.7.3 Procedure

Step	Direction	Message	Comments
1			Start an application in the MS that continually reads all received data
2	SS -> MS	PACKET PAGING REQUEST	Contains P-TMSI of the MS. Sent on PPCH.
3	MS -> SS	PACKET CHANNEL REQUEST	ACCESS TYPE = " Page Response ". Received on PRACH.
4	SS -> MS	PACKET UPLINK ASSIGNMENT	Random Reference = pertaining to the message received in step 3. Sent on PAGCH. Single block assignment.
5	MS -> SS	UPLINK RLC DATA BLOCK	LLC PDU implicitly indicating paging response, containing TLLI in the RLC/MAC header. .
6	SS -> MS	PACKET UPLINK ACK/NACK	Acknowledge the received RLC data block. Sent on PACCH. Poll bit in the MAC header is set to indicate a valid RRBP.
7	MS -> SS	PACKET CONTROL ACKNOWLEDGEMENT	As RLC/MAC control block. Received on PACCH.
8	SS -> MS	PACKET DOWNLINK ASSIGNMENT	Poll bit in the MAC header is set to indicate a valid RRBP. Sent on PCCCH. TIMESLOT_ALLOCATION arbitrarily chosen but shall not exceed the multislot capabilities of the MS. Other parameters as specified in each test case.
9	MS -> SS	PACKET CONTROL ACKNOWLEDGEMENT	Received on PACCH.

Note. The MS is always granted a USF whenever the MS is expected to send.

10.7.4 Specific message contents

See section 40.

10.8 Generic procedure for GPRS uplink data transfer

In the test procedures described in this EN, unless otherwise stated in the test description, the Mobile Originated Data transfer procedure shall be as described in this subclause.

NOTE: In test cases where a fading profile is required, a different and appropriate ARFCN may be selected, for instance if the fading simulator bandwidth does not allow use of the default ARFCN.

10.8.1 Initial conditions

System Simulator:

- 1 cell, default parameters as specified in section 40.
- Ideal radio conditions and Timing advance set to 0.

Mobile Station:

- The MS shall be operated under normal test conditions (see annex 1 TC.2.1)
- The special Test-SIM (see annex 4) shall be inserted.
- The MS is GPRS attached with a P-TMSI allocated and the test PDP context3 activated.

10.8.2 Definition of system information messages

See section 40.

10.8.3 Procedure

Step	Direction	Message	Comments
1			Start an application in the MS that continually sends data
2	MS -> SS	PACKET CHANNEL REQUEST	Received on PRACH.
3	SS -> MS	PACKET UPLINK ASSIGNMENT	Single block assignment, to order the MS to follow the two phase access procedure. Sent on PAGCH.
4	MS -> SS	PACKET RESOURCE REQUEST	Two phase access procedure. Received on the single block assigned in step 3.
5	SS -> MS	PACKET UPLINK ASSIGNMENT	Sent on PACCH of the same PDCH assigned in step 2. TIMESLOT_ALLOCATION arbitrarily chosen but shall not exceed the multislot capabilities of the MS. Open ended assignment.
6	SS -> MS	PACKET DOWNLINK DUMMY CONTROL BLOCK	Sent on PACCH containing USF assigned to the MS.

Note. The MS is always granted a USF whenever the MS is expected to send.

10.8.4 Specific message contents

PACKET UPLINK ACK/NACK message:

MESSAGE_TYPE	001001
PAGE_MODE	Normal Paging
UPLINK_TFI	00, same as the TFI value of the TBF which the message applies
CHANNEL_CODING_COMMAND	0, message escape Same coding scheme as in the assigned TBF which the message applies to
Ack/Nack Description	
- FINAL_ACK_INDICATION	0 (not a final ACK)
- STARTING_SEQUENCE_NUMBER	V(R)
- RECEIVED_BLOCK_BITMAP	Acknowledge the all data blocks transmitted by the MS
{0 1<CONTENTION_RESOLUTION_TLLI>}	0 (no contention resolution TLLI)
{0 1<Packet Timing Advance>}	0 (no packet timing advance)
{0 1<Power Control Parameters>}	0 (no power control parameters)
{0 1<Extension bits>}	0 (no extension bits present)
{0 1<Fixed Allocation parameters>}	0 (no fixed allocation parameters present)
spare padding	Spare Padding

PACKET UPLINK ASSIGNMENT message (two-phase dynamic allocation assigning a TBF):

MESSAGE_TYPE	001010
PAGE_MODE	Normal Paging
{0 1<PERSISTENCE_LEVEL>}	0 (no persistence level present)
- Address information	10 (TLLI)
- TLLI	The value received from the MS
CHANNEL_CODING_COMMAND	0, message escape
TLLI_BLOCK_CHANNEL_CODING	Arbitrarily chosen from the valid values (default CS-1)
Packet Timing Advance	'0'B, cs-1
- {0 1<TIMING_ADVANCE_VALUE>}	1 (timing advance value)
- TIMING_ADVANCE_VALUE	0 bit periods
- {0 1<TIMING_ADVANCE_INDEX>	0 (no timing advance index)
<TIMING_ADVANCE_TIMESLOT_NUMBER >}	
{0 1<Frequency Parameters>}	1 (Frequency Parameters present)
- Frequency Parameters	
- TSC	Arbitrarily chosen (default 5)
-	01 (indirect encoding)
- MAIO	Value arbitrarily chosen
- MA_NUMBER	Value arbitrarily chosen from PSI2s defined (default 0001)
- {0 1<CHANGE_MARK_1>	00
{0 1<CHANGE_MARK_2>}}	
Dynamic allocation	01
- Extended Dynamic Allocation	0 (Dynamic allocation)
- {0 1<P0><PR_MODE>}	0
- USF_GRANULARITY	0, one block
- {0 1<UPLINK_TFI_ASSIGNMENT>}	1 (uplink TFI assignment)
- UPLINK_TFI_ASSIGNMENT	Arbitrarily chosen (default 00101)
- {0 1<RLC_DATA_BLOCKS_GRANTED>}	0 (no RLC_DATA_BLOCKS_GRANTED, open-ended TBF)
- {0 1<TBF_STARTING_TIME>}	0 (no starting time)
-	1 (Timeslot Allocation with Power Control Parameters)
	one slot arbitrarily chosen and the following USF_TNx and GAMMA_TNx shall be corresponding to the chosen value, default timeslot 2 assigned)
- ALPHA	0.5
- {0 1<USF_TN0><GAMMA_TN0>}	0 (timeslot 0 not assigned)
- {0 1<USF_TN1><GAMMA_TN1>}	0 (timeslot 1 not assigned)
- {0 1<USF_TN2><GAMMA_TN2>}	1 (timeslot 2 assigned)
- USF_TN2	Arbitrarily chosen (default 101)
- GAMMA_TN2	For GSM 900, +9 dBm
	For DCS 1800, +6 dBm
	For PCS 1900, +6 dBm
- {0 1<USF_TN3><GAMMA_TN3>}	0 (timeslot 3 not assigned)
- {0 1<USF_TN4><GAMMA_TN4>}	0 (timeslot 4 not assigned)
- {0 1<USF_TN5><GAMMA_TN5>}	0 (timeslot 5 not assigned)
- {0 1<USF_TN6><GAMMA_TN6>}	0 (timeslot 6 not assigned)
- {0 1<USF_TN7><GAMMA_TN7>}	0 (timeslot 7 not assigned)
spare padding	Spare Padding

See also section 40.

11 General tests

11.1 Verification of support and non-support of services (multiple numbering scheme or ISDN)

11.1.1 Mobile Terminated (MT) calls

11.1.1.1 Definition and applicability

This test applies to all MS. It is repeated for all Mobile Terminated Bearer Services / Teleservices according to GSM 02.02 and GSM 02.03 except Teleservices 21, 22 and 23.

11.1.1.2 Conformance requirement

1. The MS shall check the Information Elements for Bearer Capability in a received SETUP message, and if it agrees to the proposed set, it shall respond with a CALL CONFIRMED message.

GSM 04.08, 5.2.2.2; GSM 04.08, 5.2.2.3.

2. The MS in the "Null" state, U0, ready to receive a SETUP shall reject a SETUP with Information Elements for Bearer Capability which are incompatible with the Bearer Services / Teleservices supported by the MS, and shall send a RELEASE COMPLETE message.

GSM 04.08, 5.2.2.2; GSM 04.08, 5.2.2.3.1; GSM 07.01, 8.3.1; GSM 04.08, B.3.2.

11.1.1.3 Test purpose

1. To verify that the MS, for the case of the Multinumbering scheme or ISDN, accepts a SETUP message, where the Information Elements for Bearer Capability are compatible with the Bearer Services / Teleservices declared as supported by the MS, by sending a CALL CONFIRMED message.

This is verified for all Mobile Terminated Bearer Services / Teleservices declared as supported by the MS.

2. To verify that the MS in the "Null" state, U0, when receiving a SETUP message containing incompatible Information Elements for Bearer Capability will respond with a RELEASE COMPLETE message.

This is verified for all Mobile Terminated Bearer Services / Teleservices not declared as supported by the MS.

11.1.1.4 Method of test

11.1.1.4.1 Initial conditions

For an MS with an external interface the interface shall be setup in such a way that the MS is able to successfully receive the call for the service in question. The manufacturer shall state how this is done in a PIXIT statement. The same applies to features which must be activated by MMI before an incoming call can be accepted.

The PIXIT statement for the service in question shall be consistent with the PICS statement made by the manufacturer and will result for this tests in one or several valid BC codings as presented in section 11.8.

The generic call set-up procedure shall be followed up to and including the reception of the CIPHERING MODE COMPLETE message from the MS.

11.1.1.4.2 Procedure

- a) For a Mobile Terminated Bearer Service / Teleservice declared as supported by the MS. The SS transmits a SETUP message.

The SETUP shall contain a single or dual BC-IE where the parameter values are arbitrarily selected among those declared as supported by the MS in PIXIT statements and corresponding to the Bearer Service / Teleservice being tested.

- b) If more than one BC-IE (or pair of) correspond to the Bearer Service / Teleservice being tested, step a) is repeated once (and only once) with another single or dual BC-IE. The BC-IE shall be chosen in such a way that as many parameters as possible are different from the previous BC-IE. In particular, if more than one value for the "Connection Element" parameter is possible, the new BC-IE shall contain a different value from the previous one for this parameter.

- c) Step a) and b) are repeated for all Bearer Services / Teleservices declared as supported by the MS.

- d) For an Mobile Terminated Bearer Service / Teleservice not declared as supported by the MS. The SS transmits SETUP. If the MS supports TS62 but not TS61, then TS61 is not tested.

The SETUP shall contain a single or dual BC-IE where the parameter values are arbitrarily selected among those defined in GSM 07.01 Annex II and corresponding to the Bearer Service / Teleservice being tested. The complete coding of the corresponding BC-IE(s) can be found in section 11.8.

- e) Step d) is repeated for all Bearer Services / Teleservices not declared as supported by the MS.

11.1.1.5 Test requirement

- 1) After steps a), b) and c), the MS shall send a CALL CONFIRMED message. The MS may contain a single or dual BC-IE. If present these IEs are not checked.
- 2) After steps d) and e), the MS shall send a RELEASE COMPLETE message with cause value 88 - incompatible destination.

11.1.2 Mobile Originated (MO) calls

11.1.2.1 Definition and applicability

This test applies to all MS able to initiate an MO call. It is repeated for all Mobile Originated Bearer Services / Teleservices according to GSM 02.02 and GSM 02.03 except Teleservices 21, 22 and 23, which are supported by the MS.

11.1.2.2 Conformance requirement

1. The MS shall set up a call with a SETUP message containing a single or multiple BC-IE and if required by the service, a single or multiple LLC according to the actual configuration of the MS. Two bearer capabilities can be present only in the cases described in GSM 07.01.

GSM 04.08, 5.2.2.2; GSM 04.08, 5.2.2.3.1; GSM 04.08, 9.3.2; GSM 07.01, 8.3.3.

2. The Repeat Indicator Information Element shall be included in the SETUP message, when the in-call modification procedure is used.

GSM 04.08, 9.3.2.

11.1.2.3 Test purpose

1. To verify that the MS generates a SETUP message which includes a single or multiple Bearer Capability and if required by the service, a single or multiple LLC, according to the actual configuration on the MS.

This is verified for all Mobile Originated Bearer Services / Teleservices described in GSM 07.01 and declared as supported by the MS.

2. To verify that the MS includes a correctly encoded Repeat Indicator if it includes multiple Bearer Capabilities in the SETUP message.

11.1.2.4 Method of test

11.1.2.4.1 Initial conditions

If possible, the MS shall be configured to initiate an outgoing call with a specified BC and with the corresponding LLC when the ITC value is "unrestricted digital" in the SETUP message. The manufacturer must state how this is done in a PIXIT statement. The same applies to features which must be activated by MMI before an outgoing call can be initiated.

The PIXIT statement for the service in question shall be consistent with the PICS statement made by the manufacturer and will result for this test in one valid BC coding as presented in section 11.8.

11.1.2.4.2 Procedure

- a) The MS shall be made to initiate a call.
- b) If the MS can be configured to send a specific BC, the test is repeated with the MS configured for all possible preferred Bearer Services and Teleservices declared as supported by the MS. The complete coding of the corresponding BC-IE(s) can be found in section 11.8.

11.1.2.5 Test requirement

The MS shall send a SETUP message, which shall contain the BC among those declared as supported by the MS. If the MS is configured to send a specific BC, the SETUP message shall contain this particular BC. The BC-IE(s) shall be set according to GSM 07.01. When an ITC value is set to "unrestricted digital" the MS shall include the corresponding LLC information element.

Where two BCs are contained in the SETUP message, it shall be checked that the combination is allowed, according to GSM 07.01 and that a Repeat Indicator is also included.

11.2 Verification of support of the single numbering scheme

11.2.1 Definition and applicability

This test applies to all MS.

11.2.2 Conformance requirement

1. The MS shall respond to a SETUP message containing no BC-IE with a CALL CONFIRMED message including the single or multiple Bearer Capability, according to the actual configuration of the MS. Two bearer capabilities can be present only in the cases described in GSM 07.01.

GSM 04.08, 5.2.2.2; GSM 04.08, 5.2.2.3.1; GSM 04.08, 9.3.2; GSM 07.01, 8.3.3

2. The Repeat Indicator Information Element shall be included in the CALL CONFIRMED message, when the in-call modification procedure is used, and no Bearer Capability Information Element is included in the received SETUP message.

GSM 04.08, 9.3.2

11.2.3 Test purpose

1. To verify that the MS, for the case of the Single Numbering Scheme, accepts a SETUP message, where the Information Elements for Bearer Capability and Lower and Higher Layer Compatibility are not present by sending a CALL CONFIRMED message, which includes the single or multiple Bearer Capabilities, according to the actual configuration on the MS.

This is verified for one Mobile Terminated Bearer Service / Teleservice described in GSM 07.01 and declared as supported by the MS.

2. To verify that the MS includes a correctly encoded Repeat Indicator if it includes multiple Bearer Capabilities in the CALL CONFIRMED message.

11.2.4 Method of test

11.2.4.1 Initial conditions

The MS is setup to receive a call. If possible, the MS shall be configured to respond to an incoming call with a specified BC selected arbitrarily from those declared as supported by the MS, in the CALL CONFIRMED message, in reply to a SETUP message with no BC, LLC or HLC elements. The manufacturer must state how this is done in a PIXIT statement. The same applies to features which must be activated by MMI before an incoming call can be accepted.

The generic call set-up procedure shall be followed up to and including the reception of the CIPHERING MODE COMPLETE message from the MS.

The PIXIT statement for the service in question shall be consistent with the PICS statement made by the manufacturer and will result for this tests in one or several valid BC codings as presented in section 11.8.

11.2.4.2 Procedure

The SS transmits a SETUP message with no BC, LLC or HLC elements.

11.2.5 Test requirement

The MS shall send a CALL CONFIRMED message, which shall contain the BC among those declared as supported by the MS. If the MS is configured to respond with a specific BC, the CALL CONFIRMED message shall contain this particular BC. The BC-IE shall be coded according to GSM 07.01.

Where two BCs are contained in the CALL CONFIRMED message, it shall be checked that the combination is allowed, according to GSM 07.01 and that a Repeat Indicator is also included.

11.3 Verification of non-support of services (Advice of Charge Charging (AoCC))

11.3.1 Definition and applicability

This test applies to MS which do **not** support AoCC.

Test procedures (a) and (b) apply to MS which support MT calls.

Test procedure (c) applies to MS which support MO calls.

Test procedure (d) applies to MS which support at least one circuit switched basic service.

11.3.2 Conformance requirement

1. An MS claiming to **not** support AoCC and in the outgoing call / U4 call delivered state, on receipt of a CONNECT message containing AoCC information shall acknowledge the CONNECT message but ignore and not acknowledge the AoCC information sent within the CONNECT.
2. An MS claiming to **not** support AoCC and in the outgoing call / U4 call delivered state, on receipt of a FACILITY message containing AoCC information shall ignore and not acknowledge the AoCC information contained within the FACILITY.
3. An MS claiming to **not** support AoCC and in the incoming call / U9 call confirmed state, on receipt of a FACILITY message containing AoCC information shall ignore and not acknowledge the AoCC information contained within the FACILITY.
4. An MS claiming to **not** support AoCC and in the U10 call active state, on receipt of a FACILITY message containing AoCC information shall ignore and not acknowledge the AoCC information contained within the FACILITY.

GSM 03.86 sections 1.2, 1.3, 2.2, 2.3; GSM 04.86 section 2.

11.3.3 Test purpose

1. To verify that an MS claiming to **not** support AoCC and in the outgoing call / U4 call delivered state, on receipt of a CONNECT message containing AoCC information acknowledges the CONNECT message but ignores and does not acknowledge the AoCC information sent within the CONNECT.
2. To verify that an MS claiming to **not** support AoCC and in the outgoing call / U4 call delivered state, on receipt of a FACILITY message containing AoCC information ignores and does not acknowledge the AoCC information contained within the FACILITY.
3. To verify that an MS claiming to not support AoCC and in the incoming call / U9 call confirmed state, on receipt of a FACILITY message containing AoCC information ignores and does not acknowledge the AoCC information contained within the FACILITY.
4. To verify that an MS claiming to **not** support AoCC and in the U10 call active state, on receipt of a FACILITY message containing AoCC information ignores and does not acknowledge the AoCC information contained within the FACILITY.

11.3.4 Method of test

11.3.4.1 Initial conditions

The generic call set up procedures are followed up to and including the reception, or transmission, of the ALERTING message by the MS.

11.3.4.2 Procedure

- a) For an Mobile Originated call in the U4 state the SS transmits CONNECT containing AoCC information.
- b) For an Mobile Originated call in the U4 state the SS transmits FACILITY containing AoCC information.
- c) For an Mobile Terminated call in the U9 state the SS transmits a FACILITY containing AoCC information.
- d) For a call in the U10 state the SS transmits a FACILITY containing AoCC information

11.3.5 Test requirement

The MS shall ignore the AoCC information sent to it in the Facility information elements as part of the CONNECT/FACILITY messages and not send any AoCC information acknowledgement. It shall be checked for 15 seconds that the MS does not transmit any AoCC information acknowledgement after the receipt of AoCC information.

11.4 Verification of non-support of services (call hold)

11.4.1 Definition and applicability

Applicable to MS which do **not** support the Call-Hold supplementary service. This test applies only to MSs that claim to support AoCC. This test applies only to MS which support MO calls.

11.4.2 Conformance requirement

An MS claiming to **not** support the Call Hold supplementary service and in the U10 call active state shall, when the appropriate Call Hold MMI command is entered:

- Fail to put the first call on hold.
- Fail to place the second call.
- Optionally provide some indication to the user of an error.

GSM 02.83; GSM 04.83

11.4.3 Test purpose

To verify that an MS claiming to **not** support the Call Hold supplementary service and in the U10 call active state, reacts in the following manner when the appropriate call hold MMI command is entered:

- MS fails to put the first call on hold
- MS fails to place the second call.
- Optionally provides some indication to the user of an error.

11.4.4 Method of test

11.4.4.1 Initial conditions

The mobile originating generic call set up procedures shall be followed up to and including the transmission by the MS of the CONNECT ACKNOWLEDGE to place the call in the U10 call active state.

11.4.4.2 Procedure

A second directory number is entered followed by "SEND" via the MMI.

11.4.5 Test requirement

The MS shall not send any HOLD messages on the dedicated channel. This is checked for 3 seconds.

The MS may however send other messages.

The MS may also give the user an indication of the error that has occurred.

11.5 Verification of non-support of services (multiparty)

11.5.1 Definition and applicability

Applicable for MSs that support the Call-Hold supplementary service but **not** the MultiParty supplementary service. This test applies only to MSs that support AoCC. This test applies only to MS which support MO calls.

11.5.2 Conformance requirement

An MS claiming to not support the MultiParty supplementary service and in the U10 call active state with one call and in the held state with another call shall, when the appropriate MultiParty MMI command is entered:

- Fail to combine the three parties in a MultiParty call.
- Optionally provide some indication to the user of an error.

GSM 02.83, 02.84; GSM 04.83, GSM 04.84.

11.5.3 Test purpose

To verify that an MS claiming to not support the MultiParty supplementary service and in the U10 call active state with one call and another call on hold, reacts in the following manner when the appropriate MultiParty MMI command is entered:

- Fails to combine the three parties in a MultiParty call.
- Optionally provides some indication to the user of an error.

11.5.4 Method of test

11.5.4.1 Initial conditions

The mobile originating generic call set up procedures shall be followed up to and including the transmission by the MS of the CONNECT ACKNOWLEDGE to place the call in the U10 call active state. A second directory number is then entered followed by send to put the first call on hold and place a second call.

11.5.4.2 Procedure

"3" followed by "SEND" is entered via the MMI.

11.5.5 Test requirement

The MS shall not send a FACILITY message, containing the build multiparty request, on the dedicated channel. This is checked for 3 seconds.

The MS may however send other messages.

The MS may also give the user an indication of the error that has occurred.

11.6 Verification of non-support of feature (Fixed Dialling Number (FDN))

11.6.1 Definition and applicability

This test applies to MS which do **not** support FDN. This test applies only to MS which support MO calls.

11.6.2 Conformance requirement

1. An MS claiming to **not** support FDN that has a SIM with FDN allocated and activated in its SIM Service Table (Service Number 3) and has FDN "enabled" shall refuse a request from the user to attempt an outgoing call.
2. An MS claiming to **not** support FDN that has a SIM with FDN allocated and activated in its SIM Service Table (Service Number 3) and has FDN "enabled" shall not respond to paging.
3. An MS claiming **not** to support FDN that has a SIM with FDN allocated and activated shall not attempt to rehabilitate the IMSI and Location Information Elementary Files of the SIM.

GSM 02.07 section B3.2, GSM 11.11 section 11.2.1.

11.6.3 Test purpose

1. To verify that an MS claiming to **not** support FDN and that has a SIM with FDN allocated and activated in its SIM Service Table and has FDN "enabled". i.e. AND, IMSI and Location Information Elementary Files are Invalidated inserted, it refuses an attempt to make an outgoing call made by the user.
2. To verify that an MS claiming to **not** support FDN and that has a SIM with FDN allocated and activated in its SIM Service Table and has FDN "enabled". i.e. AND, IMSI and Location Information Elementary Files are Invalidated inserted, it does not answer to paging.
3. To verify that an MS claiming **not** to support FDN and that has a SIM with FDN allocated and activated in its SIM Service Table and has FDN "enabled". i.e. AND, IMSI and Location Information Elementary Files are Invalidated inserted, does not attempt to rehabilitate IMSI and Location Information.

11.6.4 Method of test

11.6.4.1 Initial conditions

The ME is powered off. No SIM is inserted in the ME.

11.6.4.2 Procedure

- a) A SIM with FDN allocated and activated in its SIM Service Table and has FDN "enabled" is inserted in the ME and the MS is powered on.
- b) An outgoing CM connection is attempted by the user.
- c) The MS paged with its IMSI.
- d) The MS is powered off and the SIM is examined using a suitable tool to determine if the IMSI and Location Information Elementary Files have been Rehabilitated.

11.6.5 Test requirement

- 1) in step b), the MS shall not send a CHANNEL REQUEST message.
- 2) in step c), the MS shall not send a CHANNEL REQUEST message.
- 3) in step d), the IMSI and Location Information Elementary Files shall be Invalidated.

11.7 IMEI Security

11.7.1 Conformance requirements

The IMEI shall not be changed after the ME's final production process. It shall resist tampering, i.e. manipulation and change, by any means (e.g. physical, electrical and software).

NOTE: This requirement is valid for new GSM Phase 2 and Release 96, 97, 98 and 99 MEs type approved after 1st June 2002.

02.09, 02.16, 03.03

11.7.2 Test purpose

To verify the conformance requirement.

11.7.3 Method of test

Not available.

11.7.4 Declaration

The manufacturer shall declare that :

He has taken necessary and sufficient steps to ensure that any individual or organisation cannot economically change the IMEI after the ME's final production process.

And that the IMEI resists tampering, i.e. manipulation and change, by any means (e.g. physical, electrical and software).

11.8 Coding of the Bearer Capability information element

This section describes the coding of the bearer capability IE in a SETUP and in a CALL CONFIRMED message according to GSM 07.01 and GSM 04.08.

More precisely, the matter of section 11.8.1 is the coding of the bearer capability IE in a mobile terminating SETUP and section 11.8.2 deals with the coding of the bearer capability IE in a mobile originating SETUP and in a CALL CONFIRMED message.

In the whole section "x", "y" and "X" have the following meanings:

- when a field is coded with values of "x", it means that several bit combinations are authorized and the allowable ones are described in the relevant paragraph or section;
- "y" means that the value of the spare bit can be set to either 0 or 1 at the sending side and that the receiving side shall accept either of these values;
- "X" in the hexadecimal coding of the Bearer Capability IE reflects all the possible values taken by an octet taking account of the number of bits coded as "x" or "y" and their place in the octet.

11.8.1 Network to MS Direction

11.8.1.1 BS 21 to 26 - Asynchronous Service

11.8.1.1.1 BS 21

11.8.1.1.1.1 3,1 kHz Audio, Transparent

BC GSM = 04 07 AX X8 81 21 X1 4X 81

Octet 1	0	0	0	0	0	1	0	0	Information Element: Bearer Capability
Octet 2	0	0	0	0	0	1	1	1	Length
Octet 3	1	y	y	0	0	0	1	0	Extension Radio Channel Requirement: Spare Coding Standard: GSM Transfer Mode: Circuit Info. Transfer Cap.: 3,1 kHz Audio
Octet 4	1	y	1	1	1	0	0	0	Extension Spare Structure: Unstructured Duplex Mode: Full duplex Configuration: Point to Point Negotiation of Intermediate Rate Requested: No meaning Establishment: Demand
Octet 5	1	0	0	0	0	0	0	1	Extension Access Id Rate Adaptation: No Signalling Access Protocol: I.440 / I.450
Octet 6	0	0	1	0	0	0	0	1	Extension Layer 1 Id: Default User Information Layer 1 Protocol Synchronous / Asynchronous: Asynchronous
Octet 6a	0	x	0	x	0	0	0	1	Extension Number of Stop Bits, Depending of the TE Configuration Negotiation: In band Negotiation not possible Number of Data Bits, Depending of the TE Configuration User Rate: 0,3 kbit/s
Octet 6b	0	1	0	0	0	x	x	x	Extension Intermediate Rate: 8kbit/s NIC on TX: Not Required NIC on RX: Not Supported Parity, Depending of the TE Configuration
Octet 6c	1	0	0	0	0	0	0	1	Extension Connection Element: Transparent Modem Type: V.21

The following configuration is also authorized:

Structure in Octet 4:	-	0	0	-	-	-	-	-	SDU Integrity
Intermediate rate in Octet 6b:	-	1	1	-	-	-	-	-	16 kbit/s
Connection element in Octet 6c:	-	1	x	-	-	-	-	-	Both T or NT preferred

11.8.1.1.1.2 3,1 kHz Audio, Non Transparent

BC GSM = 04 0X X2 XX 81 21 X1 6X A1 (CX)

Octet 1	0	0	0	0	0	1	0	0	Information Element: Bearer Capability
Octet 2	0	0	0	0	x	x	x	x	Length (7 or 8) depending on presence of octet 7.
Octet 3	1	y	y	0	0	0	1	0	Extension Radio Channel Requirement: Spare Coding Standard: GSM Transfer Mode: Circuit Info. Transfer Cap.: 3,1 kHz Audio
Octet 4	1	y	0	0	1	0	x	0	Extension Spare Structure: SDU Integrity Duplex Mode: Full duplex Configuration: Point to Point Negotiation of Intermediate Rate Requested Establishment: Demand
Octet 5	1	0	0	0	0	0	0	1	Extension Access Id Rate Adaptation: No Signalling Access Protocol: I.440 / I.450
Octet 6	0	0	1	0	0	0	0	1	Extension Layer 1 Id: Default User Information Layer 1 Protocol Synchronous / Asynchronous: Asynchronous
Octet 6a	0	x	0	x	0	0	0	1	Extension Number of Stop Bits, Depending of the TE Configuration Negotiation: In band Negotiation not possible Number of Data Bits, Depending of the TE Configuration User Rate: 0,3 kbit/s
Octet 6b	0	1	1	0	0	x	x	x	Extension Intermediate Rate: 16kbit/s NIC on TX: Not Required NIC on RX: Not Supported Parity, Depending of the TE Configuration
Octet 6c	1	0	1	0	0	0	0	1	Extension Connection Element: Non transparent Modem Type: V.21
Octet 7 (NOTE 1)	1	1	0	0	1	x	0	0	Extension Layer 2 Id. User Inform. layer 2 protocol, Depending on the TE Configuration

NOTE 1: Because Modem Type is V.21, Octet7 shall be present.

Depending of the type of flow control supported by the TE, the coding of octet 7 is different. The value ISO 6429 (0 1000) means "Inband flow control" and the value COPnoFLCT (0 1100) means "No flow control".

The following configuration is also authorized:

Connection element in Octet 6c: - 1 x - - - - - - Both T or NT preferred

11.8.1.1.1.3 UDI, Transparent

BC GSM = 04 07 X1 X8 89 21 X1 4X 80

Octet 1	0	0	0	0	0	1	0	0	Information Element: Bearer Capability
Octet 2	0	0	0	0	0	1	1	1	Length
Octet 3	1	y	y	0	0	0	0	1	Extension Radio Channel Requirement: Spare Coding Standard: GSM Transfer Mode: Circuit Info. Transfer Cap.: UDI
Octet 4	1	y	1	1	1	0	0	0	Extension Spare Structure: Unstructured Duplex Mode: Full duplex Configuration: Point to Point Negotiation of Intermediate Rate Requested: No meaning Establishment: Demand
Octet 5	1	0	0	0	1	0	0	1	Extension Access Id Rate Adaptation: V.110 Signalling Access Protocol: I.440 / I.450
Octet 6	0	0	1	0	0	0	0	1	Extension Layer 1 Id: Default User Information Layer 1 Protocol Synchronous / Asynchronous: Asynchronous
Octet 6a	0	x	0	x	0	0	0	1	Extension Number of Stop Bits, Depending of the TE Configuration Negotiation: In band Negotiation not possible Number of Data Bits, Depending of the TE Configuration User Rate: 0,3 kbit/s
Octet 6b	0	1	0	0	0	x	x	x	Extension Intermediate Rate: 8kbit/s NIC on TX: Not Required NIC on RX: Not Supported Parity, Depending of the TE Configuration
Octet 6c	1	0	0	0	0	0	0	0	Extension Connection Element: Transparent Modem Type: None

The following configuration is also authorized:

Structure in Octet 4:	-	0	0	-	-	-	-	-	SDU Integrity
Intermediate rate in Octet 6b:	-	1	1	-	-	-	-	-	16 kbit/s
Connection element in Octet 6c:	-	1	x	-	-	-	-	-	Both T or NT preferred

11.8.1.1.1.4 UDI, Non Transparent

BC GSM = 04 0X X1 XX 89 21 X1 6X A0 (CX)

Octet 1	0	0	0	0	0	1	0	0	Information Element: Bearer Capability
Octet 2	0	0	0	0	x	x	x	x	Length (7 or 8) depending on presence of octet 7.
Octet 3	1	y	y	0	0	0	0	1	Extension Radio Channel Requirement : Spare Coding Standard: GSM Transfer Mode: Circuit Info. Transfer Cap.: UDI
Octet 4	1	y	0	0	1	0	x	0	Extension Spare Structure: SDU Integrity Duplex Mode: Full duplex Configuration: Point to Point Negotiation of Intermediate Rate Requested Establishment: Demand
Octet 5	1	0	0	0	1	0	0	1	Extension Access Id Rate Adaptation: V.110 Signalling Access Protocol: I.440 / I.450
Octet 6	0	0	1	0	0	0	0	1	Extension Layer 1 Id: Default User Information Layer 1 Protocol Synchronous / Asynchronous: Asynchronous
Octet 6a	0	x	0	x	0	0	0	1	Extension Number of Stop Bits, Depending of the TE Configuration Negotiation: In band Negotiation not possible Number of Data Bits, Depending of the TE Configuration User Rate: 0,3 kbit/s
Octet 6b	0	1	1	0	0	x	x	x	Extension Intermediate Rate: 16kbit/s NIC on TX: Not Required NIC on RX: Not Supported Parity, Depending of the TE Configuration
Octet 6c	1	0	1	0	0	0	0	0	Extension Connection Element: Non Transparent Modem Type: None
Octet 7 (need not be present)	1	1	0	0	1	x	0	0	Extension Layer 2 Id. User Inform. layer 2 protocol, Depending of the TE Configuration

Depending of the type of flow control supported by the TE, octet 7 is present or not. If not present, it means "outband flow control". If octet 7 is present, the value ISO 6429 (0 1000) means "Inband flow control" and the value COPnoFLCT (0 1100) means "No flow control".

The following configuration is also authorized:

Connection element in Octet 6c: - 1 x - - - - - Both T or NT preferred

11.8.1.1.2 BS 22

Same as BS 21 except

	User Rate in Octet 6a:	-	-	-	-	0	0	1	0	1,2 kbit/s
If different from "none",	Modem Type Octet 6c:	-	-	-	0	0	0	1	0	Modem V.22

In case of 3,1kHz Audio non transparent service, depending of the type of flow control supported by the TE, octet 7 is present or not. If not present, it means "outband flow control".

11.8.1.1.3 BS 24

Same as BS 21 except

	User Rate in Octet 6a:	-	-	-	-	0	0	1	1	2,4 kbit/s
If different from "none",	Modem Type Octet 6c:	-	-	-	0	0	0	1	1	Modem V.22bis

In case of 3,1kHz Audio non transparent service, depending of the type of flow control supported by the TE, octet 7 is present or not. If not present, it means "outband flow control".

11.8.1.1.4 BS 25

Same as BS 21 except

	User Rate in Octet 6a:	-	-	-	-	0	1	0	0	4,8 kbit/s
If different from "none",	Modem Type Octet 6c:	-	-	-	0	0	1	1	0	Modem V.32

In case of 3,1kHz Audio non transparent service, depending of the type of flow control supported by the TE, octet 7 is present or not. If not present, it means "outband flow control".

11.8.1.1.5 BS 26

Same as BS 21 except

	NIRR in Octet 4	-	-	-	-	-	-	0	-	no meaning
	User Rate in Octet 6a:	-	-	-	-	0	1	0	1	9,6 kbit/s
	Interm. Rate in Octet 6b:	-	1	1	-	-	-	-	-	16 kbit/s
If different from "none",	Modem Type Octet 6c:	-	-	-	0	0	1	1	0	Modem V.32

In case of 3,1kHz Audio non transparent service, depending of the type of flow control supported by the TE, octet 7 is present or not. If not present, it means "outband flow control".

11.8.1.1.6 BS 23

For MOC only.

11.8.1.2 BS 31 to 34 - Synchronous Service

11.8.1.2.1 BS 32

11.8.1.2.1.1 3,1 kHz Audio, Transparent, non-X.32 case

BC GSM = 04 07 X2 X8 81 20 13 43 83

Octet 1	0	0	0	0	0	1	0	0	Information Element: Bearer Capability
Octet 2	0	0	0	0	0	1	1	1	Length
Octet 3	1	y	y	0	0	0	1	0	Extension Radio Channel Requirement : Spare Coding Standard: GSM Transfer Mode: Circuit Info. Transfer Cap.: 3,1 kHz Audio
Octet 4	1	y	1	1	1	0	0	0	Extension Spare Structure: Unstructured Duplex Mode: Full duplex Configuration: Point to Point Negotiation of Intermediate Rate Requested: No meaning Establishment: Demand
Octet 5	1	0	0	0	0	0	0	1	Extension Access Id Rate Adaptation: No Signalling Access Protocol: I.440 / I.450
Octet 6	0	0	1	0	0	0	0	0	Extension Layer 1 Id: Default User Information Layer 1 Protocol Synchronous / Asynchronous: Synchronous
Octet 6a	0	0	0	1	0	0	1	1	Extension Number of Stop Bits: NA Negotiation: In band Negotiation not possible Number of Data Bits: NA User Rate: 2,4 kbit/s
Octet 6b	0	1	0	0	0	0	1	1	Extension Intermediate Rate: 8kbit/s NIC on TX: Not Required NIC on RX: Not Supported Parity: NA
Octet 6c	1	0	0	0	0	0	1	1	Extension Connection Element: Transparent Modem Type: V.22 bis

11.8.1.2.1.3 3,1 kHz Audio, Transparent mode, X.32 case (Packet Service)

BC GSM = 04 07 X2 X8 86 20 13 43 83

Octet 1	0	0	0	0	0	1	0	0	Information Element: Bearer Capability
Octet 2	0	0	0	0	0	1	1	1	Length
Octet 3	1	y	y	0	0	0	1	0	Extension Radio Channel Requirement : Spare Coding Standard: GSM Transfer Mode: Circuit Info. Transfer Cap.: 3,1 kHz Audio
Octet 4	1	y	1	1	1	0	0	0	Extension Spare Structure: unstructured Duplex Mode: Full duplex Configuration: Point to Point Negotiation of Intermediate Rate Requested: No meaning Establishment: Demand
Octet 5	1	0	0	0	0	1	1	0	Extension Access Id Rate Adaptation: No Signalling Access Protocol: X.32
Octet 6	0	0	1	0	0	0	0	0	Extension Layer 1 Id: Default User Information Layer 1 Protocol Synchronous / Asynchronous: Synchronous
Octet 6a	0	0	0	1	0	0	1	1	Extension Number of Stop Bits: NA Negotiation: In band Negotiation not possible Number of Data Bits: NA User Rate: 2,4 kbit/s
Octet 6b	0	1	0	0	0	0	1	1	Extension Intermediate Rate: 8kbit/s NIC on TX: Not Required NIC on RX: Not Supported Parity: NA
Octet 6c	1	0	0	0	0	0	1	1	Extension Connection Element: Transparent Modem Type: V.22 bis

The following configuration is also authorized:

Structure in Octet 4:	-	0	0	-	-	-	-	-	SDU Integrity
Intermediate rate in Octet 6b:	-	1	1	-	-	-	-	-	16 kbit/s
Connection element in Octet 6c:	-	1	x	-	-	-	-	-	Both T or NT preferred
UIL2P in Octet 7	-	-	-	0	0	1	1	0	X.25

11.8.1.2.1.4 3,1 kHz Audio, Non Transparent mode, X.32 case (Packet Service)

BC GSM = 04 07 X2 XX 86 20 13 63 A3 C6

Octet 1	0	0	0	0	0	1	0	0	Information Element: Bearer Capability
Octet 2	0	0	0	0	1	0	0	0	Length
Octet 3	1	y	y	0	0	0	1	0	Extension Radio Channel Requirement : Spare Coding Standard: GSM Transfer Mode: Circuit Info. Transfer Cap.: 3,1 kHz Audio
Octet 4	1	y	0	0	1	0	x	0	Extension Spare Structure: SDU integrity Duplex Mode: Full duplex Configuration: Point to Point Negotiation of Intermediate Rate Requested Establishment: Demand
Octet 5	1	0	0	0	0	1	1	0	Extension Access Id Rate Adaptation: No Signalling Access Protocol: X.32
Octet 6	0	0	1	0	0	0	0	0	Extension Layer 1 Id: Default User Information Layer 1 Protocol Synchronous / Asynchronous: Synchronous
Octet 6a	0	0	0	1	0	0	1	1	Extension Number of Stop Bits: NA Negotiation: In band Negotiation not possible Number of Data Bits: NA User Rate: 2,4 kbit/s
Octet 6b	0	1	1	0	0	0	1	1	Extension Intermediate Rate: 16kbit/s NIC on TX: Not Required NIC on RX: Not Supported Parity: NA
Octet 6c	1	0	1	0	0	0	1	1	Extension Connection Element: Non Transparent Modem Type: V.22 bis
Octet 7	1	1	0	0	0	1	1	0	Extension Layer 2 Id. X.25

The following configuration is also authorized:

Connection element in Octet 6c: - 1 x - - - - - Both T or NT preferred

11.8.1.2.1.5 UDI, Non Transparent mode, X.32 case (Packet Service)

BC GSM = 04 08 X1 XX 96 20 13 63 A0 C6

Octet 1	0	0	0	0	0	1	0	0	Information Element: Bearer Capability
Octet 2	0	0	0	0	1	0	0	0	Length
Octet 3	1	y	y	0	0	0	0	1	Extension Radio Channel Requirement : Spare Coding Standard: GSM Transfer Mode: Circuit Info. Transfer Cap.: UDI
Octet 4	1	y	0	0	1	0	x	0	Extension Spare Structure: SDU integrity Duplex Mode: Full duplex Configuration: Point to Point Negotiation of Intermediate Rate Requested Establishment: Demand
Octet 5	1	0	0	1	0	1	1	0	Extension Access Id Rate Adaptation: X.31 flagstuffing Signalling Access Protocol: X.32
Octet 6	0	0	1	0	0	0	0	0	Extension Layer 1 Id: Default User Information Layer 1 Protocol Synchronous / Asynchronous: Synchronous
Octet 6a	0	0	0	1	0	0	1	1	Extension Number of Stop Bits: NA Negotiation: In band Negotiation not possible Number of Data Bits: NA User Rate: 2,4 kbit/s
Octet 6b	0	1	1	0	0	0	1	1	Extension Intermediate Rate: 16kbit/s NIC on TX: Not Required NIC on RX: Not Supported Parity: NA
Octet 6c	1	0	1	0	0	0	0	0	Extension Connection Element: Non Transparent Modem Type: None
Octet 7	1	1	0	0	0	1	1	0	Extension Layer 2 Id. X.25

11.8.1.2.2 BS 31

For non X.32 case only, same as BS 32 except

	User Rate in Octet 6a:	-	-	-	-	0	0	1	0	1,2 kbit/s
If different from "none",	Modem Type Octet 6c:	-	-	-	0	0	0	1	0	Modem V.22

BS31 for Packet Service does not exist.

11.8.1.2.3 BS 33

Same as BS 32 except

	User Rate in Octet 6a:	-	-	-	-	0	1	0	0	4,8 kbit/s
If different from "none",	Modem Type Octet 6c:	-	-	-	0	0	1	1	0	Modem V.32

11.8.1.2.4 BS 34

Same as BS 32 except

	NIRR in Octet 4	-	-	-	-	-	-	0	-	no meaning
	User Rate in Octet 6a:	-	-	-	-	0	1	0	1	9,6 kbit/s
	Interm. Rate in Octet 6b:	-	1	1	-	-	-	-	-	16 kbit/s
If different from "none",	Modem Type Octet 6c:	-	-	-	0	0	1	1	0	Modem V.32

11.8.1.3 BS 61 - Alternate Speech / Data

The first BC in the Setup message is coded "Speech": 04 01 A0

The repeat Indicator in the Setup message is coded "Circular for successive selection (alternate)": D1

The second BC in the Setup message is coded as described below.

11.8.1.3.1 Speech/Asynchronous Data, Transparent

BC GSM = 04 07 X2 X8 81 21 XX XX 8X

Octet 1	0	0	0	0	0	1	0	0	Information Element: Bearer Capability
Octet 2	0	0	0	0	0	1	1	1	Length
Octet 3	1	y	y	0	0	0	1	0	Extension Radio Channel Requirement : Spare Coding Standard: GSM Transfer Mode: Circuit Info. Transfer Cap.: 3,1 kHz Audio
Octet 4	1	y	1	1	1	0	0	0	Extension Spare Structure: Unstructured Duplex Mode: Full duplex Configuration: Point to Point Negotiation of Intermediate Rate Requested: No meaning Establishment: Demand
Octet 5	1	0	0	0	0	0	0	1	Extension Access Id Rate Adaptation: No Signalling Access Protocol: I.440 / I.450
Octet 6	0	0	1	0	0	0	0	1	Extension Layer 1 Id: Default User Information Layer 1 Protocol Synchronous / Asynchronous: Asynchronous
Octet 6a	0	x	0	x	x	x	x	x	Extension Number of Stop Bits, Depending of the TE Configuration Negotiation: In band Negotiation not possible Number of Data Bits, Depending of the TE Configuration User Rate
Octet 6b	0	1	x	0	0	x	x	x	Extension Intermediate Rate NIC on TX: Not Required NIC on RX: Not Supported Parity, Depending of the TE Configuration
Octet 6c	1	0	0	0	x	x	x	x	Extension Connection Element: Transparent Modem Type

Depending of the user rate supported by the MS, the user rate, the modem type and the intermediate rate change:

User Rate in Octet 6a:	-	-	-	-	0	0	0	1	0,3 kbit/s
Intermediate rate in Octet 6b:	-	1	0	-	-	-	-	-	8 kbit/s
Modem type in Octet 6c:	-	-	-	0	0	0	0	1	Modem V.21

User Rate in Octet 6a:	-	-	-	-	0	0	1	0	1,2 kbit/s
Intermediate rate in Octet 6b:	-	1	0	-	-	-	-	-	8 kbit/s
Modem type in Octet 6c:	-	-	-	0	0	0	1	0	Modem V.22

User Rate in Octet 6a:	-	-	-	-	0	0	1	1	2,4 kbit/s
Intermediate rate in Octet 6b:	-	1	0	-	-	-	-	-	8 kbit/s
Modem type in Octet 6c:	-	-	-	0	0	0	1	1	Modem V.22bis

User Rate in Octet 6a:	-	-	-	-	0	1	0	0	4,8 kbit/s
Intermediate rate in Octet 6b:	-	1	0	-	-	-	-	-	8 kbit/s
Modem type in Octet 6c:	-	-	-	0	0	1	1	0	Modem V.32

NIRR in Octet 4	-	-	-	-	-	-	0	-	no meaning
User Rate in Octet 6a:	-	-	-	-	0	1	0	1	9,6 kbit/s
Intermediate rate in Octet 6b:	-	1	1	-	-	-	-	-	16 kbit/s
Modem type in Octet 6c:	-	-	-	0	0	1	1	0	Modem V.32

The following configuration is also authorized:

Structure in Octet 4:	-	0	0	-	-	-	-	-	SDU Integrity
Intermediate rate in Octet 6b:	-	1	1	-	-	-	-	-	16 kbit/s
Connection element in Octet 6c:	-	1	x	-	-	-	-	-	Both T or NT preferred
User Information L2 Protocol (see Non Transparent service)									

11.8.1.3.2 Speech/Asynchronous Data, Non Transparent

BC GSM = 04 0X X2 XX 81 21 XX 6X AX (CX)

Octet 1	0	0	0	0	0	1	0	0	Information Element: Bearer Capability
Octet 2	0	0	0	0	x	x	x	x	Length (7 or 8) depending on presence of octet 7.
Octet 3	1	y	y	0	0	0	1	0	Extension Radio Channel Requirement : Spare Coding Standard: GSM Transfer Mode: Circuit Info. Transfer Cap.: 3,1 kHz Audio
Octet 4	1	y	0	0	1	0	x	0	Extension Spare Structure: SDU Integrity Duplex Mode: Full duplex Configuration: Point to Point Negotiation of Intermediate Rate Requested Establishment: Demand
Octet 5	1	0	0	0	0	0	0	1	Extension Access Id Rate Adaptation: No Signalling Access Protocol: I.440 / I.450
Octet 6	0	0	1	0	0	0	0	1	Extension Layer 1 Id: Default User Information Layer 1 Protocol Synchronous / Asynchronous: Asynchronous
Octet 6a	0	x	0	x	x	x	x	x	Extension Number of Stop Bits, Depending of the TE Configuration Negotiation: In band Negotiation not possible Number of Data Bits, Depending of the TE Configuration User Rate
Octet 6b	0	1	1	0	0	x	x	x	Extension Intermediate Rate: 16kbit/s NIC on TX: Not Required NIC on RX: Not Supported Parity, Depending of the TE Configuration
Octet 6c	1	0	1	0	x	x	x	x	Extension Connection Element: Non transparent Modem Type
Octet 7 (may not be present)	1	1	0	0	1	x	0	0	Extension Layer 2 Id. User Inform. layer 2 protocol, Depending of the TE Configuration

Depending of the type of flow control supported by the TE, the coding of octet 7 is different. The value ISO 6429 (0 1000) means "Inband flow control" and the value COPnoFLCT (0 1100) means "No flow control". The "Outband Flow control is not allowed with V.21 modem).

Depending of the user rate supported by the MS, the user rate and the modem type change:

User Rate in Octet 6a:	-	-	-	-	0	0	0	1	0,3 kbit/s
Modem type in Octet 6c:	-	-	-	0	0	0	0	1	Modem V.21

	User Rate in Octet 6a:	-	-	-	-	0	0	1	0	1,2 kbit/s
	Modem type in Octet 6c:	-	-	-	0	0	0	1	0	Modem V.22

	User Rate in Octet 6a:	-	-	-	-	0	0	1	1	2,4 kbit/s
	Modem type in Octet 6c:	-	-	-	0	0	0	1	1	Modem V.22bis

	User Rate in Octet 6a:	-	-	-	-	0	1	0	0	4,8 kbit/s
	Modem type in Octet 6c:	-	-	-	0	0	1	1	0	Modem V.32

	NIRR in Octet 4	-	-	-	-	-	-	0	-	no meaning
	User Rate in Octet 6a:	-	-	-	-	0	1	0	1	9,6 kbit/s
	Modem type in Octet 6c:	-	-	-	0	0	1	1	0	Modem V.32

The following configuration is also authorized:

Connection element in Octet 6c: - 1 x - - - - - Both T or NT preferred

11.8.1.3.3 Speech/Synchronous Data

BC GSM = 04 07 X2 X8 81 20 1X X3 8X

Octet 1	0	0	0	0	0	1	0	0	Information Element: Bearer Capability
Octet 2	0	0	0	0	0	1	1	1	Length
Octet 3	1	y	y	0	0	0	1	0	Extension Radio Channel Requirement : Spare Coding Standard: GSM Transfer Mode: Circuit Info. Transfer Cap.: 3,1 kHz Audio
Octet 4	1	y	1	1	1	0	0	0	Extension Spare Structure: Unstructured Duplex Mode: Full duplex Configuration: Point to Point Negotiation of Intermediate Rate Requested: No meaning Establishment: Demand
Octet 5	1	0	0	0	0	0	0	1	Extension Access Id Rate Adaptation: No Signalling Access Protocol: I.440 / I.450
Octet 6	0	0	1	0	0	0	0	0	Extension Layer 1 Id: Default User Information Layer 1 Protocol Synchronous / Asynchronous: Synchronous
Octet 6a	0	0	0	1	x	x	x	x	Extension Number of Stop Bits: NA Negotiation: In band Negotiation not possible Number of Data Bits: NA User Rate
Octet 6b	0	1	x	0	0	0	1	1	Extension Intermediate Rate NIC on TX: Not Required NIC on RX: Not Supported Parity: NA
Octet 6c	1	0	0	0	x	x	x	x	Extension Connection Element: Transparent Modem Type

Depending of the user rate supported by the MS, the user rate, the modem type and the intermediate rate change:

User Rate in Octet 6a:	-	-	-	-	0	0	1	0	1,2 kbit/s
Intermediate rate in Octet 6b:	-	1	0	-	-	-	-	-	8 kbit/s
Modem type in Octet 6c:	-	-	-	0	0	0	1	0	Modem V.22

User Rate in Octet 6a:	-	-	-	-	0	0	1	1	2,4 kbit/s
Intermediate rate in Octet 6b:	-	1	0	-	-	-	-	-	8 kbit/s
Modem type in Octet 6c:	-	-	-	0	0	0	1	1	Modem V.22bis

	User Rate in Octet 6a:	-	-	-	-	0	1	0	0	4,8 kbit/s
	Intermediate rate in Octet 6b:	-	1	0	-	-	-	-	-	8 kbit/s
	Modem type in Octet 6c:	-	-	-	0	0	1	1	0	Modem V.32

	NIRR in Octet 4	-	-	-	-	-	-	0	-	no meaning
	User Rate in Octet 6a:	-	-	-	-	0	1	0	1	9,6 kbit/s
	Intermediate rate in Octet 6b:	-	1	1	-	-	-	-	-	16 kbit/s
	Modem type in Octet 6c:	-	-	-	0	0	1	1	0	Modem V.32

11.8.1.4 BS 81 - Speech followed by Data

The first BC in the Setup message is coded "Speech": 04 01 A0

The repeat Indicator in the Setup message is coded "Sequential for successive selection (followed by)": D3

The second BC in the Setup message is coded as described below.

11.8.1.4.1 Speech followed by Asynchronous Data

See chapters 11.8.1.3.1 and 11.8.1.3.2

11.8.1.4.2 Speech followed by Synchronous Data

See chapter 11.8.1.3.3

11.8.1.5 TS 61 - Alternate Speech / Facsimile group 3

The first BC in the Setup message is coded "Speech": 04 01 A0

The repeat Indicator in the Setup message is coded "Circular for successive selection (alternate)": D1

The second BC in the Setup message is coded as described below.

11.8.1.5.1 TS 61 - Alternate Speech / Facsimile group 3, Transparent

BC GSM = 04 07 X3 X8 81 20 1X X3 80

Octet 1	0	0	0	0	0	1	0	0	Information Element: Bearer Capability
Octet 2	0	0	0	0	0	1	1	1	Length
Octet 3	1	y	y	0	0	0	1	1	Extension Radio Channel Requirement : Spare Coding Standard: GSM Transfer Mode: Circuit Info. Transfer Cap.: FAX3
Octet 4	1	y	1	1	1	0	0	0	Extension Spare Structure: Unstructured Duplex Mode: Full duplex Configuration: Point to Point Negotiation of Intermediate Rate Requested: No meaning Establishment: Demand
Octet 5	1	0	0	0	0	0	0	1	Extension Access Id Rate Adaptation: No Signalling Access Protocol: NA
Octet 6	0	0	1	0	0	0	0	0	Extension Layer 1 Id: Default User Information Layer 1 Protocol Synchronous / Asynchronous: synchronous
Octet 6a	0	0	0	1	x	x	x	x	Extension Number of Stop Bits: NA Negotiation: In band Negotiation not possible Number of Data Bits: NA User Rate
Octet 6b	0	1	x	0	0	0	1	1	Extension Intermediate Rate NIC on TX: Not Required NIC on RX: Not Supported Parity: NA
Octet 6c	1	0	0	0	0	0	0	0	Extension Connection Element: Transparent Modem Type: None

Depending of the user rate supported by the MS, the user rate and the intermediate rate change:

User Rate in Octet 6a:	-	-	-	-	0	0	1	1	2,4 kbit/s
Intermediate rate in Octet 6b:	-	1	0	-	-	-	-	-	8 kbit/s

User Rate in Octet 6a:	-	-	-	-	0	1	0	0	4,8 kbit/s
Intermediate rate in Octet 6b:	-	1	0	-	-	-	-	-	8 kbit/s

NIRR in Octet 4	-	-	-	-	-	-	0	-	no meaning
User Rate in Octet 6a:	-	-	-	-	0	1	0	1	9,6 kbit/s
Intermediate rate in Octet 6b:	-	1	1	-	-	-	-	-	16 kbit/s

11.8.1.5.2 TS 61 - Alternate Speech / Facsimile group 3, Non-Transparent

BC GSM = 04 07 X3 XX 81 20 1X 63 X0

Octet 1	0	0	0	0	0	1	0	0	Information Element: Bearer Capability
Octet 2	0	0	0	0	0	1	1	1	Length
Octet 3	1	y	y	0	0	0	1	1	Extension Radio Channel Requirement : Spare Coding Standard: GSM Transfer Mode: Circuit Info. Transfer Cap.: FAX3
Octet 4	1	y	0	0	1	0	x	0	Extension Spare Structure: SDU integrity Duplex Mode: Full duplex Configuration: Point to Point Negotiation of Intermediate Rate Requested Establishment: Demand
Octet 5	1	0	0	0	0	0	0	1	Extension Access Id Rate Adaptation: No Signalling Access Protocol: NA
Octet 6	0	0	1	0	0	0	0	0	Extension Layer 1 Id: Default User Information Layer 1 Protocol Synchronous / Asynchronous: synchronous
Octet 6a	0	0	0	1	x	x	x	x	Extension Number of Stop Bits: NA Negotiation: In band Negotiation not possible Number of Data Bits: NA User Rate
Octet 6b	0	1	1	0	0	0	1	1	Extension Intermediate Rate: 16 kbit/s NIC on TX: Not Required NIC on RX: Not Supported Parity: NA
Octet 6c	1	x	x	0	0	0	0	0	Extension Connection Element Modem Type: None

Depending of the user rate supported by the MS, the MS may have the following values:

User Rate in Octet 6a:	-	-	-	-	0	0	1	1	2,4 kbit/s
------------------------	---	---	---	---	---	---	---	---	------------

User Rate in Octet 6a:	-	-	-	-	0	1	0	0	4,8 kbit/s
------------------------	---	---	---	---	---	---	---	---	------------

User Rate in Octet 6a:	-	-	-	-	0	1	0	1	9,6 kbit/s
------------------------	---	---	---	---	---	---	---	---	------------

Depending on the support or not of both modes, Non Transparent and Transparent, the connection element field may have the following values:

Connection element in Octet 6c:	-	0	1	-	-	-	-	-	-	Non transparent
---------------------------------	---	---	---	---	---	---	---	---	---	-----------------

Connection element in Octet 6c:	-	1	x	-	-	-	-	-	-	Both T or NT preferred
---------------------------------	---	---	---	---	---	---	---	---	---	------------------------

If present, Octet 7 shall have the following value:

Octet 7	1	1	0	0	0	1	1	0	Extension Layer 2 id X.25
---------	---	---	---	---	---	---	---	---	---------------------------

11.8.1.6 TS 62 - Automatic Facsimile group 3

The repeat Indicator in the Setup message is not available.

The BC GSM is coded as described in chapter 11.8.1.5.

11.8.2 MS to SS direction

In the whole section 11.8.2, “1)” and “2)” stand for:

1) Not applicable in a CALL CONFIRMED message.

2) Not applicable in a CALL CONFIRMED message responding to a SETUP message with no BC-IE (PSTN-originated call with single numbering scheme).

If the MS supports only Full Rate

Radio Channel Requirement in Octet 3:	-	0	1	-	-	-	-	-	Full rate support only mobile station
---------------------------------------	---	---	---	---	---	---	---	---	---------------------------------------

Else

Radio Channel Requirement in Octet 3:	-	1	x	-	-	-	-	-	Dual rate mobile station
---------------------------------------	---	---	---	---	---	---	---	---	--------------------------

11.8.2.1 BS 21 to 26 - Asynchronous Service

If the MS supports only SAP I.440/I.450

SAP in Octet 5:	-	-	-	-	-	0	0	1	I.440/I.450
-----------------	---	---	---	---	---	---	---	---	-------------

If the MS supports only SAP X.28 non dedicated PAD

SAP in Octet 5:	-	-	-	-	-	1	0	1	X.28 nond
-----------------	---	---	---	---	---	---	---	---	-----------

Else

SAP in Octet 5:	-	-	-	-	-	x	0	1	I.440/I.450 or X.28 nond
-----------------	---	---	---	---	---	---	---	---	--------------------------

The use of the alternative configuration “Autobauding modem type 1” in BS 22 to BS 26 is the same as indicated for BS 21 in clause 11.8.2.1.1.1 and 11.8.2.1.1.2.

11.8.2.1.1 BS 21

11.8.2.1.1.1 3,1 kHz Audio, Transparent

BC GSM = 04 0X X2 X8 8X 21 X1 XX X1 (CX)

Octet 1	0	0	0	0	0	1	0	0	Information Element: Bearer Capability
Octet 2	0	0	0	0	x	x	x	x	Length (7 or 8) depending on the presence of octet 7.
Octet 3	1	x	x	0	0	0	1	0	Extension Radio Channel Requirement Coding Standard: GSM Transfer Mode: Circuit Info. Transfer Cap.: 3,1 kHz Audio
Octet 4	1	y	x	x	1	0	0	0	Extension Spare Structure Duplex Mode Configuration: Point to Point Negotiation of Intermediate Rate Requested: No meaning Establishment: Demand
Octet 5	1	0	0	0	0	x	0	1	Extension Access Id Rate Adaptation: No Signalling Access Protocol
Octet 6	0	0	1	0	0	0	0	1	Extension Layer 1 Id: Default User Information Layer 1 Protocol Synchronous / Asynchronous: Asynchronous
Octet 6a	0	x	0	x	0	0	0	1	Extension Number of Stop Bits, Depending of the TE Configuration Negotiation: In band Negotiation not possible Number of Data Bits, Depending of the TE Configuration User Rate: 0,3 kbit/s
Octet 6b	0	1	x	0	0	x	x	x	Extension Intermediate Rate: 8kbit/s NIC on TX: Not Required NIC on RX: Not Supported Parity, Depending of the TE Configuration
Octet 6c	1	x	x	0	0	0	0	1	Extension Connection Element Modem Type: V.21

If the mobile station supports only Transparent mode or responds with a CALL CONFIRMED message:

Structure in Octet 4:	-	1	1	-	-	-	-	-	Unstructured
Intermediate rate in Octet 6b:	-	1	0	-	-	-	-	-	8 kbit/s
Connection element in Octet 6c:	-	0	0	-	-	-	-	-	Transparent

¹⁾ If the mobile station supports both Transparent and Non Transparent modes

Structure in Octet 4:	-	0	0	-	-	-	-	-	SDU Integrity
Intermediate rate in Octet 6b:	-	1	1	-	-	-	-	-	16 kbit/s
Connection element in Octet 6c:	-	1	x	-	-	-	-	-	Both T or NT preferred

User Information L2 protocol in Octet 7 (see Non Transparent service)

¹⁾The following configuration is also authorised in the SETUP message:

Connection element in Octet 6c: - 1 x - - - - - Both T or NT preferred
 Modem type in Octet 6c (if CE = - - - 0 1 0 0 0 Autobauding Type 1
 "both":

11.8.2.1.1.2 3,1 kHz Audio, Non Transparent

BC GSM = 04 0X X2 XX 8X 21 X1 6X X1 (CX)

Octet 1	0	0	0	0	0	1	0	0	Information Element: Bearer Capability
Octet 2	0	0	0	0	x	x	x	x	Length (7 or 8) depending on presence of octet 7.
Octet 3	1	x	x	0	0	0	1	0	Extension Radio Channel Requirement Coding Standard: GSM Transfer Mode: Circuit Info. Transfer Cap.: 3,1 kHz Audio
Octet 4	1	y	0	0	1	0	x	0	Extension Spare Structure: SDU Integrity Duplex Mode: Full duplex Configuration: Point to Point Negotiation of Intermediate Rate Requested Establishment: Demand
Octet 5	1	0	0	0	0	x	0	1	Extension Access Id Rate Adaptation: No Signalling Access Protocol
Octet 6	0	0	1	0	0	0	0	1	Extension Layer 1 Id: Default User Information Layer 1 Protocol Synchronous / Asynchronous: Asynchronous
Octet 6a	0	x	0	x	0	0	0	1	Extension <i>Number of Stop Bits, Depending of the TE Configuration</i> Negotiation: In band Negotiation not possible <i>Number of Data Bits, Depending of the TE Configuration</i> User Rate: 0,3 kbit/s
Octet 6b	0	1	1	0	0	x	x	x	Extension Intermediate Rate: 16kbit/s NIC on TX: Not Required NIC on RX: Not Supported <i>Parity, Depending of the TE Configuration</i>
Octet 6c	1	x	x	0	0	0	0	1	Extension Connection Element: NT, (Both T or Both NT) ¹⁾ Modem Type: V.21
Octet 7 (need not be present)	1	1	0	0	1	x	0	0	Extension Layer 2 Id. <i>User Inform. layer 2 protocol, Depending on the TE Configuration</i>

The following configuration is also authorised:

Modem type in Octet 6c: - - - 0 1 0 0 0 Autobauding Type 1

Depending of the type of flow control supported by the TE, the coding of octet 7 is different. The value ISO 6429 (0 1000) means "Inband flow control" and the value COPnoFLCT (0 1100) means "No flow control".

11.8.2.1.1.3 ²⁾ UDI, Transparent

BC GSM = 04 0X X1 X8 8X 21 X1 XX X0

Octet 1	0	0	0	0	0	1	0	0	Information Element: Bearer Capability
Octet 2	0	0	0	0	x	x	x	x	Length (7 or 8) depending on the presence of octet 7
Octet 3	1	x	x	0	0	0	0	1	Extension Radio Channel Requirement Coding Standard: GSM Transfer Mode: Circuit Info. Transfer Cap.: UDI
Octet 4	1	y	x	x	1	0	0	0	Extension Spare Structure Duplex Mode: Full duplex Configuration: Point to Point Negotiation of Intermediate Rate Requested: No meaning Establishment: Demand
Octet 5	1	0	0	0	1	x	0	1	Extension Access Id Rate Adaptation: V.110 Signalling Access Protocol
Octet 6	0	0	1	0	0	0	0	1	Extension Layer 1 Id: Default User Information Layer 1 Protocol Synchronous / Asynchronous: Asynchronous
Octet 6a	0	x	0	x	0	0	0	1	Extension Number of Stop Bits, Depending of the TE Configuration Negotiation: In band Negotiation not possible Number of Data Bits, Depending of the TE Configuration User Rate: 0,3 kbit/s
Octet 6b	0	1	x	0	0	x	x	x	Extension Intermediate Rate NIC on TX: Not Required NIC on RX: Not Supported Parity, Depending of the TE Configuration
Octet 6c	1	x	x	0	0	0	0	0	Extension Connection Element Modem Type: None

If the mobile station supports only Transparent mode or responds with a CALL CONFIRMED message:

Structure in Octet 4: - 1 1 - - - - - Unstructured
Intermediate rate in Octet 6b: - 1 0 - - - - - 8 kbit/s
Connection element in Octet 6c: - 0 0 - - - - - Transparent

¹⁾ If the mobile station supports both Transparent and Non Transparent modes

Structure in Octet 4: - 0 0 - - - - - SDU Integrity
Intermediate rate in Octet 6b: - 1 1 - - - - - 16 kbit/s
Connection element in Octet 6c: - 1 x - - - - - Both T or NT preferred
User Information L2 protocol in Octet 7 (see Non Transparent service)

11.8.2.1.1.4 ²⁾ UDI, Non Transparent

BC GSM = 04 0X X1 XX 8X 21 X1 6X X0 (CX)

Octet 1	0	0	0	0	0	1	0	0	Information Element: Bearer Capability
Octet 2	0	0	0	0	x	x	x	x	Length (7 or 8) depending on presence of octet 7.
Octet 3	1	x	x	0	0	0	0	1	Extension Radio Channel Requirement Coding Standard: GSM Transfer Mode: Circuit Info. Transfer Cap.: UDI
Octet 4	1	y	0	0	1	0	x	0	Extension Spare Structure: SDU Integrity Duplex Mode: Full duplex Configuration: Point to Point Negotiation of Intermediate Rate Requested Establishment: Demand
Octet 5	1	0	0	0	1	x	0	1	Extension Access Id Rate Adaptation: V.110 Signalling Access Protocol
Octet 6	0	0	1	0	0	0	0	1	Extension Layer 1 Id: Default User Information Layer 1 Protocol Synchronous / Asynchronous: Asynchronous
Octet 6a	0	x	0	x	0	0	0	1	Extension Number of Stop Bits, Depending of the TE Configuration Negotiation: In band Negotiation not possible Number of Data Bits, Depending of the TE Configuration User Rate: 0,3 kbit/s
Octet 6b	0	1	1	0	0	x	x	x	Extension Intermediate Rate: 16kbit/s NIC on TX: Not Required NIC on RX: Not Supported Parity, Depending of the TE Configuration
Octet 6c	1	x	x	0	0	0	0	0	Extension Connection Element: NT, (Both T or Both NT) ¹⁾ Modem Type: None
Octet 7 (need not be present)	1	1	0	0	1	x	0	0	Extension Layer 2 Id. User Inform. layer 2 protocol, Depending of the TE Configuration

Depending of the type of flow control supported by the TE, octet 7 is present or not. If not present, it means "outband flow control". If octet 7 is present, the value ISO 6429 (0 1000) means "Inband flow control" and the value COPnoFLCT (0 1100) means "No flow control".

11.8.2.1.2 BS 22

Same as BS 21 except

	User Rate in Octet 6a:	-	-	-	-	0	0	1	0	1,2 kbit/s
If different from "none",	Modem Type Octet 6c:	-	-	-	0	0	0	1	0	Modem V.22

In case of 3,1kHz Audio non transparent service, depending of the type of flow control supported by the TE, octet 7 is present or not. If not present, it means "outband flow control".

11.8.2.1.3 BS 24

Same as BS 21 except

	User Rate in Octet 6a:	-	-	-	-	0	0	1	1	2,4 kbit/s
If different from "none",	Modem Type Octet 6c:	-	-	-	0	0	0	1	1	Modem V.22bis
							1	0	1	Modem V.26ter

In case of 3,1kHz Audio non transparent service, depending of the type of flow control supported by the TE, octet 7 is present or not. If not present, it means "outband flow control".

11.8.2.1.4 BS 25

Same as BS 21 except

	User Rate in Octet 6a:	-	-	-	-	0	1	0	0	4,8 kbit/s
If different from "none",	Modem Type Octet 6c:	-	-	-	0	0	1	1	0	Modem V.32

In case of 3,1kHz Audio non transparent service, depending of the type of flow control supported by the TE, octet 7 is present or not. If not present, it means "outband flow control".

11.8.2.1.5 BS 26

Same as BS 21 except

	NIRR in Octet 4:	-	-	-	-	-	-	0	-	no meaning
	User Rate in Octet 6a:	-	-	-	-	0	1	0	1	9,6 kbit/s
	Interm. Rate in Octet 6b:	-	1	1	-	-	-	-	-	16 kbit/s
If different from "none",	Modem Type Octet 6c:	-	-	-	0	0	1	1	0	Modem V.32

In case of 3,1kHz Audio non transparent service, depending of the type of flow control supported by the TE, octet 7 is present or not. If not present, it means "outband flow control".

11.8.2.1.6 BS 23

Same as BS 21 except

	User Rate in Octet 6a:	-	-	-	-	0	1	1	1	1,2 kbit/s/75 bit/s
If different from "none",	Modem Type Octet 6c:	-	-	-	0	0	1	0	0	Modem V.23

In case of 3,1kHz Audio non transparent service, depending of the type of flow control supported by the TE, octet 7 is present or not. If not present, it means "outband flow control".

11.8.2.2 BS 31 to 34 - Synchronous Service

11.8.2.2.1 BS 32

11.8.2.2.1.1 3,1 kHz Audio, Transparent, non-X.32 case

BC GSM = 04 07 X2 X8 81 20 13 43 83

Octet 1	0	0	0	0	0	1	0	0	Information Element: Bearer Capability
Octet 2	0	0	0	0	0	1	1	1	Length
Octet 3	1	x	x	0	0	0	1	0	Extension Radio Channel Requirement : Spare Coding Standard: GSM Transfer Mode: Circuit Info. Transfer Cap.: 3,1 kHz Audio
Octet 4	1	y	1	1	1	0	0	0	Extension Spare Structure: Unstructured Duplex Mode: Full duplex Configuration: Point to Point Negotiation of Intermediate Rate Requested: No meaning Establishment: Demand
Octet 5	1	0	0	0	0	0	0	1	Extension Access Id Rate Adaptation: No Signalling Access Protocol: I.440 / I.450
Octet 6	0	0	1	0	0	0	0	0	Extension Layer 1 Id: Default User Information Layer 1 Protocol Synchronous / Asynchronous: Synchronous
Octet 6a	0	0	0	1	0	0	1	1	Extension Number of Stop Bits: NA Negotiation: In band Negotiation not possible Number of Data Bits: NA User Rate: 2,4 kbit/s
Octet 6b	0	1	0	0	0	0	1	1	Extension Intermediate Rate: 8kbit/s NIC on TX: Not Required NIC on RX: Not Supported Parity: NA
Octet 6c	1	0	0	0	0	x	x	1	Extension Connection Element: Transparent Modem Type: V.22 bis or V.26 ter

11.8.2.2.1.2 ²⁾ UDI, Transparent mode, non-X.32 case

BC GSM = 04 07 X1 X8 8X 20 13 43 80

Octet 1	0	0	0	0	0	1	0	0	Information Element: Bearer Capability
Octet 2	0	0	0	0	0	1	1	1	Length
Octet 3	1	x	x	0	0	0	0	1	Extension Radio Channel Requirement Coding Standard: GSM Transfer Mode: Circuit Info. Transfer Cap.: UDI
Octet 4	1	y	1	1	1	0	0	0	Extension Spare Structure: Unstructured Duplex Mode: Full duplex Configuration: Point to Point Negotiation of Intermediate Rate Requested: No meaning Establishment: Demand
Octet 5	1	0	0	0	1	0	x	x	Extension Access Id Rate Adaptation: V.110 Signalling Access Protocol
Octet 6	0	0	1	0	0	0	0	0	Extension Layer 1 Id: Default User Information Layer 1 Protocol Synchronous / Asynchronous: Synchronous
Octet 6a	0	0	0	1	0	0	1	1	Extension Number of Stop Bits: NA Negotiation: In band Negotiation not possible Number of Data Bits: NA User Rate: 2,4 kbit/s
Octet 6b	0	1	0	0	0	0	1	1	Extension Intermediate Rate: 8kbit/s NIC on TX: Not Required NIC on RX: Not Supported Parity: NA
Octet 6c	1	0	0	0	0	0	0	0	Extension Connection Element: Transparent Modem Type: none

If the mobile station supports only SAP I.440/450

SAP in Octet 5: - - - - - 0 0 1 I.440/I.450

If the MS supports only SAP X.21

SAP in Octet 5: - - - - - 0 1 0 X.21

Else

SAP in Octet 5: - - - - - 0 x x I.440/I.450 or X.21

11.8.2.2.1.3 3,1 kHz Audio, Transparent mode, X.32 case (Packet Service)

BC GSM = 04 0X X2 X8 86 20 13 X3 X3 (C6)

Octet 1	0	0	0	0	0	1	0	0	Information Element: Bearer Capability
Octet 2	0	0	0	0	0	1	1	1	Length
Octet 3	1	x	x	0	0	0	1	0	Extension Radio Channel Requirement Coding Standard: GSM Transfer Mode: Circuit Info. Transfer Cap.: 3,1 kHz Audio
Octet 4	1	y	x	x	1	0	0	0	Extension Spare Structure Duplex Mode: Full duplex Configuration: Point to Point Negotiation of Intermediate Rate Requested: No meaning Establishment: Demand
Octet 5	1	0	0	0	0	1	1	0	Extension Access Id Rate Adaptation: No Signalling Access Protocol: X.32
Octet 6	0	0	1	0	0	0	0	0	Extension Layer 1 Id: Default User Information Layer 1 Protocol Synchronous / Asynchronous: Synchronous
Octet 6a	0	0	0	1	0	0	1	1	Extension Number of Stop Bits: NA Negotiation: In band Negotiation not possible Number of Data Bits: NA User Rate: 2,4 kbit/s
Octet 6b	0	1	x	0	0	0	1	1	Extension Intermediate Rate NIC on TX: Not Required NIC on RX: Not Supported Parity: NA
Octet 6c	1	x	x	0	0	x	x	1	Extension Connection Element: Transparent Modem Type: V.22 bis or V.26 ter

If the mobile station supports only Transparent mode or responds with a CALL CONFIRMED message:

Structure in Octet 4:	-	1	1	-	-	-	-	-	Unstructured
Intermediate rate in Octet 6b:	-	1	0	-	-	-	-	-	8 kbit/s
Connection element in Octet 6c:	-	0	0	-	-	-	-	-	Transparent

¹⁾ If the mobile station supports both Transparent and Non Transparent modes

Structure in Octet 4:	-	0	0	-	-	-	-	-	SDU Integrity
Intermediate rate in Octet 6b:	-	1	1	-	-	-	-	-	16 kbit/s
Connection element in Octet 6c:	-	1	x	-	-	-	-	-	Both T or NT preferred
UIL2P in Octet 7	-	-	-	0	0	1	1	0	X.25

11.8.2.2.1.4 3,1 kHz Audio, Non Transparent mode, X.32 case (Packet Service)

BC GSM = 04 08 A2 XX 86 20 13 63 X3 C6

Octet 1	0	0	0	0	0	1	0	0	Information Element: Bearer Capability
Octet 2	0	0	0	0	1	0	0	0	Length
Octet 3	1	x	x	0	0	0	1	0	Extension Radio Channel Requirement Coding Standard: GSM Transfer Mode: Circuit Info. Transfer Cap.: 3,1 kHz Audio
Octet 4	1	y	0	0	1	0	x	0	Extension Spare Structure: SDU integrity Duplex Mode: Full duplex Configuration: Point to Point Negotiation of Intermediate Rate Requested Establishment: Demand
Octet 5	1	0	0	0	0	1	1	0	Extension Access Id Rate Adaptation: No Signalling Access Protocol: X.32
Octet 6	0	0	1	0	0	0	0	0	Extension Layer 1 Id: Default User Information Layer 1 Protocol Synchronous / Asynchronous: Synchronous
Octet 6a	0	0	0	1	0	0	1	1	Extension Number of Stop Bits: NA Negotiation: In band Negotiation not possible Number of Data Bits: NA User Rate: 2,4 kbit/s
Octet 6b	0	1	1	0	0	0	1	1	Extension Intermediate Rate: 16kbit/s NIC on TX: Not Required NIC on RX: Not Supported Parity: NA
Octet 6c	1	x	x	0	0	x	x	1	Extension Connection Element: NT, (Both T or Both NT) ¹⁾ Modem Type: V.22 bis or V.26 ter
Octet 7	1	1	0	0	0	1	1	0	Extension Layer 2 Id. X.25

11.8.2.2.1.5 ²⁾ UDI, Non Transparent mode, X.32 case (Packet Service)

BC GSM = 04 08 X1 XX 96 20 13 63 A0 C6

Octet 1	0	0	0	0	0	1	0	0	Information Element: Bearer Capability
Octet 2	0	0	0	0	1	0	0	0	Length
Octet 3	1	x	x	0	0	0	0	1	Extension Radio Channel Requirement Coding Standard: GSM Transfer Mode: Circuit Info. Transfer Cap.: UDI
Octet 4	1	y	0	0	1	0	x	0	Extension Spare Structure: SDU integrity Duplex Mode: Full duplex Configuration: Point to Point Negotiation of Intermediate Rate Requested Establishment: Demand
Octet 5	1	0	0	1	0	1	1	0	Extension Access Id Rate Adaptation: X.31 flagstuffing Signalling Access Protocol: X.32
Octet 6	0	0	1	0	0	0	0	0	Extension Layer 1 Id: Default User Information Layer 1 Protocol Synchronous / Asynchronous: Synchronous
Octet 6a	0	0	0	1	0	0	1	1	Extension Number of Stop Bits: NA Negotiation: In band Negotiation not possible Number of Data Bits: NA User Rate: 2,4 kbit/s
Octet 6b	0	1	1	0	0	0	1	1	Extension Intermediate Rate: 16kbit/s NIC on TX: Not Required NIC on RX: Not Supported Parity: NA
Octet 6c	1	0	1	0	0	0	0	0	Extension Connection Element: Non Transparent Modem Type: None
Octet 7	1	1	0	0	0	1	1	0	Extension Layer 2 Id. X.25

11.8.2.2.2 BS 31

For non X.32 case only, same as BS 32 except

	User Rate in Octet 6a:	-	-	-	-	0	0	1	0	1,2 kbit/s
If different from "none",	Modem Type Octet 6c:	-	-	-	0	0	0	1	0	Modem V.22

BS31 for Packet Service does not exist.

11.8.2.2.3 BS 33

Same as BS 32 except

	User Rate in Octet 6a:	-	-	-	-	0	1	0	0	4,8 kbit/s
If different from "none",	Modem Type Octet 6c:	-	-	-	0	0	1	1	0	Modem V.32

11.8.2.2.4 BS 34

Same as BS 32 except

	NIRR in Octet 4:	-	-	-	-	-	-	0	-	no meaning
	User Rate in Octet 6a:	-	-	-	-	0	1	0	1	9,6 kbit/s
	Interm. Rate in Octet 6b:	-	1	1	-	-	-	-	-	16 kbit/s
If different from "none",	Modem Type Octet 6c:	-	-	-	0	0	1	1	0	Modem V.32

11.8.2.3 BS 41 to 46 - PAD Access Asynchronous

11.8.2.3.1 ²⁾BS 4111.8.2.3.1.1 ²⁾UDI, Transparent

BC GSM = 04 0X X1 X8 8C 21 X1 XX X0 (CX)

Octet 1	0	0	0	0	0	1	0	0	Information Element: Bearer Capability
Octet 2	0	0	0	0	0	1	1	1	Length
Octet 3	1	x	x	0	0	0	0	1	Extension Radio Channel Requirement Coding Standard: GSM Transfer Mode: Circuit Info. Transfer Cap.: UDI
Octet 4	1	y	x	x	1	0	0	0	Extension Spare Structure Duplex Mode: Full duplex Configuration: Point to Point Negotiation of Intermediate Rate Requested: No meaning Establishment: Demand
Octet 5	1	0	0	0	1	1	0	0	Extension Access Id Rate Adaptation: V.110 Signalling Access Protocol: X.28 dedicated universal NUI
Octet 6	0	0	1	0	0	0	0	1	Extension Layer 1 Id: Default User Information Layer 1 Protocol Synchronous / Asynchronous: Asynchronous
Octet 6a	0	x	0	x	0	0	0	1	Extension Number of Stop Bits, Depending of the TE Configuration Negotiation: In band Negotiation not possible Number of Data Bits, Depending of the TE Configuration User Rate: 0,3 kbit/s
Octet 6b	0	1	x	0	0	x	x	x	Extension Intermediate Rate NIC on TX: Not Required NIC on RX: Not Supported Parity, Depending of the TE Configuration
Octet 6c	1	x	x	0	0	0	0	0	Extension Connection Element Modem Type: None

If the mobile station supports only Transparent mode or responds with a CALL CONFIRMED message:

Structure in Octet 4:	-	1	1	-	-	-	-	-	Unstructured
Intermediate rate in Octet 6b:	-	1	0	-	-	-	-	-	8 kbit/s
Connection element in Octet 6c:	-	0	0	-	-	-	-	-	Transparent

¹⁾ If the mobile station supports both Transparent and Non Transparent modes

Structure in Octet 4:	-	0	0	-	-	-	-	-	SDU Integrity
Intermediate rate in Octet 6b:	-	1	1	-	-	-	-	-	16 kbit/s
Connection element in Octet 6c:	-	1	x	-	-	-	-	-	Both T or NT preferred

User Information L2 Protocol (see Non Transparent service)

11.8.2.3.1.2 ²⁾UDI, Non transparent

BC GSM = 04 08 X1 XX 8C 21 X1 6X X0 CX

Octet 1	0	0	0	0	0	1	0	0	Information Element: Bearer Capability
Octet 2	0	0	0	0	1	0	0	0	Length.
Octet 3	1	x	x	0	0	0	0	1	Extension Radio Channel Requirement Coding Standard: GSM Transfer Mode: Circuit Info. Transfer Cap.: UDI
Octet 4	1	y	0	0	1	0	x	0	Extension Spare Structure: SDU Integrity Duplex Mode: Full duplex Configuration: Point to Point Negotiation of Intermediate Rate Requested Establishment: Demand
Octet 5	1	0	0	0	1	1	0	0	Extension Access Id Rate Adaptation: V.110 Signalling Access Protocol: X.28 dedicated PAD, universal NUI
Octet 6	0	0	1	0	0	0	0	1	Extension Layer 1 Id: Default User Information Layer 1 Protocol Synchronous / Asynchronous: Asynchronous
Octet 6a	0	x	0	x	0	0	0	1	Extension Number of Stop Bits, Depending of the TE Configuration Negotiation: In band Negotiation not possible Number of Data Bits, Depending of the TE Configuration User Rate: 0,3 kbit/s
Octet 6b	0	1	1	0	0	x	x	x	Extension Intermediate Rate: 16kbit/s NIC on TX: Not Required NIC on RX: Not Supported Parity, Depending of the TE Configuration
Octet 6c	1	x	x	0	0	0	0	0	Extension Connection Element: NT, (Both T or Both NT) ¹⁾ Modem Type: None
Octet 7	1	1	0	0	1	x	0	0	Extension Layer 2 Id. User Inform. layer 2 protocol: Depending on the TE Configuration

Depending on the type of flow control supported by the TE, octet 7 is present or not. If not present, it means "outband flow control". If octet 7 is present, the value COPnoFLCT (01100) means "No flow control".

11.8.2.3.2 BS 42

Same as BS 41 except

	User Rate in Octet 6a:	-	-	-	-	0	0	1	0	1,2 kbit/s
--	------------------------	---	---	---	---	---	---	---	---	------------

11.8.2.3.3 BS 44

Same as BS 41 except

	User Rate in Octet 6a:	-	-	-	-	0	0	1	1	2,4 kbit/s
--	------------------------	---	---	---	---	---	---	---	---	------------

11.8.2.3.4 BS 45

Same as BS 41 except

	User Rate in Octet 6a:	-	-	-	-	0	1	0	0	4,8 kbit/s
--	------------------------	---	---	---	---	---	---	---	---	------------

11.8.2.3.5 BS 46

Same as BS 41 except

	NIRR in Octet 4	-	-	-	-	-	-	0	-	no meaning
	User Rate in Octet 6a:	-	-	-	-	0	1	0	1	9,6 kbit/s
	Interm. Rate in Octet 6b:	-	1	1	-	-	-	-	-	16 kbit/s

11.8.2.3.6 BS 43

Same as BS 41 except

	User Rate in Octet 6a:	-	-	-	-	0	1	1	1	1,2 kbit/s 75bit/s
--	------------------------	---	---	---	---	---	---	---	---	-----------------------

11.8.2.4 BS 51 to 53 - Packet Service Synchronous

11.8.2.4.1 ²⁾BS 51

BC GSM = 04 08 X1 X8 96 20 13 63 A0 C6

Octet 1	0	0	0	0	0	1	0	0	Information Element: Bearer Capability
Octet 2	0	0	0	0	1	0	0	0	Length
Octet 3	1	x	x	0	0	0	0	1	Extension Radio Channel Requirement Coding Standard: GSM Transfer Mode: Circuit Info. Transfer Cap.: UDI
Octet 4	1	y	0	0	1	0	0	0	Extension Spare Structure: Unstructured Duplex Mode: Full duplex Configuration: Point to Point Negotiation of Intermediate Rate Requested: No meaning Establishment: Demand
Octet 5	1	0	0	1	0	1	1	0	Extension Access Id Rate Adaptation: X.31 flag. Signalling Access Protocol: X.32
Octet 6	0	0	1	0	0	0	0	0	Extension Layer 1 Id: Default User Information Layer 1 Protocol Synchronous / Asynchronous: Synchronous
Octet 6a	0	0	0	1	0	0	1	1	Extension Number of Stop Bits: NA Negotiation: In band Negotiation not possible Number of Data Bits: NA User Rate: 2,4 kbit/s
Octet 6b	0	1	1	0	0	0	1	1	Extension Intermediate Rate: 16kbit/s NIC on TX: Not Required NIC on RX: Not Supported Parity: NA
Octet 6c	1	0	1	0	0	0	0	0	Extension Connection Element: Non Transparent Modem Type: None
Octet 7	1	1	0	0	0	1	1	0	Extension Layer 2 Id. X.25

11.8.2.4.2 BS 52

Same as BS 51 except

User Rate in Octet 6a:	-	-	-	-	0	1	0	0	4,8 kbit/s
------------------------	---	---	---	---	---	---	---	---	------------

11.8.2.4.3 BS 53

Same as BS 51 except

User Rate in Octet 6a:	-	-	-	-	0	1	0	1	9,6 kbit/s
------------------------	---	---	---	---	---	---	---	---	------------

11.8.2.5 BS 61 - Alternate Speech / Data

The first BC is coded as follows :

IF speech full rate version 2 is supported by the mobile, see 11.8.2.9.2

ELSE see 11.8.2.9.1

The repeat Indicator in the Setup message is coded "Circular for successive selection (alternate)": D1.

The second BC in the Setup message is coded as described below.

11.8.2.5.1 Speech/Asynchronous Data, Transparent

BC GSM = 04 0X X2 X8 81 21 XX XX XX (CX)

Octet 1	0	0	0	0	0	1	0	0	Information Element: Bearer Capability
Octet 2	0	0	0	0	0	1	1	1	Length
Octet 3	1	x	x	0	0	0	1	0	Extension Radio Channel Requirement Coding Standard: GSM Transfer Mode: Circuit Info. Transfer Cap.: 3,1 kHz Audio
Octet 4	1	y	x	x	1	0	0	0	Extension Spare Structure Duplex Mode: Full duplex Configuration: Point to Point Negotiation of Intermediate Rate Requested: No meaning Establishment: Demand
Octet 5	1	0	0	0	0	0	0	1	Extension Access Id Rate Adaptation: No Signalling Access Protocol: I.440 / I.450
Octet 6	0	0	1	0	0	0	0	1	Extension Layer 1 Id: Default User Information Layer 1 Protocol Synchronous / Asynchronous: Asynchronous
Octet 6a	0	x	0	x	x	x	x	x	Extension Number of Stop Bits, Depending of the TE Configuration Negotiation: In band Negotiation not possible Number of Data Bits, Depending of the TE Configuration User Rate
Octet 6b	0	1	x	0	0	x	x	x	Extension Intermediate Rate NIC on TX: Not Required NIC on RX: Not Supported Parity, Depending of the TE Configuration
Octet 6c	1	x	x	0	x	x	x	x	Extension Connection Element Modem Type

If the mobile station supports only Transparent mode or responds with a CALL CONFIRMED message:

Structure in Octet 4:	-	1	1	-	-	-	-	-	Unstructured
Intermediate rate in Octet 6b:	-	1	x	-	-	-	-	-	Depending on the user rate
Connection element in Octet 6c:	-	0	0	-	-	-	-	-	Transparent

¹⁾ If the mobile station supports both Transparent and Non Transparent modes

Structure in Octet 4: - 0 0 - - - - - SDU Integrity
 Intermediate rate in Octet 6b: - 1 1 - - - - - 16 kbit/s
 Connection element in Octet 6c: - 1 x - - - - - Both T or NT preferred
 User Information L2 protocol in Octet 7 (see Non Transparent service)

Depending of the user rate supported by the MS, the user rate, the modem type and the intermediate rate change:

User Rate in Octet 6a:	-	-	-	-	0	0	0	1	0,3 kbit/s
Intermediate rate in Octet 6b:	-	1	0	-	-	-	-	-	8 kbit/s in Transparent mode
Modem type in Octet 6c:	-	-	-	0	0	0	0	1	Modem V.21

¹⁾The following configuration is also authorised if CE = Both:

Modem type in Octet 6c:	-	-	-	0	1	0	0	0	Autobauding Type 1
-------------------------	---	---	---	---	---	---	---	---	--------------------

User Rate in Octet 6a:	-	-	-	-	0	0	1	0	1,2 kbit/s
Intermediate rate in Octet 6b:	-	1	0	-	-	-	-	-	8 kbit/s in Transparent mode
Modem type in Octet 6c:	-	-	-	0	0	0	1	0	Modem V.22

¹⁾The following configuration is also authorised if CE = Both:

Modem type in Octet 6c:	-	-	-	0	1	0	0	0	Autobauding Type 1
-------------------------	---	---	---	---	---	---	---	---	--------------------

User Rate in Octet 6a:	-	-	-	-	0	0	1	1	2,4 kbit/s
Intermediate rate in Octet 6b:	-	1	0	-	-	-	-	-	8 kbit/s in Transparent mode
Modem type in Octet 6c:	-	-	-	0	0	0	1	1	Modem V.22bis
						1	0	1	Modem V.26ter

¹⁾The following configuration is also authorised if CE = Both:

Modem type in Octet 6c:	-	-	-	0	1	0	0	0	Autobauding Type 1
-------------------------	---	---	---	---	---	---	---	---	--------------------

User Rate in Octet 6a:	-	-	-	-	0	1	0	0	4,8 kbit/s
Intermediate rate in Octet 6b:	-	1	0	-	-	-	-	-	8 kbit/s in Transparent mode
Modem type in Octet 6c:	-	-	-	0	0	1	1	0	Modem V.32

¹⁾The following configuration is also authorised if CE = Both:

Modem type in Octet 6c:	-	-	-	0	1	0	0	0	Autobauding Type 1
-------------------------	---	---	---	---	---	---	---	---	--------------------

NIRR in Octet 4:	-	-	-	-	-	-	0	-	no meaning
User Rate in Octet 6a:	-	-	-	-	0	1	0	1	9,6 kbit/s
Intermediate rate in Octet 6b:	-	1	1	-	-	-	-	-	16 kbit/s in Transparent mode
Modem type in Octet 6c:	-	-	-	0	0	1	1	0	Modem V.32

¹⁾The following configuration is also authorised if CE = Both:

Modem type in Octet 6c:	-	-	-	0	1	0	0	0	Autobauding Type 1
-------------------------	---	---	---	---	---	---	---	---	-----------------------

User Rate in Octet 6a:	-	-	-	-	0	1	1	1	1,2 kbits/s 75bit/2
Intermediate rate in Octet 6b:	-	1	0	-	-	-	-	-	8 kbit/s in Transparent mode
Modem type in Octet 6c:	-	-	-	0	0	1	0	0	Modem V.23

¹⁾The following configuration is also authorised if CE = Both:

Modem type in Octet 6c:	-	-	-	0	1	0	0	0	Autobauding Type 1
-------------------------	---	---	---	---	---	---	---	---	-----------------------

11.8.2.5.2 Speech/Asynchronous Data, Non Transparent

BC GSM = 04 0X X2 XX 81 21 XX 6X XX (CX)

Octet 1	0	0	0	0	0	1	0	0	Information Element: Bearer Capability
Octet 2	0	0	0	0	x	x	x	x	Length (7 or 8) depending on presence of octet 7.
Octet 3	1	x	x	0	0	0	1	0	Extension Radio Channel Requirement Coding Standard: GSM Transfer Mode: Circuit Info. Transfer Cap.: 3,1 kHz Audio
Octet 4	1	y	0	0	1	0	x	0	Extension Spare Structure: SDU Integrity Duplex Mode: Full duplex Configuration: Point to Point Negotiation of Intermediate Rate Requested Establishment: Demand
Octet 5	1	0	0	0	0	0	0	1	Extension Access Id Rate Adaptation: No Signalling Access Protocol: I.440 / I.450
Octet 6	0	0	1	0	0	0	0	1	Extension Layer 1 Id: Default User Information Layer 1 Protocol Synchronous / Asynchronous: Asynchronous
Octet 6a	0	x	0	x	x	x	x	x	Extension Number of Stop Bits, Depending of the TE Configuration Negotiation: In band Negotiation not possible Number of Data Bits, Depending of the TE Configuration User Rate
Octet 6b	0	1	1	0	0	x	x	x	Extension Intermediate Rate: 16kbit/s NIC on TX: Not Required NIC on RX: Not Supported Parity, Depending of the TE Configuration
Octet 6c	1	x	x	0	x	x	x	x	Extension Connection Element: NT, (Both T or Both NT) ¹⁾ Modem Type
Octet 7 (may not be present)	1	1	0	0	1	x	0	0	Extension Layer 2 Id. User Inform. layer 2 protocol, Depending of the TE Configuration

Depending of the type of flow control supported by the TE, the coding of octet 7 is different. The value ISO 6429 (0 1000) means "Inband flow control" and the value COPnoFLCT (0 1100) means "No flow control". The "Outband Flow control is not allowed with V.21 modem).

Depending of the user rate supported by the MS, the user rate and the modem type change:

	User Rate in Octet 6a:	-	-	-	-	0	0	0	1	0,3 kbit/s
	Modem type in Octet 6c:	-	-	-	0	0	0	0	1	Modem V.21
		-	-	-	0	1	0	0	0	Autobauding Type 1

	User Rate in Octet 6a:	-	-	-	-	0	0	1	0	1,2 kbit/s
	Modem type in Octet 6c:	-	-	-	0	0	0	1	0	Modem V.22
		-	-	-	0	1	0	0	0	Autobauding Type 1

	User Rate in Octet 6a:	-	-	-	-	0	0	1	1	2,4 kbit/s
	Modem type in Octet 6c:	-	-	-	0	0	0	1	1	Modem V.22bis
							1	0	1	Modem V.26ter
		-	-	-	0	1	0	0	0	Autobauding Type 1

	User Rate in Octet 6a:	-	-	-	-	0	1	0	0	4,8 kbit/s
	Modem type in Octet 6c:	-	-	-	0	0	1	1	0	Modem V.32
		-	-	-	0	1	0	0	0	Autobauding Type 1

	NIRR in Octet 4:	-	-	-	-	-	-	0	-	no meaning
	User Rate in Octet 6a:	-	-	-	-	0	1	0	1	9,6 kbit/s
	Modem type in Octet 6c:	-	-	-	0	0	1	1	0	Modem V.32
		-	-	-	0	1	0	0	0	Autobauding Type 1

	User Rate in Octet 6a:	-	-	-	-	0	1	1	1	1,2 kbit/s 75bit/s
	Modem type in Octet 6c:	-	-	-	0	0	1	0	0	Modem V.23
		-	-	-	0	1	0	0	0	Autobauding Type 1

11.8.2.5.3 Speech/Synchronous Data

BC GSM = 04 07 X2 X8 81 20 1X X3 8X

Octet 1	0	0	0	0	0	1	0	0	Information Element: Bearer Capability
Octet 2	0	0	0	0	0	1	1	1	Length
Octet 3	1	x	x	0	0	0	1	0	Extension Radio Channel Requirement Coding Standard: GSM Transfer Mode: Circuit Info. Transfer Cap.: 3,1 kHz Audio
Octet 4	1	y	1	1	1	0	0	0	Extension Spare Structure: Unstructured Duplex Mode: Full duplex Configuration: Point to Point Negotiation of Intermediate Rate Requested: No meaning Establishment: Demand
Octet 5	1	0	0	0	0	0	0	1	Extension Access Id Rate Adaptation: No Signalling Access Protocol: I.440 / I.450
Octet 6	0	0	1	0	0	0	0	0	Extension Layer 1 Id: Default User Information Layer 1 Protocol Synchronous / Asynchronous: Synchronous
Octet 6a	0	0	0	1	x	x	x	x	Extension Number of Stop Bits: NA Negotiation: In band Negotiation not possible Number of Data Bits: NA User Rate
Octet 6b	0	1	x	0	0	0	1	1	Extension Intermediate Rate NIC on TX: Not Required NIC on RX: Not Supported Parity: NA
Octet 6c	1	0	0	0	x	x	x	x	Extension Connection Element: Transparent Modem Type

Depending of the user rate supported by the MS, the user rate, the modem type and the intermediate rate change:

User Rate in Octet 6a:	-	-	-	-	0	0	1	0	1,2 kbit/s
Intermediate rate in Octet 6b:	-	1	0	-	-	-	-	-	8 kbit/s
Modem type in Octet 6c:	-	-	-	0	0	0	1	0	Modem V.22

User Rate in Octet 6a:	-	-	-	-	0	0	1	1	2,4 kbit/s
Intermediate rate in Octet 6b:	-	1	0	-	-	-	-	-	8 kbit/s
Modem type in Octet 6c:	-	-	-	0	0	0	1	1	Modem V.22bis
						1	0	1	Modem V.26ter

	User Rate in Octet 6a:	-	-	-	-	0	1	0	0	4,8 kbit/s
	Intermediate rate in Octet 6b:	-	1	0	-	-	-	-	-	8 kbit/s
	Modem type in Octet 6c:	-	-	-	0	0	1	1	0	Modem V.32

	NIRR in Octet 4:	-	-	-	-	-	-	0	-	no meaning
	User Rate in Octet 6a:	-	-	-	-	0	1	0	1	9,6 kbit/s
	Intermediate rate in Octet 6b:	-	1	1	-	-	-	-	-	16 kbit/s
	Modem type in Octet 6c:	-	-	-	0	0	1	1	0	Modem V.32

11.8.2.6 BS 81 - Speech followed by Data

The first BC is coded as follows :

IF speech full rate version 2 is supported by the mobile, see 11.8.2.9.2

ELSE see 11.8.2.9.1

The repeat Indicator in the Setup message is coded "Sequential for successive selection (followed by)": D3.

The second BC in the Setup message is coded as described below.

11.8.2.6.1 Speech followed by Asynchronous Data

See chapters 11.8.2.5.1 and 11.8.2.5.2.

11.8.2.6.2 Speech followed by Synchronous Data

See chapter 11.8.2.5.3.

11.8.2.7 TS 61 - Alternate Speech / Facsimile group 3

The first BC is coded as follows :

IF speech full rate version 2 is supported by the mobile, see 11.8.2.9.2

ELSE see 11.8.2.9.1

The repeat Indicator in the Setup message is coded "Circular for successive selection (alternate)": D1.

The second BC in the Setup message is coded as described below.

11.8.2.7.1 TS 61 - Alternate Speech / Facsimile group 3, Transparent

BC GSM = 04 07 X3 X8 81 20 1X X3 80

Octet 1	0	0	0	0	0	1	0	0	Information Element: Bearer Capability
Octet 2	0	0	0	0	0	1	1	1	Length
Octet 3	1	y	y	0	0	0	1	1	Extension Radio Channel Requirement: Spare Coding Standard: GSM Transfer Mode: Circuit Info. Transfer Cap.: FAX3
Octet 4	1	y	1	1	1	0	0	0	Extension Spare Structure: Unstructured Duplex Mode: Full duplex Configuration: Point to Point Negotiation of Intermediate Rate Requested: No meaning Establishment: Demand
Octet 5	1	0	0	0	0	0	0	1	Extension Access Id Rate Adaptation: No Signalling Access Protocol: NA
Octet 6	0	0	1	0	0	0	0	0	Extension Layer 1 Id: Default User Information Layer 1 Protocol Synchronous / Asynchronous: synchronous
Octet 6a	0	0	0	1	x	x	x	x	Extension Number of Stop Bits: NA Negotiation: In band Negotiation not possible Number of Data Bits: NA User Rate
Octet 6b	0	1	x	0	0	0	1	1	Extension Intermediate Rate NIC on TX: Not Required NIC on RX: Not Supported Parity: NA
Octet 6c	1	0	0	0	0	0	0	0	Extension Connection Element: Transparent Modem Type: None

Depending of the user rate supported by the MS, the user rate and the intermediate rate change:

	User Rate in Octet 6a:	-	-	-	-	0	0	1	1	2,4 kbit/s
	Interm. Rate in Octet 6b:	-	1	0	-	-	-	-	-	8 kbit/s

	User Rate in Octet 6a:	-	-	-	-	0	1	0	0	4,8 kbit/s
	Interm. Rate in Octet 6b:	-	1	0	-	-	-	-	-	8 kbit/s

	NIRR in Octet 4:	-	-	-	-	-	-	0	-	no meaning
	User Rate in Octet 6a:	-	-	-	-	0	1	0	1	9,6 kbit/s
	Interm. Rate in Octet 6b:	-	1	1	-	-	-	-	-	16 kbit/s

11.8.2.7.2 TS 61 - Alternate Speech / Facsimile group 3, Non Transparent

BC GSM = 04 07 X3 XX 81 20 1X 63 X0 66

Octet 1	0	0	0	0	0	1	0	0	Information Element: Bearer Capability
Octet 2	0	0	0	0	0	1	1	1	Length
Octet 3	1	y	y	0	0	0	1	1	Extension Radio Channel Requirement: Spare Coding Standard: GSM Transfer Mode: Circuit Info. Transfer Cap.: FAX3
Octet 4	1	y	0	0	1	0	x	0	Extension Spare Structure: SDU Integrity Duplex Mode: Full duplex Configuration: Point to Point Negotiation of Intermediate Rate Requested Establishment: Demand
Octet 5	1	0	0	0	0	0	0	1	Extension Access Id Rate Adaptation: No Signalling Access Protocol: NA
Octet 6	0	0	1	0	0	0	0	0	Extension Layer 1 Id: Default User Information Layer 1 Protocol Synchronous / Asynchronous: synchronous
Octet 6a	0	0	0	1	x	x	x	x	Extension Number of Stop Bits: NA Negotiation: In band Negotiation not possible Number of Data Bits: NA User Rate
Octet 6b	0	1	1	0	0	0	1	1	Extension Intermediate Rate: 16 kbit/s NIC on TX: Not Required NIC on RX: Not Supported Parity: NA
Octet 6c	1	x	x	0	0	0	0	0	Extension Connection Element Modem Type: None
Octet 7	1	1	0	0	0	1	1	0	Extension Layer 2 Id X.25

The user rate supported by the MS may have the following values:

User Rate in Octet 6a:	-	-	-	-	0	0	1	1	2,4 kbit/s
------------------------	---	---	---	---	---	---	---	---	------------

User Rate in Octet 6a:	-	-	-	-	0	1	0	0	4,8 kbit/s
------------------------	---	---	---	---	---	---	---	---	------------

NIRR in Octet 4:	-	-	-	-	-	-	0	-	no meaning
User Rate in Octet 6a:	-	-	-	-	0	1	0	1	9,6 kbit/s

If present, Octet 7 shall have the following value:

UI2LP in Octet 7	-	-	-	0	0	1	1	0	X.25
------------------	---	---	---	---	---	---	---	---	------

11.8.2.8 TS 62 - Automatic Facsimile group 3

The repeat Indicator in the Setup message is not available.

The BC GSM is coded as described in chapter 11.8.2.7.

11.8.2.9 TS 11 and TS 12- Speech

11.8.2.9.1 Support of only full/half rate speech version 1

The BC in the Setup message is coded as described below.

BC GSM = 04 01 X0

Octet 1	0	0	0	0	0	1	0	0	Information Element : Bearer Capability
Octet 2	0	0	0	0	0	0	0	1	Length
Octet 3	1	x	x	0	0	0	0	0	Extension Radio Channel Requirement Coding Standard : GSM Transfer Mode : Circuit Info. Transfer Cap. : speech

11.8.2.9.2 Support of speech full rate version 2 (Enhanced Full Rate)

This BC will be used by MS supportingEFR as the most advanced speech version. Those supportingEFR and newer codec speech version such as speech version 3, half rate speech version 2 will not use this BC.

The BC in the Setup message is coded as described below.

BC GSM = 04 0X X0 0X XX (1X)

Octet 1	0	0	0	0	0	1	0	0	Information Element : Bearer Capability
Octet 2	0	0	0	0	0	x	x	x	Length
Octet 3	0	x	x	0	0	0	0	0	Extension Radio Channel Requirement Coding Standard : GSM Transfer Mode : Circuit Info. Transfer Cap. : speech
Octet_3a_1	0	0	0	0	0	x	x	x	Extension Coding Spare Speech version indication
Octet_3a_2	x	0	0	0	0	x	x	x	Extension Coding Spare Speech version indication
Octet_3a_3	1	0	0	0	0	x	x	x	Extension Coding Spare Speech version indication

IF the MS supports only Full Rate

Octet 2	0	0	0	0	0	0	1	1	Length
Radio Channel Requirement in Octet 3:	-	0	1	-	-	-	-	-	Full rate support only mobile station/preference as in octets3a_etc

Octet_3a_1	-	-	-	-	-	0	x	0	x=0 : full rate speech version 1 x=1 : full rate speech version 2
------------	---	---	---	---	---	---	---	---	--

Octet_3a_2	1	-	-	-	-	0	x	0	x=0 : full rate speech version 1 x=1 : full rate speech version 2
------------	---	---	---	---	---	---	---	---	--

the speech indication in Octet_3a_1 shall be different from the one in Octet_3a_2.

Octet_3a_3 is not present.

ELSE

Octet 2	0	0	0	0	0	1	0	0	Length
Radio Channel Requirement in Octet 3:	-	1	x	-	-	-	-	-	x=0 or 1 :Dual rate mobile station/ preference as in octets3a_etc

Octet_3a_1	-	-	-	-	-	0	x	x	(0,0) :full rate speech version 1 (1,0) : full rate speech version 2 (0,1) : half rate speech version 1
------------	---	---	---	---	---	---	---	---	---

Octet_3a_2	0	-	-	-	-	0	x	x	(0,0) :full rate speech version 1 (1,0) : full rate speech version 2 (0,1) : half rate speech version 1
------------	---	---	---	---	---	---	---	---	---

Octet_3a_3	1	-	-	-	-	0	x	x	(0,0) :full rate speech version 1 (1,0) : full rate speech version 2 (0,1) : half rate speech version 1
------------	---	---	---	---	---	---	---	---	---

Each speech indication in Octet_3a_i shall be different from the one in Octet_3a_j, $i \neq j$.

12 Transceiver

12.1 Conducted spurious emissions

12.1.1 MS allocated a channel

12.1.1.1 Definition and applicability

Conducted spurious emissions, when the MS has been allocated a channel, are emissions from the antenna connector at frequencies other than those of the carrier and sidebands associated with normal modulation.

The requirements and this test apply to all types of GSM 400, GSM 700, GSM 850, GSM 900, DCS 1 800 and PCS 1 900 MS with a permanent antenna connector.

12.1.1.2 Conformance requirement

1. The conducted spurious power emitted by the MS, when allocated a channel, shall be no more than the levels in table 12.1.

1.1 Under normal voltage conditions; GSM 05.05, 4.3/4.3.3.

1.2 Under extreme voltage conditions; GSM 05.05, 4.3/4.3.3/Annex D.2.

Table 12.1

Frequency range	Power level in dBm		
	GSM400, GSM 700, GSM 850, GSM900	DCS1800	PCS1900
9 kHz to 1 GHz	-36	-36	-36
1 GHz to 12,75 GHz	-30		-30
1 GHz to 1710 MHz		-30	
1710 MHz to 1785 MHz		-36	
1785 MHz to 12,75 GHz		-30	

12.1.1.3 Test purpose

1. To verify that conducted spurious emissions, in the frequency band 100 kHz to 12,75 GHz excluding the GSM 400, GSM 700, GSM 850, GSM900, DCS 1 800 and PCS 1 900 receive bands, from the MS when allocated a channel do not exceed the conformance requirements.

1.1 Under normal voltage conditions.

1.2 Under extreme voltage conditions.

NOTE: The band 9 - 100 kHz is not tested, because of test implementation problems.

12.1.1.4 Method of test

12.1.1.4.1 Initial conditions

A call is set up by the SS according to the generic call set up procedure on a channel in the Mid ARFCN range.

The SS commands the MS to loop back its channel decoder output to channel encoder input.

The SS sends Standard Test Signal C1.

The SS sets the MS to operate at its maximum output power.

12.1.1.4.2 Procedure

- a) Measurements are made in the frequency range 100 kHz to 12,75 GHz. Spurious emissions are measured at the connector of the transceiver, as the power level of any discrete signal, higher than the requirement in table 12.1 minus 6 dB, delivered into a 50 Ohm load.

The measurement bandwidth based on a 5 pole synchronously tuned filter is according to table 12.2. The power indication is the peak power detected by the measuring system.

The measurement on any frequency shall be performed for at least one TDMA frame period with the exception of the idle frame.

NOTE: This ensures that both the active times (MS transmitting) and the quiet times are measured.

b) The test is repeated under extreme voltage test conditions ([Annex 1, TC2.2 and TC3]).

Table 12.2

Frequency range	Frequency offset	Filter bandwidth	Approx video bandwidth
100 kHz to 50 MHz	-	10 kHz	30 kHz
50 to 500 MHz excl. relevant TX band: GSM 450: 450.4 to 457.6 MHz; GSM 480: 478.8 to 486 MHz, and the RX bands: 460.4 to 467.6 MHz; 488.8 to 496 MHz.	-	100 kHz	300 kHz
500 MHz to 12,75 GHz, excl. relevant TX band: GSM 750: 777 to 792 MHz GSM 850: 824 to 849 MHz; P-GSM: 890 to 915 MHz; E-GSM: 880 to 915 MHz; DCS: 1710 to 1785 MHz, PCS 1 900: 1850 to 1910 MHz; and the RX bands: 747 to 762 MHz; 869 to 894 MHz; 925 to 960 MHz; 1805 to 1880 MHz. 1930 to 1990 MHz;	0 to 10 MHz >= 10 MHz >= 20 MHz >= 30 MHz (offset from edge of relevant TX band)	100 kHz 300 kHz 1 MHz 3 MHz	300 kHz 1 MHz 3 MHz 3 MHz
relevant TX band: GSM 450: 450.4 to 457.6 MHz GSM 480: 478.8 to 486 MHz GSM 750: 777 to 792 MHz GSM 850: 824 to 849 MHz P-GSM: 890 to 915 MHz E-GSM: 880 to 915 MHz DCS: 1710 to 1785 MHz PCS 1 900: 1850 to 1910 MHz;	1,8 to 6,0 MHz > 6,0 MHz (offset from carrier)	30 kHz 100 kHz	100 kHz 300 kHz

NOTE 1: The frequency ranges 460.4 to 467.6 MHz, 488.8 to 496 MHz, 747 to 762 MHz, 869 to 894 MHz, 925 MHz to 960 MHz, 1 805 MHz to 1 880 MHz and 1930 to 1990 MHz are excluded as these ranges are tested in section [13.4].

NOTE 2: The filter and video bandwidths, and frequency offsets are only correct for measurements on an MS transmitting on a channel in the Mid ARFCN range.

NOTE 3: Due to practical implementation, the video bandwidth is restricted to a maximum of 3 MHz.

12.1.1.5 Test requirement

The power of any spurious emission shall not exceed the levels given in table 12.3.

Table 12.3

Frequency range		Power level in dBm		
		GSM400, GSM 700, GSM 850, GSM900	DCS1800	PCS 1900
100 kHz to	1 GHz	-36	-36	-36
1 GHz to	12,75 GHz	-30		-30
1 GHz to	1710 MHz		-30	
1710 MHz to	1785 MHz		-36	
1785 MHz to	12,75 GHz		-30	

12.1.2 MS in idle mode

12.1.2.1 Definition and applicability

Conducted spurious emissions are any emissions from the antenna connector, when the MS is in idle mode.

The requirements and this test apply to all types of GSM 400, GSM 700, GSM 850, GSM 900, DCS 1 800 MS and PCS 1 900 with a permanent antenna connector.

12.1.2.2 Conformance requirement

1. The conducted spurious power emitted by the MS, when in idle mode, shall be no more than the levels in table 12.4.
 - 1.1 Under normal voltage conditions; GSM 05.05, 4.3/4.3.3.
 - 1.2 Under extreme voltage conditions; GSM 05.05, 4.3/4.3.3/Annex D.2.

Table 12.4

Frequency range		Power level in dBm	
		GSM400, GSM900, DCS1800	GSM 700, GSM 850, PCS1900
9 kHz to	880 MHz	-57	-57
880 MHz to	915 MHz	-59	-57
915 MHz to	1000 MHz	-57	-57
1 GHz to	1710 MHz	-47	
1710 MHz to	1785 MHz	-53	
1785 MHz to	12,75 GHz	-47	
1 GHz to	1850 MHz		-47
1850 MHz to	1910 MHz		-53
1910 MHz to	12,75 GHz		-47

12.1.2.3 Test purpose

1. To verify that conducted spurious emissions, in the frequency band 100 kHz to 12,75 GHz from the MS when in idle mode do not exceed the conformance requirements.
 - 1.1 Under normal voltage conditions.
 - 1.2 Under extreme voltage conditions.

NOTE: The band 9 - 100 kHz is not tested, because of test implementation problems.

12.1.2.4 Method of test

12.1.2.4.1 Initial conditions

The BCCH message content from the serving cell shall ensure that Periodic Location Updating is not used and that page mode is continuously set to Paging Reorganization and BS_AG_BLK_RES is set to 0 so that the MS receiver will operate continually.

The CCCH_CONF shall be set to 000. 1 basic physical channel used for CCCH not combined with SDCCHs.

The BCCH allocation shall either be empty or contain only the serving cell BCCH.

NOTE: This is to ensure that the receiver does not scan other ARFCN. Scanning other ARFCN could lead to a moving in frequency of the spurious and therefore to the possibility of either not measuring a spurious emission or measuring it more than once.

The MS is in MM state "idle, updated".

12.1.2.4.2 Procedure

- a) Measurements are made in the frequency range 100 kHz to 12,75 GHz. Spurious emissions are measured as the power level of any discrete signal, higher than the requirement in table 12.4 minus 6 dB, delivered into a 50 Ohm load.

The measurement bandwidth based on a 5 pole synchronously tuned filter is set according to table 12.5. The power indication is the peak power detected by the measuring system.

The measurement time on any frequency shall be such that it includes the time during which the MS receives a TDMA frame containing the paging channel.

Table 12.5

Frequency range	Filter bandwidth	Video bandwidth
100 kHz to 50 MHz	10 kHz	30 kHz
50 MHz to 12,75 GHz	100 kHz	300 kHz

- b) The test is repeated under extreme voltage test conditions ([Annex 1, TC2.2 and TC3]).

12.1.2.5 Test requirement

The power of any spurious emission shall not exceed the levels given in table 12.6.

Table 12.6

Frequency range		Power level in dBm	
		GSM400, GSM900, DCS1800	GSM 700, GSM 850, PCS1900
100 kHz to	880 MHz	-57	-57
880 MHz to	915 MHz	-59	-57
915 MHz to	1000 MHz	-57	-57
1 GHz to	1710 MHz	-47	
1710 MHz to	1785 MHz	-53	
1785 MHz to	12,75 GHz	-47	
1 GHz to	1850 MHz		-47
1850 MHz to	1910 MHz		-53
1910 MHz to	12,75 GHz		-47

12.2 Radiated spurious emissions

This test is performed either on an outdoor test site, fulfilling the requirements of [GC4 of Annex 1], or in an anechoic shielded chamber, fulfilling the requirements of ([GC5 of Annex 1]). Performing the measurement in the anechoic shielded chamber is preferred. The sample shall be placed at the specified height on the support.

NOTE: The test method described has been written for measurement in an anechoic shielded chamber. If an outdoor test site is used then additional precautions are necessary to ensure correct measurement. These measures are familiar to test houses which perform spurious emissions tests and are:

- a) Raise/lower the test antenna through the specified height range during both the emission detection and substitution parts of the test.
- b) Perform a qualitative pre-search in a shielded environment for test sites where the ambient RF environment can prevent the detection of spurious emissions which exceed the limit.
- c) Detect emissions at a more sensitive threshold to that specified in section 12.2.1.4 to allow for destructive interference due to ground plane reflections at the test antenna search height.

12.2.1 MS allocated a channel

12.2.1.1 Definition and applicability

Radiated spurious emissions, when the MS has been allocated a channel, are any emissions radiated by the cabinet and structure of the mobile station, including all interconnecting cables.

This is also known as "cabinet radiation".

The requirements apply to all types of GSM 400, GSM 700, GSM 850, GSM 900, DCS 1 800 and PCS 1 900 MS. The test applies to all types of GSM 400, GSM 700, GSM 850, GSM 900, DCS 1 800 and PCS 1 900 MS with the exception of the test at extreme voltages for an MS where a practical connection, to an external power supply, is not possible.

NOTE: A "practical connection" shall be interpreted to mean it is possible to connect extreme voltages to the MS without interfering with the configuration of the MS in a way which could invalidate the test.

12.2.1.2 Conformance requirement

1. The radiated spurious power emitted by the MS, when allocated a channel, shall be no more than the levels in table 12.7 under normal voltage conditions; GSM 05.05, 4.3/4.3.3.
2. The radiated spurious power emitted by the MS, when allocated a channel, shall be no more than the levels in table 12.7 under extreme voltage conditions; GSM 05.05, 4.3/4.3.3/annex D.2.

Table 12.7

Frequency range		Power level in dBm		
		GSM400, GSM 700, GSM 850, GSM900	DCS1800	PCS 1900
30 MHz to	1 GHz	-36	-36	-36
1 GHz to	4 GHz	-30		-30
1 GHz to	1710 MHz		-30	
1710 MHz to	1785 MHz		-36	
1785 MHz to	4 GHz		-30	

12.2.1.3 Test purpose

1. To verify that radiated spurious emissions from the MS when allocated a channel do not exceed the conformance requirements under normal voltage conditions.
2. To verify that radiated spurious emissions from the MS when allocated a channel do not exceed the conformance requirements under extreme voltage conditions.

12.2.1.4 Method of test

12.2.1.4.1 Initial conditions

A call is set up by the SS according to the generic call set up procedure on a channel in the Mid ARFCN range.

NOTE: The power supply shall be connected to the MS such that the physical configuration does not change in a way that could have an effect on the measurement. In particular, the battery pack of the MS should not normally be removed. In cases where no practical connection can be made to the power supply, the MS's intended battery source shall be used.

The SS commands the MS to loop back its channel decoder output to its channel encoder input.

The SS sends Standard Test Signal C1.

The SS sets the MS to operate at its maximum output power.

12.2.1.4.2 Procedure

- a) Initially the test antenna is closely coupled to the MS and any spurious emission radiated by the MS is detected by the test antenna and receiver in the range 30 MHz to 4 GHz.

NOTE: This is a qualitative step to identify the frequency and presence of spurious emissions which are to be measured in subsequent steps.

- b) The test antenna separation is set to the appropriate measurement distance and at each frequency at which an emission has been detected, the MS shall be rotated to obtain maximum response and the effective radiated power of the emission determined by a substitution measurement. In case of an anechoic shielded chamber pre-calibration may be used instead of a substitution measurement.

- c) The measurement bandwidth, based on a 5 pole synchronously tuned filter, is set according to table 12.8. The power indication is the peak power detected by the measuring system.

The measurement on any frequency shall be performed for at least one TDMA frame period, with the exception of the idle frame.

NOTE 1: This ensures that both the active times (MS transmitting) and the quiet times are measured.

NOTE 2: For these filter bandwidths some difficulties may be experienced with noise floor above required measurement limit. This will depend on the gain of the test antenna, and adjustment of the measuring system bandwidth is permissible. Alternatively, for test frequencies above 900 MHz, the test antenna separation from the MS may be reduced to 1 metre.

- d) The measurements are repeated with the test antenna in the orthogonal polarization plane.
- e) The test is repeated under extreme voltage test conditions (see [Annex 1, TC2.2]).

Table 12.8

Frequency range	Frequency offset	Filter bandwidth	Approx video bandwidth
30 to 50 MHz	-	10 kHz	30 kHz
50 to 500 MHz excl. relevant TX band: GSM 450: 450.4 to 457.6 MHz; GSM 480: 478.8 to 486 MHz 500 MHz to 4 GHz,	-	100 kHz	300 kHz
Excl. relevant TX band: GSM 750: 777 to 792 MHz GSM 850: 824 to 849 MHz P-GSM: 890 to 915 MHz; E-GSM: 880 to 915 MHz; DCS: 1710 to 1785 MHz. PCS 1 900: 1850 to 1910 MHz Relevant TX band: GSM 450: 450.4 to 457.6 MHz GSM 480: 478.8 to 486 MHz GSM 750: 777 to 792 MHz GSM 850: 824 to 849 MHz P-GSM: 890 to 915 MHz E-GSM: 880 to 915 MHz DCS: 1710 to 1785 MHz PCS 1 900: 1850 to 1910 MHz	0 to 10 MHz	100 kHz	300 kHz
	>= 10 MHz	300 kHz	1 MHz
	>= 20 MHz	1 MHz	3 MHz
	>= 30 MHz	3 MHz	3 MHz
	(offset from edge of relevant TX band)		
	1,8 to 6,0 MHz	30 kHz	100 kHz
	> 6,0 MHz	100 kHz	300 kHz
	(offset from carrier)		

NOTE 1: The filter and video bandwidths, and frequency offsets are only correct for measurements on an MS transmitting on a channel in the Mid ARFCN range.

NOTE 2: Due to practical implementation of a SS, the video bandwidth is restricted to a maximum of 3 MHz.

12.2.1.5 Test requirement

The power of any spurious emission shall not exceed the levels given in table 12.7.

12.2.2 MS in idle mode

12.2.2.1 Definition and applicability

Radiated spurious emissions, when the MS is in idle mode, are any emissions radiated by the cabinet and structure of the mobile station, including all interconnecting cables.

This is also known as "cabinet radiation".

The requirements apply to all types of GSM 400, GSM 700, GSM 850, GSM 900, DCS 1 800 and PCS 1 900 MS. The test applies to all types of GSM 400, GSM 700, GSM 850, GSM 900, DCS 1 800 and PCS 1 900 MS with the exception of the test at extreme voltages for an MS where a practical connection, to an external power supply, is not possible.

NOTE: A "practical connection" shall be interpreted to mean it is possible to connect extreme voltages to the MS without interfering with the configuration of the MS in a way which could invalidate the test.

12.2.2.2 Conformance requirement

1. The radiated spurious power emitted by the MS, when in idle mode, shall be no more than the levels in table 12.9. under normal voltage conditions; GSM 05.05, 4.3/4.3.3.
2. The radiated spurious power emitted by the MS, when in idle mode, shall be no more than the levels in table 12.9. under extreme voltage conditions; GSM 05.05, 4.3/4.3.3/Annex D.2.

Table 12.9

Frequency range		Power level in dBm	
		GSM400, GSM900, DCS1800	GSM 700, GSM 850, PCS 1900
30 MHz to	880 MHz	-57	-57
880 MHz to	915 MHz	-59	-57
915 MHz to	1000 MHz	-57	-57
1 GHz to	1710 MHz	-47	
1710 MHz to	1785 MHz	-53	
1785 MHz to	4 GHz	-47	
1 GHz to	1850 MHz		-47
1850 MHz to	1910 MHz		-53
1910 MHz to	4GHz		-47

12.2.2.3 Test purpose

1. To verify that radiated spurious emissions from the MS when in idle mode do not exceed the requirements under normal voltage conditions.
2. To verify that radiated spurious emissions from the MS when in idle mode do not exceed the requirements under extreme voltage conditions.

12.2.2.4 Method of test

12.2.2.4.1 Initial conditions

NOTE: The power supply shall be connected to the MS such that the physical configuration does not change in a way that could have an effect on the measurement. In particular, the battery pack of the MS should not normally be removed. In cases where no practical connection can be made to the power supply, the MS's intended battery source shall be used.

The BCCH message content from the serving cell shall ensure that Periodic Location Updating is not used and that page mode is continuously set to Paging Reorganization and BS_AG_BLK_RES is set to 0 so that the MS receiver will operate continually.

The CCCH_CONF shall be set to 000. 1 basic physical channel used for CCCH not combined with SDCCHs.

The BCCH allocation shall either be empty or contain only the serving cell BCCH.

NOTE: This is to ensure that the receiver does not scan other ARFCN. Scanning other ARFCN could lead to a moving in frequency of the spurious and therefore to the possibility of either not measuring a spurious emission or measuring it more than once.

The MS is in MM state "idle, updated".

12.2.2.4.2 Procedure

- a) Initially the test antenna is closely coupled to the MS and any spurious emission radiated by the MS are detected by the test antenna and receiver in the range 30 MHz to 4 GHz.

NOTE: This is a qualitative step to identify the frequency and presence of spurious emissions which are to be measured in subsequent steps.

- b) The test antenna separation is set to the appropriate measurement distance and at each frequency at which a spurious emission has been detected the MS is rotated to obtain a maximum response. The effective radiated power of the emission is determined by a substitution measurement. In case of an anechoic shielded chamber pre-calibration may be used instead of a substitution measurement.
- c) The measurement bandwidth based on a 5 pole synchronously tuned filter shall be according to table 12.10. The power indication is the peak power detected by the measuring system.

The measurement time on any frequency shall be such that it includes the time during which the MS receives a TDMA frame containing the paging channel.

NOTE: For these filter bandwidths some difficulties may be experienced with noise floor above required measurement limit. This will depend on the gain of the test antenna, and adjustment of the measuring system bandwidth is permissible. Alternatively, for test frequencies above 900 MHz, the test antenna separation from the MS may be reduced to 1 metre.

Table 12.10

Frequency range	Filter bandwidth	Video bandwidth
30 MHz to 50 MHz	10 kHz	30 kHz
50 MHz to 4 GHz	100 kHz	300 kHz

d) The measurements are repeated with the test antenna in the orthogonal polarization plane.

e) The test is repeated under extreme voltage test conditions (see [Annex 1, TC2.2]).

12.2.2.5 Test requirement

The power of any spurious emission shall not exceed the levels given in table 12.9.

12.3 Conducted spurious emissions for MS supporting the R-GSM frequency band

This section applies only to MS supporting the R-GSM frequency band

12.3.1 MS allocated a channel

12.3.1.1 Definition and applicability

Conducted spurious emissions, when the MS has been allocated a channel, are emissions from the antenna connector at frequencies other than those of the carrier and sidebands associated with normal modulation.

The requirements and this test apply to all types of R-GSM 900 MS with a permanent antenna connector.

12.3.1.2 Conformance requirement

1. The conducted spurious power emitted by the MS, when allocated a channel, shall be no more than the levels in table 12.11.

1.1 Under normal voltage conditions; GSM 05.05, 4.3/4.3.3.

1.2 Under extreme voltage conditions; GSM 05.05, 4.3/4.3.3/Annex D.2.

Table 12.11

Frequency range	Power level in dBm	
	R-GSM900 small MS	R-GSM900 other MS
9 kHz to 1 GHz	-36	
9 kHz to 876 MHz		-36
876 MHz to 915 MHz		-42
915 MHz to 1 GHz		-36
1 GHz to 12,75 GHz	-30	-30

12.3.1.3 Test purpose

1. To verify that conducted spurious emissions, in the frequency band 100 kHz to 12,75 GHz excluding the R-GSM900 and DCS 1 800 receive bands, from the MS when allocated a channel do not exceed the conformance requirements.

1.1 Under normal voltage conditions.

1.2 Under extreme voltage conditions.

NOTE: The band 9 - 100 kHz is not tested, because of test implementation problems.

12.3.1.4 Method of test

12.3.1.4.1 Initial conditions

A call is set up by the SS according to the generic call set up procedure on a channel in the Mid ARFCN range.

The SS commands the MS to loop back its channel decoder output to channel encoder input.

The SS sends Standard Test Signal C1.

The SS sets the MS to operate at its maximum output power.

12.3.1.4.2 Procedure

- a) Measurements are made in the frequency range 100 kHz to 12,75 GHz. Spurious emissions are measured at the connector of the transceiver, as the power level of any discrete signal, higher than the requirement in table 12.11 minus 6 dB, delivered into a 50 Ohm load.

The measurement bandwidth based on a 5 pole synchronously tuned filter is according to table 12.12. The power indication is the peak power detected by the measuring system.

The measurement on any frequency shall be performed for at least one TDMA frame period with the exception of the idle frame.

NOTE: This ensures that both the active times (MS transmitting) and the quiet times are measured.

- b) The test is repeated under extreme voltage test conditions ([Annex 1, TC2.2 and TC3]).

Table 12.12

Frequency range	Frequency offset	Filter bandwidth	Approx video bandwidth
100 kHz to 50 MHz	-	10 kHz	30 kHz
50 to 500 MHz	-	100 kHz	300 kHz
500 MHz to 12,75 GHz, excl. relevant TX band: R-GSM: 876 to 915 MHz; ; ; and the RX bands: 921 to 960 MHz; 1805 to 1880 MHz.	0 to 10 MHz ≥ 10 MHz ≥ 20 MHz ≥ 30 MHz (offset from edge of relevant TX band)	100 kHz 300 kHz 1 MHz 3 MHz	300 kHz 1 MHz 3 MHz 3 MHz
relevant TX band: R-GSM: 876 to 915 MHz	1,8 to 6,0 MHz > 6,0 MHz (offset from carrier)	30 kHz 100 kHz	100 kHz 300 kHz

NOTE 1: The frequency ranges 921 MHz to 960 MHz and 1 805 MHz to 1 880 MHz are excluded as these ranges are tested in section [13.9].

NOTE 2: The filter and video bandwidths, and frequency offsets are only correct for measurements on an MS transmitting on a channel in the Mid ARFCN range.

NOTE 3: Due to practical implementation, the video bandwidth is restricted to a maximum of 3 MHz.

12.3.1.5 Test requirement

The power of any spurious emission shall not exceed the levels given in table 12.13.

Table 12.13

Frequency range		Power level in dBm	
		R-GSM900 small MS	R-GSM900 other MS
100 kHz to	1 GHz	-36	
100 kHz to	876 MHz		-36
876 MHz to	915 MHz		-42
915 MHz to	1 GHz		-36
1 GHz to	12,75 GHz	-30	-30

12.3.2 MS in idle mode

12.3.2.1 Definition and applicability

Conducted spurious emissions are any emissions from the antenna connector, when the MS is in idle mode.

The requirements and this test apply to all types of R-GSM 900 MS with a permanent antenna connector.

12.3.2.2 Conformance requirement

1. The conducted spurious power emitted by the MS, when in idle mode, shall be no more than the levels in table 12.14.

1.1 Under normal voltage conditions; GSM 05.05, 4.3/4.3.3.

1.2 Under extreme voltage conditions; GSM 05.05, 4.3/4.3.3/Annex D.2.

Table 12.14

Frequency range		Power level in dBm
9 kHz to	880 MHz	-57
880 MHz to	915 MHz	-59
915 MHz to	1000 MHz	-57
1 GHz to	1710 MHz	-47
1710 MHz to	1785 MHz	-53
1785 MHz to	12,75 GHz	-47

12.3.2.3 Test purpose

1. To verify that conducted spurious emissions, in the frequency band 100 kHz to 12,75 GHz from the MS when in idle mode do not exceed the conformance requirements.

1.1 Under normal voltage conditions.

1.2 Under extreme voltage conditions.

NOTE: The band 9 - 100 kHz is not tested, because of test implementation problems.

12.3.2.4 Method of test

12.3.2.4.1 Initial conditions

The BCCH message content from the serving cell shall ensure that Periodic Location Updating is not used and that page mode is continuously set to Paging Reorganization and BS_AG_BLK_RES is set to 0 so that the MS receiver will operate continually.

The CCCH_CONF shall be set to 000. 1 basic physical channel used for CCCH not combined with SDCCHs.

The BCCH allocation shall either be empty or contain only the serving cell BCCH.

NOTE: This is to ensure that the receiver does not scan other ARFCN. Scanning other ARFCN could lead to a moving in frequency of the spurious and therefore to the possibility of either not measuring a spurious emission or measuring it more than once.

The MS is in MM state "idle, updated".

12.3.2.4.2 Procedure

- a) Measurements are made in the frequency range 100 kHz to 12,75 GHz. Spurious emissions are measured as the power level of any discrete signal, higher than the requirement in table 12.14 minus 6 dB, delivered into a 50 Ohm load.

The measurement bandwidth based on a 5 pole synchronously tuned filter is set according to table 12.15. The power indication is the peak power detected by the measuring system.

The measurement time on any frequency shall be such that it includes the time during which the MS receives a TDMA frame containing the paging channel.

Table 12.15

Frequency range	Filter bandwidth	Video bandwidth
100 kHz to 50 MHz	10 kHz	30 kHz
50 MHz to 12,75 GHz	100 kHz	300 kHz

- b) The test is repeated under extreme voltage test conditions ([Annex 1, TC2.2 and TC3]).

12.3.2.5 Test requirement

The power of any spurious emission shall not exceed the levels given in table 12.16.

Table 12.16

Frequency range	Power level in dBm
100 kHz to 880 MHz	-57
880 MHz to 915 MHz	-59
915 MHz to 1000 MHz	-57
1 GHz to 1710 MHz	-47
1710 MHz to 1785 MHz	-53
1785 MHz to 12,75 GHz	-47

12.4 Radiated spurious emissions for MS supporting the R-GSM frequency band

This section applies only to MS supporting the R-GSM frequency band.

This test is performed either on an outdoor test site, fulfilling the requirements of [GC4 of Annex 1], or in an anechoic shielded chamber, fulfilling the requirements of ([GC5 of Annex 1]). Performing the measurement in the anechoic shielded chamber is preferred. The sample shall be placed at the specified height on the support.

NOTE: The test method described has been written for measurement in an anechoic shielded chamber. If an outdoor test site is used then additional precautions are necessary to ensure correct measurement. These measures are familiar to test houses which perform spurious emissions tests and are:

- a) Raise/lower the test antenna through the specified height range during both the emission detection and substitution parts of the test.

- b) Perform a qualitative pre-search in a shielded environment for test sites where the ambient RF environment can prevent the detection of spurious emissions which exceed the limit.
- c) Detect emissions at a more sensitive threshold to that specified in section 12.4.1.4 to allow for destructive interference due to ground plane reflections at the test antenna search height.

12.4.1 MS allocated a channel

12.4.1.1 Definition and applicability

Radiated spurious emissions, when the MS has been allocated a channel, are any emissions radiated by the cabinet and structure of the mobile station, including all interconnecting cables.

This is also known as "cabinet radiation".

The requirements apply to all types of R-GSM 900 MS. The test applies to all types of R-GSM with the exception of the test at extreme voltages for an MS where a practical connection, to an external power supply, is not possible.

NOTE: A "practical connection" shall be interpreted to mean it is possible to connect extreme voltages to the MS without interfering with the configuration of the MS in a way which could invalidate the test.

12.4.1.2 Conformance requirement

1. The radiated spurious power emitted by the MS, when allocated a channel, shall be no more than the levels in table 12.17 under normal voltage conditions; GSM 05.05, 4.3/4.3.3.
2. The radiated spurious power emitted by the MS, when allocated a channel, shall be no more than the levels in table 12.17 under extreme voltage conditions; GSM 05.05, 4.3/4.3.3/annex D.2.

Table 12.17

Frequency range		Power level in dBm	
		R-GSM900 small MS	R-GSM900 other MS
30 MHz to	1 GHz	-36	
30 MHz to	876 MHz		-36
876 MHz to	915 MHz		-42
915 MHz to	1 GHz	-36	
1 GHz to	4 GHz	-30	-30

12.4.1.3 Test purpose

1. To verify that radiated spurious emissions from the MS when allocated a channel do not exceed the conformance requirements under normal voltage conditions.
2. To verify that radiated spurious emissions from the MS when allocated a channel do not exceed the conformance requirements under extreme voltage conditions.

12.4.1.4 Method of test

12.4.1.4.1 Initial conditions

A call is set up by the SS according to the generic call set up procedure on a channel in the Mid ARFCN range.

NOTE: The power supply shall be connected to the MS such that the physical configuration does not change in a way that could have an effect on the measurement. In particular, the battery pack of the MS should not normally be removed. In cases where no practical connection can be made to the power supply, the MS's intended battery source shall be used.

The SS commands the MS to loop back its channel decoder output to its channel encoder input.

The SS sends Standard Test Signal C1.

The SS sets the MS to operate at its maximum output power.

12.4.1.4.2 Procedure

- a) Initially the test antenna is closely coupled to the MS and any spurious emission radiated by the MS is detected by the test antenna and receiver in the range 30 MHz to 4 GHz.

NOTE: This is a qualitative step to identify the frequency and presence of spurious emissions which are to be measured in subsequent steps.

- b) The test antenna separation is set to the appropriate measurement distance and at each frequency at which an emission has been detected, the MS shall be rotated to obtain maximum response and the effective radiated power of the emission determined by a substitution measurement. In case of an anechoic shielded chamber pre-calibration may be used instead of a substitution measurement.
- c) The measurement bandwidth, based on a 5 pole synchronously tuned filter, is set according to table 12.18. The power indication is the peak power detected by the measuring system.

The measurement on any frequency shall be performed for at least one TDMA frame period, with the exception of the idle frame.

NOTE 1: This ensures that both the active times (MS transmitting) and the quiet times are measured.

NOTE 2: For these filter bandwidths some difficulties may be experienced with noise floor above required measurement limit. This will depend on the gain of the test antenna, and adjustment of the measuring system bandwidth is permissible. Alternatively, for test frequencies above 900 MHz, the test antenna separation from the MS may be reduced to 1 metre.

- d) The measurements are repeated with the test antenna in the orthogonal polarization plane.

- e) The test is repeated under extreme voltage test conditions (see [Annex 1, TC2.2]).

Table 12.18

Frequency range	Frequency offset	Filter bandwidth	Approx video bandwidth
30 to 50 MHz	-	10 kHz	30 kHz
50 to 500 MHz	-	100 kHz	300 kHz
500 MHz to 4 GHz, excl. relevant TX band: R-GSM: 876 to 915 MHz;	0 to 10 MHz ≥ 10 MHz ≥ 20 MHz ≥ 30 MHz	100 kHz 300 kHz 1 MHz 3 MHz	300 kHz 1 MHz 3 MHz 3 MHz
relevant TX band: R-GSM: 876 to 915 MHz	(offset from edge of relevant TX band) 1,8 to 6,0 MHz > 6,0 MHz (offset from carrier)	30 kHz 100 kHz	100 kHz 300 kHz

NOTE 1: The filter and video bandwidths, and frequency offsets are only correct for measurements on an MS transmitting on a channel in the Mid ARFCN range.

NOTE 2: Due to practical implementation of a SS, the video bandwidth is restricted to a maximum of 3 MHz.

12.4.1.5 Test requirement

The power of any spurious emission shall not exceed the levels given in table 12.17.

12.4.2 MS in idle mode

12.4.2.1 Definition and applicability

Radiated spurious emissions, when the MS is in idle mode, are any emissions radiated by the cabinet and structure of the mobile station, including all interconnecting cables.

This is also known as "cabinet radiation".

The requirements apply to all types of R-GSM 900 MS. The test applies to all types of R-GSM 900 with the exception of the test at extreme voltages for an MS where a practical connection, to an external power supply, is not possible.

NOTE: A "practical connection" shall be interpreted to mean it is possible to connect extreme voltages to the MS without interfering with the configuration of the MS in a way which could invalidate the test.

12.4.2.2 Conformance requirement

1. The radiated spurious power emitted by the MS, when in idle mode, shall be no more than the levels in table 12.19. under normal voltage conditions; GSM 05.05, 4.3/4.3.3.
2. The radiated spurious power emitted by the MS, when in idle mode, shall be no more than the levels in table 12.19. under extreme voltage conditions; GSM 05.05, 4.3/4.3.3/Annex D.2.

Table 12.19

Frequency range		Power level in dBm
30 MHz to	880 MHz	-57
880 MHz to	915 MHz	-59
915 MHz to	1000 MHz	-57
1 GHz to	1710 MHz	-47
1710 MHz to	1785 MHz	-53
1785 MHz to	4 GHz	-47

12.4.2.3 Test purpose

1. To verify that radiated spurious emissions from the MS when in idle mode do not exceed the requirements under normal voltage conditions.
2. To verify that radiated spurious emissions from the MS when in idle mode do not exceed the requirements under extreme voltage conditions.

12.4.2.4 Method of test

12.4.2.4.1 Initial conditions

NOTE: The power supply shall be connected to the MS such that the physical configuration does not change in a way that could have an effect on the measurement. In particular, the battery pack of the MS should not normally be removed. In cases where no practical connection can be made to the power supply, the MS's intended battery source shall be used.

The BCCH message content from the serving cell shall ensure that Periodic Location Updating is not used and that page mode is continuously set to Paging Reorganization and BS_AG_BLK_RES is set to 0 so that the MS receiver will operate continually.

The CCCH_CONF shall be set to 000. 1 basic physical channel used for CCCH not combined with SDCCHs.

The BCCH allocation shall either be empty or contain only the serving cell BCCH.

NOTE: This is to ensure that the receiver does not scan other ARFCN. Scanning other ARFCN could lead to a moving in frequency of the spurious and therefore to the possibility of either not measuring a spurious emission or measuring it more than once.

The MS is in MM state "idle, updated".

12.4.2.4.2 Procedure

- a) Initially the test antenna is closely coupled to the MS and any spurious emission radiated by the MS are detected by the test antenna and receiver in the range 30 MHz to 4 GHz.

NOTE: This is a qualitative step to identify the frequency and presence of spurious emissions which are to be measured in subsequent steps.

- b) The test antenna separation is set to the appropriate measurement distance and at each frequency at which a spurious emission has been detected the MS is rotated to obtain a maximum response. The effective radiated power of the emission is determined by a substitution measurement. In case of an anechoic shielded chamber pre-calibration may be used instead of a substitution measurement.
- c) The measurement bandwidth based on a 5 pole synchronously tuned filter shall be according to table 12.20. The power indication is the peak power detected by the measuring system.

The measurement time on any frequency shall be such that it includes the time during which the MS receives a TDMA frame containing the paging channel.

NOTE: For these filter bandwidths some difficulties may be experienced with noise floor above required measurement limit. This will depend on the gain of the test antenna, and adjustment of the measuring system bandwidth is permissible. Alternatively, for test frequencies above 900 MHz, the test antenna separation from the MS may be reduced to 1 metre.

Table 12.20

Frequency range	Filter bandwidth	Video bandwidth
30 MHz to 50 MHz	10 kHz	30 kHz
50 MHz to 4 GHz	100 kHz	300 kHz

- d) The measurements are repeated with the test antenna in the orthogonal polarization plane.
- e) The test is repeated under extreme voltage test conditions (see [Annex 1, TC2.2]).

12.4.2.5 Test requirement

The power of any spurious emission shall not exceed the levels given in table 12.19.

13 Transmitter

13.1 Frequency error and phase error

13.1.1 Definition and applicability

The frequency error is the difference in frequency, after adjustment for the effect of the modulation and phase error, between the RF transmission from the MS and either:

- the RF transmission from the BS, or
- the nominal frequency for the ARFCN used.

The phase error is the difference in phase, after adjustment for the effect of the frequency error, between the RF transmission from the MS and the theoretical transmission according to the intended modulation.

The requirements and this test apply to all types of GSM 400, GSM 700, GSM 850, GSM 900, DCS 1 800 and PCS 1 900 MS.

13.1.2 Conformance requirement

1. The MS carrier frequency shall be accurate to within 0,1 ppm, or accurate to within 0,1 ppm compared to signals received from the BS. For GSM 400 MS a value of 0.2 ppm shall be used in both cases.
 - 1.1 Under normal conditions; GSM 05.10, 6.1.
 - 1.2 Under vibration conditions; GSM 05.10, 6.1; GSM 05.05, annex D D.2.3.
 - 1.3 Under extreme conditions; GSM 05.10, 6.1; GSM 05.05, 4.4; GSM 05.05, annex D D.2.1, D.2.2.
2. The RMS phase error (difference between the phase error trajectory and its linear regression on the active part of the time slot) for each burst shall not be greater than 5 degrees.
 - 2.1 Under normal conditions; GSM 05.05, 4.6.
 - 2.2 Under vibration conditions; GSM 05.05, 4.6; GSM 05.05, annex D D.2.3.
 - 2.3 Under extreme conditions; GSM 05.05, 4.6; GSM 05.05, annex D D.2.1, D.2.2.
3. The maximum peak deviation during the useful part of each burst shall not be greater than 20 degrees.
 - 3.1 Under normal conditions; GSM 05.05, 4.6.
 - 3.2 Under vibration conditions; GSM 05.05, 4.6; GSM 05.05, annex D D.2.3.
 - 3.3 Under extreme conditions; GSM 05.05, 4.6; GSM 05.05, annex D D.2.1, D.2.2.

13.1.3 Test purpose

1. To verify that the MS carrier frequency error does not exceed 0,1 ppm (0.2 ppm for GSM 400):
 - 1.1 Under normal conditions.
 - 1.2 When the MS is being vibrated.
 - 1.3 Under extreme conditions.

NOTE: The transmit frequency accuracy of the SS is expected to be sufficient to ensure that the difference between 0,1 ppm (0.2 ppm for GSM 400) absolute and 0,1 ppm (0.2 ppm for GSM 400) compared to signals received from the BS would be small enough to be considered insignificant.

2. To verify that the RMS phase error on the useful part of the bursts transmitted by the MS does not exceed conformance requirement 2:
 - 2.1 Under normal conditions.
 - 2.2 When the MS is being vibrated.
 - 2.3 Under extreme conditions.
3. To verify that the maximum phase error on the useful part of the bursts transmitted by the MS does not exceed conformance requirement 3.
 - 3.1 Under normal conditions.
 - 3.2 When the MS is being vibrated.
 - 3.3 Under extreme conditions.

13.1.4. Method of test

NOTE: In order to measure the accuracy of the frequency and phase error a sampled measurement of the transmitted phase trajectory is obtained. This is compared with the theoretically expected phase trajectory. The regression line of the difference between the expected trajectory and the measured trajectory is an indication of the frequency error (assumed constant through the burst), whilst the departure of the phase differences from this trajectory is a measure of the phase error. The peak phase error is the value furthest from the regression line and the RMS phase error is the root mean square average of the phase error of all samples.

13.1.4.1 Initial conditions

A call is set up according to the Generic call setup procedure.

The SS commands the MS to hopping mode (table 6.1).

NOTE: It is not necessary to test in hopping mode but is done here as a simple means of making the MS change channel, it would be sufficient to test in non hopping mode and to make sure bursts are taken from a few different channels.

The SS activates ciphering mode.

NOTE: Ciphering mode is active during this test to give a pseudo-random bit stream to the modulator.

The SS commands the MS to complete the traffic channel loop back without signalling of erased frames (see 36.2.1.1).

The SS generates Standard Test Signal C1 of annex 5.

13.1.4.2 Procedure

- a) For one transmitted burst, the SS captures the signal as a series of phase samples over the period of the burst. These samples are evenly distributed over the duration of the burst with a minimum sampling rate of $2/T$, where T is the modulation symbol period. The received phase trajectory is then represented by this array of at least 294 samples.
- b) The SS then calculates, from the known bit pattern and the formal definition of the modulator contained in GSM 05.04, the expected phase trajectory.
- c) From a) and b) the phase trajectory error is calculated, and a linear regression line computed through this phase trajectory error. The slope of this regression line is the frequency error of the mobile transmitter relative to the simulator reference. The difference between the regression line and the individual sample points is the phase error of that point.

- c.1) The sampled array of at least 294 phase measurements is represented by the vector:

$$\varnothing_m = \varnothing_m(0) \dots \varnothing_m(n)$$

where the number of samples in the array $n+1 \geq 294$.

- c.2) The calculated array, at the corresponding sampling instants, is represented by the vector:

$$\varnothing_c = \varnothing_c(0) \dots \varnothing_c(n).$$

- c.3) The error array is represented by the vector:

$$\varnothing_e = \{\varnothing_m(0) - \varnothing_c(0)\} \dots \{\varnothing_m(n) - \varnothing_c(n)\} = \varnothing_e(0) \dots \varnothing_e(n).$$

- c.4) The corresponding sample numbers form a vector $t = t(0) \dots t(n)$.

- c.5) By regression theory the slope of the samples with respect to t is k where:

$$k = \frac{\sum_{j=0}^{j=n} t(j) * \varnothing_e(j)}{\sum_{j=0}^{j=n} t(j)^2}$$

c.6) The frequency error is given by $k/(360 * \gamma)$, where γ is the sampling interval in s and all phase samples are measured in degrees.

c.7) The individual phase errors from the regression line are given by:

$$\varnothing_e(j) - k * t(j).$$

c.8) The RMS value \varnothing_e of the phase errors is given by:

$$\varnothing_e(\text{RMS}) = \left[\frac{\sum_{j=0}^{j=n} \{\varnothing_e(j) - k * t(j)\}^2}{n+1} \right]^{1/2}$$

d) Steps a) to c) are repeated for 20 bursts, not necessarily contiguous.

e) The SS instructs the MS to its maximum power control level, all other conditions remaining constant. Steps a) to d) are repeated.

f) The SS instructs the MS to the minimum power control level, all other conditions remaining constant. Steps a) to d) are repeated.

g) The MS is hard mounted on a vibration table and vibrated at the frequency/amplitudes specified in annex 1, TC4. During the vibration steps a) to f) are repeated.

NOTE: If the call is terminated when mounting the MS to the vibration table, it will be necessary to establish the initial conditions again before repeating steps a) to f).

h) The MS is re-positioned on the vibration table in the two orthogonal planes to the plane used in step g). For each of the orthogonal planes step g) is repeated.

i) Steps a) to f) are repeated under extreme test conditions (see annex 1, TC2.2).

NOTE: The series of samples taken to determine the phase trajectory could also be used, with different post-processing, to determine the transmitter burst characteristics of 13.3. Although described independently, it is valid to combine the tests of 13.1 and 13.3, giving both answers from single sets of captured data.

13.1.5 Test requirements

13.1.5.1 Frequency error

For all measured bursts, the frequency error, derived in step c.6), shall be less than 0.1 ppm, except for GSM 400 MS where a value of 0.2 ppm shall be used.

13.1.5.2 Phase error

For all measured bursts, the RMS phase error, derived in step c.8), shall not exceed 5 degrees.

For all measured bursts, each individual phase error, derived in step c.7), shall not exceed 20 degrees.

13.2 Frequency error under multipath and interference conditions

13.2.1 Definition and applicability

The frequency error under multipath and interference conditions is a measure of the ability of the MS to maintain frequency synchronization with the received signal under conditions of Doppler shift, multipath reception and interference.

The requirements and this test apply to all types of GSM 400, GSM 700, GSM 850, GSM 900, DCS 1 800 and PCS 1 900 MS.

13.2.2 Conformance requirement

1. The MS carrier frequency error for each burst shall be accurate to within 0,1 ppm (0,2 ppm for GSM 400), or 0,1 ppm (0,2 ppm for GSM 400) compared to signals received from the BS for signal levels down to 3 dB below the reference sensitivity level.
 - 1.1 Under normal conditions; GSM 05.10, 6/6.1.
 - 1.2 Under extreme conditions; GSM 05.10, 6/6.1; GSM 05.05 annex D D.2.1, D.2.2.
2. The MS carrier frequency error for each burst shall be accurate to within 0,1 ppm (0,2 ppm for GSM 400), or 0,1 ppm (0,2 ppm for GSM 400) compared to signals received from the BS for 3 dB less carrier to interference ratio than the reference interference ratios (GSM 05.10, 6/6.1).

13.2.3 Test purpose

1. To verify that the MS carrier frequency error at reference sensitivity, under conditions of multipath and Doppler shift does not exceed 0,1 ppm (0.2 ppm for GSM 400) + the frequency error due to the Doppler shift of the received signal and the assessment error in the MS.
 - 1.1 Under normal conditions.
 - 1.2 Under extreme conditions.

NOTE: Although the conformance requirement states that frequency synchronization should be maintained for input signals 3 dB below reference sensitivity. Due to the Radio Link Failure counter this test condition cannot be established. Hence all tests in this section are conducted at reference sensitivity level.

2. To verify that the MS carrier frequency error, under interference conditions and TUlow fading profile, does not exceed 0,1 ppm (0.2 ppm for GSM 400) + the frequency error due to the Doppler shift of the received signal and the assessment error in the MS.

NOTE: The test adds the effect of Doppler shift to the requirements as the conformance requirement refers to signals input to the MS receiver whereas the frequency reference for measurement will not take account of the Doppler shift.

13.2.4 Method of test

This test uses the same measurement process as test 13.1 for the MS operating under various RF conditions.

NOTE: The BA list sent on the BCCH and the SACCH will indicate at least six surrounding cells with at least one near to each band edge. It is not necessary to generate any of these BCCH but if they are provided none will be within 5 channels of the ARFCN used for the serving BCCH or TCH.

13.2.4.1 Initial conditions

The MS is brought into the idle updated state on a serving cell with BCCH in the mid ARFCN range.

13.2.4.2 Procedure

- a) The level of the serving cell BCCH is set to 10 dB above the reference sensitivity level() and the fading function set to RA. The SS waits 30 s for the MS to stabilize to these conditions. The SS is set up to capture the

first burst transmitted by the MS during call establishment. A call is initiated by the SS on a channel in the mid ARFCN range as described for the generic call set up procedure but to a TCH at level 10 dB above the reference sensitivity level() and fading function set to RA.

- b) The SS calculates the frequency accuracy of the captured burst as described in test 13.1.
- c) The SS sets the serving cell BCCH and TCH to the reference sensitivity level() applicable to the type of MS, still with the fading function set to RA and then waits 30 s for the MS to stabilize to these conditions.
- d) The SS shall capture subsequent bursts from the traffic channel in the manner described in test 13.1.

NOTE: Due to the very low signal level at the MS receiver input the MS receiver is liable to error. The "looped back" bits are therefore also liable to error, and hence the SS does not know the expected bit sequence. The SS will have to demodulate the received signal to derive (error free) the transmitter burst bit pattern. Using this bit pattern the SS can calculate the expected phase trajectory according to the definition within GSM 05.04.

- e) The SS calculates the frequency accuracy of the captured burst as described in test 13.1.
- f) Steps d) and e) are repeated for 5 traffic channel bursts spaced over a period of not less than 20 s.
- g) The initial conditions are established again and steps a) to f) are repeated but with the fading function set to HT100 (HT200 for GSM 400, HT120 for GSM 700).
- h) The initial conditions are established again and steps a) to f) are repeated but with the fading function set to TU50 (TU100 for GSM 400, TU 60 for GSM 700).
- i) The initial conditions are established again and steps a) and b) are repeated but with the following differences:
 - the levels of the BCCH and TCH are set to 18 dB above reference sensitivity level().
 - two further independent interfering signals are sent on the same nominal carrier frequency as the BCCH and TCH and at a level 10 dB below the level of the TCH and modulated with random data, including the midamble.
 - the fading function for all channels is set to TUlow.
- j) The SS waits 100 s for the MS to stabilize to these conditions.
- k) Repeat steps d) to f), except that at step f) the measurement period must be extended to 200 s and the number of measurements increased to 20.
- l) The initial conditions are established again and steps a) to k) are repeated for ARFCN in the Low ARFCN range.
- m) The initial conditions are established again and steps a) to k) are repeated for ARFCN in the High ARFCN range.
- n) Repeat step h) under extreme test conditions (see annex 1, TC2.2).

13.2.5 Test requirements

The frequency error, with reference to the SS carrier frequency as measured in repeats of step e), for each measured burst shall be less than the values shown in tables 13-1a and 13-1b.

Table 13-1a: Requirements for frequency error under multipath, Doppler shift and interference conditions

GSM 850 and GSM 900		DCS 1 800		PCS 1 900	
Propagation condition	Permitted frequency error	Propagation condition	Permitted frequency error	Propagation condition	Permitted frequency error
RA250	+/- 300 Hz	RA130	+/- 400 Hz	RA130	+/- 420 Hz
HT100	+/- 180 Hz	HT100	+/- 350 Hz	HT100	+/- 370 Hz
TU50	+/- 160 Hz	TU50	+/- 260 Hz	TU50	+/- 280 Hz
TU3	+/- 230 Hz	TU1,5	+/- 320 Hz	TU1,5	+/- 330 Hz

Table 13-1b: Requirements for frequency error under multipath, Doppler shift and interference conditions

GSM 450		GSM 480		GSM 700	
Propagation condition	Permitted frequency error	Propagation condition	Permitted frequency error	Propagation condition	Permitted frequency error
RA500	+/- 300 Hz	RA500	+/- 300 Hz	RA 300	+/- 300 Hz
HT200	+/- 180 Hz	HT200	+/- 180 Hz	HT 120	+/- 180 Hz
TU100	+/- 160 Hz	TU100	+/- 160 Hz	TU 60	+/- 160 Hz
TU6	+/- 230 Hz	TU6	+/- 230 Hz	TU 3.6	+/- 230 Hz

13.3 Transmitter output power and burst timing

13.3.1 Definition and applicability

The transmitter output power is the average value of the power delivered to an artificial antenna or radiated by the MS and its integral antenna, over the time that the useful information bits of one burst are transmitted.

The transmit burst timing is the envelope of the RF power transmitted with respect to time. The timings are referenced to the transition from bit 13 to bit 14 of the Training Sequence ("midamble") before differential decoding. The timing of the modulation is referenced to the timing of the received signal from the SS.

The requirements and this test apply to all types of GSM 400, GSM 700, GSM 850, GSM 900, DCS 1 800 and PCS 1 900 MS.

13.3.2 Conformance requirement

1. The MS maximum output power shall be as defined in GSM 05.05, 4.1.1, table for GMSK modulation, according to its power class, with a tolerance of +/- 2 dB under normal conditions; GSM 05.05, 4.1.1, table for GMSK modulation.
2. The MS maximum output power shall be as defined in GSM 05.05, 4.1.1, table for GMSK modulation, according to its power class, with a tolerance of +/- 2,5 dB under extreme conditions; GSM 05.05, 4.1.1, table for GMSK modulation; GSM 05.05 annex D D.2.1, D.2.2.
3. The power control levels shall have the nominal output power levels as defined in GSM 05.05, 4.1.1, from the lowest power control level up to the maximum output power corresponding to the class of the MS (for tolerance on maximum output power see conformance requirements 1), with a tolerance of +/- 3, 4 or 5 dB under normal conditions; GSM 05.05, 4.1.1.
4. The power control levels shall have the nominal output power levels as defined in GSM 05.05, 4.1.1, from the lowest power control level up to the maximum output power corresponding to the class of the MS (for tolerance on maximum output power see conformance requirements 2), with a tolerance of +/- 4, 5 or 6 dB under extreme conditions; GSM 05.05, 4.1.1; GSM 05.05 annex D D.2.1, D.2.2.

5. The output power actually transmitted by the MS at consecutive power control levels shall form a monotonic sequence and the interval between power control levels shall be $2 \pm 1,5$ dB (1 ± 1 dB between power control level 30 and 31 for PCS 1 900); GSM 05.05, 4.1.1.
6. The transmitted power level relative to time for a normal burst shall be within the power/time template given in GSM 05.05, annex B figure B.1:
 - 6.1 Under normal conditions; GSM 05.05, 4.5.2..
 - 6.2 Under extreme conditions; GSM 05.05, 4.5.2, GSM 05.05 annex D D.2.1, D.2.2.
7. When accessing a cell on the RACH and before receiving the first power command during a communication on a DCCH or TCH (after an IMMEDIATE ASSIGNMENT), all GSM, class 1 and class 2 DCS 1 800 and PCS 1 900 MS shall use the power control level defined by the MS_TXPWR_MAX_CCH parameter broadcast on the BCCH of the cell, or if MS_TXPWR_MAX_CCH corresponds to a power control level not supported by the MS as defined by its power class, the MS shall act as though the closest supported power control level had been broadcast. A Class 3 DCS 1 800 MS shall use the POWER_OFFSET parameter.
8. The transmissions from the MS to the BS, measured at the MS antenna, shall be $468,75 - TA$ bit periods behind the transmissions received from the BS, where TA is the last timing advance received from the current serving BS. The tolerance on these timings shall be ± 1 bit period:
 - 8.1 Under normal conditions; GSM 05.10, 6.4.
 - 8.2 Under extreme conditions; GSM 05.10, 6.4, GSM 05.05 annex D D.2.1, D.2.2.
9. The transmitted power level relative to time for a random access burst shall be within the power/time template given in GSM 05.05, annex B figure B.3:
 - 9.1 Under normal conditions; GSM 05.05, 4.5.2.
 - 9.2 Under extreme conditions; GSM 05.05, 4.5.2, GSM 05.05 annex D D.2.1, D.2.2.
- 10 The MS shall use a TA value of 0 for the Random Access burst sent:
 - 10.1 Under normal conditions; GSM 05.10, 6.6.
 - 10.2 Under extreme conditions; GSM 05.10, 6.6, GSM 05.05 annex D D.2.1, D.2.2.

13.3.3 Test purpose

1. To verify that the maximum output power of the MS, under normal conditions, is within conformance requirement 1.
2. To verify that the maximum output power of the MS, under extreme conditions, is within conformance requirement 2.
3. To verify that all power control levels, relevant to the class of MS, are implemented in the MS and have output power levels, under normal conditions, within conformance requirement 3.
4. To verify that all power control levels have output power levels, under extreme conditions, within conformance requirement 4.
5. To verify that the step in the output power transmitted by the MS at consecutive power control levels is within conformance requirement 5 under normal conditions.
6. To verify that the output power relative to time, when sending a normal burst is within conformance requirement 6:
 - 6.1 Under normal conditions.
 - 6.2 Under extreme conditions.
7. To verify that the MS uses the maximum power control level according to its power class if commanded to a power control level exceeding its power class.

8. To verify that, for normal bursts, the MS transmissions to the BS are timed within conformance requirement 8:
 - 8.1 Under normal conditions.
 - 8.2 Under extreme conditions.
9. To verify that the output power relative to time, when sending an access burst is within conformance requirement 9:
 - 9.1 Under normal conditions.
 - 9.2 Under extreme conditions.
10. To verify that, for an access burst, the MS transmission to the BS is timed within conformance requirement 10:
 - 10.1 Under normal conditions.
 - 10.2 Under extreme conditions.

13.3.4 Methods of test

Two methods of test are described, separately for:

- 1) equipment fitted with a permanent antenna connector and for
- 2) equipment fitted with an integral antenna, and which cannot be connected to an external antenna except by the fitting of a temporary test connector as a test fixture.

NOTE: The behaviour of the MS in the system is determined to a high degree by the antenna, and this is the only transmitter test in this EN using the integral antenna. Further studies are ongoing on improved testing on the integral antenna, taking practical conditions of MS use into account.

13.3.4.1 Method of test for equipment with a permanent antenna connector

13.3.4.1.1 Initial conditions

A call is set up by the SS according to the generic call set up procedure on a channel with ARFCN in the Mid ARFCN range, power control level set to Max power. MS TXPWR_MAX_CCH is set to the maximum value supported by the Power Class of the Mobile under test. For DCS 1 800 mobile stations the POWER_OFFSET parameter is set to 6 dB.

13.3.4.1.2 Procedure

- a) Measurement of normal burst transmitter output power

The SS takes power measurement samples evenly distributed over the duration of one burst with a sampling rate of at least $2/T$, where T is the bit duration. The samples are identified in time with respect to the modulation on the burst. The SS identifies the centre of the useful 147 transmitted bits, i.e. the transition from bit 13 to bit 14 of the midamble, as the timing reference.

The transmitter output power is calculated as the average of the samples over the 147 useful bits. This is also used as the 0 dB reference for the power/time template.

- b) Measurement of normal burst timing delay

The burst timing delay is the difference in time between the timing reference identified in a) and the corresponding transition in the burst received by the MS immediately prior to the MS transmit burst sampled.

- c) Measurement of normal burst power/time relationship

The array of power samples measured in a) are referenced in time to the centre of the useful transmitted bits and in power to the 0 dB reference, both identified in a).

- d) Steps a) to c) are repeated with the MS commanded to operate on each of the power control levels defined, even those not supported by the MS.

- e) The SS commands the MS to the maximum power control level supported by the MS and steps a) to c) are repeated for ARFCN in the Low and High ranges.
- f) Measurement of access burst transmitter output power

The SS causes the MS to generate an Access Burst on an ARFCN in the Mid ARFCN range, this could be either by a handover procedure or a new request for radio resource. In the case of a handover procedure the Power Level indicated in the HANOVER COMMAND message is the maximum power control level supported by the MS. In the case of an Access Burst the MS shall use the Power Level indicated in the MS_TXPWR_MAX_CCH parameter. If the power class of the MS is DCS 1 800 Class 3, the MS shall also use the POWER_OFFSET parameter.

The SS takes power measurement samples evenly distributed over the duration of the access burst as described in a). However, in this case the SS identifies the centre of the useful bits of the burst by identifying the transition from the last bit of the synch sequence. The centre of the burst is then five data bits prior to this point and is used as the timing reference.

The transmitter output power is calculated as the average of the samples over the 87 useful bits of the burst. This is also used as the 0 dB reference for the power/time template.

- g) Measurement of access burst timing delay

The burst timing delay is the difference in time between the timing reference identified in f) and the MS received data on the common control channel.

- h) Measurement of access burst power/time relationship

The array of power samples measured in f) are referenced in time to the centre of the useful transmitted bits and in power to the 0 dB reference, both identified in f).

- i) Depending on the method used in step f) to cause the MS to send an Access Burst, the SS sends either a HANOVER COMMAND with power control level set to 10 or it changes the System Information elements MS_TXPWR_MAX_CCH and for DCS 1 800 the POWER_OFFSET on the serving cell BCCH in order to limit the MS transmit power on the Access Burst to power control level 10 (+23 dBm for GSM 400, GSM 700, GSM 850, and GSM 900 or +10 dBm for DCS 1 800 and PCS 1 900) and then steps f) to h) are repeated.
- j) Steps a) to i) are repeated under extreme test conditions (annex 1, TC2.2) except that the repeats at step d) are only performed for power control level 10 and the minimum power control level of the MS.

13.3.4.2 Method of test for equipment with an integral antenna

NOTE: If the MS is equipped with a permanent connector, such that the antenna can be disconnected and the SS be connected directly, then the method of section 13.3.4.1 will be applied.

The tests in this section are performed on an unmodified test sample.

13.3.4.2.1 Initial conditions

The MS is placed in the anechoic shielded chamber (annex 1, GC5) or on the outdoor test site, on an isolated support, in the position for normal use, at a distance of at least 3 metres from a test antenna, connected to the SS.

NOTE: The test method described has been written for measurement in an anechoic shielded chamber. If an outdoor test site is used then, in addition, it is necessary to raise/lower the test antenna through the specified height range to maximize the received power levels from both the test sample and the substitution antenna.

A call is set up by the SS according to the generic call set up procedure on a channel with ARFCN in the Mid ARFCN range, power control level set to Max power. MS_TXPWR_MAX_CCH is set to the maximum value supported by the Power Class of the Mobile under test. For DCS 1 800 mobile stations the POWER_OFFSET parameter is set to 6 dB.

13.3.4.2.2 Procedure

- a) With the initial conditions set according to subclause 13.3.4.2.1 the test procedure in 13.3.4.1.2 is followed up to and including step i), except that in step a), when measurements are done at maximum power for ARFCN in the

Low, Mid and High range, the measurement is made eight times with the MS rotated by $n \cdot 45$ degrees for all values of n in the range 0 to 7.

The measurements taken are received transmitter output power measurements rather than transmitter output power measurements, the output power measurement values can be derived as follows.

- b) Assessment of test site loss for scaling of received output power measurements.

The MS is replaced by a half-wave dipole, resonating at the centre frequency of the transmit band, connected to an RF generator.

The frequency of the RF signal generator is set to the frequency of the ARFCN used for the 24 measurements in step a), the output power is adjusted to reproduce the received transmitter output power averages recorded in step a).

For each indication the power, delivered by the generator (in Watts) to the half-wave dipole, is recorded. These values are recorded in the form P_{nc} , where n = MS rotation and c = channel number.

For each channel number used compute:

$$P_{ac}(\text{Watts into dipole}) = \frac{1}{8} * \sum_{n=0}^{n=7} P_{nc}$$

from which: $P_{ac}(\text{Tx dBm}) = 10\log_{10}(P_{ac}) + 30 + 2,15$

The difference, for each of the three channels, between the actual transmitter output power averaged over the 8 measurement orientations and the received transmitter output power at orientation $n = 0$ is used to scale the received measurement results to actual transmitter output powers for all measured power control levels and ARFCN, which can then be checked against the requirements.

- c) Temporary antenna connector calibration factors (transmit)

A modified test sample equipped with a temporary antenna connector is placed in a climatic test chamber and is linked to the SS by means of the temporary antenna connector.

Under normal test conditions, the power measurement and calculation parts of steps a) to i) of 13.3.4.1.2 are repeated except that the repeats at step d) are only performed for power control level 10 and the minimum power control level of the MS.

NOTE: The values noted here are related to the output transmitter carrier power levels under normal test conditions, which are known after step b). Therefore frequency dependent calibration factors that account for the effects of the temporary antenna connector can be determined.

- d) Measurements at extreme test conditions.

NOTE: Basically the procedure for extreme conditions is:

- the power/time template is tested in the "normal" way,
- the radiated power is measured by measuring the difference with respect to the radiated power under normal test conditions.

Under extreme test conditions steps a) to i) of 13.3.4.1.2 are repeated except that the repeats at step d) are only performed for power control level 10 and the minimum power control level of the MS.

The transmitter output power under extreme test conditions is calculated for each burst type, power control level and for every frequency used by adding the frequency dependent calibration factor, determined in c), to the values obtained at extreme conditions in this step.

13.3.5 Test requirements

- a) The transmitter output power, under every combination of normal and extreme test conditions, for normal bursts and access bursts, at each frequency and for each power control level applicable to the MS power class, shall be at the relevant level shown in table 13-2, table 13-3 or table 13-4 within the tolerances also shown in table 13-2, table 13-3 or table 13-4.

GSM 400, GSM 700, GSM 850 and GSM 900 only - begin

Table 13-2: GSM 400, GSM 700, GSM 850 and GSM 900 transmitter output power for different power classes

Power class				Power control level	Transmitter output power dBm	Tolerances	
2	3	4	5			normal	extreme
.	.	.	.	2	39	+/-2 dB	+/-2,5 dB
.	.	.	.	3	37	+/-3 dB*)	+/-4 dB*)
.	.	.	.	4	35	+/-3 dB	+/-4 dB
.	.	.	.	5	33	+/-3 dB*)	+/-4 dB*)
.	.	.	.	6	31	+/-3 dB	+/-4 dB
.	.	.	.	7	29	+/-3 dB*)	+/-4 dB*)
.	.	.	.	8	27	+/-3 dB	+/-4 dB
.	.	.	.	9	25	+/-3 dB	+/-4 dB
.	.	.	.	10	23	+/-3 dB	+/-4 dB
.	.	.	.	11	21	+/-3 dB	+/-4 dB
.	.	.	.	12	19	+/-3 dB	+/-4 dB
.	.	.	.	13	17	+/-3 dB	+/-4 dB
.	.	.	.	14	15	+/-3 dB	+/-4 dB
.	.	.	.	15	13	+/-3 dB	+/-4 dB
.	.	.	.	16	11	+/-5 dB	+/-6 dB
.	.	.	.	17	9	+/-5 dB	+/-6 dB
.	.	.	.	18	7	+/-5 dB	+/-6 dB
.	.	.	.	19	5	+/-5 dB	+/-6 dB

*) When the power control level corresponds to the power class of the MS, then the tolerances shall be 2,0 dB under normal test conditions and 2,5 dB under extreme test conditions.

GSM 400, GSM 700, GSM 850 and GSM 900 only - end

DCS 1 800 only - begin

Table 13-3: DCS 1 800 transmitter output power for different power classes

Power class			Power control level	Transmitter output power	Tolerances	
1	2	3			dBm	normal
		.	29	36	+/-2,0 dB	+/-2,5 dB
		.	30	34	+/-3,0 dB	+/-4,0 dB
		.	31	32	+/-3,0 dB	+/-4,0 dB
.	.	.	0	30	+/-3,0 dB*)	+/-4 dB*)
.	.	.	1	28	+/-3 dB	+/-4 dB
.	.	.	2	26	+/-3 dB	+/-4 dB
.	.	.	3	24	+/-3 dB*)	+/-4 dB*)
.	.	.	4	22	+/-3 dB	+/-4 dB
.	.	.	5	20	+/-3 dB	+/-4 dB
.	.	.	6	18	+/-3 dB	+/-4 dB
.	.	.	7	16	+/-3 dB	+/-4 dB
.	.	.	8	14	+/-3 dB	+/-4 dB
.	.	.	9	12	+/-4 dB	+/-5 dB
.	.	.	10	10	+/-4 dB	+/-5 dB
.	.	.	11	8	+/-4 dB	+/-5 dB
.	.	.	12	6	+/-4 dB	+/-5 dB
.	.	.	13	4	+/-4 dB	+/-5 dB
.	.	.	14	2	+/-5 dB	+/-6 dB
.	.	.	15	0	+/-5 dB	+/-6 dB

*) When the power control level corresponds to the power class of the MS, then the tolerances shall be 2,0 dB under normal test conditions and 2,5 dB under extreme test conditions.

DCS 1 800 only – end

PCS 1 900 only - begin

Table 13-4: PCS 1 900 transmitter output power for different power classes

Power class			Power control level	Transmitter output power	Tolerances	
1	2	3			Normal	Extreme
		.	30	33	+/-2,0 dB	+/-2,5 dB
		.	31	32	+/-2,0 dB	+/-2,5 dB
.	.	.	0	30	+/-3,0 dB*)	+/-4 dB*)
.	.	.	1	28	+/-3 dB	+/-4 dB
.	.	.	2	26	+/-3 dB	+/-4 dB
.	.	.	3	24	+/-3 dB*)	+/-4 dB*)
.	.	.	4	22	+/-3 dB	+/-4 dB
.	.	.	5	20	+/-3 dB	+/-4 dB
.	.	.	6	18	+/-3 dB	+/-4 dB
.	.	.	7	16	+/-3 dB	+/-4 dB
.	.	.	8	14	+/-3 dB	+/-4 dB
.	.	.	9	12	+/-4 dB	+/-5 dB
.	.	.	10	10	+/-4 dB	+/-5 dB
.	.	.	11	8	+/-4 dB	+/-5 dB
.	.	.	12	6	+/-4 dB	+/-5 dB
.	.	.	13	4	+/-4 dB	+/-5 dB
.	.	.	14	2	+/-5 dB	+/-6 dB
.	.	.	15	0	+/-5 dB	+/-6 dB

*) When the power control level corresponds to the power class of the MS, then the tolerances shall be 2,0 dB under normal test conditions and 2,5 dB under extreme test conditions.

PCS 1 900 only - end

- b) The difference between the transmitter output power at two adjacent power control levels, measured at the same frequency, shall not be less than 0,5 dB and not be more than 3,5 dB. For PCS 1 900 Class 3 the difference between the transmitter output power at power controls level 30 and 31, measured at the same frequency, shall not be less than 0 dB and not be more than 2 dB.
- c) The power/time relationship of the measured samples for normal bursts shall be within the limits of the power time template of figure 13-1 at each frequency, under every combination of normal and extreme test conditions and at each power control level measured.

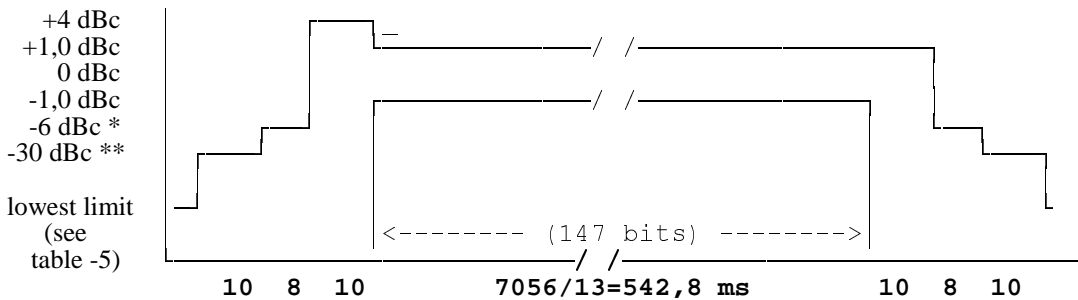

Figure 13-1: Power / time template for normal bursts

* For GSM400, GSM 700, GSM 850 and GSM900 MS:

- 4 dBc for power control level 16
- 2 dBc for power control level 17
- 1 dBc for power control levels 18 and 19

For DCS1800 and PCS1900 MS: -4 dBc for power control level 11

- 2 dBc for power control level 12
- 1 dBc for power control levels 13, 14 and 15

** For GSM400, GSM 700, GSM 850 and GSM900 MS:

-30 dBc or -17 dBm, whichever is the higher

For DCS1800 MS: -30 dBc or -20 dBm, whichever is the higher

Table 13-5: Lowest measurement limit for power / time template

	lowest limit
GSM400, GSM 700, GSM 850, GSM900	-59 dBc or -54 dBm whichever is the highest, except for the timeslot preceding the active slot, for which the allowed level is equal to -59 dBc or -36 dBm, whichever is the highest
DCS1800, PCS1900	-48 dBc or -48 dBm whichever is the highest

- d) All the power control levels, for the type and power class of the MS as stated by the manufacturer, shall be implemented in the MS.
- e) When the transmitter is commanded to a power control level outside of the capability corresponding to the type and power class of the MS as stated by the manufacturer, then the transmitter output power shall be within the tolerances for the closest power control level corresponding to the type and power class as stated by the manufacturer.
- f) The centre of the transmitted normal burst as defined by the transition of bits 13/14 of the midamble shall be 3 timeslot periods (1731 μ s) +/- 1 bit period (+/- 3,69 μ s) after the centre of the corresponding received burst.

- g) The power/time relationship of the measured samples for access bursts shall be within the limits of the power time template of figure 13-2 at each frequency, under every combination of normal and extreme test conditions and at each power control level measured.

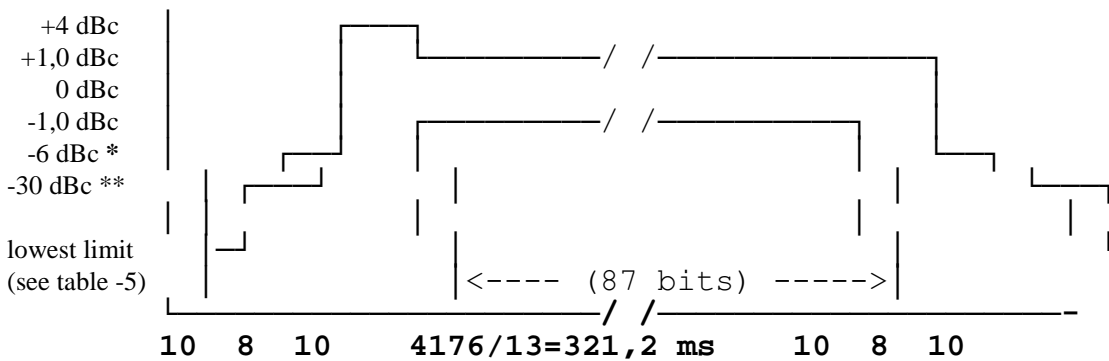

Figure 13-2: Power / time template for access burst

* For GSM400, GSM 700, GSM 850 and GSM900 MS:

- 4 dBc for power control level 16
- 2 dBc for power control level 17
- 1 dBc for power control levels 18 and 19

For DCS1800 and PCS1900 MS: -4 dBc for power control level 11

- 2 dBc for power control level 12
- 1 dBc for power control levels 13, 14 and 15

** For GSM400, GSM 700, GSM 850 and GSM900 MS:

- 30 dBc or -17 dBm, whichever is the higher

For DCS1800 and PCS1900 MS: -30 dBc or -20 dBm, whichever is the higher

- h) The centre of the transmitted access burst shall be an integer number of timeslot periods less 30 bit periods relative to any CCCH midamble centre with a tolerance of +/- 1 bit period (+/- 3,69 μ s).

13.4 Output RF spectrum

13.4.1 Definition and applicability

The output RF spectrum is the relationship between the frequency offset from the carrier and the power, measured in a specified bandwidth and time, produced by the MS due to the effects of modulation and power ramping.

The requirements and this test apply to all types of GSM 400, GSM 700, GSM 850, GSM 900, DCS 1 800 and PCS 1 900 MS.

13.4.2 Conformance requirement

1. The level of the output RF spectrum due to modulation shall be no more than that given in GSM 05.05, 4.2.1, table a1) for GSM 400, GSM 700, GSM 850 and GSM 900, table b1) for DCS 1 800 or table c1) for PCS 1 900, with the following lowest measurement limits:
 - -36 dBm below 600 kHz offset from the carrier,
 - -51 dBm for GSM 400, GSM 700, GSM 850 and GSM 900 or -56 dBm for DCS 1 800 and PCS 1 900 from 600 kHz out to less than 1 800 kHz offset from the carrier,

- -46 dBm for GSM 400, GSM 700, GSM 850 and GSM 900 or -51 dBm for DCS 1 800 and PCS 1 900 at and beyond 1 800 kHz offset from the carrier,

but with the following exceptions at up to -36 dBm:

- up to three bands of 200 kHz width centred on a frequency which is an integer multiple of 200 kHz in the combined range 600 kHz to 6000 kHz above and below the carrier,
- up to 12 bands of 200 kHz width centred on a frequency which is an integer multiple of 200 kHz at more than 6 000 kHz offset from the carrier.

1.1 Under normal conditions; GSM 05.05, 4.2.1.

1.2 Under extreme conditions; GSM 05.05, 4.2.1; GSM 05.05, annex D D.2.1, D.2.2.

2. The level of the output RF spectrum due to switching transients shall be no more than given in GSM 05.05, 4.2.2, table "a) Mobile Station:".

2.1 Under normal conditions; GSM 05.05, 4.2.2.

2.2 Under extreme conditions; GSM 05.05, 4.2.2; GSM 05.05 annex D D.2.1, D.2.2.

3. When allocated a channel, the power emitted by a GSM 400, GSM 900 and DCS 1 800 MS, in the band 935 to 960 MHz shall be no more than -79 dBm, in the band 925 to 935 MHz shall be no more than -67 dBm and in the band 1 805 to 1 880 MHz shall be no more than -71 dBm except in five measurements in each of the bands 925 to 960 MHz and 1 805 to 1 880 MHz where exceptions at up to -36 dBm are permitted. For GSM 400 MS, in addition, the power emitted by MS, in the bands of 460.4 to 467.6 MHz and 488.8 to 496 MHz shall be no more than -67 dBm except in three measurements in each of the bands 460.4 to 467.6 MHz and 488.8 to 496 MHz where exceptions at up to -36 dBm are permitted. For GSM 700, GSM 850 and PCS 1 900 MS, the power emitted by MS, in the band of 747 to 757 MHz shall be no more than -79 dBm, in the band of 757 to 762 MHz shall be no more than -73 dBm, in the band 869 to 894 MHz shall be no more than -79 dBm, in the band 1 930 to 1 990 MHz shall be no more than -71 dBm except in five measurements in each of the bands 747 to 762 MHz, 869 to 894 MHz and 1 930 to 1 990 MHz where exceptions at up to -36 dBm are permitted. Under normal conditions; GSM 05.05, 4.3.3.

13.4.3 Test purpose

1. To verify that the output RF spectrum due to modulation does not exceed conformance requirement 1.
 - 1.1 Under normal conditions.
 - 1.2 Under extreme conditions.
2. To verify that the output RF spectrum due to switching transients does not exceed conformance requirement 2 when a reasonable margin is allowed for the effect of spectrum due to modulation.
 - 2.1 Under normal conditions.
 - 2.2 Under extreme conditions.
3. To verify that the MS spurious emissions in the MS receive band do not exceed conformance requirement 3.

13.4.4 Method of test

13.4.4.1 Initial conditions

A call is set up according to the generic call set up procedure.

The SS commands the MS to hopping mode. The hopping pattern includes only three channels, namely one with an ARFCN in the Low ARFCN range, a second one with an ARFCN in the Mid ARFCN range and the third one with an ARFCN in the High ARFCN range.

NOTE 1: Although the measurement is made whilst the MS is in hopping mode, each measurement is on one single channel.

NOTE 2: This test is specified in hopping mode as a simple means of making the MS change channel, it would be sufficient to test in non hopping mode and to handover the MS between the three channels tested at the appropriate time.

The SS commands the MS to complete the traffic channel loop back without signalling of erased frames (see 36.2.1.1). This is to set a defined random pattern for the transmitter.

The SS sends Standard Test Signal C1 (annex 5) to the MS at a level of $23 \text{ dB}\mu\text{Vemf}(\)$.

13.4.4.2 Procedure

NOTE: When averaging is in use during frequency hopping mode, the averaging only includes bursts transmitted when the hopping carrier corresponds to the nominal carrier of the measurement.

a) In steps b) to h) the FT is equal to the hop pattern ARFCN in the Mid ARFCN range.

b) The other settings of the spectrum analyser are set as follows:

- Zero frequency scan
- Resolution bandwidth: 30 kHz
- Video bandwidth: 30 kHz
- Video averaging: may be used, depending on the implementation of the test

The video signal of the spectrum analyser is "gated" such that the spectrum generated by at least 40 of the bits 87 to 132 of the burst is the only spectrum measured. This gating may be analogue or numerical, dependent upon the design of the spectrum analyser. Only measurements during transmitted bursts on the nominal carrier of the measurement are included. The spectrum analyser averages over the gated period and over 200 or 50 such bursts, using numerical and/or video averaging.

The MS is commanded to its maximum power control level.

c) By tuning the spectrum analyser centre frequency to the measurement frequencies the power level is measured over 50 bursts at all multiples of 30 kHz offset from FT to < 1 800 kHz.

d) The resolution and video bandwidth on the spectrum analyser are adjusted to 100 kHz and the measurements are made at the following frequencies:

on every ARFCN from 1 800 kHz offset from the carrier to the edge of the relevant transmit band for each measurement over 50 bursts.

at 200 kHz intervals over the 2 MHz either side of the relevant transmit band for each measurement over 50 bursts.

For GSM 400, GSM 900 and DCS 1 800:

at 200 kHz intervals over the band 925 - 960 MHz for each measurement over 50 bursts.

at 200 kHz intervals over the band 1805 - 1880 MHz for each measurement over 50 bursts.

In addition for GSM 400 MS:

at 200 kHz intervals over the band 460.4 to 467.6 MHz for each measurement over 50 bursts,

at 200 kHz intervals over the band 488.8 to 496 MHz for each measurement over 50 bursts.

For GSM 700, GSM 850 and PCS 1 900:

at 200 kHz intervals over the band 747 to 762 MHz for each measurement over 50 bursts.

at 200 kHz intervals over the band 869 - 894 MHz for each measurement over 50 bursts.

at 200 kHz intervals over the band 1930 – 1990 MHz for each measurement over 50 bursts.

- e) The MS is commanded to its minimum power control level. The spectrum analyser is set again as in b).
- f) By tuning the spectrum analyser centre frequency to the measurement frequencies the power level is measured over 200 bursts at the following frequencies:

FT

FT + 100 kHz FT - 100 kHz

FT + 200 kHz FT - 200 kHz

FT + 250 kHz FT - 250 kHz

FT + 200 kHz * N FT - 200 kHz * N

where N = 2, 3, 4, 5, 6, 7, and 8

and FT = RF channel nominal centre frequency.

- g) The spectrum analyser settings are adjusted to:

- Zero frequency scan
- Resolution bandwidth: 30 kHz
- Video bandwidth: 100 kHz
- Peak hold

The spectrum analyser gating of the signal is switched off.

The MS is commanded to its maximum power control level.

- h) By tuning the spectrum analyser centre frequency to the measurement frequencies the power level is measured at the following frequencies:

FT + 400 kHz FT - 400 kHz

FT + 600 kHz FT - 600 kHz

FT + 1,2 MHz FT - 1,2 MHz

FT + 1,8 MHz FT - 1,8 MHz

where FT = RF channel nominal centre frequency.

The duration of each measurement (at each frequency) will be such as to cover at least 10 burst transmissions at FT.

- i) Step h) is repeated for power control levels 7 and 11.
- j) Steps b), f), g) and h) are repeated with FT equal to the hop pattern ARFCN in the Low ARFCN range except that in step g) the MS is commanded to power control level 11 rather than maximum power.
- k) Steps b), f), g) and h) are repeated with FT equal to the hop pattern ARFCN in the High ARFCN range except that in step g) the MS is commanded to power control level 11 rather than maximum power.
- l) Steps a) b) f) g) and h) are repeated under extreme test conditions (annex 1, TC2.2). except that at step g) the MS is commanded to power control level 11.

13.4.5 Test requirements

For absolute measurements, performed on a temporary antenna connector, in the frequency band 450.4 to 457.6 MHz, 478.8 to 486 MHz, 777 to 792 MHz, 824 to 849 MHz, 880 to 915 MHz, 1710 to 1785 MHz, or 1 850 to 1 910 MHz, the temporary antenna connector coupling factor, determined according to 13.3.4.2.2 and annex 1 GC7, for the nearest relevant frequency, will be used.

For absolute measurements, performed on a temporary antenna connector, in the frequency band 925 to 960 MHz, the temporary antenna connector coupling factor, will be as determined according to annex 1 GC7 for GSM 900 MS. For a GSM 400, GSM 700, GSM 850, DCS 1 800 or PCS 1 900 MS 0 dB will be assumed.

For absolute measurements, performed on a temporary antenna connector, in the frequency band 1805 to 1880 MHz, the temporary antenna connector coupling factor, will be as determined according to annex 1 GC7 for DCS 1 800 MS. For GSM 400, GSM 700, GSM 850, GSM 900 or PCS 1 900 MS 0 dB will be assumed.

For absolute measurements, performed on a temporary antenna connector, in the frequency band 460.4 to 467.6 MHz or 488.8 to 496 MHz, the temporary antenna connector coupling factor, will be as determined according to annex 1 GC7 for GSM 400 MS. For a GSM 700, GSM 850, GSM 900, DCS 1800 or PCS 1 900 MS 0 dB will be assumed.

For absolute measurements, performed on a temporary antenna connector, in the frequency band 1930 to 1990 MHz, the temporary antenna connector coupling factor, will be as determined according to annex 1 GC7 for PCS 1 900 MS. For GSM 400, GSM 700, GSM 850, GSM 900 or DCS 1 800 MS 0 dB will be assumed.

For absolute measurements, performed on a temporary antenna connector, in the frequency band 747 to 762 MHz, the temporary antenna connector coupling factor, will be as determined according to annex 1 GC7 for GSM 700 MS. For a GSM 400, GSM 850, GSM 900, DCS 1800 or PCS 1900 MS 0 dB will be assumed.

For absolute measurements, performed on a temporary antenna connector, in the frequency band 869 to 894 MHz, the temporary antenna connector coupling factor, will be as determined according to annex 1 GC7 for GSM 850 MS. For a GSM 400, GSM 700, GSM 900, DCS 1800 or PCS 1900 MS 0 dB will be assumed.

The figures in the tables below, at the listed frequencies from the carrier (kHz), are the maximum level (dB) relative to a measurement in 30 kHz bandwidth on the carrier (reference GSM 05.05 section 4.2.1).

- a) For the modulation sidebands out to less than 1 800 kHz offset from the carrier frequency (FT) measured in step c), f), h), j), k) and l) the measured power level in dB relative to the power level measured at FT, for all types of MS, shall not exceed the limits derived from the values shown in table 13-6 for GSM 400, GSM 700, GSM 850 and GSM 900, table 13-7 for DCS 1 800 or table 13-8 for PCS 1 900 according to the actual transmit power and frequency offset from FT. However any failures in the combined range 600 kHz to less than 1 800 kHz above and below the carrier may be counted towards the exceptions allowed in test requirements c) below.

Table 13-6a: GSM 400, GSM 700, GSM 850 and GSM 900 Spectrum due to modulation out to less than 1 800 kHz offset

	power levels in dB relative to the measurement at FT				
Power level	Frequency offset (kHz)				
(dBm)	0-100	200	250	400	600 to <1800
39	+0,5	-30	-33	-60	-66
37	+0,5	-30	-33	-60	-64
35	+0,5	-30	-33	-60	-62
<= 33	+0,5	-30	-33	-60	-60
The values above are subject to the minimum absolute levels (dBm) below.					
	-36	-36	-36	-36	-51

Table 13-7: DCS 1 800 Spectrum due to modulation out to less than 1 800 kHz offset

power levels in dB relative to the measurement at FT					
Power level	Frequency offset (kHz)				
(dBm)	0-100	200	250	400	600 to <1800
<= 36	+0,5	-30	-33	-60	-60
The values above are subject to the minimum absolute levels (dBm) below.					
	-36	-36	-36	-36	-56

Table 13-8: PCS 1 900 Spectrum due to modulation out to less than 1 800 kHz offset

power levels in dB relative to the measurement at FT						
Power level	Frequency offset (kHz)					
(dBm)	0-100	200	250	400	600 to <1200	1200 to <1800
<= 33	+0,5	-30	-33	-60	-60	-60
The values above are subject to the minimum absolute levels (dBm) below.						
	-36	-36	-36	-36	-56	-56

NOTE 1: For frequency offsets between 100 kHz and 600 kHz the requirement is derived by a linear interpolation between the points identified in the table with linear frequency and power in dB relative.

- b) For the modulation sidebands from 1 800 kHz offset from the carrier frequency (FT) and out to 2 MHz beyond the edge of the relevant transmit band, measured in step d), the measured power level in dB relative to the power level measured at FT, shall not exceed the values shown in table 13-7 according to the actual transmit power, frequency offset from FT and system on which the MS is designed to operate. However any failures in the combined range 1 800 kHz to 6 MHz above and below the carrier may be counted towards the exceptions allowed in test requirements c) below, and any other failures may be counted towards the exceptions allowed in test requirements d) below.

Table 13-9: Spectrum due to modulation from 1 800 kHz offset to the edge of the transmit band (wideband noise)

power levels in dB relative to the measurement at FT									
GSM400, GSM 700, GSM 850 and GSM900				DCS1800			PCS1900		
Power Level	Frequency offset kHz			Power level	Frequency offset KHz		Power level	Frequency offset kHz	
(dBm)	1800 to < 3000	3000 to < 6000	>= 6000	(dBm)	1800 to < 6000	>= 6000	(dBm)	1800 to < 6000	>= 6000
39	-69	-71	-77	36	-71	-79	33	-68	-76
37	-67	-69	-75	34	-69	-77	32	-67	-75
35	-65	-67	-73	32	-67	-75	30	-65	-73
<= 33	-63	-65	-71	30	-65	-73	28	-63	-71
				28	-63	-71	26	-61	-69
				26	-61	-69	<= 24	-59	-67
				<= 24	-59	-67			
The values above are subject to the minimum absolute levels (dBm) below.									
	-46	-46	-46		-51	-51		-51	-51

- c) Any failures (from a) and b) above) in the combined range 600 kHz to 6 MHz above and below the carrier should be re-checked for allowed spurious emissions. For each of the three ARFCN used, spurious emissions are allowed in up to three 200 kHz bands centred on an integer multiple of 200 kHz so long as no spurious emission exceeds -36 dBm. Any spurious emissions measured in a 30 kHz bandwidth which spans two 200 kHz bands can be counted towards either 200 kHz band, whichever minimizes the number of 200 kHz bands containing spurious exceptions.

- d) Any failures (from b) above) beyond 6 MHz offset from the carrier should be re-checked for allowed spurious emissions. For each of the three ARFCN used, up to twelve spurious emissions are allowed so long as no spurious emission exceeds -36 dBm.
- e) For GSM 400, GSM 900 and DCS 1 800 MS the spurious emissions in the bands 925 - 935 MHz, 935 - 960 MHz and 1 805 - 1 880 MHz, measured in step d), shall not exceed the values shown in table 13-10 except in up to five measurements in the band 925 to 960 MHz and five measurements in the band 1 805 to 1 880 MHz where a level up to -36 dBm is permitted. For GSM 400 MS, in addition, the MS spurious emissions in the bands 460.4 to 467.6 MHz and 488.8 to 496 MHz shall not exceed the value of -67 dBm, except in up to three measurements in each of the bands 460.4 to 467.6 MHz and 488.8 to 496 MHz where a level up to -36 dBm is permitted. For GSM 700, GSM 850 and PCS 1 900 MS the spurious emissions in the bands 747 - 757 MHz, 757 - 762 MHz, 869 - 894 MHz and 1930 - 1990 MHz shall not exceed the values shown in table 13-10 except in up to five measurements in each of the bands 747 to 762 MHz, 869 MHz to 894 MHz and 1 930 MHz to 1 990 MHz where a level up to -36 dBm is permitted.

Table 13-10: Spurious emissions in the MS receive bands

Band (MHz)	Spurious emissions level (dBm)	
	GSM400, GSM900 and DCS1800	GSM 700, GSM 850 and PCS1900
925 to 935	-67	
935 to 960	-79	
1805 to 1880	-71	
747 to 757		-79
757 to 762		-73
869 to 894		-79
1930 to 1990		-71

- f) For the power ramp sidebands of steps h) and i) the power levels must not exceed the values shown in table 13-11 for GSM 400, GSM 700, GSM 850 and GSM 900, table 13-12 for DCS 1 800 or table 13-13 for PCS 1 900.

Table 13-11: GSM Spectrum due to switching transients

Power level	Maximum level for various offsets from carrier frequency			
	400 kHz	600 kHz	1200 kHz	1800 kHz
39 dBm	-13 dBm	-21 dBm	-21 dBm	-24 dBm
37 dBm	-15 dBm	-21 dBm	-21 dBm	-24 dBm
35 dBm	-17 dBm	-21 dBm	-21 dBm	-24 dBm
33 dBm	-19 dBm	-21 dBm	-21 dBm	-24 dBm
31 dBm	-21 dBm	-23 dBm	-23 dBm	-26 dBm
29 dBm	-23 dBm	-25 dBm	-25 dBm	-28 dBm
27 dBm	-23 dBm	-26 dBm	-27 dBm	-30 dBm
25 dBm	-23 dBm	-26 dBm	-29 dBm	-32 dBm
23 dBm	-23 dBm	-26 dBm	-31 dBm	-34 dBm
<= +21 dBm	-23 dBm	-26 dBm	-32 dBm	-36 dBm

Table 13-12: DCS 1 800 Spectrum due to switching transients

Power level	Maximum level for various offsets from carrier frequency			
	400 kHz	600 kHz	1200 kHz	1800 kHz
36 dBm	-16 dBm	-21 dBm	-21 dBm	-24 dBm
34 dBm	-18 dBm	-21 dBm	-21 dBm	-24 dBm
32 dBm	-20 dBm	-22 dBm	-22 dBm	-25 dBm
30 dBm	-22 dBm	-24 dBm	-24 dBm	-27 dBm
28 dBm	-23 dBm	-25 dBm	-26 dBm	-29 dBm
26 dBm	-23 dBm	-26 dBm	-28 dBm	-31 dBm
24 dBm	-23 dBm	-26 dBm	-30 dBm	-33 dBm
22 dBm	-23 dBm	-26 dBm	-31 dBm	-35 dBm
<= +20 dBm	-23 dBm	-26 dBm	-32 dBm	-36 dBm

Table 13-13: PCS 1 900 Spectrum due to switching transients

Power level	Maximum level for various offsets from carrier frequency			
	400 kHz	600 kHz	1200 kHz	1800 kHz
33 dBm	-19 dBm	-22 dBm	-22 dBm	-25 dBm
32 dBm	-20 dBm	-22 dBm	-22 dBm	-25 dBm
30 dBm	-22 dBm	-24 dBm	-24 dBm	-27 dBm
28 dBm	-23 dBm	-25 dBm	-26 dBm	-29 dBm
26 dBm	-23 dBm	-26 dBm	-28 dBm	-31 dBm
24 dBm	-23 dBm	-26 dBm	-30 dBm	-33 dBm
22 dBm	-23 dBm	-26 dBm	-31 dBm	-35 dBm
<= +20 dBm	-23 dBm	-26 dBm	-32 dBm	-36 dBm

NOTE 2: These figures are different from the requirements in GSM 05.05 because at higher power levels it is the modulation spectrum which is being measured using a peak hold measurement. This allowance is given in the table.

NOTE 3: The figures for table 13-11, table 13-12 and table 13-13 assume that, using the peak hold measurement, the lowest level measurable is 8 dB above the level of the modulation specification using the 30 kHz bandwidth gated average technique for 400 kHz offset from the carrier. At 600 and 1200 kHz offset the level is 6 dB above and at 1 800 kHz offset the level is 3 dB above. The figures for 1 800 kHz have assumed the 30 kHz bandwidth spectrum due to modulation specification at <1 800 kHz.

13.5 Intermodulation attenuation

13.5.1 Definition and applicability

The intermodulation attenuation is the ratio, in dB, of the power level of the wanted signal to the power level of the highest intermodulation component.

The requirements and this test apply to all types of DCS 1 800 and PCS 1 900 MS.

13.5.2 Conformance requirement

The maximum level of any intermodulation product shall be no less than 50 dB below the level of the wanted signal when an interfering CW signal is applied, within the transmit band, at a frequency offset of 800 kHz and with a power level 40 dB below the power level of the wanted signal; GSM 05.05, 4.7.3.

13.5.3 Test purpose

To verify that the MS intermodulation attenuation is no less than conformance requirement 1.

13.5.4 Method of test

NOTE 1: When the measurements are performed precautions must be taken, so that non-linearities in the selective measuring device do not influence the results appreciably. Furthermore it should be ensured that intermodulation components which may be generated by non-linear elements in the test equipment (e.g. signal generator, circulators, selective measuring device) are sufficiently reduced. The RF transmit equipment under test and the test signal source should be physically separated in such a way that the measurement is not influenced by direct radiation.

NOTE 2: In the case of an MS which does not normally include an antenna connector, the coupling loss of the temporary antenna connector must be taken into account.

13.5.4.1 Initial conditions

The antenna output of the MS is connected to the SS via a coupling device, presenting to the MS a load with an impedance of 50 ohms. The coupling device may consist of a circulator with one port connected by a coaxial cable to the output terminal of the MS, the second port correctly terminated with 50 ohms into a selective measuring device (e.g. a spectrum analyser) and the third port connected to the interfering test signal source via an isolator.

A call is set up by the SS according to the generic call set up procedure on a channel with ARFCN in the Mid ARFCN range, power control level set to Max power.

13.5.4.2 Procedure

- a) The interfering test signal will be unmodulated and the frequency will be 800 kHz above the transmit frequency of the MS under test. The power level is adjusted to give the equivalent of 40 dB below the transmit power level of the MS, if both the MS transmit power and the interfering test signal were measured with a correct termination but with the other signal absent.
- b) The frequency selective measuring device is set to measure peak hold in a bandwidth of 300 kHz. Any intermodulation components in the MS transmit band, are then measured.

Note: Due to practical measurement restrictions only intermodulation products outside the measurement bandwidth of 1.8 MHz can be considered.

- c) Steps a) and b) are repeated with the test signal at a frequency 800 kHz below the transmitted frequency.

13.5.5 Test requirements

The level of each intermodulation component, in the MS transmit band, shall be no less than 50 dB below the level of the transmit power of the wanted MS carrier.

13.6 Frequency error and phase error in HSCSD multislots configurations

13.6.1 Definition and applicability

The frequency error is the difference in frequency, after adjustment for the effect of the modulation and phase error, between the RF transmission from the MS and either:

- the RF transmission from the BS, or
- the nominal frequency for the ARFCN used.

The phase error is the difference in phase, after adjustment for the effect of the frequency error, between the RF transmission from the MS and the theoretical transmission according to the intended modulation.

The requirements and this test apply to all types of GSM 400, GSM 700, GSM 850, GSM 900, DCS 1 800 and PCS 1 900 MS and any multiband MS which are capable of HSCSD multislots operation.

13.6.2 Conformance requirement

1. The MS carrier frequency shall be accurate to within 0,1 ppm, or accurate to within 0,1 ppm compared to signals received from the BS.
 - 1.1 Under normal conditions; GSM 05.10, 6.1.
 - 1.2 Under vibration conditions; GSM 05.10, 6.1; GSM 05.05, annex D D.2.3.
 - 1.3 Under extreme conditions; GSM 05.10, 6.1; GSM 05.05, 4.4; GSM 05.05, annex D D.2.1, D.2.2.
2. The RMS phase error (difference between the phase error trajectory and its linear regression on the active part of the time slot) for each burst shall not be greater than 5 degrees.
 - 2.1 Under normal conditions; GSM 05.05, 4.6.
 - 2.2 Under vibration conditions; GSM 05.05, 4.6; GSM 05.05, annex D D.2.3.
 - 2.3 Under extreme conditions; GSM 05.05, 4.6; GSM 05.05, annex D D.2.1, D.2.2.
3. The maximum peak deviation during the useful part of each burst shall not be greater than 20 degrees.
 - 3.1 Under normal conditions; GSM 05.05, 4.6.
 - 3.2 Under vibration conditions; GSM 05.05, 4.6; GSM 05.05, annex D D.2.3.
 - 3.3 Under extreme conditions; GSM 05.05, 4.6; GSM 05.05, annex D D.2.1, D.2.2.

13.6.3 Test purpose

1. To verify that in a multislots configuration the MS carrier frequency error does not exceed 0,1 ppm:
 - 1.1 Under normal conditions.
 - 1.2 When the MS is being vibrated.
 - 1.3 Under extreme conditions.

NOTE: The transmit frequency accuracy of the SS is expected to be sufficient to ensure that the difference between 0,1 ppm absolute and 0,1 ppm compared to signals received from the BS would be small enough to be considered insignificant.

2. To verify that the RMS phase error on the useful part of the bursts transmitted by the MS in a multislots configuration does not exceed conformance requirement 2:
 - 2.1 Under normal conditions.
 - 2.2 When the MS is being vibrated.
 - 2.3 Under extreme conditions.
3. To verify that the maximum phase error on the useful part of the bursts transmitted by the MS in a multislots configuration does not exceed conformance requirement 3.
 - 3.1 Under normal conditions.
 - 3.2 When the MS is being vibrated.
 - 3.3 Under extreme conditions.

13.6.4 Method of test

NOTE: In order to measure the accuracy of the frequency and phase error a sampled measurement of the transmitted phase trajectory is obtained. This is compared with the theoretically expected phase trajectory. The regression line of the difference between the expected trajectory and the measured trajectory is an indication of the frequency error (assumed constant through the burst), whilst the departure of the phase differences from this trajectory is a measure of the phase error. The peak phase error is the value furthest from the regression line and the RMS phase error is the root mean square average of the phase error of all samples.

13.6.4.1 Initial conditions

A call is set up according to the generic call setup procedure for multislot HSCSD.

The SS commands the MS to hopping mode (table 13.6.1).

NOTE: It is not necessary to test in hopping mode but is done here as a simple means of making the MS change channel, it would be sufficient to test in non hopping mode and to make sure bursts are taken from a few different channels.

The SS activates ciphering mode.

NOTE: Ciphering mode is active during this test to give a pseudo-random bit stream to the modulator.

The SS sets the MS to operate in a multislot configuration with maximum number of transmitted time slots.

The SS commands the MS to complete the traffic channel multislot loop back including signalling of erased frames.

The SS generates Standard Test Signal C1 of annex 5.

13.6.4.2 Procedure

- a) For one transmitted burst on the last multislot subchannel, the SS captures the signal as a series of phase samples over the period of the burst. These samples are evenly distributed over the duration of the burst with a minimum sampling rate of $2/T$, where T is the modulation symbol period. The received phase trajectory is then represented by this array of at least 294 samples.
- b) The SS then calculates, from the known bit pattern and the formal definition of the modulator contained in GSM 05.04, the expected phase trajectory.
- c) From a) and b) the phase trajectory error is calculated, and a linear regression line computed through this phase trajectory error. The slope of this regression line is the frequency error of the mobile transmitter relative to the simulator reference. The difference between the regression line and the individual sample points is the phase error of that point.

- c.1) The sampled array of at least 294 phase measurements is represented by the vector:

$$\varnothing_m = \varnothing_m(0) \dots \varnothing_m(n)$$

where the number of samples in the array $n+1 \geq 294$.

- c.2) The calculated array, at the corresponding sampling instants, is represented by the vector:

$$\varnothing_c = \varnothing_c(0) \dots \varnothing_c(n).$$

- c.3) The error array is represented by the vector:

$$\varnothing_e = \{\varnothing_m(0) - \varnothing_c(0)\} \dots \{\varnothing_m(n) - \varnothing_c(n)\} = \varnothing_e(0) \dots \varnothing_e(n).$$

- c.4) The corresponding sample numbers form a vector $t = t(0) \dots t(n)$.

- c.5) By regression theory the slope of the samples with respect to t is k where:

$$k = \frac{\sum_{j=0}^{j=n} t(j) * \varnothing_e(j)}{\sum_{j=0}^{j=n} t(j)^2}$$

c.6) The frequency error is given by $k/(360 * \gamma)$, where γ is the sampling interval in s and all phase samples are measured in degrees.

c.7) The individual phase errors from the regression line are given by:

$$\varnothing_e(j) - k * t(j).$$

c.8) The RMS value \varnothing_e of the phase errors is given by:

$$\varnothing_e(\text{RMS}) = \left[\frac{\sum_{j=0}^{j=n} \{\varnothing_e(j) - k * t(j)\}^2}{n+1} \right]^{1/2}$$

- d) Steps a) to c) are repeated for 20 bursts, not necessarily contiguous.
- e) The SS instructs the MS to its maximum power control level on each multislot subchannel, all other conditions remaining constant. Steps a) to d) are repeated.
- f) The SS instructs the MS to the minimum power control level on each multislot subchannel, all other conditions remaining constant. Steps a) to d) are repeated.
- g) The MS is hard mounted on a vibration table and vibrated at the frequency/amplitudes specified in annex 1, TC4. During the vibration steps a) to f) are repeated.

NOTE: If the call is terminated when mounting the MS to the vibration table, it will be necessary to establish the initial conditions again before repeating steps a) to f).

- h) The MS is re-positioned on the vibration table in the two orthogonal planes to the plane used in step g). For each of the orthogonal planes step g) is repeated.
- i) Steps a) to f) are repeated under extreme test conditions (see annex 1, TC2.2).

NOTE: The series of samples taken to determine the phase trajectory could also be used, with different post-processing, to determine the transmitter burst characteristics of 'Transmitter output power and burst timing in multislot configuration'. Although described independently, it is valid to combine these two tests, giving both answers from single sets of captured data.

13.6.5 Test requirements

13.6.5.1 Frequency error

For all measured bursts, the frequency error, derived in step c.6), shall be less than 10E-7.

13.6.5.2 Phase error

For all measured bursts, the RMS phase error, derived in step c.8), shall not exceed 5 degrees.

For all measured bursts, each individual phase error, derived in step c.7), shall not exceed 20 degrees.

13.7 Transmitter output power and burst timing in HSCSD configurations

13.7.1 Definition and applicability

The transmitter output power is the average value of the power delivered to an artificial antenna or radiated by the MS and its integral antenna, over the time that the useful information bits of one burst are transmitted.

The transmit burst timing is the envelope of the RF power transmitted with respect to time. The timings are referenced to the transition from bit 13 to bit 14 of the Training Sequence ("midamble") before differential decoding. The timing of the modulation is referenced to the timing of the received signal from the SS.

The requirements and this test apply to all types of GSM 400, GSM 700, GSM 850, GSM 900, DCS 1 800 and PCS 1 900 MS and multiband any MS which are capable of HSCSD multislot operation.

13.7.2 Conformance requirement

1. The MS maximum output power shall be as defined in GSM 05.05, 4.1.1, first table, according to its power class, with a tolerance of ± 2 dB under normal conditions; GSM 05.05, 4.1.1, first table.
2. The MS maximum output power shall be as defined in GSM 05.05, 4.1.1, first table, according to its power class, with a tolerance of $\pm 2,5$ dB under extreme conditions; GSM 05.05, 4.1.1, first table; GSM 05.05 annex D D.2.1, D.2.2.
3. The power control levels shall have the nominal output power levels as defined in GSM 05.05, 4.1.1, third table (for GSM 400, GSM 700, GSM 850 and GSM 900), fourth table (for DCS 1 800) or fifth table (for PCS 1900), from the lowest power control level up to the maximum output power corresponding to the class of the MS (for tolerance on maximum output power see conformance requirements 1), with a tolerance of $\pm 3, 4$ or 5 dB under normal conditions; GSM 05.05, 4.1.1, third, fourth or fifth table.
4. The power control levels shall have the nominal output power levels as defined in GSM 05.05, 4.1.1, third table (for GSM 400, GSM 700, GSM 850 and GSM 900), fourth table (for DCS 1 800) or fifth table (for PCS 1900), from the lowest power control level up to the maximum output power corresponding to the class of the MS (for tolerance on maximum output power see conformance requirements 2), with a tolerance of $\pm 4, 5$ or 6 dB under extreme conditions; GSM 05.05, 4.1.1, third, fourth or fifth table; GSM 05.05 annex D D.2.1, D.2.2.
5. The output power actually transmitted by the MS at consecutive power control levels shall form a monotonic sequence and the interval between power control levels shall be $2 \pm 1,5$ dB (1 ± 1 dB between power control level 30 and 31 for PCS 1 900); GSM 05.05, 4.1.1.
6. The transmitted power level relative to time for a normal burst shall be within the power/time template given in GSM 05.05, annex B figure B1. In multislot configurations where the bursts in two or more consecutive time slots are actually transmitted at the same frequency, the template of annex B shall be respected at the beginning and the end of the series of consecutive bursts. The output power during the guard period between every two consecutive active timeslots shall not exceed the level allowed for the useful part of the first timeslot or the level allowed for the useful part of the second timeslot plus 3dB, whichever is the highest:
 - 6.1 Under normal conditions; GSM 05.05, 4.5.2..
 - 6.2 Under extreme conditions; GSM 05.05, 4.5.2, GSM 05.05 annex D D.2.1, D.2.2.
7. In multislot configurations, bidirectional subchannels shall be individually power controlled; GSM 05.08, 4.2.
8. When accessing a cell on the RACH and before receiving the first power command during a communication on a DCCH or TCH (after an IMMEDIATE ASSIGNMENT), all GSM and class 1 and class 2 DCS 1 800 and PCS 1 900 MS shall use the power control level defined by the MS_TXPWR_MAX_CCH parameter broadcast on the BCCH of the cell, or if MS_TXPWR_MAX_CCH corresponds to a power control level not supported by the MS as defined by its power class, the MS shall act as though the closest supported power control level had been broadcast. A Class 3 DCS 1 800 MS shall use the POWER_OFFSET parameter.
9. The transmissions from the MS to the BS, measured at the MS antenna, shall be 468,75 - TA bit periods behind the transmissions received from the BS, where TA is the last timing advance received from the current serving BS. The tolerance on these timings shall be ± 1 bit period:

9.1 Under normal conditions; GSM 05.10, 6.4.

9.2 Under extreme conditions; GSM 05.10, 6.4, GSM 05.05 annex D D.2.1, D.2.2.

10. The transmitted power level relative to time for a random access burst shall be within the power/time template given in GSM 05.05, annex B figure B3:

10.1 Under normal conditions; GSM 05.05, 4.5.2.

10.2 Under extreme conditions; GSM 05.05, 4.5.2, GSM 05.05 annex D D.2.1, D.2.2.

11 The MS shall use a TA value of 0 for the Random Access burst sent:

11.1 Under normal conditions; GSM 05.10, 6.6.

11.2 Under extreme conditions; GSM 05.10, 6.6, GSM 05.05 annex D D.2.1, D.2.2.

13.7.3 Test purpose

1. To verify that the maximum output power of the MS in HSCSD multislot configuration, under normal conditions, is within conformance requirement 1.
2. To verify that the maximum output power of the MS in HSCSD multislot configuration, under extreme conditions, is within conformance requirement 2.
3. To verify that all power control levels, relevant to the class of MS, are implemented in the MS in HSCSD multislot configuration and have output power levels, under normal conditions, within conformance requirement 3.
4. To verify that all power control levels have output power levels, under extreme conditions, within conformance requirement 4.
5. To verify that the step in the output power transmitted by the MS in HSCSD multislot configuration at consecutive power control levels is within conformance requirement 5 under normal conditions.
6. To verify that the output power relative to time, when sending a normal burst is within conformance requirement 6 in HSCSD multislot configuration:
 - 6.1 Under normal conditions.
 - 6.2 Under extreme conditions.
7. To verify that the MS in HSCSD multislot configuration uses the maximum power control level according to its power class if commanded to a power control level exceeding its power class.
8. To verify that, for normal bursts, the MS transmissions to the BS are timed within conformance requirement 8 in HSCSD multislot configuration:
 - 8.1 Under normal conditions.
 - 8.2 Under extreme conditions.
9. To verify that the output power relative to time, when sending an access burst is within conformance requirement 9 in HSCSD multislot configuration:
 - 9.1 Under normal conditions.
 - 9.2 Under extreme conditions.
10. To verify that, for an access burst, the MS transmission to the BS is timed within conformance requirement 10 in HSCSD multislot configuration:
 - 10.1 Under normal conditions.
 - 10.2 Under extreme conditions.
11. To verify that, power is individually controlled on bidirectional HSCSD subchannels

13.7.4 Methods of test

Two methods of test are described, separately for:

- 1) equipment fitted with a permanent antenna connector and for
- 2) equipment fitted with an integral antenna, and which cannot be connected to an external antenna except by the fitting of a temporary test connector as a test fixture.

NOTE: The behaviour of the MS in the system is determined to a high degree by the antenna, and this is the only transmitter test in this EN using the integral antenna. Further studies are ongoing on improved testing on the integral antenna, taking practical conditions of MS use into account.

13.7.4.1 Method of test for equipment with a permanent antenna connector

13.7.4.1.1 Initial conditions

A call is set up by the SS according to the generic call set up procedure for HSCSD multislot configuration on a channel with ARFCN in the Mid ARFCN range, power control level set to Max power and MS to operate in its highest number of uplink slots. MS_TXPWR_MAX_CCH is set to the maximum value supported by the Power Class of the Mobile under test. For DCS 1 800 mobile stations the POWER_OFFSET parameter is set to 6 dB.

13.7.4.1.2 Procedure

a) Measurement of normal burst transmitter output power

The SS takes power measurement samples evenly distributed over the duration of one burst with a sampling rate of at least $2/T$, where T is the bit duration. The samples are identified in time with respect to the modulation on the burst. The SS identifies the centre of the useful 147 transmitted bits, i.e. the transition from bit 13 to bit 14 of the midamble, as the timing reference.

The transmitter output power is calculated as the average of the samples over the 147 useful bits. This is also used as the 0 dB reference for the power/time template.

b) Measurement of normal burst timing delay

The burst timing delay is the difference in time between the timing reference identified in a) and the corresponding transition in the burst received by the MS immediately prior to the MS transmit burst sampled.

c) Measurement of normal burst power/time relationship

The array of power samples measured in a) are referenced in time to the centre of the useful transmitted bits and in power to the 0 dB reference, both identified in a).

d) Steps a) to c) are repeated on each multislot subchannel with the MS commanded to operate on each of the power control levels defined, even those not supported by the MS.

e) The SS commands the MS to the maximum power control level supported by the MS and steps a) to c) are repeated on each multislot subchannel for ARFCN in the Low and High ranges.

f) The SS commands the MS to the maximum power control level in the first multislot subchannel allocated and to the minimum power control level in the second multislot subchannel allocated. Any further timeslots allocated are to be set to the maximum power control level. Steps a) to c) and corresponding measurements on each subchannel are repeated.

g) Measurement of access burst transmitter output power

The SS causes the MS to generate an Access Burst on an ARFCN in the Mid ARFCN range, this could be either by a handover procedure or a new request for radio resource. In the case of a handover procedure the Power Level indicated in the HANDOVER COMMAND message is the maximum power control level supported by the MS. In the case of an Access Burst the MS shall use the Power Level indicated in the MS_TXPWR_MAX_CCH parameter. If the power class of the MS is DCS 1 800 Class 3, the MS shall also use the POWER_OFFSET parameter.

The SS takes power measurement samples evenly distributed over the duration of the access burst as described in a). However, in this case the SS identifies the centre of the useful bits of the burst by identifying the transition from the last bit of the synch sequence. The centre of the burst is then five data bits prior to this point and is used as the timing reference.

The transmitter output power is calculated as the average of the samples over the 87 useful bits of the burst. This is also used as the 0 dB reference for the power/time template.

h) Measurement of access burst timing delay

The burst timing delay is the difference in time between the timing reference identified in g) and the MS received data on the common control channel.

i) Measurement of access burst power/time relationship

The array of power samples measured in g) are referenced in time to the centre of the useful transmitted bits and in power to the 0 dB reference, both identified in g).

j) Depending on the method used in step g) to cause the MS to send an Access Burst, the SS sends either a HANDOVER COMMAND with power control level set to 10 or it changes the System Information elements MS_TXPWR_MAX_CCH and for DCS 1 800 the POWER_OFFSET on the serving cell BCCH in order to limit the MS transmit power on the Access Burst to power control level 10 (+23 dBm for GSM 400, GSM 700, GSM 850 and GSM 900 or +10 dBm for DCS 1 800 and PCS 1900) and then steps g) to i) are repeated.

k) Steps a) to j) are repeated under extreme test conditions (annex 1, TC2.2) except that the repeats at step d) are only performed for power control level 10 and the minimum power control level of the MS.

13.7.4.2 Method of test for equipment with an integral antenna

NOTE: If the MS is equipped with a permanent connector, such that the antenna can be disconnected and the SS be connected directly, then the method of section 13.7.4.1 will be applied.

The tests in this section are performed on an unmodified test sample.

13.7.4.2.1 Initial conditions

The MS is placed in the anechoic shielded chamber (annex 1, GC5) or on the outdoor test site, on an isolated support, in the position for normal use, at a distance of at least 3 metres from a test antenna, connected to the SS.

NOTE: The test method described has been written for measurement in an anechoic shielded chamber. If an outdoor test site is used then, in addition, it is necessary to raise/lower the test antenna through the specified height range to maximize the received power levels from both the test sample and the substitution antenna.

A call is set up by the SS according to the generic call set up procedure on a channel with ARFCN in the Mid ARFCN range, power control level set to Max power. MS_TXPWR_MAX_CCH is set to the maximum value supported by the Power Class of the Mobile under test. For DCS 1 800 mobile stations the POWER_OFFSET parameter is set to 6 dB.

13.7.4.2.2 Procedure

a) With the initial conditions set according to subclause 13.7.4.2.1 the test procedure in 13.7.4.1.2 is followed up to and including step j), except that in step a), when measurements are done at maximum power for ARFCN in the Low, Mid and High range, the measurement is made eight times with the MS rotated by $n \cdot 45$ degrees for all values of n in the range 0 to 7.

The measurements taken are received transmitter output power measurements rather than transmitter output power measurements, the output power measurement values can be derived as follows.

b) Assessment of test site loss for scaling of received output power measurements.

The MS is replaced by a half-wave dipole, resonating at the centre frequency of the transmit band, connected to an RF generator.

The frequency of the RF signal generator is set to the frequency of the ARFCN used for the 24 measurements in step a), the output power is adjusted to reproduce the received transmitter output power averages recorded in step a).

For each indication the power, delivered by the generator (in Watts) to the half-wave dipole, is recorded. These values are recorded in the form Pnc, where n = MS rotation and c = channel number.

For each channel number used compute:

$$P_{ac}(\text{Watts into dipole}) = \frac{1}{8} * \sum_{n=0}^{n=7} P_{nc}$$

from which: $P_{ac}(\text{Tx dBm}) = 10\log_{10}(P_{ac}) + 30 + 2,15$

The difference, for each of the three channels, between the actual transmitter output power averaged over the 8 measurement orientations and the received transmitter output power at orientation n = 0 is used to scale the received measurement results to actual transmitter output powers for all measured power control levels and ARFCN, which can then be checked against the requirements.

c) Temporary antenna connector calibration factors (transmit)

A modified test sample equipped with a temporary antenna connector is placed in a climatic test chamber and is linked to the SS by means of the temporary antenna connector.

Under normal test conditions, the power measurement and calculation parts of steps a) to j) of 13.7.4.1.2 are repeated except that the repeats at step d) are only performed for power control level 10 and the minimum power control level of the MS.

NOTE: The values noted here are related to the output transmitter carrier power levels under normal test conditions, which are known after step b). Therefore frequency dependent calibration factors that account for the effects of the temporary antenna connector can be determined.

d) Measurements at extreme test conditions.

NOTE: Basically the procedure for extreme conditions is:

- the power/time template is tested in the "normal" way,
- the radiated power is measured by measuring the difference with respect to the radiated power under normal test conditions.

Under extreme test conditions steps a) to j) of 13.7.4.1.2 are repeated except that the repeats at step d) are only performed for power control level 10 and the minimum power control level of the MS.

The transmitter output power under extreme test conditions is calculated for each burst type, power control level and for every frequency used by adding the frequency dependent calibration factor, determined in c), to the values obtained at extreme conditions in this step.

13.7.5 Test requirements

- a) The transmitter output power on each subchannel, under every combination of normal and extreme test conditions, for normal bursts and access bursts, at each frequency and for each power control level applicable to the MS power class, shall be at the relevant level shown in table 13.7-1, table 13.7-2 or table 13.7-3 within the tolerances also shown in table 13.7-1, table 13.7-2 or table 13.7-3.

GSM 400, GSM 700, GSM 850 and GSM 900 only - begin

Table 13.7-1: GSM 400, GSM 700, GSM 850 and GSM 900 transmitter output power for different power classes

Power class				Power control level	Transmitter output power dBm	Tolerances	
2	3	4	5			normal	extreme
.	.	.	.	2	39	+/-2 dB	+/-2,5 dB
.	.	.	.	3	37	+/-3 dB*)	+/-4 dB*)
.	.	.	.	4	35	+/-3 dB	+/-4 dB
.	.	.	.	5	33	+/-3 dB*)	+/-4 dB*)
.	.	.	.	6	31	+/-3 dB	+/-4 dB
.	.	.	.	7	29	+/-3 dB*)	+/-4 dB*)
.	.	.	.	8	27	+/-3 dB	+/-4 dB
.	.	.	.	9	25	+/-3 dB	+/-4 dB
.	.	.	.	10	23	+/-3 dB	+/-4 dB
.	.	.	.	11	21	+/-3 dB	+/-4 dB
.	.	.	.	12	19	+/-3 dB	+/-4 dB
.	.	.	.	13	17	+/-3 dB	+/-4 dB
.	.	.	.	14	15	+/-3 dB	+/-4 dB
.	.	.	.	15	13	+/-3 dB	+/-4 dB
.	.	.	.	16	11	+/-5 dB	+/-6 dB
.	.	.	.	17	9	+/-5 dB	+/-6 dB
.	.	.	.	18	7	+/-5 dB	+/-6 dB
.	.	.	.	19	5	+/-5 dB	+/-6 dB

*) When the power control level corresponds to the power class of the MS, then the tolerances shall be 2,0 dB under normal test conditions and 2,5 dB under extreme test conditions.

GSM 400, GSM 700, GSM 850 and GSM 900 only - end

DCS 1 800 only - begin

Table 13.7-2: DCS 1 800 transmitter output power for different power classes

Power class			Power control level	Transmitter output power	Tolerances	
1	2	3			dBm	normal
		.	29	36	+/-2,0 dB	+/-2,5 dB
		.	30	34	+/-3,0 dB	+/-4,0 dB
		.	31	32	+/-3,0 dB	+/-4,0 dB
.	.	.	0	30	+/-3,0 dB*)	+/-4 dB*)
.	.	.	1	28	+/-3 dB	+/-4 dB
.	.	.	2	26	+/-3 dB	+/-4 dB
.	.	.	3	24	+/-3 dB*)	+/-4 dB*)
.	.	.	4	22	+/-3 dB	+/-4 dB
.	.	.	5	20	+/-3 dB	+/-4 dB
.	.	.	6	18	+/-3 dB	+/-4 dB
.	.	.	7	16	+/-3 dB	+/-4 dB
.	.	.	8	14	+/-3 dB	+/-4 dB
.	.	.	9	12	+/-4 dB	+/-5 dB
.	.	.	10	10	+/-4 dB	+/-5 dB
.	.	.	11	8	+/-4 dB	+/-5 dB
.	.	.	12	6	+/-4 dB	+/-5 dB
.	.	.	13	4	+/-4 dB	+/-5 dB
.	.	.	14	2	+/-5 dB	+/-6 dB
.	.	.	15	0	+/-5 dB	+/-6 dB

*) When the power control level corresponds to the power class of the MS, then the tolerances shall be 2,0 dB under normal test conditions and 2,5 dB under extreme test conditions.

DCS 1 800 only - end

PCS 1 900 only - begin

Table 13.7-3: PCS 1 900 transmitter output power for different power classes

Power class			Power control level	Transmitter output power	Tolerances	
1	2	3			Normal	Extreme
		.	30	33	+/-2,0 dB	+/-2,5 dB
		.	31	32	+/-2,0 dB	+/-2,5 dB
.	.	.	0	30	+/-3,0 dB*)	+/-4 dB*)
.	.	.	1	28	+/-3 dB	+/-4 dB
.	.	.	2	26	+/-3 dB	+/-4 dB
.	.	.	3	24	+/-3 dB*)	+/-4 dB*)
.	.	.	4	22	+/-3 dB	+/-4 dB
.	.	.	5	20	+/-3 dB	+/-4 dB
.	.	.	6	18	+/-3 dB	+/-4 dB
.	.	.	7	16	+/-3 dB	+/-4 dB
.	.	.	8	14	+/-3 dB	+/-4 dB
.	.	.	9	12	+/-4 dB	+/-5 dB
.	.	.	10	10	+/-4 dB	+/-5 dB
.	.	.	11	8	+/-4 dB	+/-5 dB
.	.	.	12	6	+/-4 dB	+/-5 dB
.	.	.	13	4	+/-4 dB	+/-5 dB
.	.	.	14	2	+/-5 dB	+/-6 dB
.	.	.	15	0	+/-5 dB	+/-6 dB

*) When the power control level corresponds to the power class of the MS, then the tolerances shall be 2,0 dB under normal test conditions and 2,5 dB under extreme test conditions.

PCS 1 900 only - end

- b) The difference between the transmitter output power at two adjacent power control levels, measured at the same frequency, shall not be less than 0,5 dB and not be more than 3,5 dB. For PCS 1 900 Class 3 the difference between the transmitter output power at power controls level 30 and 31, measured at the same frequency, shall not be less than 0 dB and not be more than 2 dB.
- c) The power/time relationship of the measured samples for normal bursts shall be within the limits of the power time template of figure 13.7-2 at each frequency, under every combination of normal and extreme test conditions and at each power control level measured.

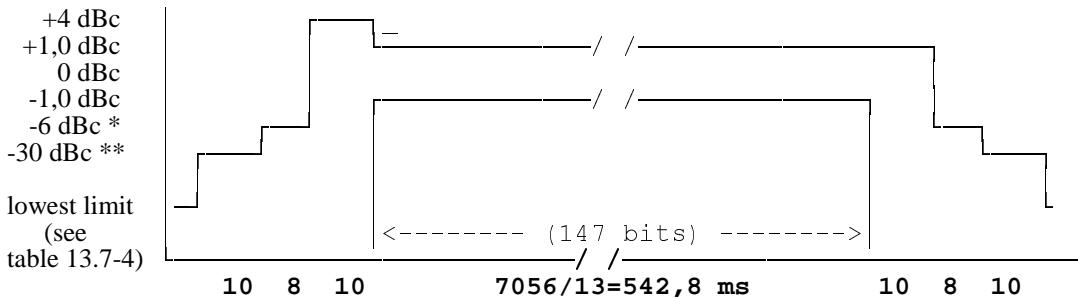

Figure 13.7-2: Power / time template for normal bursts

* For GSM400, GSM 700, GSM 850 and GSM900 MS:

- 4 dBc for power control level 16
- 2 dBc for power control level 17
- 1 dBc for power control levels 18 and 19

For DCS1800 and PCS 1900 MS: -4 dBc for power control level 11

- 2 dBc for power control level 12
- 1 dBc for power control levels 13, 14 and 15

** For GSM400, GSM 700, GSM 850 and GSM900 MS:

-30 dBc or -17 dBm, whichever is the higher

For DCS1800 and PCS 1900 MS: -30 dBc or -20 dBm, whichever is the higher

Table 13.7-4: Lowest measurement limit for power / time template

	lowest limit
GSM400, GSM 700, GSM 850, GSM900	-59 dBc or -54 dBm whichever is the highest, except for the timeslot preceding the active slot, for which the allowed level is -59 dBc or -36 dBm, whichever is the highest
DCS1800, PCS 1900	-48 dBc or -48 dBm whichever is the highest

- d) All the power control levels, for the type and power class of the MS as stated by the manufacturer, shall be implemented in the MS.
- e) When the transmitter is commanded to a power control level outside of the capability corresponding to the type and power class of the MS as stated by the manufacturer, then the transmitter output power shall be within the tolerances for the closest power control level corresponding to the type and power class as stated by the manufacturer.
- f) The centre of the transmitted normal burst as defined by the transition of bits 13/14 of the midamble shall be 3 timeslot periods (1731 μs) +/- 1 bit period (+/- 3,69 μs) after the centre of the corresponding received burst.

- g) The power/time relationship of the measured samples for access bursts shall be within the limits of the power time template of figure 13.7-3 at each frequency, under every combination of normal and extreme test conditions and at each power control level measured.

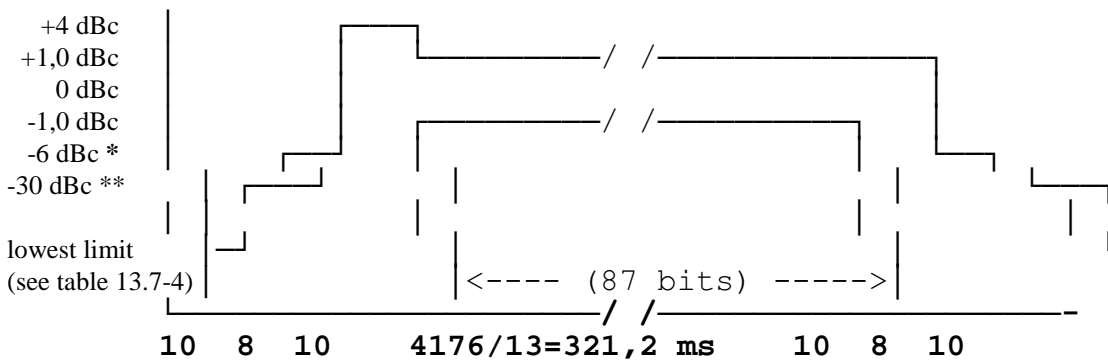

Figure 13.7-3: Power / time template for access burst

* For GSM400, GSM 700, GSM 850 and GSM900 MS:

- 4 dBc for power control level 16
- 2 dBc for power control level 17
- 1 dBc for power control levels 18 and 19

For DCS1800 and PCS 1900 MS: -4 dBc for power control level 11

- 2 dBc for power control level 12
- 1 dBc for power control levels 13, 14 and 15

** For GSM400, GSM 700, GSM 850 and GSM900 MS:

- 30 dBc or -17 dBm, whichever is the higher

For DCS1800 and PCS 1900 MS: -30 dBc or -20 dBm, whichever is the higher

- h) The centre of the transmitted access burst shall be an integer number of timeslot periods less 30 bit periods relative to any CCCH midamble centre with a tolerance of +/- 1 bit period (+/- 3,69 μ s).

13.8 Output RF spectrum in HSCSD multislot configuration

13.8.1 Definition and applicability

The output RF spectrum is the relationship between the frequency offset from the carrier and the power, measured in a specified bandwidth and time, produced by the MS due to the effects of modulation and power ramping.

The requirements and this test apply to all types of GSM 400, GSM 700, GSM 850, GSM 900, DCS 1 800 and PCS 1900 MS and any multiband MS, which are capable of HSCSD multislot operation.

13.8.2 Conformance requirement

1. The level of the output RF spectrum due to modulation shall be no more than that given in GSM 05.05, 4.2.1, table a) for GSM 400, GSM 700, GSM 850 and GSM 900, table b) for DCS 1 800 or table c) for PCS 1 900, with the following lowest measurement limits:
 - -36 dBm below 600 kHz offset from the carrier,
 - -51 dBm for GSM 400 and GSM 900 or -56 dBm for DCS 1 800 and PCS 1900 from 600 kHz out to less than 1 800 kHz offset from the carrier,

- -46 dBm for GSM 400 and GSM 900 or -51 dBm for DCS 1 800 and PCS 1900 at and beyond 1 800 kHz offset from the carrier,

but with the following exceptions at up to -36 dBm:

- up to three bands of 200 kHz width centred on a frequency which is an integer multiple of 200 kHz in the combined range 600 kHz to 6000 kHz above and below the carrier,
- up to 12 bands of 200 kHz width centred on a frequency which is an integer multiple of 200 kHz at more than 6 000 kHz offset from the carrier.

1.1 Under normal conditions; GSM 05.05, 4.2.1.

1.2 Under extreme conditions; GSM 05.05, 4.2.1; GSM 05.05, annex D D.2.1, D.2.2.

2. The level of the output RF spectrum due to switching transients shall be no more than given in GSM 05.05, 4.2.2, table "a) Mobile Station:".

2.1 Under normal conditions; GSM 05.05, 4.2.2.

2.2 Under extreme conditions; GSM 05.05, 4.2.2; GSM 05.05 annex D D.2.1, D.2.2.

3. When allocated a channel, the power emitted by a GSM 400, GSM 900 and DCS 1 800 MS, in the band 935 to 960 MHz shall be no more than -79 dBm, in the band 925 to 935 MHz shall be no more than -67 dBm and in the band 1 805 to 1 880 MHz shall be no more than -71 dBm except in five measurements in each of the bands 925 to 960 MHz and 1 805 to 1 880 MHz where exceptions at up to -36 dBm are permitted. For GSM 400 MS, in addition, the power emitted by MS, in the bands of 460.4 to 467.6 MHz and 488.8 to 496 MHz shall be no more than -67 dBm except in three measurements in each of the bands 460.4 to 467.6 MHz and 488.8 to 496 MHz where exceptions at up to -36 dBm are permitted. For PCS 1 900 MS, the power emitted by MS, in the band 869 to 894 MHz shall be no more than -79 dBm, in the band 1 930 to 1 990 MHz shall be no more than -71 dBm except in five measurements in each of the bands 869 to 894 MHz and 1 930 to 1 990 MHz where exceptions at up to -36 dBm are permitted. For GSM 700 and GSM 850, the power emitted by MS, in the band 747 to 757 MHz shall be no more than -79 dBm, in the band of 757 to 762 MHz shall be no more than -73 dBm, in the band 869 to 894 MHz shall be no more than -79 dBm, in the band 1 930 to 1 990 MHz shall be no more than -71 dBm except in five measurements in each of the bands 747 to 762 MHz, 869 to 894 MHz and 1 930 to 1 990 MHz where exceptions at up to -36 dBm are permitted. Under normal conditions; GSM 05.05, 4.3.3.

13.8.3 Test purpose

1. To verify that the output RF spectrum due to modulation does not exceed conformance requirement 1 in the multislot configurations.
 - 1.1 Under normal conditions.
 - 1.2 Under extreme conditions.
2. To verify that the output RF spectrum due to switching transients does not exceed conformance requirement 2 in the multislot configurations when a reasonable margin is allowed for the effect of spectrum due to modulation.
 - 2.1 Under normal conditions.
 - 2.2 Under extreme conditions.
3. To verify that the MS spurious emissions in the MS receive band do not exceed conformance requirement 3 in the multislot configurations.

13.8.4 Method of test

13.8.4.1 Initial conditions

A call is set up according to the generic call set up procedure for multislot HSCSD.

The SS commands the MS to hopping mode. The hopping pattern includes only three channels, namely one with an ARFCN in the Low ARFCN range, a second one with an ARFCN in the Mid ARFCN range and the third one with an ARFCN in the High ARFCN range.

NOTE 1: Although the measurement is made whilst the MS is in hopping mode, each measurement is on one single channel.

NOTE 2: This test is specified in hopping mode as a simple means of making the MS change channel, it would be sufficient to test in non hopping mode and to handover the MS between the three channels tested at the appropriate time.

The SS sends Standard Test Signal C1 (annex 5) to the MS at a level of $23 \text{ dB}\mu\text{Vemf}$ ().

The SS sets the MS to operate in a multislot configuration where is maximum number of transmitting timeslots. Maximum power level is set in all channels.

13.8.4.2 Procedure

NOTE: When averaging is in use during frequency hopping mode, the averaging only includes bursts transmitted when the hopping carrier corresponds to the nominal carrier of the measurement.

a) In steps b) to h) the FT is equal to the hop pattern ARFCN in the Mid ARFCN range.

b) The other settings of the spectrum analyser are set as follows:

- Zero frequency scan
- Resolution bandwidth: 30 kHz
- Video bandwidth: 30 kHz
- Video averaging: may be used, depending on the implementation of the test

The video signal of the spectrum analyser is "gated" such that the spectrum generated by at least 40 of the bits 87 to 132 of the burst in one of the active time slots is the only spectrum measured. This gating may be analogue or numerical, dependent upon the design of the spectrum analyser. Only measurements during transmitted bursts on the nominal carrier of the measurement are included. The spectrum analyser averages over the gated period and over 200 or 50 such bursts, using numerical and/or video averaging.

c) By tuning the spectrum analyser centre frequency to the measurement frequencies the power level is measured over 50 bursts at all multiples of 30 kHz offset from FT to $< 1\ 800 \text{ kHz}$.

d) The resolution and video bandwidth on the spectrum analyser are adjusted to 100 kHz and the measurements are made at the following frequencies:

on every ARFCN from 1 800 kHz offset from the carrier to the edge of the relevant transmit band for each measurement over 50 bursts.

at 200 kHz intervals over the 2 MHz either side of the relevant transmit band for each measurement over 50 bursts.

For GSM 400, GSM 900 and DCS 1 800:

at 200 kHz intervals over the band 925 - 960 MHz for each measurement over 50 bursts.

at 200 kHz intervals over the band 1805 - 1880 MHz for each measurement over 50 bursts.

in addition for GSM 400 MS:

at 200 kHz intervals over the band 460.4 to 467.6 MHz for each measurement over 50 bursts.

at 200 kHz intervals over the band 488.8 to 496 MHz for each measurement over 50 bursts.

For GSM 700 and GSM 850.

at 200 kHz intervals over the band 747 to 762 MHz for each measurement over 50 bursts.

at 200 kHz intervals over the band 869 - 894 MHz for each measurement over 50 bursts.

at 200 kHz intervals over the band 1930 – 1990 MHz for each measurement over 50 bursts.

For PCS 1 900:

at 200 kHz intervals over the band 869 - 894 MHz for each measurement over 50 bursts.

at 200 kHz intervals over the band 1930 – 1990 MHz for each measurement over 50 bursts.

- e) The MS is commanded to its minimum power control level. The spectrum analyser is set again as in b).
- f) By tuning the spectrum analyser centre frequency to the measurement frequencies the power level is measured over 200 bursts at the following frequencies:

FT

FT + 100 kHz FT - 100 kHz

FT + 200 kHz FT - 200 kHz

FT + 250 kHz FT - 250 kHz

FT + 200 kHz * N FT - 200 kHz * N

where N = 2, 3, 4, 5, 6, 7, and 8

and FT = RF channel nominal centre frequency.

- g) Steps a) to f) is repeated except that in step a) the spectrum analyzer is gated so that the burst of the next active time slot is measured.

- h) The spectrum analyser settings are adjusted to:

- Zero frequency scan
- Resolution bandwidth: 30 kHz
- Video bandwidth: 100 kHz
- Peak hold

The spectrum analyser gating of the signal is switched off.

The MS is commanded to its maximum power control level in every transmitted time slot.

- i) By tuning the spectrum analyser centre frequency to the measurement frequencies the power level is measured at the following frequencies:

FT + 400 kHz FT - 400 kHz

FT + 600 kHz FT - 600 kHz

FT + 1,2 MHz FT - 1,2 MHz

FT + 1,8 MHz FT - 1,8 MHz

where FT = RF channel nominal centre frequency.

The duration of each measurement (at each frequency) will be such as to cover at least 10 burst transmissions at FT.

- j) Step i) is repeated for power control levels 7 and 11.
- k) Steps b), f), h) and i) are repeated with FT equal to the hop pattern ARFCN in the Low ARFCN range except that in step h) the MS is commanded to power control level 11 rather than maximum power.
- l) Steps b), f), h) and i) are repeated with FT equal to the hop pattern ARFCN in the High ARFCN range except that in step h) the MS is commanded to power control level 11 rather than maximum power.

m) Steps a) b) f) h), and i) are repeated under extreme test conditions (annex 1, TC2.2). except that at step h) the MS is commanded to power control level 11.

13.8.5 Test requirements

For absolute measurements, performed on a temporary antenna connector, in the frequency band 450.4 to 457.6 MHz, 478.8 to 486 MHz, 777 to 792 MHz, 824 to 849 MHz, 880 to 915 MHz, 1710 to 1785 MHz or 1 850 to 1 910 MHz, the temporary antenna connector coupling factor, determined according to 13.3.4.2.2 and annex 1 GC7, for the nearest relevant frequency, will be used.

For absolute measurements, performed on a temporary antenna connector, in the frequency band 925 to 960 MHz, the temporary antenna connector coupling factor, will be as determined according to annex 1 GC7 for GSM 900 MS. For a GSM 400, GSM 700, GSM 850 or DCS 1 800 or PCS 1 900 MS 0 dB will be assumed.

For absolute measurements, performed on a temporary antenna connector, in the frequency band 1805 to 1880 MHz, the temporary antenna connector coupling factor, will be as determined according to annex 1 GC7 for DCS 1 800 MS. For GSM 400, GSM 700, GSM 850, GSM 900 or PCS 1 900 MS 0 dB will be assumed.

For absolute measurements, performed on a temporary antenna connector, in the frequency band 460.4 to 467.6 MHz or 488.8 to 496 MHz, the temporary antenna connector coupling factor, will be as determined according to annex 1 GC7 for GSM 400 MS. For a GSM 700, GSM 850, GSM 900, DCS 1800 or PCS 1 900 MS 0 dB will be assumed.

For absolute measurements, performed on a temporary antenna connector, in the frequency band 747 to 762 MHz, the temporary antenna connector coupling factor, will be as determined according to annex 1 GC7 for GSM 700 MS. For a GSM 400, GSM 850, GSM 900 or DCS 1800 MS 0 dB will be assumed.

For absolute measurements, performed on a temporary antenna connector, in the frequency band 869 to 894 MHz, the temporary antenna connector coupling factor, will be as determined according to annex 1 GC7 for GSM 850 MS. For a GSM 400, GSM 700, GSM 900 or DCS 1800 MS 0 dB will be assumed.

For absolute measurements, performed on a temporary antenna connector, in the frequency band 1930 to 1990 MHz, the temporary antenna connector coupling factor, will be as determined according to annex 1 GC7 for PCS 1 900 MS. For GSM 400, GSM 900 or DCS 1 800 MS 0 dB will be assumed.

The figures in the tables below, at the listed frequencies from the carrier (kHz), are the maximum level (dB) relative to a measurement in 30 kHz bandwidth on the carrier (reference GSM 05.05 section 4.2.1).

- a) For the modulation sidebands out to less than 1 800 kHz offset from the carrier frequency (FT) measured in step c), f), i), k), l) and m) the measured power level in dB relative to the power level measured at FT, for all types of MS, shall not exceed the limits derived from the values shown in table 1 for GSM 400, GSM 700, GSM 850 and GSM 900, table 2 for DCS 1 800 or table 3 for PCS 1 900 according to the actual transmit power and frequency offset from FT. However any failures in the combined range 600 kHz to less than 1 800 kHz above and below the carrier may be counted towards the exceptions allowed in test requirements c) below.

Table 1: GSM 400, GSM 700, GSM 850 and GSM 900 Spectrum due to modulation out to less than 1 800 kHz offset

Power level (dBm)	power levels in dB relative to the measurement at FT				
	Frequency offset (kHz)				
	0-100	200	250	400	600 to <1800
39	+0,5	-30	-33	-60	-66
37	+0,5	-30	-33	-60	-64
35	+0,5	-30	-33	-60	-62
<= 33	+0,5	-30	-33	-60	-60
The values above are subject to the minimum absolute levels (dBm) below.					
	-36	-36	-36	-36	-51

Table 2: DCS 1 800 Spectrum due to modulation out to less than 1 800 kHz offset

power levels in dB relative to the measurement at FT					
Power level	Frequency offset (kHz)				
(dBm)	0-100	200	250	400	600 to <1800
<= 36	+0,5	-30	-33	-60	-60
The values above are subject to the minimum absolute levels (dBm) below.					
	-36	-36	-36	-36	-56

Table 3: PCS 1 900 Spectrum due to modulation out to less than 1 800 kHz offset

power levels in dB relative to the measurement at FT						
Power level	Frequency offset (kHz)					
(dBm)	0-100	200	250	400	600 to <1200	1200 to <1800
<= 33	+0,5	-30	-33	-60	-60	-60
The values above are subject to the minimum absolute levels (dBm) below.						
	-36	-36	-36	-36	-56	-56

NOTE 1: For frequency offsets between 100 kHz and 600 kHz the requirement is derived by a linear interpolation between the points identified in the table with linear frequency and power in dB relative.

- b) For the modulation sidebands from 1 800 kHz offset from the carrier frequency (FT) and out to 2 MHz beyond the edge of the relevant transmit band, measured in step d), the measured power level in dB relative to the power level measured at FT, shall not exceed the values shown in table 4 according to the actual transmit power, frequency offset from FT and system on which the MS is designed to operate. However any failures in the combined range 1 800 kHz to 6 MHz above and below the carrier may be counted towards the exceptions allowed in test requirements c) below, and any other failures may be counted towards the exceptions allowed in test requirements d) below.

Table 4: Spectrum due to modulation from 1 800 kHz offset to the edge of the transmit band (wideband noise)

power levels in dB relative to the measurement at FT									
GSM400, GSM 700, GSM 850 and GSM900				DCS1800			PCS1900		
Power Level	Frequency offset kHz			Power Level	Frequency offset KHz		Power level	Frequency offset KHz	
(dBm)	1800 to < 3000	3000 to < 6000	>= 6000	(dBm)	1800 to < 6000	>= 6000	(dBm)	1800 to < 6000	>= 6000
39	-69	-71	-77	36	-71	-79	33	-68	-76
37	-67	-69	-75	34	-69	-77	32	-67	-75
35	-65	-67	-73	32	-67	-75	30	-65	-73
<= 33	-63	-65	-71	30	-65	-73	28	-63	-71
				28	-63	-71	26	-61	-69
				26	-61	-69	<= 24	-59	-67
				<= 24	-59	-67			
The values above are subject to the minimum absolute levels (dBm) below.									
	-46	-46	-46		-51	-51		-51	-51

- c) Any failures (from a) and b) above) in the combined range 600 kHz to 6 MHz above and below the carrier should be re-checked for allowed spurious emissions. For each of the three ARFCN used, spurious emissions are allowed in up to three 200 kHz bands centred on an integer multiple of 200 kHz so long as no spurious emission exceeds -36 dBm. Any spurious emissions measured in a 30 kHz bandwidth which spans two 200 kHz bands can be counted towards either 200 kHz band, whichever minimizes the number of 200 kHz bands containing spurious exceptions.

- d) Any failures (from b) above) beyond 6 MHz offset from the carrier should be re-checked for allowed spurious emissions. For each of the three ARFCN used, up to twelve spurious emissions are allowed so long as no spurious emission exceeds -36 dBm.
- e) For GSM 400, GSM 900 and DCS 1 800 MS spurious emissions in the bands 925 - 935 MHz, 935 - 960 MHz and 1 805 - 1 880 MHz, measured in step d), shall not exceed the values shown in table 5 except in up to five measurements in the band 925 to 960 MHz and five measurements in the band 1 805 to 1 880 MHz where a level up to -36 dBm is permitted. For GSM 400 MS, in addition, the MS spurious emissions in the bands 460.4 to 467.6 MHz and 488.8 to 496 MHz shall not exceed the value of -67 dBm, except in up to three measurements in each of the bands 460.4 to 467.6 MHz and 488.8 to 496 MHz where a level up to -36 dBm is permitted. For GSM 700 and GSM 850 the spurious emissions in the bands 747 - 757 MHz, 757 - 762 MHz and 869 - 894 MHz and 1930 - 1990 MHz shall not exceed the values shown in table 4 except in up to five measurements in each of the bands 747 to 762 MHz and 869 MHz to 894 MHz and 1 930 MHz to 1 990 MHz where a level up to -36 dBm is permitted. For PCS 1 900 MS the spurious emissions in the bands 869 - 894 MHz and 1930 - 1990 MHz shall not exceed the values shown in table 5 except in up to five measurements in each of the bands 869 MHz to 894 MHz and 1 930 MHz to 1 990 MHz where a level up to -36 dBm is permitted.

Table 5: Spurious emissions in the MS receive bands

Band (MHz)	Spurious emissions level (dBm)	
	GSM400, GSM900 and DCS1800	GSM 700, GSM 850 and PCS1900
925 to 935	-67	
935 to 960	-79	
1805 to 1880	-71	
747 to 757		-79
757 to 762		-73
869 to 894		-79
1930 to 1990		-71

- f) For the power ramp sidebands of steps h), i) and k) the power levels must not exceed the values shown in table 6 for GSM 400, GSM 700, GSM 850 and GSM 900, table 7 for DCS 1 800 or table 8 for PCS 1 900.

Table 6: GSM Spectrum due to switching transients

Power level	Maximum level for various offsets from carrier frequency			
	400 kHz	600 kHz	1200 kHz	1800 kHz
39 dBm	-13 dBm	-21 dBm	-21 dBm	-24 dBm
37 dBm	-15 dBm	-21 dBm	-21 dBm	-24 dBm
35 dBm	-17 dBm	-21 dBm	-21 dBm	-24 dBm
33 dBm	-19 dBm	-21 dBm	-21 dBm	-24 dBm
31 dBm	-21 dBm	-23 dBm	-23 dBm	-26 dBm
29 dBm	-23 dBm	-25 dBm	-25 dBm	-28 dBm
27 dBm	-23 dBm	-26 dBm	-27 dBm	-30 dBm
25 dBm	-23 dBm	-26 dBm	-29 dBm	-32 dBm
23 dBm	-23 dBm	-26 dBm	-31 dBm	-34 dBm
<= +21 dBm	-23 dBm	-26 dBm	-32 dBm	-36 dBm

Table 7: DCS 1 800 Spectrum due to switching transients

Power level	Maximum level for various offsets from carrier frequency			
	400 kHz	600 kHz	1200 kHz	1800 kHz
36 dBm	-16 dBm	-21 dBm	-21 dBm	-24 dBm
34 dBm	-18 dBm	-21 dBm	-21 dBm	-24 dBm
32 dBm	-20 dBm	-22 dBm	-22 dBm	-25 dBm
30 dBm	-22 dBm	-24 dBm	-24 dBm	-27 dBm
28 dBm	-23 dBm	-25 dBm	-26 dBm	-29 dBm
26 dBm	-23 dBm	-26 dBm	-28 dBm	-31 dBm
24 dBm	-23 dBm	-26 dBm	-30 dBm	-33 dBm
22 dBm	-23 dBm	-26 dBm	-31 dBm	-35 dBm
<= +20 dBm	-23 dBm	-26 dBm	-32 dBm	-36 dBm

Table 8: PCS 1 900 Spectrum due to switching transients

Power level	Maximum level for various offsets from carrier frequency			
	400 kHz	600 kHz	1200 kHz	1800 kHz
33 dBm	-19 dBm	-22 dBm	-22 dBm	-25 dBm
32 dBm	-20 dBm	-22 dBm	-22 dBm	-25 dBm
30 dBm	-22 dBm	-24 dBm	-24 dBm	-27 dBm
28 dBm	-23 dBm	-25 dBm	-26 dBm	-29 dBm
26 dBm	-23 dBm	-26 dBm	-28 dBm	-31 dBm
24 dBm	-23 dBm	-26 dBm	-30 dBm	-33 dBm
22 dBm	-23 dBm	-26 dBm	-31 dBm	-35 dBm
<= +20 dBm	-23 dBm	-26 dBm	-32 dBm	-36 dBm

NOTE 2: These figures are different from the requirements in GSM 05.05 because at higher power levels it is the modulation spectrum which is being measured using a peak hold measurement. This allowance is given in the table.

NOTE 3: The figures for table 6, table 7 and table 8 assume that, using the peak hold measurement, the lowest level measurable is 8 dB above the level of the modulation specification using the 30 kHz bandwidth gated average technique for 400 kHz offset from the carrier. At 600 and 1200 kHz offset the level is 6 dB above and at 1 800 kHz offset the level is 3 dB above. The figures for 1 800 kHz have assumed the 30 kHz bandwidth spectrum due to modulation specification at <1 800 kHz.

13.9 Output RF spectrum for MS supporting the R-GSM band

13.9.1 Definition and applicability

The output RF spectrum is the relationship between the frequency offset from the carrier and the power, measured in a specified bandwidth and time, produced by the MS due to the effects of modulation and power ramping.

The requirements and this test apply to all types of R-GSM 900.

13.9.2 Conformance requirement

1. The level of the output RF spectrum due to modulation shall be no more than that given in GSM 05.05, 4.2.1, table a) for R-GSM 900 with the following lowest measurement limits:

- -36 dBm below 600 kHz offset from the carrier,
- -51 dBm for R-GSM 900 from 600 kHz out to less than 1 800 kHz offset from the carrier,
- -46 dBm for R-GSM 900 at and beyond 1 800 kHz offset from the carrier,

but with the following exceptions at up to -36 dBm:

- up to three bands of 200 kHz width centred on a frequency which is an integer multiple of 200 kHz in the combined range 600 kHz to 6000 kHz above and below the carrier,
- up to 12 bands of 200 kHz width centred on a frequency which is an integer multiple of 200 kHz at more than 6 000 kHz offset from the carrier.

1.1 Under normal conditions; GSM 05.05, 4.2.1.

1.2 Under extreme conditions; GSM 05.05, 4.2.1; GSM 05.05, annex D D.2.1, D.2.2.

2. The level of the output RF spectrum due to switching transients shall be no more than given in GSM 05.05, 4.2.2, table "a) Mobile Station:".

2.1 Under normal conditions; GSM 05.05, 4.2.2.

2.2 Under extreme conditions; GSM 05.05, 4.2.2; GSM 05.05 annex D D.2.1, D.2.2.

3. When allocated a channel, the power emitted by the MS, in the band 935 to 960 MHz shall be no more than -79 dBm, in the band 925 to 935 MHz shall be no more than -67 dBm, in the band 921 to 925 MHz shall be no more than -60 dBm and in the band 1 805 to 1 880 MHz shall be no more than -71 dBm except in five measurements in each of the bands 925 to 960 MHz and 1 805 to 1 880 MHz where exceptions at up to -36 dBm are permitted. Under normal conditions; GSM 05.05, 4.3.3.

13.9.3 Test purpose

1. To verify that the output RF spectrum due to modulation does not exceed conformance requirement 1.

1.1 Under normal conditions.

1.2 Under extreme conditions.

2. To verify that the output RF spectrum due to switching transients does not exceed conformance requirement 2 when a reasonable margin is allowed for the effect of spectrum due to modulation.

2.1 Under normal conditions.

2.2 Under extreme conditions.

3. To verify that the MS spurious emissions in the MS receive band do not exceed conformance requirement 3.

13.9.4 Method of test

13.9.4.1 Initial conditions

A call is set up according to the generic call set up procedure.

The SS commands the MS to hopping mode. The hopping pattern includes only three channels, namely one with an ARFCN in the Low R-GSM ARFCN range, a second one with an ARFCN in the Mid ARFCN range and the third one with an ARFCN in the High ARFCN range.

NOTE 1: Although the measurement is made whilst the MS is in hopping mode, each measurement is on one single channel.

NOTE 2: This test is specified in hopping mode as a simple means of making the MS change channel, it would be sufficient to test in non hopping mode and to handover the MS between the three channels tested at the appropriate time.

The SS commands the MS to complete the traffic channel loop back without signalling of erased frames (see 36.2.1.1). This is to set a defined random pattern for the transmitter.

The SS sends Standard Test Signal C1 (annex 5) to the MS at a level of 23 dB μ Vemf().

13.9.4.2 Procedure

NOTE: When averaging is in use during frequency hopping mode, the averaging only includes bursts transmitted when the hopping carrier corresponds to the nominal carrier of the measurement.

a) In steps b) to h) the FT is equal to the hop pattern ARFCN in the Mid ARFCN range.

b) The other settings of the spectrum analyser are set as follows:

- Zero frequency scan
- Resolution bandwidth: 30 kHz
- Video bandwidth: 30 kHz
- Video averaging: may be used, depending on the implementation of the test

The video signal of the spectrum analyser is "gated" such that the spectrum generated by at least 40 of the bits 87 to 132 of the burst is the only spectrum measured. This gating may be analogue or numerical, dependent upon the design of the spectrum analyser. Only measurements during transmitted bursts on the nominal carrier of the measurement are included. The spectrum analyser averages over the gated period and over 200 or 50 such bursts, using numerical and/or video averaging.

The MS is commanded to its maximum power control level.

c) By tuning the spectrum analyser centre frequency to the measurement frequencies the power level is measured over 50 bursts at all multiples of 30 kHz offset from FT to < 1 800 kHz.

d) The resolution and video bandwidth on the spectrum analyser are adjusted to 100 kHz and the measurements are made at the following frequencies:

on every ARFCN from 1 800 kHz offset from the carrier to the edge of the relevant transmit band for each measurement over 50 bursts.

at 200 kHz intervals over the 2 MHz either side of the relevant transmit band for each measurement over 50 bursts.

at 200 kHz intervals over the band 921 - 960 MHz for each measurement over 50 bursts.

at 200 kHz intervals over the band 1805 - 1880 MHz for each measurement over 50 bursts.

e) The MS is commanded to its minimum power control level. The spectrum analyser is set again as in b).

f) By tuning the spectrum analyser centre frequency to the measurement frequencies the power level is measured over 200 bursts at the following frequencies:

FT

FT + 100 kHz FT - 100 kHz

FT + 200 kHz FT - 200 kHz

FT + 250 kHz FT - 250 kHz

FT + 200 kHz * N FT - 200 kHz * N

where N = 2, 3, 4, 5, 6, 7, and 8

and FT = RF channel nominal centre frequency.

g) The spectrum analyser settings are adjusted to:

- Zero frequency scan
- Resolution bandwidth: 30 kHz
- Video bandwidth: 100 kHz

- Peak hold

The spectrum analyser gating of the signal is switched off.

The MS is commanded to its maximum power control level.

- h) By tuning the spectrum analyser centre frequency to the measurement frequencies the power level is measured at the following frequencies:

FT + 400 kHz	FT - 400 kHz
FT + 600 kHz	FT - 600 kHz
FT + 1,2 MHz	FT - 1,2 MHz
FT + 1,8 MHz	FT - 1,8 MHz

where FT = RF channel nominal centre frequency.

The duration of each measurement (at each frequency) will be such as to cover at least 10 burst transmissions at FT.

- i) Step h) is repeated for power control levels 7 and 11.
- j) Steps b), f), g) and h) are repeated with FT equal to the hop pattern ARFCN in the Low R-GSM ARFCN range except that in step g) the MS is commanded to power control level 11 rather than maximum power.
- k) Steps b), f), g) and h) are repeated with FT equal to the hop pattern ARFCN in the High ARFCN range except that in step g) the MS is commanded to power control level 11 rather than maximum power.
- l) Steps a), b), f), g) and h) are repeated under extreme test conditions (annex 1, TC2.2). except that at step g) the MS is commanded to power control level 11.

13.9.5 Test requirements

For absolute measurements, performed on a temporary antenna connector, in the frequency band 876 to 915 MHz or 1710 to 1785 MHz, the temporary antenna connector coupling factor, determined according to 13.3.4.2.2 and annex 1 GC7, for the nearest relevant frequency, will be used.

For absolute measurements, performed on a temporary antenna connector, in the frequency band 921 to 960 MHz, the temporary antenna connector coupling factor, will be as determined according to annex 1 GC7 for GSM 900 MS

For absolute measurements, performed on a temporary antenna connector, in the frequency band 1805 to 1880 MHz for R-GSM 900 MS 0 dB will be assumed.

The figures in the tables below, at the listed frequencies from the carrier (kHz), are the maximum level (dB) relative to a measurement in 30 kHz bandwidth on the carrier (reference GSM 05.05 section 4.2.1).

- a) For the modulation sidebands out to less than 1 800 kHz offset from the carrier frequency (FT) measured in step c), f), h), j), k) and l) the measured power level in dB relative to the power level measured at FT, for all types of MS, shall not exceed the limits derived from the values shown in table 13.9-1 for R-GSM 900 according to the actual transmit power and frequency offset from FT. However any failures in the combined range 600 kHz to less than 1 800 kHz above and below the carrier may be counted towards the exceptions allowed in test requirements c) below.

Table 13.9-1a: R-GSM 900 Spectrum due to modulation out to less than 1 800 kHz offset

power levels in dB relative to the measurement at FT					
Power level	Frequency offset (kHz)				
(dBm)	0-100	200	250	400	600 to <1800
39	+0,5	-30	-33	-60	-66
37	+0,5	-30	-33	-60	-64
35	+0,5	-30	-33	-60	-62
<= 33	+0,5	-30	-33	-60	-60
The values above are subject to the minimum absolute levels (dBm) below.					
	-36	-36	-36	-36	-51

NOTE 1: For frequency offsets between 100 kHz and 600 kHz the requirement is derived by a linear interpolation between the points identified in the table with linear frequency and power in dB relative.

- b) For the modulation sidebands from 1 800 kHz offset from the carrier frequency (FT) and out to 2 MHz beyond the edge of the relevant transmit band, measured in step d), the measured power level in dB relative to the power level measured at FT, shall not exceed the values shown in table 13.9-2 according to the actual transmit power, frequency offset from FT and system on which the MS is designed to operate. However any failures in the combined range 1 800 kHz to 6 MHz above and below the carrier may be counted towards the exceptions allowed in test requirements c) below, and any other failures may be counted towards the exceptions allowed in test requirements d) below.

Table 13.9-2: Spectrum due to modulation from 1 800 kHz offset to the edge of the transmit band (wideband noise)

Power levels in dB relative to the measurement at FT			
R-GSM900			
Power level	Frequency offset kHz		
(dBm)	1800 to < 3000	3000 to < 6000	>= 6000
39	-69	-71	-77
37	-67	-69	-75
35	-65	-67	-73
<= 33	-63	-65	-71
The values above are subject to the minimum absolute levels (dBm) below			
	-46	-46	-46

- c) Any failures (from a) and b) above) in the combined range 600 kHz to 6 MHz above and below the carrier should be re-checked for allowed spurious emissions. For each of the three ARFCN used, spurious emissions are allowed in up to three 200 kHz bands centred on an integer multiple of 200 kHz so long as no spurious emission exceeds -36 dBm. Any spurious emissions measured in a 30 kHz bandwidth which spans two 200 kHz bands can be counted towards either 200 kHz band, whichever minimizes the number of 200 kHz bands containing spurious exceptions.
- d) Any failures (from b) above) beyond 6 MHz offset from the carrier should be re-checked for allowed spurious emissions. For each of the three ARFCN used, up to twelve spurious emissions are allowed so long as no spurious emission exceeds -36 dBm.
- e) The MS spurious emissions in the bands 921 – 925, 925 - 935 MHz, 935 - 960 MHz and 1 805 - 1 880 MHz, measured in step d), for all types of MS, shall not exceed the values shown in table 13.9-3 except in up to five measurements in the band 925 to 960 MHz and five measurements in the band 1 805 to 1 880 MHz where a level up to -36 dBm is permitted.

Table 13.9-3: Spurious emissions in the R-GSM MS receive bands

Band (MHz)	Spurious emissions level (dBm)
921 to 925	-60
925 to 935	-67
935 to 960	-79
1805 to 1880	-71

- f) For the power ramp sidebands of steps h) and i) the power levels must not exceed the values shown in table 13.9-4 for GSM 900.

Table 13.9-4: R-GSM Spectrum due to switching transients

Power level	Maximum level for various offsets from carrier frequency			
	400 kHz	600 kHz	1200 kHz	1800 kHz
39 dBm	-13 dBm	-21 dBm	-21 dBm	-24 dBm
37 dBm	-15 dBm	-21 dBm	-21 dBm	-24 dBm
35 dBm	-17 dBm	-21 dBm	-21 dBm	-24 dBm
33 dBm	-19 dBm	-21 dBm	-21 dBm	-24 dBm
31 dBm	-21 dBm	-23 dBm	-23 dBm	-26 dBm
29 dBm	-23 dBm	-25 dBm	-25 dBm	-28 dBm
27 dBm	-23 dBm	-26 dBm	-27 dBm	-30 dBm
25 dBm	-23 dBm	-26 dBm	-29 dBm	-32 dBm
23 dBm	-23 dBm	-26 dBm	-31 dBm	-34 dBm
<= +21 dBm	-23 dBm	-26 dBm	-32 dBm	-36 dBm

NOTE 2: These figures are different from the requirements in GSM 05.05 because at higher power levels it is the modulation spectrum which is being measured using a peak hold measurement. This allowance is given in the table.

NOTE 3: The figures for table 13.9-4 assume that, using the peak hold measurement, the lowest level measurable is 8 dB above the level of the modulation specification using the 30 kHz bandwidth gated average technique for 400 kHz offset from the carrier. At 600 and 1200 kHz offset the level is 6 dB above and at 1800 kHz offset the level is 3 dB above. The figures for 1800 kHz have assumed the 30 kHz bandwidth spectrum due to modulation specification at <1800 kHz.

13.10 *[Reserved for future GSM test]*

13.11 *[Reserved for future GSM test]*

13.12 *[Reserved for future GSM test]*

13.13 *[Reserved for future GSM test]*

13.14 *[Reserved for future GSM test]*

13.15 *[Reserved for future GSM test]*

13.16 GPRS transmitter tests

13.16.1 Frequency error and phase error in GPRS multislots configuration

13.16.1.1 Definition and applicability

The frequency error is the difference in frequency, after adjustment for the effect of the modulation and phase error, between the RF transmission from the MS and either:

- the RF transmission from the BS, or
- the nominal frequency for the ARFCN used.

The phase error is the difference in phase, after adjustment for the effect of the frequency error, between the RF transmission from the MS and the theoretical transmission according to the intended modulation.

The requirements and this test apply to all types of GSM 400, GSM 700, GSM 850, GSM 900, DCS 1 800 and PCS 1900 MS which are capable of GPRS multislots operation on the uplink.

13.16.1.2 Conformance requirement

1. The MS carrier frequency shall be accurate to within 0,1 ppm compared to signals received from the BS.
 - 1.1 Under normal conditions; GSM 05.10, 6.1.
 - 1.2 Under vibration conditions; GSM 05.10, 6.1; GSM 05.05, annex D D.2.3.
 - 1.3 Under extreme conditions; GSM 05.10, 6.1; GSM 05.05, 4.4; GSM 05.05, annex D D.2.1, D.2.2.
2. The RMS phase error (difference between the phase error trajectory and its linear regression on the active part of the time slot) for each burst shall not be greater than 5 degrees.
 - 2.1 Under normal conditions; GSM 05.05, 4.6.
 - 2.2 Under vibration conditions; GSM 05.05, 4.6; GSM 05.05, annex D D.2.3.
 - 2.3 Under extreme conditions; GSM 05.05, 4.6; GSM 05.05, annex D D.2.1, D.2.2.
3. The maximum peak deviation during the useful part of each burst shall not be greater than 20 degrees.
 - 3.1 Under normal conditions; GSM 05.05, 4.6.
 - 3.2 Under vibration conditions; GSM 05.05, 4.6; GSM 05.05, annex D D.2.3.

3.3 Under extreme conditions; GSM 05.05, 4.6; GSM 05.05, annex D D.2.1, D.2.2.

13.16.1.3 Test purpose

1. To verify that in a multislot configuration the MS carrier frequency error does not exceed 0.1 ppm:
 - Under normal conditions
 - 1.2 When the MS is being vibrated
 - 1.3 Under extreme conditions
2. To verify that the RMS phase error on the useful parts of the bursts transmitted by the MS in a multislot configuration does not exceed conformance requirement 2:
 - 2.1 Under normal conditions
 - 2.2 When the MS is being vibrated
 - 2.3 Under extreme conditions
3. To verify that the maximum phase error on the useful parts of the bursts transmitted by the MS in a multislot configuration does not exceed conformance requirement 3:
 - 3.1 Under normal conditions
 - 3.2 When the MS is being vibrated
 - 3.3 Under extreme conditions

13.16.1.4 Method of the test

NOTE: In order to measure the accuracy of the frequency and phase error a sampled measurement of the transmitted phase trajectory is obtained. This is compared with the theoretically expected phase trajectory. The regression line of the difference between the expected trajectory and the measured trajectory is an indication of the frequency error (assumed constant through the burst), whilst the departure of the phase differences from this trajectory is a measure of the phase error. The peak phase error is the value furthest from the regression line and the RMS phase error is the root mean square average of the phase error of all samples.

13.16.1.4.1 Initial conditions

The test shall be run under the default GPRS conditions defined in section 40.

The SS commands the MS to hopping mode (table 13.6.1, GSM 11.10).

NOTE: It is not necessary to test in hopping mode but is done here as a simple means of making the MS change channel, it would be sufficient to test in non hopping mode and to make sure bursts are taken from a few different channels.

The MS shall be operated with it's highest number of uplink slots.

The Test Mode defined in GSM Rec. 4.14 (par 5.4) will be utilised. If the MS is capable of both:

- Mode (a) transmitting pseudo-random data sequence in RLC data blocks
- Mode (b) transmitting looped-back RLC data blocks

then Mode (a) will be used.

If Mode (b) is used then the SS sends the psuedo-random data sequence specified for Mode (a) on the downlink for loopback on the uplink.

13.16.1.4.2 Procedure

- a) For one transmitted burst on the last slot of the multislot configuration, the SS captures the signal as a series of phase samples over the period of the burst. These samples are evenly distributed over the duration of the burst with a minimum sampling rate of $2/T$, where T is the modulation symbol period. The received phase trajectory is then represented by this array of at least 294 samples.
- b) The SS then calculates, from the known bit pattern and the formal definition of the modulator contained in GSM 05.04, the expected phase trajectory.
- c) From a) and b) the phase trajectory error is calculated, and a linear regression line computed through this phase trajectory error. The slope of this regression line is the frequency error of the mobile transmitter relative to the simulator reference. The difference between the regression line and the individual sample points is the phase error of that point.

- c.1) The sampled array of at least 294 phase measurements is represented by the vector:

$$\varnothing_m = \varnothing_m(0) \dots \varnothing_m(n)$$

where the number of samples in the array $n+1 \geq 294$.

- c.2) The calculated array, at the corresponding sampling instants, is represented by the vector:

$$\varnothing_c = \varnothing_c(0) \dots \varnothing_c(n).$$

- c.3) The error array is represented by the vector:

$$\varnothing_e = \{\varnothing_m(0) - \varnothing_c(0)\} \dots \dots \dots \{\varnothing_m(n) - \varnothing_c(n)\} = \varnothing_e(0) \dots \varnothing_e(n).$$

- c.4) The corresponding sample numbers form a vector $t = t(0) \dots t(n)$.

- c.5) By regression theory the slope of the samples with respect to t is k where:

$$k = \frac{\sum_{j=0}^{j=n} t(j) * \varnothing_e(j)}{\sum_{j=0}^{j=n} t(j)^2}$$

- c.6) The frequency error is given by $k/(360 * g)$, where g is the sampling interval in s and all phase samples are measured in degrees.

- c.7) The individual phase errors from the regression line are given by:

$$\varnothing_e(j) - k * t(j).$$

- c.8) The RMS value \varnothing_e of the phase errors is given by:

$$\varnothing_e(\text{RMS}) = \left[\frac{\sum_{j=0}^{j=n} \{\varnothing_e(j) - k * t(j)\}^2}{n+1} \right]^{1/2}$$

- d) Steps a) to c) are repeated for 20 bursts, not necessarily contiguous.
- e) The SS instructs the MS to its maximum power control level by setting the power control parameter ALPHA (α) to 0 and GAMMA_TN (Γ_{CH}) for each timeslot to the desired power level in the Packet Uplink Assignment message (Closed Loop Control, see 05.08. Annex B.2), all other conditions remaining constant. Steps a) to d) are repeated.
- f) The SS instructs the MS to the minimum power control level, all other conditions remaining constant. Steps a) to d) are repeated.

g) The MS is hard mounted on a vibration table and vibrated at the frequency/amplitudes specified in annex 1, TC4.

During the vibration steps a) to f) are repeated.

NOTE: If the call is terminated when mounting the MS to the vibration table, it will be necessary to establish the initial conditions again before repeating steps a) to f).

h) The MS is re-positioned on the vibration table in the two orthogonal planes to the plane used in step g). For each of the orthogonal planes step g) is repeated.

i) Steps a) to f) are repeated under extreme test conditions (see annex 1, TC2.2).

13.16.1.5.1 Frequency error

For all measured bursts, the frequency error, derived in step c.6), shall be less than $10E-7$.

13.16.1.5.2 Phase error

For all measured bursts, the RMS phase error, derived in step c.8), shall not exceed 5 degrees.

For all measured bursts, each individual phase error, derived in step c.7), shall not exceed 20 degrees.

13.16.2 Transmitter output power in GPRS multislot configuration

13.16.2.1 Definition and applicability

The transmitter output power is the average value of the power delivered to an artificial antenna or radiated by the MS and its integral antenna, over the time that the useful information bits of one burst are transmitted.

The requirements and this test apply to all types of GSM 400, GSM 700, GSM 850, GSM 900, DCS 1 800 and PCS 1900 MS and any multiband MS, which are capable of GPRS multislot operation on the uplink.

13.16.2.2 Conformance requirement

1. The MS maximum output power shall be as defined in GSM 05.05, 4.1.1, first table, according to its power class, with a tolerance of ± 2 dB under normal conditions; GSM 05.05, 4.1.1, first table.
2. The MS maximum output power shall be as defined in GSM 05.05, 4.1.1, first table, according to its power class, with a tolerance of $\pm 2,5$ dB under extreme conditions; GSM 05.05, 4.1.1, first table; GSM 05.05 annex D D.2.1, D.2.2.
3. The power control levels shall have the nominal output power levels as defined in GSM 05.05, 4.1.1, third table (for GSM 400, GSM 700, GSM 850 and GSM 900), fourth table (for DCS 1 800) or fifth table (for PCS 1 900), from the lowest power control level up to the maximum output power corresponding to the class of the MS (for tolerance on maximum output power see conformance requirements 1), with a tolerance of $\pm 3, 4$ or 5 dB under normal conditions; GSM 05.05, 4.1.1, third, fourth or fifth table.
4. The power control levels shall have the nominal output power levels as defined in GSM 05.05, 4.1.1, third table (for GSM 400, GSM 700, GSM 850 and GSM 900), fourth table (for DCS 1 800) or fifth table (for PCS 1 900), from the lowest power control level up to the maximum output power corresponding to the class of the MS (for tolerance on maximum output power see conformance requirements 2), with a tolerance of $\pm 4, 5$ or 6 dB under extreme conditions; GSM 05.05, 4.1.1, third, fourth or fifth table; GSM 05.05 annex D D.2.1, D.2.2.
5. The output power actually transmitted by the MS at consecutive power control levels shall form a monotonic sequence and the interval between power control levels shall be $2 \pm 1,5$ dB (1 ± 1 dB between power control level 30 and 31 for PCS 1 900); GSM 05.05, 4.1.1.
6. The transmitted power level relative to time for a normal burst shall be within the power/time template given in GSM 05.05, annex B figure B1. In multislot configurations where the bursts in two or more consecutive time slots are actually transmitted at the same frequency the template of annex B shall be respected during the useful part of each burst and at the beginning and the end of the series of consecutive bursts. The output power during the guard period between every two consecutive active timeslots shall not exceed the level allowed for the useful

part of the first timeslot or the level allowed for the useful part of the second timeslot plus 3 dB, whichever is the highest.:

6.1 Under normal conditions; GSM 05.05, 4.5.2..

6.2 Under extreme conditions; GSM 05.05, 4.5.2, GSM 05.05 annex D D.2.1, D.2.2.

When accessing a cell on the PRACH or RACH and before receiving the first power control parameters during packet transfer on PDCH, all GSM and class 1 and class 2 DCS 1 800 and PCS 1900 MS shall use the power control level defined by the GPRS_MS_TXPWR_MAX_CCH parameter broadcast on the PBCCH or MS_TXPWR_MAX_CCH parameter broadcast on the BCCH of the cell. When MS_TXPWR_MAX_CCH is received on the BCCH, a class 3 DCS 1800 MS shall add to it the value POWER_OFFSET broadcast on the BCCH. If MS_TXPWR_MAX_CCH or the sum defined by: MS_TXPWR_MAX_CCH plus POWER_OFFSET corresponds to a power control level not supported by the MS as defined by its power class, the MS shall act as though the closest supported power control level had been broadcast.

8. The transmitted power level relative to time for a Random Access burst shall be within the power/time template given in GSM 05.05, annex B figure B3:

9.1 Under normal conditions; GSM 05.05, 4.5.2.

9.2 Under extreme conditions; GSM 05.05, 4.5.2, GSM 05.05 annex D D.2.1, D.2.2.

13.16.2.3 Test purpose

1. To verify that the maximum output power of the MS in GPRS multislot configuration, under normal conditions, is within conformance requirement 1.
2. To verify that the maximum output power of the MS in GPRS multislot configuration, under extreme conditions, is within conformance requirement 2.
3. To verify that all power control levels, relevant to the class of MS, are implemented in the MS in GPRS multislot configuration and have output power levels, under normal conditions, within conformance requirement 3.
4. To verify that all power control levels have output power levels, under extreme conditions, within conformance requirement 4.
5. To verify that the step in the output power transmitted by the MS in GPRS multislot configuration at consecutive power control levels is within conformance requirement 5 under normal conditions.
6. To verify that the output power relative to time, when sending a normal burst is within conformance requirement 6 in GPRS multislot configuration:
 - 6.1 Under normal conditions.
 - 6.2 Under extreme conditions.
7. To verify that the MS in GPRS multislot configuration uses the maximum power control level according to its power class if commanded to a power control level exceeding its power class.
8. To verify that the output power relative to time, when sending an access burst is within conformance requirement 8 in GPRS multislot configuration:
 - 9.1 Under normal conditions.
 - 9.2 Under extreme conditions.

13.16.2.4 Methods of test

Two methods of test are described, separately for:

- 1) equipment fitted with a permanent antenna connector and for
- 2) equipment fitted with an integral antenna, and which cannot be connected to an external antenna except by the fitting of a temporary test connector as a test fixture.

NOTE: The behaviour of the MS in the system is determined to a high degree by the antenna, and this is the only transmitter test in this ETS using the integral antenna. Further studies are ongoing on improved testing on the integral antenna, taking practical conditions of MS use into account.

13.16.2.4.1 Method of test for equipment with a permanent antenna connector

13.16.2.4.1.1 Initial conditions

The test shall be run under the default GPRS conditions defined in section 40.

The MS shall be operated with its highest number of uplink slots.

The Test Mode defined in GSM Rec. 4.14 (par 5.4) will be utilised. If the MS is capable of both:

Mode (a) transmitting pseudo-random data sequence in RLC data blocks

Mode (b) transmitting looped-back RLC data blocks

then Mode (a) will be used.

If Mode (b) is used then the SS sends the pseudo-random data sequence specified for Mode (a) on the downlink for loopback on the uplink.

The SS controls the power level by setting the concerned time slot's power control parameter ALPHA (α) to 0 and GAMMA_TN (Γ_{CH}) to the desired power level in the Packet Uplink Assignment message (Closed Loop Control, see 05.08. Annex B.2) GPRS_MS_TXPWR_MAX_CCH / MS_TXPWR_MAX_CCH is set to the maximum value supported by the Power Class of the Mobile under test. For DCS 1 800 mobile stations the POWER_OFFSET parameter is set to 6 dB.

13.16.2.4.1.2 Procedure

a) Measurement of normal burst transmitter output power

The SS takes power measurement samples evenly distributed over the duration of one burst with a sampling rate of at least $2/T$, where T is the bit duration. The samples are identified in time with respect to the modulation on the burst. The SS identifies the centre of the useful 147 transmitted bits, i.e. the transition from bit 13 to bit 14 of the midamble, as the timing reference.

The transmitter output power is calculated as the average of the samples over the 147 useful bits. This is also used as the 0 dB reference for the power/time template.

b) Measurement of normal burst power/time relationship

The array of power samples measured in a) are referenced in time to the centre of the useful transmitted bits and in power to the 0 dB reference, both identified in a).

c) Steps a) to b) are repeated on each timeslot within the multislot configuration with the MS commanded to operate on each of the power control levels defined, even those not supported by the MS.

d) The SS commands the MS to the maximum power control level supported by the MS and steps a) to b) are repeated on each timeslot within the multislot configuration for ARFCN in the Low and High ranges.

e) The SS commands the MS to the maximum power control level in the first timeslot allocated within the multislot configuration and to the minimum power control level in the second timeslot allocated. Any further timeslots allocated are to be set to the maximum power control level. Steps a) to b) and corresponding measurements on each timeslot within the multislot configuration are repeated.

f) Measurement of access burst transmitter output power

The SS causes the MS to generate an Access Burst on an ARFCN in the Mid ARFCN range, this could be either by a cell re-selection or a new request for radio resource. In the case of a cell re-selection procedure the Power Level indicated in the PSI3 message is the maximum power control level supported by the MS. In the case of an Access Burst the MS shall use the Power Level indicated in the GPRS_MS_TXPWR_MAX_CCH parameter. If

the power class of the MS is DCS 1 800 Class 3 and the Power Level is indicated by the MS_TXPWR_MAX_CCH parameter, the MS shall also use the POWER_OFFSET parameter.

The SS takes power measurement samples evenly distributed over the duration of the access burst as described in a). However, in this case the SS identifies the centre of the useful bits of the burst by identifying the transition from the last bit of the synch sequence. The centre of the burst is then five data bits prior to this point and is used as the timing reference.

The transmitter output power is calculated as the average of the samples over the 87 useful bits of the burst. This is also used as the 0 dB reference for the power/time template.

g) Measurement of access burst power/time relationship

The array of power samples measured in f) are referenced in time to the centre of the useful transmitted bits and in power to the 0 dB reference, both identified in f).

h) Depending on the method used in step f) to cause the MS to send an Access Burst, the SS sends either a PACKET CELL CHANGE ORDER along with power control level set to 10 in PSI3 parameter GPRS_MS_TXPWR_MAX_CCH or it changes the (Packet) System Information elements (GPRS_)MS_TXPWR_MAX_CCH and for DCS 1 800 the POWER_OFFSET on the serving cell PBCCH/BCCH in order to limit the MS transmit power on the Access Burst to power control level 10 (+23 dBm for GSM 400, GSM 700, GSM 850 and GSM 900 or +10 dBm for DCS 1 800 and PCS 1900) and then steps f) to g) are repeated.

i) Steps a) to h) are repeated under extreme test conditions (annex 1, TC2.2) except that the repeats at step d) are only performed for power control level 10 and the minimum power control level of the MS.

13.16.2.4.2 Method of test for equipment with an integral antenna

NOTE: If the MS is equipped with a permanent connector, such that the antenna can be disconnected and the SS be connected directly, then the method of section 13.16.2.4.1 will be applied.

The tests in this section are performed on an unmodified test sample.

13.16.2.4.2.1 Initial conditions

The MS is placed in the anechoic shielded chamber (annex 1, GC5) or on the outdoor test site, on an isolated support, in the position for normal use, at a distance of at least 3 metres from a test antenna, connected to the SS.

NOTE: The test method described has been written for measurement in an anechoic shielded chamber. If an outdoor test site is used then, in addition, it is necessary to raise/lower the test antenna through the specified height range to maximize the received power levels from both the test sample and the substitution antenna.

The Initial Conditions for the test are defined in 13.16.2.4.1.1.

13.16.2.4.2.2 Procedure

a) With the initial conditions set according to subclause 13.16.2.4.2.1 the test procedure in 13.16.2.4.1.2 is followed up to and including step h), except that in step a), when measurements are done at maximum power for ARFCN in the Low, Mid and High range, the measurement is made eight times with the MS rotated by $n \cdot 45$ degrees for all values of n in the range 0 to 7.

The measurements taken are received transmitter output power measurements rather than transmitter output power measurements, the output power measurement values can be derived as follows.

b) Assessment of test site loss for scaling of received output power measurements.

The MS is replaced by a half-wave dipole, resonating at the centre frequency of the transmit band, connected to an RF generator.

The frequency of the RF signal generator is set to the frequency of the ARFCN used for the 24 measurements in step a), the output power is adjusted to reproduce the received transmitter output power averages recorded in step a).

For each indication the power, delivered by the generator (in Watts) to the half-wave dipole, is recorded. These values are recorded in the form Pnc, where n = MS rotation and c = channel number.

For each channel number used compute:

$$P_{ac}(\text{Watts into dipole}) = \frac{1}{8} * \sum_{n=0}^{n=7} P_{nc}$$

from which: $P_{ac}(\text{Tx dBm}) = 10\log_{10}(P_{ac}) + 30 + 2,15$

The difference, for each of the three channels, between the actual transmitter output power averaged over the 8 measurement orientations and the received transmitter output power at orientation n = 0 is used to scale the received measurement results to actual transmitter output powers for all measured power control levels and ARFCN, which can then be checked against the requirements.

c) Temporary antenna connector calibration factors (transmit)

A modified test sample equipped with a temporary antenna connector is placed in a climatic test chamber and is linked to the SS by means of the temporary antenna connector.

Under normal test conditions, the power measurement and calculation parts of steps a) to j) of 13.16.2.4.1.2 are repeated except that the repeats at step d) are only performed for power control level 10 and the minimum power control level of the MS.

NOTE: The values noted here are related to the output transmitter carrier power levels under normal test conditions, which are known after step b). Therefore frequency dependent calibration factors that account for the effects of the temporary antenna connector can be determined.

d) Measurements at extreme test conditions.

NOTE: Basically the procedure for extreme conditions is:

- the power/time template is tested in the "normal" way,
- the radiated power is measured by measuring the difference with respect to the radiated power under normal test conditions.

Under extreme test conditions steps a) to h) of 13.16.2.4.1.2 are repeated except that the repeats at step d) are only performed for power control level 10 and the minimum power control level of the MS.

The transmitter output power under extreme test conditions is calculated for each burst type, power control level and for every frequency used by adding the frequency dependent calibration factor, determined in c), to the values obtained at extreme conditions in this step.

13.16.2.5 Test requirements

- a) The transmitter output power, under every combination of normal and extreme test conditions, for normal bursts and access bursts, at each frequency and for each power control level applicable to the MS power class, shall be at the relevant level shown in table 13.16.2-1, table 13.16.2-2 or table 13.16.2-3 within the tolerances also shown in table 13.16.2-1, table 13.16.2-2 or table 13.16.2-3.

GSM 400, GSM 700, GSM 850 and GSM 900 only - begin

Table 13.16.2-1: GSM 400, GSM 700, GSM 850 and GSM 900 transmitter output power for different power classes

Power class				Power control level	Transmitter output power dBm	Tolerances	
2	3	4	5			normal	extreme
.	.	.	.	2	39	+/-2 dB	+/-2,5 dB
.	.	.	.	3	37	+/-3 dB*)	+/-4 dB*)
.	.	.	.	4	35	+/-3 dB	+/-4 dB
.	.	.	.	5	33	+/-3 dB*)	+/-4 dB*)
.	.	.	.	6	31	+/-3 dB	+/-4 dB
.	.	.	.	7	29	+/-3 dB*)	+/-4 dB*)
.	.	.	.	8	27	+/-3 dB	+/-4 dB
.	.	.	.	9	25	+/-3 dB	+/-4 dB
.	.	.	.	10	23	+/-3 dB	+/-4 dB
.	.	.	.	11	21	+/-3 dB	+/-4 dB
.	.	.	.	12	19	+/-3 dB	+/-4 dB
.	.	.	.	13	17	+/-3 dB	+/-4 dB
.	.	.	.	14	15	+/-3 dB	+/-4 dB
.	.	.	.	15	13	+/-3 dB	+/-4 dB
.	.	.	.	16	11	+/-5 dB	+/-6 dB
.	.	.	.	17	9	+/-5 dB	+/-6 dB
.	.	.	.	18	7	+/-5 dB	+/-6 dB
.	.	.	.	19	5	+/-5 dB	+/-6 dB

*) When the power control level corresponds to the power class of the MS, then the tolerances shall be 2,0 dB under normal test conditions and 2,5 dB under extreme test conditions.

GSM 400, GSM 700, GSM 850 and GSM 900 only - end

DCS 1 800 only - begin

Table 13.16.2-2: DCS 1 800 transmitter output power for different power classes

Power class			Power control level	Transmitter output power	Tolerances	
1	2	3			dBm	normal
		.	29	36	+/-2,0 dB	+/-2,5 dB
		.	30	34	+/-3,0 dB	+/-4,0 dB
		.	31	32	+/-3,0 dB	+/-4,0 dB
.	.	.	0	30	+/-3,0 dB*)	+/-4 dB*)
.	.	.	1	28	+/-3 dB	+/-4 dB
.	.	.	2	26	+/-3 dB	+/-4 dB
.	.	.	3	24	+/-3 dB*)	+/-4 dB*)
.	.	.	4	22	+/-3 dB	+/-4 dB
.	.	.	5	20	+/-3 dB	+/-4 dB
.	.	.	6	18	+/-3 dB	+/-4 dB
.	.	.	7	16	+/-3 dB	+/-4 dB
.	.	.	8	14	+/-3 dB	+/-4 dB
.	.	.	9	12	+/-4 dB	+/-5 dB
.	.	.	10	10	+/-4 dB	+/-5 dB
.	.	.	11	8	+/-4 dB	+/-5 dB
.	.	.	12	6	+/-4 dB	+/-5 dB
.	.	.	13	4	+/-4 dB	+/-5 dB
.	.	.	14	2	+/-5 dB	+/-6 dB
.	.	.	15	0	+/-5 dB	+/-6 dB

*) When the power control level corresponds to the power class of the MS, then the tolerances shall be 2,0 dB under normal test conditions and 2,5 dB under extreme test conditions.

DCS 1 800 only - end

PCS 1 900 only - begin

Table 13.16.2-3: PCS 1 900 transmitter output power for different power classes

Power class			Power control level	Transmitter output power	Tolerances	
1	2	3			Normal	Extreme
		.	30	33	+/-2,0 dB	+/-2,5 dB
		.	31	32	+/-2,0 dB	+/-2,5 dB
.	.	.	0	30	+/-3,0 dB*)	+/-4 dB*)
.	.	.	1	28	+/-3 dB	+/-4 dB
.	.	.	2	26	+/-3 dB	+/-4 dB
.	.	.	3	24	+/-3 dB*)	+/-4 dB*)
.	.	.	4	22	+/-3 dB	+/-4 dB
.	.	.	5	20	+/-3 dB	+/-4 dB
.	.	.	6	18	+/-3 dB	+/-4 dB
.	.	.	7	16	+/-3 dB	+/-4 dB
.	.	.	8	14	+/-3 dB	+/-4 dB
.	.	.	9	12	+/-4 dB	+/-5 dB
.	.	.	10	10	+/-4 dB	+/-5 dB
.	.	.	11	8	+/-4 dB	+/-5 dB
.	.	.	12	6	+/-4 dB	+/-5 dB
.	.	.	13	4	+/-4 dB	+/-5 dB
.	.	.	14	2	+/-5 dB	+/-6 dB
.	.	.	15	0	+/-5 dB	+/-6 dB

*) When the power control level corresponds to the power class of the MS, then the tolerances shall be 2,0 dB under normal test conditions and 2,5 dB under extreme test conditions.

PCS 1 900 only - end

- b) The difference between the transmitter output power at two adjacent power control levels, measured at the same frequency, shall not be less than 0,5 dB and not be more than 3,5 dB. For PCS 1 900 Class 3 the difference between the transmitter output power at power controls level 30 and 31, measured at the same frequency, shall not be less than 0 dB and not be more than 2 dB.
- c) The power/time relationship of the measured samples for normal bursts shall be within the limits of the power time template of figure 13-7-2 (GSM 11.10) at each frequency, under every combination of normal and extreme test conditions and at each power control level measured.

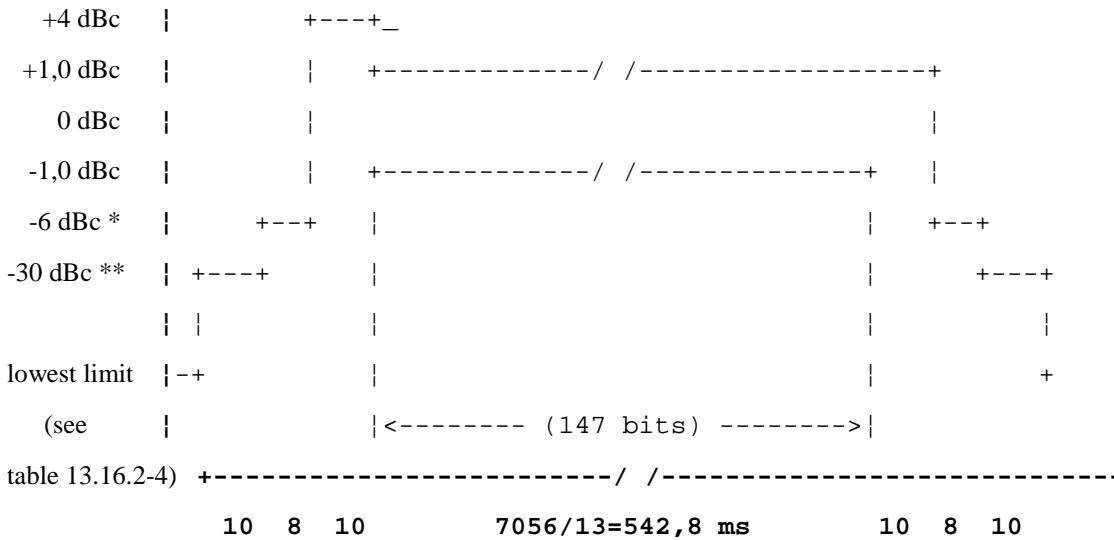

Figure 13.16.2-1: Power / time template for normal bursts

* For GSM400, GSM 700, GSM 850 and GSM900 MS:

- 4 dBc for power control level 16
- 2 dBc for power control level 17
- 1 dBc for power control levels 18 and 19

For DCS1800 and PCS 1900 MS: -4 dBc for power control level 11

- 2 dBc for power control level 12
- 1 dBc for power control levels 13, 14 and 15

** For GSM400, GSM 700, GSM 850 and GSM900 MS:

-30 dBc or -17 dBm, whichever is the higher

For DCS1800 and PCS 1900MS: -30 dBc or -20 dBm, whichever is the higher

Table 13.16.2-4: Lowest measurement limit for power / time template

	lowest limit
GSM400, GSM 700, GSM 850, GSM900	-59 dBc or -54 dBm whichever is the highest, except for the timeslot preceding the active slot, for which the allowed level is -59 dBc or -36 dBm, whichever is the highest
DCS1800 PCS 1900	-48 dBc or -48 dBm whichever is the highest

- d) All the power control levels, for the type and power class of the MS as stated by the manufacturer, shall be implemented in the MS.

- e) When the transmitter is commanded to a power control level outside of the capability corresponding to the type and power class of the MS as stated by the manufacturer, then the transmitter output power shall be within the tolerances for the closest power control level corresponding to the type and power class as stated by the manufacturer.
- f) The power/time relationship of the measured samples for access bursts shall be within the limits of the power time template of figure 13-7-3 at each frequency, under every combination of normal and extreme test conditions and at each power control level measured.

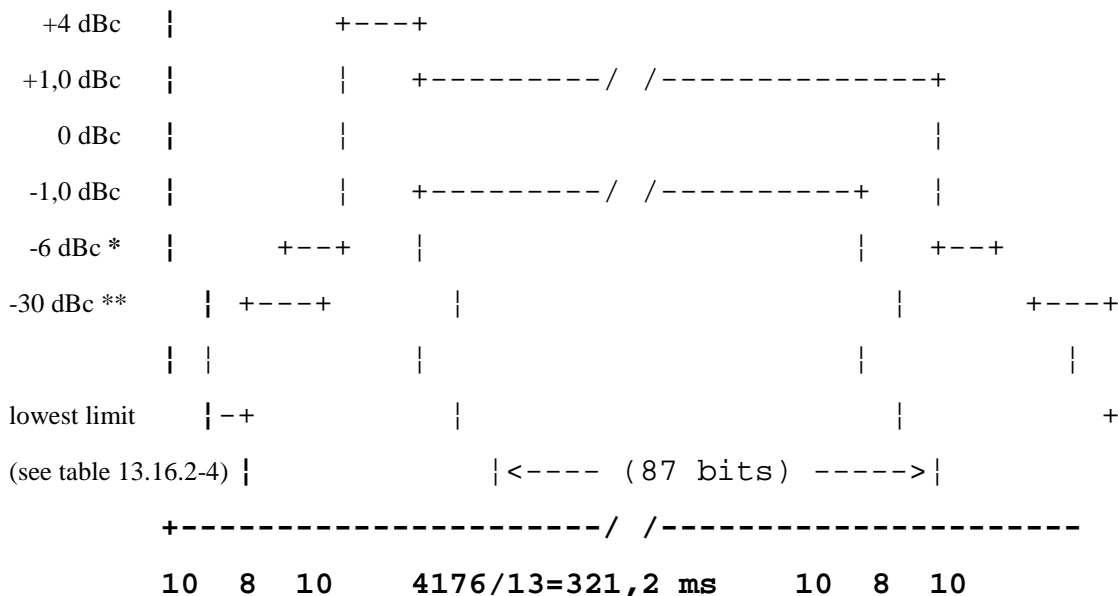

Figure 13.16.2-2: Power / time template for access burst

* For GSM400, GSM 700, GSM 850 and GSM900 MS:

- 4 dBc for power control level 16
- 2 dBc for power control level 17
- 1 dBc for power control levels 18 and 19

For DCS1800 and PCS 1900 MS: -4 dBc for power control level 11

- 2 dBc for power control level 12
- 1 dBc for power control levels 13, 14 and 15

** For GSM400, GSM 700, GSM 850 and GSM900 MS:

- 30 dBc or -17 dBm, whichever is the higher

For DCS1800 and PCS 1900 MS: -30 dBc or -20 dBm, whichever is the higher

13.16.3 Output RF spectrum in GPRS multislots configuration

13.16.3.1 Definition and applicability

The output RF spectrum is the relationship between the frequency offset from the carrier and the power, measured in a specified bandwidth and time, produced by the MS due to the effects of modulation and power ramping.

The requirements and this test apply to all types of GSM 400, GSM 700, GSM 850, GSM 900, DCS 1 800 and PCS 1900 MS and any multiband MS, which are capable of GPRS multislots operation on the uplink.

13.16.3.2 Conformance requirement

1. The level of the output RF spectrum due to modulation shall be no more than that given in GSM 05.05, 4.2.1, table a) for GSM 400, GSM 700, GSM 850 and GSM 900, table b) for DCS 1 800 or table c) for PCS 1 900, with the following lowest measurement limits:
 - -36 dBm below 600 kHz offset from the carrier,
 - -51 dBm for GSM 400, GSM 700, GSM 850 and GSM 900 or -56 dBm for DCS 1 800 and PCS 1 900 from 600 kHz out to less than 1 800 kHz offset from the carrier,
 - -46 dBm for GSM 400, GSM 700, GSM 850 and GSM 900 or -51 dBm for DCS 1 800 and PCS 1 900 at and beyond 1 800 kHz offset from the carrier,but with the following exceptions at up to -36 dBm:
 - up to three bands of 200 kHz width centred on a frequency which is an integer multiple of 200 kHz in the combined range 600 kHz to 6000 kHz above and below the carrier,
 - up to 12 bands of 200 kHz width centred on a frequency which is an integer multiple of 200 kHz at more than 6 000 kHz offset from the carrier.
 - 1.1 Under normal conditions; GSM 05.05, 4.2.1.
 - 1.2 Under extreme conditions; GSM 05.05, 4.2.1; GSM 05.05, annex D D.2.1, D.2.2.
2. The level of the output RF spectrum due to switching transients shall be no more than given in GSM 05.05, 4.2.2, table "a) Mobile Station":
 - 2.1 Under normal conditions; GSM 05.05, 4.2.2.
 - 2.2 Under extreme conditions; GSM 05.05, 4.2.2; GSM 05.05 annex D D.2.1, D.2.2.
3. When allocated a channel, the power emitted by a GSM 400, GSM 900 and DCS 1 800 MS, in the band 935 to 960 MHz shall be no more than -79 dBm, in the band 925 to 935 MHz shall be no more than -67 dBm and in the band 1 805 to 1 880 MHz shall be no more than -71 dBm except in five measurements in each of the bands 925 to 960 MHz and 1 805 to 1 880 MHz where exceptions at up to -36 dBm are permitted. For GSM 400 MS, in addition, the power emitted by MS, in the bands of 460.4 to 467.6 MHz and 488.8 to 496 MHz shall be no more than -67 dBm except in three measurements in each of the bands 460.4 to 467.6 MHz and 488.8 to 496 MHz where exceptions at up to -36 dBm are permitted. For GSM 700 and GSM 850, the power emitted by MS, in the band of 747 to 757 MHz shall be no more than -79 dBm, in the band of 757 to 762 MHz shall be no more than -73 dBm, in the band 869 to 894 MHz shall be no more than -79 dBm, in the band 1 930 to 1 990 MHz shall be no more than -71 dBm except in five measurements in each of the bands 747 to 762 MHz, 869 to 894 MHz and 1 930 to 1 990 MHz where exceptions at up to -36 dBm are permitted. For PCS 1 900 MS, the power emitted by MS, in the band 869 to 894 MHz shall be no more than -79 dBm, in the band 1 930 to 1 990 MHz shall be no more than -71 dBm except in five measurements in each of the bands 869 to 894 MHz and 1 930 to 1 990 MHz where exceptions at up to -36 dBm are permitted. Under normal conditions; GSM 05.05, 4.3.3.

13.16.3.3 Test purpose

1. To verify that the output RF spectrum due to modulation does not exceed conformance requirement 1 in the GPRS multislot configurations.
 - 1.1 Under normal conditions.
 - 1.2 Under extreme conditions.
2. To verify that the output RF spectrum due to switching transients does not exceed conformance requirement 2 in the GPRS multislot configurations when a reasonable margin is allowed for the effect of spectrum due to modulation.
 - 2.1 Under normal conditions.
 - 2.2 Under extreme conditions.

3. To verify that the MS spurious emissions in the MS receive band do not exceed conformance requirement 3 in the GPRS multislot configurations.

13.16.3.4 Method of test

13.16.3.4.1 Initial conditions

The test shall be run under the default GPRS conditions defined in section 40.

The MS shall be operated with its highest number of uplink slots.

The Test Mode defined in GSM Rec. 4.14 (par 5.4) will be utilised. If the MS is capable of both:

Mode (a) transmitting pseudo-random data sequence in RLC data blocks

Mode (b) transmitting looped-back RLC data blocks

then Mode (a) will be used.

If Mode (b) is used then the SS sends the pseudo-random data sequence specified for Mode (a) on the downlink for loopback on the uplink. The SS shall use a level of $23 \text{ dB}\mu\text{Vemf}(\)$.

The SS commands the MS to hopping mode. The hopping pattern includes only three channels, namely one with an ARFCN in the Low ARFCN range, a second one with an ARFCN in the Mid ARFCN range and the third one with an ARFCN in the High ARFCN range.

NOTE 1: Although the measurement is made whilst the MS is in hopping mode, each measurement is on one single channel.

NOTE 2: This test is specified in hopping mode as a simple means of making the MS change channel, it would be sufficient to test in non hopping mode and to cell re-select the MS between the three channels tested at the appropriate time.

13.16.3.4.2 Procedure

NOTE: When averaging is in use during frequency hopping mode, the averaging only includes bursts transmitted when the hopping carrier corresponds to the nominal carrier of the measurement.

a) In steps b) to h) the FT is equal to the hop pattern ARFCN in the Mid ARFCN range.

b) The other settings of the spectrum analyser are set as follows:

- Zero frequency scan
- Resolution bandwidth: 30 kHz
- Video bandwidth: 30 kHz
- Video averaging: may be used, depending on the implementation of the test

The video signal of the spectrum analyser is "gated" such that the spectrum generated by at least 40 of the bits 87 to 132 of the burst in one of the active time slots is the only spectrum measured. This gating may be analogue or numerical, dependent upon the design of the spectrum analyser. Only measurements during transmitted bursts on the nominal carrier of the measurement are included. The spectrum analyser averages over the gated period and over 200 or 50 such bursts, using numerical and/or video averaging.

c) By tuning the spectrum analyser centre frequency to the measurement frequencies the power level is measured over 50 bursts at all multiples of 30 kHz offset from FT to $< 1\ 800 \text{ kHz}$.

d) The resolution and video bandwidth on the spectrum analyser are adjusted to 100 kHz and the measurements are made at the following frequencies:

on every ARFCN from 1 800 kHz offset from the carrier to the edge of the relevant transmit band for each measurement over 50 bursts.

at 200 kHz intervals over the 2 MHz either side of the relevant transmit band for each measurement over 50 bursts.

For GSM 400, GSM 900 and DCS 1 800:

at 200 kHz intervals over the band 925 - 960 MHz for each measurement over 50 bursts.

at 200 kHz intervals over the band 1805 - 1880 MHz for each measurement over 50 bursts.

in addition for GSM 400 MS:

at 200 kHz intervals over the band 460.4 to 467.6 MHz for each measurement over 50 bursts.

at 200 kHz intervals over the band 488.8 to 496 MHz for each measurement over 50 bursts.

For GSM 700 and GSM 850:

at 200 kHz intervals over the band 747 to 762 MHz for each measurement over 50 bursts.

at 200 kHz intervals over the band 869 - 894 MHz for each measurement over 50 bursts.

at 200 kHz intervals over the band 1930 – 1990 MHz for each measurement over 50 bursts.

For PCS 1 900:

at 200 kHz intervals over the band 869 - 894 MHz for each measurement over 50 bursts.

at 200 kHz intervals over the band 1930 – 1990 MHz for each measurement over 50 bursts.

- e) The MS is commanded to its minimum power control level. The spectrum analyser is set again as in b).
- f) By tuning the spectrum analyser centre frequency to the measurement frequencies the power level is measured over 200 bursts at the following frequencies:

FT

FT + 100 kHz FT - 100 kHz

FT + 200 kHz FT - 200 kHz

FT + 250 kHz FT - 250 kHz

FT + 200 kHz * N FT - 200 kHz * N

where N = 2, 3, 4, 5, 6, 7, and 8

and FT = RF channel nominal centre frequency.

- g) Steps a) to f) is repeated except that in step a) the spectrum analyzer is gated so that the burst of the next active time slot is measured.
- h) The spectrum analyser settings are adjusted to:
- Zero frequency scan
 - Resolution bandwidth: 30 kHz
 - Video bandwidth: 100 kHz
 - Peak hold

The spectrum analyser gating of the signal is switched off.

The MS is commanded to its maximum power control level in every transmitted time slot.

- i) By tuning the spectrum analyser centre frequency to the measurement frequencies the power level is measured at the following frequencies:

FT + 400 kHz	FT - 400 kHz
FT + 600 kHz	FT - 600 kHz
FT + 1,2 MHz	FT - 1,2 MHz
FT + 1,8 MHz	FT - 1,8 MHz

where FT = RF channel nominal centre frequency.

The duration of each measurement (at each frequency) will be such as to cover at least 10 burst transmissions at FT.

- j) Step i) is repeated for power control levels 7 and 11.
- k) Steps b), f), h) and i) are repeated with FT equal to the hop pattern ARFCN in the Low ARFCN range except that in step h) the MS is commanded to power control level 11 rather than maximum power.
- l) Steps b), f), h) and i) are repeated with FT equal to the hop pattern ARFCN in the High ARFCN range except that in step h) the MS is commanded to power control level 11 rather than maximum power.
- m) Steps a) b) f) h), and i) are repeated under extreme test conditions (annex 1, TC2.2). except that at step h) the MS is commanded to power control level 11.

13.16.3.5 Test requirements

For absolute measurements, performed on a temporary antenna connector, in the frequency band 450.4 to 457.6 MHz, 478.8 to 486 MHz, 777 to 792 MHz, 824 to 849 MHz, 880 to 915 MHz, 1710 to 1785 MHz, or 1 850 to 1 910 MHz, the temporary antenna connector coupling factor, determined according to 13.3.4.2.2 and annex 1 GC7, for the nearest relevant frequency, will be used.

For absolute measurements, performed on a temporary antenna connector, in the frequency band 925 to 960 MHz, the temporary antenna connector coupling factor, will be as determined according to annex 1 GC7 for GSM 900 MS. For a GSM 400, GSM 700, GSM 850, DCS 1 800 or PCS 1900 MS 0 dB will be assumed.

For absolute measurements, performed on a temporary antenna connector, in the frequency band 1805 to 1880 MHz, the temporary antenna connector coupling factor, will be as determined according to annex 1 GC7 for DCS 1 800 MS. For a GSM 400, GSM 700, GSM 850, GSM 900 or PCS 1900 MS 0 dB will be assumed.

For absolute measurements, performed on a temporary antenna connector, in the frequency band 460.4 to 467.6 MHz or 488.8 to 496 MHz, the temporary antenna connector coupling factor, will be as determined according to annex 1 GC7 for GSM 400 MS. For a GSM 700, GSM 850, GSM 900, DCS 1800 or PCS 1900 MS 0 dB will be assumed.

For absolute measurements, performed on a temporary antenna connector, in the frequency band 747 to 762 MHz, the temporary antenna connector coupling factor, will be as determined according to annex 1 GC7 for GSM 700 MS. For a GSM 400, GSM 850, GSM 900 or DCS 1800 MS 0 dB will be assumed.

For absolute measurements, performed on a temporary antenna connector, in the frequency band 869 to 894 MHz, the temporary antenna connector coupling factor, will be as determined according to annex 1 GC7 for GSM 850 MS. For a GSM 400, GSM 700, GSM 900 or DCS 1800 MS 0 dB will be assumed.

For absolute measurements, performed on a temporary antenna connector, in the frequency band 1930 to 1990 MHz, the temporary antenna connector coupling factor, will be as determined according to annex 1 GC7 for PCS 1 900 MS. For GSM 400, GSM 900 or DCS 1 800 MS 0 dB will be assumed.

The figures in the tables below, at the listed frequencies from the carrier (kHz), are the maximum level (dB) relative to a measurement in 30 kHz bandwidth on the carrier (reference GSM 05.05 section 4.2.1).

- a) For the modulation sidebands out to less than 1 800 kHz offset from the carrier frequency (FT) measured in step c), f), i), k), l) and m) the measured power level in dB relative to the power level measured at FT, for all types of MS, shall not exceed the limits derived from the values shown in table 13.16.3-1 for GSM 400, GSM 700, GSM 850 and GSM 900, table 13.16.3-2 for DCS 1 800 or table 13.16.3-3 for PCS 1 900 according to the actual transmit power and frequency offset from FT. However any failures in the combined range 600 kHz to less than 1 800 kHz above and below the carrier may be counted towards the exceptions allowed in test requirements c) below.

Table 13.16.3-1: GSM 400, GSM 700, GSM 850 and GSM 900 Spectrum due to modulation out to less than 1 800 kHz offset

power levels in dB relative to the measurement at FT					
Power level	Frequency offset (kHz)				
(dBm)	0-100	200	250	400	600 to <1800
39	+0,5	-30	-33	-60	-66
37	+0,5	-30	-33	-60	-64
35	+0,5	-30	-33	-60	-62
<= 33	+0,5	-30	-33	-60	-60
The values above are subject to the minimum absolute levels (dBm) below.					
	-36	-36	-36	-36	-51

Table 13.16.3-2: DCS 1 800 Spectrum due to modulation out to less than 1 800 kHz offset

power levels in dB relative to the measurement at FT					
Power level	Frequency offset (kHz)				
(dBm)	0-100	200	250	400	600 to <1800
<= 36	+0,5	-30	-33	-60	-60
The values above are subject to the minimum absolute levels (dBm) below.					
	-36	-36	-36	-36	-56

Table 13.16.3-3: PCS 1 900 Spectrum due to modulation out to less than 1 800 kHz offset

power levels in dB relative to the measurement at FT						
Power level	Frequency offset (kHz)					
(dBm)	0-100	200	250	400	600 to <1200	1200 to <1800
<= 33	+0,5	-30	-33	-60	-60	-60
The values above are subject to the minimum absolute levels (dBm) below.						
	-36	-36	-36	-36	-56	-56

NOTE 1: For frequency offsets between 100 kHz and 600 kHz the requirement is derived by a linear interpolation between the points identified in the table with linear frequency and power in dB relative.

- b) For the modulation sidebands from 1 800 kHz offset from the carrier frequency (FT) and out to 2 MHz beyond the edge of the relevant transmit band, measured in step d), the measured power level in dB relative to the power level measured at FT, shall not exceed the values shown in table 13.16.3-4 according to the actual transmit power, frequency offset from FT and system on which the MS is designed to operate. However any failures in the combined range 1 800 kHz to 6 MHz above and below the carrier may be counted towards the exceptions allowed in test requirements c) below, and any other failures may be counted towards the exceptions allowed in test requirements d) below.

Table 13.16.3-4: Spectrum due to modulation from 1 800 kHz offset to the edge of the transmit band (wideband noise)

power levels in dB relative to the measurement at FT									
GSM400, GSM 700, GSM 850 and GSM900				DCS1800			PCS1900		
Power Level	Frequency offset kHz			Power level	Frequency offset KHz		Power level	Frequency offset KHz	
(dBm)	1800 to < 3000	3000 to < 6000	>= 6000	(dBm)	1800 to < 6000	>= 6000	(dBm)	1800 to < 6000	>= 6000
39	-69	-71	-77	36	-71	-79	33	-68	-76
37	-67	-69	-75	34	-69	-77	32	-67	-75
35	-65	-67	-73	32	-67	-75	30	-65	-73
<= 33	-63	-65	-71	30	-65	-73	28	-63	-71
				28	-63	-71	26	-61	-69
				26	-61	-69	<= 24	-59	-67
				<= 24	-59	-67			
The values above are subject to the minimum absolute levels (dBm) below.									
	-46	-46	-46		-51	-51		-51	-51

- c) Any failures (from a) and b) above) in the combined range 600 kHz to 6 MHz above and below the carrier should be re-checked for allowed spurious emissions. For each of the three ARFCN used, spurious emissions are allowed in up to three 200 kHz bands centred on an integer multiple of 200 kHz so long as no spurious emission exceeds -36 dBm. Any spurious emissions measured in a 30 kHz bandwidth which spans two 200 kHz bands can be counted towards either 200 kHz band, whichever minimizes the number of 200 kHz bands containing spurious exceptions.
- d) Any failures (from b) above) beyond 6 MHz offset from the carrier should be re-checked for allowed spurious emissions. For each of the three ARFCN used, up to twelve spurious emissions are allowed so long as no spurious emission exceeds -36 dBm.
- e) For GSM 400, GSM 900 and DCS 1 800 MS the MS spurious emissions in the bands 925 - 935 MHz, 935 - 960 MHz and 1 805 - 1 880 MHz, measured in step d), shall not exceed the values shown in table 13.16.3-5 except in up to five measurements in the band 925 to 960 MHz and five measurements in the band 1 805 to 1 880 MHz where a level up to -36 dBm is permitted. For GSM 400 MS, in addition, the MS spurious emissions in the bands 460.4 to 467.6 MHz and 488.8 to 496 MHz shall not exceed the value of -67 dBm, except in up to three measurements in each of the bands 460.4 to 467.6 MHz and 488.8 to 496 MHz where a level up to -36 dBm is permitted. For GSM 700 and GSM 850 the spurious emissions in the bands 747 to 757 MHz, 757 to 762 MHz, 869 - 894 MHz and 1930 - 1990 MHz shall not exceed the values shown in table 13.16.3-4 except in up to five measurements in each of the bands 747 to 762 MHz, 869 MHz to 894 MHz and 1 930 MHz to 1 990 MHz where a level up to -36 dBm is permitted. For PCS 1 900 MS the spurious emissions in the bands 869 - 894 MHz and 1930 - 1990 MHz shall not exceed the values shown in table 13.16.3-5 except in up to five measurements in each of the bands 869 MHz to 894 MHz and 1 930 MHz to 1 990 MHz where a level up to -36 dBm is permitted.

Table 13.16.3-5: Spurious emissions in the MS receive bands

Band (MHz)	Spurious emissions level (dBm)	
	GSM400, GSM900 and DCS1800	PCS1900
925 to 935	-67	
935 to 960	-79	
1805 to 1880	-71	
747 to 757		-79
757 to 762		-73
869 to 894		-79
1930 to 1990		-71

- f) For the power ramp sidebands of steps h), i) and k) the power levels must not exceed the values shown in table 13.16.3-6 for GSM 400, GSM 700, GSM 850 and GSM 900, table 13.16.3-7 for DCS 1 800 or table 13.16.3-8 for PCS 1 900.

Table 13.16.3-6: GSM Spectrum due to switching transients

Power level	Maximum level for various offsets from carrier frequency			
	400 kHz	600 kHz	1200 kHz	1800 kHz
39 dBm	-13 dBm	-21 dBm	-21 dBm	-24 dBm
37 dBm	-15 dBm	-21 dBm	-21 dBm	-24 dBm
35 dBm	-17 dBm	-21 dBm	-21 dBm	-24 dBm
33 dBm	-19 dBm	-21 dBm	-21 dBm	-24 dBm
31 dBm	-21 dBm	-23 dBm	-23 dBm	-26 dBm
29 dBm	-23 dBm	-25 dBm	-25 dBm	-28 dBm
27 dBm	-23 dBm	-26 dBm	-27 dBm	-30 dBm
25 dBm	-23 dBm	-26 dBm	-29 dBm	-32 dBm
23 dBm	-23 dBm	-26 dBm	-31 dBm	-34 dBm
<= +21 dBm	-23 dBm	-26 dBm	-32 dBm	-36 dBm

Table 13.16.3-7: DCS 1 800 Spectrum due to switching transients

Power level	Maximum level for various offsets from carrier frequency			
	400 kHz	600 kHz	1200 kHz	1800 kHz
36 dBm	-16 dBm	-21 dBm	-21 dBm	-24 dBm
34 dBm	-18 dBm	-21 dBm	-21 dBm	-24 dBm
32 dBm	-20 dBm	-22 dBm	-22 dBm	-25 dBm
30 dBm	-22 dBm	-24 dBm	-24 dBm	-27 dBm
28 dBm	-23 dBm	-25 dBm	-26 dBm	-29 dBm
26 dBm	-23 dBm	-26 dBm	-28 dBm	-31 dBm
24 dBm	-23 dBm	-26 dBm	-30 dBm	-33 dBm
22 dBm	-23 dBm	-26 dBm	-31 dBm	-35 dBm
<= +20 dBm	-23 dBm	-26 dBm	-32 dBm	-36 dBm

Table 13.16.3-8: PCS 1 900 Spectrum due to switching transients

Power level	Maximum level for various offsets from carrier frequency			
	400 kHz	600 kHz	1200 kHz	1800 kHz
33 dBm	-19 dBm	-22 dBm	-22 dBm	-25 dBm
32 dBm	-20 dBm	-22 dBm	-22 dBm	-25 dBm
30 dBm	-22 dBm	-24 dBm	-24 dBm	-27 dBm
28 dBm	-23 dBm	-25 dBm	-26 dBm	-29 dBm
26 dBm	-23 dBm	-26 dBm	-28 dBm	-31 dBm
24 dBm	-23 dBm	-26 dBm	-30 dBm	-33 dBm
22 dBm	-23 dBm	-26 dBm	-31 dBm	-35 dBm
<= +20 dBm	-23 dBm	-26 dBm	-32 dBm	-36 dBm

NOTE 2: These figures are different from the requirements in GSM 05.05 because at higher power levels it is the modulation spectrum which is being measured using a peak hold measurement. This allowance is given in the table.

NOTE 3: The figures for table 13.16.3-6, table 13.16.3-7 and table 13.16.3-8 assume that, using the peak hold measurement, the lowest level measurable is 8 dB above the level of the modulation specification using the 30 kHz bandwidth gated average technique for 400 kHz offset from the carrier. At 600 and 1200 kHz offset the level is 6 dB above and at 1 800 kHz offset the level is 3 dB above. The figures for 1 800 kHz have assumed the 30 kHz bandwidth spectrum due to modulation specification at <1 800 kHz.

13.17 EGPRS transmitter tests

13.17.1 Frequency error and Modulation accuracy in EGPRS Configuration

13.17.1.1 Definition and applicability

The frequency error is the difference in frequency, after adjustment for the effect of the modulation accuracy between the RF transmission from the MS and either:

- the RF transmission from the BS, or
- the nominal frequency for the ARFCN used.

Modulation Accuracy

For GMSK, the modulation accuracy of the transmitted signal is described as the phase accuracy (phase error) of the GMSK modulated signal. The phase error for GSMK modulation is the difference in phase, after adjustment for the effect of the frequency error, between the RF transmission from the MS and the theoretical transmission according to the intended modulation.

For 8-PSK, the error vector between the vector representing the transmitted signal and the vector representing the error-free modulated signal defines modulation accuracy. The magnitude of the error vector is called Error Vector Magnitude (EVM). Origin suppression is defined to be the ratio of the carrier leakage to the modulated signal.

The requirements and this test apply to all types of MSs.

which are capable of EGPRS operation. For multiband MS, requirements and this test apply to all applicable bands.

13.17.1.2 Conformance requirement

1. The carrier frequency under GMSK and 8PSK modulation shall be accurate to within 0,2ppm for GSM 400 and 0,1 ppm for all other bands compared to signals received from the BS.
 - 1.1 Under normal conditions; GSM 05.10, 6.1.
 - 1.2 Under vibration conditions; GSM 05.10, 6.1; GSM 05.05, annex D D.2.3.
 - 1.3 Under extreme conditions; GSM 05.10, 6.1; GSM 05.05, 4.4; GSM 05.05, annex D D.2.1, D.2.2.
2. The RMS phase error for GMSK modulated signal (difference between the phase error trajectory and its linear regression on the active part of the time slot) for each burst shall not be greater than 5 degrees.
 - 2.1 Under normal conditions; GSM 05.05, 4.6.
 - 2.2 Under vibration conditions; GSM 05.05, 4.6; GSM 05.05, annex D D.2.3.
 - 2.3 Under extreme conditions; GSM 05.05, 4.6; GSM 05.05, annex D D.2.1, D.2.2.
3. The maximum peak deviation for GMSK modulated signal during the useful part of each burst shall not be greater than 20 degrees.
 - 3.1 Under normal conditions; GSM 05.05, 4.6.
 - 3.2 Under vibration conditions; GSM 05.05, 4.6; GSM 05.05, annex D D.2.3.
 - 3.3 Under extreme conditions; GSM 05.05, 4.6; GSM 05.05, annex D D.2.1, D.2.2.
4. The RMS EVM over the useful part of any burst of the 8-PSK modulated signal shall not exceed:
 - 4.1 9.0% Under normal conditions; GSM 05.05, 4.6.
 - 4.2 10.0% Under extreme conditions; GSM 05.05, 4.6; GSM 05.05, annex D D.2.1, D.2.2.
5. The peak EVM values of any burst of the 8PSK modulated signal shall be $\leq 30\%$

5.1 Under normal conditions; GSM 05.05, 4.6.

5.2 Under extreme conditions; GSM 05.05, 4.6; GSM 05.05, annex D D.2.1, D.2.2.

6. The 95:th-percentile value of any burst of the 8-PSK modulated signal shall be $\leq 15\%$.

6.1 Under normal conditions; GSM 05.05, 4.6.

6.2 Under extreme conditions; GSM 05.05, 4.6; GSM 05.05, annex D D.2.1, D.2.2.

7. The Origin Offset for any 8PSK modulated signal shall be -30dBc .

7.1 Under normal conditions; 05.05 4.6.

7.2 Under extreme conditions; 05.05 4.6.2.2; GSM 05.05, annex D D.2.1, D.2.2.

13.17.1.3 Test purpose

To verify that the carrier frequency error does not exceed conformance requirement 1:

1.1 Under normal conditions

1.2 When the MS is being vibrated

1.3 Under extreme conditions

To verify that the RMS phase error on the useful parts of the bursts transmitted by the MS does not exceed conformance requirement 2:

2.1 Under normal conditions

2.2 When the MS is being vibrated

2.3 Under extreme conditions

To verify that the maximum phase error on the useful parts of the bursts transmitted by the MS configuration does not exceed conformance requirement 3:

3.1 Under normal conditions

3.2 When the MS is being vibrated

3.3 Under extreme conditions

To verify that the RMS EVM over the useful part of the burst, excluding tail bits, transmitted by the MS does not exceed conformance requirement 4:

4.1 Under normal conditions

4.2 When the MS is being vibrated

4.3 Under extreme conditions

To verify that the peak EVM values over the useful part of the burst, excluding tail bits, transmitted by the MS does not exceed conformance requirement 5:

5.1 Under normal conditions

5.2 When the MS is being vibrated

5.3 Under extreme conditions

To verify that the 95:th percentile EVM over the useful part of any burst, excluding tail bits, does not exceed conformance requirement 6:

6.1 Under normal conditions

6.2 When the MS is being vibrated

6.3 Under extreme conditions

To verify that the origin suppression does not exceed conformance requirement 7:

7.1 Under normal conditions

7.2 When the MS is being vibrated

7.3 Under extreme conditions

13.17.1.4 Method of the test

Initial conditions

A downlink TBF is set up according to the generic procedure in section 40. The SS orders the MS to transmit on the uplink in hopping mode. This is achieved using the EGPRS test mode by transmitting a EGPRS TEST_CMD (see 04.14, section TBD).

NOTE: It is not necessary to test in hopping mode but is done here as a simple means of making the MS change channel, it would be sufficient to test in non hopping mode and to make sure bursts are taken from a few different channels.

The SS controls the power level by setting the concerned timeslot's power control parameter ALPHA (α) to 0 and GAMMA_TN (Γ_{CH}) to the desired power level in the Packet Uplink Assignment message (Closed Loop Control, see 05.08. Annex B.2) GPRS_MS_TXPWR_MAX_CCH / MS_TXPWR_MAX_CCH is set to the maximum value supported by the Power Class of the Mobile under test. For DCS 1 800 mobile stations the POWER_OFFSET parameter is set to 6 dB.

For the GMSK and 8PSK procedures described below, the initial power value of each active timeslot shall be set to a mid-range power value.

13.17.1.4.2 Test procedure

Procedure for GMSK Frequency error measurement and Phase error

- a) For one transmitted burst on the last slot of the multislot configuration, the SS captures the signal as a series of phase samples over the period of the burst. These samples are evenly distributed over the duration of the burst with a minimum sampling rate of $2/T$, where T is the modulation symbol period. The received phase trajectory is then represented by this array of at least 294 samples.
- b) The SS then calculates, from the known bit pattern and the formal definition of the modulator contained in GSM 05.04, the expected phase trajectory.
- c) From a) and b) the phase trajectory error is calculated, and a linear regression line computed through this phase trajectory error. The slope of this regression line is the frequency error of the mobile transmitter relative to the simulator reference. The difference between the regression line and the individual sample points is the phase error of that point.

- c.1) The sampled array of at least 294 phase measurements is represented by the vector:

$$\varnothing_m = \varnothing_m(0) \dots \varnothing_m(n)$$

where the number of samples in the array $n+1 \geq 294$.

- c.2) The calculated array, at the corresponding sampling instants, is represented by the vector:

$$\varnothing_c = \varnothing_c(0) \dots \varnothing_c(n).$$

- c.3) The error array is represented by the vector:

$$\varnothing_e = \{\varnothing_m(0) - \varnothing_c(0)\} \dots \dots \dots \{\varnothing_m(n) - \varnothing_c(n)\} = \varnothing_e(0) \dots \varnothing_e(n).$$

- c.4) The corresponding sample numbers form a vector $t = t(0) \dots t(n)$.

c.5) By regression theory the slope of the samples with respect to t is k where:

$$k = \frac{\sum_{j=0}^{j=n} t(j) * \varnothing_e(j)}{\sum_{j=0}^{j=n} t(j)^2}$$

c.6) The frequency error is given by $k/(360 * g)$, where g is the sampling interval in s and all phase samples are measured in degrees.

c.7) The individual phase errors from the regression line are given by:

$$\varnothing_e(j) - k * t(j).$$

c.8) The RMS value \varnothing_e of the phase errors is given by:

$$\varnothing_e(\text{RMS}) = \left[\frac{\sum_{j=0}^{j=n} \{\varnothing_e(j) - k * t(j)\}^2}{n+1} \right]^{1/2}$$

- d) Steps a) to c) are repeated for 20 bursts, not necessarily contiguous.
- e) The SS instructs the MS to its maximum power control level by setting the power control parameter ALPHA (α) to 0 and GAMMA_TN (Γ_{CH}) for each timeslot to the desired power level in the Packet Uplink Assignment message (Closed Loop Control, see 05.08. Annex B.2), all other conditions remaining constant. Steps a) to d) are repeated.
- f) The SS instructs the MS to the minimum power control level, all other conditions remaining constant. Steps a) to d) are repeated.
- g) The MS is hard mounted on a vibration table and vibrated at the frequency/amplitudes specified in annex 1, TC4. During the vibration steps a) to f) are repeated.

NOTE: If the call is terminated when mounting the MS to the vibration table, it will be necessary to establish the initial conditions again before repeating steps a) to f).

- h) The MS is re-positioned on the vibration table in the two orthogonal planes to the plane used in step g). For each of the orthogonal planes step g) is repeated.
- i) Steps a) to f) are repeated under extreme test conditions (see annex 1, TC2.2).

Procedure for 8PSK Frequency error and modulation accuracy measurements

- j) For one transmitted burst on the last slot of the multislot configuration, the SS captures the transmitted signal by taking at least four samples per symbol. The transmitted signal is modeled by:

$$Y(t) = C1 \{R(t) + D(t) + C0\} W^t$$

R(t) is defined to be an ideal transmitter signal

D(t) is the residual complex error on signal R(t)

C0 is a constant origin offset representing carrier feedthrough

$C1$ is a complex constant representing the arbitrary phase and output power of the transmitter

$W = e^{\alpha + j 2\pi f t}$ accounts for both a frequency offset of " $2\pi f$ " radians per second phase rotation and an amplitude change of " α " nepers per second

The symbol timing phase of $Y(t)$ is aligned with $R(t)$.

- k) The SS shall generate the ideal transmitter signal as a reference. The ideal transmitter signal can be constructed from a priori knowledge of the transmitted symbols or from the demodulated symbols of the transmitted burst. In the latter case, unknown symbols shall be detected with an error rate sufficiently small to ensure the accuracy of the measurement equipment (see Annex 5).

- 1.1) The transmitted signal $Y(t)$ is compensated in amplitude, frequency and phase by multiplying with the factor:

$$W^{-t}/C1$$

The values for W and $C1$ are determined using an iterative procedure. $W(\alpha, f)$, $C1$ and $C0$ are chosen to minimise the RMS value of EVM on a burst-by-burst basis.

- 1.2) After compensation, $Y(t)$ is passed through the specified measurement filter (GSM 05.05, 4.6.2) to produce the signal

$$Z(k) = S(k) + E(k) + C0$$

where

$S(k)$ is the ideal transmitter signal observed through the measurement filter

$k = \text{floor}(t/T_s)$, where $T_s = 1/270.833\text{kHz}$ corresponding to the symbol times

- 1.3) The error vector is defined to be:

$$E(k) = Z(k) - C0 - S(k)$$

It is measured and calculated for each instant k over the useful part of the burst excluding tail bits. The RMS vector error is defined as:

$$\text{RMS EVM} = \sqrt{\frac{\sum_{k \in K} |E(k)|^2}{\sum_{k \in K} |S(k)|^2}}$$

- 1.4) Steps 1.1) to 1.3) are repeated with successive approximations of $W(\alpha, f)$, $C1$ and $C0$ until the minimum value of RMS EVM is found. The minimised value of RMS EVM and the final values for $C1$, $C0$ and f are noted. (f represents the frequency error of the burst).

- m) For each symbol in the useful part of the burst excluding tail bits, the SS shall calculate the error vector magnitude as:

$$\text{EVM}(k) = \sqrt{\frac{|E(k)|^2}{\frac{\sum_{k \in K} |S(k)|^2}{N}}}$$

The peak value of symbol EVM in the useful part of the burst, excluding tail bits, is noted.

- n) The SS shall calculate the value for Origin Offset Suppression for the burst as:

$$\text{OOS (dB)} = -10 \log_{10} \left(\frac{|C_0|^2}{\frac{1}{N} \sum_{k \in K} |S(k)|^2} \right)$$

- o) Steps j) to n) are repeated for a total of 200 bursts.
 - p) The peak values of symbol EVM noted in step m) are averaged for the 200 measured bursts.
 - q) From the distribution of symbol EVM values calculated in step m) for the 200 measured bursts, the SS shall determine the 95:th percentile value.
 - r) The SS instructs the MS to its maximum power control level by setting the power control parameter ALPHA (α) to 0 and GAMMA_TN (Γ_{CH}) for each timeslot to the desired power level in the Packet Uplink Assignment message (Closed Loop Control, see 05.08. Annex B.2), all other conditions remaining constant. Steps j) to q) are repeated.
 - s) The SS instructs the MS to the minimum power control level, all other conditions remaining constant. Steps j) to q) are repeated.
 - t) The MS is hard mounted on a vibration table and vibrated at the frequency/amplitudes specified in annex 1, TC4.
During the vibration steps j) to q) are repeated.
- NOTE: If the call is terminated when mounting the MS to the vibration table, it will be necessary to establish the initial conditions again before repeating steps a) to f).
- u) The MS is re-positioned on the vibration table in the two orthogonal planes to the plane used in step t). For each of the orthogonal planes step t) is repeated.
 - v) Steps j) to q) are repeated under extreme test conditions (see annex 1, TC2.2).

13.17.1.5 Test Requirements

1. For all measured bursts, the frequency error, derived in steps c.6) and l.4), shall be less than 10E-7.
2. For all measured bursts, the RMS phase error, derived in step c.8), shall not exceed 5 degrees.
3. For all measured bursts, each individual phase error, derived in step c.7), shall not exceed 20 degrees.
4. For all measured bursts, the RMS EVM, derived in step l.3) shall not exceed 9.0% under normal conditions and 10.0% under extreme conditions.
5. The (averaged) value of peak EVM derived in step p) shall not exceed 30%.
6. The 95:th percentile value derived in step q) shall not exceed 15%.
7. For all measured bursts, the origin offset suppression derived in step n) shall not exceed 30dB.

13.17.2 Frequency error under multipath and interference conditions.

13.17.2.1 Definition and applicability

The frequency error under multipath and interference conditions is a measure of the ability of the MS to maintain frequency synchronization with the received signal under conditions of Doppler shift, multipath reception and interference.

The requirements and this test apply to all types of MSs.

13.17.2.2 Conformance requirement

1. The MS carrier frequency error for each burst shall be accurate to within 0,1 ppm for GSM 700, GSM 850, GSM 900, DCS 1800 and 0,2 ppm for GSM 400 compared to signals received from the BS for signal levels down to 3 dB below the reference sensitivity level.
 - 1.1 Under normal conditions; GSM 05.10, 6/6.1.
 - 1.2 Under extreme conditions; GSM 05.10, 6/6.1; GSM 05.05 annex D D.2.1, D.2.2.
2. The MS carrier frequency error for each burst shall be accurate to within 0,1 ppm, for GSM 700, GSM 850, GSM 900, DCS 1800 and PCS 1900 and 0,2 ppm for GSM 400 compared to signals received from the BS for 3 dB less carrier to interference ratio than the reference interference ratios; GSM 05.10, 6/6.1.

13.17.2.3 Test purpose

1. To verify that the MS carrier frequency error at reference sensitivity, under conditions of multipath and Doppler shift does not exceed 0,1 ppm for GSM 700, GSM 850, GSM900, DCS1800 and PCS 1900 and 0,2 ppm for GSM400 + the frequency error due to the Doppler shift of the received signal and the assessment error in the MS.
 - 1.1 Under normal conditions.
 - 1.2 Under extreme conditions.

NOTE: Although the conformance requirement states that frequency synchronization should be maintained for input signals 3 dB below reference sensitivity. Due to the Radio Link Failure counter this test condition cannot be established. Hence all tests in this section are conducted at reference sensitivity level.

2. To verify that the MS carrier frequency error, under interference conditions and TUlow fading profile, does not exceed 0,1 ppm for GSM 700, GSM 850, GSM900, DCS1800 and PCS 1900 and 0,2 ppm for GSM400 + the frequency error due to the Doppler shift of the received signal and the assessment error in the MS.

NOTE: The test adds the effect of Doppler shift to the requirements as the conformance requirement refers to signals input to the MS receiver whereas the frequency reference for measurement will not take account of the Doppler shift.

13.17.2.4 Method of test

This test uses the same measurement process as test 13.17.1 for the MS operating under various RF conditions.

NOTE: The BA list sent on the BCCH will indicate at least six surrounding cells with at least one near to each band edge. It is not necessary to generate any of these BCCH but if they are provided none will be within 5 channels of the ARFCN used for the serving BCCH or PDTCH.

13.17.2.4.1 Initial conditions

The MS is brought into the packet idle GPRS attached state on a serving cell with BCCH in the mid ARFCN range. The level of the serving cell BCCH is set to 10 dB above the reference sensitivity level() and the fading function set to RA. The SS waits 30 s for the MS to stabilize to these conditions.

13.17.2.4.2 Procedure

- a) The SS is set up to capture the first burst transmitted by the MS during the uplink TBF. The SS orders the MS to transmit on the uplink for the duration of the test. This is achieved using the EGPRS test mode by transmitting a EGPRS TEST_CMD (see 04.14, section TBD). A downlink TBF is initiated by the SS on a channel in the mid ARFCN range. This downlink TBF is established according to the generic procedure in section 10 with the exceptions that the PDTCH level is set to 10 dB above the reference sensitivity level() and the fading function is set to RA The TBF is maintained for the duration of the test.
- b) The SS calculates the frequency accuracy of the captured burst as described in test 13.1.
- c) The SS sets the serving cell BCCH and PDTCH to the reference sensitivity level() applicable to the type of MS, still with the fading function set to RA and then waits 30 s for the MS to stabilize to these conditions.

d) The SS shall capture subsequent bursts from the traffic channel in the manner described in test 13.1.

NOTE: Due to the very low signal level at the MS receiver input the MS receiver is liable to error. The “looped back” bits are therefore also liable to error, and hence the SS does not know the expected bit sequence. The SS will have to demodulate the received signal to derive (error free) the transmitter burst bit pattern. Using this bit pattern the SS can calculate the expected phase trajectory according to the definition within GSM 05.04.

e) The SS calculates the frequency accuracy of the captured burst as described in test 13.1.

f) Steps d) and e) are repeated for 5 traffic channel bursts spaced over a period of not less than 20 s.

g) Both downlink and uplink TBFs are terminated. The initial conditions are established again and steps a) to f) are repeated but with the fading function set to HT200 for GSM400, HT120 for GSM700 and HT100 for all other bands.

h) The initial conditions are established again and steps a) to f) are repeated but with the fading function set to TU100 for GSM400, TU60 for GSM700 and TU50 for all other bands.

i) The initial conditions are established again and steps a) and b) are repeated but with the following differences:

- the levels of the BCCH and PDTCH are set to 18 dB above reference sensitivity level().
- two further independent 8-PSK modulated interfering signals are sent on the same nominal carrier frequency as the BCCH and PDTCH and at a level 10 dB below the level of the PDTCH and modulated with random data, including the midamble.
- the fading function for all channels is set to TUlow.

j) The SS waits 100 s for the MS to stabilize to these conditions.

k) Repeat steps d) to f), except that at step f) the measurement period must be extended to 200 s and the number of measurements increased to 20.

l) The initial conditions are established again and steps a) to k) are repeated for ARFCN in the Low ARFCN range.

m) The initial conditions are established again and steps a) to k) are repeated for ARFCN in the High ARFCN range.

n) Repeat step h) under extreme test conditions (see annex 1, TC2.2).

13.17.2.5 Test requirements

The frequency error, with reference to the SS carrier frequency as measured in repeats of step e), for each measured burst shall be less than the values shown in table 13-17-1.

Table 13-17-1: Requirements for frequency error under multipath, Doppler shift and interference conditions

GSM 400		GSM 850 & GSM 900		DCS 1 800 & PCS 1900	
Propagation condition	Permitted frequency error	Propagation condition	Permitted frequency error	Propagation condition	Permitted frequency error
RA500	+/- 300 Hz	RA250	+/- 300 Hz	RA130	+/- 400 Hz
HT200	+/- 180 Hz	HT100	+/- 180 Hz	HT100	+/- 350 Hz
TU100	+/- 160 Hz	TU50	+/- 160 Hz	TU50	+/- 260 Hz
TU6	+/- 230 Hz	TU3	+/- 230 Hz	TU1,5	+/- 320 Hz

GSM 700	
Propagation condition	Permitted frequency error
RA 300	+/- 300 Hz
HT 120	+/- 180 Hz
TU 60	+/- 160 Hz
TU 3.6	+/- 230 Hz

13.17.3 EGPRS Transmitter output power

13.17.3.1 Definition and applicability

The transmitter output power is the average value of the power delivered to an artificial antenna or radiated by the MS and its integral antenna, over the time that the useful information bits of one burst are transmitted.

The requirements and this test apply to all types of MSs which are capable of EGPRS multislot operation. 8-PSK requirements are only applicable to EGPRS class B.

13.17.3.2 Conformance requirement

1. The MS maximum output power for GMSK modulated signal shall be as defined in GSM 05.05, 4.1.1, first table, according to its power class, with a tolerance of +/- 2 dB under normal conditions; GSM 05.05, 4.1.1, first table.
2. The MS maximum output power for GMSK modulated signal shall be as defined in GSM 05.05, 4.1.1, first table, according to its power class, with a tolerance of +/- 2,5 dB under extreme conditions; GSM 05.05, 4.1.1, first table; GSM 05.05 annex D D.2.1, D.2.2.
3. The MS maximum output power for 8-PSK modulated signal shall be as defined in GSM 05.05, 4.1.1, second table, according to its power class, with a tolerances of +/-2; +/-3; +3/-4 dB defined under normal conditions in the GSM 05.05, 4.1.1, second table.
4. The MS maximum output power for 8-PSK modulated signal shall be as defined in GSM 05.05, 4.1.1, second table, according to its power class, with a tolerances of +/-2.5; +/-4; +4/-4.5 dB defined under extreme conditions in the GSM 05.05, 4.1.1, second table.
5. The power control levels for both GMSK and 8-PSK shall have the nominal output power levels as defined in GSM 05.05, 4.1.1, third table (for GSM400, GSM 700, GSM 850 & GSM 900), fourth table (for DCS 1 800) or fifth table (for PCS 1900), from the lowest power control level up to the maximum output power corresponding to the class of the MS (for tolerance on maximum output power see conformance requirements 1), with a tolerance of +/-2; +/- 3, 4 or 5 dB under normal conditions; GSM 05.05, 4.1.1, third, fourth or fifth table.
6. The power control levels for both GMSK and 8-PSK shall have the nominal output power levels as defined in GSM 05.05, 4.1.1, third table (for GSM 400, GSM 700, GSM 850 & GSM 900), fourth table (for DCS 1 800) or fifth table (for PCS 1900),, from the lowest power control level up to the maximum output power corresponding to the class of the MS (for tolerance on maximum output power see conformance requirements 2), with a tolerance of +/-2.5; +/- 4, 5 or 6 dB under extreme conditions; GSM 05.05, 4.1.1, third, fourth or fifth table; GSM 05.05 annex D D.2.1, D.2.2.
7. For both GMSK and 8-PSK, the output power actually transmitted by the MS at consecutive power control levels shall form a monotonic sequence and the interval between power control levels shall be 2 +/- 1,5 dB; GSM 05.05, 4.1.1.
8. The transmitted power level relative to time for a normal burst shall be within the power/time template given in GSM 05.05, annex B top figure for GMSK modulated signal. In multislot configurations where the bursts in two or more consecutive time slots are actually transmitted at the same frequency, no requirements are specified to the power ramping in the guard times between the active slots, and the template of annex B shall respected at the beginning and the end of the series of consecutive bursts:
 - 8.1 Under normal conditions; GSM 05.05, 4.5.2..

8.2 Under extreme conditions; GSM 05.05, 4.5.2, GSM 05.05 annex D D.2.1, D.2.2.

9. The transmitted power level relative to time for a normal burst shall be within the power/time template given in GSM 05.05, annex B bottom figure for 8PSK modulated signal. In the case of Multislot Configurations where the bursts in two or more consecutive time slots are actually transmitted at the same frequency, the template of annex B shall be respected during the useful part of each burst and at the beginning and the end of the series of consecutive bursts. The output power during the guard period between every two consecutive active timeslots shall not exceed the level allowed for the useful part of the first timeslot, or the level allowed for the useful part of the second timeslot plus 3 dB, whichever is the highest.

9.1 Under normal conditions; GSM 05.05, 4.5.2.

9.2 Under extreme conditions; GSM 05.05, 4.5.2, GSM 05.05 annex D D.2.1, D.2.2.

10. When accessing a cell on the PRACH or RACH (random access) and before receiving the first power control parameters during packet transfer on PDCH, the MS shall use the output power defined by P_{MAX}. MS_TXPWR_MAX_CCH is broadcast on the BCCH of the cell. A class 3 DCS1 800 MS shall add to it the value POWER_OFFSET broadcast on the BCCH P_{MAX} is the maximum allowed output power in the cell =GPRS_MS_TXPWR_MAX_CCH if PBCCH exists MS_TXPWR_MAX_CCH otherwise. GSM05.08,10.2.1

11. The transmitted power level relative to time for a Random Access burst shall be within the power/time template given in GSM 05.05, annex B figure 3:

11.1 Under normal conditions; GSM 05.05, 4.5.2.

11.2 Under extreme conditions; GSM 05.05, 4.5.2, GSM 05.05 annex D D.2.1, D.2.2.

13.17.3.3 Test purpose

1. To verify that the maximum output power of the GMSK modulated signal of the MS in EGPRS multislot configuration, under normal conditions, is within conformance requirement 1.
2. To verify that the maximum output power of the GMSK modulated signal of the MS in EGPRS multislot configuration, under extreme conditions, is within conformance requirement 2.
3. To verify that the maximum output power of the 8-PSK modulated signal of the MS in EGPRS multislot configuration, under normal conditions, is within conformance requirement 3.
4. To verify that the maximum output power of the 8-PSK modulated signal of the MS in EGPRS multislot configuration, under extreme conditions, is within conformance requirement 4.
5. To verify that all power control levels, relevant to the class of MS, are implemented in the MS in EGPRS multislot configuration and have output power levels, under normal conditions, within conformance requirement 5.
6. To verify that all power control levels have output power levels, under extreme conditions, within conformance requirement 6.
7. To verify that the step in the output power transmitted by the MS in EGPRS multislot configuration at consecutive power control levels is within conformance requirement 7 under normal conditions.
8. To verify that the output power relative to time, when sending a normal burst of the GMSK modulated signal is within conformance requirement 8 in EGPRS multislot configuration:
 - 8.1 Under normal conditions.
 - 8.2 Under extreme conditions.
9. To verify that the output power relative to time, when sending a normal burst of the 8-PSK modulated signal is within conformance requirement 9 in EGPRS multislot configuration:
 - 9.1 Under normal conditions.
 - 9.2 Under extreme conditions.

10. To verify that the MS in EGPRS is within conformance requirement 10., when accessing the cell on RACH or PRACH.
11. To verify that the output power relative to time, when sending an access burst is within conformance requirement 11 in EGPRS multislot configuration:
 - 11.1 Under normal conditions
 - 11.2 Under extreme conditions

13.17.3.4 Methods of test

Two methods of test are described, separately for:

- 1) equipment fitted with a permanent antenna connector and for
- 2) equipment fitted with an integral antenna, and which cannot be connected to an external antenna except by the fitting of a temporary test connector as a test fixture.

NOTE: The behaviour of the MS in the system is determined to a high degree by the antenna, and this is the only transmitter test in this ETS using the integral antenna. Further studies are ongoing on improved testing on the integral antenna, taking practical conditions of MS use into account.

13.17.3.4.1 Method of test for equipment with a permanent antenna connector

Initial conditions

A downlink TBF is set up according to the generic procedure in section 40. The SS orders the MS to transmit on the uplink on a mid range ARFCN, power control level set to Max power and MS to operate in its highest number of uplink slots. This is achieved using the EGPRS test mode by transmitting a EGPRS TEST_CMD (see 04.14, section TBD)

The SS controls the power level by setting the concerned timeslot's power control parameter ALPHA (α) to 0 and GAMMA_TN (Γ_{CH}) to the desired power level in the Packet Uplink Assignment message (Closed Loop Control, see 05.08. Annex B.2) GPRS_MS_TXPWR_MAX_CCH / MS_TXPWR_MAX_CCH is set to the maximum value supported by the Power Class of the Mobile under test. For DCS 1 800 mobile stations the POWER_OFFSET parameter is set to 6 dB.

Test procedure

- a) Measurement of normal burst transmitter output power

For GMSK, average power is determined for each burst as follows:

The SS takes power measurement samples evenly distributed over the duration of one burst with a sampling rate of at least $2/T$, where T is the symbol duration. The samples are identified in time with respect to the modulation on the burst. The SS identifies the centre of the useful 147 transmitted symbols, i.e. the transition from symbol 13 to 14 of the midamble, as the timing reference.

The transmitter output power is calculated as the average of the samples over the 147 useful symbols. This is also used as the 0 dB reference for the power/time template.

For 8PSK, power may be determined by applying the technique described for GMSK above and then averaging over multiple bursts to achieve sufficient accuracy (see Annex 5). Alternatively, an estimation technique based on a single burst which can be demonstrated to yield the same result as the long term average may be used. The long term average or the estimate of long term average is used as the 0dB reference for the power/time template.

- b) Measurement of normal burst power/time relationship. The array of power samples measured in a) are referenced in time to the centre of the useful transmitted symbols and in power to the 0 dB reference, both identified in a).
- c) Steps a) to b) are repeated on each timeslot within the multislot configuration with the MS commanded to operate on each of the power control levels defined, even those not supported by the MS.

- d) The SS commands the MS to the maximum power control level supported by the MS and steps a) to b) are repeated on each timeslot within the multislot configuration for ARFCN in the Low and High ranges.
- e) The SS commands the MS to the maximum power control level in the first timeslot allocated within the multislot configuration and to the minimum power control level in the second timeslot allocated. Any further timeslots allocated are to be set to the maximum power control level. Steps a) to b) and corresponding measurements on each timeslot within the multislot configuration are repeated. This step is only applicable to MS which support more than one uplink time slot.

- f) Measurement of access burst transmitter output power

The SS causes the MS to generate an Access Burst on an ARFCN in the Mid ARFCN range, this could be either by a cell re-selection or a new request for radio resource. In the case of a cell re-selection procedure the Power Level indicated in the PSI3 message is the maximum power control level supported by the MS. The Power Level of the Access Burst shall be as indicated in the GPRS_MS_TXPWR_MAX_CCH parameter. If the power class of the MS is DCS 1 800 Class 3 and the Power Level is indicated by the MS_TXPWR_MAX_CCH parameter, the MS shall also use the POWER_OFFSET parameter.

The SS takes power measurement samples evenly distributed over the duration of the access burst as described in a). However, in this case the SS identifies the centre of the useful symbols of the burst by identifying the transition from the last bit of the synch sequence. The centre of the burst is then five data symbols prior to this point and is used as the timing reference.

The transmitter output power is calculated as the average of the samples over the 87 useful symbols of the burst. This is also used as the 0 dB reference for the power/time template.

- g) Measurement of access burst power/time relationship

The array of power samples measured in f) are referenced in time to the centre of the useful transmitted symbols and in power to the 0 dB reference, both identified in f).

- h) Depending on the method used in step f) to cause the MS to send an Access Burst, the SS sends either a PACKET CELL CHANGE ORDER along with power control level set to 10 in PSI3 parameter GPRS_MS_TXPWR_MAX_CCH or it changes the (Packet) System Information elements (GPRS_)MS_TXPWR_MAX_CCH and for DCS 1 800 the POWER_OFFSET on the serving cell PBCCCH/BCCH in order to limit the MS transmit power on the Access Burst to power control level 10 (+23 dBm for GSM 400, GSM 700, GSM 850 & GSM 900 or +10 dBm for DCS 1 800 & PCS 1900) and then steps f) to g) are repeated.
- i) Steps a) to h) are repeated under extreme test conditions (annex 1, TC2.2) except that the repeats at step d) are only performed for power control level 10 and the minimum power control level of the MS.

13.17.3.4.2 Method of test for equipment with an integral antenna

NOTE: If the MS is equipped with a permanent connector, such that the antenna can be disconnected and the SS be connected directly, then the method of section 13.17.3.4.1 will be applied.

The tests in this section are performed on an unmodified test sample.

Initial conditions

The MS is placed in the anechoic shielded chamber (annex 1, GC5) or on the outdoor test site, on an isolated support, in the position for normal use, at a distance of at least 3 metres from a test antenna, connected to the SS.

NOTE: The test method described has been written for measurement in an anechoic shielded chamber. If an outdoor test site is used then, in addition, it is necessary to raise/lower the test antenna through the specified height range to maximize the received power levels from both the test sample and the substitution antenna.

The initial conditions for the MS are defined in 13.17.3.4.1.1

Test procedure

- a) With the initial conditions set according to subclause 13.17.3.4.2.1 the test procedure in 13.17.3.4.1.2 is followed up to and including step h), except that in step a), when measurements are done at maximum power for ARFCN in the Low, Mid and High range, the measurement is made eight times with the MS rotated by $n \cdot 45$ degrees for all values of n in the range 0 to 7.

The measurements taken are received transmitter output power measurements rather than transmitter output power measurements, the output power measurement values can be derived as follows.

- b) Assessment of test site loss for scaling of received output power measurements.

The MS is replaced by a half-wave dipole, resonating at the centre frequency of the transmit band, connected to an RF generator.

The frequency of the RF signal generator is set to the frequency of the ARFCN used for the 24 measurements in step a), the output power is adjusted to reproduce the received transmitter output power averages recorded in step a).

For each indication the power, delivered by the generator (in Watts) to the half-wave dipole, is recorded. These values are recorded in the form P_{nc} , where n = MS rotation and c = channel number.

For each channel number used compute:

$$P_{ac}(\text{Watts into dipole}) = \frac{1}{8} * \sum_{n=0}^{n=7} P_{nc}$$

from which: $P_{ac}(\text{Tx dBm}) = 10 \log_{10}(P_{ac}) + 30 + 2,15$

The difference, for each of the three channels, between the actual transmitter output power averaged over the 8 measurement orientations and the received transmitter output power at orientation $n = 0$ is used to scale the received measurement results to actual transmitter output powers for all measured power control levels and ARFCN, which can then be checked against the requirements.

- c) Temporary antenna connector calibration factors (transmit)

A modified test sample equipped with a temporary antenna connector is placed in a climatic test chamber and is linked to the SS by means of the temporary antenna connector.

Under normal test conditions, the power measurement and calculation parts of steps a) to j) of 13.17.3.4.1.2 are repeated except that the repeats at step d) are only performed for power control level 10 and the minimum power control level of the MS.

NOTE: The values noted here are related to the output transmitter carrier power levels under normal test conditions, which are known after step b). Therefore frequency dependent calibration factors that account for the effects of the temporary antenna connector can be determined.

- d) Measurements at extreme test conditions.

NOTE: Basically the procedure for extreme conditions is:

- the power/time template is tested in the "normal" way,
- the radiated power is measured by measuring the difference with respect to the radiated power under normal test conditions.

Under extreme test conditions steps a) to h) of 13.17.3.4.1.2 are repeated except that the repeats at step d) are only performed for power control level 10 and the minimum power control level of the MS.

The transmitter output power under extreme test conditions is calculated for each burst type, power control level and for every frequency used by adding the frequency dependent calibration factor, determined in c), to the values obtained at extreme conditions in this step.

13.17.3.5 Test requirements

- a) The transmitter output power for the GMSK modulated signals, under every combination of normal and extreme test conditions, for normal bursts and access bursts, at each frequency and for each power control level applicable to the MS power class, shall be at the relevant level shown in table 13.17.3-1 or table 13.17.3-3 within the tolerances also shown in table 13.17.3-1 or table 13.17.3-3
- b) The transmitter output power for the 8-PSK modulated signals, under every combination of normal and extreme test conditions, for normal bursts and access bursts, at each frequency and for each power control level applicable to the MS power class, shall be at the relevant level shown in table 13.17.3-2 or table 13.17.3-4 within the tolerances also shown in table 13.17.3-2 or table 13.17.3-4

GSM 400, GSM 700, GSM 850 & GSM 900 beginning

Table 13.17.3-1: GSM400, GSM 700, GSM 850 & GSM 900 transmitter output power for different power classes GMSK

Power class				Power control level	Transmitter output power dBm	Tolerances	
2	3	4	5			normal	extreme
.	.	.	.	2	39	+/-2 dB	+/-2,5 dB
.	.	.	.	3	37	+/-3 dB*)	+/-4 dB*)
.	.	.	.	4	35	+/-3 dB	+/-4 dB
.	.	.	.	5	33	+/-3 dB*)	+/-4 dB*)
.	.	.	.	6	31	+/-3 dB	+/-4 dB
.	.	.	.	7	29	+/-3 dB*)	+/-4 dB*)
.	.	.	.	8	27	+/-3 dB	+/-4 dB
.	.	.	.	9	25	+/-3 dB	+/-4 dB
.	.	.	.	10	23	+/-3 dB	+/-4 dB
.	.	.	.	11	21	+/-3 dB	+/-4 dB
.	.	.	.	12	19	+/-3 dB	+/-4 dB
.	.	.	.	13	17	+/-3 dB	+/-4 dB
.	.	.	.	14	15	+/-3 dB	+/-4 dB
.	.	.	.	15	13	+/-3 dB	+/-4 dB
.	.	.	.	16	11	+/-5 dB	+/-6 dB
.	.	.	.	17	9	+/-5 dB	+/-6 dB
.	.	.	.	18	7	+/-5 dB	+/-6 dB
.	.	.	.	19	5	+/-5 dB	+/-6 dB

*) When the power control level corresponds to the power class of the MS, then the tolerances shall be 2,0 dB under normal test conditions and 2,5 dB under extreme test conditions.

Table 13.17.3-2: GSM 400, GSM 700, GSM 850 & GSM 900 transmitter output power for different power classes 8PSK Modulated Signals

Power class			Power control level	Transmitter output power	Tolerances	
E1	E2	E3				
.	.	.	5	33	+/-2 dB	+/-2.5dB
.	.	.	6	31	+/-3 dB	+/-4 dB
.	.	.	7	29	+/-3 dB	+/-4 dB
.	.	.	8	27	+/-3 dB	+/-4 dB
.	.	.	9	25	+/-3 dB	+/-4 dB
.	.	.	10	23	+/-3 dB	+/-4 dB
.	.	.	11	21	+/-3 dB	+/-4 dB
.	.	.	12	19	+/-3 dB	+/-4 dB
.	.	.	13	17	+/-3 dB	+/-4 dB
.	.	.	14	15	+/-3 dB	+/-4 dB
.	.	.	15	13	+/-3 dB	+/-4 dB
.	.	.	16	11	+/-5 dB	+/-6 dB
.	.	.	17	9	+/-5 dB	+/-6 dB
.	.	.	18	7	+/-5 dB	+/-6 dB
.	.	.	19	5	+/-5 dB	+/-6 dB

GSM400, GSM 700, GSM 850 & GSM 900 - end

DCS 1 800 & PCS1900 - beginning

**Table 13.17.3-3: DCS 1 800 and PCS 1900 transmitter output power for different power classes
GMSK Modulated signal**

Power class			Power control level	Transmitter output power	Tolerances	
1	2	3			dBm	normal
		.	29	36	+/-2,0 dB	+/-2,5 dB
		.	30	34	+/-3,0 dB	+/-4,0 dB
		.	31	32	+/-3,0 dB	+/-4,0 dB
.	.	.	0	30	+/-3,0 dB*)	+/-4 dB*)
.	.	.	1	28	+/-3 dB	+/-4 dB
.	.	.	2	26	+/-3 dB	+/-4 dB
.	.	.	3	24	+/-3 dB*)	+/-4 dB*)
.	.	.	4	22	+/-3 dB	+/-4 dB
.	.	.	5	20	+/-3 dB	+/-4 dB
.	.	.	6	18	+/-3 dB	+/-4 dB
.	.	.	7	16	+/-3 dB	+/-4 dB
.	.	.	8	14	+/-3 dB	+/-4 dB
.	.	.	9	12	+/-4 dB	+/-5 dB
.	.	.	10	10	+/-4 dB	+/-5 dB
.	.	.	11	8	+/-4 dB	+/-5 dB
.	.	.	12	6	+/-4 dB	+/-5 dB
.	.	.	13	4	+/-4 dB	+/-5 dB
.	.	.	14	2	+/-5 dB	+/-6 dB
.	.	.	15	0	+/-5 dB	+/-6 dB

*) When the power control level corresponds to the power class of the MS, then the tolerances shall be 2,0 dB under normal test conditions and 2,5 dB under extreme test conditions.

**Table 13.17.3-4: DCS1800 and PCS1900 transmitter output power for different power classes
8-PSK Modulated Signals**

Power class			Power control level	Transmitter output power	Tolerances	
E1	E2	E3			NORMAL	EXTREME
.			0	30	+/-3 dB	+/-4dB
.			1	28	+/-3 dB	+/-4 dB
.	.		2	26	+/-3 dB	+/-4 dB
.	.		3	24	+/-3 dB	+/-4 dB
.	.	.	4	22	+/-3 dB	+/-4 dB
.	.	.	5	20	+/-3 dB	+/-4 dB
.	.	.	6	18	+/-3 dB	+/-4 dB
.	.	.	7	16	+/-3 dB	+/-4 dB
.	.	.	8	14	+/-4 dB	+/-4 dB
.	.	.	9	12	+/-4 dB	+/-5 dB
.	.	.	10	10	+/-4 dB	+/-5 dB
.	.	.	11	8	+/-4 dB	+/-5 dB
.	.	.	12	6	+/-4 dB	+/-5 dB
.	.	.	13	4	+/-5 dB	+/-5 dB
.	.	.	14	2	+/-5 dB	+/-6 dB

DCS 1 800 & PCS1900 - end

c) The difference between the transmitter output power at two adjacent power control levels, measured at the same frequency, shall not be less than 0,5 dB and not be more than 3,5 dB.

d) The power/time relationship of the measured samples for normal bursts shall be within the limits of the power time template of figure 13.17.3-1 for GMSK and figure 13.17.3-2 for 8-PSK at each frequency, under every combination of normal and extreme test conditions and at each power control level measured.

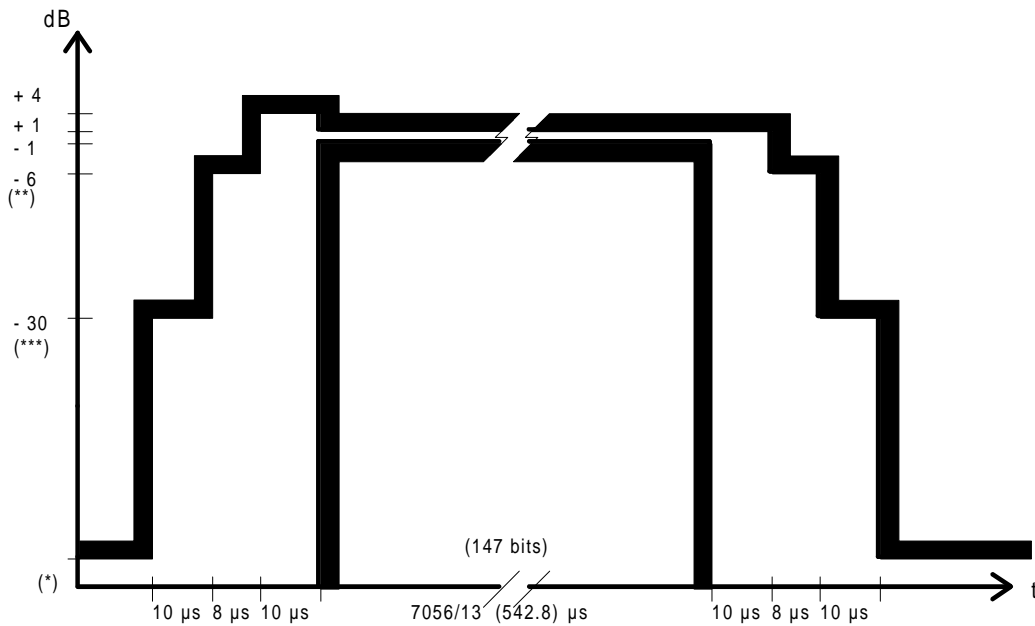

Figure 13.17.3-1: Power / time template for normal bursts (GMSK modulation)

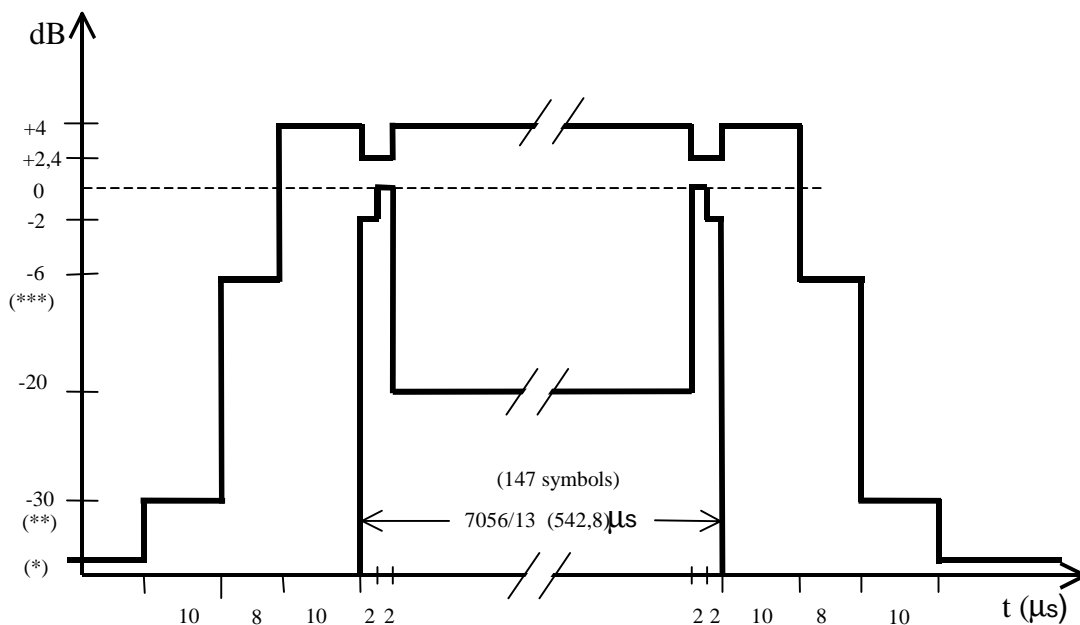

Figure 13.17.3-2: Time mask for normal duration bursts (NB) at 8-PSK modulation

- d) All the power control levels, for the type and power class of the MS as stated by the manufacturer, shall be implemented in the MS.
- f) When the transmitter is commanded to a power control level outside of the capability corresponding to the type and power class of the MS as stated by the manufacturer, then the transmitter output power shall be within the

tolerances for the closest power control level corresponding to the type and power class as stated by the manufacturer.

- g) The power/time relationship of the measured samples for access bursts shall be within the limits of the power time template of figure 13.17.3-3 at each frequency, under every combination of normal and extreme test conditions and at each power control level measured.

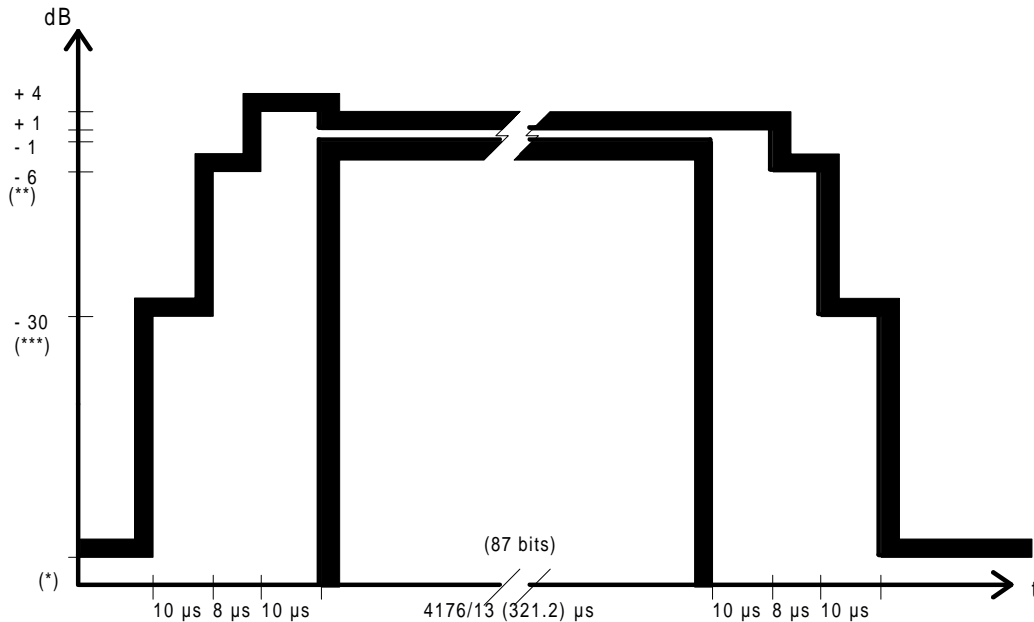

Figure 13.17.3-3: Power / time template for access burst

Table 13.17.3-3: Lowest measurement limit for power / time template

(*)	For GSM 400, GSM 700, GSM 850 and GSM 900 MS	:	59 dBc or -54 dBm whichever is the highest, except for the timeslot preceding the active slot, for which the allowed level is -59 dBc or -36 dBm, whichever is the highest
	For DCS 1 800 MS and PCS 1900 MS	:	-48 dBc or -48 dBm, whichever is the higher. no requirement below -30 dBc (see 4.5.1).
(**)	For GSM 400, GSM 700, GSM 850 and GSM 900 MS	:	-4 dBc for power control level 16; -2 dBc for power level 17; -1 dBc for power level controls levels 18 and 19.
	For DCS 1 800 MS	:	-4dBc for power control level 11, -2dBc for power level 12, -1dBc for power control levels 13,14 and 15
(***)	For GSM 400, GSM 700, GSM 850 and GSM 900 MS	:	-30 dBc or -17 dBm, whichever is the higher.
	For DCS 1 800 MS	:	-30dBc or -20dBm, whichever is the higher.

13.17.4 Output RF spectrum in EGPRS configuration

13.17.4.1 Definition and applicability

The output RF spectrum is the relationship between the frequency offset from the carrier and the power, measured in a specified bandwidth and time, produced by the MS due to the effects of modulation and power ramping.

The requirements and this test apply to all types of MSs which are capable of EGPRS multislots operation.

13.17.4.2 Conformance requirement

1. The level of the output RF spectrum due to GMSK and 8PSK modulations shall be no more than that given in GSM 05.05, 4.2.1, with the following lowest measurement limits:
 - 36 dBm below 600 kHz offset from the carrier,
 - 51 dBm for GSM 400, GSM 700, GSM 850 & GSM 900 or -56 dBm for DCS 1 800 and PCS1900 from 600 kHz out to less than 1 800 kHz offset from the carrier,
 - 46 dBm for GSM 400, GSM 700, GSM 850 & GSM 900 or -51 dBm for DCS 1 800 and PCS1900 at and beyond 1 800 kHz offset from the carrier,

but with the following exceptions at up to -36 dBm:

- up to three bands of 200 kHz width centred on a frequency which is an integer multiple of 200 kHz in the combined range 600 kHz to 6000 kHz above and below the carrier,
- up to 12 bands of 200 kHz width centred on a frequency which is an integer multiple of 200 kHz at more than 6 000 kHz offset from the carrier.

1.1 Under normal conditions; GSM 05.05, 4.2.1.

1.2 Under extreme conditions; GSM 05.05, 4.2.1; GSM 05.05, annex D D.2.1, D.2.2.

2. The level of the output RF spectrum due to switching transients shall be no more than given in GSM 05.05, 4.2.2, table "a) Mobile Station:".

2.1 Under normal conditions; GSM 05.05, 4.2.2.

2.2 Under extreme conditions; GSM 05.05, 4.2.2; GSM 05.05 annex D D.2.1, D.2.2.

3. When allocated a channel, the power emitted by the GSM 400, GSM 900 & DCS 1800 MS, in the band 935 to 960 MHz shall be no more than -79 dBm, in the band 925 to 935 MHz shall be no more than -67 dBm and in the band 1 805 to 1 880 MHz shall be no more than -71 dBm, except in five measurements in each of the bands 925 to 960 MHz and 1 805 to 1 880 MHz, where exceptions at up to -36 dBm are permitted. For GSM 400 mobiles, in addition, a limit of -67 dBm shall apply in the frequency bands 460.4 – 467.6 MHz and 488.8 – 496 MHz.

For GSM 700, GSM 850 and PCS 1900, the power emitted by MS, in the band of 747 to 757 MHz shall be no more than -79 dBm, in the band of 757 to 762 MHz shall be no more than -73 dBm, in the band 869 to 894 MHz shall be no more than -79 dBm, in the band 1 930 to 1 990 MHz shall be no more than -71 dBm except in five measurements in each of the bands 747 to 762 MHz, 869 to 894 MHz and 1 930 to 1 990 MHz where exceptions at up to -36 dBm are permitted; GSM 05.05, 4.3.3.

13.17.4.3 Test purpose

1. To verify that the output RF spectrum due to modulation does not exceed conformance requirement 1 in the EGPRS multislot configurations.
 - 1.1 Under normal conditions.
 - 1.2 Under extreme conditions.
2. To verify that the output RF spectrum due to switching transients does not exceed conformance requirement 2 in the EGPRS multislot configurations when a reasonable margin is allowed for the effect of spectrum due to modulation.
 - 2.1 Under normal conditions.
 - 2.2 Under extreme conditions.
3. To verify that the MS spurious emissions in the MS receive band do not exceed conformance requirement 3 in the EGPRS multislot configurations.

13.17.4.4 Method of test

Initial conditions

The MS is ordered to transmit EGPRS RLC data blocks containing random data with the highest number of uplink slots. This is achieved using the EGPRS test mode by transmitting a EGPRS TEST_CMD (see 04.14, section TBD)

The SS commands the MS to hopping mode. The hopping pattern includes only three channels, namely one with an ARFCN in the Low ARFCN range, a second one with an ARFCN in the Mid ARFCN range and the third one with an ARFCN in the High ARFCN range.

In the case that loop-back method of the EGPRS test mode is used, the SS sends the pseudo-random signal specified for the uplink only transmission method of EGPRS test mode in GSM 04.14. The SS shall use a level of 23 dB μ V_{emf} ().

NOTE 1: Although the measurement is made whilst the MS is in hopping mode, each measurement is on one single channel.

NOTE 2: This test is specified in hopping mode as a simple means of making the MS change channel, it would be sufficient to test in non hopping mode and to cell re-select the MS between the three channels tested at the appropriate time.

13.17.4.4.2 Test procedure

This procedure shall apply to both GMSK and 8PSK modulations.

NOTE: When averaging is in use during frequency hopping mode, the averaging only includes bursts transmitted when the hopping carrier corresponds to the nominal carrier of the measurement.

a) In steps b) to h) the FT is equal to the hop pattern ARFCN in the Mid ARFCN range.

b) The other settings of the spectrum analyser are set as follows:

- Zero frequency scan
- Resolution bandwidth: 30 kHz
- Video bandwidth: 30 kHz
- Video averaging: may be used, depending on the implementation of the test

The video signal of the spectrum analyser is “gated” such that the spectrum generated by at least 40 of the symbols 87 to 132 of the burst in one of the active time slots is the only spectrum measured. This gating may be analogue or numerical, dependent upon the design of the spectrum analyser. Only measurements during transmitted bursts on the nominal carrier of the measurement are included. The spectrum analyser averages over the gated period and over 200 or 50 such bursts, using numerical and/or video averaging.

c) By tuning the spectrum analyser centre frequency to the measurement frequencies the power level is measured over 50 bursts at all multiples of 30 kHz offset from FT to < 1 800 kHz.

d) The resolution and video bandwidth on the spectrum analyser are adjusted to 100 kHz and the measurements are made at the following frequencies:

on every ARFCN from 1 800 kHz offset from the carrier to the edge of the relevant transmit band for each measurement over 50 bursts.

at 200 kHz intervals over the 2 MHz either side of the relevant transmit band for each measurement over 50 bursts.

For GSM 400, GSM 900 and DCS 1800:

at 200 kHz intervals over the band 450-496 MHz for each measurement over 50 bursts.

at 200 kHz intervals over the band 925 - 960 MHz for each measurement over 50 bursts.

at 200 kHz intervals over the band 1805 - 1880 MHz for each measurement over 50 bursts.

For GSM 700, GSM 850 and DCS 1900:

at 200 kHz intervals over the band 747 to 762 MHz for each measurement over 50 bursts.

at 200 kHz intervals over the band 869 - 894 MHz for each measurement over 50 bursts.

at 200 kHz intervals over the band 1930 – 1990 MHz for each measurement over 50 bursts.

- e) The MS is commanded to its minimum power control level. The spectrum analyser is set again as in b).
- f) By tuning the spectrum analyser centre frequency to the measurement frequencies the power level is measured over 200 bursts at the following frequencies:

FT

FT + 100 kHz	FT - 100 kHz
FT + 200 kHz	FT - 200 kHz
FT + 250 kHz	FT - 250 kHz
FT + 200 kHz * N	FT - 200 kHz * N

where N = 2, 3, 4, 5, 6, 7, and 8

and FT = RF channel nominal centre frequency.

- g) Steps a) to f) is repeated except that in step a) the spectrum analyzer is gated so that the burst of the next active time slot is measured.
- h) The spectrum analyser settings are adjusted to:
- Zero frequency scan
 - Resolution bandwidth: 30 kHz
 - Video bandwidth: 100 kHz
 - Peak hold

The spectrum analyser gating of the signal is switched off.

The MS is commanded to its maximum power control level in every transmitted time slot.

- i) By tuning the spectrum analyser centre frequency to the measurement frequencies the power level is measured at the following frequencies:

FT + 400 kHz	FT - 400 kHz
FT + 600 kHz	FT - 600 kHz
FT + 1,2 MHz	FT - 1,2 MHz
FT + 1,8 MHz	FT - 1,8 MHz

where FT = RF channel nominal centre frequency.

The duration of each measurement (at each frequency) will be such as to cover at least 10 burst transmissions at FT.

- j) Step i) is repeated for power control levels 7 and 11.
- k) Steps b), f), h) and i) are repeated with FT equal to the hop pattern ARFCN in the Low ARFCN range except that in step h) the MS is commanded to power control level 11 rather than maximum power.
- l) Steps b), f), h) and i) are repeated with FT equal to the hop pattern ARFCN in the High ARFCN range except that in step h) the MS is commanded to power control level 11 rather than maximum power.

- m) Steps a) b) f) h), and i) are repeated under extreme test conditions (annex 1, TC2.2). except that at step h) the MS is commanded to power control level 11.

13.17.4.5 Test requirements

For absolute measurements, performed on a temporary antenna connector, in the frequency band 450-486 or 777 to 792 MHz or 824 to 849 MHz or 880 to 915 MHz or 1710 to 1785 MHz or 1850-1910, the temporary antenna connector coupling factor, determined according to 13.3.4.2.2 and annex 1 GC7, for the nearest relevant frequency, will be used.

For absolute measurements, performed on a temporary antenna connector, in the frequency band 450-486 or 925 to 960 MHz, the temporary antenna connector coupling factor, will be as determined according to annex 1 GC7 for GSM 400 or GSM 900 MS respectively. For a DCS 1 800 MS & PCS 1900 MS 0 dB will be assumed.

For absolute measurements, performed on a temporary antenna connector, in the frequency band 1805 to 1880 MHz, the temporary antenna connector coupling factor, will be as determined according to annex 1 GC7 for DCS 1 800 MS. For GSM 400 MS & GSM 900 MS 0 dB will be assumed.

For absolute measurements, performed on a temporary antenna connector, in the frequency band 747 to 762 MHz, the temporary antenna connector coupling factor, will be as determined according to annex 1 GC7 for GSM 700 MS. For a GSM 400, GSM 850, GSM 900, DCS 1800 or PCS 1900 MS 0 dB will be assumed.

For absolute measurements, performed on a temporary antenna connector, in the frequency band 869 to 894 MHz, the temporary antenna connector coupling factor, will be as determined according to annex 1 GC7 for GSM 850 MS. For a GSM 400, GSM 700, GSM 900, DCS 1800 or PCS 1900 MS 0 dB will be assumed.

The figures in the tables below, at the listed frequencies from the carrier (kHz), are the maximum level (dB) relative to a measurement in 30 kHz bandwidth on the carrier (reference GSM 05.05 section 4.2.1).

- a) For the modulation sidebands out to less than 1 800 kHz offset from the carrier frequency (FT) measured in step c), f), i), k), l) and m) the measured power level in dB relative to the power level measured at FT, for all types of MS, shall not exceed the limits derived from the values shown in table 13.17.4-1 for GSM 400, GSM 700, GSM 850 & GSM 900 or table 13.17.4-2 for DCS 1 800 & PCS 1900 MS, according to the actual transmit power and frequency offset from FT. However any failures in the combined range 600 kHz to less than 1 800 kHz above and below the carrier may be counted towards the exceptions allowed in test requirements c) below.

Table 13.17.4-1: GSM400, GSM 700, GSM 850 & GSM 900 Spectrum due to modulation out to less than 1 800 kHz offset

		power levels in dB relative to the measurement at FT				
Power level	Frequency offset (kHz)					
(dBm)	0-100	200	250	400	600 to <1800	
39	+0,5	-30	-33	-60	-66	
37	+0,5	-30	-33	-60	-64	
35	+0,5	-30	-33	-60	-62	
<= 33	+0,5	-30	-33	-60*	-60	
The values above are subject to the minimum absolute levels (dBm) below.						
	-36	-36	-36	-36	-51	

*For equipment supporting 8PSK, the requirement for 8-PSK modulation is -54dB.

Table 13.17.4-2: DCS 1 800/PCS 1900 Spectrum due to modulation out to less than 1 800 kHz offset

power levels in dB relative to the measurement at FT					
Power level	Frequency offset (kHz)				
(dBm)	0-100	200	250	400	600 to <1800
<= 36	+0,5	-30	-33	-60	-60
34	+0.5	-30	-33	-60	-60
32	+0.5	-30	-33	-60	-60
30	+0.5	-30	-33	-60*	-60
The values above are subject to the minimum absolute levels (dBm) below.					
	-36	-36	-36	-36	-56

*For equipment supporting 8-PSK, the requirement for 8-PSK modulation is -54dB.

NOTE 1: For frequency offsets between 100 kHz and 600 kHz the requirement is derived by a linear interpolation between the points identified in the table with linear frequency and power in dB relative.

b) For the modulation sidebands from 1 800 kHz offset from the carrier frequency (FT) and out to 2 MHz beyond the edge of the relevant transmit band, measured in step d), the measured power level in dB relative to the power level measured at FT, shall not exceed the values shown in table 13.17.4-3 according to the actual transmit power, frequency offset from FT and system on which the MS is designed to operate. However any failures in the combined range 1 800 kHz to 6 MHz above and below the carrier may be counted towards the exceptions allowed in test requirements c) below, and any other failures may be counted towards the exceptions allowed in test requirements d) below.

Table 13.17.4-3: Spectrum due to modulation from 1 800 kHz offset to the edge of the transmit band (wideband noise)

power levels in dB relative to the measurement at FT						
GSM400, GSM 700, GSM 850 & GSM900				DCS1800 & PCS 1900		
Power level	Frequency offset			Power level	Frequency offset	
(dBm)	kHz			(dBm)	kHz	
	1800 to	3000 to	>= 6000		1800 to	>= 6000
	< 3000	< 6000			< 6000	
39	-69	-71	-77	36	-71	-79
37	-67	-69	-75	34	-69	-77
35	-65	-67	-73	32	-67	-75
<= 33	-63	-65	-71	30	-65	
						-73
				28	-63	
						-71
				26	-61	
						-69
				<= 24	-59	
						-67
The values above are subject to the minimum absolute levels (dBm) below.						
	-46	-46	-46		-51	-51

- c) Any failures (from a) and b) above) in the combined range 600 kHz to 6 MHz above and below the carrier should be re-checked for allowed spurious emissions. For each of the three ARFCN used, spurious emissions are allowed in up to three 200 kHz bands centred on an integer multiple of 200 kHz so long as no spurious emission exceeds -36 dBm. Any spurious emissions measured in a 30 kHz bandwidth which spans two 200 kHz bands can be counted towards either 200 kHz band, whichever minimizes the number of 200 kHz bands containing spurious exceptions.
- d) Any failures (from b) above) beyond 6 MHz offset from the carrier should be re-checked for allowed spurious emissions. For each of the three ARFCN used, up to twelve spurious emissions are allowed so long as no spurious emission exceeds -36 dBm.
- e) The MS spurious emissions in the bands 460.4 – 467.6 MHz, 488.8 – 496 MHz,

925 - 935 MHz, 935 - 960 MHz, 1 805 - 1 880 MHz and 1850-1910 MHz measured in step d), for all types of MS, shall not exceed the values shown in table 13.16.4-4 except in up to 3 measurements in the band 460.4-467.6 and 488.8-496MHz, in up to five measurements in the band 925 to 960 MHz and five measurements in the band 1 805 to 1 880 MHz where a level up to -36 dBm is permitted. For GSM 700, GSM 850 and PCS 1900 the spurious emissions in the bands 747 to 757 MHz, 757 to 762 MHz, 869 - 894 MHz and 1930 – 1990 MHz shall not exceed the values shown in table 13-17.4-4 except in up to five measurements in each of the bands 747 to 762 MHz, 869 MHz to 894 MHz and 1 930 MHz to 1 990 MHz where a level up to -36 dBm is permitted.

Table 13.17.4-4: Spurious emissions in the MS receive bands

Band (MHz)	Spurious emissions level for GSM 400, GSM 900 and DCS 1800 (dBm)	Spurious emissions level for GSM 700, GSM 850 and PCS 1900 (dBm)
460-496	-67 Applicable only for GSM 400 mobiles	
925 to 935	-67	
935 to 960	-79	
1805 to 1880	-71	
747 to 757		-79
757 to 762		-73
869 to 894		-79
1930 to 1990		-71
1850-1910		Comply with FCC rules for wideband PCS services (see GSM 05.05, 4.3, applicable only for PCS)

- f) For the power ramp sidebands of steps h), i) and k) the power levels must not exceed the values shown in table 13.17.4-5 for GSM 700, GSM 850 and GSM 900 or table 13.17.4-6 for DCS 1 800.

Table 13.17.4-5: GSM700, GSM 850 and GSM 900 Spectrum due to switching transients

Power level	Maximum level for various offsets from carrier frequency			
	400 kHz	600 kHz	1200 kHz	1800 kHz
39 dBm	-13 dBm	-21 dBm	-21 dBm	-24 dBm
37 dBm	-15 dBm	-21 dBm	-21 dBm	-24 dBm
35 dBm	-17 dBm	-21 dBm	-21 dBm	-24 dBm
33 dBm	-19 dBm	-21 dBm	-21 dBm	-24 dBm
31 dBm	-21 dBm	-23 dBm	-23 dBm	-26 dBm
29 dBm	-23 dBm	-25 dBm	-25 dBm	-28 dBm
27 dBm	-23 dBm	-26 dBm	-27 dBm	-30 dBm
25 dBm	-23 dBm	-26 dBm	-29 dBm	-32 dBm
23 dBm	-23 dBm	-26 dBm	-31 dBm	-34 dBm
<= +21 dBm	-23 dBm	-26 dBm	-32 dBm	-36 dBm

Table 13.17.4-6: DCS 1 800/PCS1900 Spectrum due to switching transients

Power level	Maximum level for various offsets from carrier frequency			
	400 kHz	600 kHz	1200 kHz	1800 kHz
36 dBm	-16 dBm	-21 dBm	-21 dBm	-24 dBm
34 dBm	-18 dBm	-21 dBm	-21 dBm	-24 dBm
32 dBm	-20 dBm	-22 dBm	-22 dBm	-25 dBm
30 dBm	-22 dBm	-24 dBm	-24 dBm	-27 dBm
28 dBm	-23 dBm	-25 dBm	-26 dBm	-29 dBm
26 dBm	-23 dBm	-26 dBm	-28 dBm	-31 dBm
24 dBm	-23 dBm	-26 dBm	-30 dBm	-33 dBm
22 dBm	-23 dBm	-26 dBm	-31 dBm	-35 dBm
<= +20 dBm	-23 dBm	-26 dBm	-32 dBm	-36 dBm

NOTE 2: These figures are different from the requirements in GSM 05.05 because at higher power levels it is the modulation spectrum which is being measured using a peak hold measurement. This allowance is given in the table.

NOTE 3: The figures for table 13.17.3-5 and table 13.17.3-6 assume that, using the peak hold measurement, the lowest level measurable is 8 dB above the level of the modulation specification using the 30 kHz bandwidth gated average technique for 400 kHz offset from the carrier. At 600 and 1200 kHz offset the level is 6 dB above and at 1 800 kHz offset the level is 3 dB above. The figures for 1 800 kHz have assumed the 30 kHz bandwidth spectrum due to modulation specification at <1 800 kHz.

13.17.5 Intermodulation attenuation

13.17.5.1 Definition and applicability

The intermodulation attenuation is the ratio, in dB, of the power level of the wanted signal to the power level of the highest intermodulation component.

The requirements and this test apply to all types of DCS 1 800 MS and PCS1900.

13.17.5.2 Conformance requirement

The maximum level of any intermodulation product shall be no less than 50 dB below the level of the wanted signal when an interfering CW signal is applied, within the transmit band, at a frequency offset of 800 kHz and with a power level 40 dB below the power level of the wanted signal; GSM 05.05, 4.7.3.

13.17.5.3 Test purpose

To verify that the MS intermodulation attenuation is no less than conformance requirement 1.

13.17.5.4 Method of test

NOTE 1: When the measurements are performed precautions must be taken, so that non-linearities in the selective measuring device do not influence the results appreciably. Furthermore it should be ensured that intermodulation components which may be generated by non-linear elements in the test equipment (e.g. signal generator, circulators, selective measuring device) are sufficiently reduced. The RF transmit equipment under test and the test signal source should be physically separated in such a way that the measurement is not influenced by direct radiation.

NOTE 2: In the case of an MS which does not normally include an antenna connector, the coupling loss of the temporary antenna connector must be taken into account.

13.17.5.4.1 Initial conditions

The antenna output of the MS is connected to the SS via a coupling device, presenting to the MS a load with an impedance of 50 ohms. The coupling device may consist of a circulator with one port connected by a coaxial cable to the output terminal of the MS, the second port correctly terminated with 50 ohms into a selective measuring device (e.g. a spectrum analyser) and the third port connected to the interfering test signal source via an isolator.

The MS is ordered to transmit EGPRS RLC data blocks containing random data with the highest number of uplink slots. This is achieved using the EGPRS test mode by transmitting a EGPRS TEST_CMD (see 04.14, section TBD) The ARFCN is set to a Mid range value and POWER control level is set to maximum.

13.17.5.4.2 Procedure

This procedure shall apply to both GMSK and 8PSK modulations.

- a) The interfering test signal will be unmodulated and the frequency will be 800 kHz above the transmit frequency of the MS under test. the power level is adjusted to give the equivalent of 40 dB below the transmit power level of the MS, if both the MS transmit power and the interfering test signal were measured with a correct termination but with the other signal absent.
- b) The frequency selective measuring device is set to measure peak hold in a bandwidth of 300 kHz. Any intermodulation components in the MS transmit band, are then measured.
- c) Steps a) and b) are repeated with the test signal at a frequency 800 kHz below the transmitted frequency.

13.17.5.5 Test requirements

The level of each intermodulation component, in the MS transmit band, shall be no less than 50 dB below the level of the transmit power of the wanted MS carrier.

14 Receiver

In this section on receiver measurements, the procedures to test equipment which is fitted with a permanent antenna connector, and the procedures to test equipment which is designed to only be used with an integral antenna, are in general combined into one single test description.

Tests on Mobile Stations fitted with an integral antenna and having no means of connecting an external antenna are specified in terms of received field strength. In order to perform tests on such Mobile Stations without the need for separated access to a calibrated test site a temporary antenna connector is used as defined in annex 1 section 1.1.3 (General Conditions).

In practice the temporary antenna connector may be used for transmitter measurements described in section 3, but the calibration factors determined in [Annex 1] will not be directly usable. The detailed calibration, when needed, for transmission tests are described in the relevant sections of 3.

Wherever in this section, for FACCH tests, the SS is required to send a Layer 3 message not requiring a Layer 3 response from the MS the message can be a TEST INTERFACE message or a STATUS message, possibly with an unknown Protocol Discriminator.

Testing philosophy

Certain assumptions concerning the functional mechanisms of GSM receivers have been made in order to define tests that will verify the receiver performance without excessive redundancy and excessive test times.

The receiver functions can be divided into:

- Analogue RF and IF stages that are affected by input levels, temperature and power supply levels.
- Demodulator that is affected by input levels and interfering signals.
- Decoders that are affected by the different logical channels and input levels.

The tests are designed to stress each of these blocks with a minimum of redundancy.

Statistical testing of receiver BER/FER performance

Error Definition

- 1) Frame Erasure Ratio (FER)

A frame is defined as erased if the error detection functions in the receiver, operating in accordance with GSM 05.03, indicate an error (BFI = 1). For full rate or half rate speech this is the result of the 3 bit cyclic redundancy check (CRC) as well as other processing functions that cause a Bad Frame Indication (BFI). For signalling channels it is the result of the FIRE code or any other block code used. For data traffic FER is not defined.

2) Residual Bit Error Ratio (RBER)

The Residual Bit Error Ratio is defined as the Bit Error Ratio (BER) in frames which have not been declared as erased.

3) Bit Error Ratio (BER)

The Bit Error Ratio is defined as the ratio of the bits wrongly received to all data bits sent.

4) Unreliable Frame Ratio (UFR)

The Unreliable Frame Ratio is defined as the ratio of frames declared as erased (BFI=1), or unreliable (UFI=1), to the total number of frames transmitted. An unreliable frame is indicated by setting the UFI flag (UFI=1) and an erased frame is indicated by setting the BFI flag (BFI=1). (See GSM 06.21.)

5) Erased SID Frame Ratio (ESIDR)

A SID Frame is erased (SID=0) when the MS does not detect a valid transmitted SID frame as a valid SID frame (SID=2), or an invalid SID frame (SID=1). The Erased SID Frame Ratio is defined as the ratio of erased SID frames (SID=0), to the total number of valid SID frames transmitted. (See GSM 06.41.)

6) Erased Valid SID Frame Ratio (EVSIDR).

An Erased Valid SID Frame is declared when the MS does not detect a valid transmitted SID frame as a valid SID frame (SID=2) and (BFI=0 and UFI=0). The Erased Valid SID Frame Ratio is defined as the ratio of erased valid SID frames (SID=0), or (SID=1), or ((BFI or UFI)=1), to the total number of valid SID frames transmitted. (See GSM 06.41.)

Test method

Each test is performed in the following manner:

- a) Set up the required test conditions.
- b) Perform the test for at least the minimum number of samples (frames, bits or bits from non erased frames) and record the number of offered samples and the number of occurred events (frame, bit or residual bit errors).
- c) Terminate the test and determine the test result ("pass" or "fail") by comparing the measured error rate against the test limit error rate.

It is permitted to run the test over more samples than the value stated for minimum number of samples. The effect of increasing the number of samples is always to give a higher probability that a good unit will pass and a lower risk that a bad unit will pass, according to the definitions of good and bad unit in this section.

Test criteria

The limits on number of samples and test limit error rate shall be defined in order to comply with different requirements:

- 1) to keep reasonably low the risk of passing a bad unit for each individual test;
- 2) to have high probability of passing a good unit for each individual test;
- 3) to perform measurements with a high degree of statistical significance;
- 4) to keep the test time as low as possible.

The risk of passing a bad unit (point 1) should be kept lower than 0,2 %. The performance on a full rate channel, or a half rate data channel, is generally considered "bad" if its BER (or FER) performance is 1,5 times worse than that specified in AWGN (Additive White Gaussian Noise) and 1,26 times worse than that specified in multipath

environment. These values have been adopted (taking into account the expected shapes of the BER performance) in order not to pass a unit with performance worse than the specifications by more than 1 dB.

The performance on a half rate speech channel, is generally considered "bad" if the BER (or FER, or UFR) is worse than that specified, multiplied by the factors given in table 14-1. These values have been adopted (taking into account the expected shapes of the BER performance) in order not to pass a unit with performance worse than the specifications by more than 1 dB.

Table 14-1: TCH/HS "bad" unit multiplication factors

Propagation Conditions	GSM 400, GSM 700, GSM 850 and GSM 900				DCS 1 800 and PCS 1 900			
	TUlow (No FH)	TUhigh (FH/ No FH)	HT (No FH)	RA (No FH)	TUlow (No FH)	TUhigh (FH/ No FH)	HT (No FH)	RA (No FH)
Reference sensitivity:								
TCH/HS FER		1,7				1,7		
TCH/HS class Ib (BFI=0)		2,2				2,0		
TCH/HS class II (BFI=0)		1,2	1,2	1,2		1,2	1,2	1,2
TCH/HS UFR		2,0				1,9		
TCH/HS class Ib (BFI=0 and UFI=0)		1,8				1,7		
Reference interference:								
TCH/HS FER		1,6				1,6		
TCH/HS class Ib (BFI=0)		1,8				1,8		
TCH/HS class II (BFI=0)		1,2				1,2		
TCH/HS UFR		1,6				1,6		
TCH/HS class Ib (BFI or UFI)=0		1,4				1,4		
EVSIDR	1,2				1,2			
RBBER (SID=2 & (BFI or UFI)=0)	1,3				1,3			
ESIDR	1,3				1,3			
RBBER (SID=1 or SID=2)	1,3				1,3			

The probability of passing a good unit operating on the specification limit of performance (point 2) should be at least 99,7 %.

If the error events can be assumed to be random independent variables, outputs of stationary random processes with identical Gaussian distributions, the previous figures suggest a number of events (point 3) not lower than 200 in AWGN channel and not lower than 600 in a multipath environment, and to test a BER (or FER) performance 1,22 times worse than that specified in AWGN and 1,12 times worse than that specified in a multipath environment (this corresponds to testing a performance, at the most, 0,5 dB worse than that specified).

For multipath propagation conditions the hypothesis of stationary random processes does not generally hold. In case of non frequency hopping operation mode, the radio channel may be assumed to change 10 times per wavelength of travelled distance and to be short term stationary in between. So, in this case, the required observation time for having good statistical properties should not be lower (with some rounding) than that reported in table 14-1.

Table 14-2: Minimum test time according to propagation profile

Propagation Conditions	GSM 400, GSM 700, GSM 850 and GSM 900				DCS 1 800 and PCS 1 900			
	TUlow	TUhigh	HT	RA	TUlow	TUhigh	HT	RA
Min. test time (s)	500	30	15	6	500	15	7,5	6

Tables 14-3 and 14-4 detail, for the different test conditions, the minimum number of samples required in order to meet points 1) to 3): the corresponding test time (point 4) can be consequently computed.

As can be seen in the tables, in some of the cases in which both FER and RBBER have to be tested on the same channel, the length of time for the FER measurement has been adopted for the RBBER measurement. This is longer than that required for the RBBER only according to the discussed criteria, but allows the use of a test limit error rate closer to the specified error rate while maintaining the same statistical significance. When, as is normal, it is desired to perform the

FER and RBER tests, the closer test limit error rate for the RBER measurement can be achieved without increasing the total test time. It is always possible to extend the length of any test and further improve the statistical significance of that test.

Table 14-3: Test conditions for GSM 400, GSM 700, GSM 850 and GSM 900

Type of test	Type of channel	Propagation/frequency conditions	Specified FER/BER %	Test limit FER/BER %	Minimum No of samples	Prob that good unit will pass %	Bad unit BER/ FER %	Risk that bad unit will pass
BFI	TCH/FS	Static	0,033	0,041	492000	99,813	0,050	0,140
	TCH/FS	Static / FH	0,033	0,041	492000	99,813	0,050	0,140
Sensitivity	TCH/FS	Static/FH	0,100* α	0,122* α	164000	99,717	0,150* α	0,140
„	TCH/FS Class Ib	Static/FH	0,400/ α	0,410/ α	20000000	100,000	0,600/ α	<0,001
„	TCH/FS Class II	Static/FH	2,000	2,439	8200	99,714	3,000	0,001
„	TCH/FS	TUhigh/No FH	6,000* α	6,742* α	8900	99,825	7,560* α	0,162
„	TCH/FS Class Ib	TUhigh/No FH	0,400/ α	0,420/ α	1000000	99,919	0,504/ α	<0,001
„	TCH/FS Class II	TUhigh/No FH	8,000	8,333	120000	99,999	10,080	<0,001
„	TCH/FS Class II	HT/No FH	9,000	9,333	60000	99,779	11,340	<0,001
„	TCH/FS Class II	RA/No FH	7,000	7,500	24000	99,873	8,694	<0,001
„	TCH/EFS	Static/FH	0,100	0,122	164000	99,758	0,150	0,171
„	TCH/EFS Class Ib	Static/FH	0,100	0,110	20000000	100	0,150	<0,001
„	TCH/EFS Class II	Static/FH	2,000	2,439	8200	99,753	3,000	0,168
„	TCH/EFS	TUhigh/No FH	8,000	8,867	8900	99,808	10,080	0,016
„	TCH/EFS Class Ib	TUhigh/No FH	0,210	0,224	1000000	99,887	0,265	<0,001
„	TCH/EFS Class II	TUhigh/No FH	7,000	7,500	120000	99,999	8,820	<0,001
„	TCH/EFS Class II	HT/No FH	9,000	9,350	60000	99,787	11,340	<0,001
„	TCH/EFS Class II	RA/No FH	7,000	7,500	24000	99,829	8,820	<0,001
„	TCH/HS (FER)	TUhigh/No FH	4,100	4,598	13050	99,776	6,970	<0,001
„	TCH/HS Class Ib (BFI=0)	TUhigh/No FH	0,360	0,404	148500	99,750	0,792	<0,001
„	TCH/HS Class II (BFI=0)	TUhigh/No FH	6,900	7,725	25500	100,00	8,280	0,061
„	TCH/HS Class II (BFI=0)	HT/No FH	7,600	8,500	20000	100,00	9,120	0,110
„	TCH/HS Class II (BFI=0)	RA/No FH	6,800	7,600	20000	100,00	8,160	0,182
„	TCH/HS (UFR)	TUhigh/No FH	5,600	6,250	9600	99,702	11,200	<0,001
„	TCH/HS Class Ib (BFI or UFI)=0	TUhigh/No FH	0,240	0,269	227000	99,721	0,432	<0,001
„	FACCH/F	TUhigh/No FH	8,000	8,961	6696	99,798	10,080	0,108
„	FACCH/H	TUhigh/No FH	6,900	7,728	7764	99,785	8,694	0,115
„	TCH/F9,6&H4,8	HT/No FH	0,700	0,778	180000	99,995	0,882	<0,001
„	TCH/F4,8	HT/No FH	0,010	0,011	5350000	99,732	0,013	0,197
„	TCH/F2,4	HT/No FH	0,001	0,001	11900000	99,734	0,002	<0,001
„	TCH/H2,4	HT/No FH	0,010	0,011	5350000	99,732	0,013	0,197
Input level	TCH/FS Class II	Static<-40dBm	0,010	0,012	1640000	99,716	0,015	0,141
Input level range	TCH/FS Class II	Static<-15dBm	0,100	0,122	164000	99,717	0,150	0,140
„	TCH/FS Class II	EQ	3,000	3,250	120000	100,000	3,780	<0,001
Co-channel rejection	TCH/FS	TUlow/No FH	21,000* α	24,000* α	25000	100,000	27,720* α	<0,001
„	TCH/FS Class Ib	TUlow/No FH	2,000/ α	2,091/ α	3300000	100,000	2,520/ α	<0,001
„	TCH/FS Class II	TUlow/No FH	4,000	4,300	2000000	100,000	5,040	<0,001
„	TCH/FS	TUhigh/FH	3,000* α	3,371* α	17800	99,797	3,780* α	0,194
„	TCH/FS Class Ib	TUhigh/FH	0,200/ α	0,215/ α	2000000	100,000	0,252/ α	<0,001
„	TCH/FS Class II	TUhigh/FH	8,000	8,333	1200000	100,000	10,080	<0,001
„	TCH/EFS	TUlow/No FH	23,000	24,000	25000	99,951	27,720	<0,001
„	TCH/EFS Class Ib	TUlow/No FH	0,2000	0,209	3300000	99,987	0,252	<0,001
„	TCH/EFS Class II	TUlow/No FH	3,000	3,039	2000000	99,927	3,780	<0,001
„	TCH/EFS	TUhigh/FH	3,000	3,357	17800	99,702	3,780	0,185
„	TCH/EFS Class Ib	TUhigh/FH	0,100	0,115	2000000	100,00	0,126	<0,001
„	TCH/EFS Class II	TUhigh/FH	8,000	8,333	1200000	99,998	10,08	<0,001
„	FACCH/F	TUlow/No FH	22,000	24,000	25000	100,000	27,720	<0,001
„	FACCH/H	TUlow/No FH	22,000	24,000	25000	100,000	27,720	<0,001
„	TCH/F9,6 or H4,8	TUhigh/FH	0,300	0,336	178500	99,716	0,378	0,180
„	TCH/F4,8	TUhigh/FH	0,010	0,011	5350000	99,732	0,013	0,197
„	TCH/F2,4	TUhigh/FH	0,001	0,001	11900000	99,734	0,002	<0,001
„	TCH/H2,4	TUhigh/FH	0,010	0,011	5350000	99,732	0,013	0,197

Table 14-3: Test conditions for GSM 400, GSM 700, GSM 850 and GSM 900 (concluded)

Type of test	Type of channel	Propagation/ frequency conditions	Specified FER/BER %	Test limit FER/BER %	Minimum No of samples	Prob that good unit will pass %	Bad unit BER/BER %	Risk that bad unit will pass
Adjacent channel 200 kHz	TCH/FS	TUhigh/No FH	6,000* α	6,742* α	8900	99,825	7,560* α	0,162
	TCH/FS Class Ib	TUhigh/No FH	0,400/ α	0,420/ α	1000000	99,919	0,504/ α	<0,001
	TCH/FS Class II	TUhigh/No FH	8,000	8,333	600000	100,000	10,080	<0,001
	TCH/HS (FER)	TUhigh/FH	5,000	5,607	10700	99,787	8,000	<0,001
	TCH/HS Class Ib (BFI=0)	TUhigh/FH	0,290	0,325	184700	99,711	0,522	<0,001
	TCH/HS Class II (BFI=0)	TUhigh/FH	7,100	7,961	25500	100,00	8,520	0,065
	TCH/HS (UFR)	TUhigh/FH	6,100	6,834	8780	99,781	9,760	<0,001
	TCH/HS Class Ib (BFI or UFI)=0	TUhigh/FH	0,210	0,235	255000	99,715	0,294	<0,001
	EVSIDR	TUlow/No FH	21,900	24,000	25000	100,000	26,280	<0,001
	SID RBER (SID=2 and (BFI or UFI)=0)	TUlow/No FH	0,020	0,022	2678500	99,705	0,026	0,010
Adjacent channel 400 kHz	ESIDR	TUlow/No FH	17,100	19,152	25000	100,000	22,230	<0,001
	SID RBER (SID=1 or SID=2)	TUlow/No FH	0,500	0,560	500000	100,000	0,650	<0,001
	FACCH/F	TUhigh/No FH	9,500	10,640	5639	99,812	11,970	0,096
	TCH/FS	TUhigh/No FH	10,200* α	11,461* α	8900	99,995	12,852* α	0,004
TCH/FS Class Ib	TUhigh/No FH	0,720/ α	0,756/ α	1000000	99,999	0,9077/ α	<0,001	
TCH/FS Class II	TUhigh/No FH	8,800	9,167	600000	100,000	11,088	<0,001	
FACCH/F	TUhigh/No FH	17,100	19,152	3133	99,878	21,546	<0,052	
Intermod.	TCH/FS Class II	Static	2,000	2,439	8200	99,741	3,000	0,122
	FACCH/F	TUhigh/No FH	8,000	8,961	6696	99,798	10,080	0,108
Blocking & spurious resp.	TCH/FS Class II	Static	2,000	2,439	8200	99,741	4,000	<0,001
	FACCH/F	TUhigh/No FH	8,000	8,961	6696	99,798	10,080	0,108

Table 14-4: Test conditions for DCS 1 800 DCS 1 800 and PCS 1 900

Type of test	Type of channel	Propagation/ Frequency conditions	Specified	Test limit FER/BER %	Mini-mum No of samples	Prob that good unit will pass %	Bad unit FER/BER %	Risk that bad unit will pass	
BFI	TCH/FS	Static	0,033	0,041	492000	99,813	0,050	0,140	
	TCH/FS	Static/FH	0,033	0,041	492000	99,813	0,050	0,140	
Sensitivity	TCH/FS	Static/FH	0,100* α	0,122* α	164000	99,717	0,150* α	0,140	
„	TCH/FS Class Ib	Static/FH	0,400/ α	0,410/ α	2000000	100,000	0,600/ α	<0,001	
„	TCH/FS Class II	Static/FH	2,000	2,439	8200	99,714	3,000	0,001	
„	TCH/FS	TUhigh/No FH	4,000* α	4,478* α	13400	99,743	5,040* α	0,133	
„	TCH/FS Class Ib	TUhigh/No FH	0,300/ α	0,320/ α	1500000	100,000	0,378/ α	<0,001	
„	TCH/FS Class II	TUhigh/No FH	8,000	8,333	60000	99,865	10,080	<0,001	
„	TCH/FS Class II	HT/No FH	9,000	9,333	30000	97,826	11,340	<0,001	
„	TCH/FS Class II	RA/No FH	7,000	7,500	24000	99,873	8,820	<0,001	
„	TCH/EFS	Static/FH	0,100	0,122	164000	99,758	0,150	0,171	
„	TCH/EFS Class Ib	Static/FH	0,100	0,110	2000000	100,00	0,150	<0,001	
„	TCH/EFS Class II	Static/FH	2,000	2,439	8200	99,753	3,000	0,168	
„	TCH/EFS	TUhigh/No FH	4,000	4,475	13400	99,701	5,040	0,179	
„	TCH/EFS Class Ib	TUhigh/No FH	0,120	0,130	1500000	99,979	0,151	<0,001	
„	TCH/EFS Class II	TUhigh/No FH	8,000	8,333	60000	99,804	10,080	<0,001	
„	TCH/EFS Class II	HT/No FH	9,000	9,498	30000	99,798	11,340	<0,001	
„	TCH/EFS Class II	RA/No FH	7,000	7,500	24000	99,829	8,820	<0,001	
„	TCH/HS (FER)	TUhigh/No FH	4,200	4,706	12750	99,763	7,140	<0,001	
„	TCH/HS Class Ib (BFI=0)	TUhigh/No FH	0,380	0,426	141000	99,706	0,760	<0,001	
„	TCH/HS Class II (BFI=0)	TUhigh/No FH	6,900	7,725	25500	100,00	8,280	0,061	
„	TCH/HS Class II (BFI=0)	HT/No FH	7,800	8,735	20000	100,00	9,360	0,114	
„	TCH/HS Class II (BFI=0)	RA/No FH	6,800	7,600	20000	100,00	8,160	0,182	
„	TCH/HS (UFR)	TUhigh/No FH	5,700	6,383	9400	99,769	10,830	<0,001	
„	TCH/HS Class Ib (BFI or UFI0=0)	TUhigh/No FH	0,260	0,291	206000	99,712	0,442	<0,001	
„	FACCH/F	TUhigh/No FH	3,900	4,368	13736	99,752	4,914	0,140	
„	FACCH/H	TUhigh/No FH	7,200	7,752	7440	97,027	9,072	0,002]	
„	TCH/F9,6	HT/No FH	0,700	0,784	76500	99,721	0,882	0,176	
„	TCH/F4,8	HT/No FH	0,010	0,011	5350000	99,732	0,013	0,197	
„	TCH/F2,4	HT/No FH	0,001	0,001	11900000	99,734	0,002	<0,001	
Input level range	TCH/FS Class II	Static-23dBm	0,100	0,122	164000	99,717	0,150	0,140	
	TCH/FS Class II	Static<-40dBm	0,010	0,012	1640000	99,716	0,015	0,141	
	TCH/FS Class II	EQ	3,000	3,250	60000	99,981	3,780	<0,001	
Co-channel rejection	TCH/FS	TUlow/No FH	21,00* α	24,00* α	25000	100,000	26,460* α	<0,001	
	TCH/FS Class Ib	TUlow/No FH	2,000/ α	2,091/ α	3300000	100,000	2,520/ α	<0,001	
	„	TCH/FS Class II	TUlow/No FH	4,000	4,300	2000000	100,000	5,040	<0,001
	„	TCH/FS	TUhigh/FH	3,000* α	3,371* α	17800	99,797	3,780* α	0,194
	„	TCH/FS Class Ib	TUhigh/FH	0,200/ α	0,215/ α	2000000	100,000	0,252/ α	<0,001
	„	TCH/FS Class II	TUhigh/FH	8,000	8,333	1200000	100,000	10,080	<0,001
	„	TCH/EFS	TUlow/No FH	23,000	24,000	25000	99,999	26,680	<0,001
	„	TCH/EFS Class Ib	TUlow/No FH	0,200	0,209	3300000	100,000	0,252	<0,001
	„	TCH/EFS Class II	TUlow/No FH	3,000	3,039	2000000	100,000	3,780	<0,001
	„	TCH/EFS	TUhigh/FH	3,000	3,357	17800	99,815	3,780	0,185
	„	TCH/EFS Class Ib	TUhigh/FH	0,100	0,115	2000000	99,999	0,126	<0,001
	„	TCH/EFS Class II	TUhigh/FH	8,000	8,333	1200000	100,00	10,08	<0,001
	„	FACCH/F	TUlow/No FH	22,000	24,000	25000	100,000	27,720	<0,001
	„	FACCH/H	TUlow/No FH	22,000	24,000	25000	100,000	27,720	<0,001
	„	TCH/F9,6 or H4,8	TUhigh/FH	0,300	0,336	178500	99,716	0,378	0,180
	„	TCH/F4,8	TUhigh/FH	0,010	0,011	5350000	99,732	0,013	0,197
	„	TCH/F2,4	TUhigh/FH	0,001	0,001	11900000	99,734	0,002	<0,001
	„	TCH/H2,4	TUhigh/FH	0,010	0,011	5350000	99,732	0,013	0,197

Table 14-4: Test conditions for DCS 1 800 DCS 1 800 and PCS 1 900 (concluded)

Type of test	Type of channel	Propagation/ Frequency conditions	Specified	Test limit FER/BER %	Minimum No of samples	Prob that good unit will pass %	Bad unit FER/BER %	Risk that bad unit will pass
Adjacent channel 200 kHz ,, ,, ,, ,, ,, ,, ,, ,, ,, ,,	TCH/FS	TUhigh/No FH	3,000* α	3,371* α	17800	99,797	3,780* α	0,194
	TCH/FS Class Ib	TUhigh/No FH	0,250/ α	0,270/ α	2000000	100,000	0,315/ α	<0,001
	TCH/FS Class II	TUhigh/No FH	8,100	8,333	1200000	100,000	10,206	<0,001
	TCH/HS (FER)	TUhigh/FH	5,000	5,607	10700	99,787	8,000	<0,001
	TCH/HS Class Ib (BFI=0)	TUhigh/FH	0,290	0,325	184700	99,711	0,522	<0,001
	TCH/HS Class II (BFI=0)	TUhigh/FH	7,200	8,078	25500	100,00	8,640	0,066
	TCH/HS (UFR)	TUhigh/FH	6,100	6,834	8780	99,781	9,760	<0,001
	TCH/HS Class Ib (BFI or UFI)=0)	TUhigh/FH	0,210	0,235	255000	99,715	0,294	<0,001
	EVSIDR	TUlow/No FH	21,900	24,000	25000	100,000	26,280	<0,001
	SID RBER (SID=2 and (BFI or UFI)=0)	TUlow/No FH	0,020	0,022	2678500	99,705	0,026	0,010
	ESIDR	TUlow/No FH	17,100	19,152	25000	100,000	22,230	<0,001
	SID RBER (SID=1 or SID=2)	TUlow/No FH	0,500	0,560	500000	100,000	0,650	<0,001
FACCH/F	TUhigh/No FH	3,400	3,808	15756	99,746	4,284	0,145	
Adjacent channel 400 kHz ,,	TCH/FS	TUhigh/No FH	5,100* α	5,714* α	10500	99,773	6,426* α	0,134
	TCH/FS Class Ib	TUhigh/No FH	0,450/ α	0,483/ α	1200000	100,000	0,567/ α	<0,001
	TCH/FS Class II	TUhigh/No FH	8,900	9,167	720000	100,000	11,214	<0,001
	FACCH/F	TUhigh/No FH	6,100	6,832	8782	99,777	7,686	0,122
Intermod,	TCH/FS Class II	Static	2,000	2,439	8200	99,741	3,000	0,122
	FACCH/F	TUhigh/No FH	3,900	4,368	13736	99,752	4,914	0,140
Blocking & spurious resp.	TCH/FS Class II	Static	2,000	2,439	8200	99,741	4,000	<0,001
	FACCH/F	TUhigh/No FH	3,900	4,368	13736	99,752	4,914	0,140

NOTE 1: α is a parameter which ranges from 1 to 1,6. The value of α for a RBER test on TCH/FS class Ib bits under particular measurement conditions shall be the same as that determined in the FER test on TCH/FS under the same conditions. For example, the value of α may be different for a TUhigh sensitivity test and an RA sensitivity test. The value of α is determined by dividing the measured error rate for the FER test by the value of the test limit error rate listed in the limits section of the test corresponding to $\alpha=1$; if the result of the division is lower than 1, a value of $\alpha=1$ shall be used, if the value of $\alpha > 1,6$ the FER test has failed (the normal treatment of stimulus uncertainties applies). The probabilities that a good unit will pass and the risks that a bad unit will pass, listed in the table are valid for $\alpha=1$, and would be slightly different for other values of α .

NOTE 2: In order to save time the sensitivity and co-channel rejection tests for the TCH/F2,4 channel does not comply with the above said constraints.

In fact, a bad unit which performs 2 times (instead of 1,26) worse than that specified is accounted for, so reducing the required number of events to 150, instead of 600. On the other hand, the specified RBER is in this case 10E-5 and, on the basis of simulations and hardware validation results, doubling this RBER results in a drop in performance of less than 1 dB.

14.1 Bad frame indication

14.1.1 Bad frame indication - TCH/FS

14.1.1.1 Bad frame indication - TCH/FS - Random RF input

14.1.1.1.1 Definition and applicability

The performance of the Bad Frame Indication (BFI) is a measure of the effectiveness of the MS under DTX conditions. It includes the effect of the 3 bit Cyclic Redundancy Check (CRC) and all other processing associated with the DTX function. The BFI is measured on a full rate speech TCH (TCH/FS) by counting the number of undetected bad frames whilst the input signal is a randomly modulated carrier.

The requirements and this test only apply to MS supporting speech.

14.1.1.1.2 Conformance requirement

On a full rate speech TCH (TCH/FS) with a random RF input, the overall reception performance shall be such that, on average, less than one undetected bad speech frame (false bad frame indication) in 60 seconds will be measured; GSM 05.05, 6.4 b

14.1.1.1.3 Test purpose

1. To verify that the BFI performance does not exceed the conformance requirement with an allowance for the statistical significance of the test.
2. To verify that on reception of a SID frame the BFI is not set.

14.1.1.1.4 Method of test

14.1.1.1.4.1 Initial conditions

A call is set up according to the generic call set up procedure on a TCH/FS with an ARFCN in the Mid ARFCN range, power control level set to maximum power.

The SS commands the MS to complete the traffic channel loop back and signal the bad frame indication.

NOTE: DTX is used during the test to prevent the MS dropping the call.

14.1.1.1.4.2 Procedure

- a) The SS simulates a BSS in DTX mode. During the period when no transmission would occur the SS transmits a GSM carrier modulated with random data at a level 11 dB above reference sensitivity level(). The SACCH is transmitted normally at a level 20 dB above reference sensitivity(). The SID frame is transmitted in its correct time interval with valid information at a level 20 dB above reference sensitivity level(). During transmission of SACCH or SID frames the random data is discontinued.
- b) The SS transmits at least the minimum number of samples of frames of TCH/FS information and checks the BFI of the looped back signal from the MS. The SS records the number of frames where the bad frame indication is not set. During transmission by the SS of SID frames the SS checks that the BFI is not set.

NOTE 1: Further explanations on the mechanism of signalling the BFI to the SS will be found in clause 36.

NOTE 2: In some cases the MS decodes half SID frames correctly even if these are not transmitted completely. Therefore, in case that a MS detects a good SID frame, the SS has to consider the received bits in detail.

14.1.1.1.5 Test requirements

The BFI performance is accepted if the measured rate of undetected bad frames does not exceed the test limit error rate:

Test limit error rate: 0,041 %

Minimum number of samples: 492 000 (excluding SID frames).

During loop back of SID frames no BFI shall be set.

14.1.1.2 Bad frame indication - TCH/FS - Frequency hopping and downlink DTX

14.1.1.2.1 Definition and applicability

The performance of the Bad Frame Indication (BFI) is a measure of the effectiveness of the MS under DTX conditions. It includes the effect of the 3 bit Cyclic Redundancy Check (CRC) and all other processing associated with the DTX function. The BFI is measured on a full rate speech TCH (TCH/FS) by counting the number of undetected bad frames whilst the input signal is a randomly modulated carrier.

The requirements and this test only apply to MS supporting speech.

14.1.1.2.2 Conformance requirement

On a speech TCH (TCH/FS or TCH/HS), when DTX is activated with frequency hopping through C0 where bursts comprising SID frames, SACCH frames and dummy bursts are received at a level 20 dB above the reference sensitivity level and with no transmissions at the other bursts of the TCH, the overall reception performance shall be such that, on average less than one undetected bad speech frame (false bad frame indication BFI) shall be measured in one minute for MS. GSM 05.05, 6.4 c.

14.1.1.2.3 Test purpose

1. To verify that the BFI performance in case of frequency hopping including the C0 radio frequency does not exceed the conformance requirement with an allowance for the statistical significance of the test.
2. To verify that on reception of a SID frame the BFI is not set.

14.1.1.2.4 Method of test

14.1.1.2.4.1 Initial conditions

A call is set up according to the generic call set up procedure on a TCH/FS with a transmitted burst 20 dB above reference sensitivity. Random frequency hopping on two channels including the C0 radio frequency with ARFCNs with at least 5 channels separation shall be used, power control level set to maximum power.

The SS commands the MS to complete the traffic channel loop back and signal the bad frame indication.

NOTE: DTX is used during the test to prevent the MS dropping the call.

14.1.1.2.4.2 Procedure

- a) The SS sets downlink DTX on.
- b) The SS performs the measurement over at least the minimum number of samples of frames of TCH/FS information and checks the BFI of the looped back signal from the MS. The SS only transmits SID frames, SACCH frames and dummy bursts, with no transmission of TCH bursts. The SS records the number of frames where the bad frame indication is not set. During transmission by the SS of SID frames the SS checks that the BFI is not set.

NOTE 1: Further explanations on the mechanism of signalling the BFI to the SS will be found in clause 36.

NOTE 2: In some cases the MS decodes half SID frames correctly even if these are not transmitted completely. Therefore, in case that a MS detects a good SID frame, the SS has to consider the received bits in detail.

14.1.1.2.5 Test requirements

The BFI performance is accepted if the measured rate of undetected bad frames does not exceed the test limit error rate:

Test limit error rate: 0,041 %

Minimum number of samples: 492 000 (excluding SID frames).

During loop back of SID frames no BFI shall be set.

14.1.2 Bad frame indication - TCH/HS

14.1.2.1 Bad frame indication - TCH/HS - Random RF input

14.1.2.1.1 Definition and applicability

The performance of the Bad Frame Indication (BFI) is a measure of the effectiveness of the MS under DTX conditions. It includes the effect of the 3 bit Cyclic Redundancy Check (CRC) and all other processing associated with the DTX function. The BFI is measured on a half rate speech TCH (TCH/HS) by counting the number of undetected bad frames whilst the input signal is a randomly modulated carrier.

The requirements and this test only apply to MS supporting half rate speech.

14.1.2.1.2 Conformance requirement

On a half rate speech TCH (TCH/HS) with a random RF input, the overall reception performance shall be such that, on average, less than one undetected bad speech frame (false bad frame indication) in 60 seconds will be measured; GSM 05.05, 6.4 b.

14.1.2.1.3 Test purpose

1. To verify that the BFI performance does not exceed the conformance requirement with an allowance for the statistical significance of the test.
2. To verify that on reception of a SID frame the BFI is not set.

14.1.2.1.4 Method of test

14.1.2.1.4.1 Initial conditions

A call is set up according to the generic call set up procedure on a TCH/HS with an ARFCN in the Mid ARFCN range, power control level set to maximum power.

The SS commands the MS to complete traffic channel loop back A and signal frames detected with BFI=1 as erased.

NOTE 1: Test loop A is defined in clause 36. Frames detected with BFI=1 are signalled as erased on the uplink.

NOTE 2: DTX is used during the test to prevent the MS dropping the call.

14.1.2.1.4.2 Procedure

- a) The SS simulates a BSS in DTX mode. During the periods when no transmission would occur, the SS transmits a GSM carrier modulated with random data, at a level 11 dB above reference sensitivity level(). The SACCH is transmitted normally, at a level 20 dB above reference sensitivity(). The SID frame is transmitted in its correct time interval, with valid information, at a level 20 dB above reference sensitivity level(). During transmission of SACCH or SID frames, the random data is discontinued.
- b) The SS transmits at least the minimum number of samples of frames of TCH/HS information and checks the BFI of the looped back signal from the MS. The SS records the number of frames where the bad frame indication is not set. During transmission by the SS of SID frames the SS checks that the BFI is not set.

14.1.2.1.5 Test requirements

The BFI performance is accepted if the measured rate of undetected bad frames does not exceed the test limit error rate:

Test limit error rate: 0,041 %

Minimum number of samples: 492 000 (excluding SID frames).

During loop back of SID frames no BFI shall be set.

14.1.2.2 Bad frame indication - TCH/HS - Frequency hopping and downlink DTX

14.1.2.2.1 Definition and applicability

The performance of the Bad Frame Indication (BFI) is a measure of the effectiveness of the MS under DTX conditions. It includes the effect of the 3 bit Cyclic Redundancy Check (CRC) and all other processing associated with the DTX function. The BFI is measured on a half rate speech TCH (TCH/HS) by counting the number of undetected bad frames whilst the input signal is a randomly modulated carrier.

The requirements and this test only apply to MS supporting half rate speech.

14.1.2.2.2 Conformance requirement

On a half rate speech TCH (TCH/HS), when DTX is activated with frequency hopping through C0 where bursts comprising SID frames, SACCH frames and dummy bursts are received at a level 20 dB above the reference sensitivity level and with no transmissions at the other bursts of the TCH, the overall reception performance shall be such that, on average less than one undetected bad speech frame (false bad frame indication BFI) shall be measured in one minute for MS. GSM 05.05, 6.4 c.

14.1.2.2.3 Test purpose

1. To verify that the BFI performance in case of frequency hopping including the C0 radio frequency does not exceed the conformance requirement with an allowance for the statistical significance of the test.
2. To verify that on reception of a SID frame the BFI is not set.

14.1.2.2.4 Method of test

14.1.2.2.4.1 Initial conditions

A call is set up according to the generic call set up procedure on a TCH/HS with a transmitted burst 20 dB above reference sensitivity. Random frequency hopping on two channels including the C0 radio frequency with ARFCNs with at least 5 channels separation shall be used, power control level set to maximum power.

The SS commands the MS to complete the traffic channel loop back and signal the bad frame indication.

NOTE: DTX is used during the test to prevent the MS dropping the call.

14.1.2.2.4.2 Procedure

- a) The SS sets downlink DTX on.
- b) The SS performs the measurement over at least the minimum number of samples of frames of TCH/HS information and checks the BFI of the looped back signal from the MS. The SS only transmits SID frames, SACCH frames and dummy bursts, with no transmission of TCH bursts. The SS records the number of frames where the bad frame indication is not set. During transmission by the SS of SID frames the SS checks that the BFI is not set.

NOTE 1: Further explanations on the mechanism of signalling the BFI to the SS will be found in clause 36.

NOTE 2: In some cases the MS decodes half SID frames correctly even if these are not transmitted completely. Therefore, in case that a MS detects a good SID frame, the SS has to consider the received bits in detail.

14.1.2.2.5 Test requirements

The BFI performance is accepted if the measured rate of undetected bad frames does not exceed the test limit error rate:

Test limit error rate: 0,041 %

Minimum number of samples: 492 000 (excluding SID frames).

During loop back of SID frames no BFI shall be set.

14.1.3 Bad frame indication - TCH/FS - Frequency hopping and downlink DTX - Phase 2 MS in a phase 1 network

14.1.3.1 Definition and applicability

The performance of the Bad Frame Indication (BFI) is a measure of the effectiveness of the MS under DTX conditions. It includes the effect of the 3 bit Cyclic Redundancy Check (CRC) and all other processing associated with the DTX function. The BFI is measured on a full rate speech TCH (TCH/FS) by counting the number of undetected bad frames whilst the input signal is a randomly modulated carrier.

Annex A of GSM 05.02 requires that a phase 2 MS behave properly in a phase 1 network.

The requirements and this test only apply to MS supporting speech.

14.1.3.2 Conformance requirement

On a full rate speech TCH (TCH/FS) in DTX conditions with a transmitted burst 20 dB above reference sensitivity and static conditions, the overall reception performance shall be such that, on average, less than one undetected bad speech frame (false bad frame indication) in 60 seconds will be measured; GSM 05.05, 6.4 b.

14.1.3.3 Test purpose

1. To verify that the BFI performance in case of frequency hopping including the C0 radio frequency does not exceed the conformance requirement with an allowance for the statistical significance of the test.
2. To verify that on reception of a SID frame the BFI is not set.

14.1.3.4 Method of test

14.1.3.4.1 Initial conditions

Initial conditions 1

A call is set up according to the generic call set up procedure on a TCH/FS with a transmitted burst 20 dB above reference sensitivity. Random frequency hopping on two channels including the C0 radio frequency with ARFCNs with at least 5 channels separation shall be used, power control level set to maximum power.

When downlink DTX is activated with frequency hopping including the C0 radio frequency, the following configuration applies for filling the bursts on the C0 carrier:

C0 filling on the TCH	Half burst filling	Dummy bursts stealing flag	Half burst Filling stealing flag
Dummy bursts with (BN61, BN 62,...) mapped from the TSC bits of normal bursts. See section A.2.1.3 of GSM 05.02	Partial SID information. See section A.2.2.1 of GSM 05.02.	0	0

The SS commands the MS to complete the traffic channel loop back and signal the bad frame indication.

Initial conditions 2

A call is set up according to the generic call set up procedure on a TCH/FS with a transmitted burst 20 dB above reference sensitivity. Random frequency hopping on two channels including the C0 radio frequency with ARFCNs with at least 5 channels separation shall be used, power control level set to maximum power.

When downlink DTX is activated with frequency hopping including the C0 radio frequency, the following configuration applies for filling the bursts on the C0 carrier:

C0 filling on the TCH	Half burst filling	Dummy bursts stealing flag	Half burst Filling stealing flag
Partial SID information. See section A.2.1.4 of GSM 05.02	Partial SID information. See section A.2.2.1 of GSM 05.02.	1	1

The SS commands the MS to complete the traffic channel loop back and signal the bad frame indication.

Initial conditions 3

A call is set up according to the generic call set up procedure on a TCH/FS with a transmitted burst 20 dB above reference sensitivity. Random frequency hopping on two channels including the C0 radio frequency with ARFCNs with at least 5 channels separation shall be used, power control level set to maximum power.

When downlink DTX is activated with frequency hopping including the C0 radio frequency, the following configuration applies for filling the bursts on the C0 carrier:

C0 filling on the TCH	Half burst filling	Dummy bursts stealing flag	Half burst Filling stealing flag
Dummy bursts with 'C0 filling training sequence'. See section A.2.1.4 of GSM 05.02	Dummy bursts mixed bits. See section A.2.2.2 of GSM 05.02.	1	1

The SS commands the MS to complete the traffic channel loop back and signal the bad frame indication.

NOTE: DTX is used during the test to prevent the MS dropping the call.

14.1.3.4.2 Procedure

The two following steps are repeated 3 times, once for each initial condition specified in the previous clause.

- a) The SS sets downlink DTX on.
- b) The SS transmits at least the minimum number of samples of frames of TCH/FS information and checks the BFI of the looped back signal from the MS. The SS records the number of frames where the bad frame indication is not set. During transmission by the SS of SID frames the SS checks that the BFI is not set.

NOTE 1: Further explanations on the mechanism of signalling the BFI to the SS will be found in clause 36.

NOTE 2: In some cases the MS decodes half SID frames correctly even if these are not transmitted completely. Therefore, in case that a MS detects a good SID frame, the SS has to consider the received bits in detail.

14.1.3.5 Test requirements

after each repetition of steps a) + b) the following requirements are applied:

The BFI performance is accepted if the measured rate of undetected bad frames does not exceed the test limit error rate:

Test limit error rate: 0,041 %

Minimum number of samples: 492 000 (excluding SID frames).

During loop back of SID frames no BFI shall be set.

14.1.4 Bad frame indication - TCH/HS - Frequency hopping and downlink DTX - Phase 2 MS in a phase 1 network

14.1.4.1 Definition and applicability

The performance of the Bad Frame Indication (BFI) is a measure of the effectiveness of the MS under DTX conditions. It includes the effect of the 3 bit Cyclic Redundancy Check (CRC) and all other processing associated with the DTX function. The BFI is measured on a half rate speech TCH (TCH/HS) by counting the number of undetected bad frames whilst the input signal is a randomly modulated carrier.

Annex A of GSM 05.02 requires that a phase 2 MS behave properly in a phase 1 network.

The requirements and this test only apply to MS supporting half rate speech.

14.1.4.2 Conformance requirement

On a half rate speech TCH (TCH/HS) in DTX conditions with a transmitted burst 20 dB above reference sensitivity and static conditions, the overall reception performance shall be such that, on average, less than one undetected bad speech frame (false bad frame indication) in 60 seconds will be measured; GSM 05.05, 6.4 b.

14.1.4.3 Test purpose

1. To verify that the BFI performance in case of frequency hopping including the C0 radio frequency does not exceed the conformance requirement with an allowance for the statistical significance of the test.
2. To verify that on reception of a SID frame the BFI is not set.

14.1.4.4 Method of test

14.1.4.4.1 Initial conditions

Initial conditions 1

A call is set up according to the generic call set up procedure on a TCH/HS with a transmitted burst 20 dB above reference sensitivity. Random frequency hopping on two channels including the C0 radio frequency with ARFCNs with at least 5 channels separation shall be used, power control level set to maximum power.

When downlink DTX is activated with frequency hopping including the C0 radio frequency, the following configuration applies for filling the bursts on the C0 carrier:

C0 filling on the TCH	Half burst filling	Dummy bursts stealing flag	Half burst Filling stealing flag
Dummy bursts with (BN61, BN 62,...) mapped from the TSC bits of normal bursts. See section A.2.1.3 of GSM 05.02	Partial SID information. See section A.2.2.1 of GSM 05.02.	0	0

The SS commands the MS to complete the traffic channel loop back and signal the bad frame indication.

Initial conditions 2

A call is set up according to the generic call set up procedure on a TCH/HS with a transmitted burst 20 dB above reference sensitivity. Random frequency hopping on two channels including the C0 radio frequency with ARFCNs with at least 5 channels separation shall be used, power control level set to maximum power.

When downlink DTX is activated with frequency hopping including the C0 radio frequency, the following configuration applies for filling the bursts on the C0 carrier:

C0 filling on the TCH	Half burst filling	Dummy bursts stealing flag	Half burst Filling stealing flag
Partial SID information. See section A.2.1.4 of GSM 05.02	Partial SID information. See section A.2.2.1 of GSM 05.02.	1	1

The SS commands the MS to complete the traffic channel loop back and signal the bad frame indication.

Initial conditions 3

A call is set up according to the generic call set up procedure on a TCH/HS with a transmitted burst 20 dB above reference sensitivity. Random frequency hopping on two channels including the C0 radio frequency with ARFCNs with at least 5 channels separation shall be used, power control level set to maximum power.

When downlink DTX is activated with frequency hopping including the C0 radio frequency, the following configuration applies for filling the bursts on the C0 carrier:

C0 filling on the TCH	Half burst filling	Dummy bursts stealing flag	Half burst Filling stealing flag
Dummy bursts with 'C0 filling training sequence'. See section A.2.1.4 of GSM 05.02	Dummy bursts mixed bits. See section A.2.2.2 of GSM 05.02.	1	1

The SS commands the MS to complete the traffic channel loop back and signal the bad frame indication.

NOTE: DTX is used during the test to prevent the MS dropping the call.

14.1.4.4.2 Procedure

The two following steps are repeated 3 times, once for each initial condition specified in the previous clause.

- a) The SS sets downlink DTX on.
- b) The SS transmits at least the minimum number of samples of frames of TCH/HS information and checks the BFI of the looped back signal from the MS. The SS records the number of frames where the bad frame indication is not set. During transmission by the SS of SID frames the SS checks that the BFI is not set.

NOTE 1: Further explanations on the mechanism of signalling the BFI to the SS will be found in clause 36.

NOTE 2: In some cases the MS decodes half SID frames correctly even if these are not transmitted completely. Therefore, in case that a MS detects a good SID frame, the SS has to consider the received bits in detail.

14.1.4.5 Test requirements

After each repetition of steps a) + b) the following requirements are applied:

The BFI performance is accepted if the measured rate of undetected bad frames does not exceed the test limit error rate:

Test limit error rate: 0,041 %

Minimum number of samples: 492 000 (excluding SID frames).

During loop back of SID frames no BFI shall be set.

14.2 Reference sensitivity

14.2.1 Reference sensitivity - TCH/FS

14.2.1.1 Definition and applicability

The reference sensitivity is the signal level at the MS receiver input at which a certain BER and FER must be achieved.

The requirements and this test apply to MS supporting speech.

For E-GSM 900 MS this test is only performed in the P-GSM band.

14.2.1.2 Conformance requirement

1. At reference sensitivity level, the TCH/FS FER shall meet the reference sensitivity performance of table 1 in GSM 05.05; GSM 05.05, 6.2.
2. At reference sensitivity level, the TCH/FS class I RBER shall meet the reference sensitivity performance of table 1 in GSM 05.05; GSM 05.05, 6.2.

- 3 At reference sensitivity level, the TCH/FS class II RBER shall meet the reference sensitivity, performance of table 1 in GSM 05.05: GSM 05.05, 6.2.
- 4 At reference sensitivity level, the TCH/FS class II RBER shall meet the reference sensitivity, performance of table 1 in GSM under extreme conditions; GSM 05.05, 6.2, GSM 05.05, annex D D.2.1, D.2.2.

14.2.1.3 Test purpose

NOTE: This test is performed under STATIC propagation conditions to allow implicit testing of the ability of the MS to hop over the full band. The tests under dynamic propagation conditions are better suited to test the reference sensitivity conformance but cannot test hopping over the full band due to limited bandwidth of available fading simulators.

1. To verify that the MS does not exceed conformance requirement 1 under STATIC and TUhigh propagation conditions with an allowance for the statistical significance of the test.
2. To verify that the MS does not exceed conformance requirement 2 under STATIC and TUhigh propagation conditions with an allowance for the statistical significance of the test.
3. To verify that the MS does not exceed conformance requirement 3 under STATIC, TUhigh, RA and HT propagation conditions with an allowance for the statistical significance of the test.
4. To verify that the MS does not exceed conformance requirement 4 under STATIC and TUhigh propagation conditions with an allowance for the statistical significance of the test.

14.2.1.4 Method of test

NOTE 1: The BA list sent on the BCCH and SACCH will indicate at least six surrounding cells with at least one near to each band edge. It is not necessary to generate any of these BCCHs but, if provided the signal strengths of BCCHs shall be in the range $15 \text{ dB}\mu\text{Vemf}(\)$ to $35 \text{ dB}\mu\text{Vemf}(\)$.

NOTE 2: The ARFCN of any BCCH shall not be co-channel or on adjacent channels to the wanted traffic channel.

NOTE 3: When frequency hopping is used, the traffic channel may fall on any of the ARFCNs defined in section 6.

14.2.1.4.1 Initial conditions

A call is set up according to the generic call set up procedure on a TCH/FS with an ARFCN in the Mid ARFCN range for GSM 400, GSM 700, GSM 850, DCS 1800 and PCS 1900 and ARFCN 70 for GSM 900, power control level set to maximum power.

NOTE: For GSM 900 ARFCN 70 is tested since this is the 73rd harmonic of the 13 MHz clock normally used internally in a MS.

The SS transmits Standard Test Signal C1 on the traffic channel.

The SS commands the MS to create traffic channel loop back signalling erased frames.

14.2.1.4.2 Procedure

- a) The fading function is set to TUhigh.
- b) the SS sets the amplitude of the wanted signal to reference sensitivity level ().
- c) The SS compares the data of the signal that it sends to the MS with the signal which is looped back from the receiver after demodulation and decoding, and checks the frame erasure indication.
- d) The SS determines the number of residual bit error events for the bits of class II, by examining sequences of at least the minimum number of samples of consecutive bits of class II. Bits are taken only from those frames not signalled as erased.
- e) The SS determines the number of residual bit error events for the bits of the class Ib, by examining sequences of at least the minimum number of samples of consecutive bits of class Ib. Bits are only taken from those frames not signalled as erased.

- f) The SS also determines the frame erasure events by examining sequences of at least the minimum number of samples of consecutive frames and assuming a frame is received successfully, if it is not signalled as erased.
- g) Steps a) to d) are repeated under extreme test conditions.
- h) Steps a) to g) are repeated for TCH/FS with ARFCNs in the Low ARFCN range for GSM 400, GSM 700, GSM 850, DCS 1800 and PCS 1900 and ARFCN 5 for GSM 900 and the High ARFCN range.

NOTE: For GSM 900 ARFCN 5 is tested since this is the 72nd harmonic of the 13 MHz clock normally used internally in a MS.

- i) Steps b) to d) are repeated with the SS fading function set in turn to RA and HT.
- j) Steps b) to g) are repeated, with the SS fading function set to static and the MS is commanded by the SS into hopping mode using the hopping sequence defined in section 6.

The amplitude of the wanted signal is set according to step b). All the other time slots, except the active ones, are set to 20 dB above reference sensitivity level(). This implicitly tests adjacent time slot rejection.

14.2.1.5 Test requirements

The error rates measured for different channels and under the different propagation conditions, under any combination of normal and extreme test voltages and ambient temperatures, shall not exceed the test limit error rate values given in table 14-5 or 14-6:

Table 14-5: Limits for GSM 400, GSM 700, GSM 850 and GSM 900 sensitivity

Channels	Propagation conditions TUhigh		Propagation conditions RA		Propagation conditions HT		Static conditions	
	Test limit error rate %	Minimum No. of samples	Test limit error rate %	Minimum No. of samples	Test limit error rate %	Minimum No. of samples	Test limit error rate %	Minimum No. of samples
TCH/FS								
FER	$6,742 \cdot \alpha$	8900					$0,122 \cdot \alpha$	164000
class Ib(RBER)	$0,42/\alpha$	1000000					$0,41/\alpha$	20000000
class II(RBER)	8,333	120000	7,5	24000	9,333	60000	2,439	8200

Table 14-6: Limits for DCS 1 800 and PCS 1900 sensitivity

Channels	Propagation conditions TUhigh		Propagation conditions RA		Propagation conditions HT		Static conditions	
	Test limit error rate %	Minimum No. of samples	Test limit error rate %	Minimum No. of samples	Test limit error rate %	Minimum No. of samples	Test limit error rate %	Minimum No. of samples
TCH/FS								
FER	$4,478 \cdot \alpha$	13400					$0,122 \cdot \alpha$	164000
class Ib(RBER)	$0,32/\alpha$	1500000					$0,41/\alpha$	20000000
class II(RBER)	8,333	60000	7,5	24000	9,333	30000	2,439	8200

where α is a parameter which can range from 1 to 1.6. The value of α for a RBER test on TCH/FS class Ib bits under particular measurement conditions shall be the same as that determined in the FER test on TCH/FS under the same conditions.

14.2.2 Reference sensitivity - TCH/HS (Speech frames)

14.2.2.1 Definition and applicability

The reference sensitivity level is the signal level at the MS receiver input at which a certain BER and FER and UFR for speech frames must be achieved.

The requirements and this test apply to MS supporting half rate speech.

14.2.2.2 Conformance requirement

1. At reference sensitivity level, the TCH/HS FER shall meet the reference sensitivity performance of table 1 in GSM 05.05; GSM 05.05, 6.2.
2. At reference sensitivity level, the TCH/HS class Ib RBER (BFI=0) shall meet the reference sensitivity performance of table 1 in GSM 05.05; GSM 05.05 6.2.
3. At reference sensitivity level, the TCH/HS class II RBER (BFI=0) shall meet the reference sensitivity performance of table 1 in GSM 05.05: GSM 05.05, 6.2.
4. At reference sensitivity level, the TCH/HS UFR shall meet the reference sensitivity performance of table 1 in GSM 05.05; GSM 05.05 6.2.
5. At reference sensitivity level, the TCH/HS class Ib RBER ((BFI or UFI)=0) shall meet the reference sensitivity performance of table 1 in GSM 05.05; GSM 05.05, 6.2.

14.2.2.3 Test purpose

1. To verify that the MS does not exceed conformance requirement 1 under TUhigh propagation conditions with an allowance for the statistical significance of the test.
2. To verify that the MS does not exceed conformance requirement 2 under TUhigh propagation conditions with an allowance for the statistical significance of the test.
3. To verify that the MS does not exceed conformance requirement 3 under TUhigh, RA and HT propagation conditions with an allowance for the statistical significance of the test.
4. To verify that the MS does not exceed conformance requirement 4 under TUhigh propagation conditions with an allowance for the statistical significance of the test.
5. To verify that the MS does not exceed conformance requirement 5 under TUhigh propagation conditions with an allowance for the statistical significance of the test.

14.2.2.4 Method of test

14.2.2.4.1 Initial conditions

The BA list sent on the BCCH and SACCH indicates at least six surrounding cells, with at least one near to each band edge. It is not necessary to generate any of these BCCHs, but if provided, the signal strengths of BCCHs shall be in the range $15 \text{ dB}\mu\text{Vemf}(\)$ to $35 \text{ dB}\mu\text{Vemf}(\)$.

The ARFCN of any BCCH shall not be co-channel or on adjacent channels to the wanted traffic channel.

A call is set up according to the generic call set up procedure on a TCH/HS with an ARFCN in the mid ARFCN range, power control level set to maximum power.

The SS transmits Standard Test Signal C1 on the traffic channel.

14.2.2.4.2 Procedure

- a) The SS commands the MS to create traffic channel loop back signalling erased frames using test loop A.

NOTE: Test loop A is defined in clause 36. Frames detected with BFI=1 are signalled as erased on the uplink.

- b) The fading function is set to TUhigh.
- c) The SS sets the amplitude of the wanted signal to reference sensitivity level ($\)$.
- d) The SS compares the data of the signal that it sends to the MS with the signal which is looped back from the receiver after demodulation and decoding, and checks the frame erasure indication.

- e) The SS determines the number of residual bit error events for the bits of class II, by examining sequences of at least the minimum number of samples of consecutive bits of class II. Bits are taken only from those frames not signalled as erased.
 - f) The SS determines the number of residual bit error events for the bits of the class Ib, by examining sequences of at least the minimum number of samples of consecutive bits of class Ib. Bits are only taken from those frames not signalled as erased.
 - g) The SS also determines the frame erasure events by examining sequences of at least the minimum number of samples of consecutive frames and assuming a frame is received successfully, if it is not signalled as erased.
 - h) Steps d) and e) are repeated, with the SS fading function set in turn to RA and HT.
 - j) The SS increases the amplitude of the wanted signal to 20 dB above reference sensitivity level.
 - k) The SS commands the MS to open test loop A and close test loop D.
- NOTE: Test loop D is defined in clause 36. Frames marked as erased (BFI=1) or unreliable (UFI=1) are signalled to the SS on the uplink.
- l) The fading function is set to TUhigh.
 - m) The SS sets the amplitude of the wanted signal to reference sensitivity level ().
 - n) The SS compares the data of the signal that it sends to the MS with the signal which is looped back from the receiver after demodulation and decoding, and checks the erased/unreliable frame indication.
 - p) The SS determines the number of residual bit error events for the bits of the class Ib, by examining sequences of at least the minimum number of samples of consecutive bits of class Ib. Bits are only taken from those frames not signalled as erased/unreliable.
 - q) The SS also determines the unreliable frame events by examining sequences of at least the minimum number of samples of consecutive frames and assuming a frame is received successfully it is not signalled as erased/unreliable.

14.2.2.5 Test requirements

The error rates measured for different channels and under the different propagation conditions, shall not exceed the test limit error rate values given in table 14-7 or 14-8:

Table 14-7: Limits for GSM 400, GSM 700, GSM 850 and GSM 900 sensitivity

Channels	Propagation conditions TUhigh		Propagation conditions RA		Propagation conditions HT	
	Test limit error rate %	Minimum No. of samples	Test limit error rate %	Minimum No. of samples	Test limit error rate %	Minimum No. of samples
TCH/HS (FER)	4,598	13050	8,500	20000	7,600	20000
TCH/HS Class Ib (BFI=0)	0,404	148500				
TCH/HS Class II (BFI=0)	7,725	25500				
TCH/HS (UFR)	6,250	9600				
TCH/HS Class Ib ((BFI or UFI)=0)	0,269	227000				

Table 14-8: Limits for DCS 1800 and PCS 1900 sensitivity

Channels	Propagation conditions TUhigh		Propagation conditions RA		Propagation conditions HT	
	Test limit error rate %	Minimum No. of samples	Test limit error rate %	Minimum No. of samples	Test limit error rate %	Minimum No. of samples
TCH/HS (FER)	4,706	12750	8,735	20000	7,600	20000
TCH/HS Class Ib (BFI=0)	0,426	141000				
TCH/HS Class II (BFI=0)	7,725	25500				
TCH/HS (UFR)	6,383	9400				
TCH/HS Class Ib ((BFI or UFI)=0)	0,291	206000				

14.2.3 Reference sensitivity - FACCH/F

14.2.3.1 Definition and applicability

The reference sensitivity for control channels is the signal level at the MS receiver input at which a certain FER must be achieved.

The requirements and this test apply to all types of MS.

14.2.3.2 Conformance requirement.

At reference sensitivity level, the FACCH/F FER shall meet the reference sensitivity performance of table 1 in GSM 05.05; (GSM 05.05, 6.2).

14.2.3.3 Test purpose.

To verify that the MS does not exceed the conformance requirement under TUhigh propagation condition with an allowance for the statistical significance of the test.

14.2.3.4 Method of test

14.2.3.4.1 Initial conditions

A call is set up according to the generic call set up procedure on a TCH/F with an ARFCN in the Low ARFCN range, power control level set to maximum power.

The SS transmits Standard Test Signal C1 on the traffic channel.

14.2.3.4.2 Procedure

- The fading function is set to TUhigh.
- The SS sets the amplitude of the wanted signal to reference sensitivity level ().
- The SS sends a Layer 3 message which does not require a Layer 3 response from the MS. Due to the low signal level the MS may not be able to acknowledge the Layer 2 frame with an RR frame and the SS will repeat the Layer 2 frame. Each repeated L2 frame will be counted and will indicate a frame erasure event.
- The SS determines the frame erasure events during at least the minimum number of samples of FACCH/F frames.

NOTE: These frames will not be consecutive but it is expected that the statistical significance of the tests will not be unduly degraded.

14.2.3.5 Test Requirements

The error rates measured shall not exceed the test limit error rate values given in table 14-9.

Table 14-9: Limits for FACCH/F sensitivity

Channels	Type of measurements	Propagation	GSM 400, GSM 700, GSM 850 and GSM 900		DCS 1 800 and PCS 1900	
			Test limit error rate %	Minimum No of samples	Test limit error rate %	Minimum No of samples
FACCH/F	FER	TUhigh	8,961	6696	4,368	13736

14.2.4 Reference sensitivity - FACCH/H

14.2.4.1 Definition and applicability

The reference sensitivity for control channels is the signal level at the MS receiver input at which a certain FER must be achieved.

The requirements and this test apply to MS supporting half rate channels.

14.2.4.2 Conformance requirement.

At reference sensitivity level, the FACCH/H FER shall meet the reference sensitivity performance of table 1 in GSM 05.05; (GSM 05.05, 6.2).

14.2.4.3 Test purpose.

To verify that the MS does not exceed the conformance requirement under TUhigh propagation condition with an allowance for the statistical significance of the test.

14.2.4.4 Method of test

14.2.4.4.1 Initial conditions

A call is set up according to the generic call set up procedure on a TCH/H with an ARFCN in the Mid ARFCN range, power control level set to maximum power.

The SS transmits Standard Test Signal C1 on the traffic channel.

14.2.4.4.2 Procedure

- a) The fading function is set to TUhigh.
- b) The SS sets the amplitude of the wanted signal to reference sensitivity level ().
- c) The SS sends a Layer 3 message which does not require a Layer 3 response from the MS. Due to the low signal level the MS may not be able to acknowledge the Layer 2 frame with an RR frame and the SS will repeat the Layer 2 frame. Each repeated L2 frame will be counted and will indicate a frame erasure event.
- d) The SS determines the frame erasure events during at least the minimum number of samples of FACCH/H frames.

NOTE: These frames will not be consecutive but it is expected that the statistical significance of the tests will not be unduly degraded.

14.2.4.5 Test requirements

The error rates measured shall not exceed the test limit error rate values given in table 14-10.

Table 14-10: Limits for FACCH/H sensitivity

Channels	Type of measurements	Propagation	GSM 400, GSM 700, GSM 850 and GSM 900		DCS 1 800 and PCS 1900	
			Test limit error rate %	Minimum No of samples	Test limit error rate %	Minimum No of samples
FACCH/H	FER	TUhigh	7,728		8,064	

14.2.5 Reference sensitivity - full rate data channels

14.2.5.1 Definition and applicability

The reference sensitivity for data channels is the signal level at the MS receiver input at which a certain BER must be achieved.

The requirements and this test apply to MS supporting data.

14.2.5.2 Conformance Requirement.

1. At reference sensitivity level, the TCH/F9,6, TCH/F4,8 and TCH/F2,4 BER shall meet the reference sensitivity performance of table 1 in GSM 05.05; (GSM 05.05, 6,2).

14.2.5.3 Test purpose

1. To verify that the MS does not exceed conformance requirement 1 under HT propagation condition with an allowance for the statistical significance of the test.

14.2.5.4 Method of test

14.2.5.4.1 Initial conditions

A call is set up according to the generic call set up procedure on a TCH with an ARFCN in the Mid ARFCN range. One of the supported TCH/(F9,6, F4,8, or F2,4) shall be used. The power control level is set to maximum power.

The SS transmits Standard Test Signal C1 on the traffic channel.

The SS commands the MS to create the traffic channel loop back signalling erased frames. (36.2.1.1.1).

14.2.5.4.2 Procedure

- a) The fading function is set to HT.
- b) The SS sets the amplitude of the wanted signal level to reference sensitivity level ().
- c) The SS compares transmitted data with received data for at least the minimum number of samples of consecutive bits and records every error bit as an error event.
- d) The SS sets the wanted signal level to 28 dB μ V_{emf}.
- e) The SS commands the MS to open the TCH loop.
- f) The SS commands the MS to another of the supported data channels.
- g) Steps b) to f) are repeated for all supported full rate data channels.

14.2.5.5 Test requirements

The Max-events measured for different channels shall not exceed the values given in table 14-11.

Table 14-11: Limits for full rate data channel sensitivity

Channels	Type of measurements	Propagation	GSM 400, GSM 700, GSM 850 and GSM 900		DCS 1 800 and PCS 1900	
			Test limit error rate %	Minimum No of samples	Test limit error rate %	Minimum No of samples
TCH/F9,6	BER	HT	0,778	180000	0,784	76500
TCH/F4,8	BER	HT	0,011	5350000	0,011	5350000
TCH/F2,4	BER	HT	0,001	11900000	0,001	11900000

14.2.6 Reference sensitivity - half rate data channels

14.2.6.1 Definition and applicability

The reference sensitivity for data channels is the signal level at the MS receiver input at which a certain BER must be achieved.

The requirements and this test apply to MS supporting half rate data.

14.2.6.2 Conformance Requirement.

1. At reference sensitivity level, the TCH/H4,8 and TCH/H2,4 BER shall meet the reference sensitivity performance of table 1 in GSM 05.05; (GSM 05.05, 6.2).

14.2.6.3 Test purpose

1. To verify that the MS does not exceed conformance requirement 1 under HT propagation condition with an allowance for the statistical significance of the test.

14.2.6.4 Method of test

14.2.6.4.1 Initial conditions

A call is set up according to the generic call set up procedure on a TCH with an ARFCN in the Mid ARFCN range. One of the supported TCH/(H4,8 or H2,4) shall be used. The power control level is set to maximum power.

The SS transmits Standard Test Signal C1 on the traffic channel.

The SS commands the MS to create the traffic channel loop back signalling erased frames. (36.2.1.1.1).

14.2.6.4.2 Procedure

- a) The fading function is set to HT.
- b) The SS sets the amplitude of the wanted signal level to reference sensitivity level ().
- c) The SS compares transmitted data with received data for at least the minimum number of samples of consecutive bits and records every error bit as an error event.
- d) The SS sets the wanted signal level to 28 dB μ V_{emf}.
- e) The SS commands the MS to open the TCH loop.
- f) The SS commands the MS to another of the supported data channels.
- g) Steps b) to f) are repeated for all supported data channels.

14.2.6.5 Test requirements

The Max-events measured for different channels shall not exceed the values given in table 14-12.

Table 14-12: Limits for half rate data channel sensitivity

			GSM 400, GSM 700, GSM 850 and GSM 900		DCS 1 800 and PCS 1900	
Channels	Type of measurements	Propagation	Test limit error rate %	Minimum No of samples	Test limit error rate %	Minimum No of samples
TCH/H4,8	BER	HT	0,778	180000	-	-
TCH/H2,4	BER	HT	0,011	5350000	-	-

14.2.7 Reference sensitivity - TCH/EFS

14.2.7.1 Definition and applicability

The reference sensitivity is the signal level at the MS receiver input at which a certain BER and FER must be achieved.

The requirements and this test apply to MS supporting speech.

For E-GSM 900 MS this test is only performed in the P-GSM band.

14.2.7.2 Conformance requirement

1. At reference sensitivity level, the TCH/EFS FER shall meet the reference sensitivity performance of table 1 in GSM 05.05; GSM 05.05, 6.2.
2. At reference sensitivity level, the TCH/EFS class I RBER shall meet the reference sensitivity performance of table 1 in GSM 05.05; GSM 05.05, 6.2.
3. At reference sensitivity level, the TCH/EFS class II RBER shall meet the reference sensitivity, performance of table 1 in GSM 05.05: GSM 05.05, 6.2.
4. At reference sensitivity level, the TCH/EFS class II RBER shall meet the reference sensitivity, performance of table 1 in GSM under extreme conditions; GSM 05.05, 6.2, GSM 05.05, annex D D.2.1, D.2.2.

14.2.7.3 Test purpose

NOTE: This test is performed under STATIC propagation conditions to allow implicit testing of the ability of the MS to hop over the full band. The tests under dynamic propagation conditions are better suited to test the reference sensitivity conformance but cannot test hopping over the full band due to limited bandwidth of available fading simulators.

1. To verify that the MS does not exceed conformance requirement 1 under STATIC and TUhigh propagation conditions with an allowance for the statistical significance of the test.
2. To verify that the MS does not exceed conformance requirement 2 under STATIC and TUhigh propagation conditions with an allowance for the statistical significance of the test.
3. To verify that the MS does not exceed conformance requirement 3 under STATIC, TUhigh, RA and HT propagation conditions with an allowance for the statistical significance of the test.
4. To verify that the MS does not exceed conformance requirement 4 under STATIC and TUhigh propagation conditions with an allowance for the statistical significance of the test.

14.2.7.4 Method of test

NOTE 1: The BA list sent on the BCCH and SACCH will indicate at least six surrounding cells with at least one near to each band edge. It is not necessary to generate any of these BCCHs but, if provided the signal strengths of BCCHs shall be in the range 15 dBmVemf() to 35 dBmVemf().

NOTE 2: The ARFCN of any BCCH shall not be co-channel or on adjacent channels to the wanted traffic channel.

NOTE 3: When frequency hopping is used, the traffic channel may fall on any of the ARFCNs defined in section 6.

14.2.7.4.1 Initial conditions

A call is set up according to the generic call set up procedure on a TCH/EFS with an ARFCN in the Mid ARFCN range for GSM 400, GSM 700, GSM 850, DCS 1800 and PCS 1900 and ARFCN 70 for GSM 900, power control level set to maximum power.

NOTE: For GSM 900 ARFCN 70 is tested since this is the 73rd harmonic of the 13 MHz clock normally used internally in a MS.

The SS transmits Standard Test Signal C1 on the traffic channel.

The SS commands the MS to create traffic channel loop back signalling erased frames.

14.2.7.4.2 Procedure

- a) The fading function is set to TUhigh.
- b) the SS sets the amplitude of the wanted signal to reference sensitivity level ().
- c) The SS compares the data of the signal that it sends to the MS with the signal which is looped back from the receiver after demodulation and decoding, and checks the frame erasure indication.
- d) The SS determines the number of residual bit error events for the bits of class II, by examining sequences of at least the minimum number of samples of consecutive bits of class II. Bits are taken only from those frames not signalled as erased.
- e) The SS determines the number of residual bit error events for the bits of the class Ib, by examining sequences of at least the minimum number of samples of consecutive bits of class Ib. Bits are only taken from those frames not signalled as erased.
- f) The SS also determines the frame erasure events by examining sequences of at least the minimum number of samples of consecutive frames and assuming a frame is received successfully, if it is not signalled as erased.
- g) Steps a) to d) are repeated under extreme test conditions.
- h) Steps a) to g) are repeated for TCH/EFS with ARFCNs in the Low ARFCN range for GSM 400, GSM 700, GSM 850, DCS 1800 and PCS 1900 and ARFCN 5 for GSM 900 and the High ARFCN range.

NOTE: For GSM 900 ARFCN 5 is tested since this is the 72nd harmonic of the 13 MHz clock normally used internally in a MS.

- i) Steps b) to d) are repeated with the SS fading function set in turn to RA and HT.
- j) Steps b) to g) are repeated, with the SS fading function set to static and the MS is commanded by the SS into hopping mode using the hopping sequence defined in section 6.

The amplitude of the wanted signal is set according to step b). All the other time slots, except the active ones, are set to 20 dB above reference sensitivity level(). This implicitly tests adjacent time slot rejection.

14.2.7.5 Test requirements

The error rates measured for different channels and under the different propagation conditions, under any combination of normal and extreme test voltages and ambient temperatures, shall not exceed the test limit error rate values given in table 14-4 or 14-13a, 14-13b:

Table 14-13a: Limits for GSM 400, GSM 700, GSM 850 and GSM 900 sensitivity

Channels	Propagation conditions TUhigh		Propagation conditions RA		Propagation conditions HT		Static conditions	
	Test limit error rate %	Minimum No. of samples	Test limit error rate %	Minimum No. of samples	Test limit error rate %	Minimum No. of samples	Test limit error rate %	Minimum No. of samples
TCH/EFS								
FER	8,867	8900					0,122	164000
class Ib(RBER)	0,224	1000000					0,110	20000000
class II (RBER)	7,500	120000	7,500	24000	9,350	60000	2,439	8200

Table 14-13b: Limits for DCS 1 800 and PCS 1900 sensitivity

Channels	Propagation conditions TUhigh		Propagation conditions RA		Propagation conditions HT		Static conditions	
	Test limit error rate %	Minimum No. of samples	Test limit error rate %	Minimum No. of samples	Test limit error rate %	Minimum No. of samples	Test limit error rate %	Minimum No. of samples
TCH/EFS								
FER	4,475	13400					0,122	164000
class Ib(RBER)	0,130	1500000					0,110	20000000
class II(RBER)	8,333	60000	7,500	24000	9,498	30000	2,439	8200

14.2.8 Reference sensitivity - full rate data channels in multislot configuration

14.2.8.1 Definition and applicability

The reference sensitivity for data channels is the signal level at the MS receiver input at which a certain BER must be achieved.

The requirements and this test apply to all types of GSM 400, GSM 700, GSM 850, GSM 900, DCS 1800 and PCS 1900 MS and any multiband MS which are capable of HSCSD multislot operation.

14.2.8.2 Conformance Requirement.

- At reference sensitivity level, the TCH/F9,6, TCH/F4,8 and TCH/F2,4 BER shall meet the reference sensitivity performance of table 1 in GSM 05.05; (GSM 05.05, 6,2).

14.2.8.3 Test purpose

- To verify that the MS does not exceed conformance requirement 1 in all multislot classes under HT propagation condition with an allowance for the statistical significance of the test.

14.2.8.4 Method of test

14.2.8.4.1 Initial conditions

A call is set up according to the generic call set up procedure for multislot HSCSD on a TCH with an ARFCN in the Mid ARFCN range. One of the supported TCH/(F9,6, F4,8, or F2,4) shall be used.

The SS sets the MS to operate in a worst case configuration where the overlapping of the transmitting and receiving timeslots are maximized. If it needs the use of timing advance, it is set to 63. If overlapping is not possible, transmitting and receiving timeslots should be as close as possible.

The power control level is set to maximum power.

The SS transmits Standard Test Signal C1 on all the channels.

The SS commands the MS to create the loop back of the closest channel to the transmitting timeslot.

14.2.8.4.2 Procedure

- a) The fading function is set to HT.
- b) The SS commands the MS to close the TCH loop.
- c) The SS sets the amplitude of the wanted signal level to reference sensitivity level () in all subchannels.
- d) The SS compares transmitted data with received data in all channels for at least the minimum number of samples of consecutive bits and records every error bit as an error event.
- e) The SS sets the wanted signal level to 28 dBmVemf.
- f) The SS commands the MS to open the TCH loop.
- g) The SS commands the MS to another of the supported data channels
- h) Steps b) to g) are repeated for all supported full rate data channels.

14.2.8.5 Test requirements

The Max-events measured for different channels shall not exceed the values given in table 14-15.

Table 14-15: Limits for full rate data channel sensitivity

Channels	Type of measurements	Propagation	GSM 400, GSM 700, GSM 850 and GSM 900		DCS 1 800 and PCS 1 900	
			Test limit error rate %	Minimum No of samples	Test limit error rate %	Minimum No of samples
TCH/F9,6	BER	HT	0,778	180000	0,784	76500
TCH/F4,8	BER	HT	0,011	5350000	0,011	5350000
TCH/F2,4	BER	HT	0,001	11900000	0,001	11900000

14.2.9 Reference sensitivity - TCH/FS for MS supporting the R-GSM band

14.2.9.1 Definition and applicability

The reference sensitivity is the signal level at the MS receiver input at which a certain BER and FER must be achieved.

The requirements and this test apply to R-GSM MS supporting speech.

14.2.9.2 Conformance requirement

1. At reference sensitivity level, the TCH/FS FER shall meet the reference sensitivity performance of table 1 in GSM 05.05; GSM 05.05, 6.2.
2. At reference sensitivity level, the TCH/FS class I RBER shall meet the reference sensitivity performance of table 1 in GSM 05.05; GSM 05.05, 6.2.
3. At reference sensitivity level, the TCH/FS class II RBER shall meet the reference sensitivity, performance of table 1 in GSM 05.05; GSM 05.05, 6.2.
4. At reference sensitivity level, the TCH/FS class II RBER shall meet the reference sensitivity, performance of table 1 in GSM under extreme conditions; GSM 05.05, 6.2, GSM 05.05, annex D D.2.1, D.2.2.

14.2.9.3 Test purpose

NOTE: This test is performed under STATIC propagation conditions to allow implicit testing of the ability of the MS to hop over the full band. The tests under dynamic propagation conditions are better suited to test the reference sensitivity conformance but cannot test hopping over the full band due to limited bandwidth of available fading simulators.

1. To verify that the MS does not exceed conformance requirement 1 under STATIC and TUhigh propagation conditions with an allowance for the statistical significance of the test.
2. To verify that the MS does not exceed conformance requirement 2 under STATIC and TUhigh propagation conditions with an allowance for the statistical significance of the test.
3. To verify that the MS does not exceed conformance requirement 3 under STATIC, TUhigh, RA and HT propagation conditions with an allowance for the statistical significance of the test.
4. To verify that the MS does not exceed conformance requirement 4 under STATIC and TUhigh propagation conditions with an allowance for the statistical significance of the test.

14.2.9.4 Method of test

NOTE 1: The BA list sent on the BCCH and SACCH will indicate at least six surrounding cells with at least one near to each band edge. It is not necessary to generate any of these BCCHs but, if provided the signal strengths of BCCHs shall be in the range $15 \text{ dB}\mu\text{Vemf}(\)$ to $35 \text{ dB}\mu\text{Vemf}(\)$.

NOTE 2: The ARFCN of any BCCH shall not be co-channel or on adjacent channels to the wanted traffic channel.

NOTE 3: When frequency hopping is used, the traffic channel may fall on any of the ARFCNs defined in section 6.

14.2.9.4.1 Initial conditions

A call is set up according to the generic call set up procedure on a TCH/FS with ARFCN 70 for R-GSM 900, power control level set to maximum power.

NOTE: For R-GSM 900 ARFCN 70 is tested since this is the 73rd harmonic of the 13 MHz clock normally used internally in a MS.

The SS transmits Standard Test Signal C1 on the traffic channel.

The SS commands the MS to create traffic channel loop back signalling erased frames.

14.2.9.4.2 Procedure

- a) The fading function is set to TUhigh.
- b) the SS sets the amplitude of the wanted signal to reference sensitivity level ().
- c) The SS compares the data of the signal that it sends to the MS with the signal which is looped back from the receiver after demodulation and decoding, and checks the frame erasure indication.
- d) The SS determines the number of residual bit error events for the bits of class II, by examining sequences of at least the minimum number of samples of consecutive bits of class II. Bits are taken only from those frames not signalled as erased.
- e) The SS determines the number of residual bit error events for the bits of the class Ib, by examining sequences of at least the minimum number of samples of consecutive bits of class Ib. Bits are only taken from those frames not signalled as erased.
- f) The SS also determines the frame erasure events by examining sequences of at least the minimum number of samples of consecutive frames and assuming a frame is received successfully, if it is not signalled as erased.
- g) Steps a) to d) are repeated under extreme test conditions.
- h) Steps a) to g) are repeated for TCH/FS with ARFCN 5 and 964 for R-GSM 900 and the High ARFCN range.

NOTE: For R-GSM 900 ARFCN 5 and 964 are tested since they are the 72nd and 71st harmonic of the 13 MHz clock normally used internally in a MS.i) Steps b) to d) are repeated with the SS fading function set in turn to RA and HT.

- j) Steps b) to g) are repeated, with the SS fading function set to static and the MS is commanded by the SS into hopping mode using the hopping sequence defined in section 6.

The amplitude of the wanted signal is set according to step b). All the other time slots, except the active ones, are set to 20 dB above reference sensitivity level(). This implicitly tests adjacent time slot rejection.

14.2.9.5 Test requirements

The error rates measured for different channels and under the different propagation conditions, under any combination of normal and extreme test voltages and ambient temperatures, shall not exceed the test limit error rate values given in table 14-5b .

Table 14-5b: Limits for GSM 900 sensitivity

Channels	Propagation conditions TUhigh		Propagation conditions RA		Propagation conditions HT		Static conditions	
	Test limit error rate %	Minimum No. of samples	Test limit error rate %	Minimum No. of samples	Test limit error rate %	Minimum No. of samples	Test limit error rate %	Minimum No. of samples
TCH/FS								
FER	6,742* α	8900					0,122* α	164000
class Ib(RBER)	0,42/ α	1000000					0,41/ α	20000000
class II(RBER)	8,333	120000	7,5	24000	9,333	60000	2,439	8200

14.3 Usable receiver input level range

14.3.1 Definition and applicability

The usable receiver input level range is the range of the radio frequency input level of a specified modulated signal over which bit error ratio or frame erasure ratios stay between specified limits.

The requirements and this test apply to MS supporting speech.

14.3.2 Conformance requirement

- The receiver input level range requirements of GSM 05.05 section 6.1 for TCH/FS class II RBER under static and EQ propagation conditions shall be met:

- Under normal conditions.
- Under extreme conditions.

14.3.3 Test purpose

1. To verify that the MS does not exceed the conformance requirement with an allowance for the statistical significance of the test.
 - 1.1 Under normal conditions.
 - 1.2 Under extreme conditions.

14.3.4 Method of test

14.3.4.1 Initial conditions

A call is set up according to the generic call set up procedure on a TCH/FS with an ARFCN in the Mid ARFCN range, power control level set to maximum.

The SS transmits Standard Test Signal C1 on the TCH/FS.

The SS commands the MS to create traffic channel loop back signalling erased frames. (36.2.1.1.2).

14.3.4.2 Procedure

- a) The SS compares the data that it sends to the MS with the signal which is looped back from the receiver after demodulation and decoding.

The SS tests the bit error ratio for the non-protected bits of TCH/FS class II, by examining sequences of at least the minimum number of samples of consecutive bits of class II. The number of error events is recorded.
- b) Step a) is repeated with the amplitude of the wanted signal increased to an input level at the receiver input of 73 dB μ Vemf().
- c) Step a) is repeated with the amplitude of the wanted signal increased to an input level at the receiver input of:

GSM 400:	98 dB μ Vemf()
GSM 700	98 dBmVemf()
GSM 850	98 dBmVemf()
GSM 900:	98 dB μ Vemf()
DCS 1 800:	90 dB μ Vemf().
PCS 1 900:	90 dB μ Vemf().
- d) The SS fading function is set to EQ.
- e) Step a) is repeated with the amplitude of the wanted signal set to respectively 20 dB above reference sensitivity level() and 73dB μ Vemf() at the receiver input.
- f) The test is repeated under extreme test conditions.

14.3.5 Test requirements

The error rate measured in this test shall not exceed the test limit error rate values given in table 14-14. This shall apply for any combination of normal and extreme test voltages and ambient temperature, for the different propagation conditions and for any level of input signal to the receiver.

Table 14-14: Limits for input level range

Propagation conditions	GSM 400, GSM 700, GSM 850 and GSM 900		DCS 1 800 and PCS 1900	
	Test limit error rate %	Minimum No. of samples	Test limit error rate %	Minimum No. of samples
Static <=73 dB μ Vemf()	0,012	1640000	0,012	1640000
Static 98 dB μ Vemf()	0,122	164000		
Static 90 dB μ Vemf()			0,122	164000
EQ	3,25	120000	3,25	60000

14.4 Co-channel rejection

14.4.1 Co-channel rejection - TCH/FS

14.4.1.1 Definition and applicability

The co-channel rejection is a measure of the capability of the receiver to receive a wanted modulated signal without exceeding a given degradation due to the presence of an unwanted modulated signal, both signals being at the nominal frequency of the receiver.

The requirements and this test apply to MS supporting speech.

14.4.1.2 Conformance requirement

1. At reference co-channel interference the TCH/FS FER shall meet the reference interference performance of table 2 in GSM 05.05; GSM 05.05, 6.3.
2. At reference co-channel interference the TCH/FS class Ib BER shall meet the reference interference performance of table 2 in GSM 05.05; GSM 05.05, 6.3.
3. At reference co-channel interference the TCH/FS class II BER shall meet the reference interference performance of table 2 in GSM 05.05; GSM 05.05, 6.3.

14.4.1.3 Test purpose

1. To verify that the MS does not exceed conformance requirement 1 under propagation condition TU_{high} with frequency hopping and TU_{low} with no frequency hopping with an allowance for the statistical significance of the test.
2. To verify that the MS does not exceed conformance requirement 2 under propagation condition TU_{high} with frequency hopping and TU_{low} with no frequency hopping, with an allowance for the statistical significance of the test.
3. To verify that the MS does not exceed conformance requirement 3 under propagation condition TU_{high} with frequency hopping and TU_{low} with no frequency hopping with an allowance for the statistical significance of the test.

14.4.1.4 Method of test

14.4.1.4.1 Initial conditions

A call is set up according to the generic call set up procedure on a TCH/FS with an ARFCN in the mid ARFCN range, power control level set to maximum power.

The SS transmits Standard Test Signal C1 on the traffic channel (wanted signal).

The SS commands the MS to create the traffic channel loop back, signalling erased frames. (36.1.2.1.1.1).

14.4.1.4.2 Procedure

- a) In addition to the wanted signal, the SS produces an independent, uncorrelated interfering signal, Standard Test Signal I1 (unwanted signal).

The unwanted signal is continuous and has no fixed relationship with the bit transitions of the wanted signal. Its amplitude is 9 dB below that of the wanted signal.

The fading characteristic of the wanted and the interfering signal is TULow.

- b) The SS compares the modulation of the signal that it sends to the MS with the signal which is looped back from the receiver after demodulation and decoding, and checks the frame erasure indication.
- c) The SS determines the number of residual bit error events for the bits of class II, by examining at least the minimum number of samples of consecutive bits of class II. Bits are taken only from those frames not signalled as erased.
- d) The SS determines the number of residual bit error events for the bits of the class Ib, by examining at least the minimum number of samples of consecutive bits of class Ib. Bits are only taken from those frames not signalled as erased.
- e) The SS also determines the frame erasure events by examining at least the minimum number of samples of consecutive frames and assuming a frame is received successfully it is not signalled as erased.
- f) Steps a) to e) are repeated except that in step a) both the wanted and interfering signal are TUhigh hopping and the SS commands the MS into hopping mode. A hop pattern covering at least 10 frequencies in a range not exceeding 5 MHz is used.

The hopping band is centred around an ARFCN in the Mid ARFCN range. The hopping frequencies are chosen from those defined in section 6.

14.4.1.5 Test requirements

The error rate measured in this test shall not exceed the test limit error rate values given in table 14-15.

Table 14-15: Limits for co-channel rejection

Channel	Type of measurement	Propagation condition	Test limit error rate %	Minimum No. of samples
TCH/FS	FER	TULow/No FH	$24 \cdot \alpha$	25000
TCH/FS Class Ib	RBER	TULow/No FH	$2,091/\alpha$	3300000
TCH/FS Class II	RBER	TULow/No FH	4,3	2000000
TCH/FS	FER	TUhigh/FH	$3,371 \cdot \alpha$	17800
TCH/FS class Ib	RBER	TUhigh/FH	$0,215/\alpha$	2000000
TCH/FS class II	RBER	TUhigh/FH	8,333	1200000

The parameter α can range from 1 to 1.6. The value of α for the RBER test on TCH/FS class Ib bits under particular measurement conditions shall be the same as that determined in the FER test on TCH/FS under the same conditions.

14.4.2 Co-channel rejection - TCH/HS

14.4.2.1 Definition and applicability

The requirements and this test apply to MS supporting half rate speech.

14.4.2.2 Conformance requirement

1. At reference cochannel interference, the TCH/HS FER (shall meet the reference interference performance of table 2 in GSM 05.05; GSM 05.05, 6.3.
2. At reference cochannel interference, the TCH/HS class Ib BER (BFI=0) shall meet the reference interference performance of table 2 in GSM 05.05; GSM 05.05, 6.3.
3. At reference cochannel interference, the TCH/HS class II BER (BFI=0) shall meet the reference interference performance of table 2 in GSM 05.05; GSM 05.05, 6.3.
4. At reference cochannel interference, the TCH/HS UFR shall meet the reference interference performance of table 2 in GSM 05.05; GSM 05.05, 6.3.
5. At reference cochannel interference, the TCH/HS class Ib RBER ((BFI or UFI)=0) shall meet the reference interference performance of table 2 in GSM 05.05; GSM 05.05, 6.3.

14.4.2.3 Test purpose

1. To verify that the MS does not exceed conformance requirement 1, under propagation conditions TU_{high} with frequency hopping, with an allowance for the statistical significance of the test.
2. To verify that the MS does not exceed conformance requirement 1, under propagation conditions TU_{high} with frequency hopping, with an allowance for the statistical significance of the test.
3. To verify that the MS does not exceed conformance requirement 1, under propagation conditions TU_{high} with frequency hopping, with an allowance for the statistical significance of the test.
4. To verify that the MS does not exceed conformance requirement 4, under propagation condition TU_{high} with frequency hopping, with an allowance for the statistical significance of the test.
5. To verify that the MS does not exceed conformance requirement 4, under propagation condition TU_{high} with frequency hopping, with an allowance for the statistical significance of the test.

14.4.2.4 Method of test

14.4.2.4.1 Initial conditions

A call is set up according to the generic call set up procedure on a TCH/HS with an ARFCN in the mid ARFCN range, power control level set to maximum power.

The SS transmits Standard Test Signal C1 on the traffic channel (wanted signal).

14.4.2.4.2 Procedure

- a) In addition to the wanted signal, the SS produces an independent, uncorrelated interfering signal, Standard Test Signal I1 (unwanted signal).

The unwanted signal is continuous and has no fixed relationship with the bit transitions of the wanted signal. Its amplitude is 9 dB below that of the wanted signal.

- b) The fading characteristic of the wanted and the interfering signal is set to TU_{high}. The SS commands the MS into hopping mode. A hop pattern covering at least 10 frequencies in a range not exceeding 5 MHz is used.

The hopping pattern is centred around an ARFCN in the Mid ARFCN range. The hopping frequencies are chosen from those defined in section 6.

c) The SS commands the MS to create traffic channel loop back signalling erased frames using test loop A.

NOTE: Test loop A is defined in clause 36. Frames marked with BFI=1 are signalled as erased on the uplink.

d) The SS compares the modulation of the signal that it sends to the MS with the signal which is looped back from the receiver after demodulation and decoding, and checks the frame erasure indication.

e) The SS determines the number of residual bit error events for the bits of class II, by examining at least the minimum number of samples of consecutive bits of class II. Bits are taken only from those frames not signalled as erased.

f) The SS determines the number of residual bit error events for the bits of the class Ib, by examining at least the minimum number of samples of consecutive bits of class Ib. Bits are only taken from those frames not signalled as erased.

g) The SS also determines the frame erasure events by examining at least the minimum number of samples of consecutive frames and assuming a frame is received successfully it is not signalled as erased.

h) The SS commands the MS to open test loop A and close test loop D.

NOTE: Test loop D is defined in clause 36. Frames marked as erased (BFI=1), or unreliable (UFI=1), are signalled to the SS on the uplink.

j) The SS compares the data of the signal that it sends to the MS with the signal which is looped back from the receiver after demodulation and decoding, and checks the erased/unreliable frame indication.

k) The SS determines the number of residual bit error events for the bits of the class Ib, by examining sequences of at least the minimum number of samples of consecutive bits of class Ib. Bits are only taken from those frames not signalled as erased/unreliable.

l) The SS also determines the unreliable frame events by examining sequences of at least the minimum number of samples of consecutive frames and assuming a frame is received successfully it is not signalled as erased/unreliable.

14.4.2.5 Test requirements

The error rate measured in this test shall not exceed the test limit error rate values given in table 14-16 or table 14-17.

Table 14-16: Limits for GSM 400, GSM 700, GSM 850 and GSM 900 co-channel rejection

Channel/Type of measurement	Propagation condition	Test limit error rate %	Minimum No. of samples
TCH/HS FER	TUhigh/FH	5,607	10700
TCH/HS Class Ib RBER (BFI=0)	TUhigh/FH	0,325	184700
TCH/HS Class II RBER (BFI=0)	TUhigh/FH	7,961	25500
TCH/HS UFR	TUhigh/FH	6,834	8780
TCH/HS Class Ib RBER ((BFI or UFI)=0)	TUhigh/FH	0,235	255000

Table 14-17: Limits for DCS 1800 and PCS 1900 co-channel rejection

Channel/Type of measurement	Propagation condition	Test limit error rate %	Minimum No. of samples
TCH/HS FER	TUhigh/FH	5,607	10700
TCH/HS Class Ib RBER (BFI=0)	TUhigh/FH	0,325	184700
TCH/HS Class II RBER (BFI=0)	TUhigh/FH	7,961	25500
TCH/HS UFR	TUhigh/FH	6,834	8780
TCH/HS Class Ib RBER ((BFI or UFI)=0)	TUhigh/FH	0,235	255000

14.4.3 Co-channel rejection - TCH/HS (SID frames)

14.4.3.1 Definition and applicability

The requirements and this test apply to MS supporting half rate speech.

14.4.3.2 Conformance requirement

1. At reference cochannel interference, the TCH/HS ESIDR, for SID frames indicated as SID=0 shall meet the reference interference performance of table 2 in GSM 05.05; GSM 05.05, 6.3.
2. At reference cochannel interference, the TCH/HS RBER for SID frames indicated as SID=1 or SID=2, shall meet the reference interference performance of table 2 in GSM 05.05; GSM 05.05, 6.3.
3. At reference cochannel interference, the TCH/HS EVSIDR for SID frames indicated as (SID=0), or (SID=1), or ((BFI or UFI)=1), shall meet the reference interference performance of table 2 in GSM 05.05; GSM 05.05, 6.3.
4. At reference cochannel interference, the TCH/HS RBER for SID frames indicated as SID=2 and (BFI or UFI)=0, shall meet the reference interference performance of table 2 in GSM 05.05; GSM 05.05, 6.3.

14.4.3.3 Test purpose

1. To verify that the MS does not exceed conformance requirement 1 under propagation condition TUlow, with an allowance for the statistical significance of the test.
2. To verify that the MS does not exceed conformance requirement 2 under propagation condition TUlow, with an allowance for the statistical significance of the test.
3. To verify that the MS does not exceed conformance requirement 3 under propagation condition TUlow, with an allowance for the statistical significance of the test.
4. To verify that the MS does not exceed conformance requirement 4 under propagation condition TUlow, with an allowance for the statistical significance of the test.

14.4.3.4 Method of test

14.4.3.4.1 Initial conditions

The BCCH data indicates that uplink DTX shall be disabled.

A call is set up according to the generic call set up procedure on a TCH/HS with an ARFCN in the mid ARFCN range, power control level set to maximum power.

The SS transmits Standard Test Signal C1 on the traffic channel.

14.4.3.4.2 Procedure

- a) In addition to the wanted signal, the SS produces an independent, uncorrelated interfering signal, Standard Test Signal I1 (unwanted signal).

The unwanted signal is continuous and has no fixed relationship with the bit transitions of the wanted signal. Its amplitude is 9 dB below that of the wanted signal.

- b) The fading function is set to TUlow.
- c) The SS commands the MS to create traffic channel loop back signalling erased frames using test loop E.

NOTE: Test loop E is defined in clause 36. Frames marked with (SID=0) shall be signalled as erased on the uplink.

- d) The SS transmits continuously SID frames on the downlink. The SID codeword is transmitted correctly, but the SID information contains random data.

- e) The SS compares the data of the signal that it sends to the MS with the signal which is looped back from the receiver after demodulation and decoding, and checks the frame erasure indication.
- f) The SS determines the number of residual bit error events for the class 1 SID bits, which do not belong to the SID codeword, by examining sequences of at least the minimum number of samples of consecutive class 1 SID bits. Bits are taken only from those frames not signalled as erased.
- g) The SS also determines the erased SID events by examining sequences of at least the minimum number of samples of consecutive frames and assuming a frame is received successfully it is not signalled as erased. Bits comprising the SID codeword are excluded.
- h) The SS commands the MS to open test loop E and close test loop F.

NOTE: Test loop F is defined in clause 36. Frames marked with (SID=0), or (SID=1), or ((BFI or UFI)=1), shall be signalled as erased on the uplink.

- j) The SS compares the data of the signal that it sends to the MS with the signal which is looped back from the receiver after demodulation and decoding, and checks the frame erasure indication.
- k) The SS determines the number of residual bit error events for the class 1 SID bits, which do not belong to the SID codeword, by examining sequences of at least the minimum number of samples of consecutive class 1 SID bits. Bits are taken only from those frames not signalled as erased.
- l) The SS also determines the erased valid SID events by examining sequences of at least the minimum number of samples of consecutive frames and assuming a frame is received successfully it is not signalled as erased.

14.4.3.5 Test requirements

The error rates measured in this test shall not exceed the test limit error rate values given in table 14-18.

Table 14-18: Limits for co-channel rejection

Channel/Type of measurement	Propagation condition	Test limit error rate %	Minimum No. of samples
ESIDR	TUlow	19,152	25000
SID RBER (SID=1 or 2)	TUlow	0,560	500000
EVSIDR	TUlow	24,000	25000
SID RBER (SID=2 and (BFI or UFI)=0)	TUlow	0,022	2678000

14.4.4 Co-channel rejection - FACCH/F

14.4.4.1 Definition and applicability

The co-channel rejection is a measure of the capability of the receiver to receive a wanted modulated signal without exceeding a given degradation due to the presence of an unwanted modulated signal, both signals being at the nominal frequency of the receiver.

The requirements and this test apply to all types of MS.

14.4.4.2 Conformance requirement

At reference cochannel interference the FACCH/F FER shall meet the reference interference performance of table 2 in GSM 05.05; (GSM 05.05, 6.3).

14.4.4.3 Test purpose

To verify that the MS does not exceed the conformance requirement under propagation condition TUlow with an allowance for the statistical significance of the test.

14.4.4.4 Method of test

14.4.4.4.1 Initial conditions

A call is set up according to the generic call set up procedure on a TCH with an ARFCN in the mid ARFCN range. For MS supporting speech this shall be a TCH/FS. For MS not supporting speech one of the supported TCH/ (F9,6, F4,8, or F2,4) shall be used. The power control level is set to maximum power.

The SS transmits Standard Test Signal C1 on the traffic channel (wanted signal).

14.4.4.4.2 Procedure

- a) In addition to the wanted signal, the SS produces an independent, uncorrelated interfering signal, Standard Test Signal I1 (unwanted signal).

The unwanted signal is continuous and has no fixed relationship with the bit transitions of the wanted signal. Its amplitude is 9 dB below that of the wanted signal.

The fading characteristic of the wanted and the interfering signal is TUlow.

- d) The SS sends a Layer 3 message which does not require a Layer 3 response from the MS. Due to the co-channel interference, the MS may not be able to acknowledge the Layer 2 frame. Each repeated L2 frame indicates a frame erasure event. The SS determines the number of frame erasure events during at least the minimum number of samples of FACCH/F frames.

NOTE: These frames will not be consecutive but it is expected that the statistical significance of the tests will not be unduly degraded.

14.4.4.5 Test requirements

The error rate measured in this test shall not exceed the test limit error rate values given in table 14-14.

Table 14-19: Limits for co-channel rejection

Channel	Type of measurement	Propagation condition	Test limit error rate %	Minimum No. of samples
FACCH/F	FER	TUlow/No FH	24	25000

14.4.5 Co-channel rejection - FACCH/H

14.4.5.1 Definition and applicability

The requirements and this test apply to MS supporting half rate channels.

14.4.5.2 Conformance requirement

At reference cochannel interference the FACCH/H FER shall meet the reference interference performance of table 2 in GSM 05.05; (GSM 05.05, 6.3).

14.4.5.3 Test purpose

To verify that the MS does not exceed the conformance requirement under propagation condition TUlow with an allowance for the statistical significance of the test.

14.4.5.4 Method of test

14.4.5.4.1 Initial conditions

A call is set up according to the generic call set up procedure on a TCH with an ARFCN in the mid ARFCN range. For MS supporting half rate speech this shall be a TCH/HS. For MS not supporting speech one of the supported TCH/(H4,8, or H2,4) shall be used. The power control level is set to maximum power.

The SS transmits Standard Test Signal C1 on the traffic channel (wanted signal).

14.4.5.4.2 Procedure

- a) In addition to the wanted signal, the SS produces an independent, uncorrelated interfering signal, Standard Test Signal I1 (unwanted signal).

The unwanted signal is continuous and has no fixed relationship with the bit transitions of the wanted signal. Its amplitude is 9 dB below that of the wanted signal.

The fading characteristic of the wanted and the interfering signal is TUlow.

- d) The SS sends a Layer 3 message which does not require a Layer 3 response from the MS. Due to the co-channel interference, the MS may not be able to acknowledge the Layer 2 frame. Each repeated L2 frame indicates a frame erasure event. The SS determines the number of frame erasure events during at least the minimum number of samples of FACCH/H frames.

NOTE: These frames will not be consecutive but it is expected that the statistical significance of the tests will not be unduly degrade.

14.4.5.5 Test requirements

The error rate measured in this test shall not exceed the test limit error rate values given in table 14-20.

Table 14-20: Limits for co-channel rejection

Channel	Type of measurement	Propagation condition	Test limit error rate %	Minimum No. of samples
FACCH/H	FER	TUlow/No FH	24,000	25000

14.4.6 Co-channel rejection - TCH/EFS

14.4.6.1 Definition and applicability

The co-channel rejection is a measure of the capability of the receiver to receive a wanted modulated signal without exceeding a given degradation due to the presence of an unwanted modulated signal, both signals being at the nominal frequency of the receiver.

The requirements and this test apply to MS supporting speech.

14.4.6.2 Conformance requirement

1. At reference co-channel interference the TCH/EFS FER shall meet the reference interference performance of table 2 in GSM 05.05; GSM 05.05, 6.3.
2. At reference co-channel interference the TCH/EFS class Ib BER shall meet the reference interference performance of table 2 in GSM 05.05; GSM 05.05, 6.3.
3. At reference co-channel interference the TCH/EFS class II BER shall meet the reference interference performance of table 2 in GSM 05.05; GSM 05.05, 6.3.

14.4.6.3 Test purpose

1. To verify that the MS does not exceed conformance requirement 1 under propagation condition TU_{high} with frequency hopping and TU_{low} with no frequency hopping with an allowance for the statistical significance of the test.
2. To verify that the MS does not exceed conformance requirement 2 under propagation condition TU_{high} with frequency hopping and TU_{low} with no frequency hopping, with an allowance for the statistical significance of the test.
3. To verify that the MS does not exceed conformance requirement 3 under propagation condition TU_{high} with frequency hopping and TU_{low} with no frequency hopping with an allowance for the statistical significance of the test.

14.4.6.4 Method of test

14.4.6.4.1 Initial conditions

A call is set up according to the generic call set up procedure on a TCH/EFS with an ARFCN in the mid ARFCN range, power control level set to maximum power.

The SS transmits Standard Test Signal C1 on the traffic channel (wanted signal).

The SS commands the MS to create the traffic channel loop back, signalling erased frames. (36.1.2.1.1.1).

14.4.6.4.2 Procedure

- a) In addition to the wanted signal, the SS produces an independent, uncorrelated interfering signal, Standard Test Signal I1 (unwanted signal).

The unwanted signal is continuous and has no fixed relationship with the bit transitions of the wanted signal. Its amplitude is 9 dB below that of the wanted signal.

The fading characteristic of the wanted and the interfering signal is TU_{low}.

- b) The SS compares the modulation of the signal that it sends to the MS with the signal which is looped back from the receiver after demodulation and decoding, and checks the frame erasure indication.
- c) The SS determines the number of residual bit error events for the bits of class II, by examining at least the minimum number of samples of consecutive bits of class II. Bits are taken only from those frames not signalled as erased.
- d) The SS determines the number of residual bit error events for the bits of the class Ib, by examining at least the minimum number of samples of consecutive bits of class Ib. Bits are only taken from those frames not signalled as erased.
- e) The SS also determines the frame erasure events by examining at least the minimum number of samples of consecutive frames and assuming a frame is received successfully it is not signalled as erased.
- f) Steps a) to e) are repeated except that in step a) both the wanted and interfering signal are TU_{high} hopping and the SS commands the MS into hopping mode. A hop pattern covering at least 10 frequencies in a range not exceeding 5 MHz is used.

The hopping band is centred around an ARFCN in the Mid ARFCN range. The hopping frequencies are chosen from those defined in section 6.

14.4.6.5 Test requirements

The error rate measured in this test shall not exceed the test limit error rate values given in table 14-21.

Table 14-21: Limits for co-channel rejection

Channel	Type of measurement	Propagation condition	Test limit error rate %	Minimum No. of samples
TCH/EFS	FER	TUlow/No FH	24	25000
TCH/EFS Class Ib	RBER	TUlow/No FH	0,209	3300000
TCH/EFS Class II	RBER	TUlow/No FH	3,039	2000000
TCH/EFS	FER	TUhigh/FH	3,357	17800
TCH/EFS class Ib	RBER	TUhigh/FH	0,115	2000000
TCH/EFS class II	RBER	TUhigh/FH	8,333	1200000

14.4.7 Receiver performance in the case of frequency hopping and co-channel interference on one carrier

14.4.7.1 Definition and applicability

The GSM receiver is specified to be able to handle one out of four carriers being strongly interfered with, if frequency hopping is applied. This is used in networks to increase the capacity.

The requirement and this test apply to all R97 MS (or later) supporting speech.

14.4.7.2 Conformance Requirement

Under the following conditions:

- a useful signal, cyclic frequency hopping over four carriers under static conditions, with equal input levels 20 dB above reference sensitivity level;
- a random, continuous, GMSK-modulated interfering signal on only one of the carriers at a level 10 dB higher than the useful signal,

the FER for TCH/FS shall be less than 5%; GSM 05.05, 6.6.

14.4.7.3 Test Purpose

To verify that the MS does not exceed the conformance requirement with an allowance for the statistical significance of the test.

14.4.7.4 Method Of Test

14.4.7.4.1 Initial conditions

A call is set up according to the generic call set up procedure on a TCH/FS channel in hopping mode, power control level set to maximum power. A cyclic hop pattern covering four frequencies with a minimum carrier distance of 600 kHz is used.

The SS transmits Standard Test Signal C1 on the traffic channel with a power level 20 dB above reference sensitivity level (wanted signal). No fading is applied.

The SS commands the MS to create the traffic channel loop back, signalling erased frames.

14.4.7.4.2 Test Procedure

- a) In addition to the wanted signal, the SS produces an independent, uncorrelated interfering signal, Standard Test Signal I1 (unwanted signal) on one of the hopping frequencies of the wanted signal, and on the timeslot used by the wanted signal. The unwanted signal is continuous and has no fixed relationship with the bit transitions of the wanted signal. Its amplitude is 10 dB above that of the wanted signal. No fading characteristics are applied.
- b) The SS compares the data of the signal that it sends to the MS with the signal which is looped back from the receiver after demodulation and decoding, and checks the frame erasure indication.
- c) The SS determines the frame erasure events by examining at least the minimum number of samples of consecutive frames and assuming a frame is received successfully it is not signalled as erased.

14.4.7.5 Test requirements

The error rate measured in this test shall not exceed the test limit error rate value given in the following table:

Channel	Type of measurement	Propagation condition	Test limit error rate (%)	Minimum No. of samples
TCH/FS	FER	Static	6.1	3300

14.5 Adjacent channel rejection

14.5.1 Adjacent channel rejection - speech channels

14.5.1.1 Definition and applicability

The adjacent channel selectivity is a measure of the capability of the receiver to receive a wanted modulated signal without exceeding a given degradation due to the presence of an unwanted signal in the adjacent channel.

The adjacent channel can be adjacent in the RF spectrum or in time. There are therefore two types of adjacent channel selectivity:

- 1) Adjacent RF channel selectivity which is specifically tested in this section.
- 2) Adjacent Time Slot selectivity, which is implicitly tested in test .2.1.

The requirements and this test apply to MS supporting speech.

14.5.1.2 Conformance requirement

1. With adjacent channel interference at 200 kHz above and below the wanted signal and signal level 9 dB above the wanted signal level:
 - 1.1 For a TUhigh faded wanted signal and a TUhigh adjacent channel interferer, the FER for TCH/FS shall be within the requirements of table 2 in GSM 05.05; GSM 05.05, 6.3.
 - 1.2 For a TUhigh faded wanted signal and a TUhigh adjacent channel interferer, the Class Ib RBER shall be within the requirements of table 2 in GSM 05.05; GSM 05.05, 6.3.
 - 1.3 For a TUhigh faded wanted signal and a TUhigh adjacent channel interferer, the Class II RBER shall be within the requirements of table 2 in GSM 05.05; GSM 05.05, 6.3.
 - 1.4 For a TUhigh faded wanted signal and a TUhigh adjacent channel interferer, the Class II RBER shall be within the requirements of table 2 in GSM 05.05 under extreme test conditions; GSM 05.05, 6.3, GSM 05.05, annex D D.2.1, D.2.2.

2. For adjacent channel interference at 400 kHz above and below the wanted signal frequency and signal level 41 dB above the wanted signal level:
 - 2.1 For a TUhigh faded wanted signal and a static adjacent channel interferer, the FER for TCH/FS shall be better than:

GSM 400, GSM 700, GSM 850 and GSM 900: $10,2 \cdot \alpha$ %; GSM 05.05, 6.3

DCS 1 800 and PCS 1 900: $5,1 \cdot \alpha$ %; GSM 05.05, 6.3.
 - 2.2 For a TUhigh faded wanted signal and a static adjacent channel interferer, the Class Ib RBER shall be better than:

GSM 400, GSM 700, GSM 850 and GSM 900: $0,72/\alpha$ %; GSM 05.05, 6.3

DCS 1 800 and PCS 1 900: $0,45/\alpha$ %; GSM 05.05, 6.3.
 - 2.3 For a TUhigh faded wanted signal and a static adjacent channel interferer, the Class II RBER shall be better than:

GSM 400, GSM 700, GSM 850 and GSM 900: 8,8 %; GSM 05.05, 6.3

DCS 1 800 and PCS 1 900: 8,9 %; GSM 05.05, 6.3.
 - 2.4 For a TUhigh faded wanted signal and a static adjacent channel interferer, the Class II RBER shall be better than:

GSM 400, GSM 700, GSM 850 and GSM 900: 8,8 %;

DCS 1 800 and PCS 1 900: 8,9 %;

under extreme test conditions; GSM 05.05, 6.3, annex D D.2.1, D.2.2.

14.5.1.3 Test purpose

- 1 To verify that with a TUhigh adjacent channel interferer at 200 kHz above and below the wanted TUhigh signal frequency and signal level 9 dB above the wanted signal level:
 - 1.1 Conformance requirement 1.1 is met with an allowance for the statistical significance of the test.
 - 1.2 Conformance requirement 1.2 is met with an allowance for the statistical significance of the test.
 - 1.3 Conformance requirement 1.3 is met with an allowance for the statistical significance of the test.
 - 1.4 Conformance requirement 1.4 is met with an allowance for the statistical significance of the test.
2. To verify that with a static adjacent channel interferer at 400 kHz above and below a TUhigh wanted signal frequency and signal level 41 dB above the wanted signal level:
 - 2.1 Conformance requirement 2.1 is met with an allowance for the statistical significance of the test.
 - 2.2 Conformance requirement 2.2 is met with an allowance for the statistical significance of the test.
 - 2.3 Conformance requirement 2.3 is met with an allowance for the statistical significance of the test.
 - 2.4 Conformance requirement 2.4 is met with an allowance for the statistical significance of the test.

14.5.1.4 Method of test

14.5.1.4.1 Initial conditions

A call is set up according to the generic call set up procedure on a TCH/FS with an ARFCN in the mid ARFCN range, power control level set to maximum power.

The SS commands the MS to create the traffic channel loop back signalling erased frames.

The SS transmits Standard Test Signal C1 on the TCH (wanted signal).

14.5.1.4.2 Procedure

- a) In addition to the wanted signal, the SS transmits an independent, uncorrelated interfering signal, Standard Test Signal I1 (unwanted signal).

The unwanted signal is continuous and has no fixed relationship with the bit transitions of the wanted signal.

The fading characteristic of the wanted and the unwanted signal is set to TUhigh.

The unwanted signal is transmitted at a nominal frequency 200 kHz above the nominal frequency of the wanted signal. Its amplitude is set to 9dB above that of the wanted signal.

- b) The SS compares the data of the signal that it sends to the MS with the signal which is looped back from the receiver after demodulation and decoding, and checks the frame erasure indication.
- c) The SS tests the frame erasure compliance for the TCH/FS by examining at least the minimum number of samples of consecutive frames. The number of frame erasure events is recorded.
- d) The SS determines the number of residual bit error events for the bits of the class Ib and class II, by examining sequences of at least the minimum number of samples of consecutive bits of class Ib and class II, Bits are only taken from those frames for which no bad frame indication was given.
- e) The measurement of steps c) and d) is repeated with the unwanted signal on a frequency at the same displacement from, but below, the frequency of the wanted signal.
- f) The measurement of steps c) to e) shall be repeated for a displacement of the unwanted signal of 400 kHz, and with the amplitude of the unwanted signal 41 dB above the level of the wanted input signal, and the unwanted signal static.
- g) Steps c) to f) are repeated under extreme test conditions.

14.5.1.5 Test requirements

Table 14-22: Limits for adjacent channel selectivity

Interference at	Channel	Type of measurement	GSM 400, GSM 700, GSM 850 and GSM 900		DCS 1 800 and PCS 1 900	
			Test limit error rate %	Minimum No. of samples	Test limit error rate %	Minimum No. of samples
200 kHz	TCH/FS class Ib class II	FER	6,742* α	8900	3,371* α	17800
		RBER	0,420/ α	1000000	0,270/ α	2000000
		RBER	8,333	600000	8,333	1200000
400 kHz	TCH/FS class Ib class II	FER	11,461* α	8900	5,714* α	10500
		RBER	0,756/ α	1000000	0,483/ α	1200000
		RBER	9,167	600000	9,167	720000

The error rates measured in this test shall not exceed the test limit error rate given in table 14-22. This shall apply for any combination of normal and extreme test voltages and ambient temperature, and with the interfering signals at either side of the wanted frequency.

The parameter α can range from 1 to 1,6. The value of α for the RBER test on TCH/FS class Ib bits under particular measurement conditions shall be the same as that determined in the FER test on TCH/FS under the same conditions.

NOTE: A static unwanted signal is used to avoid a potential problem with the implementation of the fading simulator.

14.5.2 Adjacent channel rejection - control channels

14.5.2.1 Definition and applicability

The adjacent channel selectivity is a measure of the capability of the receiver to receive a wanted modulated signal without exceeding a given degradation due to the presence of an unwanted signal in the adjacent channel.

The adjacent channel can be the adjacent in the RF spectrum or in time. There are therefore two types of adjacent channel selectivity:

- 1) Adjacent RF channel selectivity which is specifically tested in this section.
- 2) Adjacent Time Slot selectivity, which is implicitly tested in test 14.2.1.

The requirements and this test apply to MS not supporting speech.

14.5.2.2 Conformance requirement

1. For adjacent channel interference at 200 kHz above and below the wanted signal frequency and signal level 9 dB above the wanted signal level:
 - 1.1 For a TUhigh faded wanted signal and a TUhigh adjacent channel interferer, the FER for the FACCH/F does not exceed the requirements of table 2 in GSM 05.05; GSM 05.05, 6.3.
 - 1.2 For a TUhigh faded wanted signal and a TUhigh adjacent channel interferer, the FER for the FACCH/F does not exceed the requirements of table 2 in GSM 05.05 under extreme test conditions; GSM 05.05, 6.3, annex D D.2.1, D.2.2.
2. With adjacent channel interference at 400 kHz above and below the wanted signal frequency and signal level 41 dB above the wanted signal level:
 - 2.1 For a TUhigh faded wanted signal and a static adjacent channel interferer, the FER for the FACCH/F shall be better than:
GSM 400, GSM 700, GSM 850 and GSM 900: 17,1 %; GSM 05.05, 6.3
DCS 1 800 and PCS 1 900: 6,1 %; GSM 05.05, 6.3.
 - 2.2 For a TUhigh faded wanted signal and a static adjacent channel interferer, the FACCH/F shall be better than:
GSM 400, GSM 700, GSM 850 and GSM 900: 17,1 %
DCS 1 800 and PCS 1 900: 6,1 %.
under extreme test conditions; GSM 05.05, 6.3, annex D D.2.1, D.2.2.

14.5.2.3 Test purpose

1. To verify that with TUhigh adjacent channel interference at 200 kHz above and below a TUhigh wanted signal frequency and signal level 9 dB above the wanted signal level:
 - 1.1 Conformance requirement 1.1 is met with an allowance for the statistical significance of the test.
 - 1.2 Conformance requirement 1.2 is met with an allowance for the statistical significance of the test.
2. To verify that with static adjacent channel interference at 400 kHz above and below a TUhigh wanted signal frequency and signal level 41 dB above the wanted signal level:
 - 2.1 Conformance requirement 2.1 is met with an allowance for the statistical significance of the test.
 - 2.2 Conformance requirement 2.2 is met with an allowance for the statistical significance of the test.

14.5.2.4 Method of test

14.5.2.4.1 Initial conditions

A call is set up according to the generic call set up procedure on a TCH in the mid ARFCN range. Any one of the supported TCH/(F9,6, F4,8, or F2,4) shall be used.

The SS transmits the Standard Test Signal C1 on the TCH (wanted signal).

14.5.2.4.2 Procedure

- a) In addition to the wanted signal, the SS transmits an independent, uncorrelated interfering signal, Standard Test Signal I1 (unwanted signal).

The unwanted signal is continuous and has no fixed relationship with the bit transitions of the wanted signal. The fading characteristic of the wanted and the unwanted signal is TUhigh.

The unwanted signal is transmitted at a nominal frequency 200 kHz above the nominal frequency of the wanted signal. Its amplitude is set to 9dB above that of the wanted signal.

- b) The SS sends a Layer 3 message which does not require a Layer 3 response from the MS. Due to the adjacent channel interference, the MS may not be able to acknowledge the Layer 2 frame. Each repeated L2 frame indicates a frame erasure event. The SS determines the number of frame erasure events during at least the minimum number of samples of FACCH/F frames.

NOTE: These frames will not be consecutive but it is expected that the statistical significance of the tests will not be unduly degraded.

- c) The measurement of step b) is repeated with the unwanted signal on a frequency at the same displacement from, but below, the frequency of the wanted signal.
- d) The measurement of steps a) to c) is repeated for a displacement of the unwanted signal of 400 kHz, and with the amplitude of the unwanted signal 41 dB above the level of the wanted input signal, and the unwanted signal static.
- e) Steps a) to d) are repeated under extreme test conditions.

14.5.2.5 Test requirements

Table 14-23: Limits for adjacent channel selectivity

			GSM 400, GSM 700, GSM 850 and GSM 900		DCS 1 800 and PCS 1 900	
Interference at	Channel	Type of measurement	Test limit error rate %	Minimum No. of samples	Test limit error rate %	Minimum No. of samples
200 kHz	FACCH/F	FER	10,640	5639	3,808	15756
400 kHz	FACCH/F	FER	19,152	3133	6,832	8782

The error rates measured in this test shall not exceed the test limit error rates given in table 14-23. This shall apply for any combination of normal and extreme test voltages and ambient temperature, and with the interfering signals at either side of the wanted frequency.

NOTE: A static unwanted signal is used to avoid a potential problem with the noise floor of the fading simulator.

14.6 Intermodulation rejection

14.6.1 Intermodulation rejection - speech channels

14.6.1.1 Definition and applicability

The intermodulation rejection is a measure of the capability of the receiver to receive a wanted modulated signal without exceeding a given degradation due to the presence of two or more unwanted signals with a specific frequency relationship to the wanted signal frequency.

The requirements and this test apply to MS supporting speech.

For E-GSM 900 and R-GSM 900 MS this test is only performed in the P-GSM band.

14.6.1.2 Conformance requirement

In the presence of two unwanted signals with a specific frequency relationship to the wanted signal frequency the Class II RBER for TCH/FS shall meet the reference sensitivity performance of table 1 in GSM 05.05; GSM 05.05, 5.3.

14.6.1.3 Test purpose

To verify that the MS does not exceed the conformance requirement with an allowance for the statistical significance of the test.

14.6.1.4 Method of test

NOTE: The measurements address the third order intermodulation, which represents the most serious case.

14.6.1.4.1 Initial conditions

A call is set up according to the generic call set up procedure on a TCH with an ARFCN in the Mid ARFCN range, power control level set to maximum power.

The SS transmits Standard Test Signal C1 on the traffic channel.

14.6.1.4.2 Procedure

- a) The amplitude of the wanted signal is set to 4 dB above the reference sensitivity level (see table 14-24).
- b) The SS commands the MS to create the loop back facility signalling erased frames.
- c) The SS produces a static wanted signal, and two static interfering (unwanted) signals at the same time. There is no correlation in the modulation between the signals.

The first interfering signal is on a frequency equal to the centre frequency of an ARFCN four above that of the receiver. This signal is static and unmodulated.

The second interfering signal is on an ARFCN eight above that of the receiver. This signal is static, continuous and modulated by random data.

The amplitude of both the interfering signals is set according to table 14-24.

- d) The SS compares the data of the signal that it sends to the MS with the signal which is looped back from the receiver after demodulation and decoding, and checks the frame erasure indication.

The SS tests the RBER compliance of class II bits by examining at least the minimum number of samples of consecutive bits. Bits only taken from those frames which do not signal frame erasure. The number of error events is recorded.

- e) The measurement of step d) is repeated with the two unwanted signals having frequencies corresponding to ARFCN four and eight below the ARFCN of the wanted signal.

- f) Steps b) to e), are repeated but with the receiver operating on an ARFCN in the Low ARFCN range.
- g) Steps b) to e), are repeated but with the receiver operating on an ARFCN in the High ARFCN range.
- h) Steps a) to g) are repeated under extreme test conditions.

Table 14-24: Intermodulation test signal levels

	GSM 400, GSM 700,				
	GSM 850 and GSM 900		DCS 1 800		
	Small MS	Other MS	Class 1 & 2	Class 3	PCS 1 900
WANTED SIGNAL dB μ Vemf()	15	13	17	15	15
FIRST INTERFERER dB μ Vemf()	64	74	64	68	64
SECOND INTERFERER dB μ Vemf()	63	63	64	68	64

NOTE: Some of the levels in table 14-24 are different to those specified in GSM 05.05 due to the consideration of the effect of modulation sideband noise from the second interferer.

14.6.1.5 Test requirements

The error rate measured in this test shall not exceed the test limit error rate values given in table 14-25.

This shall apply under normal condition and under any combination of normal and extreme test voltages and ambient temperature, and with the two interfering signals at either side of the wanted frequency.

Table 14-25: Limits for intermodulation rejection

Channel	Propagation conditions	Type of measurement	Test limit error rate %	Minimum No. of samples
TCH/FS Class II	Static	RBER	2,439	8200

14.6.2 Intermodulation rejection - control channels

14.6.2.1 Definition and applicability

The intermodulation rejection is a measure of the capability of the receiver to receive a wanted modulated signal without exceeding a given degradation due to the presence of two or more unwanted signals with a specific frequency relationship to the wanted signal frequency.

The requirements and this test apply to MS not supporting speech.

For E-GSM 900 and R-GSM 900 MS this test is only performed in the P-GSM band.

14.6.2.2 Conformance requirement

In the presence of two unwanted signals with a specific frequency relationship to the wanted signal frequency the FER for FACCH/F shall meet the reference sensitivity performance of table 1 in GSM 05.05; GSM 05.05, 5.3.

14.6.2.3 Test purpose

To verify that the MS does not exceed the conformance requirement with an allowance for the statistical significance of the test.

14.6.2.4 Method of test

NOTE: The measurements address the third order intermodulation, which represents the most serious case.

14.6.2.4.1 Initial conditions

A call is set up according to the generic call set up procedure on a TCH with an ARFCN in the Mid ARFCN range, power control level set to maximum.

The SS transmits Standard Test Signal C1 on the traffic channel. The amplitude of the wanted signal is set to 4 dB above the reference sensitivity level (see table 14-25).

14.6.2.4.2 Procedure

- a) The SS produces a TUhigh wanted signal, and two static interfering (unwanted) signals at the same time. There is no correlation in the modulation between the signals.

The first interfering signal is on a frequency equal to the centre frequency of an ARFCN four above that of the receiver. This signal is static and unmodulated.

The second interfering signal is on an ARFCN eight above that of the receiver. This signal is static, continuous and modulated by random data.

The amplitude of both the interfering signals is set according to table 14-26.

- b) The SS sends a Layer 3 message which does not require a Layer 3 response from the MS. The SS determines the number of frame erasure events during at least the minimum number of samples of FACCH/F frames.

NOTE: These frames will not be consecutive but it is expected that the statistical significance of the tests will not be unduly degraded.

- c) The measurement of step b) is repeated with the two unwanted signals having frequencies corresponding to ARFCN four and eight below the ARFCN of the wanted signal.
- d) Steps a) to c), are repeated but with the receiver operating on an ARFCN in the Low ARFCN range.
- e) Steps a) to c), are repeated but with the receiver operating on an ARFCN in the High ARFCN range.
- f) Steps a) to e) are repeated under extreme test conditions.

Table 14-26: Intermodulation test signal levels

	GSM 400, GSM 700,				
	GSM 850 and GSM 900		DCS 1 800		PCS 1 900
	Small MS	Other MS	Class 1 & 2	Class 3	
WANTED SIGNAL dB μ Vemf()	15	13	17	15	15
FIRST INTERFERER dB μ Vemf()	64	74	64	68	64
SECOND INTERFERER dB μ Vemf()	63	63	64	68	64

NOTE: Some of the levels in table 14-26 are different to those specified in GSM 05.05 due to the consideration of the effect of modulation sideband noise from the second interferer.

14.6.2.5 Test requirements

The error rate measured in this test shall not exceed the test limit error rate values given in table 14-27.

This shall apply under normal condition and under any combination of normal and extreme test voltages and ambient temperature, and with the two interfering signals at either side of the wanted frequency.

Table 14-27: Limits for intermodulation rejection

Channel	Propagation conditions	Type of measurement	GSM 400, GSM 700, GSM 850 and GSM 900		DCS 1 800 and PCS 1 900	
			Test limit error rate %	Minimum No. of max-samples	Test limit error rate %	Min No. of max-samples
FACCH/F	TUhigh/No FH	FER	8,961	6696	4,368	13736

14.7 Blocking and spurious response

14.7.1 Blocking and spurious response - speech channels

14.7.1.1 Definition and applicability

Blocking is a measure of the ability of the receiver to receive a modulated wanted input signal in the presence of an unwanted input signal, on frequencies other than those of the spurious responses or the adjacent channels, without exceeding a given degradation.

The requirements and this test apply to MS supporting speech.

14.7.1.2 Conformance requirement

1. The blocking characteristics of the receiver are specified separately for in-band and out-of-band performance as identified in GSM 05.05 section 5.1.

The reference sensitivity performance as specified in table 1 of GSM 05.05 shall be met when the following signals are simultaneously input to the receiver:

- a useful signal at frequency f_0 , 3 dB above the reference sensitivity level as specified in GSM 05.05 section 6.2;

- a continuous, static sine wave signal at a level as in the table of GSM 05.05 section 5.1 and at a frequency (f) which is an integer multiple of 200 kHz.

with the following exceptions, called spurious response frequencies:

- a) GSM 700, GSM 850 and GSM 900: in band, for a maximum of six occurrences (which if grouped shall not exceed three contiguous occurrences per group);

DCS 1 800: in band, for a maximum of twelve occurrences (which if grouped shall not exceed three contiguous occurrences per group);

PCS 1 900: in band, for a maximum of twelve occurrences (which if grouped shall not exceed three contiguous occurrences per group);

GSM 400: in band, for a maximum of three occurrences;

- b) out of band, for a maximum of 24 occurrences (which if below f_0 and grouped shall not exceed three contiguous occurrences per group).

where the above performance shall be met when the continuous sine wave signal (f) is set to a level of 70 dB μ V (emf) (i.e. -43 dBm). GSM 05.05, 5.1.

14.7.1.3 Test purpose

1. To verify that the in band blocking performance is met without exceeding the total number of allowed in band spurious responses. An allowance is made for the statistical significance of the test.
2. To verify that at selected out of band frequencies, the out of band blocking performance is met without exceeding the total number of allowed out of band spurious responses. An allowance is made for the statistical significance of the test.

NOTE: Not all of the possible out of band frequencies are tested as this results in excessive test time. However, the total number of out of band spurious responses, specified in GSM 05.05, are allowed to ensure a fair test of the MS.

14.7.1.4 Method of test

14.7.1.4.1 Initial conditions

A call is set up according to the generic call set up procedure, except the BCCH frequency list shall be empty, on a TCH with an arbitrary ARFCN in the range supported by the MS. The power control level is set to maximum power.

The SS transmits Standard Test Signal C1 on the traffic channel. (TCH frequency FR).

The SS commands the MS to create traffic channel loop back signalling erased frames.

14.7.1.4.2 Procedure

- a) The SS produces a static wanted signal and a static interfering signal at the same time. The amplitude of the wanted signal is set to 4 dB above the reference sensitivity level.
- b) The unwanted signal is a C.W. signal (Standard test signal IO) of frequency FB. It is applied in turn on the subset of frequencies calculated in step c) in the overall range 100 kHz to 12,75 GHz, where FB is an integer multiple of 200 kHz.

However, frequencies in the range FR +/- 600 kHz are excluded.

NOTE: Allowance must be made for possible spurious signals arising from the SS. These are particularly likely at sub harmonic frequencies nFB where n = 2, 3, 4, 5, etc.

- c) The frequencies at which the test is performed (adjusted to an integer multiple of 200 kHz channels most closely approximating the absolute frequency of the calculated blocking signal frequency) are the combined frequencies from i), ii) and iii) below:-

- i) The total frequency range formed by:-

GSM 400 the frequencies between $F_{lo} + (IF_1 + IF_2 + \dots + IF_n + 3,6 \text{ MHz})$
and $F_{lo} - (IF_1 + IF_2 + \dots + IF_n + 3,6 \text{ MHz})$.

GSM 700 the frequencies between $F_{lo} + (IF_1 + IF_2 + \dots + IF_n + 7,5 \text{ MHz})$
and $F_{lo} - (IF_1 + IF_2 + \dots + IF_n + 7,5 \text{ MHz})$.

GSM 850 and P-GSM 900 the frequencies between $F_{lo} + (IF_1 + IF_2 + \dots + IF_n + 12,5 \text{ MHz})$
and $F_{lo} - (IF_1 + IF_2 + \dots + IF_n + 12,5 \text{ MHz})$.

E-GSM 900 the frequencies between $F_{lo} + (IF_1 + IF_2 + \dots + IF_n + 17,5 \text{ MHz})$
and $F_{lo} - (IF_1 + IF_2 + \dots + IF_n + 17,5 \text{ MHz})$.

DCS 1 800 the frequencies between $F_{lo} + (IF_1 + IF_2 + \dots + IF_n + 37,5 \text{ MHz})$
and $F_{lo} - (IF_1 + IF_2 + \dots + IF_n + 37,5 \text{ MHz})$.

PCS 1 900 the frequencies between $F_{lo} + (IF_1 + IF_2 + \dots + IF_n + 30,0 \text{ MHz})$
and $F_{lo} - (IF_1 + IF_2 + \dots + IF_n + 30,0 \text{ MHz})$.

and

the frequencies $+ 100 \text{ MHz}$ and $- 100 \text{ MHz}$ from the edge of the relevant receive band.

Measurements are made at 200 kHz intervals.

ii) The three frequencies IF_1 , $IF_1 + 200 \text{ kHz}$, $IF_1 - 200 \text{ kHz}$.

iii) The frequencies:

$mF_{lo} + IF_1$,

$mF_{lo} - IF_1$,

mFR ,

where m is all positive integers greater than or equal to 2 such that either sum lies in the range 100 kHz to $12,75 \text{ GHz}$.

The frequencies in step ii) and iii) lying in the range of frequencies defined by step i) above need not be repeated.

Where:-

F_{lo} - local oscillator applied to first receiver mixer

$IF_1 \dots IF_n$ - are the n intermediate frequencies

F_{lo} , IF_1 , $IF_2 \dots IF_n$ shall be declared by the manufacturer in the PIXIT statement
GSM 11.10 annex 3.

d) The level of the unwanted signal is set according to table 14-28.

Table 14-28a: Level of unwanted signals

FREQUENCY	GSM 900		DCS 1 800
	Small MS	Other MS	
	LEVEL IN dB μ Vemf()		
FR +/- 600 kHz to FR +/- 800 kHz	70	75	70
FR +/- 800 kHz to FR +/- 1,6 MHz	70	80	70
FR +/- 1,6 MHz to FR +/- 3 MHz	80	90	80
915 MHz to FR - 3 MHz	90	90	-
FR + 3 MHz to 980 MHz	90	90	-
1785 MHz to FR - 3 MHz	-	-	87
FR + 3 MHz to 1920 MHz	-	-	87
835 MHz to <915 MHz	113	113	
>980 MHz to 1000 MHz	113	113	
100 kHz to <835 MHz	90	90	
>1000 MHz to 12,75 GHz	90	90	
100 kHz to 1705 MHz	-	-	113
>1705 MHz to <1785 MHz	-	-	101
>1920 MHz to 1980 MHz	-	-	101
>1980 MHz to 12,75 GHz	-	-	90

Table 14-28b: Level of unwanted signals

FREQUENCY	GSM 450		GSM 480	
	Small MS	Other MS	Small MS	Other MS
	LEVEL IN dB μ Vemf()			
FR +/- 600 kHz to FR +/- 800 kHz	70	75	70	75
FR +/- 800 kHz to FR +/- 1,6 MHz	70	80	70	80
FR +/- 1,6 MHz to FR +/- 3 MHz	80	90	80	90
457,6 to FR - 3 MHz	90	90	-	-
FR + 3 MHz to 473,6 MHz	90	90	-	-
486 to FR - 3 MHz	-	-	90	90
FR + 3 MHz to 502 MHz	-	-	90	90
100 kHz to <457,6 MHz	113	113	-	-
>473,6 MHz to 12,75 GHz	113	113	-	-
100 kHz to <486 MHz	-	-	113	113
>502 MHz to 12,75 GHz	-	-	113	113

Table 14-28c: Level of unwanted signals

FREQUENCY	PCS 1 900
	LEVEL IN dB μ Vemf()
FR +/- 600 kHz to FR +/- 800 kHz	70
FR +/- 800 kHz to FR +/- 1,6 MHz	70
FR +/- 1,6 MHz to FR +/- 3 MHz	80
1910 MHz to FR - 3 MHz	87
FR + 3 MHz to 2010 MHz	87
100 kHz to 1830 MHz	113
>1830 MHz to <1910 MHz	101
>2010 MHz to 2070 MHz	101
>2070 MHz to 12,75 GHz	90

Table 14-28d: Level of unwanted signals

FREQUENCY	GSM 750	GSM 850
	LEVEL IN dB μ Vemf()	
FR +/- 600 kHz to FR +/- 800 kHz	70	70
FR +/- 800 kHz to FR +/- 1,6 MHz	70	70
FR +/- 1,6 MHz to FR +/- 3 MHz	80	80
727 to FR – 3 MHz	90	-
FR + 3 MHz to 782 MHz	90	-
849 MHz to FR – 3 MHz	-	90
FR + 3 MHz to 914 MHz	-	90
100 kHz to <727 MHz	113	-
>782 MHz to 12,75 GHz	113	-
100 kHz to <849 MHz	-	113
>914 MHz to 12,75 GHz	-	113

NOTE 1: These values differ from GSM 05.05 because of practical generator limits in the SS.

NOTE 2: For an E-GSM 900 MS the level of the unwanted signal in the band 905 MHz to <915 MHz is relaxed to 108 dB μ Vemf().

NOTE 3: For a GSM 450 small MS the level of the unwanted signal in the band 450,4 MHz to <457,6 MHz is relaxed to 108 dB μ Vemf(). For a GSM 480 small MS the level of the unwanted signal in the band 478,8 MHz to <486 MHz is relaxed to 108 dB μ Vemf().

- e) The SS compares the data of the signal that it sends to the MS with the signal which is looped back from the receiver after demodulation and decoding, and checks the frame erasure indication.

The SS tests the RBER compliance for the bits of class II, by examining sequences of at least the minimum number of samples of consecutive bits of class II, where bits are taken only from those frames for which no bad frame indication was given. The number of error events is recorded.

If a failure is indicated it is noted and counted towards the allowed exemption totals.

In the case of failures discovered at the predicted frequencies at steps f ii), iii) or iv) the test is repeated on the adjacent channels +/- 200 kHz away. If either of these two frequencies fail then the next channel 200 kHz beyond is also tested. This process is repeated until all channels constituting the group of failures is known.

14.7.1.5 Test requirements

The error rate measured in this test shall not exceed the test limit error rate values given in table 14-29.

This shall apply under normal test voltage and ambient temperature, and with the interfering signal at any frequency in the range specified.

Table 14-29: Limits for blocking

Channel	Type of measurement	Test limit error rate %	Minimum number of samples
TCH/FS Class II	RBER	2,439	8200

The following exceptions are allowed:

GSM 450: A maximum of three failures in the frequency band 457,6 MHz to 473,6 MHz.

A maximum of 24 failures in the combined bands 100 kHz to 457,6 MHz and 473,6 MHz to 12,75 GHz (which, if below FR and grouped, shall not exceed three 200 kHz channels per group).

GSM 480: A maximum of three failures in the frequency band 486 MHz to 502 MHz.

A maximum of 24 failures in the combined bands 100 kHz to 486 MHz and 502 MHz to 12,75 GHz (which, if below FR and grouped, shall not exceed three 200 kHz channels per group).

- GSM 750: A maximum of six failures in the frequency band 727 MHz to 782 MHz (which, if grouped, shall not exceed three 200 kHz channels per group).
A maximum of 24 failures in the combined bands 100 kHz to 727 MHz and 782 MHz to 12,75 GHz (which, if below FR and grouped, shall not exceed three 200 kHz channels per group).
- GSM 850: A maximum of six failures in the frequency band 849 MHz to 914 MHz (which, if grouped, shall not exceed three 200 kHz channels per group).
A maximum of 24 failures in the combined bands 100 kHz to 849 MHz and 914 MHz to 12,75 GHz (which, if below FR and grouped, shall not exceed three 200 kHz channels per group).
- GSM 900: A maximum of six failures in the frequency band 915 MHz to 980 MHz (which, if grouped, shall not exceed three 200 kHz channels per group).
A maximum of 24 failures in the combined bands 100 kHz to 915 MHz and 980 MHz to 12,75 GHz (which, if below FR and grouped, shall not exceed three 200 kHz channels per group).
- DCS 1 800: A maximum of twelve failures in the band 1785 MHz to 1920 MHz (which, if grouped, shall not exceed three 200 kHz channels per group).
A maximum of 24 in the combined bands 100 kHz to 1785 MHz and 1920 MHz to 12,75 GHz (which, if below FR and grouped, shall not exceed three 200 kHz channels per group).
- PCS 1 900: A maximum of twelve failures in the band 1910 MHz to 2010 MHz (which, if grouped, shall not exceed three 200 kHz channels per group).
A maximum of 24 in the combined bands 100 kHz to 1910 MHz and 2010 MHz to 12,75 GHz (which, if below FR and grouped, shall not exceed three 200 kHz channels per group).

If the number of failures do not exceed the maximum allowed figures stated above, the test of 14.7.1.4 is repeated at the frequencies at which the failures occurred. The level of the unwanted signal is set to 70 dB μ Vemf() and the performance requirement is once again that that stated in the table above.

The number Error rate measured in this test shall not exceed the test limit error rate values given in table 14-29.

No failures are allowed at this lower unwanted signal level.

14.7.2 Blocking and spurious response - control channels

14.7.2.1 Definition and applicability

Blocking is a measure of the ability of the receiver to receive a modulated wanted input signal in the presence of an unwanted input signal, on frequencies other than those of the spurious responses or the adjacent channels, without exceeding a given degradation.

The requirements and this test apply to MS not supporting speech.

14.7.2.2 Conformance requirement

1. The blocking characteristics of the receiver are specified separately for in-band and out-of-band performance as identified in GSM 05.05 section 5.1.

The reference sensitivity performance as specified in table 1 of GSM 05.05 shall be met when the following signals are simultaneously input to the receiver:

- a useful signal at frequency f_0 , 3 dB above the reference sensitivity level as specified in GSM 05.05 section 6.2;
- a continuous, static sine wave signal at a level as in the table of GSM 05.05 section 5.1 and at a frequency (f) which is an integer multiple of 200 kHz.

with the following exceptions, called spurious response frequencies:-

- a) GSM 700, GSM 850 or GSM 900: in band, for a maximum of six occurrences (which if grouped shall not exceed three contiguous occurrences per group),

DCS 1 800: in band, for a maximum of twelve occurrences (which if grouped shall not exceed three contiguous occurrences per group).

PCS 1 900: in band, for a maximum of twelve occurrences (which if grouped shall not exceed three contiguous occurrences per group).

GSM 400: in band, for a maximum of three occurrences;

- b) out of band, for a maximum of 24 occurrences (which if below f_0 and grouped shall not exceed three contiguous occurrences per group).

where the above performance shall be met when the continuous sine wave signal (f) is set to a level of 70 dB μ V (emf) (i.e. -43 dBm). GSM 05.05, 5.1.

14.7.2.3 Test purpose

1. To verify that the in band blocking performance is met without exceeding the total number of allowed in band spurious responses. An allowance is made for the statistical significance of the test.
2. To verify that at selected out of band frequencies, the out of band blocking performance is met without exceeding the total number of allowed out of band spurious responses. An allowance is made for the statistical significance of the test.

NOTE: Not all of the possible out of band frequencies are tested as this results in excessive test time. However, the total number of out of band spurious responses, specified in GSM 05.05, are allowed to ensure a fair test of the MS.

14.7.2.4 Method of test

14.7.2.4.1 Initial conditions

A call is set up according to the generic call set up procedure, except the BCCH frequency list shall be empty, on a TCH with an arbitrary ARFCN in the range supported by the MS. The power control level is set to maximum power.

The SS transmits Standard Test Signal C1 on the traffic channel. (TCH frequency FR).

14.7.2.4.2 Procedure

- a) The SS sends a Layer 3 message which does not require a Layer 3 response from the MS. Due to interfering signals, the MS may not be able to acknowledge the Layer 2 frame. Frame erasures are indicated by repeated L2 frames.
- b) The SS is set to produce a TUhigh wanted signal and a static interfering signal at the same time. The SS sets the amplitude of the wanted signal to 4 dB above the reference sensitivity level.
- c) The unwanted signal is a C.W. signal (Standard test signal IO) of frequency FB. It is applied in turn on the subset of frequencies calculated at step f) in the overall range 100 kHz to 12,75 GHz, where FB is an integer multiple of 200 kHz.

However, frequencies in the range FR +/- 600 kHz are excluded.

NOTE: Allowance must be made for possible spurious signals arising from the SS. These are particularly likely at sub harmonic frequencies nFB where n = 2, 3, 4, 5, etc.

- d) The frequencies at which the test is performed (adjusted to an integer multiple of 200 kHz channels most closely approximating the absolute frequency of the calculated blocking signal frequency) are the combined frequencies from i), ii) and iii) which follow:

- i) The total frequency range formed by:-

GSM 400 the frequencies between $F_{10} + (IF_1 + IF_2 + \dots + IF_n + 3,6 \text{ MHz})$

and $F_{lo} - (IF_1 + IF_2 + \dots + IF_n + 3,6 \text{ MHz})$.

GSM 700 the frequencies between $F_{lo} + (IF_1 + IF_2 + \dots + IF_n + 7,5 \text{ MHz})$

and $F_{lo} - (IF_1 + IF_2 + \dots + IF_n + 7,5 \text{ MHz})$.

GSM 850 the frequencies between $F_{lo} + (IF_1 + IF_2 + \dots + IF_n + 12,5 \text{ MHz})$

and $F_{lo} - (IF_1 + IF_2 + \dots + IF_n + 12,5 \text{ MHz})$.

P-GSM 900 the frequencies between $F_{lo} + (IF_1 + IF_2 + \dots + IF_n + 12,5 \text{ MHz})$

and $F_{lo} - (IF_1 + IF_2 + \dots + IF_n + 12,5 \text{ MHz})$.

E-GSM 900 the frequencies between $F_{lo} + (IF_1 + IF_2 + \dots + IF_n + 17,5 \text{ MHz})$

and $F_{lo} - (IF_1 + IF_2 + \dots + IF_n + 17,5 \text{ MHz})$.

DCS 1 800 the frequencies between $F_{lo} + (IF_1 + IF_2 + \dots + IF_n + 37,5 \text{ MHz})$

and $F_{lo} - (IF_1 + IF_2 + \dots + IF_n + 37,5 \text{ MHz})$.

PCS 1 900 the frequencies between $F_{lo} + (IF_1 + IF_2 + \dots + IF_n + 30,0 \text{ MHz})$

and $F_{lo} - (IF_1 + IF_2 + \dots + IF_n + 30,0 \text{ MHz})$.

and

the frequencies $+ 100 \text{ MHz}$ and $- 100 \text{ MHz}$ from the edge of the relevant receive band.

Measurement are made at 200 kHz intervals.

ii) The three frequencies IF_1 , $IF_1 + 200 \text{ kHz}$, $IF_1 - 200 \text{ kHz}$.

iii) The frequencies:

$mF_{lo} + IF_1$,

$mF_{lo} - IF_1$,

mFR ,

where m is all positive integers greater than or equal to 2 such that either sum lies in the range 100 kHz to $12,75 \text{ GHz}$.

The frequencies in step ii) and iii) lying in the range of frequencies defined by step i) above need not be repeated.

Where:-

F_{lo} - local oscillator applied to first receiver mixer

$IF_1 \dots IF_n$ - are the n intermediate frequencies

F_{lo} , IF_1 , $IF_2 \dots IF_n$ shall be declared by the manufacturer in the PIXIT statement
GSM 11.10 annex 3.

e) The level of the unwanted signal is set according to table 14-30.

Table 14-30a: Level of unwanted signals

FREQUENCY	GSM 900		DCS 1 800
	Small MS	Other MS	
	LEVEL IN dB μ Vemf()		
FR +/- 600 kHz to FR +/- 800 kHz	70	75	70
FR +/- 800 kHz to FR +/- 1,6 MHz	70	80	70
FR +/- 1,6 MHz to FR +/- 3 MHz	80	90	80
915 MHz to FR - 3 MHz	90	90	-
FR + 3 MHz to 980 MHz	90	90	-
1785 MHz to FR - 3 MHz	-	-	87
FR + 3 MHz to 1920 MHz	-	-	87
835 MHz to <915 MHz	113	113	
>980 MHz to 1000 MHz	113	113	
100 kHz to <835 MHz	90	90	
>1000 MHz to 12,75 GHz	90	90	
100 kHz to 1705 MHz	-	-	113
>1705 MHz to <1785 MHz	-	-	101
>1920 MHz to 1980 MHz	-	-	101
>1980 MHz to 12,75 GHz	-	-	90

Table 14-30b: Level of unwanted signals

FREQUENCY	GSM 450		GSM 480	
	Small MS	Other MS	Small MS	Other MS
	LEVEL IN dB μ Vemf()			
FR +/- 600 kHz to FR +/- 800 kHz	70	75	70	75
FR +/- 800 kHz to FR +/- 1,6 MHz	70	80	70	80
FR +/- 1,6 MHz to FR +/- 3 MHz	80	90	80	90
457,6 to FR - 3 MHz	90	90	-	-
FR + 3 MHz to 473,6 MHz	90	90	-	-
486 to FR - 3 MHz	-	-	90	90
FR + 3 MHz to 502 MHz	-	-	90	90
100 kHz to <457,6 MHz	113	113	-	-
>473,6 MHz to 12,75 GHz	113	113	-	-
100 kHz to <486 MHz	-	-	113	113
>502 MHz to 12,75 GHz	-	-	113	113

Table 14-30c: Level of unwanted signals

FREQUENCY	PCS 1 900 LEVEL IN dB μ Vemf()
FR +/- 600 kHz to FR +/- 800 kHz	70
FR +/- 800 kHz to FR +/- 1,6 MHz	70
FR +/- 1,6 MHz to FR +/- 3 MHz	80
1910 MHz to FR - 3 MHz	87
FR + 3 MHz to 2010 MHz	87
100 kHz to 1830 MHz	113
>1830 MHz to <1910 MHz	101
>2010 MHz to 2070 MHz	101
>2070 MHz to 12,75 GHz	90

Table 14-30d: Level of unwanted signals

FREQUENCY	GSM 750	GSM 850
	LEVEL IN dB μ Vemf()	
FR +/- 600 kHz to FR +/- 800 kHz	70	70
FR +/- 800 kHz to FR +/- 1,6 MHz	70	70
FR +/- 1,6 MHz to FR +/- 3 MHz	80	80
727 to FR – 3 MHz	90	-
FR + 3 MHz to 782 MHz	90	-
849 MHz to FR – 3 MHz	-	90
FR + 3 MHz to 914 MHz	-	90
100 kHz to <727 MHz	113	-
>782 MHz to 12,75 GHz	113	-
100 kHz to <849 MHz	-	113
>914 MHz to 12,75 GHz	-	113

NOTE 1: These values differ from GSM 05.05 because of practical generator limits in the SS.

NOTE 2: For an E-GSM 900 MS the level of the unwanted signal in the band 905 MHz to < 915 MHz is relaxed to 108 dB μ Vemf().

NOTE 3: For a GSM 450 small MS the level of the unwanted signal in the band 450,4 MHz to <457,6 MHz is relaxed to 108 dB μ Vemf(). For a GSM 480 small MS the level of the unwanted signal in the band 478,8 MHz to <486 MHz is relaxed to 108 dB μ Vemf().

f) The SS determines the number of frame erasure events during at least the minimum number of samples. If a failure is indicated, it is noted and counted towards the allowed exemption total.

In the case of failures discovered at the predicted frequencies at steps f ii), iii) or iv) the test is repeated on the adjacent channels +/- 200 kHz away. If either of these two frequencies fail then the next channel 200 kHz beyond is also be tested. This process is repeated until all channels constituting the group of failures is known.

14.7.2.5 Test requirements

The error rate measured in this test shall not exceed the test limit error rate given in table 14-31.

This shall apply under normal test voltage and ambient temperature, and with the interfering signal at any frequency in the range specified.

Table 14-31: Limits for blocking

Channel	Type of measurement	GSM 400 and GSM 900		DCS 1 800 and PCS 1 900	
		Test limit error rate	Minimum No. of samples	Test limit error rate	Minimum No. of samples
FACCH/F	FER	8,961	6696	4,368	13736

The following exceptions are allowed:

GSM 450: A maximum of three failures in the frequency band 457,6 MHz to 473,6 MHz.

A maximum of 24 failures in the combined bands 100 kHz to 457,6 MHz and 473,6 MHz to 12,75 GHz (which, if below FR and grouped, shall not exceed three 200 kHz channels per group).

GSM 480: A maximum of three failures in the frequency band 486 MHz to 502 MHz.

A maximum of 24 failures in the combined bands 100 kHz to 486 MHz and 502 MHz to 12,75 GHz (which, if below FR and grouped, shall not exceed three 200 kHz channels per group).

GSM 750: A maximum of six failures in the frequency band 727 MHz to 782 MHz (which, if grouped, shall not exceed three 200 kHz channels per group).

A maximum of 24 failures in the combined bands 100 kHz to 727 MHz and 782 MHz to 12,75 GHz (which, if below FR and grouped, shall not exceed three 200 kHz channels per group).

- GSM 850: A maximum of six failures in the frequency band 849 MHz to 914 MHz (which, if grouped, shall not exceed three 200 kHz channels per group).
- A maximum of 24 failures in the combined bands 100 kHz to 849 MHz and 914 MHz to 12,75 GHz (which, if below FR and grouped, shall not exceed three 200 kHz channels per group).
- GSM 900: A maximum of six failures in the band 915 MHz to 980 MHz (which, if grouped, shall not exceed three 200 kHz channels per group).
- A maximum of 24 in the combined bands 100 kHz to 915 MHz and 980 MHz to 12,75 GHz (which, if below FR and grouped, shall not exceed three 200 kHz channels per group).
- DCS 1 800: A maximum of twelve failures in the band 1785 MHz to 1 920 MHz (which, if grouped, shall not exceed three 200 kHz channels per group).
- A maximum of 24 in the combined bands 100 kHz to 1785 MHz and 1 920 MHz to 12,75 GHz (which, if below FR and grouped, shall not exceed three 200 kHz channels per group).
- PCS 1 900: A maximum of twelve failures in the band 1910 MHz to 2010 MHz (which, if grouped, shall not exceed three 200 kHz channels per group).
- A maximum of 24 in the combined bands 100 kHz to 1910 MHz and 2010 MHz to 12,75 GHz (which, if below FR and grouped, shall not exceed three 200 kHz channels per group).

If the number of failures do not exceed the maximum allowed figures stated above, the test of 14.7.2.4 is repeated at the frequencies at which the failures occurred. The level of the unwanted signal is set to $70 \text{ dB}\mu\text{Vemf}(\)$ and the performance requirement is once again that stated above.

The number of Error Events recorded in this test shall not exceed the test limit error rate values given above, when using the maximum number of samples.

No failures are allowed at this lower unwanted signal level.

14.7.3 Blocking and spurious response - speech channels for MS supporting the R-GSM band

14.7.3.1 Definition and applicability

Blocking is a measure of the ability of the receiver to receive a modulated wanted input signal in the presence of an unwanted input signal, on frequencies other than those of the spurious responses or the adjacent channels, without exceeding a given degradation.

The requirements and this test apply to R-GSM MS supporting speech.

14.7.3.2 Conformance requirement

1. The blocking characteristics of the receiver are specified separately for in-band and out-of-band performance as identified in GSM 05.05 section 5.1.

The reference sensitivity performance as specified in table 1 of GSM 05.05 shall be met when the following signals are simultaneously input to the receiver:

- a useful signal at frequency f_0 , 3 dB above the reference sensitivity level as specified in GSM 05.05 section 6.2;
- a continuous, static sine wave signal at a level as in the table of GSM 05.05 section 5.1 and at a frequency (f) which is an integer multiple of 200 kHz.

With the following exceptions, called spurious response frequencies:

- a) R-GSM 900: in band, for a maximum of six occurrences (which if grouped shall not exceed three contiguous occurrences per group);

- b) out of band, for a maximum of 24 occurrences (which if below f_0 and grouped shall not exceed three contiguous occurrences per group).

Where the above performance shall be met when the continuous sine wave signal (f) is set to a level of 70 dB μ V (emf) (i.e. -43 dBm). GSM 05.05, 5.1.

14.7.3.3 Test purpose

1. To verify that the in band blocking performance is met without exceeding the total number of allowed in band spurious responses. An allowance is made for the statistical significance of the test.
2. To verify that at selected out of band frequencies, the out of band blocking performance is met without exceeding the total number of allowed out of band spurious responses. An allowance is made for the statistical significance of the test.

NOTE: Not all of the possible out of band frequencies are tested as this results in excessive test time. However, the total number of out of band spurious responses, specified in GSM 05.05, are allowed to ensure a fair test of the MS.

14.7.3.4 Method of test

14.7.3.4.1 Initial conditions

A call is set up according to the generic call set up procedure, except the BCCH frequency list shall be empty, on a TCH with an arbitrary ARFCN in the range supported by the MS. The power control level is set to maximum power.

The SS transmits Standard Test Signal C1 on the traffic channel. (TCH frequency FR).

The SS commands the MS to create traffic channel loop back signalling erased frames.

14.7.3.4.2 Procedure

- a) The SS produces a static wanted signal and a static interfering signal at the same time. The amplitude of the wanted signal is set to 4 dB above the reference sensitivity level.
- b) The unwanted signal is a C.W. signal (Standard test signal IO) of frequency FB. It is applied in turn on the subset of frequencies calculated in step c) in the overall range 100 kHz to 12,75 GHz, where FB is an integer multiple of 200 kHz.

However, frequencies in the range $FR \pm 600$ kHz are excluded.

NOTE: Allowance must be made for possible spurious signals arising from the SS. These are particularly likely at sub harmonic frequencies nFB where $n = 2, 3, 4, 5$, etc.

- c) The frequencies at which the test is performed (adjusted to an integer multiple of 200 kHz channels most closely approximating the absolute frequency of the calculated blocking signal frequency) are the combined frequencies from i), ii) and iii) below:-

- i) The total frequency range formed by:-

R-GSM 900 the frequencies between $F_{10} + (IF_1 + IF_2 + \dots + IF_n + 19,5 \text{ MHz})$

and $F_{10} - (IF_1 + IF_2 + \dots + IF_n + 19,5 \text{ MHz})$.

And the frequencies + 100 MHz and - 100 MHz from the edge of the relevant receive band.

Measurements are made at 200 kHz intervals.

- ii) The three frequencies IF_1 , $IF_1 + 200 \text{ kHz}$, $IF_1 - 200 \text{ kHz}$.

- iii) The frequencies:

$mF_{10} + IF_1$,

$mF_{10} - IF_1$,

mFR,

where m is all positive integers greater than or equal to 2 such that either sum lies in the range 100 kHz to 12,75 GHz.

The frequencies in step ii) and iii) lying in the range of frequencies defined by step i) above need not be repeated.

Where:-

F_{lo} - local oscillator applied to first receiver mixer

$IF_1 \dots IF_n$ - are the n intermediate frequencies

$F_{lo}, IF_1, IF_2 \dots IF_n$ shall be declared by the manufacturer in the PIXIT statement GSM 11.10 annex 3.

- d) The level of the unwanted signal is set according to table 14-28b.

Table 14-28b: Level of unwanted signals for R-GSM MS

FREQUENCY	R-GSM 900	
	Small MS	Other MS
	LEVEL IN dB μ Vemf()	
FR +/- 600 kHz to FR +/- 800 kHz	70	75
FR +/- 800 kHz to FR +/- 1,6 MHz	70	80
FR +/- 1,6 MHz to FR +/- 3 MHz	80	90
915 MHz to FR - 3 MHz	90	90
FR + 3 MHz to 980 MHz	90	90
1785 MHz to FR - 3 MHz	-	-
FR + 3 MHz to 1920 MHz	-	-
835 MHz to <876 MHz	113	113
876 MHz to 880 MHz	106	113
880 MHz to 915 MHz	106	108
>980 MHz to 1000 MHz	113	113
100 kHz to <835 MHz	90	90
>1000 MHz to 12,75 GHz	90	90

NOTE: These values differ from GSM 05.05 because of practical generator limits in the SS.

- e) The SS compares the data of the signal that it sends to the MS with the signal which is looped back from the receiver after demodulation and decoding, and checks the frame erasure indication.

The SS tests the RBER compliance for the bits of class II, by examining sequences of at least the minimum number of samples of consecutive bits of class II, where bits are taken only from those frames for which no bad frame indication was given. The number of error events is recorded.

If a failure is indicated it is noted and counted towards the allowed exemption totals.

In the case of failures discovered at the predicted frequencies at steps f ii), iii) or iv) the test is repeated on the adjacent channels +/- 200 kHz away. If either of these two frequencies fail then the next channel 200 kHz beyond is also tested. This process is repeated until all channels constituting the group of failures is known.

14.7.3.5 Test requirements

The error rate measured in this test shall not exceed the test limit error rate values given in table 14-29b.

This shall apply under normal test voltage and ambient temperature, and with the interfering signal at any frequency in the range specified.

Table 14-29b: Limits for blocking

Channel	Type of measurement	Test limit error rate %	Minimum number of samples
TCH/FS Class II	RBER	2,439	8200

The following exceptions are allowed:

R-GSM 900: A maximum of six failures in the frequency band 915 MHz to 980 MHz (which, if grouped, shall not exceed three 200 kHz channels per group).

A maximum of 24 failures in the combined bands 100 kHz to 915 MHz and 980 MHz to 12,75 GHz (which, if below FR and grouped, shall not exceed three 200 kHz channels per group).

If the number of failures do not exceed the maximum allowed figures stated above, the test of 14.7.3.4 is repeated at the frequencies at which the failures occurred. The level of the unwanted signal is set to 70 dB μ Vemf() and the performance requirement is once again that that stated in the table above.

The number Error rate measured in this test shall not exceed the test limit error rate values given in table 14-29b.

No failures are allowed at this lower unwanted signal level.

14.7.4 Blocking and spurious response - control channels for MS supporting the R-GSM band

14.7.4.1 Definition and applicability

Blocking is a measure of the ability of the receiver to receive a modulated wanted input signal in the presence of an unwanted input signal, on frequencies other than those of the spurious responses or the adjacent channels, without exceeding a given degradation.

The requirements and this test apply to R-GSM MS not supporting speech.

14.7.4.2 Conformance requirement

- The blocking characteristics of the receiver are specified separately for in-band and out-of-band performance as identified in GSM 05.05 section 5.1.

The reference sensitivity performance as specified in table 1 of GSM 05.05 shall be met when the following signals are simultaneously input to the receiver:

- a useful signal at frequency f_0 , 3 dB above the reference sensitivity level as specified in GSM 05.05 section 6.2;
- a continuous, static sine wave signal at a level as in the table of GSM 05.05 section 5.1 and at a frequency (f) which is an integer multiple of 200 kHz.

With the following exceptions, called spurious response frequencies:-

- a) R-GSM 900: in band, for a maximum of six occurrences (which if grouped shall not exceed three contiguous occurrences per group),
- b) out of band, for a maximum of 24 occurrences (which if below f_0 and grouped shall not exceed three contiguous occurrences per group).

Where the above performance shall be met when the continuous sine wave signal (f) is set to a level of 70 dB μ V (emf) (i.e. -43 dBm). GSM 05.05, 5.1.

14.7.4.3 Test purpose

- To verify that the in band blocking performance is met without exceeding the total number of allowed in band spurious responses. An allowance is made for the statistical significance of the test.

2. To verify that at selected out of band frequencies, the out of band blocking performance is met without exceeding the total number of allowed out of band spurious responses. An allowance is made for the statistical significance of the test.

NOTE: Not all of the possible out of band frequencies are tested as this results in excessive test time. However, the total number of out of band spurious responses, specified in GSM 05.05, are allowed to ensure a fair test of the MS.

14.7.4.4 Method of test

14.7.4.4.1 Initial conditions

A call is set up according to the generic call set up procedure, except the BCCH frequency list shall be empty, on a TCH with an arbitrary ARFCN in the range supported by the MS. The power control level is set to maximum power.

The SS transmits Standard Test Signal C1 on the traffic channel. (TCH frequency FR).

14.7.4.4.2 Procedure

- a) The SS sends a Layer 3 message which does not require a Layer 3 response from the MS. Due to interfering signals, the MS may not be able to acknowledge the Layer 2 frame. Frame erasures are indicated by repeated L2 frames.
- b) The SS is set to produce a TUhigh wanted signal and a static interfering signal at the same time. The SS sets the amplitude of the wanted signal to 4 dB above the reference sensitivity level.
- c) The unwanted signal is a C.W. signal (Standard test signal IO) of frequency FB. It is applied in turn on the subset of frequencies calculated at step f) in the overall range 100 kHz to 12,75 GHz, where FB is an integer multiple of 200 kHz.

However, frequencies in the range FR +/- 600 kHz are excluded.

NOTE: Allowance must be made for possible spurious signals arising from the SS. These are particularly likely at sub harmonic frequencies nFB where $n = 2, 3, 4, 5$, etc.

- d) The frequencies at which the test is performed (adjusted to an integer multiple of 200 kHz channels most closely approximating the absolute frequency of the calculated blocking signal frequency) are the combined frequencies from i), ii) and iii) which follow:

- i) The total frequency range formed by:-

R-GSM 900 the frequencies between $F_{10} + (IF_1 + IF_2 + \dots + IF_n + 19,5 \text{ MHz})$

and $F_{10} - (IF_1 + IF_2 + \dots + IF_n + 19,5 \text{ MHz})$.

and

the frequencies + 100 MHz and - 100 MHz from the edge of the relevant receive band.

Measurement are made at 200 kHz intervals.

- ii) The three frequencies IF_1 , $IF_1 + 200 \text{ kHz}$, $IF_1 - 200 \text{ kHz}$.

- iii) The frequencies:

$mF_{10} + IF_1$,

$mF_{10} - IF_1$,

mFR ,

where m is all positive integers greater than or equal to 2 such that either sum lies in the range 100 kHz to 12,75 GHz.

The frequencies in step ii) and iii) lying in the range of frequencies defined by step i) above need not be repeated.

Where:-

F_{lo} - local oscillator applied to first receiver mixer

$IF_1 \dots IF_n$ - are the n intermediate frequencies

$F_{lo}, IF_1, IF_2 \dots IF_n$ shall be declared by the manufacturer in the PIXIT statement GSM 11.10 annex 3.

e) The level of the unwanted signal is set according to table 14-30b.

Table 14-30b: Level of unwanted signals

FREQUENCY	GSM 900	
	Small MS	Other MS
	LEVEL IN dB μ Vemf()	
FR +/- 600 kHz to FR +/- 800 kHz	70	75
FR +/- 800 kHz to FR +/- 1,6 MHz	70	80
FR +/- 1,6 MHz to FR +/- 3 MHz	80	90
915 MHz to FR - 3 MHz	90	90
FR + 3 MHz to 980 MHz	90	90
835 MHz to <876 MHz	113	113
876 MHz to 880 MHz	106	113
880 MHz to 915 MHz	106	108
>980 MHz to 1000 MHz	113	113
100 kHz to <835 MHz	90	90
>1000 MHz to 12,75 GHz	90	90

NOTE: These values differ from GSM 05.05 because of practical generator limits in the SS.

f) The SS determines the number of frame erasure events during at least the minimum number of samples. If a failure is indicated, it is noted and counted towards the allowed exemption total.

In the case of failures discovered at the predicted frequencies at steps f ii), iii) or iv) the test is repeated on the adjacent channels +/- 200 kHz away. If either of these two frequencies fail then the next channel 200 kHz beyond is also be tested. This process is repeated until all channels constituting the group of failures is known.

14.7.4.5 Test requirements

The error rate measured in this test shall not exceed the test limit error rate given in table 14-31b.

This shall apply under normal test voltage and ambient temperature, and with the interfering signal at any frequency in the range specified.

Table 14-31b: Limits for blocking

Channel	Type of measurement	GSM 900		DCS 1 800	
		Test limit error rate	Minimum No. of samples	Test limit error rate	Minimum No. of samples
FACCH/F	FER	8,961	6696	4,368	13736

The following exceptions are allowed:

R-GSM 900: A maximum of six failures in the band 915 MHz to 980 MHz (which, if grouped, shall not exceed three 200 kHz channels per group).

A maximum of 24 in the combined bands 100 kHz to 915 MHz and 980 MHz to 12,75 GHz (which, if below FR and grouped, shall not exceed three 200 kHz channels per group).

If the number of failures do not exceed the maximum allowed figures stated above, the test of 14.7.4.4 is repeated at the frequencies at which the failures occurred. The level of the unwanted signal is set to $70 \text{ dB}\mu\text{Vemf}(\)$ and the performance requirement is once again that stated above.

The number of Error Events recorded in this test shall not exceed the test limit error rate values given above, when using the maximum number of samples.

No failures are allowed at this lower unwanted signal level.

14.8 AM suppression

14.8.1 AM suppression - speech channels

14.8.1.1 Definition and applicability

AM suppression is a measure of the ability of the receiver to receive a modulated wanted input signal in the presence of an unwanted TDMA modulated interferer.

The requirements and this test apply to MS supporting speech.

14.8.1.2 Conformance requirement

The reference sensitivity performance as specified in table 1 shall be met when the following signals are simultaneously input to the receiver:

- a useful signal at frequency f_0 , 3 dB above the reference sensitivity level as specified in GSM 05.05 section 5.2.
- a single frequency (f), in the relevant receive band, $|f - f_0| \geq 6\text{MHz}$, which is an integer multiple of 200 kHz, a GSM TDMA signal modulated by any 148-bits subsequence of the 511-bits pseudo random bit sequence, defined in CCITT Recommendation O.153 fascicle IV.4, at a level as defined in the table below. The interferer shall have one timeslot active and the frequency shall be at least 2 channels separated from any identified spurious responses. The transmitted bursts shall be synchronized to but, delayed in time between 61 and 86 bit periods relative to the bursts of the wanted signal. GSM 05.05, 5.2.

MS type	Signal level
GSM400	-31 dBm
GSM 700	-31 dBm
GSM 850	-31 dBm
GSM900	-31 dBm
DCS1800	-29 / -31 * dBm
PCS1900	-29 dBm

- * The -31 dBm level shall apply to DCS1800 class 1 and class 2 MS meeting the -102 dBm reference sensitivity level requirement according to GSM 05.05, 6.2.

14.8.1.3 Test purpose

To verify that the AM suppression performance of the MS meets the conformance requirement with an allowance for the statistical significance of the test.

14.8.1.4 Method of test

14.8.1.4.1 Initial conditions

A call is set up according to the generic call set up procedure, on a TCH/FS with an ARFCN in the mid ARFCN range. The power control level is set to maximum power.

The SS transmits standard Test Signal C1 on the traffic channel (TCH frequency FR).

The SS commands the MS to create traffic channel loop back signalling erased frames.

This test is performed after test 14.7.

14.8.1.4.2 Procedure

- a) The SS produces a static wanted signal with an amplitude 4 dB above reference sensitivity level.
- b) The SS produces an interfering signal as described below:
 - static fading profile;
 - at an in band frequency greater than 6 MHz separated from FR and separated by at least two ARFCNs from any spurious responses.

NOTE: Spurious responses are identified by test cases 14.7.1 and 14.7.2.

- at a level as described in table 14-32.
- GSM TDMA modulated by random data with one timeslot active.
- synchronized to, but delayed between 61 and 86 bit periods to the bursts of the wanted signal.

Table 14-32: Interferer signal level

MS type	Signal level (dB μ V _{emf})
GSM400	82
GSM 700	82
GSM 850	82
GSM900	82
DCS1800	82/84
PCS1900	84

* The 82 dB μ V_{emf} (ie. -31 dBm) level shall apply to DCS1800 class 1 and class 2 MS meeting the -102 dBm reference sensitivity level requirement according to GSM 05.05, 6.2.

- c) The SS compares the data of the signal that it sends to the MS with the signal which is looped back from the receiver after demodulation and decoding, and checks the frame erasure indication.
- d) The SS tests the RBER compliance of class II bits by examining at least the minimum number of samples of consecutive bits. Bits only taken from those frames which do not signal frame erasure. The number of error events is recorded.

14.8.1.5 Test requirements

The error rates measured in this test shall not exceed the test limit error rate values given in table 14.27.

Table 14-33: Limits for AM suppression

Channel	Propagation conditions	Type of measurement	Test limit error rate %	Minimum No. of samples
TCH/FS Class II	Static	RBER	2,439	8200

14.8.2 AM suppression - control channels

14.8.2.1 Definition and applicability

AM suppression is a measure of the ability of the receiver to receive a modulated wanted input signal in the presence of an unwanted TDMA modulated interferer.

The requirements and this test apply to MS not supporting speech.

14.8.2.2 Conformance requirement

The reference sensitivity performance as specified in table 1 shall be met when the following signals are simultaneously input to the receiver:

- a useful signal at frequency f_0 , 3 dB above the reference sensitivity level as specified in GSM 05.05 section 5.2.
- a single frequency (f), in the relevant receive band, $|f - f_0| \geq 6\text{MHz}$, which is an integer multiple of 200 kHz, a GSM TDMA signal modulated by any 148-bits subsequence of the 511-bits pseudo random bit sequence, defined in CCITT Recommendation O.153 fascicle IV.4, at a level as defined in the table below. The interferer shall have one timeslot active and the frequency shall be at least 2 channels separated from any identified spurious responses. The transmitted bursts shall be synchronized to but, delayed in time between 61 and 86 bit periods relative to the bursts of the wanted signal. GSM 05.05, 5.2.

MS type	Signal level
GSM400	-31 dBm
GSM 700	-31 dBm
GSM 850	-31 dBm
GSM900	-31 dBm
DCS1800	-29 / -31 * dBm
PCS1900	-29 dBm

- * The -31 dBm level shall apply to DCS1800 class 1 and class 2 MS meeting the -102 dBm reference sensitivity level requirement according to GSM 05.05, 6.2.

14.8.2.3 Test purpose

To verify that the AM suppression performance of the MS meets the conformance requirement with an allowance for the statistical significance of the test.

14.8.2.4 Method of test

14.8.2.4.1 Initial conditions

A call is set up according to the generic call set up procedure, on a TCH with an ARFCN in the mid ARFCN range. The power control level is set to maximum power.

The SS transmits standard Test Signal C1 on the traffic channel (TCH frequency FR).

This test is performed after test 14.7.

14.8.2.4.2 Procedure

- a) The SS produces a TUhigh wanted signal with an amplitude 4 dB above reference sensitivity level.
- b) The SS produces an interfering signal as described below:
 - static fading profile;
 - an in band frequency greater than 6 MHz separated from FR and separated by at least two ARFCNs from any spurious responses.

NOTE: Spurious responses are identified by test cases 14.7.1 and 14.7.2.

- at a level as described in table 14-34.
- GSM TDMA modulated by random data with one timeslot active.
- synchronized to, but delayed between 61 and 86 bit periods to the bursts of the wanted signal.

Table 14-34: Interferer signal level

MS type	Signal level (dB μ V _{emf})
GSM400	82
GSM 700	82
GSM 850	82
GSM900	82
DCS1800	82/84
PCS1900	84

* The 82 dB μ V_{emf} (ie. -31 dBm) level shall apply to DCS1800 class 1 and class 2 MS meeting the -102 dBm reference sensitivity level requirement according to GSM 05.05, 6.2.

- c) The SS sends the status message. Due to interfering signals, the MS may not be able acknowledge the Layer 2 frame. Frame erasures are indicated by repeated L2 frames.
- d) The SS determines the number of frame erasure events during at least the minimum number of samples. If a failure is indicated, it is noted and counted towards the allowed exemption total.

14.8.2.5 Test requirements

The error rates measured in this test shall not exceed the test limit error rate values given in table 14.35.

Table 14-35: Limits for AM suppression

			GSM 400, GSM 700, GSM 850 and GSM 900		DCS 1 800 and PCS 1 900	
Channel	Propagation conditions	Type of measurement	Test limit error rate %	Minimum No. of max-samples	Test limit error rate %	Min No. of max-samples
FACCH/F	TUhigh/No FH	FER	8,961	6696	4,368	13736

14.9 Paging performance at high input levels

14.9.1 Definition and applicability

The paging performance at high input levels is the signal level at the MS receiver input at which a certain FER for the PCH must be achieved.

The requirements and this test apply to all types of MS.

14.9.2 Conformance requirement

The paging performance at high input levels requirements of GSM 05.05 section 6.5 a) for PCH under static propagation conditions shall be met from 20 dB above reference sensitivity level up to -15 dBm for GSM 400, GSM 700, GSM 850 and GSM900 and -23 dBm for DCS1800 and PCS1900.

14.9.3 Test purpose

To verify that the MS does not exceed the conformance requirement with an allowance for the statistical significance of the test.

14.9.4 Method of test

14.9.4.1 Initial conditions

System Simulator:

1 cell, Tx-Integer = 3, MAX RETRANS is set to minimum. The CCCH is combined with SDCCH. BS_PA_MFRMS = 9 to achieve worst case sleep mode (DRX). The signal level at the receiver input is set to:

GSM 400: -15 dBm
GSM 700: -15 dBm
GSM 850: -15 dBm
GSM 900: -15 dBm
DCS 1800: -23 dBm.
PCS 1900: -23 dBm

Mobile Station:

The MS has a valid TMSI. It is "idle updated". The MS should have been powered up immediately before running the test, i.e. if a Location update is necessary the MS must be switched off and on again.

14.9.4.2 Procedure

The MS is paged and the SS starts timer T3113. If a CHANNEL REQUEST is received before expiry of T3113 the SS sends an IMMEDIATE ASSIGNMENT REJECT. The sequence is performed 4 times.

Between two consecutive executions the SS must wait for an amount of time which is enough to guarantee that the MS is in service (listening to its paging subchannel).

14.9.5 Test requirements

If the MS answers all pagings with a CHANNEL REQUEST the requirements are met.

NOTE: The probability for a good MS to fail this test is less than 1%.

14.10 *[Reserved for future GSM test]*

14.11 *[Reserved for future GSM test]*

14.12 *[Reserved for future GSM test]*

14.13 *[Reserved for future GSM test]*

14.14 *[Reserved for future GSM test]*

14.15 *[Reserved for future GSM test]*

14.16 GPRS receiver tests

Statistical testing of receiver BLER performance

Error Definition

Block Error Ratio (BLER):

The Block Error Ratio is the ratio of blocks received in error to the total number of received blocks, where a block is defined as received in error if the error detection functions in the receiver, operating in accordance with GSM 05.03, indicate an error as a result of the Block Check Sequence (BCS).

For USF the Block Error Ratio is the ratio of incorrectly interpreted USF to the total number of received USF.

Test criteria

In the receiver tests for circuit switched channels, test error rates have been defined in order not to pass MS with a performance worse than the specification by 1 dB, with tests to be performed at the sensitivity and interference levels defined in GSM 05.05. For circuit switched channels GSM 05.05 defines the error rates at a fixed sensitivity or interference level.

For packet switched channels GSM 05.05 defines the receive or interference level at which a fixed Block Error Ratio is met. Therefore, for GPRS the receiver is tested with a 1 dB offset in the receive level and the interference level.

If the error events can be assumed to be random independent variables, outputs of stationary random processes with identical Gaussian distributions, the previous figures suggest a number of events not lower than 200 in AWGN channel and not lower than 600 in a multipath environment.

For multipath propagation conditions the hypothesis of stationary random processes does not generally hold. In case of non frequency hopping operation mode, the radio channel may be assumed to change 10 times per wavelength of travelled distance and to be short term stationary in between. So, in this case, the required observation time for having good statistical properties should not be lower (with some rounding) than that reported in table 14.16-1.

Table 14.16-1: Minimum test time according to propagation profile

Propagation Conditions	GSM 400, GSM 700, GSM 850 and GSM 900				DCS 1 800 and PCS 1900			
	TUlow	TUhigh	HT	RA	TUlow	TUhigh	HT	RA
Min. test time (s)	500	30	15	6	500	15	7,5	6

Table 14.16-2 details, for the different test conditions, the minimum number of blocks required in order to meet points 1) to 3): the corresponding test time (point 4) can be consequently computed.

Table 14.16-2: Test conditions

Type of test	Type of channel	Propagation/ frequency conditions	Speci- fied BLER %	Minimum No of blocks
Sensitivity	PDTCH/CS-1	static	10	2000
"	PDTCH/CS-1	TUhigh/no FH	10	6000
"	PDTCH/CS-1	TUhigh/FH	10	6000
"	PDTCH/CS-1	RA/no FH	10	6000
"	PDTCH/CS-1	HT/no FH	10	6000
"	PDTCH/CS-2	static	10	2000
"	PDTCH/CS-2	TUhigh/no FH	10	6000
"	PDTCH/CS-2	TUhigh/FH	10	6000
"	PDTCH/CS-2	RA/no FH	10	6000
"	PDTCH/CS-2	HT/no FH	10	6000
"	PDTCH/CS-3	static	10	2000
"	PDTCH/CS-3	TUhigh/no FH	10	6000
"	PDTCH/CS-3	TUhigh/FH	10	6000
"	PDTCH/CS-3	RA/no FH	10	6000
"	PDTCH/CS-3	HT/no FH	10	6000
"	PDTCH/CS-4	static	10	2000
"	PDTCH/CS-4	TUhigh/no FH	10	6000
"	PDTCH/CS-4	TUhigh/FH	10	6000
"	USF/CS-1	static	1	20000
"	USF/CS-1	TUhigh/no FH	1	60000
"	USF/CS-1	TUhigh/FH	1	60000
"	USF/CS-1	RA/no FH	1	60000
"	USF/CS-1	HT/no FH	1	60000
"	USF/CS-2/CS-3/CS-4	static	1	20000
"	USF/CS-2/CS-3/CS-4	TUhigh/noFH	1	60000
"	USF/CS-2/CS-3/CS-4	TUhigh/FH	1	60000
"	USF/CS-2/CS-3/CS-4	RA/no FH	1	60000
"	USF/CS-2/CS-3/CS-4	HT/no FH	1	60000
Co-channel	PDTCH/CS-1	TUlow/no FH	10	6000, but minimum of 500s
"	PDTCH/CS-1	TUhigh/no FH	10	6000
"	PDTCH/CS-1	TUhigh/FH	10	6000
"	PDTCH/CS-1	RA/no FH	10	6000
"	PDTCH/CS-2	TUlow/no FH	10	6000, but minimum of 500s
"	PDTCH/CS-2	TUhigh/no FH	10	6000
"	PDTCH/CS-2	TUhigh/FH	10	6000
"	PDTCH/CS-2	RA/no FH	10	6000
"	PDTCH/CS-3	TUlow/no FH	10	6000, but minimum of 500s
"	PDTCH/CS-3	TUhigh/no FH	10	6000
"	PDTCH/CS-3	TUhigh/FH	10	6000
"	PDTCH/CS-3	RA/no FH	10	6000
"	PDTCH/CS-4	TUlow/no FH	10	6000, but minimum of 500s
"	PDTCH/CS-4	TUhigh/no FH	10	6000
"	PDTCH/CS-4	TUhigh/FH	10	6000
"	USF/CS-1	TUlow/no FH	1	60000
"	USF/CS-1	TUhigh/no FH	1	60000
"	USF/CS-1	TUhigh/FH	1	60000
"	USF/CS-1	RA/no FH	1	60000
"	USF/CS-2/CS-3/CS-4	TUlow/no FH	1	60000
"	USF/CS-2/CS-3/CS-4	TUhigh/no FH	1	60000
"	USF/CS-2/CS-3/CS-4	TUhigh/FH	1	60000
"	USF/CS-2/CS-3/CS-4	RA/no FH	1	60000

14.16.1 Minimum Input level for Reference Performance

14.16.1.1 Definition and applicability

The minimum input level is the signal level at the MS receiver input at which a certain BLER is met.

The requirements and this test apply to MS supporting packet channels.

14.16.1.2 Conformance requirement

1. The block error rate (BLER) performance shall not exceed 10 % at input levels according to the Table below.

Type of channel		Propagation conditions				
		static	TUhigh (no FH)	TUhigh (ideal FH)	RA (no FH)	HT (no FH)
GSM 400, GSM 700, GSM 850 and GSM 900						
PDTCH/CS-1	dBm	-104	-104	-104	-104	-103
PDTCH/CS-2	dBm	-104	-100	-101	-101	-99
PDTCH/CS-3	dBm	-104	-98	-99	-98	-96
PDTCH/CS-4	dBm	-101	-90	-90	*	*
DCS 1 800 and PCS 1900						
PDTCH/CS-1	dBm	-104	-104	-104	-104	-103
PDTCH/CS-2	dBm	-104	-100	-100	-101	-99
PDTCH/CS-3	dBm	-104	-98	-98	-98	-94
PDTCH/CS-4	dBm	-101	-88	-88	*	*

The input levels given in the above Table are referenced to normal GSM 900 MS, and have to be corrected by the following values for other MS:

GSM 400, GSM 700, GSM 850 and GSM 900 small MS	+2 dB
DCS 1800 class 1 or 2 MS	+4 dB
DCS 1800 class 3 and PCS 1900 class 1 or 2 MS	+2 dB
PCS 1900 class 3 MS	0 dB

GSM 05.05, Table 1a; GSM 05.05, 6.2.

2. The block error rate (BLER) performance shall not exceed 1 % at input levels according to the Table below.

Type of channel		Propagation conditions				
		static	TUhigh (no FH)	TUhigh (ideal FH)	RA (no FH)	HT (no FH)
GSM 400, GSM 700, GSM 850 and GSM 900						
USF/CS-1	dBm	< -104	-103	-104	-104	-104
USF/CS-2 to 4	dBm	< -104	-104	-104	-104	-104
DCS 1 800 and PCS 1900						
USF/CS-1	dBm	< -104	-104	-104	-104	-104
USF/CS-2 to 4	dBm	< -104	-104	-104	-104	-104

The input levels given in the above Table are referenced to normal GSM 900 MS, and have to be corrected by the following values for other MS:

GSM 400, GSM 700, GSM 850 and GSM 900 small MS	+2 dB
DCS 1800 class 1 or 2 MS	+4 dB
DCS 1800 class 3 and PCS 1900 class 1 or 2 MS	+2 dB
PCS 1900 class 3 MS	0 dB

GSM 05.05, Table 1a; GSM 05.05, 6.2.

3. The BLER shall not exceed the the conformance requirements given in 1. - 2. under extreme conditions; GSM 05.05, 6.2, GSM 05.05, annex D D.2.1, D.2.2.

4. The reference sensitivity performance specified above need not be met in the following cases:

for MS at the static channel, if the received level on either of the two adjacent timeslots to the wanted exceed the wanted timeslot by more than 20 dB;

for MS on a multislot configuration, if the received level on any of the timeslots belonging to the same multislot configuration as the wanted time slot, exceed the wanted time slot by more than 6 dB.

The interfering adjacent time slots shall be static with valid GSM signals in all cases.

GSM 05.05, 6.2.

- 5) For an MS allocated a USF on a PDCH with a random RF input or a valid PDCH signal with a random USF not equal to the allocated USF, the overall reception shall be such that the MS shall detect the allocated USF in less than 1% of the radio blocks. This requirement shall be met for all input levels up to -40 dBm.

GSM 05.05, 6.4

14.16.1.3 Test purpose

NOTE: This test is performed under STATIC propagation conditions to allow implicit testing of the ability of the MS to hop over the full band. The tests under dynamic propagation conditions are better suited to test the minimum input level for reference BLER performance conformance but cannot test hopping over the full band due to limited bandwidth of available fading simulators.

1. To verify that the MS sends a Packet Not Acknowledge in the Packet Downlink Ack/Nack in case of a the Block Check Sequence indicating a Block Error.
2. To verify that the MS does not exceed conformance requirement 1 for CS-3 and CS-4 under STATIC, TUhigh, HT and RA propagation conditions with an allowance for the statistical significance of the test.
3. To verify that the MS does not exceed conformance requirement 2 under HT propagation conditions with an allowance for the statistical significance of the test.
4. To verify that the MS does not exceed conformance requirement 3 under STATIC, TUhigh, HT and RA propagation conditions for the PDTCH, and HT propagation conditions for the USF, with an allowance for the statistical significance of the test.
5. To verify that the MS meets the conformance requirements also 1 and 2 for the conditions allowed by conformance requirement 4, with an allowance for the statistical significance of the test.
6. To verify that the MS meets conformance requirement 5, with an allowance for the statistical significance of the test.

14.16.1.4 Method of test

14.16.1.4.1 Initial conditions

NOTE 1: The BA list sent on the BCCH and SACCH will indicate at least six surrounding cells with at least one near to each band edge. It is not necessary to generate any of these BCCHs but, if provided the signal strengths of BCCHs shall be in the range $15 \text{ dB}\mu\text{Vemf}(\)$ to $35 \text{ dB}\mu\text{Vemf}(\)$. Surrounding cell signal levels and cell reselection parameters are set so that the MS will not try a cell reselection

NOTE 2: The ARFCN of any BCCH shall not be co-channel or on adjacent channels to the wanted traffic channel.

NOTE 3: When frequency hopping is used, the traffic channel may fall on any of the ARFCNs defined in section 6.

NOTE 4: The PSII message is included in the PACCH when the MS is in packet transfer mode. The PBCCH_CHANGE_MARK value in PSII is not changed. This, together with preventing cell reselection as per Note 1, ensures that the MS is highly unlikely to suspend the TBF (GSM 04.60 clause 5.5.1.4.2 Suspension of operation to receive system operation), and thus making the effect of TBF suspension statistically insignificant for the test result.

A call is set up according to the generic call set up procedure for packet switched on an ARFCN in the Mid range, on the maximum number of receive timeslots, with the MS transmitting at maximum power.

For the ACK/NACK BLER and the BCS BLER parts of the test case, a downlink TBF will be established.

For the USF BLER parts of the test case the Test Mode defined in GSM Rec. 4.14 (para 5.4) will be used for uplink TBF. If the MS is capable of both:

Mode (a) transmitting pseudo-random data sequence in RLC data blocks

Mode (b) transmitting looped-back RLC data blocks

then Mode (a) will be used.

If Mode (b) is used then the SS sends the pseudo-random data sequence specified for Mode (a) on the downlink for loopback on the uplink.

14.16.1.4.2 Procedure

- a) The SS transmits packets under TU50 propagation conditions, using CS-3 coding at a level of 1 dB above the level given in conformance reference 1. Out of the 400 blocks transmitted by the SS, 20 blocks are sent with incorrect BCS, at (pseudo) random positions. The SS checks, for the blocks it transmitted with incorrect BCS, whether or not the MS Packet Downlink Ack/Nack as sent by the MS indicates these blocks as not acknowledged.
- b) The SS transmits packets under static conditions, with the MS commanded to hopping mode using the hopping sequence used in clause 6, and using CS-3 coding to the MS on all allocated timeslots, at a level of 1 dB above the level given in the table in conformance requirement 1. On the time slots not allocated to the MS, the SS transmits at a level of 20 dB above the level given in the table in conformance requirement 1. This implicitly tests adjacent time slot rejection.
- c) The SS counts the number of blocks transmitted with CS-3 and the number of these blocks not acknowledged based on the content of the Ack/Nack Description information element (see 04.60, 12.3) in the Packet Downlink Ack/Nack as sent from the MS to the SS on the PACCH.

Note: Due to the error rates related to the USF, the MS is likely to occasionally miss its USF for transmitting the Packet Downlink Ack/Nack. As this requirement is not verified in this part of the test, the SS then again assigns uplink resources so the MS can send this message.

- d) Once the number of blocks transmitted with CS-3 as counted in step c) reaches or exceeds the minimum number of blocks as given in Table 14-16.2, the SS calculates the Block error ratio. The SS resets both counters.
- e) The SS repeats step b) to d) with the following four fading conditions and hopping modes: TUhigh/noFH, TUhigh/FH, HT/noFH and RA/noFH. For these tests with fading channels, the SS does not transmit on the timeslots not allocated to the MS.
- f) The SS repeats steps b) to e) using CS-4 coding without RA/noFH.
- g) The SS repeats steps b) to f) under extreme test conditions.
- h) This step is only performed for a multislot MS. The SS establishes the normal test conditions with the exceptions in the parameter settings of Packet Downlink Assignment message:
 - $P_0 = 14$ dBm
 - `BTS_PWR_CTRL_MODE = Mode A`
 - `PR_MODE = B`

Furthermore, the SS has to set the PR fields in the MAC headers of each downlink RLC data block to correspond the applied downlink power level, as defined below. The SS repeats steps b) to d) with only one of the active timeslots at 1 dB above the level at which the reference sensitivity performance shall be met, and all other timeslots belonging to the same multislot configuration at a level of 6 dB above this timeslot.

- i) The SS establishes the normal test conditions, and sets the fading function to HT/noFH.
- j) The SS sets the value of the USF/CS-1 such as to allocate the uplink to the MS, transmitting at a level of 1 dB above the level given in the table in conformance requirement 2.
- k) The SS counts the number of times the USF is allocated to the MS, and the number of times the MS does not transmit while being allocated the uplink.

- l) Once the number of USF/CS-1 allocating the uplink for the MS as counted in step k) reaches or exceeds the minimum number of blocks as given in Table 14-16.2, the SS calculates the Block error ratio. The SS resets both counters.
- m) The SS repeats steps j) to l) using USF/CS2 to 4 coding.
- n) The SS repeats steps i) to m) under extreme test conditions.
- o) The SS establishes normal test condition and a static channel. The SS sets the value of the USF/CS-1 to all values randomly, with the exception of the one allocated to the MS, transmitting at 3 dB below the level at which reference performance shall be met, and counts the number of times the MS transmits on the uplink. This is done for 2000 blocks.

14.16.1.5 Test requirements

In step a) the Packet Downlink Ack/Nack as sent by the MS shall indicate every block transmitted by the SS with incorrect BCS as not acknowledged.

The block error ratio, as calculated by the SS for different channels and under the different propagation conditions, under any combination of normal and extreme test voltages and ambient temperatures, shall not exceed the conformance requirement.

In step o) the MS shall transmit no more than 25 times.

In the case when downlink power control is not used and the output power used on the transmitted blocks is not equal to (BCCH level – P_b) then the MS is not required to fulfil GSM 05.05 requirements for the first 25 blocks addressed to this MS. (GSM 05.08, 10.2.2)

NOTE: This is stated in the Rel 99 version of GSM 05.08.

14.16.2 Co-channel rejection

14.16.2.1 Co-channel rejection for packet channels

14.16.2.1.1 Definition and applicability

The co-channel rejection is a measure of the capability of the receiver to receive a wanted modulated signal without exceeding a given degradation due to the presence of an unwanted modulated signal, both signals being at the nominal frequency of the receiver.

The requirements and this test apply to MS supporting packet channels.

14.16.2.1.2 Conformance requirement

1. The block error rate (BLER) performance shall not exceed 10 % at co-channel interference ratios (C/I_c) exceeding those according to the Table below.

Type of channel		Propagation conditions			
		TUlow (no FH)	TUhigh (no FH)	TUhigh (ideal FH)	RA (no FH)
GSM 400, GSM 700, GSM 850 and GSM 900					
PDTCH/CS-1	dB	13	10	9	9
PDTCH/CS-2	dB	15	14	13	13
PDTCH/CS-3	dB	16	16	15	16
PDTCH/CS-4	dB	21	24	23	-
DCS 1 800 and PCS 1900					
PDTCH/CS-1	dB	13	9	9	9
PDTCH/CS-2	dB	15	13	13	13
PDTCH/CS-3	dB	16	16	16	16
PDTCH/CS-4	dB	21	27	25	-

GSM 05.05, Table 2a; GSM 05.05, 6.2.

2. The block error rate (BLER) performance shall not exceed 1 % at co-channel interference ratios (C/I_c) exceeding those according to the Table below.

Type of channel		Propagation conditions			
		TUlow (no FH)	TUhigh (no FH)	TUhigh (ideal FH)	RA (no FH)
GSM 400, GSM 700, GSM 850 and GSM 900					
USF/CS-1	dB	19	12	10	10
USF/CS-2 to 4	dB	18	10	9	8
DCS 1 800 and PCS 1900					
USF/CS-1	dB	19	10	10	10
USF/CS-2 to 4	dB	18	9	9	7

14.16.2.1.3 Test purpose

1. To verify that the MS does not exceed conformance requirement 1 under propagation condition TUlow/no FH, TUhigh/noFH, TUhigh/FH and RA/no FH with an allowance for the statistical significance of the test.
2. To verify that the MS does not exceed conformance requirement 2 under propagation condition TUhigh/noFH, with an allowance for the statistical significance of the test.

14.16.2.1.4 Method of test

14.16.2.1.4.1 Initial conditions

A call is set up according to the generic call set up procedure with an ARFCN in the mid ARFCN range, power control level set to maximum power.

The SS transmits Standard Test Signal C1.

In addition to this wanted signal (C), the SS produces an independent, uncorrelated interfering signal (I).

This unwanted signal is random, continuous and GSM-modulated, and has no fixed relationship with the bit transitions of the wanted signal.

For the ACK/NACK BLER and the BCS BLER parts of the test case, a downlink TBF will be established.

For the USF BLER parts of the test case the Test Mode defined in GSM Rec. 4.14 (para 5.4) will be used for uplink TBF. If the MS is capable of both:

Mode (a) transmitting pseudo-random data sequence in RLC data blocks

Mode (b) transmitting looped-back RLC data blocks

then Mode (a) will be used.

If Mode (b) is used then the SS sends the pseudo-random data sequence specified for Mode (a) on the downlink for loopback on the uplink.

14.16.2.1.4.2 Procedure

- a) The SS transmits packets using CS-1 coding to the MS on all allocated timeslots.
- b) The fading characteristic of the wanted and the interfering signal is TU_{low}, no FH applies.
- c) The co-channel interference level is set to 1 dB above the level given in the table in conformance requirement 1. The interferer shall have the same frequency hopping sequence as the wanted signal, as well as be subject to the same fading profile.
- d) The SS counts the number of blocks transmitted with current coding scheme and the number of these blocks not acknowledged based on the content of the Ack/Nack Description information element (see 04.60, 12.3) in the Packet Downlink Ack/Nack as sent from the MS to the SS on the PACCH.

Note: Due to the error rates related to the USF, the MS is likely to occasionally miss its USF for transmitting the Packet Downlink Ack/Nack. As this requirement is not verified in this part of the test, the SS then again assigns uplink resources so the MS can send this message.

- e) Once the number of blocks transmitted with the current coding scheme as counted in step d) reaches or exceeds the minimum number of blocks as given in Table 14-x, the SS calculates the Block error ratio. The SS resets both counters.
- f) In the case of CS-1 the SS repeats step c) to e) with the following three fading conditions and hopping modes: TU_{high}/noFH, TU_{high}/FH, and RA/noFH.
In the case of CS-2 the SS repeats step c) to e) with the fading condition and hopping mode RA/no FH only.

In the case of CS-3 the SS repeats step c) to e) with the fading condition and hopping mode TU_{high}/FH only.
In the case of CS-4 the SS repeats step c) to e) with the fading condition and hopping modes: TU_{high}/noFH,.

- g) The SS repeats the steps b) to f) for each of the coding schemes CS-2, CS-3 and CS-4.
- h) The SS establishes the normal test conditions, and sets the fading function to TU_{high}/noFH.
- i) The SS sets the value of the USF/CS-1 such as to allocate the uplink to the MS, using a co-channel interference level of 1 dB above the level given in the table in conformance requirement 2.
- j) The SS counts the number of times the USF is allocated to the MS, and the number of times the MS does not transmit while being allocated the uplink.
- k) Once the number of USF/CS-1 allocating the uplink for the MS as counted in step j) reaches or exceeds the minimum number of blocks as given in Table 14-x, the SS calculates the Block error ratio. The SS resets both counters.
- l) The SS repeats steps i) to k) using USF/CS2 coding.

14.16.2.1.5 Test requirements

The block error ratio, as calculated by the SS for different channels and under the different propagation conditions, under any combination of normal and extreme test voltages and ambient temperatures, shall not exceed the conformance requirement.

14.18 EGPRS receiver tests

Statistical testing of receiver BLER performance

Error Definition

Block Error Ratio (BLER):

The Block Error Ratio is the ratio of blocks received in error to the total number of received blocks, where a block is defined as received in error if the error detection functions in the receiver, operating in accordance with GSM 05.03, indicate an error as the result of the Block Check Sequence (BCS).

For USF the Block Error Ratio is the ratio of incorrectly interpreted USF to the total number of received USF.

Test criteria

In the receiver tests for circuit switched channels, test error rates have been defined in order not to pass MS with a performance worse than the specification by 1 dB, with tests to be performed at the sensitivity and interference levels defined in GSM 05.05. For circuit switched channels GSM 05.05 defines the error rates at a fixed sensitivity or interference level.

For packet switched channels GSM 05.05 defines the receive or interference level at which a fixed Block Error Ratio is met. Therefore, for EGPRS the receiver is tested with a 1 dB offset in the receive level and the interference level.

If the error events can be assumed to be random independent variables, outputs of stationary random processes with identical Gaussian distributions, the previous figures suggest a number of events not lower than 200 in AWGN channel and not lower than 600 in a multipath environment.

For multipath propagation conditions the hypothesis of stationary random processes does not generally hold. In case of non frequency hopping operation mode, the radio channel may be assumed to change 10 times per wavelength of travelled distance and to be short term stationary in between. So, in this case, the required observation time for having good statistical properties should not be lower (with some rounding) than that reported in table 14.18-1

Table 14.18-1: Minimum test time according to propagation profile

Propagation Conditions	GSM400, GSM 700, GSM 850 & GSM 900				DCS 1 800&PCS1900			
	TUlow	TUhigh	HT	RA	TUlow	TUhigh	HT	RA
Min. test time (s)	500	30	15	6	500	15	7,5	6

Table 14.18-2 details, for the different test conditions, the minimum number of blocks required in order to meet points 1) to 3): the corresponding test time (point 4) can be consequently computed.

Table 14.18-2: Test conditions

Type of test	Type of channel	Propagation/ frequency/ conditions	Specified BLER %	Minimum No of RLC blocks
Sensitivity	PDTCH/MCS-1 to 4	static	10	2000
"	PDTCH/MCS-1 to 4	TUhigh/no FH	10	6000
"	PDTCH/MCS-1 to 4	TUhigh/FH	10	6000
"	PDTCH/MCS-1 to 4	RA/no FH	10	6000
"	PDTCH/MCS-1 to 4	HT/no FH	10	6000
"	PDTCH/MCS-5 to 9	static	10	2000
"	PDTCH/MCS-5 to 9	TUhigh/no FH	10 or 30	6000 or 2000
"	PDTCH/MCS-5 to 9	TUhigh/FH	10 or 30	6000 or 2000
"	PDTCH/MCS-5 to 9	RA/noFH	10 or 30	6000 or 2000
"	PDTCH/MCS-5 to 9	HT/noFH	10 or 30	6000 or 2000
"	USF/MCS-1to 4	static	1	20000
"	USF/MCS-1 to 4	TUhigh/no FH	1	60000
"	USF/MCS-1 to 4	TUhigh/FH	1	60000
"	USF/MCS-1 to 4	RA/no FH	1	60000
"	USF/MCS-1 to 4	HT/no FH	1	60000
"	USF/MCS-5 to 9	static	1	20000
"	USF/MCS-5 to 9	Tuhigh/noFH	1	60000
"	USF/MCS-5 to 9	Tuhigh/FH	1	60000
"	USF/MCS-5 to 9	RA/no FH	1	60000
"	USF/MCS-5 to 9	HT/no FH	1	60000
Co-channel	PDTCH/MCS-1 to 4	TUlow/no FH	10	6000, but minimum of 500s
"	PDTCH/MCS-1 to 4	TUhigh/no FH	10	6000
"	PDTCH/MCS-1 to 4	TUhigh/FH	10	6000
"	PDTCH/MCS-1 to 4	RA/no FH	10	6000
"	PDTCH/MCS-5 to 9	TUlow/no FH	10 or 30	6000 or 2000, but minimum of 500s
"	PDTCH/MCS-5 to 9	TUhigh/no FH	10 or 30	6000 or 2000
"	PDTCH/MCS-5 to 9	TUhigh/FH	10 or 30	6000 or 2000
"	PDTCH/MCS-5 to 9	RA/no FH	10 or 30	6000 or 2000
"	USF/MCS-1 to 4	TUlow/no FH	1	60000
"	USF/MCS-1 to 4	TUhigh/no FH	1	60000
"	USF/MCS-1 to 4	TUhigh/FH	1	60000
"	USF/MCS-1 to 4	RA/no FH	1	60000
"	USF/MCS-5 to 9	TUlow/no FH	1	60000
"	USF/MCS-5 to 9	TUhigh/no FH	1	60000
"	USF/MCS-5 to 9	TUhigh/FH	1	60000
"	USF/MCS-5 to 9	RA/no FH	1	60000
Adjacent Channel 200kHz	PDTCH/MCS-1 to 4	TUlow/No FH	10	6000
"	PDTCH/MCS-1 to 4	TUhigh/NoFH	10	6000
"	PDTCH/MSC-5 to 9	TUlow/No FH	10 or 30	6000 or 2000
"	PDTCH/MSC-5 to 9	TUhigh/No FH	10 or 30	6000 or 2000
"	USF/MCS-1 to 4	TUlow/No FH	1	60000
"	USF/MCS-1 to 4	TUhigh/No FH	1	60000
"	USF/MCS-5 to 9	TUlow/No FH	1	60000
"	USF/MCS-5 to 9	TUhigh/No FH	1	60000

Adjacent Channel 400kHz	PDTCH/MCS-1 to 4	TUhigh/No FH	10	6000
“	PDTCH/MCS-5 to 9	TUhigh/No FH	10 or 30	6000 or 2000
“	USF/MCS-1 to 4	TUhigh/No FH	1	60000
“	USF/MCS-5 to 9	TUhigh/No FH	1	60000
Intermodulation Rejection	PDTCH/MCS-1 to 4	static	10	2000
“	PDTCH/MCS-5 to 9	static	10	2000
“	USF/MCS-1 to 4	static	1	20000
“	USF/MCS-1 to 9	static	1	20000
Blocking & Spurious	PDTCH/MCS-1 to 4	TUhigh/No FH	10	6000
“	PDTCH/MCS-5 to 9	TUhigh/No FH	10 or 30	6000 or 2000
“	USF/MCS-1 to 4	TUhigh/No FH	1	60000
“	USF/MCS-5 to 9	TUhigh/No FH	1	60000

Notes:

1. For MCS-7,8 & 9 the BLER of 10% or 30% is specified in the conformance requirements. For MCS-5 to 6 a BLER of 10% is always applied.
2. Under fading conditions the number of RLC blocks indicated above shall be transmitted on each timeslot of the multislot configuration.

14.18.1 Minimum Input level for Reference Performance

14.18.1.1 Definition and applicability

The minimum input level is the signal level at the MS receiver input at which a certain BLER is met.

The requirements and this test apply to all types of MS which are capable of EGPRS operation.

14.18.1.2 Conformance requirement

1. The block error rate (BLER) performance for PDTCH/MCS1 to 4 shall not exceed 10 % at input levels according to the Table 14.18-3a; and for PDTCH/MCS5 to 9 shall not exceed 10% or 30% depending on Coding Schemes at input levels according to the Table 14.18-3b below.

Table 14.18-3a: PDTCH Sensitivity Input Level for GMSK modulation

Type of Channel		Propagation conditions				
		static	TUhigh (no FH)	TUhigh (ideal FH)	RA (no FH)	HT (no FH)
GSM 400, GSM 700, GSM 850 and GSM 900						
PDTCH/MCS-1	dBm	-104	-102.5	-103	-103	-102
PDTCH/MCS-2	dBm	-104	-100.5	-101	-100.5	-100
PDTCH/MCS-3	dBm	-104	-96.5	-96.5	-92.5	-95.5
PDTCH/MCS-4	dBm	-101.5	-91	-91	*	*
DCS 1 800 and PCS 1900						
PDTCH/MCS-1	dBm	-104	-102.5	-103	-103	-101.5
PDTCH/MCS-2	dBm	-104	-100.5	-101	-100.5	-99.5
PDTCH/MCS-3	dBm	-104	-96.5	-96.5	-92.5	-94.5
PDTCH/MCS-4	dBm	-101.5	-90.5	-90.5	*	*

The input levels given in the above Table are applicable to GSM400, GSM 700, GSM 850, GSM 900 and PCS 1900 MS, and have to be corrected by the following values for the following classes of MS:

GSM 400 small MS +2 dB

GSM 700, GSM 850, GSM 900 small MS +2 dB

DCS 1800 class 1 or 2 MS +4 dB

DCS 1800 class 3 MS +2 dB

PCS 1900 class 1 or 2 MS +2 dB

Note: PDTCH/MCS-4 can not meet the reference performance for some propagation conditions (*)

GSM 05.05, Table 1a; GSM 05.05, 6.2.

Table 14.18-3b: PDTCH Sensitivity Input Level for MS for 8-PSK modulation

GSM 400, GSM 700, GSM 850 and GSM 900						
Type of channel		Propagation conditions				
		static	TUhigh (no FH)	TUhigh (ideal FH)	RA (no FH)	HT (no FH)
PDTCH/MCS-5	dBm	-98	-93	-94	-93	-92
PDTCH/MCS-6	dBm	-96	-91	-91.5	-88	-89
PDTCH/MCS-7	dBm	-93	-84	-84	*	-83**
PDTCH/MCS-8	dBm	-90.5	-83**	-83**	*	*
PDTCH/MCS-9	dBm	-86	-78.5**	-78.5**	*	*
DCS 1 800 and PCS 1900						
Type of channel		Propagation conditions				
		static	TUhigh (no FH)	TUhigh (ideal FH)	RA (no FH)	HT (no FH)
PDTCH/MCS-5	dBm	-98	-93.5	-93.5	-93	-89.5
PDTCH/MCS-6	dBm	-96	-91	-91	-88	-83.5
PDTCH/MCS-7	dBm	-93	-81.5	-80.5	*	*
PDTCH/MCS-8	dBm	-90.5	-80**	-80**	*	*
PDTCH/MCS-9	dBm	-86	*	*	*	*
NOTE 1: Ideal FH case assumes perfect decorrelation between bursts. This case may only be tested if such a decorrelation is ensured in the test. For TUhigh (ideal FH), sufficient decorrelation may be achieved with 4 frequencies spaced over 5 MHz.						
NOTE 2: PDTCH for MCS-x can not meet the reference performance for some propagation conditions (*).						
NOTE 3: Performance is specified at 30% BLER for some cases(**)						

The input levels given in the above Table are applicable to Class 4 or Class 5 MS for GSM400, GSM 700, GSM 850 & GSM 900 and to Class 1 or Class 2 MS for DCS1800 & PCS 1900. For all other MS the input levels have to be corrected by the value of -2dB.

GSM 05.05, Tables 1c; GSM 05.05, 6.2

- The block error rate (BLER) performance for USF/MCS1 to 9 shall not exceed 1 % at input levels according to the Tables 14.18-4a & 14.18-4b below.

Table 14.18-4a: USF Sensitivity Input Level for GMSK modulation

Type of channel		Propagation conditions				
		static	TUhigh (no FH)	TUhigh (ideal FH)	RA (no FH)	HT (no FH)
GSM 400, GSM 700, GSM 850 and GSM 900						
USF/MCS-1 to 4	dBm	-104	-102.5	-104	-104	-102.5
DCS 1 800 and PCS1900						
USF/MCS-1 to 4	dBm	-104	-104	-104	-104	-102.5

The input levels given in the above Table are applicable to GSM 400, GSM 700, GSM 850, GSM 900 and PCS1900 MS, and have to be corrected by the following values for the following classes of MS:

GSM 400 small MS +2 dB

GSM 700, GSM 850 & GSM 900 small MS +2 dB

DCS 1800 class 1 or 2 MS +4 dB

DCS 1800 class 3 MS +2 dB

PCS1900 class 1 or 2 MS +2 dB

GSM 05.05, Table 1a; GSM 05.05, 6.2.

Table 14.18-4b: USF Sensitivity Input Level for 8-PSK modulation

Type of Channel		Propagation conditions				
		static	TUhigh (no FH)	TUhigh (ideal FH)	RA (no FH)	HT (no FH)
GSM 400, GSM 700, GSM 850 and GSM 900						
USF/MCS-5 to 9	dBm	-102	-97.5	-99	-100	-99
DCS 1 800 and PCS1900						
USF/MCS-5 to 9	dBm	-102	-99	-99	-100	-99

The input levels given in the above Table are applicable to Class 4 or Class 5 MS for GSM400, GSM 700, GSM 850 & GSM 900 and to Class 1 or Class 2 MS for DCS1800 & PCS 1900. For all other MS the input levels have to be corrected by the value of -2dB.

GSM 05.05, Table 1c; GSM 05.05, 6.2

3. The BLER shall not exceed the conformance requirements given in 1. - 2. under extreme conditions; GSM 05.05, 6.2, GSM 05.05, annex D D.2.1, D.2.2.

4. The reference sensitivity performance specified above need not be met in the following cases:

For MS at the static channel, if the received level on either of the two adjacent timeslots to the wanted exceed the wanted timeslot by more than 20 dB.

For MS on a multislot configuration, if the received level on any of the timeslots belonging to the same multislot configuration as the wanted time slot, exceed the wanted time slot by more than 6 dB.

The interfering adjacent time slots shall be static with valid GSM signals in all cases.

GSM 05.05, 6.2.

5. For an MS allocated a USF on a PDCH with a random RF input or a valid PDCH signal with a random USF not equal to the allocated USF, the overall reception shall be such that the MS shall detect the allocated USF in less than 1% of the radio blocks for GMSK modulated signals and 1% for 8-PSK modulated signals. This requirement shall be met for all input levels up to -40 dBm for GMSK modulated signals and up to -40 dBm for 8-PSK modulated signals.

GSM 05.05, 6.4

14.18.1.3 Test purpose

1. To verify that the MS sends a Packet Not Acknowledge in the Packet Downlink Ack/Nack in case of the Block Check Sequence indicating a Block Error.
2. To verify that the MS does not exceed conformance requirement 1 for PDTCH with different coding schemes and under different propagation conditions with an allowance for the statistical significance of the test.
3. To verify that the MS does not exceed conformance requirement 2 under HT propagation conditions with an allowance for the statistical significance of the test.
4. To verify that the MS does not exceed conformance requirement 3 under STATIC, TUhigh, HT and RA propagation conditions for the PDTCH, and under HT propagation conditions for the USF, with an allowance for the statistical significance of the test.
5. To verify that the MS meets the conformance requirements also 1 and 2 for the conditions allowed by conformance requirement 4, with an allowance for the statistical significance of the test.
6. To verify that the MS meets conformance requirement 5, with an allowance for the statistical significance of the test.

14.18.1.4 Method of test

Initial conditions

NOTE 1: The BA list sent on the BCCH will indicate at least six surrounding cells with at least one near to each band edge. It is not necessary to generate any of these BCCHs but, if provided the signal strengths of BCCHs shall be in the range $15 \text{ dB}\mu\text{Vemf}(\)$ to $35 \text{ dB}\mu\text{Vemf}(\)$. Surrounding cell signal levels and cell reselection parameters are set so that the MS will not try a cell reselection.

NOTE 2: The ARFCN of any BCCH shall not be co-channel or on adjacent channels to the wanted traffic channel.

NOTE 3: When frequency hopping is used, the traffic channel may fall on any of the ARFCNs defined in section 6.

NOTE 4: The PSI1 message is included in the PACCH when the MS is in packet transfer mode. The PBCCH_CHANGE_MARK value in PSI1 is not changed. This, together with preventing cell reselection as per Note 1, ensures that the MS is highly unlikely to suspend the TBF (GSM 04.60 clause 5.5.1.4.2 Suspension of operation to receive system operation), and thus making the effect of TBF suspension statistically insignificant for the test result.

For both GMSK and 8-PSK modulations, a downlink TBF is set up according to the generic procedure specified in section 40 for packet switched on an ARFCN in the Mid range. The SS shall transmit on the maximum number of receive timeslots. The SS commands the MS to transmit at maximum power.

Test procedure

For GMSK Modulation:

- a) The SS transmits packets under TUhigh propagation conditions, using MCS-4 coding at a level of 1 dB above the level given in conformance reference 1. Out of the 400 blocks transmitted by the SS, 20 blocks are sent with incorrect BCS, at (pseudo) random positions. The SS checks, for the blocks it transmitted with incorrect BCS, whether or not the MS Packet Downlink Ack/Nack as sent by the MS indicates these blocks as not acknowledged.
- b) The SS transmits packets under static conditions, with the MS commanded to hopping mode using the hopping sequence used in clause 6, and using MCS-4 coding to the MS on all allocated timeslots, at a level of 1 dB above the level given in the table in conformance requirement 1. On the time slots not allocated to the MS, the SS transmits at a level of 20 dB above the level given in the table in conformance requirement 1. This implicitly tests adjacent time slot rejection.

- c) The SS counts the number of blocks transmitted with MCS-4 and the number of these blocks not acknowledged based on the content of the Ack/Nack Description information element (see 04.60, 12.3) in the Packet Downlink Ack/Nack as sent from the MS to the SS on the PACCH.

Note: Due to the error rates related to the USF, the MS is likely to occasionally miss its USF for transmitting the Packet Downlink Ack/Nack. As this requirement is not verified in this part of the test, the SS then again assigns uplink resources so the MS can send this message.

- d) Once the number of blocks transmitted with MCS-4 as counted in step c) reaches or exceeds the minimum number of blocks as given in Table 14-18-2, the SS calculates the Block error ratio. The SS resets both counters.
- e) The SS repeats step b) to d) with the following two fading conditions and hopping modes: TUhigh/noFH and TUhigh/FH. For these tests with fading channels, the SS does not transmit on the timeslots not allocated to the MS.
- f) The SS repeats steps b) to d) using MCS-3 coding with RA/No FH, MCS-2 coding with HT/No FH and MCS-1 coding with TUhigh/No FH. For these tests, the SS does not transmit on the timeslots not allocated to the MS.
- g) The SS repeats steps b) to e) under extreme test conditions for MCS-4 coding only.
- h) This step is only performed for a multislot MS. The SS establishes the normal test conditions, and repeats steps b) to d) with only one of the active timeslots at 1 dB above the level at which the reference sensitivity performance shall be met, and all other timeslots belonging to the same multislot configuration at a level of 6 dB above this timeslot.
- i) The SS establishes the normal test conditions, and sets the fading function to HT/noFH. An uplink TBF shall be established.
- j) The SS sets the value of the USF/MCS-1 such as to allocate the uplink to the MS, transmitting at a level of 1 dB above the level given in the table in conformance requirement 2.
- k) The SS counts the number of times the USF is allocated to the MS, and the number of times the MS does not transmit while being allocated the uplink.
- l) Once the number of USF/MCS-1 allocating the uplink for the MS as counted in step k) reaches or exceeds the minimum number of blocks as given in Table 14-18-2, the SS calculates the Block error ratio. The SS resets both counters
- m) The SS repeats steps j) to l) using USF/MCS2 to 4 coding.
- n) The SS repeats steps i) to l) under extreme test conditions for MCS-4 coding only.
- o) The SS establishes normal test condition and a static channel. The SS sets the value of the USF/MCS-1 to all values randomly, with the exception of the one allocated to the MS, transmitting at 3 dB below the level at which reference performance shall be met, and counts the number of times the MS transmits on the uplink. This is done for 2000 blocks.

For 8-PSK Modulation:

- a) The SS transmits packets under TUhigh propagation conditions, using MCS-8 coding at a level of 1 dB above the level given in conformance reference 1. Out of the 400 blocks transmitted by the SS, 20 blocks are sent with incorrect BCS, at (pseudo) random positions. The SS checks, for the blocks it transmitted with incorrect BCS, whether or not the MS Packet Downlink Ack/Nack as sent by the MS indicates these blocks as not acknowledged.
- b) The SS transmits packets under static conditions, with the MS commanded to hopping mode using the hopping sequence used in clause 6, and using MCS-8 coding to the MS on all allocated timeslots, at a level of 1 dB above the level given in the table in conformance requirement 1. On the time slots not allocated to the MS, the SS transmits at a level of 20 dB above the level given in the table in conformance requirement 1. This implicitly tests adjacent time slot rejection.
- c) The SS counts the number of blocks transmitted with MCS-8 and the number of these blocks not acknowledged based on the content of the Ack/Nack Description information element (see 04.60, 12.3) in the Packet Downlink Ack/Nack as sent from the MS to the SS on the PACCH.

Note: Due to the error rates related to the USF, the MS is likely to occasionally miss its USF for transmitting the Packet Downlink Ack/Nack. As this requirement is not verified in this part of the test, the SS then again assigns uplink resources so the MS can send this message.

- d) Once the number of blocks transmitted with MCS-8 as counted in step c) reaches or exceeds the minimum number of blocks as given in Table 14-18-2, the SS calculates the Block error ratio. The SS resets both counters.
- e) The SS repeats step b) to d) with the following two fading conditions and hopping modes: TUhigh/noFH and TUhigh/FH. For these tests with fading channels, the SS does not transmit on the timeslots not allocated to the MS.
- f) The SS repeats steps b) to d) using MCS-9 with static condition, MCS-7 with TUhigh/FH, MCS-6 with HT/No FH and MCS-5 with RA/No FH. For these tests, the SS does not transmit on the timeslots not allocated to the MS.
- g) The SS repeats steps b) to e) under extreme test conditions for MCS-8 coding only.
- h) This step is only performed for a multislot MS. The SS establishes the normal test conditions, and repeats steps b) to d) with only one of the active timeslots at 1 dB above the level at which the reference sensitivity performance shall be met, and all other timeslots belonging to the same multislot configuration at a level of 6 dB above this timeslot.
- i) The SS establishes the normal test conditions, and sets the fading function to HT/noFH. An uplink TBF shall be established.
- j) The SS sets the value of the USF/MCS-5 such as to allocate the uplink to the MS, transmitting at a level of 1 dB above the level given in the table in conformance requirement 2.
- k) The SS counts the number of times the USF is allocated to the MS, and the number of times the MS does not transmit while being allocated the uplink.
- l) Once the number of USF/MCS-5 allocating the uplink for the MS as counted in step k) reaches or exceeds the minimum number of blocks as given in Table 14-18-2, the SS calculates the Block error ratio. The SS resets both counters.
- m) The SS repeats steps j) to l) using USF/MCS-6 to 9 coding.
- n) The SS repeats steps j) to l) under extreme test conditions for MCS-9 coding only.
- o) The SS establishes normal test condition and a static channel. The SS sets the value of the USF/MCS-5 to all values randomly, with the exception of the one allocated to the MS, transmitting at 3 dB below the level at which reference performance shall be met, and counts the number of times the MS transmits on the uplink. This is done for 2000 blocks.

14.18.1.5 Test requirements

In step a) the Packet Downlink Ack/Nack as sent by the MS shall indicate every block transmitted by the SS with incorrect BCS as not acknowledged.

The block error ratio, as calculated by the SS for different channels and under the different propagation conditions, under any combination of normal and extreme test voltages and ambient temperatures, shall not exceed the conformance requirement.

In step o) for both GMSK modulation and 8-PSK modulation the MS shall transmit no more than 25 times

14.18.2 Co-channel rejection

14.18.2.1 Definition and applicability

The co-channel rejection is a measure of the capability of the receiver to receive a wanted modulated signal without exceeding a given degradation due to the presence of an unwanted modulated signal, both signals being at the nominal frequency of the receiver. "Wanted signal" in this test is the signal generated by the transmitted RLC data blocks.

The requirements and this test apply to all types of MS which are capable of EGPRS operation.

14.18.2.2 Conformance requirement

- The block error rate (BLER) performance for PDTCH/MCS1 to 4 shall not exceed 10 % at co-channel interference ratios (C/I_c) exceeding those according to the Table 14.18-5a; and for PDTCH/MCS5 to 9 shall not exceed 10% or 30% depending on Coding Schemes at co-channel interference ratios (C/I_c) exceeding those according to the Table 14.18-5b below.

Table 14.18-5a: PDTCH Co-channel Interference Ratio for GMSK modulation

Type of channel		Propagation conditions			RA (no FH)
		TUlow (no FH)	TUhigh (no FH)	TUhigh (ideal FH)	
GSM 400, GSM 700, GSM 850 and GSM 900					
PDTCH/MCS-1	dB	13	10.5	9.5	10
PDTCH/MCS-2	dB	15	12.5	12	12
PDTCH/MCS-3	dB	16.5	17	17	19
PDTCH/MCS-4	dB	19	22	22	*
DCS 1 800 and PCS1900					
PDTCH/MCS-1	dB	13	10	9.5	10
PDTCH/MCS-2	dB	15	12	12	12
PDTCH/MCS-3	dB	16.5	17	18	19
PDTCH/MCS-4	dB	19	23	23	*

Note: PDTCH/MCS-4 can not meet the reference performance for some propagation condition (*)

GSM 05.05, Table 2a; GSM 05.05, 6.3.

Table 14.18-5b: Cochannel interference ratio for MS at reference performance for 8-PSK modulation

GSM 400, GSM 700, GSM 850 and GSM900					
Type of channel		Propagation conditions			RA (no FH)
		TUlow (no FH)	TUhigh (no FH)	TUhigh (ideal FH)	
PDTCH/MCS-5	dB	19.5	15.5	14.5	16.5
PDTCH/MCS-6	dB	21.5	18	17.5	21
PDTCH/MCS-7	dB	26.5	25	24.5	*
PDTCH/MCS-8	dB	30.5	25.5**	25.5**	*
PDTCH/MCS-9	dB	25.5**	30.5**	30.5**	*
DCS 1800 and PCS 1900					
Type of channel		Propagation conditions			RA (no FH)
		TUlow (no FH)	TUhigh (no FH)	TUhigh (ideal FH)	
PDTCH/MCS-5	dB	19.5	15	15.5	16.5
PDTCH/MCS-6	dB	21.5	18	18.5	21
PDTCH/MCS-7	dB	26.5	27.5	28	*
PDTCH/MCS-8	dB	30.5	29.5**	29**	*
PDTCH/MCS-9	dB	25.5**	*	*	*

Note 1: PDTCH/MCS-x can not meet the reference performance for some propagation condition (*)

Note 2: Performance is specified at 30% BLER for some cases (**)

GSM 05.05, Table 2c; GSM 05.05, 6.3.

- The block error rate (BLER) performance for USF/MCS1 to 9 shall not exceed 1 % at co-channel interference ratios (C/I_c) exceeding those according to the Tables 14.18-6a & 14.18-6b below.

Table 14.18-6a: USF Co-channel Interference Ratio for GMSK modulation

Type of channel		Propagation conditions			RA (no FH)
		TUlow (no FH)	TUhigh (no FH)	TUhigh (ideal FH)	
GSM 400, GSM 700, GSM 850 and GSM 900					
USF/MCS-1 to 4	dB	18	11	9.5	9.5
DCS 1 800 and PCS1900					
USF/MCS-1 to 4	dB	18	9.5	9.5	9.5

GSM 05.05, Tables 2a.

Table 14.18-6b: USF Co-channel Interference Ratio for 8-PSK modulation

Type of channel		Propagation conditions			RA (no FH)
		TUlow (no FH)	TUhigh (no FH)	TUhigh (ideal FH)	
GSM 400, GSM 700, GSM 850 and GSM 900					
USF/MCS-5 to 9	dB	17	11.5	9	9
DCS 1 800 and PCS1900					
USF/MCS-5 to 9	dB	17	10	9	9

GSM 05.05, Tables 2c.

14.18.2.3 Test purpose

1. To verify that the MS does not exceed conformance requirement 1 for different coding schemes and under different propagation conditions with an allowance for the statistical significance of the test.
2. To verify that the MS does not exceed conformance requirement 2 under propagation condition TUhigh/noFH, with an allowance for the statistical significance of the test.

14.18.2.4 Method of test

Initial conditions

For both GMSK and 8-PSK modulations, a downlink TBF is set up according to the generic procedure specified in section 40 for packet switched with an ARFCN in the mid ARFCN range, power control level set to maximum power.

The SS transmits EGPRS RLC data blocks containing random data. In addition to these data blocks, the SS produces an independent, uncorrelated interfering signal (I1).

Test procedure

For GMSK Modulation:

- a) The SS transmits packets on PDTCH using MCS-4 coding to the MS on all allocated timeslots.
- b) The fading characteristic of the wanted signal and the interfering signal is TUlow, no FH applies.
- c) The co-channel interference ratio is set to 1 dB above the ratio given in the table in conformance requirement 1. The interferer shall have the same frequency hopping sequence as the wanted signal, as well as be subject to the same fading profile.
- d) The SS counts the number of blocks transmitted with current coding scheme and the number of these blocks not acknowledged based on the content of the Ack/Nack Description information element (see 04.60, 12.3) in the Packet Downlink Ack/Nack as sent from the MS to the SS on the PACCH.

Note: Due to the error rates related to the USF, the MS is likely to occasionally miss its USF for transmitting the Packet Downlink Ack/Nack. As this requirement is not verified in this part of the test, the SS then again assigns uplink resources so the MS can send this message.

- e) Once the number of blocks transmitted with the current coding scheme as counted in step d) reaches or exceeds the minimum number of blocks as given in Table 14-18-2, the SS calculates the Block error ratio. The SS resets both counters.
- f) The SS repeats step c) to e) with the TUhigh/noFH fading condition
- g) The SS repeats the steps b) to e) for the coding schemes MCS-3 with TUhigh/noFH, MCS-2 with TUhigh/FH and MCS-1 with RA/noFH.
- h) The SS establishes the normal test conditions, and sets the fading function to TUhigh/noFH. An uplink TBF shall be established.
- i) The SS sets the value of the USF/MCS-4 such as to allocate the uplink to the MS, using a co-channel interference ratio of 1 dB above the ratio given in the table in conformance requirement 2.
- j) The SS counts the number of times the USF is allocated to the MS, and the number of times the MS does not transmit while being allocated the uplink.
- k) Once the number of USF/MCS-4 allocating the uplink for the MS as counted in step j) reaches or exceeds the minimum number of blocks as given in Table 14-18-2, the SS calculates the Block error ratio. The SS resets both counters.
- l) The SS repeats steps i) to k) for each of the coding scheme MCS-1 to 3.

For 8-PSK Modulation:

- a) The SS transmits packets on PDTCH using MCS-8 coding to the MS on all allocated timeslots.
- b) The fading characteristic of the wanted signal and the interfering signal is TULow, no FH applies.
- c) The co-channel interference ratio is set to 1 dB above the ratio given in the table in conformance requirement 1. The interferer shall have the same frequency hopping sequence as the wanted signal, as well as be subject to the same fading profile.
- d) The SS counts the number of blocks transmitted with current coding scheme and the number of these blocks not acknowledged based on the content of the Ack/Nack Description information element (see 04.60, 12.3) in the Packet Downlink Ack/Nack as sent from the MS to the SS on the PACCH.

Note: Due to the error rates related to the USF, the MS is likely to occasionally miss its USF for transmitting the Packet Downlink Ack/Nack. As this requirement is not verified in this part of the test, the SS then again assigns uplink resources so the MS can send this message.

- e) Once the number of blocks transmitted with the current coding scheme as counted in step d) reaches or exceeds the minimum number of blocks as given in Table 14-18-2, the SS calculates the Block error ratio. The SS resets both counters.
- f) The SS repeats step c) to e) with the TUhigh/noFH fading condition.
- g) The SS repeats steps c) to e) for MCS-9 with TULow/NoFH, MCS-7 with TUhigh/noFH, MCS-6 with TUhigh/FH and MSC-5 with RA/noFH.
- h) The SS establishes the normal test conditions, and sets the fading function to TUhigh/noFH. An uplink TBF shall be established.
- i) The SS sets the value of the USF/MCS-9 such as to allocate the uplink to the MS, using a co-channel interference ratio of 1 dB above the ratio given in the table in conformance requirement 2.
- j) The SS counts the number of times the USF is allocated to the MS, and the number of times the MS does not transmit while being allocated the uplink.

- k) Once the number of USF/MCS-9 allocating the uplink for the MS as counted in step j) reaches or exceeds the minimum number of blocks as given in Table 14-18-2, the SS calculates the Block error ratio. The SS resets both counters.
- l) The SS repeats steps i) to k) using USF/MCS-5,6,7 & 8 coding.

14.18.2.5 Test requirements

The block error ratio, as calculated by the SS for different channels and under the different propagation conditions, under any combination of normal and extreme test voltages and ambient temperatures, shall not exceed the conformance requirement.

14.18.3 Adjacent channel rejection

14.18.3.1 Definition and applicability

The adjacent channel selectivity is a measure of the capability of the receiver to receive wanted data packets without exceeding a given degradation due to the presence of an interfering signal (I1) in the adjacent channel. "Wanted signal" in this test is the signal generated by the transmitted RLC data blocks.

The adjacent channel can be the adjacent in the RF spectrum or in time. There are therefore two types of adjacent channel selectivity:

- 1) Adjacent RF channel selectivity which is specifically tested in this section.
- 2) Adjacent Time Slot selectivity, which is implicitly tested in test 14.18.2.

The requirements and this test apply to all types of MS which are capable of EGPRS operation.

14.18.3.2 Conformance requirement

1. For GMSK modulation, under adjacent channel interference at 200 kHz above and below the wanted signal frequency and at the adjacent interference ratio (C/I_{a1}) exceeding $C/I_c - 18$ dB where C/I_c is the co-channel interference ratio specified in Table 14.18-5a for PDTCH and Table 14.18-6a for USF channels.

1.1 For a TUhigh faded wanted signal and a TUhigh adjacent channel interferer, The block error rate (BLER) performance for PDTCH/MCS-1 to 4 shall not exceed 10%; GSM 05.05, 6.2.

1.2 For a TUhigh faded wanted signal and a TUhigh adjacent channel interferer, The block error rate (BLER) performance for USF/MSC-1 to 4 shall not exceed 1 %; GSM 05.05, 6.2.

For 8-PSK modulation, under adjacent channel interference at 200 kHz above and below the wanted signal frequency and at the adjacent interference ratio (C/I_{a1}) specified in Table 14.18-7a

1.3 For a TUhigh faded wanted signal and a TUhigh adjacent channel interferer, The block error rate (BLER) performance for PDTCH/MCS-5 to 9 shall not exceed 10% or 30% depending on Coding Scheme; GSM 05.05, 6.2.

1.4 For a TUhigh faded wanted signal and a TUhigh adjacent channel interferer, The block error rate (BLER) performance for USF/MSC-5 to 9 shall not exceed 1 %; GSM 05.05, 6.2.

Table 14.18-7a: Adjacent channel interference ratio for MS at reference performance for 8-PSK modulation

GSM 400, GSM 700, GSM 850 and GSM 900						
Type of channel		Propagation conditions				RA (no FH)
		TUlow (no FH)	TUlow (ideal FH)	TUhigh (no FH)	TUhigh (ideal FH)	
PDTCH/MCS-5	dB	2.5	-2	-1	-2	1
PDTCH/MCS-6	dB	5.5	0.5	2	1	6.5
PDTCH/MCS-7	dB	10.5	8	10	9	*
PDTCH/MCS-8	dB	15.5	9**	11**	10.5**	*

PDTCH/MCS-9	dB	10**	12.5**	17**	15.5**	*
USF/MCS-5 to 9	dB	-1	-8.5	-8	-9.5	-9
DCS 1 800 and PCS 1900						
Type of channel		Propagation conditions				RA (no FH)
		TUlow (no FH)	TUlow (ideal FH)	TUhigh (no FH)	TUhigh (ideal FH)	
PDTCH/MCS-5	dB	2.5	-2	-2	-1.5	1
PDTCH/MCS-6	dB	5.5	0.5	1.5	1.5	6.5
PDTCH/MCS-7	dB	10.5	8	12.5	12	*
PDTCH/MCS-8	dB	15.5	9**	16**	15.5**	*
PDTCH/MCS-9	dB	10**	12.5**	*	*	*
USF/MCS-5 to 9	dB	-1	-8.5	-9	-9.5	-9
Note1: PDTCH for MCS-x can not meet the reference performance for some propagation conditions (*).						
Note 2: Performance is specified at 30% BLER for some cases(**),						

GSM 05.05, Table2g; GSM 05.05, 6.3.

- 2 For both GMSK and 8-PSK modulations, under adjacent channel interference conditions with interfering signals at 400 kHz above and below the wanted signal frequency and at the adjacent interference ratio (C/I_{a2}) exceeding $C/I_c - 50$ dB

2.1 For a TUhigh faded wanted signal and a TUhigh adjacent channel interferer, The block error rate (BLER) performance for PDTCH/MCS-1 to 4 shall not exceed 10% for GMSK modulation; and for PDTCH/MCS-5 to 9 shall not exceed 10% or 30% depending on Coding Schemes; GSM 05.05, 6.2.

2.2 For a TUhigh faded wanted signal and a TUhigh adjacent channel interferer, The block error rate (BLER) performance for USF/MSC-1 to 9 shall not exceed 1 %; GSM 05.05, 6.2.

C/I_c is the co-channel interference ratio. For a PDTCH with GMSK modulation C/I_c is specified in Table 14.18-5a; for a PDTCH with 8-PSK modulation C/I_c is specified in Table 14.18-5b, for a USF with GMSK modulation C/I_c is specified in Tables 14.18-6a; and for USF with 8-PSK modulation C/I_c is specified in Table 14.18-6b. GSM 05.05, 6.3.

3. The BLER shall not exceed the conformance requirements given in 1. - 2. under extreme conditions; GSM 05.05, 6.2, GSM 05.05, annex D D.2.1, D.2.2.

14.18.3.3 Test purpose

- To verify that the conformance requirements 1.1, 1.2, 1.3 and 1.4 are met with an allowance for the statistical significance of the test in the presence of a GMSK modulated adjacent channel interferer under propagation condition TUhigh at 200 kHz above and below the wanted signal frequency.
- To verify that the conformance requirements 2.1 and 2.2 are met with an allowance for the statistical significance of the test in the presence of a GMSK modulated adjacent channel interferer under propagation condition TUhigh at 400 kHz above and below the wanted signal frequency.
- To verify that Conformance Requirements are met under extreme conditions.

14.18.3.4 Method of test

Initial conditions

For both GMSK and 8-PSK modulations, a downlink TBF is set up according to the generic procedure specified in section 40 for packet switched with an ARFCN in the mid ARFCN range, power control level set to maximum power. The SS transmits EGPRS RLC data blocks containing random data. In addition to the wanted test signal, the SS transmits an independent, uncorrelated interfering signal Standard Test Signal (I1). This unwanted signal is random, continuous and GMSK-modulated, and has no fixed relationship with the bit transitions of the wanted signal.

The fading characteristic of the wanted and the interfering signal is TUhigh.

Test procedure

For GMSK Modulation:

- a) The SS transmits packets on PDTCH using MCS-1 coding to the MS on all allocated timeslots.
- b) The SS transmits the unwanted signal at a nominal frequency 200kHz above the nominal frequency of the wanted signal. Its amplitude is set to achieve the adjacent interference ratio as specified in the conformance requirements.
- c) The SS counts the number of blocks transmitted with current coding scheme and the number of these blocks not acknowledged based on the content of the Ack/Nack Description information element (see 04.60, 12.3) in the Packet Downlink Ack/Nack as sent from the MS to the SS on the PACCH.

Note: Due to the error rates related to the USF, the MS is likely to occasionally miss its USF for transmitting the Packet Downlink Ack/Nack. As this requirement is not verified in this part of the test, the SS then again assigns uplink resources so the MS can send this message.

- d) Once the number of blocks transmitted with the current coding scheme as counted in step c) reaches or exceeds the minimum number of blocks as given in Table 14-18-2, the SS calculates the Block error ratio. The SS resets both counters.
- e) The SS repeats steps c) & d) with the unwanted signal transmitted at a nominal frequency 200kHz below the nominal frequency of the wanted signal. & its amplitude is set to achieve the adjacent interference ratio as specified in the conformance requirements.
- f) The SS repeats steps c) & d) with the unwanted signal transmitted at a nominal frequency 400kHz above the nominal frequency of the wanted signal & its amplitude is set to to achieve the adjacent interference ratio as specified in the conformance requirements.
- g) The SS repeats steps c) & d) with the unwanted signal transmitted at a nominal frequency 400kHz below the nominal frequency of the wanted signal & its amplitude is set to to achieve the adjacent interference ratio as specified in the conformance requirements.
- h) The SS repeats steps b) to g) for each of the coding schemes MCS-2 to 4.
- i) The SS repeats steps a) to g) under extreme test conditions for MCS-4 coding scheme only.
- j) The SS establishes the normal test conditions. An uplink TBF shall be established.
- k) The SS sets the value of the USF/MCS-1 such as to allocate the uplink to the MS.
- l) The SS transmits the unwanted signal at a nominal frequency 200kHz above the nominal frequency of the wanted signal. Its amplitude is set to to achieve the adjacent interference ratio as specified in the conformance requirements.
- m) The SS counts the number of times the USF is allocated to the MS, and the number of times the MS does not transmit while being allocated the uplink.
- n) Once the number of USF/MCS-1 allocating the uplink for the MS as counted in step m) reaches or exceeds the minimum number of blocks as given in Table 14.18-2, the SS calculates the Block error ratio. The SS resets both counters.
- o) The SS repeats steps m) & n) with the unwanted signal transmitted at a nominal frequency 200kHz below the nominal frequency of the wanted signal & its amplitude is set at to achieve the adjacent interference ratio as specified in the conformance requirements.
- p) The SS repeats steps m) & n) with the unwanted signal transmitted at a nominal frequency 400kHz above the nominal frequency of the wanted signal & its amplitude is set to achieve the adjacent interference ratio as specified in the conformance requirements.
- q) The SS repeats steps m) & n) with the unwanted signal transmitted at a nominal frequency 400kHz below the nominal frequency of the wanted signal & its amplitude is set to achieve the adjacent interference ratio as specified in the conformance requirements.
- r) The SS repeats steps k) to q) for each of the coding schemes USF/MCS-2 to 4.

- s) The SS repeats steps k) to q) under extreme test conditions for coding scheme USF/MCS-4 only.

For 8-PSK Modulation:

- a) The SS transmits packets on PDTCH using MCS-5 coding to the MS on all allocated timeslots.
- b) The SS transmits the unwanted signal at a nominal frequency 200kHz above the nominal frequency of the wanted signal. Its amplitude is set to achieve the adjacent interference ratio as specified in the conformance requirements.
- c) The SS counts the number of blocks transmitted with current coding scheme and the number of these blocks not acknowledged based on the content of the Ack/Nack Description information element (see 04.60, 12.3) in the Packet Downlink Ack/Nack as sent from the MS to the SS on the PACCH.

Note: Due to the error rates related to the USF, the MS is likely to occasionally miss its USF for transmitting the Packet Downlink Ack/Nack. As this requirement is not verified in this part of the test, the SS then again assigns uplink resources so the MS can send this message.

- d) Once the number of blocks transmitted with the current coding scheme as counted in step c) reaches or exceeds the minimum number of blocks as given in Table 14-18-2, the SS calculates the Block error ratio. The SS resets both counters.
- e) The SS repeats steps c) & d) with the unwanted signal transmitted at a nominal frequency 200kHz below the nominal frequency of the wanted signal & its amplitude is set to achieve the adjacent interference ratio as specified in the conformance requirements.
- f) The SS repeats steps c) & d) with the unwanted signal transmitted at a nominal frequency 400kHz above the nominal frequency of the wanted signal & its amplitude is set to achieve the adjacent interference ratio as specified in the conformance requirements.
- g) The SS repeats steps c) & d) with the unwanted signal transmitted at a nominal frequency 400kHz below the nominal frequency of the wanted signal & its amplitude is set to achieve the adjacent interference ratio as specified in the conformance requirements.
- h) The SS repeats steps b) to g) for each of the coding schemes MCS-6 to 8 and for the coding scheme MCS-9 with the TU low fading condition for both the wanted and the interfering signal.
- i) The SS repeats steps a) to h) under extreme test conditions for coding scheme MCS-9 only.
- j) The SS establishes the normal test conditions. An uplink TBF shall be established.
- k) The SS sets the value of the USF/MCS-5 such as to allocate the uplink to the MS.
- l) The SS transmits the unwanted signal at a nominal frequency 200kHz above the nominal frequency of the wanted signal. Its amplitude is set to achieve the adjacent interference ratio as specified in the conformance requirements.
- m) The SS counts the number of times the USF is allocated to the MS, and the number of times the MS does not transmit while being allocated the uplink.
- n) Once the number of USF/MCS-5 allocating the uplink for the MS as counted in step m) reaches or exceeds the minimum number of blocks as given in Table 14-18-2, the SS calculates the Block error ratio. The SS resets both counters.
- o) The SS repeats steps m) & n) with the unwanted signal transmitted at a nominal frequency 200kHz below the nominal frequency of the wanted signal & its amplitude is set to achieve the adjacent interference ratio as specified in the conformance requirements.
- p) The SS repeats steps m) & n) with the unwanted signal transmitted at a nominal frequency 400kHz above the nominal frequency of the wanted signal & its amplitude is set to achieve the adjacent interference ratio as specified in the conformance requirements.

- q) q) The SS repeats steps m) & n) with the unwanted signal transmitted at a nominal frequency 400kHz below the nominal frequency of the wanted signal & its amplitude is set to achieve the adjacent interference ratio as specified in the conformance requirements.
- r) The SS repeats steps k) to q) for each of the coding schemes MCS-6 to 9.
- s) The SS repeats steps k) to r) under extreme test conditions for coding scheme MCS-9 only.

14.18.3.5 Test requirements

The block error ratio, as calculated by the SS for different channels with different coding schemes and under TUhigh propagation condition, under any combination of normal and extreme test voltages and ambient temperatures, shall not exceed the conformance requirement.

14.18.4 Intermodulation rejection

14.18.4.1 Definition and applicability

The intermodulation rejection is a measure of the capability of the receiver to receive a wanted modulated signal without exceeding a given degradation due to the presence of two or more unwanted signals with a specific frequency relationship to the wanted signal frequency. "Wanted signal" in this test is the signal generated by the transmitted RLC data blocks.

The requirements and this test apply to all types of MS which are capable of EGPRS operation.

14.18.4.2 Conformance requirement

In the presence of two unwanted signals with a specific frequency relationship to the wanted signal frequency in both GMSK and 8-PSK modulations

1. The block error rate (BLER) performance for PDTCH/MCS1 to 4 shall not exceed 10 % and for PDTCH/MCS5 to 9 shall not exceed 10% or 30% depending on Coding Schemes; GSM 05.05, 6.2.
2. The block error rate (BLER) performance for USF/MSC-1 to 9 shall not exceed 1 %; GSM 05.05, 6.2.
3. The BLER shall not exceed the conformance requirements given in 1. - 2. under extreme conditions; GSM 05.05, 6.2, GSM 05.05, annex D D.2.1, D.2.2.

14.18.4.3 Test purpose

1. To verify that the MS does not exceed the conformance requirements for different channels and coding schemes under the static condition with an allowance for the statistical significance of the test.
2. To verify that Conformance Requirements are met under extreme conditions.

14.18.4.4 Method of test

NOTE: The measurements address the third order intermodulation, which represents the most serious case.

Initial conditions

For both GMSK and 8-PSK modulations, a downlink TBF is set up according to the generic procedure specified in section 40 for packet switched with an ARFCN in the Mid ARFCN range, power control level set to maximum.

The SS transmits EGPRS RLC data blocks containing random data. The amplitude of the wanted signal is set to 4 dB above the reference sensitivity level with appropriate correction value as specified in Table 14.18-3a for GMSK modulation and Table 14.18-3b for 8-PSK modulation for PDTCH channel and in Tables 14.18-4a for GMSK modulation & 14.18-4b for 8-PSK modulation for USF channel.

In addition to the static wanted test signal, the SS transmits two static interfering (unwanted) signals at the same time. There is no correlation in the modulation between the signals.

Test procedure

For GMSK modulation:

- a) The SS transmits packets on PDTCH using MCS-4 coding to the MS on all allocated timeslots.
- b) The first interfering signal is on a frequency equal to the centre frequency of an ARFCN four above the ARFCN of the wanted signal. This signal is static, continuous and unmodulated.
- c) The second interfering signal is on an ARFCN eight above the ARFCN of the wanted signal. This signal is static, continuous and GMSK modulated by random data (I1).

The amplitude of both the interfering signals is set according to table 14.18-8.

- d) The SS counts the number of blocks transmitted with current coding scheme and the number of these blocks not acknowledged based on the content of the Ack/Nack Description information element (see 04.60, 12.3) in the Packet Downlink Ack/Nack as sent from the MS to the SS on the PACCH.

Note: Due to the error rates related to the USF, the MS is likely to occasionally miss its USF for transmitting the Packet Downlink Ack/Nack. As this requirement is not verified in this part of the test, the SS then again assigns uplink resources so the MS can send this message.

- e) Once the number of blocks transmitted with the current coding scheme as counted in step d) reaches or exceeds the minimum number of blocks as given in Table 14-18-2, the SS calculates the Block error ratio. The SS resets both counters.
- f) The SS repeats steps d) & e) with the two unwanted signals having frequencies corresponding to ARFCN four and eight below the ARFCN of the wanted signal.
- g) The SS repeats steps a) to f) with the receiver operating on an ARFCN in the Low ARFCN.
- h) The SS repeats steps a) to f) with the receiver operating on an ARFCN in the High ARFCN range.
- i) The SS repeats steps a) to f) for each of the coding schemes MCS-1 to 3.
- j) Steps a) to h) are repeated under extreme test conditions for MCS-4 only.
- k) The SS establishes the normal test conditions. An uplink TBF shall be established.
- l) The SS sets the value of the USF/MCS-4 such as to allocate the uplink to the MS.
- m) The first interfering signal is on a frequency equal to the centre frequency of an ARFCN four above the ARFCN of the wanted signal. This signal is static, continuous and unmodulated.
- n) The second interfering signal is on an ARFCN eight above the ARFCN of the wanted signal. This signal is static, continuous and GMSK modulated by random data (I1).

The amplitude of both the interfering signals is set according to table 14.18-8.

- o) The SS counts the number of times the USF is allocated to the MS, and the number of times the MS does not transmit while being allocated the uplink.
- p) Once the number of USF/MCS-4 allocating the uplink for the MS as counted in step o) reaches or exceeds the minimum number of blocks as given in Table 14-18-2, the SS calculates the Block error ratio. The SS resets both counters.
- q) The SS repeats steps o) & p) with the two unwanted signals having frequencies corresponding to ARFCN four and eight below the ARFCN of the wanted signal.
- r) The SS repeats steps l) to q) with the receiver operating on an ARFCN in the Low ARFCN.
- s) The SS repeats steps l) to q) with the receiver operating on an ARFCN in the High ARFCN range.

- t) The SS repeats steps l) to q) for each of the coding schemes MCS-1 to 3 with the receiver operating on an ARFCN in the Middle ARFCN range.
- u) The SS repeats steps l) to s) under extreme test conditions for MCS-4 only.

For 8-PSK Modulation:

- a) The SS transmits packets on PDTCH using MCS-9 coding to the MS on all allocated timeslots.
- b) The first interfering signal is on a frequency equal to the centre frequency of an ARFCN four above the ARFCN of the wanted signal. This signal is static, continuous and unmodulated.
- c) The second interfering signal is on an ARFCN eight above the ARFCN of the wanted signal. This signal is static, continuous and GMSK modulated by random data (I1).

The amplitude of both the interfering signals is set according to table 14.18-8.

- d) The SS counts the number of blocks transmitted with current coding scheme and the number of these blocks not acknowledged based on the content of the Ack/Nack Description information element (see 04.60, 12.3) in the Packet Downlink Ack/Nack as sent from the MS to the SS on the PACCH.

Note: Due to the error rates related to the USF, the MS is likely to occasionally miss its USF for transmitting the Packet Downlink Ack/Nack. As this requirement is not verified in this part of the test, the SS then again assigns uplink resources so the MS can send this message.

- e) Once the number of blocks transmitted with the current coding scheme as counted in step d) reaches or exceeds the minimum number of blocks as given in Table 14.18-2, the SS calculates the Block error ratio. The SS resets both counters.
- f) The SS repeats steps d) & e) with the two unwanted signals having frequencies corresponding to ARFCN four and eight below the ARFCN of the wanted signal.
- g) The SS repeats steps a) to f) with the receiver operating on an ARFCN in the Low ARFCN.
- h) The SS repeats steps a) to f) with the receiver operating on an ARFCN in the High ARFCN range.
- i) The SS repeats steps a) to f) for each of the coding schemes MCS-5,6,7 & 8 with the receiver operating on an ARFCN in the Middle ARFCN range.
- j) The SS repeats steps a) to h) under extreme test conditions for MCS-9 only.
- k) The SS establishes the normal test conditions. An uplink TBF shall be established.
- l) The SS sets the value of the USF/MCS-9 such as to allocate the uplink to the MS.
- m) The first interfering signal is on a frequency equal to the centre frequency of an ARFCN four above the ARFCN of the wanted signal. This signal is static, continuous and unmodulated.
- n) The second interfering signal is on an ARFCN eight above the ARFCN of the wanted signal. This signal is static, continuous and GMSK modulated by random data (I1).

The amplitude of both the interfering signals is set according to table 14.18-8.

- o) The SS counts the number of times the USF is allocated to the MS, and the number of times the MS does not transmit while being allocated the uplink.
- p) Once the number of USF/MCS-9 allocating the uplink for the MS as counted in step o) reaches or exceeds the minimum number of blocks as given in Table 14.18-2, the SS calculates the Block error ratio. The SS resets both counters.
- q) The SS repeats steps o) & p) with the two unwanted signals having frequencies corresponding to ARFCN four and eight below the ARFCN of the wanted signal.
- r) The SS repeats steps l) to q) with the receiver operating on an ARFCN in the Low ARFCN

- s) The SS repeats steps l) to q) with the receiver operating on an ARFCN in the High ARFCN range.
- t) The SS repeats steps l) to q) for each of the coding schemes MCS-5,6,7 & 8 with the receiver operating on an ARFCN in the Middle ARFCN range.
- u) The SS repeats steps l) to s) under extreme test conditions for MCS-9 only.

Table 14.18-8: Intermodulation interfering test signal levels

	GSM400, GSM 700, GSM 850, GSM900, PCS1900		DCS1800	
	Small MS	Other MS	Class 1 & 2	Class 3
FIRST INTERFERER dB μ Vemf()	64	74	64	68
SECOND INTERFERER dB μ Vemf()	63	63	64	68

NOTE: Some of the levels in table 14.18-8 are different to those specified in GSM 05.05 due to the consideration of the effect of modulation sideband noise from the second interferer.

14.18.4.5 Test requirements

The block error ratio, as calculated by the SS for different channels with different coding schemes and under static condition, under any combination of normal and extreme test voltages and ambient temperatures, shall not exceed the conformance requirement.

14.18.5 Blocking and spurious response

14.18.5.1 Definition and applicability

Blocking is a measure of the ability of the receiver to receive a modulated wanted input signal in the presence of an unwanted input signal, on frequencies other than those of the spurious responses or the adjacent channels, without exceeding a given degradation. "Wanted signal" in this test is the signal generated by the transmitted RLC data blocks.

The requirements and this test apply to all types of MS which are capable of EGPRS operation.

14.18.5.2 Conformance requirement

1. The blocking characteristics of the receiver are specified separately for in-band and out-of-band performance as identified in GSM 05.05 section 5.1.
2. The block error rate (BLER) performance for PDTCH/MCS1 to 4 shall not exceed 10 % and for PDTCH/MCS5 to 9 shall not exceed 10% or 30% depending on Coding Schemes and for USF/MCS1 to 9 shall not exceed 1% when the following signals are simultaneously input to the receiver; GSM 05.05, 6.2.:
 - a useful signal at frequency f_0 , 3 dB above the reference sensitivity level specified in Table 14.18-3a for GMSK modulation and Table 14.18-3b for 8-PSK modulation for PDTCH channels; and in Tables 14.18-4a for GMSK modulation & 14.18-4b for 8-PSK modulation for USF channel with correction values as specified in GSM 05.05 section 6.2;
 - a continuous, static sine wave unwanted signal at a level as in the table 14.18-9 below and at a frequency (f) which is an integer multiple of 200 kHz.

with the following exceptions, called spurious response frequencies:-

- a) GSM 400: inband, for a maximum of three occurrences. GSM05.05, Section 5.1.

GSM 700, GSM 850 or GSM 900: in band, for a maximum of six occurrences (which if grouped shall not exceed three contiguous occurrences per group). GSM05.05, Section 5.1.

DCS 1 800 & PCS 1900: in band, for a maximum of twelve occurrences (which if grouped shall not exceed three contiguous occurrences per group). GSM05.05, Section 5.1.

- b) out of band, for a maximum of 24 occurrences (which if below f_0 and grouped shall not exceed three contiguous occurrences per group). GSM05.05, Section 5.1.

where the above performance shall be met when the continuous sine wave signal (f) is set to a level of 70 dB μ V (emf) (i.e. -43 dBm). GSM 05.05, 5.1.

14.18.5.3 Test purpose

1. To verify that the in band blocking performance is met without exceeding the total number of allowed in band spurious responses. An allowance is made for the statistical significance of the test.
2. To verify that at selected out of band frequencies, the out of band blocking performance is met without exceeding the total number of allowed out of band spurious responses. An allowance is made for the statistical significance of the test.

NOTE: Not all of the possible out of band frequencies are tested as this results in excessive test time. However, the total number of out of band spurious responses, specified in GSM 05.05, are allowed to ensure a fair test of the MS.

14.18.5.4 Method of test

Initial conditions

For both GMSK and 8-PSK modulations, a downlink TBF is set up according to the generic procedure specified in section 40 for packet switched, except the BCCH frequency list shall be empty, on an arbitrary ARFCN in the range supported by the MS. The power control level is set to a maximum power of 0dBm.

The SS transmits EGPRS RLC data blocks containing random data.

In addition to the wanted Test Signal, the SS transmit a static unmodulated continuous interfering signal (Standard Test Signal I0).

Test procedure

For GMSK Modulation:

- a) The SS is set to produce a TUhigh GMSK wanted signal and a static interfering signal at the same time. The SS sets the amplitude of the wanted signal to 4 dB above the reference sensitivity level specified in Table 14.18-3a for PDTCH channel and in Table 14.18-4a for USF channel with correction values as specified in GSM 05.05 section 6.2;
- b) The SS transmits packets on PDTCH using MSC-4 coding to MS on all allocated timeslots.
- c) The unwanted signal is of frequency FB. It is applied in turn on the subset of frequencies calculated at step d) in the overall range 100 kHz to 12,75 GHz, where FB is an integer multiple of 200 kHz.

However, frequencies in the range $FR \pm 600$ kHz are excluded.

NOTE: Allowance must be made for possible spurious signals arising from the SS. These are particularly likely at sub harmonic frequencies nFB where $n = 2, 3, 4, 5$, etc.

- d) The frequencies at which the test is performed (adjusted to an integer multiple of 200 kHz channels most closely approximating the absolute frequency of the calculated blocking signal frequency) are the combined frequencies from i), ii) and iii) which follow:

- i) The total frequency range formed by:

GSM 400 the frequencies between $F_{10} + (IF_1 + IF_2 + \dots + IF_n + 3,6 \text{ MHz})$

and $F_{10} - (IF_1 + IF_2 + \dots + IF_n + 3,6 \text{ MHz})$.

GSM 700 the frequencies between $F_{lo} + (IF_1 + IF_2 + \dots + IF_n + 7,5 \text{ MHz})$
and $F_{lo} - (IF_1 + IF_2 + \dots + IF_n + 7,5 \text{ MHz})$.

GSM 850 the frequencies between $F_{lo} + (IF_1 + IF_2 + \dots + IF_n + 12,5 \text{ MHz})$
and $F_{lo} - (IF_1 + IF_2 + \dots + IF_n + 12,5 \text{ MHz})$.

P-GSM 900: the frequencies between $F_{lo} + (IF_1 + IF_2 + \dots + IF_n + 12,5 \text{ MHz})$
and $F_{lo} - (IF_1 + IF_2 + \dots + IF_n + 12,5 \text{ MHz})$.

E-GSM 900: the frequencies between $F_{lo} + (IF_1 + IF_2 + \dots + IF_n + 17,5 \text{ MHz})$
and $F_{lo} - (IF_1 + IF_2 + \dots + IF_n + 17,5 \text{ MHz})$.

DCS 1 800: the frequencies between $F_{lo} + (IF_1 + IF_2 + \dots + IF_n + 37,5 \text{ MHz})$
and $F_{lo} - (IF_1 + IF_2 + \dots + IF_n + 37,5 \text{ MHz})$.

PCS 1900: the frequencies between $F_{lo} + (IF_1 + IF_2 + \dots + IF_n + 30 \text{ MHz})$
and $F_{lo} - (IF_1 + IF_2 + \dots + IF_n + 30 \text{ MHz})$.

and

the frequencies $+ 100 \text{ MHz}$ and $- 100 \text{ MHz}$ from the edge of the relevant receive band.

Measurement are made at 200 kHz intervals.

ii) The three frequencies IF_1 , $IF_1 + 200 \text{ kHz}$, $IF_1 - 200 \text{ kHz}$.

iii) The frequencies:

$mF_{lo} + IF_1$,

$mF_{lo} - IF_1$,

mFR ,

where m is all positive integers greater than or equal to 2 such that either sum lies in the range 100 kHz to $12,75 \text{ GHz}$.

The frequencies in step ii) and iii) lying in the range of frequencies defined by step i) above need not be repeated.

Where:

F_{lo} - local oscillator applied to first receiver mixer

$IF_1 \dots IF_n$ - are the n intermediate frequencies

F_{lo} , IF_1 , $IF_2 \dots IF_n$ shall be declared by the manufacturer in the PIXIT statement GSM 11.10 annex 3.

e) The level of the unwanted signal is set according to table 14.18-9.

Table 14.18-9a: Level of unwanted signals

	GSM450		GSM480		GSM900		DCS 1 800	PCS 1900
	Small MS	Other MS	Small MS	Other MS	Small MS	Other MS		
FREQUENCY	LEVEL IN dBμVemf()							
FR +/- 600 kHz to FR +/- 800 kHz	70	75	70	75	70	75	70	70
FR +/- 800 kHz to FR +/- 1,6 MHz	70	80	70	80	70	80	70	70
FR +/- 1,6 MHz to FR +/- 3 MHz	80	90	80	90	80	90	80	80
457.6 MHz to FR - 3 MHz	90	90	-	-	-	-	-	-
FR + 3 MHz to 473.6 MHz	90	90	-	-	-	-	-	-
486 MHz to FR - 3MHz	-	-	90	90	-	-	-	-
FR + 3MHz to 502 MHz	-	-	90	90	-	-	-	-
915 MHz to FR - 3 MHz	-	-	-	-	90	90	-	-
FR + 3 MHz to 980 MHz	-	-	-	-	90	90	-	-
1785 MHz to FR - 3 MHz	-	-	-	-	-	-	87	-
FR + 3 MHz to 1920 MHz	-	-	-	-	-	-	87	-
1910 MHz to FR - 3 MHz	-	-	-	-	-	-	-	87
FR + 3 MHz to 2010 MHz	-	-	-	-	-	-	-	87
100kHz to <457.6MHz	113	113	-	-	-	-	-	-
>473.6MHz to 12,750MHz	113	113	-	-	-	-	-	-
100kHz to <486MHz	-	-	113	113	-	-	-	-
>502MHz to 12,750MHz	-	-	113	113	-	-	-	-
835 MHz to <915 MHz	-	-	-	-	113	113	-	-
>980 MHz to 1000 MHz	-	-	-	-	113	113	-	-
100 kHz to <835 MHz	-	-	-	-	113	113	-	-
>1000 MHz to 12,750 MHz	-	-	-	-	113	113	-	-
100 kHz to 1705 MHz	-	-	-	-	-	-	113	-
>1705 MHz to <1785 MHz	-	-	-	-	-	-	101	-
>1920 MHz to 1980 MHz	-	-	-	-	-	-	101	-
>1980 MHz to 12,750 MHz	-	-	-	-	-	-	113	-
100kHz to <1830MHz	-	-	-	-	-	-	-	113
1830MHz to <1910MHz	-	-	-	-	-	-	-	101
>2010 to 2070MHz	-	-	-	-	-	-	-	101
>2070MHz to 12,750MHz	-	-	-	-	-	-	-	113

Table 14-18-9b: Level of unwanted signals

	GSM 750	GSM 850
FREQUENCY	LEVEL IN dBμVemf()	
FR +/- 600 kHz to FR +/- 800 kHz	70	70
FR +/- 800 kHz to FR +/- 1,6 MHz	70	70
FR +/- 1,6 MHz to FR +/- 3 MHz	80	80
727 to FR - 3 MHz	90	-
FR + 3 MHz to 782 MHz	90	-
849 MHz to FR - 3 MHz	-	90
FR + 3 MHz to 914 MHz	-	90
100 kHz to <727 MHz	113	-
>782 MHz to 12,75 GHz	113	-
100 kHz to <849 MHz	-	113
>914 MHz to 12,75 GHz	-	113

NOTE 1: For E-GSM 900 MS the level of the unwanted signal in the band 905 MHz to 915 MHz is relaxed to 108 dB μ Vemf(). GSM05.05, Section 5.1

NOTE 2: a) For R-GSM 900 MS the level of the unwanted signal in the band 880 MHz to 915 MHz is relaxed to 108 dBuVemf(). GSM05.05, Section 5.1

b) For R-GSM 900 small MS the level of the unwanted signal in the band 876 MHz to 915 MHz is relaxed to 106 dBuVemf(). GSM05.05, Section 5.1

NOTE 3: a) For GSM 450 small MS the level of the unwanted signal in the band 450.4 MHz to 457.6 MHz is relaxed to 108 dBuVemf(). GSM05.05, Section 5.1

b) For GSM 480 small MS the level of the unwanted signal in the band 478.8 MHz to 486 MHz is relaxed to 108 dBuVemf(). GSM05.05, Section 5.1

f) The SS counts the number of blocks transmitted with current coding scheme and the number of these blocks not acknowledged based on the content of the Ack/Nack Description information element (see 04.60, 12.3) in the Packet Downlink Ack/Nack as sent from the MS to the SS on the PACCH.

Note: Due to the error rates related to the USF, the MS is likely to occasionally miss its USF for transmitting the Packet Downlink Ack/Nack. As this requirement is not verified in this part of the test, the SS then again assigns uplink resources so the MS can send this message.

g) Once the number of blocks transmitted with the current coding scheme as counted in step f) reaches or exceeds the minimum number of blocks as given in Table 14-18-2, the SS calculates the Block error ratio. The SS resets both counters.

If a failure is indicated, it is noted and counted towards the allowed exemption total. In the case of failures discovered at the predicted frequencies at steps d i), ii) or iii) the test is repeated on the adjacent channels +/- 200 kHz away. If either of these two frequencies fail then the next channel 200 kHz beyond is also be tested. This process is repeated until all channels constituting the group of failures is known.

h) The SS sets the value of the USF/MCS-4 such as to allocate the uplink to the MS.

i) The unwanted signal is of frequency FB. It is applied in turn on the subset of frequencies calculated at step d) in the overall range 100 kHz to 12,75 GHz, where FB is an integer multiple of 200 kHz.

However, frequencies in the range FR +/- 600 kHz are excluded.

NOTE: Allowance must be made for possible spurious signals arising from the SS. These are particularly likely at sub harmonic frequencies nFB where n = 2, 3, 4, 5, etc.

j) The level of the unwanted signal is set according to table 14.18-9.

k) The SS counts the number of times the USF is allocated to the MS, and the number of times the MS does not transmit while being allocated the uplink.

l) Once the number of USF/MCS-4 allocating the uplink for the MS as counted in step k) reaches or exceeds the minimum number of blocks as given in Table 14-18-2, the SS calculates the Block error ratio. The SS resets both counters. If a failure is indicated, it is noted and counted towards the allowed exemption total.

In the case of failures discovered at the predicted frequencies at steps d i), ii) or iii) the test is repeated on the adjacent channels +/- 200 kHz away. If either of these two frequencies fail then the next channel 200 kHz beyond is also be tested. This process is repeated until all channels constituting the group of failures is known.

For 8-PSK Modulation:

a) The SS is set to produce a static 8-PSK wanted signal and a static interfering signal at the same time. The SS sets the amplitude of the wanted signal to 4 dB above the reference sensitivity level specified in Table 14.18-3b for PDTCH channel and in Table 14.18-4b for USF channel with correction values as specified in GSM 05.05 section 6.2;

b) The SS transmits packets on PDTCH using MSC-9 coding to MS on all allocated timeslots.

c) The unwanted signal is of frequency FB. It is applied in turn on the subset of frequencies calculated at step d) in the overall range 100 kHz to 12,75 GHz, where FB is an integer multiple of 200 kHz.

However, frequencies in the range FR +/- 600 kHz are excluded.

NOTE: Allowance must be made for possible spurious signals arising from the SS. These are particularly likely at sub harmonic frequencies nFB where n = 2, 3, 4, 5, etc.

d) The frequencies at which the test is performed (adjusted to an integer multiple of 200 kHz channels most closely approximating the absolute frequency of the calculated blocking signal frequency) are the combined frequencies from i), ii) and iii) which follow:

i) The total frequency range formed by:

GSM 400 the frequencies between $F_{lo} + (IF_1 + IF_2 + \dots + IF_n + 3,6 \text{ MHz})$
and $F_{lo} - (IF_1 + IF_2 + \dots + IF_n + 3,6 \text{ MHz})$.

GSM 700 the frequencies between $F_{lo} + (IF_1 + IF_2 + \dots + IF_n + 7,5 \text{ MHz})$
and $F_{lo} - (IF_1 + IF_2 + \dots + IF_n + 7,5 \text{ MHz})$.

GSM 850 the frequencies between $F_{lo} + (IF_1 + IF_2 + \dots + IF_n + 12,5 \text{ MHz})$
and $F_{lo} - (IF_1 + IF_2 + \dots + IF_n + 12,5 \text{ MHz})$.

P-GSM 900: the frequencies between $F_{lo} + (IF_1 + IF_2 + \dots + IF_n + 12,5 \text{ MHz})$
and $F_{lo} - (IF_1 + IF_2 + \dots + IF_n + 12,5 \text{ MHz})$.

E-GSM 900: the frequencies between $F_{lo} + (IF_1 + IF_2 + \dots + IF_n + 17,5 \text{ MHz})$
and $F_{lo} - (IF_1 + IF_2 + \dots + IF_n + 17,5 \text{ MHz})$.

DCS 1 800: the frequencies between $F_{lo} + (IF_1 + IF_2 + \dots + IF_n + 37,5 \text{ MHz})$
and $F_{lo} - (IF_1 + IF_2 + \dots + IF_n + 37,5 \text{ MHz})$.

PCS 1900: the frequencies between $F_{lo} + (IF_1 + IF_2 + \dots + IF_n + 30 \text{ MHz})$
and $F_{lo} - (IF_1 + IF_2 + \dots + IF_n + 30 \text{ MHz})$.

and

the frequencies + 100 MHz and - 100 MHz from the edge of the relevant receive band.

Measurement are made at 200 kHz intervals.

ii) The three frequencies IF_1 , $IF_1 + 200 \text{ kHz}$, $IF_1 - 200 \text{ kHz}$.

iii) The frequencies:

$mF_{lo} + IF_1$,

$mF_{lo} - IF_1$,

mFR ,

where m is all positive integers greater than or equal to 2 such that either sum lies in the range 100 kHz to 12,75 GHz.

The frequencies in step ii) and iii) lying in the range of frequencies defined by step i) above need not be repeated.

Where:

F_{lo} - local oscillator applied to first receiver mixer

$IF_1 \dots IF_n$ - are the n intermediate frequencies

F_{lo} , IF_1 , $IF_2 \dots IF_n$ shall be declared by the manufacturer in the PIXIT statement GSM 11.10 annex 3.

- e) The level of the unwanted signal is set according to table 14.18-9.
- f) The SS counts the number of blocks transmitted with current coding scheme and the number of these blocks not acknowledged based on the content of the Ack/Nack Description information element (see 04.60, 12.3) in the Packet Downlink Ack/Nack as sent from the MS to the SS on the PACCH.

Note: Due to the error rates related to the USF, the MS is likely to occasionally miss its USF for transmitting the Packet Downlink Ack/Nack. As this requirement is not verified in this part of the test, the SS then again assigns uplink resources so the MS can send this message.

- g) Once the number of blocks transmitted with the current coding scheme as counted in step f) reaches or exceeds the minimum number of blocks as given in Table 14-18-2, the SS calculates the Block error ratio. The SS resets both counters. If a failure is indicated, it is noted and counted towards the allowed exemption total.

In the case of failures discovered at the predicted frequencies at steps d i), ii) or iii) the test is repeated on the adjacent channels +/- 200 kHz away. If either of these two frequencies fail then the next channel 200 kHz beyond is also be tested. This process is repeated until all channels constituting the group of failures is known.

- h) The SS sets the value of the USF/MCS-9 such as to allocate the uplink to the MS.
- j) The unwanted signal is of frequency FB. It is applied in turn on the subset of frequencies calculated at step d) in the overall range 100 kHz to 12,75 GHz, where FB is an integer multiple of 200 kHz.

However, frequencies in the range FR +/- 600 kHz are excluded.

NOTE: Allowance must be made for possible spurious signals arising from the SS. These are particularly likely at sub harmonic frequencies nFB where n = 2, 3, 4, 5, etc.

- k) The level of the unwanted signal is set according to table 14.18-9.
- l) The SS counts the number of times the USF is allocated to the MS, and the number of times the MS does not transmit while being allocated the uplink.
- m) Once the number of USF/MCS-9 allocating the uplink for the MS as counted in step l) reaches or exceeds the minimum number of blocks as given in Table 14-18-2, the SS calculates the Block error ratio. The SS resets both counters. If a failure is indicated, it is noted and counted towards the allowed exemption total.

In the case of failures discovered at the predicted frequencies at steps d i), ii) or iii) the test is repeated on the adjacent channels +/- 200 kHz away. If either of these two frequencies fail then the next channel 200 kHz beyond is also be tested. This process is repeated until all channels constituting the group of failures is known.

14.18.5.5 Test requirements

The block error ratio as calculated by the SS for different channels and coding schemes shall not exceed the conformance requirement.

This shall apply under normal test voltage and ambient temperature, and with the interfering signal at any frequency in the range specified.

The following exceptions are allowed:

- GSM 400: A maximum of three failures in the band 457.6 MHz to 473.6 MHz for GSM450 and in the band 486.0 MHz to 502.0 MHz for GSM480

A maximum of 24 in the combined bands 100 kHz to 457.6 MHz & 473.6 MHz to 12,75 GHz for GSM450 and in the combined bands 100 kHz to 486.0 MHz & 502.0 MHz to 12,75 GHz for GSM480 (which, if below FR and grouped, shall not exceed three 200 kHz channels per group).
- GSM 750: A maximum of six failures in the frequency band 727 MHz to 782 MHz (which, if grouped, shall not exceed three 200 kHz channels per group).

A maximum of 24 failures in the combined bands 100 kHz to 727 MHz and 782 MHz to 12,75 GHz (which, if below FR and grouped, shall not exceed three 200 kHz channels per group).

- GSM 850:** A maximum of six failures in the frequency band 849 MHz to 914 MHz (which, if grouped, shall not exceed three 200 kHz channels per group).
- A maximum of 24 failures in the combined bands 100 kHz to 849 MHz and 914 MHz to 12,75 GHz (which, if below FR and grouped, shall not exceed three 200 kHz channels per group).
- GSM 900:** A maximum of six failures in the band 915 MHz to 980 MHz (which, if grouped, shall not exceed three 200 kHz channels per group).
- A maximum of 24 in the combined bands 100 kHz to 915 MHz and 980 MHz to 12,75 GHz (which, if below FR and grouped, shall not exceed three 200 kHz channels per group).
- DCS 1 800:** A maximum of twelve failures in the band 1785 MHz to 1 920 MHz (which, if grouped, shall not exceed three 200 kHz channels per group).
- A maximum of 24 in the combined bands 100 kHz to 1785 MHz and 1 920 MHz to 12,75 GHz (which, if below FR and grouped, shall not exceed three 200 kHz channels per group).
- PCS 1900:** A maximum of twelve failures in the band 1910 MHz to 2010 MHz (which, if grouped, shall not exceed three 200 kHz channels per group).
- A maximum of 24 in the combined bands 100 kHz to 1910 MHz and 2010 MHz to 12,75 GHz (which, if below FR and grouped, shall not exceed three 200 kHz channels per group).

If the number of failures do not exceed the maximum allowed figures stated above, the test of 14.18.5.4 is repeated at the frequencies at which the failures occurred. The level of the unwanted signal is set to 70 dBuVemf() and the performance requirement is once again that stated above.

The number of Error Events recorded in this test shall not exceed the test limit error rate values given above, when using the maximum number of samples.

No failures are allowed at this lower unwanted signal level.

14.18.6 EGPRS Usable receiver input level range

14.18.6.1 Definition and applicability

The usable receiver input level range is the range of the radio frequency input level of a specified modulated signal over which bit error ratio stay between specified limits.

The requirements and this test apply to all types of MS which are capable of EGPRS operation.

14.18.6.2 Conformance requirement

1. The receiver input level range requirements of GSM 05.05 section 6.1 for raw data bits of GMSK modulation under static and EQ propagation conditions shall be met:
 - 1.1 Under normal conditions.
 - 1.2 Under extreme conditions.
2. The receiver input level range requirements of GSM 05.05 section 6.1 for raw data bits of 8PSK modulation under static condition shall be met:
 - 2.1 Under normal conditions.
 - 2.2 Under extreme conditions.
3. The receiver input level range requirements of GSM 05.05 section 6.1 for raw data bits of 8PSK modulation with random frequency offset under static condition shall be met:

3.1 Under normal conditions.

3.2 Under extreme conditions.

14.18.6.3 Test purpose

1. To verify that the MS does not exceed the conformance requirement with an allowance for the statistical significance of the test.

1.1 Under normal conditions.

1.2 Under extreme conditions.

14.18.6.4 Test Method

Initial Conditions

The MS is assumed to be EGPRS attached.

The SS establishes a downlink TBF on one timeslot.

The SS commands the MS to request an establishment of the TBF Uplink and to create a channel loop back after demodulation and before decoding. This is achieved using the EGPRS test mode by transmitting a EGPRS TEST_CMD (see 04.14, section TBD)

Test Procedure

For GMSK Modulation:

- a) The SS shall transmit the pseudo-random data using the standard GMSK-modulated test signal in the Mid ARFCN range and the input level at the receiver input shall be 20dB above the Reference Sensitivity Level.
- b) The SS compares the data that it sends to the MS with the data which is looped back from the receiver after demodulation and before decoding.

The SS tests the bit error ratio for the data bits, by examining sequences of at least the minimum number of samples specified in the test requirements. The number of error events is recorded.

- c) Step b) is repeated with the input level at the receiver input increased to 73 dB μ Vemf().
- d) Step b) is repeated with the input level at the receiver input increased to the following values:
For GSM400 & GSM900: 98 dB μ Vemf().
For DCS1800 & PCS1900: 90 dB μ Vemf().
- e) The SS fading function is set to EQ.
- f) Step b) is repeated with the input level at the receiver input set to 20dB above the reference sensitivity level() and then increased to 73 dB μ Vemf().
- g) Steps a) to f) are repeated under extreme test conditions.

For 8PSK Modulation:

- a) The SS shall transmit the pseudo-random data using the standard 8PSK-modulated test signal in the Mid ARFCN range and the input level at the receiver input shall be 20dB above the Reference Sensitivity Level. For the EGPRS Class A MS, the standard GMSK-modulated test signal will be used for UL transmission.
- b) The SS compares the data that it sends to the MS with the data which is looped back from the receiver after demodulation and before decoding.

The SS tests the bit error ratio for the data bits, by examining sequences of at least the minimum number of samples specified in the test requirements. The number of error events is recorded.

- c) Step b) is repeated with the input level at the receiver input increased to 73 dB μ Vemf().
- d) Step b) is repeated with the input level at the receiver input increased to 87 dB μ Vemf().
- e) Steps a) to d) are repeated under extreme test conditions.

For 8PSK Modulation with random frequency offset:

- a) The SS shall transmit the pseudo-random data using the standard 8PSK-modulated test signal with random frequency offset within 0.1ppm in the Mid ARFCN range and the input level at the receiver input shall be 20dB above the Reference Sensitivity Level. For the EGPRS Class A MS, the standard GMSK-modulated test signal will be used for UL transmission.
- b) The SS compares the data that it sends to the MS with the data which is looped back from the receiver after demodulation and before decoding.

The SS tests the bit error ratio for the data bits, by examining sequences of at least the minimum number of samples specified in the test requirements. The number of error events is recorded.

- c) Step b) is repeated with the input level at the receiver input increased to 73 dB μ Vemf().
- d) Step a) to c) are repeated under extreme test conditions.

14.18.6.5 Test Requirements

The error rate measured in this test shall not exceed the test limit error rate values given in table 14.18-10. This shall apply for any combination of normal and extreme test voltages and ambient temperature, for the different propagation conditions and for any level of input signal to the receiver.

Table 14.18-10: Limits for input level range

Type of test signals	Type of measurement	Propaga-tion Conditions	GSM400 & 900		DCS1800 & PCS1900	
			Test limit Error rate %	Minimum No. of samples	Test limit Error rate %	Minimum No. of samples
GMSK	BER	Static <= 73dB μ Vemf()	0.012	1640000	0.012	1640000
		Static <= 98dB μ Vemf()	0.122	164000	0.122	164000
		Static <= 90dB μ Vemf() EQ	3.25	120000	3.25	120000
8PSK	BER	Static<= 73dB μ Vemf()	0.012	1640000	0.012	1640000
		Static <= 87dB μ Vemf()	0.122	164000	0.122	164000
8PSK with frequency offset within 0.1ppm	BER	Static <= 73dB μ Vemf()	0.012	1640000	0.122	164000

15 Timing advance and absolute delay

15.1 Definition and applicability

Timing advance (TA) is a time offset in bits as sent to the MS by the BS. The MS shall advance its transmissions to the BS by the timing advance relative to 3 timeslots behind transmissions received from the BS.

The absolute delay is the delay between a common burst reference point within the received and the transmitted RF burst.

NOTE: For normal or dummy bursts, the common burst reference point is defined to be the transition from bit 13 to bit 14 of the midamble. For an access burst it is defined to be the transition from bit 48 to bit 49 of the burst.

Equivalently the delay can be referenced to the modulator input vs. the demodulator output or to the differential encoder input vs. the differential decoder output, provided the measured delay is corrected for the additional delays in the signal path.

The requirement and this test apply to all types of GSM 400, GSM 700, GSM 850, GSM 900, DCS 1 800 and PCS 1 900 MS.

15.2 Conformance requirement

- 1) The random access burst transmission, measured at the MS antenna, shall use a TA of 0, and therefore be 3 timeslots behind the transmissions received from the BTS, with an absolute tolerance of +/- 1 bit period.

GSM 05.10, 6.4; GSM 05.10, 6.6.

- 2) The normal burst transmission, measured at the MS antenna, shall be 3 timeslots - TA behind the transmissions received from the BTS, with an absolute tolerance of +/- 1 bit period.

GSM 05.10, 6.4.

- 3) When the MS receives a new value of TA on the SACCH, it shall implement the new value of TA at the first TDMA frame belonging to the next reporting period, after the SACCH frame containing the new TA value.

GSM 05.10, 6.5.

- 4) The MS shall signal the used TA to the BS, in the L1 header of the uplink SACCH message.

GSM 05.10, 6.4, GSM 04.04, 7.2.

15.3 Test purpose

- 1) To verify that the MS uses a TA value of 0 for the access burst.
- 2) To verify that the MS meets the absolute receive/transmit delay requirement for the access burst.
- 3) To verify that the MS meets the absolute receive/transmit delay requirement for normal bursts.
- 4) To verify that the MS implements a new timing advance value as signalled on the SACCH as in the requirement.
- 5) To verify that the MS sends the TA used on the uplink SACCH as in the requirement.

15.4 Method of test

15.4.1 Initial conditions

The SS sends "MAXRETRANS = 7" and "TX-INTEGER = 3" on the BCCH.

The MS is brought into MM state "idle, updated".

15.4.2 Procedure

- a) The SS pages the MS after 10 s.
- b) The SS does not respond to the first 7 CHANNEL REQUEST messages from the MS. The SS responds to the 8th CHANNEL REQUEST from the MS on the RACH by sending an IMMEDIATE ASSIGNMENT message, with TA set to 0.
- c) The SS continues to set up a call according to the generic call set up procedure.
- d) The SS signals the TA values 10, 20, 30, 40, 50, 60, 63, and one random value other than these values to the MS in consecutive SACCH blocks.

For GSM 400 MS, the SS signals the TA values 35, 70, 105, 140, 175, 210, 219, and one random value other than these values to the MS in consecutive SACCH blocks.

The SS determines the TA value set in the L1 header on the uplink SACCH for each timing advance.

The SS measures the absolute delay for all bursts.

15.5 Test requirement

The measured receive/transmit delay for each burst shall equal the following nominal values with an absolute tolerance of +/- 1 bit period:

access bursts: 3 timeslots (= 45/26 ms)

normal bursts: 3 timeslots (= 45/26 ms) minus the last TA value received from the SS.

The MS shall use the new timing advance at the first TDMA frame belonging to the next reporting period after the SACCH frame containing the new TA value.

The TA field in the uplink SACCH L1 header shall contain to the most recently ordered TA value.

15.6 GPRS Timing advance and absolute delay

15.6.1 Definition and applicability

Timing advance (TA) is a time offset in bits as sent to the MS by the BS. The MS shall advance its transmissions to the BS by the timing advance relative to 3 timeslots behind transmissions received from the BS.

The absolute delay is the delay between a common burst reference point within the received and the transmitted RF burst.

The timing advance procedure is used to derive the correct value for timing advance that the MS has to use for the uplink transmission of radio blocks.

The timing advance procedure comprises two parts:

- initial timing advance estimation;
- continuous timing advance update.

NOTE: For normal or dummy bursts, the common burst reference point is defined to be the transition from bit 13 to bit 14 of the midamble. For an access burst it is defined to be the transition from bit 48 to bit 49 of the burst.

Equivalently the delay can be referenced to the modulator input vs. the demodulator output or to the differential encoder input vs. the differential decoder output, provided the measured delay is corrected for the additional delays in the signal path.

The requirement and this test apply to all types of GSM 400, GSM 700, GSM 850, GSM 900, DCS 1 800 and PCS 1900 MS supporting GPRS.

15.6.2 Conformance requirement

- 1) The random access burst transmission, measured at the MS antenna, shall use a TA of 0, and therefore be 3 timeslots behind the transmissions received from the BTS, with an absolute tolerance of +/- 1 bit period.

GSM 05.10, 6.4; GSM 05.10, 6.6.

- 2) The normal burst transmission, measured at the MS antenna, shall be 3 timeslots - TA behind the transmissions received from the BTS, with an absolute tolerance of +/- 1 bit period. In case of a multislot configuration, the MS shall use a common timebase for transmission of all channels. In this case, the MS may optionally use a timeslot length of 157 bit periods on timeslots $TN = 0$ and 4, and 156 bit periods on timeslots with $TN = 1, 2, 3, 5, 6$ and 7, rather than 156,25 bit periods on all timeslots. In case of a packet switched multislot configuration the common timebase shall be derived from all timeslots monitored by the MS. In this case, the MS may assume that the BTS uses a timeslot length of 156,25 bit periods on all timeslots

GSM 05.10, 6.4.

- 3) For an MS in Packet transfer mode, except MS class A in dedicated mode:

Within the packet resource assignments (see GSM 04.08 and GSM 04.60) for uplink or downlink messages the MS gets the Timing Advance Index (TAI). The MS shall send access bursts on the subchannel defined by the TAI on the PTCCH using TA=0.

GSM 05.10 6.5.2

- 4) For an MS in Packet transfer mode, except MS class A in dedicated mode:

When the MS receives the updated value of TA from the BTS on the downlink PTCCH, it shall always use the last received TA value for the uplink transmission.

GSM 05.10 6.5.2

- 5) For an MS in Packet transfer mode, except MS class A in dedicated mode:

Upon initiation of the continuous timing advance procedure the MS shall disregard the TA values on PTCCH until it has sent its first access burst on PTCCH.

GSM 05.10 6.5.2

- 6) For an MS in Packet transfer mode, except MS class A in dedicated mode:

The network may request the MS to send 4 access bursts to calculate a new TA value. For this purpose the network sets the system information element CONTROL_ACK_TYPE to indicate that the MS is to respond with a PACKET_CONTROL_ACKNOWLEDGEMENT consisting of 4 access bursts (see GSM 04.60), and sends a PACKET_POLLING_REQUEST to the MS. In this case, the MS shall transmit 4 consecutive access bursts on the assigned resources.

GSM 05.10 6.5.2

- 7) For an MS in Packet transfer mode, except MS class A in dedicated mode:

If the MS receives a resource assignment or power control/timing advance message (see GSM 04.60), the MS shall use the included TA value until it receives a new value on PTCCH.

GSM 05.10 6.5.2

- 8) For an MS in Packet transfer mode, except MS class A in dedicated mode:

If the MS receive a packet resource assignment (see GSM 04.08 and GSM 04.60) indicating to the MS that it can only start the uplink transmission on PDTCH after the timing advance is obtained by the continuous update procedure, the MS shall start the packet transfer after the TA value is received on the PTCCH.

GSM 05.10 6.5.2

- 9) For an MS in Packet transfer mode, except MS class A in dedicated mode:

If the MS receives a packet resource assignment (see GSM 04.08 and GSM 04.60) indicating that a default timing advance shall be used, the MS shall not use the continuous timing advance procedure.

GSM 05.10 6.5.2

10) For an MS in Packet transfer mode, except MS class A in dedicated mode:

When the MS receives a new or updated TA value on the downlink PTCCH or downlink PACCH, the MS shall be ready to transmit using the new TA value within 40 ms of the end of the last timeslot of the message block containing the new TA value.

GSM 05.10, 6.9

NOTE: A MS class A in dedicated mode has to follow the procedures described in GSM 05.10 subclause 6.5.1.

15.6.3 Test purpose

- 1) To verify that the MS uses a TA value of 0 for the access burst.
- 2) To verify that the MS meets the absolute receive/transmit delay requirement for the access burst.
- 3) To verify that the MS meets the absolute receive/transmit delay requirement for normal bursts.
- 4) To verify that an MS in Packet transfer mode, except for a GPRS Class A MS in dedicated mode, when it receives an updated value of TA from the BTS on the downlink PTCCH, uses the last received TA value for the uplink transmission, respecting conformance requirement 10.
- 5) To verify that an MS in Packet transfer mode, except for a GPRS Class A MS in dedicated mode, upon initiation of the continuous timing advance procedure shall disregard the TA values on PTCCH until it has sent its first access burst on PTCCH.
- 6) To verify that an MS in Packet transfer mode, except for a GPRS Class A MS in dedicated mode, if it receives a packet polling message as defined in conformance requirement 6, sends 4 access bursts on a network assigned uplink resource.
- 7) To verify that an MS in Packet transfer mode, except for a GPRS Class A MS in dedicated mode, if it receives a resource assignment or power control/timing advance message (see GSM 04.60), uses the included TA value until it receives a new value on PTCCH.
- 8) To verify that an MS in Packet transfer mode, except for a GPRS Class A MS in dedicated mode, if it receives a packet resource assignment (see GSM 04.08 and GSM 04.60) indicating to the MS that it can only start the uplink transmission on PDTCH after the timing advance is obtained by the continuous update procedure, it starts the packet transfer after the TA value is received on the PTCCH respecting conformance requirement 10.
- 9) To verify that an MS in Packet transfer mode, except for a GPRS Class A MS in dedicated mode, if it receives a packet resource assignment (see GSM 04.08 and GSM 04.60) indicating that a default timing advance shall be used, does not use the continuous timing advance procedure.

15.6.4 Method of test

15.6.4.1 Initial conditions

The test shall be run under the default GPRS conditions defined in section 40.

The SS sets the Packet System Information 1 parameter CONTROL_ACK_TYPE to "0".

The MS is brought into packet idle mode.

The Test Mode defined in GSM Rec. 4.14 (para 5.4) will be used for uplink TBF. If the MS is capable of both:

- Mode (a) transmitting pseudo-random data sequence in RLC data blocks
- Mode (b) transmitting looped-back RLC data blocks

then Mode (a) will be used.

If Mode (b) is used then the SS sends the pseudo-random data sequence specified for Mode (a) on the downlink for loopback on the uplink.

15.6.4.2 Procedure

- a) The SS pages MS on the PPCH. The SS measures the receive/transmit delay for each burst.
- b) The MS is brought into packet transfer mode. The SS transmits a packet resource assignment to the MS with a valid TAI. The SS transmits a TA value on the PTCCH for this TAI which is not 0 nor 1. The SS measures the receive/transmit delay for each burst.
- c) The SS transmits a number of different TA values on the PTCCH for the TAI assigned to the MS. The SS also changes the TA values on the PTCCH for the other TAI in such a way that there is no correlation between TA values. The SS measures the receive/transmit delay for each burst.
- d) The SS transmits a new TA value, different by more than 1 from the previously transmitted one, in such a way that the MS can only correctly receive the last (4th) occurrence of the new TA value. The SS measures the receive/transmit delay for each burst.
- e) The MS is made to send a Packet Channel Request. The SS responds with a Packet Queuing Notification. After 10 s the SS sends a Packet Polling, addressing the MS with its Temporary Queuing Identity. The SS measures the receive/transmit delay for each burst.

NOTE: The 10 s is an arbitrary value.

- f) The SS sends a Packet Uplink Assignment to the MS with valid TIMING_ADVANCE_INDEX, TIMING_ADVANCE_TIMESLOT_NUMBER, and TIMING_ADVANCE_VALUE. As part of the subsequent continuous timing advance update procedure, the SS sends a timing advance value on the downlink PTCCH for the MS, that is different from the TIMING_ADVANCE_VALUE in the Packet Uplink Assignment. The SS measures the receive/transmit delay for each burst.
- g) The SS sends a Packet Uplink Assignment to the MS with valid TIMING_ADVANCE_INDEX and TIMING_ADVANCE_TIMESLOT_NUMBER corresponding to the PTCCH, and with the TIMING_ADVANCE_VALUE field not present. The SS allocates uplink resources to the MS in such a way that the allocated uplink resources occur before the uplink PTCCH allocated to the MS. The SS measures the receive/transmit delay for each burst.
- h) The SS sends a Packet Uplink Assignment to the MS with TIMING_ADVANCE_VALUE set to a value different from the last one ordered on the PTCCH, and the TIMING_ADVANCE_INDEX and TIMING_ADVANCE_TIMESLOT_NUMBER fields not present. The SS continues to transmit TA values on the PTCCH. These shall be different from the TA value TIMING_ADVANCE_VALUE in the Packet Uplink Assignment. The SS measures the receive/transmit delay for each burst.

15.6.5 Test requirement

The measured receive/transmit delay for each burst shall equal the following nominal values with an absolute tolerance of +/- 1 bit period.

access bursts: 3 timeslots (= 45/26 ms)

normal bursts: 3 timeslots (= 45/26 ms) minus the last TA value received from the SS.

In step a) the MS shall transmit an access burst on the PRACH.

In step b) the MS shall send access bursts on the PTCCH on the subchannel defined by the TAI with TA = 0.

In step c) the MS shall use the updated TA values.

In step d) the MS shall use the updated TA value.

In step e) the MS shall transmit 4 access bursts.

In step f) the MS shall use the TIMING_ADVANCE_VALUE in the Packet Uplink Assignment first, and change to the Timing Advance value transmitted on the downlink PTCCH in response to the sending of an access burst on the uplink PTCCH.

After step h) the MS shall not transmit on the allocated resources before it received a Timing Advance value on the downlink PTCCCH in response to the sending of an access burst on the uplink PTCCCH.

In step h) the last TA value received from the SS is the TIMING_ADVANCE_VALUE in the Packet Uplink Assignment.

15.7 ECSD Timing advance and absolute delay

15.7.1 Definition and applicability

Timing advance (TA) is a time offset in symbols as sent to the MS by the BS. The MS shall advance its transmissions to the BS by the timing advance relative to 3 timeslots behind transmissions received from the BS.

The absolute delay is the delay between a common burst reference point within the received and the transmitted RF burst.

NOTE: For normal bursts for GMSK modulation, the common burst reference point is defined to be the transition from bit 13 to bit 14 of the midamble. For normal bursts for 8-PSK modulation, the common burst reference point is defined to be the transition from symbol 13 to symbol 14 of the midamble. For an access burst it is defined to be the transition from bit 48 to bit 49 of the burst.

Equivalently the delay can be referenced to the modulator input vs. the demodulator output or to the differential encoder input vs. the differential decoder output, provided the measured delay is corrected for the additional delays in the signal path.

The requirement and this test apply to all types of MSs supporting ECSD.

15.7.2 Conformance requirement

- 1) The random access burst transmission, measured at the MS antenna, shall use a TA of 0, and therefore be 3 timeslots behind the transmissions received from the BTS, with an absolute tolerance of +/- 1 symbol period.

GSM 05.10, 6.4; GSM 05.10, 6.6.

- 2) The normal burst transmission, measured at the MS antenna, shall be 3 timeslots - TA behind the transmissions received from the BTS, with an absolute tolerance of +/- 1 symbol period. In case of a multislot configuration, the MS shall use a common timebase for transmission of all channels. In this case, the MS may optionally use a timeslot length of 157 symbol periods on timeslots $TN = 0$ and 4, and 156 symbol periods on timeslots with $TN = 1, 2, 3, 5, 6$ and 7, rather than 156,25 symbol periods on all timeslots. In case of a circuit switched multislot configuration, the common timebase shall be derived from the main channel and the TA values received on other channels shall be neglected.

GSM 05.10, 6.4.

- 3) When the MS receives a new value of TA on the SACCH, it shall implement the new value of TA at the first TDMA frame belonging to the next reporting period, after the SACCH frame containing the new TA value.

GSM 05.10, 6.5.1

- 4) The MS shall signal the used TA to the BS, in the L1 header of the uplink SACCH message.

GSM 05.10, 6.5.1, GSM 04.04, 7.2.

15.7.3 Test purpose

- 1) To verify that the MS uses a TA value of 0 for the access burst.
- 2) To verify that the MS meets the absolute receive/transmit delay requirement for the access burst.
- 3) To verify that the MS meets the absolute receive/transmit delay requirement for normal bursts.
- 4) To verify that the MS implements a new timing advance value as signalled on the SACCH as in the requirement.
- 5) To verify that the MS sends the TA used on the uplink SACCH as in the requirement.

- 6) To verify that a multislot capable MS operates in accordance with the conformance requirement 2.

15.7.4 Method of test

Initial conditions

The SS sends "MAXRETRANS = 7" and "TX-INTEGGER = 3" on the BCCH.

The MS is brought into MM state "idle, updated".

Procedure

- a) The SS pages the MS after 10 s.
- b) The SS does not respond to the first 7 CHANNEL REQUEST messages from the MS. The SS responds to the 8th CHANNEL REQUEST from the MS on the RACH by sending an IMMEDIATE ASSIGNMENT message, with TA set to 0.
- c) The SS continues to set up a call according to the generic call set up procedure for ECSD. In the case of a multislot capable MS, the call is set up according to the generic call set up procedure for multislot configuration for ECSD and the SS commands the MS to operate with maximum number of both uplink and downlink timeslots according to the multislot class of the MS. In the case of class A ECSD MS, 8-PSK modulated channels shall be used in the downlink. In the case of class B ECSD MS, GMSK modulated channels shall be used in the downlink and 8-PSK modulated channels in the uplink.
- d) The SS signals the TA values 10, 20, 30, 40, 50, 60, 63, and one random value other than these values to the MS in consecutive SACCH blocks.

For GSM 400 MS, the SS signals the TA values 35, 70, 105, 140, 175, 210, 219, and one random value other than these values to the MS in consecutive SACCH blocks.

In the case of a multislot capable MS, the TA values defined above are signalled on the main channel of the multislot configuration, and on the subchannels TA values different from those ones are signalled.

The SS determines the TA value set in the L1 header on the uplink SACCH for each timing advance.

The SS measures the absolute delay for all bursts.

15.7.5 Test requirement

The measured receive/transmit delay for each burst shall equal the following nominal values with an absolute tolerance of +/- 1 symbol period:

access bursts: 3 timeslots (= 45/26 ms)

normal bursts: 3 timeslots (= 45/26 ms) minus the last TA value received from the SS.

The MS shall use the new timing advance at the first TDMA frame belonging to the next reporting period after the SACCH frame containing the new TA value.

The TA field in the uplink SACCH L1 header shall contain to the most recently ordered TA value.

The multislot capable MS shall use a common TA value for all uplink channels, derived from the main downlink channel of the multislot configuration. The TA value in the uplink SACCH L1 header shall be that one.

15.8 EGPRS timing advance and absolute delay

15.8.1 Definition and applicability

Timing advance (TA) is a time offset in symbols as sent to the MS by the BS. The MS shall advance its transmissions to the BS by the timing advance relative to 3 timeslots behind transmissions received from the BS.

The absolute delay is the delay between a common burst reference point within the received and the transmitted RF burst.

The timing advance procedure is used to derive the correct value for timing advance that the MS has to use for the uplink transmission of radio blocks.

The timing advance procedure comprises two parts:

- initial timing advance estimation;
- continuous timing advance update.

NOTE: For normal bursts for GMSK modulation, the common burst reference point is defined to be the transition from bit 13 to bit 14 of the midamble. For normal bursts for 8-PSK modulation, the common burst reference point is defined to be the transition from symbol 13 to symbol 14 of the midamble. For an access burst it is defined to be the transition from bit 48 to bit 49 of the burst.

Equivalently the delay can be referenced to the modulator input vs. the demodulator output or to the differential encoder input vs. the differential decoder output, provided the measured delay is corrected for the additional delays in the signal path.

The requirement and this test apply to all types of MSs supporting EGPRS.

15.8.2 Conformance requirement

- 1) The random access burst transmission, measured at the MS antenna, shall use a TA of 0, and therefore be 3 timeslots behind the transmissions received from the BTS, with an absolute tolerance of +/- 1 symbol period.

GSM 05.10, 6.4; GSM 05.10, 6.6.

- 2) The normal burst transmission, measured at the MS antenna, shall be 3 timeslots - TA behind the transmissions received from the BTS, with an absolute tolerance of +/- 1 symbol period. In case of a multislot configuration, the MS shall use a common timebase for transmission of all channels. In this case, the MS may optionally use a timeslot length of 157 symbol periods on timeslots TN = 0 and 4, and 156 symbol periods on timeslots with TN = 1, 2, 3, 5, 6 and 7, rather than 156,25 symbol periods on all timeslots. In case of a packet switched multislot configuration the common timebase shall be derived from all timeslots monitored by the MS. In this case, the MS may assume that the BTS uses a timeslot length of 156,25 symbol periods on all timeslots

GSM 05.10, 6.4.

- 3) For an MS in Packet transfer mode, except MS class A in dedicated mode:

Within the packet resource assignments (see GSM 04.08 and GSM 04.60) for uplink or downlink messages the MS gets the Timing Advance Index (TAI). The MS shall send access bursts on the subchannel defined by the TAI on the PTCCH using TA=0.

GSM 05.10 6.5.2

- 4) For an MS in Packet transfer mode, except MS class A in dedicated mode:

When the MS receives the updated value of TA from the BTS on the downlink PTCCH, it shall always use the last received TA value for the uplink transmission.

GSM 05.10 6.5.2

- 5) For an MS in Packet transfer mode, except MS class A in dedicated mode:

Upon initiation of the continuous timing advance procedure the MS shall disregard the TA values on PTCCH until it has sent its first access burst on PTCCH.

GSM 05.10 6.5.2

- 6) For an MS in Packet transfer mode, except MS class A in dedicated mode:

The network may request the MS to send 4 access bursts to calculate a new TA value. For this purpose the network sets the system information element CONTROL_ACK_TYPE to indicate that the MS is to respond with

a PACKET_CONTROL_ACKNOWLEDGEMENT consisting of 4 access bursts (see GSM 04.60), and sends a PACKET_POLLING_REQUEST to the MS. In this case, the MS shall transmit 4 consecutive access bursts on the assigned resources.

GSM 05.10 6.5.2

- 7) For an MS in Packet transfer mode, except MS class A in dedicated mode:

If the MS receives a resource assignment or power control/timing advance message (see GSM 04.60), the MS shall use the included TA value until it receives a new value on PTCCH.

GSM 05.10 6.5.2

- 8) For an MS in Packet transfer mode, except MS class A in dedicated mode:

If the MS receive a packet resource assignment (see GSM 04.08 and GSM 04.60) indicating to the MS that it can only start the uplink transmission on PDTCH after the timing advance is obtained by the continuous update procedure, the MS shall start the packet transfer after the TA value is received on the PTCCH.

GSM 05.10 6.5.2

- 9) For an MS in Packet transfer mode, except MS class A in dedicated mode:

If the MS receives a packet resource assignment (see GSM 04.08 and GSM 04.60) indicating that a default timing advance shall be used, the MS shall not use the continuous timing advance procedure.

GSM 05.10 6.5.2

- 10) For an MS in Packet transfer mode, except MS class A in dedicated mode:

When the MS receives a new or updated TA value on the downlink PTCCH or downlink PACCH, the MS shall be ready to transmit using the new TA value within 40 ms of the end of the last timeslot of the message block containing the new TA value.

GSM 05.10, 6.9

Note: A MS class A in dedicated mode has to follow the procedures described in GSM 05.10 subclause 6.5.1.

15.8.3 Test purpose

- 1) To verify that the MS uses a TA value of 0 for the access burst.
- 2) To verify that the MS meets the absolute receive/transmit delay requirement for the access burst.
- 3) To verify that the MS meets the absolute receive/transmit delay requirement for normal bursts in accordance with the conformance requirement 2.
- 4) To verify that an MS in Packet transfer mode, except for aMS Class A in dedicated mode, when it receives an updated value of TA from the BTS on the downlink PTCCH, uses the last received TA value for the uplink transmission, respecting conformance requirement 10.
- 5) To verify that an MS in Packet transfer mode, except for aMS Class A in dedicated mode, upon initiation of the continuous timing advance procedure shall disregard the TA values on PTCCH until it has sent its first access burst on PTCCH.
- 6) To verify that an MS in Packet transfer mode, except for a MS Class A in dedicated mode, if it receives a packet polling message as defined in conformance requirement 6, sends 4 access bursts on a network assigned uplink resource.
- 7) To verify that an MS in Packet transfer mode, except for a MS Class A in dedicated mode, if it receives a resource assignment or power control/timing advance message (see GSM 04.60), uses the included TA value until it receives a new value on PTCCH.
- 8) To verify that an MS in Packet transfer mode, except for a MS Class A in dedicated mode, if it receives a packet resource assignment (see GSM 04.08 and GSM 04.60) indicating to the MS that it can only start the uplink

transmission on PDTCH after the timing advance is obtained by the continuous update procedure, it starts the packet transfer after the TA value is received on the PTCCH respecting conformance requirement 10.

- 9) To verify that an MS in Packet transfer mode, except for a MS Class A in dedicated mode, if it receives a packet resource assignment (see GSM 04.08 and GSM 04.60) indicating that a default timing advance shall be used, does not use the continuous timing advance procedure.

15.8.4 Method of test

Initial conditions

The SS sets the Packet System Information 1 parameter CONTROL_ACK_TYPE to "0".

The MS is brought into packet idle mode.

Procedure

- a) The SS pages MS on the PPCH. The SS measures the receive/transmit delay for each burst.
- b) The SS brings the MS into packet transfer mode and orders the MS to transmit on the uplink for the duration of the test. This is achieved using the EGPRS test mode by transmitting a EGPRS TEST_CMD (see GSM 04.14). Maximum number of uplink and downlink PDTCHs is allocated according to the multislot class of the MS. In case of class A EGPRS MS, 8-PSK modulated PDTCHs are used in the downlink. In case of class B EGPRS MS, GMSK modulated PDTCHs are used in the downlink and 8-PSK modulated PDTCHs are used in the uplink. The SS transmits a packet resource assignment to the MS with a valid TAI. The SS transmits a TA value on the PTCCH for this TAI which is not 0 nor 1. The SS measures the receive/transmit delay for each burst.
- c) The SS transmits a number of different TA values on the PTCCH for the TAI assigned to the MS. The SS also changes the TA values on the PTCCH for the other TAI in such a way that there is no correlation between TA values. For multislot capable MS, the TA values are transmitted on arbitrary downlink channels allocated for the MS. The SS measures the receive/transmit delay for each burst.
- d) The SS transmits a new TA value, different by more than 1 from the previously transmitted one, in such a way that the MS can only correctly receive the last (4th) occurrence of the new TA value. The SS measures the receive/transmit delay for each burst. The uplink TBF is terminated.
- e) The MS is made to send a Packet Channel Request by transmitting a EGPRS_TEST_CMD. The SS responds with a Packet Queuing Notification. After 10 s the SS sends a Packet Polling, addressing the MS with its Temporary Queuing Identity. The SS measures the receive/transmit delay for each burst.

Note: The 10 s is an arbitrary value.

- f) The SS sends a Packet Uplink Assignment to the MS with valid TIMING_ADVANCE_INDEX, TIMING_ADVANCE_TIMESLOT_NUMBER, and TIMING_ADVANCE_VALUE. As part of the subsequent continuous timing advance update procedure, the SS sends a timing advance value on the downlink PTCCH for the MS, that is different from the TIMING_ADVANCE_VALUE in the Packet Uplink Assignment. The SS measures the receive/transmit delay for each burst.
- g) The SS sends a Packet Uplink Assignment to the MS with valid TIMING_ADVANCE_INDEX and TIMING_ADVANCE_TIMESLOT_NUMBER corresponding to the PTCCH, and with the TIMING_ADVANCE_VALUE field not present. The SS allocates uplink resources to the MS in such a way that the allocated uplink resources occur before the uplink PTCCH allocated to the MS. The SS measures the receive/transmit delay for each burst.
- h) The SS sends a Packet Uplink Assignment to the MS with TIMING_ADVANCE_VALUE set to a value different from the last one ordered on the PTCCH, and the TIMING_ADVANCE_INDEX and TIMING_ADVANCE_TIMESLOT_NUMBER fields not present. The SS continues to transmit TA values on the PTCCH. These shall be different from the TA value TIMING_ADVANCE_VALUE in the Packet Uplink Assignment. The SS measures the receive/transmit delay for each burst.

15.8.4.3 Test requirement

The measured receive/transmit delay for each burst shall equal the following nominal values with an absolute tolerance of +/- 1 symbol period.

access bursts: 3 timeslots (= 45/26 ms)

normal bursts: 3 timeslots (= 45/26 ms) minus the last TA value received from the SS.

In step a) the MS shall transmit an access burst on the PRACH.

In step b) the MS shall send access bursts on the PTCCH on the subchannel defined by the TAI with TA = 0.

In step c) the MS shall use the updated TA values on all of the allocated uplink channels.

In step d) the MS shall use the updated TA value.

In step e) the MS shall transmit 4 access bursts.

In step f) the MS shall use the TIMING_ADVANCE_VALUE in the Packet Uplink Assignment first, and change to the Timing Advance value transmitted on the downlink PTCCH in response to the sending of an access burst on the uplink PTCCH.

After step h) the MS shall not transmit on the allocated resources before it received a Timing Advance value on the downlink PTCCH in response to the sending of an access burst on the uplink PTCCH.

In step h) the last TA value received from the SS is the TIMING_ADVANCE_VALUE in the Packet Uplink Assignment.

16 Reception time tracking speed

16.1 Definition and applicability

Reception time tracking speed is the speed at which the MS adapts its transmit time to a change in the timing of the received signal.

The requirement and this test apply to all types of GSM 400, GSM 700, GSM 850, GSM 900, DCS 1 800 and PCS 1 900 MS.

16.2 Conformance requirement

If the MS determines that the timing difference with signals received from the BS exceeds 2 μ s, the MS shall adjust its timebase in steps of 1/4 bit period, in intervals not less than 1 s and not greater than 2 s until the timing difference is less than 1/2 bit period at 3 dB below reference sensitivity and 3 dB less carrier to interference ratio than the reference interference ratios.

GSM 05.10, 6/6.2.

16.3 Test purpose

- 1) To verify that the MS adapts its transmit time to the timing of the received signal as in the conformance requirement under TUHigh propagation conditions at 2 dB above reference sensitivity level().
- 2) To verify that the MS adapts its transmit time to the timing of the received signal as in the conformance requirement under RA propagation conditions at 2 dB above reference sensitivity level().

NOTE: This test is performed at a level higher than in the conformance requirement because of test implementation problems.

16.4 Method of test

16.4.1 Initial conditions

The SS sets up a call according to the generic call set up procedure on a channel in the Mid ARFCN range.

The SS sets TUHigh.

16.4.2 Procedure

- a) After 10 s the SS sets the input signal level to 2 dB above reference sensitivity level().
- b) For the last second before step c) the SS takes an average receive/transmit delay of all bursts in that 1 s.
- c) The SS increases the delay of the transmitted signal to the MS by a 2 bit step (about 7,4 μ s) and keeps this delay for 20 s.
- d) The SS measures the absolute receive/transmit delay for each burst.
- e) The SS increases the input signal level to 5 dB above reference sensitivity level() and sets propagation condition RA.
- f) The SS repeats steps a) to d).

16.5 Test requirement

The MS shall adjust the timing of its transmit burst back to the correct receive/transmit timing delay. All burst timings shall be within the shaded part of 16.1.

bits change
of transmit
timing

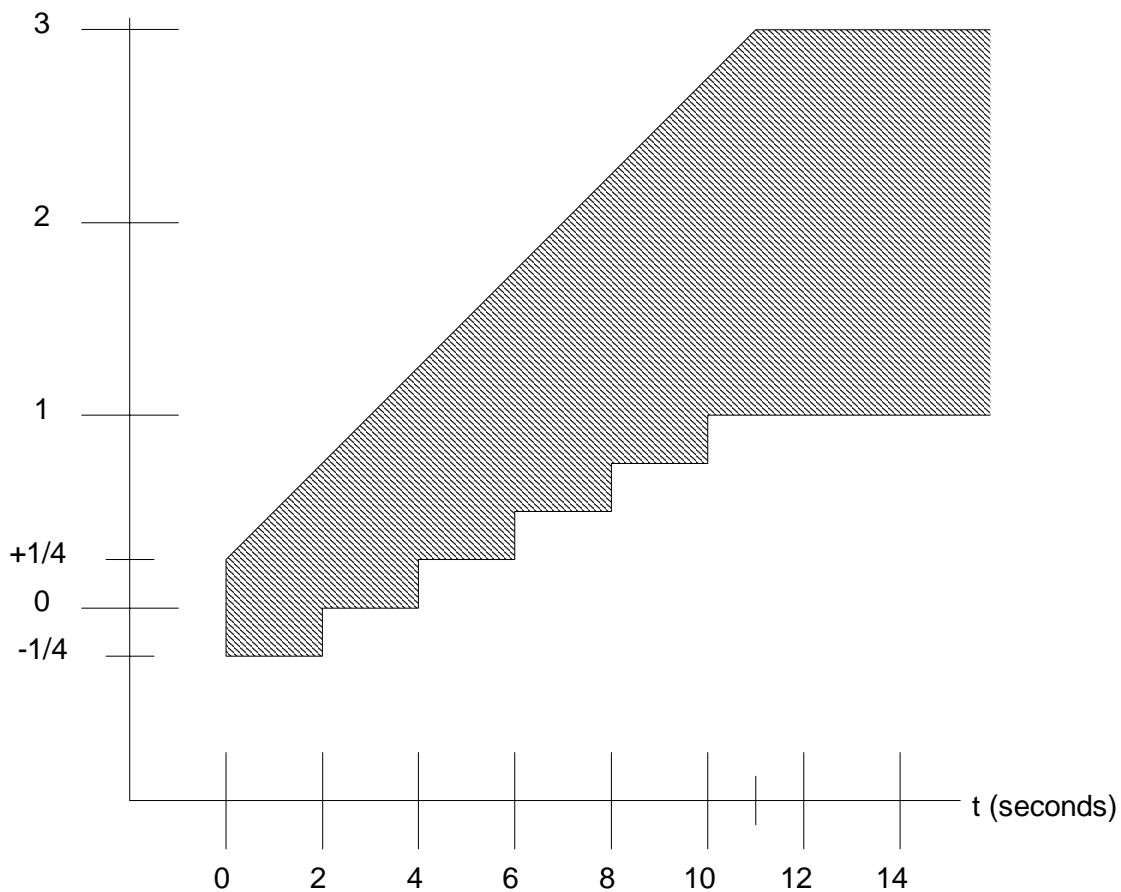

t=0 is the time at which the SS makes the transmission timing step change in c) of subclause 16.4.2.

Figure 16.1

17 Access times during handover

17.1 Intra cell channel change

17.1.1 Definition and applicability

The access times are:

- the time between either receipt by the MS of the last timeslot of the message block containing an ASSIGNMENT COMMAND or HANDOVER COMMAND and the time it has to be ready to transmit on the new channel, and
- the time between the end of the last complete speech or data frame or message block sent on the old channel and the time the MS is ready to transmit on the new channel.

The requirement and this test apply to all types of GSM 400, GSM 700, GSM 850, GSM 900, DCS 1 800 and PCS 1 900 MS. For E-GSM 900 and R-GSM 900 MS this test is performed in the P-GSM band (ref. table 3.3 P-GSM 900ARFCN ranges).

17.1.2 Conformance requirement

- 1) When for an intracell channel change, the MS receives an ASSIGNMENT COMMAND command or a HANDOVER COMMAND it shall be ready to transmit on the new channel within 120 ms of the last timeslot of the message block containing the command.

GSM 05.10, 6.8.

- 2) For an intracell channel change, the time between the end of the last complete speech or data frame or message block sent on the old channel and the time the MS is ready to transmit on the new channel shall be less than 20 ms.

GSM 05.10, 6.8.

17.1.3 Test purpose

- 1) To verify that the MS, when commanded to perform an intracell channel change to a new ARFCN and/or a new timeslot number within the same cell, if the starting time is not used in the ASSIGNMENT COMMAND, is ready to transmit on the new channel within 120 ms of the last timeslot containing the ASSIGNMENT COMMAND.
- 2) To verify that the MS, when commanded to perform an intracell channel change to a new ARFCN and/or a new timeslot number within the same cell, if the starting time is not used in the ASSIGNMENT COMMAND, is ready to transmit on the new channel within 20 ms of the last complete speech/data frame or message block sent on the old channel.

17.1.4 Method of test

17.1.4.1 Initial conditions

The SS sets up a call according to the generic call set up procedure on a channel in the Low ARFCN range on timeslot 1.

17.1.4.2 Procedure

- a) The SS sends an ASSIGNMENT COMMAND to the MS allocating a channel in the high ARFCN range on timeslot 2, and with a power command of 7. These old and new carriers have a relative frequency tolerance of 0, and a relative timing tolerance of 1/4 bit.

- b) The SS, after it has sent the ASSIGNMENT COMMAND, measures the reception time of bursts received on the new channel, and the time at which transmission ceases on the old channel.

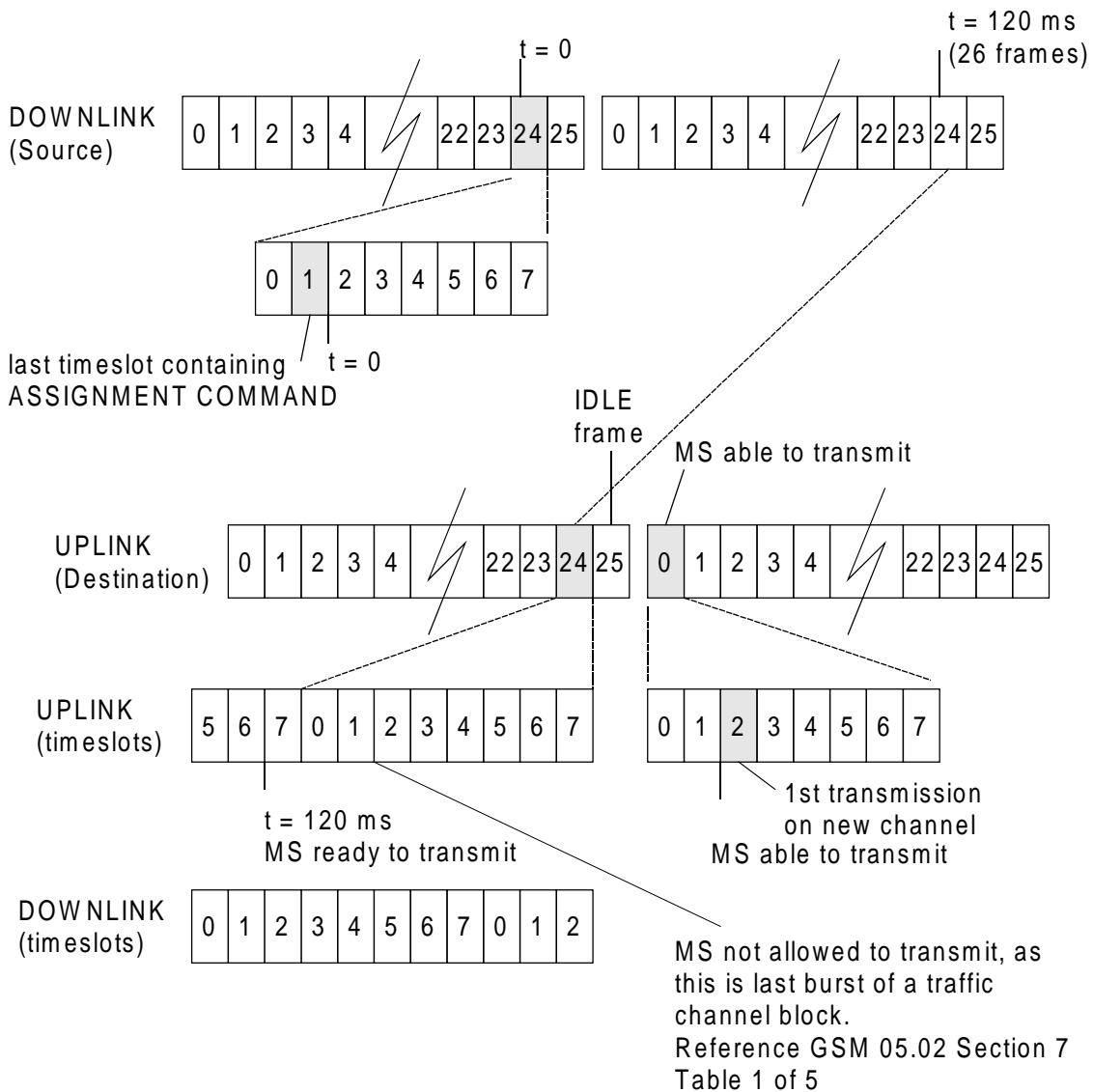

Timing difference between Downlink and Uplink is 3 timeslots.

Relative timing difference between the 2 carriers is a $1/4$ bit period.

Maximum time to first transmission on the new channel is 131 ms (120ms + 2 frames + 3 timeslots + $1/4$ bit period)

Figure 17-1: Access time - Intra cell channel change (Test Requirement 1)

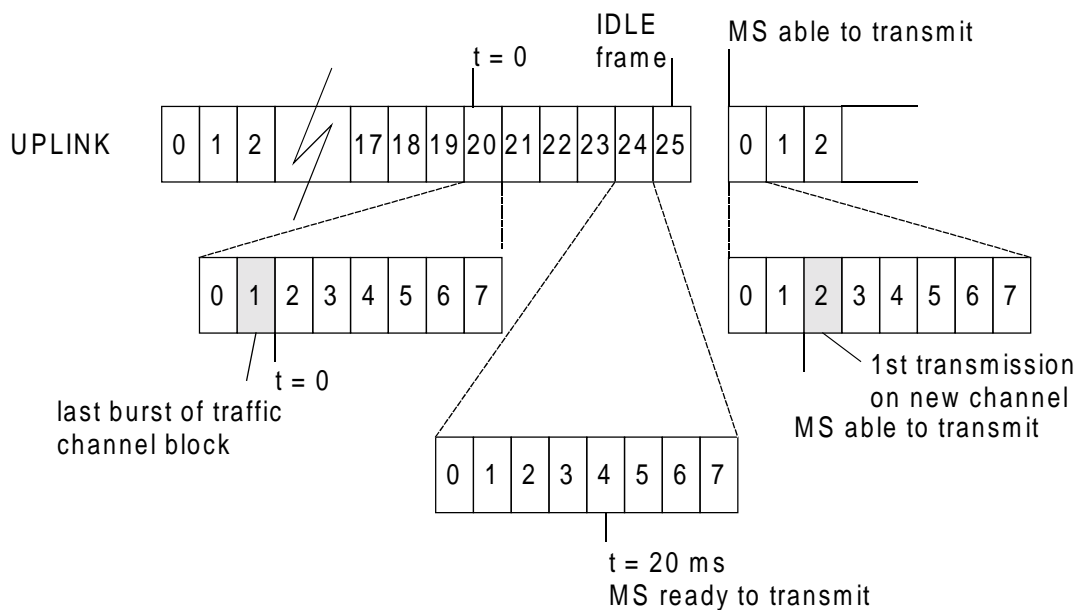

Figure 17-2: Access time - Intra cell channel change (Test Requirement 2)

17.1.5 Test requirement

- 1) The MS shall transmit its first burst on the new channel within 131 ms from the last timeslot of the message block containing the ASSIGNMENT COMMAND.

NOTE 1: The requirement time of 120 ms, at which the MS shall be ready to transmit, will expire right at the beginning of a new downlink burst on timeslot 2, which will be the last burst of a traffic channel block. The following frame could be an IDLE frame and the MS would then transmit in the next frame. Taking into account the 3 timeslot shift between up and downlink, and the 1/4 bit relative timing tolerance between the carriers, means that the MS may first transmit on the new channel after 131 ms (120 ms + 2 frames + 3 timeslots + 1/4 bit period). See figure 17-1.

- 2) The MS shall transmit its first burst on the new channel within 27,7 ms from the last complete speech or data frame or message block sent on the old channel.

NOTE 2: The requirement time of 20 ms, at which the MS shall be ready to transmit, will expire at just over 4 frames after the sending of the last bit on the old channel. The next frame could be an IDLE frame and the MS would then transmit in the following frame. This equates to 6 frames so in the worst case, including the 1/4 bit relative timing tolerance between the carriers, the MS may take 27,7 ms before starting transmissions on the new channel.

17.2 Inter cell handover

17.2.1 Definition and applicability

The access times are:

- the time between receipt by the MS of the last timeslot of the message block containing a HANDOVER COMMAND and the time it has to be ready to transmit on the new channel, and
- the time between the end of the last complete speech or data frame or message block sent on the old channel and the time the MS is ready to transmit on the new channel.

The requirement and this test apply to all types of GSM 400, GSM 700, GSM 850, GSM 900, DCS 1 800 and PCS 1 900 MS.

17.2.2 Conformance requirement

- 1) When the MS receives a HANOVER COMMAND it shall be ready to transmit on the new channel within 120 ms of the last timeslot of the message block containing the HANOVER COMMAND.

GSM 05.10, 6.8

- 2) The time between the end of the last complete speech or data frame or message block sent on the old channel and the time the MS is ready to transmit on the new channel shall be less than 20 ms.

GSM 05.10, 6.8.

- 3) When the MS receives a new TA value in response to a handover access burst, the MS shall be ready to transmit using the new TA value within 40 ms of the end of the last timeslot of the message block containing the new TA.

GSM 05.10, 6.9.

- 4) The MS shall use a TA value of 0 for the handover access bursts sent.

GSM 05.10, 6.6.

17.2.3 Test purpose

- 1) To verify that the MS, when commanded to handover on a new ARFCN and a new timeslot number in a new, not synchronized cell, starting time not used in the HANOVER COMMAND, will be ready to transmit on the new channel within 120 ms of the last timeslot containing the HANOVER COMMAND.
- 2) To verify that the MS, when commanded to handover on a new ARFCN and a new timeslot number in a new, not synchronized cell, starting time not used in the HANOVER COMMAND, will be ready to transmit on the new channel within 20 ms of the last complete speech or data frame or message block sent on the old channel.
- 3) To verify that the MS, when it receives a new TA value in response to a handover access burst, is ready to transmit using the new TA value within 50 ms of the end of the last timeslot of the message block containing the new TA value.
- 4) To verify that the MS uses a TA value of 0 for the handover access burst sent.

17.2.4 Method of test

17.2.4.1 Initial conditions

The SS establishes two non-synchronized cells, A and B, under ideal radio conditions. A is the old cell and B is the target for the handover.

The SS uses two traffic channels with the following properties:

		GSM900	DCS1800	PCS 1900
Cell A	TN	2	2	2
	ARFCN	1	512	512
	offset	+267 Hz	+320 Hz	+366 Hz
Cell B	TN	0	0	0
	ARFCN	124	885	810
	offset	-267 Hz	-320 Hz	-366 Hz

		GSM450	GSM480
Cell A	TN	2	2
	ARFCN	259	306
	offset	+240 Hz	+260 Hz
Cell B	TN	0	0
	ARFCN	293	340
	offset	-240 Hz	-260 Hz

		GSM 750	GSM 850
Cell A	TN	2	2
	ARFCN	438	128
	offset	+250 Hz	+252 Hz
Cell B	TN	0	0
	ARFCN	511	251
	offset	-250 Hz	-252 Hz

NOTE: This offset is representing worst cases for Doppler shift at 500 km/h, 300km/h, 250 km/h, 250 km/h and 130 km/h for GSM 400, GSM 700, GSM 850, GSM 900, DCS 1 800 and PCS 1 900 respectively, and a frequency inaccuracy of 0,05 ppm.

The BCCH for the two cells have the following differences in timing:

Timer T1 50
 Timer T2 15
 Timer T3 40
 1/4 bit number 17
 Timeslots 2

The SS sets up a call according to the generic call set up procedure on the channel in cell A.

17.2.4.2 Procedure

- The SS sends a HANOVER COMMAND on the main DCCH on cell A ordering the MS to go to the channel in cell B. The power command is set to 7.
- After the SS has sent HANOVER COMMAND it measures the reception time of bursts received on the new channel and the time at which transmission ceases on the old channel.
- The SS also measures the absolute transmit/receive delay for the access bursts on the new channel.
- The SS sends the PHYSICAL INFORMATION with TA set to 50. The SS then measures the reception time and absolute delay of the bursts transmitted on the new cell.

17.2.5 Test requirement

- The MS shall transmit its first burst on cell B within 142,6 ms from the last timeslot of the message block containing the HANOVER COMMAND.

NOTE 1: The requirement time of 120 ms, at which the MS shall be ready to transmit, will expire right at the end of the last burst of a downlink traffic channel block on the old channel. Due to the two timeslot difference in cell timing, the two timeslots difference in the channel allocation and the 15 frames difference in multiframe timing, this point could occur 2,5 frames before the end of the last burst of a downlink traffic channel block on the new channel. The following frame could be an IDLE frame and the MS would then transmit in the next frame. Taking into account the three timeslot shift between up and downlink, and the 17 1/4 bit periods timing difference between the two carriers, means that the MS may first transmits on the new channel after 142,6 ms (120 ms + 2,5 frames + 2 frames + 3 timeslots + 17 1/4 bit periods).

- The MS shall transmit its first burst on cell B within 39,2 ms from the last complete speech or data frame or message block sent on cell A.

NOTE 2: The requirement time of 20 ms, at which the MS shall be ready to transmit, will expire at just over 4 frames after the sending of the last bit on the old channel. Due to the two timeslot difference in cell timing, the two timeslots difference in the channel allocation and the 15 frames difference in multiframe timing, this point could occur 2 frames before the end of the last burst of an uplink traffic channel block on the new channel. The following frame could be an IDLE frame and the MS would then transmit in the next frame. This equates to 8,5 frames so in the worst case the MS may take 39,2 ms between cessation of transmission on the old channel and transmission beginning on the new channel.

- 3) The MS shall transmit using the TA value in the PHYSICAL INFORMATION within 50 ms from the end of the last timeslot of the message block containing the new TA value.
- 4) The measured absolute delay for the access bursts in steps c) and d) shall equal 3 timeslots (=45/26 ms), with an absolute tolerance of +/- 1 bit.

18 Temporary reception gaps

18.1 Temporary reception gaps, single slot

18.1.1 Definition and applicability

A temporary reception gap is a limited period of time in which the RF reception is interrupted. During this gap the MS shall maintain the frequency and timing of its transmission within specifications.

The requirement and this test apply to all types of GSM 400, GSM 700, GSM 850, GSM 900, DCS 1 800 MS and PCS 1900, except where an application layer is always running which would perform a normal release of the call due to loss of traffic (see PICS/PIXIT).

18.1.2 Conformance requirement

- 1) During a temporary total loss of signal, of up to 64 SACCH block periods, the MS shall update its timebase with a clock which is accurate to within 0,2 ppm, or to within 0,2 ppm of the signals previously received from the BTS. The MS shall use the same frequency source for both RF frequency generation and clocking the timebase.

GSM 05.10, 6.7; GSM 05.10 6.1.

- 2) The MS shall time its transmissions to the BTS according to signals received from the BTS. The MS transmissions to the BTS, measured at the MS antenna, shall be 3 timeslots - TA behind the transmissions received from the BTS, where TA is the last timing advance received from the current serving BTS.

GSM 05.10, 6.4.

- 3) During a temporary total loss of signal, of up to 64 SACCH block periods, the MS shall update its timebase with a clock which is accurate to within 0,2 ppm, or to within 0,2 ppm of the signals previously received from the BTS.

GSM 05.10, 6.7.

18.1.3 Test purpose

- 1) To verify that, during a temporary total loss of signal of up to 63 SACCH block periods, the MS carrier frequency is accurate to within 0,2 ppm of the signals previously received from the BTS.
- 2) To verify that, the MS transmissions to the BTS, measured at the MS antenna, is 3 timeslots behind the transmissions received from the BTS, with a tolerance of +/-1 bit period.
- 3) To verify that, during a temporary total loss of signal, of up to 63 SACCH block periods, the MS transmission timing may have drifted resulting in an error not greater than +/- 6,048 μ s (0,2 ppm of 63 SACCH blocks).

18.1.4 Method of test

18.1.4.1 Initial conditions

The SS signals RADIO_LINK_TIMEOUT = 64 and "DTX OFF" on the BCCH.

The MS is brought into MM state "idle, updated".

After 10 s, the SS continues to set up a call according to the generic call set up procedure.

18.1.4.2 Procedure

- a) The SS, in a TDMA frame immediately following the transmission of a complete SACCH block, removes the downlink signal for 63 SACCH blocks.

NOTE: This gives the maximum temporary reception gap.

- b) The SS measures the frequency and timing of the MS transmissions immediately before, and at least 5 times at approximately equally spaced intervals during the gap, one of these measurements being at the end of the gap.
- c) The SS resumes transmission for a period sufficient to allow the MS reception of 1 SACCH block.
- d) The SS again removes downlink transmission for a period equal to at least 3 SACCH blocks. The SS measures the frequency and timing of the MS transmissions immediately before and during this second reception gap.

18.1.5 Test requirement

- 1) The MS carrier frequency shall be accurate to within 0,2 ppm compared to signals received from the SS.
- 2) The receive/transmit delay timing shall be 3 timeslots +/- 1 bit.
- 3) During the second reception gap the MS shall maintain transmission for a period up to but not exceeding 3 SACCH blocks.
- 4) During the first, maximum, reception gap the MS transmission timing may have drifted resulting in an error of not greater than +/- 6,048 μ s.

NOTE: The SS determines the error at the start of the reception gap from the first measurement of MS transmission frequency and timing.

18.2 Temporary reception gaps in HSCSD multislots configurations

18.2.1 Definition and applicability

A temporary reception gap is a limited period of time in which the RF reception is interrupted. During this gap the MS shall maintain the frequency and timing of its transmission within specifications.

The requirements and this test apply to all types of GSM 400, GSM 700, GSM 850, GSM 900, DCS 1 800, PCS 1 900 MS and any multiband MS which are capable of HSCSD multislots operation, except where an application layer is always running which would perform a normal release of the call due to loss of traffic (see PICS/PIXIT).

18.2.2 Conformance requirement

- 1) During a temporary total loss of signal, of up to 64 SACCH block periods, the MS shall update its timebase with a clock which is accurate to within 0,2 ppm, or to within 0,2 ppm of the signals previously received from the BTS. The MS shall use the same frequency source for both RF frequency generation and clocking the timebase.

GSM 05.10, 6.7; GSM 05.10 6.1.

- 2) The MS shall time its transmissions to the BTS according to signals received from the BTS. The MS transmissions to the BTS, measured at the MS antenna, shall be 3 timeslots - TA behind the transmissions received from the BTS, where TA is the last timing advance received from the current serving BTS.

GSM 05.10, 6.4.

- 3) During a temporary total loss of signal, of up to 64 SACCH block periods, the MS shall update its timebase with a clock which is accurate to within 0,2 ppm, or to within 0,2 ppm of the signals previously received from the BTS.

GSM 05.10, 6.7.

18.2.3 Test purpose

- 1) To verify that, during a temporary total loss of signal of up to 63 SACCH block periods on the main multislot channel, the MS carrier frequency is accurate to within 0,2 ppm of the signals previously received from the BTS.
- 2) To verify that, the MS transmissions to the BTS, measured at the MS antenna, is 3 timeslots behind the transmissions received from the BTS, with a tolerance of +/-1 bit period.
- 3) To verify that, during a temporary total loss of signal, of up to 63 SACCH block periods on the main multislot channel, the MS transmission timing may have drifted resulting in an error not greater than +/- 6,048 μ s (0,2 ppm of 63 SACCH blocks).
- 4) To verify that, during a temporary loss of more than 64 SACCH block periods on other than the main channel in symmetric configuration, the MS meet the requirements 1, 2 and 3.

18.2.4 Method of test

18.2.4.1 Initial conditions

The SS signals RADIO_LINK_TIMEOUT = 64 and "DTX OFF" on the BCCH.

The MS is brought into MM state "idle, updated".

After 10 s, the SS continues to set up a call according to the generic call set up procedure for multislot HSCSD.

The SS commands the MS to operate in a highest possible asymmetric configuration, with a maximum number of downlink timeslots.

18.2.4.2 Procedure

- a) The SS, in a TDMA frame immediately following the transmission of a complete SACCH block, removes the downlink signal for 63 SACCH blocks of the main channel.
NOTE: This gives the maximum temporary reception gap.
- b) The SS measures the frequency and timing of the MS transmissions immediately before, and at least 5 times at approximately equally spaced intervals during the gap, one of these measurements being at the end of the gap.
- c) The SS resumes transmission for a period sufficient to allow the MS reception of 1 SACCH block.
- d) The SS again removes downlink transmission for a period equal to at least 3 SACCH blocks of the main channel. The SS measures the frequency and timing of the MS transmissions immediately before and during this second reception gap.
- e) SS signals RADIO_LINK_TIMEOUT=64 and commands the MS to operate in a highest possible symmetric multislot configuration, with a maximum number of uplink timeslots.
- f) For a symmetric multislot configuration steps a) and b) are repeated with the exception that a 69 SACCH blocks are removed from a channel other than the main channel.

18.2.5 Test requirement

- 1) The MS carrier frequency shall be accurate to within 0,2 ppm compared to signals received from the SS.
- 2) The receive/transmit delay timing shall be 3 timeslots +/- 1 bit.
- 3) During the second reception gap the MS shall maintain transmission for a period up to but not exceeding 3 SACCH blocks.
- 4) During the first, maximum, reception gap the MS transmission timing may have drifted resulting in an error of not greater than +/- 6,048 μ s.
- 5) During the last reception gap, the MS shall maintain transmission.

NOTE: The SS determines the error at the start of the reception gap from the first measurement of MS transmission frequency and timing.

19 Channel release after unrecoverable errors

NOTE: It is not possible to explicitly verify the correct functioning of all aspects of the radio link failure algorithm in the MS. Therefore 3 tests are used to implicitly verify correct implementation.

19.1 Channel release after unrecoverable errors -1

19.1.1 Definition and applicability

Channel release after unrecoverable errors is a procedure to abort the call if the radio link has been severely corrupted for some time, according to a link failure criterion.

The requirement and this test apply to all types of GSM 400, GSM 700, GSM 850, GSM 900, DCS 1 800 and PCS 1 900 MS, except where an application layer is always running which would perform a normal release of the call due to loss of traffic (see PICS/PIXIT).

19.1.2 Conformance requirement

- 1) If the MS is unable to decode a SACCH message, the radio link counter S is decreased by 1. In the case of a successful reception of a SACCH message S is increased by 2. In any case S shall not exceed the value of RADIO_LINK_TIMEOUT. If S reaches 0 a radio link failure shall be declared.

GSM 05.08, 5.2.

- 2) The MS shall continue transmitting as normal on the uplink until S reaches 0.

GSM 05.08, 5.2.

- 3) The algorithm shall start after the assignment of a dedicated channel and S shall be initialized to RADIO_LINK_TIMEOUT.

GSM 05.08, 5.2.

- 4) (Re-)initialization and start of the algorithm shall be done whenever the MS switches to a new channel (this includes the old channel in assignment and handover failure cases), at the latest when the main signalling link (see GSM 04.08) has been established.

GSM 05.08, 5.2.

19.1.3 Test purpose

- 1) To verify correct handling of the radio link counter S.
- 2) To verify that the MS that is transmitting continues to transmit as normal on the uplink until S reaches 0.
- 3) To verify that the algorithm starts after the assignment of a dedicated channel, with S initialized to RADIO_LINK_TIMEOUT.
- 4) To verify that the MS declares RADIO_LINK_FAILURE, and clears the RR connection when S = 0.

19.1.4 Method of test

19.1.4.1 Initial conditions

The SS sends a randomly chooses value N for the parameter RADIO_LINK_TIMEOUT on the BCCH. CALL RE-ESTABLISHMENT is not allowed.

19.1.4.2 Procedure

- a) A MS originated call is set up according to the generic call set up procedure.
- b) The SS sends 32 error free SACCH messages, followed by N SACCH messages that contain unrecoverable errors, and then continuously sends error free SACCH messages.

NOTE: The SS shall continue sending error free SACCH messages for a time that allows the MS to release the RR connection.

- c) The SS sets N to a different but randomly chosen value, and broadcasts this on the BCCH. The SS repeats steps a) to b).

19.1.5 Test requirement

After receiving the N SACCH messages with unrecoverable errors, the MS shall abort the RR-connection, i.e. there is no more MS activity on the SACCH channel.

19.2 Channel release after unrecoverable errors - 2

19.2.1 Definition and applicability

Channel release after unrecoverable errors is a procedure to abort the call if the radio link has been severely corrupted for some time, according to a link failure criterion.

The requirement and this test apply to all types of GSM 400, GSM 700, GSM 850, GSM 900, DCS 1 800 and PCS 1 900 MS, except where an application layer is always running which would perform a normal release of the call due to loss of traffic (see PICS/PIXIT).

19.2.2 Conformance requirement

- 1) If the MS is unable to decode a SACCH message, the radio link counter S is decreased by 1. In the case of a successful reception of a SACCH message S is increased by 2. In any case S shall not exceed the value of RADIO_LINK_TIMEOUT. If S reaches 0 a radio link failure shall be declared.

GSM 05.08, 5.2.

- 2) The MS shall continue transmitting as normal on the uplink until S reaches 0.

GSM 05.08, 5.2.

- 3) The algorithm shall start after the assignment of a dedicated channel and S shall be initialized to RADIO_LINK_TIMEOUT.

GSM 05.08, 5.2.

- 4) (Re-)initialization and start of the algorithm shall be done whenever the MS switches to a new channel (this includes the old channel in assignment and handover failure cases), at the latest when the main signalling link (see GSM 04.08) has been established.

GSM 05.08, 5.2.

19.2.3 Test purpose

- 1) To verify correct handling of the radio link counter S.
- 2) To verify that the MS that is transmitting continues to transmit as normal on the uplink until S reaches 0.
- 3) To verify that the algorithm starts after the assignment of a dedicated channel, with S initialized to RADIO_LINK_TIMEOUT.

19.2.4 Method of test

19.2.4.1 Initial conditions

The SS sends a randomly chooses value N for the parameter RADIO_LINK_TIMEOUT on the BCCH. CALL RE-ESTABLISHMENT is not allowed.

19.2.4.2 Procedure

- a) A MS originated call is set up according to the generic call set up procedure.
- b) The SS sends 2 SACCH messages with unrecoverable errors followed by one error free SACCH message. This step is repeated 64 times.
- c) The SS sets N to a different but randomly chosen value, and broadcasts this on the BCCH. The SS repeats steps a) to b).

19.2.5 Test requirement

The MS shall not abort the RR-connection.

19.3 Channel release after unrecoverable errors - 3

19.3.1 Definition and applicability

Channel release after unrecoverable errors is a procedure to abort the call if the radio link has been severely corrupted for some time, according to a link failure criterion.

The requirement and this test apply to all types of GSM 400, GSM 700, GSM 850, GSM 900, DCS 1 800 and PCS 1 900 MS, except where an application layer is always running which would perform a normal release of the call due to loss of traffic (see PICS/PIXIT).

19.3.2 Conformance requirements

- 1) If the MS is unable to decode a SACCH message, the radio link counter S is decreased by 1. In the case of a successful reception of a SACCH message S is increased by 2. In any case S shall not exceed the value of RADIO_LINK_TIMEOUT. If S reaches 0 a radio link failure shall be declared.

GSM 05.08, 5.2.

- 2) The MS shall continue transmitting as normal on the uplink until S reaches 0.

GSM 05.08, 5.2.

- 3) The algorithm shall start after the assignment of a dedicated channel and S shall be initialized to RADIO_LINK_TIMEOUT.

GSM 05.08, 5.2.

- 4) (Re-)initialization and start of the algorithm shall be done whenever the MS switches to a new channel (this includes the old channel in assignment and handover failure cases), at the latest when the main signalling link (see GSM 04.08) has been established.

GSM 05.08, 5.2.

19.3.3 Test purpose

- 1) To verify correct handling of the radio link counter S.
- 2) To verify that the MS that is transmitting continues to transmit as normal on the uplink until S reaches 0.
- 3) To verify that the algorithm starts after the assignment of a dedicated channel, with S initialized to RADIO_LINK_TIMEOUT.
- 4) To verify that the MS declares RADIO_LINK_FAILURE, and clears the RR connection when S = 0.

19.3.4 Method of test

19.3.4.1 Initial conditions

The SS sends a randomly chooses value N for the parameter RADIO_LINK_TIMEOUT on the BCCH. CALL RE_ESTABLISHMENT is not allowed.

19.3.4.2 Procedure

- a) A MS originated call is set up according to the generic call set up procedure.
- b) The SS sends 32 error free SACCH messages, followed by 3 SACCH messages with unrecoverable errors, and the sends 1 error free SACCH message. This step is repeated N - 2 times.
- c) The SS shall continuously send error free SACCH messages.

NOTE: The SS shall continue sending error free SACCH messages for a time that allows the MS to release the RR connection.

- d) The SS sets N to a different but randomly chosen value, and broadcasts this on the BCCH. The SS repeats steps a) to c).

19.3.5 Test requirement

After receiving the $3 * (N - 2)$ erroneous SACCH messages the MS shall abort the RR-connection, i.e. there is no more activity on the SACCH channel.

20 Cell selection and reselection

In the following paragraphs some explanatory text is given concerning the nature of the tests in this section and the general behaviour of the SS is described.

Since the conformance requirements of most of the tests in this section cannot be tested explicitly, testing is done implicitly by testing the MS behaviour from its responses to the SS.

The SS transmits one BCCH carrier per cell as indicated in the initial conditions for each test. These are referred to as carrier 1, carrier 2, etc. Each of these cell control channels are non-combined with SDCCHs. It is assumed that the SS can simultaneously transmit seven BCCH carriers and monitor three random access channels. For multiband tests it is assumed that at least one of the BCCH carriers and one of the monitored random access channels is in a different frequency band from the others. In some cases, a test is performed in multiple stages in order that the requirements can be tested within the above constraints.

For any MS all the carriers are in its supported band(s) of operation. For an E-GSM mobile station at least one of the carriers is in the extension band and one of the carriers is in the primary band.

Unless otherwise stated in the method of test, in all of the tests of this section:

- The SS is continuously paging the MS on all carriers at the start of the test and does not respond to RACH requests from the MS. Where a test specifies that the MS is not paged on a particular carrier, only idle paging is transmitted according to GSM 04.08, 3.2.2.2.

- The default values of the system information data fields given in table 20.1 are used.
- The SIM is in the idle updated state in the default location area with a TMSI assigned at the beginning of each test.
- The ARFCNs used for the carriers in each test are chosen from those in table 20.1 with adjacent carriers separated by a minimum of three channels.

The absolute accuracy of the MS signal level measurements is assumed to be ± 6 dB. A difference of at least 8 dB is allowed for cases of discrimination between C1 or C2 values and 0.

The relative accuracy of the MS signal level measurements is assumed to be ± 3 dB for the signal levels used in the tests of this section, except for section 20.20, where the relative accuracy is assumed to be ± 5 dB if the measurements are on different frequency bands. A difference of at least 5 dB is allowed for cases of discrimination between C1 or C2 values on different carriers, except for section 20.20, where a difference of at least 10 dB is allowed if the measurements are on different frequency bands.

NOTE 1: The accuracy of MS signal level measurements is specified in GSM 05.08. For all of the tests in this section, the signal levels used are greater than 1 dB above reference sensitivity level.

NOTE 2: The tolerance on timers specified in GSM 05.08 is ± 10 % except for PENALTY_TIME where it is ± 2 seconds. In the tests of this section, the test requirements include these tolerances. Consequently, the times stated in the test requirement sometimes differ from the corresponding timer in the conformance requirement.

Where pulsed signals are specified, the SS tolerance on pulse width is ± 2 % and the SS tolerance on power level ± 1 dB.

Table 20.1: Default values of the system information fields

Parameter	GSM 04.08 reference	Abbr.	Normal Setting
Cell channel description	10.5.2.1	-	Any values
MAX retrans	10.5.2.29	-	1
TX-integer	10.5.2.29	-	Any value
CELL_BAR_QUALIFY	10.5.2.35	CBQ	0
CELL_BAR_ACCESS	10.5.2.29	CBA	0 (not barred)
AC CN	10.5.2.29	AC	All 0
RE	10.5.2.29	RE	0 (re-establishment allowed)
NCC	10.5.2.2	NCC	Any value
Cell Identity	10.5.1.1	-	Any value
MCC, MNC	10.5.1.3	PLMN	MS Home PLMN
LAC	10.5.1.3	LAC	1111 (Hex)
ATT	10.5.2.11	-	0 (Attach/Detach not allowed)
BS_AG_BLK_RES	10.5.2.11	-	Any values
CCCH_CONF	10.5.2.11	-	1 basic physical channel used for CCCH, non-combined with SDCCHs.
T3212	10.5.2.11	-	Any values
BS_PA_MFRMS	10.5.2.11	BPM	5 frames
Cell Options	10.5.2.3	-	Any values
CELL_RESELECT_HYSTERESIS	10.5.2.4	CRH	4 dB
MS_TXPWR_MAX_CCH	10.5.2.4	MTMC	Max. output power of MS
RXLEV_ACCESS_MIN	10.5.2.4	RAM	-90 dBm
CELL_RESELECT_OFFSET	10.5.2.35	CRO	0
TEMPORARY_OFFSET	10.5.2.35	TO	0
PENALTY_TIME	10.5.2.35	PT	0
Power Offset	10.5.2.35	PO	0
BA ARFCN	10.5.2.22	BA	All 0 except:
			GSM 450 ARFCNs 259, 263, 269, 275, 279, 283, 287, 292, broadcast in SYSTEM INFORMATION type 2 GSM 480 ARFCNs 306, 310, 316, 322, 326, 330, 334, 339, broadcast in SYSTEM INFORMATION type 2 For GSM 750 ARFCNs 441, 446, 452, 455, 461, 462, 466, 470, 477, 485, 493, 511, 207,219, 251, broadcast in SYSTEM INFORMATION type 2 For GSM 850 ARFCNs 130, 136, 145, 152, 168, 170, 176, 177, 181, 185, 189, 193, 197, 207,219, 251, broadcast in SYSTEM INFORMATION type 2 For GSM900, both P-GSM and E-GSM ARFCNs are broadcast: GSM ARFCNs 3, 9, 18, 25, 41, 43, 49, 50, 54, 58, 62, 66, 70, 80, 92, 124, broadcast in SYSTEM INFORMATION type 2 E-GSM ARFCNs 985, 989, 995, 1010, 1014 broadcast in SYSTEM INFORMATION type 2bis
			For DCS1800 ARFCNs 512, 543, 568, 589, 602, 641, 662, 683, 696, 711, 732, 754, 794, 851, 870, 871, 872, 884 broadcast in SYSTEM INFORMATION TYPE 2.
			For GSM1900 ARFCNs 512, 543, 568, 589, 602, 629, 641, 653, 662, 683, 696, 711, 727, 732, 754, 777, 794, 809 broadcast in SYSTEM INFORMATION TYPE 2
			For multiband tests, ARFCNs 3, 18, 41, 49, 62, 70, 92, 124 broadcast in SYSTEM

	<p>INFORMATION TYPE 2 (GSM 900 cell) and TYPE 2ter (other band cell), ARFCNs 259, 263, 269, 275, 279, 283, 287, 292 broadcast in SYSTEM INFORMATION TYPE 2 (GSM 450 cell) and SYSTEM INFORMATION TYPE 2ter (other band cell), ARFCNs 306, 310, 316, 322, 326, 330, 334, 339 broadcast in SYSTEM INFORMATION TYPE 2 (GSM 480 cell) and SYSTEM INFORMATION TYPE 2ter (other band cell), and ARFCNs 512, 568, 602, 662, 696, 732, 794, 870 broadcast in SYSTEM INFORMATION TYPE 2 (DCS cell) and TYPE 2ter (other band cell) ARFCNs 441, 452, 461, 477, 493, 511 broadcast in SYSTEM INFORMATION TYPE 2 (GSM 750 cell) and SYSTEM INFORMATION TYPE 2ter (other band cell) ARFCNs 136, 152, 170, 177, 185, 193, 207, 251, broadcast in SYSTEM INFORMATION TYPE 2 (GSM 850 cell) and SYSTEM INFORMATION TYPE 2ter (other band cell).</p>
--	---

20.1 Cell selection

20.1.1 Definition and applicability

Cell selection is a process in which a MS, whenever a new PLMN is selected, attempts to find a suitable cell of that PLMN to camp on. Two methods of searching for a suitable cell are possible, normal cell selection and stored list cell selection. The process ensures that the MS is camped on a cell from which it can reliably decode downlink data and with which it has a high probability of communications on the uplink. Once the MS is camped on a cell, access to the network is allowed.

This test is applicable for all types of GSM 400, GSM 700, GSM 850, GSM 900, DCS 1 800 and PCS 1 900 MSs.

20.1.2 Conformance requirement

1. The MS shall be able to select the correct (fourth strongest) cell and be able to respond to paging on that cell within 30 seconds of switch on, when the three strongest cells are not suitable. This assumes a valid SIM, with PIN disabled and ideal radio conditions; GSM 05.08, 6.1.
2. There are various requirements that a cell must satisfy before an MS can perform normal camping on it:
 - 2.1 (i) It should be a cell of the selected PLMN
 - 2.2 (ii) It should not be "barred" (see section 3.5.1)
 - 2.3 (iv) The radio path loss between MS and BTS must be below a threshold set by the PLMN operator. This is estimated as shown in section 3.6.

GSM 03.22, 3.2.1.

NOTE: Criteria (iii) is not applicable for Cell Selection.

3. Initially the MS looks for a cell which satisfies these 4 constraints ("suitable cell") by checking cells in descending order of received signal strength. If a suitable cell is found, the MS camps on it; GSM 03.22, 3.2.1.
4. The MS shall be able to calculate correctly the path loss criterion parameter C1, used for cell selection and reselection; GSM 05.08, 6.4.

20.1.3 Test purpose

1. To verify that the MS meets conformance requirement 1.
2. To verify that:
 - 2.1 The MS does not select a cell of a PLMN which is not the selected PLMN.
 - 2.2 The MS does not select a cell which is "barred".
 - 2.3 The MS does not select a cell with $C1 < 0$.
3. To verify that the MS selects suitable cells in descending order of received signal strength.
4. To verify that the MS does not select a cell with $C1 < 0$.

20.1.4 Method of test

20.1.4.1 Initial conditions

Parameters changed from the default values in table 20.1.

Parameter	Carrier 1	Carrier 2	Carrier 3	Carrier 4	Carrier 5	Carrier 6
RF Signal Level (dB μ V emf) / dBm)	48 / -65	38 / -75	43 / -70	33 / -80	28 / -85	OFF
CBA	1	0	0	0	0	
RXLEV_ACCESS_MIN (dBm)	-90	-67	-90	-88	-98	
MNC			01 (011 for PCS 1900)			
MCC			002			
C1	25	-8	20	8	13	
C2	25	-8	20	8	13	

For an E-GSM MS carrier 2 and carrier 4 ARFCNs are chosen in the E-GSM band, carrier 1 and carrier 3 ARFCNs in the P-GSM band.

20.1.4.2 Procedure

- a) The SS activates the carriers and monitors carriers 2, 4 and 5 for RA requests from the MS.
- b) The MS is switched on.
- c) The MS is switched off.
- d) The SS monitors carriers 1 and 3 for RA requests from the MS
- e) The MS is switched on.

20.1.5 Test requirements

- 1) After step b), the first response from the MS shall be on carrier 4 within 33 seconds. There shall be no response from the MS on carrier 2.
- 2) After step e), there shall be no response from the MS on either carrier 1 or carrier 3 within 33 seconds.

20.2 Cell selection with varying signal strength values

20.2.1 Definition and applicability

For definition see conformance requirement.

This test is applicable for all types of GSM 400, GSM 700, GSM 850, GSM 900, DCS 1 800 and PCS 1 900 MSs.

20.2.2 Conformance requirement

1. The MS shall:

The MS shall search all RF channels in the system (35 for GSM 450, 35 for GSM 480, 74 for GSM 750, 124 for GSM 850, 124 for GSM, 174 for E-GSM, 374 for DCS 1 800 and 299 for PCS 1900), take readings of received RF signal strength on each RF channel, and calculate the received level average for each. The averaging is based on at least five measurement samples per RF carrier spread over 3 to 5 s, the measurement samples from the different RF carriers being spread evenly during this period. GSM 05.08, 6.2.

1.1 The MS shall search all RF channels in the system (35 for GSM 450, 35 for GSM 480, 74 for GSM 750, 124 for GSM 700, 124 for GSM, 174 for E-GSM, 374 for DCS 1 800 and 299 for PCS 1900), take readings of received RF signal strength on each RF channel, and calculate the received level average for each.

1.2 The averaging is based on at least five measurement samples per RF carrier spread over T_{av} (3 to 5 s).

1.3 The measurement samples from the different RF carriers being spread evenly during this period.

2. These quantities are termed the "receive level averages", shall be unweighted averages of the received signal strengths measured in dBm. GSM 05.08, 6.1.

20.2.3 Test purpose

1. To verify that:

1.1 The MS meets conformance requirement 1.1.

1.2 The MS meets conformance requirement 1.2.

1.3 The MS meets conformance requirement 1.3.

2. To verify that the MS meets conformance requirement 2.

20.2.4 Method of test

20.2.4.1 Initial conditions

Parameters changed from the default values in table 20.1.

Parameter	Carrier 1	Carrier 2	Carrier 3	Carrier 4	Carrier 5	Carrier 6
RF Signal Level (dB μ V emf() / dBm)	23 / -90	58 / -55	OFF	OFF	OFF	OFF
RXLEV_ACCESS_MIN (dB μ V emf() / dBm)	13 / -100	13 / -100				
C1	10	53				

For an E-GSM MS carrier 1 ARFCN is chosen in the E-GSM band.

The manufacturer of the equipment shall declare his averaging time T_{av} . This time is the time between the first and the last measurement sample taken on one carrier during one averaging period.

20.2.4.2 Procedure

- a) The SS transmits on carriers 1 and 2. After a period of $b \cdot T_{av}$ carrier 2 reduces its transmit level to -85 dBm (28 dB μ V emf()). After a further period of $a \cdot T_{av}$, carrier 2 increases its transmit level again to -55 dBm (58 dB μ V emf()). Switching of carrier 2 continues with these levels and duty cycle until the end of the test.

T_{av} is the averaging time declared by the manufacturer.

The parameters a and b are chosen according to the following rules:

$$(a + b) * T_{av} > T_{av}$$

$$0 < a * T_{av} < 2/3 * T_{av}$$

$$0,5 * T_{av} < b * T_{av} < T_{av}$$

In the equations < and > means at least one TDMA frame less or greater than the given value.

While satisfying the conditions given above:

a is chosen to be as close as possible to 2/3.

b is chosen to be as close as possible to 0,5.

- b) The MS is switched on.
- c) The SS monitors all RA requests from MS on carriers 1 and 2.

20.2.5 Test requirements

In step c), the first response from the MS shall be on carrier 2 within 33 seconds.

NOTE 1: With the selected duty cycle it can be guaranteed that a "good" MS passes the test even at the worst case situations. The minimum averaged value of carrier 2 is in any case higher or equal to -75 dBm which is still 6 dB above carrier 1's level (for a "good" MS).

NOTE 2: With the selected levels and duty cycle the probability that a "bad" MS (i.e. MS that averages over shorter period than 3 s) fails the test is maximized. However, it can not be guaranteed that all the MSs not fulfilling the conformance requirement of averaging or uniform sampling will fail this test.

20.3 Basic cell reselection

20.3.1 Definition and applicability

While camped on a cell of the selected PLMN the MS may need to select a different cell in order to fulfil the normal service state. This ensures that the MS is camped on a cell from which it can reliably decode downlink data and with which it has a high probability of communications on the uplink.

This test is applicable for all types of GSM 400, GSM 700, GSM 850, GSM 900, DCS 1 800 and PCS 1900 MSs.

20.3.2 Conformance requirement

1. While camped on a cell of the selected PLMN ("camped normally"), the MS may need to select a different cell ("normal cell reselection" state). The following events trigger a cell reselection:

1.1 (iii) The cell camped on (current serving cell) has become barred.

1.2 (iv) There is a better cell (in terms of the path loss criterion C2) in the same LA, or a much better cell in another LA of the selected PLMN (using the CRH parameter).

The MS will then reselect a new cell in order to fulfil the process goal.; GSM 03.22, 4.5.

NOTE 1: Criterion (i) is tested in section 20.8 (Cell reselection when C1(serving cell) < 0 for 5 seconds).

NOTE 2: Criterion (ii) is tested section 20.16 (Downlink signalling failure).

NOTE 3: Criterion (v) is tested in section 20.6 (Cell reselection timings).

2. There are various requirements that a cell must satisfy before an MS can perform normal camping on it:

2.1 (ii) It should not be "barred".

2.2 (iv) The radio path loss between MS and BTS must be below a threshold set by the PLMN operator. GSM 03.22, 3.2.1.

NOTE 4: Criterion (i) is not relevant for cell reselection and for cell selection it is tested in section 20.1.

NOTE 5: Criterion (iv) refers to the C1 parameter.

3. The MS shall be able to calculate correctly the path loss criterion parameter C2 used for cell reselection; GSM 05.08, 6.4.
4. At least every 5 s the MS shall calculate the value of C1 and C2 for the serving cell and recalculate C1 and C2 values for non serving cells (if necessary). The MS shall then check whether:
 - i) The path loss criterion (C1) for current serving cell falls below zero for a period of 5 seconds. This indicates that the path loss to the cell has become too high.
 - ii) The calculated value of C2 for a non-serving suitable cell exceeds the value of C2 for the serving cell for a period of 5 seconds, except in the case of the new cell being in a different location area in which case the C2 value for the new cell shall exceed the C2 value of the serving cell by at least CELL_RESELECT_HYSTERESIS dB as defined by the BCCH data from the current serving cell, for a period of 5 seconds. This indicates that it is a better cell. GSM 05.08, 6.6.2.
5. The MS shall attempt to decode the full BCCH data of the serving cell at least every 30 seconds; GSM 05.08, 6.6.1.

20.3.3 Test purpose

1. To verify that:
 - 1.1 The MS meets conformance requirement 1.1.
 - 1.2 The MS meets conformance requirement 1.2.
2. To verify that:
 - 2.1 The MS does not reselect a cell which is barred.
 - 2.2 The MS does not reselect a cell which has a $C1 < 0$.
3. To verify that the MS calculates the C2 parameter correctly when the CELL_RESELECT_OFFSET, TEMPORARY_OFFSET and PENALTY_TIME parameters are not used.
4. To verify that the MS takes into account the CELL_RESELECT_HYSTERESIS parameter when reselecting a cell in a different location area.
5. To verify that the MS decodes the CELL_BAR_ACCESS and CELL_BAR_QUALIFY parameters from the BCCH every 30 seconds.

20.3.4 Method of test

20.3.4.1 Initial conditions

Parameters changed from the default values in table 20.1.

Parameter	Carrier 1	Carrier 2	Carrier 3	Carrier 4	Carrier 5	Carrier 6
RF Signal Level (dB μ V emf() / dBm)	43 / -70	33 / -80	43 / -70	38 / -75	38 / -75	
RXLEV_ACCESS_MIN (dBm)	-85	-90	-90	-85	-67	
CRH	10 dB					
LAC			different from other carriers			
CBA				1		
CBQ				0		
C1	15	10	20	10	-8	
C2	15	10	20	10	-8	

The BA(BCCH) list only contains the ARFCNs of the carriers used during the test.

20.3.4.2 Procedure

- a) The SS activates carriers 1, 2, 4 and 5. The MS is not paged on carrier 1. The SS monitors carriers 2, 4 and 5 for RA requests from the MS.
- b) The MS is switched on.
- c) The SS stops paging on all carriers except carrier 2. The level of carrier 2 is increased to 43 dB μ V_{emf} (C2 becomes 20 dB), and the SS monitors carrier 2 for RA requests from the MS.
- d) When the SS receives a response from the MS on carrier 2, it stops paging the MS on this carrier.
- e) The MS is switched off.
- f) The SS is reconfigured and sets CBA = 1 on carriers 1 and 5.
- g) The MS is switched on.
- h) After 33 seconds, the SS starts paging continuously on carrier 1 and sets CBA=1 on carrier 2 and CBA=0 on carriers 1, 4 and 5.
- i) When the SS receives a response on carrier 1, it stops paging the MS and waits for 25 seconds. (The MS should reselect and camp onto carrier 1).
- j) The SS activates carrier 3, pages the MS continuously on this carrier and monitors carrier 3 for RA requests from the MS.
- k) The SS increases the level of carrier 3 to 53 dB μ V_{emf} (C2 increases to 30 dB.).

20.3.5 Test requirements

- 1) After step b), there shall be no response from the MS on carriers 2, 4, or 5 within 50 seconds.
- 2) In step c), the MS shall respond on carrier 2 within 20 seconds of increasing the level of carrier 2.

NOTE 1: 5 seconds to perform running average, 10 seconds to detect C2 differences, 2,4 seconds to read BCCH of carrier 2, 1 second to perform RA. Total 18,4 seconds, allow 20 seconds.

- 3) In step h), the MS shall respond on carrier 1 within 50 seconds of setting CBA=1 on carrier 2.

NOTE 2: 33 seconds for the MS to read the BCCH of carrier 2 (30 seconds + 10 %), 15 seconds for the MS to reselect cell 1, since the MS already has a running average on carrier 1, allow 50 seconds.

- 4) After step j), there shall be no response from the MS within 50 seconds.
- 5) After step k), the MS shall respond on carrier 3 within 20 seconds.

20.4 Cell reselection using TEMPORARY_OFFSET, CELL_RESELECT_OFFSET, POWER_OFFSET and PENALTY_TIME parameters

20.4.1 Definition and applicability

This test is applicable for all types of GSM 400, GSM 700, GSM 850, GSM 900, DCS 1 800 and PCS 1 900 MSs

20.4.2 Conformance requirement

1. The MS shall be able to calculate correctly the path loss criterion parameter C2 used for cell reselection; GSM 05.08, 6.4.

20.4.3 Test purpose

1. To verify that the MS calculates the C2 parameter correctly when the CELL_RESELECT_OFFSET, TEMPORARY_OFFSET and PENALTY_TIME parameters are used.
2. To verify DCS 1 800 and PCS 1 900 MS correctly calculate the C2 parameter when the POWER_OFFSET parameter is present.

20.4.4 Method of test

20.4.4.1 Initial conditions

Parameters changed from the default values in table 20.1.

Parameter	Carrier 1	Carrier 2	Carrier 3	Carrier 4	Carrier 5	Carrier 6
RF Signal Level (dB μ V emf) / dBm)	53 / -60	43 / -70	48 / -65	48 / -65		
RXLEV_ACCESS_MIN (dBm)	-80	-100	-85	-85		
PT		11111	40 s	60 s		
CRO		16 dB	20 dB	20 dB		
TO			20 dB	20 dB		
K = 1						
C1	20	30	20	20		
C2	20	14	20 -> 40	20 -> 40		
K = 2 (DCS1800 Class 3 MS only)						
POWER_OFFSET	0	2	6	6		

The BA(BCCH) list only contains the ARFCNs of the carriers used during the test.

20.4.4.2 Procedure

For testing of GSM MS, the test procedure is performed for execution counter K = 1.

For testing of DCS 1 800 MS, the test procedure is performed for execution counter K = 1 and 2

On execution counter K = 1, the POWER_OFFSET Parameter is not present.

On execution counter K = 2, the POWER_OFFSET parameter is present.

- a) The SS activates carriers 1 and 2. The MS is not paged on carrier 1. The SS monitors carrier 2 for RA requests from the MS.
- b) The MS is switched on.
- c) The SS increases the level of carrier 2 to 54 dB μ Vemf (C2 becomes 25 dB).
- d) When the SS receives a response on carrier 2, the SS stops paging on that carrier and waits for 20 seconds (The MS should reselect and camp onto carrier 2).
- e) The SS activates carriers 3 and 4 and continuously pages the MS on these carriers. The SS monitors carriers 3 and 4 for RA requests from the MS.

20.4.4.3 Requirements

For execution counter $K = 1$ and $K = 2$.

- 1) After step b), there shall be no response from the MS on carrier 2 within 50 seconds.
- 2) After step c), the MS shall respond on carrier 2 within 20 seconds of increasing the level of carrier 2.
- 3) After step e), there shall be no response from the MS on carrier 3 within 38 seconds of activating the carriers but, the MS shall respond on carrier 3 within 90 seconds. The response on carrier 3 shall be before any response on carrier 4.

NOTE: Minimum time of 38 seconds set by penalty timer on carrier 3 less 2 second tolerance. Maximum time, total of 33 seconds to read BCCH of carrier 3, 42 seconds for expiry of penalty timer on carrier 3, 15 seconds for reselection, since the MS will already have running averages on carriers 3 and 4, when the penalty timers expire, allow 90 seconds.

20.5 Cell reselection using parameters transmitted in the System Information type 2bis, type 2ter, type 7 and type 8 messages

20.5.1 Definition and applicability

System information (SI) type 7 and 8 are transmitted on the BCCH Ext when the system information type 4 message does not contain all information needed for cell selection.

The system information type 2 bis message is used when the system information type 2 message does not contain all neighbour cell ARFCNs.

The system information type 2 ter message is used when system information type 2 messages broadcast by one cell which are system information 2 or both system information 2 and 2bis do not contain all neighbour cell ARFCNs.

Test purposes 1 and 3 are applicable to all types of GSM 400, GSM 700, GSM 850, GSM900, DCS1800 and PCS 1 900 MS.

Test purpose 2 is only applicable for E-GSM, DCS 1 800 and PCS 1 900 MS. This is reflected in initial conditions step d).

Test purpose 4 is only applicable to an E-GSM MS. This is reflected in initial conditions step f), test procedures d) and e) and test requirements clause 3).

20.5.2 Conformance requirement

1. The MS shall be able to calculate correctly the path loss criterion parameter $C2$ used for cell reselection. GSM 05.08, 6.4.
2. Whilst in idle mode, an MS shall continue to monitor all BCCH carriers as indicated by the BCCH allocation. GSM 05.08, 6.6.1.
3. Mobile stations shall treat all ARFCNs in the set $\{0, 1, 2 \dots 1023\}$ as valid ARFCN values even if the mobile station is unable to transmit or receive on that ARFCN. GSM 04.08, 10.5.2.1b.
4. An E-GSM MS shall correctly decodes parameters transmitted in the system information type 2 ter message. GSM 04.08, 9.1.34:

20.5.3 Test purpose

1. To verify that the MS correctly calculates the $C2$ criterion when the parameters affecting cell reselection are transmitted in the system information type 7 and 8 messages.
2. To verify that E-GSM, DCS 1 800 and PCS 1 900 MS decode parameters transmitted in the system information type 2 bis message.

3. To verify that the MS treats ARFCNs as valid ARFCNs even if the MS is unable to transmit or receive on that ARFCN.
4. To verify that an E-GSM mobile correctly decode parameters transmitted in the system information type 2 ter message.

20.5.4 Method of test

20.5.4.1 Initial conditions

- a) Parameters changed from the default values in table 20.1.

Parameter	Carrier 1	Carrier 2	Carrier 3 *)	Carrier 4	Carrier 5	Carrier 6
RF Signal Level (dB μ V emf() / dBm)	53 / -60	32 / -81	40 / -73	OFF	OFF	OFF
RXLEV_ACCESS_MIN (dB μ V emf() / dBm)	23 / -90	23 / -90	30 / -83			
BS_AG_BLKES_RES	1	1	1			
PT		0	0			
CRO		16 dB	10 dB			
TO		0 dB	0 dB			
C1	30	9	10			
C2	30	25	20			

*) : Carrier 3 is off for P-GSM, DCS 1800 and PCS 1 900 MS. Carrier 3 is only required for E-GSM MS.

The BA(BCCH) list only contains the ARFCNs of the carriers used during the test and the ARFCNs specified in d) below.

- b) The ARFCNs of carriers 1, 2 and 3 are chosen from those in table 20.1.
- c) The cell reselection parameters PENALTY_TIME, CELL_RESELECT_OFFSET and TEMPORARY_OFFSET are transmitted in the SI3, SI7 and SI8 messages on carrier 2. They are not transmitted in SI4 and the ADDITIONAL RESELECT PARAM IND parameter is set to 1.
- d) The SI2bis message is transmitted on carrier 1 and contains the ARFCN of carrier 2 and ARFCNs 43, 70, 500, 550, 990 and 995. For an E-GSM MS, a DCS 1 800 and PCS 1 900 MS, the ARFCN of carrier 2 is not transmitted in the SI2 message.
- e) Carriers 1 and 2 are synchronized, but staggered in frame number so that the transmission of the SI3 message on carrier 2, coincides with the paging block which the MS is listening to on carrier 1.

NOTE: Under these conditions, the MS can only decode the parameters affecting cell reselection from the SI7 or SI8 messages.

To achieve this, the following conditions are used:

BS_PA_MFRMS = 4

IMSI mod 1000 = 12

FN carrier 1 = FN carrier 2-21, for simultaneously transmitted frames.

- f) For an E-GSM MS, the SI3 message on carrier 2 indicates that SI2ter is used on carrier 2. SI2ter message contains the ARFCN of carrier 3 and ARFCNs 45, 76, 891, 905. The ARFCN of carrier 3 is transmitted neither in the SI2 nor in the SI2bis messages on carriers 1 and 2.

20.5.4.2 Test Procedure

- a) The SS activates the channels. The MS is not paged on carrier 1.
- b) The MS is switched on.
- c) After 50 seconds, the SS increases the level of carrier 2 to 42 dB μ V_{emf}().
- d) For an E-GSM MS only, when the SS receives a response on carrier 2, the SS stops paging on that carrier and after 30 seconds, the SS increases the level of carrier 3 to 60 dB μ V_{emf}().

20.5.5 Test Requirements

- 1) After step b), there shall be no response from the MS on carrier 2. For an E-GSM MS there shall also be no response on carrier 3.
- 2) After increasing the level of carrier 2 in step c), the MS shall respond on carrier 2 within 20 seconds.
- 3) After increasing the level of carrier 3 in step d), an E-GSM mobile shall respond on carrier 3 within 20 seconds.

20.6 Cell reselection timings

20.6.1 Definition and applicability

This test is applicable for all types of GSM 400, GSM 700, GSM 850, GSM 900, DCS 1 800 and PCS 1 900 MSs.

20.6.2 Conformance requirement

1. At least every 5 s the MS shall calculate the value of C1 and C2 for the serving cell and recalculate C1 and C2 values for non serving cells (if necessary). The MS shall then check whether:
 - 1.1 ii) The calculated value of C2 for a non-serving suitable cell exceeds the value of C2 for the serving cell for a period of 5 seconds,
 - 1.2 Cell reselection for any other reason (see GSM 03.22) shall take place immediately, but the cell that the MS was camped on shall not be returned to within 5 seconds if another suitable cell can be found.;

GSM 05.08, 6.6.2.

20.6.3 Test purpose

1. To verify that:
 - 1.1 The MS does not perform a cell reselection when the C2 value for a non serving cell does not exceed the C2 value of the serving cell for a period of at least 5 seconds.
 - 1.2 When the MS performs an immediate cell reselection due to an unsuccessful random access attempt, the cell that the MS was camped onto is not returned to within 5 seconds when another suitable cell exists.

20.6.4 Method of test

20.6.4.1 Initial conditions

Parameters changed from the default values in table 20.1.

Parameter	Carrier 1	Carrier 2	Carrier 3	Carrier 4	Carrier 5	Carrier
RF Signal Level (dB μ V emf() / dBm)	56 / -57	46 / -67	OFF	OFF	OFF	OFF
RXLEV_ACCESS_MIN (dB μ V emf() / dBm)	29 / -84	33 / -80				
Max. Retrans	00	00				
C1	27	13				
C2	27	13				

Below is an alternative table of parameters for use with test equipment that cannot reach the upper RF levels as specified in the table above. These carrier levels are reduced by 5 dB and will not effect the purpose of the test case:

Parameter	Carrier 1	Carrier 2	Carrier 3	Carrier 4	Carrier 5	Carrier
RF Signal Level (dB μ V emf() / dBm)	51 / -62	41 / -72	OFF	OFF	OFF	OFF
RXLEV_ACCESS_MIN (dB μ V emf() / dBm)	24 / -89	28 / -85				
Max. Retrans	00	00				
C1	27	13				
C2	27	13				

The BA(BCCH) list only contains 5 ARFCNs including the ARFCNs of the carriers used during the test.

NOTE: With 5 ARFCNs in the BA(BCCH) list and BS_PA_MFRMS=5 (default value) the MS will maintain a running average on surrounding cells over a period of 5 seconds.

20.6.4.2 Procedure

- a) The SS activates the channels. The MS is not paged on any of the carriers.
- b) The MS is switched on.
- c) After 50 seconds, the SS starts paging continuously on carriers 1 and 2 for 20 seconds. The SS monitors carriers 1 and 2 for RA requests from the MS.
- d) The SS stops paging on carriers 1 and 2 and waits for 20 seconds. (The MS should revert to carrier 1 due to cell reselection.)
- e) The SS starts paging continuously on carrier 2.
- f) The SS increases the transmit level of carrier 2 by 20 dB for a period of 4 s and then reduces the level back to the original value.
- g) The SS increases the transmit level of carrier 2 by 20dB and waits for the MS to access on carrier 2.

20.6.5 Test requirements

- 1) In step c), the MS shall transmit 2 RA requests on carrier 1 followed by 2 RA requests on carrier 2. Subsequent RA requests on either carrier shall not occur within 4,5 s of the second RA request on that carrier.
- 2) In step f), there shall be no access on carrier 2 within 34 seconds of increasing the level of carrier 2.
- 3) After step g), the MS shall respond on carrier 2.

20.7 Priority of cells

20.7.1 Definition and applicability

In general, cell prioritization is a means of encouraging MSs to select some suitable cells in preference to others.

This test is applicable for all types of GSM 400, GSM 700, GSM 850, GSM 900, DCS 1 800 and PCS 1 900 MSs.

20.7.2 Conformance requirement

1. During cell selection a cell with low priority indication will only be selected if a suitable cell of normal priority cannot be found; GSM 03.22, 3.5.2.1.
2. Table 1a. Parameters affecting cell priority for cell selection

CELL_BAR_QUALIFY	CELL_BAR_ACCESS	Cell selection priority	Status for cell reselection
0	0	normal	normal
0	1	barred	barred
1	0	low	normal (see note 2)
1	1	low	normal (see note 2)

GSM 05.08, table 1.a

3. If all the following conditions are met then the "Cell selection priority" and the "Status for cell reselection" shall be set to normal:
 - the cell belongs to the MS HPLMN
 - the MS is in cell test operation mode
 - the CELL_BAR_ACCESS is set to "1"
 - the CELL_BAR_QUALIFY is set to "0"
 - the Access Control class 15 is barred

GSM 05.08, table 1.a

20.7.3 Test purpose

1. To verify that the MS does not select a cell of low priority when a suitable cell of normal priority exists with a lower received signal strength.
2. To verify that the MS takes into account CELL_BAR_ACCESS and CELL BAR _QUALIFY when performing cell selection and reselection.
3. To verify that the MS meets conformance requirement 3.

20.7.4 Method of test

20.7.4.1 Initial conditions

Parameters changed from Default values table 20.1

Parameter	Carrier 1	Carrier 2	Carrier 3	Carrier 4	Carrier 5	Carrier 6
RF Signal Level (dB μ V emf() / dBm)	33 / -80	43 / -70	33 / -80	23 / -90	OFF	OFF
RXLEV_ACCESS_MIN (dB μ V emf() / dBm)	3 / -110	23 / -90	13 / -100	13 / -100		
CBA	0	1	1	0		
CBQ	1	1	0	0		
Access class 15	barred	barred	barred	barred		
C1	30	20	20	10		

20.7.4.2 Procedure

- a) The SS activates the carriers and monitors for RA requests from the MS on carriers 1, 2, and 4.
- b) The MS is switched on.
- c) The MS is switched off. The SS deactivates the carriers.
- d) The MS is placed in cell test operation mode.

NOTE: Cell test mode is a mode of operation defined in SIM administrative data field.

- e) The SS activates the carriers and monitors for RA requests from the MS on carriers 1, 2, and 3.
- f) The MS is switched on.

20.7.5 Test requirements

- 1) After step b), the first response from the MS shall be on carrier 4 within 33 seconds, followed by a response on carrier 1 before a response (if any) on carrier 2 within 50 seconds.
- 2) After step f), the first response from the MS shall be on carrier 3 within 33 seconds, followed by a response on carrier 1 before a response (if any) on carrier 2 within 50 seconds.

20.8 Cell reselection when C1 (serving cell) < 0 for 5 seconds

20.8.1 Definition and applicability

This test is applicable for all types of GSM 400, GSM 700, GSM 850, GSM 900, DCS 1 800 and PCS 1 900 MSs.

20.8.2 Conformance requirement

1. At least every 5 s the MS shall calculate the value of C1 and C2 for the serving cell and recalculate C1 and C2 values for non serving cells (if necessary). The MS shall then check whether:
 - i) The path loss criterion (C1) for current serving cell falls below zero for a period of 5 seconds. This indicates that the path loss to the cell has become too high. GSM 05.08, 6.6.2.
2. While camped on a cell of the selected PLMN ("camped normally"), the MS may need to select a different cell ("normal cell reselection" state). The following events trigger a cell reselection:
 - i) The path loss criterion parameter C1 (see section 3.6) indicates that the path loss to the cell has become too high.; GSM 03.22, 4.5.

20.8.3 Test purpose

1. To verify that the MS meets conformance requirement 1.
2. To verify that the MS meets conformance requirement 2.

20.8.4 Method of test

20.8.4.1 Initial conditions

Parameters changed from Default values table 20.1

Parameter	Carrier 1	Carrier 2	Carrier 3	Carrier 4	Carrier 5	Carrier 6
RF Signal Level (dB μ V emf() / dBm)	63 / -50	33 / -80	OFF	OFF	OFF	OFF
RXLEV_ACCESS_MIN (dB μ V emf() / dBm)	43 / -70	23 / -90				
CRO	30 dB					
TO	0					
PT	0					
C1	20	10				
C2	50	10				

NOTE: With BS_PA_MFRMS = 5 (default value), the averaging time of the MS on the serving cell BCCH is 5,9s.

20.8.4.2 Procedure

- a) The SS activates the carriers. The MS is not paged on carrier 1. The SS monitors carriers 1 and 2 for RA requests from the MS.
- b) The MS is switched on.
- c) The SS reduces signal level on carrier 1 to -80 dBm / 33 dB μ V emf() for 4 s. Then, the SS raises the level back to -50 dBm / 63 dB μ V emf(). (C1 becomes -10 dB and C2, 20 dB during this period).
- d) The SS reduces signal level on carrier 1 to -80 dBm / 33 dB μ V emf()

20.8.5 Test requirements

- 1) After step b), there shall be no access on carrier 1 or carrier 2, within 50 seconds.
- 2) After step c), there shall be no access on carrier 2 within 30 seconds.
- 3) After step d), the MS shall access on carrier 2 within 20 seconds.

20.9 Running average of the surrounding cell BCCH carrier signal levels

20.9.1 Definition and applicability

This test is applicable for all types of GSM 400, GSM 700, GSM 850, GSM 900, DCS 1 800 and PCS 1 900 MSs.

20.9.2 Conformance requirement

1. Whilst in idle mode an MS shall continue to monitor all BCCH carriers as indicated by the BCCH allocation (BA - See table 1). A running average of received level in the preceding 5 to

Max. $\{5, ((5 * N + 6) \text{ DIV } 7) * \text{BS_PA_MFRMS} / 4\}$

seconds shall be maintained for each carrier in the BCCH allocation. N is the number of non-serving cell BCCH carriers in BA and the parameter BS_PA_MFRMS is defined in GSM 05.02; GSM 05.08, 6.6.1.

2. The same number of measurement samples shall be taken for all non-serving cell BCCH carriers of the BA list, and the samples allocated to each carrier shall as far as possible be uniformly distributed over each evaluation period.; GSM 05.08, 6.6.1

20.9.3 Test purpose

1. To verify that if the MS calculates a received level average (over 5 seconds) for a non-serving suitable cell which results in the value of C2 exceeding the value of C2 for the serving cell, then cell reselection takes place to the non-serving cell.
2. To verify that by using suitable varying levels of signal strength for non serving cells, the MS samples on non serving cell BCCH carriers are as far as possible distributed uniformly over each evaluation period.

20.9.4 Method of test

20.9.4.1 Initial conditions

Parameters changed from Default values table 20.1

Parameter	Carrier 1	Carrier 2	Carrier 3	Carrier 4	Carrier 5	Carrier 6
RF Signal Level (dB μ V emf() / dBm)	53 / -60	33 / -80	OFF	OFF	OFF	OFF
RXLEV_ACCESS_MIN (dB μ V emf() / dBm)	23 / -90	23 / -90				
C1	30	10				
C2	30	10				

BS_PA_MFRMS is set to 4 for this test.

The BA(BCCH) list only contains 7 ARFCNs including the ARFCNs of the carriers used during the test.

NOTE: With 7 ARFCNs in the BA(BCCH) list and BS_PA_MFRMS=4 the MS will maintain a running average on surrounding cells over a period of 5 seconds.

20.9.4.2 Procedure

- a) The SS activates the carriers. The MS is not paged on carrier 1. The SS monitors carriers 1 and 2.
- b) The MS is switched on.
- c) The SS starts switching the level of carrier 2 between -80 dBm and -57 dBm every 2,7 seconds and continues to do so until the end of the test.
- d) The SS decreases the level of carrier 1 to -76 dBm.

NOTE: As a result of the switching in levels, the running average on carrier 2 will be between -66dBm and -71dBm, assuming that samples are distributed over five consecutive paging blocks.

20.9.5 Test requirements

- 1) After step b), there shall be no access from the MS on carrier 1 or carrier 2, within 50 seconds..
- 2) After step c), there shall be no access from the MS on carrier 1 or 2 within 25 seconds

NOTE: Any potential access on is likely to occur within 20 seconds.

- 3) After step d), the MS shall access on carrier 2 within 20 seconds.

20.10 Running average of the serving cell BCCH carrier signal level

20.10.1 Definition and applicability

The MS is required to monitor continuously the BCCH carrier signal level of the serving cell (and to compare it to the BCCH carrier signal levels of the non-serving cells) to guarantee that it is camped on the most suitable cell.

This test is applicable for all types of GSM 400, GSM 700, GSM 850, GSM 900, DCS 1 800 and PCS 1 900 MSs.

20.10.2 Conformance requirement

1. For the serving cell, receive level measurement samples shall be taken at least for each paging block of the MS. The receive level average shall be a running average determined using samples collected over a period of 5 s or five consecutive paging blocks of that MS, whichever is the greater period. New receiving level average values shall be calculated as often as possible.; GSM 05.08, 6.6.1.

20.10.3 Test purpose

1. To verify that by using suitable varying levels of signal strength for the serving cell, the MS performs a running average over 5 consecutive paging blocks.

20.10.4 Method of test

20.10.4.1 Initial conditions

Parameters changed from Default values table 20.1 are below,

Parameter	Carrier 1	Carrier 2	Carrier 3	Carrier 4	Carrier 5	Carrier 6
RF signal level (dB μ V emf() / dBm)	63 / -50	39 / -74	OFF	OFF	OFF	OFF
RXLEV_ACCESS_MIN (dB μ V emf() / dBm)	23 / -90	23 / -90				
C1	40	16				
C2	40	16				

NOTE: With BS_PA_MFRMS = 5 (default value), the averaging time of the MS on the serving cell BCCH is 5,9s.

20.10.4.2 Procedure

- a) The SS activates the carriers. The MS is not paged on carrier 1. The SS monitors carriers 1 and 2 for RA requests from the MS.
- b) The MS is switched on.
- c) After 50 seconds the SS starts switching the level of carrier 1 between -80 dBm and -50 dBm every 3 seconds.

NOTE: As a result of the switching in levels, the running average on carrier 1 will be between -62 dBm and -68 dBm over five consecutive paging blocks.

- d) The SS increases the level of carrier 2 to -56 dBm.

20.10.5 Test requirement

- 1) After step c), the MS shall not access on carrier 2, within 25 seconds.
- 2) After step d), the MS shall access on carrier 2, within 30 seconds.

NOTE 1: 13,75 seconds to perform running average, 10 seconds to detect C2 differences, 2,4 seconds to read BCCH of carrier 2, 1 second to perform RA. Total 27,15 seconds, allow 30 seconds.

20.11 Updating the list of six strongest neighbour carriers and decoding the BCCH information of a new carrier on the list

20.11.1 Definition and applicability

This test is applicable for all types of GSM 400, GSM 700, GSM 850, GSM 900, DCS 1 800 and PCS 1 900 MSs.

20.11.2 Conformance requirement

1. The list of the 6 strongest non-serving carriers shall be updated at least as often as the duration of the running average defined for measurements on the BCCH allocation and may be updated more frequently; GSM 05.08, 6.6.1.
2. When the MS recognizes that a new BCCH carrier has become one of the 6 strongest, the BCCH data shall be decoded for the new carrier within 30 seconds; GSM 05.08, 6.6.1.

20.11.3 Test purpose

1. To verify that MS meets conformance requirement 1.
2. To verify that MS meets conformance requirement 2.

20.11.4 Method of test

20.11.4.1 Initial conditions

Six BCCH carriers are established with the system information contents of table 20.1.

Parameters changed from Default values table 20.1 are below,

Parameter	Carrier 1	Carrier 2	Carrier 3	Carrier 4	Carrier 5	Carrier 6	Carrier 7
RF signal level (dB μ V emf ()/dBm)	53 / -60	48 / -65	43 / -70	38 / -75	33 / -80	33 / -80	38 / -75
RXLEV_ACCESS_MIN	-90	-90	-90	-90	-90	-90	-110
C1	30	25	20	15	10	10	35
C2	30	25	20	15	10	10	35

The BA(BCCH) list contains only eight ARFCNs and includes those of carriers 1 to 7.

BS_PA_MFRMS is set to 3 during this test.

NOTE: The combination of 8 carriers on the BA list and BS_PA_MFRMS = 3 leads to averaging time of 5 seconds. Hence 5 seconds is also the updating time of the list of six strongest neighbour carriers.

20.11.4.2 Procedure

- a) The SS activates carriers 1 to 6. The MS is not paged on any of the carriers.
- b) The MS is switched on.
- c) After 60 seconds, the SS activates carrier 7 and pages the MS continuously on this carrier. The SS monitors carrier 7 for RA requests from the MS.

20.11.5 Test requirements

- 1) The MS shall access on carrier 7 within 55 s of activating carrier 7.

NOTE: 5,5 seconds to notice new strongest carrier in top 6 (because the updating time for six strongest is 5 seconds (+10 %)), 33 seconds to read BCCH, 15 seconds for reselection, since the MS has already performed the running average on the new strongest carrier, allow 55 seconds.

20.12 Decoding the BCCH information of the neighbour carriers on the list of six strongest neighbour carriers

20.12.1 Definition and applicability

This test is applicable for all types of GSM 400, GSM 700, GSM 850, GSM 900, DCS 1 800 and PCS 1 900 MSs.

20.12.2 Conformance requirement

1. The MS shall attempt to decode the BCCH data block that contains the parameters affecting cell reselection for each of the 6 strongest non-serving cell BCCH carriers at least every 5 minutes; GSM 05.08, 6.6.1.

NOTE: Verification of cell reselection as implicitly tested here is performed in section 20.3.

20.12.3 Test purpose

1. To verify that the MS decodes the BCCH data block that contains the parameters affecting cell reselection for a non-serving cell BCCH carrier, (which is in the list of six strongest neighbour cells), at least every 5 minutes. This is achieved by changing the BCCH data such that the value of C2 for the non serving cell exceeds the value of C2 for the serving cell, and observing that the MS performs cell reselection within 5 minutes plus the time allowed for cell reselection after the change of the BCCH data.

20.12.4 Method of test

20.12.4.1 Initial conditions

Parameters changed from Default values table 20.1 are below,

Parameter	Carrier 1	Carrier 2	Carrier 3	Carrier 4	Carrier 5	Carrier 6
RF signal level (dB μ V emf() / dBm)	38 / -75	33 / -80	OFF	OFF	OFF	OFF
C1	15	10				
C2	15	10				

20.12.4.2 Procedure

- a) The SS activates the carriers. The MS is not paged on carrier 1. The SS monitors carriers 1 and 2.

- b) The MS is switched on.
- c) The SS changes the RXLEV_ACCESS_MIN in the BCCH data of carrier 2 to be -100 dBm.

NOTE: With the above change the C2 of carrier 2 becomes 20 whereas the C2 of carrier 1 stays at 15.

20.12.5 Test requirements

- 1) After step b), there shall be no access from the MS on carrier 1 or carrier 2 within 50 seconds.
- 2) After step c), the MS shall access on carrier 2 within 345 s of the change in the BCCH data of carrier 2.

NOTE: 330 s for decode of BCCH of carrier 2 (300 s +10 %), 15 seconds for reselection of carrier 2, since the MS already has a running average on carrier 2.

20.13 Decoding the BSIC of the neighbour carriers on the list of six strongest neighbour carriers

20.13.1 Definition and applicability

This test is applicable for all types of GSM 400, GSM 700, GSM 850, GSM 900, DCS 1 800 and PCS 1 900 MSs.

20.13.2 Conformance requirement

- 1. The MS shall attempt to check the BSIC for each of the 6 strongest non-serving cell BCCH carriers at least every 30 seconds, to confirm that it is monitoring the same cell. If a change of BSIC is detected then the carrier shall be treated as a new carrier and the BCCH data redetermined; GSM 05.08, 6.6.1.

NOTE: Verification of cell reselection as implicitly tested here is performed in section 20.3.

20.13.3 Test purpose

- 1. To verify that the MS will check the BSIC of the non-serving cell, which is in the list of six strongest neighbour cells, by changing the BSIC and the BCCH data of the non-serving cell such that the value of C2 for that cell exceeds the value of C2 of the serving cell, and observing that the MS performs cell reselection within the time allowed to check the BSIC, redetermine the BCCH data and perform cell reselection.

20.13.4 Method of test

20.13.4.1 Initial conditions

Parameters changed from Default values table 20.1 are below:

Parameter	Carrier 1	Carrier 2	Carrier 3	Carrier 4	Carrier 5	Carrier 6
RF signal level (dBµV emf) / dBm)	38 / -75	33 / -80	OFF	OFF	OFF	OFF
C1	15	10				
C2	15	10				

20.13.4.2 Procedure

- a) The SS activates the carriers. The MS is not paged on carrier 1. The SS monitors carriers 1 and 2.
- b) The MS is switched on.
- c) The SS changes the BSIC of carrier 2 by changing the Base Station Colour Code (BCC) part of the BSIC. The SS also changes the RXLEV_ACCESS_MIN in the BCCH data of carrier 2 to be -100 dBm.

NOTE: With the above change to the BCCH data the C2 of carrier 2 becomes 20 whereas the C2 of carrier 1 stays at 15.

20.13.5 Test requirements

- 1) In step b), there shall be no access from the MS on carrier 1 or carrier 2 within 50 seconds.
- 2) After step c), the MS shall access on carrier 2 within 85 s of the change in the BSIC value (and BCCH data) of carrier 2.

NOTE: 33 seconds for check of BSIC on carrier 2, 33 seconds for decode of BCCH of carrier 2, 15 seconds for reselection of carrier 2, since the MS already has a running average on carrier 2, allow 85 seconds.

20.14 Emergency calls

20.14.1 Definition and applicability

This test is applicable for GSM 400, GSM 700, GSM 850, GSM 900, DCS 1 800 and PCS 1 900 MSs supporting speech.

20.14.2 Conformance requirement

1. When in a limited service state, the MS shall be able to initiate emergency calls; GSM 05.08, 6.8.
2. When in a limited service state and if not camped on a cell, the MS shall monitor the signal strength of all 35 (GSM 450), all 35 (GSM 480), all 74 (for GSM 750), all 124 (for GSM 850), all 124 (for GSM), all 174 (for E-GSM), all 374 (for DCS 1 800) or all 299 (for PCS 1 900) RF channels, and search for a BCCH carrier which has $C1 > 0$ and which is not barred. When such a carrier is found, the MS shall camp on that cell, irrespective of the PLMN identity; GSM 05.08, 6.8.
3. The MS shall perform cell reselection at least among the cells of the PLMN of the cell on which the MS has camped, according to the algorithm of GSM 03.22, 4.5 & 3.7, except that a zero value of CELL_RESELECT_HYSTERESIS shall be used; GSM 05.08, 6.8.

20.14.3 Test purpose

1. To verify that the MS shall be able to initiate emergency calls when no suitable cells of the selected PLMN are available, but at least one acceptable cell is available.
2. To verify that the MS selects a cell with $C1 > 0$ and $CBA = 0$ when no suitable cells of the selected PLMN are available.
3. To verify that the MS, when performing cell reselection in the limited service state, uses CELL_RESELECT_HYSTERESIS = 0.

20.14.4 Method of test

20.14.4.1 Initial conditions

Parameters changed from Default values table 20.1 are below

Parameter	Carrier 1	Carrier 2	Carrier 3	Carrier 4	Carrier 5	Carrier 6
RF signal level (dB μ V emf() / dBm)	38 / -75	33 / -80	33 / -80	OFF	OFF	OFF
RXLEV_ACCESS_MIN (dB μ V emf() / dBm)	23 / -90	43 / -70	23 / -90			
CELL_BAR_ACCESS	1 (barred)	0	0			
MCC,MNC	forbidden	forbidden	forbidden			
CELL_RESELECT_HYST	0	0	14 dB			
C1	15	-10	10			

NOTE: All the BCCH carriers belong to the same PLMN, which is not the MS's home PLMN and is in the SIM's forbidden PLMN's list.

20.14.4.2 Procedure

- a) The SS activates the carriers. The SS monitors for RA attempts from the MS on carriers 1, 2 and 3 for the duration of the test.
- b) The MS is switched on.
- c) 50 seconds after switch on, an emergency call is initiated on the MS.
- d) The SS changes the CBA of carrier 1 to 0.

NOTE: The MS should reselect to carrier 1 because it should not take into account the CELL_RESELECT_HYST value of 14 but use 0 instead.

- e) After 345 s an emergency call is initiated on the MS.

NOTE: 330 seconds to detect change of BCCH data, 15 seconds to perform reselection of carrier 1, since the MS already has a running average on carrier 1.

20.14.5 Test requirements

- 1) In step c), the first access by the MS shall be on carrier 3.
- 2) In step e), the first access from the MS shall be on carrier 1.

20.15 Cell reselection due to MS rejection "LA not allowed"

20.15.1 Definition and applicability

While camped on a cell of the selected PLMN the MS may need to select a different cell in order to fulfil the normal service state. This ensures that the MS is camped on a cell from which it can reliably decode downlink data and with which it has a high probability of communications on the uplink.

This process goes on while camping on a cell which pertains to an LA which is placed in the list of "forbidden LAIs for regional provision of service".

This test is applicable for all types of GSM 400, GSM 700, GSM 850, GSM 900, DCS 1 800 and PCS 1 900 MSs.

20.15.2 Conformance requirement

1. In response to a registration attempt, when receiving an LU reject with cause value "LA not allowed", the MS stores this LAI in a list of "forbidden LAIs for regional provision of service", to prevent repeated attempts to access a cell of the forbidden LA, GSM 03.22, 3.3.
2. If the MS has received the cause 'LA not allowed', it shall ignore this fact when selecting a cell to camp on, i.e. it shall not reject a cell for camping on because that cell is part of a LA where this cause has been received, GSM 03.22, 3.5.4.
3. In response to a registration attempt, when receiving an LU reject with cause value "LA not allowed", the MS continues to perform normal cell-reselection, GSM 03.22, 4.4.2
4. A new LU attempt shall only be performed when a new LA (or new PLMN) is entered according to the cell reselection procedure, GSM 03.22, 3.3 & figure 4.

NOTE: LA stands for "Location Area" and LU stands for "Location Update".

20.15.3 Test purpose

1. To verify that if an LU is rejected with cause "LA not allowed" that the LAI of that cell is written into a forbidden list which prevents the MS from performing LU onto another cell in that LA. This is verified indirectly in test purposes 2,3 and 4.
2. To verify that the MS will not reject a cell for camping on because that cell is part of a LA in the list of "forbidden LAIs for regional provision of service". This is verified indirectly by making the MS attempt an emergency call and checking that the channel request message is transmitted on the correct cell.
3. To verify that the MS when receiving an LU reject with cause value "LA not allowed", the MS continues to perform normal cell-reselection:

Cell reselection is triggered if there is a better cell (in terms of the path loss criterion C2) in the same LA, or a much better cell in another LA of the selected PLMN (using the CRH parameter). GSM 03.22, 3.4 & 4.5.

4. To verify that a new LU attempt will be performed when a new LA (or new PLMN) is entered, GSM 03.22, 3.3 & figure 4.

20.15.4 Method of test

20.15.4.1 Initial conditions

Parameters changed from Default values table (table 20.1)

Parameter	Carrier 1	Carrier 2	Carrier 3	Carrier 4	Carrier 5	Carrier 6
RF Signal Level (dB μ V emf() / dBm)	63 / -50	54 / -59	44 / -69	OFF	OFF	OFF
RXLEV_ACCESS_MIN (dB μ V emf() / dBm)	53 / -60	35 / -78	29 / -84			
CRH	14	0	10			
LAC	H1111	H2222	H1111			
ATT	1	1	1			
C1	10	19	15			
C2	10	19	15			

20.15.4.2 Procedure

- a) The SS activates the carriers. The SS monitors all RA requests from MS on carriers 1, 2 & 3 until step e) has been completed. Only idle-paging is sent on all channels.
- b) The MS is switched on.
- c) When the MS performs an IMSI attach onto carrier 1, the SS shall reject it with cause "LA not allowed"
- d) 30 seconds after the MS has returned to idle mode (channel release after LU reject), the MS is manually commanded to set up an emergency call.

NOTE 1: C2 of carrier 3 > C2 of carrier 1. Carriers 1 and 3 belong to the same LA.

- e) The SS rejects the CM service request from the MS, with a CM service reject message with cause value #17 (Network Failure).

NOTE 2: Cause values #4 (IMSI unknown in VLR) or #6 (Illegal ME) lead to unwanted behaviour of the mobile.

- f) 10 seconds after the MS has returned to idle mode (channel release after CM service reject), the SS increases the level of carrier 2 to 65 dB μ V emf().

NOTE 3: C2 of carrier 2 = 30, now larger than C2 of carrier 3 + CRH.

- g) The SS shall accept any LU on carrier 2.

20.15.5 Test requirements

- 1) After step b), the MS shall respond on carrier 1 within 33 s.

- 2) In step d), the MS shall access on carrier 3 with a channel request message, within 15 seconds of being commanded to set up the emergency call.
- 3) After increasing the level of carrier 2 in step f), the MS shall reselect and access onto carrier 2 requesting an LU within 30 seconds.

NOTE 1: 13,75 seconds to perform running average, 10 seconds to detect C2 differences, 2,4 seconds to read BCCH of carrier 2, 1 second to perform RA. Total 27,15 seconds, allow 30 seconds.

20.16 Downlink signalling failure

20.16.1 Definition and applicability

See conformance requirement.

20.16.2 Conformance requirement

The downlink signalling failure criterion is based on the downlink signalling failure counter DSC.

1. When the MS camps on a cell, DSC shall be initialized to a value equal to the nearest integer to $90/N$ where N is the BS_PA_MFRMS parameter for that cell (see GSM 05.02).
2. Thereafter, whenever the MS attempts to decode a message in its paging subchannel; if a message is successfully decoded DSC is increased by 1,(however never beyond the nearest integer to $90/N$).
3. Whenever the MS can not successfully decode a message in its paging subchannel the DSC is decreased by 4.
4. When DSC reaches 0, a downlink signalling failure shall be declared. A downlink signalling failure shall result in cell reselection, GSM 03.22, 4.5 (ii) and GSM 05.08, 6.5.

NOTE: The network sends the paging subchannel for a given MS every BS_PA_MFRMS multiframes. The requirement for network transmission on the paging subchannel is specified in GSM 04.08. The MS is required to attempt to decode a message every time its paging subchannel is sent.

20.16.3 Test purpose

1. To verify that the MS initializes the DSC counter in accordance with the conformance requirement. This is verified indirectly.
2. To verify that whenever the MS successfully decodes a message on paging subchannel, the DSC is increased by 1, (however never beyond the nearest integer to $90/N$). This is verified indirectly.
3. To verify that whenever the MS can not successfully decode a message on paging subchannel, the DSC decreased by 4. This is verified indirectly.
4. To verify that when the DSC reaches 0, a downlink signalling failure shall be declared and the MS will perform cell reselection.

20.16.4 Method of test

20.16.4.1 Initial conditions

Two BCCH carriers are established with the system information contents of table 20.1.

Parameters changed from Default values table (table 20.1) are below

Parameter	Carrier 1	Carrier 2	Carrier 3	Carrier 4	Carrier 5	Carrier 6
RF signal level (dB μ V emf() / dBm)	43 / -70	33 / -80	OFF	OFF	OFF	OFF
C1 = C2	20	10				

NOTE: The DSC counter will have a value 18 ($90/5$).

20.16.4.2 Procedure

- a) The MS is switched on. On carrier 1 valid layer 3 messages shall be sent in the paging blocks, but not paging the MS (idle paging). On carrier 2 the MS is paged continuously in all paging blocks.
- b) After 40 s the SS sends corrupted data (using random data, wrong parity bits see GSM 05.03, 4.3 & 4.1.2 or other lower layer error) in four successive paging blocks to carrier 1 and then reverts to sending normal data.

NOTE 1: Sending corrupted, i.e. non-decodable data on four successive paging blocks should decrease the DSC to 2.

- c) The SS monitors all accesses on both carriers for 30 s.
- d) The SS sends corrupted data in five successive paging blocks to carrier 1 and then reverts to sending normal data.

NOTE 2: Sending random, data on five successive paging blocks should decrease the DSC to < 0 and cause a cell reselection.

- e) The SS monitors all accesses on both carriers for 30 s.

20.16.5 Test requirements

- 1) There shall be no access to carrier 2 in test steps a) and c).
- 2) The MS shall access on carrier 2 at test step e) within 15 seconds.

20.17 Cell selection if no suitable cell found in 10 s

20.17.1 Definition and applicability

See conformance requirement.

20.17.2 Conformance requirement

If no suitable cell is found in cell reselection process within 10 seconds, the cell selection algorithm of GSM 03.22 shall be performed, GSM 05.08; 6.6.2.

20.17.3 Test purpose

To verify that the MS fulfils the conformance requirement

20.17.4 Method of test

20.17.4.1 Initial conditions

One BCCH carrier is established with the system information contents of table 20.1.

Parameters changed from Default values table (table 20.1) are below

Parameter	Carrier 1	Carrier 2	Carrier 3	Carrier 4	Carrier 5	Carrier 6
RF signal level (dB μ V emf() / dBm)	43 / -70	OFF	OFF	OFF	OFF	OFF
C1 = C2	20					

20.17.4.2 Procedure

- a) The MS is switched on. Idle paging is sent on carrier 1.

b) After the MS indicates service the SS reduces the transmit level of carrier 1 to 13 dB μ V emf() (so that C1 of carrier 1 becomes -10) and turns on a new carrier (carrier 2) at a level of 33 dB μ V emf(). Carrier 2 shall not be in the MS BA list (i.e. it shall not be one of the carriers that MS has been monitoring after camped on carrier 1)

c) The SS shall monitor all accesses on carriers 1 and 2 for 60 s.

NOTE: The access on carrier 2 should not take longer than 50 s. (5 seconds to rxlev averages, 5 s for C1<0 duration, 10 s for searching another suitable cell, 30 s for cell selection), 60 s is a safe time to wait.

20.17.5 Test requirements

The MS shall access on carrier 2 at test step c) within 60 s.

20.18 Cell reselection due to MS rejection "Roaming not allowed in this LA"

20.18.1 Definition and applicability

While camped on a cell of the selected PLMN the MS may need to select a different cell in order to fulfil the normal service state. This ensures that the MS is camped on a cell from which it can reliably decode downlink data and with which it has a high probability of communications on the uplink.

The MS looks for suitable neighbour cells which satisfies 4 constraints including that It should not be in an LA which is in the list of "forbidden LAs for roaming".

This test is applicable for all types of GSM 400, GSM 700, GSM 850, GSM 900, DCS 1 800 and PCS 1 900 MSs.

20.18.2 Conformance requirement

1. To prevent repeated attempts to have roaming service on a not allowed LA, when the MS is informed that an LA is forbidden, the LA is added to a list of "forbidden LAs for roaming" which is stored in the MS, GSM 03.22; 3.1.
2. If the MS has received the cause "Roaming not allowed in this LA", in response to a LU attempt, the Network Selection Procedure shall be started, GSM 03.22; 4.3.3 L3, GSM 04.08; 4.4.4.7.
3. The MS can only perform camping on a suitable cell, which:
 - should not be in an LA which is in the list of "forbidden LAs for roaming" GSM 03.22, 3.2.1.

NOTE: LA stands for "Location Area" and LU stands for "Location Update".

20.18.3 Test purpose

1. To verify that if an LU is rejected with cause "Roaming not allowed in this LA", that the LAI of that cell is written into a forbidden list which prevents the MS from camping onto any cell in that LA.
2. To verify that if the MS has received the cause "Roaming not allowed in this LA", in response to a LU attempt, the Network Selection Procedure is initiated. This is verified indirectly by test purpose 3, in that the new LA is accessed as part of cell selection, hence CRH is disregarded.
3. To verify that if an LU is rejected, when attempting LU in a LA with LAI = LAI1, with cause "Roaming not allowed in this LA" and only cells of the selected PLMN are available, the MS will only camp and attempt LU in any LA with LAI <> LAI1.

20.18.4 Method of test

20.18.4.1 Initial conditions

Parameters changed from Default values table (table 20.1)

Parameter	Carrier 1	Carrier 2	Carrier 3	Carrier 4	Carrier 5	Carrier 6
RF Signal Level (dB μ V emf() / dBm)	63 / -50	53 / -60	OFF	OFF	OFF	OFF
RXLEV_ACCESS_MIN (dB μ V emf() / dBm)	23 / -90	23 / -90				
MNC	MNC <>	MNC <>				
MCC	HPLMN MCC of HPLMN	HPLMN MCC of HPLMN				
CRH	0	0				
LAC	H1111	H2222				
ATT	1	1				
C1	40	30				
C2	40	30				

20.18.4.2 Procedure

- a) The MS is switched on. Idle paging is sent on all carriers.
- b) The SS monitors all RA requests from MS on carriers 1 & 2.
- c) When the MS performs an IMSI attach onto carrier 1, the SS shall reject it with cause "Roaming not allowed in this LA".
- d) The SS shall accept any LU on carrier 2.
- e) The SS monitors all RA requests from MS on carriers 1 to 2.

20.18.5 Test requirements

- 1) The MS should respond on carrier 1 within 33 s of switch on.
- 2) After LU reject, the MS shall initiate the Network Selection Procedure and access onto Carrier 2 as part of cell selection within 33 seconds from returning to idle mode after the LU reject.

NOTE: The timing requirement in b) is given only for testing purposes only. No timing requirements are defined for the Network Selection Procedure, but the time allowed for cell selection (see 20.1) should be adequate.

- 3) After the LU reject on carrier 1, there shall be no more access attempts on this carrier.

20.19 Cell selection on release of SDCCH and TCH

20.19.1 Definition and applicability

20.19.2 Conformance requirement

1. When the SS releases a TCH or SDCCH and returns to idle mode, it shall, as quickly as possible camp on the BCCH carrier of the cell whose channel has just been released. If the full BCCH data for that cell was not decoded in the preceding 30s, the MS shall then attempt to decode the full BCCH data. Until the MS has decoded the BCCH data required for determining the paging group, it shall also monitor all paging blocks on timeslot 0 of the BCCH carrier for possible paging messages that might address it. If the MS receives a page before having decoded the full BCCH data for the cell, the MS shall store the page and respond once the full BCCH data has been decoded, provided that the cell is not barred and the MSs access class is allowed.
GSM 05.08, 6.7.

20.19.3 Test purpose

1. To verify that on release of a TCH or an SDCCH, the MS camps as quickly as possible on the BCCH carrier of the cell whose channel has just been released.

NOTE: This is implicitly tested by the MS responding to a paging request. The decoding of BCCH data cannot be explicitly tested. However, the MS shall monitor for paging messages which may address it if it decodes the BCCH.

20.19.4 Method of test

20.19.4.1 Initial conditions

- a) Parameters changed from default values in table 20.1

Parameter	Carrier 1	Carrier 2	Carrier 3	Carrier 4	Carrier 5	Carrier 6
RF Signal Level (dBmV emf() / dBm)	53 / -60	33 / -80	OFF	OFF	OFF	OFF
RXLEV_ACCESS_MIN (dBmV emf() / dBm)	23 / -90	23 / -90				
BS_PA_MFRMS	2	2				
ATT	1					
C1	30	10				
C2	30	10				

- b) Carrier 1 is configured to have a combined control channel.
- c) Carrier 2 is configured to have a non combined control channel.

20.19.4.2 Test procedure

- a) The SS activates the carriers. No paging messages are transmitted on carrier 1 or carrier 2.
- b) The MS is switched on.
- c) In response to the MS access for IMSI attach, the SS allocates a combined SDDCH/4, accepts the IMSI attach procedure and then releases the link. After 0,5 seconds but within 1 second of transmitting the UA frame on completion of the IMSI attach procedure, the SS transmits a single PAGING REQUEST in the appropriate paging block of the MS on carrier 1.
- d) When the MS responds to paging, the SS establishes a call on a traffic channel.
- e) The SS increases the level of carrier 2 to 63 dBmV emf().
- f) After 10 seconds the SS performs a handover to another TCH, with the parameters of carrier 2 indicated in the CELL DESCRIPTION information element of the HANDOVER COMMAND message.
- g) After a further 10 seconds, the SS clears down the call. After 0,5 seconds but within 1 second of transmitting the UA frame, the SS transmits a single PAGING REQUEST on carrier 2 in the appropriate paging block of the MS.

20.19.5 Test requirements

- 1) After step b) the MS shall access in order to commence an IMSI attach procedure on carrier 1 within 33 seconds.
- 2) In step c), the MS shall respond to paging within 3 seconds of transmitting the PAGING REQUEST.
- 3) In step g), the MS shall respond to paging within 3 seconds of transmitting the PAGING REQUEST.

20.20 Multiband cell selection and reselection

20.20.1 Multiband cell selection and reselection / Cell Selection

20.20.1.1 Definition and applicability

Multiband cell selection is a process in which a multiband MS, whenever a new PLMN is selected, attempts to find a suitable cell of that PLMN to camp on, irrespective of frequency band. Two methods of searching for a suitable cell are possible, normal cell selection and stored list cell selection. The process ensures that the MS is camped on a cell from which it can reliably decode downlink data and with which it has a high probability of communications on the uplink. Once the MS is camped on a cell, access to the network is allowed.

This test is applicable for any multiband MSs supporting simultaneous multiband operation.

20.20.1.2 Conformance requirement

1. A multiband MS shall search all channels within its bands of operation (35 for GSM 450, 35 for GSM 480, 74 for GSM 750, 124 for GSM 850, 124 for P-GSM, 174 for E-GSM and 374 for DCS). The number of channels searched will be the sum of channels on each band of operation; GSM 05.08, 6.2.
2. The MS shall be able to select the correct (fourth strongest) cell and be able to respond to paging on that cell within 30 seconds of switch on, when the three strongest cells are not suitable. This assumes a valid SIM, with PIN disabled and ideal radio conditions; GSM 05.08, 6.1.
3. There are various requirements that a cell must satisfy before an MS can perform normal camping on it:
 - 3.1 (i) It should be a cell of the selected PLMN
 - 3.2 (ii) It should not be "barred" (see section 3.5.1)
 - 3.3 (iv) The radio path loss between MS and BTS must be below a threshold set by the PLMN operator. This is estimated as shown in section 3.6.

GSM 03.22, 3.2.1.

NOTE: Criteria (iii) is not applicable for Cell Selection

4. Initially the MS looks for a cell which satisfies these 4 constraints ("suitable cell") by checking cells in descending order of received signal strength. If a suitable cell is found, the MS camps on it; GSM 03.22, 3.2.1.
5. The MS shall be able to calculate correctly the path loss criterion parameter $C1$, used for cell selection and reselection; GSM 05.08, 6.4.

20.20.1.3 Test purpose

1. To verify that the MS meets conformance requirement 1.
2. To verify that the MS meets conformance requirement 2 in a multiband environment.
3. To verify that:
 - 3.1 The MS does not select a cell of a PLMN which is not the selected PLMN.
 - 3.2 The MS does not select a cell which is "barred".
 - 3.3 The MS does not select a cell with $C1 < 0$.
4. To verify that the MS selects suitable cells in descending order of received signal strength, irrespective of frequency band.
5. To verify that the MS does not select a cell with $C1 < 0$.

20.20.1.4 Method of test

20.20.1.4.1 Initial conditions

Parameters changed from the default values in table 20.1.

Parameter	Carrier 1	Carrier 2	Carrier 3	Carrier 4	Carrier 5	Carrier 6
RF Signal Level (dBmV emf() / dBm)	48 / -65	36 / -77	43 / -70	33 / -80	23 / -90	OFF
CBA	1	0	0	0	0	
RXLEV_ACCESS_MIN (dBm)	-90	-69	-90	-88	-98	
MNC			01			
MCC			002			
MS_TXPWR_MAX_CCH	7	7		7		
C1	25	-8	20	8	8	
C2	25	-8	20	8	8	

Carrier 1, carrier 2 and carrier 4 ARFCNs are chosen in the lower band, carrier 3 and carrier 5 ARFCNs in the higher band.

20.20.1.4.2 Procedure

- a) The SS activates the carriers and monitors carriers 2, 4 and 5 for RA requests from the MS.
- b) The MS is switched on.
- c) The MS is switched off.
- d) The SS monitors carriers 1 and 3 for RA requests from the MS
- e) The MS is switched on.
- f) The MS is switched off.
- g) The SS is reconfigured and sets MCC of carrier 3 to 001 (same as the other carriers).
- h) The SS activates the carriers and monitors carriers 3, 4 and 5 for RA requests from the MS.
- i) The MS is switched on.
- j) The MS is switched off.
- k) For multiband MS supporting three or more bands all combinations of two bands shall be tested using the steps from a) to j).

20.20.1.4.3 Related PICS/PIXIT statement(s)

Support for stored list cell selection Yes/No.

20.20.1.5 Test requirements

- 1) After step b), the first response from the MS shall be on carrier 4 within 33 seconds. If the MS supports stored list cell selection MS may be also on carrier 5. There shall be no response from the MS on carrier 2.
- 2) After step e), there shall be no response from the MS on either carrier 1 or carrier 3 within 33 seconds.
- 3) After step i), the first response from the MS shall be on carrier 3 within 33 seconds. If the MS supports stored list cell selection the first response may be also on carrier 4 or carrier 5.

20.20.2 Multiband cell selection and reselection / Cell reselection

20.20.2.1 Definition and applicability

While camped on a cell of the selected PLMN the multiband MS may need to select a different cell (irrespective of frequency band used) in order to fulfil the normal service state. This ensures that the MS is camped on a cell from which it can reliably decode downlink data and with which it has a high probability of communications on the uplink.

This test is applicable for any multiband MS supporting simultaneous multiband operation.

20.20.2.2 Conformance requirement

1. The list of the 6 strongest non-serving carriers shall be updated at least as often as the duration of the running average defined for measurements on the BCCH allocation and may be updated more frequently; GSM 05.08, 6.6.1.
2. When the MS recognizes that a new BCCH carrier has become one of the 6 strongest, the BCCH data shall be decoded for the new carrier within 30 seconds; GSM 05.08, 6.6.1.
3. The MS shall be able to calculate correctly the path loss criterion parameter C2 used for cell reselection; GSM 05.08, 6.4.

20.20.2.3 Test purpose

1. To verify that MS meets conformance requirement 1.
2. To verify that MS meets conformance requirement 2.
3. To verify that the MS calculates the C2 parameter correctly when the CELL_RESELECT_OFFSET, and PENALTY_TIME parameters are used to give different priorities to different frequency bands.

20.20.2.4 Method of test

20.20.2.4.1 Initial conditions

Six BCCH carriers are established with the system information contents of table 20.1.

Parameters changed from Default values table 20.1 are below:

Parameter	Carrier 1	Carrier 2	Carrier 3	Carrier 4	Carrier 5	Carrier 6	Carrier 7
RF signal level (dBmV emf ()/dBm)	53 / -60	48 / -65	43 / -70	38 / -75	33 / -80	33 / -80	43 / -70
RXLEV_ACCESS_MIN (dBm)	-90	-90	-90	-90	-90	-90	-110
PT							11111
CRO							20 dB
MS_TXPWR_MAX_CCH	7	7	7				
C1	30	25	20	15	10	10	40
C2	30	25	20	15	10	10	20

Carrier 1, 2 and 3 ARFCNs are chosen in the lower band, carrier 4, 5, 6 and 7 ARFCNs in the higher band.

The BA(BCCH) list contains only eight ARFCNs and includes those of carriers 1 to 7.

BS_PA_MFRMS is set to 3 during this test.

NOTE: The combination of 8 carriers on the BA list and BS_PA_MFRMS = 3 leads to averaging time of 5 seconds. Hence 5 seconds is also the updating time of the list of six strongest neighbour carriers.

20.20.2.4.2 Procedure

- a) The SS activates carriers 1 to 6. The MS is not paged on any of the carriers.

- b) The MS is switched on.
- c) After 60 seconds, the SS deactivates carrier 4 and activates carrier 7 and pages the MS continuously on carrier 7. The SS monitors carrier 7 for RA requests from the MS.
- d) The MS is switched off.
- e) The SS is reconfigured and sets $PT = 0$ and $CRO = 0$ on carrier 7 (thus increasing C2 to 40 dB).
- f) The SS activates carriers 1 to 6. The MS is not paged on any of the carriers.
- g) The MS is switched on.
- h) After 60 seconds, the SS deactivates carrier 4 and activates carrier 7 and pages the MS continuously on carrier 7. The SS monitors carrier 7 for RA requests from the MS.
- i) 20 seconds after receiving an RA request on carrier 7 the SS sets $PT = 11111$ and $CRO = 20$ dB on carrier 7 (thus decreasing C2 to 20dB), stops paging on carrier 7, and pages the MS continuously on carrier 1. The SS monitors carrier 1 for RA requests from the MS.
- j) The MS is switched off.
- k) For multiband MS supporting three or more bands all combinations of two bands shall be tested using the steps from a) to j).

20.20.2.5 Test requirements

- 1) After step c) there shall be no response from the MS on carrier 7 within 55 s of activating carrier 7.
- 2) After step h) the MS shall access on carrier 7 within 55 s of activating carrier 7.

NOTE: 5,5 seconds to notice new strongest carrier in top 6 (because the updating time for six strongest is 5 seconds (+10 %)), 33 seconds to read BCCH, 15 seconds for reselection, since the MS has already performed the running average on the new strongest carrier, allow 55 seconds.

- 3) After step i) the MS shall access on carrier 1 within 55 s of setting PT and CRO on carrier 7.

20.21 R-GSM cell selection and reselection

This clause is applicable for the MS supporting R-GSM band except when otherwise stated.

In the following paragraphs some explanatory text is given concerning the nature of the tests in this section and the general behaviour of the SS is described.

Since the conformance requirements of most of the tests in this section cannot be tested explicitly, testing is done implicitly by testing the MS behaviour from its responses to the SS.

The SS transmits one BCCH carrier per cell as indicated in the initial conditions for each test. These are referred to as carrier 1, carrier 2, etc. It is assumed that the SS can simultaneously transmit seven BCCH carriers and monitor three random access channels. For multiband tests it is assumed that at least one of the BCCH carriers and one of the monitored random access channels is in a different frequency band from the others. In some cases, a test is performed in multiple stages in order that the requirements can be tested within the above constraints.

For any MS all the carriers are in its supported band(s) of operation. For an R-GSM mobile station at least one of the carriers is chosen between ARFCN 955-974 and one of the carriers is in the primary band.

Unless otherwise stated in the method of test, in all of the tests of this section:

- The SS is continuously paging the MS on all carriers at the start of the test and does not respond to RACH requests from the MS. Where a test specifies that the MS is not paged on a particular carrier, only idle paging is transmitted according to GSM 04.08, 3.2.2.2.
- The default values of the system information data fields given in table 20.21.1 are used.
- The SIM is in the idle updated state in the default location area with a TMSI assigned at the beginning of each test.
- The ARFCNs used for the carriers in each test are chosen from those in table 20.21.1 with adjacent carriers separated by a minimum of three channels.

The absolute accuracy of the MS signal level measurements is assumed to be ± 6 dB. A difference of at least 8 dB is allowed for cases of discrimination between C1 or C2 values and 0.

The relative accuracy of the MS signal level measurements is assumed to be ± 3 dB for the signal levels used in the tests of this section, except for section 20.20, where the relative accuracy is assumed to be ± 5 dB if the measurements are on different frequency bands. A difference of at least 5 dB is allowed for cases of discrimination between C1 or C2 values on different carriers, except for section 20.20, where a difference of at least 10 dB is allowed if the measurements are on different frequency bands.

NOTE 1: The accuracy of MS signal level measurements is specified in GSM 05.08. For all of the tests in this section, the signal levels used are greater than 1 dB above reference sensitivity level.

NOTE 2: The tolerance on timers specified in GSM 05.08 is ± 10 % except for PENALTY_TIME where it is ± 2 seconds. In the tests of this section, the test requirements include these tolerances. Consequently, the times stated in the test requirement sometimes differ from the corresponding timer in the conformance requirement.

Where pulsed signals are specified, the SS tolerance on pulse width is ± 2 % and the SS tolerance on power level ± 1 dB.

Table 20.21.1: Default values of the system information fields

Parameter	GSM 04.08 reference	Abbr.	Normal Setting
Cell channel description	10.5.2.1	-	Any values
MAX retrans	10.5.2.29	-	1
TX-integer	10.5.2.29	-	Any value
CELL_BAR_QUALIFY	10.5.2.35	CBQ	0
CELL_BAR_ACCESS	10.5.2.29	CBA	0 (not barred)
AC CN	10.5.2.29	AC	All 0
RE	10.5.2.29	RE	0 (re-establishment allowed)
NCC	10.5.2.2	NCC	Any value
Cell Identity	10.5.1.1	-	Any value
MCC, MNC	10.5.1.3	PLMN	MS Home PLMN
LAC	10.5.1.3	LAC	1111 (Hex)
ATT	10.5.2.11	-	0 (Attach/Detach not allowed)
BS_AG_BLKES_RES	10.5.2.11	-	Any values
T3212	10.5.2.11	-	Any values
BS_PA_MFRMS	10.5.2.11	BPM	5 frames
Cell Options	10.5.2.3	-	Any values
CELL_RESELECT_HYSTERESIS	10.5.2.4	CRH	4 dB
MS_TXPWR_MAX_CCH	10.5.2.4	MTMC	Max. output power of MS
RXLEV_ACCESS_MIN	10.5.2.4	RAM	-90 dBm
CELL_RESELECT_OFFSET	10.5.2.35	CRO	0
TEMPORARY_OFFSET	10.5.2.35	TO	0
PENALTY_TIME	10.5.2.35	PT	0
Power Offset	10.5.2.35	PO	0
BA ARFCN	10.5.2.22	BA	All 0 except:
			For GSM900, both P-GSM and R-GSM ARFCNs are broadcast: GSM ARFCNs 3, 9, 18, 25, 41, 43, 49, 50, 54, 58, 62, 66, 70, 80, 92, 124, broadcast in SYSTEM INFORMATION type 2 R-GSM ARFCNs 956, 960, 969, 985, 989, 995, 1010, 1014 broadcast in SYSTEM INFORMATION type 2bis
			For DCS1800 ARFCNs 512, 543, 568, 589, 602, 641, 662, 683, 696, 711, 732, 754, 794, 851, 870, 871, 872, 884 broadcast in SYSTEM INFORMATION TYPE 2.
			For GSM1900 ARFCNs 512, 543, 568, 589, 602, 629, 641, 653, 662, 683, 696, 711, 727, 732, 754, 777, 794, 809 broadcast in SYSTEM INFORMATION TYPE 2
			For multiband tests, ARFCNs 3, 18, 41, 49, 62, 70, 92, 124 broadcast in SYSTEM INFORMATION TYPE 2 (GSM cell) and TYPE 2ter (DCS cell), and ARFCNs 512, 568, 602, 662, 696, 732, 794, 870 broadcast in SYSTEM INFORMATION TYPE 2 (DCS cell) and TYPE 2ter (GSM cell)

20.21.1 R-GSM cell selection

20.21.1.1 Definition and applicability

Cell selection is a process in which a MS, whenever a new PLMN is selected, attempts to find a suitable cell of that PLMN to camp on. Two methods of searching for a suitable cell are possible, normal cell selection and stored list cell selection. The process ensures that the MS is camped on a cell from which it can reliably decode downlink data and

with which it has a high probability of communications on the uplink. Once the MS is camped on a cell, access to the network is allowed.

20.21.1.2 Conformance requirement

1. The MS shall be able to select the correct (fourth strongest) cell and be able to respond to paging on that cell within 30 seconds of switch on, when the three strongest cells are not suitable. This assumes a valid SIM, with PIN disabled and ideal radio conditions; GSM 05.08, 6.1.
2. There are various requirements that a cell must satisfy before an MS can perform normal camping on it:
 - 2.1 (i) It should be a cell of the selected PLMN
 - 2.2 (ii) It should not be "barred" (see section 3.5.1)
 - 2.3 (iv) The radio path loss between MS and BTS must be below a threshold set by the PLMN operator. This is estimated as shown in section 3.6.

GSM 03.22, 3.2.1.

NOTE: Criteria (iii) is not applicable for Cell Selection.

3. Initially the MS looks for a cell which satisfies these 4 constraints ("suitable cell") by checking cells in descending order of received signal strength. If a suitable cell is found, the MS camps on it; GSM 03.22, 3.2.1.
4. The MS shall be able to calculate correctly the path loss criterion parameter C1, used for cell selection and reselection; GSM 05.08, 6.4.

20.21.1.3 Test purpose

1. To verify that the MS meets conformance requirement 1.
2. To verify that:
 - 2.1 The MS does not select a cell of a PLMN which is not the selected PLMN.
 - 2.2 The MS does not select a cell which is "barred".
 - 2.3 The MS does not select a cell with $C1 < 0$.
3. To verify that the MS selects suitable cells in descending order of received signal strength.
4. To verify that the MS does not select a cell with $C1 < 0$.

20.21.1.4 Method of test

20.21.1.4.1 Initial conditions

Parameters changed from the default values in table 20.21.1.

Parameter	Carrier 1	Carrier 2	Carrier 3	Carrier 4	Carrier 5	Carrier 6
RF Signal Level (dBμV emf) / dBm)	48 / -65	38 / -75	43 / -70	33 / -80	28 / -85	OFF
CBA	1	0	0	0	0	
RXLEV_ACCESS_MIN (dBm)	-90	-67	-90	-88	-98	
MNC			01			
MCC			002			
C1	25	-8	20	8	13	
C2	25	-8	20	8	13	

Carrier 2 and carrier 4 are chosen between ARFCN 955 - 974. Carrier 1 is chosen between 975 - 1023, 0; and carrier 3 remains in the P-GSM band.

20.21.1.4.2 Procedure

- a) The SS activates the carriers and monitors carriers 2, 4 and 5 for RA requests from the MS.
- b) The MS is switched on.
- c) The MS is switched off.
- d) The SS monitors carriers 1 and 3 for RA requests from the MS
- e) The MS is switched on.

20.21.1.5 Test requirements

- 1) After step b), the first response from the MS shall be on carrier 4 within 33 seconds. There shall be no response from the MS on carrier 2.
- 2) After step e), there shall be no response from the MS on either carrier 1 or carrier 3 within 33 seconds.

20.21.2 R-GSM cell selection with varying signal strength values

20.21.2.1 Definition and applicability

For definition see conformance requirement.

20.21.2.2 Conformance requirement

1. The MS shall:

The MS shall search all RF channels in the system (194 ARFCNs for R-GSM), take readings of received RF signal strength on each RF channel, and calculate the received level average for each. The averaging is based on at least five measurement samples per RF carrier spread over 3 to 5 s, the measurement samples from the different RF carriers being spread evenly during this period. GSM 05.08, 6.2.

1.1 The MS shall search all RF channels in the system (194 ARFCNs for R-GSM), take readings of received RF signal strength on each RF channel, and calculate the received level average for each.

1.2 The averaging is based on at least five measurement samples per RF carrier spread over T_{av} (3 to 5 s).

1.3 The measurement samples from the different RF carriers being spread evenly during this period.

2. These quantities are termed the "receive level averages", shall be unweighted averages of the received signal strengths measured in dBm. GSM 05.08, 6.1.

20.21.2.3 Test purpose

1. To verify that:
 - 1.1 The MS meets conformance requirement 1.1.
 - 1.2 The MS meets conformance requirement 1.2.
 - 1.3 The MS meets conformance requirement 1.3.
- 2 To verify that the MS meets conformance requirement 2.

20.21.2.4 Method of test

20.21.2.4.1 Initial conditions

Parameters changed from the default values in table 20.21.1.

Parameter	Carrier 1	Carrier 2	Carrier 3	Carrier 4	Carrier 5	Carrier 6
RF Signal Level (dB μ V emf() / dBm)	23 / -90	58 / -55	OFF	OFF	OFF	OFF
RXLEV_ACCESS_MIN (dB μ V emf() / dBm)	13 / -100	13 / -100				
C1	10	53				

Carrier 1 is chosen between ARFCN 955 - 974.

The manufacturer of the equipment shall declare his averaging time T_{av} . This time is the time between the first and the last measurement sample taken on one carrier during one averaging period.

20.21.2.4.2 Procedure

- a) The SS transmits on carriers 1 and 2. After a period of $b \cdot T_{av}$ carrier 2 reduces its transmit level to -85 dBm (28 dB μ V emf()). After a further period of $a \cdot T_{av}$, carrier 2 increases its transmit level again to -55 dBm (58 dB μ V emf()). Switching of carrier 2 continues with these levels and duty cycle until the end of the test.

T_{av} is the averaging time declared by the manufacturer.

The parameters a and b are chosen according to the following rules:

$$(a + b) \cdot T_{av} > T_{av}$$

$$0 < a \cdot T_{av} < 2/3 \cdot T_{av}$$

$$0,5 \cdot T_{av} < b \cdot T_{av} < T_{av}$$

In the equations < and > means at least one TDMA frame less or greater than the given value.

While satisfying the conditions given above:

a is chosen to be as close as possible to 2/3.

b is chosen to be as close as possible to 0,5.

- b) The MS is switched on.
c) The SS monitors all RA requests from MS on carriers 1 and 2.

20.21.2.5 Test requirements

In step c), the first response from the MS shall be on carrier 2 within 33 seconds.

NOTE 1: With the selected duty cycle it can be guaranteed that a "good" MS passes the test even at the worst case situations. The minimum averaged value of carrier 2 is in any case higher or equal to -75 dBm which is still 6 dB above carrier 1's level (for a "good" MS).

NOTE 2: With the selected levels and duty cycle the probability that a "bad" MS (i.e. MS that averages over shorter period than 3 s) fails the test is maximized. However, it can not be guaranteed that all the MSs not fulfilling the conformance requirement of averaging or uniform sampling will fail this test.

20.21.3 R-GSM basic cell reselection

20.21.3.1 Definition and applicability

While camped on a cell of the selected PLMN the MS may need to select a different cell in order to fulfil the normal service state. This ensures that the MS is camped on a cell from which it can reliably decode downlink data and with which it has a high probability of communications on the uplink.

20.21.3.2 Conformance requirement

1. While camped on a cell of the selected PLMN ("camped normally"), the MS may need to select a different cell ("normal cell reselection" state). The following events trigger a cell reselection:

1.1 (iii) The cell camped on (current serving cell) has become barred.

1.2 (iv) There is a better cell (in terms of the path loss criterion C2) in the same LA, or a much better cell in another LA of the selected PLMN (using the CRH parameter).

The MS will then reselect a new cell in order to fulfil the process goal.; GSM 03.22, 4.5.

NOTE 1: Criterion (i) is tested in section 20.21.8 (Cell reselection when $C1(\text{serving cell}) < 0$ for 5 seconds).

NOTE 2: Criterion (ii) is tested section 20.21.16 (Downlink signalling failure).

NOTE 3: Criterion (v) is tested in section 20.21.6 (Cell reselection timings).

2. There are various requirements that a cell must satisfy before an MS can perform normal camping on it:

2.1 (ii) It should not be "barred".

2.2 (iv) The radio path loss between MS and BTS must be below a threshold set by the PLMN operator. GSM 03.22, 3.2.1.

NOTE 4: Criterion (i) is not relevant for cell reselection and for cell selection it is tested in section 20.21.1.

NOTE 5: Criterion (iv) refers to the C1 parameter.

3. The MS shall be able to calculate correctly the path loss criterion parameter C2 used for cell reselection; GSM 05.08, 6.4.

4. At least every 5 s the MS shall calculate the value of C1 and C2 for the serving cell and recalculate C1 and C2 values for non serving cells (if necessary). The MS shall then check whether:

i) The path loss criterion (C1) for current serving cell falls below zero for a period of 5 seconds. This indicates that the path loss to the cell has become too high.

ii) The calculated value of C2 for a non-serving suitable cell exceeds the value of C2 for the serving cell for a period of 5 seconds, except in the case of the new cell being in a different location area in which case the C2 value for the new cell shall exceed the C2 value of the serving cell by at least `CELL_RESELECT_HYSTERESIS` dB as defined by the BCCH data from the current serving cell, for a period of 5 seconds. This indicates that it is a better cell. GSM 05.08, 6.6.2.

5. The MS shall attempt to decode the full BCCH data of the serving cell at least every 30 seconds; GSM 05.08, 6.6.1.

20.21.3.3 Test purpose

1. To verify that:

1.1 The MS meets conformance requirement 1.1.

1.2 The MS meets conformance requirement 1.2.

2. To verify that:
 - 2.1 The MS does not reselect a cell which is barred.
 - 2.2 The MS does not reselect a cell which has a $C1 < 0$.
3. To verify that the MS calculates the C2 parameter correctly when the CELL_RESELECT_OFFSET, TEMPORARY_OFFSET and PENALTY_TIME parameters are not used.
4. To verify that the MS takes into account the CELL_RESELECT_HYSTERESIS parameter when reselecting a cell in a different location area.
5. To verify that the MS decodes the CELL_BAR_ACCESS and CELL_BAR_QUALIFY parameters from the BCCH every 30 seconds.

20.21.3.4 Method of test

20.21.3.4.1 Initial conditions

Parameters changed from the default values in table 20.21.1.

Parameter	Carrier 1	Carrier 2	Carrier 3	Carrier 4	Carrier 5	Carrier 6
RF Signal Level (dB μ V emf() / dBm)	43 / -70	33 / -80	43 / -70	38 / -75	38 / -75	
RXLEV_ACCESS_MIN (dBm)	-85	-90	-90	-85	-67	
CRH	10 dB					
LAC			different from other carriers			
CBA				1		
CBQ				0		
C1	15	10	20	10	-8	
C2	15	10	20	10	-8	

The BA(BCCH) list only contains the ARFCNs of the carriers used during the test.

20.21.3.4.2 Procedure

- a) The SS activates carriers 1, 2, 4 and 5. The MS is not paged on carrier 1. The SS monitors carriers 2, 4 and 5 for RA requests from the MS.
- b) The MS is switched on.
- c) The SS stops paging on all carriers except carrier 2. The level of carrier 2 is increased to 43 dB μ Vemf (C2 becomes 20 dB), and the SS monitors carrier 2 for RA requests from the MS.
- d) When the SS receives a response from the MS on carrier 2, it stops paging the MS on this carrier.
- e) The MS is switched off.
- f) The SS is reconfigured and sets CBA = 1 on carriers 1 and 5.
- g) The MS is switched on.
- h) After 33 seconds, the SS starts paging continuously on carrier 1 and sets CBA=1 on carrier 2 and CBA=0 on carriers 1, 4 and 5.
- i) When the SS receives a response on carrier 1, it stops paging the MS and waits for 25 seconds. (The MS should reselect and camp onto carrier 1).
- j) The SS activates carrier 3, pages the MS continuously on this carrier and monitors carrier 3 for RA requests from the MS.
- k) The SS increases the level of carrier 3 to 53 dB μ Vemf (C2 increases to 30 dB.).

20.21.3.5 Test requirements

- 1) After step b), there shall be no response from the MS on carriers 2, 4, or 5 within 50 seconds.
- 2) In step c), the MS shall respond on carrier 2 within 20 seconds of increasing the level of carrier 2.

NOTE 1: 5 seconds to perform running average, 10 seconds to detect C2 differences, 2,4 seconds to read BCCH of carrier 2, 1 second to perform RA. Total 18,4 seconds, allow 20 seconds.

- 3) In step h), the MS shall respond on carrier 1 within 50 seconds of setting CBA=1 on carrier 2.

NOTE 2: 33 seconds for the MS to read the BCCH of carrier 2 (30 seconds + 10 %), 15 seconds for the MS to reselect cell 1, since the MS already has a running average on carrier 1, allow 50 seconds.

- 4) After step j), there shall be no response from the MS within 50 seconds.
- 5) After step k), the MS shall respond on carrier 3 within 20 seconds.

20.21.4 R-GSM cell reselection using TEMPORARY_OFFSET, CELL_RESELECT_OFFSET, POWER_OFFSET and PENALTY_TIME parameters

20.21.4.1 Definition and applicability

20.21.4.2 Conformance requirement

1. The MS shall be able to calculate correctly the path loss criterion parameter C2 used for cell reselection; GSM 05.08, 6.4.

20.21.4.3 Test purpose

1. To verify that the MS calculates the C2 parameter correctly when the CELL_RESELECT_OFFSET, TEMPORARY_OFFSET and PENALTY_TIME parameters are used.
2. To verify DCS 1 800 MS correctly calculate the C2 parameter when the POWER_OFFSET parameter is present.

20.21.4.4 Method of test

20.21.4.4.1 Initial conditions

Parameters changed from the default values in table 20.21.1.

Parameter	Carrier 1	Carrier 2	Carrier 3	Carrier 4	Carrier 5	Carrier 6
RF Signal Level (dBμV emf() / dBm)	53 / -60	43 / -70	48 / -65	48 / -65		
RXLEV_ACCESS_MIN (dBm)	-80	-100	-85	-85		
PT		11111	40 s	60 s		
CRO		16 dB	20 dB	20 dB		
TO			20 dB	20 dB		
K = 1						
C1	20	30	20	20		
C2	20	14	20 -> 40	20 -> 40		
K = 2 (DCS1800 Class 3 MS only)						
POWER_OFFSET	0	2	6	6		

The BA(BCCH) list only contains the ARFCNs of the carriers used during the test.

20.21.4.4.2 Procedure

For testing of GSM MS, the test procedure is performed for execution counter $K = 1$.

For testing of DCS 1 800 MS, the test procedure is performed for execution counter $K = 1$ and 2

On execution counter $K = 1$, the POWER_OFFSET Parameter is not present.

On execution counter $K = 2$, the POWER_OFFSET parameter is present.

- a) The SS activates carriers 1 and 2. The MS is not paged on carrier 1. The SS monitors carrier 2 for RA requests from the MS.
- b) The MS is switched on.
- c) The SS increases the level of carrier 2 to 54 dB μ V_{emf} (C2 becomes 25 dB).
- d) When the SS receives a response on carrier 2, the SS stops paging on that carrier and waits for 20 seconds (The MS should reselect and camp onto carrier 2).
- e) The SS activates carriers 3 and 4 and continuously pages the MS on these carriers. The SS monitors carriers 3 and 4 for RA requests from the MS.

20.21.4.4.3 Requirements

For execution counter $K = 1$ and $K = 2$.

- 1) After step b), there shall be no response from the MS on carrier 2 within 50 seconds.
- 2) After step c), the MS shall respond on carrier 2 within 20 seconds of increasing the level of carrier 2.
- 3) After step e), there shall be no response from the MS on carrier 3 within 38 seconds of activating the carriers but, the MS shall respond on carrier 3 within 90 seconds. The response on carrier 3 shall be before any response on carrier 4.

NOTE: Minimum time of 38 seconds set by penalty timer on carrier 3 less 2 second tolerance. Maximum time, total of 33 seconds to read BCCH of carrier 3, 42 seconds for expiry of penalty timer on carrier 3, 15 seconds for reselection, since the MS will already have running averages on carriers 3 and 4, when the penalty timers expire, allow 90 seconds.

20.21.5 R-GSM cell reselection using parameters transmitted in the System Information type 2bis, type 2ter, type 7 and type 8 messages

20.21.5.1 Definition and applicability

System information (SI) type 7 and 8 are transmitted on the BCCH Ext when the system information type 4 message does not contain all information needed for cell selection.

The system information type 2 bis message is used when the system information type 2 message does not contain all neighbour cell ARFCNs.

The system information type 2 ter message is used when system information type 2 messages broadcast by one cell which are system information 2 or both system information 2 and 2bis do not contain all neighbour cell ARFCNs.

20.21.5.2 Conformance requirement

1. The MS shall be able to calculate correctly the path loss criterion parameter C2 used for cell reselection. GSM 05.08, 6.4.
2. Whilst in idle mode, an MS shall continue to monitor all BCCH carriers as indicated by the BCCH allocation. GSM 05.08, 6.6.1.
3. Mobile stations shall treat all ARFCNs in the set {0, 1, 2 ... 1023} as valid ARFCN values even if the mobile station is unable to transmit or receive on that ARFCN. GSM 04.08, 10.5.2.1b.

- 4 The MS shall correctly decodes parameters transmitted in the system information type 2 ter message. GSM 04.08, 9.1.34:

20.21.5.3 Test purpose

1. To verify that the MS correctly calculates the C2 criterion when the parameters affecting cell reselection are transmitted in the system information type 7 and 8 messages.
2. To verify that the MS decodes parameters transmitted in the system information type 2 bis message.
3. To verify that the MS treats ARFCNs as valid ARFCNs even if the MS is unable to transmit or receive on that ARFCN.
4. To verify that the MS correctly decodes parameters transmitted in the system information type 2 ter message.

20.21.5.4 Method of test

20.21.5.4.1 Initial conditions

- a) Parameters changed from the default values in table 20.21.1.

Parameter	Carrier 1	Carrier 2	Carrier 3	Carrier 4	Carrier 5	Carrier 6
RF Signal Level (dBμV emf() / dBm)	53 / -60	32 / -81	40 / -73	OFF	OFF	OFF
RXLEV_ACCESS_MIN (dBμV emf() / dBm)	23 / -90	23 / -90	30 / -83			
BS_AG_BLKs_RES	1	1	1			
PT		0	0			
CRO		16 dB	10 dB			
TO		0 dB	0 dB			
C1	30	9	10			
C2	30	25	20			

- b) The ARFCNs of carriers 1, 2 and 3 are chosen from those in table 20.21.1 with carrier 3 chosen between ARFCN 955 - 974.
- c) The cell reselection parameters PENALTY_TIME, CELL_RESELECT_OFFSET and TEMPORARY_OFFSET are transmitted in the SI3, SI7 and SI8 messages on carrier 2. They are not transmitted in SI4 and the ADDITIONAL RESELECT PARAM IND parameter is set to 1.
- d) The SI2bis message is transmitted on carrier 1 and contains the ARFCN of carrier 2 and ARFCNs 43, 70, 500, 550, 958, 963, 990 and 995. The ARFCN of carrier 2 is not transmitted in the SI2 message.
- e) Carriers 1 and 2 are synchronized, but staggered in frame number so that the transmission of the SI3 message on carrier 2, coincides with the paging block which the MS is listening to on carrier 1.

NOTE: Under these conditions, the MS can only decode the parameters affecting cell reselection from the SI7 or SI8 messages.

To achieve this, the following conditions are used:

BS_PA_MFRMS = 4

IMSI mod 1000 = 12

FN carrier 1 = FN carrier 2-21, for simultaneously transmitted frames.

- f) The SI3 message on carrier 2 indicates that SI2ter is used on carrier 2. SI2ter message contains the ARFCN of carrier 3 and ARFCNs 45, 76, 891, 905. The ARFCN of carrier 3 is transmitted neither in the SI2 nor in the SI2bis messages on carriers 1 and 2.

20.21.5.4.2 Test Procedure

- a) The SS activates the channels. The MS is not paged on carrier 1.
- b) The MS is switched on.
- c) After 50 seconds, the SS increases the level of carrier 2 to 42 dB μ V_{emf}().
- d) When the SS receives a response on carrier 2, the SS stops paging on that carrier and after 30 seconds, the SS increases the level of carrier 3 to 60 dB μ V_{emf}().

20.21.5.5 Test Requirements

- 1) After step b), there shall be no response from the MS on carrier 2. There shall also be no response on carrier 3.
- 2) After increasing the level of carrier 2 in step c), the MS shall respond on carrier 2 within 33 seconds.
- 3) After increasing the level of carrier 3 in step d), the mobile shall respond on carrier 3 within 35 seconds.

20.21.6 R-GSM cell reselection timings

20.21.6.1 Definition and applicability

20.21.6.2 Conformance requirement

1. At least every 5 s the MS shall calculate the value of C1 and C2 for the serving cell and recalculate C1 and C2 values for non serving cells (if necessary). The MS shall then check whether:
 - 1.1 ii) The calculated value of C2 for a non-serving suitable cell exceeds the value of C2 for the serving cell for a period of 5 seconds,
 - 1.2 In case ii) above, cell reselection shall not take place if there was a cell reselection within the previous 15 seconds.
 - 1.3 Cell reselection for any other reason (see GSM 03.22) shall take place immediately, but the cell that the MS was camped on shall not be returned to within 5 seconds if another suitable cell can be found.;

GSM 05.08, 6.6.2.

20.21.6.3 Test purpose

1. To verify that:
 - 1.1 The MS does not perform a cell reselection when the C2 value for a non serving cell does not exceed the C2 value of the serving cell for a period of at least 5 seconds.
 - 1.2 The MS meets conformance requirement 1.2 with an allowance for the uncertainty of the test.
 - 1.3 When the MS performs an immediate cell reselection due to an unsuccessful random access attempt, the cell that the MS was camped onto is not returned to within 5 seconds when another suitable cell exists.

20.21.6.4 Method of test

20.21.6.4.1 Initial conditions

Parameters changed from the default values in table 20.21.1.

Parameter	Carrier 1	Carrier 2	Carrier 3	Carrier 4	Carrier 5	Carrier
RF Signal Level (dB μ V emf() / dBm)	56 / -57	46 / -67	OFF	OFF	OFF	OFF
RXLEV_ACCESS_MIN (dB μ V emf() / dBm)	29 / -84	33 / -80				
Max. Retrans	00	00				
C1	27	13				
C2	27	13				

Below is an alternative table of parameters for use with test equipment that cannot reach the upper RF levels as specified in the table above. These carrier levels are reduced by 5 dB and will not effect the purpose of the test case:

Parameter	Carrier 1	Carrier 2	Carrier 3	Carrier 4	Carrier 5	Carrier
RF Signal Level (dB μ V emf() / dBm)	51 / -62	41 / -72	OFF	OFF	OFF	OFF
RXLEV_ACCESS_MIN (dB μ V emf() / dBm)	24 / -89	28 / -85				
Max. Retrans	00	00				
C1	27	13				
C2	27	13				

The BA(BCCH) list only contains 5 ARFCNs including the ARFCNs of the carriers used during the test.

NOTE: With 5 ARFCNs in the BA(BCCH) list and BS_PA_MFRMS=5 (default value) the MS will maintain a running average on surrounding cells over a period of 5 seconds.

20.21.6.4.2 Procedure

- a) The SS activates the channels. The MS is not paged on any of the carriers.
- b) The MS is switched on.
- c) After 50 seconds, the SS starts paging continuously on carriers 1 and 2 for 20 seconds. The SS monitors carriers 1 and 2 for RA requests from the MS.
- d) The SS stops paging on carriers 1 and 2 and waits for 20 seconds. (The MS should revert to carrier 1 due to cell reselection.)
- e) The SS starts paging continuously on carrier 2.
- f) The SS increases the transmit level of carrier 2 by 20 dB for a period of 4 s and then reduces the level back to the original value.
- g) The SS increases the transmit level of carrier 2 by 20dB and waits for the MS to access on carrier 2. The SS records the time t from the increase in the level of carrier 2 to the first response from the MS.
- h) The SS stops paging on carrier 2 and decreases the transmit level of carrier 2 back to the original value.
- j) The SS waits 20 seconds. (The MS should revert to carrier 1 due to cell reselection.)
- k) The SS increases the transmit level of carrier 2 by 20 dB. After t+2 seconds, the SS starts paging continuously on carrier 1 and reduces the level of carrier 2 back to the original level.

20.21.6.5 Test requirements

- 1) In step c), the MS shall transmit 2 RA requests on carrier 1 followed by 2 RA requests on carrier 2. Subsequent RA requests on carrier 1 shall not occur within 4,5 s of the second RA request on carrier 1.
- 2) In step f), there shall be no access on carrier 2 within 34 seconds of increasing the level of carrier 2.
- 3) After step g), the MS shall respond on carrier 2.

- 4) In step k) , there shall be no response on carrier 1 within 11 seconds after the level of carrier 2 is reduced back to the original level.

NOTE: The 11 seconds is derived from (t+15) seconds minimum cell reselection timer minus (t+2) seconds from the start of step k) up to the reduction of the level of carrier 2. A further 2 seconds are subtracted to cover for any uncertainty introduced by the RA process occurring after step g).

20.21.7 R-GSM priority of cells

20.21.7.1 Definition and applicability

In general, cell prioritization is a means of encouraging MSs to select some suitable cells in preference to others.

20.21.7.2 Conformance requirement

1. During cell selection a cell with low priority indication will only be selected if a suitable cell of normal priority cannot be found; GSM 03.22, 3.5.2.1.
2. Table 1a. Parameters affecting cell priority for cell selection

CELL_BAR_QUALIFY	CELL_BAR_ACCESS	Cell selection priority	Status for cell reselection
0	0	normal	normal
0	1	barred	barred
1	0	low	normal (see note 2)
1	1	low	normal (see note 2)

GSM 05.08, table 1.a

3. If all the following conditions are met then the "Cell selection priority" and the "Status for cell reselection" shall be set to normal:
 - the cell belongs to the MS HPLMN
 - the MS is in cell test operation mode
 - the CELL_BAR_ACCESS is set to "1"
 - the CELL_BAR_QUALIFY is set to "0"
 - the Access Control class 15 is barred

GSM 05.08, table 1.a

20.21.7.3 Test purpose

1. To verify that the MS does not select a cell of low priority when a suitable cell of normal priority exists with a lower received signal strength.
2. To verify that the MS takes into account CELL_BAR_ACCESS and CELL BAR _QUALIFY when performing cell selection and reselection.
3. To verify that the MS meets conformance requirement 3.

20.21.7.4 Method of test

20.21.7.4.1 Initial conditions

Parameters changed from Default values table 20.21.1

Parameter	Carrier 1	Carrier 2	Carrier 3	Carrier 4	Carrier 5	Carrier 6
RF Signal Level (dB μ V emf() / dBm)	33 / -80	43 / -70	33 / -80	23 / -90	OFF	OFF
RXLEV_ACCESS_MIN (dB μ V emf() / dBm)	3 / -110	23 / -90	13 / -100	13 / -100		
CBA	0	1	1	0		
CBQ	1	1	0	0		
Access class 15	barred	barred	barred	barred		
C1	30	20	20	10		

20.21.7.4.2 Procedure

- a) The SS activates the carriers and monitors for RA requests from the MS on carriers 1, 2, and 4.
- b) The MS is switched on.
- c) The MS is switched off. The SS deactivates the carriers.
- d) The MS is placed in cell test operation mode.

NOTE: Cell test mode is a mode of operation defined in SIM administrative data field.

- e) The SS activates the carriers and monitors for RA requests from the MS on carriers 1, 2, and 3.
- f) The MS is switched on.

20.21.7.5 Test requirements

- 1) After step b), the first response from the MS shall be on carrier 4 within 33 seconds, followed by a response on carrier 1 before a response (if any) on carrier 2 within 50 seconds.
- 2) After step f), the first response from the MS shall be on carrier 3 within 33 seconds, followed by a response on carrier 1 before a response (if any) on carrier 2 within 50 seconds.

20.21.8 R-GSM cell reselection when C1 (serving cell) < 0 for 5 seconds

20.21.8.1 Definition and applicability

20.21.8.2 Conformance requirement

1. At least every 5 s the MS shall calculate the value of C1 and C2 for the serving cell and recalculate C1 and C2 values for non serving cells (if necessary). The MS shall then check whether:
 - i) The path loss criterion (C1) for current serving cell falls below zero for a period of 5 seconds. This indicates that the path loss to the cell has become too high. GSM 05.08, 6.6.2.
2. While camped on a cell of the selected PLMN ("camped normally"), the MS may need to select a different cell ("normal cell reselection" state). The following events trigger a cell reselection:
 - i) The path loss criterion parameter C1 (see section 3.6) indicates that the path loss to the cell has become too high.; GSM 03.22, 4.5.

20.21.8.3 Test purpose

1. To verify that the MS meets conformance requirement 1.
2. To verify that the MS meets conformance requirement 2.

20.21.8.4 Method of test

20.21.8.4.1 Initial conditions

Parameters changed from Default values table 20.21.1

Parameter	Carrier 1	Carrier 2	Carrier 3	Carrier 4	Carrier 5	Carrier 6
RF Signal Level (dB μ V emf() / dBm)	63 / -50	33 / -80	OFF	OFF	OFF	OFF
RXLEV_ACCESS_MIN (dB μ V emf() / dBm)	43 / -70	23 / -90				
CRO	30 dB					
TO	0					
PT	0					
C1	20	10				
C2	50	10				

NOTE: With BS_PA_MFRMS = 5 (default value), the averaging time of the MS on the serving cell BCCH is 5,9s.

20.21.8.4.2 Procedure

- The SS activates the carriers. The MS is not paged on carrier 1. The SS monitors carriers 1 and 2 for RA requests from the MS.
- The MS is switched on.
- The SS reduces signal level on carrier 1 to -80 dBm / 33 dB μ V emf() for 4 s. Then, the SS raises the level back to -50 dBm / 63 dB μ V emf(). (C1 becomes -10 dB and C2, 20 dB during this period).
- The SS reduces signal level on carrier 1 to -80 dBm / 33 dB μ V emf()

20.21.8.5 Test requirements

- After step b), there shall be no access on carrier 1 or carrier 2, within 50 seconds.
- After step c), there shall be no access on carrier 2 within 30 seconds.
- After step d), the MS shall access on carrier 2 within 20 seconds.

20.21.9 R-GSM running average of the surrounding cell BCCH carrier signal levels

20.21.9.1 Definition and applicability

20.21.9.2 Conformance requirement

- Whilst in idle mode an MS shall continue to monitor all BCCH carriers as indicated by the BCCH allocation (BA - See table 1). A running average of received level in the preceding 5 to

$$\text{Max. } \{5, ((5 * N + 6) \text{ DIV } 7) * \text{BS_PA_MFRMS} / 4\}$$

seconds shall be maintained for each carrier in the BCCH allocation. N is the number of non-serving cell BCCH carriers in BA and the parameter BS_PA_MFRMS is defined in GSM 05.02; GSM 05.08, 6.6.1.

- The same number of measurement samples shall be taken for all non-serving cell BCCH carriers of the BA list, and the samples allocated to each carrier shall as far as possible be uniformly distributed over each evaluation period.; GSM 05.08, 6.6.1

20.21.9.3 Test purpose

1. To verify that if the MS calculates a received level average (over 5 seconds) for a non-serving suitable cell which results in the value of C2 exceeding the value of C2 for the serving cell, then cell reselection takes place to the non-serving cell.
2. To verify that by using suitable varying levels of signal strength for non serving cells, the MS samples on non serving cell BCCH carriers are as far as possible distributed uniformly over each evaluation period.

20.21.9.4 Method of test

20.21.9.4.1 Initial conditions

Parameters changed from Default values table 20.21.1

Parameter	Carrier 1	Carrier 2	Carrier 3	Carrier 4	Carrier 5	Carrier 6
RF Signal Level (dBμV emf() / dBm)	53 / -60	33 / -80	OFF	OFF	OFF	OFF
RXLEV_ACCESS_MIN (dBμV emf() / dBm)	23 / -90	23 / -90				
C1	30	10				
C2	30	10				

BS_PA_MFRMS is set to 4 for this test.

The BA(BCCH) list only contains 7 ARFCNs including the ARFCNs of the carriers used during the test.

NOTE: With 7 ARFCNs in the BA(BCCH) list and BS_PA_MFRMS=4 the MS will maintain a running average on surrounding cells over a period of 5 seconds.

20.21.9.4.2 Procedure

- a) The SS activates the carriers. The MS is not paged on carrier 1. The SS monitors carriers 1 and 2.
- b) The MS is switched on.
- c) The SS starts switching the level of carrier 2 between -80 dBm and -57 dBm every 2,7 seconds and continues to do so until the end of the test.
- d) The SS decreases the level of carrier 1 to -76 dBm.

NOTE: As a result of the switching in levels, the running average on carrier 2 will be between -66dBm and -71dBm, assuming that samples are distributed over five consecutive paging blocks.

20.21.9.5 Test requirements

- 1) After step b), there shall be no access from the MS on carrier 1 or carrier 2, within 50 seconds..
- 2) After step c), there shall be no access from the MS on carrier 1 or 2 within 25 seconds

NOTE: Any potential access on is likely to occur within 20 seconds.

- 3) After step d), the MS shall access on carrier 2 within 20 seconds.

20.21.10 R-GSM running average of the serving cell BCCH carrier signal level

20.21.10.1 Definition and applicability

The MS is required to monitor continuously the BCCH carrier signal level of the serving cell (and to compare it to the BCCH carrier signal levels of the non-serving cells) to guarantee that it is camped on the most suitable cell.

20.21.10.2 Conformance requirement

1. For the serving cell, receive level measurement samples shall be taken at least for each paging block of the MS. The receive level average shall be a running average determined using samples collected over a period of 5 s or five consecutive paging blocks of that MS, whichever is the greater period. New receiving level average values shall be calculated as often as possible.; GSM 05.08, 6.6.1.

20.21.10.3 Test purpose

1. To verify that by using suitable varying levels of signal strength for the serving cell, the MS performs a running average over 5 consecutive paging blocks.

20.21.10.4 Method of test

20.21.10.4.1 Initial conditions

Parameters changed from Default values table 20.21.1 are below,

Parameter	Carrier 1	Carrier 2	Carrier 3	Carrier 4	Carrier 5	Carrier 6
RF signal level (dB μ V emf() / dBm)	63 / -50	39 / -74	OFF	OFF	OFF	OFF
RXLEV_ACCESS_MIN (dB μ V emf() / dBm)	23 / -90	23 / -90				
C1	40	16				
C2	40	16				

NOTE: With BS_PA_MFRMS = 5 (default value), the averaging time of the MS on the serving cell BCCH is 5,9s.

20.21.10.4.2 Procedure

- a) The SS activates the carriers. The MS is not paged on carrier 1. The SS monitors carriers 1 and 2 for RA requests from the MS.
- b) The MS is switched on.
- c) After 50 seconds the SS starts switching the level of carrier 1 between -80 dBm and -50 dBm every 3 seconds.

NOTE: As a result of the switching in levels, the running average on carrier 1 will be between -62 dBm and -68 dBm over five consecutive paging blocks.

- d) The SS increases the level of carrier 2 to -56 dBm.

20.21.10.5 Test requirement

- 1) After step c), the MS shall not access on carrier 2, within 25 seconds.
- 2) After step d), the MS shall access on carrier 2, within 30 seconds.

NOTE 1: 13,75 seconds to perform running average, 10 seconds to detect C2 differences, 2,4 seconds to read BCCH of carrier 2, 1 second to perform RA. Total 27,15 seconds, allow 30 seconds.

20.21.11 Updating the list of six strongest neighbour carriers and decoding the BCCH information of a new carrier on the list

20.21.11.1 Definition and applicability

20.21.11.2 Conformance requirement

1. The list of the 6 strongest non-serving carriers shall be updated at least as often as the duration of the running average defined for measurements on the BCCH allocation and may be updated more frequently; GSM 05.08, 6.6.1.
2. When the MS recognizes that a new BCCH carrier has become one of the 6 strongest, the BCCH data shall be decoded for the new carrier within 30 seconds; GSM 05.08, 6.6.1.

20.21.11.3 Test purpose

1. To verify that MS meets conformance requirement 1.
2. To verify that MS meets conformance requirement 2.

20.21.11.4 Method of test

20.21.11.4.1 Initial conditions

Six BCCH carriers are established with the system information contents of table 20.21.1.

Parameters changed from Default values table 20.21.1 are below,

Parameter	Carrier 1	Carrier 2	Carrier 3	Carrier 4	Carrier 5	Carrier 6	Carrier 7
RF signal level (dB μ V emf ()/dBm)	53 / -60	48 / -65	43 / -70	38 / -75	33 / -80	33 / -80	38 / -75
RXLEV_ACCESS_MIN	-90	-90	-90	-90	-90	-90	-110
C1	30	25	20	15	10	10	35
C2	30	25	20	15	10	10	35

The BA(BCCH) list contains only eight ARFCNs and includes those of carriers 1 to 7.

BS_PA_MFRMS is set to 3 during this test.

NOTE: The combination of 8 carriers on the BA list and BS_PA_MFRMS = 3 leads to averaging time of 5 seconds. Hence 5 seconds is also the updating time of the list of six strongest neighbour carriers.

20.21.11.4.2 Procedure

- a) The SS activates carriers 1 to 6. The MS is not paged on any of the carriers.
- b) The MS is switched on.
- c) After 60 seconds, the SS activates carrier 7 and pages the MS continuously on this carrier. The SS monitors carrier 7 for RA requests from the MS.

20.21.11.5 Test requirements

- 1) The MS shall access on carrier 7 within 55 s of activating carrier 7.

NOTE: 5,5 seconds to notice new strongest carrier in top 6 (because the updating time for six strongest is 5 seconds (+10 %)), 33 seconds to read BCCH, 15 seconds for reselection, since the MS has already performed the running average on the new strongest carrier, allow 55 seconds.

20.21.12 R-GSM decoding the BCCH information of the neighbour carriers on the list of six strongest neighbour carriers

20.21.12.1 Definition and applicability

20.21.12.2 Conformance requirement

1. The MS shall attempt to decode the BCCH data block that contains the parameters affecting cell reselection for each of the 6 strongest non-serving cell BCCH carriers at least every 5 minutes; GSM 05.08, 6.6.1.

NOTE: Verification of cell reselection as implicitly tested here is performed in section 20.21.3.

20.21.12.3 Test purpose

1. To verify that the MS decodes the BCCH data block that contains the parameters affecting cell reselection for a non-serving cell BCCH carrier, (which is in the list of six strongest neighbour cells), at least every 5 minutes. This is achieved by changing the BCCH data such that the value of C2 for the non serving cell exceeds the value of C2 for the serving cell, and observing that the MS performs cell reselection within 5 minutes plus the time allowed for cell reselection after the change of the BCCH data.

20.21.12.4 Method of test

20.21.12.4.1 Initial conditions

Parameters changed from Default values table 20.21.1 are below,

Parameter	Carrier 1	Carrier 2	Carrier 3	Carrier 4	Carrier 5	Carrier 6
RF signal level (dBμV emf) / dBm)	38 / -75	33 / -80	OFF	OFF	OFF	OFF
C1	15	10				
C2	15	10				

20.21.12.4.2 Procedure

- a) The SS activates the carriers. The MS is not paged on carrier 1. The SS monitors carriers 1 and 2.
- b) The MS is switched on.
- c) The SS changes the RXLEV_ACCESS_MIN in the BCCH data of carrier 2 to be -100 dBm.

NOTE: With the above change the C2 of carrier 2 becomes 20 whereas the C2 of carrier 1 stays at 15.

20.21.12.5 Test requirements

- 1) After step b), there shall be no access from the MS on carrier 1 or carrier 2 within 50 seconds.
- 2) After step c), the MS shall access on carrier 2 within 345 s of the change in the BCCH data of carrier 2.

NOTE: 330 s for decode of BCCH of carrier 2 (300 s +10 %), 15 seconds for reselection of carrier 2, since the MS already has a running average on carrier 2.

20.21.13 R-GSM decoding the BSIC of the neighbour carriers on the list of six strongest neighbour carriers

20.21.13.1 Definition and applicability

20.21.13.2 Conformance requirement

1. The MS shall attempt to check the BSIC for each of the 6 strongest non-serving cell BCCH carriers at least every 30 seconds, to confirm that it is monitoring the same cell. If a change of BSIC is detected then the carrier shall be treated as a new carrier and the BCCH data redetermined; GSM 05.08, 6.6.1.

NOTE: Verification of cell reselection as implicitly tested here is performed in section 20.21.3.

20.21.13.3 Test purpose

1. To verify that the MS will check the BSIC of the non-serving cell, which is in the list of six strongest neighbour cells, by changing the BSIC and the BCCH data of the non-serving cell such that the value of C2 for that cell exceeds the value of C2 of the serving cell, and observing that the MS performs cell reselection within the time allowed to check the BSIC, redetermine the BCCH data and perform cell reselection.

20.21.13.4 Method of test

20.21.13.4.1 Initial conditions

Parameters changed from Default values table 20.21.1 are below:

Parameter	Carrier 1	Carrier 2	Carrier 3	Carrier 4	Carrier 5	Carrier 6
RF signal level (dB μ V emf() / dBm)	38 / -75	33 / -80	OFF	OFF	OFF	OFF
C1	15	10				
C2	15	10				

20.21.13.4.2 Procedure

- a) The SS activates the carriers. The MS is not paged on carrier 1. The SS monitors carriers 1 and 2.
- b) The MS is switched on.
- c) The SS changes the BSIC of carrier 2 by changing the Base Station Colour Code (BCC) part of the BSIC. The SS also changes the RXLEV_ACCESS_MIN in the BCCH data of carrier 2 to be -100 dBm.

NOTE: With the above change to the BCCH data the C2 of carrier 2 becomes 20 whereas the C2 of carrier 1 stays at 15.

20.21.13.5 Test requirements

- 1) In step b), there shall be no access from the MS on carrier 1 or carrier 2 within 50 seconds.
- 2) After step c), the MS shall access on carrier 2 within 85 s of the change in the BSIC value (and BCCH data) of carrier 2.

NOTE: 33 seconds for check of BSIC on carrier 2, 33 seconds for decode of BCCH of carrier 2, 15 seconds for reselection of carrier 2, since the MS already has a running average on carrier 2, allow 85 seconds.

20.21.14 R-GSM emergency calls

20.21.14.1 Definition and applicability

This test is applicable for R-GSM MSs supporting speech.

20.21.14.2 Conformance requirement

1. When in a limited service state, the MS shall be able to initiate emergency calls; GSM 05.08, 6.8.
2. When in a limited service state and if not camped on a cell, the MS shall monitor the signal strength of all 194 RF channels, and search for a BCCH carrier which has $C1 > 0$ and which is not barred. When such a carrier is found, the MS shall camp on that cell, irrespective of the PLMN identity; GSM 05.08, 6.8.
3. The MS shall perform cell reselection at least among the cells of the PLMN of the cell on which the MS has camped, according to the algorithm of GSM 03.22, 4.5 & 3.7, except that a zero value of CELL_RESELECT_HYSTERESIS shall be used; GSM 05.08, 6.8.

20.21.14.3 Test purpose

1. To verify that the MS shall be able to initiate emergency calls when no suitable cells of the selected PLMN are available, but at least one acceptable cell is available.
2. To verify that the MS selects a cell with $C1 > 0$ and $CBA = 0$ when no suitable cells of the selected PLMN are available.
3. To verify that the MS, when performing cell reselection in the limited service state, uses $CELL_RESELECT_HYSTERESIS = 0$.

20.21.14.4 Method of test

20.21.14.4.1 Initial conditions

Parameters changed from Default values table 20.21.1 are below

Parameter	Carrier 1	Carrier 2	Carrier 3	Carrier 4	Carrier 5	Carrier 6
RF signal level (dB μ V emf) / dBm)	38 / -75	33 / -80	33 / -80	OFF	OFF	OFF
RXLEV_ACCESS_MIN (dB μ V emf) / dBm)	23 / -90	43 / -70	23 / -90			
CELL_BAR_ACCESS MCC,MNC	1 (barred) forbidden	0 forbidden	0 forbidden			
CELL_RESELECT_HYST	0	0	14 dB			
C1	15	-10	10			

NOTE: All the BCCH carriers belong to the same PLMN, which is not the MS's home PLMN and is in the SIM's forbidden PLMN's list.

20.21.14.4.2 Procedure

- a) The SS activates the carriers. The SS monitors for RA attempts from the MS on carriers 1, 2 and 3 for the duration of the test.
- b) The MS is switched on.
- c) 50 seconds after switch on, an emergency call is initiated on the MS.
- d) The SS changes the CBA of carrier 1 to 0.

NOTE: The MS should reselect to carrier 1 because it should not take into account the $CELL_RESELECT_HYST$ value of 14 but use 0 instead.

- e) After 345 s an emergency call is initiated on the MS.

NOTE: 330 seconds to detect change of BCCH data, 15 seconds to perform reselection of carrier 1, since the MS already has a running average on carrier 1.

20.21.14.5 Test requirements

- 1) In step c), the first access by the MS shall be on carrier 3.
- 2) In step e), the first access from the MS shall be on carrier 1.

20.21.15 R-GSM cell reselection due to MS rejection "LA not allowed"

20.21.15.1 Definition and applicability

While camped on a cell of the selected PLMN the MS may need to select a different cell in order to fulfil the normal service state. This ensures that the MS is camped on a cell from which it can reliably decode downlink data and with which it has a high probability of communications on the uplink.

This process goes on while camping on a cell which pertains to an LA which is placed in the list of "forbidden LAIs for regional provision of service".

20.21.15.2 Conformance requirement

1. In response to a registration attempt, when receiving an LU reject with cause value "LA not allowed", the MS stores this LAI in a list of "forbidden LAIs for regional provision of service", to prevent repeated attempts to access a cell of the forbidden LA, GSM 03.22, 3.3.
2. If the MS has received the cause 'LA not allowed', it shall ignore this fact when selecting a cell to camp on, i.e. it shall not reject a cell for camping on because that cell is part of a LA where this cause has been received, GSM 03.22, 3.5.4.
3. In response to a registration attempt, when receiving an LU reject with cause value "LA not allowed", the MS continues to perform normal cell-reselection, GSM 03.22, 4.4.2
4. A new LU attempt shall only be performed when a new LA (or new PLMN) is entered according to the cell reselection procedure, GSM 03.22, 3.3 & figure 4.

NOTE: LA stands for "Location Area" and LU stands for "Location Update".

20.21.15.3 Test purpose

1. To verify that if an LU is rejected with cause "LA not allowed" that the LAI of that cell is written into a forbidden list which prevents the MS from performing LU onto another cell in that LA. This is verified indirectly in test purposes 2,3 and 4.
2. To verify that the MS will not reject a cell for camping on because that cell is part of a LA in the list of "forbidden LAIs for regional provision of service". This is verified indirectly by making the MS attempt an emergency call and checking that the channel request message is transmitted on the correct cell.
3. To verify that the MS when receiving an LU reject with cause value "LA not allowed", the MS continues to perform normal cell-reselection:

Cell reselection is triggered if there is a better cell (in terms of the path loss criterion C2) in the same LA, or a much better cell in another LA of the selected PLMN (using the CRH parameter). GSM 03.22, 3.4 & 4.5.

4. To verify that a new LU attempt will be performed when a new LA (or new PLMN) is entered, GSM 03.22, 3.3 & figure 4.

20.21.15.4 Method of test

20.21.15.4.1 Initial conditions

Parameters changed from Default values table (table 20.21.1)

Parameter	Carrier 1	Carrier 2	Carrier 3	Carrier 4	Carrier 5	Carrier 6
RF Signal Level (dB μ V emf() / dBm)	63 / -50	54 / -59	44 / -69	OFF	OFF	OFF
RXLEV_ACCESS_MIN (dB μ V emf() / dBm)	53 / -60	35 / -78	29 / -84			
CRH	14	0	10			
LAC	H1111	H2222	H1111			
ATT	1	1	1			
C1	10	19	15			
C2	10	19	15			

20.21.15.4.2 Procedure

- a) The SS activates the carriers. The SS monitors all RA requests from MS on carriers 1, 2 & 3 until step e) has been completed. Only idle-paging is sent on all channels.
- b) The MS is switched on.

- c) When the MS performs an IMSI attach onto carrier 1, the SS shall reject it with cause "LA not allowed"
- d) 30 seconds after the MS has returned to idle mode (channel release after LU reject), the MS is manually commanded to set up an emergency call.

NOTE 1: $C2$ of carrier 3 > $C2$ of carrier 1. Carriers 1 and 3 belong to the same LA.

- e) The SS rejects the CM service request from the MS, with a CM service reject message with cause value #17 (Network Failure).

NOTE 2: Cause values #4 (IMSI unknown in VLR) or #6 (Illegal ME) lead to unwanted behaviour of the mobile.

- f) 10 seconds after the MS has returned to idle mode (channel release after CM service reject), the SS increases the level of carrier 2 to 65 dB μ V emf().

NOTE 3: $C2$ of carrier 2 = 30, now larger than $C2$ of carrier 3 + CRH.

- g) The SS shall accept any LU on carrier 2.

20.21.15.5 Test requirements

- 1) After step b), the MS shall respond on carrier 1 within 33 s.
- 2) In step d), the MS shall access on carrier 3 with a channel request message, within 15 seconds of being commanded to set up the emergency call.
- 3) After increasing the level of carrier 2 in step f), the MS shall reselect and access onto carrier 2 requesting an LU within 30 seconds.

NOTE 1: 13,75 seconds to perform running average, 10 seconds to detect $C2$ differences, 2,4 seconds to read BCCH of carrier 2, 1 second to perform RA. Total 27,15 seconds, allow 30 seconds.

20.21.16 R-GSM downlink signalling failure

20.21.16.1 Definition and applicability

See conformance requirement.

20.16.2 Conformance requirement

The downlink signalling failure criterion is based on the downlink signalling failure counter DSC.

1. When the MS camps on a cell, DSC shall be initialized to a value equal to the nearest integer to $90/N$ where N is the BS_PA_MFRMS parameter for that cell (see GSM 05.02).
2. Thereafter, whenever the MS attempts to decode a message in its paging subchannel; if a message is successfully decoded DSC is increased by 1, (however never beyond the nearest integer to $90/N$).
3. Whenever the MS can not successfully decode a message in its paging subchannel the DSC is decreased by 4.
4. When DSC reaches 0, a downlink signalling failure shall be declared. A downlink signalling failure shall result in cell reselection, GSM 03.22, 4.5 (ii) and GSM 05.08, 6.5.

NOTE: The network sends the paging subchannel for a given MS every BS_PA_MFRMS multiframes. The requirement for network transmission on the paging subchannel is specified in GSM 04.08. The MS is required to attempt to decode a message every time its paging subchannel is sent.

20.21.16.3 Test purpose

1. To verify that the MS initializes the DSC counter in accordance with the conformance requirement. This is verified indirectly.
2. To verify that whenever the MS successfully decodes a message on paging subchannel, the DSC is increased by 1, (however never beyond the nearest integer to $90/N$). This is verified indirectly.

- 3 To verify that whenever the MS can not successfully decode a message on paging subchannel, the DSC decreased by 4. This is verified indirectly.
4. To verify that when the DSC reaches 0, a downlink signalling failure shall be declared and the MS will perform cell reselection.

20.21.16.4 Method of test

20.21.16.4.1 Initial conditions

Two BCCH carriers are established with the system information contents of table 20.21.1.

Parameters changed from Default values table (table 20.21.1) are below

Parameter	Carrier 1	Carrier 2	Carrier 3	Carrier 4	Carrier 5	Carrier 6
RF signal level (dB μ V emf() / dBm) C1 = C2	43 / -70 20	33 / -80 10	OFF	OFF	OFF	OFF

NOTE: The DSC counter will have a value 18 (90/5).

20.21.16.4.2 Procedure

- a) The MS is switched on. On carrier 1 valid layer 3 messages shall be sent in the paging blocks, but not paging the MS (idle paging). On carrier 2 the MS is paged continuously in all paging blocks.
- b) After 40 s the SS sends corrupted data (using random data, wrong parity bits see GSM 05.03, 4.3 & 4.1.2 or other lower layer error) in four successive paging blocks to carrier 1 and then reverts to sending normal data.

NOTE 1: Sending corrupted, i.e. non-decodable data on four successive paging blocks should decrease the DSC to 2.

- c) The SS monitors all accesses on both carriers for 30 s.
- d) The SS sends corrupted data in five successive paging blocks to carrier 1 and then reverts to sending normal data.

NOTE 2: Sending random, data on five successive paging blocks should decrease the DSC to < 0 and cause a cell reselection.

- e) The SS monitors all accesses on both carriers for 30 s.

20.21.16.5 Test requirements

- 1) There shall be no access to carrier 2 in test steps a) and c).
- 2) The MS shall access on carrier 2 at test step e) within 15 seconds.

20.21.17 R-GSM cell selection if no suitable cell found in 10 s

20.21.17.1 Definition and applicability

See conformance requirement.

20.21.17.2 Conformance requirement

If no suitable cell is found in cell reselection process within 10 seconds, the cell selection algorithm of GSM 03.22 shall be performed, GSM 05.08; 6.6.2.

20.21.17.3 Test purpose

To verify that the MS fulfils the conformance requirement

20.21.17.4 Method of test

20.21.17.4.1 Initial conditions

One BCCH carrier is established with the system information contents of table 20.21.1.

Parameters changed from Default values table (table 20.21.1) are below

Parameter	Carrier 1	Carrier 2	Carrier 3	Carrier 4	Carrier 5	Carrier 6
RF signal level (dB μ V emf() / dBm)	43 / -70	OFF	OFF	OFF	OFF	OFF
C1 = C2	20					

20.21.17.4.2 Procedure

- a) The MS is switched on. Idle paging is sent on carrier 1.
- b) After the MS indicates service the SS reduces the transmit level of carrier 1 to 13 dB μ V emf() (so that C1 of carrier 1 becomes -10) and turns on a new carrier (carrier 2) at a level of 33 dB μ V emf(). Carrier 2 shall not be in the MS BA list (i.e. it shall not be one of the carriers that MS has been monitoring after camped on carrier 1)
- c) The SS shall monitor all accesses on carriers 1 and 2 for 60 s.

NOTE: The access on carrier 2 should not take longer than 50 s. (5 seconds to rxlev averages, 5 s for C1<0 duration, 10 s for searching another suitable cell, 30 s for cell selection), 60 s is a safe time to wait.

20.21.17.5 Test requirements

The MS shall access on carrier 2 at test step c) within 60 s.

20.21.18 R-GSM cell reselection due to MS rejection "Roaming not allowed in this LA"

20.21.18.1 Definition and applicability

While camped on a cell of the selected PLMN the MS may need to select a different cell in order to fulfil the normal service state. This ensures that the MS is camped on a cell from which it can reliably decode downlink data and with which it has a high probability of communications on the uplink.

The MS looks for suitable neighbour cells which satisfies 4 constraints including that It should not be in an LA which is in the list of "forbidden LAs for roaming".

20.21.18.2 Conformance requirement

1. To prevent repeated attempts to have roaming service on a not allowed LA, when the MS is informed that an LA is forbidden, the LA is added to a list of "forbidden LAs for roaming" which is stored in the MS, GSM 03.22; 3.1.
2. If the MS has received the cause "Roaming not allowed in this LA", in response to a LU attempt, the Network Selection Procedure shall be started, GSM 03.22; 4.3.3 L3, GSM 04.08; 4.4.4.7.
3. The MS can only perform camping on a suitable cell, which:
 - should not be in an LA which is in the list of "forbidden LAs for roaming" GSM 03.22, 3.2.1.

NOTE: LA stands for "Location Area" and LU stands for "Location Update".

20.21.18.3 Test purpose

1. To verify that if an LU is rejected with cause "Roaming not allowed in this LA", that the LAI of that cell is written into a forbidden list which prevents the MS from camping onto any cell in that LA.

2. To verify that if the MS has received the cause "Roaming not allowed in this LA", in response to a LU attempt, the Network Selection Procedure is initiated. This is verified indirectly by test purpose 3, in that the new LA is accessed as part of cell selection, hence CRH is disregarded.
3. To verify that if an LU is rejected, when attempting LU in a LA with LAI = LAI1, with cause "Roaming not allowed in this LA" and only cells of the selected PLMN are available, the MS will only camp and attempt LU in any LA with LAI <> LAI1.

20.21.18.4 Method of test

20.21.18.4.1 Initial conditions

Parameters changed from Default values table (table 20.21.1)

Parameter	Carrier 1	Carrier 2	Carrier 3	Carrier 4	Carrier 5	Carrier 6
RF Signal Level (dB μ V emf() / dBm)	63 / -50	53 / -60	OFF	OFF	OFF	OFF
RXLEV_ACCESS_MIN (dB μ V emf() / dBm)	23 / -90	23 / -90				
MNC	MNC <> HPLMN	MNC <> HPLMN				
MCC	MCC of HPLMN	MCC of HPLMN				
CRH	0	0				
LAC	H1111	H2222				
ATT	1	1				
C1	40	30				
C2	40	30				

20.21.18.4.2 Procedure

- a) The MS is switched on. Idle paging is sent on all carriers.
- b) The SS monitors all RA requests from MS on carriers 1 & 2.
- c) When the MS performs an IMSI attach onto carrier 1, the SS shall reject it with cause "Roaming not allowed in this LA".
- d) The SS shall accept any LU on carrier 2.
- e) The SS monitors all RA requests from MS on carriers 1 to 2.

20.21.18.5 Test requirements

- 1) The MS should respond on carrier 1 within 33 s of switch on.
- 2) After LU reject, the MS shall initiate the Network Selection Procedure and access onto Carrier 2 as part of cell selection within 33 seconds from returning to idle mode after the LU reject.

NOTE: The timing requirement in b) is given only for testing purposes only. No timing requirements are defined for the Network Selection Procedure, but the time allowed for cell selection (see 20.21.1) should be adequate.

- 3) After the LU reject on carrier 1, there shall be no more access attempts on this carrier.

20.21.19 R-GSM cell selection on release of SDCCH and TCH

20.21.19.1 Definition and applicability

20.21.19.2 Conformance requirement

1. When the SS releases a TCH or SDCCH and returns to idle mode, it shall, as quickly as possible camp on the BCCH carrier of the cell whose channel has just been released. If the full BCCH data for that cell was not decoded in the preceding 30s, the MS shall then attempt to decode the full BCCH data. Until the MS has decoded the BCCH data required for determining the paging group, it shall also monitor all paging blocks on timeslot 0 of the BCCH carrier for possible paging messages that might address it. If the MS receives a page before having decoded the full BCCH data for the cell, the MS shall store the page and respond once the full BCCH data has been decoded, provided that the cell is not barred and the MSs access class is allowed. GSM 05.08, 6.7.

20.21.19.3 Test purpose

1. To verify that on release of a TCH or an SDCCH, the MS camps as quickly as possible on the BCCH carrier of the cell whose channel has just been released.

NOTE: This is implicitly tested by the MS responding to a paging request. The decoding of BCCH data cannot be explicitly tested. However, the MS shall monitor for paging messages which may address it if it decodes the BCCH.

20.21.19.4 Method of test

20.21.19.4.1 Initial conditions

- a) Parameters changed from default values in table 20.21.1

Parameter	Carrier 1	Carrier 2	Carrier 3	Carrier 4	Carrier 5	Carrier 6
RF Signal Level (dBmV emf() / dBm)	53 / -60	33 / -80	OFF	OFF	OFF	OFF
RXLEV_ACCESS_MIN (dBmV emf() / dBm)	23 / -90	23 / -90				
BS_PA_MFRMS	2	2				
ATT	1					
C1	30	10				
C2	30	10				

- b) Carrier 1 is configured to have a combined control channel.
- c) Carrier 2 is configured to have a non combined control channel.

20.21.19.4.2 Test procedure

- a) The SS activates the carriers. No paging messages are transmitted on carrier 1 or carrier 2.
- b) The MS is switched on.
- c) In response to the MS access for IMSI attach, the SS allocates a combined SDDCH/4, accepts the IMSI attach procedure and then releases the link. After 0,5 seconds but within 1 second of transmitting the UA frame on completion of the IMSI attach procedure, the SS transmits a single PAGING REQUEST in the appropriate paging block of the MS on carrier 1.
- d) When the MS responds to paging, the SS establishes a call on a traffic channel.
- e) The SS increases the level of carrier 2 to 63 dBmV emf().
- f) After 10 seconds the SS performs a handover to another TCH, with the parameters of carrier 2 indicated in the CELL DESCRIPTION information element of the HANDOVER COMMAND message.

- g) After a further 10 seconds, the SS clears down the call. After 0,5 seconds but within 1 second of transmitting the UA frame, the SS transmits a single PAGING REQUEST on carrier 2 in the appropriate paging block of the MS.

20.21.19.5 Test requirements

- 1) After step b) the MS shall access in order to commence an IMSI attach procedure on carrier 1 within 33 seconds.
- 2) In step c), the MS shall respond to paging within 3 seconds of transmitting the PAGING REQUEST.
- 3) In step g), the MS shall respond to paging within 3 seconds of transmitting the PAGING REQUEST.

20.22 GPRS Cell Selection and Reselection

The absolute accuracy of the MS signal level measurements is assumed to be +/-6 dB. A difference of at least 8 dB is allowed for cases of discrimination between C1, C31,C32 values and 0.

The relative accuracy of the MS signal level measurements is assumed to be +/-3 dB for the signal levels used in the tests of this section. A difference of at least 5 dB is allowed for cases of discrimination between C1 and C31 and C32 values on different carriers.

NOTE 1: The accuracy of MS signal level measurements is specified in GSM 05.08. For all of the tests in this section, the signal levels used are greater than 1 dB above reference sensitivity level.

NOTE 2: The tolerance on timers specified in GSM 05.08 is +/-10 % except for PENALTY_TIME where it is +/-2 seconds. In the tests of this section, the test requirements include these tolerances. Consequently, the times stated in the test requirement sometimes differ from the corresponding timer in the conformance requirement.

Where pulsed signals are specified, the SS tolerance on pulse width is +/-2 % and the SS tolerance on power level +/-1 dB.

The cell re-selection tests defined in the sections 20.22.1 to 20.22.7 apply to the MSs attached to GPRS if a PBCCH exists in the serving cell. The cell re-selection tests defined in the sections 20.22.8 and 20.22.9 apply to the MSs attached to GPRS when no PBCCH exists in the serving cell. Otherwise the MS shall perform cell re-selection according to the idle mode procedures defined in clause 6 of GSM 05.08 and therefore tests defined in section 20 of GSM 11.10 apply.

The support of GPRS in a cell is indicated by the presence of the field GPRS Indicator in the SI 3 Rest Octets (GSM 04.08, 10.5.2.34) or in SI 4 Rest Octets (GSM 04.08, 10.5.2.35). This means the SS has to include this field in one of the two Rest Octets in order to enable support of GPRS in a cell.

The following definitions are applicable to tests 20.22.1 to 20.22.9 :

- Carrier X supports GPRS : the SS includes the field GPRS Indicator in SI 3 Rest Octets and in SI 4 Rest Octets.
- The SS enables GPRS on carrier X : the SS starts including the field GPRS Indicator in SI 3 Rest Octets and in SI 4 Rest Octets.
- The SS disables GPRS on carrier X : the SS stops including the field GPRS Indicator in SI 3 Rest Octets and in SI 4 Rest Octets.

Unless otherwise stated in the method of test, in all of the tests of this section:

- The SIM is in the idle updated state in the default registration area with a PTMSI assigned at the beginning of each test.
- All carriers support GPRS on BCCH without a separate PBCCH channel
- The Scheduling of Packet System information should be such that a complete set of consistent PSI messages can be decoded within 8 multiframe.
- The MS is configured to automatically attach to GPRS at switch on by using the PICS/PIXIT Statement "Automatic GPRS attach procedure at switch on or power on Yes/No" as in GPRS Attach procedure tests (see section 44.2.1)

Table 20.22.1: Default values of the system information fields

Parameter	GSM 04.60 reference	Abbr.	Normal Setting
PRIORITY_CLASS	11.2.20	PC	1
C31_HYST	11.2.20	C31H	0
RA_RESELECT_HYSTERESIS	11.2.20	RARH	0 dB
HCS_THR	11.2.20	HT	-110dBm
GPRS_RESELECT_OFFSET	11.2.20	GRO	0 dB
REPORTING_PERIOD	11.2.23	RP	60s
NETWORK_CONTROL_ORDER	11.2.23	NCO	NC0
GPRS_CELL_RESELECT_HYST	11.2.20	GCRH	0 dB
GPRS_TEMPORARY_OFFSET	11.2.20	GTO	0 db
GPRS_PENALTY_TIME	11.2.20	GPT	0 s
SPLIT_PG_CYCLE	5.5.1.5	SPGC	0
GPRS_CELL_RESELECT_HYSTERESIS	11.2.20	GCRH	4 dB
GPRS_MS_TXPWR_MAX_CCH	11.2.20	GMTMC	Max. output power of MS
GPRS_RXLEV_ACCESS_MIN	11.2.20	GRAM	-90 dBm
C32_QUAL	11.2.20	C32Q	0
BA(GPRS) ARFCN	11.2.20	BA	All 0 except: For GSM 450 ARFCNs 259, 263, 269, 275, 279, 283, 287, 292, broadcast in PACKET SYSTEM INFORMATION type 3 For GSM 480 ARFCNs 306, 310, 316, 322, 326, 330, 334, 339, broadcast in PACKET SYSTEM INFORMATION type 3 For GSM 750 ARFCNs 441, 446, 452, 455, 461, 462, 466, 470, 477, 485, 493, 511, 207,219, 251, broadcast in PACKET SYSTEM INFORMATION type 3 For GSM 850 ARFCNs 130, 136, 145, 152, 168, 170, 176, 177, 181, 185, 189, 193, 197, 207,219, 251, broadcast in PACKET SYSTEM INFORMATION type 3 For GSM900, both P-GSM and E-GSM ARFCNs are broadcast: GSM ARFCNs 3, 9, 18, 25, 41, 43, 49, 50, 54, 58, 62, 66, 70, 80, 92, 124, broadcast in PACKET SYSTEM INFORMATION type 3 E-GSM ARFCNs 985, 989, 995, 1010, 1014 broadcast in PACKET SYSTEM INFORMATION type 3 For DCS1800 ARFCNs 512, 543, 568, 589, 602, 641, 662, 683, 696, 711, 732, 754, 794, 851, 870, 871, 872, 884 broadcast in PACKET SYSTEM INFORMATION TYPE 3.
			For GSM1900 ARFCNs 512, 543, 568, 589, 602, 629, 641, 653, 662, 683, 696, 711, 727, 732, 754, 777, 794, 809 broadcast in SYSTEM INFORMATION TYPE 2

20.22.1 Cell selection

20.22.1.1 Definition and applicability

Cell selection is a process in which an MS, whenever a new PLMN is selected, attempts to find a suitable cell of that PLMN to camp on. Two methods of searching for a suitable cell are possible, normal cell selection and stored list cell selection. The process ensures that the MS is camped on a cell from which it can reliably decode downlink data and with which it has a high probability of communications on the uplink. Once the MS is camped on a cell, access to the network is allowed.

20.22.1.2 Conformance requirement

1. The MS shall be able to select the strongest cell within 30 seconds of switch on. This assumes a valid SIM, with PIN disabled and ideal radio conditions, GSM 05.08, 6.1.
2. There are various requirements that a cell must satisfy before an MS can perform normal camping on it:
 - 2.1 (i) It should be a cell of the selected PLMN
 - 2.2 (ii) It should not be "barred" (see section 3.5.1)
 - 2.3 (iii) It should not be in an LA which is in the list of "forbidden LAs for roaming";
 - 2.4 (iv) The radio path loss between MS and BTS must be below a threshold set by the PLMN operator. This is estimated as shown in section 3.6. GSM 03.22, 3.2.1.

NOTE: Criteria 2.3 (iii) is not applicable for Cell Selection.

3. Initially the MS looks for a cell which satisfies these 4 constraints ("suitable cell") by checking cells in descending order of received signal strength. If a suitable cell is found, the MS camps on it, GSM 03.22, 3.2.1.
4. The MS shall be able to calculate correctly the path loss criterion parameter $C1$, used for cell selection and reselection, GSM 05.08, 6.4.

20.22.1.3 Test purpose

1. To verify that the MS meets conformance requirement 1. even when one of the other cells supports GPRS.
2. To verify that:
 - 2.1 The MS does not select a cell of a PLMN, which is not the selected PLMN.
 - 2.2 The MS does not select a cell which is "barred".
 - 2.4 The MS does not select a cell with $C1 < 0$.
3. To verify that the MS selects suitable cells in descending order of received signal strength.
4. To verify that the MS does not select a cell with $C1 < 0$.

20.22.1.4 Method of test

20.22.1.4.1 Initial conditions

Parameters changed from the default values in table 20.22.1.

Parameter	Carrier 1	Carrier 2	Carrier 3	Carrier 4	Carrier 5	Carrier 6
RF Signal Level (dBm)	-75	-80	-70	-60	-70	-80
CBA	0	0	0	1	0	
RXLEV_ACCESS_MIN (dBm)	-90		-90	-90	-60	
GPRS_RXLEV_ACCESS_MIN		-90				-90
MNC			01 (011 for PCS 1900)			
MCC			002			
C1	15	10	20	30	-10	

NOTE 1: For an E-GSM MS carrier 1 and carrier 5 ARFCNs are chosen in the E-GSM band, carrier 3 and carrier 4 ARFCNs in the P-GSM band.

NOTE 2: Carrier 2 is the BCCH carrier which broadcasts the position of the PBCCH channel in the cell (Carrier 6.)

NOTE 3: Carriers 1,3,4 and 5 do not support GPRS.

20.22.1.4.2 Procedure

- a) The SS activates and pages on the MS on all carriers. All Carriers are monitored for RA requests from the MS.
- b) The MS is switched on.

20.22.1.5 Test requirements

- 1) After step b), the first response from the MS shall be on carrier 1 within 33 seconds. There shall be no response from the MS on any other carrier

20.22.2 Cell reselection in Packet Idle mode

20.22.2.1 Definition and applicability

This test is applicable for all types of GPRS mobiles

20.22.2.2 Conformance requirement

1. At least for every new sample or every second, whichever is the greatest, the MS shall update RLA_P and calculate the value of C1, C31 and C32 for the serving cell and the non-serving cells; GSM 05.08, 10.1.2 The MS shall make a cell re-selection if:
 - (i) The path loss criterion parameter (C1) for the serving cell falls below zero.
 - (ii) A non-serving suitable cell (see GSM 03.22) is evaluated to be better than the serving cell. The best cell is the cell with the highest value of C32 among
 - those cells that have the highest PRIORITY_CLASS among those that fulfil the criterion $C31 \geq 0$, or
 - all cells, if no cells fulfil the criterion $C31 \geq 0$.

If the parameter C32_QUAL is set, positive GPRS_RESELECT_OFFSET values shall only be applied to the neighbour cell with the highest RLA_P value of those cells for which C32 is compared above.

PRIORITY_CLASS and C32_QUAL are broadcast on PBCCH of the serving cell.

When evaluating the best cell, the following hysteresis values shall be subtracted from the C32 value for the neighbour cells:

- in standby state, if the new cell is in the same routing area: 0.
- in ready state, if the new cell is in the same routing area:
GPRS_CELL_RESELECT_HYSTERESIS. If the parameter C31_HYST is set,
GPRS_CELL_RESELECT_HYSTERESIS shall also be subtracted from the C31 value for the neighbour cells.
- in standby or ready state, if the new cell is in a different routing area:
RA_RESELECT_HYSTERESIS.
- in case of a cell re-selection occurred within the previous 15 seconds: 5 dB.

GPRS_CELL_RESELECT_HYSTERESIS, C31_HYST and RA_RESELECT_HYSTERESIS are broadcast on PBCCH of the serving cell.

20.22.2.3 Test purpose

To verify that the MS reselects the correct cell based on the C32 parameter when GPRS_RESELECT_OFFSET, TEMPORARY_OFFSET and PENALTY_TIME parameters are transmitted in the System information messages.

1. To verify MS does not reselect on the basis of C31 as there are no HCS threshold values transmitted in the System information messages.

20.22.2.4 Method of test

20.22.2.4.1 Initial conditions

Parameters changed from the default values in table 20.22.1.

Parameter	Carrier 1	Carrier 2	Carrier 3	Carrier 4	Carrier 5
RF Signal Level (dBm)	-70	-60	-70	-65	-60
GPRS_RXLEV_ACCESS_MIN (dBm)	-90	-90	-100	-85	-90
GPT				40 s	
GRO			-20 dB	20 dB	
GTO				20 dB	
C1	20		30	20	30
C32	20		10	20-40	30

NOTE 1: The BA(GPRS) list only contains the ARFCNs of the carriers used during the test.

NOTE 2: The HCS structure is omitted from the packet system information messages .

NOTE 3: Carrier 5 is the BCCH carrier which broadcasts the position of the PBCCH channel in the cell (Carrier 2.)

20.22.2.4.2 Procedure

- a) The SS activates carriers 1, 2 and 5. The MS is paged on Carriers 1 and 2. The SS starts monitoring carriers 1 and 2 for RA requests from the MS.
- b) The MS is switched on.
- c) The SS activates carriers 3 and 4. The MS is paged on both carriers. The SS monitors carriers 3 and 4 for RA requests from the MS.

20.22.2.5 Test Requirements

1) After step b) there should be a response on carrier 2 within 33 seconds.

NOTE: The SS should ensure that the MS final state is in Packet Idle mode on carrier 2.

2) After step d) there should be no response on carrier 4 within 38 seconds of activating the carrier but MS should respond on carrier 4 within 50 seconds of activating the carrier.

NOTE: Minimum time of 38 seconds set by penalty timer on carrier 4 less 2 second tolerance. Maximum time includes 42 seconds (40 seconds + 2 second tolerance) for expiry of penalty timer on carrier 4, 2 seconds to decode BCCH, 1 second for reselection, since the MS will already have running averages on carrier 4, when the penalty timers expire, allow 50 seconds.

20.22.3 Priority of cells

20.22.3.1 Definition and applicability

This test is applicable for all types of GPRS mobiles

20.22.3.2 Conformance requirement

At least for every new sample or every second, whichever is the greatest, the MS shall update RLA_P and calculate the value of C1, C31 and C32 for the serving cell and the non-serving cells; GSM 05.08, 10.1.2 The MS shall make a cell re-selection if:

- (i) The path loss criterion parameter (C1) for the serving cell falls below zero.
- (ii) A non-serving suitable cell (see GSM 03.22) is evaluated to be better than the serving cell. The best cell is the cell with the highest value of C32 among
 - those cells that have the highest PRIORITY_CLASS among those that fulfil the criterion $C31 \geq 0$, or
 - all cells, if no cells fulfil the criterion $C31 \geq 0$.

If the parameter C32_QUAL is set, positive GPRS_RESELECT_OFFSET values shall only be applied to the neighbour cell with the highest RLA_P value of those cells for which C32 is compared above.

PRIORITY_CLASS and C32_QUAL are broadcast on PBCCH of the serving cell.

When evaluating the best cell, the following hysteresis values shall be subtracted from the C32 value for the neighbour cells:

- in standby state, if the new cell is in the same routing area: 0.
- in ready state, if the new cell is in the same routing area: GPRS_CELL_RESELECT_HYSTERESIS. If the parameter C31_HYST is set, GPRS_CELL_RESELECT_HYSTERESIS shall also be subtracted from the C31 value for the neighbour cells.
- in standby or ready state, if the new cell is in a different routing area: RA_RESELECT_HYSTERESIS.
- in case of a cell re-selection occurred within the previous 15 seconds: 5 dB.

GPRS_CELL_RESELECT_HYSTERESIS, C31_HYST and RA_RESELECT_HYSTERESIS are broadcast on PBCCH of the serving cell.

20.22.3.3 Test purpose

1. To verify that the MS reselects to the correct cell by calculating C31 correctly when C31_HYST is set on the network.

20.22.3.4 Method of Test

20.22.3.4.1 Initial Conditions

Parameters changed from the default values in table 20.22.1.

Parameter	Carrier 1	Carrier 2	Carrier 3	Carrier 4	Carrier 5	Carrier 6
RF Signal Level (dBm)	-60	-60	-80	-64	-70	-70
GPRS_RXLEV_ACCESS_MIN (dBm)	-100	-100	-100	-92	-100	-102
C31_HYST = 1						
Priority Class	1		1	1	1	3
GRO			10	4	10	14
HCS_THR	-90		-70	-80	-86	-86
GCRH	6					
C1	40 to 15		20	28	30	32
C31	30 to 5		-16	10	10	10
C32	40 to 15		24	26	34	40

NOTE 1: GRO = GPRS_RESELECT_OFFSET, GCRH = GPRS_CELL_RESELECT_HYSTERESIS, RARH = RA_RESELECT_HYSTERESIS.

NOTE 2: The BA(GPRS) list only contains the ARFCNs of the carriers used during the test. The HCS structure is transmitted in the Packet system information messages.

NOTE 3: Carrier 1 is the BCCH carrier which broadcasts the position of the PBCCH channel in the cell (Carrier 2.)

20.22.3.4.2 Procedure

- a) The MS is switched on and a call is set-up on carrier 2
- b) The SS waits 10 seconds.
- c) The RF level of Carriers 1 & 2 are reduced to -85 dBm (C1=decreases to 15)

20.22.3.5 Test Requirements

After step c) the MS should respond on carrier 5 within 10 seconds. (Carrier 3 should be rejected as C31 <0, Carrier 6 has a lower priority class than Carrier 4 and Carrier 5 so is rejected, even though C32= 36, out of carrier 4 and 5, Carrier 5 has highest C32 value.

Note: Time allowed includes 5 sec for MS to determine C32 on neighbour cell is higher, 2 seconds to decode BCCH and 1 sec for re-selection.

20.22.4 Cell re-selection with cells in different routing area

20.22.4.1 Definition and applicability

This test is applicable for all types of GPRS mobiles

20.22.4.2 Conformance requirement

At least for every new sample or every second, whichever is the greatest, the MS shall update RLA_P and calculate the value of C1, C31 and C32 for the serving cell and the non-serving cells; GSM 05.08, 10.1.2 The MS shall make a cell re-selection if:

- (i) The path loss criterion parameter (C1) for the serving cell falls below zero.

(ii) A non-serving suitable cell (see GSM 03.22) is evaluated to be better than the serving cell. The best cell is the cell with the highest value of C32 among

- those cells that have the highest PRIORITY_CLASS among those that fulfil the criterion $C31 \geq 0$, or
- all cells, if no cells fulfil the criterion $C31 \geq 0$.

If the parameter C32_QUAL is set, positive GPRS_RESELECT_OFFSET values shall only be applied to the neighbour cell with the highest RLA_P value of those cells for which C32 is compared above.

PRIORITY_CLASS and C32_QUAL are broadcast on PBCCH of the serving cell.

When evaluating the best cell, the following hysteresis values shall be subtracted from the C32 value for the neighbour cells:

- in standby state, if the new cell is in the same routing area: 0.
- in ready state, if the new cell is in the same routing area:
GPRS_CELL_RESELECT_HYSTERESIS. If the parameter C31_HYST is set,
GPRS_CELL_RESELECT_HYSTERESIS shall also be subtracted from the C31 value for the neighbour cells.
- in standby or ready state, if the new cell is in a different routing area:
RA_RESELECT_HYSTERESIS.
- in case of a cell re-selection occurred within the previous 15 seconds: 5 dB.

GPRS_CELL_RESELECT_HYSTERESIS, C31_HYST and RA_RESELECT_HYSTERESIS are broadcast on PBCCH of the serving cell.

20.22.4.3 Test purpose

To verify that the MS reselects to the correct cell by calculating C32 correctly when one of the cells is in a different routing area.

20.22.4.4 Method of Test

20.22.4.4.1 Initial Conditions

Parameters changed from the default values in table 20.22.1.

Parameter	Carrier 1	Carrier 2	Carrier 3	Carrier 4	Carrier 5	Carrier 6
RF Signal Level (dBm)	-60	-60	-70	-70	-70	-70
RAI					Different	
GPRS_RXLEV_ACCESS_MIN (dBm)	-100	-100	-80	-100	-100	-80
GRO			4	4	6	4
GCRH	4					
RARH	14					
C1	40 to 15		10	30	30	10
C32	40 to 15		14	34	22	14

Note 1: GRO = GPRS_RESELECT_OFFSET, GCRH = GPRS_CELL_RESELECT_HYSTERESIS, RARH = RA_RESELECT_HYSTERESIS.

Note 2: The BA(GPRS) list only contains the ARFCNs of the carriers used during the test. The HCS structure is transmitted in the Packet system information messages.

Note 3: Carrier 1 is the BCCH carrier which broadcasts the position of the PBCCH channel in the cell (Carrier 2.)

20.22.4.4.2 Procedure

- a) The MS is switched on and a call is set-up on carrier 2
- b) The SS waits 10 seconds.
- c) The RF level of Carriers 1 & 2 are reduced to -85 dBm (C1=decreases to 15)

20.22.4.5 Test Requirements

After step c) the MS should respond on carrier 4 within 10 seconds. (Carrier 5 C32=22 if RA_RESELECT_HYSTERESIS is used correctly by MS otherwise it will be 36 and MS will select carrier 5 incorrectly)

Note: Time allowed includes 5 sec for MS to determine C32 on neighbour cell is higher, 2 seconds to decode BCCH and 1 sec for re-selection.

20.22.5 Network controlled Cell re-selection in Transfer Mode

20.22.5.1 Definition and applicability

This test is applicable for all types of GPRS mobiles

20.22.5.2 Conformance requirement

1. A cell re-selection command may be sent from the network to an MS. When the MS receives the command, it shall immediately re-select the cell according to the included cell description and change the network control mode according to the command (GSM 04. 60, GSM05.08: 10.1.4).

20.22.5.3 Test purpose

To verify the MS can correctly interpret the network control commands and reselect to the correct cell.

20.22.5.4 Method of Test

20.22.5.4.1 Initial Conditions

Parameters changed from the default values in table 20.22.1.

Parameter	Carrier 1	Carrier 2	Carrier 3	Carrier 4	Carrier 5
RF Signal Level (dBm)	-60	-60	-80	-70	-70
GPRS_RXLEV_ACCESS_MIN (dBm)	-100	-100	-100	-100	-100
NETWORK_CONTROL_ORDER	NC2	NC2	NC0	NC2	NC2
NC_REPORTING_PERIOD_T (s)	0.96	0.96		0.96	0.96
C1	40-20		20-40	30	
C32	40-20		20-40	30	

Note 1: The HCS structure is omitted from the packet system information messages on all the cells. Therefore C31 is not used.

Note 2: Carrier 1 is a BCCH carrier which broadcasts the position of the PBCCH channel in the cell (Carrier 2.) and Carrier 4 is a BCCH carrier which broadcasts the position of the PBCCH channel in the cell (Carrier 5.)

20.22.5.4.2 Procedure

The MS is switched on and a call is set up on carrier 2.

The RF level of carriers 1 and 2 are reduced to -80dBm . (C32 becomes 20).

The SS waits 15 seconds after the RF level of carriers 1 and 2 are reduced before sending a reselect command to the MS to select carrier 4.

The RF level of carrier 3 is increased to -60dBm . (C32 becomes 40).

The SS waits 15 seconds after increasing the RF level of carrier 3 before the Network Control Order is changed to NCO on carriers 4 and 5. The SS sends a RESET command to the MS.

20.22.5.5 Test Requirements

- 1) After step b) there should be no response on carriers 3, 4 or 5.
- 2) After step c) there should be a response on carrier 5 within 5 seconds of the re-select command. (The 5s = 2s for BCCH decoding + 2s for PBCCH decoding + 1s fo re-selection + tolerance)
- 3) After step d) there should be no response on carriers 1, 2, 3.
- 4) After step e) there should be a response on carrier 3 within 3 seconds of the SS sending the RESET command. (The 3s = 2s for BCCH decoding + 1s for re-selection + tolerance).

20.22.6 Cell reselection timings

20.22.6.1 Definition and applicability

This test is applicable for all types of GPRS mobiles

20.22.6.2 Conformance requirement

At least for every sample or every second, whichever is greatest, the MS shall calculate the value of C1, C31 and C32 for the serving cell and recalculate C1, C31 and C32 values for non serving cells (if necessary). The MS shall make a cell re-selection if:

- i) The path loss criterion parameter (C1) for the serving cells falls below zero.

20.22.6.3 Test purpose

1. To verify that the MS meets conformance requirement 6.2 (i) within time allowed.

20.22.6.4 Method of Test

20.22.6.4.1 Initial Conditions

Parameters changed from the default values in table 20.22.1.

Parameter	Carrier 1	Carrier 2	Carrier 3	Carrier 4
RF Signal Level (dBm)	-60	-60	-70	-70
GPRS_RXLEV_ACCESS_MIN (dBm)	-90	-90	-100	-100
GRO			-28	
SPLIT_PG_CYCLE	4	4	4	4
C1	30		30	
C32	30		2	

Note 1: The HCS structure is omitted from the system information messages on all the cells. Therefore C31 is not used.

Note 2: The RLA_P should be updated every 3.84 seconds with SPLIT_PG_CYCLE=4

Note 3: Carriers 1 and 3 are the BCCH carriers which broadcast the position of the PBCCH channel in the cell (Carriers 2 and 4)

20.22.6.4.2 Procedure

- a) The SS activates all carriers and pages the MS on carrier 4. The SS starts to monitor carriers 3 and 4 for responses from the MS.
- b) The MS is switched on.
- c) The SS waits 30s before the RF level of carriers 1 & 2 are reduced to -100 dBm for 8 seconds. (During this period C1 becomes -10). Then the SS raises the level back to -60 dBm. The SS waits 20 seconds.
- d) The SS reduces the RF level on carriers 1 & 2 to -100dBm.

20.22.6.5 Test Requirements

- 1) After step c) there shall be no access on carrier 3 or carrier 4.
- 2) After step d) there shall be access on carrier 4 within 25 seconds (allow 20s for c1 average to reach -10 + 2s to decode BCCH + 2s to decode PBCCH)

20.22.7 Downlink signalling failure

20.22.7.1 Definition and applicability

This test is applicable for all types of GPRS MSs.

20.22.7.2 Conformance requirement

The downlink signalling failure criterion is based on the downlink signalling failure counter DSC.

1. If DRX period split is supported , DSC shall be initialised to a value equal to the nearest integer to $\max(10, 90/64 * \text{SPLIT_PG_CYCLE})$ where SPLIT_PG_CYCLE is a parameter defined at GPRS attach (see 05.02)
2. Thereafter, whenever the MS attempts to decode a message in its paging subchannel; if a message is successfully decoded DSC is increased by 1, however never beyond the max value defined in 1.
3. Whenever the MS can not successfully decode a message in its paging subchannel the DSC is decreased by 4.
4. When DSC reaches 0, a downlink signalling failure shall be declared. A downlink signalling failure shall result in cell reselection, GSM 03.22, 4.5 (ii) and GSM 05.08, 6.5

NOTE: The network sends the paging subchannel for a given MS every $64/\text{SPLIT_PG_CYCLE}$ multiframes . The requirement for network transmission on the paging subchannel is specified in GSM 04.08. The MS is required to attempt to decode a message every time its paging subchannel is sent.

20.22.7.3 Test purpose

1. To verify that the MS initialises the DSC counter in accordance with the conformance requirement. This is verified indirectly.
2. To verify that whenever the MS successfully decodes a message on paging subchannel, the DSC is increased by 1, (however never beyond the nearest integer to max defined in 16.2.1). This is verified indirectly.
3. To verify that whenever the MS can not successfully decode a message on paging subchannel, the DSC decreased by 4. This is verified indirectly.
4. To verify that when the DSC reaches 0, a downlink signalling failure shall be declared and the MS will perform cell reselection.

20.22.7.4 Method of Test

20.22.7.4.1 Initial Conditions

Parameters changed from the default values in table 20.22.1.

Parameter	Carrier 1	Carrier 2	Carrier 3	Carrier 4
RF Signal Level (dB μ V emf() / dBm)	-65	-65	-60	-60
GPRS_RXLEV_ACCESS_MIN (dBm)	-95	-95	-100	-100
SPLIT_PG_CYCLE	4	4	4	4
C1	30		40	
C32	30		40	

Note 1: The HCS structure is omitted from the system information messages on all the cells. Therefore C31 is not used.

Note 2: With SPLIT_PG_CYCLE=4 DSC should be set to 10, Paging blocks occur every 832 frames or 3.84 seconds.

Note 3: Carrier 1 and 3 are BCCH carriers which broadcast the position of the PBCCH channel in the cell (Carrier 2 and 4.)

20.22.7.4.2 Procedure

- The MS is switched on. On carrier 4 valid layer 3 messages shall be sent in the paging blocks, but not paging the MS. On carrier 2 the MS is paged continuously in all paging blocks.
- After 40s the SS sends corrupted data (using random data, wrong parity bits see GSM 05.03, 4.3 & 4.1.2 or other lower layer error) in 2 successive paging blocks on carrier 4 and then reverts to sending normal data.

NOTE 1: Sending corrupted, i.e. non-decodable data on 2 successive paging blocks should decrease the DSC to 2.

- The SS monitors all accesses on both carriers for 40 s. (Allows the DSC counter to go back to maximum of 10, paging block every 3.84 secs)
- The SS sends corrupted data in 3 successive paging blocks on carrier 4 and then reverts to sending normal data..

NOTE 2: Sending corrupted, data on 3 successive paging blocks should decrease the DSC to < 0 (-2) and cause a cell reselection.

- The SS monitors all accesses on both carriers for 30s

20.22.7.5 Test requirements

- There shall be no access on carriers 1 or 2 after step b).
- The MS shall access on carrier 2 at test step e) within 5 seconds. (The time should be measured from the transmission of the complete 3rd successive paging block with errors and allows 4 secs for decoding BCCH and PBCCH).

20.22.8 Cell selection when the best cell does not support GPRS

20.22.8.1 Definition and applicability

Cell selection is a process in which an MS, whenever a new PLMN is selected, attempts to find a suitable cell of that PLMN to camp on. Two methods of searching for a suitable cell are possible, normal cell selection and stored list cell selection. The process ensures that the MS is camped on a cell from which it can reliably decode downlink data and with which it has a high probability of communications on the uplink. The support of GPRS is not a condition to select a cell. Once the MS is camped on a cell, access to the network is allowed.

This test is applicable for all types of GPRS MSs.

20.22.8.2 Conformance requirement

1. The MS shall be able to select the strongest cell within 30 seconds of switch on. This assumes a valid SIM, with PIN disabled and ideal radio conditions, GSM 05.08, 6.1.
2. There are various requirements that a cell must satisfy before an MS can perform normal camping on it:
 - 2.1 (i) It should be a cell of the selected PLMN
 - 2.2 (ii) It should not be "barred" (see section 3.5.1)
 - 2.3 (iii) It should not be in an LA which is in the list of "forbidden LAs for roaming";
 - 2.4 (iv) The radio path loss between MS and BTS must be below a threshold set by the PLMN operator. This is estimated as shown in section 3.6. GSM 03.22, 3.2.1.

NOTE: Criteria 2.3 (iii) is not applicable for Cell Selection.

3. Initially the MS looks for a cell which satisfies these 4 constraints ("suitable cell") by checking cells in descending order of received signal strength. If a suitable cell is found, the MS camps on it, GSM 03.22, 3.2.1.
4. The MS shall be able to calculate correctly the path loss criterion parameter C1, used for cell selection and reselection, GSM 05.08, 6.4.

20.22.8.3 Test purpose

1. To verify that the MS meets conformance requirement 1. even when one of the other cells supports GPRS.
2. To verify that:
 - 2.1 The MS does not select a cell of a PLMN, which is not the selected PLMN.
 - 2.2 The MS does not select a cell which is "barred".
 - 2.4 The MS does not select a cell with $C1 < 0$.
3. To verify that the MS selects suitable cells in descending order of received signal strength.
4. To verify that the MS does not select a cell with $C1 < 0$.

20.22.8.4 Method of test

20.22.8.4.1 Initial conditions

Parameters changed from the default values in table 20.22.1.

Parameter	Carrier 1	Carrier 2	Carrier 3	Carrier 4	Carrier 5
RF Signal Level (dBm)	-75	-80	-70	-60	-70
CBA	0	0	0	1	0
RXLEV_ACCESS_MIN (dBm)	-90	-90	-90	-90	-60
GPRS_RXLEV_ACCESS_MIN					
MNC			01 (011 for PCS 1900)		
MCC			002		
C1	15	10	20	30	-10

Note 1: For an E-GSM MS carrier 1 and carrier 5 ARFCNs are chosen in the E-GSM band, carrier 3 and carrier 4 ARFCNs in the P-GSM band.

Note 2: Carrier 2 supports GPRS without PBCCH channel in the cell.

Note 3: Carriers 1, 3, 4 and 5 do not support GPRS.

20.22.8.4.2 Procedure

- a) The SS activates and pages on the MS on all carriers. All Carriers are monitored for RA requests from the MS.
- b) The MS is switched on.

20.22.8.5 Test requirements

- 1) After step b), the first response from the MS shall be on carrier 1 within 33 seconds. There shall be no response from the MS on any other carrier

20.22.9 Cell reselection when the best cell does not support GPRS

20.22.9.1 Definition and applicability

While camped on a cell of the selected PLMN the MS may need to select a different cell in order to fulfil the normal service state. This ensures that the MS is camped on a cell from which it can reliably decode downlink data and with which it has a high probability of communications on the uplink. The target cell should be reselected despite it does not support GPRS.

This test is applicable for all types of GPRS MSs.

20.22.9.2 Conformance requirement

1. While camped on a cell of the selected PLMN ("camped normally"), the MS may need to select a different cell ("normal cell reselection" state). The following events trigger a cell reselection:
 - 1.1 (iii) The cell camped on (current serving cell) has become barred.
 - 1.2 (iv) There is a better cell (in terms of the path loss criterion C2) in the same LA, or a much better cell in another LA of the selected PLMN (using the CRH parameter).

The MS will then reselect a new cell in order to fulfil the process goal.; GSM 03.22, 4.5.

NOTE 1: Criterion (i) is tested in section 20.8 (Cell reselection when C1(serving cell) < 0 for 5 seconds).

NOTE 2: Criterion (ii) is tested section 20.16 (Downlink signalling failure).

NOTE 3: Criterion (v) is tested in section 20.6 (Cell reselection timings).

2. There are various requirements that a cell must satisfy before an MS can perform normal camping on it:

2.1 (ii) It should not be "barred".

2.2 (iv) The radio path loss between MS and BTS must be below a threshold set by the PLMN operator. GSM 03.22, 3.2.1.

NOTE 4: Criterion (i) is not relevant for cell reselection and for cell selection it is tested in section 20.1.

NOTE 5: Criterion (iv) refers to the C1 parameter.

3. The MS shall be able to calculate correctly the path loss criterion parameter C2 used for cell reselection; GSM 05.08, 6.4.

4. At least every 5 s the MS shall calculate the value of C1 and C2 for the serving cell and recalculate C1 and C2 values for non serving cells (if necessary). The MS shall then check whether:

i) The path loss criterion (C1) for current serving cell falls below zero for a period of 5 seconds. This indicates that the path loss to the cell has become too high.

ii) The calculated value of C2 for a non-serving suitable cell exceeds the value of C2 for the serving cell for a period of 5 seconds, except in the case of the new cell being in a different location area in which case the C2 value for the new cell shall exceed the C2 value of the serving cell by at least CELL_RESELECT_HYSTERESIS dB as defined by the BCCH data from the current serving cell, for a period of 5 seconds. This indicates that it is a better cell. GSM 05.08, 6.6.2.

5. The MS shall attempt to decode the full BCCH data of the serving cell at least every 30 seconds; GSM 05.08, 6.6.1.

20.22.9.3 Test purpose

1. To verify that:
 - 1.1 The MS meets conformance requirement 1.1.
 - 1.2 The MS meets conformance requirement 1.2.
 - 1.3 The MS meets conformance requirement 1.3.
2. To verify that:
 - 2.1 The MS does not reselect a cell which is barred.
 - 2.2 The MS does not reselect a cell which has a $C1 < 0$.
 - 2.3 The MS does reselect a cell even if does not support GPRS.
 - 2.4 The MS keeps camping on the serving cell despite it does not support GPRS and there is a non-serving suitable cell with a lower $C2$ that supports GPRS.
 - 2.5 The MS does not attempt to attach to GPRS when camping on a cell that does not support GPRS despite there is a non-serving suitable cell with a lower $C2$ that supports GPRS.
3. To verify that the MS calculates the $C2$ parameter correctly when the `CELL_RESELECT_OFFSET`, `TEMPORARY_OFFSET` and `PENALTY_TIME` parameters are not used.
4. To verify that the MS takes into account the `CELL_RESELECT_HYSTERESIS` parameter when reselecting a cell in a different location area, whether the this cell supports GPRS or not.
5. To verify that the MS decodes the `CELL_BAR_ACCESS` and `CELL_BAR_QUALIFY` parameters from the BCCH every 30 seconds.

20.22.9.4 Method of test

20.22.9.4.1 Initial conditions

Parameters changed from the default values in table 20.1.

Parameter	Carrier 1	Carrier 2	Carrier 3	Carrier 4	Carrier 5
RF Signal Level (dB μ V emf) / dBm)	43 / -70	33 / -80	43 / -70	38 / -75	38 / -75
RXLEV_ACCESS_MIN (dBm)	-85	-90	-90	-85	-67
CRH	10 dB				
LAC			different from other carriers		
CBA				1	
CBQ				0	
C1	15	10	20	10	-8
C2	15	10	20	10	-8

Note 1: Carrier 1 and 3 support GPRS without PBCCH channel in the cell.

Note 2: Carriers 2, 4 and 5 do not support GPRS.

The BA(BCCH) list only contains the ARFCNs of the carriers used during the test.

20.22.9.4.2 Procedure

- a) The SS activates carriers 1, 2, 4 and 5. The MS is paged on carriers 1, 2, 4 and 5. The SS monitors carriers 2, 4 and 5 for RA requests from the MS.
- b) The MS is switched on.
- c) When the SS receives a response on carrier 1, it stops paging the MS on this carrier and waits for 25 seconds. (The MS should reselect and camp onto carrier 1).
- d) The SS disables GPRS on carrier 1 and enables GPRS on carrier 2.
- e) The SS enables GPRS on carrier 1 and disables GPRS on carrier 2.
- f) The SS stops paging on all carriers except carrier 2. The level of carrier 2 is increased to 43 dB μ Vemf (C2 becomes 20 dB), and the SS monitors carrier 2 for RA requests from the MS.
- g) When the SS receives a response from the MS on carrier 2, it stops paging the MS on this carrier.
- h) The MS is switched off then on and the MS is paged on carriers 1, 4 and 5. The SS monitors carrier 1, 4 and 5 for RA requests from the MS.
- i) The MS is switched off.
- j) The SS is reconfigured and sets CBA = 1 on carriers 1 and 5, enables GPRS on carrier 2 and disables GPRS on carrier 1.
- k) The MS is switched on.
- l) After 33 seconds, the SS starts paging continuously on carrier 1 and sets CBA=1 on carrier 2 and CBA=0 on carriers 1, 4 and 5.
- m) When the SS receives a response on carrier 1, it stops paging the MS and waits for 25 seconds. (The MS should reselect and camp onto carrier 1).
- n) The SS activates carrier 3, pages the MS continuously on this carrier and monitors carrier 3 for RA requests from the MS.
- o) The SS increases the level of carrier 3 to 53 dB μ Vemf (C2 increases to 30 dB.).
- p) The SS is reconfigured and sets CBA = 1 on carriers 1 and 5, disables GPRS on carrier 3 and enables GPRS on carrier 1.
- q) The MS is switched on.
- r) After 33 seconds, the SS starts paging continuously on carrier 1 and sets CBA=1 on carrier 2 and CBA=0 on carriers 1, 4 and 5.
- s) When the SS receives a response on carrier 1, it stops paging the MS and waits for 25 seconds. (The MS should reselect and camp onto carrier 1).
- t) The SS activates carrier 3, pages the MS continuously on this carrier and monitors carrier 3 for RA requests from the MS.
- u) The SS increases the level of carrier 3 to 53 dB μ Vemf (C2 increases to 30 dB.).

20.22.9.5 Test requirements

- 1) After step c), there shall be no response from the MS on carriers 2, 4, or 5 within 50 seconds.

NOTE 1: 33 seconds for the MS to read the BCCH of carrier 2 (30 seconds + 10 %), 15 seconds for the MS to reselect cell 1, since the MS already has a running average on carrier 1, allow 50 seconds.

- 2) After step d), there shall be no response from the MS on carriers 2, 4, or 5 within 50 seconds.
- 3) After step e), there shall be no response from the MS on carriers 2, 4, or 5 within 50 seconds.

4) In step f), the MS shall respond on carrier 2 within 20 seconds of increasing the level of carrier 2.

NOTE 2: 5 seconds to perform running average, 10 seconds to detect C2 differences, 2,4 seconds to read BCCH of carrier 2, 1 second to perform RA. Total 18,4 seconds, allow 20 seconds.

5) After step h), there shall be no response from the MS on carriers 1, 4, or 5 within 50 seconds.

6) In step l), the MS shall respond on carrier 1 within 50 seconds of setting CBA=1 on carrier 2.

7) After step n), there shall be no response from the MS within 50 seconds.

8) After step o), the MS shall respond on carrier 3 within 20 seconds.

9) In step r), the MS shall respond on carrier 1 within 50 seconds of setting CBA=1 on carrier 2.

NOTE 2: 33 seconds for the MS to read the BCCH of carrier 2 (30 seconds + 10 %), 15 seconds for the MS to reselect cell 1, since the MS already has a running average on carrier 1, allow 50 seconds.

10) After step t), there shall be no response from the MS within 50 seconds.

11) After step u), the MS shall respond on carrier 3 within 20 seconds.

20.23 COMPACT Cell Selection and Reselection

The absolute accuracy of the MS signal level measurements is assumed to be ± 6 dB. A difference of at least 8 dB is allowed for cases of discrimination between C1, C31, C32 values and 0.

The relative accuracy of the MS signal level measurements is assumed to be ± 3 dB for the signal levels used in the tests of this section. A difference of at least 5 dB is allowed for cases of discrimination between C1 and C31 and C32 values on different carriers.

NOTE 1: The accuracy of MS signal level measurements is specified in GSM 05.08. For all of the tests in this section, the signal levels used are greater than 1 dB above reference sensitivity level.

NOTE 2: The tolerance on timers specified in GSM 05.08 is ± 10 % except for PENALTY_TIME where it is ± 2 seconds. In the tests of this section, the test requirements include these tolerances. Consequently, the times stated in the test requirement sometimes differ from the corresponding timer in the conformance requirement.

Where pulsed signals are specified, the SS tolerance on pulse width is ± 2 % and the SS tolerance on power level ± 1 dB.

The cell re-selection tests defined in the following sections applies to the MSs attached to EGPRS if a CPBCCH exists in the serving cell. Otherwise the MS shall perform cell re-selection according to the idle mode procedures defined in clause 6 or clause 10 of GSM 05.08 and therefore tests defined in section 20 or 20.22 of GSM 11.10 apply respectively.

Unless otherwise stated in the method of test, in all of the tests of this section:

- The SIM is in the idle updated state in the default registration area with a PTMSI assigned at the beginning of each test.
- All carriers support COMPACT
- The Scheduling of Packet System information should be such that a complete set of consistent PSI messages can be decoded within 8 multiframe
- The mobile station supports COMPACT
- The mobile station is either packet data only capable or it does not support GSM CS services
- Time Group 0 is used to send CPBCCH / CPCCCH blocks for all ARFCN values (one active timegroup/carrier)
- 1 CPBCCH block and 3 CPPCH blocks are allocated in all timegroups ($N_{CCCH_NH} = 4$)

- All cells must be timeslot and frame synchronized to each other

Table 20.23.1: Default values of the system information fields

Parameter	GSM 04.60 reference	Abbr.	Normal Setting
PRIORITY_CLASS	11.2.20	PC	1
C31_HYST	11.2.20	C31H	0
RA_RESELECT_HYSTERESIS	11.2.20	RARH	0 dB
HCS_THR	11.2.20	HT	-110dBm
GPRS_RESELECT_OFFSET	11.2.20	GRO	0 dB
REPORTING_PERIOD	11.2.23	RP	60s
NETWORK_CONTROL_ORDER	11.2.23	NCO	NC0
GPRS_CELL_RESELECT_HYST	11.2.20	GCRH	0 dB
GPRS_TEMPORARY_OFFSET	11.2.20	GTO	0 db
GPRS_PENALTY_TIME	11.2.20	GPT	0 s
SPLIT_PG_CYCLE	5.5.1.5	SPGC	0
GPRS_CELL_RESELECT_HYSTERESIS	11.2.20	GCRH	4 dB
ESIS			
GPRS_MS_TXPWR_MAX_CCH	11.2.20	GMTMC	Max. output power of MS
GPRS_RXLEV_ACCESS_MIN	11.2.20	GRAM	-90 dBm
C32_QUAL	11.2.20	C32Q	0
BA(GPRS) ARFCN	11.2.20	BA	All 0 except: For GSM 450 ARFCNs 259, 263, 269, 275, 279, 283, 287, 292, broadcast in PACKET SYSTEM INFORMATION type 3 For GSM 480 ARFCNs 306, 310, 316, 322, 326, 330, 334, 339, broadcast in PACKET SYSTEM INFORMATION type 3 For GSM 750 ARFCNs 441, 446, 452, 455, 461, 462, 466, 470, 477, 485, 493, 511, 207,219, 251, broadcast in PACKET SYSTEM INFORMATION type 3 For GSM 850 ARFCNs 130, 136, 145, 152, 168, 170, 176, 177, 181, 185, 189, 193, 197, 207,219, 251, broadcast in PACKET SYSTEM INFORMATION type 3 For GSM900, both P-GSM and E-GSM ARFCNs are broadcast: GSM ARFCNs 3, 9, 18, 25, 41, 43, 49, 50, 54, 58, 62, 66, 70, 80, 92, 124, broadcast in PACKET SYSTEM INFORMATION type 3 E-GSM ARFCNs 985, 989, 995, 1010, 1014 broadcast in PACKET SYSTEM INFORMATION type 3 For DCS1800 ARFCNs 512, 543, 568, 589, 602, 641, 662, 683, 696, 711, 732, 754, 794, 851, 870, 871, 872, 884 broadcast in PACKET SYSTEM INFORMATION TYPE 3. For PCS 1900 ARFCNs 512, 543, 568, 589, 602, 641, 662, 683, 696, 711, 732, 754, 790, 791, 792, 809, broadcast in PACKET SYSTEM INFORMATION TYPE 3
GUAR_CONSTANT_PWR_BLKs	11.2.20	GCPB	0
CELL_BAR_ACCESS_2	11.2.20	CBA2	0
Cell Bar Qualify 2	11.2.20	CBQ2	0

20.23.1 Cell selection

20.23.1.1 Definition and applicability

Cell selection is a process in which an MS, whenever a new PLMN is selected, attempts to find a suitable cell of that PLMN to camp on. Two methods of searching for a suitable cell are possible, normal cell selection and stored list cell selection. The process ensures that the MS is camped on a cell from which it can reliably decode downlink data and with which it has a high probability of communications on the uplink. Once the MS is camped on a cell, access to the network is allowed.

20.23.1.2 Conformance requirement

1. The MS shall be able to select the strongest COMPACT cell within 120 seconds of switch on. This assumes a valid SIM, with PIN disabled and ideal radio conditions.
2. There are various requirements that a cell must satisfy before an MS can perform normal camping on it:
 - 2.1 (i) It should be a cell of the selected PLMN
 - 2.2 (ii) It should not be "barred" (see GSM 03.22 section 3.5.1)
 - 2.3 (iii) It should not be in an LA which is in the list of "forbidden LAs for roaming";
 - 2.4 (iv) The radio path loss between MS and BTS must be below a threshold set by the PLMN operator. This is estimated as shown in section 3.6. (GSM 03.22, 3.2.1)

NOTE: Criteria 2.3 (iii) is not applicable for Cell Selection.

3. Initially the MS looks for a cell which satisfies these 4 constraints ("suitable cell") by checking cells in descending order of received signal strength. If a suitable cell is found, the MS camps on it, GSM 03.22, 3.2.1.
4. The MS shall be able to calculate correctly the path loss criterion parameter C1, used for cell selection and reselection, GSM 05.08, 12.3.4.

20.23.1.3 Test purpose

1. To verify that the MS meets conformance requirement 1. when all cells support COMPACT.
2. To verify that:
 - 2.1 The MS does not select a cell of a PLMN, which is not the selected PLMN.
 - 2.2 The MS does not select a cell which is "barred".
 - 2.4 The MS does not select a cell with $C1 < 0$.
3. To verify that the MS selects suitable cells in descending order of received signal strength.
4. To verify that the MS does not select a cell with $C1 < 0$.

20.23.1.4 Method of test

Initial conditions

Parameters changed from the default values in table 20.23.1.

Parameter	Carrier 1	Carrier 2	Carrier 3	Carrier 4	Carrier 5	Carrier 6
RF Signal Level (dBm)	-75	-80	-70	-60	-70	-80
CBA2	0	0	0	1	0	
RXLEV_ACCESS_MIN (dBm)						-90
GPRS_RXLEV_ACCESS_MIN	-90	-90	-90	-90	-60	
MNC			01			
MCC			002			
C1	15	10	20	30	-10	10

NOTE 1: For an E-GSM MS carrier 1 and carrier 5 ARFCNs are chosen in the E-GSM band, carrier 3 and carrier 4 ARFCNs in the P-GSM band.

NOTE 2: Carrier 6 is GSM BCCH and do not support GPRS/EGPRS.

Procedure

- a) The SS activates and pages on the MS on all carriers. All Carriers are monitored for RA requests from the MS.
- b) The MS is switched on.

20.23.1.5 Test requirements

- 1) After step b), the first response from the MS shall be on carrier 1 within 123 seconds. There shall be no response from the MS on any other carrier

20.23.2 Cell reselection in Packet Idle mode

20.23.2.1 Definition and applicability

This test is applicable for mobile stations either packet data only capable or mobile stations not supporting GSM CS services.

20.23.2.2 Conformance requirement

2. At least for every new sample or every second, whichever is the greatest, the MS shall update RLA_P and calculate the value of C1, C31 and C32 for the serving cell and the non-serving cells; GSM 05.08, 10.1.2 The MS shall make a cell re-selection if:
 - (i) The path loss criterion parameter (C1) for the serving cell falls below zero.
 - (ii) A non-serving suitable cell (see GSM 03.22) is evaluated to be better than the serving cell. The best cell is the cell with the highest value of C32 among
 - those cells that have the highest PRIORITY_CLASS among those that fulfil the criterion $C31 \geq 0$, or
 all cells, if no cells fulfil the criterion $C31 \geq 0$.

If the parameter C32_QUAL is set, positive GPRS_RESELECT_OFFSET values shall only be applied to the neighbour cell with the highest RLA_P value of those cells for which C32 is compared above.

PRIORITY_CLASS and C32_QUAL are broadcast on CPBCCCH of the serving cell.

When evaluating the best cell, the following hysteresis values shall be subtracted from the C32 value for the neighbour cells:

- in standby state, if the new cell is in the same routing area: 0.
- in ready state, if the new cell is in the same routing area:
GPRS_CELL_RESELECT_HYSTERESIS. If the parameter C31_HYST is set,
GPRS_CELL_RESELECT_HYSTERESIS shall also be subtracted from the C31 value for the neighbour cells.
- in standby or ready state, if the new cell is in a different routing area:
RA_RESELECT_HYSTERESIS.
- in case of a cell re-selection occurred within the previous 15 seconds: 5 dB.

GPRS_CELL_RESELECT_HYSTERESIS, C31_HYST and RA_RESELECT_HYSTERESIS are broadcast on CPBCCCH of the serving cell.

20.23.2.3 Test purpose

To verify that the MS reselects the correct cell based on the C32 parameter when GPRS_RESELECT_OFFSET, TEMPORARY_OFFSET and PENALTY_TIME parameters are transmitted in the System information messages.

1. To verify MS does not reselect on the basis of C31 as there are no HCS threshold values transmitted in the System information messages.

20.23.2.4 Method of test

Initial conditions

Parameters changed from the default values in table 20.23.1.

Parameter	Carrier 1	Carrier 2	Carrier 3	Carrier 4
RF Signal Level (dBm)	-70	-70	-65	-60
GPRS_RXLEV_ACCESS_MIN (dBm)	-90	-100	-85	-90
GPT			40 s	
GRO		-20 dB	20 dB	
GTO			20 dB	
C1	20	30	20	30
C32	20	10	20-40	30

NOTE 1: The BA(GPRS) list only contains the ARFCNs of the carriers used during the test.

NOTE 2: The HCS structure is omitted from the packet system information messages .

Procedure

- a) The SS activates carriers 1 and 4. The MS is paged on Carriers 1 and 4. The SS starts monitoring carriers 1 and 4 for RA requests from the MS.
- b) The MS is switched on.
- c) The SS activates carriers 2 and 3. The MS is paged on both carriers. The SS monitors carriers 2 and 3 for RA requests from the MS.

20.23.2.5 Test Requirements

1) After step b) there should be a response on carrier 4 within 123 seconds.

NOTE: The SS should ensure that the MS final state is in Packet Idle mode on carrier 4.

2) After step c) there should be no response on carrier 3 within 38 seconds of activating the carrier but MS should respond on carrier 3 within 50 seconds of activating the carrier.

NOTE: Minimum time of 38 seconds set by penalty timer on carrier 4 less 2 second tolerance. Maximum time includes 42 seconds (40 seconds + 2 second tolerance) for expiry of penalty timer on carrier 4, 2 seconds to decode CPBCCCH, 1 second for reselection, since the MS will already have running averages on carrier 4, when the penalty timers expire, allow 50 seconds.

20.23.3 Priority of cells

20.23.3.1 Definition and applicability

This test is applicable for mobile stations either packet data only capable or mobile stations not supporting GSM CS services.

20.23.3.2 Conformance requirement

At least for every new sample or every second, whichever is the greatest, the MS shall update RLA_P and calculate the value of C1, C31 and C32 for the serving cell and the non-serving cells; GSM 05.08, 10.1.2 The MS shall make a cell re-selection if:

- (i) The path loss criterion parameter (C1) for the serving cell falls below zero.
- (ii) A non-serving suitable cell (see GSM 03.22) is evaluated to be better than the serving cell. The best cell is the cell with the highest value of C32 among
 - those cells that have the highest PRIORITY_CLASS among those that fulfil the criterion $C31 \geq 0$, or
 - all cells, if no cells fulfil the criterion $C31 \geq 0$.

If the parameter C32_QUAL is set, positive GPRS_RESELECT_OFFSET values shall only be applied to the neighbour cell with the highest RLA_P value of those cells for which C32 is compared above.

PRIORITY_CLASS and C32_QUAL are broadcast on CPBCCCH of the serving cell.

When evaluating the best cell, the following hysteresis values shall be subtracted from the C32 value for the neighbour cells:

- in standby state, if the new cell is in the same routing area: 0.
- in ready state, if the new cell is in the same routing area:
GPRS_CELL_RESELECT_HYSTERESIS. If the parameter C31_HYST is set, GPRS_CELL_RESELECT_HYSTERESIS shall also be subtracted from the C31 value for the neighbour cells.
- in standby or ready state, if the new cell is in a different routing area:
RA_RESELECT_HYSTERESIS.
- in case of a cell re-selection occurred within the previous 15 seconds: 5 dB.

GPRS_CELL_RESELECT_HYSTERESIS, C31_HYST and RA_RESELECT_HYSTERESIS are broadcast on CPBCCCH of the serving cell.

20.23.3.3 Test purpose

1. To verify that the MS reselects to the correct cell by calculating C31 correctly when C31_HYST is set on the network.

20.23.3.4 Method of Test

Initial Conditions

Parameters changed from the default values in table 20.23.1.

Parameter	Carrier 1	Carrier 2	Carrier 3	Carrier 4	Carrier 5
RF Signal Level (dBm)	-60	-80	-65	-70	-70
GPRS_RXLEV_ACCESS_MIN (dBm)	-100	-100	-95	-100	-102
C31_HYST = 1					
Priority Class	1	1	1	1	3
GRO		10	4	10	14
HCS_THR	-90	-70	-76	-80	-80
GCRH	10				
C1	40 to 15	20	30	30	32
C31	20 to 5	-10	11	10	10
C32	40 to 15	20	24	30	36

NOTE 1: GRO = GPRS_RESELECT_OFFSET, GCRH = GPRS_CELL_RESELECT_HYSTERESIS, RARH = RA_RESELECT_HYSTERESIS.

NOTE 2: The BA(GPRS) list only contains the ARFCNs of the carriers used during the test. The HCS structure is transmitted in the Packet system information messages.

Procedure

- a) The MS is switched on and a downlink TBF is set-up on carrier 1
- b) The SS waits 10 seconds.
- c) The RF level of Carrier 1 is reduced to -85 dBm (C1=decreases to 15)

20.23.3.5 Test Requirements

After step c) the MS should respond on carrier 4 within 10 seconds. (Carrier 2 should be rejected as C31 <0, Carrier 5 has a lower priority class than Carrier 3 and Carrier 4 so is rejected, even though C32= 36, out of carrier 3 and 4, Carrier 4 has highest C32 value.

Note: Time allowed includes 5 sec for MS to determine C32 on neighbour cell is higher, 2 seconds to decode CPBCCCH and 1 sec for re-selection.

20.23.4 Cell re-selection with cells in different routing area

20.23.4.1 Definition and applicability

This test is applicable for mobile stations either packet data only capable or mobile stations not supporting GSM CS services.

20.23.4.2 Conformance requirement

At least for every new sample or every second, whichever is the greatest, the MS shall update RLA_P and calculate the value of C1, C31 and C32 for the serving cell and the non-serving cells; GSM 05.08, 10.1.2 The MS shall make a cell re-selection if:

- (i) The path loss criterion parameter (C1) for the serving cell falls below zero.

(ii) A non-serving suitable cell (see GSM 03.22) is evaluated to be better than the serving cell. The best cell is the cell with the highest value of C32 among

- those cells that have the highest PRIORITY_CLASS among those that fulfil the criterion $C31 \geq 0$, or
- all cells, if no cells fulfil the criterion $C31 \geq 0$.

If the parameter C32_QUAL is set, positive GPRS_RESELECT_OFFSET values shall only be applied to the neighbour cell with the highest RLA_P value of those cells for which C32 is compared above.

PRIORITY_CLASS and C32_QUAL are broadcast on CPBCCCH of the serving cell.

When evaluating the best cell, the following hysteresis values shall be subtracted from the C32 value for the neighbour cells:

- in standby state, if the new cell is in the same routing area: 0.
- in ready state, if the new cell is in the same routing area:
GPRS_CELL_RESELECT_HYSTERESIS. If the parameter C31_HYST is set, GPRS_CELL_RESELECT_HYSTERESIS shall also be subtracted from the C31 value for the neighbour cells.
- in standby or ready state, if the new cell is in a different routing area:
RA_RESELECT_HYSTERESIS.
- in case of a cell re-selection occurred within the previous 15 seconds: 5 dB.

GPRS_CELL_RESELECT_HYSTERESIS, C31_HYST and RA_RESELECT_HYSTERESIS are broadcast on CPBCCCH of the serving cell.

20.23.4.3 Test purpose

To verify that the MS reselects to the correct cell by calculating C32 correctly when one of the cells is in a different routing area.

20.23.4.4 Method of Test

Initial Conditions

Parameters changed from the default values in table 20.23.1.

Parameter	Carrier 1	Carrier 2	Carrier 3	Carrier 4	Carrier 5
RF Signal Level (dBm)	-60	-70	-70	-70	-70
RAI				Different	
GPRS_RXLEV_ACCESS_MIN (dBm)	-100	-80	-100	-100	-80
GRO		4	4	6	4
GCRH	4				
RARH	14				
C1	40 to 15	10	30	30	10
C32	40 to 15	14	34	22	14

Note 1: GRO = GPRS_RESELECT_OFFSET, GCRH = GPRS_CELL_RESELECT_HYSTERESIS, RARH = RA_RESELECT_HYSTERESIS.

Note 2: The BA(GPRS) list only contains the ARFCNs of the carriers used during the test. The HCS structure is transmitted in the Packet system information messages.

Procedure

- a) The MS is switched on and a downlink TBF is set-up on carrier 1
- b) The SS waits 10 seconds.
- c) The RF level of Carrier 1 is reduced to -85 dBm (C1=decreases to 15)

20.23.4.5 Test Requirements

After step c) the MS should respond on carrier 3 within 10 seconds. (Carrier 4 C32=22 if RA_RESELECT_HYSTERESIS is used correctly by MS otherwise it will be 36 and MS will select carrier 4 incorrectly)

Note: Time allowed includes 5 sec for MS to determine C32 on neighbour cell is higher, 2 seconds to decode CPBCCCH and 1 sec for re-selection.

20.23.5 Network controlled Cell re-selection in Transfer Mode

20.23.5.1 Definition and applicability

This test is applicable for mobile stations either packet data only capable or mobile stations not supporting GSM CS services.

20.23.5.2 Conformance requirement

1. A cell re-selection command may be sent from the network to an MS. When the MS receives the command, it shall immediately re-select the cell according to the included cell description and change the network control mode according to the command (GSM 04. 60, GSM05.08: 10.1.4).

20.23.5.3 Test purpose

To verify the MS can correctly interpret the network control commands and reselect to the correct cell.

20.23.5.4 Method of Test

Initial Conditions

Parameters changed from the default values in table 20.23.1.

Parameter	Carrier 1	Carrier 2	Carrier 3
RF Signal Level (dBm)	-60	-80	-70
GPRS_RXLEV_ACCESS_MIN (dBm)	-100	-100	-100
NETWORK_CONTROL_ORDER	NC2	NC0	NC2
NC_REPORTING PERIOD_T (s)	0.96		0.96
C1	40-20	20-40	30
C32	40-20	20-40	30

Note 1: The HCS structure is omitted from the packet system information messages on all the cells. Therefore C31 is not used.

20Procedure

- a) The MS is switched on and a downlink TBF is set up on carrier 1.
- b) The RF level of carrier 1 is reduced to -80dBm. (C32 becomes 20).
- c) The SS waits 15 seconds after the RF level of carrier 1 is reduced before sending a reselect command to the MS to select carrier 3.

- d) The RF level of carrier 2 is increased to -60dBm . (C32 becomes 40).
- e) The SS waits 15 seconds after increasing the RF level of carrier 2 before the Network Control Order is changed to NC0 on carrier 3. The SS sends a RESET command to the MS.

20.23.5.5 Test Requirements

- 1) After step b) there should be no response on carriers 2 or 3.
- 2) After step c) there should be a response on carrier 3 within 5 seconds of the re-select command. (The $3s = 2s$ for CPBCCCH decoding + 1s fo re-selection + tolerance)
- 3) After step d) there should be no response on carriers 1 or 2.
- 4) After step e) there should be a response on carrier 2 within 3 seconds of the SS sending the RESET command. (The $3s = 2s$ for CPBCCCH decoding + 1s for re-selection + tolerance).

20.23.6 Cell reselection timings

20.23.6.1 Definition and applicability

This test is applicable for mobile stations either packet data only capable or mobile stations not supporting GSM CS services.

20.23.6.2 Conformance requirement

At least for every sample or every second, whichever is greatest, the MS shall calculate the value of C1, C31 and C32 for the serving cell and recalculate C1, C31 and C32 values for non serving cells (if necessary). The MS shall make a cell re-selection if:

- i) The path loss criterion parameter (C1) for the serving cells falls below zero.

20.23.6.3 Test purpose

- 1. To verify that the MS meets conformance requirement 6.2 (i) within time allowed.

20.23.6.4 Method of Test

Initial Conditions

Parameters changed from the default values in table 20.23.1.

Parameter	Carrier 1	Carrier 2
RF Signal Level (dBm)	-60	-70
GPRS_RXLEV_ACCESS_MIN (dBm)	-90	-100
GRO		-28
SPLIT_PG_CYCLE	4	4
C1	30	30
C32	30	2

Note 1: The HCS structure is omitted from the system information messages on all the cells. Therefore C31 is not used.

Note 2: The RLA_P should be updated every 3.84 seconds with SPLIT_PG_CYCLE=4

Procedure

- a) The SS activates both carriers and pages the MS on carrier 2. The SS starts to monitor carrier 2 for responses from the MS.
- b) The MS is switched on.

- c) The SS waits 120s before the RF level of carrier 1 is reduced to -100 dBm for 8 seconds. (During this period C1 becomes -10). Then the SS raises the level back to -60 dBm. The SS waits 20 seconds.
- d) The SS reduces the RF level on carrier 1 to -100 dBm.

20.23.6.5 Test Requirements

- 1) After step c) there shall be no access on carrier 2.
- 2) After step d) there shall be access on carrier 2 within 23 seconds (allow 20s for c1 average to reach $-10 + 2s$ to decode CPBCCCH)

20.23.7 Downlink signalling failure

20.23.7.1 Definition and applicability

This test is applicable for mobile stations either packet data only capable or mobile stations not supporting GSM CS services.

20.23.7.2 Conformance requirement

The downlink signalling failure criterion is based on the downlink signalling failure counter DSC.

1. If DRX period split is supported , DSC shall be initialised to a value equal to the nearest integer to $\max(10, 90/64 * \text{SPLIT_PG_CYCLE})$ where SPLIT_PG_CYCLE is an parameter defined at GPRS attach (see 05.02)
2. Thereafter, whenever the MS attempts to decode a message in its paging subchannel; if a message is successfully decoded DSC is increased by 1, however never beyond the max value defined in 1.
3. Whenever the MS can not successfully decode a message in its paging subchannel the DSC is decreased by 4.
4. When DSC reaches 0, a downlink signalling failure shall be declared. A downlink signalling failure shall result in cell reselection, GSM 03.22, 4.5 (ii) and GSM 05.08, 6.5

NOTE: The network sends the paging subchannel for a given MS every $64/\text{SPLIT_PG_CYCLE}$ multiframes . The requirement for network transmission on the paging subchannel is specified in GSM 04.08. The MS is required to attempt to decode a message every time its paging subchannel is sent.

20.23.7.3 Test purpose

1. To verify that the MS initialises the DSC counter in accordance with the conformance requirement. This is verified indirectly.
2. To verify that whenever the MS successfully decodes a message on paging subchannel, the DSC is increased by 1, (however never beyond the nearest integer to max defined in 16.2.1). This is verified indirectly.
- 3 To verify that whenever the MS can not successfully decode a message on paging subchannel, the DSC decreased by 4. This is verified indirectly.
4. To verify that when the DSC reaches 0, a downlink signalling failure shall be declared and the MS will perform cell reselection.

20.23.7.4 Method of Test

Initial Conditions

Parameters changed from the default values in table 20.23.1.

Parameter	Carrier 1	Carrier 2
RF Signal Level (dBμV emf() / dBm)	-65	-60
GPRS_RXLEV_ACCESS_MIN (dBm)	-95	-100
SPLIT_PG_CYCLE	4	4
C1	30	40
C32	30	40

Note 1: The HCS structure is omitted from the system information messages on all the cells. Therefore C31 is not used.

Note 2: With SPLIT_PG_CYCLE=4 DSC should be set to 10, Paging blocks occur every 832 frames or 3.84 seconds.

Procedure

- The MS is switched on. On carrier 2 valid layer 3 messages shall be sent in the paging blocks, but not paging the MS. On carrier 1 the MS is paged continuously in all paging blocks.
- After 40s the SS sends corrupted data (using random data, wrong parity bits see GSM 05.03, 4.3 & 4.1.2 or other lower layer error) in 2 successive paging blocks on carrier 2 and then reverts to sending normal data.

NOTE 1: Sending corrupted, i.e. non-decodable data on 2 successive paging blocks should decrease the DSC to 2.

- The SS monitors all accesses on both carriers for 40 s. (Allows the DSC counter to go back to maximum of 10, paging block every 3.84 secs)

- The SS sends corrupted data in 3 successive paging blocks on carrier 2 and then reverts to sending normal data..

NOTE 2: Sending corrupted, data on 3 successive paging blocks should decrease the DSC to < 0 (-2) and cause a cell reselection.

- The SS monitors all accesses on both carriers for 30s

20.23.7.5 Test requirements

- There shall be no access on carrier 1 after step b).
- The MS shall access on carrier 1 at test step e) within 3 seconds. (The time should be measured from the transmission of the complete 3rd successive paging block with errors and allows 2 secs for decoding CPBCCCH).

20.23.8 COMPACT Cell re-selection when target cell is BCCH supporting EGPRS and different routing area

20.23.8.1 Definition and applicability

This test is applicable for mobile stations either packet data only capable or mobile stations not supporting GSM CS services.

20.23.8.2 Conformance requirement

At least for every new sample or every second, whichever is the greatest, the MS shall update RLA_P and calculate the value of C1, C31 and C32 for the serving cell and the non-serving cells; GSM 05.08, 10.1.2 The MS shall make a cell re-selection if:

- The path loss criterion parameter (C1) for the serving cell falls below zero.
- A non-serving suitable cell (see GSM 03.22) is evaluated to be better than the serving cell. The best cell is the cell with the highest value of C32 among
 - those cells that have the highest PRIORITY_CLASS among those that fulfil the criterion C31 ≥ 0, or

- all cells, if no cells fulfil the criterion $C31 \geq 0$.

If the parameter `C32_QUAL` is set, positive `GPRS_RESELECT_OFFSET` values shall only be applied to the neighbour cell with the highest `RLA_P` value of those cells for which `C32` is compared above.

`PRIORITY_CLASS` and `C32_QUAL` are broadcast on CPBCCCH of the serving cell.

When evaluating the best cell, the following hysteresis values shall be subtracted from the `C32` value for the neighbour cells:

- in standby state, if the new cell is in the same routing area: 0.
- in ready state, if the new cell is in the same routing area:
`GPRS_CELL_RESELECT_HYSTERESIS`. If the parameter `C31_HYST` is set,
`GPRS_CELL_RESELECT_HYSTERESIS` shall also be subtracted from the `C31` value for the neighbour cells.
- in standby or ready state, if the new cell is in a different routing area:
`RA_RESELECT_HYSTERESIS`.
- in case of a cell re-selection occurred within the previous 15 seconds: 5 dB.

`GPRS_CELL_RESELECT_HYSTERESIS`, `C31_HYST` and `RA_RESELECT_HYSTERESIS` are broadcast on CPBCCCH of the serving cell.

20.23.8.3 Test purpose

To verify that the MS is able to reselect a correct cell when target cell is non COMPACT cell supporting EGPRS,

20.23.8.4 Method of Test

Initial Conditions

Parameters changed from the default values in table 20.23.1.

Parameter	Carrier 1	Carrier 2	Carrier 3	Carrier 4	Carrier 5
RF Signal Level (dBm)	-60	-70	-70	-65	-70
RAI				Different	
GPRS_RXLEV_ACCESS_MIN (dBm)	-100	-80	-100	-100	-80
GRO		4	4	6	4
GCRH	4				
RARH	6				
C1	40 to 15	10	30	35	10
C32	40 to 15	10	30	35	10

Note1: GRO = `GPRS_RESELECT_OFFSET`, GCRH = `GPRS_CELL_RESELECT_HYSTERESIS`, RARH = `RA_RESELECT_HYSTERESIS`.

Note 2: The BA(GPRS) list only contains the ARFCNs of the carriers used during the test. The HCS structure is transmitted in the Packet system information messages.

Note 3: Carrier 4 is continuous GSM BCCH supporting EGPRS.

Procedure

- The MS is switched on and a downlink TBF is set-up on carrier 1
- The SS waits 10 seconds.
- The RF level of Carrier 1 is reduced to -85 dBm (C1=decreases to 15)

20.23.8.5 Test Requirements

1. After step c) the MS should respond on carrier 4 within 10 seconds. (Carrier 4 C32=35 if RA_RESELECT_HYSTERESIS is used correctly by MS)

Note : Time allowed includes 5 sec for MS to determine C32 on neighbour cell is higher, 2 seconds to decode CPBCCCH and 1 sec for re-selection.

20.23.9 Cell re-selection when target cell is COMPACT CPBCCCH in different routing area.

20.23.9.1 Definition and applicability

This test is applicable for mobile stations either packet data only capable or mobile stations not supporting GSM CS services.

20.23.9.2 Conformance requirement

At least for every new sample or every second, whichever is the greatest, the MS shall update RLA_P and calculate the value of C1, C31 and C32 for the serving cell and the non-serving cells; GSM 05.08, 10.1.2 The MS shall make a cell re-selection if:

- (i) The path loss criterion parameter (C1) for the serving cell falls below zero.
- (ii) A non-serving suitable cell (see GSM 03.22) is evaluated to be better than the serving cell. The best cell is the cell with the highest value of C32 among
 - those cells that have the highest PRIORITY_CLASS among those that fulfil the criterion $C31 \geq 0$, or
 - all cells, if no cells fulfil the criterion $C31 \geq 0$.

If the parameter C32_QUAL is set, positive GPRS_RESELECT_OFFSET values shall only be applied to the neighbour cell with the highest RLA_P value of those cells for which C32 is compared above.

PRIORITY_CLASS and C32_QUAL are broadcast on PBCCH of the serving cell.

When evaluating the best cell, the following hysteresis values shall be subtracted from the C32 value for the neighbour cells:

- in standby state, if the new cell is in the same routing area: 0.
- in ready state, if the new cell is in the same routing area:
GPRS_CELL_RESELECT_HYSTERESIS. If the parameter C31_HYST is set, GPRS_CELL_RESELECT_HYSTERESIS shall also be subtracted from the C31 value for the neighbour cells.
- in standby or ready state, if the new cell is in a different routing area:
RA_RESELECT_HYSTERESIS.
- in case of a cell re-selection occurred within the previous 15 seconds: 5 dB.

GPRS_CELL_RESELECT_HYSTERESIS, C31_HYST and RA_RESELECT_HYSTERESIS are broadcast on PBCCH of the serving cell.

20.23.9.3 Test purpose

To verify that the MS reselects to the correct cell by calculating C32 correctly when the target cells are supporting COMPACT.

20.23.9.4 Method of Test

Initial Conditions

Parameters changed from the default values in table 20.23.1.

Parameter	Carrier 1	Carrier 2	Carrier 3	Carrier 4	Carrier 5	Carrier 6
RF Signal Level (dBm)	-60	-60	-70	-70	-65	-70
RAI					Different	
GPRS_RXLEV_ACCESS_MIN (dBm)	-100	-100	-80	-100	-100	-80
GRO			4	4	6	4
GCRH	4					
RARH	6					
C1	40 to 15		10	30	35	10
C32	40 to 15		10	30	35	10

Note1: GRO = GPRS_RESELECT_OFFSET, GCRH = GPRS_CELL_RESELECT_HYSTERESIS, RARH = RA_RESELECT_HYSTERESIS.

Note 2: The BA(GPRS) list only contains the ARFCNs of the carriers used during the test. The HCS structure is transmitted in the Packet system information messages.

Note 3: Carrier 1 is the BCCH carrier which broadcasts the position of the PBCCH channel supporting EGPRS in the cell (Carrier 2.)

Note 4: Carriers 3, 4 and 6 are continuous GSM BCCH's supporting EGPRS.

Procedure

- The MS is switched on and a downlink TBF is set-up on carrier 2
- The SS waits 10 seconds.
- The RF level of Carriers 1 & 2 are reduced to -85 dBm (C1=decreases to 15)

20.23.9.5 Test Requirements

After step c) the MS should respond on carrier 5 within 10 seconds. (Carrier 5 C32=35 if RA_RESELECT_HYSTERESIS is used correctly by MS)

- Note : Time allowed includes 5 sec for MS to determine C32 on neighbour cell is higher, 2 seconds to decode CPBCCH and 1 sec for re-selection.

20.24 SoLSA Cell Selection and Reselection

All GSM test cases presented in GSM 11.10 chapter 20 are applicable for SoLSA ME with or without LSA SIM. Nevertheless, if LSA SIM are used, it must be checked that no LSA subscription matches the information broadcast by the cell. Otherwise, test cases dealing with cell reselection would fail.

The cell re-selection tests defined in the following sections apply to the SoLSA MS if an LSA support exists in the serving cell. Otherwise the SoLSA MS shall perform cell re-selection according to the idle mode procedures defined in clause 6 of GSM 05.08.

The SS transmits one BCCH carrier per cell as indicated in the initial conditions for each test. These are referred to as carrier 1, carrier 2, etc. Each of these cell control channels are non-combined with SDCCHs. It is assumed that the SS can simultaneously transmit seven BCCH carriers and monitor three random access channels. In some cases, a test is performed in multiple stages in order that the requirements can be tested within the above constraints.

For any SoLSA MS all the carriers are in its supported band(s) of operation. For an E-GSM mobile station at least one of the carriers is in the extension band and one of the carriers is in the primary band.

Unless otherwise stated in the method of test, in all of the tests of this section:

- The SS is continuously paging the SoLSA MS on all carriers at the start of the test and does not respond to RACH requests from the SoLSA MS. Where a test specifies that the SoLSA MS is not paged on a particular carrier, only idle paging is transmitted according to GSM 04.18, 3.2.2.2.
- The default values of the system information data fields given in Table 20.24.1 are used.
- The SIM is in the idle updated state in the default location area with a TMSI assigned at the beginning of each test.
- The ARFCNs used for the carriers in each test are chosen from those in Table 20.24.1 with adjacent carriers separated by a minimum of three channels.

The absolute accuracy of the SoLSA MS signal level measurements is assumed to be ± 6 dB. A difference of at least 8 dB is allowed for cases of discrimination between C1, C2 or C4 values and 0.

The relative accuracy of the SoLSA MS signal level measurements is assumed to be ± 3 dB for the signal levels used in the tests of this section. A difference of at least 5 dB is allowed for cases of discrimination between C1, C2 or C4 values on different carriers.

NOTE 1: The accuracy of SoLSA MS signal level measurements is specified in GSM 05.08. For all of the tests in this section, the signal levels used are greater than 1 dB above reference sensitivity level.

NOTE 2: The tolerance on timers specified in GSM 05.08 is ± 10 % except for PENALTY_TIME where it is ± 2 seconds. In the tests of this section, the test requirements include these tolerances. Consequently, the times stated in the test requirement sometimes differ from the corresponding timer in the conformance requirement.

Where pulsed signals are specified, the SS tolerance on pulse width is ± 2 % and the SS tolerance on power level ± 1 dB.

NOTE 3: Additional to the abbreviations and definitions in 3G TR 21.905 the following definitions are used within this section:

Definitions:

LSA cell	A cell in which SoLSA features are possible
LSA only SIM	A SIM with LSA only access
LSA SIM	A SIM with SoLSA files
Normal LSA cell	An LSA cell which is not an LSA exclusive access cell
Normal LSA SIM	An LSA SIM which is not an LSA only SIM
SoLSA ME	An ME supporting SoLSA
SoLSA MS	A SoLSA ME with LSA SIM

Table 20.24.1: Default values of the system information fields

Parameter	Reference	Abbr.	Normal Setting
Cell channel description	GSM 04.18, 10.5.2.1b	-	Any values
MAX retrans	GSM 04.18, 10.5.2.29	-	1
TX-integer	GSM 04.18, 10.5.2.29	-	Any value
CELL_BAR_QUALIFY	GSM 04.18, 10.5.2.35	CBQ	0
CELL_BAR_ACCESS	GSM 04.18, 10.5.2.29	CBA	0 (not barred)
AC CN	GSM 04.18, 10.5.2.29	AC	All 0
RE	GSM 04.18, 10.5.2.29	RE	0 (re-establishment allowed)
NCC	GSM 04.18, 10.5.2.2	NCC	Any value
Cell Identity	GSM 24.008, 10.5.1.1	CI	Any values
MCC, MNC	GSM 24.008, 10.5.1.3	PLMN	MS Home PLMN
MCC_ESC, MNC_ESC	GSM 23.003, 4.1	escape PLMN	MCC = 901, MNC = 08
LAC	GSM 24.008, 10.5.1.3	LAC	Any value
ATT	GSM 04.18, 10.5.2.11	-	0 (Attach/Detach not allowed)
BS_AG_BLKES_RES	GSM 04.18, 10.5.2.11	-	Any values
CCCH_CONF	GSM 04.18, 10.5.2.11	-	1 basic physical channel used for CCCH, non-combined with SDCCHs.
T3212	GSM 04.18, 10.5.2.11	-	Any values
BS_PA_MFRMS	GSM 04.18, 10.5.2.11	BPM	5 frames
Cell Options	GSM 04.18, 10.5.2.3	-	Any values
CELL_RESELECT_HYSTERESIS	GSM 04.18, 10.5.2.4	CRH	4 dB
MS_TXPWR_MAX_CCH	GSM 04.18, 10.5.2.4	MTMC	Max. output power of MS
RXLEV_ACCESS_MIN	GSM 04.18, 10.5.2.4	RAM	-90 dBm
CELL_RESELECT_OFFSET	GSM 04.18, 10.5.2.35	CRO	0
TEMPORARY_OFFSET	GSM 04.18, 10.5.2.35	TO	0
PENALTY_TIME	GSM 04.18, 10.5.2.35	PT	0
Power Offset	GSM 04.18, 10.5.2.35	PO	0
BA ARFCN	GSM 04.18, 10.5.2.22	BA	All 0 except:
			GSM 450 ARFCNs 259, 263, 269, 275, 279, 283, 287, 292, broadcast in SYSTEM INFORMATION type 2 GSM 480 ARFCNs 306, 310, 316, 322, 326, 330, 334, 339, broadcast in SYSTEM INFORMATION type 2 For GSM 750 ARFCNs 441, 446, 452, 455, 461, 462, 466, 470, 477, 485, 493, 511, 207,219, 251, broadcast in SYSTEM INFORMATION type 2 For GSM 850 ARFCNs 130, 136, 145, 152, 168, 170, 176, 177, 181, 185, 189, 193, 197, 207,219, 251, broadcast in SYSTEM INFORMATION type 2 For GSM 900, both P-GSM and E-GSM ARFCNs are broadcast: GSM ARFCNs 3, 9, 18, 25, 41, 43, 49, 50, 54, 58, 62, 66, 70, 80, 92, 124, broadcast in SYSTEM INFORMATION type 2 E-GSM ARFCNs 985, 989,

			995, 1010, 1014 broadcast in SYSTEM INFORMATION type 2bis
			For DCS 1800 ARFCNs 512, 543, 568, 589, 602, 641, 662, 683, 696, 711, 732, 754, 794, 851, 870, 871, 872, 884 broadcast in SYSTEM INFORMATION type 2.
			For PCS 1900 ARFCNs 512, 543, 568, 589, 602, 641, 662, 683, 696, 711, 732, 754, 794 broadcast in SYSTEM INFORMATION type 2.
			For multiband tests, ARFCNs 3, 18, 41, 49, 62, 70, 92, 124 broadcast in SYSTEM INFORMATION TYPE 2 (GSM 900 cell) and TYPE 2ter (other band cell), ARFCNs 259, 263, 269, 275, 279, 283, 287, 292 broadcast in SYSTEM INFORMATION type 2 (GSM 450 cell) and SYSTEM INFORMATION type 2ter (other band cell), ARFCNs 306, 310, 316, 322, 326, 330, 334, 339 broadcast in SYSTEM INFORMATION type 2 (GSM 480 cell) and SYSTEM INFORMATION type 2ter (other band cell), and ARFCNs 512, 568, 602, 662, 696, 732, 794, 870 broadcast in SYSTEM INFORMATION type 2 (DCS cell) and type 2ter (other band cell) and ARFCNs 512, 568, 602, 662, 696, 732, 794, broadcast in SYSTEM INFORMATION type 2 (PCS cell) and type 2ter (other band cell) , ARFCNs 441, 452, 461, 477, 493, 511 broadcast in SYSTEM INFORMATION TYPE 2 (GSM 750 cell) and SYSTEM INFORMATION TYPE 2ter (other band cell) ARFCNs 136, 152, 170, 177, 185, 193, 207, 251, broadcast in SYSTEM INFORMATION TYPE 2 (GSM 850 cell) and SYSTEM INFORMATION TYPE 2ter (other band cell) . , ARFCNs 441, 452, 461, 477, 493, 511 broadcast in SYSTEM INFORMATION TYPE 2 (GSM 750 cell) and SYSTEM INFORMATION TYPE 2ter (other band cell) ARFCNs 136, 152, 170, 177, 185, 193, 207, 251, broadcast in SYSTEM

			INFORMATION TYPE 2 (GSM 850 cell) and SYSTEM INFORMATION TYPE 2ter (other band cell).
LSA Identifier LSA Offset	GSM 24.008, 10.5.3.11 GSM 4.18,10.5.2.35; GSM 5.08, 9. Table 1	LSA ID LSA_OFFSET	Any value 0
Priority Threshold	GSM 4.18, 10.5.2.35 GSM 5.08, 9. Table 1	PRIO_THR	0

Default values of the SIM card:

The “LSA only access indicator” byte of file EF_{SAI} on the SIM card shall be disabled unless otherwise stated. (see chap. 20.24. General remark 3.)

General initial conditions:

1. Following LSA shall be defined in the fields of the EF_{SLL} (GSM 11.11, 10.4.1.2) and in the LSA descriptor files (GSM 11.11, 10.4.1.3) on the SIM card used for testing:

	LSA ID	CI	LAC	LAC + CI	PLMN code (see NOTE)	LSA Priority	Idle mode support	LSA indication for idle mode
LSA1	54 66.001				HPLMN	0	On	Off
LSA2	66.000				HPLMN	0	Off	On
LSA3	9.000.000			2 + [250..254]	HPLMN	8	On	On
LSA4	9.000.001				HPLMN	8	Off	Off
LSA5	30.000	[256..260]			HPLMN	15	On	On
LSA6	5		1		HPLMN	7	On	On
LSA7	100		10	3 + 500	HPLMN	0	On	On
LSA8	9.000.001				VPLMN	15	On	On
LSA9	54				VPLMN	8	On	On

NOTE: VPLMN is a set of values for MCC and MNC for the LSA which shall not be in the list of the forbidden PLMNs on the SIM card.

2. List of values, that shall not be found in the SIM card, in order to be sure that the SoLSA MS is not subscribed to the LSA defined by the current carrier:

	LSA ID	CI	LAC	LAC + CI
LSA value	[250..255]	[5000..5005]	5	5 + [5000..5005]

3. The initial condition “escape PLMN” is set to “Yes” in the following tables of this section, in case of testing with an LSA exclusive access cell.

General Remark

1) Elementary File EF_{SLL} (GSM 11.11, 10.4.1.2)

The information regarding ‘idle mode support’ and ‘LSA indication for idle mode’ is contained on the SIM card, in the Elementary File EF_{SLL} SoLSA LSA List (identifier ‘4F31’) and, more precisely, in the ‘Configuration Parameters’ byte.

File EF_{SLL} is represented in the table below, from GSM 11.11, 10.4.1.2.

Each LSA is described by one record that is linked to an LSA Descriptor file. Each record contains information of the PLMN, priority of the LSA, information about the subscription and may also contain a text string and/or an icon that identifies the LSA to the user. The text string can be edited by the user.

Identifier: '4F31'		Structure: linear fixed		Optional	
Record length: X + 10 bytes			Update activity: low		
Access Conditions:					
READ		CHV1			
UPDATE		CHV1			
INVALIDATE		ADM			
REHABILITATE		ADM			
Bytes	Description			M/O	Length
1 to X	LSA name			O	X bytes
X+1	Configuration parameters			M	1 byte
X+2	RFU			M	1 byte
X+3	Icon Identifier			M	1 byte
X+4	Priority			M	1 byte
X+5 to X+7	PLMN code			M	3 bytes
X+8 to X+9	LSA Descriptor File Identifier			M	2 byte
X+10	LSA Descriptor Record Identifier			M	1 byte

- Configuration parameters

Contents: Icon qualifier, control of idle mode support and control of LSA indication for idle mode.

Coding:

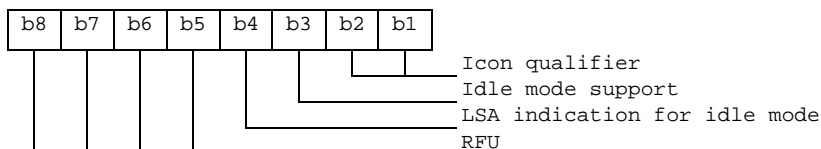

Idle mode support:

Contents: The idle mode support is used to indicate whether the ME shall favour camping on the LSA cells in idle mode.

- b3 = 0: Idle mode support disabled
- b3 = 1: Idle mode support enabled

LSA indication for idle mode:

Contents: The LSA indication for idle mode is used to indicate whether or not the ME shall display the LSA name when the ME is camped on a cell within the LSA.

- b4 = 0: LSA indication for idle mode disabled
- b4 = 1: LSA indication for idle mode enabled

- Priority

Contents: Priority of the LSA which gives the ME the preference of this LSA relative to the other LSAs.

Coding:

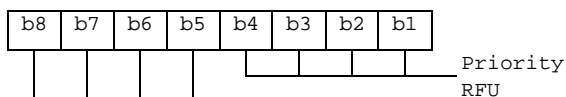

'0' is lowest priority, 'F' is highest.

- PLMN code

Contents: MCC + MNC for the LSA.

Coding: according to GSM 04.08 [15] and EF_{LOCI}.

- LSA Descriptor File Identifier:

Contents: these bytes identify the EF which contains the LSA Descriptors forming the LSA.

Coding: byte X+8: high byte of the LSA Descriptor file;
 byte X+9: low byte of the LSA Descriptor file.

- LSA Descriptor Record Identifier:

Contents: this byte identifies the number of the first record in the LSA Descriptor file forming the LSA.

Coding: binary.

2) Elementary Files „LSA Descriptor File“ (GSM 11.11, 10.4.1.3)

The information regarding the LSA identification is contained on the SIM card in the LSA descriptor files, more precisely in the byte ‘LSA descriptor type and number’ (see table below, from GSM 11.11, 10.4.1.3).

Residing under DF_{SoLSA}, there may be several LSA Descriptor files. These EFs contains one or more records again containing LSA Descriptors forming the LSAs. LSAs can be described in four different ways. As a list of LSA IDs, as a list of LAC + CIs, as a list of CIs or as a list of LACs. As the basic elements (LSA ID, LAC + CI, CI and LAC) of the four types of lists are of different length, they can not be mixed within one record.

Different records may contain different kinds of lists within the EFs.

Identifier: '4FXX'		Structure: linear fixed		Optional
Record length: n*X+2 bytes		Update activity: low		
Access Conditions:				
READ		CHV1		
UPDATE		ADM		
INVALIDATE		ADM		
REHABILITATE		ADM		
Bytes	Description	M/O	Length	
1	LSA descriptor type and number	M	1 byte	
2 to X+1	1 st LSA Descriptor	M	X bytes	
X+2 to 2X+1	2 nd LSA Descriptor	M	X bytes	
(n-1)*X+2 to n*X+1	n th LSA Descriptor	M	X bytes	
n*X+2	Record Identifier	M	1 byte	

- LSA descriptor type and number:

Contents: The LSA descriptor type gives the format of the LSA descriptor and the number of valid LSA Descriptors within the record.

Coding:

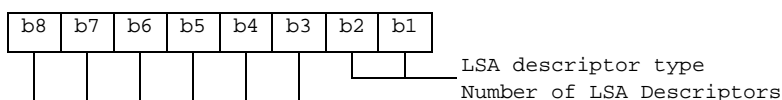

The bit 1 and bit 2 of the first byte of the LSA descriptor file identify the LSA descriptor type.

LSA descriptor type:

Contents: Gives the format of the LSA Descriptors.

- b2, b1: 00: LSA ID. identification of the LSA is done by means of the LSA ID
- 01: LAC + CI identification of the LSA is done by means of the LAC + CI
- 10: CI identification of the LSA is done by means of the CI
- 11: LAC identification of the LSA is done by means of the LAC

3) Elementary File EF_{SAL} (GSM 11.11, 10.4.1.1)

This EF contains the 'LSA only access indicator'. This EF shall always be allocated if DF_{SoLSA} is present.

If the indicator is set, the network will prevent terminated and/or originated calls when the MS is camped in cells that are not included in the list of allowed LSAs in EF_{SLL}. Emergency calls are, however, always allowed.

The EF also contains a text string which may be displayed when the MS is out of the served area(s).

Identifier: '4F30'		Structure: transparent		Optional	
File size: X + 1 bytes			Update activity: low		
Access Conditions:					
READ		CHV1			
UPDATE		ADM			
INVALIDATE		ADM			
REHABILITATE		ADM			
Bytes	Description			M/O	Length
1	LSA only access indicator			M	1 byte
2 to X+1	LSA only access indication text			M	X bytes

- LSA only access indicator

Contents: indicates whether the MS is restricted to use LSA cells only or not.

Coding:

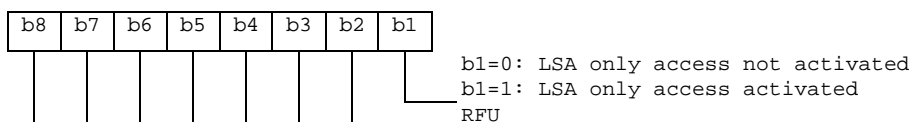

- LSA only access indication text

Contents: text to be displayed by the ME when it's out of LSA area.

20.24.1 SoLSA Cell Selection suitable cell

20.24.1.1 Definition and applicability

SoLSA Cell selection is a process in which a SoLSA MS, whenever a new PLMN is selected, attempts to find a "suitable cell" of that PLMN to camp on. Two methods of searching for a "suitable cell" are possible, normal cell selection and stored list cell selection. The process ensures that the SoLSA MS is camped on a cell from which it can reliably decode downlink data and with which it has a high probability of communications on the uplink. Once the SoLSA MS is camped on a cell, access to the network is allowed.

This test is applicable for all types of SoLSA MS.

20.24.1.2 Conformance requirement

1. The SoLSA MS shall be able to select the strongest "suitable cell" and be able to respond to paging on that cell within 30 seconds of switch on. This requires a valid normal LSA SIM with PIN disabled and ideal radio conditions; GSM 05.08, 6.1. And it requires a list of LSAs for the subscriber stored on the SIM; GSM 11.11, 10.4.1.2.

NOTE: For camping on an LSA cell the LSA subscription is not necessary except for camping on an LSA exclusive access cell; GSM 03.73, 11.4.2.

NOTE: There should be no extra delay in cell selection procedure; GSM 02.43, 4.2.2.

2. There are various requirements that a cell must satisfy before a SoLSA MS can perform normal camping on it:

2.1 (i) It should be a cell of the selected PLMN.

2.2 (ii) It should not be "barred".

2.3 (iv) The radio path loss between SoLSA MS and BTS must be below a threshold set by the PLMN operator.

2.4 (v) It should not be an LSA exclusive access cell to which the SoLSA MS does not subscribe.

GSM 03.22, 3.2.1.

NOTE: Criteria (iii) is not applicable for Cell Selection.

3. Initially the SoLSA MS looks for a cell which satisfies these 5 constraints ("suitable cell") by checking cells in descending order of received signal strength. If a "suitable cell" is found, the SoLSA MS camps on it; GSM 03.22, 3.2.1.

4. The SoLSA MS shall be able to calculate correctly the path loss criterion parameter C1, used for cell selection and reselection; GSM 05.08, 6.4.

5. The LSA identification shall be stored on the SIM card in the LSA descriptor files.

LSAs can be described in four different ways; GSM 11.11, 10.4.1.3:

- as a list of LSA IDs (3 bytes)

- as a list of LAC + CIs (4 bytes)

- as a list of CIs (2 bytes)

- as a list of LACs (2 bytes)

- or as a combination of the lists above

20.24.1.3 Test purpose

The SoLSA MS shall be able to select a "suitable cell" according to the normal cell selection criteria. The identification of the LSA is done by using the LSA ID, the CI, the LAC or the LAC + CI.

20.23.1.4 Method of tests

20.24.1.4.1 SoLSA Cell Selection suitable cell / LSA identified by LSA ID

20.24.1.4.1.1 Initial conditions

a) Identification of the LSA by means of LSA ID (see chap. 20.24. General remark 2.)

b) Parameters changed from the default values in Table 20.24.1.; further initial conditions

Parameter/condition	Carrier 1	Carrier 2	Carrier 3	Carrier 4
RF Signal Level (dB μ V emf() / dBm)	43/-70	13/-100	53/-60	63/-50
CBA	0	0	1	0
RXLEV_ACCESS_MIN (dBm)	-90	-90	-90	-90
MNC				1
MCC				002
C1	20	-10	30	40
LSA ID	66.001	66.001	66.001	66.001
LAC	5	5	5	5
CI	5.000	5.001	5.002	5.003
Matching LSA on SIM	LSA1	LSA1	LSA1	-
Escape PLMN	No	No	No	No

c) Parameters changed from the default values in Table 20.24.1;
further initial conditions (for test procedure step g)

Parameter/condition	Carrier 1	Carrier 2	Carrier 3	Carrier 4
RF Signal Level (dB μ V emf() / dBm)	43/-70	13/-100	53/-60	OFF
CBA	0	0	1	
RXLEV_ACCESS_MIN (dBm)	-90	-90	-90	
C1	20	-10	30	
LSA ID	250	66.001	250	
LAC	5	5	5	
CI	5.000	5.001	5.002	
Matching LSA on SIM	-	LSA1	-	
Escape PLMN	Yes	Yes	No	

20.24.1.4.1.2 Test Procedure

- a) The SS activates all carriers according to Table b) and monitors carriers 1, 2 and 4 for RA requests from the SoLSA MS.
- b) The SoLSA MS is switched on.
- c) The SoLSA MS is switched off.
- d) The SS monitors carrier 3 for RA requests from the SoLSA MS.
- e) The SoLSA MS is switched on.
- f) The SoLSA MS is switched off.
- g) The SS is reconfigured according to Table c). The SS monitors carriers 1, 2, and 3 for RA requests from the SoLSA MS.
- h) The SoLSA MS is switched on.

- i) The SoLSA MS is switched off.
- j) The SS is reconfigured and the level of carrier 2 increases to 33 dB μ V / - 80 dBm (C1 increases to 10 dBm). The SS monitors carriers 1, 2 and 3 for RA requests from the SoLSA MS.
- k) The SoLSA MS is switched on.

20.24.1.4.1.3 Related PICS/PIXIT statement(s)

- Support of SoLSA

20.24.1.4.1.4 Test Requirements

- 1) After step b), the first response from the SoLSA MS shall be received on carrier 1 within 50 seconds. There shall be no response from the SoLSA MS on the other monitored carriers.
NOTE: 33 seconds for cell selection, 10 seconds for communicating the data between SIM and ME, 5 seconds for search of a matching LSA on SIM: allow 50 seconds.
- 2) There shall be no response from the SoLSA MS on the monitored carrier after step e) within 60 seconds.
NOTE: Any potential access is likely to occur within 50 seconds.
- 3) After step h), there shall be no response from the SoLSA MS on the monitored carriers within 60 seconds (carrier 1 is not fulfilling conformance requirement 2.4).
- 4) After step k), the first response from the SoLSA MS shall be received on carrier 2 within 50 seconds. There shall be no response from the SoLSA MS on the other monitored carriers .

20.24.1.4.2 SoLSA Cell Selection suitable cell / LSA identified by LAC + CI

20.24.1.4.2.1 Initial conditions

a) Identification of the LSA by means of LAC + CI (see chap. 20.24. General remark 2.)

b) Parameters changed from the default values in Table 20.24.1; further initial conditions

Parameter/condition	Carrier 1	Carrier 2	Carrier 3	Carrier 4
RF Signal Level (dBμV emf() / dBm)	43/-70	13/-100	53/-60	63/-50
CBA	0	0	1	0
RXLEV_ACCESS_MIN (dBm)	-90	-90	-90	-90
MNC				1
MCC				002
C1	20	-10	30	40
LSA ID	250	250	250	250
LAC	2	2	2	2
CI	250	251	252	253
Matching LSA on SIM	LSA3	LSA3	LSA3	-
Escape PLMN	No	No	No	No

c) Parameters changed from the default values in Table 20.24.1;
further initial conditions (for test procedure step g)

Parameter/condition	Carrier 1	Carrier 2	Carrier 3	Carrier 4
RF Signal Level (dBμV emf() / dBm)	43/-70	13/-100	53/-60	OFF
CBA	0	0	1	
RXLEV_ACCESS_MIN (dBm)	-90	-90	-90	
C1	20	-10	30	
LSA ID	250	250	250	
LAC	2	2	5	
CI	5000	250	251	
Matching LSA on SIM	-	LSA3	-	
Escape PLMN	Yes	Yes	No	

20.24.1.4.2.2 Test Procedure

- a) The SS activates all carriers according to Table b) and monitors carriers 1, 2 and 4 for RA requests from the SoLSA MS.
- b) The SoLSA MS is switched on.
- c) The SoLSA MS is switched off.
- d) The SS monitors carrier 3 for RA requests from the SoLSA MS.
- e) The SoLSA MS is switched on.
- f) The SoLSA MS is switched off.
- g) The SS is reconfigured according to Table c). The SS monitors carriers 1, 2, and 3 for RA requests from the SoLSA MS.
- h) The SoLSA MS is switched on.
- i) The SoLSA MS is switched off.

- j) The SS is reconfigured and the level of carrier 2 increases to 33 dB μ V / - 80 dBm (C1 increases to 10 dBm). The SS monitors carriers 1, 2 and 3 for RA requests from the SoLSA MS.
- k) The SoLSA MS is switched on.

20.24.1.4.2.3 Related PICS/PIXIT statement(s)

- Support of SoLSA

20.24.1.4.2.4 Test Requirements

- 1) After step b), the first response from the SoLSA MS shall be received on carrier 1 within 50 seconds. There shall be no response from the SoLSA MS on the other monitored carriers.
- 2) There shall be no response from the SoLSA MS on the monitored carrier after step e) within 60 seconds.
NOTE: Any potential access is likely to occur within 50 seconds.
- 3) After step h), there shall be no response from the SoLSA MS on the monitored carriers within 60 seconds.
- 4) After step k), the first response from the SoLSA MS shall be received on carrier 2 within 50 seconds. There shall be no response from the SoLSA MS on the other monitored carriers .

20.24.1.4.3 SoLSA Cell Selection suitable cell / LSA identified by CI

20.24.1.4.3.1 Initial conditions

- a) Identification of the LSA by means of CI (see chap. 20.24. General remark 2.)
- b) Parameters changed from the default values in Table 20.24.1; further initial conditions

Parameter/condition	Carrier 1	Carrier 2	Carrier 3	Carrier 4
RF Signal Level (dBμV emf() / dBm)	43/-70	13/-100	53/-60	63/-50
CBA	0	0	1	0
RXLEV_ACCESS_MIN (dBm)	-90	-90	-90	-90
MNC				1
MCC				002
C1	20	-10	30	40
LSA ID	250	250	250	250
LAC	5	5	5	5
CI	257	258	259	260
Matching LSA on SIM	LSA5	LSA5	LSA5	-
Escape PLMN	No	No	No	No

- c) Parameters changed from the default values in Table 20.24.1;
further initial conditions (for test procedure step g)

Parameter/condition	Carrier 1	Carrier 2	Carrier 3	Carrier 4
RF Signal Level (dBμV emf() / dBm)	43/-70	13/-100	53/-60	OFF
CBA	0	0	1	
RXLEV_ACCESS_MIN (dBm)	-90	-90	-90	
C1	20	-10	30	
LSA ID	250	250	250	
LAC	5	5	5	
CI	5.000	258	5.001	
Matching LSA on SIM	-	LSA5	-	
Escape PLMN	Yes	Yes	No	

20.24.1.4.3.2 Test Procedure

- a) The SS activates all carriers according to Table b) and monitors carriers 1, 2 and 4 for RA requests from the SoLSA MS.
- b) The SoLSA MS is switched on.
- c) The SoLSA MS is switched off.
- d) The SS monitors carrier 3 for RA requests from the SoLSA MS.
- e) The SoLSA MS is switched on.
- f) The SoLSA MS is switched off.
- g) The SS is reconfigured according to Table c). The SS monitors carriers 1, 2, and 3 for RA requests from the SoLSA MS.
- h) The SoLSA MS is switched on.
- i) The SoLSA MS is switched off.

- j) The SS is reconfigured and the level of carrier 2 increases to 33 dB μ V / - 80 dBm (C1 increases to 10 dBm). The SS monitors carriers 1, 2 and 3 for RA requests from the SoLSA MS.
- k) The SoLSA MS is switched on.

20.24.1.4.3.3 Related PICS/PIXIT statement(s)

- Support of SoLSA

20.24.1.4.3.4 Test Requirements

- 1) After step b), the first response from the SoLSA MS shall be received on carrier 1 within 50 seconds. There shall be no response from the SoLSA MS on the other monitored carriers.
- 2) There shall be no response from the SoLSA MS on the monitored carrier after step e) within 60 seconds.
NOTE: Any potential access is likely to occur within 50 seconds.
- 3) After step h), there shall be no response from the SoLSA MS on the monitored carriers within 60 seconds.
- 4) After step k), the first response from the SoLSA MS shall be received on carrier 2 within 50 seconds. There shall be no response from the SoLSA MS on the other monitored carriers .

20.24.1.4.4 SoLSA Cell Selection suitable cell / LSA identified by LAC

20.24.1.4.4.1 Initial conditions

a) Identification of the LSA by means of LAC (see chap. 20.24. General remark 2.)

b) Parameters changed from the default values in Table 20.24.1; further initial conditions

Parameter/condition	Carrier 1	Carrier 2	Carrier 3	Carrier 4
RF Signal Level (dBμV emf() / dBm)	43/-70	13/-100	53/-60	63/-50
CBA	0	0	1	0
RXLEV_ACCESS_MIN (dBm)	-90	-90	-90	-90
MNC				1
MCC				002
C1	20	-10	30	40
LSA ID	250	250	250	250
LAC	1	1	1	1
CI	5.000	5.001	5.002	5.003
Matching LSA on SIM	LSA6	LSA6	LSA6	-
Escape PLMN	No	No	No	No

c) Parameters changed from the default values in Table 20.24.1;
further initial conditions (for test procedure step g)

Parameter/condition	Carrier 1	Carrier 2	Carrier 3	Carrier 4
RF Signal Level (dBμV emf() / dBm)	43/-70	13/-100	53/-60	OFF
CBA	0	0	1	
RXLEV_ACCESS_MIN (dBm)	-90	-90	-90	
C1	20	-10	30	
LSA ID	250	250	250	
LAC	5	1	5	
CI	5.000	5.001	5.002	
Matching LSA on SIM	-	LSA6	-	
Escape PLMN	Yes	Yes	No	

20.24.1.4.4.2 Test Procedure

- a) The SS activates all carriers according to Table b) and monitors carriers 1, 2 and 4 for RA requests from the SoLSA MS.
- b) The SoLSA MS is switched on.
- c) The SoLSA MS is switched off.
- d) The SS monitors carrier 3 for RA requests from the SoLSA MS.
- e) The SoLSA MS is switched on.
- f) The SoLSA MS is switched off.
- g) The SS is reconfigured according to Table c). The SS monitors carriers 1, 2, and 3 for RA requests from the SoLSA MS.
- h) The SoLSA MS is switched on.
- i) The SoLSA MS is switched off.

- j) The SS is reconfigured and the level of carrier 2 increases to 33 dB μ V / - 80 dBm (C1 increases to 10 dBm). The SS monitors carriers 1, 2 and 3 for RA requests from the SoLSA MS.
- k) The SoLSA MS is switched on.

20.24.1.4.4.3 Related PICS/PIXIT statement(s)

- Support of SoLSA

20.24.1.4.4.4 Test Requirements

- 1) After step b), the first response from the SoLSA MS shall be received on carrier 1 within 50 seconds. There shall be no response from the SoLSA MS on the other monitored carriers.
- 2) There shall be no response from the SoLSA MS on the monitored carrier after step e) within 60 seconds.
NOTE: Any potential access is likely to occur within 50 seconds.
- 3) After step h), there shall be no response from the SoLSA MS on the monitored carriers within 60 seconds.
- 4) After step k), the first response from the SoLSA MS shall be received on carrier 2 within 50 seconds. There shall be no response from the SoLSA MS on the other monitored carriers .

20.24.2 SoLSA Cell (Re)Selection Emergency Call

20.24.2.1 Definition and applicability

This test is applicable for all types of SoLSA MS.

20.24.2.2 Conformance requirement

1. The SoLSA MS shall be able to initiate emergency calls when no “suitable cells” of the selected PLMN are available, but at least one acceptable cell is available. The SoLSA MS is in limited service state.
An LSA exclusive access cell is “suitable” only if the LSA of the cell is one of the allowed LSA according to the SIM. Emergency calls are always allowed if no cells are found suitable; GSM 03.73, 11.4.2
2. When in a limited service state and if not camped on a cell, the MS shall monitor the received signal level of all RF channels within its band of operation, and search for a BCCH carrier which has $C1 > 0$ and which is not barred. When such a carrier is found, the MS shall camp on that cell, irrespective of the PLMN identity; GSM 05.08, 6.8.
3. The MS shall perform cell reselection at least among the cells of the PLMN of the cell on which the MS has camped, according to the algorithm of GSM 03.22, except that a zero value of CELL_RESELECT_HYSTERESIS shall be used.

20.24.2.3 Test purpose

1. To verify that the SoLSA MS shall be able to initiate emergency calls when no “suitable cells” of selected PLMN are available, but at least one acceptable cell is available. The available cells are
 - a) LSA exclusive access cells of the selected PLMN with no LSA subscription
 - b) Normal LSA cell of forbidden PLMN
2. To verify that the MS selects a cell with $C1 > 0$ and $CBA = 0$ when no suitable cells of the selected PLMN are available.
3. To verify that the MS, when performing cell reselection in the limited service state, uses $CELL_RESELECT_HYSTERESIS = 0$, GSM 05.08, 6.8.

20.24.2.4 Method of test

20.24.2.4.1 Initial conditions

a) Parameters changed from the default values in Table 20.24.1; further initial conditions for LSA exclusive access cell

Parameter/condition	Carrier 1	Carrier 2	Carrier 3	Carrier 4
RF Signal Level (db μ V emf() / dBm)	38/ -75	23/ -90	33 / -80	OFF
RXLEV_ACCESS_MIN (dBm)	-90	-80	-90	
CBA	1 (barred)	0	0	
MCC, MNC	Home PLMN	Home PLMN	Home PLMN	
CRH (dB)	0	0	14	
C1	15	-10	10	
LSA_ID	250	251	252	
LAC	5	5	5	
CI	5000	5001	5002	
Matching LSA on SIM	-	-	-	
Escape PLMN	Yes	Yes	Yes	

b) Parameters changed from the default values in Table 20.24.1; further initial conditions for normal LSA cell

Parameter/condition	Carrier 1	Carrier 2	Carrier 3	Carrier 4
RF Signal Level (db μ V emf() / dBm)	38/ -75	23/ -90	33 / -80	OFF
RXLEV_ACCESS_MIN (dBm)	-90	-80	-90	
CBA	1 (barred)	0	0	
MCC, MNC	forbidden	forbidden	forbidden	
CRH (dB)	0	0	14	
C1	15	-10	10	
LSA_ID	250	251	252	
LAC	5	5	5	
CI	5000	5001	5002	
Matching LSA on SIM	-	-	-	
Escape PLMN	No	No	No	

NOTE: All the BCCH carriers belong to the same PLMN, which is not the MS's home PLMN and which is in the SIM's forbidden PLMN list.

Run the following test procedure twice by using two different sets of initial conditions:

- using initial conditions a).
- using initial conditions b).

20.24.2.4.2 Test Procedure

- a) The SS activates the carriers. The SS monitors carriers 1, 2 and 3 for RA requests for the duration of the test.
- b) The SoLSA MS is switched on.
- c) 60 seconds after switch on, an emergency call is initiated on the SoLSA MS.
- d) The SS changes the CBA of carrier 1 to 0.

NOTE: The MS should reselect carrier 1 because it should not take into account the CRH value of 14 but use 0 instead.

- e) After 350 s an emergency call is initiated on the SoLSA MS.

NOTE: 330 seconds to detect change of BCCH data on neighbour cell, 15 seconds to perform reselection of carrier 1 since the SoLSA MS already has a running average on carrier 1, 5 seconds for search of a matching LSA on SIM.

20.24.2.4.3 Related PICS/PIXIT statement(s)

- Support of SoLSA

20.24.2.4.4 Test requirements

- 1) In step c), the first access of the SoLSA MS shall be on carrier 3.
- 2) In step e), the first access of the SoLSA MS shall be on carrier 1.

20.24.3 SoLSA Cell Reselection / idle mode support enabled

General Remark

The identification of the LSA is done by means of the LSA ID, see General Remark 2) in chapter 20.24.

20.24.3.1 General conformance requirement

1. There are various requirements that a cell must satisfy before a SoLSA MS can perform normal camping on it:
 - i) It should be a cell of the selected PLMN.
 - ii) It should not be “barred”.
 - iii) It should not be in an LA which is in the list of “forbidden LA for roaming”.
 - iv) The radio path loss between SoLSA MS and BTS must be below a threshold set by the PLMN operator.
 - v) It should not be an LSA exclusive access cell to which the SoLSA MS does not subscribe.

GSM 03.22, 3.2.1.
2. While camped on a cell of the selected PLMN (“camped normally”), the SoLSA MS may need to select a different cell (“normal cell reselection” state). The following events trigger a cell reselection:
 - The cell camped on (current serving cell) has become barred.
 - There is a better cell (in terms of the path loss criterion C2) in the same LA, or a much better cell in another LA of the selected PLMN (using the CRH parameter).

The SoLSA MS will then reselect a new cell in order to fulfil the process goal.

GSM 03.22, 4.5.

3. At least for every new sample or every second, whichever is the greatest, the SoLSA MS calculates the value of C1, C2 and C4 for the serving cell and the non-serving cells. The SoLSA MS shall make a cell reselection if:
 - i) The path loss criterion parameter (C1) for the serving cell falls below zero for a period of 5 seconds.
 - ii) A non-serving suitable cell (see GSM 03.22) is evaluated to be better than the serving cell for a period of 5 seconds. The best cell is:
 - the cell with the highest value of $C2 + LSA_OFFSET$ among those cells that have highest LSA priority among those that fulfil the criteria $C4 \geq 0$, or
 - the cell with the highest value of C2 among all cells, if no cell fulfil the criterion $C4 \geq 0$.

LSA_OFFSET and LSA ID(s) are broadcast on BCCH. LSA priority is defined by the list of LSAs for the subscriber stored on the SIM. Cells with no LSA priority, e.g. non-LSA cells, are given LSA priority lower than 0. If no LSA_OFFSET parameter is broadcast, LSA_OFFSET shall be set to 0.

When evaluating the best cell, the following hysteresis values shall be subtracted from the C2 value for the neighbour cells:

- if the new cell is in the same location area: 0.
- if the new cell is in a different location area:
CELL_RESELECT_HYSTERESIS, which is broadcast on BCCH of the serving cell.
- in case of a cell reselection occurred within the previous 15 seconds: 5 dB.

GSM 05.08, 6.6.3.

4. Cell reselection for any other reason shall take place immediately, but the cell that the SoLSA MS was camped on shall not be returned to within 5 seconds if another suitable cell can be found. If valid receive level averages are not available, the SoLSA MS shall wait until these values are available and then perform the cell reselection if it is still required. The SoLSA MS may accelerate the measurement procedure within the requirements in 05.08, subclause 6.6.1 to minimise the cell reselection delay. GSM 05.08, 6.6.3.
5. If no suitable cell is found within 10 seconds, the cell selection algorithm of GSM 03.22 shall be performed. Since information concerning a number of channels is already known to the SoLSA MS, it may assign high priority to measurements on the strongest carriers from which it has not previously made attempts to obtain BCCH information, and omit repeated measurements on the known ones. GSM 05.08, 6.6.3.
6. At least every 5 s the MS shall calculate the value of C1 and C2 for the serving cell and re-calculate C1 and C2 values for non serving cells (if necessary). The MS shall then check whether:
 - i) The path loss criterion (C1) for current serving cell falls below zero for a period of 5 seconds. This indicates that the path loss to the cell has become too high.
 - ii) The calculated value of C2 for a non-serving suitable cell exceeds the value of C2 for the serving cell for a period of 5 seconds, except;
 - a) in the case of the new cell being in a different location area or, for a GPRS MS, in a different routing area or always for a GPRS MS in ready state in which case the C2 value for the new cell shall exceed the C2 value of the serving cell by at least CELL_RESELECT_HYSTERESIS dB as defined by the BCCH data from the current serving cell, for a period of 5 seconds;

or

 - b) in case of a cell reselection occurring within the previous 15 seconds in which case the C2 value for the new cell shall exceed the C2 value of the serving cell by at least 5 dB for a period of 5 seconds.

This indicates that it is a better cell.

GSM 05.08, 6.6.2.

7. The SoLSA MS shall attempt to decode the full BCCH data of the serving cell at least every 30 seconds; GSM 05.08, 6.6.1.
8. The signal strength threshold criterion parameter C4 is used to determine whether prioritised LSA cell reselection shall apply and is defined by:

$$C4 = A - \text{PRIO_THR}$$

where

$$A = \text{RLA_C} - \text{RXLEV_ACCESS_MIN}$$

and PRIO_THR is the signal threshold for applying LSA reselection. PRIO_THR is broadcast on the BCCH. If the idle mode support is disabled for the LSA (GSM 11.11, 10.4.1.2) or if the cell does not belong to any LSA to which the MS is subscribed or if no PRIO_THR parameter is broadcast, PRIO_THR shall be set to ∞ .

GSM 05.08, 6.4.

9. The LSA identification is stored on the SIM card within the descriptor file for the LSA. GSM 11.11, 10.4.1.3.

20.24.3.2 SoLSA Cell Reselection / idle mode support enabled / LSA Priority

20.24.3.2.1 Definition and applicability

While camped on a cell of the selected PLMN the SoLSA MS may need to select a different cell in order to fulfil the normal service state. This ensures that the SoLSA MS is camped on a cell from which it can reliably decode downlink data and with which it has a high probability of communications on the uplink.

Idle mode support for SoLSA on the SIM card is enabled. (See General Remark 1. in chapter 20.24).

This test is applicable for all types of SoLSA MS.

20.24.3.2.2 Conformance requirement

1. While camped on a cell of the selected PLMN (“camped normally”), the SoLSA MS may need to select a different cell (“normal cell reselection” state). The following events trigger a cell reselection:

- The cell camped on (current serving cell) has become barred.
- There is a better cell (in terms of the path loss criterion C2) in the same LA.

The SoLSA MS will then reselect a new cell in order to fulfil the process goal.

GSM 03.22, 4.5.

2. A SoLSA MS with SIM indicating LSA subscription shall always try to reselect the cell with highest LSA priority according to the information stored on the SIM. GSM 03.73, 11.4.2.

20.24.3.2.3 Test purpose

To verify that the SoLSA MS when idle mode support for SoLSA on the SIM card is enabled shall favour camping on those LSA cells with the highest LSA priority the SoLSA MS is subscribed to.

20.24.3.2.4 Method of test

20.24.3.2.4.1 Initial conditions

a) Identification of the LSA by means of LSA ID (see chap. 20.24. General remark 2.)

b) Parameters changed from the default values in Table 20.24.1.

Parameter	Carrier 1	Carrier 2	Carrier 3	Carrier 4
RF Signal Level (dBµV emf() / dBm)	63/ -50	53/ -60	33 / -80	OFF
CBA	0	0	0	
RXLEV_ACCESS_MIN (dBm)	-90	-90	-90	
LAC				
C1	40	30	10	
C2	40	30	10	
C4	40	30	10	
LSA IDs	66.001	9.000.000	30.000	
	250	66.001	66.001	
	251	250	9.000.000	
	252	251	250	
LAC	5	5	5	
CI	5000	5001	5002	

c) Further initial conditions (Carrier 1-3 are normal LSA cells):

	Carrier 1	Carrier 2	Carrier 3	Carrier 4
Matching LSA on SIM	LSA1	LSA1, LSA3	LSA1, LSA3, LSA5	
Escape PLMN	No	No	No	

d) Further initial conditions (Carrier 1-3 are LSA exclusive access cells):

	Carrier 1	Carrier 2	Carrier 3	Carrier 4
Matching LSA on SIM	LSA1	LSA1, LSA3	LSA1, LSA3, LSA5	
Escape PLMN	Yes	Yes	Yes	

Run the following test procedure twice by using two different sets of initial conditions:

- using initial conditions a), b) and c)
- using initial conditions a), b) and d)

20.24.3.2.4.2 Test Procedure

- a) The SS activates carriers 1, 2, and 3 and monitors these carriers for RA requests from the SoLSA MS.
- b) The SoLSA MS is switched on.
- c) After approx. 60s the SS is reconfigured and carrier 3 becomes barred (CBA = 1) in order to give the MS the time to perform cell reselection on carrier 3
- d) The SS is reconfigured and the level of carrier 2 is decreased to $13 \text{ dB}\mu\text{Vemf}() / -100 \text{ dBm}$. (C2 decreases to -10 dB).

20.24.3.2.4.3 Related PICS/PIXIT statement(s)

- Support of SoLSA

20.24.3.2.4.4 Test Requirements

- 1) After step b), the first response from the SoLSA MS shall be received on carrier 1 (highest C1) within 50 seconds (Cell Selection).

NOTE: 33 seconds for the MS to read the BCCH of carrier 3 (30 seconds + 10 %), 10 seconds for communicating the data between SIM and ME, 5 seconds for search of a matching LSA on SIM. Total 48 seconds, allow 50 seconds.

- 2) The following response from the SoLSA MS shall be received on carrier 3 within 25 seconds after the first response on carrier 1 (Reselection, highest LSA Priority (15)).

NOTE: 5 seconds for the running average, 10 seconds to detect C2 differences, 2,4 seconds to read BCCH of carrier 1, 1 second to perform RA, 5 seconds for search of a matching LSA on SIM. Total 23,4 seconds, allow 25 seconds.

- 3) After step c), there shall be response from the SoLSA MS on carrier 2 within 55 seconds after carrier 3 has been barred (Highest LSA Priority on the SIM (8)).

NOTE: 30 seconds for the MS to read the BCCH of carrier 3, 20 seconds to reselect carrier 2, 5 seconds for search of a matching LSA on SIM: total 55 seconds.

- 4) After step d), there shall be response from the SoLSA MS on carrier 1 within 25 seconds after carrier 2 has been reconfigured.

NOTE: 5 seconds for the running average, 10 seconds to detect C2 differences, 2,4 seconds to read BCCH of carrier 1, 1 second to perform RA, 5 seconds for search of a matching LSA on SIM. Total 23,4 seconds, allow 25 seconds.

20.24.3.3 SoLSA Cell Reselection / idle mode support enabled / LSA Priority / different location area

20.23.3.3.1 Definition and applicability

While camped on a cell of the selected PLMN the SoLSA MS may need to select a different cell in order to fulfil the normal service state. This ensures that the SoLSA MS is camped on a cell from which it can reliably decode downlink data and with which it has a high probability of communications on the uplink.

Idle mode support for SoLSA on the SIM card is enabled (See General Remark 1. of chapter 20.24).

This test is applicable for all types of SoLSA MS.

20.24.3.3.2 Conformance requirement

1. While camped on a cell of the selected PLMN (“camped normally”), the SoLSA MS may need to select a different cell (“normal cell reselection” state). The following events trigger a cell reselection:
 - The cell camped on (current serving cell) has become barred.
 - There is a better cell (in terms of the path loss criterion C2) in the same LA, or a much better cell in another LA of the selected PLMN (using the CRH parameter).

The SoLSA MS will then reselect a new cell in order to fulfil the process goal.

GSM 03.22, 4.5.

2. A SoLSA MS with SIM indicating LSA subscription shall always try to reselect the cell with highest LSA priority according to the information stored on the SIM. GSM 03.73, 11.4.2.
3. The LSA identification shall be stored on the SIM card in the LSA descriptor files (EF). LSAs can be described in four different ways (see GSM 11.11, 10.4.1.3):
 - as a list of LSA IDs (3 bytes)
 - as a list of LAC + CIs (4 bytes)
 - as a list of CIs (2 bytes)
 - as a list of LACs (2 bytes)
 - or as a combination of the lists above

20.24.3.3.3 Test purpose

To verify that the SoLSA MS when idle mode support for SoLSA on the SIM card is enabled shall favour camping on those LSA cells with the highest C2 among those cells with the highest LSA priority the SoLSA MS is subscribed to even if the cell belongs to a different location area.

20.24.3.3.4 Method of test

20.24.3.3.4.1 Initial conditions

- a) Identification of the LSA by means of LSA ID (see chap. 20.24. General remark 2.)
- b) Parameters changed from the default values in Table 20.24.1.

Parameter	Carrier 1	Carrier 2	Carrier 3	Carrier 4
RF Signal Level (dBuV emf() / dBm)	43/ -70	33/ -80	33 / -80	13 / -100
CBA	0	0	0	0
RXLEV_ACCESS_MIN (dBm)	-90	-90	-90	-90
CRH (dB)	10		10	
C1	20	10	10	-10
C2	20	10	10	-10
C4	20	10	10	-10
LSA ID	54	54	54	30.000
LAC	5	5	3	3
CI	5000	5001	5002	5003

- c) Further initial conditions (Carrier 1-3 are normal LSA cells):

	Carrier 1	Carrier 2	Carrier 3	Carrier 4
Matching LSA on SIM	LSA1	LSA1	LSA1	LSA5
Escape PLMN	No	No	No	No

- d) Further initial conditions (Carrier 1-3 are LSA exclusive access cells):

	Carrier 1	Carrier 2	Carrier 3	Carrier 4
Matching LSA on SIM	LSA1	LSA1	LSA1	LSA5
Escape PLMN	Yes	Yes	Yes	Yes

- e) Identification of the LSA by means of:
- LSA ID on Carrier 1
 - LAC + CI on Carrier 2
 - LAC on Carrier 3
 - CI on carrier 4

(see chap. 20.24. General remark 2.)

f) Parameters changed from the default values in Table 20.24.1.

Parameter	Carrier 1	Carrier 2	Carrier 3	Carrier 4
RF Signal Level (dB μ V emf() / dBm)	43/ -70	33/ -80	33 / -80	13 / -100
CBA	0	0	0	0
RXLEV_ACCESS_MIN (dBm)	-90	-90	-90	-90
CRH (dB)	10		10	
C1	20	10	10	-10
C2	20	10	10	-10
C4	20	10	10	-10
LSA ID	100	250	250	250
LAC	3	3	10	5
CI	5000	500	5002	256

g) Further initial conditions (Carrier 1-4 are normal LSA cells):

	Carrier 1	Carrier 2	Carrier 3	Carrier 4
Matching LSA on SIM	LSA7	LSA7	LSA7	LSA5
Escape PLMN	No	No	No	No

h) Further initial conditions (Carrier 1-4 are LSA exclusive access cells):

	Carrier 1	Carrier 2	Carrier 3	Carrier 4
Matching LSA on SIM	LSA7	LSA7	LSA7	LSA5
Escape PLMN	Yes	Yes	Yes	Yes

Run the following test procedure twice by using four different sets of initial conditions:

- using initial conditions a), b) and c)
- using initial conditions a), b) and d)
- using initial conditions e), f) and g)
- using initial conditions e), f) and h)

20.24.3.3.4.2 Test Procedure

- a) The SS activates carriers 1, 2, and 3 and monitors these carriers for RA requests from the SoLSA MS. Carrier 4 is switched off.
- b) The SoLSA MS is switched on.
- c) The SS is reconfigured and the level of carrier 3 is increased to 63 dB μ V emf() / -50 dBm (C2 increases to 40 dB).
- d) The SS is reconfigured and the level of carrier 2 is increased to 63 dB μ V emf() / -50 dBm (C2 increases to 40 dB).
- e) The SS is reconfigured and carrier 3 becomes barred (CBA = 1).
- f) The SS activates carrier 4 and monitors carriers 1, 2, and 4. Carrier 3 is switched off.
- g) The SS is reconfigured and the level of carrier 4 is increased to 33 dB μ V emf () / -80 dBm (C2 increases to 10 dB).

20.24.3.3.4.3 Related PICS/PIXIT statement(s)

- Support of SoLSA

20.24.3.3.4.4 Test Requirements

- 1) After step b), the first response from the SoLSA MS shall be received on carrier 1 within 50 seconds. (Cell Selection, highest C1). There shall be no response from the SoLSA MS on any other carrier within 35 seconds after first response on carrier 1.
NOTE: Any potential access is likely to occur within 25s.
- 2) After step c), there shall be response from the SoLSA MS on carrier 3 within 25 seconds after increasing the level of carrier 3 (now highest C2 (C2-CRH), for cells with $C4 > 0$)
- 3) After step d), there shall be no response from the SoLSA MS on carrier 2 within 35 seconds after increasing the level of carrier 2 (still highest C2/C2-CRH for carrier 3).
NOTE: Any potential access is likely to occur within 25s.
- 4) After step e), there shall be response from the SoLSA MS on carrier 2 within 55 seconds after carrier 3 becomes barred.
- 5) After step f), there shall be no response from the SoLSA MS on carrier 4 within 60 seconds after carrier 4 is switched on (Highest LSA Priority (15), but $C2 < 0$).
- 6) After step g), there shall be response from the SoLSA MS on carrier 4 within 25 seconds after increasing level of carrier 4. (not highest C2, but $C4 > 0$ and highest LSA Priority (15) on the SIM)

20.24.3.4 SoLSA Cell Reselection / idle mode support enabled / Priority Threshold

20.24.3.4.1 Definition and applicability

While camped on a cell of the selected PLMN the SoLSA MS may need to select a different cell in order to fulfil the normal service state. This ensures that the SoLSA MS is camped on a cell from which it can reliably decode downlink data and with which it has a high probability of communications on the uplink.

Idle mode support for SoLSA on the SIM card is enabled (See General Remark 1 in chapter 20.24).

This test is applicable for all types of SoLSA MS.

20.24.3.4.2 Conformance requirement

The SoLSA MS shall be able to calculate correctly the signal strength threshold criterion parameter C4 which is to determine whether prioritised LSA cell reselection shall apply.

The signal strength threshold criterion parameter C4 is used to determine whether prioritised LSA cell reselection shall apply and is defined by:

$$C4 = A - \text{PRIO_THR}$$

where

A is defined as above and PRIO_THR is the signal threshold for applying LSA reselection. PRIO_THR is broadcast on the BCCH. If the idle mode support is disabled for the LSA (see GSM 11.11) or if the cell does not belong to any LSA to which the MS is subscribed or if no PRIO_THR parameter is broadcast, PRIO_THR shall be set to ∞ .

GSM 05.08, 6.4.

20.24.3.4.3 SoLSA Cell Reselection / idle mode support enabled / Priority Threshold any value

20.24.3.4.3.1 Test purpose

To verify that the SoLSA MS is able to reselect cells correctly according to parameter PRIO_THR. (parameter C4 criterion).

20.24.3.4.3.2 Method of test

20.24.3.4.3.2.1 Initial conditions

a) Identification of the LSA by means of LSA ID (see chap. 20.24. General remark 2.)

b) Parameters changed from the default values in Table 20.24.1

Parameter	Carrier 1	Carrier 2	Carrier 3	Carrier 4
RF Signal Level (dBµV emf() / dBm)	47 / - 66	55 / -58	63 / -50	OFF
CBA	0	0	0	
RXLEV_ACCESS_MIN (dBm)	-90	-90	-90	
C1	15	25	40	
C2	15	25	40	
PRIO_THR (level / dB)	1 / 6	6 / 36	2 / 12	
C4	9	-11	28	
LSA ID	66.001	9.000.000	30.000	
LAC	5	5	5	
CI	5000	5001	5002	

NOTE: The level of PRIO_THR is evaluated according to GSM 05.08, 9. Table 1.

c) Further initial conditions (Carrier 1-3 are normal LSA cells):

	Carrier 1	Carrier 2	Carrier 3	Carrier 4
Matching LSA on SIM Escape PLMN	LSA1 No	LSA3 No	LSA5 No	

d) Further initial conditions (Carrier 1-3 are LSA exclusive access cells):

	Carrier 1	Carrier 2	Carrier 3	Carrier 4
Matching LSA on SIM Escape PLMN	LSA1 Yes	LSA3 Yes	LSA5 Yes	

Run the following test procedure twice by using two different sets of initial conditions:

- using initial conditions a), b) and c)
- using initial conditions a), b) and d)

20.24.3.4.3.2.2 Test Procedure

a) The SS activates carriers 1, 2 and 3 and monitors these carriers for RA requests from the SoLSA MS.

b) The SoLSA MS is switched on.

- c) Carrier 3 is barred (CBA = 1).
- d) The PRIO_THR value of carrier 2 is set to 0 dB (level 0).
- e) The PRIO_THR value of carrier 2 is set to 36 dB (level 6).

20.24.3.4.3.2.3 Related PICS/PIXIT statement(s)

- Support of SoLSA

20.24.3.4.3.2.4 Test Requirements

- 1) After step b), the first response from the SoLSA MS shall be received on carrier 3 within 50 seconds after switch on.
- 2) After step c), the SoLSA MS shall respond on carrier 1 within 55 seconds after barring of carrier 3 (Highest Priority + C4>0).
- 3) After step d), the SoLSA MS shall respond on carrier 2 within 55 seconds after changing the PRIO_THR value of carrier 2 (C4>0 + Highest C2+LSA_OFFSET).
- 4) After step e), the SoLSA MS shall respond on carrier 1 within 55 seconds after changing the PRIO_THR value of carrier 2 (C4>0, Highest priority).

20.24.3.4.4 SoLSA Cell Reselection / idle mode support enabled / Priority Threshold infinite

20.24.3.4.4.1 Test purpose

To verify that the SoLSA MS is able to reselect cells correctly according to parameter C2 among those cell not fulfilling $C4 \geq 0$.

20.24.3.4.4.2 Method of test

20.24.3.4.4.2.1 Initial conditions

a) Identification of the LSA by means of LSA ID (see chap. 20.24. General remark 2.)

b) Parameters changed from the default values in Table 20.24.1.

Parameter	Carrier 1	Carrier 2	Carrier 3	Carrier 4
RF Signal Level (dB μ V emf() / dBm)	63 / -50	53 / -60	58 / -55	31 / -82
CBA	0	0	0	0
RXLEV_ACCESS_MIN (dBm)	-90	-90	-90	-90
CRH (dB)	10			
PRIO_THR (level / dB)	7 / 'infinite'	7 / 'infinite'	7 / 'infinite'	
C1	40	30	35	8
C2	40	30	35	8
C4	<0	<0	<0	8
LSA_OFFSET (level / dB)		5 / 32		
LSA ID	66.001	66.001	9.000.000	30.000
LAC	5	5	3	3
CI	5000	5001	5002	5003

c) Further initial conditions (Carrier 1-4 are normal LSA cells):

	Carrier 1	Carrier 2	Carrier 3	Carrier 4
Matching LSA on SIM	LSA1	LSA1	LSA3	LSA5
Escape PLMN	No	No	No	No

d) Further initial conditions (Carrier 1-4 are LSA exclusive access cells):

	Carrier 1	Carrier 2	Carrier 3	Carrier 4
Matching LSA on SIM	LSA1	LSA1	LSA3	LSA5
Escape PLMN	Yes	Yes	Yes	Yes

Run the following test procedure twice by using two different sets of initial conditions:

- using initial conditions a), b) and c)
- using initial conditions a), b) and d)

20.24.3.4.4.2.2 Test Procedure

a) The SS activates carriers 1, 2, and 3 and monitors these carriers for RA requests from the SoLSA MS. Carrier 4 is switched off.

- b) The SoLSA MS is switched on.
- c) The SS is reconfigured and the level of carrier 1 is decreased to 33 dB μ V emf() / -80 dBm (C2 of carrier 1 becomes 10).
- d) The SS is reconfigured and the level of carrier 3 is increased to 63 dB μ V emf() / -50 dBm (C2 of carrier 3 becomes 40).
- e) Carrier 1 is switched off. Carrier 4 is switched on. The SS monitors carriers 2, 3, and 4.

20.24.3.4.4.2.3 Related PICS/PIXIT statement(s)

- Support of SoLSA

20.24.3.4.4.2.4 Test Requirements

- 1) After step b), the first response from the SoLSA MS shall be received on carrier 1 within 50 seconds. There shall be no response from the SoLSA MS on any other carrier within 35 seconds after the first response on carrier 1.
NOTE: Any potential access is likely to occur within 25s.
- 2) After step c), there shall be response from the SoLSA MS on carrier 2 within 25 seconds after carrier 1 has been reconfigured (Highest C2/C2-CRH).
- 3) After step d), there shall be response on carrier 3 within 25 seconds after carrier 2 has been reconfigured (Highest C2/C2-CRH).
- 4) After step e), there shall be response on carrier 4 within 60 seconds after the system has been reconfigured (idle mode support enabled for carrier 4).
NOTE: 5,5 seconds to notice new strongest carriers on top 6 (because the updating time for the 6 strongest is 5 seconds (+/- 10%)), 33 seconds to read BCCH, 15 seconds for reselection, 5 seconds for search of a matching LSA on SIM. Allow 60s.

20.24.3.5 SoLSA Cell Reselection / idle mode support enabled / LSA Priority / LSA_OFFSET

20.24.3.5.1 Definition and applicability

While camped on a cell of the selected PLMN the SoLSA MS may need to select a different cell in order to fulfil the normal service state. This ensures that the SoLSA MS is camped on a cell from which it can reliably decode downlink data and with which it has a high probability of communications on the uplink.

This test is applicable for all types of SoLSA MS.

20.24.3.5.2 Conformance requirement

While performing cell reselection, the SoLSA MS shall be able to calculate correctly the signal strength threshold criterion parameter consisting of C2 + LSA_OFFSET to determine which LSA cell shall be selected among those having the same LSA priority; GSM 05.08, 6.6.3.

20.24.3.5.3 Test Purpose

To verify that the SoLSA MS shall be able to reselect the cell with the highest value of C2 + LSA_OFFSET among those cells that have highest LSA priority and fulfil the criteria $C4 \geq 0$.

20.24.3.5.4 Method of test

20.24.3.5.4.1 Initial conditions

a) Identification of the LSA by means of LSA ID (see chap. 20.24. General remark 2.)

b) Parameters changed from the default values in Table 20.24.1.

Parameter	Carrier 1	Carrier 2	Carrier 3	Carrier 4
RF Signal Level (dBµV emf() / dBm)	63 / -50	43 / -70	33 / -80	OFF
CBA	0	0	0	
RXLEV_ACCESS_MIN (dBm)	-90	-90	-90	
C1	40	20	10	
C2	40	20	10	
C4	40	20	10	
LSA_OFFSET (level / dB)	0 / 0	1 / 4	4 / 24	
LSA ID	30.000	66.001	66.001	
LAC	5	5	5	
CI	5000	5001	5002	

NOTE: The level of LSA_OFFSET is evaluated according to GSM 05.08, 9 Table 1.

c) Further initial conditions (Carrier 1-3 are normal LSA cells):

	Carrier 1	Carrier 2	Carrier 3	Carrier 4
Matching LSA on SIM Escape PLMN	LSA5 No	LSA1 No	LSA1 No	

d) Further initial conditions (Carrier 1-3 are LSA exclusive access cells):

	Carrier 1	Carrier 2	Carrier 3	Carrier 4
Matching LSA on SIM Escape PLMN	LSA5 Yes	LSA1 Yes	LSA1 Yes	

Run the following test procedure twice by using two different sets of initial conditions:

- using initial conditions a), b) and c)
- using initial conditions a), b) and d)

20.24.3.5.4.2 Test Procedure

- a) The SS activates carriers 1, 2 and 3 and monitors these carriers for RA requests from the SoLSA MS.
- b) The SoLSA MS is switched on.
- c) Carrier 1 is barred (CBA = 1).
- d) Carrier 3 is barred (CBA = 1)

20.24.3.5.4.3 Related PICS/PIXIT statement(s)

- Support of SoLSA

20.24.3.5.4.4 Test Requirements

- 1) After step b), the first response from the SoLSA MS shall be received on carrier 1 after 50 seconds. (highest value of C1). There shall be no response from the SoLSA MS on other carriers within 35s after the first response sent on carrier 1.
NOTE: Any potential access is likely to occur within 25 seconds.
- 2) After step c), the SoLSA MS shall respond on carrier 3 within 55 seconds after carrier 1 becomes barred. (same priority as for LSA on carrier 2 but highest value of C2+LSA_OFFSET).
- 3) After step d), the SoLSA MS shall respond on carrier 2 within 55 seconds after carrier 3 becomes barred.

20.24.3.6 SoLSA Cell Reselection / idle mode support enabled / LSA Priority / cell combinations

20.24.3.6.1 Definition and applicability

This test is applicable for all types of SoLSA MS.

20.24.3.6.2 Conformance requirement

1. While camped on a cell of the selected PLMN ("camped normally"), the SoLSA MS may need to select a different cell ("normal cell reselection" state). The following events trigger a cell reselection:
 - The cell camped on (current serving cell) has become barred.
 - There is a better cell (in terms of the path loss criterion C2) in the same LA.The MS will then reselect a new cell in order to fulfil the process goal.
GSM 03.22, 4.5.
2. The SoLSA MS shall reselect the correct cell when subscription for normal LSA cells and LSA exclusive access cells varies; GSM 03.73, 4.3.1, 4.3.3.
The setting of the LSA only bit on the SIM shall not influence the behaviour of the cell reselection: for subscribers with LSA only access call unrelated service requests are accepted even outside of the allowed LSAs. GSM 03.73, 4.5.4.
3. When MS is out of the allowed LSA it shall be registered in PLMN but indicate subscriber/service specific "out of LSA area" notification. It shall be a network controlled function to prevent terminated or/and originated calls. Emergency calls are however always allowed. GSM 02.11, 5.3.

20.24.3.6.3 Test purpose

To verify that the SoLSA MS shall reselect the correct cell when subscription for normal LSA cells and LSA exclusive access cells varies. The setting of LSA only bit on the SIM shall not influence the behaviour of the cell reselection.

20.24.3.6.4 Method of tests

20.24.3.6.4.1 Initial conditions

a) Parameters changed from the default values in Table 20.24.1.

Parameter	Carrier 1	Carrier 2	Carrier 3	Carrier 4
RF Signal Level (dB μ V emf() / dBm)	53/ -60	43/ -70	63 / -50	OFF
CBA	0	0	0	
RXLEV_ACCESS_MIN (dBm)	-90	-90	-90	
C1	30	20	40	
C2	30	20	40	
C4	30	20	<0	

b) Further parameters changed from the default values in Table 20.24.1; further initial conditions

Parameter/condition	Carrier 1	Carrier 2	Carrier 3	Carrier 4
LSA ID	9.000.000	30.000	250	
LAC	5	5	5	
CI	5000	5001	5002	
Matching LSA on SIM	LSA3	LSA5	-	
Escape PLMN	Yes	No	No	

c) Further parameters changed from the default values in Table 20.24.1; further initial conditions

Parameter/condition	Carrier 1	Carrier 2	Carrier 3	Carrier 4
LSA ID	250	9.000.000	250	
LAC	5	5	5	
CI	5000	5001	5002	
Matching LSA on SIM	-	LSA3	-	
Escape PLMN	No	Yes	No	

d) Further parameters changed from the default values in Table 20.24.1; further initial conditions

Parameter/condition	Carrier 1	Carrier 2	Carrier 3	Carrier 4
LSA ID	250	30.000	250	
LAC	5	5	5	
CI	5000	5001	5002	
Matching LSA on SIM	-	LSA5	-	
Escape PLMN	No	No	Yes	

e) Further parameters changed from the default values in Table 20.24.1; further initial conditions

Parameter/condition	Carrier 1	Carrier 2	Carrier 3	Carrier 4
LSA ID	250	250	250	
LAC	5	5	5	
CI	5000	5001	5002	
Matching LSA on SIM	-	-	-	
Escape PLMN	Yes	No	No	

f) Identification of the LSA by means of LSA ID (see chap. 20.24. General remark 2.)

Run the following test procedures twice using two different sets of initial conditions:

- with an LSA only SIM
- with a normal LSA SIM

20.24.3.6.4.2.1 Test Procedure

Using conditions from Table a),b) and f).

- a) The SS activates the carriers 1,2,3 and monitors these carriers for RA requests from the SoLSA MS.
- b) The SoLSA MS is switched on.
- c) The SS is reconfigured and carrier 3 becomes barred (CBA = 1)
- d) The SS is reconfigured and carrier 2 becomes barred (CBA = 1) and carrier 3 becomes not barred (CBA = 0).

20.24.3.6.4.2.2 Related PICS/PIXIT statement(s)

- Support of SoLSA

20.24.3.6.4.2.3 Test Requirements

- 1) After step b), the first response from the SoLSA MS shall be received on carrier 3 within 50 seconds. There shall be no response from the SoLSA MS on any other carrier within 35 seconds after the first response on carrier 3.

NOTE: Any potential access is likely to occur within 35s.

- 2) After step c), there shall be response from the SoLSA MS on carrier 2 within 60 seconds after activating of carriers 2 and 3. (Highest LSA Priority on the SIM (15) for $C4 \geq 0$ in the present subscription).

NOTE: 5,5 seconds to notice new strongest carriers on top 6 (because the updating time for the 6 strongest is 5 seconds (+/- 10%)), 33 seconds to read BCCH, 15 seconds for reselection, 5 seconds for search of a matching LSA on SIM. Allow 60s.

- 3) After step d), there shall be response from SoLSA MS on carrier 1 within 55 seconds after carrier 2 has become barred. (highest priority (8) with $C4 \geq 0$)

20.24.3.6.4.3.1 Test Procedure

Using conditions from Table a), c) and f).

- a) The SS activates carrier 1 and monitors that carrier for RA requests from the SoLSA MS. Carrier 2 and 3 are switched off.
- b) The SoLSA MS is switched on.
- c) The SS activates the carriers 2 and 3 (carrier 1 is still switched on) and monitors carriers 1, 2 and 3 for RA requests from the SoLSA MS.
- d) The SS is reconfigured and the carrier 2 becomes barred (CBA = 1).

20.24.3.6.4.3.2 Related PICS/PIXIT statement(s)

- Support of SoLSA

20.24.3.6.4.3.3 Test Requirements

- 1) After step b), the first response from the SoLSA MS shall be received on carrier 1 within 50 seconds.

- 2) After step c), there shall be response from the SoLSA MS on carrier 2 after 60 seconds. (highest LSA Priority on the SIM (8) with $C4 \geq 0$).
- 3) After step d), there shall be response from SoLSA MS on carrier 3 within 55 seconds after carrier 2 becomes barred (no subscription, Highest C2).

20.24.3.6.4.4.1 Test Procedure

Using conditions from Table a), d) and f).

- a) The SS activates the carrier 1 and monitors that carrier for RA requests from the SoLSA MS. Carrier 2 and 3 are switched off.
- b) The SoLSA MS is switched on.
- c) The SS activates the carriers 2 and 3 (carrier 1 is still switched on) and monitors carriers 1, 2 and 3 for RA requests from the SoLSA MS.
- d) The SS is reconfigured and carrier 2 becomes barred (CBA = 1).

20.24.3.6.4.4.2 Related PICS/PIXIT statement(s)

- Support of SoLSA

20.24.3.6.4.4.3 Test Requirements

- 1) After step b), the first response from the SoLSA MS shall be received on carrier 1 within 50 seconds.
- 2) After step c), there shall be response from the SoLSA MS on carrier 2 after 60 seconds after carrier 2 and 3 were switched on. (LSA with highest Priority (15))
- 3) After step d), there shall be response from SoLSA MS on carrier 1 within 55 seconds after carrier 2 has become barred (Carrier 3 is an LSA exclusive access cell with no matching subscription).

20.24.3.6.4.5.1 Test Procedure

Using conditions from Table a),e) and f).

- a) The SS activates carriers 1 and 3 and monitors these for RA requests from the SoLSA MS.
- b) The SoLSA MS is switched on.
- c) The SS activates carrier 2 and carrier 3 becomes barred. (CBA = 1).
- d) The SS is reconfigured and carrier 2 becomes barred. (CBA = 1).

20.24.3.6.4.5.2 Related PICS/PIXIT statement(s)

- Support of SoLSA

20.24.3.6.4.5.3 Test Requirements

- 1) After step b), the first response from the SoLSA MS shall be received on carrier 3 within 50 seconds (Carrier 1 is an LSA exclusive access cell with no matching subscription).
- 2) After step c), there shall be response from the SoLSA MS on carrier 2 within 55 seconds.
- 3) After step d), there shall be no paging response from SoLSA MS on any carrier (Carrier 2 and 3 are barred, carrier 1 is an exclusive access cell, the SoLSA MS is in the limited state) within 65s.

NOTE: Any potential access is likely to occur quicker.

20.24.3.7 SoLSA Cell Reselection / roaming

20.24.3.7.1 Definition and applicability

While camped on a cell of the selected PLMN the SoLSA MS may need to select a different cell in order to fulfil the normal service state. This ensures that the SoLSA MS is camped on a cell from which it can reliably decode downlink data and with which it has a high probability of communications on the uplink.

Idle mode support for SoLSA on the SIM card is enabled. (See General Remark 1. in chapter 20.24)

This test is applicable for all types of SoLSA MS.

20.23.3.7.2 Conformance requirement

1. While camped on a cell of the selected PLMN (“camped normally”), the SoLSA MS may need to select a different cell (“normal cell reselection” state). The following events trigger a cell reselection:
 - There is a better cell (in terms of the path loss criterion C2) in the same LA.

The SoLSA MS will then reselect a new cell in order to fulfil the process goal.
GSM 03.22, 4.5.

2. A SoLSA MS with SIM indicating LSA subscription shall always try to reselect the cell with highest LSA priority according to the information stored on the SIM. GSM 03.73, 11.4.2.

20.24.3.7.3 Test Purpose

To verify that the SoLSA MS when idle mode support for SoLSA on the SIM card is enabled shall favour camping on those LSA cells with the highest LSA priority the SoLSA MS is subscribed to even if subscriber is outside of his HPLMN.

20.24.3.7.4. Method of test

20.24.3.7.4.1 Initial conditions

- a) Identification of the LSA by means of LSA ID (see chap. 20.24. General remark 2.)
- b) Parameters changed from the default values in Table 20.24.1

Parameter	Carrier 1	Carrier 2	Carrier 3	Carrier 4
RF Signal Level (dBμV emf() / dBm)	43/-70	53/-60	33/-80	63/-50
RXLEV_ACCESS_MIN (dBm)	-90	-90	-90	-90
MCC, MNC	VPLMN	VPLMN	VPLMN	VPLMN
C1	20	30	10	40
C2	20	30	10	40
C4	20	<0	10	40
LSA ID	9.000.000	-	9.000.001	54
LAC	5	5	5	5
CI	5000	5001	5002	5003

c) Further initial conditions (Carrier 1-3 are normal LSA cells):

	Carrier 1	Carrier 2	Carrier 3	Carrier 4
Matching LSA on SIM	-	-	LSA8	LSA9
Escape PLMN	No	No	No	No

d) Further initial conditions (Carrier 1-3 are LSA exclusive access cells):

	Carrier 1	Carrier 2	Carrier 3	Carrier 4
Matching LSA on SIM	-	-	LSA8	LSA9
Escape PLMN	Yes	Yes	Yes	Yes

Run the following test procedure twice by using two different sets of initial conditions:

- using initial conditions a), b) and c)
- using initial conditions a), b) and d)

20.24.3.7.4.2 Test Procedure

- a) The SS activates carrier 1 and carrier 2, pages the MS on these carriers and monitors these for RA requests from the SoLSA MS. Carrier 3 and 4 are switched off.
- b) The SoLSA MS is switched on.
- c) After approx. 60s the SS is reconfigured and level of carrier 2 decreases to 33 dB μ V/-80dBm (C2 decreases to 10). The SS monitors carriers 1 and 2 for RA requests from the SoLSA MS.
- d) The SS activates carriers 3 and 4. The SS pages the MS on carriers 3 and 4, and monitors these carriers for RA requests from the SoLSA MS.
- e) The SS is reconfigured and carrier 3 becomes barred (CBA = 1). The SS pages the MS on carrier 4, and monitors this carrier for RA requests from the SoLSA MS.

20.24.3.7.4.3 Related PICS/PIXIT statement(s)

- Support of SoLSA

20.24.3.7.4.4 Test Requirements

- 1) After step b), the first response from the SoLSA MS shall be received on carrier 2 within 50 seconds.
- 2) After step c), there shall be response from the SoLSA MS on carrier 1 within 25 seconds after decreasing the level of carrier 2 (highest C2).
- 3) After step d), there shall be response from the SoLSA MS on carrier 3 within 55 seconds (highest priority on the SIM card for matching LSA subscription).
- 4) After step e), there shall be response from the SoLSA MS on carrier 4 within 55 seconds.

20.24.4 SoLSA Cell Reselection / idle mode support / any value

General Remark

Definition of "idle mode support" is given in chapter 20.24 General Remark 1.

"Idle mode support" is only controlling if 'favouring' shall be done at cell reselection. It does not disable the LSA subscription.

20.24.4.1 Definition and applicability

While camped on a cell of the selected PLMN a SoLSA MS may need to select a different cell in order to fulfil the normal service state. This ensures that the SoLSA MS is camped on a cell from which it can reliably decode downlink data and with which it has a high probability of communications on the uplink.

This test is applicable for all types of SoLSA MS.

20.24.4.2 Conformance requirement

1. While camped on a cell of the selected PLMN ("camped normally"), the SoLSA MS may need to select a different cell ("normal cell reselection" state). The following events trigger a cell reselection:

- The cell camped on (current serving cell) has become barred.
- There is a better cell (in terms of the path loss criterion C2) in the same LA, or a much better cell in another LA of the selected PLMN (using the CRH parameter).

The SoLSA MS will then reselect a new cell in order to fulfil the process goal.

GSM 03.22, 4.5.

20.24.4.3 Test purpose

To verify that the SoLSA MS shall not favour camping on the LSA for which support in idle mode is disabled.

20.24.4.4 Method of test

20.24.4.5 Initial conditions

- a) Identification of the LSA by means of LSA ID (see chap. 20.24. General remark 2.)
- b) Parameters changed from the default values in Table 20.24.1.

Parameter	Carrier 1	Carrier 2	Carrier 3	Carrier 4
RF Signal Level (dBμV emf() / dBm)	63/ -50	53/-60	58/-55	31 / -82
CBA	0	0	0	0
RXLEV_ACCESS_MIN (dBm)	-90	-90	-90	-90
CRH (dB)	10			
C1	40	30	35	8
C2	40	30	35	8
C4	40	30	35	8
LSA ID	66.000	66.000	9.000.001	5
LAC	5	5	3	3
CI	5000	5001	5002	5003

c) Further initial conditions (Carrier 1-4 are normal LSA cells):

	Carrier 1	Carrier 2	Carrier 3	Carrier 4
Idle mode support enabled	No	No	No	Yes
Matching LSA on SIM	LSA2	LSA2	LSA4	LSA6
Escape PLMN	No	No	No	No

d) Further initial conditions (Carrier 1-4 are LSA exclusive access cells):

	Carrier 1	Carrier 2	Carrier 3	Carrier 4
Idle mode support enabled	No	No	No	Yes
Matching LSA on SIM	LSA2	LSA2	LSA4	LSA6
Escape PLMN	Yes	Yes	Yes	Yes

Run the following test procedure twice by using two different sets of initial conditions:

- using initial conditions a), b) and c)
- using initial conditions a), b) and d)

20.24.4.6 Test Procedure

- a) The SS activates carriers 1, 2, and 3 and monitors these carriers for RA requests from the SoLSA MS. Carrier 4 is switched off.
- b) The SoLSA MS is switched on.
- c) The SS is reconfigured and the level of carrier 1 is decreased to 33 dB μ V emf() / -80 dBm (C2 of carrier 1 becomes 10).
- d) The SS is reconfigured and the level of carrier 3 is increased to 63 dB μ V emf() / -50 dBm (C2 of carrier 3 becomes 40).
- e) Carrier 1 is switched off. Carrier 4 is switched on. The SS monitors carriers 2, 3, and 4.

20.24.4.7 Related PICS/PIXIT statement(s)

- Support of SoLSA

20.24.4.8 Test Requirements

- 1) After step b), the first response from the SoLSA MS shall be received on carrier 1 within 50 seconds. There shall be no response from the SoLSA MS on any other carrier within 35 seconds after the first response on carrier 1.
NOTE: Any potential access is likely to occur within 25s.
- 2) After step c), there shall be response from the SoLSA MS on carrier 2 within 25 seconds after carrier 1 has been reconfigured (Highest C2/C2-CRH).
- 3) After step d), there shall be response on carrier 3 within 25 seconds after carrier 3 has been reconfigured (Highest C2/C2-CRH).
- 4) After step e), there shall be response on carrier 4 within 60 seconds after the system has been reconfigured (idle mode support enabled for carrier 4).
NOTE: 5,5 seconds to notice new strongest carriers on top 6 (because the updating time for the 6 strongest is 5 seconds (+/- 10%)), 33 seconds to read BCCH, 15 seconds for reselection, 5 seconds for search of a matching LSA on SIM. Allow 60s.

20.24.5 SoLSA Cell Reselection / LSA indication for idle mode

General Remark

Definition of “LSA indication for idle mode” is given in chapter 20.24 General Remark 1.

“LSA indication for idle mode” is only controlling if indication of the LSA name shall be done. It has no influence on the LSA subscription.

20.24.5.1 General definition and applicability

The SoLSA MS in idle mode may inform the user whether or not the serving cell belongs to the subscribed LSA.

- The indication is dependent on the setting of the idle mode indication bit on the SIM card for that LSA.
- The indication is independent from the setting of the LSA idle mode support bit on the SIM card for that LSA. (see chap. 20.24 General Remark 1.)

20.24.5.2 General conformance requirement

1. The service subscriber can define a name (alphanumeric name, icon, etc) for each of her allowed LSAs. The MS will, in idle mode and if required by the user, indicate to the user the current LSA. The indication may be the name of the current LSA, as set by the user. The form of display and indication are left to manufacturer's choice. GSM 03.73, 4.3.2.
2. In addition to indicate the registered PLMN, an MS with subscription for an LSA in the registered PLMN shall indicate this LSA when it is available. The indication towards the user is optional and may be done by displaying the stored LSA name that corresponds to the ID of the current LSA. An MS with LSA only access subscription may also give an indication towards the user, when the no subscribed LSAs are available to the user. The indication is optional and may be done by displaying the LSA only access text stored in the SIM. GSM 03.73, 11.8.1.

20.24.5.3 SoLSA Cell Reselection / LSA indication for idle mode / idle mode support enabled

20.24.5.3.1 Definition and applicability

See general definition and applicability of this section.

This test is applicable for all types of SoLSA MS.

20.24.5.3.2 Conformance requirement

1. When both idle mode support and idle mode indication are enabled on the SIM card, the SoLSA MS shall display the name (which was defined by the service subscriber) of the current LSA to the user.
2. When idle mode support is enabled and idle mode indication is disabled on the SIM card, it is expected that the SoLSA MS does not display the LSA name (which was defined by the service subscriber) of the current LSA to the user.

GSM 03.73, 4.3.2; GSM 03.73, 11.8.1; GSM 11.11, 10.4.1.2.

20.24.5.3.3 Test Purpose

1. To verify that if idle mode indication bit on the SIM card is enabled for the LSA, the SoLSA MS supports the LSA indication. The LSA name (text/icon) shall be displayed on the SoLSA MS.
2. To verify that if idle mode indication bit on the SIM card is disabled for the LSA the SoLSA MS does not support the LSA indication.

20.24.5.3.4 Method of test

20.24.5.3.4.1 Initial conditions

- a) Identification of the LSA by means of LSA ID (see chap. 20.24. General remark 2.)
- b) Parameters changed from the default values in Table 20.24.1; further initial conditions

Parameter/condition	Carrier 1	Carrier 2	Carrier 3	Carrier 4
RF Signal Level (dB μ V emf() / dBm)	43/-70	53/-60	33/-80	OFF
RXLEV_ACCESS_MIN (dBm)	-90	-90	-90	
C1	20	30	10	
C2	20	30	10	
LSA ID	-	66.001	9.000.000	
LAC	5	5	5	
CI	5000	5001	5002	
Matching LSA on SIM	-	LSA1	LSA3	
Escape PLMN	No	No	No	

20.24.5.3.4.2 Test Procedure

- a) The SS activates carrier 1, pages the MS on this carrier and monitors it for RA requests from the SoLSA MS. Carrier 2 and 3 are switched off.
- b) The SoLSA MS is switched on.
- c) Carrier 2 and Carrier 3 are switched on. The SS pages the MS on carriers 1, 2, and 3, and monitors these carriers for RA requests from the SoLSA MS.
- d) The SS is reconfigured and carrier 3 becomes barred (CBA=1). The SS pages the MS on carriers 1, 2 and 3, and monitors these carriers for RA requests from the SoLSA MS.
- e) The SS is reconfigured and sets CBA=0 on carrier 3. The SS pages the MS on carriers 1, 2 and 3 and monitors these carriers for RA requests from the SoLSA MS.

20.24.5.3.4.3 Related PICS/PIXIT statement(s)

- Support of SoLSA
- Interface to the human user (p1=Y/N)
- Way to indicate the identity of the current LSA to the human user (only applicable if the SoLSA MS has an interface to the human user)
- Way to indicate the change of the current LSA to the human user (only applicable if the SoLSA MS has an interface to the human user)

20.24.5.3.4.4 Test Requirements

- 1) After step b), the first response from the SoLSA MS shall be received on carrier 1 within 50 seconds. There shall be no LSA indication on the SoLSA MS. (No LSA)
- 2) After step c), there shall be response from the SoLSA MS on carrier 3 within 25 seconds (highest LSA Priority (8) on the SIM card). An LSA indication is expected on the SoLSA MS.
- 3) After step d), there shall be response from the SoLSA MS on carrier 2 within 55 seconds. There shall be no indication on the SoLSA MS. (highest LSA Priority on the SIM card, no indication on the SIM card)
- 4) After step e), there shall be response from the SoLSA MS on carrier 3 within 55 seconds (LSA carrier on the SIM card). An LSA indication is expected on the SoLSA MS. (idle mode indication for that LSA is enabled)

20.24.5.4 SoLSA Cell Reselection / LSA indication for idle mode / idle mode support disabled

20.24.5.4.1 Definition and applicability

See general definition and applicability of this section.

This test is applicable for all types of SoLSA MS.

20.24.5.4.2 Conformance requirement

1. When idle mode support is disabled and idle mode indication is enabled on the SIM card, it is expected that the SoLSA MS displays the LSA name (which was defined by the service subscriber) of the current LSA to the user.
2. When idle mode support is disabled and idle mode indication is disabled on the SIM card, the SoLSA MS shall not display the LSA name (which was defined by the service subscriber) of the current LSA to the user.

GSM 03.73, 4.3.2; GSM 03.73, 11.8.1; GSM 11.11, 10.4.1.2.

20.24.5.4.3 Test Purpose

To verify that when idle mode support is disabled, the SoLSA MS shall display the LSA name in dependence from the idle mode indication bit.

20.24.5.4.4 Method of test

20.24.5.4.4.1 Initial conditions

- a) Identification of the LSA by means of LSA ID (see chap. 20.24. General remark 2.)
- b) Parameters changed from the default values in Table 20.24.1; further initial conditions

Parameter/condition	Carrier 1	Carrier 2	Carrier 3	Carrier 4
RF Signal Level (dBμV emf) / dBm)	43/-70	53/-60	33/-80	OFF
CBA	0	0	0	
RXLEV_ACCESS_MIN (dBm)	-90	-90	-90	
C1	20	30	10	
C2	20	30	10	
LSA ID	250	66.000	9.000.001	
LAC	5	5	5	
CI	5000	5001	5002	
Matching LSA on SIM	-	LSA2	LSA4	
Escape PLMN	No	No	No	

20.24.5.4.4.2 Test Procedure

- a) The SS activates carrier 1, pages this carrier and monitors it for RA requests from the SoLSA MS. Carriers 2 and 3 are switched off.
- b) The SoLSA MS is switched on.
- c) Carrier 2 and carrier 3 are switched on. The SS pages the MS on carriers 1, 2, and 3, and monitors these carriers for RA requests from the SoLSA MS.
- d) The SS is reconfigured and the level of carrier 3 increases to 63 dBμVemf / -50dBm (C2 increases to 40 dB).
- e) The SS is reconfigured and the level of carrier 3 decreases to 33 dBμVemf0,1,0 /- 80dBm (C2 decreases to 10dB).

20.24.5.4.4.3 Related PICS/PIXIT statement(s)

- Support of SoLSA
- Interface to the human user (p1=Y/N)
- Way to indicate the identity of the current LSA to the human user (only applicable if the SoLSA MS has an interface to the human user)
- Way to indicate the change of the current LSA to the human user (only applicable if the SoLSA MS has an interface to the human user)

20.24.5.4.4.4 Test Requirements

- 1) After step b), the first response from the SoLSA MS shall be received on carrier 1 within 50 seconds. There shall be no LSA indication on the SoLSA MS.
- 2) After step c), there shall be response from the SoLSA MS on carrier 2 within 25 seconds (highest C2). An LSA indication is expected on the SoLSA MS.
- 3) After step d), there shall be response from the SoLSA MS on carrier 3 within 25 seconds (highest C2). There shall be no LSA indication on the SoLSA MS.
- 4) After step e), there shall be response from the SoLSA MS on carrier 2 within 25 seconds (highest C2). An LSA indication is expected on the SoLSA MS

21 Received signal measurements

For evaluating the reception quality (the basis for handover and power control) the following two criteria are used:

- signal strength (RXLEV)
- signal quality (RXQUAL).

21.1 Signal strength

21.1.1 Definition and applicability

The MS reports RXLEV values related to the apparent received RF signal strength. It is necessary for these levels to attain sufficient accuracy for the correct functioning of the system.

The requirements and this test apply to all types of GSM 400, GSM 700, GSM 850, GSM 900, DCS 1 800, PCS 1900 and any multiband MSs.

21.1.2 Conformance requirement

1. The RMS received signal level at the receiver input shall be measured by the MS over the full range of -110 dBm to -48 dBm with a relative accuracy between signals with levels up to 20 dB difference according to table 21-1
 - 1.1 under normal conditions, GSM 05.08, 8.1.2 and GSM 05.05, 6.2.
 - 1.2 under extreme conditions, GSM 05.08, 8.1.2, GSM 05.05, annex D.1, D.2.

Table 21-1: Tolerance for relative accuracy of receive signal measurement

Absolute level of lower level signal dBm						Tolerance dB			
GSM Small MS	GSM Other MS	DCS 1800 Class 1&2	DCS 1800 Class 3	PCS 1900 Class 1&2	PCS 1900 Other MS	Lower limit		Upper limit	
						Single	Multi	Single	Multi
>= -88	>= -90	>= -86	>= -88	>= -88	>= -90	2	4	2	4
>=-101	>=-103	>= -99	>=-101	>=-101	>=-103	3	5	2	5
< -101	< -103	< -99	< -101	< -101	< -103	4	6	2	6

Single means that the measurements are on the same or different RF channel within the same frequency band.

Multi means that the measurements are on different RF channel on different frequency bands.

For measurements between ARFCN in different bands the 'Absolute level of lower level signal' column for the band including the lower level signal shall be used to determine which tolerance applies.

At extreme temperature conditions an extra 2 dB shall be added to the Multi limits in above table.

2. The RMS received signal level at the receiver input shall be measured with an absolute accuracy of +/-4 dB from -110 dBm to -70 dBm under normal conditions; GSM 05.08, 8.1.2.
3. The RMS received signal level at the receiver input shall be measured with an absolute accuracy of +/-6 dB over the full range of -110 dBm to -48 dBm under both normal and extreme conditions; GSM 05.08, 8.1.2.
4. If the received signal level falls below the reference sensitivity level for the type of MS then the MS shall report a level between the reference sensitivity level and the actual received level, but with the tolerances given in conformance requirements 2. and 3. above.

5. The measured signal level shall be mapped to an RXLEV value between 0 and 63 as specified in GSM 05.08; GSM 05.08, 8.1.4.

21.1.3 Test purpose

1. To verify that the RXLEV reported by the MS does not exceed conformance requirement 1.
 - 1.1 under normal conditions;
 - 1.2 under extreme conditions.
2. To verify that the RXLEV reported by the MS does not exceed conformance requirement 2 under normal conditions.
3. To verify that the RXLEV reported by the MS does not exceed conformance requirement 3 under extreme conditions and under normal conditions from -48 dBm to -70 dBm.
4. To verify that the RXLEV reported by the MS does not exceed conformance requirement 4.

NOTE: Conformance requirement 5 is inherently tested in each of the test purposes 1. to 4.

21.1.4 Method of test

21.1.4.1 Initial conditions

The SS is set to produce the BCCH of the serving cell at $63 \text{ dB}\mu\text{Vemf}(\)$ and the BCCHs of 6 surrounding cells at $28 \text{ dB}\mu\text{Vemf}(\)$. The BCCH of the serving cell indicates these BCCHs, but not the BCCH of the serving cell. The ARFCN of the serving cell BCCH is chosen so as not to interfere with the other channels as shown in table 21-2. The fading profile for the BCCHs of the serving and surrounding cells will be set to static.

After 30 s, a call is set up according to the generic call set up procedure to an ARFCN, within the supported band of operation. The SACCH indicates the same surrounding cell BCCHs as the BCCH of the serving cell.

NOTE: The 30 s is to allow the MS to scan and find all BCCHs.

21.1.4.2 Procedure

- a) The levels of the TCH and BCCHs are set according to table 21-2 step 1. The SS waits 20 s before continuing.

Table 21-2: Signal levels at receiver input in dB μ Vemf()

Step	ARFCN	TCH	BCCH1	BCCH2	BCCH3	BCCH4	BCCH5	BCCH6
	GSM450	259	276	293	264	269	281	288
	GSM480	306	323	340	311	316	328	335
	GSM900:	1	62	124	20	40	80	100
	DCS1800	512	700	885	585	660	790	835
	PCS1900	512	700	805	585	660	790	550
	450/900	259	124	276	293	269	288	1
	480/900	306	124	323	340	316	335	1
	450/1800	259	885	276	293	269	288	512
	480/1800	306	885	323	340	316	335	512
	900/1800	1	885	62	124	40	100	512
	450/900/1800	259	124	276	885	293	1	512
	480/900/1800	306	124	323	885	340	1	512
	GSM850	128	189	251	150	170	210	230
	GSM 750	438	475	511	440	455	485	500
	750/850	438	251	475	511	455	485	128
1+m*21		64,5-m*10	64,5-m*10	64,5-m*10	64,5-m*10	64,5-m*10	64,5-m*10	64,5-m*10
2+m*21		54,5-m*10	63,5-m*10	54,5-m*10	54,5-m*10	54,5-m*10	54,5-m*10	54,5-m*10
3+m*21		54,5-m*10	62,5-m*10	44,5-m*10	44,5-m*10	44,5-m*10	44,5-m*10	44,5-m*10
.		44,5-m*10	44,5-m*10
17+m*21		54,5-m*10	44,5-m*10	44,5-m*10
18+m*21		44,5-m*10	44,5-m*10	44,5-m*10
.		44,5-m*10	44,5-m*10
21+m*21		44,5-m*10	44,5-m*10	44,5-m*10	44,5-m*10	44,5-m*10	44,5-m*10	44,5-m*10

m = 0, 1, 2, 3, 4.

- b) The measurement is done in 105 steps. The initial signal levels of the TCH of the serving cell and the BCCHs of the surrounding cells are adjusted according to table 21-2. At each step the SS keeps the signal levels stable for one reporting period, except at steps 21+m*21 where the level is held stable for 1,75 reporting periods. The RXLEV value for the period in which the change occurs (reported in the following period) is discarded. The SS records the RXLEV values reported for the surrounding cell BCCHs in steps 1 + m * 21 and 21 + m * 21. The RXLEV values for BCCH 1 are recorded by the SS for all 105 steps.

NOTE: This extension at steps 21+m*21 is to allow an extra quarter reporting period for the MS to stabilize for steps 1+m*21.

At steps 1 to 30 the SS simulates a base station with DTX off and at steps 31 to 105 the SS simulates a base station with DTX on.

At steps 1 to 30 the SS checks the accuracy of the measured signal strength of TCH by checking the values of the parameters RXLEV_FULL and RXLEV_SUB. At steps 31 to 105 the SS shall check only the value of the parameter RXLEV_SUB.

At step 64, within every 480 ms reporting period, out of the 4 SACCH and 8 SID timeslots the SS transmits the first six active timeslots of the TCH with signal level 39,5 dB μ Vemf() and the last six active timeslots of the TCH with signal level 29,5 dB μ Vemf().

- c) Step b) is repeated under extreme conditions (annex 1, TC2,2 and TC3).

21.1.5 Test requirements

21.1.5.1 Relative accuracy of measurements on different ARFCN

For normal and each of the 4 extreme conditions tested the following applies;

- a) For each of the steps 1, 21, 22, 42, 43, and 64, of the 7 reported RXLEV values checked, the difference between the minimum reported RXLEV value and the maximum reported RXLEV value shall be no more than 4 if the measurements are on the same or on different RF channel within the same frequency band and no more than 8 (12 for extreme temperature conditions) if the measurements are on different frequency bands.
- b) For each of the steps 63 and 85, of the 7 reported RXLEV values checked, the difference between the minimum reported RXLEV value and the maximum reported RXLEV value shall be no more than 5 for small MS, DCS 1 800 and PCS 1 900 (Class 1&2) MS or 4 for other MS if the measurements are on the same or on different RF channel within the same frequency band and no more than 9 for small MS, DCS 1 800 and PCS 1 900 (Class

1&2) MS or 8 for other MS and other PCS 1 900 MS (13 and 12 for extreme temperature conditions) if the measurements are on different frequency bands.

- c) For step 84, of the 7 reported RXLEV values checked, the difference between the minimum reported RXLEV value and the maximum reported RXLEV value shall be no more than 5 if the measurements are on the same or on different RF channel within the same frequency band and no more than 9 (13 for extreme temperature conditions) if the measurements are on different frequency bands.
- d) For step 105, of the reported RXLEV values checked, the difference between the minimum reported RXLEV value and the maximum reported RXLEV value shall be no more than 6 if the measurements are on the same or on different RF channel within the same frequency band and no more than 10 (14 for extreme temperature conditions) if the measurements are on different frequency bands.

NOTE: It is not mandatory for the MS to report any of the BCCHs in step 105.

21.1.5.2 Relative accuracy at a single frequency (BCCH1)

For normal and each of the 4 extreme conditions tested the following applies;

For $n \leq 21$ and $RXLEV_1 = 63$

$RXLEV_n - (63 - n + r)$ shall be between:

-2 and +2

NOTE: This formula allows for an MS with an absolute accuracy worse than +0,5 dB and therefore reporting an RXLEV of 63 for more than one step. The formula checks the relative accuracy from the lowest input level for which the MS last reports RXLEV of 63.

Otherwise

$RXLEV_{(m*21+1)} - RXLEV_{(m*21+n)} - n + 1$ shall be between:

-2 and +2

for steps 2 to 62 and 65 to 71 for DCS 1 800 class 1/2 MS; or steps 2 to 62 and 65 to 73 for DCS 1 800 class 3, PCS 1 900 (Class 1&2) and Small GSM MS; or 2 to 75 for other MS and other PCS 1 900 MS.

-3 and +2

for steps 63 and 72 to 96 for DCS 1 800 class 1/2 MS; or steps 63 and 74 to 98 for DCS 1 800 class 3, PCS 1 900 (Class 1&2) and Small GSM MS; or 76 to 100 for other MS and other PCS 1 900 MS.

-4 and +2

for steps 97 to 105 for DCS 1 800 class 1/2 MS; or steps 99 to 105 for DCS 1 800 class 3, PCS 1 900 (Class 1&2) and Small GSM MS; or 101 to 105 for other MS and other PCS 1 900 MS.

where: $1 < n \leq 21$ and $0 \leq m \leq 4$ as identified in table 21-2, and r is the number of the last step where RXLEV of 63 was reported.

NOTE: It is not mandatory for the MS to report BCCH1 for steps greater than 99 for GSM 400, GSM 700, GSM 850 or GSM 900 Small MS or 101 for other GSM and other PCS 1 900 MS or 97 for a DCS 1 800 Class 1 or Class 2 MS and 99 for DCS 1 800 Class 3 and PCS 1 900 (Class 1&2) MS. If the MS reports a level and the upper limit for this step in the above formula implies a level below the reference sensitivity level for the type of MS, then the upper limit shall be considered as equal to a value corresponding to the reference sensitivity level.

21.1.5.3 Absolute accuracy

For each BCCH reported, $|RXLEV_{MS} + m * 10 - 62|$ shall be no more than:

4 for steps 64 and 85 under normal conditions.

6 for steps 64 and 85 under extreme conditions.

6 for steps 1, 22 and 43 under normal and extreme conditions.

where: $0 \leq m \leq 4$ as identified in table 21-2.

21.2 Signal strength selectivity

21.2.1 Definition and applicability

The signal strength selectivity is a measure of the ability of the signal strength measuring part of the MS to discriminate against RF power from adjacent ARFCN. The RXLEV selectivity figure corresponds to the amount by which the adjacent channel power shall be attenuated.

The requirements and this test apply to all types of GSM 400, GSM 700, GSM 850, GSM 900, DCS 1 800 and PCS 1 900 MS.

21.2.2 Conformance requirement

The selectivity of the received signal measurement shall be as follows:

- for adjacent (200 kHz) channel; ≥ 16 dB
- for adjacent (400 kHz) channel; ≥ 48 dB
- for adjacent (600 kHz) channel; ≥ 56 dB

GSM 05.08, 8.1.2.

21.2.3 Test purpose

To verify that the MS meets the conformance requirement at the 200 kHz adjacent channel above and below the wanted.

21.2.4 Method of test

21.2.4.1 Initial conditions

For GSM 450:

A call is set up according to the generic call set up procedure on ARFCN 269 and with surrounding cell BCCH3 indicated in the BA list at ARFCN 281.

The RF level of the TCH and BCCH3 is set to 20 dB above reference sensitivity level().

BCCH1 and 2 at ARFCN 270 and 280 are off.

These conditions are kept for 30 s to ensure the MS has time to decode the BCCH.

For GSM 480:

A call is set up according to the generic call set up procedure on ARFCN 316 and with surrounding cell BCCH3 indicated in the BA list at ARFCN 328.

The RF level of the TCH and BCCH3 is set to 20 dB above reference sensitivity level().

BCCH1 and 2 at ARFCN 317 and 327 are off.

These conditions are kept for 30 s to ensure the MS has time to decode the BCCH.

For GSM 750:

A call is set up according to the generic call set up procedure on ARFCN 450 and with surrounding cell BCCH3 indicated in the BA list at ARFCN 485.

The RF level of the TCH and BCCH3 is set to 20 dB above reference sensitivity level().

BCCH1 and 2 at ARFCN 451 and 484 are off.

These conditions are kept for 30 s to ensure the MS has time to decode the BCCH.

For GSM 850:

A call is set up according to the generic call set up procedure on ARFCN 170 and with surrounding cell BCCH3 indicated in the BA list at ARFCN 210.

The RF level of the TCH and BCCH3 is set to 20 dB above reference sensitivity level().

BCCH1 and 2 at ARFCN 171 and 209 are off.

These conditions are kept for 30 s to ensure the MS has time to decode the BCCH.

For GSM 900:

A call is set up according to the generic call set up procedure on ARFCN 40 and with surrounding cell BCCH3 indicated in the BA list at ARFCN 80.

The RF level of the TCH and BCCH3 is set to 20 dB above reference sensitivity level().

BCCH1 and 2 at ARFCN 41 and 79 are off.

These conditions are kept for 30 s to ensure the MS has time to decode the BCCH.

For DCS 1 800 and PCS 1 900:

A call is set up according to the generic call set up procedure on ARFCN 690 and with surrounding cell BCCH3 indicated in the BA list at ARFCN 790.

The RF level of the TCH and BCCH3 is set to 20 dB above reference sensitivity level().

BCCH1 and 2 at ARFCN 691 and 789 are off.

These conditions are kept for 30 s to ensure the MS has time to decode the BCCH.

21.2.4.2 Procedure

- a) The SS records the RXLEV values reported for the TCH and BCCH3.
- b) BCCH1 and 2 are set to 9 dB above the signal level of the TCH and BCCH3.

NOTE: The first adjacent channel interference requirement limits the level of BCCHs 1 and 2 to 9 dB. This ensures that the MS can maintain the call, and read BCCH3.

- c) These conditions are kept for 30 s.
- d) The SS records the RXLEV values reported for the TCH and BCCH3.

21.2.5 Test requirements

The values of RXLEV recorded in step d) shall be no more than 1 above the values recorded in step a).

NOTE: This one change in the reported value of RXLEV is calculated as follows: The level of the first adjacent interfering signal is such that C/I is -9 dB. With an RXLEV selectivity for the first adjacent channel of 16 dB, the power from the adjacent channel is equal to -7 dB with respect to the power level of the useful signal. The increase in power therefore is equal to $10\log(1 + 10^{-0.7}) = 0,71$ dB. Thus, the value of RXLEV could increase by 1.

21.3 Signal quality under static conditions

21.3.1 Signal quality under static conditions - TCH/FS

21.3.1.1 Definition and applicability

The MS must be capable of measuring the received signal quality, which is specified in terms of bit error ratio (BER) before channel decoding averaged over the reporting period of length of one SACCH multiframe defined in section 8.4 of GSM 05.08. The MS has to map this BER into RXQUAL values using the coding scheme defined in section 8.2.4 of GSM 05.08. For the full rate channel without downlink DTX, the error assessment is based on 104 TDMA frames: RXQUAL_FULL. In case downlink DTX is used, the assessment is based on 12 TDMA frames: RXQUAL_SUB.

The requirement and this test apply to all types of GSM 400, GSM 700, GSM 850, GSM 900, DCS 1 800 and PCS 1 900 MS supporting speech on a full rate channel.

21.3.1.2 Conformance requirement

1. The received signal quality shall be measured by the MS in a manner that can be related to an equivalent average BER before channel decoding (i.e. chip error ratio), assessed over the reporting period of one SACCH multiframe. When the quality is assessed over the full-set and sub-set of frames, eight levels of RXQUAL are defined and shall be mapped to the equivalent BER before channel decoding as per the table in GSM 05.08, 8.2.4; GSM 05.08, 8.2.2 & 8.2.4.
2. The reported parameters (RXQUAL) shall be the received signal quality, averaged over the reporting period of length one SACCH multiframe; GSM 05.08, 8.2.3.

21.3.1.3 Test purpose

1. To verify, under static propagation conditions, that the received signal quality is measured and mapped to the eight levels of RXQUAL_FULL by the MS in a manner that can be related to an equivalent average BER before channel decoding (i.e. chip error ratio), assessed over the reporting period of one SACCH multiframe. The probability that the correct RXQUAL band is reported shall meet the values given in as per the table in GSM 05.08, 8.2.4.
2. To verify that the reported parameters (RXQUAL) are the received signal quality, averaged over the reporting period of length one SACCH multiframe.
3. To verify that, for downlink DTX, the reported parameter RXQUAL_SUB is the received signal quality, averaged over the correct frames (SID).

21.3.1.4 Method of test

21.3.1.4.1 Initial conditions

A call is set up by the SS according to the generic call set up procedure on a full rate speech channel in the mid ARFCN range. The RADIO_LINK_TIMEOUT parameter value is set to maximum.

The SS commands the MS to establish the TCH burst-by-burst loop, see subclause 36.2.1.1.3.

The SS produces a wanted signal and an independent uncorrelated interfering (unwanted) signal, both with static propagation characteristics. The wanted signal is the standard test signal C1. It is at the nominal frequency of the receiver and its level is $28 \text{ dB}\mu\text{Vemf}$ (). The unwanted signal is the standard test signal I1, on the same timeslot on a nominal frequency 200 kHz above the nominal frequency of the wanted signal.

21.3.1.4.2 Procedure

- a) The SS sets the level of the unwanted signal at a value for which the BER of the looped back bursts, averaged over the reporting period as defined in GSM 05.08, clause 8.4, is in the "Range of actual BER" for "Quality band" RXQUAL_i, given in the table of GSM 05.08, subclause 8.2.4, with i equal to 0.
- b) The SS verifies that the MS reports RXQUAL and whether or not the reported level is correct by comparison with the RXQUAL level of the corresponding looped back bursts. The SS increases an event counter for each incorrect MS reported RXQUAL level and continues the test for Max-samples, as given in subclause 21.3.1.5 for every i. For i = 7, the test is performed in steps using 60 SACCH blocks. In between steps, at least 35 SACCH blocks, are transmitted with a level of the unwanted signal that allows the radio link counter in the MS to reach the maximum value.

NOTE 1: This special procedure for i = 7 is due to the high error rates involved with testing RXQUAL₇, that could lead to the MS experiencing a radio link time-out.

- c) The SS repeats steps a) to b) for i equals 1, 2, ...,7.
- d) The SS removes the unwanted signal and sets downlink DTX on.
- e) The SS verifies that the MS reports RXQUAL_{SUB} = 0 and RXQUAL_{FULL} = 7.

NOTE 2: When testing RXQUAL_{SUB}, on a full rate speech channel, the MS has approximately twice as many bits as the SS to assess BER. The MS has both SID and SACCH bits, whereas the SS only has the looped back SID bits. Therefore it is only tested that the MS uses the correct frames for RXQUAL_{SUB} reporting by checking both RXQUAL_{SUB} and RXQUAL_{FULL} reports. No quantitative assessment is done.

- f) The SS releases the call.

21.3.1.5 Test requirements

The number of errors in reporting the RXQUAL bands recorded in each of the considered cases shall not exceed the corresponding value of max-events shown in the following tables, when the number of samples relevant to the case under test is equal to max-samples.

Table 21.3: Maximum number of incorrectly reported RXQUAL_{FULL} for TCH/FS

CASE	Expected RXQUAL _{FULL}	Specified reporting error rate	Max-events	Max-samples
0	RXQUAL ₀	10%	200	1640
1	RXQUAL ₁	25%	200	666
2	RXQUAL ₂	15%	200	1093
3	RXQUAL ₃	10%	200	1640
4	RXQUAL ₄	10%	200	1640
5	RXQUAL ₅	5%	200	3279
6	RXQUAL ₆	5%	200	3279
7	RXQUAL ₇	5%	201	3300

NOTE: In order to have a testing performance corresponding to that in clause 14 for high error rates, the multiplication factor of the tested error rate with respect to the specified error rate, and the minimum number for Max-events, need to be increased. The following figures are used for static propagation conditions:

specified error rate	multiplication factor	min. Max-events
≤ 25 %	1,22	200

21.3.2 Signal quality under static conditions - TCH/HS

21.3.2.1 Definition and applicability

The MS shall be capable of measuring the received signal quality, which is specified in terms of bit error ratio (BER) before channel decoding averaged over the reporting period of length of one SACCH multiframe defined in section 8.4 of GSM 05.08. The MS shall map this BER into RXQUAL values using the coding scheme defined in section 8.2.4 of GSM 05.08. For the half rate channel without downlink DTX, the error assessment is based on 52 TDMA frames: RXQUAL_FULL. In case downlink DTX is used, the assessment is based on 12 TDMA frames: RXQUAL_SUB.

The requirement and this test apply to all types of GSM 400, GSM 700, GSM 850, GSM 900, DCS 1 800 and PCS 1 900 MS supporting speech on a half rate channel.

21.3.2.2 Conformance requirement

1. The received signal quality shall be measured by the MS in a manner that can be related to an equivalent average BER before channel decoding (i.e. chip error ratio), assessed over the reporting period of one SACCH multiframe. When the quality is assessed over the full-set and sub-set of frames, eight levels of RXQUAL are defined and shall be mapped to the equivalent BER before channel decoding as per the table in GSM 05.08, 8.2.4; GSM 05.08, 8.2.2 & 8.2.4.
2. The reported parameters (RXQUAL) shall be the received signal quality, averaged over the reporting period of length one SACCH multiframe; GSM 05.08, 8.2.3.

21.3.2.3 Test purpose

1. To verify, under static propagation conditions, that the received signal quality is measured and mapped to the eight levels of RXQUAL_FULL by the MS in a manner that can be related to an equivalent average BER before channel decoding (i.e. chip error ratio), assessed over the reporting period of one SACCH multiframe. The probability that the correct RXQUAL band is reported shall meet the values given as per the table in GSM 05.08, 8.2.4.
2. To verify that the reported parameters (RXQUAL) are the received signal quality, averaged over the reporting period of length one SACCH multiframe.
3. To verify that, for downlink DTX, the reported parameter RXQUAL_SUB is the received signal quality, averaged over the correct frames (SID).

21.3.2.4 Method of test

21.3.2.4.1 Initial conditions

A call is set up by the SS according to the generic call set up procedure on a half rate speech channel in the mid ARFCN range. The RADIO_LINK_TIMEOUT parameter value is set to maximum.

The SS commands the MS to establish the TCH burst-by-burst loop, see subclause 36.2.1.1.3.

The SS produces a wanted signal and an independent uncorrelated interfering (unwanted) signal, both with static propagation characteristics. The wanted signal is the standard test signal C1. It is at the nominal frequency of the receiver and its level is 28 dB μ V_{emf}(). The unwanted signal is the standard test signal I1, on the same timeslot on a nominal frequency 200 kHz above the nominal frequency of the wanted signal.

21.3.2.4.2 Procedure

- a) The SS sets the level of the unwanted signal at a value for which the BER of the looped back bursts, averaged over the reporting period as defined in GSM 05.08, clause 8.4, is in the "Range of actual BER" for "Quality band" RXQUAL_i, given in the table of GSM 05.08, subclause 8.2.4, with i equal to 0.
- b) The SS verifies that the MS reports RXQUAL and whether or not the reported level is correct by comparison with the RXQUAL level of the corresponding looped back bursts. The SS increases an event counter for each incorrect MS reported RXQUAL level and continues the test for Max-samples, as given in subclause 21.3.2.5 for every i. For i = 7, the test is performed in steps using 60 SACCH blocks. In between steps, at least 35 SACCH

blocks, are transmitted with a level of the unwanted signal that allows the radio link counter in the MS to reach the maximum value.

NOTE 1: This special procedure for $i = 7$ is due to the high error rates involved with testing RXQUAL_7, that could lead to the MS experiencing a radio link time-out.

- c) The SS repeats steps a) to b) for i equals 1, 2, ...,7.
- d) The SS removes the unwanted signal and sets downlink DTX on.
- e) The SS verifies that the MS reports RXQUAL_SUB = 0 and RXQUAL_FULL = 7.

NOTE 2: When testing RXQUAL_SUB, on a half rate speech channel, the MS has approximately twice as many bits as the SS to assess BER. The MS has both SID and SACCH bits, whereas the SS only has the looped back SID bits. Therefore it is only tested that the MS uses the correct frames for RXQUAL_SUB reporting reporting by checking both RXQUAL_SUB and RXQUAL_FULL reports. No quantitative assessment is done.

- f) The SS releases the call.

21.3.2.5 Test requirements

The number of errors in reporting the RXQUAL bands recorded in each of the considered cases shall not exceed the corresponding value of max-events shown in the following tables, when the number of samples relevant to the case under test is equal to max-samples.

Table 21.6: Maximum number of incorrectly reported RXQUAL_FULL for TCH/HS

CASE	Expected RXQUAL_FULL	Specified reporting error rate	Max-events	Max-samples
0	RXQUAL_0	10%	200	1640
1	RXQUAL_1	40%	300	660
2	RXQUAL_2	30%	300	870
3	RXQUAL_3	15%	200	1093
4	RXQUAL_4	15%	200	1093
5	RXQUAL_5	5%	200	3279
6	RXQUAL_6	5%	200	3279
7	RXQUAL_7	5%	201	3300

NOTE: In order to have a testing performance corresponding to that in clause 14 for high error rates, the multiplication factor of the tested error rate with respect to the specified error rate, and the minimum number for Max-events, need to be increased. The following figures are used for static propagation conditions:

specified error rate	multiplication factor	min. Max-events
≤ 25 %	1,22	200
30 - 40 %	1,15	300
> 40 %	1,1	400

21.4 Signal quality under TUhigh propagation conditions

21.4.1 Definition and applicability

The MS must be capable of measuring the received signal quality, which is specified in terms of bit error ratio (BER) before channel decoding averaged over the reporting period of length of one SACCH multiframe defined in section 8.4 of GSM 05.08. The MS has to map this BER into RXQUAL values using the coding scheme defined in section 8.2.4 of GSM 05.08. For the full rate channel without downlink DTX, the error assessment is based on 104 TDMA frames: RXQUAL_FULL.

The requirement and this test apply to all types of GSM 400, GSM 700, GSM 850, GSM 900, DCS 1800 and PCS 1 900 MS supporting speech on a full rate channel.

21.4.2 Conformance requirement

1. The received signal quality shall be measured by the MS in a manner that can be related to an equivalent average BER before channel decoding (i.e. chip error ratio), assessed over the reporting period of 1 SACCH multiframe. The assessed equivalent BER before channel decoding shall be mapped to the eight levels of RXQUAL using the coding scheme defined in section 8.2.4 of GSM 05.08; GSM 05.08 8.2.2, 8.2.4.
2. The reported parameters (RXQUAL) shall be the received signal quality, averaged over the reporting period of length one SACCH multiframe.

GSM 05.08, 8.2.3.

21.4.3 Test purpose

1. To verify, under TUhigh conditions, that the received signal quality is measured and reported to the eight levels of RXQUAL_FULL by the MS in a manner that can be related to an equivalent average BER before channel decoding (i.e. chip error ratio), assessed over the reporting period of length one SACCH multiframe for the TCH/FS. The probability that the correct RXQUAL band is reported shall meet the values given as per the Table in GSM 05.08 8.2.
2. To verify that the reported parameters (RXQUAL) is the received signal quality, averaged over the reporting period of length one SACCH multiframe.

21.4.4 Method of test

21.4.4.1 Initial conditions

The SS sets up a call according to the generic call set up procedure on a full rate speech channel in the mid ARFCN range. The RADIO_LINK_TIMEOUT parameter is set to maximum.

The SS commands the MS to establish the TCH burst-by-burst loop, see subclause 36.2.1.1.3.

The SS produces the standard test signal C1, with TUhigh propagation profile. It shall be at the nominal frequency of the receiver at a level of 28 dB μ V_{emf}().

21.4.4.2 Procedure

- a) The SS counts the number of bit errors occurring in 50 SACCH multiframe and the relevant BER is computed. If this BER does correspond to one out of the 8 different cases shown in Table 21.7, the procedure is continued from step c).

Table 21.7

CASE	Average BER (%)
0	< 0,10
1	0,26 to 0,30
2	0,51 to 0,64
3	1,0 to 1,3
4	1,9 to 2,7
5	3,8 to 5,4
6	7,6 to 11
7	> 15

- b) The SS generates an independent, uncorrelated interfering (unwanted) signal with TUhigh propagation profile. The unwanted signal is on the same channel as the wanted signal but has no fixed relationship with the bit transitions of the wanted signal, and is modulated with random data. The SS sets the level of this signal such that the BER computed on the basis of the number of bit errors occurring in 50 SACCH multiframe corresponds to one of the cases: case_i in Table 21.7.

- c) The SS verifies that the MS reports RXQUAL. The SS also computes the RXQUAL level for the multiframe based on the looped back bits. The SS compares the RXQUAL level it computed based on the looped back bits of the multiframe with the RXQUAL level reported by the MS for that multiframe. The reported level is considered correct if RXQUAL reported by the MS is equal to RXQUAL_i (with $i = 0, 1, \dots, 7$), or to one of the adjacent bands RXQUAL_(i-1) (with $i = 1, 2, \dots, 7$) and RXQUAL_(i+1) (with $i = 0, 1, \dots, 6$). For each failure (to be in the correct or one of the adjacent bands) that is found, if any, a counter Max-events_i is increased by one. This step is continued for Max_samples_i RXQUAL_i based on the looped back bits.

If the MS reports RXQUAL = 7 during the test period, then at least 35 SACCH multiframes, are transmitted with a level of the unwanted signal that allows the radio link counter in the MS to reach the maximum value.

NOTE: This special procedure for RXQUAL = 7 is due to the high error, that could lead to the MS experiencing a radio link time-out.

- d) The SS repeats steps b) and c) for all of the eight case_i.

21.4.5 Test requirements

The number of errors in reporting the RXQUAL bands recorded in each of the considered cases shall not exceed the corresponding value of Max-events shown in Table 21.8, when the number of samples relevant for the case is equal to Max_samples.

Table 21.8: Maximum number of incorrectly reported RXQUAL_FULL for TCH/FS

CASE	Expected RXQUAL_FULL	Specified reporting error rate	Max-events	Max_samples
0	RXQUAL_0/1	15%	200	1093
1	RXQUAL_1/0/2	15%	200	1093
2	RXQUAL_2/1/3	15%	200	1093
3	RXQUAL_3/2/4	10%	200	1640
4	RXQUAL_4/3/5	10%	200	1640
5	RXQUAL_5/4/6	10%	200	1640
6	RXQUAL_6/5/7	10%	200	1640
7	RXQUAL_7/6	10%	200	1640

21.5 Received signal measurements in HSCSD multislot configuration

21.5.1 Signal strength

21.5.1.1 Definition and applicability

The MS reports RXLEV values related to the apparent received RF signal strength. It is necessary for these levels to attain sufficient accuracy for the correct functioning of the system.

The requirements and this test apply to all types of GSM 400, GSM 700, GSM 850, GSM 900, DCS 1 800, PCS 1 900 and any multiband MSs which are capable of HSCSD multislot operation.

21.5.1.2 Conformance requirement

- The RMS received signal level at the receiver input shall be measured by the MS over the full range of -110 dBm to -48 dBm with a relative accuracy between signals with levels up to 20 dB difference according to table 21.5-1
 - under normal conditions, GSM 05.08, 8.1.2 and GSM 05.05, 6.2.
 - under extreme conditions, GSM 05.08, 8.1.2, GSM 05.05, annex D.1, D.2.

Table 21.5-1: Tolerance for relative accuracy of receive signal measurement

Absolute level of lower level signal dBm						Tolerance dB			
GSM Small MS	GSM Other MS	DCS1800 Class 1&2	DCS1800 Class 3	PCS1900 Class 1&2	PCS1900 Other MS	Lower limit		Upper limit	
						Single	Multi	Single	Multi
>= -88	>= -90	>= -86	>= -88	>= -88	>= -90	2	4	2	4
>= -101	>= -103	>= -99	>= -101	>= -101	>= -103	3	5	2	5
< -101	< -103	< -99	< -101	< -101	< -103	4	6	2	6

Single means that the measurements are on the same or different RF channel within the same frequency band.

Multi means that the measurements are on different RF channel on different frequency bands.

For measurements between ARFCN in different bands the 'Absolute level of lower level signal' column for the band including the lower level signal shall be used to determine which tolerance applies.

At extreme temperature conditions an extra 2 dB shall be added to the Multi limits in above table.

- The RMS received signal level at the receiver input shall be measured with an absolute accuracy of +/-4 dB from -110 dBm to -70 dBm under normal conditions; GSM 05.08, 8.1.2.
- The RMS received signal level at the receiver input shall be measured with an absolute accuracy of +/-6 dB over the full range of -110 dBm to -48 dBm under both normal and extreme conditions; GSM 05.08, 8.1.2.
- If the received signal level falls below the reference sensitivity level for the type of MS then the MS shall report a level between the reference sensitivity level and the actual received level, but with the tolerances given in conformance requirements 2. and 3. above.
- The measured signal level shall be mapped to an RXLEV value between 0 and 63 as specified in GSM 05.08; GSM 05.08, 8.1.4.

21.5.1.3 Test purpose

- To verify that the RXLEV reported by the MS in HSCSD multislot configuration does not exceed conformance requirement 1.
 - under normal conditions;
 - under extreme conditions.
- To verify that the RXLEV reported by the MS in HSCSD multislot configuration does not exceed conformance requirement 2 under normal conditions.
- To verify that the RXLEV reported by the MS in HSCSD multislot configuration does not exceed conformance requirement 3 under extreme conditions and under normal conditions from -48 dBm to -70 dBm.
- To verify that the RXLEV reported by the MS in HSCSD multislot configuration does not exceed conformance requirement 4.

NOTE: Conformance requirement 5 is inherently tested in each of the test purposes 1. to 4.

21.5.1.4 Method of test

21.5.1.4.1 Initial conditions

The SS is set to produce the BCCH of the serving cell at 63 dBμVemf() and the BCCHs of 6 surrounding cells at 28 dBμVemf(). The BCCH of the serving cell indicates these BCCHs, but not the BCCH of the serving cell. The ARFCN of the serving cell BCCH is chosen so as not to interfere with the other channels as shown in table 21.5-2. The fading profile for the BCCHs of the serving and surrounding cells will be set to static.

After 30 s, a call is set up according to the generic call set up procedure for multislot HSCSD to an ARFCN, within the supported band of operation. The SACCH indicates the same surrounding cell BCCHs as the BCCH of the serving cell.

SS commands the MS to operate in the multislot class with maximum number of bidirectional channels.

NOTE: The 30 s is to allow the MS to scan and find all BCCHs.

21.5.1.4.2 Procedure

- a) The levels of the TCH and BCCHs are set according to table 21.5-2 step 1. The SS waits 20 s before continuing. Same TCH levels are set to all multislot subchannels.

Table 21.5-2: Signal levels at receiver input in dB μ Vemf()

Step	ARFCN	TCH	BCCH1	BCCH2	BCCH3	BCCH4	BCCH5	BCCH6
	GSM450	259	276	293	264	269	281	288
	GSM480	306	323	340	311	316	328	335
	GSM900:	1	62	124	20	40	80	100
	DCS1800	512	700	885	585	660	790	835
	PCS1900	512	700	805	585	660	790	550
	450/900	259	124	276	293	269	288	1
	480/900	306	124	323	340	316	335	1
	450/1800	259	885	276	293	269	288	512
	480/1800	306	885	323	340	316	335	512
	900/1800	1	885	62	124	40	100	512
	450/900/1800	259	124	276	885	293	1	512
	480/900/1800	306	124	323	885	340	1	512
	GSM850	128	189	251	150	170	210	230
	GSM 750	438	475	511	440	455	485	500
	750/850	438	251	475	511	455	485	128
1+m*21		64,5-m*10	64,5-m*10	64,5-m*10	64,5-m*10	64,5-m*10	64,5-m*10	64,5-m*10
2+m*21		54,5-m*10	63,5-m*10	54,5-m*10	54,5-m*10	54,5-m*10	54,5-m*10	54,5-m*10
3+m*21		54,5-m*10	62,5-m*10	44,5-m*10	44,5-m*10	44,5-m*10	44,5-m*10	44,5-m*10
.		44,5-m*10	44,5-m*10
17+m*21		54,5-m*10	44,5-m*10	44,5-m*10
18+m*21		44,5-m*10	44,5-m*10	44,5-m*10
.		44,5-m*10	44,5-m*10
21+m*21		44,5-m*10	44,5-m*10	44,5-m*10	44,5-m*10	44,5-m*10	44,5-m*10	44,5-m*10

m = 0, 1, 2, 3, 4.

- b) The measurement is done in 105 steps. The initial signal levels of each multislot TCH of the serving cell and the BCCHs of the surrounding cells are adjusted according to table 21.5-2. At each step the SS keeps the signal levels stable for one reporting period, except at steps 21+m*21 where the level is held stable for 1,75 reporting periods. The RXLEV value for the period in which the change occurs (reported in the following period) is discarded. The SS records the RXLEV values reported for the surrounding cell BCCHs in steps 1 + m * 21 and 21 + m * 21. The RXLEV values for BCCH 1 are recorded by the SS for all 105 steps.

NOTE: This extension at steps 21+m*21 is to allow an extra quarter reporting period for the MS to stabilize for steps 1+m*21.

At steps 1 to 30 the SS simulates a base station with DTX off and at steps 31 to 105 the SS simulates a base station with DTX on.

At steps 1 to 30 the SS checks the accuracy of the measured signal strength of TCH by checking the values of the parameters RXLEV_FULL and RXLEV_SUB. At steps 31 to 105 the SS shall check only the value of the parameter RXLEV_SUB.

At step 64, within every 480 ms reporting period, out of the 4 SACCH and 8 SID timeslots the SS transmits the first six active timeslots of the TCH with signal level 39,5 dB μ Vemf() and the last six active timeslots of the TCH with signal level 29,5 dB μ Vemf().

- c) The SS sets signal levels for all multislot subchannels and BCCH as in step 50 of the table 21.5-2. The SS lowers the signal level on one of the subchannels in 6 steps of 1 dB. This is repeated on all subchannels. The SS simulates a base station with DTX off.
- d) Steps b) and c) are repeated under extreme conditions (annex 1, TC2,2 and TC3).

21.5.1.5 Test requirements

21.5.1.5.1 Relative accuracy of measurements on different ARFCN

For normal and each of the 4 extreme conditions for all multislot subchannels tested the following applies;

- a) For each of the steps 1, 21, 22, 42, 43, and 64, of the at least 7 (depending on the multislot class the MS is capable) reported RXLEV values checked, the difference between the minimum reported RXLEV value and the maximum reported RXLEV value shall be no more than 4 if the measurements are on the same or on different RF channel within the same frequency band and no more than 8 (12 for extreme temperature conditions) if the measurements are on different frequency bands.
- b) For each of the steps 63 and 85, of the at least 7 reported RXLEV values checked, the difference between the minimum reported RXLEV value and the maximum reported RXLEV value shall be no more than 5 for small MS, DCS 1 800 and PCS 1 900 (Class 1&2) MS or 4 for other MS if the measurements are on the same or on different RF channel within the same frequency band and no more than 9 for small MS, DCS 1 800 and PCS 1 900 (Class 1&2) MS or 8 for other MS and other PCS 1 900 MS (13 and 12 for extreme temperature conditions) if the measurements are on different frequency bands.
- c) For step 84, of the at least 7 reported RXLEV values checked, the difference between the minimum reported RXLEV value and the maximum reported RXLEV value shall be no more than 5 if the measurements are on the same or on different RF channel within the same frequency band and no more than 9 (13 for extreme temperature conditions) if the measurements are on different frequency bands.
- d) For step 105, of the reported RXLEV values checked, the difference between the minimum reported RXLEV value and the maximum reported RXLEV value shall be no more than 6 if the measurements are on the same or on different RF channel within the same frequency band and no more than 10 (14 for extreme temperature conditions) if the measurements are on different frequency bands.

NOTE: It is not mandatory for the MS to report any of the BCCHs in step 105.

21.5.1.5.2 Relative accuracy at a single frequency (BCCH1)

For normal and each of the 4 extreme conditions tested the following applies;

For $n \leq 21$ and $RXLEV_1 = 63$

$RXLEV_n - (63 - n + r)$ shall be between:

-2 and +2

NOTE: This formula allows for an MS with an absolute accuracy worse than +0,5 dB and therefore reporting an RXLEV of 63 for more than one step. The formula checks the relative accuracy from the lowest input level for which the MS last reports RXLEV of 63.

Otherwise

$RXLEV_{(m*21+1)} - RXLEV_{(m*21+n)} - n + 1$ shall be between:

-2 and +2

for steps 2 to 62 and 65 to 71 for DCS 1 800 class 1/2 MS; or steps 2 to 62 and 65 to 73 for DCS 1 800 class 3, PCS 1 900 (Class 1&2) and Small GSM MS; or 2 to 75 for other MS and other PCS 1 900 MS.

-3 and +2

for steps 63 and 72 to 96 for DCS 1 800 class 1/2 MS; or steps 63 and 74 to 98 for DCS 1 800 class 3, PCS 1 900 (Class 1&2) and Small GSM MS; or 76 to 100 for other MS and other PCS 1 900 MS.

-4 and +2

for steps 97 to 105 for DCS 1 800 class 1/2 MS; or steps 99 to 105 for DCS 1 800 class 3, PCS 1 900 (Class 1&2) and Small GSM MS; or 101 to 105 for other MS and other PCS 1 900 MS.

where: $1 < n \leq 21$ and $0 \leq m \leq 4$ as identified in table 21-2, and r is the number of the last step where RXLEV of 63 was reported.

NOTE: It is not mandatory for the MS to report BCCH1 for steps greater than 99 for GSM 400, GSM 700, GSM 850 or GSM 900 Small MS or 101 for other GSM and other PCS 1 900 MS or 97 for a DCS 1 800 Class 1 or Class 2 MS and 99 for DCS 1 800 Class 3 and PCS 1 900 (Class 1&2) MS. If the MS reports a level and the upper limit for this step in the above formulae implies a level below the reference sensitivity level for the type of MS, then the upper limit shall be considered as equal to a value corresponding to the reference sensitivity level.

21.5.1.5.3 Absolute accuracy

For each BCCH reported, $|RXLEV_{MS} + m * 10 - 62|$ shall be no more than:

- 4 for steps 64 and 85 under normal conditions.
- 6 for steps 64 and 85 under extreme conditions.
- 6 for steps 1, 22 and 43 under normal and extreme conditions.

where: $0 \leq m \leq 4$ as identified in table 21.5-2.

21.5.1.5.4 Relative accuracy of measurements of different subchannel

In step c) the RXLEV values reported for all subchannels are checked, allowing +/- 2 dB relative accuracy. Reporting shall be independent on all bidirectional subchannels.

21.6 COMPACT Signal strength

21.6.1 Definition and applicability

The MS reports RXLEV values related to the apparent received RF signal strength. It is necessary for these levels to attain sufficient accuracy for the correct functioning of the system.

The requirements and this test apply to all types of MSs supporting COMPACT.

21.6.2 Conformance requirement

1. The RMS received signal level at the receiver input shall be measured by the MS over the full range of -110 dBm to -48 dBm with a relative accuracy between signals with levels up to 20 dB difference according to table 21-6
 - 1.1 under normal conditions, GSM 05.08, 8.1.2 and GSM 05.05, 6.2.
 - 1.2 under extreme conditions, GSM 05.08, 8.1.2, GSM 05.05, annex D.1, D.2.

Table 21-6: Tolerance for relative accuracy of receive signal measurement

Absolute level of lower level signal dBm	Tolerance dB
--	--------------

GSM 400, 700, 850 and 900	GSM 400, 700, 850 and 900	DCS1800, PCS1900	DCS1800, PCS1900		
Small MS	Other MS	Class 1 & 2	Class 3	Lower limit Single Multi	Upper limit Single Multi
≥ -88	≥ -90	≥ -86	≥ -88	2 4	2 4
≥ -101	≥ -103	≥ -99	≥ -101	3 5	2 5
< -101	< -103	< -99	< -101	4 6	2 6

Single means that the measurements are on the same or different RF channel within the same frequency band.

Multi means that the measurements are on different RF channel on different frequency bands.

For measurements between ARFCN in different bands the 'Absolute level of lower level signal' column for the band including the lower level signal shall be used to determine which tolerance applies.

At extreme temperature conditions an extra 2 dB shall be added to the Multi limits in above table.

- The RMS received signal level at the receiver input shall be measured with an absolute accuracy of +/-4 dB from -110 dBm to -70 dBm under normal conditions; GSM 05.08, 8.1.2.
- The RMS received signal level at the receiver input shall be measured with an absolute accuracy of +/-6 dB over the full range of -110 dBm to -48 dBm under both normal and extreme conditions; GSM 05.08, 8.1.2.
- If the received signal level falls below the reference sensitivity level for the type of MS then the MS shall report a level between the reference sensitivity level and the actual received level, but with the tolerances given in conformance requirements 2. and 3. above.
- The measured signal level shall be mapped to an RXLEV value between 0 and 63 as specified in GSM 05.08; GSM 05.08, 8.1.4.

21.6.3 Test purpose

- To verify that the RXLEV reported by the MS does not exceed conformance requirement 1.
 - under normal conditions;
 - under extreme conditions.
- To verify that the RXLEV reported by the MS does not exceed conformance requirement 2 under normal conditions.
- To verify that the RXLEV reported by the MS does not exceed conformance requirement 3 under extreme conditions and under normal conditions from -48 dBm to -70 dBm.
- To verify that the RXLEV reported by the MS does not exceed conformance requirement 4.
- To Verify that the MS is able to adjust measurement timing.
- To verify that the MS is able to decode BSIC from the neighbors.

NOTE: Conformance requirement 5 is inherently tested in each of the test purposes 1. to 4.

21.6.4 Method of test

Initial conditions

The SS is set to produce the CPBCCCH of the serving cell at $63 \text{ dB}\mu\text{Vemf}(\)$ and the CPBCCCHs of 6 surrounding cells at $28 \text{ dB}\mu\text{Vemf}(\)$. The CPBCCCH of the serving cell indicates these CPBCCCHs, but not the CPBCCCH of the serving cell. The ARFCN of the serving cell CPBCCCH is chosen so as not to interfere with the other channels as shown in table 21-6. The fading profile for the CPBCCCHs of the serving and surrounding cells will be set to static.

After 120 s, a downlink TBF is set up according to the generic TBF set up procedure to an ARFCN, within the supported band of operation. Furthermore, the MS is forced to establish an uplink TBF applying EGPRS test mode, see GSM 04.14. All blocks are used for timeslot 0 for both downlink and uplink transactions. MCS-1 coding is used.

NOTE: The 120 s is to allow the MS to scan and find all CPBCCBs.

The SS must broadcast to MS a parameter NETWORK_CONTROL_ORDER set to value NC2. The MS shall send measurement reports to the network and the MS shall not perform autonomous cell re-selection. Parameter NC_REPORTINGPERIOD_T (time period for cell reselection measurement reporting for packet transfer mode) is set to 1.92 s (corresponding 8*52multiframes). The MS is able to take at least 18 samples / timegroup in every 4*52 multiframe. The average number of samples / carrier should be $(4 * 18) * 2 / 6 = 24$. In every TDMA frame possible, a received signal level measurement sample shall be taken on at least one of the CPBCCB carriers, as evenly distributed as possible among the neighbours.

Procedure

- a) The TimeGroups are set according to table 21-6-1.

Table 21-6-1: CPBCCB Timegroups

CPBCCB	TG
1, 5	0
2, 6	1
3	2
4	3

- b) The levels of the PDTCH and CPBCCBs are set according to table 21-6-2 step 1. The SS waits 20 s before continuing.

Table 21-6-2: Signal levels at receiver input in dBµVemf()

Step	ARFCN	PDTCH	CPBCCB1	CPBCCB2	CPBCCB3	CPBCCB4	CPBCCB5	CPBCCB6
	GSM450	259	276	293	264	269	281	288
	GSM480	306	323	340	311	316	328	335
	GSM900:	1	62	124	20	40	80	100
	DCS1800	512	700	885	585	660	790	835
	450/900	259	124	276	293	269	288	1
	480/900	306	124	323	340	316	335	1
	450/1800	259	885	276	293	269	288	512
	480/1800	306	885	323	340	316	335	512
	900/1800	1	885	62	124	40	100	512
	450/900/1800	259	124	276	885	293	1	512
	480/900/1800	306	124	323	885	340	1	512
	GSM850	128	189	251	150	170	210	230
	PCS1900	512	661	810	560	610	710	760
	850/1900	128	810	189	251	170	230	512
	GSM 750	438	475	511	440	455	485	500
	750/850	438	251	475	511	455	485	128
	750/1900	438	810	475	511	455	485	512
	750/850/1900	438	251	475	810	511	128	512
1+m*21		64,5-m*10	64,5-m*10	64,5-m*10	64,5-m*10	64,5-m*10	64,5-m*10	64,5-m*10
2+m*21		54,5-m*10	63,5-m*10	54,5-m*10	54,5-m*10	54,5-m*10	54,5-m*10	54,5-m*10
3+m*21		54,5-m*10	62,5-m*10	44,5-m*10	44,5-m*10	44,5-m*10	44,5-m*10	44,5-m*10
.		44,5-m*10	44,5-m*10
17+m*21		54,5-m*10	44,5-m*10	44,5-m*10
18+m*21		44,5-m*10	44,5-m*10	44,5-m*10
.		44,5-m*10	44,5-m*10
21+m*21		44,5-m*10	44,5-m*10	44,5-m*10	44,5-m*10	44,5-m*10	44,5-m*10	44,5-m*10

m = 0, 1, 2, 3, 4.

- b) The first measurement is done in 105 steps. The initial signal levels of the PDTCH of the serving cell and the CPBCCBs of the surrounding cells are adjusted according to table 21-6-2. At each step the SS keeps the signal

levels stable for one reporting period, except at steps $21+m*21$ where the level is held stable for 1,75 reporting periods. The RXLEV value for the period in which the change occurs (reported in the following period) is discarded. The SS records the RXLEV values reported for the surrounding cell CPBCCCHs in steps $1 + m * 21$ and $21 + m * 21$. The RXLEV values for CPBCCCH 1 are recorded by the SS for all 105 steps.

NOTE: This extension at steps $21+m*21$ is to allow an extra quarter reporting period for the MS to stabilize for steps $1+m*21$.

At steps 1 to 105 the SS checks the accuracy of the measured signal strength of PDTCH by checking the values of the parameter RXLEV.

The second part of test (105 steps) is done by following the rules defined above with the inclusion that the SS shall delay the transmission (CBCCCH's) from surrounding cells by $n*3$ bits ($n=1,2,3,\dots,21$), where n is incremented by 1 after every 5 performed measurement steps (5,10,15,20,...,100).

- c) Step b) is repeated under extreme conditions (annex 1, TC2,2 and TC3).

21.6.5 Test requirements

21.6.5.1 Relative accuracy of measurements on different ARFCN

For normal and each of the 4 extreme conditions (both with and without the delay) tested the following applies;

- a) For each of the steps 1, 21, 22, 42, 43, and 64, of the 7 reported RXLEV values checked, the difference between the minimum reported RXLEV value and the maximum reported RXLEV value shall be no more than 4 if the measurements are on the same or on different RF channel within the same frequency band and no more than 8 (12 for extreme temperature conditions) if the measurements are on different frequency bands.
 - b) For each of the steps 63 and 85, of the 7 reported RXLEV values checked, the difference between the minimum reported RXLEV value and the maximum reported RXLEV value shall be no more than 5 for small MS and DCS 1 800/PCS 1900 MS or 4 for other MS if the measurements are on the same or on different RF channel within the same frequency band and no more than 9 for small MS and DCS 1 800/PCS 1900 MS or 8 for other MS (13 and 12 for extreme temperature conditions) if the measurements are on different frequency bands.
 - c) For step 84, of the 7 reported RXLEV values checked, the difference between the minimum reported RXLEV value and the maximum reported RXLEV value shall be no more than 5 if the measurements are on the same or on different RF channel within the same frequency band and no more than 9 (13 for extreme temperature conditions) if the measurements are on different frequency bands.
 - d) For step 105, of the reported RXLEV values checked, the difference between the minimum reported RXLEV value and the maximum reported RXLEV value shall be no more than 6 if the measurements are on the same or on different RF channel within the same frequency band and no more than 10 (14 for extreme temperature conditions) if the measurements are on different frequency bands.
- d) For Step 1, check that the MS reports correctly the BSIC from all the neighbors and the reported BSIC value is unchanged during the whole tests

NOTE: It is not mandatory for the MS to report any of the CPBCCCHs in step 105.

21.6.5.2 Relative accuracy at a single frequency (CPBCCCH1)

For normal and each of the 4 extreme conditions tested the following applies;

For $n \leq 21$ and $RXLEV_1 = 63$

$RXLEV_n - (63 - n + r)$ shall be between:

-2 and +2

NOTE: This formula allows for an MS with an absolute accuracy worse than +0,5 dB and therefore reporting an RXLEV of 63 for more than one step. The formula checks the relative accuracy from the lowest input level for which the MS last reports RXLEV of 63.

Otherwise

$RXLEV_{(m*21+1)} - RXLEV_{(m*21+n)} - n + 1$ shall be between:

-2 and +2

for steps 2 to 62 and 65 to 71 for DCS 1 800/ PCS 1900 class 1/2 MS; or steps 2 to 62 and 65 to 73 for DCS 1 800/PCS 1900 class 3 and Small GSM MS; or 2 to 75 for other MS.

-3 and +2

for steps 63 and 72 to 96 for DCS 1 800/PCS1900 class 1/2 MS; or steps 63 and 74 to 98 for DCS 1 800/PCS 1900 class 3 and Small GSM MS; or 76 to 100 for other MS.

-4 and +2

for steps 97 to 105 for DCS 1 800/PCS 1900 class 1/2 MS; or steps 99 to 105 for DCS 1 800/ PCS 1900 class 3 and Small GSM MS; or 101 to 105 for other MS.

where: $1 < n \leq 21$ and $0 \leq m \leq 4$ as identified in table 21-6, and r is the number of the last step where $RXLEV$ of 63 was reported.

NOTE: It is not mandatory for the MS to report CPBCH1 for steps greater than 99 for GSM 400, GSM 700, GSM 850 OR GSM 900 Small MS or 101 for other GSM MS or 97 for a DCS 1 800/PCS1900 Class 1 or Class 2 MS and 99 for DCS 1 800/PCS1900 Class 3 MS. If the MS reports a level and the upper limit for this step in the above formulae implies a level below the reference sensitivity level for the type of MS, then the upper limit shall be considered as equal to a value corresponding to the reference sensitivity level.

21.6.5.3 Absolute accuracy

For each BCCH reported, $|RXLEV_{MS} + m * 10 - 62|$ shall be no more than:

- 4 for steps 64 and 85 under normal conditions.
- 6 for steps 64 and 85 under extreme conditions.
- 6 for steps 1, 22 and 43 under normal and extreme conditions.

where: $0 \leq m \leq 4$ as identified in table 21-2.

21.7 COMPACT Signal strength selectivity

21.7.1 Definition and applicability

The signal strength selectivity is a measure of the ability of the signal strength measuring part of the MS to discriminate against RF power from adjacent ARFCN. The $RXLEV$ selectivity figure corresponds to the amount by which the adjacent channel power shall be attenuated.

The requirements and this test apply to all types of MS supporting COMPACT.

21.7.2 Conformance requirement

The selectivity of the received signal measurement shall be as follows:

- for adjacent (200 kHz) channel; ≥ 16 dB
- for adjacent (400 kHz) channel; ≥ 48 dB
- for adjacent (600 kHz) channel; ≥ 56 dB

GSM 05.08, 8.1.2.

21.7.3 Test purpose

To verify that the MS meets the conformance requirement at the 200 kHz adjacent channel above and below the wanted.

21.7.4 Method of test

All CPBCCH's are using time group 0.

The SS must broadcast to MS a parameter NETWORK_CONTROL_ORDER set to value NC2. The MS shall send measurement reports to the network and the MS shall not perform autonomous cell re-selection. Parameter NC_REPORTINGPERIOD_T (time period for cell reselection measurement reporting for packet transfer mode) is set to 0.96 s (corresponding 4*52multiframe).

Initial conditions

For GSM 450:

A TBF is set up according to the generic downlink TBF set up procedure on ARFCN 269 and with surrounding cell CPBCCH3 indicated in the BA list at ARFCN 281. Furthermore, the MS is forced to establish an uplink TBF applying EGPRS test mode, see GSM 04.14. All blocks are used for timeslot 0 for both downlink and uplink transactions. The received data is transmitted back on the uplink blocks assigned for mobile station. MCS-1 coding is used.

The RF level of the PDTCH and CPBCCH3 is set to 20 dB above reference sensitivity level().

CPBCCH1 and 2 at ARFCN 270 and 280 are off.

These conditions are kept for 30 s to ensure the MS has time to decode the CPBCCH.

For GSM 480:

A TBF is set up according to the generic downlink TBF set up procedure on ARFCN 316 and with surrounding cell CPBCCH3 indicated in the BA list at ARFCN 328. Furthermore, the MS is forced to establish an uplink TBF applying EGPRS test mode, see GSM 04.14. All blocks are used for timeslot 0 for both downlink and uplink transactions. The received data is transmitted back on the uplink blocks assigned for mobile station. MCS-1 coding is used.

The RF level of the PDTCH and CPBCCH3 is set to 20 dB above reference sensitivity level().

CPBCCH1 and 2 at ARFCN 317 and 327 are off.

These conditions are kept for 30 s to ensure the MS has time to decode the CPBCCH.

For GSM 750:

A TBF is set up according to the generic downlink TBF set up procedure on ARFCN 450 and with surrounding cell CPBCCH3 indicated in the BA list at ARFCN 485. Furthermore, the MS is forced to establish an uplink TBF applying EGPRS test mode, see GSM 04.14. All blocks are used for timeslot 0 for both downlink and uplink transactions. The received data is transmitted back on the uplink blocks assigned for mobile station. MCS-1 coding is used.

The RF level of the PDTCH and CPBCCH3 is set to 20 dB above reference sensitivity level().

CPBCCH1 and 2 at ARFCN 451 and 484 are off.

These conditions are kept for 30 s to ensure the MS has time to decode the CPBCCH.

For GSM 850:

A TBF is set up according to the generic downlink TBF set up procedure on ARFCN 170 and with surrounding cell CPBCCH3 indicated in the BA list at ARFCN 210. Furthermore, the MS is forced to establish an uplink TBF applying EGPRS test mode, see GSM 04.14. All blocks are used for timeslot 0 for both downlink and uplink transactions. The received data is transmitted back on the uplink blocks assigned for mobile station. MCS-1 coding is used.

The RF level of the PDTCH and CPBCCH3 is set to 20 dB above reference sensitivity level().

CPBCCH1 and 2 at ARFCN 171 and 209 are off.

These conditions are kept for 30 s to ensure the MS has time to decode the CPBCCH.

For GSM 900:

A TBF is set up according to the generic downlink TBF set up procedure on ARFCN 40 and with surrounding cell CPBCCH3 indicated in the BA list at ARFCN 80. Furthermore, the MS is forced to establish an uplink TBF applying EGPRS test mode, see GSM 04.14. All blocks are used for timeslot 0 for both downlink and uplink transactions. The received data is transmitted back on the uplink blocks assigned for mobile station. MCS-1 coding is used.

The RF level of the PDTCH and CPBCCH3 is set to 20 dB above reference sensitivity level().

CPBCCH1 and 2 at ARFCN 41 and 79 are off.

These conditions are kept for 30 s to ensure the MS has time to decode the CPBCCH.

For DCS 1 800:

A TBF is set up according to the generic downlink TBF set up procedure on ARFCN 690 and with surrounding cell CPBCCH3 indicated in the BA list at ARFCN 790. Furthermore, the MS is forced to establish an uplink TBF applying EGPRS test mode, see GSM 04.14. All blocks are used for timeslot 0 for both downlink and uplink transactions. The received data is transmitted back on the uplink blocks assigned for mobile station. MCS-1 coding is used.

The RF level of the PDTCH and CPBCCH3 is set to 20 dB above reference sensitivity level().

CPBCCH1 and 2 at ARFCN 691 and 789 are off.

These conditions are kept for 30 s to ensure the MS has time to decode the CPBCCH.

For PCS 1 900:

A TBF is set up according to the generic downlink TBF set up procedure on ARFCN 650 and with surrounding cell CPBCCH3 indicated in the BA list at ARFCN 710. Furthermore, the MS is forced to establish an uplink TBF applying EGPRS test mode, see GSM 04.14. All blocks are used for timeslot 0 for both downlink and uplink transactions. The received data is transmitted back on the uplink blocks assigned for mobile station. MCS-1 coding is used.

The RF level of the PDTCH and CPBCCH3 is set to 20 dB above reference sensitivity level().

CPBCCH1 and 2 at ARFCN 651 and 709 are off.

These conditions are kept for 30 s to ensure the MS has time to decode the CPBCCH.

Procedure

- a) The SS records the RXLEV values reported for the PDTCH and CPBCCH3.
 - b) CPBCCH1 and 2 are set to 9 dB above the signal level of the PDTCH and CPBCCH3.
- NOTE: The first adjacent channel interference requirement limits the level of CPBCCHs 1 and 2 to 9 dB. This ensures that the MS can maintain the call, and read CPBCCH3.
- c) These conditions are kept for 30 s.
 - d) The SS records the RXLEV values reported for the PDTCH and CPBCCH3.

21.7.5 Test requirements

The values of RXLEV recorded in step d) shall be no more than 1 above the values recorded in step a).

NOTE: This one change in the reported value of RXLEV is calculated as follows: The level of the first adjacent interfering signal is such that C/I is -9 dB. With an RXLEV selectivity for the first adjacent channel of 16 dB, the power from the adjacent channel is equal to -7 dB with respect to the power level of the useful signal. The increase in power therefore is equal to $10\log(1 + 10^{-0.7}) = 0,71$ dB. Thus, the value of RXLEV could increase by 1.

22 Transmit power control timing and confirmation

22.1 Transmit power control timing and confirmation, single slot

22.1.1 Definition and applicability

The RF power level to be employed by the MS is indicated by means of the 5 bit TXPWR field sent in the layer 1 header of each downlink SACCH message block and may be sent in a dedicated signalling block.

When a power change is signalled the MS must change its power control level to the new level at a certain rate of change.

The MS shall confirm the power level that it is currently employing by setting the MS_TXPWR_CONF field in the uplink SACCH L1 header.

The requirements and this test apply to all types of GSM 400, GSM 700, GSM 850, GSM 900, DCS 1 800 and PCS 1900 MS.

22.1.2 Conformance requirement

1. The RF power control level to be employed by the MS is indicated by means of the power control information sent in the layer 1 header of each downlink SACCH message block and may be sent in a dedicated signalling block; GSM 05.08, 4.2.
2. The MS shall confirm the power level that it is currently employing in the uplink SACCH L1 header. The indicated value shall be the power control level actually used by the MS for the last burst of the previous SACCH period; GSM 05.08, 4.2.
3. Upon receipt of a command on the SACCH to change its RF power level, the MS shall change to the new level at a rate of one nominal 2 dB power control step every 60 ms; GSM 05.08, 4.7.
4. The change (in conformance requirement 3) shall commence at the first TDMA frame belonging to the next reporting period; GSM 05.08, 4.7.
5. In case of channel change the commanded power level shall be applied on the new channel immediately; GSM 05.08, 4.7.

22.1.3 Test purpose

1. To verify that the MS will set its transmitter output power in accordance with conformance requirement 1.
2. To verify that the MS will confirm the power level it is currently employing according to conformance requirement 2.
3. To verify that the MS, upon receipt of a command from the SACCH to change its RF power level, will change according to conformance requirement 3.
4. To verify that the MS will commence the change of power level at least by the sixth TDMA frame belonging to the next reporting period.
5. To verify that in case of new channel assignment the commanded power level is applied on the new channel according to conformance requirement 5.

22.1.4 Method of test

NOTE: The method of measuring the MS transmitter output power is given in section 13.3.

22.1.4.1 Initial conditions

A call is set up by the SS according to the generic call set up procedure on a channel with ARFCN in the Mid ARFCN range (ref. table 3.3), power control level set to maximum power.

22.1.4.2 Procedure

- a) The SS signals minimum power control level to the MS in the SACCH.
- b) The SS measures the MS transmitter output power on TDMA frames 6, 19, 32 and every subsequent 13th TDMA frame to TDMA frame 214. The SS also monitors the MS_TXPWR_CONF field in the uplink SACCH L1 header for the four SACCH multiframes after the SS signals the power change.
- c) The SS now sets TXPWR in the SACCH to the maximum peak power appropriate to the class of the MS.
- d) The SS measures the MS transmitter output power on TDMA frames 6, 19, 32 and every subsequent 13th TDMA frame to TDMA frame 214. The SS also monitors the MS_TXPWR_CONF field in the uplink SACCH L1 header for the four SACCH multiframes after the SS signals the power change.
- e) The SS now sets the SACCH TXPWR to 8.
- f) After 3 s the SS sets the SACCH TXPWR to 9.
- g) The SS measures the MS transmitter output power on TDMA frame 6.
- h) The SS sets the SACCH TXPWR to 8.
- i) The SS measures the MS transmitter output power on TDMA frame 6.
- j) The channel assignment is changed and the demanded power within the channel assignment is set to the minimum power control level of the MS.
- k) When the MS has changed channel its output power is measured on the first burst on the new channel.

22.1.5 Test requirements

NOTE: Refer to tables 13-2, 13-3 and 13-4 for relationship between the power class, power control level, transmitter output power and the relevant tolerances.

- a) In steps b) and d), the transmitter output power shall change by one power step towards the new level signalled for each measured burst until the MS is operating at the closest supported power control level and from then on, all transmissions shall be at that level.
- b) In steps b) and d), the value of the MS_TXPWR_CONF field in the uplink SACCH L1 header shall correspond to the actual power control level used for the last transmitted burst of the previous SACCH multiframe. The first one shall indicate the initial transmitted power control level, the subsequent ones shall change by 8 each time until the final power control level has been reached in which case that value shall be indicated.
- c) In steps g) and i) the transmitter output power of TDMA frame 6 shall correspond to the new commanded power control level.
- d) In step k) the MS output power, measured on the new channel shall correspond to the power control level in the channel assignment.

22.2 Transmit power control timing and confirmation in HSCSD multislot configurations

22.2.1 Definition and applicability

The RF power level to be employed by the MS is indicated by means of the 5 bit TXPWR field sent in the layer 1 header of each downlink SACCH message block and may be sent in a dedicated signalling block.

When a power change is signalled the MS must change its power control level to the new level at a certain rate of change.

The MS shall confirm the power level that it is currently employing by setting the MS_TXPWR_CONF field in the uplink SACCH L1 header.

The requirements and this test apply to all types of GSM 400, GSM 700, GSM 850, GSM 900, DCS 1 800 and PCS 1900 MS and any multiband MS which are capable of HSCSD multislot operation.

22.2.2 Conformance requirement

1. The RF power control level to be employed by the MS is indicated by means of the power control information sent in the layer 1 header of each downlink SACCH message block and may be sent in a dedicated signalling block; GSM 05.08, 4.2.
2. The MS shall confirm the power level that it is currently employing in the uplink SACCH L1 header. The indicated value shall be the power control level actually used by the MS for the last burst of the previous SACCH period; GSM 05.08, 4.2.
3. Upon receipt of a command on the SACCH to change its RF power level, the MS shall change to the new level at a rate of one nominal 2 dB power control step every 60 ms; GSM 05.08, 4.7.
4. The change (in conformance requirement 3) shall commence at the first TDMA frame belonging to the next reporting period; GSM 05.08, 4.7.
5. In case of channel change the commanded power level shall be applied on the new channel immediately; GSM 05.08, 4.7.

22.2.3 Test purpose

1. To verify that the MS will set its transmitter output power in accordance with conformance requirement 1.
2. To verify that the MS will confirm the power level it is currently employing according to conformance requirement 2.
3. To verify that the MS, upon receipt of a command from the SACCH to change its RF power level, will change according to conformance requirement 3.
4. To verify that the MS will commence the change of power level at least by the sixth TDMA frame belonging to the next reporting period.
5. To verify that in case of new channel assignment the commanded power level is applied on the new channel according to conformance requirement 5.

22.2.4 Method of test

NOTE: The method of measuring the MS transmitter output power is given in section 13.3.

22.2.4.1 Initial conditions

A call is set up by the SS according to the generic call set up procedure for multislot configuration on a channel with ARFCN in the Mid ARFCN range (ref. table 3.3), power control level set to maximum power.

The SS commands the MS to operate in multislot configuration where it has highest possible number of Tx slots.

22.2.4.2 Procedure

- a) The SS signals minimum power control level to the MS in the SACCH for one of the subchannels.
- b) The SS measures the MS transmitter output power on TDMA frames 6, 19, 32 and every subsequent 13th TDMA frame to TDMA frame 214. The SS also monitors the MS_TXPWR_CONF field in the uplink SACCH L1 header for the four SACCH multiframes after the SS signals the power change.
- c) The SS now sets TXPWR in the SACCH to the maximum peak power appropriate to the class of the MS.
- d) The SS measures the MS transmitter output power on TDMA frames 6, 19, 32 and every subsequent 13th TDMA frame to TDMA frame 214. The SS also monitors the MS_TXPWR_CONF field in the uplink SACCH L1 header for the four SACCH multiframes after the SS signals the power change.
- e) The SS now sets the SACCH TXPWR to 8.
- f) After 3 s the SS sets the SACCH TXPWR to 9.
- g) The SS measures the MS transmitter output power on TDMA frame 6.
- h) The SS sets the SACCH TXPWR to 8.
- i) The SS measures the MS transmitter output power on TDMA frame 6.
- j) The channel assignment is changed and the demanded power within the channel assignment is set to the minimum power control level of the MS.
- k) When the MS has changed channel its output power is measured on the first burst on the new channel.
- l) Steps a) to k) are repeated on the next subchannel until each is tested.

22.2.5 Test requirements

NOTE: Refer to tables 13-2, 13-3 and 13-4 for relationship between the power class, power control level, transmitter output power and the relevant tolerances.

- a) In steps b) and d), the transmitter output power shall change by one power step towards the new level signalled for each measured burst until the MS is operating at the closest supported power control level and from then on, all transmissions shall be at that level.
- b) In steps b) and d), the value of the MS_TXPWR_CONF field in the uplink SACCH L1 header shall correspond to the actual power control level used for the last transmitted burst of the previous SACCH multiframe. The first one shall indicate the initial transmitted power control level, the subsequent ones shall change by 8 each time until the final power control level has been reached in which case that value shall be indicated.
- c) In steps g) and i) the transmitter output power of TDMA frame 6 shall correspond to the new commanded power control level.
- d) In step k) the MS output power, measured on the new channel shall correspond to the power control level in the channel assignment.

22.3 GPRS Uplink Power Control – Use of α and Γ_{CH} parameters

22.3.1 Definition and applicability

Power control is important for spectrum efficiency as well as for power consumption in a cellular system. Power control for a packet oriented connection is more complicated than for a circuit switched connection, since there is no continuous two-way connection.

The RF output power, P_{CH} , to be employed by the MS on each individual uplink PDCH shall be:

$$P_{CH} = \min(\Gamma_0 - \Gamma_{CH} - \alpha * (C + 48), P_{MAX}),$$

Where

Γ_{CH} is an MS and channel specific power control parameter, sent to the MS in an RLC control message (see GSM 04.60).

Γ_0 = 39 dBm for GSM 400, GSM 700, GSM 850 and GSM900
= 36 dBm for DCS1800 and PCS 1900

α is a system parameter, broadcast on PBCCH or optionally sent to MS in an RLC control message (see GSM 04.08 and 04.60).

C is the normalised received signal level at the MS as defined in GSM 05.08, 10.2.3.1.

P_{MAX} is the maximum allowed output power in the cell =
GPRS_MS_TXPWR_MAX_CCH if PBCCH exists
MS_TXPWR_MAX_CCH otherwise

All power values are expressed in dBm. (Note that the constants Γ_0 and 48 are included only for optimising the coding of Γ_{CH} and C -value).

This is a flexible tool that can be used for different power control algorithms.

A pure open loop is achieved by setting $\alpha = 1$ and keeping Γ_{CH} constant. With this method the output power is based on the received signal level assuming the same path loss in uplink and downlink. This is useful in the beginning of a packet transmission.

A pure closed loop is achieved by setting $\alpha = 0$. With this method the output power is commanded by the network based on received signal level measurements made in the BTS in a similar way as for a circuit switched connection.

This test applies to all GSM 400, GSM 700, GSM 850, GSM900, DCS1800 and PCS 1900 which support GPRS.

22.3.2 Conformance requirement

The MS shall use the same output power on all four bursts within one radio block. GSM 05.08, 10.2.1.

If a calculated output power is not supported by the MS, the MS shall use the supported output power which is closest to the calculated output power. GSM 05.08, 10.2.1.

When the MS receives new Γ_{CH} or α values, the MS shall use the new value to update P_{CH} 2 radio blocks after the end of the frame containing the last timeslot of the message block containing the new value. GSM 05.08, 10.2.1.

The transmitted power shall be a monotonic function of the calculated output power and any change of 2 dB in the calculated value shall correspond to a change of 2 ± 1.5 dB in the transmitted value. The MS may round the calculated output power to the nearest nominal output power value. GSM 05.08, 10.2.1.

22.3.3 Test purpose

To verify the MS uses that the same output power on all four bursts of a radio block under normal conditions.

To verify that the highest power supported by the MS is used if the calculated power is greater.

To verify that the MS applies new Γ_{CH} or α values 2 radio blocks after the end of the frame containing the last timeslot of the message block containing the new value.

To verify that any change of 2dB in the calculated power corresponds to a change of 2 ± 1.5 dB in the transmitted value under normal conditions.

NOTE: For changes in calculated power which are less than the tolerances specified for absolute power accuracy in a MS, the transmitted power as a function of calculated power cannot be tested for monotonicity. Monotonicity between power control steps is implicitly tested in section 13.16.

22.3.4 Method of test

22.3.4.1 Initial conditions

The SS establishes a BCCH and a PBCCH on the same carrier in the mid ARFCN range. GPRS_MS_TXPWR_MAX_CCH is set to the maximum level (39dBm for GSM and 36dBm for DCS and PCS). The Γ_{CH} value is set such that $(\Gamma_0 - \Gamma_{CH})$ equals the maximum power control level supported by the Power Class of the MS under test. The α value is set to 0.

The SS establishes a downlink TBF on the same ARFCN as the BCCH and PBCCH. The MS shall transmit on the uplink. This is achieved using the GPRS test mode by transmitting a GPRS_TEST_MODE_CMD (see GSM 04.14, section 5.4). The downlink power level is adjusted until a stable C-value of -52 dBm is reported by the MS in the channel quality report (see GSM 05.08, 10.2.3).

22.3.4.2 Procedure

- a) The SS shall trigger a transmitter output power measurement on each of the four bursts of any radio block.

The method of power measurement is described in section 13.16.

- b) The SS shall modify the Γ_{CH} value such that $(\Gamma_0 - \Gamma_{CH})$ equals the minimum power control level supported by the MS under test (5dBm for GSM 400, GSM 700, GSM 850 and GSM900 and 0dBm for DCS1800 and PCS 1 900). If the transmission of the RLC control message containing the new Γ_{CH} value is completed in radio block N, the SS shall trigger a transmitter output power measurement on each of the four bursts of radio block N+3.
- c) The SS shall modify the Γ_{CH} value such that $(\Gamma_0 - \Gamma_{CH})$ equals the maximum power control level supported by the power class of the MS under test. If the transmission of the RLC control message containing the new Γ_{CH} value is completed in radio block N, the SS shall trigger a transmitter output power measurement on each of the four bursts of radio block N+3.
- d) The SS shall modify the Γ_{CH} value such that $(\Gamma_0 - \Gamma_{CH})$ equals the value 4dB below the maximum power control level supported by the power class of the MS under test. The α value is set to 1.
- e) The SS shall decrement the α value with a step size of 0.1 until α equals 0. For each step change in α value, if the transmission of the RLC control message containing the new α value is completed in radio block N, the SS shall trigger a transmitter output power measurement on each of the four bursts of radio block N+3.
- f) For each value of α , the SS shall note the maximum and minimum power values measured from the four bursts of the radio block in step e). The SS shall then calculate the maximum and minimum changes in output power measured for the following pairs of α values: 1.0 and 0.5; 0.9 and 0.4; 0.8 and 0.3; 0.7 and 0.2; 0.6 and 0.1; 0.5 and 0. The maximum change is calculated by subtracting the minimum power measured from the smaller value of α from the maximum power measured for the larger value of α . The minimum step change is calculated by subtracting the maximum power measured from the smaller value of α from the minimum power measured for the larger value of α .

NOTE

If the power values measured for the four bursts of the radio block with α equal to 1.0 are:

$$P_{m0}, P_{m1}, P_{m2}, P_{m3}$$

And, the power values measured for the four bursts of the radio block with α equal to 0.5 are:

$$P_{n0}, P_{n1}, P_{n2}, P_{n3}$$

Then,

$$P_{m(\max)} = \text{MAX}(P_{m0}, P_{m1}, P_{m2}, P_{m3})$$

$$P_{m(\min)} = \text{MIN}(P_{m0}, P_{m1}, P_{m2}, P_{m3})$$

$$P_{n(\max)} = \text{MAX}(P_{n0}, P_{n1}, P_{n2}, P_{n3})$$

$$P_{n(\min)} = \text{MIN}(P_{n0}, P_{n1}, P_{n2}, P_{n3})$$

The maximum and minimum step sizes are:

$$\text{STEP}(\text{MAX}) = P_{m(\max)} - P_{n(\min)}$$

$$\text{STEP}(\text{MIN}) = P_{m(\min)} - P_{n(\max)}$$

- g) The SS shall modify the Γ_{CH} value such that $(\Gamma_0 - \Gamma_{\text{CH}})$ equals the midrange power control level supported by the MS under test. The α value is set to 0.
- h) The SS shall increment the α value with a step size of 0.1 until α equals 1. For each step change in α value, if the transmission of the RLC control message containing the new α value is completed in radio block N, the SS shall trigger a transmitter output power measurement on each of the four bursts of radio block N+3.
- i) For each value of α , the SS shall note the maximum and minimum power values measured from the four bursts of the radio block in step h). The SS shall then calculate the maximum and minimum changes in output power measured for the following pairs of α values: 1.0 and 0.5; 0.9 and 0.4; 0.8 and 0.3; 0.7 and 0.2; 0.6 and 0.1; 0.5 and 0. The maximum change is calculated by subtracting the minimum power measured from the smaller value of α from the maximum power measured for the larger value of α . The minimum step change is calculated by subtracting the maximum power measured from the smaller value of α from the minimum power measured for the larger value of α .
- j) The SS shall modify the Γ_{CH} value such that $(\Gamma_0 - \Gamma_{\text{CH}})$ equals the minimum power control level supported by the MS under test (5dBm for GSM 400, GSM 700, GSM 850 and GSM900 and 0dBm for DCS1800 and PCS 1900). The α value is set to 0.
- k) The SS shall increment the α value with a step size of 0.1 until α equals 1. For each step change in α value, if the transmission of the RLC control message containing the new α value is completed in radio block N, the SS shall trigger a transmitter output power measurement on each of the four bursts of radio block N+3.
- l) For each value of α , the SS shall note the maximum and minimum power values measured from the four bursts of the radio block in step k). The SS shall then calculate the maximum and minimum changes in output power measured for the following pairs of α values: 1.0 and 0.5; 0.9 and 0.4; 0.8 and 0.3; 0.7 and 0.2; 0.6 and 0.1; 0.5 and 0. The maximum change is calculated by subtracting the minimum power measured from the smaller value of α from the maximum power measured for the larger value of α . The minimum step change is calculated by subtracting the maximum power measured from the smaller value of α from the minimum power measured for the larger value of α .

22.3.5 Test requirements

- The power of all four bursts within the radio block measured in step a) and c) shall be within the accuracies specified for the power class of the mobile under test, as indicated in the following table:

Power class	GSM 400, GSM 700, GSM 850 & GSM 900 Nominal Maximum output power	DCS 1 800 Nominal Maximum output power	PCS 1900 Nominal Maximum output power	Tolerance (dB) for normal conditions
1	-----	1 W (30 dBm)	1 W (30dBm)	± 2
2	8 W (39 dBm)	0.25 W (24 dBm)	0.25 W (24 dBm)	± 2
3	5 W (37 dBm)	4 W (36 dBm)	2 W (33 dBm)	± 2
4	2 W (33 dBm)			± 2
5	0.8 W (29 dBm)			± 2

- The power of all four bursts within the radio block measured in step b) shall be 5dBm for a GSM 400, GSM 700, GSM 850 or GSM900 MS and 0dBm for a DCS1800 and PCS 1900 MS with an accuracy of ± 5 dB in both cases.
- In steps f), i) and l), the maximum change in transmitted power between each identified pair of α values shall be 3.5dB.

4. In steps f), i) and l), the minimum change in transmitted power between each identified pair of α values shall be 0.5dB.

22.4 GPRS Uplink Power Control – Independence of TS Power Control

22.4.1 Definition and applicability

This test applies to all GSM 400, GSM 700, GSM 850, GSM900, DCS1800 and PCS 1900 MS which support multislots GPRS on the uplink.

22.4.2 Conformance requirement

For a GPRS multislots MS supporting 2 or more uplink PDCHs, power control shall be employed by the MS on each individual uplink PDCH. GSM 05.08, 10.2.1.

22.4.3 Test purpose

To verify that for a GPRS multislots MS supporting 2 or more uplink PDCHs, power control shall be employed by the MS on each individual uplink PDCH.

22.4.4 Method of test

22.4.4.1 Initial conditions

The MS shall transmit on the uplink with the maximum number of TS for the multislots class of the MS.. This is achieved using the GPRS test mode by first establishing a downlink TBF and transmitting a GPRS_TESST_MODE_CMD (see GSM 04.14, section 5,4). Each TS is transmitting on its maximum power. The α -value is set to 0.

22.4.4.2 Procedure

The SS shall modify the Γ_{CH} value of one TS such that $(\Gamma_0 - \Gamma_{CH})$ equals the minimum power control level supported by the MS under test (5dBm for GSM 400, GSM 700, GSM 850 and GSM900 and 0dBm for DCS1800 and PCS 1900).

- a) The SS shall trigger a transmitter output power measurement on each of the four bursts of any radio block of the TS under test.
- b) The SS shall trigger a transmitter output power measurement on each of the four bursts of any radio block of the other active TS.
- c) The SS shall modify the Γ_{CH} value for the TS under test such that $(\Gamma_0 - \Gamma_{CH})$ equals the maximum power control level supported by the MS under test.
- d) Steps a) to c) shall be repeated for each TS of the multislots configuration.

22.4.5 Test requirements

1. The power of all four bursts within the radio block measured in step b) shall be 5dBm for a GSM 400, GSM 700, GSM 850 or GSM900 MS and 0dBm for a DCS1800 and PCS 1900 MS with an accuracy of ± 5 dB in both cases.
2. For all TS, the power of all four bursts within the radio block measured in step c) shall be within the accuracies specified for the power class of the mobile under test, as indicated in the following table:

Power class	GSM 400, GSM 700, GSM 850 & GSM 900 Nominal Maximum output power	DCS 1 800 Nominal Maximum output power	PCS 1900 Nominal Maximum output power	Tolerance (dB) for normal conditions
1	-----	1 W (30 dBm)	1 W (30dBm)	± 2
2	8 W (39 dBm)	0.25 W (24 dBm)	0.25 W (24 dBm)	± 2
3	5 W (37 dBm)	4 W (36 dBm)	2 W (33 dBm)	± 2
4	2 W (33 dBm)			± 2
5	0.8 W (29 dBm)			± 2

22.5 [Reserved for future GPRS test]

22.6 Normal transmit power control timing and confirmation in ECSD

22.6.1 Definition and applicability

The RF power level to be employed by the MS is indicated by means of the 5 bit TXPWR field sent in the layer 1 header of each downlink SACCH message block and may be sent in a dedicated signalling block.

When a power change is signalled the MS must change its power control level to the new level at a certain rate of change.

The MS shall confirm the power level that it is currently employing by setting the MS_TXPWR_CONF field in the uplink SACCH L1 header.

The requirements and this test apply to all types of MSs which are capable of ECSD operation.

22.6.2 Test conformance

1. The RF power control level to be employed by the MS is indicated by means of the power control information sent in the layer 1 header of each downlink SACCH message block and may be sent in a dedicated signalling block; GSM 05.08, 4.2.
2. The MS shall confirm the power level that it is currently employing in the uplink SACCH L1 header. The indicated value shall be the power control level actually used by the MS for the last burst of the previous SACCH period; GSM 05.08, 4.2.
3. Upon receipt of a command on the SACCH to change its RF power level, the MS shall change to the new level at a rate of one nominal 2 dB power control step every 60 ms; GSM 05.08, 4.7.
4. The change (in conformance requirement 3) shall commence at the first TDMA frame belonging to the next reporting period; GSM 05.08, 4.7.
5. In case of channel change the commanded power level shall be applied on the new channel immediately; GSM 05.08, 4.7.

22.6.3 Test purpose

1. To verify that the MS will set its transmitter output power in accordance with conformance requirement 1.
2. To verify that the MS will confirm the power level it is currently employing according to conformance requirement 2.
3. To verify that the MS, upon receipt of a command from the SACCH to change its RF power level, will change according to conformance requirement 3.

4. To verify that the MS will commence the change of power level at least by the sixth TDMA frame belonging to the next reporting period.
5. To verify that in case of new channel assignment the commanded power level is applied on the new channel according to conformance requirement 5.

22.6.4 Test method

NOTE: The method of measuring the MS transmitter output power is given in section 13.3. For 8PSK modulation, a measurement method for estimating the long term average power from a single burst shall be employed. See section 13.17.3.

22.6.4.1 Initial conditions

A call is set up by the SS according to the generic call set up procedure for multislot configuration on a channel with ARFCN in the Mid ARFCN range (ref. table 3.3), power control level set to maximum power.

The SS commands the MS to operate in multislot configuration where it has highest possible number of Tx slots.

22.6.4.2 Procedure

If the MS supports both GMSK and 8PSK modulation on the uplink, the test is repeated with each modulation format.

- a) The SS signals minimum power control level to the MS in the SACCH for one of the subchannels.
- b) The SS measures the MS transmitter output power on TDMA frames 6, 19, 32 and every subsequent 13th TDMA frame to TDMA frame 214. The SS also monitors the MS_TXPWR_CONF field in the uplink SACCH L1 header for the four SACCH multiframes after the SS signals the power change.
- c) The SS now sets TXPWR in the SACCH to the maximum peak power appropriate to the class of the MS.
- d) The SS measures the MS transmitter output power on TDMA frames 6, 19, 32 and every subsequent 13th TDMA frame to TDMA frame 214. The SS also monitors the MS_TXPWR_CONF field in the uplink SACCH L1 header for the four SACCH multiframes after the SS signals the power change.
- e) The SS now sets the SACCH TXPWR to 8.
- f) After 3 s the SS sets the SACCH TXPWR to 9.
- g) The SS measures the MS transmitter output power on TDMA frame 6.
- h) The SS sets the SACCH TXPWR to 8.
- i) The SS measures the MS transmitter output power on TDMA frame 6.
- j) The channel assignment is changed and the demanded power within the channel assignment is set to the minimum power control level of the MS.
- k) When the MS has changed channel its output power is measured on the first burst on the new channel.
- l) Steps a) to k) are repeated on the next subchannel until each is tested.

22.6.5 Test requirement

NOTE: Refer to tables 13.17.3-1, 13.17.3-2, 13.17.3-3 and 13.17.3-4 for relationship between the power class, power control level, transmitter output power and the relevant tolerances.

- a) In steps b) and d), the transmitter output power shall change by one power step towards the new level signalled for each measured burst until the MS is operating at the closest supported power control level and from then on, all transmissions shall be at that level.
- b) In steps b) and d), the value of the MS_TXPWR_CONF field in the uplink SACCH L1 header shall correspond to the actual power control level used for the last transmitted burst of the previous SACCH multiframe. The first one shall indicate the initial transmitted power control level, the subsequent ones shall change by 8 each time until the final power control level has been reached in which case that value shall be indicated.

- c) In steps g) and i) the transmitter output power of TDMA frame 6 shall correspond to the new commanded power control level.
- d) In step k) the MS output power, measured on the new channel shall correspond to the power control level in the channel assignment.

22.7 ECSD Fast Power Control (FPC) timing and interworking with normal power control

22.7.1 Definition and applicability

Using the SACCH L1 header, normal uplink power control modifies the MS transmit power at a maximum rate of one power control level change per SACCH period (480ms). Under Fast Power Control the output power of an MS, in E-TCH mode, is updated each fast power reporting period. There are 24 fast power reporting periods in a 104 frame SACCH period.

The requirements and this test apply to all types of MSs which are capable of class B ECSD operation.

22.7.2 Test conformance

1. In the E-TCH mode, the MS shall, if so indicated by the BSS in the SACCH L1 header or Assignment command, use FPC (fast power control); GSM 05.08, 4.2
2. Switching between the normal power control mechanism and FPC shall be done if FPC is enabled or disabled via signalling in the SACCH L1 header. The respective power control mechanism to be used shall then be active as from the first TDMA frame belonging to the next reporting period; GSM 05.08, 4.7
3. The initial power control level to be used by the MS immediately after switching between normal and fast power control mechanisms shall, in both cases, be the level last commanded by the normal power control mechanism; GSM 05.08, 4.7
4. The fast power control mechanism shall use the differential power control mechanism defined in the table of GSM 05.08, 4.3
5. The MS shall employ the most recently commanded fast power control level on each uplink E-TCH channel; GSM 05.08, 4.2
6. If a power control command is received but the requested output power is not supported by the MS, the MS shall use the supported output power which is closest to the requested output power; GSM 05.08, 4.3
7. If FPC is in use, the MS shall report, in the SACCH L1 header, the power control level used at the end of the normal power control reporting period; GSM 05.08, 4.2
8. In case of a multislot configuration, each bi-directional channel shall be power controlled individually by the corresponding SACCH or fast inband signalling link, whichever is applicable; GSM 05.08, 4.2

22.7.3 Test purpose

1. To verify that the MS switches between normal power control and fast power control mechanisms in accordance with conformance requirements 1 and 2.
2. To verify that the initial power control level used by the MS after switching between normal and fast power control mechanisms is in accordance with conformance requirement 3.
3. To verify that power level changes using the fast power control are implemented by the MS in accordance with conformance requirements 4 and 5.
4. To verify that power control commands requesting levels not supported by the MS are treated in accordance with conformance requirement 6.
5. To verify that the power reported by the MS at the end of the normal power control reporting period is in accordance with conformance requirement 7.

6. To verify that in a multislot configuration the MS implements fast power control independently on each bi-directional E-TCH in accordance with conformance requirement 8.

22.7.4 Test method

22.7.4.1 Initial conditions

A call is set up by the SS according to the generic call set up procedure for multislot configuration on a channel with ARFCN in the Mid ARFCN range (ref. table 3.3).

The SS commands the MS to operate in multislot configuration where it has the highest possible number of bi-directional E-TCHs. Using normal power control, the level of each TX slot is set to maximum power.

22.7.4.2 Procedure

For the purpose of this test the SS shall randomly select one bi-directional E-TCH to exercise. All other E-TCHs shall maintain the state defined under the initial conditions. In this procedure these other E-TCHs are referred to as the active but unselected channels.

- a) Using the normal power control mechanism, the SS shall command the MS to transmit at power level 15 in the case of GSM400, GSM 700, GSM 850 and GSM900 or power level 8 in the case of DCS1800 and PCS1900 on the selected E-TCH. After 1s, a power measurement shall be made on each TX slot of the multislot configuration.

NOTE: The method of measuring the MS transmitter output power is given in section 13.3. For 8PSK modulation, a measurement method for estimating the long term average power from a single burst shall be employed. See section 13.17.3.

- b) The SS shall command the MS to switch between the normal power control and the fast power control mechanism by means of the SACCH L1 header (see GSM 04.04). Each power control mechanism shall be maintained for a single SACCH period. This cycle shall be repeated until all power measurements specified in steps c) to h) have been completed.

During the SACCH periods when normal power control is active, the SS shall command the MS to maintain the power levels set in step a). During the SACCH period when Fast Power Control is active, the SS shall command the MS to follow the schedule of fast power control detailed in the table below.

FPC Reporting Period Number	Fast Power Control Command	Nominal Output Power during FPC Reporting period GSM400, GSM 700, GSM 850 & GSM900	Nominal Output Power during FPC Reporting Period DCS1800 & PCS1900	Pn
0	2 Step Decrease	13dBm	14dBm	P0
1	2 Step Decrease	11dBm	12dBm	
2	2 Step Decrease	9dBm	10dBm	
3	2 Step Decrease	7dBm	8dBm	
4	2 Step Decrease	5dBm	6dBm	
5	2 Step Decrease	5dBm	4dBm	
6	2 Step Decrease	5dBm	2dBm	
7	2 Step Decrease	5dBm	0dBm	
8	4 Step Increase	5dBm	0dBm	P34
9	4 Step Increase	9dBm	4dBm	
10	4 Step Increase	13dBm	8dBm	
11	4 Step Increase	17dBm	12dBm	
12	4 Step Increase	21dBm	16dBm	
13	4 Step Increase	Max(25dBm,Pmax)	20dBm	
14	4 Step Increase	Max(29dBm,Pmax)	Max(24dBm,Pmax)	
15	4 Step Increase	Max(33dBm,Pmax)	Max(28dBm,Pmax)	
16	2 Step Decrease	Pmax	Pmax	P69
17	1 Step Increase	Pmax – 4dB	Pmax – 4dB	P73
18	2 Step Decrease	Pmax – 2dB	Pmax – 2dB	P78
19	3 Step Increase	Pmax – 6dB	Pmax – 6dB	P82
20	2 Step Decrease	Pmax	Pmax	P86
21	2 Step Decrease	Pmax – 4dB	Pmax – 4dB	P91
22	4 Step Increase	Pmax – 8dB	Pmax – 8dB	P95
23	No Change	Pmax	Pmax	P99

Pmax is the maximum power for the mobile class.

Pn values refer to the power measured in the nth frame of the SACCH period.

- a) The SS shall make power measurements on each active, but unselected timeslot of the multislot configuration during frames 0 and 103 of the SACCH period when normal power control is active.
- b) The SS shall make power measurements on each active, but unselected timeslot of the multislot configuration during frames 0, 34, 69, 73, 78, 82, 86, 91, 95 and 99 of the SACCH period when fast power control is active.
- c) The SS shall make power measurements of the selected timeslots during frames 0 and 103 of the SACCH period when normal power control is active.
- d) The SS shall make power measurements on the selected timeslot during frames 0, 34, 69, 73, 78, 82, 86, 91, 95 and 99 of the SACCH period when fast power control is active. These power measurements shall be referred to as P0, P34, P69, P73, P78, P82, P86, P91, P95 and P99 respectively.
- e) The SS shall note the MS TX power reported by the MS for the selected timeslot in the SACCH reporting period following the change from fast power control to normal power control.
- f) The SS shall note the MS TX power reported by the MS for the selected timeslot in the SACCH reporting period following the change from normal power control to fast power control.

22.7.5 Test requirement

- a) The powers measured for the unselected timeslots in steps a), c) and d) shall conform with the Pmax specification for the MS power class given in the following table.

Power class	GSM400, GSM 700, GSM 850 & GSM900 Nominal Maximum output power (MS TX Level)	GSM400, GSM 700, GSM 850 & GSM900 Tolerance (dB) for normal conditions	DCS 1 800 Nominal Maximum output power	PCS 1900 Nominal Maximum Output Power (MS TX Level)	DCS1800 & PCS1900 Tolerance (dB) for normal conditions
E1	33 dBm (5)	±2	30dBm	30dBm (0)	±2
E2	27dBm (8)	±3	26dBm	26dBm (2)	-4/+3
E3	23dBm (10)	±3	22dBm	22dBm (4)	±3

- b) The power measured for the selected timeslot in steps a) and e) shall be 13dBm in the case of GSM 400, GSM 700, GSM 850 and GSM900, and 14dBm in the case of DCS1800 and PCS1900. In all cases the tolerance shall be +/-3dB.
- c) The powers measured in step f) shall conform with the power specifications in the following table.

Pn	GSM400/GSM700/ GSM850/GSM900	DCS1800/PCS1900	Tolerance
P0	13dBm	14dBm	+/-3dB
P34	5dBm	0dBm	+/-5dB
P69	Pmax	Pmax	+/-2dB
P73	Pmax – 4dB	Pmax – 4dB	+/-3dB
P78	Pmax – 2dB	Pmax – 2dB	+/-3dB
P82	Pmax – 6dB	Pmax – 6dB	+/-3dB
P86	Pmax	Pmax	+/-2dB
P91	Pmax – 4dB	Pmax – 4dB	+/-3dB
P95	Pmax – 8dB	Pmax – 8dB	+/-3dB
P99	Pmax	Pmax	+/-2dB

See table in test requirement a) for Pmax value for MS power class.

- a) The power level reported by the MS in step g) shall be MS TX level corresponding to Pmax for the MS power class. See the table in test requirement a).
- b) The power level reported by the MS in step h) shall be MS TX Level 15 in the case of GSM400, GSM 700, GSM 850 and GSM900 and MS TX Level 8 in the case of DCS1800 and PCS1900.

22.8 EGPRS Uplink Power Control – Use of α and Γ_{CH} parameters

22.8.1 Definition and applicability

Power control is important for spectrum efficiency as well as for power consumption in a cellular system. Power control for a packet oriented connection is more complicated than for a circuit switched connection, since there is no continuous two-way connection.

The RF output power, P_{CH} , to be employed by the MS on each individual uplink PDCH shall be:

$$P_{CH} = \min(\Gamma_0 - \Gamma_{CH} - \alpha * (C + 48), P_{MAX}),$$

Where

Γ_{CH} is an MS and channel specific power control parameter, sent to the MS in an RLC control message (see GSM 04.60).

Γ_0 = 39 dBm for GSM400, GSM 700, GSM 850 and GSM900
= 36 dBm for DCS1800 and PCS1900

α	is a system parameter, broadcast on PBCCH or optionally sent to MS in an RLC control message (see GSM 04.08 and 04.60).
C	is the normalised received signal level at the MS as defined in GSM 05.08, 10.2.3.1.
PMAX	is the maximum allowed output power in the cell = GPRS_MS_TXPWR_MAX_CCH if PBCCH exists MS_TXPWR_MAX_CCH otherwise

All power values are expressed in dBm. (Note that the constants Γ_0 and 48 are included only for optimising the coding of Γ_{CH} and C-value).

This is a flexible tool that can be used for different power control algorithms.

A pure open loop is achieved by setting $\alpha = 1$ and keeping Γ_{CH} constant. With this method the output power is based on the received signal level assuming the same path loss in uplink and downlink. This is useful in the beginning of a packet transmission.

A pure closed loop is achieved by setting $\alpha = 0$. With this method the output power is commanded by the network based on received signal level measurements made in the BTS in a similar way as for a circuit switched connection.

This test applies to all types of MSs which support EGPRS.

22.8.2 Conformance requirement

1. The MS shall use the same output power on all four bursts within one radio block. GSM 05.08, 10.2.1.
2. If a calculated output power is not supported by the MS, the MS shall use the supported output power which is closest to the calculated output power. GSM 05.08, 10.2.1.
3. When the MS receives new Γ_{CH} or α values, the MS shall use the new value to update P_{CH} 2 radio blocks after the end of the frame containing the last timeslot of the message block containing the new value. GSM 05.08, 10.2.1.
4. The transmitted power shall be a monotonic function of the calculated output power and any change of 2 dB in the calculated value shall correspond to a change of 2 ± 1.5 dB in the transmitted value. The MS may round the calculated output power to the nearest nominal output power value. GSM 05.08, 10.2.1.

22.8.3 Test purpose

1. To verify the MS uses that the same output power on all four bursts of a radio block under normal conditions.
2. To verify that the highest power supported by the MS is used if the calculated power is greater.
3. To verify that the MS applies new Γ_{CH} or α values 2 radio blocks after the end of the frame containing the last timeslot of the message block containing the new value.
4. To verify that any change of 2dB in the calculated power corresponds to a change of 2 ± 1.5 dB in the transmitted value under normal conditions.

NOTE: For changes in calculated power which are less than the tolerances specified for absolute power accuracy in a MS, the transmitted power as a function of calculated power cannot be tested for monotonicity. Monotonicity between power control steps is implicitly tested in section 13.16.

22.8.4 Test method

22.8.4.1 Initial conditions

The SS establishes a BCCH and a PBCCH on the same carrier in the mid ARFCN range. GPRS_MS_TXPWR_MAX_CCH is set to the maximum level (39dBm for GSM400, GSM 700, GSM 850 and GSM900 and 36dBm for DCS1800 and PCS1900). The Γ_{CH} value is set such that $(\Gamma_0 - \Gamma_{CH})$ equals the maximum power control level supported by the Power Class of the MS under test. The α value is set to 0.

The SS establishes a downlink TBF on the same ARFCN as the BCCH and PBCCH. The SS orders the MS to transmit on the uplink. This is achieved using the EGPRS test mode by transmitting a EGPRS_TEST_MODE_CMD (see GSM 04.14, section TBD).

The downlink power level is adjusted until a stable C-value of -52dBm is reported by the MS in the channel quality report (see GSM 05.08, 10.2.3).

22.8.4.2 Procedure

If the MS supports both GMSK and 8PSK modulation on the uplink, the test is repeated with each modulation format.

- a) The SS shall trigger a transmitter output power measurement on each of the four bursts of any radio block.
- b) The method of power measurement is described in section 13.17.3.
- c) NOTE: For 8PSK modulation, a measurement method for estimating the long term average power from a single burst shall be employed. See section 13.17.3.
- d) The SS shall modify the Γ_{CH} value such that $(\Gamma_0 - \Gamma_{\text{CH}})$ equals the minimum power control level supported by the MS under test (5dBm for GSM400, GSM 700, GSM 850 and GSM900 and 0dBm for DCS1800 and PCS1900). If the transmission of the RLC control message containing the new Γ_{CH} value is completed in radio block N, the SS shall trigger a transmitter output power measurement on each of the four bursts of radio block N+3.
- e) The SS shall modify the Γ_{CH} value such that $(\Gamma_0 - \Gamma_{\text{CH}})$ equals the maximum power control level supported by the power class of the MS under test. If the transmission of the RLC control message containing the new Γ_{CH} value is completed in radio block N, the SS shall trigger a transmitter output power measurement on each of the four bursts of radio block N+3.
- f) The SS shall modify the Γ_{CH} value such that $(\Gamma_0 - \Gamma_{\text{CH}})$ equals the value 4dB below the maximum power control level supported by the power class of the MS under test. The α value is set to 1.
- g) The SS shall decrement the α value with a step size of 0.1 until α equals 0. For each step change in α value, if the transmission of the RLC control message containing the new α value is completed in radio block N, the SS shall trigger a transmitter output power measurement on each of the four bursts of radio block N+3.
- h) For each value of α , the SS shall note the maximum and minimum power values measured from the four bursts of the radio block in step e). The SS shall then calculate the maximum and minimum changes in output power measured for the following pairs of α values: 1.0 and 0.5; 0.9 and 0.4; 0.8 and 0.3; 0.7 and 0.2; 0.6 and 0.1; 0.5 and 0. The maximum change is calculated by subtracting the minimum power measured from the smaller value of α from the maximum power measured for the larger value of α . The minimum step change is calculated by subtracting the maximum power measured from the smaller value of α from the minimum power measured for the larger value of α .

NOTE:

If the power values measured for the four bursts of the radio block with α equal to 1.0 are:

$$P_{m0}, P_{m1}, P_{m2}, P_{m3}$$

And, the power values measured for the four bursts of the radio block with α equal to 0.5 are:

$$P_{n0}, P_{n1}, P_{n2}, P_{n3}$$

Then,

$$P_{m(\text{max})} = \text{MAX}(P_{m0}, P_{m1}, P_{m2}, P_{m3})$$

$$P_{m(\text{min})} = \text{MIN}(P_{m0}, P_{m1}, P_{m2}, P_{m3})$$

$$P_{n(\text{max})} = \text{MAX}(P_{n0}, P_{n1}, P_{n2}, P_{n3})$$

$$P_{n(\text{min})} = \text{MIN}(P_{n0}, P_{n1}, P_{n2}, P_{n3})$$

The maximum and minimum step sizes are:

$$\text{STEP(MAX)} = P_{n(\text{max})} - P_{n(\text{min})}$$

$$\text{STEP(MIN)} = P_{n(\text{min})} - P_{n(\text{max})}$$

- g) The SS shall modify the Γ_{CH} value such that $(\Gamma_0 - \Gamma_{\text{CH}})$ equals the midrange power control level supported by the MS under test. The α value is set to 0.
- h) The SS shall increment the α value with a step size of 0.1 until α equals 1. For each step change in α value, if the transmission of the RLC control message containing the new α value is completed in radio block N, the SS shall trigger a transmitter output power measurement on each of the four bursts of radio block N+3.
- i) For each value of α , the SS shall note the maximum and minimum power values measured from the four bursts of the radio block in step h). The SS shall then calculate the maximum and minimum changes in output power measured for the following pairs of α values: 1.0 and 0.5; 0.9 and 0.4; 0.8 and 0.3; 0.7 and 0.2; 0.6 and 0.1; 0.5 and 0. The maximum change is calculated by subtracting the minimum power measured from the smaller value of α from the maximum power measured for the larger value of α . The minimum step change is calculated by subtracting the maximum power measured from the smaller value of α from the minimum power measured for the larger value of α .
- j) The SS shall modify the Γ_{CH} value such that $(\Gamma_0 - \Gamma_{\text{CH}})$ equals the minimum power control level supported by the MS under test (5dBm for GSM400, GSM 700, GSM 850 and GSM900 and 0dBm for DCS1800 and PCS1900). The α value is set to 0.
- k) The SS shall increment the α value with a step size of 0.1 until α equals 1. For each step change in α value, if the transmission of the RLC control message containing the new α value is completed in radio block N, the SS shall trigger a transmitter output power measurement on each of the four bursts of radio block N+3.
- l) For each value of α , the SS shall note the maximum and minimum power values measured from the four bursts of the radio block in step k). The SS shall then calculate the maximum and minimum changes in output power measured for the following pairs of α values: 1.0 and 0.5; 0.9 and 0.4; 0.8 and 0.3; 0.7 and 0.2; 0.6 and 0.1; 0.5 and 0. The maximum change is calculated by subtracting the minimum power measured from the smaller value of α from the maximum power measured for the larger value of α . The minimum step change is calculated by subtracting the maximum power measured from the smaller value of α from the minimum power measured for the larger value of α .

22.8.5 Test requirement

- The power of all four bursts within the radio block measured in step a) and c) shall be within the accuracies specified for the power class of the mobile under test, as indicated in the following table:

Power class	GSM400, GSM 700, GSM 850 & GSM 900 Nominal Maximum output power	GSM400, GSM 700, GSM 850 & GSM 900 Tolerance (dB) for normal conditions	DCS 1 800 Nominal Maximum output power	PCS 1900 Nominal Maximum Output power	DCS1800 & PCS1900 Tolerance (dB) for normal conditions
1	-----		30 dBm	30dBm	± 2
2	39 dBm		24 dBm	24dBm	± 2
3	37 dBm		36 dBm	33dBm	± 2
4	33 dBm				± 2
5	29 dBm				± 2
E1	33 dBm	± 2	30dBm	30dBm	± 2
E2	27dBm	± 3	26dBm	26dBm	-4/+3
E3	23dBm	± 3	22dBm	22dBm	± 3

- The power of all four bursts within the radio block measured in step b) shall be 5dBm for a GSM400, GSM 700, GSM 850 and GSM900 MS and 0dBm for a DCS1800 or PCS1900 MS with an accuracy of ± 5 dB in all cases.
- In steps f), i) and l), the maximum change in transmitted power between each identified pair of α values shall be 3.5dB.

4. In steps f), i) and l), the minimum change in transmitted power between each identified pair of α values shall be 0.5dB.

22.9 EGPRS Uplink Power Control – Independence of TS Power Control

22.9.1 Definition and applicability

This test applies to all types of MS and all multiband MSs which support multislot EGPRS.

22.9.2 Test conformance

For an EGPRS multislot MS supporting 2 or more uplink PDCHs, power control shall be employed by the MS on each individual uplink PDCH. GSM 05.08, 10.2.1.

22.9.3 Test purpose

To verify that EGPRS power control is applied to each PDCH in a multislot configuration independently.

22.9.4 Test method

22.9.4.1 Initial conditions

The SS establishes a downlink TBF. The SS orders the MS to transmit on the maximum number of timeslots for the multislot class of the MS on the uplink. This is achieved using the EGPRS test mode by transmitting a EGPRS_TEST_MODE_CMD (see GSM 04.14, section TBD).

Each timeslot is transmitting on its maximum power. The α -value is set to 0.

22.9.4.2 Procedure

If the MS supports both GMSK and 8PSK modulation on the uplink, the test is repeated with each modulation format.

- a) The SS shall modify the Γ_{CH} value of one timeslot such that $(\Gamma_0 - \Gamma_{CH})$ equals the minimum power control level supported by the MS under test (5dBm for GSM400, GSM 700, GSM 850 and GSM900 and 0dBm for DCS1800 and PCS1900).
- b) The SS shall make a transmitter output power measurement on each of the four bursts of any radio block of the timeslot under test.

NOTE: For 8PSK modulation, a measurement method for estimating the long term average power from a single burst shall be employed. See section 13.17.3.

- c) The SS shall make a transmitter output power measurement on each of the four bursts of any radio block of the other active timeslots.
- d) The SS shall modify the Γ_{CH} value for the timeslot under test such that $(\Gamma_0 - \Gamma_{CH})$ equals the maximum power control level supported by the MS under test.
- e) Steps a) to d) shall be repeated for each timeslot of the multislot configuration.

22.9.5 Test requirement

1. The power of all four bursts within the radio block measured in step b) shall be 5dBm for a GSM400, GSM 700, GSM 850 and GSM900 MS and 0dBm for a DCS1800 or PCS1900 MS with an accuracy of ± 5 dB in all cases.
2. For all TS, the power of all four bursts within the radio block measured in step c) shall be within the accuracies specified for the power class of the mobile under test, as indicated in the following table:

Power class	GSM400, GSM 700, GSM 850 & GSM 900 Nominal Maximum output power	GSM400, GSM 700, GSM 850 & GSM 900 Tolerance (dB) for normal conditions	DCS 1 800 Nominal Maximum output power	PCS 1900 Nominal Maximum Output power	DCS1800 & PCS1900 Tolerance (dB) for normal conditions
1	-----		30 dBm	30dBm	±2
2	39 dBm		24 dBm	24dBm	±2
3	37 dBm		36 dBm	33dBm	±2
4	33 dBm				±2
5	29 dBm				±2
E1	33 dBm	±2	30dBm	30dBm	±2
E2	27dBm	±3	26dBm	26dBm	-4/+3
E3	23dBm	±3	22dBm	22dBm	±3

22.10 [Reserved for future EGPRS test]

23 Single frequency reference

23.1 Definition and applicability

The MS is required to use one single frequency reference for both RF generation/reception and baseband signals. A test method to verify this is not available.

The requirement applies to all types of MSs.

23.2 Conformance requirement

The MS shall use the same frequency source for both RF frequency generation and clocking the timebase; GSM 05.10, 6.1.

23.3 Test purpose

There is no test specified.

24 Tests of the layer 1 signalling functions

Testing of Layer 1 signalling functions is included in the tests in sections 15, 16, 17, 18, 19, 20, 21, 22, 23. Other Layer 1 functions are tested in sections 12, 13 and 14. Some testing of Layer 1 functions is integrated with Layer 3 signalling testing (26).

25 Tests of the layer 2 signalling functions

References:

- 1 ETSI ETS 300 555 (GSM 04.06) and ETS 300 557 (GSM 04.08), GSM 04.05.
- 2 CCITT Rec. X.290: OSI Conformance Testing Methodology and Framework for CCITT applications, Part 2: Abstract Test Suite Specification.

25.1 Introduction, objective and scope

25.1.1 General

The objective of section 25 is to provide detail of how Layer 2 of the MS is tested to verify conformance to the testable parameters given in GSM 04.06. The tests cover SAPI = 0, and they will be carried out on SDCCH and FACCH/F and on FACCH/H if the MS supports half-rate. Testing of unnumbered information transfer on SACCHs is covered implicitly by the test in section 26.6.3.

The testing is performed using the test configuration described in section 25.1.1.2. This configuration does not provide for testing of conformance of any maintenance functions.

The MS under test shall conform to the test configuration, and the Remote Single layer (RS) test method (CCITT X.290, section 8.1.4) will be used.

25.1.2 Test configurations

The Layer 2 test configuration defines the Layer 2 functional blocks of a MS being tested and the access arrangement between MS and tester.

NOTE: These functional blocks provide the Layer 2 basic capabilities which have to be implemented in accordance with the specification given in GSM 04.06. However, the definition of Layer 2 in the form of a number of functional blocks places no requirements on the Layer 2 implementation in a MS.

An example of a functional composition of the MS Layer 2 is given in GSM 04.05. These function blocks provide basic capabilities which have to be implemented in accordance with GSM 04.05 and GSM 04.06.

Also there are alternatives or options included in GSM 04.05 and GSM 04.06, these are provided as complementary capabilities.

25.1.3 Pre-conditions

Before carrying out any Layer 2 tests the tests specified in section 12, 13, 14 and 15 to 23 (Layer 1 tests) shall be performed.

Apart from powering up the MS to be tested and being able to establish a call the only access to the MS needed and used for Layer 2 testing is the radio interface. It therefore is necessary that the MS is able to synchronize to the System Simulator and to decode its BCCH and CCCH. Furthermore, the MS must be able to perform the following elementary Layer 3 procedures:

- Paging
- Immediate Assignment
- Dedicated Channel Assignment
- Handover
- Channel Release.

It is necessary that the tests are performed in the order specified, except where the starting point is set (25.1.5).

The data link is maintained by the MS and the SS sending fill frames (c.f. GSM 04.06, sect. 5.4.2.3) on the SDCCH when no other frames are to be transmitted. Fill frames are also sent on the FACCH while the channel mode is set to signalling. The default mode is signalling. The tests will normally be performed with the MS sending fill frames on the main DCCH (i.e. FACCH or SDCCH). Consequently throughout the tests fill frames will be sent and received even while waiting for other Layer 2 frames. The scheduling of the fill frame sending cannot be specified as this sending is closely linked to the processing times in the MS. Therefore, the instants of transmission of fill frames cannot be tested nor the number of these transmissions however, in certain circumstances, the fact that a fill frame is sent can be used as proof that the MS requirement has been fulfilled.

25.1.4 Layer 2 test frames

The Layer 2 conformance test is accomplished by sequences of those frames which are contained in GSM 04.06 (Layer 2 frame repertoire etc.).

These frame sequences are under control of the System Simulator and are related to the state that the System Simulator perceives the MS to be in as a result of frames transferred across the MS-BS interface.

These frame sequences shall comply with the following rules:

- 1) The test sequences exchanged between the System Simulator and MS are assumed to be free from transmission errors.
- 2) The tester may introduce errors in the direction tester to MS by inserting wrong parameters in the address, control and length indication field.
- 3) The tester may simulate errors in the direction MS to tester by ignoring the receipt of frames from the MS.
- 4) The tester may violate the protocol rules related to the control of state variables to provoke sequence gaps.
- 5) There is no contention on the Dm channel at Layer 1 (Layer 1 point-to-point).
- 6) With respect to contention on the Dm channel at Layer 2, two distinct situations are defined:
 - i) Test of the protocol procedure supported by a single entity. In this case there is no contention on the Dm channel (one peer-to-peer information transfer invoked at a time). This test applies to all MSs and is performed for SAPI = 0.
 - ii) Test of Layer 2 multiplexing and MS processing capacity in terms of the number of SAPs and links which a MS is able to support simultaneously. In this case there is contention on the Dm channel at Layer 2 and this contention is resolved within Layer 2 based on the SAPI. This test applies to MSs which are designed for supporting SAPI in addition to SAPI = 0.

Examples of special GSM Layer 2 functions to be tested:

- Correct L2 functions on specific GSM control channels;
- Length indication;
- Fill bits;
- Segmentation, more data bit;
- SABM/UA containing information for contention resolution;
- Abnormal release.

25.1.5 Establishment of the dedicated physical resource

The System Simulator shall simulate a BS with BCCH/CCCH on one carrier. The MS shall be listening to this CCCH and able to respond to paging messages. The system simulator sends Paging Request to the MS on the paging channel. The MS shall respond with Channel Request on the random access channel. The system simulator sends Immediate Assign to the MS, thereby ordering the MS either to a SDCCH or to a TCH, that is FACCH. Each test is performed once on SDCCH, once on FACCH/F and once on FACCH/H if the MS supports half-rate. However tests that explicitly check SDCCH and FACCH are performed once if the MS does not support half-rate and twice (once with FACCH/F and once with FACCH/H) if the MS supports half-rate.

25.1.6 Release of the dedicated physical resource

After a test has been performed the System Simulator shall initiate the release of the SDCCH or FACCH, as laid out in GSM 04.08, section 7.1.6. This shall return the MS to the idle mode, i.e. the MS shall again be listening to the CCCH of the System Simulator.

25.2 Test sequences

Timing requirement:

The MS shall respond to a command within T200 as defined in GSM 04.06.

The MS shall repeat a command after time-out of T200 if the command has not been acknowledged as defined in GSM 04.06.

Constant bit values:

In each frame from the MS:

- bits 6 through 8 of the address field shall be set to zero as defined in GSM 04.06.
- except for test 25.2.7, the address extension bit (EA bit) shall be set to 1 as defined in GSM 04.06.
- except for test 25.2.7, the length indicator field extension bit (EL bit) shall be set to 1 as defined in GSM 04.06.

This shall be checked each time a frame from the MS is received.

Fill bits:

The fill bits transmitted with each frame from the MS whose length indicator L is less than N201 as defined in GSM 04.06 shall be set as defined in GSM 04.06.

Frame format description

The frames are described by the following parameter sets:

SABM (C, P, M = 0, L = 0) (* SABM without an information field*)

SABM (C, P, M = 0, L > 0) (* SABM with an information field*)

DISC (C, P, M = 0, L = 0)

UA, (F, M = 0, L = 0) (* UA without an information field*)

UA, (F, M = 0, L > 0) (* UA with an information field*)

DM (R, F, M = 0, L = 0)

RR (C, P, M = 0, L = 0, N(R))

RR (R, F, M = 0, L = 0, N(R))

REJ (C, P, M = 0, L = 0, N(R))

REJ (R, F, M = 0, L = 0, N(R))

I (C, P, M = 0, L < N201, N(S), N(R))

I (C, P, M = 1, L = N201, N(S), N(R))

UI (C, P = 0, M = 0, L = 0)

UI (C, P = 0, M = 0, L < N201)

where:

C = command

R = response

P = poll

F = final

M = M bit

L = length indicator

N(S) = send sequence number

N(R) = receive sequence number.

25.2.1 Initialization

25.2.1.1 Initialization when contention resolution required

25.2.1.1.1 Normal initialization

25.2.1.1.1.1 Test purpose

To test the normal establishment of multiple frame operation between the SS and the MS when contention resolution is required.

25.2.1.1.1.2 Method of test

The MS is paged as described in the Layer 2 tests general section at 25.1.5.

The MS shall then continue the setup by sending a SABM frame.

The SS responds with a UA frame.

The MS shall send a UI fill frame.

The SS waits for at least T200 after the UA to ensure the SABM frame is not repeated. This confirms that the UA has been received.

The MS is returned to the idle state as described in 25.1.1.6.

Expected sequence

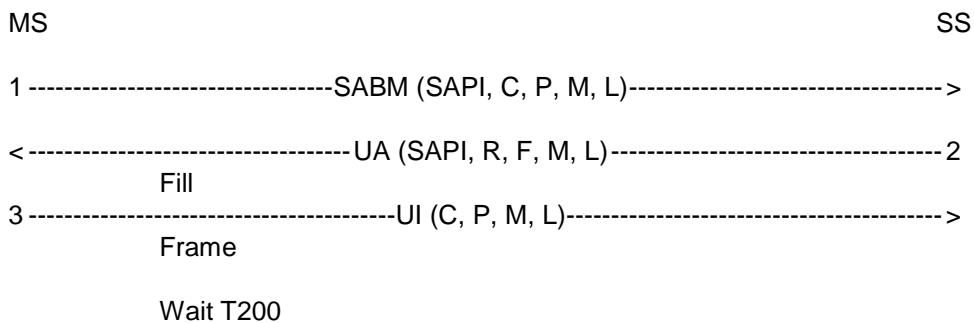

The frames from the SS will be:

2: One UA frame containing:

SAPI = 0, R = 0, F = 1, M = 0, L = L of SABM

information field = information field of SABM

25.2.1.1.1.3 Test requirements

The frames from the MS shall be:

1: One SABM frame containing:

SAPI = 0, C = 0, P = 1, M = 0, $0 \leq L \leq N201$

information field = Page Response

3: One UI frame containing:

C = 0, P = 0, M = 0, L = 0

25.2.1.1.2 Initialization failure

25.2.1.1.2.1 Loss of UA frame

25.2.1.1.2.1.1 Test purpose

To test the MS response to the loss of a Layer 2 UA frame during initialization.

25.2.1.1.2.1.2 Method of test

The MS is paged as described in the Layer 2 tests general section at 25.1.5.

The MS shall then continue the setup by sending an SABM frame.

The SS ignores the first SABM frame from the MS.

The MS shall wait for time-out of timer T200 and then send a second SABM frame.

The SS responds with a UA frame.

The MS shall send a UI fill frame.

The SS waits for at least T200 to ensure the SABM frame is not repeated

The MS is returned to the initial condition by clearing of the call (not part of this test).

Expected sequence

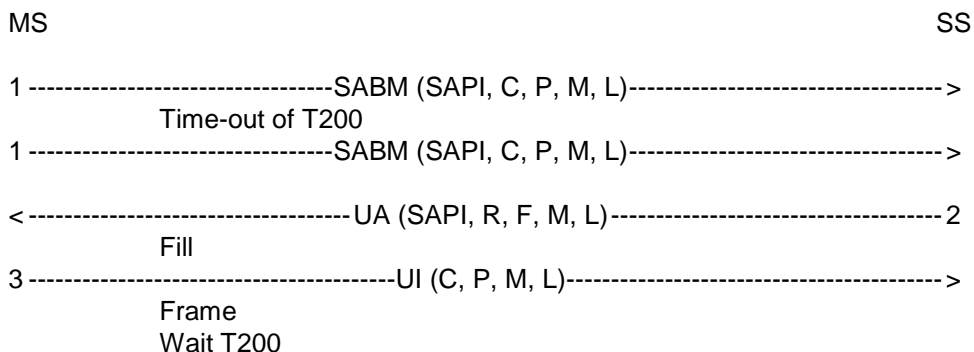

The frames from the SS will be:

2: One UA frame containing:

SAPI = 0, R = 0, F = 1, M = 0, L = L of SABM
 information field = information field of SABM

25.2.1.1.2.1.3 Test requirements

The frames from the MS shall be:

1: One SABM frame (occurs twice) containing:

SAPI = 0, C = 0, P = 1, M = 0, 0 <= L <= N201
 information field = Page Response

The second SABM frame shall follow the first SABM frame after
 time-out of timer T200.

3: One UI frame containing:

C = 0, P = 0, M = 0, L = 0

25.2.1.1.2.2 UA frame with different information field

25.2.1.1.2.2.1 Test purpose

To test that the MS will leave the channel and return to the idle state when multiple frame establishment fails because a UA frame with a different information field is received in response to the SABM frame.

To test that the MS will thereafter repeat the immediate assignment procedure returning to the idle state when multiple frame establishment fails because a UA frame with a different information field is received in response to the SABM frame.

To test that MS will not attempt to perform the immediate assignment procedure after the first repetition.

25.2.1.1.2.2.2 Method of test

The MS is paged as described in the general section for Layer 2 testing in section 25.1.5. The MS is now in a condition to test the Layer 2 aspects of multiple frame establishment with contention resolution and a UA frame with an information field different from the one in its SABM frame.

The MS shall send an SABM frame.

The SS shall respond with an UA frame whose information field is different from the one in the SABM frame.

The MS shall send an SABM frame.

The SS shall respond with an UA frame whose information field is different from the one in the SABM frame.

The SS shall wait for $3 \cdot T200$ to check that the MS does not send any L2 frames other than L2 fill frames on the assigned channel.

After a time equal to $3 \cdot T200$ the SS checks that there are no more Layer 2 frames on the assigned channel, for a period of 1 second.

NOTE 1: Possible fill frames are allowed in order to take into account processing time inside the MS.

NOTE 2: There are no further attempts of immediate assignment procedure after the repetition.

15 seconds after sending the UA frame in response to the repetition of the immediate assignment procedure the SS pages the MS according to 25.2.1.1.1, to make sure that the MS has returned to the idle state.

MS	SS
<-----PAGING REQUEST-----	1
2 ----- CHANNEL REQUEST ----->	
<----- IMMEDIATE ASSIGNMENT----->	3
4 -----SABM (SAPI, C, P, M, L)----->	
<----- UA (SAPI, R, F, M, L)----->	5
6 ----- CHANNEL REQUEST ----->	
<----- IMMEDIATE ASSIGNMENT----->	7
8 -----SABM (SAPI, C, P, M, L)----->	
<----- UA (SAPI, R, F, M, L)----->	9
Wait for at least $3 \cdot T200$, fill frames may occur.	
There are no Layer 2 frames on the assigned channel for 1 second.	
The MS is paged 15 seconds after step 9.	
MS is in idle state.	
<-----PAGING REQUEST-----	10
11 ----- CHANNEL REQUEST ----->	

The frames from the SS will be:

5,9: Two UA frames containing:

SAPI = 0, R = 0, F = 1, M = 0, L = 0

25.2.1.1.2.2.3 Test requirements

The frames from the MS shall be:

4,8: Two SABM frames containing:

SAPI = 0, C = 0, P = 1, M = 0, $0 < L \leq N201$

information field = Page Response

25.2.1.1.2.3 Information frame and supervisory frames in response to an SABM frame

25.2.1.1.2.3.1 Test purpose

To test that the MS will ignore receipt of frames other than a UA when received in response to the SABM frame.

25.2.1.1.2.3.2 Method of test

As in 25.2.1.1.2.2, but instead of returning a UA frame the SS will respond with an I frame, RR frame, REJ frame. (So this test will actually be performed 3 times.). The MS shall ignore receipt of the frames sent by the SS and therefore resend its SABM frame after time-out of T200.

Expected Sequence

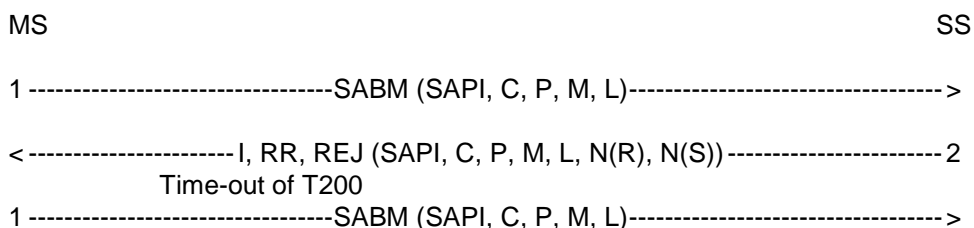

The frames from the SS will be:

2: One I frame containing:

SAPI = 0, C = 1, P = 1, M = 0, 0 <= L <= N201 (arbitrary), N(R), N(S) arbitrary
 information field arbitrary

or One RR frame containing:

SAPI = 0, C = 1, P = 1, N(R) arbitrary

or One REJ frame containing:

SAPI = 0, C = 1, P = 1, N(R) arbitrary

25.2.1.1.2.3.3 Test requirements

The frames from the MS shall be:

1: One SABM frame (occurs twice) containing:

SAPI = 0, C = 0, P = 1, M = 0, 0 <= L <= N201
 information field = Page Response

The second SABM frame shall follow the first SABM frame after time-out of timer T200.

25.2.1.1.3 Initialization denial

25.2.1.1.3.1 Test purpose

To test that the MS takes appropriate action if the network side indicates that it can not enter the multiple frame established state.

25.2.1.1.3.2 Method of test

The MS is paged as described in the Layer 2 tests general section at 25.1.5.

The MS shall then continue the setup by sending a SABM frame.

The SS responds with a DM frame.

The SS then waits at least T200 for the MS to transmit.

The MS shall not repeat the SABM frame.

Expected Sequence

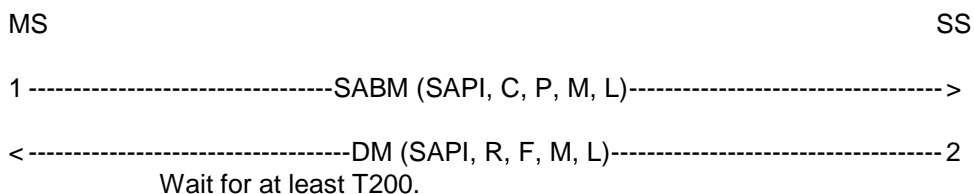

The frames from the SS will be:

2: One DM frame containing:

SAPI = 0, R = 0, F = 1, M = 0, L = 0

25.2.1.1.3.3 Test requirements

The frames from the MS shall be:

1: One SABM frame containing:

SAPI = 0, C = 0, P = 1, M = 0, 0 <= L <= N201

information field = Page Response

25.2.1.1.4 Total initialization failure

25.2.1.1.4.1 Test purpose

To test the MS response to the lack of the system to respond to requests to initialize the data link.

25.2.1.1.4.2 Method of test

The MS is paged as described in the Layer 2 tests general section at 25.1.5.

The MS shall then continue the setup by sending a SABM frame.

The SS ignores the first SABM frame from the MS.

The MS shall wait for time-out of timer T200 and then send a second SABM frame.

This is repeated until the MS has sent the SABM frame six times. The MS shall not send the SABM any more than six times.

The SS continues to send paging messages on the BCCH/CCCH and the test continues as in test 25.2.1.1.1.

Expected Sequence

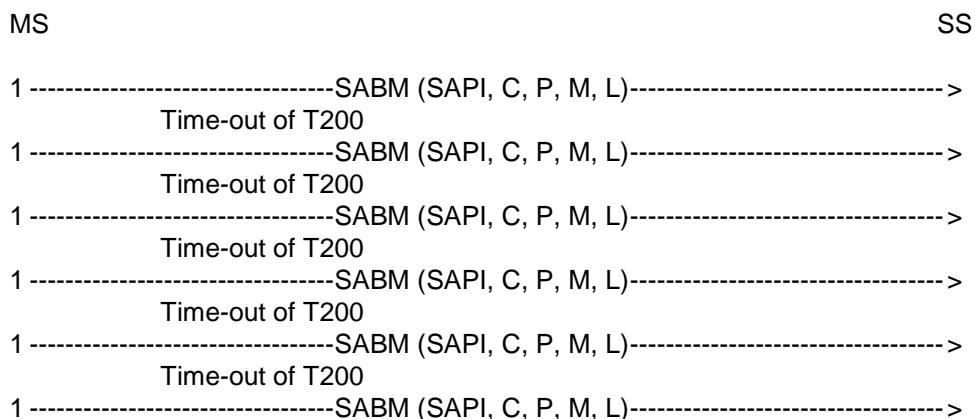

25.2.1.1.4.3 Test requirements

The frames from the MS shall be:

1: One SABM frame (occurs six times) containing:

SAPI = 0, C = 0, P = 1, M = 0, $\leq L \leq N201$

information field = Page Response

The subsequent SABM frames shall follow the previous SABM frame after time-out of timer T200.

25.2.1.2 Initialization, contention resolution not required

This procedure is used after a data link has been established with contention resolution and a new data link is established on a new channel e.g. handover, dedicated channel assignment.

25.2.1.2.1 Normal initialization without contention resolution

25.2.1.2.1.1 Test purpose

To test the normal initialization of multiple-frame operation when contention resolution is not required.

25.2.1.2.1.2 Method of test

The data link is setup between the MS and the SS as in test 25.2.1.1.1.

After the MS has sent the UI frame the SS initiates the dedicated channel assignment procedure to assign an SDCCH.

The MS shall then continue the setup by sending a SABM frame without contention resolution.

The SS responds with a UA frame.

The MS shall then send an I frame containing the assignment complete message.

The SS shall acknowledge the I frame with an RR frame.

The SS then waits for the MS to send a UI fill frame.

The SS then initiates the dedicated channel assignment procedure to assign an FACCH.

The expected sequence is then repeated. The SS waits for at least T200 to ensure that the SABM is not repeated.

Expected Sequence

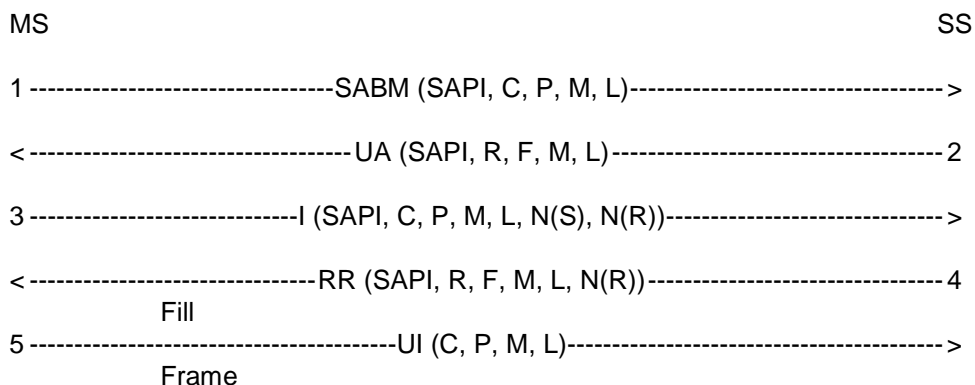

The frames from the SS will be:

2: One UA frame containing:

SAPI = 0, R = 0, F = 1, M = 0, L = 0

4: One RR frame containing:

SAPI = 0, R = 0, F = 0, M = 0, L = 0, N(R) = 1

25.2.1.2.1.3 Test requirements

The frames from the MS shall be:

1: One SABM frame containing:

SAPI = 0, C = 0, P = 1, M = 0, L = 0

3: One I frame containing:

SAPI = 0, C = 0, P = 0, M = 0, $0 \leq L \leq N201$, N(S) = 0, N(R) = 0

Information field = Assignment Complete

5 One UI frame containing:

C = 0, P = 0, M = 0, L = 0

25.2.1.2.2 Initialization failure

25.2.1.2.2.1 Test purpose

To test the MS response to the loss of a Layer 2 UA frame during initialization.

25.2.1.2.2.2 Method of test

The SS initiates the dedicated channel assignment procedure to assign an SDCCH.

The MS shall then continue the setup by sending a SABM frame.

The SS ignores the first SABM frame from the MS.

The MS shall wait for time-out of timer T200 and then send a second SABM frame.

The SS responds with a UA frame.

The MS shall then send an I frame containing the assignment complete message.

The SS shall acknowledge the I frame with an RR frame.

The SS then waits for the MS to send a UI fill frame.

The SS then initiates the dedicated channel assignment procedure to assign a FACCH.

The expected sequence is then repeated. The SS waits for at least T200 to ensure that the SABM is not repeated.

The MS is returned to the idle state as described in 25.1.1.6.

Expected Sequence

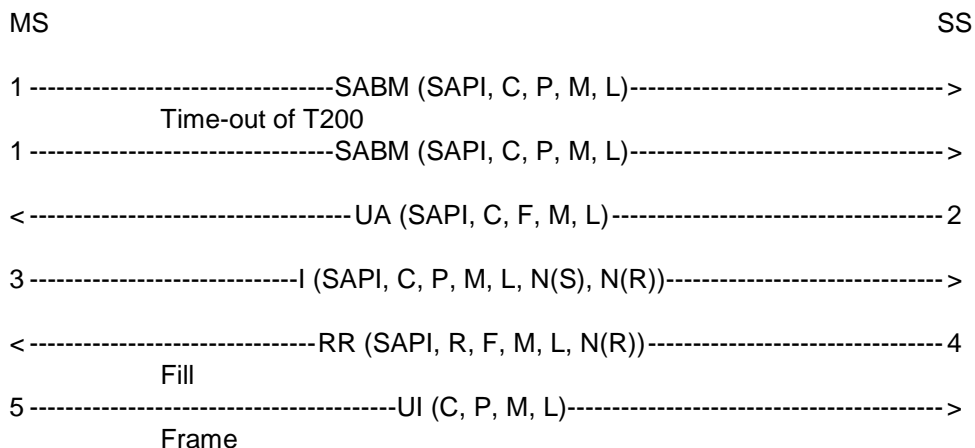

The frames from the SS will be:

2: One UA frame containing:

SAPI = 0, R = 0, F = 1, M = 0, L = 0

4: One RR frame containing:

SAPI = 0, R = 0, F = 0, M = 0, L = 0, N(R) = 1

25.2.1.2.2.3 Test requirements

The frames from the MS shall be:

1: One SABM frame (occurs twice) containing:

SAPI = 0, C = 0, P = 1, M = 0, L = 0

The second SABM frame shall follow the first SABM frame after time-out of timer T200.

3: One I frame containing:

SAPI = 0, C = 0, P = 0, M = 0, $0 \leq L \leq N201$, N(S) = 0, N(R) = 0

Information field = Assignment Complete

5: One UI frame containing:

C = 0, P = 0, M = 0, L = 0

25.2.1.2.3 Initialization denial

25.2.1.2.3.1 Test purpose

To test that the MS takes appropriate action if the data link can not be initialized if the network side indicates the Layer 3 process is busy.

25.2.1.2.3.2 Method of test

The data link is setup between the MS and the SS as in test 25.2.1.1.1.

After the MS has sent the UI frame the SS initiates the dedicated channel assignment procedure to assign a SDCCH.

The MS shall then continue the setup by sending a SABM frame.

The SS responds with a DM frame.

The SS then waits at least T200.

The MS shall not repeat the SABM frame. However the MS will attempt to re-establish the link on the previous channel.

The test is repeated, but a FACCH is assigned in place of the SDCCH.

Expected Sequence

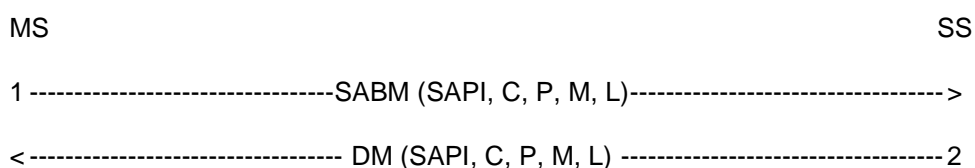

The frames from the SS will be:

2: One DM frame containing:

SAPI = 0, R = 0, F = 1, M = 0, L = 0

25.2.1.2.3.3 Test requirements

The frames from the MS shall be:

1: One SABM frame containing:

SAPI = 0, C = 0, P = 1, M = 0, L = 0

25.2.1.2.4 Total initialization failure

25.2.1.2.4.1 Test purpose

To test the MS response to the lack of the system to respond to requests to initialize the data link.

25.2.1.2.4.2 Method of test

The data link is setup between the MS and the SS as in test 25.2.1.1.1.

After the MS has sent the UI frame the SS initiates the dedicated channel assignment procedure to assign a SDCCH.

The MS shall then continue the setup by sending a SABM frame.

The SS ignores the first SABM frame from the MS.

The MS shall wait for time-out of timer T200 and then send a second SABM frame.

This is repeated until the MS has sent the SABM frame six times.

The MS shall not send the SABM any more than six times.

The test is repeated, but a FACCH is assigned in place of the SDCCH.

Expected Sequence

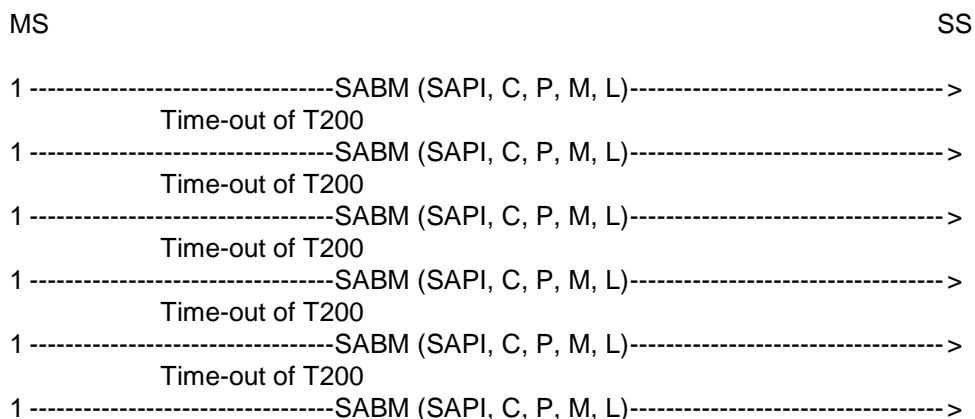

25.2.1.2.4.3 Test requirements

The frames from the MS shall be:

1: One SABM frame (occurs six times) containing:

SAPI = 0, C = 0, P = 1, M = 0, L = 0

The subsequent SABM frames shall follow the previous SABM frame after time-out of timer T200.

25.2.2 Normal information transfer

25.2.2.1 Sequence counting and I frame acknowledgements

25.2.2.1.1 Test purpose

To test the operation of Layer 2 sequence numbering. Since there are 8 sequence numbers the test cycles through 9 information frame transfers.

25.2.2.1.2 Method of test

The MS is brought into the multiple frame established state as described in test 25.2.1.1.1.

The SS sends an Identity Request message asking for IMEI to the MS.

The MS shall acknowledge this I frame with an Identity Response I frame or a RR frame.

This is repeated a further 8 times as rapidly as possible assuming a window size 1.

The MS Layer 3 response time should be less than $4 * T200$ and therefore the MS responses to at least the 5th, 6th, 7th, 8th and 9th I frames must be an I frame on the SDCCH. On the FACCH it is possible that all MS responses at Layer 2 will be RR frames.

The frames from the SS will be:

1,3,5,7,9,11,13,15,17: One I frame (occurs nine times) containing:

SAPI = 0, C = 1, P = 0, M = 0, $0 \leq L \leq N201$

$N(S) = 0, 1, 2, 3 \dots 7, 0$

$N(R) = (\text{number of I frames received in the test sequence hitherto}) \bmod 8$

information field = Identity Request (IMEI)

19, 21, and so on, until the SS has received 9 I frames from the MS: One RR frame containing:

$$\text{SAPI} = 0, \text{R} = 0, \text{F} = 0, \text{M} = 0, \text{L} = 0$$

$$\text{N(R)} = (\text{number of I frames received in the test sequence hitherto}) \bmod 8$$

25.2.2.1.3 Test requirements

There shall be an integer $k \geq 0$ such that for $i = 1, 2, \dots, k + 9$ the following conditions (a) and (b) both hold:

(a) The MS sends 9 I frames and k RR frames during the test.

(b) The frames sent by the MS in step $2*i$ are:

(b1) If the frame is an RR frame (occurs k times): one RR frame containing:

$$\text{SAPI} = 0, \text{R} = 1, \text{F} = 0, \text{M} = 0, \text{L} = 0$$

$$\text{N(R)} = ((\text{Value of N(S) in the last received I frame from the SS}) + 1) \bmod 8$$

(b2) If the frame is an I frame (occurs 9 times): one I frame containing:

$$\text{SAPI} = 0, \text{C} = 0, \text{P} = 0, \text{M} = 0, 0 \leq \text{L} \leq \text{N201}$$

$$\text{N(R)} = ((\text{Value of N(S) in the last received I frame from the SS}) + 1) \bmod 8$$

$$\text{N(S)} = (\text{number of I frame sent hitherto by the MS to SS excluding the actual I frame}) \bmod 8$$

information field = Identity Response (IMEI)

Example of expected sequence (assuming $3xT200 < L3 \text{ reaction time} < 4xT200$):

MS	SS
<-----I (SAPI, C, P, M, L, N(S), N(R))-----	1
2-----RR (SAPI, R, M, L, N(R), F)----->	
<-----I (SAPI, C, P, M, L, N(S), N(R))-----	3
4-----RR (SAPI, R, M, L, N(R), F)----->	
<-----I (SAPI, C, P, M, L, N(S), N(R))-----	5
6-----RR (SAPI, R, M, L, N(R), F)----->	
<-----I (SAPI, C, P, M, L, N(S), N(R))-----	7
8-----RR (SAPI, R, M, L, N(R), F)----->	
<-----I (SAPI, C, P, M, L, N(S), N(R))-----	9
10-----I (SAPI, C, P, M, L, N(S), N(R))----->	
<-----I (SAPI, C, P, M, L, N(S), N(R))-----	11
12-----I (SAPI, C, P, M, L, N(S), N(R))----->	
<-----I (SAPI, C, P, M, L, N(S), N(R))-----	13
14-----I (SAPI, C, P, M, L, N(S), N(R))----->	
<-----I (SAPI, C, P, M, L, N(S), N(R))-----	15
16-----I (SAPI, C, P, M, L, N(S), N(R))----->	
<-----I (SAPI, C, P, M, L, N(S), N(R))-----	17
18-----I (SAPI, C, P, M, L, N(S), N(R))----->	
<-----RR (SAPI, R, M, L, N(R), F)-----	19
20-----I (SAPI, C, P, M, L, N(S), N(R))----->	
<-----RR (SAPI, R, M, L, N(R), F)-----	21
22-----I (SAPI, C, P, M, L, N(S), N(R))----->	
<-----RR (SAPI, R, M, L, N(R), F)-----	23
24-----I (SAPI, C, P, M, L, N(S), N(R))----->	
<-----RR (SAPI, R, M, L, N(R), F)-----	25
26-----I (SAPI, C, P, M, L, N(S), N(R))----->	
<-----RR (SAPI, R, M, L, N(R), F)-----	27

The frames from the SS will be:

1, 3, 5, 7, 9, 11, 13, 15, 17: One I frame (occurs nine times) containing:

SAPI = 0, C = 1, P = 0, M = 0, $0 \leq L \leq N201$

N(S) = 0, 1, 2, 3...7, 0

N(R) = 0, 0, 0, 0, 0, 1, 2, 3, 4

information field = Identity Request (IMEI)

19, 21, 23, 25, 27: One RR frame (occurs five times) containing:

SAPI = 0, R = 0, F = 0, M = 0, L = 0

N(R) = 5, 6, 7, 0, 1

The frames from the MS shall be:

2, 4, 6, 8: One RR frame (occurs four times) containing:

SAPI = 0, R = 1, F = 0, M = 0, L = 0

N(R) = 1, 2, 3, 4

10, 12, 14, 16, 18, 20, 22, 24, 26: One I frame (occurs nine times) containing:

SAPI = 0, C = 0, P = 0, M = 0, $0 \leq L \leq N201$

N(R) = 5, 6, 7, 0, 1, 1, 1, 1, 1

N(S) = 0, 1, 2, 3, 4, 5, 6, 7, 0

information field = Identity Response (IMEI)

25.2.2.2 Receipt of an I frame in the timer recovery state

25.2.2.2.1 Test purpose

To test that the MS is able to respond to I frames whilst in the timer recovery state.

25.2.2.2.2 Method of test

The MS is brought into the multiple frame established state as described in test 25.2.1.1.1.

The SS sends an Identity Request message asking for IMEI to the MS.

The MS shall respond with a RR frame though this may be incorporated with the Identity Response I frame.

The SS does not respond to the I frame.

The MS shall wait for expiry of timer T200 and then repeat the I frame but with the P bit set to 1.

The SS then sends a valid Identity Request I frame asking for IMEI which does not acknowledge receipt of the I frame from the MS.

On the FACCH the MS may send an RR frame acknowledging the I frame.

The MS shall repeat the I frame, this frame will acknowledge receipt of the second I frame from the SS.

The SS then acknowledges receipt of the MS I frame by sending a RR frame.

The MS shall send the next I frame. The SS acknowledges this I frame.

Expected Sequence

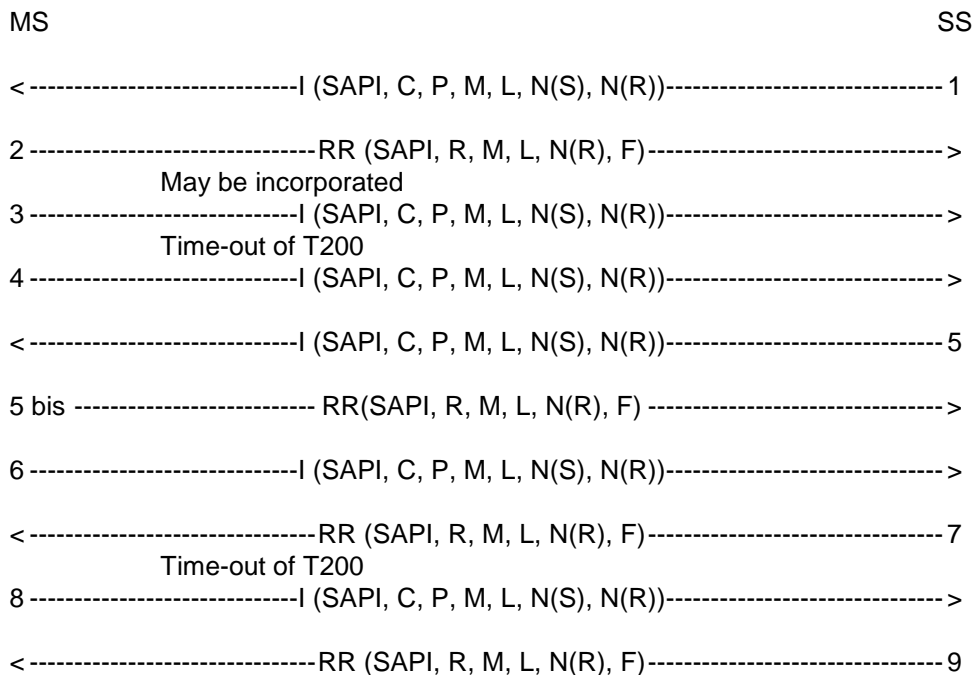

The frames from the SS will be:

1, 5: One I frame (occurs twice) containing:

SAPI = 0, C = 1, P = 0, M = 0, $0 \leq L \leq N201$, N(S) = 0, 1, N(R) = 0

information field = Identity Request

7, 9: One RR frame (occurs twice) containing:

SAPI = 0, R = 0, F = 1, 0, M = 0, L = 0, N(R) = 1, 2

25.2.2.2.3 Test requirements

The frames from the MS shall be:

2: One RR frame containing:

SAPI = 0, R = 1, F = 0, M = 0, L = 0, N(R) = 1

3, 8: One I frame (occurs twice) containing:

SAPI = 0, C = 0, P = 0, M = 0, $0 \leq L \leq N201$, N(R) = 1, 2, N(S) = 0, 1

information field = Identity Response

4, 6: One I frame (occurs twice) containing:

SAPI = 0, C = 0, P = 1, M = 0, $0 \leq L \leq N201$, N(R) = 1, 2, N(S) = 0

information field = Identity Response

5 bis: (possible only on the FACCH) One RR frame containing:

SAPI = 0, R = 1, F = 0, M = 0, L = 0, N(R) = 2

25.2.2.3 Segmentation and concatenation

25.2.2.3.1 Test purpose

To test the proper use of segmentation and concatenation, suspend and resume.

25.2.2.3.2 Method of test

If the MS supports the UnStructuredSSData operation, then the MS is made to activate an unknown supplementary service as defined in GSM 02.30 with the following sequence *NN*si#: NN is chosen to be undefined in GSM 02.30 annex 2 and is an IA5. Total length of *NN*si# shall be 20 characters.

If the MS does not support the UnStructuredSSData operation, then the MS is made to initiate a call.

The SS responds with the Immediate Assign procedure firstly allocating a SDCCH and on the second repeat of the test a TCH.

The MS is brought into the multiple frame established state by continuing as described in test 25.2.1.1.1. The layer three message element in the SABM will be CM Serv Request.

The SS sends the UA and waits for 10 s. The SS then sends an I frame with CM Serv Accept.

The MS sends either:

- a REGISTER message which is segmented between two I frames;
- or
- a SETUP message.

The SS shall acknowledge only the I frame with more bit set to 1 (if any) but it shall not acknowledge the I frame with more bit set to 0.

The SS then performs a handover (in the case of SDCCH this shall be finely synchronized) while still on the assigned channel and without acknowledging the last I frame of the MS layer 3 message, making sure to fill the handover command to more than 21 octets (for example by using the cell channel description element).

On the SDCCH the MS will go into timer recovery and resend the last I frame of the layer 3 message with the P bit set to 1 when it acknowledges the two I frames of the handover command. On the FACCH the MS may simply acknowledge both I frames.

The MS does not attempt to resend the last I frame of the REGISTER or SETUP message on the old channel but instead goes to the new channel where it performs a random access using the Handover Access message and then multiple frame establishment without contention resolution as described in test 25.2.1.2.1.

The MS shall then send an I frame with the Handover complete message. Assuming this is a finely synchronized handover.

The SS acknowledges this I frame.

The MS shall then resend the previous REGISTER or SETUP message, that is all frames which are acknowledged in the usual way.

The test has to be repeated on the FACCH.

Expected Sequence

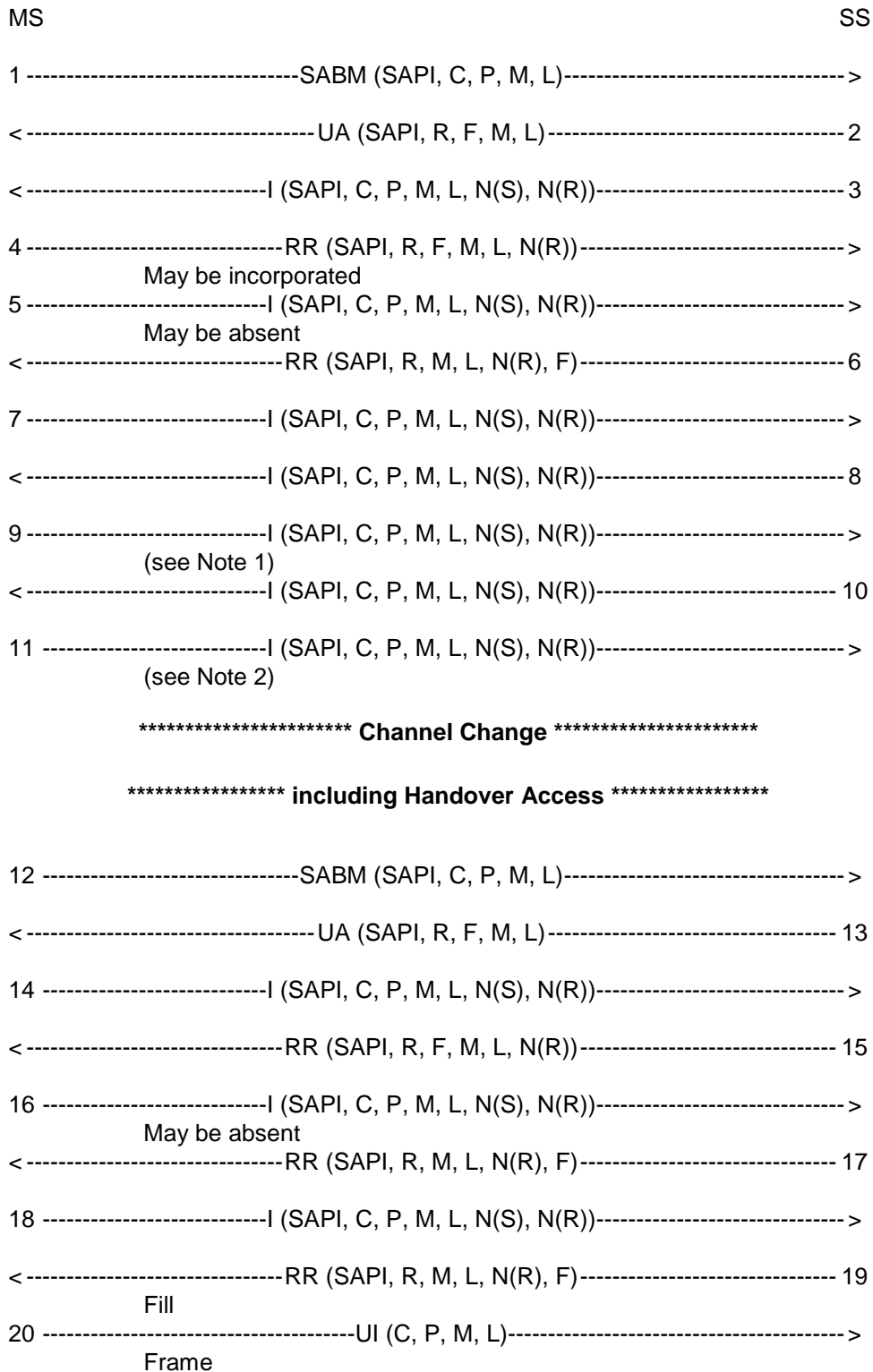

NOTE 1: The MS may send RR frames on the FACCH in addition to the I frames in 9 and 11.

NOTE 2: The I frame in 11 is optional.

The frames from the SS will be:

2: One UA frame containing:

SAPI = 0, R = 0, F = 1, M = 0, L = L of SABM

information field = information field of SABM

3: One I frame containing:

$SAPI = 0, C = 1, P = 0, M = 0, 0 < L < N201, N(S) = 0, N(R) = 0$

information field = CM Service Accept

6: One RR frame containing: (This frame is sent only if frame 5 was received)

$SAPI = 0, R = 0, F = 0, M = 0, L = 0, N(R) = 1$

8, 10: Two I frames containing:

$SAPI = 0, C = 1, P = 0, M = 1, 0, L = N201, \leq N201, N(S) = 1, 2, N(R) = 1 \text{ or } 0$

information field = Handover

13: One UA frame containing:

$SAPI = 0, R = 0, F = 1, M = 0, L = 0$

15, 17, 19: Two or three RR frames containing:

$SAPI = 0, R = 0, F = 0, M = 0, L = 0, N(R) = 1, 2 \text{ or } 1, 2, 3$

25.2.2.3.3 Test requirements

The frames from the MS shall be:

1: One SABM frame containing:

$SAPI = 0, C = 0, P = 1, M = 0, 0 \leq L \leq N201$

information field = CM Service Request

4: One RR frame containing:

$SAPI = 0, R = 1, F = 0, M = 0, L = 0, N(R) = 1$

5, 7: Two I frames containing: (The first I frame may be missing)

$SAPI = 0, C = 0, P = 0, M = 1, 0, L = N201, \leq N201, N(S) = 0, 1 \text{ or } 0, N(R) = 1$

information field = Register or Setup

9, 11: Two I frames containing:

$SAPI = 0, C = 0, P = 1, M = 0, 0 < L \leq N201, N(S) = 1 \text{ or } 0, N(R) = 2, 3$

information field = Register or Setup

NOTE: The I frame in 11 is optional.

12: One SABM frame containing:

$SAPI = 0, C = 0, P = 1, M = 0, L = 0$

14: One I frame containing:

$SAPI = 0, C = 0, P = 0, M = 0, 0 < L < N201, N(S) = 0, N(R) = 0$

information field = Handover Complete

16, 18: Two I frames containing: (The first I frame may be missing)

$SAPI = 0, C = 0, P = 0, M = 1, 0, L = N201, 0 < L \leq N201, N(S) = 1, 2 \text{ or } 1, N(R) = 0$

information field = Register or Setup

20: UI frame containing:

C = 0, P = 0, M = 0, L = 0

25.2.3 Normal layer 2 disconnection

25.2.3.1 Test purpose

To test the normal data link disconnection sequences.

25.2.3.2 Method of test

The data link is setup between the MS and the SS as in test 25.2.1.1.1.

The SS sends a Layer 2 Disconnect message to the MS.

The MS shall respond with a UA frame and return to the idle state; no more Layer 2 (I, S or U) frames, except possibly one or more "Fill" frames, shall be sent. The SS may receive "Fill" frames after the sending of the DISC frame. If this occurs this may only happen for up to T200 after the sending of the DISC frame. The checking for Layer 2 frames, and the recording of any "Fill" frames, is done for a time defined as 4 * T200.

The SS confirms that the MS has returned to the idle state by performing test 25.2.1.1.1.

Expected Sequence

MS		SS
	<----- DISC (SAPI, C, P, M, L) ----->	1
	2-----UA (SAPI, R, M, L, F)----->	

The frames from the SS will be:

1: One DISC frame containing:

SAPI = 0, C = 1, P = 1, M = 0, L = 0

25.2.3.3 Test requirements

The frames from the MS shall be:

2: One UA frame containing:

SAPI = 0, R = 1, F = 1, M = 0, L = 0

No other Layer 2 (I, S or U) frames shall occur. If "Fill" frames are sent this may only be done for up to T200 after the sending of the DISC frame.

25.2.4 Test of link failure

25.2.4.1 I frame loss (MS to SS)

25.2.4.1.1 Test purpose

To test that the MS repeats an I frame N200 times with T200 between two I frames and that the MS releases the layer 2 link after N200 repetitions of the I frame in the case when no answer to the I frame is received.

25.2.4.1.2 Method of test

The MS is brought into the multiple frame established state as described in test 25.2.1.1.1.

The SS sends an Identity Request message asking for IMEI to the MS.

The MS shall respond with a RR frame though this may be incorporated with the Identity Response I frame.

The SS does not respond to the I frame.

The MS shall wait for expiry of timer T200 and then repeat the I frame but with the P bit set to 1.

This is repeated until the MS has sent the I frame N200+1 times. The MS shall not send any layer 2 frame. This is checked for a time of 4 * T200. The MS shall return to the idle state. This is checked by performing test 25.2.1.1.1.

Expected Sequence

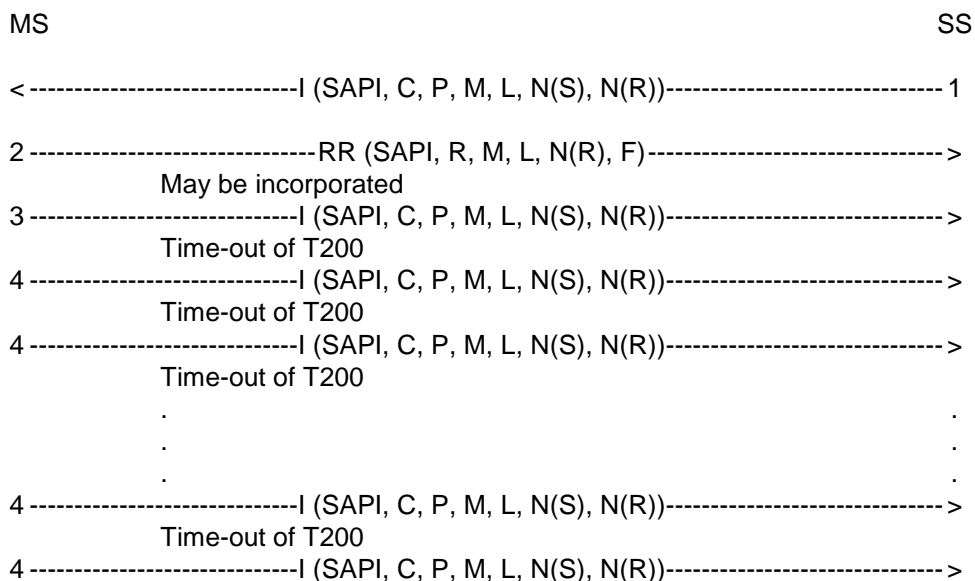

The frames from the SS will be:

1: One I frame containing:

SAPI = 0, C = 1, P = 0, M = 0, 0 <= L <= N201, N(S) = 0, N(R) = 0

information field = Identity Request

25.2.4.1.3 Test requirements

The frames from the MS shall be:

2: One RR frame containing:

SAPI = 0, R = 1, F = 0, M = 0, L = 0, N(R) = 1

3: One I frame containing:

SAPI = 0, C = 0, P = 0, M = 0, 0 <= L <= N201, N(R) = 1, N(S) = 0

information field = Identity Response

4: One I frame (occurs N200 times) containing:

SAPI = 0, C = 0, P = 1, M = 0, 0 <= L <= N201, N(R) = 1, N(S) = 0

information field = Identity Response

25.2.4.2 RR response frame loss (SS to MS)

Covered in test 25.2.2.2.

25.2.4.3 RR response frame loss (MS to SS)

25.2.4.3.1 Test purpose

To test the Layer 2 recovery mechanism in the event of RR frame loss.

25.2.4.3.2 Method of test

The MS is brought into the multiple frame established state as described in test 25.2.1.1.1.

The SS sends a I frame containing a Layer 3 message using PD=1111 (e.g. 0FH) to the MS. The L3 message is TEST INTERFACE with tested device equal to 0.

The MS shall respond with a RR frame.

The SS ignores the RR frame from the MS but after T200 from the I frame sent by the SS the SS repeats the I frame but with the P bit set to 1. This simulates loss of the RR from the MS.

The MS shall respond with either an RR or REJ frame.

NOTE: This requirement is less restrictive than GSM 04.06.

Expected Sequence

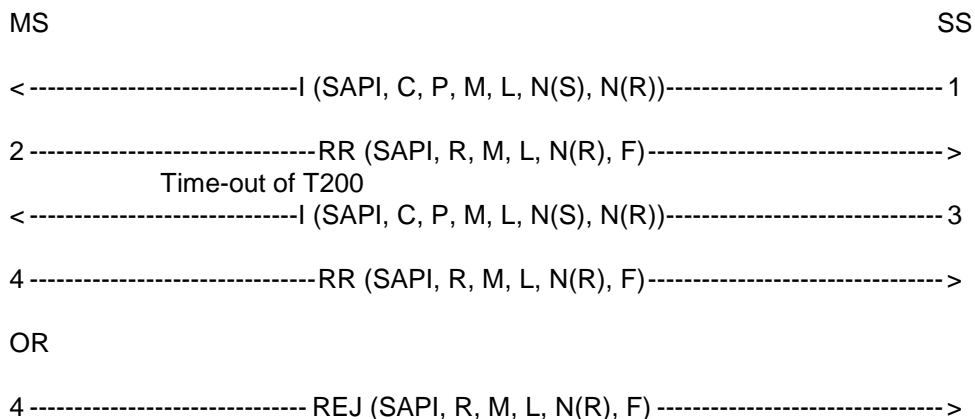

The frames from the SS will be:

1: One I frame containing:

SAPI = 0, C = 1, P = 0, M = 0, L = 3, N(S) = 0, N(R) = 0

3: One I frame containing:

SAPI = 0, C = 1, P = 1, M = 0, L = 3, N(S) = 0, N(R) = 0

25.2.4.3.3 Test requirements

The frames from the MS shall be:

2: One RR frame containing:

SAPI = 0, R = 1, F = 0, M = 0, L = 0, N(R) = 1

4: One RR frame containing:

SAPI = 0, R = 1, F = 1, M = 0, L = 0, N(R) = 1

OR

4: One REJ frame containing:

SAPI = 0, R = 1, F = 1, M = 0, L = 0, N(R) = 1

25.2.5 Test of frame transmission with incorrect C/R values

Purpose of tests

To test that the MS will react correctly upon the reception of a frame with incorrect C/R value.

Initial Conditions

Perform the establishment of the dedicated physical resource according to 25.1.5 and initialize the link as in 25.2.1.1.1. Then proceed as stated below.

25.2.5.1 I frame with C bit set to zero

25.2.5.1.1 Test purpose

To test that the MS will take no action when it receives an I frame with the C bit set to zero (R).

25.2.5.1.2 Method of test

The data link is set up between the MS and the SS as in test 25.2.1.1.1.

The SS shall send an I frame with the C bit set to zero to the MS.

The SS shall then wait for at least 4 times T200 to make sure that the MS does not respond to that I frame but that the MS keeps sending fill frames.

The SS shall after 4 times T200 send a RR command, P bit set to 1.

The MS shall respond with a RR response, F bit set to 1.

Expected Sequence

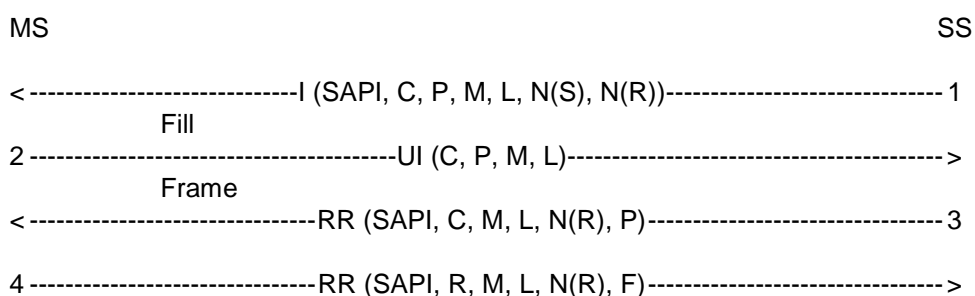

The frames from the SS will be:

1: One I frame containing:

SAPI = 0, C = 0, P = 1, M = 0, $0 \leq L \leq N201$, N(R) = 0, N(S) = 0

Information field = Identity Request

3: One RR frame containing:

SAPI = 0, C = 1, P = 1, M = 0, L = 0, N(R) = 0

25.2.5.1.3 Test requirements

The frames from the MS shall be:

2: UI frames containing:

$C = 0, P = 0, M = 0, L = 0$

4: One RR frame containing:

$SAPI = 0, R = 1, F = 1, M = 0, L = 0, N(R) = 0$

25.2.5.2 SABM frame with C bit set to zero

25.2.5.2.1 Test purpose

To test that the MS will take no action when it receives an SABM frame with the C bit set to zero (R).

25.2.5.2.2 Method of test

The MS is brought into the multiple frame established state as described in test 25.2.1.1.1.

The SS sends an I frame containing a Layer 3 message using PD=1111 (e.g. OFH) in order to raise V(R) in the MS to 1. The L3 message is TEST INTERFACE with tested device equal to 0.

The MS shall acknowledge this by the appropriate RR frame.

The SS sends SABM with the C bit set to zero.

The SS shall after 4 times T200 send a RR command, P bit set to 1.

The MS shall respond with a RR response, F bit set to 1.

The MS is returned to the idle state as described in 25.2.1.1.6.

Expected Sequence

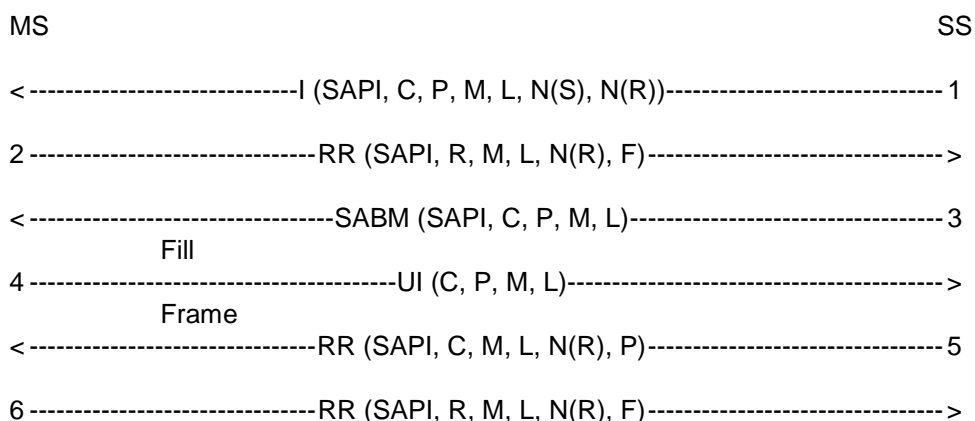

The frames from the SS will be:

1: One I frame containing:

$SAPI = 0, C = 1, P = 0, M = 0, L = 3, N(S) = 0, N(R) = 0$

3: One SABM frame containing:

$SAPI = 0, C = 0, P = 1, M = 0, L = 0$

5: One RR frame containing:

$SAPI = 0, C = 1, P = 1, M = 0, L = 0, N(R) = 0$

25.2.5.2.3 Test requirements

The frames from the MS shall be:

2: One RR frame containing:

SAPI = 0, R = 1, F = 0, M = 0, L = 0, N(R) = 1

4: One UI frame containing:

C = 0, P = 0, M = 0, L = 0

6: One RR frame containing:

SAPI = 0, R = 1, F = 1, M = 0, L = 0, N(R) = 1

25.2.6 Test of errors in the control field

Purpose of tests

To test that the MS will react in the proper way to errors in the Control Field.

25.2.6.1 N(S) sequence error

25.2.6.1.1 Test purpose

To test that the MS will ignore the contents of the I field of an out-of-sequence I frame from the SS.

25.2.6.1.2 Method of test

The MS is brought into the multiple frame established state as described in test 25.2.1.1.1.

The SS shall send a correct I frame containing Identity Request.

The MS shall acknowledge this in a RR frame or piggy back the acknowledgement onto the I frame carrying Identity Response.

The SS shall then send an I frame containing Identity Request with incorrect N(S) but correctly acknowledging the MS's I frame; P bit set to zero.

The MS shall send a REJ frame.

The SS shall, after T200, send another I frame with incorrect N(S), P bit set to 1 this time.

The MS shall respond with a REJ, F bit set to 1.

The MS shall resume the transmission of fill frames.

Expected Sequence

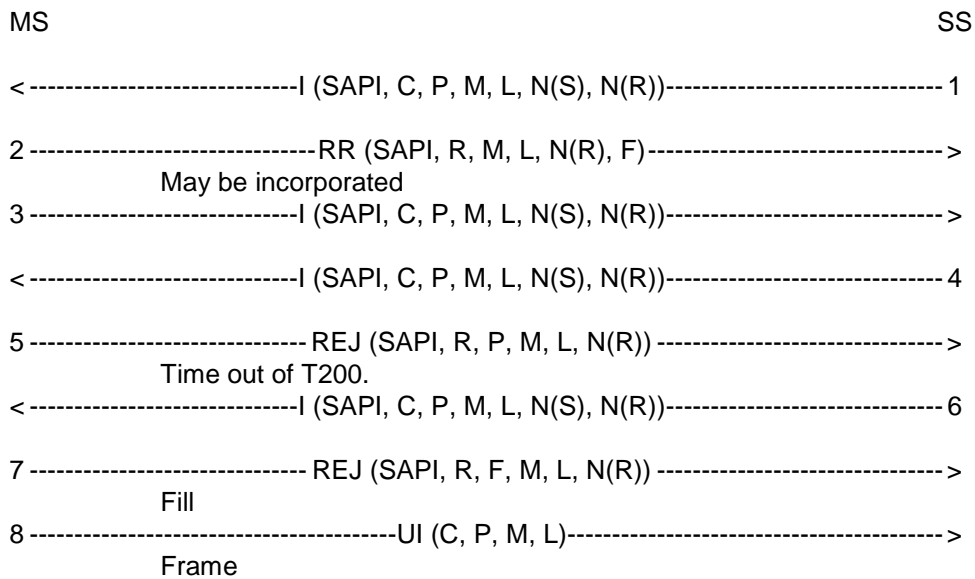

The frames from the SS will be:

1: One I frame containing:

$SAPI = 0, C = 1, P = 0, M = 0, 0 \leq L \leq N201, N(S) = 0, N(R) = 0$

information field = Identity Request

4: One I frame containing:

$SAPI = 0, C = 1, P = 0, M = 0, 0 \leq L \leq N201, N(S) = 0, N(R) = 1$

information field = Identity Request

6: One I frame containing:

$SAPI = 0, C = 1, P = 1, M = 0, 0 \leq L \leq N201, N(S) = 0, N(R) = 1$

information field = Identity Request

25.2.6.1.3 Test requirements

The frames from the MS shall be:

2: One RR frame containing:

$SAPI = 0, R = 1, F = 0, M = 0, L = 0, N(R) = 1$

3: One I frame containing:

$SAPI = 0, C = 0, P = 0, M = 0, 0 \leq L \leq N201, N(R) = 1, N(S) = 0$

information field = Identity Response

5: One REJ frame containing:

$SAPI = 0, R = 1, P = 0, M = 0, L = 0, N(R) = 1$

7: One REJ frame containing:

$SAPI = 0, R = 1, F = 1, M = 0, L = 0, N(R) = 1$

8: One UI frame containing:

C = 0, P = 0, M = 0, L = 0

25.2.6.2 N(R) sequence error

25.2.6.2.1 Test purpose

To test that the MS will detect a N(R) sequence error and react in the proper way to it.

25.2.6.2.2 Method of test

The MS is brought into the multiple frame established state as described in test 25.2.1.1.1.

The SS shall send an I frame containing an information field of length N201 and an incorrect receive sequence number.

The MS may

- a) send a DISC frame within N200*T200 or
- b) perform a "local end release".

In case a) the SS shall respond with a UA frame. In case b) it detects a lower layer failure.

NOTE: The delay N200*T200 is specified for test purpose only. It is assumed that the L3 reaction time within the MS to command a release is less than this delay, which is less than the delay before the SS would detect a L2 failure.

Expected Sequence

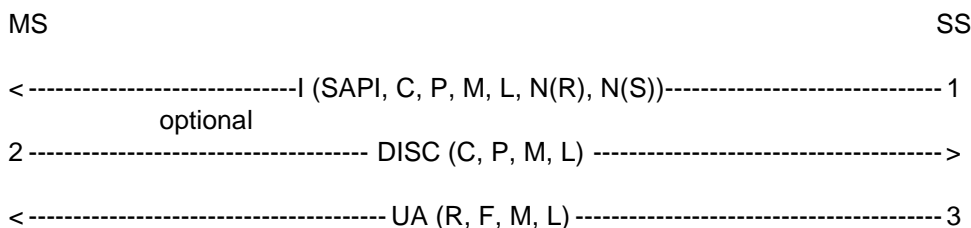

The frames from the SS are:

1: One I frame:

SAPI 0, C = 1, P = 0, M = 1, L = N201, N(R) = 1, N(S) = 0

In case a):

3: One UA frame:

SAPI = 0, R = 0, F = 1, M = 0, L = 0

25.2.6.2.3 Test requirements

The frame from the MS in case a) shall be:

2: One DISC frame:

SAPI = 0, C = 0, P = 1, M = 0, L = 0

25.2.6.3 Improper F bit

25.2.6.3.1 Test purpose

To test that the MS, being in the timer recovery state, will return to the multiple frame established state only after having received an RR response with the F bit set to 1. This test is covered in test 25.2.2.2.

25.2.7 Test on receipt of invalid frames

25.2.7.1 Test purpose

To test that the MS will ignore all invalid frames.

25.2.7.2 Method of test

The data link is set up between the MS and the SS as in test 25.2.1.1.1.

The SS shall then transmit an:

- RR frame with the Length indicator greater than zero and a faulty N(R)
- REJ frame with the EA bit set to zero and a faulty N(R)
- SABM frame with the EL bit set to zero
- DM frame with the Length indicator greater than zero
- DISC frame with the M bit set to 1
- UA frame with the EA bit set to zero
- I frame with the Length indicator greater than N201
- I frame with the M bit set to 1 and the Length indicator less than N201.
- command frames with correct Address and Length indicator field and a non-implemented control field.

After T200 the SS shall in every case transmit an RR command, P bit set to 1.

The MS shall respond with an RR response, F bit set to 1.

Expected Sequence

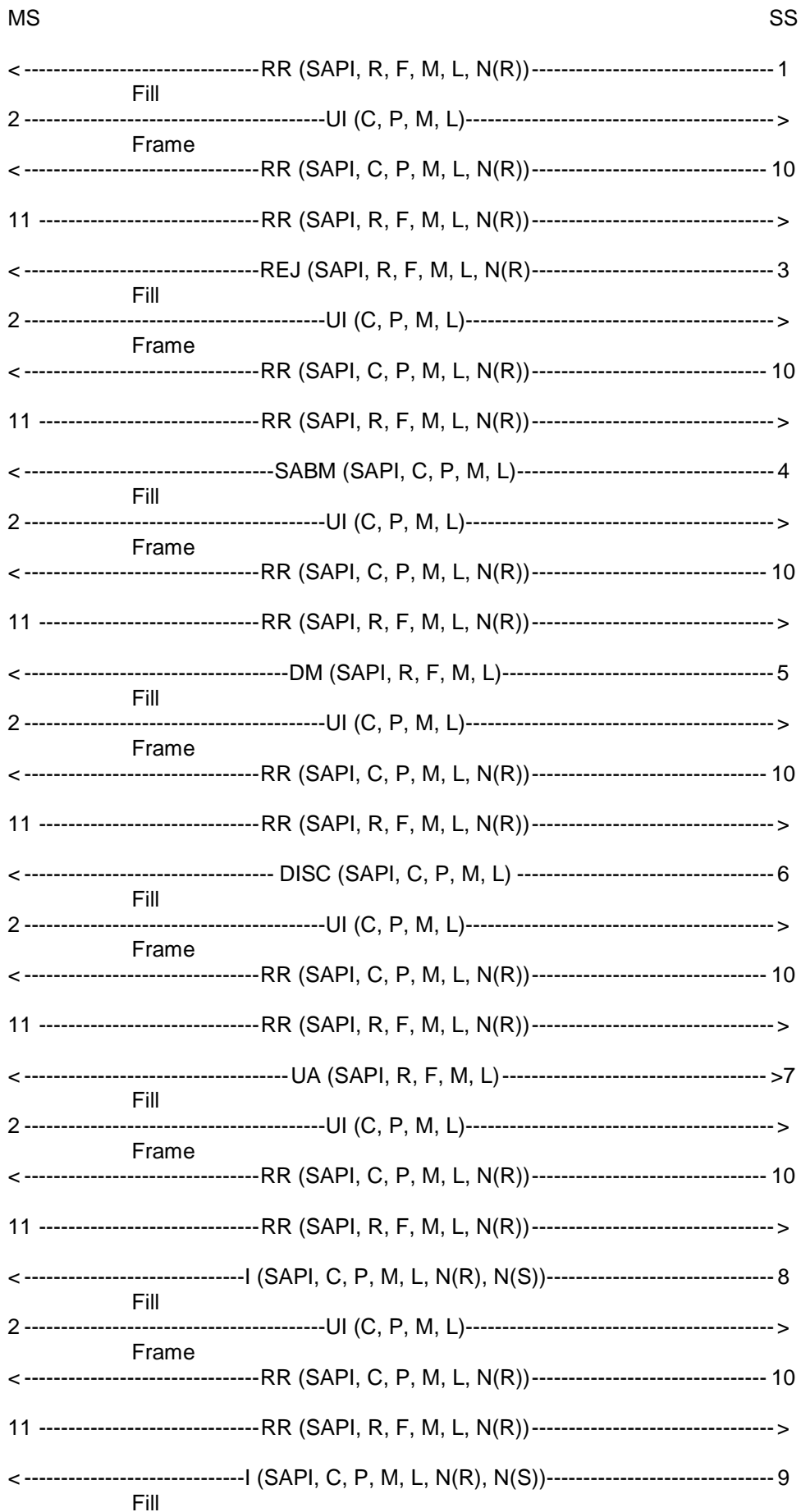

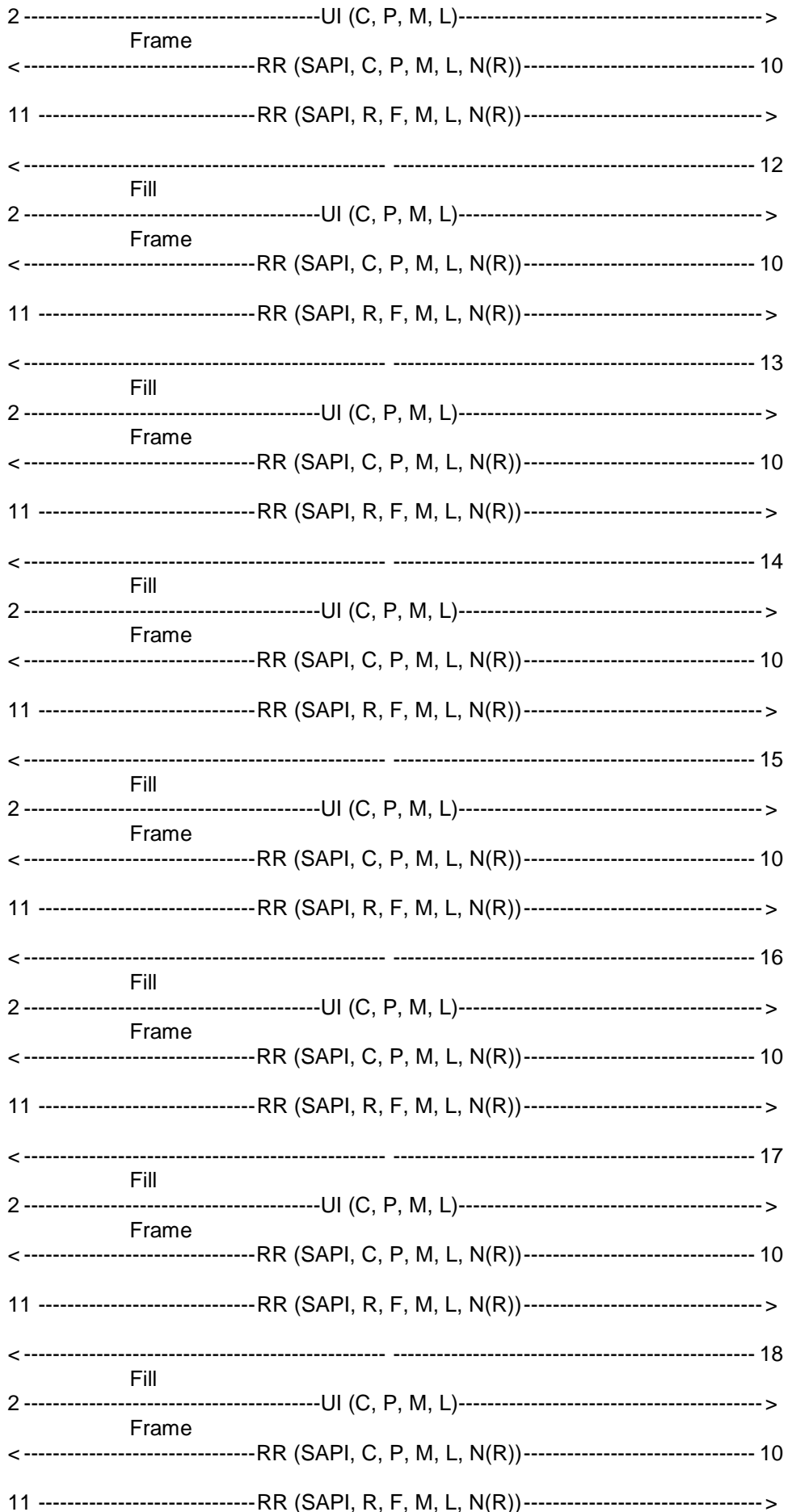

The frames from the SS are:

1: One RR frame:

$SAPI = 0, R = 0, F = 0, M = 0, L > 0, N(R) = 1$

3: One REJ frame:

$SAPI = 0, R = 0, F = 0, M = 0, L = 0, N(R) = 1, EA = 0$

4: One SABM frame:

$SAPI = 0, C = 1, P = 1, M = 0, L = 0, EL = 0$

5: One DM frame:

$SAPI = 0, R = 0, F = 1, M = 0, L > 0$

6: One DISC frame:

$SAPI = 0, C = 1, P = 1, M = 1, L = 0,$

7: One UA frame:

$SAPI = 0, R = 0, F = 0, M = 0, L = 0, EA = 0$

8: One I frame:

$SAPI = 0, C = 1, P = 0, M = 0, L > N201, N(R) = 0, N(S) = 6$

9: One I frame:

$SAPI = 0, C = 1, P = 0, M = 1, L < N201, N(R) = 0, N(S) = 7$

10: One RR frame:

$SAPI = 0, C = 1, P = 1, M = 0, L = 0, N(R) = 0$

12: One command frame with

Control Field = xxx1 1101

13: One command frame with

Control field = xxx1 1011

14: One command frame with

Control field = xxx1 0111

15: One command frame with

Control field = 01x1 1111

16: One command frame with

Control field = 1xx1 1111

17: One command frame with

Control field = 0011 0011

18: One command frame with

Control field = 1xx1 0011

NOTE: An "x" stands for an arbitrary bit value.

25.2.7.3 Test requirements

The frames from the MS shall be:

2: One UI frame (occurs fifteen times):

$$C = 0, P = 0, M = 0, L = 0$$

11: One RR frame (occurs fifteen times):

$$SAPI = 0, R = 1, F = 1, M = 0, L = 0, N(R) = 0$$

26 Testing of layer 3 functions

Ref.: GSM 04.08

NOTE: The tests on functioning of the elementary procedures in the MS are grouped as the description of those procedures in GSM 04.08. However, the test procedures are carried out in an order which is more logic for the purpose of testing.

26.1 Default conditions and structured sequence of tests

26.1.1 Default test conditions during layer 3 tests

During tests in section 26 the following default test conditions shall apply if not otherwise stated within the test description. In the table below, decimal values are normally used. Sometimes a hexadecimal value, indicated with a "H", or a binary value, indicated with a "B" is given.

	GSM 900	DCS 1 800
General signalling conditions for all carriers		
Ciphering	yes	yes
General RF-conditions for all carriers		
Frequency hopping mode	Non-hopping	Non-hopping
Propagation profile	Static	Static
Downlink Input Level	63 dB μ Vemf()	63 dB μ Vemf()
Uplink output power	Minimum according to MS power class	Minimum according to MS power class
Serving cell, BCCH/CCCH carrier		
Channel ARFCN	20	590
Alternative channels	40 or 60	690 or 830
Serving cell, Traffic channel, SDCCH		
Channel ARFCN	30	650
Alternative channels	50 or 70	750 or 850
Power Control Indicator	0	0
Neighbouring cells BCCH/CCCH carriers		
Channel ARFCN	10, 80, 90, 100, 110, 120	520, 600, 700, 780, 810, 870
Alternative channels	15, 85, 95, 105, 115, 122	530, 610, 710, 790, 820, 880
Input level	53 dB μ Vemf()	53 dB μ Vemf()
Network dependent parameters		
Cell identity	0001H	0001H
Mobile country code, MCC	001 (decimal)	001 (decimal)
Mobile network code, MNC	01 (decimal)	01 (decimal)
Location area code, LAC	0001H	0001H
Frequency List	Bit Map 0	Range 512
BCCH allocation sequence number(BA_IND)	0	0
Cell Channel Descriptor	Bit Map 0	Range 512
PLMN colour code, NCC	1	1
BS colour code, BCC	5	5
SMS Cell Broadcast	not active	not active
DTX	MS must not use	MS must not use
IMSI Attach-detach	MS shall not apply	MS shall not apply
CCCH_CONF	1 basic physical channel for CCCH combined with SDCCH	1 basic physical channel for CCCH combined with SDCCH
BS_AG_BLKS_RES	0 blocks reserved	0 blocks reserved
BS_PA_MFRMS	5 paging subgroups	5 paging subgroups

	GSM 900	DCS 1 800
CELL_BAR_ACCESS Call-reestablishment (RE) Emergency Call allowed Access Control Class (AC) (0..9, 11..15) Network dependent timers Radio_Link_Time-out T3212 Periodic updating in decihours	(not barred) (allowed) allowed allowed 8 Infinite	(not barred) (allowed) same same 8 Infinite
Access control parameters		
Max retrans Tx-integer, nr. of slots CELL_RESELECT_HYSTERESIS MS_TXPWR_MAX_CCH RXLEV_ACCESS_MIN NECI ACS (ADDITIONAL RESELECTION PARAM IND) P1 and C2 parameters POI and POWER OFFSET	1 5 12 dB minimum level minimum New establishment causes are not supported No additional cell parameters are present in SI messages 7 and 8 C2 parameters not present N/A	1 5 12 dB minimum level minimum same same same POWER OFFSET Parameter not present.

	GSM 450	GSM 480
General signalling conditions for all carriers		
Ciphering	yes	yes
General RF-conditions for all carriers		
Frequency hopping mode Propagation profile Downlink Input Level Uplink output power	Non-hopping Static 63 dB μ Vemf() Minimum according to MS power class	Non-hopping Static 63 dB μ Vemf() Minimum according to MS power class
Serving cell, BCCH/CCCH carrier		
Channel ARFCN Alternative channels	263 274 or 276	310 321 or 323
Serving cell, Traffic channel, SDCCH		
Channel ARFCN Alternative channels Power Control Indicator	267 275 or 279 0	314 322 or 326 0
Neighbouring cells BCCH/CCCH carriers		
Channel ARFCN Alternative channels Input level	260, 281, 284, 287, 290, 293 261, 280, 283, 286, 289, 292 53 dB μ Vemf()	307, 328, 331, 334, 337, 340 308, 327, 330, 333, 336, 339 53 dB μ Vemf()
Network dependent parameters		
Cell identity Mobile country code, MCC Mobile network code, MNC Location area code, LAC Frequency List BCCH allocation sequence number(BA_IND) Cell Channel Descriptor PLMN colour code, NCC BS colour code, BCC SMS Cell Broadcast DTX IMSI Attach-detach CCCH_CONF BS_AG_BLKS_RES BS_PA_MFRMS	0001H 001 (decimal) 01 (decimal) 0001H Range 128 0 Range 128 1 5 not active MS must not use MS shall not apply 1 basic physical channel for CCCH combined with SDCCH 0 blocks reserved 5 paging subgroups	0001H 001 (decimal) 01 (decimal) 0001H Range 128 0 Range 128 1 5 not active MS must not use MS shall not apply 1 basic physical channel for CCCH combined with SDCCH 0 blocks reserved 5 paging subgroups

	GSM 450	GSM 480
CELL_BAR_ACCESS Call-reestablishment (RE) Emergency Call allowed Access Control Class (AC) (0..9, 11..15) Network dependent timers Radio_Link_Time-out T3212 Periodic updating in decihours	(not barred) (allowed) allowed allowed 8 Infinite	(not barred) (allowed) same same 8 Infinite
Access control parameters		
Max retrans Tx-integer, nr. of slots CELL_RESELECT_HYSTERESIS MS_TXPWR_MAX_CCH RXLEV_ACCESS_MIN NECI ACS (ADDITIONAL RESELECTION PARAM IND) P1 and C2 parameters POI and POWER OFFSET	1 5 12 dB minimum level minimum New establishment causes are not supported No additional cell parameters are present in SI messages 7 and 8 C2 parameters not present N/A	1 5 12 dB minimum level minimum same same same POWER OFFSET Parameter not present.

These informations are provided by system information 1, 2, 3 and 4 messages.

The system information elements which are broadcast on the SACCH during the dedicated mode should be consistent with those sent on the BCCH when the MS was in idle mode prior to the channel request.

In addition, all fill paging messages sent on the paging sub-channels will have by default, their page mode set to NORMAL PAGING.

26.1.2 Structured sequence of the tests

The tests shall be performed in the order as indicated in the following table.

The validity of the tests depends upon the results of the tests performed before.

Channel request (basic test)	RR	26.2.1
Immediate assignment	RR	26.6.1
IMSI attach/detach (basic)	RR	26.2.2
Paging	RR	26.6.2
Test of the mobile station functions in idle mode	RR	26.3
Frequency redefinition	RR	26.6.6
Measurement report (incl. system info not idle)	RR	26.6.3
Authentication	MM	26.7.2
Cipher mode setting	RR	26.6.8
Identification	MM	26.7.3
Sequenced MM/CM message transfer	..	26.2.3
Channel release	RR	26.6.12
Location updating	MM	26.7.4
TMSI reallocation	MM	26.7.1
Classmark change	RR	26.6.11
Call control (verification on CC state diagram)	CC	26.8.1.1 and 26.8.1.2
Call rearrangement	CC	26.8.1.4.4
DTMF information transfer	CC	26.8.1.4.1
Handover	RR	26.6.5
Additional assignment	RR	26.6.9
Partial release	RR	26.6.10
Re-establishment	CC	26.8.2
Dedicated channel assignment (during calls)	RR	26.6.4
Transmission mode change	RR	26.6.7
Mobility management connection establishment	MM	26.7.5
Test of Layer 3 error handling		26.5
User to user signalling	CC	26.8.3
Testing of structured procedures		26.9
E-GSM or R-GSM signalling		26.10
Multiband signalling		26.11

26.1.3 General rules for message parameters

The following rules concerning message parameters apply to section 26:

- 1) Those values of parameters which are a consequence of the context of a test and which are not specific to that test need not be defined.
- 2) If the value of a parameter of an uplink message (MS to Network) is specified in a test, the implicit meaning is that it has to be checked; if the value is not specified, it is not to be checked unless stated otherwise.
- 3) An optional field or optional Information Element of a downlink message (Network to MS), the presence of which is not a consequence of a test description, shall be absent in that test.
- 4) If an optional field or Information Element is not indicated for the uplink (MS to Network) - unless specified otherwise -, it may be included or not.
- 5) The Protocol Discriminator, Transaction Identifier and Message Type of all uplink messages have to be checked.

26.1.4 General rules for layer 3 testing

Unless otherwise specified, before the SS pages the MS, the MS must be given the necessary time to be able to receive paging (see section 20). In addition and unless otherwise specified, the SS must wait at least 1s after the last time slot of the message block containing a CHANNEL RELEASE, before sending a PAGING to the mobile (see 04.13).

In the signalling tests, where the following statement is used:

‘the RF level of cell x is set sufficiently low to ensure that cell x is not suitable as defined in GSM 05.08 section 6.6.2’

this means that for the cell to be “not suitable” by virtue of its RF level, the RF level is to be lowered until C1 is below 0.

26.1.5 Format of layer 3 test descriptions

In sections 26.2, 26.5, 26.6, 26.7, 26.9, 26.10 and 26.11 a rigorous description technique is used which is defined here.

For every test, a subsection titled "method of test" and a subsection titled "expected sequence" define the exact test steps and the verifications to be performed in the test. These sections are normative and give requirements for the MS behaviour. The information of both subsections applies.

For the message contents further normative requirements for the MS behaviour are defined in the following parts which apply in the following order (starting with the highest) on basis of the general rules of 26.1.3:

- specifications in the "method of test" and "expected sequence" subsections;
- specifications in the subsection titled "specific message contents";
- specifications in the subsection "default message contents" at the end of the relevant sections 26.5, 26.6, 26.7, 26.9, 26.10 or 26.11;
- specifications of default conditions in 26.1.

The relevant section may contain the definition of abbreviations of L3 message names that are used in that section.

In many cases, a test description contains an introductory subsection explaining the background of the relevant procedures and explaining why the tests of that description are essential.

For every test, test purposes are given. In general conformance testing methodology, the correspondence between test purposes and test cases can be n to m: To one test purpose more than one test case may correspond (e.g. different test cases checking data variations); also a test case may serve more than one test purpose. In some contexts a structure of conformance test descriptions is advisable which specifies in one part (non-duplicated) test purposes with references to corresponding test suites serving the test purposes, in another part test suites realizing the test purposes; this structuring is especially useful for gaining completeness and avoiding duplications. In this specification, however, it is preferred to group descriptions by test cases. The reasons are:

- The structure is more sought to assist the test execution and evaluation than test development. It must be easy to determine why a wrong behaviour leads to a verdict.
- The structure is to be close to GSM 11.10 phase 1.

For every test purpose of a test, a conformance requirement is given.

For each conformance requirement in a test description, references to core specifications are given.

For every test, the related PICS/PIXIT statements that are necessary for performing the test are given.

For every test, initial conditions for both the System Simulator and the Mobile Station are given. Unless otherwise specified, these initial conditions apply together with the default conditions of 26.1, the initial conditions of the test prevailing over the default conditions of 26.1.

For every test, the foreseen final state of the MS after the test and the maximum duration of the test are specified. These parts are non-normative and do not contain a description of verifications to be performed. The contained information might be used for sequencing different tests and for the decision when a test is to be interrupted.

The expected sequence specifies the actions in numbered steps in a tabular form. In the column "direction", "SS -> MS" denotes a message sent from the SS to the MS, "MS -> SS" denotes a message sent from the MS to the SS, "SS" denotes an action at the SS, "MS" denotes an action at the MS (e.g. interaction with the user or higher layers). The column "message" defines the L3 messages to be sent or expected by the SS. In the "comments" column, further normative information is to be found, e.g. message parameters. In some cases, different alternative behaviours are possible in a test. Then test steps in alternative sequences are numbered as:

"A n", "A n+1", ..., "A n+k"

"B n", "B n+1", ..., "B n+l"

"C n", "C n+1", ..., "C n+m"

etc. (n,m,l,k integers > 0)

and step numbering of a re-unified sequence resumes with the lowest of n+k+1, n+l+1, n+m+1.

In some cases the test steps of a test are to be repeated. Then an execution counter is introduced for the test.

26.2 Initial tests

26.2.1 Channel request

The random access procedure is used by the MS to ask for resources to the network. If it is not performed correctly, the MS could prevent other MSs from obtaining resources, or the network could be overloaded if the MS does not respect the duration between 2 CHANNEL REQUEST messages.

26.2.1.1 Channel request / initial time

26.2.1.1.1 Conformance requirement

- 1) The MS shall start the initial access procedure at the latest 0,7 second after reception of the paging message.
- 2) The MS shall spread the initial CHANNEL REQUEST with equal probability on the correct number of time slots.

Reference(s)

GSM 04.08 sections 3.3.1.1.2 and 3.3.2.2.

26.2.1.1.2 Test purpose

- 1) To verify that the MS answers to a PAGING message by sending a CHANNEL REQUEST message within 0,7 seconds after reception of the PAGING message.
- 2) To verify that the MS does not always use the same delay between reception of paging message and sending of the CHANNEL REQUEST message. If an MS uses a fixed delay, there is a high probability that different MSs of the same product series use the same delay. There would then be a high risk of collision.

26.2.1.1.3 Method of test

Initial Conditions

System Simulator:

1 cell, Tx-Integer = 5. The CCCH is either combined or not with SDCCH. This is arbitrarily chosen.

Mobile Station:

The MS has a valid TMSI. It is "idle updated".

Related PICS/PIXIT Statement(s)

None.

Foreseen Final State of the MS

The MS has a valid TMSI. It is "idle updated".

Test Procedure

Specific test parameters:

$$K = 200.$$

The MS is paged. The SS measures and stores the number of CCCH RACH slots between the sending of the PAGING REQUEST message and the reception of the CHANNEL REQUEST from the MS, excluding the slots containing the messages themselves. The SS sends an IMMEDIATE ASSIGNMENT REJECT. The sequence is performed K times.

Maximum Duration of Test

30 min.

Between two consecutive executions (for k and k+1), the SS must wait for an amount of time which is enough to guarantee that the MS is in service (listening to its paging subchannel).

Expected Sequence

The sequence is executed for execution counter k = 1, ... , K.

Step	Direction	Message	Comments
1	SS -> MS	PAGING REQUEST TYPE 1	"Mobile Identity" IE contains the TMSI allocated to the MS.
2	SS		The SS measures the number f of CCCH RACH slots between the sending of PAGING REQUEST message and the reception of a CHANNEL REQUEST message from the MS.
3	SS		The SS stores f. f(k) shall be lower than 700/4,615+8 if the CCCH is not combined or lower than 81+8 if the CCCH is combined with SDCCH.
4	MS -> SS	CHANNEL REQUEST	"Establishment Cause" = Answer to paging.
5	SS -> MS	IMMEDIATE ASSIGNMENT REJECT	the first "request reference" corresponds to the CHANNEL REQUEST sent by the MS.

NOTE: The test limit has been computed to give a confidence of [99,74 %] that a unit which follows the requirements will pass. The number of samples (200) has been chosen to get a good compromise between the test time and the risk of passing a bad unit.

26.2.1.1.4 Test requirements

$$S(n) = \text{CARD} \{k \mid f(k) = n\}$$

The following requirements shall be met:

$$S(n) \leq 41 \text{ for all } n.$$

NOTE: $\text{CARD} \{k \mid f(k) = n\}$ is mathematical notation for the number of times that f(k) equals n.

26.2.1.2 Channel request / repetition time

26.2.1.2.1 Conformance requirement

- 1) The MS shall spread retransmissions of a CHANNEL REQUEST message, with equal probability on Tx-Integer timeslots and with the correct delay after the reception of the PAGING REQUEST.

- 2) The MS shall not retransmit another CHANNEL REQUEST message when Max-retrans is reached.

Reference(s)

GSM 04.08 section 3.3.1.1.2

26.2.1.2.2 Test purpose

- 1) To verify that the MS spreads retransmission of a CHANNEL REQUEST message with equal probability on Tx-Integer time slots and correctly applies the fixed delay when the following conditions apply:
 - the CCCH is combined or not combined with SDCCHs;
 - the maximum number of retransmissions is equal to one of the following values: 1, 2, 4, 7;
 - Tx-Integer is put to any of the allowed values among those which are greater or equal to 6.
- 2) To verify that the MS retransmits exactly Max_Retrans times a CHANNEL REQUEST message if the network never responds to the CHANNEL REQUEST message.

26.2.1.2.3 Method of test

Initial Conditions

System Simulator:

1 cell.

Tx-Integer is arbitrarily chosen in the set {6, 7, 8, 9, 10, 11, 12, 14, 16, 20, 25, 32, 50}.

Max_Retrans is arbitrarily chosen in the set {1,2,4,7}.

Mobile Station:

The MS has a valid TMSI. It is "idle updated".

Related PICS/PIXIT Statement(s)

None.

Foreseen Final State of the MS

The MS has a valid TMSI. It is "idle updated".

Test Procedure

Specific test parameters

K equals the upper rounded value of $230/\text{Max_Retrans}$.

m equals the upper rounded value of $0,5*\text{Tx-Integer}$.

Counter M = 0.

Parameter S: according to table 3.1/GSM 04.08 (this parameter depend on the value chosen for Tx-Integer).

$N0 = \max(8, \text{Tx-Integer})$

The MS is paged. The MS sends a CHANNEL REQUEST message. The MS retransmits CHANNEL REQUEST messages Max_Retrans times. The SS measures the number of CCCH RACH slots $f(i,k)$ between the moment where a CHANNEL REQUEST message has been received, and the reception of the following CHANNEL REQUEST message, excluding the slots containing the messages themselves. The SS updates the counter M. The SS does not

answer to the CHANNEL REQUEST messages Max_Retrans times. After the last CHANNEL REQUEST message in every sequence where k is lower than K, the SS sends an IMMEDIATE ASSIGNMENT REJECT . In the last sequence (k = K), the SS does not respond to the MS. The MS shall not send any other CHANNEL REQUEST message.

Maximum Duration of Test

The execution of one sequence (for one value k): 10s.

Between two consecutive executions (for k and k+1), the SS must wait for 35 seconds, which is enough to guarantee that the MS is in service (listening to its paging subchannel).

Expected Sequence

The sequence is executed for execution counter k = 1, ... , K for each of the 2 test cases.

Step	Direction	Message	Comments
1	SS -> MS	PAGING REQUEST TYPE 1	"Mobile Identity" = TMSI of the MS.
2	MS -> SS	CHANNEL REQUEST	"Establishment Cause" = Answer to paging.
3 4	MS -> SS SS	CHANNEL REQUEST	Steps 3, 4, 5 are executed for execution counter i = 1,...,Max_Retrans. "Establishment Cause" = Answer to paging. The SS measures the number f(i,k) of CCCH RACH slots between: - the moment where the last CHANNEL REQUEST message has been received, and - the reception of the new CHANNEL REQUEST message from the MS, excluding the slots containing the messages themselves. f(i,k) shall be in the set {S,S+1,...,S+T-1}
5	SS		If f(i,k)-S >= m, M = M+1
A6 B6	SS -> MS SS	IMMEDIATE ASSIGNMENT REJECT	Depending on the value of k, step A6 or B6 is performed: k < K The third "Request Reference" IE corresponds to the last CHANNEL REQUEST message received. The third "Wait Indication" IE specifies 0 second. Other fields do not address the MS under test. k = K The SS checks that the MS sends no more CHANNEL REQUEST messages. This is verified during 3 seconds.
7	SS		M / (K * Max_Retrans) shall be inside the following interval: [0,8 - m/Tx-Integer ; 1,2 - m/Tx-Integer]

NOTE: The confidence interval in step 7, and the number of samples are chosen in such a way that the possibility of not accepting a correct MS is less than [0,26 %].

26.2.1.3 Channel request / random reference

26.2.1.3.1 Conformance requirement

A CHANNEL REQUEST message sent by the MS shall include a random reference randomly drawn from a uniform probability distribution for every new transmission.

Reference(s)

GSM 04.08 section 3.3.1.1.23.3.1.2.

26.2.1.3.2 Test purpose

To verify that an MS produces different random references for a CHANNEL REQUEST. If a MS always produces the same random reference, it makes possible that different MSs of the same product series produce the same random reference.

26.2.1.3.3 Method of test

Initial Conditions

System Simulator:

1 cell, CCCH not combined with SDCCH.

Mobile Station:

The MS has a valid TMSI. It is "idle updated".

Related PICS/PIXIT Statement(s)

None.

Foreseen Final State of the MS

The MS has a valid TMSI. It is in the MM-state "idle, updated" and in the RR idle-mode.

Test Procedure

Specific test parameters:

K = 7.

D = 4.

The SS sends a PAGING REQUEST message. The SS stores the "Random Reference" r(k) contained as a parameter in the CHANNEL REQUEST message sent by the MS. This sequence is performed K times, and it is verified that the MS produces different values r(k).

Maximum Duration of Test

6 min

Between two consecutive executions (for k and k+1), the SS must wait for an amount of time which is enough to guarantee that the MS is in service (listening to its paging subchannel).

Expected Sequence

The sequence is executed for execution counter k = 1, ..., K.

Step	Direction	Message	Comments
1	SS -> MS	PAGING REQUEST TYPE 1	"Establishment Cause" = Answer to paging. The SS stores the "Random Reference" contained in the CHANNEL REQUEST message.
2	MS -> SS	CHANNEL REQUEST	
3	SS		

26.2.1.3.4 Test requirements

At least D values of r(1),...,r(k) shall be different.

NOTE: D has been computed such that the probability of refusing a correct MS is less than [0,027 %].

26.2.2 IMSI detach and IMSI attach

The IMSI detach/attach procedures are used to indicate to the network that the MS is deactivated/activated. These procedures are allowed or not by the network (ATT flag set to "MSs in the cell shall apply IMSI attach and detach procedure" or "MSs in the cell are not allowed to apply IMSI attach and detach procedure").

If the IMSI attach procedure does not work correctly then the network would in certain situations not try to establish Mobile Terminating call even if the MS is "idle updated".

If an MS performs an unwanted IMSI detach procedure or does not perform IMSI detach when required, network resources are wasted.

26.2.2.1 Conformance requirement

- 1) When the Attach-detach flag in the Control Channel Description of the System Information Type 3 indicates "MSs in the cell are not allowed to apply IMSI attach and detach procedure", the MS shall not perform the IMSI detach procedure upon deactivation.
- 2) When the Attach-detach flag in the Control Channel Description of the System Information Type 3 indicates "MSs in the cell are not allowed to apply IMSI attach and detach procedure", the MS shall not perform the IMSI attach procedure upon activation.
- 3) The MS shall not perform the IMSI detach procedure if the Subscriber Identity Module is removed when the Attach-detach flag in the Control Channel Description of the System Information Type 3 indicates "MSs in the cell are not allowed to apply IMSI attach and detach procedure".
- 4) The MS shall not perform the IMSI attach procedure if the Subscriber Identity Module is inserted, when the Attach-detach flag in the Control Channel Description of the System Information Type 3 indicates "MSs in the cell are not allowed to apply IMSI attach and detach procedure".
- 5) The MS shall correctly perform the IMSI detach procedure, upon switch off, when it is required by the network to do so.
- 6) The MS shall correctly perform the IMSI attach procedure upon switch on when the IMSI attach procedure is required by the network. The MS shall correctly acknowledge the implicit TMSI reallocation procedure, which is part of this IMSI attach procedure, this means that the MS shall send a TMSI REALLOCATION COMPLETE message.
- 7) The MS shall correctly perform the IMSI detach procedure upon SIM removal when it is required by the network to do so.
- 8) The MS shall correctly perform the IMSI attach procedure, following SIM insertion and switch on when the IMSI attach procedure is required by the network. The MS shall correctly acknowledge the implicit TMSI reallocation procedure which is part of this IMSI attach procedure. This means that the MS shall send a TMSI REALLOCATION COMPLETE message.

Reference(s):

GSM 02.07, normative annex B, section B1.17.

GSM 04.08 sections 4.4.3 and 4.4.4.

26.2.2.2 Test purpose

- 1) To verify that the MS correctly performs IMSI detach/attach procedures when it is required by the network and upon deactivation/activation or SIM removal/insertion and does not perform these procedures when not required.
- 2) To verify that the mobile station acknowledges a re-allocated TMSI during IMSI attach.

26.2.2.3 Method of test

Initial Conditions

System Simulator:

1 cell, default parameters.

For procedures 1 and 2 ATT flag is set to "MSs in the cell are not allowed to apply IMSI attach and detach procedure".

For procedures 3 and 4 ATT flag is set to "MSs in the cell should apply IMSI attach and detach procedure".

Mobile Station:

The MS has a valid TMSI. It is "idle updated".

Related PICS/PIXIT Statement(s)

a:	SIM removal possible without removing power source	Yes / No.
b:	On/off switch	Yes / No.
c:	IMSI detach after SIM removal	Yes / No.
d:	IMSI detach after removing power source	Yes / No.

Foreseen Final State of the MS

The MS has a valid TMSI which may be different from the initial one. It is "idle updated".

Test Procedure

The SS indicates that IMSI detach/attach is not allowed. If possible the MS is switched off, then switched on, otherwise it has its power source removed and then restored (see b in PICS). The SS checks that the MS does not perform IMSI detach/attach procedures. If possible (if a = Yes, see PICS), the SIM is removed, then the SIM is inserted. The SS checks that the MS does not perform IMSI detach/attach procedures.

The SS indicates that IMSI detach/attach is allowed. After a delay of 35s the MS should have detected The SS indicates now, that IMSI detach/attach is allowed. If possible (if b = Yes, see PICS) the MS is switched off, otherwise it has its power source removed (if d = Yes, see PICS). The MS initiates an IMSI detach procedure. Then depending on what has been performed before, the MS is switched on or has its power source restored. It initiates an IMSI attach procedure. The location updating procedure contains an implicit TMSI reallocation. The SIM is removed. If (a = yes and c = yes) or (a = no and d = yes) the MS initiates an IMSI detach procedure. Then the SIM is inserted, it initiates an IMSI attach procedure, the location updating procedure contains an implicit TMSI reallocation.

Maximum Duration of Test

4 min

Expected Sequence

Procedure 1

Step	Direction	Message	Comments
1	MS		If possible the MS is switched off (see b in PICS), otherwise the MS has its power source removed. The MS shall not initiate the IMSI detach procedure. This is checked by the SS during 5 seconds. Depending on what has been performed in step 1, the MS is brought back to operation. The MS shall not initiate an IMSI attach procedure. This is checked by the SS during 30 seconds.
2	MS		
3	MS		
4	MS		

Procedure 2

1	MS		If possible (a = Yes, see PICS), the SIM is removed from the MS. The MS shall not initiate the IMSI detach procedure. This is checked by the SS during 5 seconds. The SIM is inserted in the MS. The MS shall not initiate an IMSI attach procedure. This is checked by the SS during 30 seconds.
2	MS		
3	MS		
4	MS		

Procedure 3

1	MS		The MS is switched off, or has its power source removed , depending on value b in the PICS file. If b = Yes or d = Yes the MS initiates an IMSI detach procedure (steps A2, A3, A4, A5), otherwise the SS goes straight to step 6.
A2 A3 A4 A5	MS -> SS SS -> MS MS -> SS SS -> MS	CHANNEL REQUEST IMMEDIATE ASSIGNMENT IMSI DETACH INDICATION CHANNEL RELEASE	After the sending of this message, the SS waits the disconnection of the main signalling link.
6	MS		Depending on what has been performed in step 1, the MS is brought back to operation.
7	MS -> SS	CHANNEL REQUEST	The MS initiates an IMSI attach procedure.
8	SS -> MS	IMMEDIATE ASSIGNMENT	
9	MS -> SS	LOCATION UPDATING REQUEST	"Location Updating Type" = IMSI attach.
10	SS -> MS	LOCATION UPDATING ACCEPT	The SS allocates a new TMSI
11	MS -> SS	TMSI REALLOCATION COMPLETE	
12	SS -> MS	CHANNEL RELEASE	After the sending of this message, the SS waits the disconnection of the main signalling link.

Specific message contents:

SYSTEM INFORMATION TYPE 3 message:

Information Element	value/remark
Control Channel Description - Attach/Detach allowed	MS shall apply IMSI attach and detach procedures.

Procedure 4

1	MS		The SIM is removed from the MS. If (a = Yes and c= Yes) or (a = no and d = yes) in PICS, the MS initiates an IMSI detach procedure (steps A2, A3, A4, A5), otherwise the SS goes straight to step 6.
A2 A3 A4 A5	MS -> SS SS -> MS MS -> SS SS -> MS	CHANNEL REQUEST IMMEDIATE ASSIGNMENT IMSI DETACH INDICATION CHANNEL RELEASE	After the sending of this message, the SS waits the disconnection of the main signalling link.
6	MS		The SIM is inserted in the MS.
7	MS -> SS	CHANNEL REQUEST	The MS initiates a IMSI attach procedure.
8	SS -> MS	IMMEDIATE ASSIGNMENT	
9	MS -> SS	LOCATION UPDATING REQUEST	"Location Updating Type" = IMSI attach.
10	SS -> MS	LOCATION UPDATING ACCEPT	The SS allocates a new TMSI
11	MS -> SS	TMSI REALLOCATION COMPLETE	
12	SS -> MS	CHANNEL RELEASE	After the sending of this message, the SS waits the disconnection of the main signalling link.

Specific message contents:

SYSTEM INFORMATION TYPE 3 message:

Information Element	value/remark
Control Channel Description - Attach/Detach allowed	MS shall apply IMSI attach and detach procedures.

26.2.3 Sequenced MM / CM message transfer

The RR sublayer of the MS shall have an associated send state variable V(SD) for sending MM and CM messages. This send state variable has been introduced to avoid the duplication of MM and CM messages. It is useful for the network after a handover or a change of channel to identify duplicated messages.

If the MS started V(SD) with 1 instead of 0 the network would incorrectly diagnose loss of message.

If the MS later on does not handle correctly incrementation of V(SD) the network would not be able to continue the dialogue.

26.2.3.1 Conformance requirement

The MS shall implement correctly the "send state variable V(SD)" ("Send duplicated"), included in transmitted MM and CM messages.

Reference(s)

GSM 04.08 section 3.1.4.3.

26.2.3.2 Test purpose

To verify that V(SD) is correctly set to 0 at the beginning of the establishment of the first RR connection and to verify that the MS handles correctly this variable in the special case of IDENTITY REQUEST messages, which are MM messages.

26.2.3.3 Method of test

Initial Conditions

System Simulator:

1 cell, default parameters.

Mobile Station:

The MS has a valid TMSI. It is "idle updated".

Related PICS/PIXIT Statement(s)

None.

Foreseen Final State of the MS

The MS has a valid TMSI. It is "idle updated".

Test Procedure

The MS is paged. After reception of the PAGING RESPONSE message from the MS, the SS sends an IDENTITY REQUEST message. The MS sends an IDENTITY RESPONSE message where N(SD) = 0. The SS repeats its IDENTITY REQUEST message 10 times. The MS transmits IDENTITY RESPONSE message with the value 1 and 0 in the N(SD) field alternately.

Maximum Duration of Test

1 min

Expected Sequence

Step	Direction	Message	Comments
1	SS -> MS	PAGING REQUEST TYPE 1	
2	MS -> SS	CHANNEL REQUEST	
3	SS -> MS	IMMEDIATE ASSIGNMENT	
4	MS -> SS	PAGING RESPONSE	
5	SS -> MS	IDENTITY REQUEST	
6	MS -> SS	IDENTITY RESPONSE	N(SD) = 0
7	SS -> MS	IDENTITY REQUEST	Steps 7, 8, 9 and 10 are repeated 5 times.
8	MS -> SS	IDENTITY RESPONSE	N(SD) = 1.
9	SS -> MS	IDENTITY REQUEST	
10	MS -> SS	IDENTITY RESPONSE	N(SD) = 0.
11	SS -> MS	CHANNEL RELEASE	After the sending of this message, the SS waits the disconnection of the main signalling link.

26.2.4 Establishment cause

The establishment cause set by the MS in the CHANNEL REQUEST message shall be consistent with the requested service or function, with the capabilities of the MS and with the indications given by the network.

If the MS uses a wrong establishment cause, the network might assign an inappropriate or incompatible resource.

In the case of Emergency call a wrong priority might be used.

If a reserved value is used, the network may discard the channel request.

26.2.4.1 Conformance requirements

In the CHANNEL REQUEST message, the MS shall include an establishment cause which correspond to the establishment cause given by the MM sublayer and the broadcasted NECI value, or which correspond to one of the establishment causes "answer to paging" given by the RR entity in response to a PAGING REQUEST message including the Channel Needed information.

Reference(s)

GSM 04.08 section 3.3.1.1.2

26.2.4.2 Test purpose

To verify that the establishment cause sent by the MS in the Max-Retrans+1 CHANNEL REQUEST messages is consistent with the requested service, with the capabilities of the MS and with the indications of the network in the following cases:

- 1) If the MS supports a service on a traffic channel:
 - when the NECI bit is set to 0 and call re-establishment is attempted and the call was established on TCH/H if the MS supports a service on half rate channel or on TCH/F otherwise.
- 2) If the MS supports a service on half rate channel:
 - when the NECI bit is set to 1 and call re-establishment is attempted and the call was established on TCH/H.
- 3) If the MS supports speech:
 - 3.1 when the NECI bit is set to 0 and a speech call is attempted.
 - 3.2 when the NECI bit is set to 1 and a speech call is attempted.

- 4) If the MS supports a data service:
- 4.1 when the NECI bit is set to 0 and a data call is attempted.
 - 4.2 when the NECI bit is set to 1 and a data call is attempted for a service supported on half rate channel (if the MS does not support any data call on half rate channel any data service is used).
- 5)
- 5.1 when the NECI bit is set to 0 and the MS is paged with the paging indication set to "any channel".
 - 5.2 when the NECI bit is set to 0 and the MS is paged with the paging indication set to "SDCCH".
 - 5.3 when the NECI bit is set to 0 and the MS is paged with the paging indication set to "TCH/F".
 - 5.4 when the NECI bit is set to 0 and the MS is paged with the paging indication set to "TCH/H or TCH/F".
- 6)
- 6.1 when the NECI bit is set to 0 and IMSI attach is attempted.
 - 6.2 when the NECI bit is set to 0 and normal location updating is attempted.
 - 6.3 when the NECI bit is set to 0 and periodic location updating is attempted.
 - 6.4 when the NECI bit is set to 0 and IMSI detach is attempted.
 - 6.5 when the NECI bit is set to 1 and IMSI attach is attempted.
 - 6.6 when the NECI bit is set to 1 and normal location updating is attempted.
 - 6.7 when the NECI bit is set to 1 and periodic location updating is attempted.
 - 6.8 when the NECI bit is set to 1 and IMSI detach is attempted.
- 7) If the MS supports a non call related supplementary service operation:
- when the NECI bit is set to 0 and a supplementary service operation is attempted at the MS.
 - when the NECI bit is set to 1 and a supplementary service operation is attempted at the MS.
- 8) If the MS supports SMS/PP MO:
- when the NECI bit is set to 0 and a mobile originated short message service transaction is attempted.
 - when the NECI bit is set to 1 and a mobile originated short message service transaction is attempted.

NOTE: To verify that when the MS supports speech and an emergency call is attempted and the NECI bit is set to 0, then the MS sends a CHANNEL REQUEST message with an establishment cause consistent with the requested service, with the capabilities of the MS and with the indications of the network is done in test 26.9.6.1.1 test purpose 1.

26.2.4.3 Method of test

Initial Conditions

System Simulator:

for all procedures: 1 cell, Max-Retrans = 7 slots. The NECI bit is set to 0.

Mobile Station:

The MS has a valid TMSI. It is "idle updated".

Related PICS/PIXIT Statement(s)

a: MS supports speech on TCH/F Yes / No

- b: MS supports speech on TCH/H Yes / No
- c: MS supports data on TCH/F Yes / No
- d: MS supports data on TCH/H Yes / No
- e: MS only supports SDCCH Yes / No
- f: MS supports a supplementary service operation Yes / No
- g: MS supports SMS/PP MO Yes / No
- h: On/Off switch Yes / No

NOTE: In the above PICS, data and speech refer to the Radio Resource Channel Mode.

Foreseen Final State of the MS

The MS has a valid TMSI. It is "idle updated".

Test Procedures

NOTE: If the procedures are chained, the SS shall ensure that at the beginning of each procedure, the initial conditions are reached and that the MS had enough time to decode the broadcasted parameters.

Procedure 1

If the MS supports a service on a traffic channel:

A call is established on TCH/H if the MS supports a service on half rate channel or on TCH/F otherwise. The SS stops transmission on the SACCH. The MS attempts call reestablishment. The SS does not answer to Max-Retrans CHANNEL REQUEST messages and answers to the next CHANNEL REQUEST with an IMMEDIATE ASSIGNMENT REJECT message. The SS checks that all CHANNEL REQUEST messages contain an establishment cause with the value "110".

Procedure 2

If the MS supports a service on half rate channel:

The NECI bit is set to 1. A call is established on TCH/H. The SS stops transmission on the SACCH. The MS attempts call reestablishment. The SS does not answer to Max-Retrans CHANNEL REQUEST messages and answers to the next CHANNEL REQUEST with an IMMEDIATE ASSIGNMENT REJECT message. The SS checks that all CHANNEL REQUEST messages contain an establishment cause with the value "011010".

Procedure 3

If the MS supports speech:

A speech call is attempted. The SS does not answer to Max-Retrans CHANNEL REQUEST messages and answers to the next CHANNEL REQUEST with an IMMEDIATE ASSIGNMENT REJECT message. The SS checks that all CHANNEL REQUEST messages contain an establishment cause with the value "111". The NECI bit is set to 1. A speech call is attempted. The SS does not answer to Max-Retrans CHANNEL REQUEST messages and answers to the next CHANNEL REQUEST with an IMMEDIATE ASSIGNMENT REJECT message. The SS checks that all CHANNEL REQUEST messages contain an establishment cause with the value "111" if the MS does not support speech on half rate channel or "0100" if the MS supports speech on half rate channel.

Procedure 4

If the MS supports a data service:

A data call is attempted. The SS does not answer to Max-Retrans CHANNEL REQUEST messages and answers to the next CHANNEL REQUEST with an IMMEDIATE ASSIGNMENT REJECT message. The SS checks

that all CHANNEL REQUEST messages contain an establishment cause with the value "111". The NECI bit is set to 1. A data call is attempted for a service supported on half rate channel (if the MS does not support any data call on half rate channel any data service is used). The SS does not answer to Max-Retrans CHANNEL REQUEST messages and answers to the next CHANNEL REQUEST with an IMMEDIATE ASSIGNMENT REJECT message. The SS checks that all CHANNEL REQUEST messages contain an establishment cause with the value "111" if the MS does not support a data service on half rate channel or "0101" if the MS supports a data service on half rate channel.

Procedure 5

The MS is paged with the paging indication set to "any channel". The SS does not answer to Max-Retrans CHANNEL REQUEST messages and answers to the next CHANNEL REQUEST with an IMMEDIATE ASSIGNMENT REJECT message. The SS checks that all CHANNEL REQUEST messages contain an establishment cause with the value "100". The SS waits for a time sufficient for the MS to be "idle updated". The MS is paged with the paging indication set to "SDCCH". The SS does not answer to Max-Retrans CHANNEL REQUEST messages and answers to the next CHANNEL REQUEST with an IMMEDIATE ASSIGNMENT REJECT message. The SS checks that all CHANNEL REQUEST messages contain an establishment cause with the value "0001". The SS waits for a time sufficient for the MS to be "idle updated". The MS is paged with the paging indication set to "TCH/F". The SS does not answer to Max-Retrans CHANNEL REQUEST messages and answers to the next CHANNEL REQUEST with an IMMEDIATE ASSIGNMENT REJECT message. The SS checks that all CHANNEL REQUEST messages contain an establishment cause with the value "100" if the MS capability is full rate only, "0010" if the MS capability is dual rate and "0001" if the MS capability is SDCCH only. The SS waits for a time sufficient for the MS to be "idle updated". The MS is paged with the paging indication set to "TCH/H or TCH/F". The SS does not answer to Max-Retrans CHANNEL REQUEST messages and answers to the next CHANNEL REQUEST with an IMMEDIATE ASSIGNMENT REJECT message. The SS checks that all CHANNEL REQUEST messages contain an establishment cause with the value "100" if the MS capability is full rate only, "0011" if the MS capability is dual rate and "0001" if the MS capability is SDCCH only.

Procedure 6

This procedure is performed twice. Once for NECI = 0 and once for NECI = 1.

The MS is switched off or powered off. Then system information messages are altered so that IMSI attach/detach is allowed in the cell. The MS is switched on or powered on. The MS performs IMSI attach. The SS does not answer to Max-Retrans CHANNEL REQUEST messages and answers to the next CHANNEL REQUEST with an IMMEDIATE ASSIGNMENT message. The SS checks that all CHANNEL REQUEST messages contain an establishment cause with the values "0000" when NECI = 1, or "000" when NECI = 0. The IMSI attach procedure is followed. The location area code of the cell is changed, T3212 is set to 1 deci-hour. The MS performs a location updating. The SS does not answer to Max-Retrans CHANNEL REQUEST messages and answers to the next CHANNEL REQUEST with an IMMEDIATE ASSIGNMENT message. The SS checks that all CHANNEL REQUEST messages contain an establishment cause with the values "0000" when NECI = 1, or "000" when NECI = 0. The location updating procedure is followed. The SS waits for at least 7 minutes. The MS performs a periodic updating. The SS does not answer to Max-Retrans CHANNEL REQUEST messages and answers to the next CHANNEL REQUEST with an IMMEDIATE ASSIGNMENT message. The SS checks that all CHANNEL REQUEST messages contain an establishment cause with the values "0000". The location updating procedure is followed. The MS is switched off or powered off. If the MS has an On/off switch (see PICS), it attempts IMSI detach. The SS does not answer to Max-Retrans CHANNEL REQUEST messages and answers to the next CHANNEL REQUEST with an IMMEDIATE ASSIGNMENT REJECT message. The SS checks that all CHANNEL REQUEST messages contain an establishment cause with the value "0001" when NECI = 1, or "111" when NECI = 0.

Procedure 7

This procedure is performed twice. Once for NECI = 0 and once for NECI = 1.

If the MS supports a non call related supplementary service operation:

A supplementary service operation is attempted at the MS. The SS does not answer to Max-Retrans CHANNEL REQUEST messages and answers to the next CHANNEL REQUEST with an IMMEDIATE ASSIGNMENT REJECT message. The SS checks that all CHANNEL REQUEST messages contain an establishment cause with the value "0001".

Procedure 8

If the MS supports SMS/PP MO:

A mobile originated short message service transaction is attempted. The SS does not answer to Max-Retrans CHANNEL REQUEST messages and answers to the next CHANNEL REQUEST with an IMMEDIATE ASSIGNMENT REJECT message. The SS checks that all CHANNEL REQUEST messages contain an establishment cause with the value "0001" when NECI = 1, or "111" when NECI = 0.

Maximum Duration of Test

For procedures 1, 2, 3, 4 and 5: 5 minutes, including 1 minute for any necessary operator actions.

For procedure 6: 20 minutes, including 2 minutes for any necessary operator actions.

For procedures 7, 8: 10 minutes, including 2 minutes for any necessary operator actions.

Expected Sequence

Procedure 1

This procedure is performed if the MS supports a service on a traffic channel.

Step	Direction	Message	Comments
1			a call is established on TCH/H if the MS supports a service on half rate channel or on TCH/F otherwise. The generic call setup procedure is used.
2	SS		the SS stops transmission on the SACCH.
3	MS -> SS	8 CHANNEL REQUEST	all messages have establishment cause set to "110"
4	SS -> MS	IMMEDIATE ASSIGNMENT REJECT	

Procedure 2

This procedure is performed if the MS supports a service on half rate channel.

Step	Direction	Message	Comments
1	SS		The NECI bit is set to 1, a call is established on TCH/H. The generic call setup procedure is used.
2			the SS stops transmission on the SACCH.
3	SS		
4	MS -> SS	8 CHANNEL REQUEST	all messages have establishment cause set to "011010"
5	SS -> MS	IMMEDIATE ASSIGNMENT REJECT	

Procedure 3

This procedure is performed if the MS supports speech.

Step	Direction	Message	Comments
1	MS		a speech call is attempted
2	MS -> SS	8 CHANNEL REQUEST	all messages have establishment cause set to "111"
3	SS -> MS	IMMEDIATE ASSIGNMENT REJECT	
4	SS		The NECI bit is set to 1
5	SS		The SS waits for 30 s
6	MS		a speech call is attempted
7	MS -> SS	8 CHANNEL REQUEST	all messages have establishment cause set to "0100" if the MS supports speech on half rate or set to "111" otherwise
8	SS -> MS	IMMEDIATE ASSIGNMENT REJECT	

Procedure 4

This procedure is performed if the MS supports a data service.

Step	Direction	Message	Comments
1	MS		a data call is attempted
2	MS -> SS	8 CHANNEL REQUEST	all messages have establishment cause set to "111"
3	SS -> MS	IMMEDIATE ASSIGNMENT REJECT	
4	SS		
5	SS		The NECI bit is set to 1
6	MS		The SS waits for 30 s
7	MS -> SS	8 CHANNEL REQUEST	a data call is attempted for a service supported by the MS on half rate (for any data service if the MS does not support any data service on half rate)
8	SS -> MS	IMMEDIATE ASSIGNMENT REJECT	all messages have establishment cause set to "0101" if the MS supports a data service on half rate or set to "111" otherwise

Procedure 5

Step	Direction	Message	Comments
1	SS -> MS	PAGING REQUEST TYPE 1	paging indication = any channel
2	MS -> SS	8 CHANNEL REQUEST	
3	SS -> MS	IMMEDIATE ASSIGNMENT REJECT	
4	SS		The SS waits for 5 seconds
5	SS -> MS	PAGING REQUEST TYPE 1	paging indication = SDCCH
6	MS -> SS	8 CHANNEL REQUEST	all messages have establishment cause set to "0001"
7	SS -> MS	IMMEDIATE ASSIGNMENT REJECT	
8	SS		The SS waits for 5 seconds
9	SS -> MS	PAGING REQUEST TYPE 1	paging indication = TCH/F
10	MS -> SS	8 CHANNEL REQUEST	all messages have establishment cause set to "100" if the MS capability is full rate only or "0010" if the MS capability is dual rate or "0001" if the MS capability is SDCCH only
11	SS -> MS	IMMEDIATE ASSIGNMENT REJECT	
12	SS		The SS waits for 5 seconds
13	SS -> MS	PAGING REQUEST TYPE 1	paging indication = TCH/H or TCH/F
14	MS -> SS	8 CHANNEL REQUEST	all messages have establishment cause set to "100" if the MS capability is full rate only or "0011" if the MS capability is dual rate or "0001" if the MS capability is SDCCH only
15	SS -> MS	IMMEDIATE ASSIGNMENT REJECT	

Procedure 6

The sequence is executed for execution counter k = 1, 2.

Step	Direction	Message	Comments
0	SS		When k = 1, NECI set to 0 When k = 2, NECI set to 1
1	MS		The MS is switched off or has its power source removed
2	SS		IMSI attach/detach is set to "MSs in the cell shall apply IMSI attach and detach procedure"
3	MS		The MS is switched on or powered on
4	MS -> SS	8 CHANNEL REQUEST	all messages have establishment cause set to: "000" when k = 1 "0000" when k = 2
5	SS -> MS	IMMEDIATE ASSIGNMENT	
6	MS -> SS	LOCATION UPDATING REQUEST	"location updating type" = IMSI attach
7	SS -> MS	LOCATION UPDATING ACCEPT	with no mobile identity
8	SS -> MS	CHANNEL RELEASE	
9	SS		the LAC of the cell is changed and T3212 is set to 6 minutes
10	MS -> SS	8 CHANNEL REQUEST	all messages have establishment cause set to: "000" when k = 1 "0000" when k = 2. The MS must send its first Channel Request within 33s after the LAC has been changed.
11	SS -> MS	IMMEDIATE ASSIGNMENT	
12	MS -> SS	LOCATION UPDATING REQUEST	"location updating type" = Normal location updating
13	SS -> MS	LOCATION UPDATING ACCEPT	with no mobile identity
14	SS -> MS	CHANNEL RELEASE	
15	MS -> SS	8 CHANNEL REQUEST	all messages have establishment cause set to: "000" when k = 1 "0000" when k = 2. The MS must send its first Channel Request within 7 minutes after the preceding Channel Release
16	SS -> MS	IMMEDIATE ASSIGNMENT	
17	MS -> SS	LOCATION UPDATING REQUEST	"location updating type" = Periodic updating
18	SS -> MS	LOCATION UPDATING ACCEPT	with no mobile identity
19	SS -> MS	CHANNEL RELEASE	
20	MS		If possible (see PICS), the MS is switched off, otherwise it has its power source removed
21	MS		If the MS was switched off it attempts IMSI detach
22	MS -> SS	8 CHANNEL REQUEST	all messages have establishment cause set to: "111" when k = 1 "0001" when k = 2
23	SS -> MS	IMMEDIATE ASSIGNMENT REJECT	

Procedure 7

The sequence is executed for execution counter k = 1, 2.

This procedure is performed if the MS supports a non call related supplementary service operation.

Step	Direction	Message	Comments
1	MS		a non call related supplementary service operation is attempted
2	MS -> SS	8 CHANNEL REQUEST	all messages have establishment cause set to: "111" when k = 1 "0001" when k = 2
3	SS -> MS	IMMEDIATE ASSIGNMENT REJECT	

Procedure 8

This procedure is performed if the MS supports SMS/PP MO.

The sequence is executed for execution counter k = 1, 2.

Step	Direction	Message	Comments
0	SS		When k = 1, NECI set to 0 When k = 2, NECI set to 1 a mobile originated short message service transaction is attempted all messages have establishment cause set to: "111" when k = 1 "0001" when k = 2
1	MS		
2	MS -> SS	8 CHANNEL REQUEST	
3	SS -> MS	IMMEDIATE ASSIGNMENT REJECT	

26.3 Test of MS functions in idle mode

26.3.1 Initial conditions

The SIM shall contain a PLMN-Selector that contains only the HPLMN of the MS, and an empty forbidden PLMN list.

Related PICS/PIXIT statements

Type of mobile station (GSM 400, P-GSM 900, E-GSM 900, R-GSM 900, DCS 1 800 or PCS 1900)

During the tests in 26.3.2 and 26.3.3, the following parameters apply according to the above PICS/PIXIT statement:

RACH control parameters

In cells

GSM 400: 1 to 7

GSM 900: 1 to 7

DCS 1 800: 1 to 6:

PCS 1900: 1 to 6:

Multiband 900/1800: 1 to 7:

Multiband 450/900: 1 to 7:

Multiband 480/900: 1 to 7:

Multiband 450/1800: 1 to 7:

Multiband 480/1800: 1 to 7:

Max retrans	= 01	2 retransmissions
Tx-integer	= 0111	(10) slots for spreading
CB, Cell Barred	= 0	access is allowed
RE	= 1	re-establishment not allowed
AC C00 to AC C15	= 0	access is not barred

In cell

GSM 400:8

GSM 900:8

DCS 1 800: 7:

PCS 1900: 7:

Multiband 900/1800:8:

Multiband 450/900: 8:

Multiband 480/900: 8:

Multiband 450/1800:8:

Multiband 480/1800:8

Max retrans	= 01	2 retransmissions
Tx-integer	= 0111	(10) slots for spreading
CB, Cell Barred	= 1	access is not allowed
RE	= 1	re-establishment not allowed
AC C00 to AC C15	= 0	access is not barred

		GSM 900							DCS 1 800							
Cell	PLMN perm.	BA - ARFCN bit = 1							BA - ARFCN bit = 1							
1	00000100	7	39	65	66	85	97	124	520	580	610	702	703	830	885	
2	00000100	8	40	67	68	86	98	123	521	581	612	704	705	831	884	
3	00000100	9	41	69	70	87	99	122	522	582	614	706	707	832	883	
4	00000100	10	42	71	72	88	100	121	523	583	616	708	709	833	882	
5	00000100	11	43	73	74	89	101	120	524	584	618	710	711	844	881	
6	00000100	12	44	75	76	90	102	119	525	585	620	712	713	835	880	
7	00000100	13	45	77	78	91	103	118	526	586	622	714	715	836	879	
8	00000100	124														

		PCS 1900					
Cell	PLMN perm.	BA - ARFCN bit = 1					

1	00000100	512	520	580	610	702	703	800
2	00000100	513	521	581	612	704	705	801
3	00000100	514	522	582	614	706	707	802
4	00000100	515	523	583	616	708	709	803
5	00000100	516	524	584	618	710	711	804
6	00000100	517	525	585	620	712	713	805
7	00000100	518	526	586	622	714	715	806

		GSM 450							GSM 480						
Cell	PLMN perm.	BA - ARFCN bit = 1							BA - ARFCN bit = 1						
1	00000100	261	267	268	281	288	291	293	308	314	315	328	335	338	340
2	00000100	260	269	270	282	289	264	275	307	316	317	329	336	311	322
3	00000100	262	271	272	283	290	265	277	309	318	319	330	337	312	324
4	00000100	263	273	274	284	292	266	279	310	320	321	331	339	313	326
5	00000100	264	275	276	285	260	269	270	311	322	323	332	307	316	317
6	00000100	265	277	278	286	262	271	272	312	324	325	333	309	318	319
7	00000100	266	279	280	287	263	273	274	313	326	327	334	310	320	321
8	00000100	293							340						

		Multiband 900/1800						
Cell	PLMN perm.	BA - ARFCN bit = 1						
1	00000100	7	39	702	66	85	885	124
2	00000100	8	40	67	68	86	98	123
3	00000100	9	41	69	70	87	99	122
4	00000100	523	583	616	708	709	833	882
5	00000100	520	7	39	702	85	885	124
6	00000100	12	44	75	76	90	102	119
7	00000100	526	586	622	714	715	836	879
8	00000100	124						

		Multiband 450/900							Multiband 480/900						
Cell	PLMN perm.	BA - ARFCN bit = 1							BA - ARFCN bit = 1						
1	00000100	261	267	65	281	288	124	293	308	314	65	328	335	124	340
2	00000100	260	269	270	282	289	264	275	307	316	317	329	336	311	322
3	00000100	262	271	272	283	290	265	277	309	318	319	330	337	312	324
4	00000100	10	42	71	72	88	100	121	10	42	71	72	88	100	121
5	00000100	7	260	267	65	288	124	293	7	307	314	65	335	124	340
6	00000100	265	277	278	286	262	271	272	312	324	325	333	309	318	319
7	00000100	13	45	77	78	91	103	118	13	45	77	78	91	103	118
8	00000100	293							340						

		Multiband 450/1800							Multiband 480/1800						
Cell	PLMN perm.	BA - ARFCN bit = 1							BA - ARFCN bit = 1						
1	00000100	261	267	702	281	288	885	293	308	314	702	328	335	885	340
2	00000100	260	269	270	282	289	264	275	307	316	317	329	336	311	322
3	00000100	262	271	272	283	290	265	277	309	318	319	330	337	312	324
4	00000100	523	583	616	708	709	833	882	523	583	616	708	709	833	882
5	00000100	520	260	267	702	288	885	293	520	307	314	702	335	885	340
6	00000100	265	277	278	286	262	271	272	312	324	325	333	309	318	319
7	00000100	526	586	622	714	715	836	879	526	586	622	714	715	836	879
8	00000100	293							340						

Location area identification

GSM 400 and GSM 900 only - begin

Cell	MCC1	MCC2	MCC3	MNC1	MNC2	LAC
1	0	0	2	0	F	x
2	0	0	3	2	F	x
3	0	0	4	3	F	x
4	0	0	5	4	F	x
5	0	0	6	5	F	x
6	0	0	7	6	F	x
7	0	0	8	7	F	x
8	0	0	1	0	1	x

The HPLMN of the MS

GSM 400 and GSM 900 only - end

DCS 1 800 only - begin

Cell	MCC1	MCC2	MCC3	MNC1	MNC2	LAC	
1	0	0	2	0	F	x	
2	0	0	3	2	F	x	
3	0	0	4	3	F	x	
4	0	0	5	4	F	x	
5	0	0	6	5	F	x	
6	0	0	7	6	F	x	
7	0	0	1	0	1	x	The HPLMN of the MS

DCS 1 800 only – end

PCS 1900 only – begin

Cell	MCC1	MCC2	MCC3	MNC1	MNC2	MNC3	LAC	
1	0	0	2	0	F	F	x	
2	0	0	3	2	F	F	x	
3	0	0	4	3	F	F	x	
4	0	0	5	4	F	F	x	
5	0	0	6	5	F	F	x	
6	0	0	7	6	F	F	x	
7	0	0	1	0	1	1	x	The HPLMN of the MS

GSM 1900 only - end

Any Multiband MS - begin

Cell	MCC1	MCC2	MCC3	MNC1	MNC2	LAC	
1	0	0	2	0	F	x	
2	0	0	3	2	F	x	
3	0	0	4	3	F	x	
4	0	0	5	4	F	x	
5	0	0	2	0	F	x	
6	0	0	7	6	F	x	
7	0	0	8	7	F	x	
8	0	0	1	0	1	x	The HPLMN of the MS

Any Multiband MS - end

NOTE 1: 'x' denotes any value.

NOTE 2: The MS representation of the MCC, MNC on the handset can be manufacturer dependant.

NOTE 3: The NCC values of each cell must be different.

Control channel description and BS options

All

GSM 400: 8 cells

GSM 900: 8 cells

DCS 1 800: 7 cells:

PCS 1900: 7 cells:

Any Multiband MS: 8 cells:

CELL_RESELECT_HYSTERESIS = 010 4dB RXLEV hysteresis
 MS_TXPWR_MAX_CCH = value corresponding to the maximum available output power from MS
 RXLEV_ACCESS_MIN = 30
 ATT = 0 no IMSI attach and detach
 DTX = 0 no discontinuous transmission
 BS_AG_BLK_RES = 1 1 block reserved for access grant
 CCCH_CONF = 001 1 SDCCH combined with the CCCH
 RADIO_LINK_TIMEOUT = 5 10 s time-out
 BS_PA_MFRMS = 010 4 multiframe periods for paging
 T3212 time-out value = H'00

Cell	GSM 900		DCS 1 800	
	level dBμVemf()	BCCH ARFCN	level dBμVemf()	BCCH ARFCN
1	+65	1	+65	520
2	+63	7	+63	580
3	+61	39	+61	610
4	+55	65	+55	702
5	+59	66	+59	703
6	+57	85	+57	830
7	+55	97	+55	885
8	+53	124		

Cell	GSM 450		DCS 480	
	level dBμVemf()	BCCH ARFCN	level dBμVemf()	BCCH ARFCN
1	+65	259	+65	306
2	+63	261	+63	308
3	+61	267	+61	314
4	+55	268	+55	315
5	+59	281	+59	328
6	+57	288	+57	335
7	+55	291	+55	338
8	+53	293	+53	340

Cell	Multiband 900/1800		PCS 1900	
	level dBμVemf()	BCCH ARFCN	level dBμVemf()	BCCH ARFCN
1	+65	520	+65	512
2	+63	7	+63	520
3	+61	39	+61	580
4	+55	702	+55	610
5	+59	66	+59	702
6	+57	85	+57	703
7	+55	885	+55	800
8	+53	124		

Cell	Multiband 450/900		Multiband 480/900	
	level dB μ Vemf()	BCCH ARFCN	level dB μ Vemf()	BCCH ARFCN
1	+65	1	+65	1
2	+63	261	+63	308
3	+61	267	+61	314
4	+55	65	+55	65
5	+59	281	+59	328
6	+57	288	+57	335
7	+55	124	+55	124
8	+53	293	+53	340

Cell	Multiband 450/1800		Multiband 480/1800	
	level dB μ Vemf()	BCCH ARFCN	level dB μ Vemf()	BCCH ARFCN
1	+65	520	+65	520
2	+63	261	+63	308
3	+61	267	+61	314
4	+55	702	+55	702
5	+59	281	+59	328
6	+57	288	+57	335
7	+55	885	+55	885
8	+53	293	+53	340

For testing an E-GSM Mobile station (see PICS/PIXIT), the BCCH ARFCN of cell 7 at GSM 900 column shall be 985 (instead of 97). For testing an R-GSM Mobile station (see PICS/PIXIT), the BCCH ARFCN of cell 7 at GSM 900 column shall be 965 (instead of 97).

NOTE 4: The SIM should contain a PLMN-Selector that contains only the HPLMN of the MS, and an empty forbidden PLMN list.

26.3.2 MS indication of available PLMNs

26.3.2.1 Test purpose

To verify that a MS can present the available PLMNs to the user when asked to do so in manual mode according to the requirements of GSM 05.08 and GSM 02.11.

26.3.2.2 Method of test

- a) The MS is switched on, equipped with a SIM containing default values except for those values listed under section 26.3.1 (initial conditions).
- b) The MS is put into manual network selection mode (see PIXIT).

26.3.2.3 Test requirements

- 1) On entering manual network selection mode, the MS shall present a list of available PLMNs in all its bands of operation (MCC and MNC values, or any other valid indications, see PIXIT), within 2 minutes. Any PLMN shall only be presented once. The list shall include the MCC and MNC of:

GSM 400 and GSM 900: cells 1 to 7, but not of cell 8.

DCS 1 800: cells 1 to 6, but not of cell 7.

PCS 1900: cells 1 to 6, but not of cell 7.

Multiband: cells 2, 3, 4, 6, 7 and 1 or 5 (cell 1 and 5 have the same MCC and MNC), but not of cell 8.

26.3.3 MS will send only if BSS is "on air"

26.3.3.1 Test purpose

To verify that the MS will not produce any RF transmission if no BSS is received.

26.3.3.2 Method of test

a) The RF-signal for the BCCHs of:

GSM 400 and GSM 900: cell 1 to 8 is switched off.

DCS 1 800: cell 1 to 7 is switched off.

PCS 1900: cell 1 to 7 is switched off.

Any Multiband: cell 1 to 8 is switched off.

b) The SS shall wait 20 s to allow the MS to detect the loss of cells.

c) By MMI, an attempt to originate a call is made.

d) By MMI, an attempt to originate an emergency call is made.

Step d) is only performed if the MS supports speech (see PICS/PIXIT statement).

26.3.3.3 Test requirements

1) The MS must not give "service indication".

2) In steps c) and d) the MS shall not produce any RF output.

26.3.4 Manual mode of PLMN selection

26.3.4.1 Conformance requirements

In manual mode, the MS can try to obtain normal service on any available VPLMN and it shall try to obtain normal service on a VPLMN if and only if the user makes a manual selection of this VPLMN.

Reference

GSM 03.22 section 3.1.

26.3.4.2 Test purpose

To check that in manual mode the MS is able to obtain normal service on a PLMN which is neither the better nor a preferred PLMN and that it tries to obtain service on VPLMN if and only if the user selects it manually.

26.3.4.3 Method of test

Initial conditions

System Simulator:

2 cells, defaults parameter unless otherwise specified.

The SS transmits 2 BCCH carriers in the supported band(s) of the mobile station (for a multiband MS carrier A and B shall be in different bands) with the initial following parameters:

carrier A	PLMN 1	level (dB μ Vemf)
carrier B	PLMN 2	38
		33

Mobile Station:

The MS is "idle updated" on PLMN1 (HPLMN) and is in manual mode.

The preferred PLMN list does not contain PLMN2, it contains PLMN 3.

Related PICS/PIXIT statement(s)

Description of the manual PLMN selector.

Support of multiband functionality

Foreseen final state of the MS

The MS is "idle updated".

Test procedure

For the different networks and during the whole test, "IMSI attach" flag is set in the BCCH data.

Carrier A is turned off. The MS does not attempt a location updating during 2 minutes.

Carrier A is turned back on with a different MCC-MNC (indicating PLMN 3) and with a higher level (48 dBmVemf) than PLMN 2. The MS does not attempt a location updating during 2 minutes.

PLMN 2 is selected manually. The MS performs a location updating on PLMN 2. Carrier B is turned off. The MS does not attempt a location updating during 2 minutes.

Maximum duration of test

10 minutes

Expected Sequence

Step	Direction	Message	Comments
1 2	SS		carrier A is turned off wait 2 min: the MS shall not send any CHANNEL REQUEST messages during this time
3 4	SS		carrier A is turned on with a different MNC-NCC (PLMN3) and with a high level (48dBmVemf) wait 2 min: the MS shall not send any CHANNEL REQUEST messages during this time
5 6 7 8 9 10	MS MS -> SS SS -> MS MS -> SS SS -> MS SS -> MS	CHANNEL REQUEST IMMEDIATE ASSIGNMENT LOCATION UPDATING REQUEST LOCATION UPDATING ACCEPT CHANNEL RELEASE	PLMN 2 selected manually on carrier B
11 12	SS		carrier B is turned off wait 2 min: the MS shall not send any CHANNEL REQUEST messages during this time

Specific message contents

None

26.4 Lower layer failures in layer 3 testing

26.4.1 Introduction

The text in this section is intended to develop a standardized way of creating lower layer failures whilst testing the performance of Layer 3 signalling.

There are two groups of lower layer failures:

- 1) Detected by analysis of reception at Layer 1 (GSM 05.08, GSM 04.08),
- 2) Data link layer failures.

References

GSM 04.08, GSM 04.06, GSM 05.08

26.4.2 Layer 1 reception failures

The absence of reception of correct frames on the SACCH until the S counter reaches value 0 will be interpreted as a Layer 1 failure.

26.4.3 Data link layer failures

Many kinds of error cases can be caused in Layer 2. For example too many "T200 - time-out/retrying" - pairs.

NOTE 1: All types of data link failures are indicated similarly to the RR layer (Release Indication).

NOTE 2: All types of L1 failures are indicated similarly to each layer (Abort Indication, Error Indication).

26.4.4 Lower layer failures, used for the tests in clause 25

For L3 testing different lower layer failures are performed:

- 1) T100 time-out in Layer 1.
- 2) Too many T200 time-outs consecutively in Layer 2.

26.5 Handling of unknown, unforeseen, and erroneous protocol data, and of parallel transactions

26.5.1 Handling of unknown, unforeseen, and erroneous protocol data, and of parallel transactions / unknown protocol discriminator

An MS ignores messages with unknown protocol discriminator. This allows for the introduction of new messages which will be ignored by MS of earlier phases.

26.5.1.1 Conformance requirements

If the mobile station receives a standard L3 message with a protocol discriminator different from those specified in table 9.2/GSM 04.07, the mobile station shall ignore the message.

References

GSM 04.07, section 11.2.1.

26.5.1.2 Test purpose

To verify that a MS supporting TCH and the call control protocol ignores a message containing an undefined protocol discriminator in the special case of a message coded otherwise like a CC STATUS ENQUIRY message received by the MS having a mobile terminating call in CC-state U10, "active".

26.5.1.3 Method of test

Initial conditions

System Simulator:

1 cell, default parameters.

Mobile Station:

The MS has been paged and an RR connection has been established.

If the MS supports the call control protocol, the test may alternatively be performed with the MS having a mobile terminating call in the CC-state U10, "active".

Related PICS/PIXIT statements

- At least one circuit switched basic service supported(Y/N).

Foreseen Final State of the MS

Same as in the initial conditions.

Test Procedure

The SS sends a message to the MS which is coded like a CC STATUS ENQUIRY message relating to the active call except for the fact that the protocol discriminator of the message is undefined.

Maximum duration of test

11 seconds.

Expected sequence

Step	Direction	Message	Comments
1	SS -> MS	UNKNOWN MESSAGE	The SS waits between 5 and 10 seconds verifying during this period that the MS does not send a L3 message on the main signalling link.
2	SS		

Specific message contents

UNKNOWN MESSAGE

Information element	Value/remark
Protocol discriminator	0000
TI flag	transaction originated by SS
TI value	TI value of the active call if the test is performed in state U10 otherwise the value is arbitrary.
Message Type	H'34

26.5.2 Handling of unknown, unforeseen, and erroneous protocol data, and of parallel transactions / TI and skip indicator

26.5.2.1 TI and skip indicator / RR

The MS ignores RR messages with skip indicator different to 0. This allows for the introduction of new RR messages which will be ignored by MS of earlier phases, especially on the downlink CCCH and BCCH.

26.5.2.1.1 TI and skip indicator / RR / Idle Mode

26.5.2.1.1.1 Conformance requirements

A radio resource message received with skip indicator different from 0000 shall be ignored.

Reference(s):

GSM 04.08, section 10.3.1.

26.5.2.1.1.2 Test purpose

To verify that the MS ignores an RR message with skip indicator different from H'0 in the special case of a PAGING REQUEST TYPE 1 message received in the MM-state "idle, updated" and in RR-idle mode.

26.5.2.1.1.3 Method of test

Initial conditions

System Simulator:

1 cell, default parameters.

Mobile Station:

The MS is in the MM-state "idle, updated" and in RR-idle mode. It has a valid TMSI.

Related PICS/PIXIT statements

None.

Foreseen Final State of the MS

The MS is in the MM-state "idle, updated" and in RR-idle mode. It has a valid TMSI.

Test Procedure

For every binary value x in the range 0001 - 0110 (binary) and for binary value x = 1000, the following procedure is performed: The SS sends a PAGING REQUEST TYPE 1 message to the MS with skip indicator set to x. It is verified that the MS does not answer to the paging request message.

Maximum duration of test

5 seconds for each execution.

Expected sequence

The sequence is executed for execution counter k = 1,2,3,4,5,6,8.

Step	Direction	Message	Comments
1	SS -> MS	PAGING REQUEST TYPE 1	The value of the skip indicator IE is the binary encoding of k.
2	SS		During 3 seconds the SS verifies that the MS does not send any message on the RACH.

Specific message contents

None.

26.5.2.1.2 TI and skip indicator / RR / RR-Connection established

26.5.2.1.2.1 Conformance requirements

A radio resource message received with skip indicator different from H'0 shall be ignored.

Reference(s):

GSM 04.08, section 10.3.1.

26.5.2.1.2.2 Test purpose

To verify that the MS ignores RR messages with skip indicator different from H'0 in the case of a message being received during the RR-connection establishment in the MM-state "idle, updated" / "wait for network command" and in RR-connected mode.

26.5.2.1.2.3 Method of test

Initial conditions

System Simulator:

1 cell, default parameters, max retrans = 2.

Mobile Station:

The MS is in the MM-state "idle, updated" and in RR-idle mode. It has a valid TMSI.

Related PICS/PIXIT statements

None.

Foreseen Final State of the MS

The MS is in the MM-state "idle, updated" and in RR-idle mode. It has a valid TMSI.

Test Procedure

The SS sends a PAGING REQUEST TYPE 1 message to the MS with skip indicator set to H'0. The first CHANNEL REQUEST message will be answered with an IMMEDIATE ASSIGNMENT addressing the MS but with skip indicator set to H'1. Transmission of the second CHANNEL REQUEST message verifies that the MS has ignored the IMMEDIATE ASSIGNMENT message.

The second CHANNEL REQUEST message is answered by an IMMEDIATE ASSIGNMENT REJECT message addressing the MS but with skip indicator set to H'2 and a reject time set to 255 seconds. Transmission of the third CHANNEL REQUEST message verifies that the MS has ignored the IMMEDIATE ASSIGNMENT REJECT message.

The third CHANNEL REQUEST message from the MS will be answered with a correct IMMEDIATE ASSIGNMENT addressing the MS and having skip indicator set to H'0.

In the RR-Connected mode messages such as CIPHERING MODE COMMAND, HANDOVER COMMAND, ASSIGNMENT COMMAND and CHANNEL RELEASE are sent with the skip indicator <> H'0 and it is checked that the MS does not take any action on these commands.

Maximum duration of test

40 seconds.

Expected sequence

Step	Direction	Message	Comments
1	SS -> MS	PAGING REQUEST TYPE 1	The value of the skip indicator IE is H'0
2	MS -> SS	CHANNEL REQUEST	
3	SS -> MS	IMMEDIATE ASSIGNMENT	skip indicator set to H'1
4	MS -> SS	CHANNEL REQUEST	
5	SS -> MS	IMMEDIATE ASSIGNMENT REJECT	skip indicator = H'2, reject time = 255 seconds
6	MS -> SS	CHANNEL REQUEST	Cause, answer to paging
7	SS -> MS	IMMEDIATE ASSIGNMENT	skip indicator = H'0
8	MS -> SS	PAGING RESPONSE	RR connection established
9	SS -> MS	AUTHENTICATION REQUEST	
10	MS -> SS	AUTHENTICATION RESPONSE	
11	SS -> MS	CIPHERING MODE COMMAND	skip indicator = H'3
12	SS		the SS neither starts ciphering nor deciphering with IMSI requested
13	SS -> MS	IDENTITY REQUEST	to check the MS still uses unciphered mode
14	MS -> SS	IDENTITY RESPONSE	
15	SS -> MS	ASSIGNMENT COMMAND	skip indicator = H'4
16	SS		SS checks no SABM is sent by the MS on the new channel
17	SS -> MS	HANDOVER COMMAND	skip indicator = H'5
18	SS		During 3 seconds the SS verifies that the MS does not send a handover failure or RR STATUS message on the old channel
19	SS -> MS	CHANNEL RELEASE	skip indicator = H'6
20	SS -> MS	IDENTITY REQUEST	with IMSI requested
21	MS -> SS	IDENTITY RESPONSE	to check the RR connection is still established
22	SS -> MS	CHANNEL RELEASE	skip indicator = H'0
23	SS		The SS checks that the layer 2 connection is released

Specific message contents

None.

26.5.2.2 Tl and skip indicator / MM

The MS ignores MM messages with skip indicator different to 0. This allows for the introduction of new MM messages which will be ignored by MS of earlier phases.

26.5.2.2.1 Conformance requirements

A mobility management message received with skip indicator different from 0000 shall be ignored.

References

GSM 04.08, section 10.3.1.

26.5.2.2.2 Test purpose

To verify that the MS ignores an MM message with skip indicator different from H'0 in the special case of an IDENTITY REQUEST message received.

26.5.2.2.3 Method of test

Initial conditions

System Simulator:

1 cell, default parameters.

Mobile Station:

The MS has a mobile terminating call in CC-state U10, "active", or alternatively, the MS has been paged and an RR connection has been established.

Related PICS/PIXIT statements

At least one circuit switched basic service supported (Y/N).

Foreseen Final State of the MS

Same as in the initial conditions.

Test Procedure

For every binary value x in the range 0001 - 0110 and for the binary value x = 1000, the following procedure is performed: The SS sends an IDENTITY REQUEST message to the MS with skip indicator set to x. It is verified during 5 seconds that the MS does not answer to the IDENTITY REQUEST message.

Maximum duration of test

15 seconds.

Expected sequence

Step	Direction	Message	Comments
1	SS -> MS	IDENTITY REQUEST	Skip indicator IE has value H'1.
2	SS		The SS starts verifying that the MS does not send any L3 message on the main signalling link. This verification continues until step 16 of this test sequence.
3	SS		The SS waits 1 second.
4	SS -> MS	IDENTITY REQUEST	Skip indicator IE has value H'2.
5	SS		The SS waits 1 second.
6	SS -> MS	IDENTITY REQUEST	Skip indicator IE has value H'3.
7	SS		The SS waits 1 second.
8	SS -> MS	IDENTITY REQUEST	Skip indicator IE has value H'4.
9	SS		The SS waits 1 second.
10	SS -> MS	IDENTITY REQUEST	Skip indicator IE has value H'5.
11	SS		The SS waits 1 second.
12	SS -> MS	IDENTITY REQUEST	Skip indicator IE has value H'6.
13	SS		The SS waits 1 second.
14	SS -> MS	IDENTITY REQUEST	Skip indicator IE has value H'8.
15	SS		The SS waits 5 seconds.
16	SS		The SS stops verifying that the MS does not send any L3 message on the main signalling link.

Specific message contents

None.

26.5.2.3 TI and skip indicator / CC

26.5.2.3.1 Conformance requirements

- a) Whenever any call control message except SETUP or RELEASE COMPLETE is received specifying a transaction identifier with a value different from 111, which is not recognized as relating to an active call or to a call in progress, the receiving entity shall send a RELEASE COMPLETE message with cause value #81 "invalid transaction identifier value" using the received transaction identifier value and remain in the Null state.
- b1) When a RELEASE COMPLETE message is received specifying a transaction identifier with a value different from 111, which is not recognized as relating to an active call or to a call in progress, the MM-connection associated with that transaction identifier shall be released.
- b2) When a SETUP message is received with a transaction identifier flag set to "1", this message shall be ignored.
- b3) When a SETUP message is received specifying a transaction identifier which is recognized as relating to an active call or to a call in progress, this SETUP message shall be ignored.
- c) When a CC message with a TI value = 111 is received, this message shall be ignored.

References

GSM 04.08, section 8.3.

26.5.2.3.2 Test purpose

- a) To verify that the MS having a mobile terminating call in CC-state U10, "active", on receipt of a DISCONNECT message which includes a transaction identifier with a value different from 111, which is not recognized as relating to an active call or a call in progress, sends a RELEASE COMPLETE message with cause value #81 and referring to the latter TI without changing the state of the active call (this is verified by use of the status enquiry procedure).
- b) To verify that the MS having a mobile terminating call in CC-state U10, "active", on receipt of a
 - b1) RELEASE COMPLETE message which includes a transaction identifier with a value different from 111, which is not recognized as relating to an active call or a call in progress, or a
 - b2) SETUP message with TI flag referring to a transaction originated by the MS (in the special case where the TI value is equal to the TI value relating to the active call), or a
 - b3) SETUP message with TI referring to the active call,

ignores that message without changing the state of the active call (this is verified by use of the status enquiry procedure).

- c) To verify that the MS ignores a CC message with a TI value of 111.

The test is only applicable to an MS supporting the call control protocol for at least one BC.

26.5.2.3.3 Method of test

Initial conditions

System Simulator:

1 cell, default parameters.

Mobile Station:

The MS has a mobile terminating call in CC-state U10, "active". No other call is active or in progress.

Related PICS/PIXIT statements

At least one circuit switched basic service supported (Y/N).

Foreseen Final State of the MS

The MS has a mobile terminating call in CC-state U10, "active". No other call is active or in progress.

Test Procedure

The SS sends a DISCONNECT message to the MS with a TI not relating to the active call. The MS shall respond with a RELEASE COMPLETE message including cause value #81 and specifying the same transaction. By means of the status enquiry procedure the SS checks that the CC-state of the active call did not change.

Then the SS sends the following call control messages to the MS;

- a RELEASE COMPLETE message, where the TI does not refer to the active call,
- a SETUP message with TI flag set to 1,
- a SETUP message with TI referring to the active call,
- a DISCONNECT message with a TI value of 111.

Each time the SS verifies that the MS does not respond to the message and each time the SS verifies by means of the status enquiry procedure that the CC-state of the active call has not been changed.

Maximum duration of test

40 seconds.

Expected sequence

Step	Direction	Message	Comments
1	SS -> MS	DISCONNECT	TI flag = 0; TI does not refer to the active call.
2	MS -> SS	RELEASE COMPLETE	TI flag = 1; TI value is equal to TI value received in step 1; Cause IE indicates cause value #81.
3	SS -> MS	STATUS ENQUIRY	TI refers to the active call.
4	MS -> SS	STATUS	TI refers to the active call; Cause IE indicates cause value #30. Call state IE indicates state U10
5	SS -> MS	RELEASE COMPLETE	TI flag = 0; TI does not refer to the active call.
6	SS		The SS verifies during 5 seconds that the MS does not send any L3 message on the main signalling link.
7	SS -> MS	STATUS ENQUIRY	TI refers to the active call.
8	MS -> SS	STATUS	TI refers to the active call; Cause IE indicates cause value #30. Call state IE indicates state U10
9	SS -> MS	SETUP	TI flag = 1; TI value is equal to TI value of the active call.
10	SS		The SS verifies during 5 seconds that the MS does not send any L3 message on the main signalling link.
11	SS -> MS	STATUS ENQUIRY	TI refers to the active call.
12	MS -> SS	STATUS	TI refers to the active call; Cause IE indicates cause value #30. Call state IE indicates state U10
13	SS -> MS	SETUP	TI flag = 0; TI refers to the active call.
14	SS		The SS verifies during 5 seconds that the MS does not send any L3 message on the main signalling link.
15	SS -> MS	STATUS ENQUIRY	TI refers to the active call.
16	MS -> SS	STATUS	TI refers to the active call; Cause IE indicates cause value #30. Call state IE indicates state U10
17	SS -> MS	DISCONNECT	TI flag = 0; TI value is 111.
18	SS		The SS verifies during 5 seconds that the MS does not send any L3 message on the main signalling link.
19	SS -> MS	STATUS ENQUIRY	TI refers to the active call.
20	MS -> SS	STATUS	TI refers to the active call; Cause IE indicates cause value #30. Call state IE indicates state U10

Specific message contents

None.

26.5.3 Handling of unknown, unforeseen, and erroneous protocol data, and of parallel transactions / undefined or unexpected message type

26.5.3.1 Undefined or unexpected message type / undefined message type / CC

26.5.3.1.1 Conformance requirements

If the Mobile Station receives a message with message type not defined for the PD, it shall ignore the message except for the fact that, if an RR-connection exists, it returns a status message (STATUS, RR STATUS or MM STATUS depending on the protocol discriminator) with cause value #97 "message type non-existent or not implemented".

References

GSM 04.08, section 8.4; GSM 04.07, section 11.2.4.

26.5.3.1.2 Test purpose

To verify that a MS supporting the call control protocol for at least one BC, having a mobile terminating call in CC-state U10, "active", on receipt of a message with CC protocol discriminator and an arbitrary undefined message type, returns a STATUS message with cause value #97 to the peer CC entity without changing the state of the active call (this is verified by use of the status enquiry procedure).

26.5.3.1.3 Method of test

Initial conditions

System Simulator:

1 cell, default parameters.

Mobile Station:

The MS has a mobile terminating call in CC-state U10, "active".

Related PICS/PIXIT statements

At least one circuit switched basic service supported(Y/N).

Foreseen Final State of the MS

The MS has a mobile terminating call in CC-state U10, "active".

Test Procedure

The SS sends a message to the MS the PD of which refers to call control, the TI of which refers to the active call, and the message type of which is undefined in the call control protocol (however bit 7 of the message type is "0"). The SS then checks that the MS responds with a STATUS message specifying cause value #97. The SS then sends a STATUS ENQUIRY message to the MS and verifies that the MS responds with a STATUS message specifying cause value #30 and call state U10, "active".

Maximum duration of test

10 s.

Expected sequence

Step	Direction	Message	Comments
1	SS -> MS	see comments	PD = "call control; call related SS messages" TI is that of the active call Message type is undefined for call control, bit 7 of the message type is "0" Cause IE indicates cause value #97. TI refers to the active call; Cause IE indicates cause value #30. Call state IE indicates state U10
2	MS -> SS	STATUS	
3	SS -> MS	STATUS ENQUIRY	
4	MS -> SS	STATUS	

Specific message contents

None.

26.5.3.2 Undefined or unexpected message type / undefined message type / MM

26.5.3.2.1 Conformance requirements

If the Mobile Station receives a message with message type not defined for the PD, it shall ignore the message except for the fact that, if an RR-connection exists, it returns a status message (STATUS, RR STATUS or MM STATUS depending on the protocol discriminator) with cause value #97 "message type non-existent or not implemented".

References

GSM 04.08, section 8.4.

26.5.3.2.2 Test purpose

To verify that a MS supporting the call control protocol for at least one BC, having a mobile terminating call in CC-state U10, "active", on receipt of a message with MM protocol discriminator and message type undefined for the mobility management protocol, returns an MM STATUS message with reject cause value #97 without changing the state of the active call (this is verified by use of the status enquiry procedure.) This is tested in the special case where the CC TI has value 0 (so that it has the same encoding as the skip indicator when sent from the SS) and where the message type has the same encoding as DISCONNECT in CC.

26.5.3.2.3 Method of test

Initial conditions

System Simulator:

1 cell, default parameters.

Mobile Station:

The MS has a mobile terminating call in CC-state U10, "active". The TI of that mobile terminating call has value 0.

Related PICS/PIXIT statements

At least one circuit switched basic service supported(Y/N).

Foreseen Final State of the MS

The MS has a mobile terminating call in CC-state U10, "active".

Test Procedure

The SS sends a message to the MS the PD of which refers to mobility management, the skip indicator of which is "0000", and the message type of which is "0000 0000". The SS then checks that the MS responds with an MM

STATUS message specifying reject cause value #97. The SS then sends a STATUS ENQUIRY message to the MS and verifies that the MS responds with a STATUS message specifying cause #30 and call state U10, "active".

Maximum duration of test

10 s.

Expected sequence

Step	Direction	Message	Comments
1	SS -> MS	see comments	PD = "mobility management messages" Skip indicator = "0000" Message type = "0000 0000" rest of the message is H'02 H'E0 H'90
2	MS -> SS	MM STATUS	Reject cause IE indicates reject cause value #97.
3	SS -> MS	STATUS ENQUIRY	
4	MS -> SS	STATUS	TI refers to the active call; Cause IE indicates cause value #30. Call state IE indicates state U10

Specific message contents

None.

26.5.3.3 Undefined or unexpected message type / undefined message type / RR

26.5.3.3.1 Conformance requirements

If the Mobile Station receives a message with message type not defined for the PD, it shall ignore the message except for the fact that, if an RR-connection exists, it returns a status message (STATUS, RR STATUS or MM STATUS depending on the protocol discriminator) with cause value #97 "message type non-existent or not implemented".

Reference(s)

GSM 04.08, section 8.4.

26.5.3.3.2 Test purpose

To verify that an MS in RR connected mode on receipt of a message with RR protocol discriminator and message type undefined for the RR protocol, returns an RR STATUS message with reject cause value #97 without changing its state (this is checked by observing that the MS does not send L3 messages.)

26.5.3.3.3 Method of test

Initial conditions

System Simulator:

1 cell, default parameters.

Mobile Station:

The MS has been paged and an RR connection has been established.

Related PICS/PIXIT statement(s)

- At least one circuit switched basic service supported(p = Y/N)

Foreseen Final State of the MS

The MS is in "idle updated" state.

Test Procedure

The SS sends a message to the MS the PD of which refers to radio resources management, the skip indicator of which is "0000", and the message type of which is "0010 1010". The SS then checks that the MS responds with an RR STATUS message specifying reject cause value #97. The SS then verifies during 5 seconds that the MS does not send a L3 message on the main signalling link but continues sending L2 fill frames on the main signalling link. Then the SS sends a SETUP message to the MS. This message specifies a BC that is supported by the MS, if there exists any; if the MS does not support any BC, the SETUP message specifies an arbitrary BC. The SS then verifies that the MS responds with a CALL CONFIRMED message if the SETUP had specified a BC supported by the MS, and that the MS responds with a RELEASE COMPLETE message otherwise. Then the SS sends a CHANNEL RELEASE to the MS and waits for the disconnection of the main signalling link.

Maximum duration of test

15 s.

Expected sequence

Step	Direction	Message	Comments
1	SS->MS	see comments	PD = "radio resources management messages" Skip indicator = "0000" Message type = "0010 0101" rest of the message is H'02 H'E0 H'90 RR cause IE indicates RR cause value #97. During 5 seconds the SS verifies that the MS does not send a L3 message on the main signalling link but still continues to send L2 fill frames on the main signalling link.
2	MS->SS	RR STATUS	
3	SS		
4	SS->MS	SETUP	If the MS supports at least one BC (p = Y), the SETUP specifies a bearer capability supported by the MS. Otherwise (p = N) the SETUP message specifies any bearer capability.
A5	MS->SS	CALL CONFIRMED	This message shall be sent by the MS if p = Y.
B5	MS->SS	RELEASE COMPLETE	This message shall be sent by the MS if p = N.
6	SS->MS	CHANNEL RELEASE	The SS waits for disconnection of the main signalling link.

Specific message contents

None.

26.5.3.4 Undefined or unexpected message type / unexpected message type / CC

26.5.3.4.1 Conformance requirements

If the Mobile Station receives a message not consistent with the protocol state, the Mobile Station shall ignore the message except for the fact that, if an RR-connection exists, it returns a status message (STATUS, RR STATUS or MM STATUS depending on the protocol discriminator) with cause value #98 "Message type not compatible with protocol state".

References

GSM 04.08, section 8.4.

26.5.3.4.2 Test purpose

To verify that a MS supporting the call control protocol for at least one BC, having a call in CC-state U10, "active", on receipt of an inopportune CC message, returns a STATUS message with reject cause value #98 without changing the state of the active call (this is verified by use of the status enquiry procedure.) This is tested in the special case where the inopportune CC message is a CALL PROCEEDING message relating to the active call.

26.5.3.4.3 Method of test

Initial conditions

System Simulator:

1 cell, default parameters.

Mobile Station:

The MS has a call in CC-state U10, "active".

Related PICS/PIXIT statements

At least one circuit switched basic service supported(Y/N).

Foreseen Final State of the MS

The MS has a call in CC-state U10, "active".

Test Procedure

The SS sends a CALL PROCEEDING message to the MS. The SS then checks that the MS responds with a STATUS message specifying reject cause value #98. The SS then sends a STATUS ENQUIRY message to the MS and verifies that the MS responds with a STATUS message specifying cause #30 and call state U10, "active".

Maximum duration of test

10 s.

Expected sequence

Step	Direction	Message	Comments
1	SS -> MS	CALL PROCEEDING	
2	MS -> SS	STATUS	Cause IE indicates cause value #98.
3	SS -> MS	STATUS ENQUIRY	
4	MS -> SS	STATUS	TI refers to the active call; Cause IE indicates cause value #30. Call state IE indicates state U10

Specific message contents

None.

26.5.4 Handling of unknown, unforeseen, and erroneous protocol data, and of parallel transactions / unforeseen information elements in the non-imperative message part

26.5.4.1 Unforeseen information elements in the non-imperative message part / duplicated information elements

26.5.4.1.1 Conformance requirements

If an information element with format T, TV, or TLV is repeated in a message in which repetition of the information element is not specified, only the contents of the information element appearing first shall be handled and all subsequent repetitions of the information element shall be ignored.

References

GSM 04.08, section 8.6.3.

26.5.4.1.2 Test purpose

To verify that the MS ignores an unforeseen second occurrence of an information element with format T, TV, or TLV in the special case of the mobile identity IE which has format TLV in the LOCATION UPDATING ACCEPT message.

26.5.4.1.3 Method of test

Initial conditions

System Simulator:

2 cells A and B belonging to different location areas, default parameters.

Mobile Station:

The MS is in the MM-state "idle, updated" and in RR-idle mode, listening to the BCCH/CCCH of cell A. It has a valid TMSI.

Related PICS/PIXIT statements

None.

Foreseen Final State of the MS

The MS is in the MM-state "idle, updated" and in RR-idle mode, listening to the BCCH/CCCH of cell B. It does not have a valid TMSI.

Test Procedure

The RF level of cell A is lowered until the MS selects cell B (according to the cell-reselection procedures of GSM 05.08). The MS shall establish an RR connection and initiate the normal location updating procedure (using TMSI). The SS responds to the location update request with the LOCATION UPDATING ACCEPT message containing the mobile identity IE specifying the IMSI of the MS followed by an additional mobile identity IE specifying the TMSI that was assigned to the MS in the initial conditions (i.e. duplication of information element).

The SS then pages the MS using the PAGING REQUEST TYPE 1 message including the TMSI which was previously used in the LOCATION UPDATE ACCEPT message. The SS then verifies during 5 seconds that the MS does not answer to paging. The SS then pages the MS with its IMSI. The SS verifies that the MS responds on cell B by initiating the immediate assignment procedure using the CHANNEL REQUEST message.

Maximum duration of test

20 s.

Expected sequence

During 3 seconds the SS verifies that the MS does not send any message on the RACH.

Step	Direction	Message	Comments
1	SS		The RF level of cell A is lowered until the MS selects cell B.
2	MS -> SS	CHANNEL REQUEST	
3	SS -> MS	IMMEDIATE ASSIGNMENT	
4	MS -> SS	LOCATION UPDATING REQUEST	Mobile identity IE specifies the TMSI of the MS.
5	SS -> MS	LOCATION UPDATING ACCEPT	(see below)
6	SS -> MS	CHANNEL RELEASE	
7	SS		The SS waits at least 5 s to give the MS time to become pageable
8	SS -> MS	PAGING REQUEST TYPE 1	Mobile identity 1 IE specifies the TMSI of the MS. Mobile identity 2 is omitted.
9	SS		The SS waits at least 5 seconds During that period the SS verifies that the MS does not send any message on the RACH.
10	SS -> MS	PAGING REQUEST TYPE 1	Mobile identity 1 IE specifies the IMSI of the MS. Mobile identity 2 is omitted.
11	MS -> SS	CHANNEL REQUEST	Establishment cause = answer to paging.
12	SS -> MS	IMMEDIATE ASSIGNMENT REJECT	

Specific message contents

LOCATION UPDATING ACCEPT

Information element	value/remark
location area identification	LAI of cell B
Mobile identity	coded TLV, specifies the IMSI of the MS
Type of identity	IMSI
Odd/even indication	corresponding to IMSI
Identity digit 1 etc.	corresponding to IMSI
Mobile identity (duplication)	coded TLV
Type of identity	TMSI of the MS
Odd/even indication	corresponding to TMSI
Identity digit 1 etc.	corresponding to TMSI

26.5.5 Handling of unknown, unforeseen, and erroneous protocol data, and of parallel transactions / non-semantical mandatory IE errors

26.5.5.1 Non-semantical mandatory IE errors / RR

26.5.5.1.1 Non-semantical mandatory IE errors / RR / missing mandatory IE error

26.5.5.1.1.1 Non-semantical mandatory IE errors / RR / missing mandatory IE error / special case

The MS shall accept a CHANNEL RELEASE message whether it contains an RR cause or not. This allows for the shortening of the message in the future.

26.5.5.1.1.1.1 Conformance requirements

When on receipt of a message a "missing mandatory IE" error is diagnosed the MS shall proceed as follows: If the message is a CHANNEL RELEASE message, the actions taken shall be the same as specified for a normal RR-connection release.

References

GSM 04.08, section 8.5.

26.5.5.1.1.1.2 Test purpose

To verify that the MS in RR connected mode releases the connection upon receipt of a CHANNEL RELEASE message with missing RR cause (which is "mandatory" in that message).

26.5.5.1.1.1.3 Method of test

Initial conditions

System Simulator:

1 cell, default parameters.

Mobile Station:

The MS is in the MM-state "idle, updated" and in RR-idle mode. It has a valid TMSI.

Related PICS/PIXIT statements

None.

Foreseen Final State of the MS

The MS is in the MM-state "idle, updated" and in RR-idle mode. It has a valid TMSI.

Test Procedure

A mobile terminating RR connection is established. Then the SS sends a CHANNEL RELEASE message in which the RR cause IE is missing. It is verified that the MS releases the main signalling link by sending a L2 DISC frame. The main signalling link release is then completed.

Maximum duration of test

10 s.

Expected sequence

Step	Direction	Message	Comments
1	SS -> MS	PAGING REQUEST TYPE 1	
2	MS -> SS	CHANNEL REQUEST	
3	SS -> MS	IMMEDIATE ASSIGNMENT	
4	MS -> SS	PAGING RESPONSE	
5	SS -> MS	CHANNEL RELEASE	The mandatory RR cause IE is missing (the message consists only of protocol discriminator, skip indicator, and message type).
6	MS -> SS		The main signalling link is released (this is observed by a L2 DISC frame sent from the MS to the SS).

Specific message contents

None.

26.5.5.1.1.2 Non-semantic mandatory IE errors / RR / missing mandatory IE error / general case

In the general case, the MS has to report an RR message with missing mandatory IE by the use of an RR STATUS message, but otherwise to ignore it. This is a recovery mechanism for unforeseen states.

26.5.5.1.1.2.1 Conformance requirements

When on receipt of a message a "missing mandatory IE" error is diagnosed the MS shall proceed as follows: If the message is not one of the messages listed in sections 8.5.1, 8.5.2, and 8.5.3 of GSM 04.08, the Mobile Station shall ignore the message except for the fact that, if an RR-connection exists, it returns a status message (STATUS, RR STATUS or MM STATUS depending on the protocol discriminator) with cause value #96 "invalid mandatory information".

References

GSM 04.08, section 8.5.

26.5.5.1.1.2.2 Test purpose

To verify that the MS in RR connected mode ignores a ciphering mode command message in which the ciphering mode setting IE and cipher response IE are missing except for the fact that it returns a RR STATUS message.

26.5.5.1.1.2.3 Method of test

Initial conditions

System Simulator:

1 cell, default parameters.

Mobile Station:

The MS is in the MM-state "idle, updated" and in RR-idle mode. It has a valid TMSI.

Related PICS/PIXIT statements

None.

Foreseen Final State of the MS

The MS is in RR-connected mode.

Test Procedure

A mobile terminating RR connection is established. Then the SS sends a ciphering mode command message in which the ciphering mode setting IE and cipher response IE are missing. The SS verifies that the MS does not start ciphering and returns a RR STATUS message.

Maximum duration of test

10 s.

Expected sequence

Step	Direction	Message	Comments
1	SS -> MS	PAGING REQUEST TYPE 1	
2	MS -> SS	CHANNEL REQUEST	
3	SS -> MS	IMMEDIATE ASSIGNMENT	
4	MS -> SS	PAGING RESPONSE	
5	SS -> MS	CIPHERING MODE COMMAND	The mandatory ciphering mode setting IE and cipher response IE are missing.
6	MS -> SS	RR STATUS	RR cause IE specifies RR cause value #96.

Specific message contents

None.

26.5.5.1.2 Non-semantic mandatory IE errors / RR / comprehension required

26.5.5.1.2.1 Conformance requirements

When an RR message containing an IE unknown in the message, but encoded as "comprehension required" (see subclause 10.5 / GSM 04.08) is received, the MS shall proceed as follows: When the message is not one of the messages listed in GSM 04.08 sections 8.5.1, 8.5.2, and 8.5.3, the Mobile Station shall ignore the message except for the fact that, if an RR-connection exists, it returns a RR STATUS message with cause value #96 "invalid mandatory information".

References

GSM 04.08, section 8.5.

26.5.5.1.2.2 Test purpose

To verify that the MS having an RR-connection established ignores a HANDOVER COMMAND message containing in the non-imperative part an IE encoded as comprehension required except for the fact that it returns a RR STATUS message with cause # 96 "invalid mandatory information".

26.5.5.1.2.3 Method of test

Initial conditions

System Simulator:

1 cell, default parameters.

Mobile Station:

The MS has an MT call in state U10, "active"; or alternatively, the MS has been paged and an RR-connection has been established.

Related PICS/PIXIT statements

At least one circuit switched basic service supported(Y/N).

Foreseen Final State of the MS

As in the initial conditions.

Test Procedure

The SS sends a HANDOVER command message containing in the non-imperative part an IE encoded as comprehension required. The SS verifies that the MS returns a RR STATUS message with cause value #96 without changing the dedicated channel.

Maximum duration of test

10 s.

Expected sequence

Step	Direction	Message	Comments
1	SS -> MS	HANDOVER COMMAND	See below.
2	MS -> SS	RR STATUS	Sent on the old channel. RR cause IE specifies RR cause value #96.

Specific message contents

HANDOVER COMMAND

Information element	value/remark
cell description	as required
channel description	as required
handover reference	as required
power command	as required
comprehension required IEI	0000 0000
length	0000 0001
unrecognized IE contents	xxxx xxxx

26.5.5.2 Non-semantic mandatory IE errors / MM

The MS shall ignore MM messages with syntactically incorrect mandatory IE. This allows to use reserved values in later phases.

26.5.5.2.1 Non-semantic mandatory IE errors / MM / syntactically incorrect mandatory IE

Test 26.5.5.2.1 is only applicable for an MS supporting at least one BC, whereas test 26.5.5.2.2 is applicable to all types of MS.

26.5.5.2.1.1 Conformance requirements

When an MM message containing a syntactically incorrect mandatory IE is received, the Mobile Station shall ignore the message except for the fact that, if an RR-connection exists, it returns a MM STATUS message with cause value #96 "invalid mandatory information".

References

GSM 04.08, section 8.5.

26.5.5.2.1.2 Test purpose

To verify that an MS supporting at least one BC, having a CC entity in state U10, "active", ignores an MM message with syntactically incorrect IE except for the fact that it sends an MM STATUS message with reject cause #96. This is tested in the special case of an IDENTITY REQUEST message in which the (mandatory) identity type IE specifies a reserved value for the type of identity; that the MS otherwise ignores the message is checked by means of the status enquiry procedure.

26.5.5.2.1.3 Method of test

Initial conditions

System Simulator:

1 cell, default parameters.

Mobile Station:

The MS has a mobile terminating call in the CC-state U10, "active".

Related PICS/PIXIT statements

At least one circuit switched basic service supported(Y/N).

Foreseen Final State of the MS

The MS has a mobile terminating call in the CC-state U10, "active".

Test Procedure

The SS sends an IDENTITY REQUEST message in which the (mandatory) identity type IE specifies a reserved value for the type of identity. The SS verifies that the MS returns an MM STATUS message specifying cause value #96 but does not change its state (this is verified by use of the status enquiry procedure).

Maximum duration of test

10 s.

Expected sequence

Step	Direction	Message	Comments
1	SS -> MS	IDENTITY REQUEST	The identity type IE is encoded as "1111" (so that the type of identity contains the reserved value "111").
2	MS -> SS	MM STATUS	Reject cause IE indicates reject cause value #96.
3	SS -> MS	STATUS ENQUIRY	TI refers to the active call.
4	MS -> SS	STATUS	TI refers to the active call; Cause IE indicates cause value #30. Call state IE indicates state U10.

Specific message contents

None.

26.5.5.2.2 Non-semantic mandatory IE errors / MM / syntactically incorrect mandatory IE

Test 26.5.5.2.1 is only applicable for an MS supporting at least one BC, whereas this test (26.5.5.2.2) is applicable to all types of MS.

26.5.5.2.2.1 Conformance requirement(s)

When an MM message containing a syntactically incorrect mandatory IE is received, the Mobile Station shall ignore the message except for the fact that, if an RR-connection exists, it returns an MM STATUS message with cause value #96 "invalid mandatory information".

Reference(s)

GSM 04.08, section 8.5.

26.5.5.2.2.2 Test purpose

To verify that an MS having been paged and having an RR connection established ignores an MM message with syntactically incorrect IE except for the fact that it sends an MM STATUS message with reject cause #96. This is tested in the special case of an IDENTITY REQUEST message in which the (mandatory) *identity type* IE specifies a reserved value for the type of identity; the fact that the MS otherwise ignores the message is checked by testing that it answers as usual to an incoming SETUP message.

26.5.5.2.2.3 Method of test

Initial conditions

System Simulator:

1 cell, default parameters.

Mobile Station:

The MS has been paged; an RR connection has been established.

The MS has a valid TMSI.

Related PICS/PIXIT statements

At least one circuit switched basic service supported(p=Y/N).

Foreseen final state of the MS

The MS is in the MM-state "idle updated" listening to the BCCH/CCCH of the cell. It has a valid TMSI.

Test Procedure

The SS sends an IDENTITY REQUEST message in which the (mandatory) identity type IE specifies a reserved value for the type of identity. The SS verifies that the MS returns an MM STATUS message specifying cause value #96 but does not change its state; this is verified as follows:

The SS sends a SETUP message to the MS. This message specifies a BC that is supported by the MS, if there exists any; if the MS does not support any BC, the SETUP message specifies an arbitrary BC. The SS then verifies that the MS responds with a CALL CONFIRMED message if the SETUP had specified a BC supported by the MS, and that the MS responds with a RELEASE COMPLETE message otherwise.

Then the SS sends a CHANNEL RELEASE to the MS and waits for the disconnection of the main signalling link.

Maximum duration of test

10 s.

Expected sequence

Step	Direction	Message	Comments
1	SS -> MS	IDENTITY REQUEST	The identity type IE is encoded as "1111" (so that the type of identity contains the reserved value "111").
2	MS -> SS	MM STATUS	Reject cause IE indicates reject cause value #96.
3	SS -> MS	SETUP	If the MS supports at least one BC (p = Y), the SETUP specifies a bearer capability supported by the MS. Otherwise (p = N) the SETUP message specifies any bearer capability.
A4	MS -> SS	CALL CONFIRMED	This message shall be sent by the MS if p = Y.
B4	MS -> SS	RELEASE COMPLETE	This message shall be sent by the MS if p = N.
5	SS -> MS	CHANNEL RELEASE	The SS waits for disconnection of the main signalling link.

Specific message contents

None.

26.5.5.2.3 Non-semantical mandatory IE errors / MM / comprehension required

The "comprehension required" mechanism allows for the introduction of essential new information elements into messages, such that a message is ignored and a report is sent if the new information element is not understood.

26.5.5.2.3.1 Conformance requirements

When an MM message containing an IE unknown in the message, but encoded as "comprehension required" (see subclause 10.5 / GSM 04.08) is received, the MS shall ignore the message except for the fact that, if an RR-connection exists, it returns an MM STATUS message with cause value #96 "invalid mandatory information".

References

GSM 04.08, section 8.5.

26.5.5.2.3.2 Test purpose

To verify that the MS on receipt of an MM message containing an IE unknown in the message, but encoded as "comprehension required" ignores the message except for the fact that it returns an MM STATUS message with cause value #96 "invalid mandatory information"; this in the special case of the MM message being a LOCATION UPDATING ACCEPT responding to a LOCATION UPDATING REQUEST from the MS.

26.5.5.2.3.3 Method of test

Initial conditions

System Simulator:

The SS simulates two cells, A and B, belonging to different location areas, default parameters.

Mobile Station:

The MS is in the MM-state "idle, updated" listening to the BCCH/CCCH of cell A. It has a valid TMSI.

Related PICS/PIXIT statements

None.

Foreseen Final State of the MS

The MS is in the MM-state "idle, updated" listening to the BCCH/CCCH of cell B. It has a valid TMSI.

Test Procedure

The Rf level of cell A is lowered until the MS selects cell B. The SS verifies that the MS establishes an RR connection and performs the normal location updating procedure using its TMSI. The SS responds to the location updating request with the LOCATION UPDATING ACCEPT message containing an optional information element coded as "comprehension required". The SS verifies that the MS returns the MM STATUS message with cause #96 in response to the LOCATION UPDATING ACCEPT. The SS then waits for the MS to abort the RR-connection. The SS verifies that the MS establishes a new RR connection and starts a new location updating procedure.

On receipt of the new LOCATION UPDATING REQUEST, the SS sends a correctly coded LOCATION UPDATING ACCEPT allocating a new TMSI.

The SS verifies that the MS sends a TMSI REALLOCATION COMPLETE message. The SS then initiates the RR connection release.

Maximum duration of test

30 s.

Expected sequence

Step	Direction	Message	Comments
1	SS		The RF level of cell A is lowered until the MS selects cell B.
2	MS -> SS	CHANNEL REQUEST	
3	SS -> MS	IMMEDIATE ASSIGNMENT	
4	MS -> SS	LOCATION UPDATING REQUEST	The mobile identity IE specifies the TMSI of the MS.
5	SS -> MS	LOCATION UPDATING ACCEPT	See below.
6	MS -> SS	MM STATUS	Reject cause IE specifies reject cause value #96.
7	MS		The MS aborts the RR connection (it initiates release of L2 on SAPI 0) using the L2 DISC / UA exchange.
8	MS -> SS	CHANNEL REQUEST	
9	SS -> MS	IMMEDIATE ASSIGNMENT	
10	MS -> SS	LOCATION UPDATING REQUEST	The mobile identity IE specifies the IMSI of the MS.
11	SS -> MS	LOCATION UPDATING ACCEPT	see below
12	MS -> SS	TMSI REALLOCATION COMPLETE	
13	SS -> MS	CHANNEL RELEASE	The RR connection is released.

Specific message contents

LOCATION UPDATING ACCEPT - first occurrence

Information element	value/remark
Location area identification	LAI of cell B
Comprehension required IEI	0000 0000
length	1
unrecognized IE contents	xxxx xxxx (arbitrary octet)

LOCATION UPDATING ACCEPT - second occurrence

Information element	value/remark
Location area identification	specifies LAI of cell B
Mobile Identity	specifies a TMSI

26.5.5.3 Non-semantical mandatory IE errors / CC

26.5.5.3.1 Non-semantical mandatory IE errors / CC / missing mandatory IE

26.5.5.3.1.1 Non-semantical mandatory IE errors / CC / missing mandatory IE / disconnect message

26.5.5.3.1.1.1 Conformance requirements

When on receipt of a message a "missing mandatory IE" error is diagnosed, the MS shall proceed as follows: If the message is a DISCONNECT message, a RELEASE message shall be returned with cause value # 96 "invalid mandatory information" and normal call clearing applies.

References

GSM 04.08, section 8.5.

26.5.5.3.1.1.2 Test purpose

To verify that the MS having an MT call in state U10, "active", on receipt of a DISCONNECT message in which the mandatory cause IE is missing shall return a RELEASE message with cause value #96 "invalid mandatory information".

26.5.5.3.1.1.3 Method of test

Initial conditions

System Simulator:

1 cell, default parameters.

Mobile Station:

The MS has an MT call in the CC-state U10, "active".

Related PICS/PIXIT statements

At least one circuit switched basic service supported(Y/N).

Foreseen Final State of the MS

The MS is in the MM-state "idle, updated" and in RR-idle mode.

Test Procedure

The SS sends a DISCONNECT message in which the (mandatory) cause IE is missing. The SS verifies that the MS returns a RELEASE message specifying cause value #96. The SS then sends a RELEASE COMPLETE message and performs the RR connection release.

Maximum duration of test

15 s.

Expected sequence

Step	Direction	Message	Comments
1	SS -> MS	DISCONNECT	The mandatory cause IE is missing.
2	MS -> SS	RELEASE	The cause IE indicates cause value #96
3	SS -> MS	RELEASE COMPLETE	
4	SS -> MS	CHANNEL RELEASE	The RR connection is released.

Specific message contents

None.

26.5.5.3.1.2 Non-semantical mandatory IE errors / CC / missing mandatory IE / general case

26.5.5.3.1.2.1 Conformance requirements

When on receipt of a message a "missing mandatory IE" error is diagnosed, the MS shall proceed as follows: If the message is not a SETUP, RELEASE, DISCONNECT, RELEASE COMPLETE, HOLD REJECT or RETRIEVE REJECT message, it shall ignore the message except for the fact that it returns a STATUS message specifying cause value #96.

References

GSM 04.08, section 8.5.

26.5.5.3.1.2.2 Test purpose

To verify that the MS having an MT call in state U10, "active", on receipt of a STATUS message in which the mandatory cause IE and call state IE are missing shall ignore the message except for the fact that it return a STATUS message with cause value #96 "invalid mandatory information" (that the MS does not change state is checked by use of the status enquiry procedure).

26.5.5.3.1.2.3 Method of test

Initial conditions

System Simulator:

1 cell, default parameters.

Mobile Station:

The MS has an MT call in the CC-state U10, "active".

Related PICS/PIXIT statements

At least one circuit switched basic service supported(Y/N).

Foreseen Final State of the MS

The MS has an MT call in the CC-state U10, "active".

Test Procedure

The SS sends a STATUS message in which the mandatory cause IE and call state IE are missing. The SS verifies that the MS returns a STATUS message with cause value #96 "invalid mandatory information". Then the SS sends a STATUS ENQUIRY message and checks that the MS returns a STATUS message indicating cause value #30 and call state U10, "active".

Maximum duration of test

15 s.

Expected sequence

Step	Direction	Message	Comments
1	SS -> MS	STATUS	The mandatory cause IE and call state IE are missing.
2	MS -> SS	STATUS	The cause IE indicates cause value #96
3	SS -> MS	STATUS ENQUIRY	TI refers to the active call.
4	MS -> SS	STATUS	TI refers to the active call; Cause IE indicates cause value #30. Call state IE indicates state U10

Specific message contents

None.

26.5.5.3.2 Non-semantic mandatory IE errors / CC / comprehension required

This test is applicable to all MS which support at least one MO circuit switched basic service.

26.5.5.3.2.1 Conformance requirements

When a CC message containing an IE unknown in the message, but encoded as "comprehension required" (see GSM 04.08, section 10.5) is received, the MS shall proceed as follows: When the message is not one of the messages listed in GSM 04.08 sections 8.5.1, 8.5.2, and 8.5.3, the Mobile Station shall ignore the message except for the fact that, if an RR-connection exists, it returns a STATUS message with cause value #96 "invalid mandatory information".

References

GSM 04.08, sections 8.5 and 10.5.

26.5.5.3.2.2 Test purpose

To verify that an MS supporting the call control protocol for at least one BC having a call control entity in state U3 ignores a CONNECT message containing in the non-imperative part an IE encoded as comprehension required except for the fact that it returns a STATUS message with cause value #96 "invalid mandatory information".

26.5.5.3.2.3 Method of test

Initial conditions

System Simulator:

1 cell, default parameters.

Mobile Station:

The MS has a call control entity in CC state U3.

Related PICS/PIXIT statements

At least one circuit switched basic service supported(Y/N).

The MS supports MO calls.

Foreseen Final State of the MS

The MS has a call control entity in CC state U3.

Test Procedure

The SS sends a CONNECT message containing an optional information element coded as "comprehension required". The SS verifies that the MS returns a STATUS message specifying cause value #96 "invalid mandatory information". The SS checks by use of the status enquiry procedure that the MS did not change the state.

Maximum duration of test

5 s.

Expected sequence

Step	Direction	Message	Comments
1	SS -> MS	CONNECT	See below.
2	MS -> SS	STATUS	TI refers to the call in progress; cause IE indicates cause value #96.
3	SS -> MS	STATUS ENQUIRY	TI refers to the call in progress.
4	MS -> SS	STATUS	TI refers to the call in progress; Cause IE indicates cause value #30. Call state IE indicates state U3.

Specific message contents

CONNECT

Information element	value/remark
Unknown IEI	0000 0000
length	1
unknown IE contents	xxxx xxxx (arbitrary octet)

26.5.6 Handling of unknown, unforeseen, and erroneous protocol data, and of parallel transactions / unknown IE, comprehension not required

26.5.6.1 Unknown information elements in the non-imperative message part / MM

26.5.6.1.1 Unknown IE, comprehension not required / MM / IE unknown in the protocol

26.5.6.1.1.1 Conformance requirements

The MS shall ignore all IEs unknown in a message which are not encoded as "comprehension required".

References

GSM 04.08, sections 8.6.1, 8.6.2 and 10.5.

26.5.6.1.1.2 Test purpose

To verify that the MS on receipt of an MM message containing an IE unknown in the message and unknown in the MM protocol which is not encoded as "comprehension required" ignores that IE; this in the special case of the MM message being a LOCATION UPDATING ACCEPT responding to a LOCATION UPDATING REQUEST from the MS.

26.5.6.1.1.3 Method of test

Initial conditions

System Simulator:

The SS simulates two cells, A and B, belonging to different location areas, default parameters.

Mobile Station:

The MS is in the MM-state "idle, updated" listening to the BCCH/CCCH of cell B. It has a valid TMSI.

Related PICS/PIXIT statements

None.

Foreseen Final State of the MS

The MS is in the MM-state "idle, updated" listening to the BCCH/CCCH of cell A. It has a valid TMSI.

Test Procedure

The RF level of cell B is lowered until the MS selects cell A. The SS verifies that the MS establishes an RR connection and performs the normal location updating procedure using its TMSI. The SS responds to the location updating request with the LOCATION UPDATING ACCEPT message containing an optional information element not coded as "comprehension required" the IE of which is unknown in the MM protocol. The LOCATION UPDATING ACCEPT message contains a new TMSI in the mobile identity IE which is placed after the unknown IE. The MS shall send the TMSI REALLOCATION COMPLETE message.

Maximum duration of test

20 s.

Expected sequence

Step	Direction	Message	Comments
1	SS		The RF level of cell B is lowered until the MS selects cell A.
2	MS -> SS	CHANNEL REQUEST	
3	SS -> MS	IMMEDIATE ASSIGNMENT	
4	MS -> SS	LOCATION UPDATING REQUEST	The mobile identity IE specifies the TMSI of the MS.
5	SS -> MS	LOCATION UPDATING ACCEPT	See below.
6	MS -> SS	TMSI REALLOCATION COMPLETE	
7	SS -> MS	CHANNEL RELEASE	The main signalling link is released.

Specific message contents

LOCATION UPDATING ACCEPT

Information element	value/remark
Location area identification	LAI of cell A
Unknown IEI	1010 xxx0 (where x is arbitrary)
Mobile Identity IEI	
length	5
Type of identity	TMSI
Identity	4 octets of "new" TMSI

26.5.6.1.2 Unknown IE, comprehension not required / MM / IE unknown in the message

26.5.6.1.2.1 Conformance requirements

The MS shall ignore all IEs unknown in a message which are not encoded as "comprehension required".

References

GSM 04.08, sections 8.6.1, 8.6.2 and 10.5.

26.5.6.1.2.2 Test purpose

To verify that the MS on receipt of an MM message containing an IE unknown in the message, but known in the MM protocol, which is not encoded as "comprehension required" ignores that IE; this in the special case of the MM message being a LOCATION UPDATING ACCEPT responding to a LOCATION UPDATING REQUEST from the MS.

26.5.6.1.2.3 Method of test

Initial conditions

System Simulator:

The SS simulates two cells, A and B, belonging to different location areas, default parameters.

Mobile Station:

The MS is in the MM-state "idle, updated" listening to the BCCH/CCCH of cell B. It has a valid TMSI.

Related PICS/PIXIT statements

None.

Foreseen Final State of the MS

The MS is in the MM-state "idle, updated" listening to the BCCH/CCCH of cell A. It has a valid TMSI.

Test Procedure

The RF level of cell B is lowered until the MS selects cell A. The SS verifies that the MS establishes an RR connection and performs the normal location updating procedure using its TMSI. The SS responds to the location updating request with the LOCATION UPDATING ACCEPT message containing an optional information element not coded as "comprehension required" the IEI of which is unknown in the message but is used as the location area identification IEI in other messages of the MM protocol. The LOCATION UPDATING ACCEPT message contains a new TMSI in the mobile identity IE which is placed after the unknown IE. The MS shall send the TMSI REALLOCATION COMPLETE message.

Maximum duration of test

20 s.

Expected sequence

Step	Direction	Message	Comments
1	SS		The RF level of cell B is lowered until the MS selects cell A.
2	MS -> SS	CHANNEL REQUEST	
3	SS -> MS	IMMEDIATE ASSIGNMENT	
4	MS -> SS	LOCATION UPDATING REQUEST	The mobile identity IE specifies the TMSI of the MS.
5	SS -> MS	LOCATION UPDATING ACCEPT	See below.
6	MS -> SS	TMSI REALLOCATION COMPLETE	
7	SS -> MS	CHANNEL RELEASE	The main signalling link is released.

Specific message contents

LOCATION UPDATING ACCEPT

Information element	value/remark
Location area identification	LAI of cell A
Unknown IEI	0001 0011
length	2
unknown IE contents	xxxx xxxx xxxx xxxx (2 arbitrary octets)
Mobile Identity IEI	
length	5
Type of identity	TMSI
Identity	4 octets of "new" TMSI

26.5.6.2 Unknown information elements in the non-imperative message part / CC

26.5.6.2.1 Unknown information elements in the non-imperative message part / CC / Call establishment

This test is applicable to all MS which support at least one MO circuit switched basic service.

26.5.6.2.1.1 Conformance requirements

The MS shall ignore all IEs unknown in a message which are not encoded as "comprehension required".

References

GSM 04.08, section 8.6.1.

26.5.6.2.1.2 Test purpose

To verify that an MS supporting the CC protocol for at least one BC receiving a CC message containing an IE unknown in the message which is not encoded as "comprehension required" ignores that IE; this in the special case of the CC message being a CALL PROCEEDING message received by the MS in state U1.

26.5.6.2.1.3 Method of test

Initial conditions

System Simulator:

1 cell, default parameters.

Mobile Station:

The MS has a call control entity in CC state U1.

Related PICS/PIXIT statements

At least one circuit switched basic service supported (Y/N).

Foreseen Final State of the MS

The MS has a call control entity in CC state U3.

Test Procedure

The SS sends a CALL PROCEEDING message containing an optional information element not coded as "comprehension required" the IEI of which is unknown in the message, but used for a called party BCD number IE in other messages of the protocol. The SS verifies by use of the status enquiry procedure that the MS did not change the state.

Maximum duration of test

30 s.

Expected sequence

Step	Direction	Message	Comments
1	SS -> MS	CALL PROCEEDING	See below.
2	SS -> MS	STATUS ENQUIRY	TI refers to the call in progress.
3	MS -> SS	STATUS	TI refers to the active call; Cause IE indicates cause value #30. Call state IE indicates state U3.

Specific message contents

CALL PROCEEDING

Information element	value/remark
Unknown IEI	0101 1110
length	1
unknown IE contents	xxxx xxxx (arbitrary octet)

26.5.6.2.2 Unknown information elements in the non-imperative message part / CC / disconnect

26.5.6.2.2.1 Conformance requirements

The MS shall ignore all IEs unknown in a message which are not encoded as "comprehension required".

References

GSM 04.08, section 8.6.1.

26.5.6.2.2.2 Test purpose

To verify that an MS supporting the CC protocol for at least one BC receiving a CC message containing an IE unknown in the message which is not encoded as "comprehension required" ignores that IE; this in the special case of a DISCONNECT message received by the MS in state U10.

26.5.6.2.2.3 Method of test

Initial conditions

System Simulator:

1 cell, default parameters.

Mobile Station:

The MS has a call control entity in CC state U10.

Related PICS/PIXIT statements

At least one circuit switched basic service supported (Y/N).

Foreseen Final State of the MS

The MS has a call control entity in CC state U19.

Test Procedure

The SS sends a DISCONNECT message containing an optional information element not coded as "comprehension required" the IEI of which is unknown in the message, but used for a connected number IE in other messages of the protocol. The SS verifies that the MS responds with a RELEASE message; the SS verifies by use of the status enquiry procedure that the MS has entered state U19.

Maximum duration of test

5 s.

Expected sequence

Step	Direction	Message	Comments
1	SS -> MS	DISCONNECT	See below. Cause IE indicates cause value #30. Call state IE indicates state U19.
2	MS -> SS	RELEASE	
3	SS -> MS	STATUS ENQUIRY	
4	MS -> SS	STATUS	

Specific message contents

DISCONNECT

Information element	value/remark
Unknown IEI	0100 1100
length	1
unknown IE contents	xxxx xxxx (arbitrary octet)

26.5.6.2.3 Unknown information elements in the non-imperative message part / CC / release

26.5.6.2.3.1 Conformance requirements

The MS shall ignore all IEs unknown in a message which are not encoded as "comprehension required".

References

GSM 04.08, section 8.6.1.

26.5.6.2.3.2 Test purpose

To verify that an MS supporting the CC protocol for at least one BC receiving a CC message containing an IE unknown in the message which is not encoded as "comprehension required" ignores that IE; this in the special case of a RELEASE message received by the MS having sent in state U10 a DISCONNECT message.

26.5.6.2.3.3 Method of test

Initial conditions

System Simulator:

1 cell, default parameters.

Mobile Station:

The MS has a call control entity in CC state U10.

Related PICS/PIXIT statements

At least one circuit switched basic service supported(Y/N).

Foreseen Final State of the MS

The MS is in the MM-state "idle, updated" and in RR-idle mode.

Test Procedure

The MS is made to send a DISCONNECT message. The SS responds with a RELEASE message containing an optional information element not coded as "comprehension required" the IEI of which is unknown in the message, but used for a high layer compatibility IE in other messages of the protocol. The SS verifies that the MS responds with a RELEASE COMPLETE message; the SS then releases the RR connection.

Maximum duration of test

10 s.

Expected sequence

Step	Direction	Message	Comments
1	MS		
2	MS -> SS	DISCONNECT	The MS is made to initiate call clearing.
3	SS -> MS	RELEASE	See below.
4	MS -> SS	RELEASE COMPLETE	
5	SS -> MS	CHANNEL RELEASE	The RR connection is released.

Specific message contents

RELEASE

Information element	value/remark
Unknown IEI	0111 1101
length	1
unknown IE contents	1 arbitrary octet

26.5.6.2.4 Unknown information elements in the non-imperative message part / CC / release complete

26.5.6.2.4.1 Conformance requirements

The MS shall ignore all IEs unknown in a message which are not encoded as "comprehension required".

References

GSM 04.08, section 8.6.1.

26.5.6.2.4.2 Test purpose

To verify that an MS supporting the CC protocol for at least one BC receiving a CC message containing an IE unknown in the message which is not encoded as "comprehension required" ignores that IE; this in the special case of a RELEASE COMPLETE message received by the MS in state U19.

26.5.6.2.4.3 Method of test

Initial conditions

System Simulator:

1 cell, default parameters.

Mobile Station:

The MS has a call control entity in CC state U10.

Related PICS/PIXIT statements

At least one circuit switched basic service supported(Y/N).

Foreseen Final State of the MS

The MS is in the MM-state "idle, updated" and in RR-idle mode.

Test Procedure

The SS sends a DISCONNECT message. The SS verifies that the MS responds with a RELEASE message. The SS answers with a RELEASE COMPLETE message containing an optional information element not coded as

"comprehension required" the IEI of which is unknown in the message, but used for an auxiliary states IE in other messages of the protocol. The SS verifies that the MS releases the link after some time.

Maximum duration of test

20 s.

Expected sequence

Step	Direction	Message	Comments
1	SS -> MS	DISCONNECT	
2	MS -> SS	RELEASE	
3	SS -> MS	RELEASE COMPLETE	See below.
4	MS		The MS aborts the RR connection (it initiates release of L2 on SAPI 0)

Specific message contents

RELEASE COMPLETE

Information element	value/remark
Unknown IEI	0010 0100
length	1
unknown IE contents	1 arbitrary octet

26.5.6.3 Unknown IE in the non-imperative message part, comprehension not required / RR

26.5.6.3.1 Conformance requirements

The MS shall ignore all IEs unknown in a message which are not encoded as "comprehension required".

References

GSM 04.08, sections 8.6.1, 8.6.2 and 10.5.

26.5.6.3.2 Test purpose

To verify that the MS ignores an IE which is unknown in a message for Radio Resource Management in the special cases of CIPHERING MODE COMMAND, ASSIGNMENT COMMAND and CHANNEL RELEASE.

26.5.6.3.3 Method of test

Initial conditions

System Simulator:

1 cell, default parameters.

Mobile Station:

The MS is in the MM-state "idle, updated" and in the RR-idle mode. It has a valid TMSI.

Related PICS/PIXIT statements

Supported frequency bands, GSM 450 or GSM 480 or PGSM or EGSM or DCS 1 800 or PCS 1900.

Foreseen Final State of the MS

The MS is in the MM-state "idle, updated" and in the RR-idle mode. It has a valid TMSI.

Test Procedure

In the normal call establishment the CIPHERING MODE COMMAND and ASSIGNMENT COMMAND contain additional IEs unknown in the message which are not encoded as "comprehension required", and therefore should be ignored by the MS. After sending an ASSIGNMENT COMPLETE, the subsequent CHANNEL RELEASE received by the MS also contains an IE unknown in a message which is not encoded as "comprehension required". The MS should ignore this IE.

Maximum duration of test

10 s.

Expected sequence

Step	Direction	Message	Comments
1	SS -> MS	PAGING REQUEST TYPE 1	
2	MS -> SS	CHANNEL REQUEST	
3	SS -> MS	IMMEDIATE ASSIGNMENT	
4	MS -> SS	PAGING RESPONSE	
5	SS -> MS	CIPHERING MODE COMMAND	See specific message contents
6	MS -> SS	CIPHERING MODE COMPLETE	
7	SS -> MS	ASSIGNMENT COMMAND	See specific message contents
8	MS -> SS	ASSIGNMENT COMPLETE	On the dedicated channel
9	SS -> MS	CHANNEL RELEASE	See specific message contents
10	SS		The SS checks the release of the main signalling link at layer 2 level.

Specific message contents

None.

Step 5: CIPHERING MODE COMMAND

Cipher mode setting - algorithm identifier - SC	cipher with A5/1 start ciphering
Cipher Response Unknown IE (type 2)	IMEI shall not be included 1001 0010

Step 7: ASSIGNMENT COMMAND

Channel Description	TCH/F + ACCHs
Channel Type	arbitrarily selected, but not zero
Timeslot number	arbitrarily selected
Training sequence code	RF hopping channel
Hopping	0
MAIO	0
HSN	arbitrarily selected
Power Command	1101 1010
First Unknown IE (Type 2)	For GSM 450 mobiles, range 128 encodes ARFCNs 267 and 275. For GSM 480 mobiles, range 128 encodes ARFCNs 315 and 322. For PGSM and EGSM mobiles, bit map 0 encodes ARFCNs 30 and 50. For DCS 1 800 and PCS 1900 mobiles, the variable bit map format encodes ARFCNs 650 and 750.
Cell Channel Description	
Second Unknown IE (Type 4)	
- IEI	0110 1001
- length	2
- contents	xxxx xxxx xxxx xxxx, where x is arbitrarily coded.
Mobile Allocation	For GSM450 mobiles, indicates ARFCN 275 only. For GSM 480 mobiles, indicates ARFCN 322 only. For PGSM and EGSM mobiles, indicates ARFCN 50, only. For DCS 1 800 and PCS 1900 mobiles, indicates ARFCN 750, only.

Step 9: CHANNEL RELEASE

RR Cause	normal event
Unknown IE (type 4)	
- IEI	0110 0010
- length	5
- contents	xxxx xxxx xxxx xxxx xxxx xxxx xxxx xxxx xxxx, where x is arbitrarily coded.

26.5.7 Handling of unknown, unforeseen, and erroneous protocol data, and of parallel transactions / spare bits

26.5.7.1 Spare bits / RR

26.5.7.1.1 Spare bits / RR / paging channel

26.5.7.1.1.1 Conformance requirements

The MS shall ignore the value of spare bits.

References

GSM 04.08, section 10.5.

26.5.7.1.1.2 Test purpose

To verify that the MS in the MM-state "idle, updated" and in RR-idle mode ignores the value of spare bits in the special case of the spare bits occurring in the P1 Rest Octets IE of a PAGING REQUEST TYPE 1 message. That the spare bits are ignored is checked by addressing the MS in that PAGING REQUEST message and verifying that the MS responds to that paging.

26.5.7.1.1.3 Method of test

Initial conditions

System Simulator:

1 cell, default parameters.

Mobile Station:

The MS is in the MM-state "idle, updated" and in RR-idle mode.

Related PICS/PIXIT statements

None.

Foreseen Final State of the MS

The MS is in the MM-state "idle, updated" and in RR-idle mode.

Test Procedure

The SS sends a PAGING REQUEST TYPE 1 message containing at least one octet in the P1 rest octets IE that is different from 0010 1011.

Maximum duration of test

10 s.

Expected sequence

Step	Direction	Message	Comments
1	SS -> MS	PAGING REQUEST TYPE 1	See below.
2	MS -> SS	CHANNEL REQUEST	
3	SS -> MS	IMMEDIATE ASSIGNMENT REJECT	

Specific message contents

PAGING REQUEST TYPE 1

Information element	Value/remark
L2 pseudo length	k+3 where k is the sum of the length of the mobile identity 1 IE
Page Mode	Normal paging
Channels needed for Mobiles 1 and 2	
Channel (first)	Any channel
Channel (second)	(spare)
Mobile identity 1	IMSI or TMSI of MS under test
Mobile identity 2	Omitted
P1 rest octets	not all octets are "0010 1011"

26.5.7.1.2 Spare bits / RR / BCCH

26.5.7.1.2.1 Conformance requirements

The MS shall ignore the value of spare bits.

References

GSM 04.08, section 10.5.

26.5.7.1.2.2 Test purpose

To verify that the MS in the MM-state "idle, updated" and in RR-idle mode ignores the value of spare bits in the special case where these spare bits are contained in the SI3 and SI4 messages. That the MS ignores the value of the spare bits is checked by changing the LAI in those message and observing the MS initiating a location update though the spare bits do not all have the default value.

26.5.7.1.2.3 Method of test

Initial conditions

System Simulator:

1 cell, default parameters.

Mobile Station:

The MS is in the MM-state "idle, updated" and in RR-idle mode.

Related PICS/PIXIT statements

None.

Foreseen Final State of the MS

The MS is in the MM-state "idle, updated" and in RR-idle mode.

Test Procedure

The SS simulates a BCCH where continuously for at least 30 seconds at least one octet of the SI3 Rest Octets IE in all SYSTEM INFORMATION TYPE 3 messages and at least one octet of the SI4 Rest Octets IE in all SYSTEM INFORMATION TYPE 4 messages is different from 0010 1011 and the location area identification IE denotes a location area different from the current location area held by the MS. The SS verifies that the MS sends a CHANNEL REQUEST message on the RACH including the establishment cause "location updating". The SS responds with an IMMEDIATE ASSIGNMENT REJECT message.

Maximum duration of test

10 s.

Expected sequence

Step	Direction	Message	Comments
1	SS -> MS		The SS starts sending modified SYSTEM INFORMATION TYPE 3 and SYSTEM INFORMATION TYPE 4 messages (as defined below) continuously for at least 30 seconds on the BCCH. Establishment cause = "location updating (SDCCH needed). This message may be received during the 30 seconds.
2	MS -> SS	CHANNEL REQUEST	
3	SS -> MS	IMMEDIATE ASSIGNMENT REJECT	

Specific message contents

SYSTEM INFORMATION TYPE 3

Information element	value/remark
L2 pseudo length	18
cell identity	as required
location area identification	denoting a new location area
control channel description	as required, but with the spare bits arbitrarily selected and at least one spare bit set to 1.
cell options	as required, but with (spare) bit 8 set to 1
cell selection parameters	as required
RACH control parameters	as required
SI3 rest octets	at least one octet is different from "0010 1011"

SYSTEM INFORMATION TYPE 4

Information element	value/remark
L2 pseudo length	12
location area identification	denoting a new location area
cell selection parameters	as required
RACH control parameters	as required
SI4 rest octets	at least one octet is different from "0010 1011"

26.5.7.1.3 Spare bits / RR / AGCH

26.5.7.1.3.1 Conformance requirements

The MS shall ignore the value of spare bits.

References

GSM 04.08, section 10.5.

26.5.7.1.3.2 Test purpose

To verify that the MS in the MM-state "idle, updated" and in RR-idle mode ignores the value of spare bits in the special case of the spare bits occurring in the Page Mode IE, the Spare Half Octet IE, the Channel Description IE, the Timing Advance IE, the IA Rest Octet IE, and in the IAR Rest Octet IE.

26.5.7.1.3.3 Method of test

Initial conditions

System Simulator:

1 cell, default parameters.

Mobile Station:

The MS is in the MM-state "idle, updated" and in RR-idle mode.

Related PICS/PIXIT statements

None.

Foreseen Final State of the MS

The MS is in the MM-state "idle, updated" and in RR-idle mode.

Test Procedure

The SS sends an IMMEDIATE ASSIGNMENT message containing arbitrary spare bits in the Page Mode IE, in the Spare Half Octet IE, in the Channel Description IE, in the Timing Advance IE, and in the IA Rest Octet IE.

It is checked that the MS answers on the dedicated channel with a PAGING RESPONSE message and releases the main signalling link after a CHANNEL RELEASE message.

After a new paging of the MS an IMMEDIATE ASSIGNMENT REJECT is sent to test the spare bits in the IAR Rest Octet IE.

The MS is then paged again to check the idle state.

Maximum duration of test

20 s.

Expected sequence

Step	Direction	Message	Comments
1	SS -> MS	PAGING REQUEST TYPE 1	Addressing the MS under test
2	MS -> SS	CHANNEL REQUEST	
3	SS -> MS	IMMEDIATE ASSIGNMENT	
4	MS -> SS	PAGING RESPONSE	
5	SS -> MS	CHANNEL RELEASE	
6	SS		
7	SS -> MS	PAGING REQUEST TYPE 1	The SS checks that the MS releases the main signalling link and waits 10 seconds for a cell reselection of the MS
8	MS -> SS	CHANNEL REQUEST	Addressing the MS under test
9	SS -> MS	IMMEDIATE ASSIGNMENT REJECT	normal, waiting time = 0, except the IAR Rest Octet IE (see below)
10	SS		The SS waits six seconds
11	SS -> MS	PAGING REQUEST TYPE 1	Addressing the MS under test
12	MS -> SS	CHANNEL REQUEST	To check that the MS has reached the idle state after the IMMEDIATE ASSIGNMENT REJECT

Specific message contents

IMMEDIATE ASSIGNMENT

Information element	Value/remark
L2 pseudo length	sum of the length of all IE except L2 pseudo length and IA Rest Octets
Protocol Discriminator	RR
Skip Indicator	0000
Message Type	Immediate Assignment
Page mode	xx00 (where "xx" is arbitrary, with at least 1 bit set to 1)
Spare half octet	xxxx (where "xxxx" is arbitrary, with at least 1 bit set to 1)
Channel description	normal, no hopping, the two spare bits before ARFCN are chosen arbitrarily with at least one bit set to 1.
Request reference	normal (derived from the CHANNEL REQUEST)
Timing advance	xx00 0000 (where "xx" is arbitrary, with at least 1 bit set to 1)
Mobile allocation Length	chosen so that, together with the channel description 0
IA rest octets first octet	00xx xxxx (where "xx xxxx" is arbitrary but different to 10 1011)
other octets	xxxx xxxx (where "xxxx xxxx" is arbitrary but different to 0010 1011)

IMMEDIATE ASSIGNMENT REJECT

Information element	Value/remark
L2 pseudo length	19
Page mode	normal
Spare half octet	xxxx (where "xxxx" is arbitrary, with at least 1 bit is set to 1)
Request reference 1	addressing the MS under test
Wait indication 1	0 seconds
...	Other Request References and Wait Indications arbitrary
IAR rest octets	
Octet 1 to 3	xxxx xxxx (where "xxxx xxxx" is arbitrary but different to 0010 1011)

26.5.7.1.4 Spare bits / RR / Connected Mode

26.5.7.1.4.1 Conformance requirements

The MS shall ignore the value of spare bits.

References

GSM 04.08, section 10.5.

26.5.7.1.4.2 Test purpose

To verify that the MS in the MM-state "MM-Connection active" and in RR-Connected mode ignores the value of spare bits in the special case of the spare bits occurring in the Cell Channel Description IE and in the Power Command IE.

26.5.7.1.4.3 Method of test

Initial conditions

System Simulator:

1 cell, default parameters, except:

GSM 450 mobiles are assigned to ARFCN 293 in step 10.

GSM 480 mobiles are assigned to ARFCN 340 in step 10.

PGSM and EGSM mobiles are assigned to ARFCN 124 in step 10.

DCS 1 800 and PCS 1900 mobiles are assigned to ARFCN 801 in step 10.

Mobile Station:

The MS is in the MM-state "idle, updated" and in RR-idle mode.

Related PICS/PIXIT statements

Mobile's frequency capabilities, GSM 450 or GSM 480 or PGSM or EGSM or DCS 1 800 or PCS 1900.

Foreseen Final State of the MS

The MS is in the MM-state "idle, updated" and in RR-idle mode.

Test Procedure

In the procedure of a normal call establishment the ASSIGNMENT COMMAND will be modified to test the spare bits in the Cell Channel Description IE and in the Power Command IE.

Maximum duration of test

10 s.

Expected sequence

Step	Direction	Message	Comments
1	SS -> MS	PAGING REQUEST TYPE 1	Addressing the MS under test
2	MS -> SS	CHANNEL REQUEST	
3	SS -> MS	IMMEDIATE ASSIGNMENT	
4	MS -> SS	PAGING RESPONSE	
5	SS -> MS	CIPHERING MODE COMMAND	
6	MS -> SS	CIPHERING MODE COMPLETE	
7	SS -> MS	SETUP	
8	MS -> SS	CALL CONFIRMED	
A9	MS -> SS	ALERTING	
B9	MS ->SS	CONNECT	
10	SS -> MS	ASSIGNMENT COMMAND	see below on the dedicated channel The SS checks that the MS release the main signalling link
11	MS -> SS	ASSIGNMENT COMPLETE	
12	SS -> MS	CHANNEL RELEASE	
13	SS		

Specific message contents

ASSIGNMENT COMMAND

For GSM 450 mobiles

Information element	Value/remark
Channel Description Power Command	normal, hopping HSN=63, MAIO=0 xxx0 0111 (where "xxx" is arbitrary, with at least 1 bit set to 1)
Cell Channel Description octet 2	10xx 110? (where "xx" is arbitrary, with at least 1 bit set to 1) Bit 1 of octet 2 and all of octets 3 to 17 (inclusive) indicate ARFCN 293 only (using the Range 128 format).
Mobile Allocation	indicates ARFCN 293 only

For GSM 480 mobiles

Information element	Value/remark
Channel Description Power Command	normal, hopping HSN=63, MAIO=0 xxx0 0111 (where "xxx" is arbitrary, with at least 1 bit set to 1)
Cell Channel Description octet 2	10xx 110? (where "xx" is arbitrary, with at least 1 bit set to 1) Bit 1 of octet 2 and all of octets 3 to 17 (inclusive) indicate ARFCN 340 only (using the Range 128 format).
Mobile Allocation	indicates ARFCN 340 only

For PGSM and EGSM mobiles

Information element	Value/remark
Channel Description Power Command	normal, hopping HSN=63, MAIO=0 xxx0 0111 (where "xxx" is arbitrary, with at least 1 bit set to 1)
Cell Channel Description octet 2	00xx 1000 (where "xx" is arbitrary, with at least 1 bit set to 1)
octet 3 to 17 (inclusive)	all bits set to zero
Mobile Allocation	indicates ARFCN 124 only

For DCS 1 800 or PCS 1900 mobiles

Information element	Value/remark
Channel Description Power Command	normal, hopping, HSN=63, MAIO=0 xxx0 0111 (where "xxx" is arbitrary, with at least 1 bit set to 1)
Cell Channel Description octet 2	10xx 111? (where "xx" is arbitrary, with at least 1 bit set to 1). Bit 1 of octet 2 and all of octets 3 to 17 (inclusive) indicate ARFCN 801 only (using the variable bit map format).
Mobile Allocation	indicates ARFCN 801 only

26.5.7.2 Spare bits / MM

26.5.7.2.1 Conformance requirements

The MS shall ignore the value of spare bits.

References

GSM 04.08, section 10.5.

26.5.7.2.2 Test purpose

To verify that the MS in the MM-state "wait net cmd" and in RR-Connected mode ignores the value of spare bits in the special case of the spare bits occurring in the Cipher Key Seq. Number IE or in the Identity Type IE.

26.5.7.2.3 Method of test

Initial conditions

System Simulator:

1 cell, default parameters.

Mobile Station:

The MS is in the MM-state "idle, updated" and in RR-idle mode.

Related PICS/PIXIT statements

None.

Foreseen Final State of the MS

The MS is in the MM-state "idle, updated" and in RR-idle mode.

Test Procedure

After the establishment of the RR-connection, in the AUTHENTICATION REQUEST message the spare bits of the Ciphering Key Sequence Number and of the Spare Half Octet IE will be randomly chosen. The spare bits of the Identity Type IE and the Spare Half Octet IE in the IDENTITY REQUEST message will also be chosen arbitrarily.

Maximum duration of test

10 s.

Expected sequence

Step	Direction	Message	Comments
1	SS -> MS	PAGING REQUEST TYPE 1	Addressing the MS under test
2	MS -> SS	CHANNEL REQUEST	
3	SS -> MS	IMMEDIATE ASSIGNMENT	
4	MS -> SS	PAGING RESPONSE	
5	SS -> MS	AUTHENTICATION REQUEST	see below
6	MS -> SS	AUTHENTICATION RESPONSE	
7	SS -> MS	IDENTITY REQUEST	see below with the right TMSI
8	MS -> SS	IDENTITY RESPONSE	
9	SS -> MS	CHANNEL RELEASE	The SS checks that the MS release the main signalling link
10	SS		

Specific message contents

AUTHENTICATION REQUEST

Information element	Value/remark
Ciphering Key Sequence Number	x000 (where "x" is set to 1)
Spare Half Octet	xxxx (where "xxxx" is arbitrary, with at least 1 bit set to 1)
Auth. Parameter RAND	standard value

IDENTITY REQ

Information element	Value/remark
Identity Type	x100 (where "x" is set to 1)
Spare Half Octet	xxxx (where "xxxx" is arbitrary, with at least 1 bit set to 1)

26.5.7.3 Spare bits / CC

This test is applicable to all MS supporting at least one MT circuit switched basic service.

26.5.7.3.1 Conformance requirements

The MS shall ignore the value of spare bits.

References

GSM 04.08, section 10.5.

26.5.7.3.2 Test purpose

To verify that the MS in the MM-state "connection established" and in RR-Connected mode ignores the value of spare bits in the special case of the spare bits occurring in the Calling Party BCD Number IE, Calling Party Subaddress IE, Called Party Subaddress IE, Cause IE and Progress Indicator IEs.

26.5.7.3.3 Method of test

Initial conditions

System Simulator:

1 cell, default parameters.

Mobile Station:

The MS is in the MM-state "idle, updated" and in RR-idle mode.

Related PICS/PIXIT statements

At least one circuit switched basic service supported.

MT calls supported.

Foreseen Final State of the MS

The MS is in the MM-state "idle, updated" and in RR-idle mode.

Test Procedure

After the establishment of the MM-connection, in the SETUP message the spare bits of the Calling Party BCD Number, Calling Party Subaddress and Called Party Subaddress will be arbitrarily chosen and also in the DISCONNECT message the spare bits of the Progress Indicator IE and of the Cause IE will be arbitrarily chosen.

Maximum duration of test

10 s.

Expected sequence

Step	Direction	Message	Comments	
1	SS -> MS	PAGING REQUEST TYPE 1	Addressing the MS under test	
2	MS -> SS	CHANNEL REQUEST		
3	SS -> MS	IMMEDIATE ASSIGNMENT		
4	MS -> SS	PAGING RESPONSE		
5	SS -> MS	AUTHENTICATION REQUEST		
6	MS -> SS	AUTHENTICATION RESPONSE		
7	SS -> MS	CIPHERING MODE COMMAND		
8	MS -> SS	CIPHERING MODE COMPLETE		
9	SS -> MS	SETUP		see below
10	MS -> SS	CALL CONFIRMED		
A11	MS -> SS	CONNECT		
B11	MS -> SS	ALERTING		
B12	MS -> SS	CONNECT		
13	SS -> MS	ASSIGNMENT COMMAND	see below with actual call state U12	
14	MS -> SS	ASSIGNMENT COMPLETE		
15	SS -> MS	CONNECT ACKNOWLEDGE		
16	SS -> MS	DISCONNECT		
17	SS -> MS	STATUS ENQUIRY		
18	MS -> SS	STATUS		
19	SS -> MS	RELEASE		
20	MS -> SS	RELEASE COMPLETE		
21	SS -> MS	CHANNEL RELEASE		

Specific message contents

SETUP

Information element	Value/remark
Calling Party BCD Number	
IEI	
length	3
octet 3	0000 0000
octet 3a	100x xx00 (where "x" is chosen arbitrarily, with at least one bit set to 1)
octet 4	0000 0001
Calling Party Subaddress	
IEI	
length	3
octet 3	1000 0xxx (where "x" is chosen arbitrarily, with at least one bit set to 1)
octet 4	0101 0000 (AFI: request IA5 character)
octet 5	0000 0001
Called Party Subaddress	
IEI	
length	3
octet 3	1000 0xxx (where "x" is chosen arbitrarily, with at least one bit set to 1)
octet 4	0101 0000 (AFI: request IA5 character)
octet 5	0000 0001

DISCONNECT

Information element	Value/remark
Cause	
Length	2
octet 3	111x 0000 (where "x" is set to 1)
octet 4	1000 0001
Progress Indicator	
IEI	
Length	2
octet 3	111x 0000 (where "x" is set to 1)
progress description	8 (in band info now available)

26.5.8 Default contents of messages

Default requirements for messages that are not mentioned in this section are given in section 26.8.4.

CHANNEL RELEASE

Information element	Value/remark
RR cause	Normal event

CHANNEL REQUEST

DISCONNECT (SS -> MS)

Information element	Value/remark
Cause	
Coding standard	Standard defined for the GSM PLMNS
Location	user
Cause value	#16

IDENTITY REQUEST

Information element	Value/remark
Identity type	Depending on test
Spare half octet	0000

IMMEDIATE ASSIGNMENT

Information element	Value/remark
L2 pseudo length	n, where n is the L2 pseudo length of the message
Page mode	arbitrary
Spare half octet	0000
Channel description	a valid description of an SDCCH + SACCH
Request reference	Corresponding to the last CHANNEL REQUEST received from the MS
Timing advance	arbitrary
Mobile allocation	chosen so that, together with the channel description IE, it describes a valid SDCCH + SACCH
Starting time	Omitted
IA rest octets	m octets, each coded as H'2B, where m = 22 - n

IMMEDIATE ASSIGNMENT REJECT

Information element	Value/remark
L2 pseudo length	19
Page mode	arbitrary
Spare half octet	0000
Request reference 1	corresponding to the last CHANNEL REQUEST received from the MS
Wait indication 1	0 seconds
Request reference 2	arbitrary
Wait indication 2	0 seconds
Request reference 3	arbitrary
Wait indication 3	0 seconds
Request reference 4	arbitrary
Wait indication 4	0 seconds
IA rest octets	3 octets, each coded as H'2B

PAGING REQUEST TYPE 1

Information element	Value/remark
L2 pseudo length	n where n is the sum of the mobile identity 1 IE and 3
Page Mode	Normal paging
Channels needed for Mobiles 1 and 2	
Channel (first)	Any channel
Channel (second)	(spare)
Mobile identity 1	IMSI or TMSI of MS under test
Mobile identity 2	Omitted
P1 rest octets	m octets, each coded as H'2B, where m = 22 - n

PAGING RESPONSE

RELEASE COMPLETE (MS -> SS)

No default requirements defined for this message.

RELEASE COMPLETE (SS -> MS)

Information element	Value/remark
Cause	
Coding standard	Standard defined for the GSM PLMNS
Location	user
Cause value	#16

STATUS (MS -> SS)

Information element	Value/remark
Cause	
Length	length of cause IE
Coding standard	Standard defined for the GSM PLMNS
Location	user
Cause value	as defined in test
Call state	as defined in test

STATUS ENQUIRY (SS -> MS)

Information element	Value/remark
Transaction identifier	relating to the active call

26.6 Test of the elementary procedures for radio resource management

NOTE: For SS implementor: if tests are concatenated, it is important that unused fields in IMMEDIATE ASSIGNMENT REJECT messages do not use Request References that relate to CHANNEL REQUEST messages recently transmitted by the MS.

26.6.1 Immediate assignment

The immediate assignment procedure is used by the network to establish a dedicated control channel for the MS and network to communicate the detail of the service requested. If the Mobile Station does not implement the procedure correctly, radio resources can be wasted as the Mobile Station might use the wrong channels.

26.6.1.1 Immediate assignment / SDCCH or TCH assignment

26.6.1.1.1 Conformance requirement

1. Following a PAGING REQUEST message, the MS shall correctly set up an RR connection on the SDCCH/8 described in the IMMEDIATE ASSIGNMENT message.
2. Following a PAGING REQUEST message, the MS shall correctly set up an RR connection on the TCH/FACCH described in the IMMEDIATE ASSIGNMENT message.

Reference(s)

GSM 04.08 section 3.3.1.1.2

26.6.1.1.2 Test purpose

To verify that the MS can correctly set up a dedicated SDCCH control channel and that the MS can correctly set up a dedicated TCH/FACCH control channel.

26.6.1.1.3 Method of test

Initial Conditions

System Simulator:

1 cell, except that CCCH_CONF is set to "1 basic physical channel used for CCCH not combined with SDCCHs".

Mobile Station:

The MS is in the "idle, updated" state, with a TMSI allocated.

Related PICS/PIXIT Statement(s)

Type of MS (GSM 450 or GSM 480 or P-GSM 900 or EGSM or DCS 1 800 or PCS 1900).

Support rate(s) of TCH: TCH/F and/or TCH/H.

Foreseen Final State of the MS

"Idle, updated", with TMSI allocated.

Test Procedure

The System Simulator pages the MS and after the MS has responded with a CHANNEL REQUEST message the SS assigns an SDCCH. The MS shall go to the correct channel and send a PAGING RESPONSE message. Then the SS initiates RR-release by sending a CHANNEL RELEASE message.

If TCH/F is supported by the MS, the test is repeated with the SS assigning a TCH/F.

If TCH/H is supported by the MS, the test is repeated with the SS assigning a TCH/H.

Maximum Duration of Test

6 seconds per value of the execution timer.

Expected Sequence

This sequence is performed for execution counter, K = 1, 2, 3 (unless the TCH is not supported).

Step	Direction	Message	Comments
1	SS -> MS	PAGING REQUEST TYPE 1	
2	MS -> SS	CHANNEL REQUEST	
3	SS -> MS	IMMEDIATE ASSIGNMENT	Channel Type: see below
4	MS -> SS	PAGING RESPONSE	Shall be sent on the correct channel
5	SS -> MS	CHANNEL RELEASE	

Specific Message Contents

IMMEDIATE ASSIGNMENT

K=1, SDCCH test: Channel Type = SDCCH/8

K=2, TCH/F test: Channel Type = Bm + ACCHs

K=3, TCH/H test: Channel Type = Lm + ACCHs, subchannel arbitrarily chosen

26.6.1.2 Immediate assignment / extended assignment

NOTE 2: In these tests the SS must send the immediate assignment messages in due time to allow for the MS to receive them and send a PAGING RESPONSE rather than another random access. This applies to the whole of section 26.

26.6.1.2.1 Conformance requirements

1. The MS shall go to the allocated SDCCH/4 and send a PAGING RESPONSE message containing its identity and its classmark.
2. The MS shall go to the allocated SDCCH/8 and send a PAGING RESPONSE message containing its identity and its classmark.
3. The MS shall correctly identify its own assignment in either the Request Reference 1 or the Request Reference 2 information element in an extended assignment message.
4. The MS shall only react to an Immediate Assignment which references one of the last 3 CHANNEL REQUEST messages from the MS.

References

GSM 04.08 section 3.3.

26.6.1.2.2 Test purpose

To verify that the MS goes to the allocated SDCCH/4 and sends a PAGING RESPONSE message containing its identity and its classmark.

To verify that the MS goes to the allocated SDCCH/8 and sends a PAGING RESPONSE message containing its identity and its classmark.

To verify that the MS can correctly identify its own assignment in either the Request Reference 1 or the Request Reference 2 information element in an extended assignment message.

To verify that the MS only reacts to an Immediate Assignment which references one of the last 3 CHANNEL REQUEST messages from the MS.

26.6.1.2.3 Method of test

Initial Conditions

System Simulator:

1 cell, Max-retrans is set to 7.

Mobile Station:

The MS is in the "idle, updated" state. with a TMSI allocated.

Related PICS/PIXIT Statements

Type of MS (GSM 450 or GSM 480 or P-GSM 900 or EGSM or DCS 1 800 or PCS 1900).

Foreseen Final State of the MS

"Idle, updated", with a TMSI allocated.

Test Procedure

In the first part of the test, the SS pages the MS, which shall react by sending CHANNEL REQUEST messages. Immediately after reception of the n-th CHANNEL REQUEST message (n being arbitrarily chosen by the SS from the set {1, 2 ... 8}) the SS sends an IMMEDIATE ASSIGNMENT EXTENDED message, which references one of the last 3 CHANNEL REQUEST messages from the MS. The MS shall then go to the correct channel and send a PAGING RESPONSE message. The SS will then release the channel.

In the second part of the test, the SS again pages the MS, which shall react by sending CHANNEL REQUEST messages. Immediately after reception of the k-th CHANNEL REQUEST message (k being arbitrarily chosen by the SS from the set {4, 5 ... 8}) the SS sends an IMMEDIATE ASSIGNMENT EXTENDED message which, instead of referencing one of the last 3 CHANNEL REQUEST messages from the MS, references an earlier CHANNEL REQUEST message. The MS shall then ignore the IMMEDIATE ASSIGNMENT EXTENDED message and continue to send CHANNEL REQUEST messages until the Max-Retrans value has been reached. Then a period of 7 seconds shall elapse in order to allow the MS to perform cell reselection (this allows for the time between the last CHANNEL REQUEST message and the beginning of cell reselection).

In the third part of the test, the CCCH_CONF of the SS is set to non-combined and the SS pages the MS, which shall react by sending CHANNEL REQUEST messages. Immediately after reception of the r-th CHANNEL REQUEST message (r being arbitrarily chosen by the SS from the set {4, 5 ... 8}) the SS sends an IMMEDIATE ASSIGNMENT EXTENDED message which, in the second request reference, references one of the last 3 CHANNEL REQUEST messages from the MS. The associated Channel Description allocates SDCCH(S) (S being arbitrarily chosen by the SS from the set {0,1 ... 7}). The MS shall then go to the correct channel and send a PAGING RESPONSE message. The SS will then release the channel.

Maximum Duration of Test

90 seconds.

Expected Sequence

Step	Direction	Message	Comments
1	SS -> MS	PAGING REQUEST TYPE 1	
2	MS -> SS	CHANNEL REQUEST	n CHANNEL REQUESTs (n being arbitrarily chosen from {1... 8}) are sent, all with Establ. Cause = "Answer to paging".
3	MS -> SS	CHANNEL REQUEST	
4	SS -> MS	IMMEDIATE ASSIGNMENT EXTENDED	see note 3.
5	MS -> SS	PAGING RESPONSE	
6	SS -> MS	CHANNEL RELEASE	
7	-----	-----	The SS waits 12 seconds to allow the MS to perform cell reselection.
8	SS -> MS	PAGING REQUEST TYPE 1	
9	MS -> SS	CHANNEL REQUEST	k CHANNEL REQUESTs (k being arbitrarily chosen from the set {4, 5, 8}) are sent all with Establ. Cause = "Answer to paging".
10	MS -> SS	CHANNEL REQUEST	
11	SS -> MS	IMMEDIATE ASSIGNMENT EXTENDED	see note 4.
12	MS -> SS	CHANNEL REQUEST	8-k CHANNEL REQUESTs are sent, all with Establ. Cause = "Answer to paging".
13	MS -> SS	CHANNEL REQUEST	
14	SS		The SS verifies that the MS does not transmit any Layer 2 frames for at least 3 seconds.
15	SS		The SS sets CCCH_CONF to non-combined.
16	SS		The SS waits 40 seconds to allow the MS to perform cell reselection and to read the BCCH information.
17	SS -> MS	PAGING REQUEST TYPE 1	
18	MS -> SS	CHANNEL REQUEST	r CHANNEL REQUESTs (r being arbitrarily chosen from {4, 5... 8}) are sent, all with Establ. Cause = "Answer to paging".
19	MS -> SS	CHANNEL REQUEST	
20	SS -> MS	IMMEDIATE ASSIGNMENT EXTENDED	see note 5.
21	MS -> SS	PAGING RESPONSE	
22	SS -> MS	CHANNEL RELEASE	

Specific Message Contents

NOTE 3: The first Request Reference is the one which pertains to the i-th CHANNEL REQUEST sent by the MS, where i is an integer in the set {max (1,n-2) ... n}, its value being arbitrarily chosen by the SS. The second Request Reference shall be different from any Request Reference the MS has generated in this test.

NOTE 4: The first Request Reference is the one which pertains to the i-th CHANNEL REQUEST sent by the MS, where i is an integer in the set {1 ... k-3}, its value being arbitrarily chosen by the SS. The second Request Reference shall be different from any Request Reference the MS has generated in this test.

NOTE 5: The second Request Reference is the one which pertains to the i-th CHANNEL REQUEST sent by the MS, where i is an integer in the set {r-2, r-1, r}, its value being arbitrarily chosen by the SS. The first Request Reference shall be different from any Request Reference the MS has generated in this test.

26.6.1.3 Immediate assignment / assignment rejection

26.6.1.3.1 Conformance requirements

1. The MS shall respond to the Paging Request message by sending a Channel Request message with establishment cause set to "Answer to Paging". After the reception of IMMEDIATE ASSIGNMENT REJECT, the MS shall not transmit during the time indicated in the "Wait Indication" field of the IMMEDIATE ASSIGNMENT REJECT message, and then it shall answer to the new paging requests.
2. After an assignment rejection, the MS shall perform a cell reselection (idle mode operation) and the MS shall not transmit unless a different cell is selected.

References

GSM 04.08, section 3.3.1.1.3 and GSM 04.13 section 5.2.2.

26.6.1.3.2 Test purpose

To verify that the MS can accept an IMMEDIATE ASSIGNMENT REJECT.

To verify that the MS can respond to paging after an IMMEDIATE ASSIGNMENT REJECT is received on a different cell.

26.6.1.3.3 Method of test

Initial Conditions

System Simulator:

2 cells with the same LAI, Max-Retrans is 7.

Mobile Station:

The MS is camped on cell A and is in the "idle, updated" state, with a TMSI allocated.

Related PICS/PIXIT Statements

Type of MS (GSM 450 or GSM 480 or P-GSM 900 or EGSM or DCS 1 800 or PCS 1900).

Foreseen Final State of the MS

The MS is camped on cell B and is in the "idle, updated" state, with a TMSI allocated.

Test Procedure

The SS pages the MS, which shall react by sending CHANNEL REQUESTs. Immediately after reception of the n-th CHANNEL REQUEST (n being an integer from the set {1, 2 ... 8}, arbitrarily chosen by the SS) the SS sends an IMMEDIATE ASSIGNMENT REJECT message, which references one of the last 3 CHANNEL REQUESTs from the MS, and with the Wait Indication set to x seconds (x being an integer from the set {5, 6 ... 255}, arbitrarily chosen by the SS). The SS continues to send paging messages for that mobile station in every block of the mobile station's paging subgroup for x+2 seconds. The MS shall not answer to the PAGING REQUEST TYPE 1 messages sent before x seconds have elapsed. The MS may respond to any one of the PAGING REQUEST TYPE 1 messages sent after x seconds have elapsed, but at the latest it shall respond to the first PAGING REQUEST TYPE 1 sent after x+1 seconds have elapsed.

The SS responds to this CHANNEL REQUEST with an IMMEDIATE ASSIGNMENT REJECT message with the Wait Indication set to 255 seconds.

Immediately afterwards the SS changes the power levels so the MS selects cell B. After 20 seconds have elapsed the SS pages the MS in cell B and the MS shall answer to this page. In order to avoid another cell reselection the SS then sends another IMMEDIATE ASSIGNMENT REJECT.

Maximum Duration of Test

5 minutes.

Expected Sequence

Step	Direction	Message	Comments
1	SS -> MS	PAGING REQUEST TYPE 1	<p>n CHANNEL REQUESTs (n being arbitrarily chosen from the set {1, 2 ... 8}) are sent, all with Establ. Cause = "Answer to paging"</p> <p>1st, 3rd and 4th Request References are different to all n Request References received from the MS under test. 2nd Request Reference: see note 6. 2nd Wait Indication = x seconds (x being arbitrarily chosen from the set {5, 6 ... 255}).</p> <p>The SS repeatedly pages the MS (on its paging subchannel) until a CHANNEL REQUEST message is received from the MS.</p> <p>(note 7).</p> <p>Establ. Cause = "Answer to paging".</p> <p>The MS may respond to any one of the PAGING REQUEST TYPE 1 messages sent after x seconds expire, but at the latest the MS shall respond to the first PAGING REQUEST TYPE 1 message sent after x+1 seconds expire.</p> <p>1st, 2nd and 4th Request References are different to all n Request References received from the MS. The 3rd Request Reference pertains to the last CHANNEL REQUEST sent by the MS. The 3rd Wait Indication is 255 seconds.</p> <p>Raise power level of cell B, lower power level of cell A until the MS selects cell B.</p> <p>Sent once, 20 seconds after the change of levels.</p> <p>Establ. Cause = "Answer to paging".</p>
2	MS -> SS	CHANNEL REQUEST	
.	.	.	
1+n	MS -> SS	CHANNEL REQUEST	
2+n	SS -> MS	IMMEDIATE ASSIGNMENT REJECT	
3+n	SS -> MS	PAGING REQUEST TYPE 1	
.	.	.	
k	SS -> MS	PAGING REQUEST TYPE 1	
k+1	MS -> SS	CHANNEL REQUEST	
k+2	SS -> MS	IMMEDIATE ASSIGNMENT REJECT	
k+3	-----	-----	
k+4	SS -> MS	PAGING REQUEST TYPE 1	
k+5	MS -> SS	CHANNEL REQUEST	
k+6	SS -> MS	IMMEDIATE ASSIGNMENT REJECT	

NOTE 6: The Request Reference is the one which pertains to the i-th CHANNEL REQUEST sent by the MS, where i is an integer from the set {max(1,n-2) ... n}, its value being arbitrarily chosen by the SS.

NOTE 7: the value of k is not important in this test.

Specific Message Contents

None.

26.6.1.4 Immediate assignment / ignore assignment

26.6.1.4.1 Conformance requirements

1. An MS waiting for a response from the network, following the sending of a CHANNEL REQUEST, shall ignore an IMMEDIATE ASSIGNMENT message with a request reference containing a wrong frame number.
2. An MS is waiting for an assignment of its own, shall ignore an IMMEDIATE ASSIGNMENT message with a request reference containing a wrong random access information.

References

GSM 04.08 section 3.3.1.1.2

26.6.1.4.2 Test purpose

To verify that the MS ignores an assignment for another MS while it is waiting for an assignment of its own.

26.6.1.4.3 Method of test

Initial Conditions

System Simulator:

1 cell.

Mobile Station:

The MS is in the "idle, updated" state, with a TMSI allocated.

Related PICS/PIXIT Statements

Type of MS (GSM 450 or GSM 480 or P-GSM 900 or EGSM or DCS 1 800 or PCS 1900).

Foreseen Final State of the MS

"Idle, updated", with TMSI allocated.

Test Procedure

The SS pages the MS, which reacts with CHANNEL REQUESTs. The SS responds to the first CHANNEL REQUEST with an IMMEDIATE ASSIGNMENT containing a wrong Request Reference (in the first run of the test the frame number is wrong, in the repetition it is the random access info that is wrong). It is verified for 2 seconds that the MS does not start signalling on the SDCCH. The MS shall ignore the assignment and send another CHANNEL REQUEST message. In order to avoid cell reselection the SS now answers with a correct IMMEDIATE ASSIGNMENT REJECT and repeats the test once.

Maximum Duration of Test

12 seconds.

Expected Sequence

Step	Direction	Message	Comments
1	SS -> MS	PAGING REQUEST TYPE 1	
2	MS -> SS	CHANNEL REQUEST	Establ. Cause = "Answer to paging".
3	SS -> MS	IMMEDIATE ASSIGNMENT	Frame number in Request Reference is 2 too high. The MS shall not start signalling on the assigned SDCCH. This is verified for a period of 2 seconds.
4	MS -> SS	CHANNEL REQUEST	Establ. Cause = "Answer to paging".
5	SS -> MS	IMMEDIATE ASSIGNMENT REJECT	
6	SS		SS waits for 6 seconds.
7	SS -> MS	PAGING REQUEST TYPE 1	
8	MS -> SS	CHANNEL REQUEST	Establ. Cause = "Answer to paging".
9	SS -> MS	IMMEDIATE ASSIGNMENT	Random access info in Request Reference is wrong. The MS shall not start signalling on the assigned SDCCH. This is verified for a period of 2 seconds.
10	MS -> SS	CHANNEL REQUEST	Establ. Cause = "Answer to paging".
11	SS -> MS	IMMEDIATE ASSIGNMENT REJECT	

Specific Message Contents

None.

26.6.1.5 Immediate assignment after immediate assignment reject

26.6.1.5.1 Conformance requirement

Following an IMMEDIATE ASSIGNMENT REJECT message, the MS shall listen for IMMEDIATE ASSIGNMENTS until T3126 expires.

Reference

GSM 04.08 section 3.3.1.1.3

26.6.1.5.2 Test purpose

To verify that the MS correctly responds to an IMMEDIATE ASSIGNMENT message sent after an IMMEDIATE ASSIGNMENT REJECT message.

26.6.1.5.3 Method of test

Initial conditions

System Simulator:

1 cell;

CCCH_CONF is set to "1 basic physical channel used for CCCH not combined with SDCCHs";

Max retrans is set to 7;

TX-integer is set to 7;

Mobile Station:

The MS is in "idle, updated" state, with a TMSI allocated.

Related PICS/PIXIT statement(s)

Type of MS (GSM 450 or GSM 480 or P-GSM 900 or EGSM or DCS 1 800 or PCS 1900).

Foreseen final state of the MS

"idle, updated", with TMSI allocated.

Test Procedure

The SS pages the MS, which shall react by sending CHANNEL REQUESTs. Immediately after reception of the third CHANNEL REQUEST the SS sends an IMMEDIATE ASSIGNMENT REJECT message which references the first CHANNEL REQUEST from the MS and has the Wait Indication IE set to 6 seconds.

Between 0,75 seconds and 1,25 seconds after sending the IMMEDIATE ASSIGNMENT REJECT message the SS sends an IMMEDIATE ASSIGNMENT message referencing the second CHANNEL REQUEST message, and assigning an SDCCH. The MS shall go to the correct channel and send a PAGING RESPONSE message. Then the SS initiates RR-release by sending a CHANNEL RELEASE message.

Maximum duration of test

10 seconds.

Expected Sequence

Step	Direction	Message	Comments
1	SS -> MS	PAGING REQUEST TYPE 1	
2	MS -> SS	CHANNEL REQUEST	first request.
3	MS -> SS	CHANNEL REQUEST	second request.
4	MS -> SS	CHANNEL REQUEST	third request.
5	SS -> MS	IMMEDIATE ASSIGNMENT REJ	references the first request from MS, Wait Indication IE set to 6 seconds.
6	SS -> MS	IMMEDIATE ASSIGNMENT	references the second request from the MS Channel type set to SDCCH/8 message sent between 0,75 s and 1,25 s after the completion of step 5.
7	MS -> SS	PAGING RESPONSE	shall be sent on the correct channel.
8	SS -> MS	CHANNEL RELEASE	

Specific message contents

None.

26.6.2 Test of paging

The Paging procedure is used by the network to cause the Mobile Station to establish a radio connection. Normally the Mobile Station listens to its paging subchannel, but this can be modified by the use of different page modes. The correct implementation of the paging procedure in the Mobile Station is essential for the basic establishment of a connection.

26.6.2.1 Normal paging

26.6.2.1.1 Paging / normal / type 1

26.6.2.1.1.1 Conformance requirements

1. The MS shall respond correctly to various PAGING REQUEST TYPE 1 messages, when the page mode is set to normal paging, in the following cases:
 - 1.1 The MS is addressed with its IMSI in the first Mobile Identity field. The optional Mobile Identity field is not present.
 - 1.2. The MS is addressed with its TMSI in the first Mobile Identity field. The optional Mobile Identity field specifies an IMSI different from that of the MS.
 - 1.3. The first Mobile Identity field specifies a TMSI different from that of the MS. The optional Mobile Identity field addresses the MS by its IMSI.
 - 1.4 The first Mobile Identity field specifies a TMSI different from that of the MS. The optional Mobile Identity field contains the correct TMSI of the MS.
2. An MS shall ignore PAGING REQUEST TYPE 1 messages with incorrect information, when the page mode is set to normal paging, in the following case:
 - 2.1 The MS is addressed with its TMSI in the first Mobile Identity field, but the type of identity in this field is set to "No Identity". The optional Mobile Identity field is not present.

References

GSM 04.08 section 3.3.2, GSM 05.02 section 6.5.

26.6.2.1.1.2 Test purpose

To test that the MS is able to determine its CCCH group and paging group correctly and that the MS responds correctly to various PAGING REQUEST TYPE 1 messages when the page mode is set to normal paging. All valid ways of addressing the MS are tested. It is tested that the MS responds with the same type of identity that is used in the PAGING REQUEST TYPE 1 message. It is tested that the MS ignores fill paging.

26.6.2.1.1.3 Method of test

Initial Conditions

System Simulator:

1 cell, Max-Retrans = 2, a legal combination of CCCH_CONF, BS_AG_BLKs_RES and BS_PA_MFRMS is chosen arbitrarily by the SS.

Mobile Station:

The MS is in the "idle, updated" state, with a TMSI allocated.

Related PICS/PIXIT Statements

Type of MS (GSM 450 or GSM 480 or P-GSM 900 or EGSM or DCS 1 800 or PCS 1900).

Foreseen Final State of the MS

"Idle, updated", with TMSI allocated.

Test Procedure

The SS pages the MS 5 times with different PAGING REQUEST TYPE 1 messages on the paging subchannel which corresponds to the MS's IMSI.

In the first 4 cases, where the MS is addressed by its IMSI or its TMSI, the MS shall answer to the paging by sending CHANNEL REQUESTs. The SS responds to the second CHANNEL REQUEST by assigning a channel, and the MS shall then send a correct PAGING RESPONSE. The SS then releases the channel.

In the last case, it is tested that the MS does not answer to paging that does not address it.

Maximum Duration of Test

2 min.

Expected Sequence

Step	Direction	Message	Comments
1	SS -> MS	PAGING REQUEST TYPE 1	1st Mobile Ident contains IMSI of MS, 2nd Mobile Ident not present.
2	MS -> SS	CHANNEL REQUEST	Establ. Cause = "Answer to paging".
3	MS -> SS	CHANNEL REQUEST	Establ. Cause = "Answer to paging".
4	SS -> MS	IMMEDIATE ASSIGNMENT	Request Reference = pertaining to the message received in step 3.
5	MS -> SS	PAGING RESPONSE	Mobile Ident: IMSI.
6	SS -> MS	CHANNEL RELEASE	
	-----	-----	The SS waits 12 seconds to allow the MS to perform cell reselection.
7	SS -> MS	PAGING REQUEST TYPE 1	1st Mobile Ident contains TMSI of MS, 2nd Mobile Ident contains IMSI of another MS.
8	MS -> SS	CHANNEL REQUEST	Establ. Cause = "Answer to paging".
9	MS -> SS	CHANNEL REQUEST	Establ. Cause = "Answer to paging".
10	SS -> MS	IMMEDIATE ASSIGNMENT	Request Reference = pertaining to the message received in step 9.
11	MS -> SS	PAGING RESPONSE	Mobile Ident: TMSI.
12	SS -> MS	CHANNEL RELEASE	
	-----	-----	The SS waits 12 seconds to allow the MS to perform cell reselection.
13	SS -> MS	PAGING REQUEST TYPE 1	1st Mobile Ident contains TMSI of another MS, 2 nd Mobile Ident contains IMSI of MS.
14	MS -> SS	CHANNEL REQUEST	Establ. Cause = "Answer to paging".
15	MS -> SS	CHANNEL REQUEST	Establ. Cause = "Answer to paging".
16	SS -> MS	IMMEDIATE ASSIGNMENT	Request Reference = pertaining to the message received in step 15.
17	MS -> SS	PAGING RESPONSE	Mobile Ident: IMSI.
18	SS -> MS	CHANNEL RELEASE	
	-----	-----	The SS waits 12 seconds to allow the MS to perform cell reselection.
19	SS -> MS	PAGING REQUEST TYPE 1	1st Mobile Ident contains TMSI of another MS, 2 nd Mobile Ident contains TMSI of MS.
20	MS -> SS	CHANNEL REQUEST	Establ. Cause = "Answer to paging".
21	MS -> SS	CHANNEL REQUEST	Establ. Cause = "Answer to paging".
22	SS -> MS	IMMEDIATE ASSIGNMENT	Request Reference = pertaining to the message received in step 21.
23	MS -> SS	PAGING RESPONSE	Mobile Ident: TMSI.
24	SS -> MS	CHANNEL RELEASE	
	-----	-----	The SS waits 12 seconds to allow the MS to perform cell reselection.
25	SS -> MS	PAGING REQUEST TYPE 1	1st Mobile Ident contains TMSI of MS but with type of identity set to "no identity", second Mobile Ident not present.
26	-----	-----	During 1 second, the SS checks that the MS does not produce any Layer 3 messages.

Specific Message Contents

None.

26.6.2.1.2 Paging / normal / type 2

26.6.2.1.2.1 Conformance requirements

1. The MS shall respond correctly (by sending CHANNEL REQUEST messages with an Establishment Cause set to "Answer to Paging") to various PAGING REQUEST TYPE 2 messages, when the page mode is set to normal paging, in the following cases:
 - 1.1 The MS is addressed in the first TMSI field.
 - 1.2 The MS is addressed in the second TMSI field.
 - 1.3 The MS is addressed in the optional Mobile Identity field with its TMSI.
 - 1.4 The MS is addressed in the optional Mobile Identity field with its IMSI.
2. The MS shall ignore PAGING REQUEST TYPE 2 messages with incorrect information, when the page mode is set to normal paging, in the following case:
 - 2.1 The MS is addressed in the optional Mobile Identity field with its TMSI, but the type of identity in this field is set to "No Identity".

References

GSM 04.08 section 3.3.2.

26.6.2.1.2.2 Test purpose

To test that the MS is able to determine its CCCH group and paging group correctly and that the MS responds correctly to various PAGING REQUEST TYPE 2 messages when the page mode is set to normal paging. All valid ways of addressing the MS are tested. It is tested that the MS responds with the same type of identity that is used in the PAGING REQUEST TYPE 2 message. It is tested that the MS ignores a PAGING REQUEST TYPE 2 message that does not address it.

26.6.2.1.2.3 Method of test

Initial Conditions

System Simulator:

1 cell, Max-Retrans = 2, a legal combination of CCCH_CONF, BS_AG_BLKES_RES and BS_PA_MFRMS is chosen arbitrarily by the SS.

Mobile Station:

The MS is in the "idle, updated" state, with a TMSI allocated.

Related PICS/PIXIT Statements

Type of MS (GSM 450 or GSM 480 or P-GSM 900 or EGSM or DCS 1 800 or PCS 1900).

Foreseen Final State of the MS

"Idle, updated", with TMSI allocated.

Test Procedure

The SS pages the MS 5 times with different PAGING REQUEST TYPE 2 messages on the paging subchannel which corresponds to the MS's IMSI.

In the first 4 cases, where the MS is addressed by its IMSI or by its TMSI, the MS shall answer to the paging by sending CHANNEL REQUESTs. The SS responds to the second request by assigning a channel, and the MS shall then send a correct PAGING RESPONSE. The SS then releases the channel.

In the last case, it is tested that the MS does not answer to paging that does not address it.

Maximum Duration of Test

5 minutes, including 1 minute for any necessary operator actions.

Expected Sequence

Step	Direction	Message	Comments
1	SS -> MS	PAGING REQUEST TYPE 2	1st TMSI addresses MS, 2nd TMSI addresses another MS, Mobile Identity IE not present.
2	MS -> SS	CHANNEL REQUEST	Establ. Cause = "Answer to paging".
3	MS -> SS	CHANNEL REQUEST	Establ. Cause = "Answer to paging".
4	SS -> MS	IMMEDIATE ASSIGNMENT	Request Reference = pertaining to the message received in step 3.
5	MS -> SS	PAGING RESPONSE	Mobile Ident: TMSI.
6	SS -> MS	CHANNEL RELEASE	
	-----	-----	The SS waits 12 seconds to allow the MS to perform cell reselection.
7	SS -> MS	PAGING REQUEST TYPE 2	1st TMSI addresses another MS, 2nd TMSI addresses MS, Mobile Identity IE not present.
8	MS -> SS	CHANNEL REQUEST	Establ. Cause = "Answer to paging".
9	MS -> SS	CHANNEL REQUEST	Establ. Cause = "Answer to paging".
10	SS -> MS	IMMEDIATE ASSIGNMENT	Request Reference = pertaining to the message received in step 9.
11	MS -> SS	PAGING RESPONSE	Mobile Ident: TMSI.
12	SS -> MS	CHANNEL RELEASE	
	-----	-----	The SS waits 12 seconds to allow the MS to perform cell reselection.
13	SS -> MS	PAGING REQUEST TYPE 2	1st TMSI addresses another MS, 2nd TMSI addresses another MS, Mobile Identity IE contains TMSI of MS.
14	MS -> SS	CHANNEL REQUEST	Establ. Cause = "Answer to paging".
15	MS -> SS	CHANNEL REQUEST	Establ. Cause = "Answer to paging".
16	SS -> MS	IMMEDIATE ASSIGNMENT	Request Reference = pertaining to the message received in step 15
17	MS -> SS	PAGING RESPONSE	Mobile Ident: TMSI.
18	SS -> MS	CHANNEL RELEASE	
	-----	-----	The SS waits 12 seconds to allow the MS to perform cell reselection
19	SS -> MS	PAGING REQUEST TYPE 2	1st TMSI addresses another MS, 2nd TMSI addresses another MS, Mobile Identity IE contains IMSI of MS.
20	MS -> SS	CHANNEL REQUEST	Establ. Cause = "Answer to paging"
21	MS -> SS	CHANNEL REQUEST	Establ. Cause = "Answer to paging"
22	SS -> MS	IMMEDIATE ASSIGNMENT	Request Reference = pertaining to the message received in step 21
23	MS -> SS	PAGING RESPONSE	Mobile Ident: IMSI.
24	SS -> MS	CHANNEL RELEASE	
	-----	-----	The SS waits 12 seconds to allow the MS to perform cell reselection
25	SS -> MS	PAGING REQUEST TYPE 2	1st TMSI addresses another MS, 2nd TMSI addresses another MS, Mobile Identity IE contains TMSI of MS but with type of identity set to "no identity".
26	-----	-----	During 1 second, the SS checks that the MS does not produce any Layer 3 messages.

Specific Message Contents

None.

26.6.2.1.3 Paging / normal / type 3

26.6.2.1.3.1 Conformance requirements

An MS shall respond correctly to various PAGING REQUEST TYPE 3 messages, when the page mode is set to normal paging. The MS shall send CHANNEL REQUEST messages, with an Establishment Cause set to "Answer to Paging", until the network answers. The number of CHANNEL REQUEST messages shall be limited by the parameter Max-retrans. After the assignment procedure, the MS shall send a PAGING RESPONSE message on the channel assigned by the network.

References

GSM 04.08 section 3.3.2.

26.6.2.1.3.2 Test purpose

To test that the MS is able to determine its CCCH group and paging group correctly and that the MS responds correctly to various PAGING REQUEST TYPE 3 messages when the page mode is set to normal paging. All valid ways of addressing the MS are tested.

26.6.2.1.3.3 Method of test

Initial Conditions

System Simulator:

1 cell, Max-Retrans = 2, a legal combination of CCCH_CONF, BS_AG_BLKES_RES and BS_PA_MFRMS is chosen arbitrarily by the SS.

Mobile Station:

The MS is in the "idle, updated" state, with a TMSI allocated.

Related PICS/PIXIT Statements

Type of MS (P-GSM 900 or EGSM or DCS 1 800 or PCS 1900).

Foreseen Final State of the MS

"Idle, updated", with TMSI allocated.

Test Procedure

The SS pages the MS 4 times with different PAGING REQUEST TYPE 3 messages on the paging subchannel which corresponds to the MS's IMSI.

In all the cases the MS shall answer to the paging by sending CHANNEL REQUESTs. The SS responds to the second request by assigning a channel, and the MS shall then send a correct PAGING RESPONSE. The SS then releases the channel.

Maximum Duration of Test

5 minutes, including 1 minute for any necessary operator actions.

Expected Sequence

Step	Direction	Message	Comments
1	SS -> MS	PAGING REQUEST TYPE 3	1st TMSI addresses MS; 2nd, 3rd and 4th TMSIs address other MSs.
2	MS -> SS	CHANNEL REQUEST	Establ. Cause = "Answer to paging".
3	MS -> SS	CHANNEL REQUEST	Establ. Cause = "Answer to paging".
4	SS -> MS	IMMEDIATE ASSIGNMENT	Request Reference = pertaining to the message received in step 3.
5	MS -> SS	PAGING RESPONSE	Mobile Ident: TMSI.
6	SS -> MS	CHANNEL RELEASE	
	-----	-----	The SS waits 12 seconds to allow the MS to perform cell reselection.
7	SS -> MS	PAGING REQUEST TYPE 3	2nd TMSI addresses MS; 1st, 3rd and 4th TMSIs address other MSs.
8	MS -> SS	CHANNEL REQUEST	Establ. Cause = "Answer to paging".
9	MS -> SS	CHANNEL REQUEST	Establ. Cause = "Answer to paging".
10	SS -> MS	IMMEDIATE ASSIGNMENT	Request Reference = pertaining to the message received in step 9.
11	MS -> SS	PAGING RESPONSE	Mobile Ident: TMSI.
12	SS -> MS	CHANNEL RELEASE	
	-----	-----	The SS waits 12 seconds to allow the MS to perform cell reselection.
13	SS -> MS	PAGING REQUEST TYPE 3	3rd TMSI addresses MS; 1st, 2nd and 4th TMSIs address other MSs.
14	MS -> SS	CHANNEL REQUEST	Establ. Cause = "Answer to paging".
15	MS -> SS	CHANNEL REQUEST	Establ. Cause = "Answer to paging".
16	SS -> MS	IMMEDIATE ASSIGNMENT	Request Reference = pertaining to the message received in step 15.
17	MS -> SS	PAGING RESPONSE	Mobile Ident: TMSI.
18	SS -> MS	CHANNEL RELEASE	
	-----	-----	The SS waits 12 seconds to allow the MS to perform cell reselection.
19	SS -> MS	PAGING REQUEST TYPE 3	4th TMSI addresses MS; 1st, 2nd and 3rd TMSIs address other MSs.
20	MS -> SS	CHANNEL REQUEST	Establ. Cause = "Answer to paging".
21	MS -> SS	CHANNEL REQUEST	Establ. Cause = "Answer to paging".
22	SS -> MS	IMMEDIATE ASSIGNMENT	Request Reference = pertaining to the message received in step 21.
23	MS -> SS	PAGING RESPONSE	Mobile Ident: TMSI.
24	SS -> MS	CHANNEL RELEASE	

Specific Message Contents

None.

26.6.2.2 Paging / extended

26.6.2.2.1 Conformance requirements

1. The MS shall operate in the extended page mode when this is ordered by the network in a PAGING REQUEST TYPE 1 message not addressing the MS but on the paging subchannel which corresponds to the MS's identity.
2. The MS shall operate in the extended page mode when this is ordered by the network in a PAGING REQUEST TYPE 2 message not addressing the MS but on the paging subchannel which corresponds to the MS's identity.
3. The MS shall operate in the extended page mode when this is ordered by the network in a PAGING REQUEST TYPE 3 message not addressing the MS but on the paging subchannel which corresponds to the MS's identity.
4. The MS shall operate in the extended page mode when this is ordered by the network in an IMMEDIATE ASSIGNMENT message on the paging subchannel which corresponds to the MS's identity.
5. The MS shall operate in the extended page mode when this is ordered by the network in an IMMEDIATE ASSIGNMENT EXTENDED message on the paging subchannel which corresponds to the MS's identity.

References

GSM 04.08 section 3.3.2.1; GSM 05.02, section 6.5.

26.6.2.2.2 Test purpose

To test that the MS is operating in the extended page mode when this is ordered by the SS in either a PAGING REQUEST message or an IMMEDIATE ASSIGNMENT message.

26.6.2.2.3 Method of test

Initial Conditions

System Simulator:

1 cell, Max-Retrans = 2, a legal combination of CCCH_CONF, BS_AG_BLKs_RES and BS_PA_MFRMS is chosen arbitrarily by the SS.

Mobile Station:

The MS is in the "idle, updated" state, with a TMSI allocated.

Related PICS/PIXIT Statements

Type of MS (GSM 450 or GSM 480 or P-GSM 900 or EGSM or DCS 1 800 or PCS 1900).

Foreseen Final State of the MS

"Idle, updated", with TMSI allocated.

Test Procedure

The SS sends a PAGING REQUEST TYPE 1 message not addressing the MS under test but on the paging subchannel which corresponds to the MS's identity. The page mode is set to "extended paging". In the next but one paging subblock on the same CCCH the SS sends a PAGING REQUEST TYPE 1 message specifying an arbitrarily chosen page mode and addressing the MS by its TMSI. The MS shall respond to the last page by sending CHANNEL REQUESTs. The SS responds to the second CHANNEL REQUEST with an IMMEDIATE ASSIGNMENT REJECT message.

The SS then sends an IMMEDIATE ASSIGNMENT on the paging subchannel which corresponds to the MS's identity. The random reference is different to those used by the Mobile Station in the last two CHANNEL REQUEST messages. (Phase 2 requires a Mobile Station to react on an IMMEDIATE ASSIGNMENT after a rejection.) The page mode is again set to "extended paging". In the next but one paging subblock on the same CCCH the SS sends a PAGING REQUEST TYPE 2 message specifying an arbitrarily chosen page mode and addressing the MS by its TMSI. The MS shall respond with CHANNEL REQUESTs. The SS responds to the second CHANNEL REQUEST with an IMMEDIATE ASSIGNMENT REJECT message.

The SS then sends an IMMEDIATE ASSIGNMENT EXTENDED on the paging subchannel which corresponds to the MS's identity. The random references are different to those used by the Mobile Station in the last three CHANNEL REQUEST messages. The page mode is again set to "extended paging". In the next but one paging subblock on the same CCCH the SS sends a PAGING REQUEST TYPE 3 message specifying an arbitrarily chosen page mode and addressing the MS by its TMSI. The MS shall respond with CHANNEL REQUESTs. The SS responds to the second CHANNEL REQUEST with an IMMEDIATE ASSIGNMENT REJECT message.

The SS then sends a PAGING REQUEST TYPE 3 message not addressing the MS under test but on the paging subchannel which corresponds to the MS's identity. The page mode is set to "extended paging". In the next but one paging subblock on the same CCCH the SS sends a PAGING REQUEST TYPE 2 message specifying an arbitrarily chosen page mode and addressing the MS by its IMSI. The MS shall respond to the last page by sending CHANNEL REQUESTs. The SS responds to the second CHANNEL REQUEST with an IMMEDIATE ASSIGNMENT REJECT message.

The SS then sends a PAGING REQUEST TYPE 2 message not addressing the MS under test but on the paging subchannel which corresponds to the MS's identity. The page mode is set to "extended paging". In the next but one paging subblock on the same CCCH the SS sends a PAGING REQUEST TYPE 1 message specifying an arbitrarily chosen page mode and addressing the MS by its IMSI. The MS shall respond to the last page by sending CHANNEL REQUESTs. The SS responds to the second CHANNEL REQUEST with an IMMEDIATE ASSIGNMENT REJECT message.

Maximum Duration of Test

10 sec.

Expected Sequence

Step	Direction	Message	Comments
1	SS -> MS	PAGING REQUEST TYPE 1	Mobile Ident: IMSI of another MS, page mode = "extended paging".
2	SS -> MS	PAGING REQUEST TYPE 1	Sent in the next but one paging subblock. Page mode is arbitrarily chosen Mobile Ident: TMSI of the MS.
3	MS -> SS	CHANNEL REQUEST	
4	MS -> SS	CHANNEL REQUEST	
5	SS -> MS	IMMEDIATE ASSIGNMENT REJECT	Wait indication = 5 seconds. page mode = normal.
6	SS SS -> MS	IMMEDIATE ASSIGNMENT	SS waits for 5 seconds. Sent in the paging subblock of MS under test. Page mode = "extended paging", Request reference chosen arbitrarily by the SS, but different from all references used earlier in this test sequence.
8	SS -> MS	PAGING REQUEST TYPE 1	Sent in the next but one paging subblock. Page mode is arbitrarily chosen. Mobile Ident: TMSI of the MS.
9	MS -> SS	CHANNEL REQUEST	
10	MS -> SS	CHANNEL REQUEST	
11	SS -> MS	IMMEDIATE ASSIGNMENT REJECT	Wait indication = 5 seconds. page mode = normal.
12	SS	--	SS waits for 5 seconds.
13	SS -> MS	IMMEDIATE ASSIGNMENT EXT	Sent in the paging subblock of MS under test. Page mode = "extended paging", Request references chosen arbitrarily by the SS, but different from all references used earlier in this test sequence.
14	SS -> MS	PAGING REQUEST TYPE 3	Sent in the next but one paging subblock. Page mode is arbitrarily chosen. Mobile Ident: TMSI of the MS.
15	MS -> SS	CHANNEL REQUEST	
16	MS -> SS	CHANNEL REQUEST	
17	SS -> MS	IMMEDIATE ASSIGNMENT REJECT	Wait indication = 5 seconds page mode = normal.
18	SS	--	SS waits for 5 seconds.
19	SS -> MS	PAGING REQUEST TYPE 3	Sent in the paging subblock of MS under test. Page mode = "extended paging".
20	SS -> MS	PAGING REQUEST TYPE 2	Sent in the next but one paging subblock. Page mode is arbitrarily chosen. Mobile Ident: IMSI of the MS.
21	MS -> SS	CHANNEL REQUEST	
22	MS -> SS	CHANNEL REQUEST	
23	SS -> MS	IMMEDIATE ASSIGNMENT REJECT	Wait indication = 5 seconds page mode = normal.
24	SS	--	SS waits for 5 seconds
25	SS -> MS	PAGING REQUEST TYPE 2	Sent in the paging subblock of MS under test. Page mode = "extended paging".
26	SS -> MS	PAGING REQUEST TYPE 1	Sent in the next but one paging subblock. Page mode is arbitrarily chosen. Mobile Ident: IMSI of the MS.
27	MS -> SS	CHANNEL REQUEST	
28	MS -> SS	CHANNEL REQUEST	
29	SS -> MS	IMMEDIATE ASSIGNMENT REJECT	Wait indication = 5 seconds.

Specific Message Contents

None.

26.6.2.3 Paging / reorganization

26.6.2.3.1 Paging / reorganization / procedure 1

26.6.2.3.1.1 Conformance requirements

1. An MS, after reception of a message with page mode set to "paging reorganization", shall answer to paging messages (with page mode set to "normal paging") sent on its old CCCH in paging blocks which do not belong to the MS's paging sub-channel.
2. When the network changes the paging group of the MS by modifying BCCH parameters (to CCCH_CONF set to "1 basic physical channel used for CCCH combined with SDCCH", and BS_AG_BLK_RES set to "2 blocks reserved for access grant"), the MS shall calculate its new paging group and answer to paging messages on its new paging subchannel.
3. When the network changes the paging group of the MS by modifying BCCH parameters (to CCCH_CONF set to "2 basic physical channels used for CCCH, not combined with SDCCHs" and BS_AG_BLK_RES set to "2 blocks reserved for access grant"), the MS shall calculate its new paging group and answer to paging messages on its new paging subchannel.

References

GSM 04.08 section 3.3.2.1; GSM 05.02, section 6.5.

26.6.2.3.1.2 Test purpose

To test that the MS correctly determines its new paging subchannel when the CCCH structure is changed from non-combined to combined and when the number of CCCHs is changed.

26.6.2.3.1.3 Method of test

Initial Conditions

System Simulator:

1 cell, Max-Retrans = 2, CCCH_CONF set to "1 basic physical channel used for CCCH, not combined with SDCCHs", a legal combination of BS_AG_BLK_RES and BS_PA_MFRMS is chosen arbitrarily by the SS, with the exception that BS_PA_MFRMS shall not be set to 9.

Mobile Station:

The MS is in the "idle, updated" state, with a TMSI allocated. The IMSI of the MS is from a defined/default range that ensures its paging channel changes when the broadcast parameters are changed.

Related PICS/PIXIT Statements

Type of MS (GSM 450 or GSM 480 or P-GSM 900 or EGSM or DCS 1 800 or PCS 1900).

Foreseen Final State of the MS

"Idle, updated", with TMSI allocated.

Test Procedure

The SS sends an IMMEDIATE ASSIGNMENT EXTENDED message on the MS's paging subchannel, with the page mode element set to "paging reorganization" and Request References that do not pertain to the MS. Before the MS's original paging subchannel re-occurs, the SS pages it on the CCCH corresponding to the Mobile Station's IMSI with a PAGING REQUEST TYPE 2 message (page mode = normal paging) containing the MS's TMSI in some paging block which does not belong to the Mobile Station's paging subchannel. The MS shall respond by sending CHANNEL REQUESTs. The SS responds to the second CHANNEL REQUEST with an IMMEDIATE ASSIGNMENT REJECT (in order to avoid a cell reselection) on an arbitrarily selected paging subchannel.

Then the SS starts sending messages (PAGING REQUEST TYPE 1 or PAGING REQUEST TYPE 2 or PAGING REQUEST TYPE 3 or IMMEDIATE ASSIGNMENT or IMMEDIATE ASSIGNMENT EXTENDED or IMMEDIATE ASSIGNMENT REJECT) with page mode set to "paging reorganization" on all paging subchannels.

After 5 seconds (to ensure T3126 expires) the SS pages the MS with its TMSI on an arbitrarily selected paging subchannel (on the CCCH corresponding to the Mobile Station's IMSI). The MS shall respond by sending CHANNEL REQUESTs. The SS responds to the second CHANNEL REQUEST with an IMMEDIATE ASSIGNMENT REJECT (in order to avoid a cell reselection).

The SS changes the paging parameters.

Then the SS sets the page mode to "normal paging".

The SS then waits for the duration of five 51-TDMA multiframes (4 to allow the MS to read all the system information type 1, 2, 3, and 4 messages on the BCCH, and one to calculate the new paging group). Not before 5 seconds after the last IMMEDIATE ASSIGNMENT REJECT message addressing the MS (to ensure T3126 expires), the MS is paged with a PAGING REQUEST TYPE 1 on its new paging subchannel. The MS shall respond by sending CHANNEL REQUESTs. The SS responds to the second CHANNEL REQUEST with an IMMEDIATE ASSIGNMENT REJECT (in order to avoid a cell reselection) and then waits 5 seconds (to ensure T3126 expires).

Then the MS is paged with a PAGING REQUEST TYPE 2 on its new paging subchannel. The MS shall respond by sending CHANNEL REQUESTs. The SS responds to the second CHANNEL REQUEST with an IMMEDIATE ASSIGNMENT REJECT (in order to avoid a cell reselection).

Maximum Duration of Test

60 sec.

Expected Sequence

This sequence is performed for execution counter, $K = 1, 2$.

Step	Direction	Message	Comments
1	SS -> MS	IMMEDIATE ASSIGNMENT EXTENDED	Sent on the MS's paging channel. Page mode set to "paging reorganization". Request Reference not pertaining to the MS.
2	SS -> MS	PAGING REQUEST TYPE 2	Sent before the MS's original paging subchannel re-occurs, but later than the next paging block of that CCCH.
3	MS -> SS	CHANNEL REQUEST	
4	MS -> SS	CHANNEL REQUEST	
5	SS -> MS	IMMEDIATE ASSIGNMENT REJECT	Wait indication = 0 seconds.
6	-----	-----	
7	SS -> MS	PAGING REQUEST TYPE 2	All L3 messages sent on any paging subchannel are paging fill frames specify "paging re organization". Sent on an arbitrarily selected paging subchannel Page mode "paging reorganization" Not sent before 5 seconds after step 5.
8	MS -> SS	CHANNEL REQUEST	
9	MS -> SS	CHANNEL REQUEST	
10	SS -> MS	IMMEDIATE ASSIGNMENT REJECT	Wait indication = 0 seconds.
11			Change of paging parameters in SYS INFO 3 as described below for $K=1, 2$.
12			The SS waits until it has sent all system information messages (page mode is still paging reorganization).
13	-----	-----	All L3 messages sent on any paging subchannel specify "normal paging".
14	-----	-----	Wait 3 seconds.
15	SS -> MS	PAGING REQUEST TYPE 1	Sent on the new paging subchannel of the MS. Not sent before 5 seconds after step 10.
16	MS -> SS	CHANNEL REQUEST	
17	MS -> SS	CHANNEL REQUEST	
18	SS -> MS	IMMEDIATE ASSIGNMENT REJECT	Wait indication = 0 seconds.
19	SS -> MS	PAGING REQUEST TYPE 2	Sent on the new paging subchannel of the MS. Not sent before 5 seconds after step 18.
20	MS -> SS	CHANNEL REQUEST	
21	MS -> SS	CHANNEL REQUEST	
22	SS -> MS	IMMEDIATE ASSIGNMENT REJECT	

Specific Message Contents

For execution counter K :

$K=1$:

SYSTEM INFORMATION TYPE 3 shall have the Control Channel Description IE changed to:

CCCH_CONF "1 basic physical channel used for CCCH, combined with SDCCHs"

BS_AG_BLK_RES 2

BS_PA_MFRMS 9

$K=2$:

SYSTEM INFORMATION TYPE 3 shall have the Control Channel Description IE changed to:

CCCH_CONF "2 basic physical channel used for CCCH, not combined with SDCCHs"

BS_AG_BLK_RES 2

BS_PA_MFRMS 9

26.6.2.3.2 Paging / reorganization / procedure 2

26.6.2.3.2.1 Conformance requirement

An MS, after reception of a message with page mode set to "paging reorganization", shall answer to paging messages (with page mode set to "normal paging") sent in a former Access Grant block.

References

GSM 04.08 section 3.3.2.1.

26.6.2.3.2.2 Test purpose

To test that the MS is operating in the "paging reorganization" page mode when this is ordered by the SS and the MS is paged in its former access grant channel.

26.6.2.3.2.3 Method of test

Initial Conditions

System Simulator:

1 cell, Max-Retrans = 1, with the constraint that BS_AG_BLK_RES > 0, a legal combination of CCCH_CONF, BS_AG_BLK_RES and BS_PA_MFRMS is chosen arbitrarily by the SS.

Mobile Station:

The MS is in the "idle, updated" state, with a TMSI allocated. The IMSI of the MS is from a defined/default range that ensures its paging channel changes when the broadcast parameters are changed.

Related PICS/PIXIT Statements

Type of MS (GSM 450 or GSM 480 or P-GSM 900 or EGSM or DCS 1 800 or PCS 1900).

Foreseen Final State of the MS

"Idle, updated", with TMSI allocated.

Test Procedure

The SS sends an IMMEDIATE ASSIGNMENT EXTENDED on the MS's paging subchannel, with the page mode element set to "paging reorganization". The MS is then paged immediately in a former Access Grant block with a PAGING REQUEST TYPE 2 message. The MS shall respond by sending CHANNEL REQUESTs. The SS responds to the second CHANNEL REQUEST with an IMMEDIATE ASSIGNMENT REJECT (in order to avoid a cell reselection).

Maximum Duration of Test

5 sec.

Expected Sequence

Step	Direction	Message	Comments
1	SS -> MS	IMMEDIATE ASSIGNMENT EXTENDED	Page mode set to "paging reorganization"
2	SS -> MS	PAGING REQUEST TYPE 2	Sent in a former access grant block.
3	MS -> SS	CHANNEL REQUEST	
4	MS -> SS	CHANNEL REQUEST	
5	SS -> MS	IMMEDIATE ASSIGNMENT REJECT	

Specific Message Contents

None.

26.6.2.4 Paging / same as before

26.6.2.4.1 Conformance requirements

An MS, after first receiving a message on its paging subchannel with page mode set to "extended paging" and then the next message on its paging subchannel with page mode set to "same as before", shall remember the page mode from the previous message and answer to paging messages in the next but one paging sub block.

References

GSM 04.08 section 3.3.2.1; GSM 05.02, section 6.5.

26.6.2.4.2 Test purpose

To test that the MS remembers the page mode from the previous paging request message.

26.6.2.4.3 Method of test

Initial Conditions

System Simulator:

1 cell, Max-Retrans = 2, a legal combination of CCCH_CONF, BS_AG_BLKES_RES and BS_PA_MFRMS is chosen arbitrarily by the SS.

Mobile Station:

The MS is in the "idle, updated" state, with a TMSI allocated.

Related PICS/PIXIT Statements

Type of MS (GSM 450 or GSM 480 or P-GSM 900 or EGSM or DCS 1 800 or PCS 1900).

Foreseen Final State of the MS

"Idle, updated", with TMSI allocated.

Test Procedure

The SS sends an IMMEDIATE ASSIGNMENT REJECT on the MS's paging subchannel, with the page mode element set to "extended paging". In the next but one subblock on the same CCCH, nothing addresses the MS. When the MS's specific paging subchannel reoccurs, a PAGING REQUEST TYPE 3 is sent, not addressing the MS under test and with page mode set to "same as before". In the next but one subblock on the same CCCH the SS sends a PAGING REQUEST TYPE 1 message specifying paging reorganization and addressing the MS. The MS shall respond by sending CHANNEL REQUESTs. The SS responds to the second CHANNEL REQUEST with an IMMEDIATE ASSIGNMENT REJECT (in order to avoid a cell reselection).

Maximum Duration of Test

10 sec.

Expected Sequence

Step	Direction	Message	Comments
1	SS -> MS	IMMEDIATE ASSIGNMENT REJECT	Page mode set to "extended paging".
2	SS -> MS	XXXX	In the next but one subblock nothing addresses the MS. This is sent in the next paging subblock on the MS's specific paging subchannel. The page mode is set to "same as before", and the MS under test is not addressed.
3	SS -> MS	PAGING REQUEST TYPE 3	
4	SS -> MS	PAGING REQUEST TYPE 1	
5	MS -> SS	CHANNEL REQUEST	The MS is addressed in this "next but one subblock". Page mode set to "paging reorganization".
6	MS -> SS	CHANNEL REQUEST	
7	SS -> MS	IMMEDIATE ASSIGNMENT REJECT	

Specific Message Contents

None.

26.6.2.5 Paging / multislots CCCH

26.6.2.5.1 Conformance requirements

The MS shall respond correctly to a PAGING REQUEST TYPE 1 message, when the page mode is set to normal paging, when a multislots CCCH is used and the MS is addressed with its IMSI in the first Mobile Identity field, the optional Mobile Identity field being not present.

References

GSM 04.08 section 3.3.2, GSM 05.02 section 6.5.

26.6.2.5.2 Test purpose

- 1) To test that the MS is able to determine its CCCH group and paging group correctly in the case of a CCCH configuration on more than one timeslot when it is paged on a timeslot other than 0. The MS is addressed with a PAGING REQUEST TYPE 1 message when the page mode is set to normal paging. The MS is paged with its IMSI in the 1st Mobile Identity field, the optional Mobile Identity field being not present, is the only way of addressing tested.
- 2) To test that in such conditions the MS answers to the paging message on the timeslot on which the paging message was sent.

26.6.2.5.3 Method of test

Initial Conditions

System Simulator:

1 cell, a legal combination of CCCH_CONF, BS_AG_BLKES_RES and BS_PA_MFRMS is chosen arbitrarily under the following constraint:

CCCH_CONF is in the set:

- 2 basic physical channels used for CCCH, not combined with SDCCHs
- 3 basic physical channels used for CCCH, not combined with SDCCHs
- 4 basic physical channels used for CCCH, not combined with SDCCHs

Mobile Station:

The IMSI last 3 digits are so that the CCCH_GROUP of the MS under test is other than 0. According to section 6.5.2 of recommendation GSM 05.02, this means that:

$$(\text{IMSI mod } 1000) \bmod (\text{BS_CC_CHANS} \times N) \text{ is greater or equal to } N, \text{ where}$$

$$N = \text{BS_PA_MFRMS} \times (9 - \text{BS_AG_BLKS_RES}).$$

The MS is in the "idle, updated" state.

Related PICS/PIXIT Statements

Type of MS (GSM 450 or GSM 480 or P-GSM 900 or EGSM or DCS 1 800 or PCS 1900).

Foreseen Final State of the MS

"Idle updated".

Test Procedure

The SS pages the MS once with a PAGING REQUEST TYPE 1 message on the timeslot and paging subchannel which correspond to the MS's IMSI.

The MS shall send the CHANNEL REQUEST on the same timeslot as the paging message.

The SS sends an IMMEDIATE ASSIGNMENT on the same timeslot as the paging message.

Maximum Duration of Test

10 s.

Expected Sequence

Step	Direction	Message	Comments
1	SS -> MS	PAGING REQUEST TYPE 1	1st Mobile Ident contains IMSI of MS, 2nd Mobile Ident not present.
2	MS -> SS	CHANNEL REQUEST	Establ. Cause = "Answer to paging". on the same timeslot as the paging message.
3	SS -> MS	IMMEDIATE ASSIGNMENT	on the same timeslot as the paging message.
4	MS -> SS	PAGING RESPONSE	Mobile Ident: IMSI.
5	SS -> MS	CHANNEL RELEASE	

Specific Message Contents

None.

26.6.3 Test of measurement report

When an RR-connection exists, the MS shall send measurement reports. These reports contain reception characteristics from serving and neighbouring cells. The measurement report procedure is described in section 3.4.1.2 of GSM 04.08.

NOTE 8: The capability to calculate RxLev and RxQual is tested in sections 15 and 16. In this test only the signalling aspect is verified.

26.6.3.1 Measurement / no neighbours

This test applies to GSM 400, GSM 900, DCS 1 800 and PCS 1900 mobile stations.

26.6.3.1.1 Conformance requirements

The MS shall continuously send MEASUREMENT REPORT messages on every SACCH block and the measurement valid indication shall be set to valid (0) within the second block at the latest.

References

GSM 04.08 section 3.4.1.2, GSM 05.08 section 8.4.

26.6.3.1.2 Test purpose

To test that, when the SS gives absolutely no information about neighbouring cells, the MS does not report on neighbouring cells.

26.6.3.1.3 Method of test

Initial Conditions

System Simulator:

For GSM 900, DCS 1800 and PCS 1900: 8 cells with the following settings:

Transmitter	Level	NCC	BCC	ARFCN (GSM900)	ARFCN (DCS1800)	ARFCN (PCS1900)	Cell Identity
Serving, S1	-60	1	3	002	514	514	0001H
Neighbour, N1	-85	1	5	008	530	530	0002H
Neighbour, N2	-80	1	7	014	602	602	0003H
Neighbour, N3	-75	1	1	020	665	665	0004H
Neighbour, N4	-55	1	3	026	762	762	0005H
Neighbour, N5	-50	1	5	032	686	686	0006H
Neighbour, N6	-45	1	7	038	549	549	0007H
Neighbour, N7	-40	1	1	044	810	810	0008H

For GSM 450 and GSM 480: 8 cells with the following settings:

Transmitter	Level	NCC	BCC	ARFCN (GSM450)	ARFCN (GSM 480)	Cell Identity
Serving, S1	-60	1	3	260	307	0001H
Neighbour, N1	-85	1	5	264	311	0002H
Neighbour, N2	-80	1	7	268	315	0003H
Neighbour, N3	-75	1	1	272	319	0004H
Neighbour, N4	-55	1	3	276	323	0005H
Neighbour, N5	-50	1	5	280	327	0006H
Neighbour, N6	-45	1	7	284	331	0007H
Neighbour, N7	-40	1	1	288	335	0008H

With the exception of the Cell Allocation, the rest of the parameters for all eight cells are the same as the default settings and default SYSTEM INFORMATION TYPE 1 to 4 message contents for cell A. The Cell Allocation for the serving cell is the same as the default setting for cell A. The Cell Allocations for the neighbour cells need have only one entry, consisting of the ARFCN of that cell's BCCH.

Mobile Station:

The MS is in the active state of a call (U10).

Related PICS/PIXIT Statements

Support for state U10 of the Call Control protocol.

Type of MS (GSM 450 or GSM 480 or P-GSM 900 or EGSM or DCS 1 800 or PCS 1900).

Foreseen Final State of the MS

Active state of a call (U10).

Test Procedure

This test procedure is performed twice.

With the MS having a call in progress, the SS sends SYSTEM INFORMATION TYPE 5 & 6 (on the second iteration of the test the SS also sends SYSTEM INFORMATION TYPE 5bis) on the SACCH. The BA is indicated as empty. The MS shall send MEASUREMENT REPORTs back to the SS, and it shall be indicated in these that no measurement results have been obtained.

Maximum Duration of Test

5 minutes, including 1 minute for any necessary operator actions.

Expected Sequence

This sequence is performed for execution counter, $k = 1, 2$.

Since when $k = 1$, SYSTEM INFORMATION TYPE 5, SYSTEM INFORMATION TYPE 6 and MEASUREMENT REPORT (and when $k = 2$ an additional SYSTEM INFORMATION TYPE 5bis is included) are sent continuously, a table is not applicable in this test. The interval between 2 successive Layer 2 frames containing MEASUREMENT REPORTs shall not exceed one Layer 2 frame.

Specific Message Contents

GSM 450 and 480 begin:

SYSTEM INFORMATION TYPE 5:

Information Element	value/remark
Neighbour Cells Description - Format Identifier - BCCH Allocation Sequence number - BCCH Allocation ARFCN - EXT IND	128 range 1 No channels belong to the BCCH allocation. $k = 1$. Information Element carries the complete BA. $k = 2$. Information Element carries only a part of the BA.

SYSTEM INFORMATION TYPE 5bis (Sent only when $k = 2$):

Information Element	value/remark
Protocol Discriminator Message Type Neighbour Cells Description - Format - EXT IND - W(i)	RR management Sys Info 5bis. 1024 range $k = 2$. Information Element carries only a part of the BA. Only channel 500 belongs to the BCCH allocation.

MEASUREMENT REPORT:

Information Element	value/remark
Protocol Discriminator	RR Management
Transaction Identifier	0000
Message Type	MEASUREMENT REPORT
Measurement Results	
BA-used	1
DTX-used	DTX was not used
RXLEV_FULL_SERVING_CELL	See note 9
RXLEV_SUB_SERVING_CELL	See note 9
MEAS_VALID	See note 10
RXQUAL_FULL_SERVING_CELL	See note 9
RXQUAL_SUB_SERVING_CELL	See note 9
NO_NCELL_M	No neighbour cell measurement result, or Neighbour cell information not available for serving cell.
RXLEV_NCELL_1	00 0000
BCCH_FREQ_NCELL_1	0 0000
BSIC_NCELL_1	00 0000
.	.
RXLEV_NCELL_6	00 0000
BCCH_FREQ_NCELL_6	0 0000
BSIC_NCELL_6	00 0000

GSM 450 and 480 end:

GSM 900 begin:

SYSTEM INFORMATION TYPE 5:

Information Element	value/remark
Neighbour Cells Description	
- Format Identifier	bit map 0
- BCCH Allocation Sequence number	1
- BCCH Allocation ARFCN	No channels belong to the BCCH allocation.
- EXT IND	k = 1. Information Element carries the complete BA. k = 2. Information Element carries only a part of the BA.

SYSTEM INFORMATION TYPE 5bis (Sent only when k = 2):

Information Element	value/remark
Protocol Discriminator	RR management
Message Type	Sys Info 5bis.
Neighbour Cells Description	
- Format	1024 range
- EXT IND	k = 2. Information Element carries only a part of the BA.
- W(i)	Only channel 500 belongs to the BCCH allocation.

MEASUREMENT REPORT:

Information Element	value/remark
Protocol Discriminator	RR Management
Transaction Identifier	0000
Message Type	MEASUREMENT REPORT
Measurement Results	
BA-used	1
DTX-used	DTX was not used
RXLEV_FULL_SERVING_CELL	See note 9
RXLEV_SUB_SERVING_CELL	See note 9
MEAS_VALID	See note 10
RXQUAL_FULL_SERVING_CELL	See note 9
RXQUAL_SUB_SERVING_CELL	See note 9
NO_NCELL_M	No neighbour cell measurement result, or Neighbour cell information not available for serving cell.
RXLEV_NCELL_1	00 0000
BCCH_FREQ_NCELL_1	0 0000
BSIC_NCELL_1	00 0000
.	.
RXLEV_NCELL_6	00 0000
BCCH_FREQ_NCELL_6	0 0000
BSIC_NCELL_6	00 0000

GSM 900 end:

DCS 1 800 begin:

SYSTEM INFORMATION TYPE 5:

Information Element	value/remark
Protocol Discriminator	RR management
Message Type	Sys Info 5.
Neighbour Cells Description	
- Format	1024 range
- EXT IND	k = 1. Information Element carries the complete BA. k = 2. Information Element carries only a part of the BA.
- W(i)	null.

SYSTEM INFORMATION TYPE 5bis (Sent only when k = 2):

Information Element	value/remark
Protocol Discriminator	RR management
Message Type	Sys Info 5bis.
Neighbour Cells Description	
- Format	1024 range
- EXT IND	k = 2. Information Element carries only a part of the BA.
- W(i)	null.

SYSTEM INFORMATION TYPE 6:

Information Element	value/remark
Protocol Discriminator	RR Management
Message Type	sys info 6
Cell Identity	default
LAI	default
Cell Options	
- Power Control Indicator	Power Control Indicator is set
- DTX Indicator	MS shall not use DTX
- Radio_Link_Timeout	default
PLMN permitted	only NCC 1 permitted

MEASUREMENT REPORT:

Information Element	value/remark
Protocol Discriminator	RR Management
Transaction Identifier	0000
Message Type	MEASUREMENT REPORT
Measurement Results	
BA_used	1
DTX_used	DTX was not used
RXLEV_FULL_SERVING_CELL	See NOTE 1
RXLEV_SUB_SERVING_CELL	See NOTE 1
MEAS_VALID	See NOTE 2
RXQUAL_FULL_SERVING_CELL	See NOTE 1
RXQUAL_SUB_SERVING_CELL	See NOTE 1
NO_NCELL_M	No neighbour cell measurement result, or Neighbour cell information not available for serving cell.
RXLEV_NCELL_1	00 0000
BCCH_FREQ_NCELL_1	0 0000
BSIC_NCELL_1	00 0000
.
.
RXLEV_NCELL_6	00 0000
BCCH_FREQ_NCELL_6	0 0000
BSIC_NCELL_6	00 0000

DSC1800 end:

PCS 1900 begin:

SYSTEM INFORMATION TYPE 5:

Information Element	value/remark
Protocol Discriminator	RR management
Message Type	Sys Info 5.
Neighbour Cells Description	
- Format	1024 range
- EXT IND	k = 1. Information Element carries the complete BA. k = 2. Information Element carries only a part of the BA.
- W(i)	null.

SYSTEM INFORMATION TYPE 5bis (Sent only when k = 2):

Information Element	value/remark
Protocol Discriminator	RR management
Message Type	Sys Info 5bis.
Neighbour Cells Description	
- Format	1024 range
- EXT IND	k = 2. Information Element carries only a part of the BA.
- W(i)	null.

SYSTEM INFORMATION TYPE 6:

Information Element	value/remark
Protocol Discriminator	RR Management
Message Type	sys info 6
Cell Identity	default
LAI	default
Cell Options	
- Power Control Indicator	Power Control Indicator is set
- DTX Indicator	MS shall not use DTX
- Radio_Link_Timeout	default
PLMN permitted	only NCC 1 permitted

MEASUREMENT REPORT:

Information Element	value/remark
Protocol Discriminator	RR Management
Transaction Identifier	0000
Message Type	MEASUREMENT REPORT
Measurement Results	
BA_used	1
DTX_used	DTX was not used
RXLEV_FULL_SERVING_CELL	See NOTE 1
RXLEV_SUB_SERVING_CELL	See NOTE 1
MEAS_VALID	See NOTE 2
RXQUAL_FULL_SERVING_CELL	See NOTE 1
RXQUAL_SUB_SERVING_CELL	See NOTE 1
NO_NCELL_M	No neighbour cell measurement result, or Neighbour cell information not available for serving cell.
RXLEV_NCELL_1	00 0000
BCCH_FREQ_NCELL_1	0 0000
BSIC_NCELL_1	00 0000
.
.
RXLEV_NCELL_6	00 0000
BCCH_FREQ_NCELL_6	0 0000
BSIC_NCELL_6	00 0000

PCS 1900 end:

NOTE 1: The actual values are not checked.

NOTE 2: The Measurement Valid Indication shall be set to valid within the second SACCH block at the latest.

26.6.3.2 Measurement / all neighbours present

This test applies to GSM 400, GSM 900, DCS 1 800 PCS 1900 mobile stations.

26.6.3.2.1 Conformance requirements

The MS shall continuously send MEASUREMENT REPORT messages on every SACCH blocks and the measurement valid indication shall be set to valid (0) within the second block at the latest. The MEASUREMENT REPORT message shall contain measurement results for the 6 strongest BCCH carriers with known and allowed NCC part of BSIC.

References

GSM 04.08 section 3.4.1.2, GSM 05.08 section 8.4.

26.6.3.2.2 Test purpose

To test that, when the SS gives information about neighbouring cells, the MS reports appropriate results.

26.6.3.2.3 Method of test

Initial Conditions

System Simulator:

For GSM 900, DCS 1800 and PCS 1900: 8 cells with the following settings:

Transmitter	Level	NCC	BCC	ARFCN (GSM900)	ARFCN (DCS1800)	ARFCN (PCS1900)	Cell Identity
Serving, S1	-60	1	3	002	514	514	0001H
Neighbour, N1	-85	1	5	008	530	530	0002H
Neighbour, N2	-80	1	7	014	602	602	0003H
Neighbour, N3	-75	1	1	020	665	665	0004H
Neighbour, N4	-55	1	3	026	762	762	0005H
Neighbour, N5	-50	1	5	032	686	686	0006H
Neighbour, N6	-45	1	7	038	549	549	0007H
Neighbour, N7	-40	1	1	044	810	810	0008H

For GSM 450 and GSM 480: 8 cells with the following settings:

Transmitter	Level	NCC	BCC	ARFCN (GSM450)	ARFCN (GSM 480)	Cell Identity
Serving, S1	-60	1	3	260	307	0001H
Neighbour, N1	-85	1	5	264	311	0002H
Neighbour, N2	-80	1	7	268	315	0003H
Neighbour, N3	-75	1	1	272	319	0004H
Neighbour, N4	-55	1	3	276	323	0005H
Neighbour, N5	-50	1	5	280	327	0006H
Neighbour, N6	-45	1	7	284	331	0007H
Neighbour, N7	-40	1	1	288	335	0008H

With the exception of the Cell Allocation, the rest of the parameters for all eight cells are the same as the default settings and default SYSTEM INFORMATION TYPE 1 to 4 message contents for cell A. The Cell Allocation for the serving cell is the same as the default setting for cell A. The Cell Allocations for the neighbour cells need have only one entry, consisting of the ARFCN of that cell's BCCH.

Mobile Station:

The MS is in the active state of a call (U10).

Related PICS/PIXIT Statements

Support for state U10 of the Call Control protocol.

Type of MS (GSM 450 or GSM 480 or P-GSM 900 or EGSM or DCS 1 800 or PCS 1900).

Foreseen Final State of the MS

Active state of a call (U10).

Test Procedure

This test procedure is performed twice.

With the MS having a call in progress, the SS sends SYSTEM INFORMATION TYPE 5 & 6 (on the second iteration of the test the SS also sends SYSTEM INFORMATION TYPE 5bis) on the SACCH. All 8 of the BCCHs "on air" are indicated in the BA. The MS shall send MEASUREMENT REPORTs back to the SS, and it shall be indicated within 20 seconds in these that measurement results for the 6 strongest carriers have been obtained.

Maximum Duration of Test

5 minutes, including 1 minute for any necessary operator actions.

Expected Sequence

This sequence is performed for execution counter, $k = 1, 2$.

Since when $k = 1$, SYSTEM INFORMATION TYPE 5, SYSTEM INFORMATION TYPE 6 and MEASUREMENT REPORT (and when $k = 2$ an additional SYSTEM INFORMATION TYPE 5bis is included) are sent continuously, a table is not applicable in this test. The interval between 2 successive Layer 2 frames containing MEASUREMENT REPORTs shall not exceed one Layer 2 frame.

Specific Message Contents

GSM 450 begin:

SYSTEM INFORMATION TYPE 5:

Information Element	value/remark
Neighbour Cells Description Format Identifier BCCH Allocation Sequence BCCH Allocation ARFCN - EXT IND	Variable bit map 1 The channel numbers 259, 260, 261, 262, 263, 264, 265, 267, 268, 269, 270, 271, 272, 273, 274, 275, 276, 278, 279, 280, 281, 282, 283, 284, 285, 286, 287, 288, 289, 290, 291 and 292 belong to the BCCH allocation. $k = 1$. Information Element carries complete BA. $k = 2$. Information Element carries only a part of the BA.

SYSTEM INFORMATION TYPE 5bis (Sent only when $k = 2$):

Information Element	value/remark
Protocol Discriminator Message Type Neighbour Cells Description - Format - EXT IND - W(i)	RR management Sys Info 5bis. 1024 range $k = 2$. Information Element carries only a part of the BA. Channel 0 and 800 belong to the BCCH allocation.

MEASUREMENT REPORT:

Information Element	value/remark
Protocol Discriminator	RR Management
Transaction Identifier	0000
Message Type	MEASUREMENT REPORT
Measurement Results	
BA_used	1
DTX_used	DTX was not used
RXLEV_FULL_SERVING_CELL	See NOTE 1
RXLEV_SUB_SERVING_CELL	See NOTE 1
MEAS_VALID	See NOTE 2
RXQUAL_FULL_SERVING_CELL	See NOTE 1
RXQUAL_SUB_SERVING_CELL	See NOTE 1
NO_NCELL_M	6 neighbour cell measurement results
RXLEV_NCELL_1	See NOTE 1
BCCH_FREQ_NCELL_1	Shall not correspond to N1 or N2
BSIC_NCELL_1	Corresponds to that of BCCH_FREQ_NCELL_1
RXLEV_NCELL_2	See NOTE 1
BCCH_FREQ_NCELL_2	Shall not correspond to N1 or N2
BSIC_NCELL_2	Corresponds to that of BCCH_FREQ_NCELL_2
RXLEV_NCELL_3	See NOTE 1
BCCH_FREQ_NCELL_3	Shall not correspond to N1 or N2
BSIC_NCELL_3	Corresponds to that of BCCH_FREQ_NCELL_3
RXLEV_NCELL_4	See NOTE 1
BCCH_FREQ_NCELL_4	Shall not correspond to N1 or N2
BSIC_NCELL_4	Corresponds to that of BCCH_FREQ_NCELL_4
RXLEV_NCELL_5	See NOTE 1
BCCH_FREQ_NCELL_5	Shall not correspond to N1 or N2
BSIC_NCELL_5	Corresponds to that of BCCH_FREQ_NCELL_5
RXLEV_NCELL_6	See NOTE 1
BCCH_FREQ_NCELL_6	Shall not correspond to N1 or N2
BSIC_NCELL_6	Corresponds to that of BCCH_FREQ_NCELL_6

GSM 450 end:

GSM 480 begin:

SYSTEM INFORMATION TYPE 5:

Information Element	value/remark
Neighbour Cells Description	
Format Identifier	Variable bit map
BCCH Allocation Sequence	1
BCCH Allocation ARFCN	The channel numbers 306, 307, 308, 309, 310, 311, 312, 314, 315, 316, 317, 318, 319, 320, 321, 322, 323, 325, 326, 327, 328, 329, 330, 331, 332, 333, 334, 335, 336, 337, 338 and 339 belong to the BCCH allocation.
- EXT IND	k = 1. Information Element carries complete BA. k = 2. Information Element carries only a part of the BA.

SYSTEM INFORMATION TYPE 5bis (Sent only when k = 2):

Information Element	value/remark
Protocol Discriminator	RR management
Message Type	Sys Info 5bis.
Neighbour Cells Description	
- Format	1024 range
- EXT IND	k = 2. Information Element carries only a part of the BA.
- W(i)	Channel 0 and 800 belong to the BCCH allocation.

MEASUREMENT REPORT:

Information Element	value/remark
Protocol Discriminator	RR Management
Transaction Identifier	0000
Message Type	MEASUREMENT REPORT
Measurement Results	
BA_used	1
DTX_used	DTX was not used
RXLEV_FULL_SERVING_CELL	See NOTE 1
RXLEV_SUB_SERVING_CELL	See NOTE 1
MEAS_VALID	See NOTE 2
RXQUAL_FULL_SERVING_CELL	See NOTE 1
RXQUAL_SUB_SERVING_CELL	See NOTE 1
NO_NCELL_M	6 neighbour cell measurement results
RXLEV_NCELL_1	See NOTE 1
BCCH_FREQ_NCELL_1	Shall not correspond to N1 or N2
BSIC_NCELL_1	Corresponds to that of BCCH_FREQ_NCELL_1
RXLEV_NCELL_2	See NOTE 1
BCCH_FREQ_NCELL_2	Shall not correspond to N1 or N2
BSIC_NCELL_2	Corresponds to that of BCCH_FREQ_NCELL_2
RXLEV_NCELL_3	See NOTE 1
BCCH_FREQ_NCELL_3	Shall not correspond to N1 or N2
BSIC_NCELL_3	Corresponds to that of BCCH_FREQ_NCELL_3
RXLEV_NCELL_4	See NOTE 1
BCCH_FREQ_NCELL_4	Shall not correspond to N1 or N2
BSIC_NCELL_4	Corresponds to that of BCCH_FREQ_NCELL_4
RXLEV_NCELL_5	See NOTE 1
BCCH_FREQ_NCELL_5	Shall not correspond to N1 or N2
BSIC_NCELL_5	Corresponds to that of BCCH_FREQ_NCELL_5
RXLEV_NCELL_6	See NOTE 1
BCCH_FREQ_NCELL_6	Shall not correspond to N1 or N2
BSIC_NCELL_6	Corresponds to that of BCCH_FREQ_NCELL_6

GSM 480 end:

GSM 900 begin:

SYSTEM INFORMATION TYPE 5:

Information Element	value/remark
Neighbour Cells Description	
Format Identifier	bit map 0
BCCH Allocation Sequence	1
BCCH Allocation ARFCN	The channel numbers 2, 4, 5, 6, 7, 8, 9, 10, 11, 12, 13, 14, 16, 17, 18, 19, 20, 21, 22, 23, 24, 26, 28, 29, 30, 32, 34, 35, 36, 38, 40 and 44 belong to the BCCH allocation.
- EXT IND	k = 1. Information Element carries complete BA. k = 2. Information Element carries only a part of the BA.

SYSTEM INFORMATION TYPE 5bis (Sent only when k = 2):

Information Element	value/remark
Protocol Discriminator	RR management
Message Type	Sys Info 5bis.
Neighbour Cells Description	
- Format	1024 range
- EXT IND	k = 2. Information Element carries only a part of the BA.
- W(i)	Channel 0 and 800 belong to the BCCH allocation.

MEASUREMENT REPORT:

Information Element	value/remark
Protocol Discriminator	RR Management
Transaction Identifier	0000
Message Type	MEASUREMENT REPORT
Measurement Results	
BA_used	1
DTX_used	DTX was not used
RXLEV_FULL_SERVING_CELL	See NOTE 1
RXLEV_SUB_SERVING_CELL	See NOTE 1
MEAS_VALID	See NOTE 2
RXQUAL_FULL_SERVING_CELL	See NOTE 1
RXQUAL_SUB_SERVING_CELL	See NOTE 1
NO_NCELL_M	6 neighbour cell measurement results
RXLEV_NCELL_1	See NOTE 1
BCCH_FREQ_NCELL_1	Shall not correspond to N1 or N2
BSIC_NCELL_1	Corresponds to that of BCCH_FREQ_NCELL_1
RXLEV_NCELL_2	See NOTE 1
BCCH_FREQ_NCELL_2	Shall not correspond to N1 or N2
BSIC_NCELL_2	Corresponds to that of BCCH_FREQ_NCELL_2
RXLEV_NCELL_3	See NOTE 1
BCCH_FREQ_NCELL_3	Shall not correspond to N1 or N2
BSIC_NCELL_3	Corresponds to that of BCCH_FREQ_NCELL_3
RXLEV_NCELL_4	See NOTE 1
BCCH_FREQ_NCELL_4	Shall not correspond to N1 or N2
BSIC_NCELL_4	Corresponds to that of BCCH_FREQ_NCELL_4
RXLEV_NCELL_5	See NOTE 1
BCCH_FREQ_NCELL_5	Shall not correspond to N1 or N2
BSIC_NCELL_5	Corresponds to that of BCCH_FREQ_NCELL_5
RXLEV_NCELL_6	See NOTE 1
BCCH_FREQ_NCELL_6	Shall not correspond to N1 or N2
BSIC_NCELL_6	Corresponds to that of BCCH_FREQ_NCELL_6

GSM 900 end:

DCS 1 800 begin:

SYSTEM INFORMATION TYPE 5:

Information Element	value/remark
Protocol Discriminator	RR management
Message Type	Sys Info 5.
Neighbour Cells Description	
- Format	1024 range
- EXT IND	k = 1. Information Element carries complete BA. k = 2. Information Element carries only a part of the BA.
- W(i)	k = 1. Non null for ARFCN 514, 530, 549, 602, 665, 686, 762, 810. k = 2. Non null for ARFCN 549, 602, 665, 686, 810.

SYSTEM INFORMATION TYPE 5bis (Sent only when k = 2):

Information Element	value/remark
Protocol Discriminator	RR management
Message Type	Sys Info 5bis.
Neighbour Cells Description	
- Format	1024 range
- EXT IND	k = 2. Information Element carries only a part of the BA.
- W(i)	k = 2. Non null ARFCN 20, 514, 530, 549, 762.

SYSTEM INFORMATION TYPE 6:

Information Element	value/remark
Protocol Discriminator	RR Management
Message Type	sys info 6
Cell Identity	default
LAI	default
Cell Options	
- Power Control Indicator	Power Control Indicator is set
- DTX Indicator	MS shall not use DTX
- Radio_Link_Timeout	default
PLMN permitted	only NCC 1 permitted

MEASUREMENT REPORT:

Information Element	value/remark
Protocol Discriminator	RR Management
Transaction Identifier	0000
Message Type	MEASUREMENT REPORT
Measurement Results	
BA_used	1
DTX_used	DTX was not used
RXLEV_FULL_SERVING_CELL	See NOTE 1
RXLEV_SUB_SERVING_CELL	See NOTE 1
MEAS_VALID	See NOTE 2
RXQUAL_FULL_SERVING_CELL	See NOTE 1
RXQUAL_SUB_SERVING_CELL	See NOTE 1
NO_NCELL_M	6 neighbour cell measurement results
RXLEV_NCELL_1	See NOTE 1
BCCH_FREQ_NCELL_1	Shall not correspond to N1 or N2
BSIC_NCELL_1	Corresponds to that of BCCH_FREQ_NCELL_1
RXLEV_NCELL_2	See NOTE 1
BCCH_FREQ_NCELL_2	Shall not correspond to N1 or N2
BSIC_NCELL_2	Corresponds to that of BCCH_FREQ_NCELL_2
RXLEV_NCELL_3	See NOTE 1
BCCH_FREQ_NCELL_3	Shall not correspond to N1 or N2
BSIC_NCELL_3	Corresponds to that of BCCH_FREQ_NCELL_3
RXLEV_NCELL_4	See NOTE 1
BCCH_FREQ_NCELL_4	Shall not correspond to N1 or N2
BSIC_NCELL_4	Corresponds to that of BCCH_FREQ_NCELL_4
RXLEV_NCELL_5	See NOTE 1
BCCH_FREQ_NCELL_5	Shall not correspond to N1 or N2
BSIC_NCELL_5	Corresponds to that of BCCH_FREQ_NCELL_5
RXLEV_NCELL_6	See NOTE 1
BCCH_FREQ_NCELL_6	Shall not correspond to N1 or N2
BSIC_NCELL_6	Corresponds to that of BCCH_FREQ_NCELL_6

DCS 1 800 end:

PCS 1900 begin:

SYSTEM INFORMATION TYPE 5:

Information Element	value/remark
Protocol Discriminator	RR management
Message Type	Sys Info 5.
Neighbour Cells Description	
- Format	1024 range
- EXT IND	k = 1. Information Element carries complete BA. k = 2. Information Element carries only a part of the BA.
- W(i)	k = 1. Non null for ARFCN 514, 530, 549, 602, 665, 686, 762, 810. k = 2. Non null for ARFCN 549, 602, 665, 686, 810..

SYSTEM INFORMATION TYPE 5bis (Sent only when k = 2):

Information Element	value/remark
Protocol Discriminator	RR management
Message Type	Sys Info 5bis.
Neighbour Cells Description	
- Format	1024 range
- EXT IND	k = 2. Information Element carries only a part of the BA.
- W(i)	k = 2. Non null ARFCN 20, 514, 530, 549, 762.

SYSTEM INFORMATION TYPE 6:

Information Element	value/ remark
Protocol Discriminator	RR Management
Message Type	sys info 6
Cell Identity	default
LAI	default
Cell Options	
- Power Control Indicator	Power Control Indicator is set
- DTX Indicator	MS shall not use DTX
- Radio_Link_Timeout	default
PLMN permitted	only NCC 1 permitted

MEASUREMENT REPORT:

Information Element	value/remark
Protocol Discriminator	RR Management
Transaction Identifier	0000
Message Type	MEASUREMENT REPORT
Measurement Results	
BA_used	1
DTX_used	DTX was not used
RXLEV_FULL_SERVING_CELL	See NOTE 1
RXLEV_SUB_SERVING_CELL	See NOTE 1
MEAS_VALID	See NOTE 2
RXQUAL_FULL_SERVING_CELL	See NOTE 1
RXQUAL_SUB_SERVING_CELL	See NOTE 1
NO_NCELL_M	6 neighbour cell measurement results
RXLEV_NCELL_1	See NOTE 1
BCCH_FREQ_NCELL_1	Shall not correspond to N1 or N2
BSIC_NCELL_1	Corresponds to that of BCCH_FREQ_NCELL_1
RXLEV_NCELL_2	See NOTE 1
BCCH_FREQ_NCELL_2	Shall not correspond to N1 or N2
BSIC_NCELL_2	Corresponds to that of BCCH_FREQ_NCELL_2
RXLEV_NCELL_3	See NOTE 1
BCCH_FREQ_NCELL_3	Shall not correspond to N1 or N2
BSIC_NCELL_3	Corresponds to that of BCCH_FREQ_NCELL_3
RXLEV_NCELL_4	See NOTE 1
BCCH_FREQ_NCELL_4	Shall not correspond to N1 or N2
BSIC_NCELL_4	Corresponds to that of BCCH_FREQ_NCELL_4
RXLEV_NCELL_5	See NOTE 1
BCCH_FREQ_NCELL_5	Shall not correspond to N1 or N2
BSIC_NCELL_5	Corresponds to that of BCCH_FREQ_NCELL_5
RXLEV_NCELL_6	See NOTE 1
BCCH_FREQ_NCELL_6	Shall not correspond to N1 or N2
BSIC_NCELL_6	Corresponds to that of BCCH_FREQ_NCELL_6

PCS 1900 end:

NOTE 1: These actual values are not checked.

NOTE 2: The Measurement Valid Indication shall be set to valid within the second SACCH block at the latest.

26.6.3.3 Measurement / barred cells and non-permitted NCCs

This test applies to GSM 400, GSM 900, DCS 1 800 and PCS 1900 mobile stations.

26.6.3.3.1 Conformance requirements

The MS shall continuously send MEASUREMENT REPORTs on every SACCH blocks and the measurement valid indication shall be set to valid (0) within the second block at the latest. After 20 seconds the messages shall contain measurement results only for the 4 BCCH carriers on which the MS is allowed to report.

References

GSM 04.08 section 3.4.1.2, GSM 05.08 section 8.4.

26.6.3.3.2 Test purpose

To test that, when a combination of normal neighbours, barred cells and non-permitted NCCs is "on air", the MS reports only on normal neighbours.

26.6.3.3.3 Method of test

Initial Conditions

System Simulator:

For GSM 900, DCS 1800 and PCS 1900: 8 cells with the following settings:

Transmitter	Level	NCC	BCC	ARFCN (GSM900)	ARFCN (DCS1800)	ARFCN (PCS1900)	Cell Identity
Serving, S1	-60	1	3	002	514	514	0001H
Neighbour, N1	-85	1	5	008	530	530	0002H
Neighbour, N2	-80	1	7	014	602	602	0003H
Neighbour, N3	-75	2	1	020	665	665	0004H
Neighbour, N4	-55	3	3	026	762	762	0005H
Neighbour, N5	-50	4	5	032	686	686	0006H
Neighbour, N6	-45	1	7	038	549	549	0007H
Neighbour, N7	-40	1	1	044	810	810	0008H

For GSM 450 and GSM 480: 8 cells with the following settings:

Transmitter	Level	NCC	BCC	ARFCN (GSM450)	ARFCN (GSM 480)	Cell Identity
Serving, S1	-60	1	3	260	307	0001H
Neighbour, N1	-85	1	5	264	311	0002H
Neighbour, N2	-80	1	7	268	315	0003H
Neighbour, N3	-75	2	1	272	319	0004H
Neighbour, N4	-55	3	3	276	323	0005H
Neighbour, N5	-50	4	5	280	327	0006H
Neighbour, N6	-45	1	7	284	331	0007H
Neighbour, N7	-40	1	1	288	335	0008H

With the exception of the Cell Allocation, the rest of the parameters for all eight cells are the same as the default settings and default SYSTEM INFORMATION TYPE 1 to 4 message contents for cell A. The Cell Allocation for the serving cell is the same as the default setting for cell A. The Cell Allocations for the neighbour cells need have only one entry, consisting of the ARFCN of that cell's BCCH.

NOTE 1: The BA sent in SYSTEM INFORMATION TYPE 5 does not include N1, N4 and N5. N1 may be the case of a barred cell, N3 simulates the case where another operator is transmitting on the same frequency (e.g. in border areas), N4 & N5 simulate the case where other operators are transmitting on other frequencies.

Mobile Station:

The MS is in the active state of a call (U10).

Related PICS/PIXIT Statements

Support for state U10 of the Call Control protocol.

Type of MS (GSM 450 or GSM 480 or P-GSM 900 or EGSM or DCS 1 800 or PCS 1900).

Foreseen Final State of the MS

Active state of a call (U10).

Test Procedure

This test procedure is performed twice.

With the MS having a call in progress, the SS sends SYSTEM INFORMATION TYPE 5 & 6 (on the second iteration of the test the SS also sends SYSTEM INFORMATION TYPE 5bis) on the SACCH. 5 of the 8 BCCHs "on air" are indicated in the BA. The MS shall send MEASUREMENT REPORTs back to the SS, and it shall be indicated in these that measurement results for the 4 strongest permitted carriers have been obtained (one of the carriers in the BA belongs to a non-permitted NCC).

Maximum Duration of Test

5 minutes, including 1 minute for any necessary operator actions.

Expected Sequence

This sequence is performed for execution counter, $k = 1, 2$.

Since when $k = 1$ SYSTEM INFORMATION TYPE 5, SYSTEM INFORMATION TYPE 6 and MEASUREMENT REPORT (and when $k = 2$ an additional SYSTEM INFORMATION TYPE 5bis is included) messages are sent continuously, a table is not applicable in this test. The interval between 2 successive Layer 2 frames containing MEASUREMENT REPORTs shall not exceed one Layer 2 frame.

Specific Message Contents

GSM 450 begin:

SYSTEM INFORMATION TYPE 5:

Information Element	value/remark
Neighbour Cells Description	
Format Identifier	128 range
BCCH Allocation Sequence	1
BCCH Allocation ARFCN	only channel numbers 260, 268, 272, 284 and 288 belong to the BCCH allocation.
- EXT IND	$k = 1$. Information Element carries complete BA. $k = 2$. Information Element carries only a part of the BA.

SYSTEM INFORMATION TYPE 5bis (Sent only when $k = 2$):

Information Element	value/remark
Protocol Discriminator	RR management
Message Type	Sys Info 5bis.
Neighbour Cells Description	
- Format	1024 range
- EXT IND	$k = 2$. Information Element carries only a part of the BA.
- W(i)	Channel 0 and 800 belong to the BCCH allocation.

MEASUREMENT REPORT:

Information Element	value/remark
Protocol Discriminator	RR Management
Transaction Identifier	0000
Message Type	MEASUREMENT REPORT
Measurement Results	
BA_used	1
DTX_used	DTX was not used
RXLEV_FULL_SERVING_CELL	See note 2
RXLEV_SUB_SERVING_CELL	See note 2
MEAS_VALID	See note 3
RXQUAL_FULL_SERVING_CELL	See note 2
RXQUAL_SUB_SERVING_CELL	See note 2
NO_NCELL_M	4 neighbour cell measurement results
RXLEV_NCELL_1	See note 2
BCCH_FREQ_NCELL_1	Corresponds to one of N7, N6, S1 or N2
BSIC_NCELL_1	Corresponds to that of BCCH_FREQ_NCELL_1
RXLEV_NCELL_2	See note 2
BCCH_FREQ_NCELL_2	Corresponds to one of N7, N6, S1 or N2
BSIC_NCELL_2	Corresponds to that of BCCH_FREQ_NCELL_2
RXLEV_NCELL_3	See note 2
BCCH_FREQ_NCELL_3	Corresponds to one of N7, N6, S1 or N2
BSIC_NCELL_3	Corresponds to that of BCCH_FREQ_NCELL_3
RXLEV_NCELL_4	See note 2
BCCH_FREQ_NCELL_4	Corresponds to one of N7, N6, S1 or N2
BSIC_NCELL_4	Corresponds to that of BCCH_FREQ_NCELL_4
RXLEV_NCELL_5	00 0000
BCCH_FREQ_NCELL_5	0 0000
BSIC_NCELL_5	00 0000
RXLEV_NCELL_6	00 0000
BCCH_FREQ_NCELL_6	0 0000
BSIC_NCELL_6	00 0000

GSM 450 end:

GSM 480 begin:

SYSTEM INFORMATION TYPE 5:

Information Element	value/remark
Neighbour Cells Description	
Format Identifier	128 range
BCCH Allocation Sequence	1
BCCH Allocation ARFCN	only channel numbers 307, 315, 319, 331 and 335 belong to the BCCH allocation.
- EXT IND	k = 1. Information Element carries complete BA. k = 2. Information Element carries only a part of the BA.

SYSTEM INFORMATION TYPE 5bis (Sent only when k = 2):

Information Element	value/remark
Protocol Discriminator	RR management
Message Type	Sys Info 5bis.
Neighbour Cells Description	
- Format	1024 range
- EXT IND	k = 2. Information Element carries only a part of the BA.
- W(i)	Channel 0 and 800 belong to the BCCH allocation.

MEASUREMENT REPORT:

Information Element	value/remark
Protocol Discriminator	RR Management
Transaction Identifier	0000
Message Type	MEASUREMENT REPORT
Measurement Results	
BA_used	1
DTX_used	DTX was not used
RXLEV_FULL_SERVING_CELL	See note 2
RXLEV_SUB_SERVING_CELL	See note 2
MEAS_VALID	See note 3
RXQUAL_FULL_SERVING_CELL	See note 2
RXQUAL_SUB_SERVING_CELL	See note 2
NO_NCELL_M	4 neighbour cell measurement results
RXLEV_NCELL_1	See note 2
BCCH_FREQ_NCELL_1	Corresponds to one of N7, N6, S1 or N2
BSIC_NCELL_1	Corresponds to that of BCCH_FREQ_NCELL_1
RXLEV_NCELL_2	See note 2
BCCH_FREQ_NCELL_2	Corresponds to one of N7, N6, S1 or N2
BSIC_NCELL_2	Corresponds to that of BCCH_FREQ_NCELL_2
RXLEV_NCELL_3	See note 2
BCCH_FREQ_NCELL_3	Corresponds to one of N7, N6, S1 or N2
BSIC_NCELL_3	Corresponds to that of BCCH_FREQ_NCELL_3
RXLEV_NCELL_4	See note 2
BCCH_FREQ_NCELL_4	Corresponds to one of N7, N6, S1 or N2
BSIC_NCELL_4	Corresponds to that of BCCH_FREQ_NCELL_4
RXLEV_NCELL_5	00 0000
BCCH_FREQ_NCELL_5	0 0000
BSIC_NCELL_5	00 0000
RXLEV_NCELL_6	00 0000
BCCH_FREQ_NCELL_6	0 0000
BSIC_NCELL_6	00 0000

GSM 480 end:

GSM 900 begin:

SYSTEM INFORMATION TYPE 5:

Information Element	value/remark
Neighbour Cells Description	
Format Identifier	bit map 0
BCCH Allocation Sequence	1
BCCH Allocation ARFCN	only channel numbers 2, 14, 20, 38, and 44 belong to the BCCH allocation.
- EXT IND	k = 1. Information Element carries complete BA. k = 2. Information Element carries only a part of the BA.

SYSTEM INFORMATION TYPE 5bis (Sent only when k = 2):

Information Element	value/remark
Protocol Discriminator	RR management
Message Type	Sys Info 5bis.
Neighbour Cells Description	
- Format	1024 range
- EXT IND	k = 2. Information Element carries only a part of the BA.
- W(i)	Channel 0 and 800 belong to the BCCH allocation.

MEASUREMENT REPORT:

Information Element	value/remark
Protocol Discriminator	RR Management
Transaction Identifier	0000
Message Type	MEASUREMENT REPORT
Measurement Results	
BA_used	1
DTX_used	DTX was not used
RXLEV_FULL_SERVING_CELL	See note 2
RXLEV_SUB_SERVING_CELL	See note 2
MEAS_VALID	See note 3
RXQUAL_FULL_SERVING_CELL	See note 2
RXQUAL_SUB_SERVING_CELL	See note 2
NO_NCELL_M	4 neighbour cell measurement results
RXLEV_NCELL_1	See note 2
BCCH_FREQ_NCELL_1	Corresponds to one of N7, N6, S1 or N2
BSIC_NCELL_1	Corresponds to that of BCCH_FREQ_NCELL_1
RXLEV_NCELL_2	See note 2
BCCH_FREQ_NCELL_2	Corresponds to one of N7, N6, S1 or N2
BSIC_NCELL_2	Corresponds to that of BCCH_FREQ_NCELL_2
RXLEV_NCELL_3	See note 2
BCCH_FREQ_NCELL_3	Corresponds to one of N7, N6, S1 or N2
BSIC_NCELL_3	Corresponds to that of BCCH_FREQ_NCELL_3
RXLEV_NCELL_4	See note 2
BCCH_FREQ_NCELL_4	Corresponds to one of N7, N6, S1 or N2
BSIC_NCELL_4	Corresponds to that of BCCH_FREQ_NCELL_4
RXLEV_NCELL_5	00 0000
BCCH_FREQ_NCELL_5	0 0000
BSIC_NCELL_5	00 0000
RXLEV_NCELL_6	00 0000
BCCH_FREQ_NCELL_6	0 0000
BSIC_NCELL_6	00 0000

GSM 900 end:

DCS 1 800 begin:

SYSTEM INFORMATION TYPE 5:

Information Element	value/remark
Protocol Discriminator	RR management
Message Type	Sys Info 5.
Neighbour Cells Description	
- Format	1024 range
- EXT IND	k = 1. Information Element carries complete BA. k = 2. Information Element carries only a part of the BA.
- W(i)	k = 1. Non null for ARFCN 514, 549, 602, 665, 810. k = 2. Non null for ARFCN 549, 602, 810.

SYSTEM INFORMATION TYPE 5bis (Sent only when k = 2):

Information Element	value/remark
Protocol Discriminator	RR management
Message Type	Sys Info 5bis.
Neighbour Cells Description	
- Format	1024 range
- EXT IND	k = 2. Information Element carries only a part of the BA.
- W(i)	k = 2. Non null ARFCN 514, 665.

SYSTEM INFORMATION TYPE 6:

Information Element	value/remark
Protocol Discriminator	RR Management
Message Type	sys info 6
Cell Identity	default
LAI	default
Cell Options	
- Power Control Indicator	Power Control Indicator is set
- DTX Indicator	MS shall not use DTX
- Radio-Link-Time-out	default
PLMN permitted	only NCC 1 permitted

MEASUREMENT REPORT:

Information Element	value/remark
Protocol Discriminator	RR Management
Transaction Identifier	0000
Message Type	MEASUREMENT REPORT
Measurement Results	
BA_used	1
DTX_used	DTX was not used
RXLEV_FULL_SERVING_CELL	See NOTE 2
RXLEV_SUB_SERVING_CELL	See NOTE 2
MEAS_VALID	See NOTE 3
RXQUAL_FULL_SERVING_CELL	See NOTE 2
RXQUAL_SUB_SERVING_CELL	See NOTE 2
NO_NCELL_M	4 neighbour cell measurement results
RXLEV_NCELL_1	See NOTE 2
BCCH_FREQ_NCELL_1	Corresponds to one of N7, N6, S1 or N2
BSIC_NCELL_1	Corresponds to that of BCCH_FREQ_NCELL_1
RXLEV_NCELL_2	See NOTE 2
BCCH_FREQ_NCELL_2	Corresponds to one of N7, N6, S1 or N2
BSIC_NCELL_2	Corresponds to that of BCCH_FREQ_NCELL_2
RXLEV_NCELL_3	See NOTE 2
BCCH_FREQ_NCELL_3	Corresponds to one of N7, N6, S1 or N2
BSIC_NCELL_3	Corresponds to that of BCCH_FREQ_NCELL_3
RXLEV_NCELL_4	See NOTE 2
BCCH_FREQ_NCELL_4	Corresponds to one of N7, N6, S1 or N2
BSIC_NCELL_4	Corresponds to that of BCCH_FREQ_NCELL_4
RXLEV_NCELL_5	00 0000
BCCH_FREQ_NCELL_5	0 0000
BSIC_NCELL_5	00 0000
RXLEV_NCELL_6	00 0000
BCCH_FREQ_NCELL_6	0 0000
BSIC_NCELL_6	00 0000

DCS 1 800 end:

PCS 1900 begin:

SYSTEM INFORMATION TYPE 5:

Information Element	value/remark
Protocol Discriminator	RR management
Message Type	Sys Info 5.
Neighbour Cells Description	
- Format	1024 range
- EXT IND	k = 1. Information Element carries complete BA. k = 2. Information Element carries only a part of the BA.
- W(i)	k = 1. Non null for ARFCN 514, 549, 602, 665, 810. k = 2. Non null for ARFCN 549, 602, 810.

SYSTEM INFORMATION TYPE 5bis (Sent only when k = 2):

Information Element	value/remark
Protocol Discriminator	RR management
Message Type	Sys Info 5bis.
Neighbour Cells Description	
- Format	1024 range
- EXT IND	k = 2. Information Element carries only a part of the BA.
- W(i)	k = 2. Non null ARFCN 514, 665.

SYSTEM INFORMATION TYPE 6:

Information Element	value/ remark
Protocol Discriminator	RR Management
Message Type	sys info 6
Cell Identity	default
LAI	default
Cell Options	
- Power Control Indicator	Power Control Indicator is set
- DTX Indicator	MS shall not use DTX
- Radio-Link-Time-out	default
PLMN permitted	only NCC 1 permitted

MEASUREMENT REPORT:

Information Element	value/remark
Protocol Discriminator	RR Management
Transaction Identifier	0000
Message Type	MEASUREMENT REPORT
Measurement Results	
BA_used	1
DTX_used	DTX was not used
RXLEV_FULL_SERVING_CELL	See NOTE 2
RXLEV_SUB_SERVING_CELL	See NOTE 2
MEAS_VALID	See NOTE 3
RXQUAL_FULL_SERVING_CELL	See NOTE 2
RXQUAL_SUB_SERVING_CELL	See NOTE 2
NO_NCELL_M	4 neighbour cell measurement results
RXLEV_NCELL_1	See NOTE 2
BCCH_FREQ_NCELL_1	Corresponds to one of N7, N6, S1 or N2
BSIC_NCELL_1	Corresponds to that of BCCH_FREQ_NCELL_1
RXLEV_NCELL_2	See NOTE 2
BCCH_FREQ_NCELL_2	Corresponds to one of N7, N6, S1 or N2
BSIC_NCELL_2	Corresponds to that of BCCH_FREQ_NCELL_2
RXLEV_NCELL_3	See NOTE 2
BCCH_FREQ_NCELL_3	Corresponds to one of N7, N6, S1 or N2
BSIC_NCELL_3	Corresponds to that of BCCH_FREQ_NCELL_3
RXLEV_NCELL_4	See NOTE 2
BCCH_FREQ_NCELL_4	Corresponds to one of N7, N6, S1 or N2
BSIC_NCELL_4	Corresponds to that of BCCH_FREQ_NCELL_4
RXLEV_NCELL_5	00 0000
BCCH_FREQ_NCELL_5	0 0000
BSIC_NCELL_5	00 0000
RXLEV_NCELL_6	00 0000
BCCH_FREQ_NCELL_6	0 0000
BSIC_NCELL_6	00 0000

PCS 1900 end:

NOTE 2: These actual values are not checked.

NOTE 3: The Measurement Valid Indication shall be set to valid within the second SACCH block at the latest.

26.6.3.4 Measurement / DTX

This test applies to GSM 400, GSM 900, DCS 1 800 and PCS 1900 mobile stations.

26.6.3.4.1 Conformance requirements

After the sending of the HANDOVER COMPLETE, the MS shall continuously send measurement reports in every SACCH blocks, the measurement valid indication shall be set to valid (0) within the second block at the latest. After 20 seconds the order of values in the MEASUREMENT REPORT message shall contain measurement results for the 6 strongest BCCH carriers among those monitored by the MS. Further, in a quiet environment, the DTX_USED field shall be set by the MS to "DTX used".

References

GSM 04.08 section 3.4.1.2, GSM 05.08 section 8.4.

26.6.3.4.2 Test purpose

To test that, in the case of the MS using DTX and the SS indicating that power control is in use, the MS reports appropriate results.

26.6.3.4.3 Method of test

Initial Conditions

System Simulator:

For GSM 900, DCS 1800 and PCS 1900: 8 cells with the following settings:

Transmitter	Level	NCC	BCC	ARFCN (GSM900)	ARFCN (DCS1800)	ARFCN (PCS1900)	Cell Identity
Serving, S1	-60	1	3	002	514	514	0001H
Neighbour, N1	-85	1	5	008	530	530	0002H
Neighbour, N2	-80	1	7	014	602	602	0003H
Neighbour, N3	-75	1	1	020	665	665	0004H
Neighbour, N4	-55	1	3	026	762	762	0005H
Neighbour, N5	-50	1	5	032	686	686	0006H
Neighbour, N6	-45	1	7	038	549	549	0007H
Neighbour, N7	-40	1	1	044	810	810	0008H

For GSM 450 and GSM 480: 8 cells with the following settings:

Transmitter	Level	NCC	BCC	ARFCN (GSM450)	ARFCN (GSM 480)	Cell Identity
Serving, S1	-60	1	3	260	307	0001H
Neighbour, N1	-85	1	5	264	311	0002H
Neighbour, N2	-80	1	7	268	315	0003H
Neighbour, N3	-75	1	1	272	319	0004H
Neighbour, N4	-55	1	3	276	323	0005H
Neighbour, N5	-50	1	5	280	327	0006H
Neighbour, N6	-45	1	7	284	331	0007H
Neighbour, N7	-40	1	1	288	335	0008H

In the serving cell, the DTX indicator is set to "MS shall use discontinuous transmission".

With the exception of the Cell Allocation, the rest of the parameters for all eight cells are the same as the default settings and default SYSTEM INFORMATION TYPE 1 to 4 message contents for cell A. The Cell Allocation for the serving cell is the same as the default setting for cell A. The Cell Allocations for the neighbour cells need have only one entry, consisting of the ARFCN of that cell's BCCH.

Mobile Station:

The MS is in the active state of a call (U10).

The MS has just completed a handover into the serving cell, S1.

Related PICS/PIXIT Statements

Support for state U10 of the Call Control protocol.

Support for transparent data services only: yes/no.

Type of MS (GSM 450 or GSM 480 or P-GSM 900 or EGSM or DCS 1 800 or PCS 1900).

Foreseen Final State of the MS

Active state of a call (U10).

Test Procedure

This test procedure is performed twice.

With the MS having a call in progress on an arbitrary cell, the MS is handed over to cell S1. On cell S1, the SS sends SYSTEM INFORMATION TYPE 5 & 6 (on the second iteration of the test the SS also sends SYSTEM INFORMATION TYPE 5bis) on the SACCH with all 8 of the BCCHs "on air" indicated in the BA. Cell S1 also indicates that DTX shall be used. The MS shall send MEASUREMENT REPORTs back to the SS, and it shall be indicated in these that measurement results for the 6 strongest carriers have been obtained and that DTX has been used. (The MS is positioned in an environment free from acoustic noise.)

Maximum Duration of Test

5 minutes, including 1 minute for any necessary operator actions.

Expected Sequence

This sequence is performed twice for execution counter, $k = 1, 2$.

Since when $k = 1$, SYSTEM INFORMATION TYPE 5, SYSTEM INFORMATION TYPE 6 and MEASUREMENT REPORT (and when $k = 2$ an additional SYSTEM INFORMATION TYPE 5bis is included) messages are sent continuously, a table is not applicable in this test. The interval between 2 successive Layer 2 frames containing MEASUREMENT REPORTs shall not exceed one Layer 2 frame.

Specific Message Contents

GSM 450 begin:

SYSTEM INFORMATION TYPE 5:

Information Element	value/remark
Neighbour Cells Description	
- Format Identifier	128 range
- BCCH Allocation Sequence	1
- BCCH Allocation ARFCN	only channel numbers 260, 264, 268, 272, 276, 280, 284 and 288 belong to the BCCH allocation.
- EXT IND	$k = 1$. Information Element carries the complete BA. $k = 2$. Information Element carries only a part of the BA.

SYSTEM INFORMATION TYPE 5bis (Sent only when k = 2):

Information Element	value/remark
Protocol Discriminator	RR management
Message Type	Sys Info 5bis.
Neighbour Cells Description	
- Format	1024 range
- EXT IND	k = 2. Information Element carries only a part of the BA.
- W(i)	Only channel 500 belongs to the BCCH allocation.

SYSTEM INFORMATION TYPE 6:

Information Element	value/remark
Cell Options	
- Power Control Indicator	Power Control Indicator is set
- DTX Indicator	MS shall use DTX
- Radio_Link_Timeout	8

MEASUREMENT REPORT:

Information Element	value/remark
Protocol Discriminator	RR Management
Transaction Identifier	0000
Message Type	MEASUREMENT REPORT
Measurement Results	
- BA_used	1
- DTX_used	DTX was used (NOTE 3)
- RXLEV_FULL_SERVING_CELL	See NOTE 1
- RXLEV_SUB_SERVING_CELL	See NOTE 1
- MEAS_VALID	See NOTE 2
- RXQUAL_FULL_SERVING_CELL	See NOTE 1
- RXQUAL_SUB_SERVING_CELL	See NOTE 1
- NO_NCELL_M	6 neighbour cell measurement results
- RXLEV_NCELL_1	See NOTE 1
- BCCH_FREQ_NCELL_1	Shall not correspond to N1 or N2
- BSIC_NCELL_1	Corresponds to that of BCCH_FREQ_NCELL_1
- RXLEV_NCELL_2	See NOTE 1
- BCCH_FREQ_NCELL_2	Shall not correspond to N1 or N2
- BSIC_NCELL_2	Corresponds to that of BCCH_FREQ_NCELL_2
- RXLEV_NCELL_3	See NOTE 1
- BCCH_FREQ_NCELL_3	Shall not correspond to N1 or N2
- BSIC_NCELL_3	Corresponds to that of BCCH_FREQ_NCELL_3
- RXLEV_NCELL_4	See NOTE 1
- BCCH_FREQ_NCELL_4	Shall not correspond to N1 or N2
- BSIC_NCELL_4	Corresponds to that of BCCH_FREQ_NCELL_4
- RXLEV_NCELL_5	See NOTE 1
- BCCH_FREQ_NCELL_5	Shall not correspond to N1 or N2
- BSIC_NCELL_5	Corresponds to that of BCCH_FREQ_NCELL_5
- RXLEV_NCELL_6	See NOTE 1
- BCCH_FREQ_NCELL_6	Shall not correspond to N1 or N2
- BSIC_NCELL_6	Corresponds to that of BCCH_FREQ_NCELL_6

GSM 450 end:

GSM 480 begin:

SYSTEM INFORMATION TYPE 5:

Information Element	value/remark
Neighbour Cells Description <ul style="list-style-type: none"> - Format Identifier - BCCH Allocation Sequence - BCCH Allocation ARFCN - EXT IND 	128 range 1 only channel numbers 307, 211, 315, 319, 323, 327, 331 and 335 belong to the BCCH allocation. k = 1. Information Element carries the complete BA. k = 2. Information Element carries only a part of the BA.

SYSTEM INFORMATION TYPE 5bis (Sent only when k = 2):

Information Element	value/remark
Protocol Discriminator Message Type Neighbour Cells Description <ul style="list-style-type: none"> - Format - EXT IND - W(i) 	RR management Sys Info 5bis. 1024 range k = 2. Information Element carries only a part of the BA. Only channel 500 belongs to the BCCH allocation.

SYSTEM INFORMATION TYPE 6:

Information Element	value/remark
Cell Options <ul style="list-style-type: none"> - Power Control Indicator - DTX Indicator - Radio_Link_Timeout 	Power Control Indicator is set MS shall use DTX 8

MEASUREMENT REPORT:

Information Element	value/remark
Protocol Discriminator	RR Management
Transaction Identifier	0000
Message Type	MEASUREMENT REPORT
Measurement Results	
- BA_used	1
- DTX_used	DTX was used (NOTE 3)
- RXLEV_FULL_SERVING_CELL	See NOTE 1
- RXLEV_SUB_SERVING_CELL	See NOTE 1
- MEAS_VALID	See NOTE 2
- RXQUAL_FULL_SERVING_CELL	See NOTE 1
- RXQUAL_SUB_SERVING_CELL	See NOTE 1
- NO_NCELL_M	6 neighbour cell measurement results
- RXLEV_NCELL_1	See NOTE 1
- BCCH_FREQ_NCELL_1	Shall not correspond to N1 or N2
- BSIC_NCELL_1	Corresponds to that of BCCH_FREQ_NCELL_1
- RXLEV_NCELL_2	See NOTE 1
- BCCH_FREQ_NCELL_2	Shall not correspond to N1 or N2
- BSIC_NCELL_2	Corresponds to that of BCCH_FREQ_NCELL_2
- RXLEV_NCELL_3	See NOTE 1
- BCCH_FREQ_NCELL_3	Shall not correspond to N1 or N2
- BSIC_NCELL_3	Corresponds to that of BCCH_FREQ_NCELL_3
- RXLEV_NCELL_4	See NOTE 1
- BCCH_FREQ_NCELL_4	Shall not correspond to N1 or N2
- BSIC_NCELL_4	Corresponds to that of BCCH_FREQ_NCELL_4
- RXLEV_NCELL_5	See NOTE 1
- BCCH_FREQ_NCELL_5	Shall not correspond to N1 or N2
- BSIC_NCELL_5	Corresponds to that of BCCH_FREQ_NCELL_5
- RXLEV_NCELL_6	See NOTE 1
- BCCH_FREQ_NCELL_6	Shall not correspond to N1 or N2
- BSIC_NCELL_6	Corresponds to that of BCCH_FREQ_NCELL_6

GSM 480 end:

GSM 900 begin:

SYSTEM INFORMATION TYPE 5:

Information Element	value/remark
Neighbour Cells Description	
- Format Identifier	bit map 0
- BCCH Allocation Sequence	1
- BCCH Allocation ARFCN	only channel numbers 2, 8, 14, 20, 26, 32, 38, and 44 belong to the BCCH allocation.
- EXT IND	k = 1. Information Element carries the complete BA. k = 2. Information Element carries only a part of the BA.

SYSTEM INFORMATION TYPE 5bis (Sent only when k = 2):

Information Element	value/remark
Protocol Discriminator	RR management
Message Type	Sys Info 5bis.
Neighbour Cells Description	
- Format	1024 range
- EXT IND	k = 2. Information Element carries only a part of the BA.
- W(i)	Only channel 500 belongs to the BCCH allocation.

SYSTEM INFORMATION TYPE 6:

Information Element	value/remark
Cell Options - Power Control Indicator - DTX Indicator - Radio_Link_Timeout	Power Control Indicator is set MS shall use DTX 8

MEASUREMENT REPORT:

Information Element	value/remark
Protocol Discriminator	RR Management
Transaction Identifier	0000
Message Type	MEASUREMENT REPORT
Measurement Results	
- BA_used	1
- DTX_used	DTX was used (NOTE 3)
- RXLEV_FULL_SERVING_CELL	See NOTE 1
- RXLEV_SUB_SERVING_CELL	See NOTE 1
- MEAS_VALID	See NOTE 2
- RXQUAL_FULL_SERVING_CELL	See NOTE 1
- RXQUAL_SUB_SERVING_CELL	See NOTE 1
- NO_NCELL_M	6 neighbour cell measurement results
- RXLEV_NCELL_1	See NOTE 1
- BCCH_FREQ_NCELL_1	Shall not correspond to N1 or N2
- BSIC_NCELL_1	Corresponds to that of BCCH_FREQ_NCELL_1
- RXLEV_NCELL_2	See NOTE 1
- BCCH_FREQ_NCELL_2	Shall not correspond to N1 or N2
- BSIC_NCELL_2	Corresponds to that of BCCH_FREQ_NCELL_2
- RXLEV_NCELL_3	See NOTE 1
- BCCH_FREQ_NCELL_3	Shall not correspond to N1 or N2
- BSIC_NCELL_3	Corresponds to that of BCCH_FREQ_NCELL_3
- RXLEV_NCELL_4	See NOTE 1
- BCCH_FREQ_NCELL_4	Shall not correspond to N1 or N2
- BSIC_NCELL_4	Corresponds to that of BCCH_FREQ_NCELL_4
- RXLEV_NCELL_5	See NOTE 1
- BCCH_FREQ_NCELL_5	Shall not correspond to N1 or N2
- BSIC_NCELL_5	Corresponds to that of BCCH_FREQ_NCELL_5
- RXLEV_NCELL_6	See NOTE 1
- BCCH_FREQ_NCELL_6	Shall not correspond to N1 or N2
- BSIC_NCELL_6	Corresponds to that of BCCH_FREQ_NCELL_6

GSM 900 end:

DCS 1 800 begin:

SYSTEM INFORMATION TYPE 5:

Information Element	value/remark
Protocol Discriminator	RR management
Message Type	Sys Info 5.
Neighbour Cells Description	
- Format	1024 range
- EXT IND	k = 1. Information Element carries complete BA. k = 2. Information Element carries only a part of the BA.
- W(i)	k = 1. Non null for ARFCN 514, 530, 549, 602 665, 686, 762, 810. k = 2. Non null for ARFCN 549, 602, 665, 686, 810.

SYSTEM INFORMATION TYPE 5bis (Sent only when k = 2):

Information Element	value/remark
Protocol Discriminator	RR management
Message Type	Sys Info 5bis.
Neighbour Cells Description	
- Format	1024 range
- EXT IND	k = 2. Information Element carries only a part of the BA.
- W(i)	k = 2. Non null ARFCN 514, 530, 762.

SYSTEM INFORMATION TYPE 6:

Information Element	value/ remark
Protocol Discriminator	RR Management
Message Type	sys info 6
Cell Identity	default
LAI	default
Cell Options	
- Power Control Indicator	Power Control Indicator is set
- DTX Indicator	MS shall use DTX
- Radio_Link_Timeout	default
PLMN permitted	only NCC 1 permitted

MEASUREMENT REPORT:

Information Element	value/remark
Protocol Discriminator	RR Management
Transaction Identifier	0000
Message Type	MEASUREMENT REPORT
Measurement Results	
BA_used	1
DTX_used	DTX was used (see NOTE 3)
RXLEV_FULL_SERVING_CELL	See NOTE 1
RXLEV_SUB_SERVING_CELL	See NOTE 1
MEAS_VALID	See NOTE 2
RXQUAL_FULL_SERVING_CELL	See NOTE 1
RXQUAL_SUB_SERVING_CELL	See NOTE 1
NO_NCELL_M	6 neighbour cell measurement results
RXLEV_NCELL_1	See NOTE 1
BCCH_FREQ_NCELL_1	Shall not correspond to N1 or N2
BSIC_NCELL_1	Corresponds to that of BCCH_FREQ_NCELL_1
RXLEV_NCELL_2	See NOTE 1
BCCH_FREQ_NCELL_2	Shall not correspond to N1 or N2
BSIC_NCELL_2	Corresponds to that of BCCH_FREQ_NCELL_2
RXLEV_NCELL_3	See NOTE 1
BCCH_FREQ_NCELL_3	Shall not correspond to N1 or N2
BSIC_NCELL_3	Corresponds to that of BCCH_FREQ_NCELL_3
RXLEV_NCELL_4	See NOTE 1
BCCH_FREQ_NCELL_4	Shall not correspond to N1 or N2
BSIC_NCELL_4	Corresponds to that of BCCH_FREQ_NCELL_4
RXLEV_NCELL_5	See NOTE 1
BCCH_FREQ_NCELL_5	Shall not correspond to N1 or N2
BSIC_NCELL_5	Corresponds to that of BCCH_FREQ_NCELL_5
RXLEV_NCELL_6	See NOTE 1
BCCH_FREQ_NCELL_6	Shall not correspond to N1 or N2
BSIC_NCELL_6	Corresponds to that of BCCH_FREQ_NCELL_6

DCS 1 800 end:

PCS 1900 begin:

SYSTEM INFORMATION TYPE 5:

Information Element	value/remark
Protocol Discriminator Message Type Neighbour Cells Description - Format - EXT IND - W(i)	RR management Sys Info 5. 1024 range k = 1. Information Element carries complete BA. k = 2. Information Element carries only a part of the BA. k = 1. Non null for ARFCN 514, 530, 549, 602, 665, 686, 762, 810. k = 2. Non null for ARFCN 549, 602, 665, 686, 810.

SYSTEM INFORMATION TYPE 5bis (Sent only when k = 2):

Information Element	value/remark
Protocol Discriminator Message Type Neighbour Cells Description - Format - EXT IND - W(i)	RR management Sys Info 5bis. 1024 range k = 2. Information Element carries only a part of the BA. k = 2. Non null ARFCN 514, 530, 762.

SYSTEM INFORMATION TYPE 6:

Information Element	value/ remark
Protocol Discriminator Message Type Cell Identity LAI Cell Options - Power Control Indicator - DTX Indicator - Radio_Link_Timeout PLMN permitted	RR Management sys info 6 default default Power Control Indicator is set MS shall use DTX default only NCC 1 permitted

MEASUREMENT REPORT:

Information Element	value/remark
Protocol Discriminator	RR Management
Transaction Identifier	0000
Message Type	MEASUREMENT REPORT
Measurement Results	
BA_used	1
DTX_used	DTX was used (see NOTE 3)
RXLEV_FULL_SERVING_CELL	See NOTE 1
RXLEV_SUB_SERVING_CELL	See NOTE 1
MEAS_VALID	See NOTE 2
RXQUAL_FULL_SERVING_CELL	See NOTE 1
RXQUAL_SUB_SERVING_CELL	See NOTE 1
NO_NCELL_M	6 neighbour cell measurement results
RXLEV_NCELL_1	See NOTE 1
BCCH_FREQ_NCELL_1	Shall not correspond to N1 or N2
BSIC_NCELL_1	Corresponds to that of BCCH_FREQ_NCELL_1
RXLEV_NCELL_2	See NOTE 1
BCCH_FREQ_NCELL_2	Shall not correspond to N1 or N2
BSIC_NCELL_2	Corresponds to that of BCCH_FREQ_NCELL_2
RXLEV_NCELL_3	See NOTE 1
BCCH_FREQ_NCELL_3	Shall not correspond to N1 or N2
BSIC_NCELL_3	Corresponds to that of BCCH_FREQ_NCELL_3
RXLEV_NCELL_4	See NOTE 1
BCCH_FREQ_NCELL_4	Shall not correspond to N1 or N2
BSIC_NCELL_4	Corresponds to that of BCCH_FREQ_NCELL_4
RXLEV_NCELL_5	See NOTE 1
BCCH_FREQ_NCELL_5	Shall not correspond to N1 or N2
BSIC_NCELL_5	Corresponds to that of BCCH_FREQ_NCELL_5
RXLEV_NCELL_6	See NOTE 1
BCCH_FREQ_NCELL_6	Shall not correspond to N1 or N2
BSIC_NCELL_6	Corresponds to that of BCCH_FREQ_NCELL_6

PCS 1900 end:

NOTE 1: These actual values are not checked.

NOTE 2: The Measurement Valid Indication shall be set to valid within the second SACCH block after the HANOVER COMPLETE message at the latest.

NOTE 3: For an MS that only supports transparent data services, the value of DTX_used shall not be checked.

26.6.3.5 Measurement / Frequency Formats

This test applies to GSM 400, GSM 900, DCS 1 800 and PCS 1900 mobile stations.

26.6.3.5.1 Conformance Requirement

The MS shall continuously send MEASUREMENT REPORT messages on every SACCH blocks and the measurement valid indication shall be set to valid (0) within the second block at the latest. After 20 seconds the values in the MEASUREMENT REPORT message shall contain measurement results for the cells on which the mobile is allowed to report.

References

GSM 04.08 section 3.4.1.2, GSM 05.08 section 8.4.

26.6.3.5.2 Test Purpose

To test that, when the SS gives information about neighbouring cells, the MS reports appropriate results.

26.6.3.5.3 Method of test

Initial Conditions

System Simulator:

For GSM 900, DCS 1800 and PCS 1900: 2 cells with the following settings:

Transmitter	Level	NCC	BCC	ARFCN (GSM900)	ARFCN (DCS1800)	ARFCN (PCS1900)	Cell Identity
Serving, S1	-60	1	3	002	715	715	0001H
Neighbour, N1	-85	1	5	008	815	805	0002H

For GSM 400: 2 cells with the following settings:

Transmitter	Level	NCC	BCC	ARFCN (GSM450)	ARFCN (GSM480)	Cell Identity
Serving, S1	-60	1	3	260	307	0001H
Neighbour, N1	-85	1	5	264	311	0002H

With the exception of the Cell Allocation, the rest of the parameters for both cells are the same as the default settings and default SYSTEM INFORMATION TYPE 1 to 4 message contents for cell A. The Cell Allocation for the serving cell is the same as the default setting for cell A. The Cell Allocations for the neighbour cells need have only one entry, consisting of the ARFCN of that cell's BCCH.

Mobile Station:

The MS is in the active state of a call (U10).

Related PICS/PIXIT Statements

Support for state U10 of the Call Control protocol.

Type of MS (GSM 450 or GSM 480 or P-GSM 900 or EGSM or DCS 1 800 or PCS 1900).

Foreseen Final State of the MS

Active state of a call (U10).

Test Procedure

This test procedure is performed three times.

With the MS having a call in progress, the SS sends SYSTEM INFORMATION TYPE 5, 5bis & 6 on the SACCH. Both of the BCCHs "on air" are indicated in the BA. The MS shall send MEASUREMENT REPORTs back to the SS, and it shall be indicated in these that no measurement results have been obtained.

For each iteration of the test the frequency format of the BA list contained in the System Information 5 and 5bis message shall change according to the specific message contents.

Maximum Duration Of Test

5 minutes, including 1 minute for any necessary operator actions.

Expected Sequence

This sequence is performed for execution counter, K = 1, 2, 3.

Since SYSTEM INFORMATION TYPE 5, SYSTEM INFORMATION 5bis, SYSTEM INFORMATION TYPE 6 and MEASUREMENT REPORT are sent continuously, a table is not applicable in this test. The interval between 2 successive Layer 2 frames containing MEASUREMENT REPORTs shall not exceed one Layer 2 frame.

Specific Message Contents

GSM 450 begin:

SYSTEM INFORMATION TYPE 5:

Information Element	value/remark
Neighbour Cells Description Format Identifier BCCH Allocation Sequence BCCH Allocation ARFCN - EXT IND	128 range 1 Channel numbers 260, 262 and 264 belong to the BCCH allocation. Information Element carries only a part of the BA.

SYSTEM INFORMATION TYPE 5bis:

Information Element	value/remark
Protocol Discriminator Message Type Neighbour Cells Description Format Identifier - EXT IND - W(i)	RR management Sys Info 5bis. K = 1. Range 1024 Format K = 2. Range 512 Format K = 3. Variable Bit Map. Information Element carries only a part of the BA. K = 1. 500, 530, 595, 965, 1000, 715, 815, 0 K = 2. 530, 595, 965, 1000, 715, 815, 0 K = 3. 965, 1000, 0, 260, 262

MEASUREMENT REPORT:

Information Element	value/remark
Protocol Discriminator Message Type Measurement Results BA_used DTX_used RXLEV_FULL_SERVING_CELL RXLEV_SUB_SERVING_CELL MEAS_VALID RXQUAL_FULL_SERVING_CELL RXQUAL_SUB_SERVING_CELL NO_NCELL_M RXLEV_NCELL_1 BCCH_FREQ_NCELL_1 BSIC_NCELL_1 RXLEV_NCELL_2 BCCH_FREQ_NCELL_2 BSIC_NCELL_2 RXLEV_NCELL_3 BCCH_FREQ_NCELL_3 BSIC_NCELL_3 . . . RXLEV_NCELL_6 BCCH_FREQ_NCELL_6 BSIC_NCELL_6	RR Management MEASUREMENT REPORT 1 DTX was not used See note 1 See note 1 See note 2 See note 1 See note 1 2 neighbour cell measurement result See note 1 Shall correspond to S1 or N1, i.e., it shall be 0 or 2. Corresponds to that of BCCH_FREQ_NCELL_1 See note 1 Shall correspond to S1 or N1, i.e. it shall be 0 or 2. Corresponds to that of BCCH_FREQ_NCELL_2 00 0000 0 0000 00 0000 . . . 00 0000 0 0000 00 0000

GSM 450 end:

GSM 480 begin:

SYSTEM INFORMATION TYPE 5:

Information Element	value/remark
Neighbour Cells Description Format Identifier BCCH Allocation Sequence BCCH Allocation ARFCN - EXT IND	128 range 1 Channel numbers 307, 309 and 311 belong to the BCCH allocation. Information Element carries only a part of the BA.

SYSTEM INFORMATION TYPE 5bis:

Information Element	value/remark
Protocol Discriminator Message Type Neighbour Cells Description Format Identifier - EXT IND - W(i)	RR management Sys Info 5bis. K = 1. Range 1024 Format K = 2. Range 512 Format K = 3. Variable Bit Map. Information Element carries only a part of the BA. K = 1. 500, 530, 595, 965, 1000, 715, 815, 0 K = 2. 530, 595, 965, 1000, 715, 815, 0 K = 3. 965, 1000, 0, 307, 309

MEASUREMENT REPORT:

Information Element	value/remark
Protocol Discriminator Message Type Measurement Results BA_used DTX_used RXLEV_FULL_SERVING_CELL RXLEV_SUB_SERVING_CELL MEAS_VALID RXQUAL_FULL_SERVING_CELL RXQUAL_SUB_SERVING_CELL NO_NCELL_M RXLEV_NCELL_1 BCCH_FREQ_NCELL_1 BSIC_NCELL_1 RXLEV_NCELL_2 BCCH_FREQ_NCELL_2 BSIC_NCELL_2 RXLEV_NCELL_3 BCCH_FREQ_NCELL_3 BSIC_NCELL_3 . . . RXLEV_NCELL_6 BCCH_FREQ_NCELL_6 BSIC_NCELL_6	RR Management MEASUREMENT REPORT 1 DTX was not used See note 1 See note 1 See note 2 See note 1 See note 1 2 neighbour cell measurement result See note 1 Shall correspond to S1 or N1, i.e., it shall be 0 or 2. Corresponds to that of BCCH_FREQ_NCELL_1 See note 1 Shall correspond to S1 or N1, i.e. it shall be 0 or 2. Corresponds to that of BCCH_FREQ_NCELL_2 00 0000 0 0000 00 0000 . . . 00 0000 0 0000 00 0000

GSM 480 end:

GSM 900 begin:

SYSTEM INFORMATION TYPE 5:

Information Element	value/remark
Neighbour Cells Description Format Identifier BCCH Allocation Sequence BCCH Allocation ARFCN - EXT IND	Bit Map 0. 1 Channel numbers 2, 6 and 8 belong to the BCCH allocation. Information Element carries only a part of the BA.

SYSTEM INFORMATION TYPE 5bis:

Information Element	value/remark
Protocol Discriminator Message Type Neighbour Cells Description Format Identifier - EXT IND - W(i)	RR management Sys Info 5bis. K = 1. Range 1024 Format K = 2. Range 512 Format K = 3. Variable Bit Map. Information Element carries only a part of the BA. K = 1. 500, 530, 595, 965, 1000, 715, 815, 0 K = 2. 530, 595, 965, 1000, 715, 815, 0 K = 3. 965, 1000, 0, 2, 6

MEASUREMENT REPORT:

Information Element	value/remark
Protocol Discriminator Message Type Measurement Results BA_used DTX_used RXLEV_FULL_SERVING_CELL RXLEV_SUB_SERVING_CELL MEAS_VALID RXQUAL_FULL_SERVING_CELL RXQUAL_SUB_SERVING_CELL NO_NCELL_M RXLEV_NCELL_1 BCCH_FREQ_NCELL_1 BSIC_NCELL_1 RXLEV_NCELL_2 BCCH_FREQ_NCELL_2 BSIC_NCELL_2 RXLEV_NCELL_3 BCCH_FREQ_NCELL_3 BSIC_NCELL_3 . . . RXLEV_NCELL_6 BCCH_FREQ_NCELL_6 BSIC_NCELL_6	RR Management MEASUREMENT REPORT 1 DTX was not used See note 1 See note 1 See note 2 See note 1 See note 1 2 neighbour cell measurement result See note 1 Shall correspond to S1 or N1, i.e., it shall be 0 or 2. Corresponds to that of BCCH_FREQ_NCELL_1 See note 1 Shall correspond to S1 or N1, i.e. it shall be 0 or 2. Corresponds to that of BCCH_FREQ_NCELL_2 00 0000 0 0000 00 0000 . . . 00 0000 0 0000 00 0000

GSM 900 end:

DCS 1 800 begin:

SYSTEM INFORMATION TYPE 5:

Information Element	value/remark
Protocol Discriminator Message Type Neighbour Cells Description - Format - EXT IND - W(i)	RR management Sys Info 5. K = 1. Range 1 024 Format K = 2. Variable Bit Map K = 3. Range 128 Format Information Element carries only a part of the BA. K = 1. Non null for 500, 530, 595, 715, 815, 965, 1 000, 0 K = 2. Non null for 965, 1 000, 0, 2, 6, 8 K = 3. Non null for 695, 715, 800

SYSTEM INFORMATION TYPE 5bis:

Information Element	value/remark
Protocol Discriminator Message Type Neighbour Cells Description - Format - EXT IND - W(i) / BCCH Allocation	RR management Sys Info 5bis. K = 1. Bit Map 0. K = 2. Range 512 Format K = 3. Range 256 Format Information Element carries only a part of the BA. K = 1. Non null for 2, 6, 8 K = 2. Non null for 500, 530, 595, 715, 815, 965 K = 3. Non Null for 815, 965, 1000, 0, 2, 6

SYSTEM INFORMATION TYPE 6:

Information Element	value/ remark
Protocol Discriminator Message Type Cell Identity LAI Cell Options - Power Control Indicator - DTX Indicator - Radio_Link_Timeout PLMN permitted	RR Management sys info 6 default default Power Control Indicator is set MS shall not use DTX default only NCC 1 permitted

MEASUREMENT REPORT:

Information Element	value/remark
Protocol Discriminator	RR Management
Message Type	MEASUREMENT REPORT
Measurement Results	
BA_used	1
DTX_used	DTX was not used
RXLEV_FULL_SERVING_CELL	See note 1
RXLEV_SUB_SERVING_CELL	See note 1
MEAS_VALID	See note 2
RXQUAL_FULL_SERVING_CELL	See note 1
RXQUAL_SUB_SERVING_CELL	See note 1
NO_NCELL_M	2 neighbour cell measurement results
RXLEV_NCELL_1	See note 1
BCCH_FREQ_NCELL_1	K= 1. Shall correspond to S1 or N1, i.e., it shall be 6 or 7 K= 2. Shall correspond to S1 or N1, i.e., it shall be 6 or 7 K= 3. Shall correspond to S1 or N1, i.e., it shall be 3 or 5
BSIC_NCELL_1	Corresponds to that of BCCH_FREQ_NCELL_1
RXLEV_NCELL_2	See note 1
BCCH_FREQ_NCELL_2	K= 1. Shall correspond to S1 or N1, i.e., it shall be 6 or 7 K= 2. Shall correspond to S1 or N1, i.e., it shall be 6 or 7 K= 3. Shall correspond to S1 or N1, i.e., it shall be 3 or 5
BSIC_NCELL_2	Corresponds to that of BCCH_FREQ_NCELL_2
RXLEV_NCELL_3	00 0000
BCCH_FREQ_NCELL_3	0 0000
BSIC_NCELL_3	00 0000
.
.
RXLEV_NCELL_6	00 0000
BCCH_FREQ_NCELL_6	0 0000
BSIC_NCELL_6	00 0000

DCS 1 800 end:

PCS 1900 begin:

SYSTEM INFORMATION TYPE 5:

Information Element	value/remark
Protocol Discriminator	RR management
Message Type	Sys Info 5.
Neighbour Cells Description	
- Format	K = 1. Range 1 024 Format K = 2. Variable Bit Map K = 3. Range 128 Format
- EXT IND	Information Element carries only a part of the BA.
- W(i)	K = 1. Non null for 500, 530, 595, 715, 805, 965, 1 000, 0 K = 2. Non null for 965, 1 000, 0, 2, 6, 8 K = 3. Non null for 695, 715, 800

SYSTEM INFORMATION TYPE 5bis:

Information Element	value/remark
Protocol Discriminator	RR management
Message Type	Sys Info 5bis.
Neighbour Cells Description	
- Format	K = 1. Bit Map 0. K = 2. Range 512 Format K = 3. Range 256 Format
- EXT IND	Information Element carries only a part of the BA.
- W(i) / BCCH Allocation	K = 1. Non null for 2, 6, 8 K = 2. Non null for 500, 530, 595, 715, 805, 965 K = 3. Non Null for 805, 965, 1000, 0, 2, 6

SYSTEM INFORMATION TYPE 6:

Information Element	value/remark
Protocol Discriminator	RR Management
Message Type	sys info 6
Cell Identity	default
LAI	default
Cell Options	
- Power Control Indicator	Power Control Indicator is set
- DTX Indicator	MS shall not use DTX
- Radio_Link_Timeout	default
PLMN permitted	only NCC 1 permitted

MEASUREMENT REPORT:

Information Element	value/remark
Protocol Discriminator	RR Management
Message Type	MEASUREMENT REPORT
Measurement Results	
BA_used	1
DTX_used	DTX was not used
RXLEV_FULL_SERVING_CELL	See note 1
RXLEV_SUB_SERVING_CELL	See note 1
MEAS_VALID	See note 2
RXQUAL_FULL_SERVING_CELL	See note 1
RXQUAL_SUB_SERVING_CELL	See note 1
NO_NCELL_M	2 neighbour cell measurement results
RXLEV_NCELL_1	See note 1
BCCH_FREQ_NCELL_1	K= 1. Shall correspond to S1 or N1, i.e., it shall be 6 or 7 K= 2. Shall correspond to S1 or N1, i.e., it shall be 6 or 7 K= 3. Shall correspond to S1 or N1, i.e., it shall be 3 or 5
BSIC_NCELL_1	Corresponds to that of BCCH_FREQ_NCELL_1
RXLEV_NCELL_2	See note 1
BCCH_FREQ_NCELL_2	K= 1. Shall correspond to S1 or N1, i.e., it shall be 6 or 7 K= 2. Shall correspond to S1 or N1, i.e., it shall be 6 or 7 K= 3. Shall correspond to S1 or N1, i.e., it shall be 3 or 5
BSIC_NCELL_2	Corresponds to that of BCCH_FREQ_NCELL_2
RXLEV_NCELL_3	00 0000
BCCH_FREQ_NCELL_3	0 0000
BSIC_NCELL_3	00 0000
.
.
RXLEV_NCELL_6	00 0000
BCCH_FREQ_NCELL_6	0 0000
BSIC_NCELL_6	00 0000

PCS 1900 end:

NOTE 1: These actual values are not checked.

NOTE 2: The Measurement Valid Indication shall be set to valid within the second SACCH block at the latest.

26.6.3.6 Measurement / multiband environment

This test applies to GSM 400, GSM 900 and DCS 1 800 mobile stations.

26.6.3.6.1 Conformance requirements

The MS shall continuously send MEASUREMENT REPORT messages on every SACCH blocks and the measurement valid indication shall be set to valid (0) within the second block at the latest. The MEASUREMENT REPORT message shall contain measurement results for up to the 6 strongest BCCH carriers among those with known and allowed NCC part of BSIC on which the mobile is asked to report.

References

GSM 04.08 section 3.4.1.2, GSM 05.08 section 8.4.

26.6.3.6.2 Test purpose

To test that, when the SS gives information about neighbouring cells using SYSTEM INFORMATION TYPE 2ter/5ter, the MS reports appropriate results.

26.6.3.6.3 Method of test

Initial Conditions

System Simulator:

For GSM 900 and DCS 1800: 8 cells with the following settings:

Transmitter	Level	NCC	BSCC	ARFCN (GSM900)	ARFCN (DCS1800)	Cell Identity
Serving, S1	-60	1	3	002	514	0001H
Neighbour, N1	-85	1	5	008	530	0002H
Neighbour, N2	-80	1	7	014	602	0003H
Neighbour, N3	-75	1	1	020	665	0004H
Neighbour, N4	-55	1	3	026	762	0005H
Neighbour, N5	-50	1	5	032	686	0006H
Neighbour, N6	-45	1	7	038	549	0007H
Neighbour, N7	-40	1	1	044	810	0008H

For GSM 450 and GSM 480: 8 cells with the following settings:

Transmitter	Level	NCC	BSCC	ARFCN (GSM450)	ARFCN (GSM480)	Cell identity
Serving, S1	-60	1	3	260	307	0001H
Neighbour, N1	-85	1	5	264	311	0002H
Neighbour, N2	-80	1	7	268	315	0003H
Neighbour, N3	-75	1	1	272	319	0004H
Neighbour, N4	-55	1	3	276	323	0005H
Neighbour, N5	-50	1	5	280	327	0006H
Neighbour, N6	-45	1	7	284	331	0007H
Neighbour, N7	-40	1	1	288	335	0008H

With the exception of the Cell Allocation, the rest of the parameters for all eight cells are the same as the default settings and default SYSTEM INFORMATION TYPE 1, 2 and 4 message contents for cell A. The Cell Allocation for the serving cell is the same as the default setting for cell A. The Cell Allocations for the neighbour cells need have only one entry, consisting of the ARFCN of that cell's BCCH.

Mobile Station:

The MS is in the active state of a call (U10).

Related PICS/PIXIT Statements

Support for state U10 of the Call Control protocol.

Type of MS (GSM 450 or GSM 480 or P-GSM 900 or EGSM or DCS 1 800).

Foreseen Final State of the MS

Active state of a call (U10).

Test Procedure

This test procedure is performed once.

With the MS having a call in progress, the SS sends SYSTEM INFORMATION TYPE 5, 5ter & 6 on the SACCH. All 8 of the BCCHs "on air" are indicated in the BA. The MS shall send MEASUREMENT REPORTs back to the SS, and it shall be indicated within 20 seconds in these that measurement results for the 6 strongest carriers, on which the mobile is asked to report, have been obtained.

Maximum Duration of Test

5 minutes, including 1 minute for any necessary operator actions.

Expected Sequence

Since SYSTEM INFORMATION TYPE 5, SYSTEM INFORMATION TYPE 5ter, SYSTEM INFORMATION TYPE 6 and MEASUREMENT REPORT are sent continuously, a table is not applicable in this test. The interval between 2 successive Layer 2 frames containing MEASUREMENT REPORTs shall not exceed one Layer 2 frame.

Specific Message Contents

GSM 450 begin:

SYSTEM INFORMATION TYPE 2ter:

Information Element	value/remark
Additional Multiband information - Multiband reporting	Minimum 2 cells reported from each band supported excluding the frequency band of the serving cell.
Extension of the BCCH Frequency list - Format identifier - BCCH Allocation Sequence - BCCH Allocation ARFCN - EXT IND	Range 512 0 ARFCN 514, 530, 549, 602, 665, 686, 762, 810 Information Element carries the complete BA.

SYSTEM INFORMATION TYPE 3:

as default except:

Information Element	value/remark
SI 3 rest octets - SI 2ter indicator - Early Classmark Sending Control	System Information 2ter is available Early Sending is explicitly accepted

SYSTEM INFORMATION TYPE 5:

Information Element	value/remark
Protocol Discriminator Message Type Neighbour Cells Description - Format Identifier - BCCH Allocation Sequence - BCCH Allocation ARFCN - EXT IND	RR management Sys Info 5. 128 range 1 ARFCN 260, 264, 268, 272, 276, 280, 284 and 288 Information Element carries the complete BA.

SYSTEM INFORMATION TYPE 5ter:

Information Element	value/remark
Protocol Discriminator	RR management
Message Type	Sys Info 5ter.
Additional Multiband information - Multiband reporting	Minimum 2 cells reported from each band supported excluding the frequency band of the serving cell.
Extension of the BCCH Frequency list - Format identifier	Range 512
- BCCH Allocation Sequence	0
- BCCH Allocation ARFCN	ARFCN 514, 530, 549, 602, 665, 686, 762, 810
- EXT IND	Information Element carries the complete BA.

MEASUREMENT REPORT:

Information Element	value/remark
Protocol Discriminator	RR Management
Transaction Identifier	0000
Message Type	MEASUREMENT REPORT
Measurement Results	
BA_used	1
DTX_used	DTX was not used
RXLEV_FULL_SERVING_CELL	See note 1
RXLEV_SUB_SERVING_CELL	See note 1
MEAS_VALID	See note 3
RXQUAL_FULL_SERVING_CELL	See note 1
RXQUAL_SUB_SERVING_CELL	See note 1
NO_NCELL_M	6 neighbour cell measurement results
RXLEV_NCELL_1	See note 1
BCCH_FREQ_NCELL_1	See note 2
BSIC_NCELL_1	Corresponds to that of BCCH_FREQ_NCELL_1
RXLEV_NCELL_2	See note 1
BCCH_FREQ_NCELL_2	See note 2
BSIC_NCELL_2	Corresponds to that of BCCH_FREQ_NCELL_2
RXLEV_NCELL_3	See note 1
BCCH_FREQ_NCELL_3	See note 2
BSIC_NCELL_3	Corresponds to that of BCCH_FREQ_NCELL_3
RXLEV_NCELL_4	See note 1
BCCH_FREQ_NCELL_4	See note 2
BSIC_NCELL_4	Corresponds to that of BCCH_FREQ_NCELL_4
RXLEV_NCELL_5	See note 1
BCCH_FREQ_NCELL_5	See note 2
BSIC_NCELL_5	Corresponds to that of BCCH_FREQ_NCELL_5
RXLEV_NCELL_6	See NOTE 1
BCCH_FREQ_NCELL_6	See NOTE 2
BSIC_NCELL_6	Corresponds to that of BCCH_FREQ_NCELL_6

NOTE 1: These actual values are not checked.

NOTE 2: report on ARFCNs 260, 272, 276, 280, 284 and 288

NOTE 3: The Measurement Valid Indication shall be set to valid within the second SACCH block at the latest.

GSM 450 end:

GSM 480 begin:

SYSTEM INFORMATION TYPE 2ter:

Information Element	value/remark
Additional Multiband information - Multiband reporting	Minimum 2 cells reported from each band supported excluding the frequency band of the serving cell.
Extension of the BCCH Frequency list - Format identifier - BCCH Allocation Sequence - BCCH Allocation ARFCN - EXT IND	Range 512 0 ARFCN 514, 530, 549, 602, 665, 686, 762, 810 Information Element carries the complete BA.

SYSTEM INFORMATION TYPE 3:

as default except:

Information Element	value/remark
SI 3 rest octets - SI 2ter indicator - Early Classmark Sending Control	System Information 2ter is available Early Sending is explicitly accepted

SYSTEM INFORMATION TYPE 5:

Information Element	value/remark
Protocol Discriminator Message Type Neighbour Cells Description - Format Identifier - BCCH Allocation Sequence - BCCH Allocation ARFCN - EXT IND	RR management Sys Info 5. 128 range 1 ARFCN 307, 311, 315, 319, 323, 327, 331 and 335 Information Element carries the complete BA.

SYSTEM INFORMATION TYPE 5ter:

Information Element	value/remark
Protocol Discriminator Message Type Additional Multiband information - Multiband reporting Extension of the BCCH Frequency list - Format identifier - BCCH Allocation Sequence - BCCH Allocation ARFCN - EXT IND	RR management Sys Info 5ter. Minimum 2 cells reported from each band supported excluding the frequency band of the serving cell. Range 512 0 ARFCN 514, 530, 549, 602, 665, 686, 762, 810 Information Element carries the complete BA.

MEASUREMENT REPORT:

Information Element	value/remark
Protocol Discriminator	RR Management
Transaction Identifier	0000
Message Type	MEASUREMENT REPORT
Measurement Results	
BA_used	1
DTX_used	DTX was not used
RXLEV_FULL_SERVING_CELL	See note 1
RXLEV_SUB_SERVING_CELL	See note 1
MEAS_VALID	See note 3
RXQUAL_FULL_SERVING_CELL	See note 1
RXQUAL_SUB_SERVING_CELL	See note 1
NO_NCELL_M	6 neighbour cell measurement results
RXLEV_NCELL_1	See note 1
BCCH_FREQ_NCELL_1	See note 2
BSIC_NCELL_1	Corresponds to that of BCCH_FREQ_NCELL_1
RXLEV_NCELL_2	See note 1
BCCH_FREQ_NCELL_2	See note 2
BSIC_NCELL_2	Corresponds to that of BCCH_FREQ_NCELL_2
RXLEV_NCELL_3	See note 1
BCCH_FREQ_NCELL_3	See note 2
BSIC_NCELL_3	Corresponds to that of BCCH_FREQ_NCELL_3
RXLEV_NCELL_4	See note 1
BCCH_FREQ_NCELL_4	See note 2
BSIC_NCELL_4	Corresponds to that of BCCH_FREQ_NCELL_4
RXLEV_NCELL_5	See note 1
BCCH_FREQ_NCELL_5	See note 2
BSIC_NCELL_5	Corresponds to that of BCCH_FREQ_NCELL_5
RXLEV_NCELL_6	See NOTE 1
BCCH_FREQ_NCELL_6	See NOTE 2
BSIC_NCELL_6	Corresponds to that of BCCH_FREQ_NCELL_6

NOTE 1: These actual values are not checked.

NOTE 2: report on ARFCNs 307, 319, 323, 327, 331 and 335

NOTE 3: The Measurement Valid Indication shall be set to valid within the second SACCH block at the latest.

GSM 480 end:

GSM 900 begin:

SYSTEM INFORMATION TYPE 2ter:

Information Element	value/remark
Additional Multiband information - Multiband reporting	Minimum 2 cells reported from each band supported excluding the frequency band of the serving cell.
Extension of the BCCH Frequency list - Format identifier - BCCH Allocation Sequence - BCCH Allocation ARFCN - EXT IND	Range 512 0 ARFCN 514, 530, 549, 602, 665, 686, 762, 810 Information Element carries the complete BA.

SYSTEM INFORMATION TYPE 3:

as default except:

Information Element	value/remark
SI 3 rest octets - SI 2ter indicator - Early Classmark Sending Control	System Information 2ter is available Early Sending is explicitly accepted

SYSTEM INFORMATION TYPE 5:

Information Element	value/remark
Protocol Discriminator Message Type Neighbour Cells Description - Format Identifier - BCCH Allocation Sequence - BCCH Allocation ARFCN - EXT IND	RR management Sys Info 5. Bit map 0 1 ARFCN 2, 8, 14, 20, 26, 32, 38, 44 Information Element carries the complete BA.

SYSTEM INFORMATION TYPE 5ter:

Information Element	value/remark
Protocol Discriminator Message Type Additional Multiband information - Multiband reporting Extension of the BCCH Frequency list - Format identifier - BCCH Allocation Sequence - BCCH Allocation ARFCN - EXT IND	RR management Sys Info 5ter. Minimum 2 cells reported from each band supported excluding the frequency band of the serving cell. Range 512 0 ARFCN 514, 530, 549, 602, 665, 686, 762, 810 Information Element carries the complete BA.

MEASUREMENT REPORT:

Information Element	value/remark
Protocol Discriminator	RR Management
Transaction Identifier	0000
Message Type	MEASUREMENT REPORT
Measurement Results	
BA_used	1
DTX_used	DTX was not used
RXLEV_FULL_SERVING_CELL	See note 1
RXLEV_SUB_SERVING_CELL	See note 1
MEAS_VALID	See note 3
RXQUAL_FULL_SERVING_CELL	See note 1
RXQUAL_SUB_SERVING_CELL	See note 1
NO_NCELL_M	6 neighbour cell measurement results
RXLEV_NCELL_1	See note 1
BCCH_FREQ_NCELL_1	See note 2
BSIC_NCELL_1	Corresponds to that of BCCH_FREQ_NCELL_1
RXLEV_NCELL_2	See note 1
BCCH_FREQ_NCELL_2	See note 2
BSIC_NCELL_2	Corresponds to that of BCCH_FREQ_NCELL_2
RXLEV_NCELL_3	See note 1
BCCH_FREQ_NCELL_3	See note 2
BSIC_NCELL_3	Corresponds to that of BCCH_FREQ_NCELL_3
RXLEV_NCELL_4	See note 1
BCCH_FREQ_NCELL_4	See note 2
BSIC_NCELL_4	Corresponds to that of BCCH_FREQ_NCELL_4
RXLEV_NCELL_5	See note 1
BCCH_FREQ_NCELL_5	See note 2
BSIC_NCELL_5	Corresponds to that of BCCH_FREQ_NCELL_5
RXLEV_NCELL_6	See NOTE 1
BCCH_FREQ_NCELL_6	See NOTE 2
BSIC_NCELL_6	Corresponds to that of BCCH_FREQ_NCELL_6

NOTE 1: These actual values are not checked.

NOTE 2: report on ARFCNs 2, 20, 26, 32, 38 and 44

NOTE 3: The Measurement Valid Indication shall be set to valid within the second SACCH block at the latest.

GSM 900 end:

DCS 1 800 begin:

SYSTEM INFORMATION TYPE 2ter:

Information Element	value/remark
Additional Multiband information - Multiband reporting	Minimum 2 cells reported from each band supported excluding the frequency band of the serving cell.
Extension of the BCCH Frequency list - Format identifier	Range 1024
- BCCH Allocation Sequence	0
- BCCH Allocation ARFCN	ARFCN 2, 8, 14, 20, 26, 32, 38, 44
- EXT IND	Information Element carries the complete BA.

SYSTEM INFORMATION TYPE 3:

as default except:

Information Element	value/remark
SI 3 rest octets - SI 2ter indicator - Early Sending Classmark Control	System Information 2ter is available Early Sending is explicitly accepted

SYSTEM INFORMATION TYPE 5:

Information Element	value/remark
Protocol Discriminator Message Type Neighbour Cells Description - Format Identifier - BCCH Allocation Sequence - BCCH Allocation ARFCN - EXT IND	RR management Sys Info 5 Range 512 1 ARFCN 514, 530, 549, 602, 665, 686, 762, 810 Information Element carries the complete BA.

SYSTEM INFORMATION TYPE 5ter:

Information Element	value/remark
Protocol Discriminator Message Type Additional Multiband information - Multiband reporting Extension of the BCCH Frequency list - Format identifier - BCCH Allocation Sequence - BCCH Allocation ARFCN - EXT IND	RR management Sys Info 5ter Minimum 2 cells reported from each band supported excluding the frequency band of the serving cell. Range 1024 0 ARFCN 2, 8, 14, 20, 26, 32, 38, 44 Information Element carries only a part of the BA.

MEASUREMENT REPORT:

Information Element	value/remark
Protocol Discriminator	RR Management
Transaction Identifier	0000
Message Type	MEASUREMENT REPORT
Measurement Results	
BA_used	1
DTX_used	DTX was not used
RXLEV_FULL_SERVING_CELL	See note 4
RXLEV_SUB_SERVING_CELL	See note 4
MEAS_VALID	See note 6
RXQUAL_FULL_SERVING_CELL	See note 4
RXQUAL_SUB_SERVING_CELL	See note 4
NO_NCELL_M	6 neighbour cell measurement results
RXLEV_NCELL_1	See note 4
BCCH_FREQ_NCELL_1	See note 5
BSIC_NCELL_1	Corresponds to that of BCCH_FREQ_NCELL_1
RXLEV_NCELL_2	See note 4
BCCH_FREQ_NCELL_2	See note 5
BSIC_NCELL_2	Corresponds to that of BCCH_FREQ_NCELL_2
RXLEV_NCELL_3	See note 4
BCCH_FREQ_NCELL_3	See note 5
BSIC_NCELL_3	Corresponds to that of BCCH_FREQ_NCELL_3
RXLEV_NCELL_4	See note 4
BCCH_FREQ_NCELL_4	See note 5
BSIC_NCELL_4	Corresponds to that of BCCH_FREQ_NCELL_4
RXLEV_NCELL_5	See note 4
BCCH_FREQ_NCELL_5	See note 5
BSIC_NCELL_5	Corresponds to that of BCCH_FREQ_NCELL_5
RXLEV_NCELL_6	See note 4
BCCH_FREQ_NCELL_6	See note 5
BSIC_NCELL_6	Corresponds to that of BCCH_FREQ_NCELL_6

NOTE 4: These actual values are not checked.

NOTE 5: report on ARFCNs 514, 549, 665, 686, 762, 810

NOTE 6: The Measurement Valid Indication shall be set to valid within the second SACCH block at the latest.

DCS 1 800 end:

26.6.3.7 Measurement / new cell reporting

This test applies to GSM 400 and GSM 900 and DCS 1 800 and PCS 1900 mobile stations.

26.6.3.7.1 Conformance requirements

The MS shall continuously send MEASUREMENT REPORT messages on every SACCH blocks and the measurement valid indication shall be set to valid (0) within the second block at the latest. The MS shall report a new strongest cell in the measurement report at the latest 5 s after a new strongest cell (which is part of the BA(SACCH)) has been activated under the following network conditions: Initial serving cell at RXLEV= -70 dBm, with 6 neighbours at RXLEV= -75 dBm. Then the new BCCH carrier is switched on at RXLEV= -60 dBm.

NOTE: Because of test equipment limitations it is acceptable to activate the new carrier to replace one of the 6 neighbours.

References

GSM 04.08 clause 3.4.1.2, GSM 05.08 clause 7.2.

26.6.3.7.2 Test purpose

To test that, when the SS activates a new strongest neighbour cell, the MS reports that cell with a maximum delay of 5 s.

26.6.3.7.3 Method of test

Initial Conditions

System Simulator:

For GSM 900 or DCS 1800 or PCS 1900: 7 cells with the following settings:

Transmitter	Level	NCC	BSCC	ARFCN	ARFCN	ARFCN	Cell identity
				(GSM900)	(DCS1800)	(PCS 1900)	
Serving, S1	-70	1	3	002	514	514	0001H
Neighbour, N1	-75	1	5	008	530	530	0002H
Neighbour, N2	-75	1	7	014	602	602	0003H
Neighbour, N3	-75	1	1	020	665	665	0004H
Neighbour, N4	-75	1	3	026	762	762	0005H
Neighbour, N5	-75	1	5	032	686	686	0006H
Neighbour, N6	-75	1	7	038	549	549	0007H

For GSM 450 or GSM 480: 7 cells with the following settings:

Transmitter	Level	NCC	BSCC	ARFCN	ARFCN	Cell identity
				(GSM 450)	(GSM 480)	
Serving, S1	-70	1	3	260	307	0001H
Neighbour, N1	-75	1	5	264	311	0002H
Neighbour, N2	-75	1	7	268	315	0003H
Neighbour, N3	-75	1	1	272	319	0004H
Neighbour, N4	-75	1	3	276	323	0005H
Neighbour, N5	-75	1	5	280	327	0006H
Neighbour, N6	-75	1	7	284	331	0007H

With the exception of the Cell Allocation, the rest of the parameters for all seven cells are the same as the default settings and default SYSTEM INFORMATION TYPE 1 to 4 message contents for cell A. The Cell Allocation for the serving cell is the same as the default setting for cell A. The Cell Allocations for the neighbour cells need have only one entry, consisting of the ARFCN of that cell's BCCH.

Mobile Station:

The MS is in the active state of a call (U10).

Related PICS/PIXIT Statements

Support for state U10 of the Call Control protocol.

Type of MS (GSM 450 or GSM 480 or P-GSM or E-GSM or R-GSM or DCS 1 800 or PCS 1900).

Foreseen Final State of the MS

Active state of a call (U10).

Test Procedure

The test is performed in two steps a) and b).

Step a)

With the MS having a call in progress, the SS sends SYSTEM INFORMATION TYPE 5 & 6 on the SACCH. All 7 of the BCCHs "on air" are indicated in the BA. The MS shall send MEASUREMENT REPORTs back to the SS, and it shall be indicated within 20 seconds in these that measurement results for the 6 strongest carriers have been obtained.

Step b)

The SS replaces neighbour cell N1 with neighbour cell N7 with a signal strength of -60 dBm, in order to have the following new settings:

For GSM 900 or DCS 1800 or PCS 1900:

Transmitter	Level	NCC	BSCC	ARFCN	ARFCN	ARFCN	Cell identity
				(GSM900)	(DCS1800)	PCS 1900	
Serving, S1	-70	1	3	002	514	514	0001H
Neighbour, N7	-60	1	1	044	810	530	0008H
Neighbour, N2	-75	1	7	014	602	602	0003H
Neighbour, N3	-75	1	1	020	665	665	0004H
Neighbour, N4	-75	1	3	026	762	762	0005H
Neighbour, N5	-75	1	5	032	686	686	0006H
Neighbour, N6	-75	1	7	038	549	549	0007H

For GSM 450 or GSM 480:

Transmitter	Level	NCC	BSCC	ARFCN	ARFCN	Cell identity
				(GSM450)	(GSM480)	
Serving, S1	-70	1	3	260	307	0001H
Neighbour, N7	-60	1	1	288	335	0008H
Neighbour, N2	-75	1	7	268	315	0003H
Neighbour, N3	-75	1	1	272	319	0004H
Neighbour, N4	-75	1	3	276	323	0005H
Neighbour, N5	-75	1	5	280	327	0006H
Neighbour, N6	-75	1	7	284	331	0007H

With a maximum delay of 5 s, the neighbour cell N7 is included in the measurement report messages.

Maximum Duration of Test

5 minutes, including 1 minute for any necessary operator actions.

Expected Sequence

Since SYSTEM INFORMATION TYPE 5, SYSTEM INFORMATION TYPE 6 and MEASUREMENT REPORT are sent continuously, a table is not applicable in this test. The interval between 2 successive Layer 2 frames containing MEASUREMENT REPORTs shall not exceed one Layer 2 frame.

Specific Message Contents

GSM 450 begin:

SYSTEM INFORMATION TYPE 5:

Information Element	value/remark
Neighbour Cells Description Format Identifier BCCH Allocation Sequence BCCH Allocation ARFCN - EXT IND	variable bit map 1 The channel numbers 259, 261, 262, 263, 264, 265, 267, 268, 269, 270, 271, 272, 273, 274, 275, 276, 278, 279, 280, 281, 282, 283, 284, 285, 286, 287, 288, 289, 290, 291 and 292 belong to the BCCH allocation. Information Element carries complete BA.

MEASUREMENT REPORT: Step a)

Information Element	value/remark
Protocol Discriminator Transaction Identifier Message Type Measurement Results BA_used DTX_used RXLEV_FULL_SERVING_CELL RXLEV_SUB_SERVING_CELL MEAS_VALID RXQUAL_FULL_SERVING_CELL RXQUAL_SUB_SERVING_CELL NO_NCELL_M RXLEV_NCELL_1 BCCH_FREQ_NCELL_1 BSIC_NCELL_1 RXLEV_NCELL_2 BCCH_FREQ_NCELL_2 BSIC_NCELL_2 RXLEV_NCELL_3 BCCH_FREQ_NCELL_3 BSIC_NCELL_3 RXLEV_NCELL_4 BCCH_FREQ_NCELL_4 BSIC_NCELL_4 RXLEV_NCELL_5 BCCH_FREQ_NCELL_5 BSIC_NCELL_5 RXLEV_NCELL_6 BCCH_FREQ_NCELL_6 BSIC_NCELL_6	RR Management 0000 MEASUREMENT REPORT 1 DTX was not used See NOTE 1 See NOTE 1 See NOTE 2 See NOTE 1 See NOTE 1 6 neighbour cell measurement results See NOTE 1 Shall correspond to N1 or N2 or N3 or N4 or N5 or N6 Corresponds to that of BCCH_FREQ_NCELL_1 See NOTE 1 Shall correspond to N1 or N2 or N3 or N4 or N5 or N6 Corresponds to that of BCCH_FREQ_NCELL_2 See NOTE 1 Shall correspond to N1 or N2 or N3 or N4 or N5 or N6 Corresponds to that of BCCH_FREQ_NCELL_3 See NOTE 1 Shall correspond to N1 or N2 or N3 or N4 or N5 or N6 Corresponds to that of BCCH_FREQ_NCELL_4 See NOTE 1 Shall correspond to N1 or N2 or N3 or N4 or N5 or N6 Corresponds to that of BCCH_FREQ_NCELL_5 See NOTE 1 Shall correspond to N1 or N2 or N3 or N4 or N5 or N6 Corresponds to that of BCCH_FREQ_NCELL_6

MEASUREMENT REPORT: Step b)

Information Element	value/remark
Protocol Discriminator	RR Management
Transaction Identifier	0000
Message Type	MEASUREMENT REPORT
Measurement Results	
BA_used	1
DTX_used	DTX was not used
RXLEV_FULL_SERVING_CELL	See NOTE 1
RXLEV_SUB_SERVING_CELL	See NOTE 1
MEAS_VALID	See NOTE 2
RXQUAL_FULL_SERVING_CELL	See NOTE 1
RXQUAL_SUB_SERVING_CELL	See NOTE 1
NO_NCELL_M	6 neighbour cell measurement results
RXLEV_NCELL_1	See NOTE 1
BCCH_FREQ_NCELL_1	Shall correspond to N2 or N3 or N4 or N5 or N6 or N7
BSIC_NCELL_1	Corresponds to that of BCCH_FREQ_NCELL_1
RXLEV_NCELL_2	See NOTE 1
BCCH_FREQ_NCELL_2	Shall correspond to N2 or N3 or N4 or N5 or N6 or N7
BSIC_NCELL_2	Corresponds to that of BCCH_FREQ_NCELL_2
RXLEV_NCELL_3	See NOTE 1
BCCH_FREQ_NCELL_3	Shall correspond to N2 or N3 or N4 or N5 or N6 or N7
BSIC_NCELL_3	Corresponds to that of BCCH_FREQ_NCELL_3
RXLEV_NCELL_4	See NOTE 1
BCCH_FREQ_NCELL_4	Shall correspond to N2 or N3 or N4 or N5 or N6 or N7
BSIC_NCELL_4	Corresponds to that of BCCH_FREQ_NCELL_4
RXLEV_NCELL_5	See NOTE 1
BCCH_FREQ_NCELL_5	Shall correspond to N2 or N3 or N4 or N5 or N6 or N7
BSIC_NCELL_5	Corresponds to that of BCCH_FREQ_NCELL_5
RXLEV_NCELL_6	See NOTE 1
BCCH_FREQ_NCELL_6	Shall correspond to N2 or N3 or N4 or N5 or N6 or N7
BSIC_NCELL_6	Corresponds to that of BCCH_FREQ_NCELL_6

GSM 450 end:

GSM 480 begin:

SYSTEM INFORMATION TYPE 5:

Information Element	value/remark
Neighbour Cells Description	
Format Identifier	variable bit map
BCCH Allocation Sequence	1
BCCH Allocation ARFCN	The channel numbers 306, 308, 309, 310, 311, 312, 314, 315, 316, 317, 318, 319, 320, 321, 322, 323, 325, 326, 327, 328, 329, 330, 331, 332, 333, 334, 335, 336, 337, 338 and 339 belong to the BCCH allocation.
- EXT IND	Information Element carries complete BA.

MEASUREMENT REPORT: Step a)

Information Element	value/remark
Protocol Discriminator	RR Management
Transaction Identifier	0000
Message Type	MEASUREMENT REPORT
Measurement Results	
BA_used	1
DTX_used	DTX was not used
RXLEV_FULL_SERVING_CELL	See NOTE 1
RXLEV_SUB_SERVING_CELL	See NOTE 1
MEAS_VALID	See NOTE 2
RXQUAL_FULL_SERVING_CELL	See NOTE 1
RXQUAL_SUB_SERVING_CELL	See NOTE 1
NO_NCELL_M	6 neighbour cell measurement results
RXLEV_NCELL_1	See NOTE 1
BCCH_FREQ_NCELL_1	Shall correspond to N1 or N2 or N3 or N4 or N5 or N6
BSIC_NCELL_1	Corresponds to that of BCCH_FREQ_NCELL_1
RXLEV_NCELL_2	See NOTE 1
BCCH_FREQ_NCELL_2	Shall correspond to N1 or N2 or N3 or N4 or N5 or N6
BSIC_NCELL_2	Corresponds to that of BCCH_FREQ_NCELL_2
RXLEV_NCELL_3	See NOTE 1
BCCH_FREQ_NCELL_3	Shall correspond to N1 or N2 or N3 or N4 or N5 or N6
BSIC_NCELL_3	Corresponds to that of BCCH_FREQ_NCELL_3
RXLEV_NCELL_4	See NOTE 1
BCCH_FREQ_NCELL_4	Shall correspond to N1 or N2 or N3 or N4 or N5 or N6
BSIC_NCELL_4	Corresponds to that of BCCH_FREQ_NCELL_4
RXLEV_NCELL_5	See NOTE 1
BCCH_FREQ_NCELL_5	Shall correspond to N1 or N2 or N3 or N4 or N5 or N6
BSIC_NCELL_5	Corresponds to that of BCCH_FREQ_NCELL_5
RXLEV_NCELL_6	See NOTE 1
BCCH_FREQ_NCELL_6	Shall correspond to N1 or N2 or N3 or N4 or N5 or N6
BSIC_NCELL_6	Corresponds to that of BCCH_FREQ_NCELL_6

MEASUREMENT REPORT: Step b)

Information Element	value/remark
Protocol Discriminator	RR Management
Transaction Identifier	0000
Message Type	MEASUREMENT REPORT
Measurement Results	
BA_used	1
DTX_used	DTX was not used
RXLEV_FULL_SERVING_CELL	See NOTE 1
RXLEV_SUB_SERVING_CELL	See NOTE 1
MEAS_VALID	See NOTE 2
RXQUAL_FULL_SERVING_CELL	See NOTE 1
RXQUAL_SUB_SERVING_CELL	See NOTE 1
NO_NCELL_M	6 neighbour cell measurement results
RXLEV_NCELL_1	See NOTE 1
BCCH_FREQ_NCELL_1	Shall correspond to N2 or N3 or N4 or N5 or N6 or N7
BSIC_NCELL_1	Corresponds to that of BCCH_FREQ_NCELL_1
RXLEV_NCELL_2	See NOTE 1
BCCH_FREQ_NCELL_2	Shall correspond to N2 or N3 or N4 or N5 or N6 or N7
BSIC_NCELL_2	Corresponds to that of BCCH_FREQ_NCELL_2
RXLEV_NCELL_3	See NOTE 1
BCCH_FREQ_NCELL_3	Shall correspond to N2 or N3 or N4 or N5 or N6 or N7
BSIC_NCELL_3	Corresponds to that of BCCH_FREQ_NCELL_3
RXLEV_NCELL_4	See NOTE 1
BCCH_FREQ_NCELL_4	Shall correspond to N2 or N3 or N4 or N5 or N6 or N7
BSIC_NCELL_4	Corresponds to that of BCCH_FREQ_NCELL_4
RXLEV_NCELL_5	See NOTE 1
BCCH_FREQ_NCELL_5	Shall correspond to N2 or N3 or N4 or N5 or N6 or N7
BSIC_NCELL_5	Corresponds to that of BCCH_FREQ_NCELL_5
RXLEV_NCELL_6	See NOTE 1
BCCH_FREQ_NCELL_6	Shall correspond to N2 or N3 or N4 or N5 or N6 or N7
BSIC_NCELL_6	Corresponds to that of BCCH_FREQ_NCELL_6

GSM 480 end:

GSM 900 begin:

SYSTEM INFORMATION TYPE 5:

Information Element	value/remark
Neighbour Cells Description	
Format Identifier	bit map 0
BCCH Allocation Sequence	1
BCCH Allocation ARFCN	The channel numbers 2, 4, 5, 6, 7, 8, 9, 10, 11, 12, 13, 14, 16, 17, 18, 19, 20, 21, 22, 23, 24, 26, 28, 29, 30, 32, 34, 35, 36, 38, 40 and 44 belong to the BCCH allocation.
- EXT IND	Information Element carries complete BA.

MEASUREMENT REPORT: Step a)

Information Element	value/remark
Protocol Discriminator	RR Management
Transaction Identifier	0000
Message Type	MEASUREMENT REPORT
Measurement Results	
BA_used	1
DTX_used	DTX was not used
RXLEV_FULL_SERVING_CELL	See NOTE 1
RXLEV_SUB_SERVING_CELL	See NOTE 1
MEAS_VALID	See NOTE 2
RXQUAL_FULL_SERVING_CELL	See NOTE 1
RXQUAL_SUB_SERVING_CELL	See NOTE 1
NO_NCELL_M	6 neighbour cell measurement results
RXLEV_NCELL_1	See NOTE 1
BCCH_FREQ_NCELL_1	Shall correspond to N1 or N2 or N3 or N4 or N5 or N6
BSIC_NCELL_1	Corresponds to that of BCCH_FREQ_NCELL_1
RXLEV_NCELL_2	See NOTE 1
BCCH_FREQ_NCELL_2	Shall correspond to N1 or N2 or N3 or N4 or N5 or N6
BSIC_NCELL_2	Corresponds to that of BCCH_FREQ_NCELL_2
RXLEV_NCELL_3	See NOTE 1
BCCH_FREQ_NCELL_3	Shall correspond to N1 or N2 or N3 or N4 or N5 or N6
BSIC_NCELL_3	Corresponds to that of BCCH_FREQ_NCELL_3
RXLEV_NCELL_4	See NOTE 1
BCCH_FREQ_NCELL_4	Shall correspond to N1 or N2 or N3 or N4 or N5 or N6
BSIC_NCELL_4	Corresponds to that of BCCH_FREQ_NCELL_4
RXLEV_NCELL_5	See NOTE 1
BCCH_FREQ_NCELL_5	Shall correspond to N1 or N2 or N3 or N4 or N5 or N6
BSIC_NCELL_5	Corresponds to that of BCCH_FREQ_NCELL_5
RXLEV_NCELL_6	See NOTE 1
BCCH_FREQ_NCELL_6	Shall correspond to N1 or N2 or N3 or N4 or N5 or N6
BSIC_NCELL_6	Corresponds to that of BCCH_FREQ_NCELL_6

MEASUREMENT REPORT: Step b)

Information Element	value/remark
Protocol Discriminator	RR Management
Transaction Identifier	0000
Message Type	MEASUREMENT REPORT
Measurement Results	
BA_used	1
DTX_used	DTX was not used
RXLEV_FULL_SERVING_CELL	See NOTE 1
RXLEV_SUB_SERVING_CELL	See NOTE 1
MEAS_VALID	See NOTE 2
RXQUAL_FULL_SERVING_CELL	See NOTE 1
RXQUAL_SUB_SERVING_CELL	See NOTE 1
NO_NCELL_M	6 neighbour cell measurement results
RXLEV_NCELL_1	See NOTE 1
BCCH_FREQ_NCELL_1	Shall correspond to N2 or N3 or N4 or N5 or N6 or N7
BSIC_NCELL_1	Corresponds to that of BCCH_FREQ_NCELL_1
RXLEV_NCELL_2	See NOTE 1
BCCH_FREQ_NCELL_2	Shall correspond to N2 or N3 or N4 or N5 or N6 or N7
BSIC_NCELL_2	Corresponds to that of BCCH_FREQ_NCELL_2
RXLEV_NCELL_3	See NOTE 1
BCCH_FREQ_NCELL_3	Shall correspond to N2 or N3 or N4 or N5 or N6 or N7
BSIC_NCELL_3	Corresponds to that of BCCH_FREQ_NCELL_3
RXLEV_NCELL_4	See NOTE 1
BCCH_FREQ_NCELL_4	Shall correspond to N2 or N3 or N4 or N5 or N6 or N7
BSIC_NCELL_4	Corresponds to that of BCCH_FREQ_NCELL_4
RXLEV_NCELL_5	See NOTE 1
BCCH_FREQ_NCELL_5	Shall correspond to N2 or N3 or N4 or N5 or N6 or N7
BSIC_NCELL_5	Corresponds to that of BCCH_FREQ_NCELL_5
RXLEV_NCELL_6	See NOTE 1
BCCH_FREQ_NCELL_6	Shall correspond to N2 or N3 or N4 or N5 or N6 or N7
BSIC_NCELL_6	Corresponds to that of BCCH_FREQ_NCELL_6

GSM 900 end:

DCS 1 800 begin:

SYSTEM INFORMATION TYPE 5:

Information Element	value/remark
Protocol Discriminator	RR management
Message Type	Sys Info 5.
Neighbour Cells Description	
- Format	1024 range
- EXT IND	Information Element carries complete BA.
- W(i)	Non null for ARFCN 514, 530, 549, 602, 665, 686, 762, 810.

SYSTEM INFORMATION TYPE 6:

Information Element	value/ remark
Protocol Discriminator	RR Management
Message Type	sys info 6
Cell Identity	default
LAI	default
Cell Options	
- Power Control Indicator	Power Control Indicator is set
- DTX Indicator	MS shall not use DTX
- Radio_Link_Timeout	default
PLMN permitted	only NCC 1 permitted

MEASUREMENT REPORT: Step a)

Information Element	value/remark
Protocol Discriminator	RR Management
Transaction Identifier	0000
Message Type	MEASUREMENT REPORT
Measurement Results	
BA_used	1
DTX_used	DTX was not used
RXLEV_FULL_SERVING_CELL	See NOTE 1
RXLEV_SUB_SERVING_CELL	See NOTE 1
MEAS_VALID	See NOTE 2
RXQUAL_FULL_SERVING_CELL	See NOTE 1
RXQUAL_SUB_SERVING_CELL	See NOTE 1
NO_NCELL_M	6 neighbour cell measurement results
RXLEV_NCELL_1	See NOTE 1
BCCH_FREQ_NCELL_1	Shall correspond to N1 or N2 or N3 or N4 or N5 or N6
BSIC_NCELL_1	Corresponds to that of BCCH_FREQ_NCELL_1
RXLEV_NCELL_2	See NOTE 1
BCCH_FREQ_NCELL_2	Shall correspond to N1 or N2 or N3 or N4 or N5 or N6
BSIC_NCELL_2	Corresponds to that of BCCH_FREQ_NCELL_2
RXLEV_NCELL_3	See NOTE 1
BCCH_FREQ_NCELL_3	Shall correspond to N1 or N2 or N3 or N4 or N5 or N6
BSIC_NCELL_3	Corresponds to that of BCCH_FREQ_NCELL_3
RXLEV_NCELL_4	See NOTE 1
BCCH_FREQ_NCELL_4	Shall correspond to N1 or N2 or N3 or N4 or N5 or N6
BSIC_NCELL_4	Corresponds to that of BCCH_FREQ_NCELL_4
RXLEV_NCELL_5	See NOTE 1
BCCH_FREQ_NCELL_5	Shall correspond to N1 or N2 or N3 or N4 or N5 or N6
BSIC_NCELL_5	Corresponds to that of BCCH_FREQ_NCELL_5
RXLEV_NCELL_6	See NOTE 1
BCCH_FREQ_NCELL_6	Shall correspond to N1 or N2 or N3 or N4 or N5 or N6
BSIC_NCELL_6	Corresponds to that of BCCH_FREQ_NCELL_6

MEASUREMENT REPORT: Step b)

Information Element	value/remark
Protocol Discriminator	RR Management
Transaction Identifier	0000
Message Type	MEASUREMENT REPORT
Measurement Results	
BA_used	1
DTX_used	DTX was not used
RXLEV_FULL_SERVING_CELL	See NOTE 1
RXLEV_SUB_SERVING_CELL	See NOTE 1
MEAS_VALID	See NOTE 2
RXQUAL_FULL_SERVING_CELL	See NOTE 1
RXQUAL_SUB_SERVING_CELL	See NOTE 1
NO_NCELL_M	6 neighbour cell measurement results
RXLEV_NCELL_1	See NOTE 1
BCCH_FREQ_NCELL_1	Shall correspond to N2 or N3 or N4 or N5 or N6 or N7
BSIC_NCELL_1	Corresponds to that of BCCH_FREQ_NCELL_1
RXLEV_NCELL_2	See NOTE 1
BCCH_FREQ_NCELL_2	Shall correspond to N2 or N3 or N4 or N5 or N6 or N7
BSIC_NCELL_2	Corresponds to that of BCCH_FREQ_NCELL_2
RXLEV_NCELL_3	See NOTE 1
BCCH_FREQ_NCELL_3	Shall correspond to N2 or N3 or N4 or N5 or N6 or N7
BSIC_NCELL_3	Corresponds to that of BCCH_FREQ_NCELL_3
RXLEV_NCELL_4	See NOTE 1
BCCH_FREQ_NCELL_4	Shall correspond to N2 or N3 or N4 or N5 or N6 or N7
BSIC_NCELL_4	Corresponds to that of BCCH_FREQ_NCELL_4
RXLEV_NCELL_5	See NOTE 1
BCCH_FREQ_NCELL_5	Shall correspond to N2 or N3 or N4 or N5 or N6 or N7
BSIC_NCELL_5	Corresponds to that of BCCH_FREQ_NCELL_5
RXLEV_NCELL_6	See NOTE 1
BCCH_FREQ_NCELL_6	Shall correspond to N2 or N3 or N4 or N5 or N6 or N7
BSIC_NCELL_6	Corresponds to that of BCCH_FREQ_NCELL_6

DCS 1 800 end:

PCS 1900 begin:

SYSTEM INFORMATION TYPE 5:

Information Element	value/remark
Protocol Discriminator	RR management
Message Type	Sys Info 5.
Neighbour Cells Description	
- Format	1024 range
- EXT IND	Information Element carries complete BA.
- W(i)	Non null for ARFCN 514, 530, 549, 602, 665, 686, 762, 810.

SYSTEM INFORMATION TYPE 6:

Information Element	value/ remark
Protocol Discriminator	RR Management
Message Type	sys info 6
Cell Identity	default
LAI	default
Cell Options	
- Power Control Indicator	Power Control Indicator is set
- DTX Indicator	MS shall not use DTX
- Radio_Link_Timeout	default
PLMN permitted	only NCC 1 permitted

MEASUREMENT REPORT: Step a)

Information Element	value/remark
Protocol Discriminator	RR Management
Transaction Identifier	0000
Message Type	MEASUREMENT REPORT
Measurement Results	
BA_used	1
DTX_used	DTX was not used
RXLEV_FULL_SERVING_CELL	See NOTE 1
RXLEV_SUB_SERVING_CELL	See NOTE 1
MEAS_VALID	See NOTE 2
RXQUAL_FULL_SERVING_CELL	See NOTE 1
RXQUAL_SUB_SERVING_CELL	See NOTE 1
NO_NCELL_M	6 neighbour cell measurement results
RXLEV_NCELL_1	See NOTE 1
BCCH_FREQ_NCELL_1	Shall correspond to N1 or N2 or N3 or N4 or N5 or N6
BSIC_NCELL_1	Corresponds to that of BCCH_FREQ_NCELL_1
RXLEV_NCELL_2	See NOTE 1
BCCH_FREQ_NCELL_2	Shall correspond to N1 or N2 or N3 or N4 or N5 or N6
BSIC_NCELL_2	Corresponds to that of BCCH_FREQ_NCELL_2
RXLEV_NCELL_3	See NOTE 1
BCCH_FREQ_NCELL_3	Shall correspond to N1 or N2 or N3 or N4 or N5 or N6
BSIC_NCELL_3	Corresponds to that of BCCH_FREQ_NCELL_3
RXLEV_NCELL_4	See NOTE 1
BCCH_FREQ_NCELL_4	Shall correspond to N1 or N2 or N3 or N4 or N5 or N6
BSIC_NCELL_4	Corresponds to that of BCCH_FREQ_NCELL_4
RXLEV_NCELL_5	See NOTE 1
BCCH_FREQ_NCELL_5	Shall correspond to N1 or N2 or N3 or N4 or N5 or N6
BSIC_NCELL_5	Corresponds to that of BCCH_FREQ_NCELL_5
RXLEV_NCELL_6	See NOTE 1
BCCH_FREQ_NCELL_6	Shall correspond to N1 or N2 or N3 or N4 or N5 or N6
BSIC_NCELL_6	Corresponds to that of BCCH_FREQ_NCELL_6

MEASUREMENT REPORT: Step b)

Information Element	value/remark
Protocol Discriminator	RR Management
Transaction Identifier	0000
Message Type	MEASUREMENT REPORT
Measurement Results	
BA_used	1
DTX_used	DTX was not used
RXLEV_FULL_SERVING_CELL	See NOTE 1
RXLEV_SUB_SERVING_CELL	See NOTE 1
MEAS_VALID	See NOTE 2
RXQUAL_FULL_SERVING_CELL	See NOTE 1
RXQUAL_SUB_SERVING_CELL	See NOTE 1
NO_NCELL_M	6 neighbour cell measurement results
RXLEV_NCELL_1	See NOTE 1
BCCH_FREQ_NCELL_1	Shall correspond to N2 or N3 or N4 or N5 or N6 or N7
BSIC_NCELL_1	Corresponds to that of BCCH_FREQ_NCELL_1
RXLEV_NCELL_2	See NOTE 1
BCCH_FREQ_NCELL_2	Shall correspond to N2 or N3 or N4 or N5 or N6 or N7
BSIC_NCELL_2	Corresponds to that of BCCH_FREQ_NCELL_2
RXLEV_NCELL_3	See NOTE 1
BCCH_FREQ_NCELL_3	Shall correspond to N2 or N3 or N4 or N5 or N6 or N7
BSIC_NCELL_3	Corresponds to that of BCCH_FREQ_NCELL_3
RXLEV_NCELL_4	See NOTE 1
BCCH_FREQ_NCELL_4	Shall correspond to N2 or N3 or N4 or N5 or N6 or N7
BSIC_NCELL_4	Corresponds to that of BCCH_FREQ_NCELL_4
RXLEV_NCELL_5	See NOTE 1
BCCH_FREQ_NCELL_5	Shall correspond to N2 or N3 or N4 or N5 or N6 or N7
BSIC_NCELL_5	Corresponds to that of BCCH_FREQ_NCELL_5
RXLEV_NCELL_6	See NOTE 1
BCCH_FREQ_NCELL_6	Shall correspond to N2 or N3 or N4 or N5 or N6 or N7
BSIC_NCELL_6	Corresponds to that of BCCH_FREQ_NCELL_6

PCS 1900 end:

NOTE 1: These actual values are not checked.

NOTE 2: The Measurement Valid Indication shall be set to valid within the second SACCH block at the latest.

26.6.4 Test of the channel assignment procedure

An intracell change of channel can be requested by upper layers in order to change the channel type, or it may be initiated by the RR-sublayer, e.g. for an intra cell handover. This change is performed using the channel assignment procedure. If the procedure is incorrectly implemented in the MS, the establishment and maintenance of connections is endangered. This applies for the successful case and for the assignment failure: the MS's correct return to the old channel after assignment failure is a necessary part of the GSM system design.

26.6.4.1 Dedicated assignment / successful case

This test is only applicable to an MS supporting a TCH.

26.6.4.1.1 Conformance requirements

1. Upon receipt of the ASSIGNMENT COMMAND message, the mobile station initiates a local end release of link layer connections, disconnects the physical channels, commands the switching to the assigned channels and initiates the establishment of lower layer connections (this includes the activation of the channels, their connection and the establishment of the main signalling links).
2. MM-messages and CM-messages using SAPI=0 sent from the mobile station to the network can be duplicated by the data link layer in the following case:

a channel change of dedicated channels is required (assignment or handover procedure) and the last layer 2 frame has not been acknowledged by the peer data link layer before the mobile station leaves the old channel.

In this case, the mobile station does not know whether the network has received the message correctly. Therefore, the mobile station has to send the message again after the new dedicated channel is established.

3. An ASSIGNMENT COMMAND message may indicate a frequency change in progress, with a starting time and possibly alternative channel descriptions.

In the case of the reception of an ASSIGNMENT COMMAND message which contains only the description of a channel to be used after the starting time, and if the starting time has not already elapsed, the mobile station shall wait up to the starting time before accessing the channel.

4. The MS shall establish the link with the power level specified in the ASSIGNMENT COMMAND message.

The MS shall confirm the power control level that it is currently employing in the uplink SACCH L1 header. The indicated value shall be the power control level actually used by the mobile for the last burst of the previous SACCH period.

5. The MS shall apply the hopping frequencies specified in ASSIGNMENT COMMAND message in the Mobile Allocation IE or the Frequency List IE at the time of accessing the new channel using the last received Cell Allocation.

6. After receipt of the ASSIGNMENT COMMAND the MS shall perform the assignment and return an ASSIGNMENT COMPLETE without undue delay.

References

- 1, 3, 5. GSM 04.08, subclause 3.4.3.
2. GSM 04.08, subclause 3.1.4.3.
4. GSM 04.08, subclause 3.4.3; GSM 05.08, subclause 4.2.
6. GSM 04.13, subclause 5.2.4.

26.6.4.1.2 Test purpose

1. To verify that upon receipt of an ASSIGNMENT COMMAND, the MS switches to the channel defined in the ASSIGNMENT COMMAND, establishes the link and sends an ASSIGNMENT COMPLETE message. This is tested for an MS supporting TCH in the special cases of a transition.
 - 1.1 from non-hopping SDCCH to hopping TCH/F using a different timeslot;
 - 1.2 from hopping TCH/F to non-hopping TCH/F using a different timeslot;
 - 1.3 from non-hopping TCH/F to non-hopping TCH/F using a different timeslot;
 - 1.4 from non-hopping TCH/F to hopping TCH/H using a different timeslot; this test purpose is only applicable if the MS supports TCH/H;
 - 1.5 from hopping TCH/H to non-hopping TCH/H using a different timeslot; this test purpose is only applicable if the MS supports TCH/H;
 - 1.6 from non-hopping TCH/H to hopping TCH/F using a different timeslot; this test purpose is only applicable if the MS supports TCH/H.
2. To verify that an MS supporting TCH, having sent an MM- or CM message which was not acknowledged on L2 before the channel assignment procedure was initiated and before the MS has left the old channel, repeats that message after completion of the assignment procedure without incrementing N(SD). This is tested in the special case of MM message AUTHENTICATION RESPONSE.
3. To verify that, if an MS supporting TCH has received an ASSIGNMENT COMMAND message which contains only the description of a channel to be used after the starting time, and if the starting time has not already elapsed, the mobile station shall wait up to the starting time before accessing the channel.

4. To verify that an MS supporting TCH, having received an ASSIGNMENT COMMAND, having sent an SABM frame to establish the main signalling link on the assigned channel, reports the power level specified in the ASSIGNMENT COMMAND message, in the uplink SACCH L1 header of the SACCH message sent in the SACCH period following the transmission of the SABM frame.
5. To verify that an MS supporting TCH, having received an ASSIGNMENT COMMAND, is able in the case of frequency hopping to decode the Mobile Allocation and Frequency List IEs correctly and applies the specified frequencies using the correct Cell Allocation.
6. To verify that after receipt of the ASSIGNMENT COMMAND the MS returns an ASSIGNMENT COMPLETE without undue delay.

26.6.4.1.3 Method of test

Initial Conditions

System Simulator:

1 cell, default parameters except:

GSM 450:

BCCH ARFCN =263.

Throughout the test, the CA broadcast in System Information 1 is (259, 261, 263, 265, 267, 269, 271, 273, 275 and 277).

Note that the actual CA of the cell contains other frequencies.

GSM 480:

BCCH ARFCN =310.

Throughout the test, the CA broadcast in System Information 1 is (306, 308, 310, 312, 314, 316, 318, 320, 322 and 324).

Note that the actual CA of the cell contains other frequencies.

GSM 900:

BCCH ARFCN =20.

Throughout the test, the CA broadcast in System Information 1 is (10, 17, 20, 26, 34, 42, 45, 46, 52, 59).

Note that the actual CA of the cell contains other frequencies.

DCS 1 800:

BCCH ARFCN =747.

Throughout the test, the CA broadcast in System Information 1 is (734, 741, 747, 754, 759, 766, 773, 775, 779, 782).

Note that the actual CA of the cell contains other frequencies.

PCS 1900:

BCCH ARFCN =647.

Throughout the test, the CA broadcast in System Information 1 is (634, 641, 647, 654, 659, 666, 673, 675, 679, 682).

Note that the actual CA of the cell contains other frequencies.

Mobile Station:

The MS is in the "idle, updated" state with a TMSI allocated.

Related PICS/PIXIT Statements

- TCH supported (Y/N).
- Supported rate(s) of TCH: (F/F+H).
- The supported channel mode(s) need to be declared.
- The supported frequencies (GSM 450, GSM 480, P-GSM, E-GSM, R-GSM or DCS 1 800 or PCS 1900).

Foreseen Final State of the MS

"Idle, updated", with TMSI allocated.

Test Procedure

The SS pages the MS and allocates an SDCCH. Then 2 different channels are assigned with ASSIGNMENT COMMANDs. Each time the MS shall switch to the assigned channel, establish the link and send an ASSIGNMENT COMPLETE message.

Then the SS sends a AUTHENTICATION REQUEST message. The MS shall answer with an AUTHENTICATION RESPONSE message, which is not acknowledged on L2 by the SS. Immediately after the AUTHENTICATION RESPONSE message is received, the SS sends an ASSIGNMENT COMMAND. The MS shall switch to the assigned channel, establish the link with the commanded power level and send as ASSIGNMENT COMPLETE message. Then MS shall repeat the AUTHENTICATION RESPONSE message, with the same N(SD) value.

Then the SS sends an ASSIGNMENT COMMAND, which includes a Starting Time IE. The MS shall react as specified above, but this shall be done at the time specified in Starting Time IE.

For an MS not supporting TCH/H, the SS initiates the channel release procedure and the test ends here. For an MS supporting TCH/H, the channel assignment procedure is performed another three times, with half rate channels involved, and again it is checked that the MS correctly completes the procedures, before the SS initiates the channel release procedure.

Maximum Duration of Test

30 s.

Expected Sequence

NOTE: TS GSM 04.08 appears to be unclear as to whether timer T3240 shall or shall not be started as a result of the AUTHENTICATION REQUEST message sent in step 10. To allow a variety of test equipment implementations, the IDENTITY REQUEST message is included in order to avoid an unexpected expiry of timer T3240 prior to the end of the expected sequence.

Step	Direction	Message	Comments
1	SS -> MS	PAGING REQUEST TYPE 1	See specific message contents.
2	MS -> SS	CHANNEL REQUEST	
3	SS -> MS	IMMEDIATE ASSIGNMENT	
4	MS -> SS	PAGING RESPONSE	
5	SS -> MS	ASSIGNMENT COMMAND	
6	MS -> SS	ASSIGNMENT COMPLETE	
7	SS		Sent on the correct channel after establishment of the main signalling link. This message shall be ready to be transmitted before 600 ms after the completion of step 5. The SS checks that the MS reports the requested power level in the layer 1 header of the SACCH message that is sent in the first SACCH multiframe following the SABM.
8	SS -> MS	ASSIGNMENT COMMAND	See specific message contents.
9	MS -> SS	ASSIGNMENT COMPLETE	Sent on the correct channel after establishment of the main signalling link. This message shall be ready to be transmitted before 600 ms after the completion of step 8.
10	SS -> MS	AUTHENTICATION REQUEST	This message is not L2 acknowledged by the SS. See specific message contents.
11	MS -> SS	AUTHENTICATION RESPONSE	
12	SS -> MS	ASSIGNMENT COMMAND	
13	MS -> SS	ASSIGNMENT COMPLETE	Sent on the correct channel after establishment of the main signalling link. This message shall be ready to be transmitted before 600 ms after the completion of step 12.
14	MS -> SS	AUTHENTICATION RESPONSE	N(SD) shall be the same as in step 10.
15	SS -> MS	ASSIGNMENT COMMAND	See specific message contents.
16	SS		The SS checks that there is no radio transmission on the new channel before the starting time.
17	MS -> SS	ASSIGNMENT COMPLETE	Sent on the correct channel after establishment of the main signalling link.
A			This test part is performed if the MS does not support TCH/H (see PICS/PIXIT).
A18	SS -> MS	CHANNEL RELEASE	The main signalling link is released.
B			This test part is performed if the MS supports TCH/H (see PICS/PIXIT).
B18	SS -> MS	ASSIGNMENT COMMAND	See specific message contents.
B19	MS -> SS	ASSIGNMENT COMPLETE	Sent on the correct channel after establishment of the main signalling link. This message shall be ready to be transmitted before 600 ms after the completion of step 19.
B20	SS -> MS	IDENTITY REQUEST	
B21	MS -> SS	IDENTITY RESPONSE	See specific message contents. Sent on the correct channel after establishment of the main signalling link. This message shall be ready to be transmitted before 600 ms after the completion of step 22.
B22	SS -> MS	ASSIGNMENT COMMAND	
B23	MS -> SS	ASSIGNMENT COMPLETE	
B24	SS -> MS	ASSIGNMENT COMMAND	See specific message contents.
B25	MS -> SS	ASSIGNMENT COMPLETE	Sent on the correct channel after establishment of the main signalling link. This message shall be ready to be transmitted before 600 ms after the completion of step 24.
B26	SS -> MS	CHANNEL RELEASE	The main signalling link is released.

Specific Message Contents

GSM 450 begin:

Step 3

IMMEDIATE ASSIGNMENT:

As default message contents except Channel Description - Channel Type TDMA offset - Timeslot Number - Training Sequence Code - Hopping - ARFCN	SDCCH/8 Chosen arbitrarily N, chosen arbitrarily Chosen arbitrarily Single RF Channel the ARFCN of the BCCH carrier
---	--

Step 5

ASSIGNMENT COMMAND:

Channel Description - Channel Type and TDMA offset - Timeslot Number - Training Sequence Code - Hopping - MAIO - HSN Power Command - Power level Frequency list IE Channel Mode - Mode Mobile Allocation Starting Time	TCH/F (N+1) mod 8 Chosen arbitrarily RF hopping channel Chosen arbitrarily from the set (0, 1 to N-1) where N is the number of frequencies in the Mobile Allocation IE. Chosen arbitrarily from the set (1 to 63) Chosen arbitrarily but with a changed value. Not included Signalling Indicates all of the CA (broadcast on the BCCH) except for the BCCH carrier. Not included
---	--

Step 8

ASSIGNMENT COMMAND:

Channel Description - Channel Type and TDMA offset - Timeslot Number - Training Sequence Code - Hopping - ARFCN Power Command - Power level Channel Mode Frequency list IE Cell Channel Description Mobile Allocation Starting Time	TCH/F (N+3) mod 8 Chosen arbitrarily Single RF Channel the ARFCN of the BCCH carrier Chosen arbitrarily but with a changed value. A non-signalling mode arbitrarily selected from the full rate capabilities declared for the MS Not Included 128 range encodes (271, 273, 275, 277, 278, 279, 281, 282, 284, 287 and 289) Not included Not included
---	--

Step 12

ASSIGNMENT COMMAND:

Channel Description - Channel Type and TDMA offset - Timeslot Number - Training Sequence Code - Hopping - MAIO - HSN Power Command - Power level Channel Mode Frequency list IE Cell Channel Description Mobile Allocation Starting Time	TCH/F (N+4) mod 8 Chosen arbitrarily RF hopping channel Chosen arbitrarily from the set (0, 1 to N-1) where N is the number of frequencies in the Mobile Allocation IE. Chosen arbitrarily from the set (1 to 63) Chosen arbitrarily but with a changed value. Not included Not included Not included (thus the CA from step 8 is used to decode the MA) Indicates frequencies (271, 273, 279, 281, 282, 284, 287 and 289) Not included
---	--

Step 15

ASSIGNMENT COMMAND:

Channel Description - Channel Type and TDMA offset - Timeslot Number - Training Sequence Code - Hopping - ARFCN Power Command - Power level Channel Mode Frequency list IE Cell Channel Description Mobile Allocation Starting Time	TCH/F (N+5) mod 8 Chosen arbitrarily Single RF Channel 259 Chosen arbitrarily but with a changed value. signalling Not included Not included Not included indicates (current frame number + 100 frames) mod 42 432
---	--

Step 19

ASSIGNMENT COMMAND:

Channel Description	TCH/H
- Channel Type	Chosen arbitrarily
TDMA offset	(N+6) mod 8
- Timeslot Number	Chosen arbitrarily
- Training Sequence Code	RF hopping channel
- Hopping	Chosen arbitrarily from the set (0, 1 to N-1) where N is the number of frequencies in the Frequency List IE.
- MAIO	0
- HSN	
Power Command	Chosen arbitrarily but with a changed value.
- Power level	
Channel Mode	A non-signalling mode arbitrarily selected from the half rate capabilities declared for the MS
Cell Channel Description	Not included
Frequency list IE	Uses 128 range to indicate (259, 267, 275, 279, 287 and 289).
Mobile Allocation	Not included
Starting Time	Not included

Step 21

ASSIGNMENT COMMAND:

Channel Description	TCH/H
- Channel Type	Chosen arbitrarily
TDMA offset	(N+7) mod 8
- Timeslot Number	Chosen arbitrarily
- Training Sequence Code	Single RF Channel
- Hopping	Chosen arbitrarily, but not the BCCH carrier
- ARFCN	
Power Command	Chosen arbitrarily but with a changed value.
- Power level	
Channel Mode	Not included
Frequency list IE	Not included
Cell Channel Description	Not included
Mobile Allocation	Not included
Starting Time	Not included

Step 23

ASSIGNMENT COMMAND:

Channel Description - Channel Type and TDMA offset - Timeslot Number - Training Sequence Code - Hopping - MAIO - HSN Power Command - Power level Cell Channel Description Frequency list IE Mobile Allocation Starting Time	TCH/F (N+1) mod 8 Chosen arbitrarily RF hopping channel Chosen arbitrarily from the set (0, 1 to N-1) where N is the number of frequencies in the Mobile Allocation IE. Chosen arbitrarily from the set (1 to 63) Chosen arbitrarily but with a changed value. Uses 128 range to indicate (261 and 263) Not included Indicates ARFCN 261 only Not included
---	--

GSM 450 end:

GSM 480 begin:

Step 3

IMMEDIATE ASSIGNMENT:

As default message contents except Channel Description - Channel Type TDMA offset - Timeslot Number - Training Sequence Code - Hopping - ARFCN	SDCCH/8 Chosen arbitrarily N, chosen arbitrarily Chosen arbitrarily Single RF Channel the ARFCN of the BCCH carrier
---	--

Step 5

ASSIGNMENT COMMAND:

Channel Description - Channel Type and TDMA offset - Timeslot Number - Training Sequence Code - Hopping - MAIO - HSN Power Command - Power level Frequency list IE Channel Mode - Mode Mobile Allocation Starting Time	TCH/F (N+1) mod 8 Chosen arbitrarily RF hopping channel Chosen arbitrarily from the set (0, 1 to N-1) where N is the number of frequencies in the Mobile Allocation IE. Chosen arbitrarily from the set (1 to 63) Chosen arbitrarily but with a changed value. Not included Signalling Indicates all of the CA (broadcast on the BCCH) except for the BCCH carrier. Not included
---	--

Step 8

ASSIGNMENT COMMAND:

Channel Description	TCH/F
- Channel Type and TDMA offset	(N+3) mod 8
- Timeslot Number	Chosen arbitrarily
- Training Sequence Code	Single RF Channel
- Hopping	the ARFCN of the BCCH carrier
- ARFCN	
Power Command	Chosen arbitrarily but with a changed value.
- Power level	A non-signalling mode arbitrarily selected from the full rate capabilities declared for the MS
Channel Mode	Not Included
Frequency list IE	Range 128 encodes (318, 320, 322, 324, 325, 326, 328, 329, 331, 334 and 336)
Cell Channel Description	Not included
Mobile Allocation	Not included
Starting Time	Not included

Step 12

ASSIGNMENT COMMAND:

Channel Description	TCH/F
- Channel Type and TDMA offset	(N+4) mod 8
- Timeslot Number	Chosen arbitrarily
- Training Sequence Code	RF hopping channel
- Hopping	Chosen arbitrarily from the set (0, 1 to N-1) where N is the number of frequencies in the Mobile Allocation IE.
- MAIO	Chosen arbitrarily from the set (1 to 63)
- HSN	
Power Command	Chosen arbitrarily but with a changed value.
- Power level	Not included
Channel Mode	Not included
Frequency list IE	Not included
Cell Channel Description	Not included (thus the CA from step 8 is used to decode the MA)
Mobile Allocation	Indicates frequencies (318, 320, 326, 328, 329, 331, 334 and 336).
Starting Time	Not included

Step 15

ASSIGNMENT COMMAND:

Channel Description	TCH/F
- Channel Type and TDMA offset	(N+5) mod 8
- Timeslot Number	Chosen arbitrarily
- Training Sequence Code	Single RF Channel
- Hopping	306
- ARFCN	
Power Command	Chosen arbitrarily but with a changed value.
- Power level	signalling
Channel Mode	Not included
Frequency list IE	Not included
Cell Channel Description	Not included
Mobile Allocation	Not included
Starting Time	indicates (current frame number + 100 frames) mod 42 432

Step 19

ASSIGNMENT COMMAND:

Channel Description	TCH/H
- Channel Type	Chosen arbitrarily
TDMA offset	(N+6) mod 8
- Timeslot Number	Chosen arbitrarily
- Training Sequence Code	RF hopping channel
- Hopping	Chosen arbitrarily from the set (0, 1 to N-1) where N is the number of frequencies in the Frequency List IE.
- MAIO	0
- HSN	
Power Command	Chosen arbitrarily but with a changed value.
- Power level	A non-signalling mode arbitrarily selected from the half rate capabilities declared for the MS
Channel Mode	Not included
Cell Channel Description	Not included
Frequency list IE	Uses 128 range to indicate (306, 314, 322, 326, 334 and 336).
Mobile Allocation	Not included
Starting Time	Not included

Step 21

ASSIGNMENT COMMAND:

Channel Description	TCH/H
- Channel Type	Chosen arbitrarily
TDMA offset	(N+7) mod 8
- Timeslot Number	Chosen arbitrarily
- Training Sequence Code	Single RF Channel
- Hopping	Chosen arbitrarily, but not the BCCH carrier
- ARFCN	
Power Command	
- Power level	Chosen arbitrarily but with a changed value.
Channel Mode	Not included
Frequency list IE	Not included
Cell Channel Description	Not included
Mobile Allocation	Not included
Starting Time	Not included

Step 23

ASSIGNMENT COMMAND:

Channel Description	TCH/F
- Channel Type and TDMA offset	(N+1) mod 8
- Timeslot Number	Chosen arbitrarily
- Training Sequence Code	RF hopping channel
- Hopping	Chosen arbitrarily from the set (0, 1 to N-1) where N is the number of frequencies in the Mobile Allocation IE.
- MAIO	Chosen arbitrarily from the set (1 to 63)
- HSN	
Power Command	
- Power level	Chosen arbitrarily but with a changed value.
Cell Channel Description	Uses 128 range to indicate (308,310)
Frequency list IE	Not included
Mobile Allocation	Indicates ARFCN 308 only
Starting Time	Not included

GSM 480 end:

GSM 900 begin:

Step 3

IMMEDIATE ASSIGNMENT:

As default message contents except	
Channel Description	SDCCH/8
- Channel Type	Chosen arbitrarily
TDMA offset	N, chosen arbitrarily
- Timeslot Number	Chosen arbitrarily
- Training Sequence Code	Single RF Channel
- Hopping	the ARFCN of the BCCH carrier
- ARFCN	

Step 5

ASSIGNMENT COMMAND:

Channel Description	TCH/F
- Channel Type and TDMA offset	(N+1) mod 8
- Timeslot Number	Chosen arbitrarily
- Training Sequence Code	RF hopping channel
- Hopping	Chosen arbitrarily from the set (0, 1 to N-1) where N is the number of frequencies in the Mobile Allocation IE.
- MAIO	Chosen arbitrarily from the set (1 to 63)
- HSN	
Power Command	Chosen arbitrarily but with a changed value.
- Power level	Not included
Frequency list IE	
Channel Mode	Signalling
- Mode	Indicates all of the CA (broadcast on the BCCH) except for the BCCH carrier.
Mobile Allocation	
Starting Time	Not included

Step 8

ASSIGNMENT COMMAND:

Channel Description	TCH/F
- Channel Type and TDMA offset	(N+3) mod 8
- Timeslot Number	Chosen arbitrarily
- Training Sequence Code	Single RF Channel
- Hopping	the ARFCN of the BCCH carrier
- ARFCN	
Power Command	Chosen arbitrarily but with a changed value.
- Power level	
Channel Mode	A non-signalling mode arbitrarily selected from the full rate capabilities declared for the MS
Frequency list IE	Not Included
Cell Channel Description	Bit map zero encodes (45, 46, 52, 59, 66, 73, 74, 75, 76, 108, 114)
Mobile Allocation	Not included
Starting Time	Not included

Step 12

ASSIGNMENT COMMAND:

Channel Description	TCH/F
- Channel Type and TDMA offset	(N+4) mod 8
- Timeslot Number	Chosen arbitrarily
- Training Sequence Code	RF hopping channel
- Hopping	Chosen arbitrarily from the set (0, 1 to N-1) where N is the number of frequencies in the Mobile Allocation IE.
- MAIO	Chosen arbitrarily from the set (1 to 63)
- HSN	
Power Command	Chosen arbitrarily but with a changed value.
- Power level	
Channel Mode	Not included
Frequency list IE	Not included
Cell Channel Description	Not included (thus the CA from step 8 is used to decode the MA)
Mobile Allocation	Indicates frequencies (45, 46, 73, 74, 75, 76, 108, 114)
Starting Time	Not included

Step 15

ASSIGNMENT COMMAND:

Channel Description	TCH/F
- Channel Type and TDMA offset	(N+5) mod 8
- Timeslot Number	Chosen arbitrarily
- Training Sequence Code	Single RF Channel
- Hopping	10
- ARFCN	
Power Command	Chosen arbitrarily but with a changed value.
- Power level	signalling
Channel Mode	Not included
Frequency list IE	Not included
Cell Channel Description	Not included
Mobile Allocation	Not included
Starting Time	indicates (current frame number + 100 frames) mod 42 432

Step 19

ASSIGNMENT COMMAND:

Channel Description	TCH/H
- Channel Type	Chosen arbitrarily
TDMA offset	(N+6) mod 8
- Timeslot Number	Chosen arbitrarily
- Training Sequence Code	RF hopping channel
- Hopping	Chosen arbitrarily from the set (0, 1 to N-1) where N is the number of frequencies in the Frequency List IE.
- MAIO	0
- HSN	
Power Command	Chosen arbitrarily but with a changed value.
- Power level	A non-signalling mode arbitrarily selected from the half rate capabilities declared for the MS
Channel Mode	Not included
Cell Channel Description	Not included
Frequency list IE	Uses bit map 0 to indicate (10, 34, 52, 73, 108, 114).
Mobile Allocation	Not included
Starting Time	Not included

Step 21

ASSIGNMENT COMMAND:

Channel Description	TCH/H
- Channel Type	Chosen arbitrarily
TDMA offset	(N+7) mod 8
- Timeslot Number	Chosen arbitrarily
- Training Sequence Code	Single RF Channel
- Hopping	Chosen arbitrarily, but not the BCCH carrier
- ARFCN	
Power Command	Chosen arbitrarily but with a changed value.
- Power level	Not included
Channel Mode	Not included
Frequency list IE	Not included
Cell Channel Description	Not included
Mobile Allocation	Not included
Starting Time	Not included

Step 23

ASSIGNMENT COMMAND:

Channel Description - Channel Type and TDMA offset - Timeslot Number - Training Sequence Code - Hopping - MAIO - HSN Power Command - Power level Cell Channel Description Frequency list IE Mobile Allocation Starting Time	TCH/F (N+1) mod 8 Chosen arbitrarily RF hopping channel Chosen arbitrarily from the set (0, 1 to N-1) where N is the number of frequencies in the Mobile Allocation IE. Chosen arbitrarily from the set (1 to 63) Chosen arbitrarily but with a changed value. Uses bit map 0 to indicate (17, 20) Not included Indicates ARFCN 17 only Not included
---	--

GSM 900 end:

DCS 1 800 begin:

Step 3

IMMEDIATE ASSIGNMENT:

As default message contents except Channel Description - Channel Type TDMA offset - Timeslot Number - Training Sequence Code - Hopping - ARFCN	SDCCH/8 Chosen arbitrarily N, chosen arbitrarily Chosen arbitrarily Single RF Channel the ARFCN of the BCCH carrier
---	--

Step 5

ASSIGNMENT COMMAND:

Channel Description - Channel Type and TDMA offset - Timeslot Number - Training Sequence Code - Hopping - MAIO - HSN Power Command - Power level Frequency list IE Channel Mode - Mode Mobile Allocation Starting Time	TCH/F (N+1) mod 8 Chosen arbitrarily RF hopping channel Chosen arbitrarily from the set (0, 1 to N-1) where N is the number of frequencies in the Mobile Allocation IE. Chosen arbitrarily from the set (1 to 63) Chosen arbitrarily but with a changed value. Not included Signalling Indicates all of the CA (broadcast on the BCCH) except for the BCCH carrier. Not included
---	--

Step 8

ASSIGNMENT COMMAND:

Channel Description - Channel Type and TDMA offset - Timeslot Number - Training Sequence Code - Hopping - ARFCN	TCH/F (N+3) mod 8 Chosen arbitrarily Single RF Channel the ARFCN of the BCCH carrier
Power Command - Power level	Chosen arbitrarily but with a changed value.
Channel Mode	A non-signalling mode arbitrarily selected from the full rate capabilities declared for the MS
Frequency list IE	Not Included
Cell Channel Description	Use Range 128 to encode (773, 775, 779, 782, 791, 798, 829, 832, 844)
Mobile Allocation	Not included
Starting Time	Not included

Step 12

ASSIGNMENT COMMAND:

Channel Description - Channel Type and TDMA offset - Timeslot Number - Training Sequence Code - Hopping - MAIO - HSN	TCH/F (N+4) mod 8 Chosen arbitrarily RF hopping channel Chosen arbitrarily from the set (0, 1 to N-1) where N is the number of frequencies in the Mobile Allocation IE. Chosen arbitrarily from the set (1 to 63)
Power Command - Power level	Chosen arbitrarily but with a changed value.
Channel Mode	Not included
Frequency list IE	Not included
Cell Channel Description	Not included (thus the CA from step 8 is used to decode the MA)
Mobile Allocation	Indicates frequencies (773, 775, 779, 829, 832, 844)
Starting Time	Not included

Step 15

ASSIGNMENT COMMAND:

Channel Description - Channel Type and TDMA offset - Timeslot Number - Training Sequence Code - Hopping - ARFCN	TCH/F (N+5) mod 8 Chosen arbitrarily Single RF Channel 734
Power Command - Power level	Chosen arbitrarily but with a changed value.
Channel Mode	signalling
Frequency list IE	Not included
Cell Channel Description	Not included
Mobile Allocation	Not included
Starting Time	indicates (current frame number + 100 frames) mod 42 432

Step 19

ASSIGNMENT COMMAND:

Channel Description	TCH/H
- Channel Type	Chosen arbitrarily
TDMA offset	(N+6) mod 8
- Timeslot Number	Chosen arbitrarily
- Training Sequence Code	RF hopping channel
- Hopping	Chosen arbitrarily from the set (0, 1 to N-1) where N is the number of frequencies in the Frequency List IE.
- MAIO	0
- HSN	
Power Command	Chosen arbitrarily but with a changed value.
- Power level	
Channel Mode	A non-signalling mode arbitrarily selected from the half rate capabilities declared for the MS
Cell Channel Description	Not included
Frequency list IE	Uses Range 1024 to indicate (734, 741, 759, 766, 773, 832, 844)
Mobile Allocation	Not included
Starting Time	Not included

Step 21

ASSIGNMENT COMMAND:

Channel Description	TCH/H
- Channel Type	Chosen arbitrarily
TDMA offset	(N+7) mod 8
- Timeslot Number	Chosen arbitrarily
- Training Sequence Code	Single RF Channel
- Hopping	Chosen arbitrarily, but not the BCCH carrier
- ARFCN	
Power Command	Chosen arbitrarily but with a changed value.
- Power level	
Channel Mode	Not included
Frequency list IE	Not included
Cell Channel Description	Not included
Mobile Allocation	Not included
Starting Time	Not included

Step 23

ASSIGNMENT COMMAND:

Channel Description	TCH/F
- Channel Type and TDMA offset	(N+1) mod 8
- Timeslot Number	Chosen arbitrarily
- Training Sequence Code	RF hopping channel
- Hopping	Chosen arbitrarily from the set (0, 1 to N-1) where N is the number of frequencies in the Mobile Allocation IE.
- MAIO	Chosen arbitrarily from the set (1 to 63)
- HSN	
Power Command	Chosen arbitrarily but with a changed value.
- Power level	
Cell Channel Description	Uses Variable Range Format to indicate (741, 747)
Frequency list IE	Not included
Mobile Allocation	Indicates ARFCN 741 only
Starting Time	Not included

DCS 1 800 end:

PCS 1900 begin:

Step 3

IMMEDIATE ASSIGNMENT:

As default message contents except Channel Description - Channel Type TDMA offset - Timeslot Number - Training Sequence Code - Hopping - ARFCN	SDCCH/8 Chosen arbitrarily N, chosen arbitrarily Chosen arbitrarily Single RF Channel the ARFCN of the BCCH carrier
---	--

Step 5

ASSIGNMENT COMMAND:

Channel Description - Channel Type and TDMA offset - Timeslot Number - Training Sequence Code - Hopping - MAIO - HSN Power Command - Power level Frequency list IE Channel Mode - Mode Mobile Allocation Starting Time	TCH/F (N+1) mod 8 Chosen arbitrarily RF hopping channel Chosen arbitrarily from the set (0, 1 to N-1) where N is the number of frequencies in the Mobile Allocation IE. Chosen arbitrarily from the set (1 to 63) Chosen arbitrarily but with a changed value. Not included Signalling Indicates all of the CA (broadcast on the BCCH) except for the BCCH carrier. Not included
---	--

Step 8

ASSIGNMENT COMMAND:

Channel Description - Channel Type and TDMA offset - Timeslot Number - Training Sequence Code - Hopping - ARFCN Power Command - Power level Channel Mode Frequency list IE Cell Channel Description Mobile Allocation Starting Time	TCH/F (N+3) mod 8 Chosen arbitrarily Single RF Channel the ARFCN of the BCCH carrier Chosen arbitrarily but with a changed value. A non-signalling mode arbitrarily selected from the full rate capabilities declared for the MS Not Included Use Range 128 to encode (673, 675, 679, 682, 691, 698, 729, 732, 744) Not included Not included
---	---

Step 12

ASSIGNMENT COMMAND:

Channel Description	TCH/F
- Channel Type and TDMA offset	(N+4) mod 8
- Timeslot Number	Chosen arbitrarily
- Training Sequence Code	RF hopping channel
- Hopping	Chosen arbitrarily from the set (0, 1 to N-1) where N is the number of frequencies in the Mobile Allocation IE.
- MAIO	Chosen arbitrarily from the set (1 to 63)
- HSN	
Power Command	Chosen arbitrarily but with a changed value.
- Power level	
Channel Mode	Not included (thus the CA from step 8 is used to decode the MA)
Frequency list IE	Not included
Cell Channel Description	Not included
Mobile Allocation	Indicates frequencies (673, 675, 679, 722, 732, 744)
Starting Time	Not included

Step 15

ASSIGNMENT COMMAND:

Channel Description	TCH/F
- Channel Type and TDMA offset	(N+5) mod 8
- Timeslot Number	Chosen arbitrarily
- Training Sequence Code	Single RF Channel
- Hopping	634
- ARFCN	
Power Command	Chosen arbitrarily but with a changed value.
- Power level	
Channel Mode	signalling
Frequency list IE	Not included
Cell Channel Description	Not included
Mobile Allocation	Not included
Starting Time	indicates (current frame number + 100 frames) mod 42 432

Step 19

ASSIGNMENT COMMAND:

Channel Description	TCH/H
- Channel Type	Chosen arbitrarily
TDMA offset	(N+6) mod 8
- Timeslot Number	Chosen arbitrarily
- Training Sequence Code	RF hopping channel
- Hopping	Chosen arbitrarily from the set (0, 1 to N-1) where N is the number of frequencies in the Frequency List IE.
- MAIO	0
- HSN	
Power Command	Chosen arbitrarily but with a changed value.
- Power level	
Channel Mode	A non-signalling mode arbitrarily selected from the half rate capabilities declared for the MS
Cell Channel Description	Not included
Frequency list IE	Uses Range 1024 to indicate (634, 641, 659, 666, 673, 732, 744)
Mobile Allocation	Not included
Starting Time	Not included

Step 21

ASSIGNMENT COMMAND:

Channel Description	TCH/H
- Channel Type	Chosen arbitrarily
TDMA offset	(N+7) mod 8
- Timeslot Number	Chosen arbitrarily
- Training Sequence Code	Single RF Channel
- Hopping	Chosen arbitrarily, but not the BCCH carrier
- ARFCN	
Power Command	
- Power level	Chosen arbitrarily but with a changed value.
Channel Mode	Not included
Frequency list IE	Not included
Cell Channel Description	Not included
Mobile Allocation	Not included
Starting Time	Not included

Step 23

ASSIGNMENT COMMAND:

Channel Description	TCH/F
- Channel Type and TDMA offset	(N+1) mod 8
- Timeslot Number	Chosen arbitrarily
- Training Sequence Code	RF hopping channel
- Hopping	Chosen arbitrarily from the set (0, 1 to N-1) where N is the number of frequencies in the Mobile Allocation IE.
- MAIO	Chosen arbitrarily from the set (1 to 63)
- HSN	
Power Command	
- Power level	Chosen arbitrarily but with a changed value.
Cell Channel Description	Uses Variable Range Format to indicate (641, 647)
Frequency list IE	Not included
Mobile Allocation	Indicates ARFCN 641 only
Starting Time	Not included

PCS 1900 end:

26.6.4.2 Dedicated assignment / failure

26.6.4.2.1 Dedicated assignment / failure / failure during active state

This test is only applicable to an MS supporting the call control protocol.

26.6.4.2.1.1 Conformance requirements

On the mobile station side, if a lower layer failure happens on the new channel before the ASSIGNMENT COMPLETE message has been sent, the mobile station deactivates the new channels, reactivates the old channels, reconnects the TCHs if any and triggers the establishment of the main signalling link. It then sends a ASSIGNMENT FAILURE message, cause "protocol error unspecified" on the main DCCH and resumes the normal operation, as if no assignment attempt had occurred. The operational parameters (e.g. ciphering mode) when returning on the old channel are those applied before the procedure.

References

GSM 04.08 section 3.4.3.3.

GSM 05.08 section 4.2.

GSM 05.05 section 4.1.1.

26.6.4.2.1.2 Test purpose

To test that, when the MS fails to seize the new channel, the MS reactivates the old channel, reporting use of the last power level used on the old channel.

This is tested in the special cases of a transition:

- from TCH/F to hopping TCH/F in state U10 if the MS supports TCH/F and call control;
- from TCH/H to hopping TCH/H in state U10 if the MS supports TCH/H and call control.

26.6.4.2.1.3 Method of test

Initial Conditions

System Simulator:

1 cell, default parameters. The SS orders the MS to use a power level P. Where P is a power level within the range supported by the Type of MS.

Mobile Station:

The MS is in the active state (U10) of a mobile terminated call.

Related PICS/PIXIT Statements

- Support for TCH/F.
- Support for TCH/H.
- Support for state U10 of the Call Control protocol.
- Type of MS (GSM 450 or GSM 480 or P-GSM 900 or EGSM or DCS 1 800 or PCS 1900).
- Power Class of MS.

Foreseen Final State of the MS

The active state (U10) of a mobile terminated call.

Test Procedure

The MS is in the active state (U10) of a mobile terminated call. The SS sends an ASSIGNMENT COMMAND allocating a new TCH/F, but does not activate the new channel. It is checked that the MS triggers the establishment of the main signalling link on the old channel and then sends an ASSIGNMENT FAILURE.

Maximum Duration of Test

30 s.

Expected Sequence

The test is repeated for execution counter k = 1, 2 if the MS supports TCH/H.

Step	Direction	Message	Comments
1	SS -> MS	ASSIGNMENT COMMAND	Channel Type = TCH/F, if k = 1, Channel Type = TCH/H, if k = 2. Power level specified in power command is different to P, again where P is a power level within the range supported by the Type of MS. The MS attempts (and fails) to establish a signalling link on the new channel.
2			The MS re-establishes the signalling link on the old channel.
3	MS -> SS	ASSIGNMENT FAILURE	RR cause value = "protocol error unspecified".
4	SS		The SS checks that the MS reports power level P in the L1 header of the SACCH message that is sent in the first SACCH multiframe following the SABM.

Specific Message Contents

None.

26.6.4.2.2 Dedicated assignment / failure / general case

26.6.4.2.2.1 Conformance requirements

On the mobile station side, if a lower layer failure happens on the new channel before the ASSIGNMENT COMPLETE message has been sent, the mobile station deactivates the new channels, reactivates the old channels, reconnects the TCHs if any and triggers the establishment of the main signalling link. It then sends a ASSIGNMENT FAILURE message, cause "protocol error unspecified" on the main DCCH and resumes the normal operation, as if no assignment attempt had occurred. The operational parameters (e.g. ciphering mode) when returning on the old channel are those applied before the procedure.

References

GSM 04.08 section 3.4.3.3.

26.6.4.2.2.2 Test purpose

To test that, when the MS fails to seize the new channel, the MS reactivates the old channel.

This is tested in the special cases of a transition:

- from SDCCH to hopping TCH/F; this test part is only applicable if the MS supports TCH/F.
- from non-hopping SDCCH to hopping TCH/H; this test part is only applicable if the MS supports TCH/H.
- from hopping TCH/F to hopping TCH/H; this test part is only applicable if the MS supports TCH/H.

NOTE: 26.6.8.4 contains the case of an assignment failure SDCCH -> SDCCH.

26.6.4.2.2.3 Method of test

Initial Conditions

System Simulator:

1 cell, default parameters.

Mobile Station:

The MS is "idle updated".

Related PICS/PIXIT Statements

- Support for TCH/F.

- Support for TCH/H.
- Type of MS (GSM 450 or GSM 480 or P-GSM 900 or EGSM or DCS 1 800 or PCS 1900).

Foreseen Final State of the MS

The MS is "idle updated".

Test Procedure

A mobile terminated RR connection is established on an SDCCH. The SS sends an ASSIGNMENT COMMAND message allocating a hopping TCH/F, but does not activate the assigned channels. The MS shall try to activate the new channel (this is not verified) and shall then reactivate the old channel and trigger the establishment of the main signalling link on the old channel. Then the MS shall send an ASSIGNMENT FAILURE.

For an MS not supporting TCH/H, the SS initiates the channel release procedure and the test ends here. For an MS supporting TCH/H, the test sequence is repeated another two times, with half rate channels involved, and again it is checked that the MS correctly returns to the old channels, before the SS initiates the channel release procedure.

Maximum Duration of Test

30 s.

Expected Sequence

Step	Direction	Message	Comments
1	SS -> MS	PAGING REQUEST TYPE 1	
2	MS -> SS	CHANNEL REQUEST	
3	SS -> MS	IMMEDIATE ASSIGNMENT	Channel Type: SDCCH.
4	MS -> SS	PAGING RESPONSE	
5	SS -> MS	ASSIGNMENT COMMAND	Channel Type = TCH/F, hopping. The MS attempts (and fails) to establish a signalling link on the new channel.
6			The MS re-establishes the signalling link on the old channel.
7	MS -> SS	ASSIGNMENT FAILURE	RR cause value = "protocol error unspecified".
A			This test part is performed if the MS does not support TCH/H.
A8	SS -> MS	CHANNEL RELEASE	The main signalling link is released.
B			This test part is performed if the MS supports TCH/H.
B8	SS -> MS	ASSIGNMENT COMMAND	Channel Type = TCH/H, hopping. The MS attempts (and fails) to establish a signalling link on the new channel.
B9			The MS re-establishes the signalling link on the old channel.
B10	MS -> SS	ASSIGNMENT FAILURE	RR cause value = "protocol error unspecified".
B11	SS -> MS	ASSIGNMENT COMMAND	Channel Type = TCH/F, hopping.
B12	MS -> SS	ASSIGNMENT COMPLETE	Sent on the assigned channel after establishment of the main signalling link.
B13	SS -> MS	ASSIGNMENT COMMAND	Channel Type = TCH/H, hopping. The MS attempts (and fails) to establish a signalling link on the new channel.
B14			The MS re-establishes the signalling link on the old channel.
B15	MS -> SS	ASSIGNMENT FAILURE	RR cause value = "protocol error unspecified".
B16	SS -> MS	CHANNEL RELEASE	The main signalling link is released.

Specific Message Contents

None.

26.6.5 Test of handover

With the Handover procedure, it is possible to completely alter the channels allocated to a MS. This makes it possible in particular to switch a call in progress from one cell to another. The procedure is always initiated by the network and with the MS in a dedicated mode.

Sections 26.6.5.1 - 26.6.5.4 contain generic test procedures to be used for executing successful Handover tests. Table 26.6-1 contains a summary of the different combinations of parameters which have to be tested, together with a reference to the appropriate generic test procedure. If a test uses a channel rate which the MS under test does not support, the test shall be skipped.

Table 26.6-1

From	To	Timing Adv.	Start Time	Syn ?	State of call	Section	Exec Counter
TCH/F, no FH	TCH/F, no FH	20	none	no	U10	26.6.5.1	1
TCH/F, no FH	TCH/F, FH	arbitrary	none	no	U10	26.6.5.1	2
TCH/F, FH	TCH/F, no FH	20	1,1s	no	U10	26.6.5.1	3
TCH/H, FH	TCH/H, no FH	20	none	no	U10	26.6.5.1	6
TCH/H, no FH	TCH/H, FH	arbitrary	none	no	U10	26.6.5.1	7
TCH/H, FH	TCH/H, FH	20	1,1s	no	U10	26.6.5.1	5
TCH/F, no FH	TCH/H, FH	arbitrary	none	no	U10	26.6.5.1	4
TCH/H, FH	TCH/F, no FH	arbitrary	none	no	U10	26.6.5.1	8
SDCCH/4, no FH	TCH/F, FH	20	none	no	estab	26.6.5.2	1
SDCCH/4, no FH	TCH/H, FH	20	none	no	estab	26.6.5.2	2
SDCCH/4, no FH	SDCCH/8, FH	20	none	no	estab	26.6.5.2	3
SDCCH/8, no FH	SDCCH/8, FH	arbitrary	none	no	estab	26.6.5.2	4
TCH/F, no FH	TCH/H, no FH	20	none	no	estab	26.6.5.2	5
TCH/H, FH	TCH/F, FH	20	none	no	estab	26.6.5.2	6
TCH/F, FH	TCH/F, FH	arbitrary	none	no	estab	26.6.5.2	7
SDCCH/8, FH	TCH/F, no FH	20	none	no	estab	26.6.5.2	8
SDCCH/8, no FH	TCH/F, FH	20	none	no	estab	26.6.5.2	9
SDCCH/8, no FH	TCH/H, FH	arbitrary	none	no	estab	26.6.5.2	10
TCH/F, FH	TCH/F, no FH	(2k+y) mod 256	none	yes	U10	26.6.5.3	1
TCH/H, FH	TCH/H, no FH	(2k+y) mod 256	none	yes	U10	26.6.5.3	2
SDCCH/8, FH	SDCCH/8, FH	(2k+y) mod 256	none	yes	estab	26.6.5.4	1
SDCCH/8, FH	SDCCH/4, no FH	(2k+y) mod 256	1,1s	yes	estab	26.6.5.4	2
TCH/F, no FH	TCH/F, FH	(2k+y) mod 256	none	yes	estab	26.6.5.4	3
SDCCH/8, no FH	TCH/F, no FH	(2k+y) mod 256	none	yes	estab	26.6.5.4	4

Table 26.6-2

	TCH/FS	TCH/HS	SDCCH
n	10-20	5-10	2-5

In addition to the successful case of Handover, 2 unsuccessful cases shall be tested. These tests are described in 26.6.5.8 and 26.6.5.9.

26.6.5.1 Handover / successful / active call / non-synchronized

26.6.5.1.1 Conformance requirements

The MS shall correctly apply the handover procedure in the non-synchronized case when a call is in progress and when handover is performed from a TCH/F without frequency hopping towards a TCH/F without frequency hopping.

The MS shall correctly apply the handover procedure in the non-synchronized case when a call is in progress and when handover is performed from a TCH/H without frequency hopping to a TCH/H with frequency hopping. This does not apply to MSs not supporting TCH/H.

References

GSM 04.08 sections 3.4.4 and 9.1.15.

GSM 04.13 section 5.2.6.2.

26.6.5.1.2 Test purpose

To test that when the MS is ordered to make a non-synchronized handover it continuously sends access bursts on the main DCCH until it receives a PHYSICAL INFORMATION message from the SS. To test that the MS correctly handles the values of any Starting Time IE in the HANDOVER COMMAND message in the case when none of the information elements referring to before the starting time are present. To test that the MS correctly handles the Timing Advance IE in the PHYSICAL INFORMATION message. To test that the MS activates the new channel correctly and transmits the HANDOVER COMPLETE message without undue delay.

26.6.5.1.3 Method of test

Initial Conditions

System Simulator:

2 cells, A and B with same LAI, default parameters except:

GSM 450:

Cell A has:

BCCH ARFCN = 263

Cell Allocation = (259, 261, 263, 265, 267, 269, 271, 273, 275, 277, 279, 281, 283, 285, 287, 289, 291)

Cell B has:

BCCH ARFCN = 274

Cell Allocation = (260, 262, 264, 266, 268, 270, 272, 274, 276, 279, 281, 283, 285, 287, 289, 291)

The Cell Allocation of both Cell A and Cell B shall be coded using range 128 format.

The frame numbers of cells A and B shall be different by 100.

The timebase of cells A and B shall be such that the edges of their timeslots are not coincident at the antenna connector.

GSM 480:

Cell A has:

BCCH ARFCN = 310

Cell Allocation = (306, 308, 310, 312, 314, 316, 318, 320, 322, 324, 326, 328, 330, 332, 334, 336, 338)

Cell B has:

BCCH ARFCN = 321

Cell Allocation = (307, 309, 311, 313, 315, 317, 319, 321, 323, 326, 328, 330, 332, 334, 336, 338)

The Cell Allocation of both Cell A and Cell B shall be coded using range 128 format.

The frame numbers of cells A and B shall be different by 100.

The timebase of cells A and B shall be such that the edges of their timeslots are not coincident at the antenna connector.

GSM 900:

Cell A has:

BCCH ARFCN = 20

Cell Allocation = (10, 17, 20, 26, 34, 42, 45, 46, 52, 59, 66, 73, 74, 75, 76, 108, 114)

Cell B has:

BCCH ARFCN = 40

Cell Allocation = (14, 18, 22, 24, 30, 31, 38, 40, 60, 66, 73, 74, 75, 76, 108, 114)

The frame numbers of cells A and B shall be different by 100.

The timebase of cells A and B shall be such that the edges of their timeslots are not coincident at the antenna connector.

DCS 1 800:

Cell A has:

BCCH ARFCN = 747

Cell Allocation = (734, 741, 747, 754, 759, 762, 766, 767, 773, 775, 779, 782, 791, 798, 829, 832, 844)

Cell B has:

BCCH ARFCN = 764

Cell Allocation = (739, 743, 746, 749, 756, 758, 761, 764, 771, 779, 782, 791, 798, 829, 832, 844)

The Cell Allocation of both Cell A and Cell B shall be coded using range 256 format.

The frame numbers of cells A and B shall be different by 100.

The timebase of cells A and B shall be such that the edges of their timeslots are not coincident at the antenna connector.

GSM 1900:

Cell A has:

BCCH ARFCN = 647

Cell Allocation = (634, 641, 647, 654, 659, 662, 666, 667, 673, 675, 679, 682, 691, 698, 729, 732, 744)

Cell B has:

BCCH ARFCN = 664

Cell Allocation = (639, 643, 646, 649, 656, 658, 661, 664, 671, 679, 682, 691, 698, 729, 732, 744)

The Cell Allocation of both Cell A and Cell B shall be coded using range 256 format.

The frame numbers of cells A and B shall be different by 100.

The timebase of cells A and B shall be such that the edges of their timeslots are not coincident at the antenna connector.

Mobile Station:

The MS is in the active state (U10) of a call on cell A.

Related PICS/PIXIT Statements

Supported rate(s) of TCH: TCH/F and/or TCH/H.

Support for state U10 of the Call Control protocol.

Support for speech: yes/no.

supported radio interface rates: 12kbps, 6kbps, 3,6kbps.

Type of Mobile Station (GSM 450 or GSM 480 or P-GSM 900 or EGSM or DCS 1 800 or PCS 1900).

Foreseen Final State of the MS

The active state (U10) of a call on cell A.

Test Procedure

This procedure is repeated for execution counter $M = 1$ to 8. (See table 26.6-1.)

The MS is in the active state (U10) of a call. The SS sends a HANOVER COMMAND on the main DCCH. The MS shall (at the time defined by the Starting Time information element, if included in the message) begin to send access bursts on the new DCCH of the target cell. The SS observes the access bursts and after receiving n (n being arbitrarily chosen between values according to table 26.6-2 of section 26.6.5) access bursts, the SS sends one PHYSICAL INFORMATION message with a Timing Advance as specified in table 26.6-1 of section 26.6.5. The MS shall activate the channel in sending and receiving mode. The MS shall establish a signalling link. The MS shall be ready to transmit a HANOVER COMPLETE message, before "x" ms after the end of the PHYSICAL INFORMATION message, but not before a UA frame has been sent by the SS.

The term "ready to transmit" is defined in GSM 04.13. The value of "x" depends upon the target channel and is specified in the specific message contents section.

Maximum Duration of Test

5 minutes, including 1 minute for any necessary operator actions.

Expected Sequence

This sequence is performed for an execution counter $M = 1, 2, 3$ for an MS which only supports TCH/F.

This sequence is performed for an execution counter $M = 1, 2.. 8$ for an MS which supports TCH/F and H

Step	Direction	Message	Comments
0	MS -> SS		The MS and SS are in the active state of a call on the channel described below.
1	SS -> MS	HANOVER COMMAND	See Specific message contents.
2	MS -> SS	HANOVER ACCESS	Repeated on every burst of the uplink main DCCH until reception of PHYSICAL INFORMATION. Handover Reference as included in the HANOVER COMMAND. If the HANOVER COMMAND includes a starting time IE then the first HANOVER ACCESS message shall be transmitted in the indicated frame (unless the indicated frame is not used by that channel, in which case the next frame used by that channel shall be used).
3	SS -> MS	PHYSICAL INFORMATION	Sent after reception of n HANOVER ACCESS messages. See specific message contents.
4	MS -> SS	SABM	Sent without information field.
5	SS -> MS	UA	
6	MS -> SS	HANOVER COMPLETE	The message shall be ready to be transmitted before "x" ms after the completion of step 3.
7	MS -> SS		The MS and SS are in the active state of a call on the channel described below.

Specific Message Contents For Mobiles Supporting Speech

For $M = 1$:

GSM 450

Step 0: The MS and SS are using a full rate TCH in non-hopping mode on cell A.

HANDOVER COMMAND

Information Element	value/remarks
As default message contents, except:	
Cell Description	
- Network Colour Code	1
- Base Station Colour Code	5
- BCCH Carrier Number	274
Synchronization Indication	
- Report Observed Time Difference	Shall not be included.
- Synchronization Indication	"Non synchronized".
- Normal Cell Indication	Ignore out of range timing advance.

PHYSICAL INFORMATION

Information Element	value/remarks
As default message contents.	

Step 6: $x = 500$

Step 7: The MS and SS are using a full rate TCH in non hopping mode on cell B.

GSM 480

Step 0: The MS and SS are using a full rate TCH in non-hopping mode on cell A.

HANDOVER COMMAND

Information Element	value/remarks
As default message contents, except:	
Cell Description	
- Network Colour Code	1
- Base Station Colour Code	5
- BCCH Carrier Number	321
Synchronization Indication	
- Report Observed Time Difference	Shall not be included.
- Synchronization Indication	"Non synchronized".
- Normal Cell Indication	Ignore out of range timing advance.

PHYSICAL INFORMATION

Information Element	value/remarks
As default message contents.	

Step 6: $x = 500$

Step 7: The MS and SS are using a full rate TCH in non hopping mode on cell B.

P-GSM 900

Step 0: The MS and SS are using a full rate TCH in non-hopping mode on cell A.

HANDOVER COMMAND

Information Element	value/remarks
As default message contents, except:	
Cell Description	
- Network Colour Code	1
- Base Station Colour Code	5
- BCCH Carrier Number	40
Synchronization Indication	
- Report Observed Time Difference	Shall not be included.
- Synchronization Indication	"Non synchronized".
- Normal Cell Indication	Ignore out of range timing advance.

PHYSICAL INFORMATION

Information Element	value/remarks
As default message contents.	

Step 6: $x = 500$

Step 7: The MS and SS are using a full rate TCH in non hopping mode on cell B.

DCS 1 800

Step 0: The MS and SS are using a full rate TCH in non-hopping mode on cell A.

HANDOVER COMMAND

Information Element	value/remarks
As default message contents, except:	
Cell Description	
- Network Colour Code	1
- Base Station Colour Code	5
- BCCH Carrier Number	764
Synchronization Indication	
- Report Observed Time Difference	Shall not be included.
- Synchronization Indication	"Non synchronized".
- Normal Cell Indication	Ignore out of range timing advance.

PHYSICAL INFORMATION

Information Element	value/remarks
As default message contents.	

Step 6: $x = 500$

Step 7: The MS and SS are using a full rate TCH in non hopping mode on cell B.

PCS 1900

Step 0: The MS and SS are using a full rate TCH in non-hopping mode on cell A.

HANDOVER COMMAND

Information Element	value/remarks
As default message contents, except:	
Cell Description	
- Network Colour Code	1
- Base Station Colour Code	5
- BCCH Carrier Number	664
Synchronization Indication	
- Report Observed Time Difference	Shall not be included.
- Synchronization Indication	"Non synchronized".
- Normal Cell Indication	Ignore out of range timing advance.

PHYSICAL INFORMATION

Information Element	value/remarks
As default message contents.	

Step 6: $x = 500$

Step 7: The MS and SS are using a full rate TCH in non hopping mode on cell B.

For $M = 2$:

GSM 450

Step 0: The MS and SS are using a full rate TCH in non-hopping mode on cell B.

HANDOVER COMMAND

Information Element	value/remarks
As default message contents, except:	
Cell Description	
- Network Colour Code	1
- Base Station Colour Code	5
- BCCH Carrier Number	263
Channel Description	
- Channel Type	TCH/F + ACCHs
- Timeslot number	Chosen arbitrarily, but not Zero.
- Training Sequence Code	Chosen arbitrarily
- Hopping	RF hopping channel.
- MAIO	Chosen arbitrarily from the set (0, 1 to N-1), where N is the number of frequencies encoded in the Frequency List IE.
- HSN	Chosen arbitrarily from the set (1,2,..63).
Synchronization Indication IE is not included.	
Channel Mode IE is not included.	
Frequency List after time	
- Frequency List	Use Range 128 to encode the following 12 frequencies (259, 261, 263, 265, 277, 279, 281, 283, 285, 287, 289, 291).

PHYSICAL INFORMATION

Information Element	value/remarks
As default message contents, except:	
Timing advance	Arbitrarily selected but different to default value.

Step 6: x = 500.

Step 7: The MS and SS are using a full rate TCH in hopping mode on cell A.

GSM 480

Step 0: The MS and SS are using a full rate TCH in non-hopping mode on cell B.

HANDOVER COMMAND

Information Element	value/remarks
As default message contents, except:	
Cell Description	
- Network Colour Code	1
- Base Station Colour Code	5
- BCCH Carrier Number	310
Channel Description	
- Channel Type	TCH/F + ACCHs
- Timeslot number	Chosen arbitrarily, but not Zero.
- Training Sequence Code	Chosen arbitrarily
- Hopping	RF hopping channel.
- MAIO	Chosen arbitrarily from the set (0, 1 to N-1), where N is the number of frequencies encoded in the Frequency List IE.
- HSN	Chosen arbitrarily from the set (1,2,..63).
Synchronization Indication IE is not included.	
Channel Mode IE is not included.	
Frequency List after time	
- Frequency List	Use Range 128 to encode the following 12 frequencies (306, 308, 310, 312, 324, 326, 328, 330, 332, 334, 336, 338).

PHYSICAL INFORMATION

Information Element	value/remarks
As default message contents, except:	
Timing advance	Arbitrarily selected but different to default value.

Step 6: x = 500.

Step 7: The MS and SS are using a full rate TCH in hopping mode on cell A.

GSM 900

Step 0: The MS and SS are using a full rate TCH in non-hopping mode on cell B.

HANDOVER COMMAND

Information Element	value/remarks
As default message contents, except:	
Cell Description	
- Network Colour Code	1
- Base Station Colour Code	5
- BCCH Carrier Number	20
Channel Description	
- Channel Type	TCH/F + ACCHs
- Timeslot number	Chosen arbitrarily, but not Zero.
- Training Sequence Code	Chosen arbitrarily
- Hopping	RF hopping channel.
- MAIO	Chosen arbitrarily from the set (0, 1 to N-1), where N is the number of frequencies encoded in the Frequency Channel Sequence IE.
- HSN	Chosen arbitrarily from the set (1,2,..63).
Synchronization Indication IE is not included.	
Channel Mode IE is not included.	
Frequency Channel Sequence after time	
- Frequency Channel Sequence	Allocates the following 12 frequencies (10, 17, 20, 26, 59, 66, 73, 74, 75, 76,108, 114).

PHYSICAL INFORMATION

Information Element	value/remarks
As default message contents, except:	
Timing advance	Arbitrarily selected but different to default value.

Step 6: $x = 500$.

Step 7: The MS and SS are using a full rate TCH in hopping mode on cell A.

DCS 1 800

Step 0: The MS and SS are using a full rate TCH in non-hopping mode on cell B.

HANDOVER COMMAND

Information Element	value/remarks
As default message contents, except:	
Cell Description	
- Network Colour Code	1
- Base Station Colour Code	5
- BCCH Carrier Number	747
Channel Description	
- Channel Type	TCH/F + ACCHs
- Timeslot number	Chosen arbitrarily, but not Zero.
- Training Sequence Code	Chosen arbitrarily.
- Hopping	RF hopping channel.
- MAIO	Chosen arbitrarily from the set (0, 1 to N-1), where N is the number of frequencies encoded in the Frequency Short List IE.
- HSN	Chosen arbitrarily from the set (1,2,..63).
Synchronization Indication IE is not included.	
Channel Mode IE is not included.	
Frequency Short List after time	
- Frequency List	Use Range 256 to encode the following 9 frequencies: (747, 775, 779, 782, 791, 798, 829, 832, 844).

PHYSICAL INFORMATION

Information Element	value/remarks
As default message contents, except: Timing advance	Arbitrarily selected but different to default value.

Step 6: $x = 500$.

Step 7: The MS and SS are using a full rate TCH in hopping mode on cell A.

PCS 1900

Step 0: The MS and SS are using a full rate TCH in non-hopping mode on cell B.

HANDOVER COMMAND

Information Element	value/remarks
As default message contents, except: Cell Description - Network Colour Code - Base Station Colour Code - BCCH Carrier Number Channel Description - Channel Type - Timeslot number - Training Sequence Code - Hopping - MAIO - HSN Synchronization Indication IE is not included. Channel Mode IE is not included. Frequency Short List after time - Frequency List	1 5 647 TCH/F + ACCHs Chosen arbitrarily, but not Zero. Chosen arbitrarily. RF hopping channel. Chosen arbitrarily from the set (0, 1 to N-1), where N is the number of frequencies encoded in the Frequency Short List IE. Chosen arbitrarily from the set (1,2,..63). Use Range 256 to encode the following 9 frequencies: (647, 675, 679, 682, 691, 698, 729, 732, 744).

PHYSICAL INFORMATION

Information Element	value/remarks
As default message contents, except: Timing advance	Arbitrarily selected but different to default value.

Step 6: $x = 500$.

Step 7: The MS and SS are using a full rate TCH in hopping mode on cell A.

For $M = 3$:

GSM 450

Step 0: The MS and SS are using a full rate TCH in hopping mode on cell A.

HANDOVER COMMAND

Information Element	value/remarks
As default message contents, except:	
Cell Description	
- Network Colour Code	1
- Base Station Colour Code	5
- BCCH Carrier Number	274
Synchronization Indication	
- Report Observed Time Difference	Shall not be included.
- Synchronization Indication	"Non synchronized".
- Normal Cell Indication	Out of range timing advance shall trigger a handover failure procedure.
Starting Time	Indicates the frame number of cell B that will occur approximately 1,1 seconds (238 frames have elapsed) after the HANDOVER COMMAND is sent by cell A.
Mode of first channel	Speech (full rate version 1 or half rate version 1).

PHYSICAL INFORMATION

Information Element	value/remarks
As default message contents.	

Step 6: $x = 500$.

Step 7: The MS and SS are using a full rate TCH in non-hopping mode on cell B.

GSM 480

Step 0: The MS and SS are using a full rate TCH in hopping mode on cell A.

HANDOVER COMMAND

Information Element	value/remarks
As default message contents, except:	
Cell Description	
- Network Colour Code	1
- Base Station Colour Code	5
- BCCH Carrier Number	321
Synchronization Indication	
- Report Observed Time Difference	Shall not be included.
- Synchronization Indication	"Non synchronized".
- Normal Cell Indication	Out of range timing advance shall trigger a handover failure procedure.
Starting Time	Indicates the frame number of cell B that will occur approximately 1,1 seconds (238 frames have elapsed) after the HANDOVER COMMAND is sent by cell A.
Mode of first channel	Speech (full rate version 1 or half rate version 1).

PHYSICAL INFORMATION

Information Element	value/remarks
As default message contents.	

Step 6: $x = 500$.

Step 7: The MS and SS are using a full rate TCH in non-hopping mode on cell B.

GSM 900

Step 0: The MS and SS are using a full rate TCH in hopping mode on cell A.

HANDOVER COMMAND

Information Element	value/remarks
As default message contents, except:	
Cell Description	
- Network Colour Code	1
- Base Station Colour Code	5
- BCCH Carrier Number	40
Synchronization Indication	
- Report Observed Time Difference	Shall not be included.
- Synchronization Indication	"Non synchronized".
- Normal Cell Indication	Out of range timing advance shall trigger a handover failure procedure.
Starting Time	Indicates the frame number of cell B that will occur approximately 1,1 seconds (238 frames have elapsed) after the HANDOVER COMMAND is sent by cell A.
Mode of first channel	Speech (full rate version 1 or half rate version 1).

PHYSICAL INFORMATION

Information Element	value/remarks
As default message contents.	

Step 6: $x = 500$.

Step 7: The MS and SS are using a full rate TCH in non-hopping mode on cell B.

DCS 1 800

Step 0: The MS and SS are using a full rate TCH in hopping mode on cell A.

HANDOVER COMMAND

Information Element	value/remarks
As default message contents, except:	
Cell Description	
- Network Colour Code	1
- Base Station Colour Code	5
- BCCH Carrier Number	764
Synchronization Indication	
- Report Observed Time Difference	Shall not be included.
- Synchronization Indication	"Non synchronized".
- Normal Cell Indication	Out of range timing advance shall trigger a handover failure procedure.
Starting Time	Indicates the frame number of cell B that will occur approximately 1,1 seconds (238 frames have elapsed) after the HANDOVER COMMAND is sent by cell A.
Mode of first channel	Speech (full rate version 1 or half rate version 1).

PHYSICAL INFORMATION

Information Element	value/remarks
As default message contents.	

Step 6: $x = 500$.

Step 7: The MS and SS are using a full rate TCH in non-hopping mode on cell B.

PCS 1900

Step 0: The MS and SS are using a full rate TCH in hopping mode on cell A.

HANDOVER COMMAND

Information Element	value/remarks
As default message contents, except:	
Cell Description	
- Network Colour Code	1
- Base Station Colour Code	5
- BCCH Carrier Number	664
Synchronization Indication	
- Report Observed Time Difference	Shall not be included.
- Synchronization Indication	"Non synchronized".
- Normal Cell Indication	Out of range timing advance shall trigger a handover failure procedure.
Starting Time	Indicates the frame number of cell B that will occur approximately 1,1 seconds (238 frames have elapsed) after the HANDOVER COMMAND is sent by cell A.
Mode of first channel	Speech (full rate version 1 or half rate version 1).

PHYSICAL INFORMATION

Information Element	value/remarks
As default message contents.	

Step 6: $x = 500$.

Step 7: The MS and SS are using a full rate TCH in non-hopping mode on cell B.

For $M = 4$:

GSM 450

Step 0: The MS and SS are using a full rate TCH in non-hopping mode on cell B.

HANDOVER COMMAND

Information Element	value/remarks
As default message contents, except: Cell Description - Network Colour Code - Base Station Colour Code - BCCH Carrier Number Channel Description - Channel Type - TDMA offset - Timeslot number - Training Sequence Code - Hopping - MAIO - HSN Synchronization Indication IE is not included. Cell Channel Description Mobile Allocation after time	1 5 263 TCH/H + ACCHs Chosen arbitrarily. Zero. Chosen arbitrarily. RF hopping channel. Chosen arbitrarily from the set (0, 1 to N-1), where N is the number of frequencies encoded in the Mobile Allocation. zero (this gives cyclic hopping). Use Range 128 to encode the complete CA of Cell A. Indicates all of the CA of cell A except for the BCCH frequency.

PHYSICAL INFORMATION

Information Element	value/remarks
As default message contents, except: Timing advance	Arbitrarily selected but different to default value.

Step 6: $x = 750$.

Step 7: The MS and SS are using a half rate TCH in hopping mode on cell A.

GSM 480

Step 0: The MS and SS are using a full rate TCH in non-hopping mode on cell B.

HANDOVER COMMAND

Information Element	value/remarks
As default message contents, except: Cell Description - Network Colour Code - Base Station Colour Code - BCCH Carrier Number Channel Description - Channel Type - TDMA offset - Timeslot number - Training Sequence Code - Hopping - MAIO - HSN Synchronization Indication IE is not included. Cell Channel Description Mobile Allocation after time	1 5 310 TCH/H + ACCHs Chosen arbitrarily. Zero. Chosen arbitrarily. RF hopping channel. Chosen arbitrarily from the set (0, 1 to N-1), where N is the number of frequencies encoded in the Mobile Allocation. zero (this gives cyclic hopping). Use Range 128 to encode the complete CA of Cell A. Indicates all of the CA of cell A except for the BCCH frequency.

PHYSICAL INFORMATION

Information Element	value/remarks
As default message contents, except: Timing advance	Arbitrarily selected but different to default value.

Step 6: $x = 750$.

Step 7: The MS and SS are using a half rate TCH in hopping mode on cell A.

GSM 900

Step 0: The MS and SS are using a full rate TCH in non-hopping mode on cell B.

HANDOVER COMMAND

Information Element	value/remarks
As default message contents, except:	
Cell Description	
- Network Colour Code	1
- Base Station Colour Code	5
- BCCH Carrier Number	20
Channel Description	
- Channel Type	TCH/H + ACCHs
- TDMA offset	Chosen arbitrarily.
- Timeslot number	Zero.
- Training Sequence Code	Chosen arbitrarily.
- Hopping	RF hopping channel.
- MAIO	Chosen arbitrarily from the set (0, 1 to N-1), where N is the number of frequencies encoded in the Mobile Allocation.
- HSN	zero (this gives cyclic hopping).
Synchronization Indication IE is not included.	
Cell Channel Description	Use bit map 0 to encode the complete CA of Cell A.
Mobile Allocation after time	Indicates all of the CA of cell A except for the BCCH frequency.

PHYSICAL INFORMATION

Information Element	value/remarks
As default message contents, except:	
Timing advance	Arbitrarily selected but different to default value.

Step 6: $x = 750$.

Step 7: The MS and SS are using a half rate TCH in hopping mode on cell A.

DCS 1 800

Step 0: The MS and SS are using a full rate TCH in non-hopping mode on cell B.

HANDOVER COMMAND

Information Element	value/remarks
As default message contents, except:	
Cell Description	
- Network Colour Code	1
- Base Station Colour Code	5
- BCCH Carrier Number	747
Channel Description	
- Channel Type	TCH/H + ACCHs
- TDMA offset	Chosen arbitrarily.
- Timeslot number	Zero.
- Training Sequence Code	Chosen arbitrarily.
- Hopping	RF hopping channel.
- MAIO	Chosen arbitrarily from the set (0, 1 to N-1), where N is the number of frequencies encoded in the Mobile Allocation.
- HSN	zero (this gives cyclic hopping).
Synchronization Indication IE is not included.	
Cell Channel Description	Use Range 512 to encode the complete CA of Cell A.
Mobile Allocation after time	Indicates all of the CA of cell A except for the BCCH frequency.

PHYSICAL INFORMATION

Information Element	value/remarks
As default message contents, except: Timing advance	Arbitrarily selected but different to default value.

Step 6: $x = 750$.

Step 7: The MS and SS are using a half rate TCH in hopping mode on cell A.

PCS 1900

Step 0: The MS and SS are using a full rate TCH in non-hopping mode on cell B.

HANDOVER COMMAND

Information Element	value/remarks
As default message contents, except: Cell Description - Network Colour Code - Base Station Colour Code - BCCH Carrier Number Channel Description - Channel Type - TDMA offset - Timeslot number - Training Sequence Code - Hopping - MAIO - HSN Synchronization Indication IE is not included. Cell Channel Description Mobile Allocation after time	1 5 647 TCH/H + ACCHs Chosen arbitrarily. Zero. Chosen arbitrarily. RF hopping channel. Chosen arbitrarily from the set (0, 1 to N-1), where N is the number of frequencies encoded in the Mobile Allocation. zero (this gives cyclic hopping). Use Range 512 to encode the complete CA of Cell A. Indicates all of the CA of cell A except for the BCCH frequency.

PHYSICAL INFORMATION

Information Element	value/remarks
As default message contents, except: Timing advance	Arbitrarily selected but different to default value.

Step 6: $x = 500$.

Step 7: The MS and SS are using a half rate TCH in hopping mode on cell A.

For $M = 5$:

GSM 450

Step 0: The MS and SS are using a half rate TCH in hopping mode on cell A.

HANDOVER COMMAND

Information Element	value/remarks
As default message contents, except: Cell Description - Network Colour Code - Base Station Colour Code - BCCH Carrier Number Channel Description - Channel Type - TDMA offset - Timeslot number - Training Sequence Code - Hopping - MAIO - HSN Frequency List after time - Frequency List Synchronization Indication - Report Observed Time Difference - Synchronization Indication - Normal Cell Indication Starting Time	 1 5 274 TCH/H + ACCHs Chosen arbitrarily. Chosen arbitrarily, but not Zero. Chosen arbitrarily. RF hopping channel. Chosen arbitrarily from the set (0, 1 to N-1), where N is the number of frequencies encoded in the Frequency List IE. Chosen arbitrarily from the set. (1,2,..63). use Range 128 to allocate the following 12 frequencies: (260, 262, 264, 266, 276, 279, 281, 283, 285, 287, 289, 291). Shall not be included. "Non synchronized". Ignore out of range timing advance. Indicates the frame number of cell B. that will occur approximately 1,1 seconds (238 frames have elapsed) after the HANDOVER COMMAND is sent by cell A.

PHYSICAL INFORMATION

Information Element	value/remarks
As default message contents.	

Step 6: x = 750.

Step 7: The MS and SS are using a half rate TCH in hopping mode on cell B.

GSM 480

Step 0: The MS and SS are using a half rate TCH in hopping mode on cell A.

HANDOVER COMMAND

Information Element	value/remarks
As default message contents, except:	
Cell Description	
- Network Colour Code	1
- Base Station Colour Code	5
- BCCH Carrier Number	321
Channel Description	
- Channel Type	TCH/H + ACCHs
- TDMA offset	Chosen arbitrarily.
- Timeslot number	Chosen arbitrarily, but not Zero.
- Training Sequence Code	Chosen arbitrarily.
- Hopping	RF hopping channel.
- MAIO	Chosen arbitrarily from the set (0, 1 to N-1), where N is the number of frequencies encoded in the Frequency List IE.
- HSN	Chosen arbitrarily from the set. (1,2,..63).
Frequency List after time	
- Frequency List	use Range 128 to allocate the following 12 frequencies: (307, 309, 311, 313, 323, 326, 328, 330, 332, 334, 336, 338).
Synchronization Indication	
- Report Observed Time Difference	Shall not be included.
- Synchronization Indication	"Non synchronized".
- Normal Cell Indication	Ignore out of range timing advance.
Starting Time	Indicates the frame number of cell B. that will occur approximately 1,1 seconds (238 frames have elapsed) after the HANDOVER COMMAND is sent by cell A.

PHYSICAL INFORMATION

Information Element	value/remarks
As default message contents.	

Step 6: x = 750.

Step 7: The MS and SS are using a half rate TCH in hopping mode on cell B.

GSM 900

Step 0: The MS and SS are using a half rate TCH in hopping mode on cell A.

HANDOVER COMMAND

Information Element	value/remarks
As default message contents, except:	
Cell Description	
- Network Colour Code	1
- Base Station Colour Code	5
- BCCH Carrier Number	40
Channel Description	
- Channel Type	TCH/H + ACCHs
- TDMA offset	Chosen arbitrarily.
- Timeslot number	Chosen arbitrarily, but not Zero.
- Training Sequence Code	Chosen arbitrarily.
- Hopping	RF hopping channel.
- MAIO	Chosen arbitrarily from the set (0, 1 to N-1), where N is the number of frequencies encoded in the Frequency List IE.
- HSN	Chosen arbitrarily from the set. (1,2,..63).
Frequency List after time	
- Frequency List	use bit map 0 to allocates the following 12 frequencies: (14, 18, 22, 24, 60, 66, 73, 74, 75, 76,108, 114).
Synchronization Indication	
- Report Observed Time Difference	Shall not be included.
- Synchronization Indication	"Non synchronized".
- Normal Cell Indication	Ignore out of range timing advance.
Starting Time	Indicates the frame number of cell B. that will occur approximately 1,1 seconds (238 frames have elapsed) after the HANDOVER COMMAND is sent by cell A.

PHYSICAL INFORMATION

Information Element	value/remarks
As default message contents.	

Step 6: $x = 750$.

Step 7: The MS and SS are using a half rate TCH in hopping mode on cell B.

DCS 1 800

Step 0: The MS and SS are using a half rate TCH in hopping mode on cell A.

HANDOVER COMMAND

Information Element	value/remarks
As default message contents, except:	
Cell Description	
- Network Colour Code	1
- Base Station Colour Code	5
- BCCH Carrier Number	764
Channel Description	
- Channel Type	TCH/H + ACCHs
- TDMA offset	Chosen arbitrarily.
- Timeslot number	Chosen arbitrarily but not Zero.
- Training Sequence Code	Chosen arbitrarily.
- Hopping	RF hopping channel.
- MAIO	Chosen arbitrarily from the set (0, 1 to N-1), where N is the number of frequencies encoded in the Frequency List IE.
- HSN	Chosen arbitrarily from the set (1,2,..63).
Frequency List after time	
- Frequency List	Use Range 1024 to allocate the following 12 frequencies: (749, 758, 761, 764, 771, 779, 782, 791, 798, 829, 832, 844).
Synchronization Indication	
- Report Observed Time Difference	Shall not be included.
- Synchronization Indication	"Non synchronized".
- Normal Cell Indication	Ignore out of range timing advance.
Starting Time	Indicates the frame number of cell B that will occur approximately 1,1 seconds (238 frames have elapsed) after the HANDOVER COMMAND is sent by cell A..

PHYSICAL INFORMATION

Information Element	value/remarks
As default message contents.	

Step 6: $x = 750$.

Step 7: The MS and SS are using a half rate TCH in hopping mode on cell B.

PCS 1900

Step 0: The MS and SS are using a half rate TCH in hopping mode on cell A.

HANDOVER COMMAND

Information Element	value/remarks
As default message contents, except:	
Cell Description	
- Network Colour Code	1
- Base Station Colour Code	5
- BCCH Carrier Number	664
Channel Description	
- Channel Type	TCH/H + ACCHs
- TDMA offset	Chosen arbitrarily.
- Timeslot number	Chosen arbitrarily but not Zero.
- Training Sequence Code	Chosen arbitrarily.
- Hopping	RF hopping channel.
- MAIO	Chosen arbitrarily from the set (0, 1 to N-1), where N is the number of frequencies encoded in the Frequency List IE.
- HSN	Chosen arbitrarily from the set (1,2,..63).
Frequency List after time	
- Frequency List	Use Range 1024 to allocate the following 12 frequencies: (649, 658, 661, 664, 671, 679, 682, 691, 698, 729, 732, 744).
Synchronization Indication	
- Report Observed Time Difference	Shall not be included.
- Synchronization Indication	"Non synchronized".
- Normal Cell Indication	Ignore out of range timing advance.
Starting Time	Indicates the frame number of cell B that will occur approximately 1,1 seconds (238 frames have elapsed) after the HANDOVER COMMAND is sent by cell A..

PHYSICAL INFORMATION

Information Element	value/remarks
As default message contents.	

Step 6: $x = 750$.

Step 7: The MS and SS are using a half rate TCH in hopping mode on cell B.

For $M = 6$:

GSM 450

Step 0: The MS and SS are using a half rate TCH in hopping mode on cell B.

HANDOVER COMMAND

Information Element	value/remarks
As default message contents, except:	
Cell Description	
- Network Colour Code	1
- Base Station Colour Code	5
- BCCH Carrier Number	263
Channel Description	
- Channel Type	TCH/H + ACCHs
- TDMA offset	Chosen arbitrarily.
- Timeslot number	Chosen arbitrarily but not Zero.
- Training Sequence Code	Chosen arbitrarily.
- Hopping	Single RF channel.
- ARFCN	Chosen arbitrarily from the Cell Allocation of Cell A.
Synchronization Indication IE not included.	

PHYSICAL INFORMATION

Information Element	value/remarks
As default message contents.	

Step 6: $x = 750$.

Step 7: The MS and SS are using a half rate TCH in non-hopping mode on cell A.

GSM 480

Step 0: The MS and SS are using a half rate TCH in hopping mode on cell B.

HANDOVER COMMAND

Information Element	value/remarks
As default message contents, except:	
Cell Description	
- Network Colour Code	1
- Base Station Colour Code	5
- BCCH Carrier Number	310
Channel Description	
- Channel Type	TCH/H + ACCHs
- TDMA offset	Chosen arbitrarily.
- Timeslot number	Chosen arbitrarily but not Zero.
- Training Sequence Code	Chosen arbitrarily.
- Hopping	Single RF channel.
- ARFCN	Chosen arbitrarily from the Cell Allocation of Cell A.
Synchronization Indication IE not included.	

PHYSICAL INFORMATION

Information Element	value/remarks
As default message contents.	

Step 6: $x = 750$.

Step 7: The MS and SS are using a half rate TCH in non-hopping mode on cell A.

GSM 900

Step 0: The MS and SS are using a half rate TCH in hopping mode on cell B.

HANDOVER COMMAND

Information Element	value/remarks
As default message contents, except:	
Cell Description	
- Network Colour Code	1
- Base Station Colour Code	5
- BCCH Carrier Number	20
Channel Description	
- Channel Type	TCH/H + ACCHs
- TDMA offset	Chosen arbitrarily.
- Timeslot number	Chosen arbitrarily but not Zero.
- Training Sequence Code	Chosen arbitrarily.
- Hopping	Single RF channel.
- ARFCN	Chosen arbitrarily from the Cell Allocation of Cell A.
Synchronization Indication IE not included.	

PHYSICAL INFORMATION

Information Element	value/remarks
As default message contents.	

Step 6: $x = 750$.

Step 7: The MS and SS are using a half rate TCH in non-hopping mode on cell A.

DCS 1 800

Step 0: The MS and SS are using a half rate TCH in hopping mode on cell B.

HANDOVER COMMAND

Information Element	value/remarks
As default message contents, except:	
Cell Description	
- Network Colour Code	1
- Base Station Colour Code	5
- BCCH Carrier Number	747
Channel Description	
- Channel Type	TCH/H + ACCHs
- TDMA offset	Chosen arbitrarily.
- Timeslot number	Chosen arbitrarily but not Zero.
- Training Sequence Code	Chosen arbitrarily.
- Hopping	Single RF channel.
- ARFCN	Chosen arbitrarily from the Cell Allocation of Cell A.
Synchronization Indication IE not included.	

PHYSICAL INFORMATION

Information Element	value/remarks
As default message contents.	

Step 6: $x = 750$.

Step 7: The MS and SS are using a half rate TCH in non-hopping mode on cell A.

PCS 1900

Step 0: The MS and SS are using a half rate TCH in hopping mode on cell B.

HANDOVER COMMAND

Information Element	value/remarks
As default message contents, except:	
Cell Description	
- Network Colour Code	1
- Base Station Colour Code	5
- BCCH Carrier Number	647
Channel Description	
- Channel Type	TCH/H + ACCHs
- TDMA offset	Chosen arbitrarily.
- Timeslot number	Chosen arbitrarily but not Zero.
- Training Sequence Code	Chosen arbitrarily.
- Hopping	Single RF channel.
- ARFCN	Chosen arbitrarily from the Cell Allocation of Cell A.
Synchronization Indication IE not included.	

PHYSICAL INFORMATION

Information Element	value/remarks
As default message contents.	

Step 6: $x = 750$.

Step 7: The MS and SS are using a half rate TCH in non-hopping mode on cell A.

For $M = 7$:

GSM 450

Step 0: The MS and SS are using a half rate TCH in non-hopping mode on cell A.

HANDOVER COMMAND

Information Element	value/remarks
As default message contents, except:	
Cell Description	
- Network Colour Code	1
- Base Station Colour Code	5
- BCCH Carrier Number	274
Channel Description	
- Channel Type	TCH/F + ACCHs
- Timeslot number	Chosen arbitrarily but not Zero.
- Training Sequence Code	Chosen arbitrarily.
- Hopping	RF hopping channel.
- MAIO	Chosen arbitrarily from the set (0, 1 to N-1), where N is the number of frequencies encoded in the Frequency List IE.
- HSN	Chosen arbitrarily from the set. (1,2,..63).
Frequency List after time	
- Frequency List	Use 128 range to encode the following 8 frequencies: (274, 279, 281, 283, 285, 287, 289, 291).
Synchronization Indication	
- Report Observed Time Difference	Shall not be included.
- Synchronization Indication	"Non synchronized".
- Normal Cell Indication	Ignore out of range timing advance.
Mode of first channel	speech (full rate version 1 or half rate version 1).

PHYSICAL INFORMATION

Information Element	value/remarks
As default message contents, except:	
Timing advance	Arbitrarily selected but different to default value.

Step 6: $x = 750$.

Step 7: The MS and SS are using a half rate TCH in hopping mode on cell B.

GSM 480

Step 0: The MS and SS are using a half rate TCH in non-hopping mode on cell A.

HANDOVER COMMAND

Information Element	value/remarks
As default message contents, except:	
Cell Description	
- Network Colour Code	1
- Base Station Colour Code	5
- BCCH Carrier Number	321
Channel Description	
- Channel Type	TCH/F + ACCHs
- Timeslot number	Chosen arbitrarily but not Zero.
- Training Sequence Code	Chosen arbitrarily.
- Hopping	RF hopping channel.
- MAIO	Chosen arbitrarily from the set (0, 1 to N-1), where N is the number of frequencies encoded in the Frequency List IE.
- HSN	Chosen arbitrarily from the set. (1,2,..63).
Frequency List after time	
- Frequency List	Use 128 range to encode the following 8 frequencies: (321, 326, 328, 330, 332, 334, 336, 338).
Synchronization Indication	
- Report Observed Time Difference	Shall not be included.
- Synchronization Indication	"Non synchronized".
- Normal Cell Indication	Ignore out of range timing advance.
Mode of first channel	speech (full rate version 1 or half rate version 1).

PHYSICAL INFORMATION

Information Element	value/remarks
As default message contents, except:	
Timing advance	Arbitrarily selected but different to default value.

Step 6: $x = 750$.

Step 7: The MS and SS are using a half rate TCH in hopping mode on cell B.

GSM 900

Step 0: The MS and SS are using a half rate TCH in non-hopping mode on cell A.

HANDOVER COMMAND

Information Element	value/remarks
As default message contents, except:	
Cell Description	
- Network Colour Code	1
- Base Station Colour Code	5
- BCCH Carrier Number	40
Channel Description	
- Channel Type	TCH/F + ACCHs
- Timeslot number	Chosen arbitrarily but not Zero.
- Training Sequence Code	Chosen arbitrarily.
- Hopping	RF hopping channel.
- MAIO	Chosen arbitrarily from the set (0, 1 to N-1), where N is the number of frequencies encoded in the Frequency Channel Sequence IE.
- HSN	Chosen arbitrarily from the set. (1,2,..63).
Frequency Channel Sequence after time	
- Frequency Channel Sequence	Allocates the following 8 frequencies: (40, 66, 73, 74, 75, 76,108, 114).
Synchronization Indication	
- Report Observed Time Difference	Shall not be included.
- Synchronization Indication	"Non synchronized".
- Normal Cell Indication	Ignore out of range timing advance.
Mode of first channel	speech (full rate version 1 or half rate version 1).

PHYSICAL INFORMATION

Information Element	value/remarks
As default message contents, except:	
Timing advance	Arbitrarily selected but different to default value.

Step 6: $x = 750$.

Step 7: The MS and SS are using a half rate TCH in hopping mode on cell B.

DCS 1 800

Step 0: The MS and SS are using a half rate TCH in non-hopping mode on cell A.

HANDOVER COMMAND

Information Element	value/remarks
As default message contents, except:	
Cell Description	
- Network Colour Code	1
- Base Station Colour Code	5
- BCCH Carrier Number	764
Channel Description	
- Channel Type	TCH/H + ACCHs
- TDMA offset	Chosen arbitrarily.
- Timeslot number	Chosen arbitrarily but not Zero.
- Training Sequence Code	Chosen arbitrarily.
- Hopping	RF hopping channel.
- MAIO	Chosen arbitrarily from the set (0, 1 to N-1), where N is the number of frequencies encoded in the Frequency List IE.
- HSN	Chosen arbitrarily from the set. (1,2,..63).
Frequency List after time	
- Frequency List	Use Variable Bit Map to encode the following 8 frequencies: (764, 779, 782, 791, 798, 829, 832, 844).
Synchronization Indication	
- Report Observed Time Difference	Shall not be included.
- Synchronization Indication	"Non synchronized".
- Normal Cell Indication	Ignore out of range timing advance.
Mode of first channel	speech (full rate version 1 or half rate version 1).

PHYSICAL INFORMATION

Information Element	value/remarks
As default message contents, except:	
Timing advance	Arbitrarily selected but different to default value.

Step 6: $x = 750$.

Step 7: The MS and SS are using a half rate TCH in hopping mode on cell B.

PCS 1900

Step 0: The MS and SS are using a half rate TCH in non-hopping mode on cell A.

HANDOVER COMMAND

Information Element	value/remarks
As default message contents, except:	
Cell Description	
- Network Colour Code	1
- Base Station Colour Code	5
- BCCH Carrier Number	664
Channel Description	
- Channel Type	TCH/H + ACCHs
- TDMA offset	Chosen arbitrarily.
- Timeslot number	Chosen arbitrarily but not Zero.
- Training Sequence Code	Chosen arbitrarily.
- Hopping	RF hopping channel.
- MAIO	Chosen arbitrarily from the set (0, 1 to N-1), where N is the number of frequencies encoded in the Frequency List IE.
- HSN	Chosen arbitrarily from the set. (1,2,..63).
Frequency List after time	
- Frequency List	Use Variable Bit Map to encode the following 8 frequencies: (664, 679, 682, 691, 698, 729, 732, 744).
Synchronization Indication	
- Report Observed Time Difference	Shall not be included.
- Synchronization Indication	"Non synchronized".
- Normal Cell Indication	Ignore out of range timing advance.
Mode of first channel	speech (full rate version 1 or half rate version 1).

PHYSICAL INFORMATION

Information Element	value/remarks
As default message contents, except:	
Timing advance	Arbitrarily selected but different to default value.

Step 6: $x = 750$.

Step 7: The MS and SS are using a half rate TCH in hopping mode on cell B.

For M = 8:

GSM 450

Step 0: The MS and SS are using a half rate TCH in hopping mode on cell B.

HANDOVER COMMAND

Information Element	value/remarks
As default message contents, except:	
Cell Description	
- Network Colour Code	1
- Base Station Colour Code	5
- BCCH Carrier Number	263
Channel Description	
- Channel Type	TCH/F + ACCHs
- Timeslot number	Chosen arbitrarily but not Zero.
- Training Sequence Code	Chosen arbitrarily.
- Hopping	Single RF channel.
- ARFCN	263
Synchronization Indication IE not included.	

PHYSICAL INFORMATION

Information Element	value/remarks
As default message contents, except:	
Timing advance	Arbitrarily selected but different to default value.

Step 6: x = 500.

Step 7: The MS and SS are using a full rate TCH in non-hopping mode on cell A.

GSM 480

Step 0: The MS and SS are using a half rate TCH in hopping mode on cell B.

HANDOVER COMMAND

Information Element	value/remarks
As default message contents, except:	
Cell Description	
- Network Colour Code	1
- Base Station Colour Code	5
- BCCH Carrier Number	310
Channel Description	
- Channel Type	TCH/F + ACCHs
- Timeslot number	Chosen arbitrarily but not Zero.
- Training Sequence Code	Chosen arbitrarily.
- Hopping	Single RF channel.
- ARFCN	310
Synchronization Indication IE not included.	

PHYSICAL INFORMATION

Information Element	value/remarks
As default message contents, except:	
Timing advance	Arbitrarily selected but different to default value.

Step 6: x = 500.

Step 7: The MS and SS are using a full rate TCH in non-hopping mode on cell A.

GSM 900

Step 0: The MS and SS are using a half rate TCH in hopping mode on cell B.

HANDOVER COMMAND

Information Element	value/remarks
As default message contents, except:	
Cell Description	
- Network Colour Code	1
- Base Station Colour Code	5
- BCCH Carrier Number	20
Channel Description	
- Channel Type	TCH/F + ACCHs
- Timeslot number	Chosen arbitrarily but not Zero.
- Training Sequence Code	Chosen arbitrarily.
- Hopping	Single RF channel.
- ARFCN	20
Synchronization Indication IE not included.	

PHYSICAL INFORMATION

Information Element	value/remarks
As default message contents, except:	
Timing advance	Arbitrarily selected but different to default value.

Step 6: x = 500.

Step 7: The MS and SS are using a full rate TCH in non-hopping mode on cell A.

DCS 1 800

Step 0: The MS and SS are using a half rate TCH in hopping mode on cell B.

HANDOVER COMMAND

Information Element	value/remarks
As default message contents, except:	
Cell Description	
- Network Colour Code	1
- Base Station Colour Code	5
- BCCH Carrier Number	747
Channel Description	
- Channel Type	TCH/F + ACCHs
- Timeslot number	Chosen arbitrarily but not Zero.
- Training Sequence Code	Chosen arbitrarily.
- Hopping	Single RF channel.
- ARFCN	747
Synchronization Indication IE not included.	

PHYSICAL INFORMATION

Information Element	value/remarks
As default message contents, except:	
Timing advance	Arbitrarily selected but different to default value.

Step 6: x = 500.

Step 7: The MS and SS are using a full rate TCH in non-hopping mode on cell A.

PCS 1900

Step 0: The MS and SS are using a half rate TCH in hopping mode on cell B.

HANDOVER COMMAND

Information Element	value/remarks
As default message contents, except:	
Cell Description	
- Network Colour Code	1
- Base Station Colour Code	5
- BCCH Carrier Number	647
Channel Description	
- Channel Type	TCH/F + ACCHs
- Timeslot number	Chosen arbitrarily but not Zero.
- Training Sequence Code	Chosen arbitrarily.
- Hopping	Single RF channel.
- ARFCN	647
Synchronization Indication IE not included.	

PHYSICAL INFORMATION

Information Element	value/remarks
As default message contents, except:	
Timing advance	Arbitrarily selected but different to default value.

Step 6: $x = 500$.

Step 7: The MS and SS are using a full rate TCH in non-hopping mode on cell A.

Specific Message Contents For Mobiles not Supporting Speech

If the mobile station supports half rate, then the 12 kbps radio interface rate is not used for this test. With this restriction, the radio interface rate is selected arbitrarily from those support.

The message contents shall be the same for the declared type of Mobile Station (GSM 450 or GSM 480 or P-GSM 900 or DCS 1 800 or PCS 1900) supporting speech , except for:

$M = 3$ and 7 :

HANDOVER COMMAND

Information Element	value/remarks
Mode of first channel	Data, with the full rate radio interface rate that is in use.

26.6.5.2 Handover / successful / call under establishment / non-synchronized

This test is applicable to all MS which support at least one MO circuit switched basic service.

26.6.5.2.1 Conformance requirements

The MS shall correctly apply the handover procedure from SDCCH/8, TCH/F or TCH/H with or without frequency hopping to SDCCH/8, TCH/F or TCH/H with or without frequency hopping in the non-synchronized case during call establishment. The mobile shall correctly apply the handover procedures from non frequency hopping SDCCH/4 to SDCCH/8, TCH/F or TCH/H with or without frequency hopping. If during call establishment a Layer 3 MM or CC message just sent by the MS is not Layer 2 acknowledged before the channel change caused by the HANDOVER COMMAND message, the MS shall send the Layer 3 message to the new cell, using the same value in the N(SD) field, after the handover procedure.

References

GSM 04.08, sections 3.1.4.2, 3.4.4 and 9.1.15.

GSM 04.13, section 5.2.6.2.

26.6.5.2.2 Test purpose

To test that when the MS is ordered to make a non-synchronized handover, it continuously sends access bursts on the main DCCH until it receives a PHYSICAL INFORMATION message from the SS. To test that the MS correctly takes the values of the Timing Advance information element in the PHYSICAL INFORMATION message into account. To test that the MS activates the new channel correctly and transmits the HANDOVER COMPLETE message without undue delay. To test that the MS correctly retransmits Layer 3 MM or CC messages, that were not acknowledged by Layer 2 before the Handover, after completion of the Handover.

26.6.5.2.3 Method of test

Initial Conditions

System Simulator:

2 cells A and B with same LAI, default parameters, except:

GSM 450:

Cell A has:

BCCH ARFCN = 263.

Cell Allocation = (259, 261, 263, 265, 267, 269, 271, 273, 275, 277, 279, 281, 283, 285, 287, 289, 291).

PLMN colour code, NCC = as defaults.

BS colour code, BCC = as defaults.

PLMN_PERM = 00001010.

Cell B has:

BCCH ARFCN = 274.

Cell Allocation = (260, 262, 264, 266, 268, 270, 272, 274, 276, 279, 281, 283, 285, 287, 289, 291).

PLMN colour code, NCC = 3.

BS colour code, BCC = 0.

Both cells send SYSTEM INFORMATION TYPE 1 messages containing the complete Cell Allocation of the cell, using range 128 format.

The timebase of Cells A and B shall be such that the edges of their timeslots are not coincident at the antenna connector.

For execution counter M = 1, 2 and 3 a combined CCH/SDCCH is used.

For execution counter M = 4 to 10 a non combined SDCCH is used.

GSM 480:

Cell A has:

BCCH ARFCN = 310.

Cell Allocation = (306, 308, 310, 312, 314, 316, 318, 320, 322, 324, 326, 328, 330, 332, 334, 336, 338).

PLMN colour code, NCC = as defaults.

BS colour code, BCC = as defaults.

PLMN_PERM = 00001010.

Cell B has:

BCCH ARFCN = 321.

Cell Allocation = (307, 309, 311, 313, 315, 317, 319, 321, 323, 326, 328, 330, 332, 334, 336, 338).

PLMN colour code, NCC = 3.

BS colour code, BCC = 0.

Both cells send SYSTEM INFORMATION TYPE 1 messages containing the complete Cell Allocation of the cell, using range 128 format.

The timebase of Cells A and B shall be such that the edges of their timeslots are not coincident at the antenna connector.

For execution counter M = 1, 2 and 3 a combined CCH/SDCCH is used.

For execution counter M = 4 to 10 a non combined SDCCH is used.

GSM 900:

Cell A has:

BCCH ARFCN = 20.

Cell Allocation = (10, 17, 20, 26, 34, 42, 45, 46, 52, 59, 66, 73, 74, 75, 76, 108, 114).

PLMN colour code, NCC = as defaults.

BS colour code, BCC = as defaults.

PLMN_PERM = 00001010.

Cell B has:

BCCH ARFCN = 40.

Cell Allocation = (14, 18, 22, 24, 30, 31, 38, 40, 60, 66, 73, 74, 75, 76, 108, 114).

PLMN colour code, NCC = 3.

BS colour code, BCC = 0.

Both cells send SYSTEM INFORMATION TYPE 1 messages containing the complete Cell Allocation of the cell, using bit map 0 format.

The timebase of Cells A and B shall be such that the edges of their timeslots are not coincident at the antenna connector.

For execution counter M = 1, 2 and 3 a combined CCH/SDCCH is used.

For execution counter M = 4 to 10 a non combined SDCCH is used.

DCS 1 800:

Cell A has:

BCCH ARFCN = 747.

Cell Allocation = (734, 741, 747, 754, 759, 762, 766, 767, 773, 775, 779, 782, 791, 798, 829, 832, 844).

PLMN colour code, NCC = as defaults.

BS colour code, BCC = as defaults.

PLMN_PERM = 00001010.

Cell B has:

BCCH ARFCN = 764.

Cell Allocation = (739, 743, 746, 749, 756, 758, 761, 764, 771, 779, 782, 791, 798, 829, 832, 844).

PLMN colour code, NCC = 3.

BS colour code, BCC = 0.

Both cells send SYSTEM INFORMATION TYPE 1 messages containing the complete Cell Allocation of the cell, using Range 512 format.

The timebase of Cells A and B shall be such that the edges of their timeslots are not coincident at the antenna connector.

For execution counter M = 1, 2 and 3 a combined CCH/SDCCH is used.

For execution counter M = 4 to 10 a non combined SDCCH is used.

PCS 1900:

Cell A has:

BCCH ARFCN = 647.

Cell Allocation = (634, 641, 647, 654, 659, 662, 666, 667, 673, 675, 679, 682, 691, 698, 729, 732, 744).

PLMN colour code, NCC = as defaults.

BS colour code, BCC = as defaults.

PLMN_PERM = 00001010.

Cell B has:

BCCH ARFCN = 664.

Cell Allocation = (639, 643, 646, 649, 656, 658, 661, 664, 671, 679, 682, 691, 698, 729, 732, 744).

PLMN colour code, NCC = 3.

BS colour code, BCC = 0.

Both cells send SYSTEM INFORMATION TYPE 1 messages containing the complete Cell Allocation of the cell, using Range 512 format.

The timebase of Cells A and B shall be such that the edges of their timeslots are not coincident at the antenna connector.

For execution counter $M = 1, 2$ and 3 a combined CCH/SDCCH is used.
For execution counter $M = 4$ to 10 a non combined SDCCH is used.

Mobile Station:

The MS is in the "idle, updated" state, with a TMSI allocated and camped on cell A.

Related PICS/PIXIT Statements

Supported rate(s) of TCH: TCH/F and/or TCH/H.

Support for MO calls.

Supported speech and data rates.

Type of MS (GSM 450 or GSM 480 or P-GSM 900 or EGSM or DCS 1 800 or PCS 1900).

Foreseen Final State of the MS

"Idle, updated" with TMSI allocated and camped on cell B.

Test Procedure

This procedure is repeated for execution counter $M = 1, 2 \dots 10$ (See table 26.6-1.)

A Mobile Originating Call is initiated on Cell A. After the MS has sent the SETUP message (and before the last L2 frame carrying the SETUP message is acknowledged by the SS) the SS sends a HANOVER COMMAND message, ordering the MS to switch to cell B. The MS shall then begin to send access bursts on the new DCCH to cell B. The SS observes the access bursts and after receiving n (n being arbitrarily chosen between values according to table 26.6-2 of section 26.6.5) access bursts, the SS sends one PHYSICAL INFORMATION message with a Timing Advance as specified in table 26.6-1 of section 26.6.5. The MS shall activate the channel in sending and receiving mode. The MS shall establish a signalling link. The MS shall be ready to transmit a HANOVER COMPLETE message before x ms after the end of the PHYSICAL INFORMATION message, but not before a UA frame has been sent by the SS. The MS shall then again send the SETUP message to the SS, using the same value in the N(SD) field. Finally the SS sends a CHANNEL RELEASE to end the test.

The term "ready to transmit" is defined in GSM 04.13. The value of " x " depends upon the target channel and is specified in the specific message contents section.

Maximum Duration of Test

5 minutes, including 1 minute for any necessary operator actions.

Expected Sequence

The sequence is performed for execution counter M = 1, 2..10 (unless a particular TCH is not supported).

Step	Direction	Message	Comments
1	-----	-----	A MO call is initiated on cell A.
2	MS -> SS	CHANNEL REQUEST	Establish. Cause = "Originating call, NECI not set to 1"
3	SS -> MS	IMMEDIATE ASSIGNMENT	See specific message contents.
4	MS -> SS	CM SERVICE REQUEST	CM Service Type = Mobile Originating Call Establishment.
5	SS -> MS	CIPHERING MODE COMMAND	
6	MS -> SS	CIPHERING MODE COMPLETE	
7	MS -> SS	SETUP	Last L2 frame not acknowledged by the SS.
8	SS -> MS	HANDOVER COMMAND	See specific message contents.
9	MS -> SS	HANDOVER ACCESS	Repeated on every burst of the uplink main DCCH until reception of PHYSICAL INFORMATION. Handover Reference as included in the HANDOVER COMMAND message. Timing Advance as specified in table 26.6-1 of section 26.6.5.
10	SS -> MS	PHYSICAL INFORMATION	Sent after reception of n HANDOVER ACCESS message. Sent without information field.
11	MS -> SS	SABM	
12	SS -> MS	UA	
13	MS -> SS	HANDOVER COMPLETE	This message shall be ready to be transmitted before "x" ms after the completion of step 10.
14	MS -> SS	SETUP	Same N(SD) as in step 7.
15	SS -> MS	CHANNEL RELEASE	

Specific Message Contents For Mobiles Supporting Speech

M = 1.

DCS 1 800:

IMMEDIATE ASSIGNMENT

Information Element	value/remark
As default message contents.	

HANDOVER COMMAND

Information Element	value/remarks
As default message contents, except:	
Cell Description	
- Network Colour Code	3
- Base Station Colour Code	0
- BCCH Carrier Number	764
Channel Description	
- Channel Type	TCH/F + ACCHs
- Timeslot number	zero.
- Training Sequence Code	Chosen arbitrarily.
- Hopping	RF hopping channel.
- MAIO	Chosen arbitrarily from the set (0, 1 to N-1), where N is the number of frequencies encoded in the Frequency Short List IE.
- HSN	Chosen arbitrarily from the set. (1,2,..63).
Synchronization IE is not included.	
Frequency Short List after time	
- Frequency Short List	Use Range 128 to encode the following 11 frequencies: (756, 758, 761, 771, 779, 782, 791, 798, 829, 832, 844).
Mode of the First Channel	Speech (full rate version 1 or half rate version 1).

Step 13: "x" = 500.

PCS 1900:

IMMEDIATE ASSIGNMENT

Information Element	value/remark
As default message contents.	

HANDOVER COMMAND

Information Element	value/remarks
As default message contents, except:	
Cell Description	
- Network Colour Code	3
- Base Station Colour Code	0
- BCCH Carrier Number	664
Channel Description	
- Channel Type	TCH/F + ACCHs
- Timeslot number	zero.
- Training Sequence Code	Chosen arbitrarily.
- Hopping	RF hopping channel.
- MAIO	Chosen arbitrarily from the set (0, 1 to N-1), where N is the number of frequencies encoded in the Frequency Short List IE.
- HSN	Chosen arbitrarily from the set. (1,2,..63).
Synchronization IE is not included.	
Frequency Short List after time	
- Frequency Short List	Use Range 128 to encode the following 11 frequencies: (656, 658, 661, 671, 679, 682, 691, 698, 729, 732, 744).
Mode of the First Channel	Speech (full rate version 1 or half rate version 1).

Step 13: "x" = 500.

For GSM 450:

IMMEDIATE ASSIGNMENT

Information Element	value/remark
As default message contents.	

HANDOVER COMMAND

Information Element	value/remarks
As default message contents, except:	
Cell Description	
- Network Colour Code	3
- Base Station Colour Code	0
- BCCH Carrier Number	274
Channel Description	
- Channel Type	TCH/F + ACCHs
- Timeslot number	Zero.
- Training Sequence Code	Chosen arbitrarily.
- Hopping	RF hopping channel.
- MAIO	Chosen arbitrarily from the set (0, 1 to N-1), where N is the number of frequencies encoded in the Frequency List IE.
- HSN	Chosen arbitrarily from the set. (1,2,..63).
Synchronization IE is not included.	
Frequency List, after time	
- Frequency List	Use Range 128 to encode the following 15 frequencies: (260, 262, 264, 266, 268, 270, 272, 292, 279, 281, 283, 285, 287, 289, 291).
Mode of the First Channel	Speech (full rate version 1 or half rate version 1).

Step 13: "x" = 500.

For GSM 480:

IMMEDIATE ASSIGNMENT

Information Element	value/remark
As default message contents.	

HANDOVER COMMAND

Information Element	value/remarks
As default message contents, except:	
Cell Description	
- Network Colour Code	3
- Base Station Colour Code	0
- BCCH Carrier Number	321
Channel Description	
- Channel Type	TCH/F + ACCHs
- Timeslot number	Zero.
- Training Sequence Code	Chosen arbitrarily.
- Hopping	RF hopping channel.
- MAIO	Chosen arbitrarily from the set (0, 1 to N-1), where N is the number of frequencies encoded in the Frequency List IE.
- HSN	Chosen arbitrarily from the set. (1,2,..63).
Synchronization IE is not included.	
Frequency List, after time	
- Frequency List	Use Range 128 to encode the following 15 frequencies: (307, 309, 311, 313, 315, 317, 319, 339, 326, 328, 330, 332, 334, 336, 338).
Mode of the First Channel	Speech (full rate version 1 or half rate version 1).

Step 13: "x" = 500.

For GSM 900:

IMMEDIATE ASSIGNMENT

Information Element	value/remark
As default message contents.	

HANDOVER COMMAND

Information Element	value/remarks
As default message contents, except:	
Cell Description	
- Network Colour Code	3
- Base Station Colour Code	0
- BCCH Carrier Number	40
Channel Description	
- Channel Type	TCH/F + ACCHs
- Timeslot number	Zero.
- Training Sequence Code	Chosen arbitrarily.
- Hopping	RF hopping channel.
- MAIO	Chosen arbitrarily from the set (0, 1 to N-1), where N is the number of frequencies encoded in the Frequency Channel Sequence IE.
- HSN	Chosen arbitrarily from the set. (1,2,..63).
Synchronization IE is not included.	
Frequency Channel Sequence, after time	
- Frequency Channel Sequence	Allocates the following 15 frequencies: (14, 18, 22, 24, 30, 31, 38, 53, 66, 73, 74, 75, 76, 108, 114).
Mode of the First Channel	Speech (full rate version 1 or half rate version 1).

Step 13: "x" = 500.

M = 2.

DCS 1 800:

IMMEDIATE ASSIGNMENT

Information Element	value/remark
As default message contents.	

HANDOVER COMMAND

Information Element	value/remarks
As default message contents, except:	
Cell Description	
- Network Colour Code	3
- Base Station Colour Code	0
- BCCH Carrier Number	764
Channel Description	
- Channel Type	TCH/H + ACCHs
- TDMA offset	Chosen arbitrarily.
- Timeslot number	Chosen arbitrarily but not zero.
- Training Sequence Code	Chosen arbitrarily.
- Hopping	RF hopping channel.
- MAIO	Chosen arbitrarily from the set (0, 1 to N-1), where N is the number of frequencies encoded in the Mobile Allocation.
- HSN	Chosen arbitrarily from the set (1, 2.. 63).
Synchronization Indication	
- Report Observed Time Difference	Shall not be included.
- Synchronization Indication	"Non synchronized".
- Normal Cell Indication	Ignore out of range timing advance.
Cell Channel Description	Use Range 512 to encode the following frequencies: (761, 764, 771, 779, 782, 791, 798, 829, 832).
Mobile Allocation after time	Indicates (791, 798, 829) only).
Mode of First Channel	Speech (full rate version 1 or half rate version 1).

Step 13: "x" = 750.

PCS 1900:

IMMEDIATE ASSIGNMENT

Information Element	value/remark
As default message contents.	

HANDOVER COMMAND

Information Element	value/remarks
As default message contents, except:	
Cell Description	
- Network Colour Code	3
- Base Station Colour Code	0
- BCCH Carrier Number	664
Channel Description	
- Channel Type	TCH/H + ACCHs
- TDMA offset	Chosen arbitrarily.
- Timeslot number	Chosen arbitrarily but not zero.
- Training Sequence Code	Chosen arbitrarily.
- Hopping	RF hopping channel.
- MAIO	Chosen arbitrarily from the set (0, 1 to N-1), where N is the number of frequencies encoded in the Mobile Allocation.
- HSN	Chosen arbitrarily from the set (1, 2.. 63).
Synchronization Indication	
- Report Observed Time Difference	Shall not be included.
- Synchronization Indication	"Non synchronized".
- Normal Cell Indication	Ignore out of range timing advance.
Cell Channel Description	Use Range 512 to encode the following frequencies: (661, 664, 671, 679, 682, 691, 698, 729, 732).
Mobile Allocation after time	Indicates (691, 698, 729) only).
Mode of First Channel	Speech (full rate version 1 or half rate version 1).

Step 13: "x" = 750.

GSM 450:

IMMEDIATE ASSIGNMENT

Information Element	value/remark
As default message contents.	

HANDOVER COMMAND

As default message contents, except:	
Cell Description	
- Network Colour Code	3
- Base Station Colour Code	0
- BCCH Carrier Number	274
Channel Description	
- Channel Type	TCH/H + ACCHs
- TDMA offset	Chosen arbitrarily.
- Timeslot number	Chosen arbitrarily.
- Training Sequence Code	Chosen arbitrarily.
- Hopping	RF hopping channel.
- MAIO	Chosen arbitrarily from the set (0, 1 to N-1), where N is the number of frequencies encoded in the Mobile Allocation.
- HSN	Chosen arbitrarily from the set (1, 2.. 63).
Synchronization Indication IE is not included	
Cell Channel Description	uses range 128 to encode: {274, 279, 281, 283, 285, 287, 289, 291} only.
Mobile Allocation after time	indicates channel {281, 283, 285} only.
Channel Mode IE	speech (full rate version 1 or half rate version 1).

Step 13: "x" = 750.

GSM 480:

IMMEDIATE ASSIGNMENT

Information Element	value/remark
As default message contents.	

HANDOVER COMMAND

As default message contents, except:	
Cell Description	
- Network Colour Code	3
- Base Station Colour Code	0
- BCCH Carrier Number	321
Channel Description	
- Channel Type	TCH/H + ACCHs
- TDMA offset	Chosen arbitrarily.
- Timeslot number	Chosen arbitrarily.
- Training Sequence Code	Chosen arbitrarily.
- Hopping	RF hopping channel.
- MAIO	Chosen arbitrarily from the set (0, 1 to N-1), where N is the number of frequencies encoded in the Mobile Allocation.
- HSN	Chosen arbitrarily from the set (1, 2.. 63).
Synchronization Indication IE is not included	
Cell Channel Description	uses range 128 to encode: {321, 326, 328, 330, 332, 334, 336, 338} only.
Mobile Allocation after time	indicates channel {328, 330, 332} only.
Channel Mode IE	speech (full rate version 1 or half rate version 1).

Step 13: "x" = 750.

GSM 900:

IMMEDIATE ASSIGNMENT

Information Element	value/remark
As default message contents.	

HANDOVER COMMAND

As default message contents, except:	
Cell Description	
- Network Colour Code	3
- Base Station Colour Code	0
- BCCH Carrier Number	40
Channel Description	
- Channel Type	TCH/H + ACCHs
- TDMA offset	Chosen arbitrarily.
- Timeslot number	Chosen arbitrarily.
- Training Sequence Code	Chosen arbitrarily.
- Hopping	RF hopping channel.
- MAIO	Chosen arbitrarily from the set (0, 1 to N-1), where N is the number of frequencies encoded in the Mobile Allocation.
- HSN	Chosen arbitrarily from the set (1, 2.. 63).
Synchronization Indication IE is not included	
Cell Channel Description	uses bit map 0 to encode: {40, 66, 73, 74, 75, 76, 108, 114} only.
Mobile Allocation after time	indicates channel {73, 74, 75} only.
Channel Mode IE	speech (full rate version 1 or half rate version 1).

Step 13: "x" = 750.

M = 3.

DCS 1 800:

IMMEDIATE ASSIGNMENT

Information Element	value/remark
As default message contents.	

HANDOVER COMMAND

Information Element	value/remarks
As default message contents, except:	
Cell Description	
- Network Colour Code	3
- Base Station Colour Code	0
- BCCH Carrier Number	764
Channel Description	
- Channel Type	SDCCH/8
- TDMA offset	Chosen arbitrarily.
- Timeslot number	Zero.
- Training Sequence Code	Chosen arbitrarily.
- Hopping	RF hopping channel.
- MAIO	Chosen arbitrarily from the set (0, 1 to N-1), where N is the number of frequencies encoded in the Frequency Short List IE.
- HSN	Zero (this gives cyclic hopping).
Synchronization Indication IE not included.	
Frequency Short List after time	
- Frequency Short List	Use Range 128 to encode the following 2 frequencies (746, 779).
Mode of First Channel	Signalling Only.

Step 13: "x" = 1 500.

PCS 1900:

IMMEDIATE ASSIGNMENT

Information Element	value/remark
As default message contents.	

HANDOVER COMMAND

Information Element	value/remarks
As default message contents, except:	
Cell Description	
- Network Colour Code	3
- Base Station Colour Code	0
- BCCH Carrier Number	664
Channel Description	
- Channel Type	SDCCH/8
- TDMA offset	Chosen arbitrarily.
- Timeslot number	Zero.
- Training Sequence Code	Chosen arbitrarily.
- Hopping	RF hopping channel.
- MAIO	Chosen arbitrarily from the set (0, 1 to N-1), where N is the number of frequencies encoded in the Frequency Short List IE.
- HSN	Zero (this gives cyclic hopping).
Synchronization Indication IE not included.	
Frequency Short List after time	
- Frequency Short List	Use Range 128 to encode the following 2 frequencies (646, 679).
Mode of First Channel	Signalling Only.

Step 13: "x" = 1 500.

GSM 450:

IMMEDIATE ASSIGNMENT

Information Element	value/remark
As default message contents.	

HANDOVER COMMAND

Information Element	value/remarks
As default message contents, except:	
Cell Description	
- Network Colour Code	3
- Base Station Colour Code	0
- BCCH Carrier Number	274
Channel Description	
- Channel Type	SDCCH/8
- TDMA offset	Chosen arbitrarily.
- Timeslot number	Zero.
- Training Sequence Code	Chosen arbitrarily.
- Hopping	RF hopping channel.
- MAIO	Chosen arbitrarily from the set (0, 1 to N-1), where N is the number of frequencies encoded in the Frequency List IE.
- HSN	Chosen arbitrarily from the set {1, 2, ..., 63}.
Synchronization Indication IE is not included	Frequency list after time.
- Frequency List	uses Range 128 to allocate the following 15 frequencies {260, 262, 264, 266, 268, 270, 272, 276, 279, 281, 283, 285, 287, 289, 291}.
Channel Mode IE	signalling only.

Step 13: "x" = 1 500.

GSM 480:

IMMEDIATE ASSIGNMENT

Information Element	value/remark
As default message contents.	

HANDOVER COMMAND

Information Element	value/remarks
As default message contents, except:	
Cell Description	
- Network Colour Code	3
- Base Station Colour Code	0
- BCCH Carrier Number	321
Channel Description	
- Channel Type	SDCCH/8
- TDMA offset	Chosen arbitrarily.
- Timeslot number	Zero.
- Training Sequence Code	Chosen arbitrarily.
- Hopping	RF hopping channel.
- MAIO	Chosen arbitrarily from the set (0, 1 to N-1), where N is the number of frequencies encoded in the Frequency List IE.
- HSN	Chosen arbitrarily from the set {1, 2, ..., 63}.
Synchronization Indication IE is not included	Frequency list after time.
- Frequency List	uses Range 128 to allocate the following 15 frequencies {307, 309, 311, 313, 315, 317, 319, 323, 326, 328, 330, 332, 334, 336, 338}.
Channel Mode IE	signalling only.

Step 13: "x" = 1 500.

GSM 900:

IMMEDIATE ASSIGNMENT

Information Element	value/remark
As default message contents.	

HANDOVER COMMAND

Information Element	value/remarks
As default message contents, except:	
Cell Description	
- Network Colour Code	3
- Base Station Colour Code	0
- BCCH Carrier Number	40
Channel Description	
- Channel Type	SDCCH/8
- TDMA offset	Chosen arbitrarily.
- Timeslot number	Zero.
- Training Sequence Code	Chosen arbitrarily.
- Hopping	RF hopping channel.
- MAIO	Chosen arbitrarily from the set (0, 1 to N-1), where N is the number of frequencies encoded in the Frequency List IE.
- HSN	Chosen arbitrarily from the set {1, 2, ..., 63}.
Synchronization Indication IE is not included	Frequency list after time.
- Frequency List	uses bit map 0 to allocate the following 15 frequencies {14, 18, 22, 24, 30, 31, 38, 60, 66, 73, 74, 75, 76, 108, 114}.
Channel Mode IE	signalling only.

Step 13: "x" = 1 500.

M = 4.

DCS 1 800:

IMMEDIATE ASSIGNMENT

Information Element	value/remark
As default message contents except:	
- Timeslot number	Arbitrary value, but not zero.
- ARFCN	747

HANDOVER COMMAND

Information Element	value/remarks
As default message contents, except:	
Cell Description	
- Network Colour Code	3
- Base Station Colour Code	0
- BCCH Carrier Number	764
Channel Description	
- Channel Type	SDCCH/8
- TDMA offset	Chosen arbitrarily.
- Timeslot number	Arbitrary value but not zero.
- Training Sequence Code	Chosen arbitrarily.
- Hopping	RF hopping channel.
- MAIO	Chosen arbitrarily from the set (0, 1 to N-1), where N is the number of frequencies encoded in the Frequency List IE.
- HSN	zero (this gives cyclic hopping).
Frequency List after time	
- Frequency List	Use Range 1024 to encode the complete CA of Cell B.
Synchronization Indication	
- Report Observed Time Difference	Shall not be included.
- Synchronization Indication	"Non synchronized".
- Normal Cell Indication	Ignore out of range timing advance.
Channel Mode IE is not included.	

Step 13: "x" = 1 500.

PCS 1900:

IMMEDIATE ASSIGNMENT

Information Element	value/remark
As default message contents except: - Timeslot number - ARFCN	Arbitrary value, but not zero. 647

HANDOVER COMMAND

Information Element	value/remarks
As default message contents, except: Cell Description - Network Colour Code - Base Station Colour Code - BCCH Carrier Number Channel Description - Channel Type - TDMA offset - Timeslot number - Training Sequence Code - Hopping - MAIO - HSN Frequency List after time - Frequency List Synchronization Indication - Report Observed Time Difference - Synchronization Indication - Normal Cell Indication Channel Mode IE is not included.	3 0 664 SDCCH/8 Chosen arbitrarily. Arbitrary value but not zero. Chosen arbitrarily. RF hopping channel. Chosen arbitrarily from the set (0, 1 to N-1), where N is the number of frequencies encoded in the Frequency List IE. zero (this gives cyclic hopping). Use Range 1024 to encode the complete CA of Cell B. Shall not be included. "Non synchronized". Ignore out of range timing advance.

Step 13: "x" = 1 500.

GSM 450:

IMMEDIATE ASSIGNMENT

Information Element	value/remark
As default message contents except: - Timeslot number - ARFCN	Arbitrary value, but not zero. 263

HANDOVER COMMAND

Information Element	value/remarks
Cell Description	
- Network Colour Code	3
- Base Station Colour Code	0
- BCCH Carrier Number	274
Channel Description	
- Channel Type	SDCCH/8
- TDMA offset	Chosen arbitrarily.
- Timeslot number	Arbitrary value, but not zero.
- Training Sequence Code	Chosen arbitrarily.
- Hopping	RF hopping channel.
- MAIO	Chosen arbitrarily from the set (0, 1 to N-1), where N is the number of frequencies encoded in the Frequency List IE.
Frequency List, after time	
- Frequency List	Use Range 128 to encode the following 14 frequencies: {260, 262, 264, 266, 268, 270, 272, 276, 279, 281, 283, 285, 287, 289}.
Synchronization Indication	
- Report Observed Time Difference	Shall not be included.
- Synchronization Indication	"Non synchronized".
- Normal Cell Indication	Ignore out of range timing advance.
Mode of first channel	Not included

Step 13: "x" = 1 500.

GSM 480:

IMMEDIATE ASSIGNMENT

Information Element	value/remark
As default message contents except:	
- Timeslot number	Arbitrary value, but not zero.
- ARFCN	310

HANDOVER COMMAND

Information Element	value/remarks
Cell Description	
- Network Colour Code	3
- Base Station Colour Code	0
- BCCH Carrier Number	321
Channel Description	
- Channel Type	SDCCH/8
- TDMA offset	Chosen arbitrarily.
- Timeslot number	Arbitrary value, but not zero.
- Training Sequence Code	Chosen arbitrarily.
- Hopping	RF hopping channel.
- MAIO	Chosen arbitrarily from the set (0, 1 to N-1), where N is the number of frequencies encoded in the Frequency List IE.
Frequency List, after time	
- Frequency List	Use Range 128 to encode the following 14 frequencies: {307, 309, 311, 313, 315, 317, 319, 323, 326, 328, 330, 332, 334, 336}.
Synchronization Indication	
- Report Observed Time Difference	Shall not be included.
- Synchronization Indication	"Non synchronized".
- Normal Cell Indication	Ignore out of range timing advance.
Mode of first channel	Not included

Step 13: "x" = 1 500.

GSM 900:

IMMEDIATE ASSIGNMENT

Information Element	value/remark
As default message contents except: - Timeslot number - ARFCN	Arbitrary value, but not zero. 20

HANDOVER COMMAND

Information Element	value/remarks
Cell Description - Network Colour Code - Base Station Colour Code - BCCH Carrier Number	3 0 40
Channel Description - Channel Type - TDMA offset - Timeslot number - Training Sequence Code - Hopping - MAIO	SDCCH/8 Chosen arbitrarily. Arbitrary value, but not zero. Chosen arbitrarily. RF hopping channel. Chosen arbitrarily from the set (0, 1 to N-1), where N is the number of frequencies encoded in the Frequency Channel Sequence IE.
Frequency Channel Sequence, after time - Frequency channel sequence	Allocates the following 14 frequencies: {14, 18, 22, 24, 30, 31, 38, 40, 66, 73, 74, 75, 76, 108}.
Synchronization Indication - Report Observed Time Difference - Synchronization Indication - Normal Cell Indication	Shall not be included. "Non synchronized". Ignore out of range timing advance.
Mode of first channel	Not included

Step 13: "x" = 1 500.

M = 5.

DCS 1 800:

IMMEDIATE ASSIGNMENT

Information Element	value/remark
As default message contents except: Channel Description - Channel Type - Timeslot number - Hopping Channel - ARFCN	TCH/F + ACCH's Arbitrary value but not zero. Single RF Channel. Chosen arbitrarily from the Cell Allocation of cell A.

HANDOVER COMMAND

Information Element	value/remarks
As default message contents, except:	
Cell Description	
- Network Colour Code	3
- Base Station Colour Code	0
- BCCH Carrier Number	764
Channel Description	
- Channel Type	TCH/H + ACCH's
- TDMA offset	Chosen arbitrarily.
- Timeslot number	Arbitrary value but not zero.
- Training Sequence Code	Chosen arbitrarily.
- Hopping	Single RF Channel.
- ARFCN	Chosen arbitrarily from the Cell Allocation of cell B.
Synchronization Indication	
- Report Observed Time Difference	Shall not be included.
- Synchronization Indication	"Non synchronized".
- Normal Cell Indication	Ignore out of range timing advance.
Mode of First Channel	Signalling only.

Step 13: "x" = 750.

PCS 1900:

IMMEDIATE ASSIGNMENT

Information Element	value/remark
As default message contents except:	
Channel Description	
- Channel Type	TCH/F + ACCH's
- Timeslot number	Arbitrary value but not zero.
- Hopping Channel	Single RF Channel.
- ARFCN	Chosen arbitrarily from the Cell Allocation of cell A.

HANDOVER COMMAND

Information Element	value/remarks
As default message contents, except:	
Cell Description	
- Network Colour Code	3
- Base Station Colour Code	0
- BCCH Carrier Number	664
Channel Description	
- Channel Type	TCH/H + ACCH's
- TDMA offset	Chosen arbitrarily.
- Timeslot number	Arbitrary value but not zero.
- Training Sequence Code	Chosen arbitrarily.
- Hopping	Single RF Channel.
- ARFCN	Chosen arbitrarily from the Cell Allocation of cell B.
Synchronization Indication	
- Report Observed Time Difference	Shall not be included.
- Synchronization Indication	"Non synchronized".
- Normal Cell Indication	Ignore out of range timing advance.
Mode of First Channel	Signalling only.

Step 13: "x" = 750.

GSM 450:

IMMEDIATE ASSIGNMENT

Information Element	value/remark
As default message contents except: Channel Description - Channel Type - Timeslot number - Hopping Channel - ARFCN	TCH/F + ACCH's Arbitrary value, but not zero. Single RF Channel. Chosen arbitrarily from the Cell Allocation of cell A.

HANDOVER COMMAND

Information Element	value/remarks
As default message contents, except: Cell Description - Network Colour Code - Base Station Colour Code - BCCH Carrier Number Channel Description - Channel Type - TDMA offset - Timeslot number - Training Sequence Code - Hopping - ARFCN Synchronization Indication - Report Observed Time Difference - Synchronization Indication - Normal Cell Indication Mode of First Channel	3 0 274 TCH/H + ACCH's Chosen arbitrarily. Arbitrary value but not zero. Chosen arbitrarily. Single RF Channel. Chosen arbitrarily from the Cell Allocation of cell B. Shall not be included. "Non synchronized". Ignore out of range timing advance. Signalling only.

Step 13: "x" = 750.

GSM 480:

IMMEDIATE ASSIGNMENT

Information Element	value/remark
As default message contents except: Channel Description - Channel Type - Timeslot number - Hopping Channel - ARFCN	TCH/F + ACCH's Arbitrary value, but not zero. Single RF Channel. Chosen arbitrarily from the Cell Allocation of cell A.

HANDOVER COMMAND

Information Element	value/remarks
As default message contents, except:	
Cell Description	
- Network Colour Code	3
- Base Station Colour Code	0
- BCCH Carrier Number	321
Channel Description	
- Channel Type	TCH/H + ACCH's
- TDMA offset	Chosen arbitrarily.
- Timeslot number	Arbitrary value but not zero.
- Training Sequence Code	Chosen arbitrarily.
- Hopping	Single RF Channel.
- ARFCN	Chosen arbitrarily from the Cell Allocation of cell B.
Synchronization Indication	
- Report Observed Time Difference	Shall not be included.
- Synchronization Indication	"Non synchronized".
- Normal Cell Indication	Ignore out of range timing advance.
Mode of First Channel	Signalling only.

Step 13: "x" = 750.

GSM 900:

IMMEDIATE ASSIGNMENT

Information Element	value/remark
As default message contents except:	
Channel Description	
- Channel Type	TCH/F + ACCH's
- Timeslot number	Arbitrary value, but not zero.
- Hopping Channel	Single RF Channel.
- ARFCN	Chosen arbitrarily from the Cell Allocation of cell A.

HANDOVER COMMAND

Information Element	value/remarks
As default message contents, except:	
Cell Description	
- Network Colour Code	3
- Base Station Colour Code	0
- BCCH Carrier Number	40
Channel Description	
- Channel Type	TCH/H + ACCH's
- TDMA offset	Chosen arbitrarily.
- Timeslot number	Arbitrary value but not zero.
- Training Sequence Code	Chosen arbitrarily.
- Hopping	Single RF Channel.
- ARFCN	Chosen arbitrarily from the Cell Allocation of cell B.
Synchronization Indication	
- Report Observed Time Difference	Shall not be included.
- Synchronization Indication	"Non synchronized".
- Normal Cell Indication	Ignore out of range timing advance.
Mode of First Channel	Signalling only.

Step 13: "x" = 750.

M = 6.

DCS 1 800:**IMMEDIATE ASSIGNMENT**

Information Element	value/remark
As default message contents except: L2 pseudo length Channel Description - Channel Type - TDMA offset - Timeslot number - Training Sequence Code - Hopping - MAIO - HSN	14 octets (11 + contents of the MA). Channel Description. TCH/H + ACCHs As default message contents. Arbitrary value but not zero. Chosen arbitrarily. RF hopping channel. Chosen arbitrarily from the set (0, 1 to N-1), where N is the number of frequencies encoded in the Mobile Allocation. Chosen arbitrarily from the set. (1,2,..63).
Mobile Allocation - Length - Contents	3 octets. Indicates all of the CA of cell A.

HANDOVER COMMAND

Information Element	value/remarks
As default message contents, except: Cell Description - Network Colour Code - Base Station Colour Code - BCCH Carrier Number Channel Description - Channel Type - Timeslot number - Training Sequence Code - Hopping - MAIO - HSN	3 0 764 TCH/F + ACCHs Arbitrary value but not zero. Chosen arbitrarily. RF hopping channel. Chosen arbitrarily from the set (0, 1 to N-1), where N is the number of frequencies encoded in the Frequency List IE. Chosen arbitrarily from the set. (1,2,..63).
Frequency List after time - Frequency List	Use Range 256 to encode the following 9 frequencies: (746, 749, 756, 761, 764, 798, 829, 832,844).
Synchronization Indication IE not included. Channel Mode	Signalling Only.

Step 13: "x" = 500.

PCS 1900:**IMMEDIATE ASSIGNMENT**

Information Element	value/remark
As default message contents except: L2 pseudo length Channel Description - Channel Type - TDMA offset - Timeslot number - Training Sequence Code - Hopping - MAIO - HSN	14 octets (11 + contents of the MA). Channel Description. TCH/H + ACCHs As default message contents. Arbitrary value but not zero. Chosen arbitrarily. RF hopping channel. Chosen arbitrarily from the set (0, 1 to N-1), where N is the number of frequencies encoded in the Mobile Allocation. Chosen arbitrarily from the set. (1,2,..63).
Mobile Allocation - Length - Contents	3 octets. Indicates all of the CA of cell A.

HANDOVER COMMAND

Information Element	value/remarks
As default message contents, except: Cell Description - Network Colour Code - Base Station Colour Code - BCCH Carrier Number Channel Description - Channel Type - Timeslot number - Training Sequence Code - Hopping - MAIO - HSN	3 0 664 TCH/F + ACCHs Arbitrary value but not zero. Chosen arbitrarily. RF hopping channel. Chosen arbitrarily from the set (0, 1 to N-1), where N is the number of frequencies encoded in the Frequency List IE. Chosen arbitrarily from the set. (1,2,..63).
Frequency List after time - Frequency List	Use Range 256 to encode the following 9 frequencies: (646, 649, 656, 661, 664, 698, 729, 732,744).
Synchronization Indication IE not included. Channel Mode	Signalling Only.

Step 13: "x" = 500.

GSM 450:

IMMEDIATE ASSIGNMENT

Information Element	value/remark
As default message contents except: L2 pseudo length Channel Description - Channel Type - TDMA offset - Timeslot number - Training Sequence Code - Hopping - MAIO - HSN Mobile Allocation - Length - Contents	14 octets (11 + contents of the MA). Channel Description. TCH/H + ACCHs. Chosen arbitrarily. Arbitrary value but not zero. Chosen arbitrarily. RF hopping channel. Chosen arbitrarily from the set (0, 1 to N-1), where N is the number of frequencies encoded in the Mobile Allocation. Chosen arbitrarily from the set. (1,2,..63). 3 octets. Indicates all of the CA of cell A.

HANDOVER COMMAND

Information Element	value/remarks
As default message contents, except: Cell Description - Network Colour Code - Base Station Colour Code - BCCH Carrier Number Channel Description - Channel Type - Timeslot number - Training Sequence Code - Hopping - MAIO - HSN Cell Channel Description Mobile Allocation after time Synchronization Indication IE not included. Channel Mode	3 0 274 TCH/F + ACCHs Arbitrary value but not zero. Chosen arbitrarily. RF hopping channel. Chosen arbitrarily from the set (0, 1 to N-1), where N is the number of frequencies encoded in the Mobile Allocation IE. Chosen arbitrarily from the set (1,2,..63). uses Range 128 to encode the complete CA of cell B. Indicates the following 5 frequencies: (260, 262, 264, 270, 274 Signalling Only.

Step 13: "x" = 500.

GSM 480:

IMMEDIATE ASSIGNMENT

Information Element	value/remark
As default message contents except: L2 pseudo length Channel Description - Channel Type - TDMA offset - Timeslot number - Training Sequence Code - Hopping - MAIO - HSN Mobile Allocation - Length - Contents	14 octets (11 + contents of the MA). Channel Description. TCH/H + ACCHs. Chosen arbitrarily. Arbitrary value but not zero. Chosen arbitrarily. RF hopping channel. Chosen arbitrarily from the set (0, 1 to N-1), where N is the number of frequencies encoded in the Mobile Allocation. Chosen arbitrarily from the set. (1,2,..63). 3 octets. Indicates all of the CA of cell A.

HANDOVER COMMAND

Information Element	value/remarks
As default message contents, except: Cell Description - Network Colour Code - Base Station Colour Code - BCCH Carrier Number Channel Description - Channel Type - Timeslot number - Training Sequence Code - Hopping - MAIO - HSN Cell Channel Description Mobile Allocation after time Synchronization Indication IE not included. Channel Mode	3 0 321 TCH/F + ACCHs Arbitrary value but not zero. Chosen arbitrarily. RF hopping channel. Chosen arbitrarily from the set (0, 1 to N-1), where N is the number of frequencies encoded in the Mobile Allocation IE. Chosen arbitrarily from the set (1,2,..63). uses Range 128 to encode the complete CA of cell B. Indicates the following 5 frequencies: (307, 309, 311, 317, 321). Signalling Only.

Step 13: "x" = 500.

GSM 900:

IMMEDIATE ASSIGNMENT

Information Element	value/remark
As default message contents except: L2 pseudo length Channel Description - Channel Type - TDMA offset - Timeslot number - Training Sequence Code - Hopping - MAIO - HSN Mobile Allocation - Length - Contents	14 octets (11 + contents of the MA). Channel Description. TCH/H + ACCHs. Chosen arbitrarily. Arbitrary value but not zero. Chosen arbitrarily. RF hopping channel. Chosen arbitrarily from the set (0, 1 to N-1), where N is the number of frequencies encoded in the Mobile Allocation. Chosen arbitrarily from the set. (1,2,..63). 3 octets. Indicates all of the CA of cell A.

HANDOVER COMMAND

Information Element	value/remarks
As default message contents, except: Cell Description - Network Colour Code - Base Station Colour Code - BCCH Carrier Number Channel Description - Channel Type - Timeslot number - Training Sequence Code - Hopping - MAIO - HSN Cell Channel Description Mobile Allocation after time Synchronization Indication IE not included. Channel Mode	3 0 40 TCH/F + ACCHs Arbitrary value but not zero. Chosen arbitrarily. RF hopping channel. Chosen arbitrarily from the set (0, 1 to N-1), where N is the number of frequencies encoded in the Mobile Allocation IE. Chosen arbitrarily from the set (1,2,..63). uses bit map 0 to encode the complete CA of cell B. Indicates the following 5 frequencies: (14, 18, 22, 31, 40). Signalling Only.

Step 13: "x" = 500.

M = 7:

DCS 1 800:

IMMEDIATE ASSIGNMENT

Information Element	value/remark
As default message contents except: L2 pseudo length Channel Description - Channel Type - Timeslot number - Training Sequence Code - Hopping - MAIO - HSN Mobile Allocation - Length - Contents	14 octets (11 + contents of the MA). Channel Description. TCH/F + ACCHs Zero. Chosen arbitrarily. RF hopping channel. Chosen arbitrarily from the set (0, 1 to N-1), where N is the number of frequencies encoded in the Mobile Allocation. Zero. 3 octets. Indicates only one frequency (844).

HANDOVER COMMAND

Information Element	value/remarks
As default message contents, except: Cell Description - Network Colour Code - Base Station Colour Code - BCCH Carrier Number Channel Description - Channel Type - Timeslot number - Training Sequence Code - Hopping - MAIO - HSN Cell Channel Description Mobile Allocation Mode of First channel	3 0 764 TCH/F + ACCHs Arbitrary value but not zero. Chosen arbitrarily. RF hopping channel. Chosen arbitrarily from the set (0, 1 to N-1), where N is the number of frequencies encoded in the Mobile Allocation. Chosen arbitrarily from the set. (1,2,..63). Use Variable bit map to encode the complete CA of cell B. Indicates all of the CA of cell B except for the following three frequencies: (764, 832 and 844). Speech (full rate version 1 or half rate version 1).

Step 13: "x" = 500.

PCS 1900:**IMMEDIATE ASSIGNMENT**

Information Element	value/remark
As default message contents except: L2 pseudo length	14 octets (11 + contents of the MA).
Channel Description	Channel Description.
- Channel Type	TCH/F + ACCHs
- Timeslot number	Zero.
- Training Sequence Code	Chosen arbitrarily.
- Hopping	RF hopping channel.
- MAIO	Chosen arbitrarily from the set (0, 1 to N-1), where N is the number of frequencies encoded in the Mobile Allocation.
- HSN	Zero.
Mobile Allocation	
- Length	3 octets.
- Contents	Indicates only one frequency (744).

HANDOVER COMMAND

Information Element	value/remarks
As default message contents, except:	
Cell Description	
- Network Colour Code	3
- Base Station Colour Code	0
- BCCH Carrier Number	664
Channel Description	
- Channel Type	TCH/F + ACCHs
- Timeslot number	Arbitrary value but not zero.
- Training Sequence Code	Chosen arbitrarily.
- Hopping	RF hopping channel.
- MAIO	Chosen arbitrarily from the set (0, 1 to N-1), where N is the number of frequencies encoded in the Mobile Allocation.
- HSN	Chosen arbitrarily from the set. (1,2,..63).
Cell Channel Description	Use Variable bit map to encode the complete CA of cell B.
Mobile Allocation	Indicates all of the CA of cell B except for the following three frequencies: (664, 732 and 744).
Mode of First channel	Speech (full rate version 1 or half rate version 1).

Step 13: "x" = 500.

GSM 450:**IMMEDIATE ASSIGNMENT**

Information Element	value/remark
As default message contents except: L2 pseudo length Channel Description - Channel Type - Timeslot number - Training Sequence Code - Hopping - MAIO - HSN Mobile Allocation - Length - Contents	14 octets (11 + contents of the MA). Channel Description. TCH/F + ACCHs Zero. Chosen arbitrarily. RF hopping channel. Chosen arbitrarily from the set (0, 1 to N-1), where N is the number of frequencies encoded in the Mobile Allocation. Zero. 3 octets. Indicates only one frequency (291).

HANDOVER COMMAND

Information Element	value/remarks
As default message contents, except: Cell Description - Network Colour Code - Base Station Colour Code - BCCH Carrier Number Channel Description - Channel Type - Timeslot number - Training Sequence Code - Hopping - MAIO - HSN Synchronization Indication IE is not included: Frequency list after time. - Frequency List IE Mode of First channel	3 0 274 TCH/F + ACCHs Arbitrary value but not zero. Chosen arbitrarily. RF hopping channel. Chosen arbitrarily from the set (0, 1 to N-1), where N is the number of frequencies encoded in the Frequency List IE. Chosen arbitrarily from the set (1,2,..63). uses Range 128 to allocate the following 16 frequencies {260, 262, 264, 266, 268, 270, 272, 274, 276, 279, 281, 283, 285, 287, 289, 291}. Speech (full rate version 1 or half rate version 1).

Step 13: "x" = 500.

GSM 480:

IMMEDIATE ASSIGNMENT

Information Element	value/remark
As default message contents except: L2 pseudo length Channel Description - Channel Type - Timeslot number - Training Sequence Code - Hopping - MAIO - HSN Mobile Allocation - Length - Contents	14 octets (11 + contents of the MA). Channel Description. TCH/F + ACCHs Zero. Chosen arbitrarily. RF hopping channel. Chosen arbitrarily from the set (0, 1 to N-1), where N is the number of frequencies encoded in the Mobile Allocation. Zero. 3 octets. Indicates only one frequency (338).

HANDOVER COMMAND

Information Element	value/remarks
As default message contents, except: Cell Description - Network Colour Code - Base Station Colour Code - BCCH Carrier Number Channel Description - Channel Type - Timeslot number - Training Sequence Code - Hopping - MAIO - HSN Synchronization Indication IE is not included: Frequency list after time. - Frequency List IE Mode of First channel	3 0 321 TCH/F + ACCHs Arbitrary value but not zero. Chosen arbitrarily. RF hopping channel. Chosen arbitrarily from the set (0, 1 to N-1), where N is the number of frequencies encoded in the Frequency List IE. Chosen arbitrarily from the set (1,2,..63). uses Range 128 to allocate the following 16 frequencies {307, 309, 311, 313, 315, 317, 319, 321, 323, 326, 328, 330, 332, 334, 336, 338}. Speech (full rate version 1 or half rate version 1).

Step 13: "x" = 500.

GSM 900:

IMMEDIATE ASSIGNMENT

Information Element	value/remark
As default message contents except: L2 pseudo length Channel Description - Channel Type - Timeslot number - Training Sequence Code - Hopping - MAIO - HSN Mobile Allocation - Length - Contents	14 octets (11 + contents of the MA). Channel Description. TCH/F + ACCHs Zero. Chosen arbitrarily. RF hopping channel. Chosen arbitrarily from the set (0, 1 to N-1), where N is the number of frequencies encoded in the Mobile Allocation. Zero. 3 octets. Indicates only one frequency (114).

HANDOVER COMMAND

Information Element	value/remarks
As default message contents, except: Cell Description - Network Colour Code - Base Station Colour Code - BCCH Carrier Number Channel Description - Channel Type - Timeslot number - Training Sequence Code - Hopping - MAIO - HSN Synchronization Indication IE is not included: Frequency list after time. - Frequency List IE Mode of First channel	3 0 40 TCH/F + ACCHs Arbitrary value but not zero. Chosen arbitrarily. RF hopping channel. Chosen arbitrarily from the set (0, 1 to N-1), where N is the number of frequencies encoded in the Frequency List IE. Chosen arbitrarily from the set (1,2,..63). uses bit map 0 to allocate the following 16 frequencies {14, 18, 22, 24, 30, 31, 38, 40, 60, 66, 73, 74, 75, 76, 108, 114}. Speech (full rate version 1 or half rate version 1).

Step 13: "x" = 500.

M = 8:

DCS 1 800:

IMMEDIATE ASSIGNMENT

Information Element	value/remark
As default message contents except: L2 pseudo length Channel Description - Channel Type - TDMA offset - Timeslot number - Training Sequence Code - Hopping - MAIO - HSN	14 octets (11 + contents of the MA). Channel Description. SDCCH/8 As default message contents. Arbitrary value but not zero. Chosen arbitrarily. RF hopping channel. Chosen arbitrarily from the set (0, 1 to N-1), where N is the number of frequencies encoded in the Mobile Allocation. Chosen arbitrarily from the set. (1,2,..63).
Mobile Allocation - Length - Contents	3octets. Indicates only three frequencies: (773, 775, 779).

HANDOVER COMMAND

Information Element	value/remarks
As default message contents, except: Cell Description - Network Colour Code - Base Station Colour Code - BCCH Carrier Number Channel Description - Channel Type - Timeslot number - Training Sequence Code - Hopping - ARFCN	3 0 764 TCH/F + ACCHs Zero. Chosen arbitrarily. Single RF Channel. Chosen arbitrarily from the Cell Allocation of Cell B, but not the BCCH carrier of Cell B.
Synchronization Indication IE not included. Mode of First Channel	Speech (full rate version 1 or half rate version 1).

Step 13: "x" = 500.

PCS 1900:

IMMEDIATE ASSIGNMENT

Information Element	value/remark
As default message contents except: L2 pseudo length Channel Description - Channel Type - TDMA offset - Timeslot number - Training Sequence Code - Hopping - MAIO - HSN	14 octets (11 + contents of the MA). Channel Description. SDCCH/8 As default message contents. Arbitrary value but not zero. Chosen arbitrarily. RF hopping channel. Chosen arbitrarily from the set (0, 1 to N-1), where N is the number of frequencies encoded in the Mobile Allocation. Chosen arbitrarily from the set. (1,2,..63).
Mobile Allocation - Length - Contents	3octets. Indicates only three frequencies: (673, 675, 679).

HANDOVER COMMAND

Information Element	value/remarks
As default message contents, except:	
Cell Description	
- Network Colour Code	3
- Base Station Colour Code	0
- BCCH Carrier Number	664
Channel Description	
- Channel Type	TCH/F + ACCHs
- Timeslot number	Zero.
- Training Sequence Code	Chosen arbitrarily.
- Hopping	Single RF Channel.
- ARFCN	Chosen arbitrarily from the Cell Allocation of Cell B, but not the BCCH carrier of Cell B.
Synchronization Indication IE not included.	
Mode of First Channel	Speech (full rate version 1 or half rate version 1).

Step 13: "x" = 500.

GSM 450:

IMMEDIATE ASSIGNMENT

Information Element	value/remark
As default message contents except:	
L2 pseudo length	14 octets (11 + contents of the MA).
Channel Description	
- Channel Type	SDCCH/8
- TDMA offset	As default message contents.
- Timeslot number	Arbitrary value, but not zero.
- Training Sequence Code	Chosen arbitrarily.
- Hopping	RF hopping channel.
- MAIO	Chosen arbitrarily from the set (0, 1 to N-1), where N is the number of frequencies encoded in the Mobile Allocation.
- HSN	Chosen arbitrarily from the set (1,2,..63).
Mobile Allocation	
- Length	3 octets.
- Contents	Indicates only three frequencies: (281, 283, 285).

HANDOVER COMMAND

Information Element	value/remarks
As default message contents, except:	
Cell Description	
- Network Colour Code	3
- Base Station Colour Code	0
- BCCH Carrier Number	274
Channel Description	
- Channel Type	TCH/F + ACCHs
- Timeslot number	Zero.
- Training Sequence Code	Chosen arbitrarily.
- Hopping	Single RF Channel.
- ARFCN	Chosen arbitrarily from the Cell Allocation of Cell B, but not the BCCH carrier of Cell B.
Mode of First Channel	Speech (full rate version 1 or half rate version 1).

Step 13: "x" = 500.

GSM 480:

IMMEDIATE ASSIGNMENT

Information Element	value/remark
As default message contents except: L2 pseudo length Channel Description - Channel Type - TDMA offset - Timeslot number - Training Sequence Code - Hopping - MAIO - HSN Mobile Allocation - Length - Contents	14 octets (11 + contents of the MA). SDCCH/8 As default message contents. Arbitrary value, but not zero. Chosen arbitrarily. RF hopping channel. Chosen arbitrarily from the set (0, 1 to N-1), where N is the number of frequencies encoded in the Mobile Allocation. Chosen arbitrarily from the set (1,2,..63). 3 octets. Indicates only three frequencies: (328, 330, 332).

HANDOVER COMMAND

Information Element	value/remarks
As default message contents, except: Cell Description - Network Colour Code - Base Station Colour Code - BCCH Carrier Number Channel Description - Channel Type - Timeslot number - Training Sequence Code - Hopping - ARFCN Mode of First Channel	 3 0 321 TCH/F + ACCHs Zero. Chosen arbitrarily. Single RF Channel. Chosen arbitrarily from the Cell Allocation of Cell B, but not the BCCH carrier of Cell B. Speech (full rate version 1 or half rate version 1).

Step 13: "x" = 500.

GSM 900:

IMMEDIATE ASSIGNMENT

Information Element	value/remark
As default message contents except: L2 pseudo length Channel Description - Channel Type - TDMA offset - Timeslot number - Training Sequence Code - Hopping - MAIO - HSN Mobile Allocation - Length - Contents	14 octets (11 + contents of the MA). SDCCH/8 As default message contents. Arbitrary value, but not zero. Chosen arbitrarily. RF hopping channel. Chosen arbitrarily from the set (0, 1 to N-1), where N is the number of frequencies encoded in the Mobile Allocation. Chosen arbitrarily from the set (1,2,..63).
	3 octets. Indicates only three frequencies: (73, 74, 75).

HANDOVER COMMAND

Information Element	value/remarks
As default message contents, except: Cell Description - Network Colour Code - Base Station Colour Code - BCCH Carrier Number Channel Description - Channel Type - Timeslot number - Training Sequence Code - Hopping - ARFCN Mode of First Channel	3 0 40 TCH/F + ACCHs Zero. Chosen arbitrarily. Single RF Channel. Chosen arbitrarily from the Cell Allocation of Cell B, but not the BCCH carrier of Cell B. Speech (full rate version 1 or half rate version 1).

Step 13: "x" = 500.

M = 9:

DCS 1 800:

IMMEDIATE ASSIGNMENT

Information Element	value/remark
As default message contents.	

HANDOVER COMMAND

Information Element	value/remarks
As default message contents, except:	
Cell Description	
- Network Colour Code	3
- Base Station Colour Code	0
- BCCH Carrier Number	764
Channel Description	
- Channel Type	TCH/F + ACCHs
- Timeslot number	Arbitrary value, but not zero.
- Training Sequence Code	Chosen arbitrarily.
- Hopping	RF hopping channel.
- MAIO	Chosen arbitrarily from the set (0, 1 to N-1), where N is the number of frequencies encoded in the Frequency Short List IE.
- HSN	Zero (this gives cyclic hopping).
Frequency Short List after time	
- Frequency Short List	Use Range 256 to encode the following 3 frequencies: (764, 779, 782).
Synchronization Indication	
- Report Observed Time Difference	Shall not be included.
- Synchronization Indication	"Non synchronized".
- Normal Cell Indication	Ignore out of range timing advance.
Channel mode	Speech (full rate version 1 or half rate version 1)

Step 13: "x" = 500.

PCS 1900:

IMMEDIATE ASSIGNMENT

Information Element	value/remark
As default message contents.	

HANDOVER COMMAND

Information Element	value/remarks
As default message contents, except:	
Cell Description	
- Network Colour Code	3
- Base Station Colour Code	0
- BCCH Carrier Number	664
Channel Description	
- Channel Type	TCH/F + ACCHs
- Timeslot number	Arbitrary value, but not zero.
- Training Sequence Code	Chosen arbitrarily.
- Hopping	RF hopping channel.
- MAIO	Chosen arbitrarily from the set (0, 1 to N-1), where N is the number of frequencies encoded in the Frequency Short List IE.
- HSN	Zero (this gives cyclic hopping).
Frequency Short List after time	
- Frequency Short List	Use Range 256 to encode the following 3 frequencies: (664, 679, 682).
Synchronization Indication	
- Report Observed Time Difference	Shall not be included.
- Synchronization Indication	"Non synchronized".
- Normal Cell Indication	Ignore out of range timing advance.
Channel mode	Speech (full rate version 1 or half rate version 1)

Step 13: "x" = 500.

GSM 450:

IMMEDIATE ASSIGNMENT

Information Element	value/remark
As default message contents.	

HANDOVER COMMAND

Information Element	value/remarks
As default message contents, except:	
Cell Description	
- Network Colour Code	3
- Base Station Colour Code	0
- BCCH Carrier Number	274
Channel Description	
- Channel Type	TCH/F + ACCHs
- Timeslot number	zero.
- Training Sequence Code	Chosen arbitrarily.
- Hopping	RF hopping channel
- MAIO	Chosen arbitrarily from the set {0, 1}.
- HSN	Chosen arbitrarily from the set {1, 2,..., 63}.
Synchronization Indication IE is not included	
Frequency List, after time.	
- Frequency List	allocates the following two frequencies {260, 291}.
Mode of the first channel	Speech (full rate version 1 or half rate version 1).

Step 13: "x" = 500.

GSM 480:

IMMEDIATE ASSIGNMENT

Information Element	value/remark
As default message contents.	

HANDOVER COMMAND

Information Element	value/remarks
As default message contents, except:	
Cell Description	
- Network Colour Code	3
- Base Station Colour Code	0
- BCCH Carrier Number	321
Channel Description	
- Channel Type	TCH/F + ACCHs
- Timeslot number	zero.
- Training Sequence Code	Chosen arbitrarily.
- Hopping	RF hopping channel
- MAIO	Chosen arbitrarily from the set {0, 1}.
- HSN	Chosen arbitrarily from the set {1, 2,..., 63}.
Synchronization Indication IE is not included	
Frequency List, after time.	
- Frequency List	allocates the following two frequencies {307, 338}.
Mode of the first channel	Speech (full rate version 1 or half rate version 1).

Step 13: "x" = 500.

GSM 900:

IMMEDIATE ASSIGNMENT

Information Element	value/remark
As default message contents.	

HANDOVER COMMAND

Information Element	value/remarks
As default message contents, except:	
Cell Description	
- Network Colour Code	3
- Base Station Colour Code	0
- BCCH Carrier Number	40
Channel Description	
- Channel Type	TCH/F + ACCHs
- Timeslot number	zero.
- Training Sequence Code	Chosen arbitrarily.
- Hopping	RF hopping channel
- MAIO	Chosen arbitrarily from the set {0, 1}.
- HSN	Chosen arbitrarily from the set {1, 2,..., 63}.
Synchronization Indication IE is not included	
Frequency Channel Sequence, after time.	
- Frequency Channel Sequence IE	allocates the following two frequencies {14, 114}.
Mode of the first channel	Speech (full rate version 1 or half rate version 1).

Step 13: "x" = 500.

M = 10:

DCS 1 800:

IMMEDIATE ASSIGNMENT

Information Element	value/remark
As default message contents.	

HANDOVER COMMAND

Information Element	value/remarks
As default message contents, except:	
Cell Description	
- Network Colour Code	3
- Base Station Colour Code	0
- BCCH Carrier Number	764
Channel Description	
- Channel Type	TCH/H + ACCHs
- TDMA offset	Chosen arbitrarily.
- Timeslot number	Arbitrary value, but not zero.
- Training Sequence Code	Chosen arbitrarily.
- Hopping	RF hopping channel.
- MAIO	Chosen arbitrarily from the set (0, 1 to N-1), where N is the number of frequencies encoded in the Frequency List IE.
- HSN	Zero (this gives cyclic hopping).
Frequency List after time	
- Frequency List	Use Variable Bit Map to encode the following 15 frequencies: (739, 743, 746, 749, 756, 758, 764, 771, 779, 782, 791, 798, 829, 832, 844).
Synchronization Indication IE is not included.	
Channel mode	Speech (full rate version 1 or half rate version 1).

Step 13: "x" = 750.

PCS 1900:

IMMEDIATE ASSIGNMENT

Information Element	value/remark
As default message contents.	

HANDOVER COMMAND

Information Element	value/remarks
As default message contents, except:	
Cell Description	
- Network Colour Code	3
- Base Station Colour Code	0
- BCCH Carrier Number	664
Channel Description	
- Channel Type	TCH/H + ACCHs
- TDMA offset	Chosen arbitrarily.
- Timeslot number	Arbitrary value, but not zero.
- Training Sequence Code	Chosen arbitrarily.
- Hopping	RF hopping channel.
- MAIO	Chosen arbitrarily from the set (0, 1 to N-1), where N is the number of frequencies encoded in the Frequency List IE.
- HSN	Zero (this gives cyclic hopping).
Frequency List after time	
- Frequency List	Use Variable Bit Map to encode the following 15 frequencies: (639, 643, 646, 649, 656, 658, 664, 671, 679, 682, 691, 698, 729, 732, 744).
Synchronization Indication IE is not included.	
Channel mode	Speech (full rate version 1 or half rate version 1).

Step 13: "x" = 750.

GSM 450:

IMMEDIATE ASSIGNMENT

Information Element	value/remark
As default message contents.	

HANDOVER COMMAND

Information Element	value/remarks
As default message contents, except:	
Cell Description	
- Network Colour Code	3
- Base Station Colour Code	0
- BCCH Carrier Number	274
Channel Description	
- Channel Type	TCH/H + ACCHs
- TDMA offset	Chosen arbitrarily.
- Timeslot number	Chosen arbitrarily but not zero.
- Training Sequence Code	Chosen arbitrarily.
- Hopping	RF hopping channel.
- MAIO	Chosen arbitrarily from the set {0, 1}.
- HSN	Chosen arbitrarily from the set {1, 2, ..., 63}.
Synchronization Indication IE is not included	
Frequency List, after time	
- Frequency List	allocates the following two frequencies {274, 291}.
Channel Mode IE	speech (full rate version 1 or half rate version 1).

Step 13: "x" = 750.

GSM 480:

IMMEDIATE ASSIGNMENT

Information Element	value/remark
As default message contents.	

HANDOVER COMMAND

Information Element	value/remarks
As default message contents, except:	
Cell Description	
- Network Colour Code	3
- Base Station Colour Code	0
- BCCH Carrier Number	321
Channel Description	
- Channel Type	TCH/H + ACCHs
- TDMA offset	Chosen arbitrarily.
- Timeslot number	Chosen arbitrarily but not zero.
- Training Sequence Code	Chosen arbitrarily.
- Hopping	RF hopping channel.
- MAIO	Chosen arbitrarily from the set {0, 1}.
- HSN	Chosen arbitrarily from the set {1, 2,..., 63}.
Synchronization Indication IE is not included	
Frequency List, after time	
- Frequency List	allocates the following two frequencies {321, 338}.
Channel Mode IE	speech (full rate version 1 or half rate version 1).

Step 13: "x" = 750.

GSM 900:

IMMEDIATE ASSIGNMENT

Information Element	value/remark
As default message contents.	

HANDOVER COMMAND

Information Element	value/remarks
As default message contents, except:	
Cell Description	
- Network Colour Code	3
- Base Station Colour Code	0
- BCCH Carrier Number	40
Channel Description	
- Channel Type	TCH/H + ACCHs
- TDMA offset	Chosen arbitrarily.
- Timeslot number	Chosen arbitrarily but not zero.
- Training Sequence Code	Chosen arbitrarily.
- Hopping	RF hopping channel.
- MAIO	Chosen arbitrarily from the set {0, 1}.
- HSN	Chosen arbitrarily from the set {1, 2,..., 63}.
Synchronization Indication IE is not included	
Frequency Channel Sequence, after time	
- Frequency Channel Sequence IE	allocates the following two frequencies {40, 114}.
Channel Mode IE	speech (full rate version 1 or half rate version 1).

Step 13: "x" = 750.

Specific Message Contents For Mobiles not Supporting Speech

The message contents shall be the same for the declared type of Mobile Station (GSM 450 or GSM 480 or P-GSM 900 or DCS 1 800 or PCS 1900 supporting speech), except for:

M = 1, 7, 8 and 9:

HANDOVER COMMAND

Information Element	value/remarks
Mode of first channel	Arbitrary from those supported (12, 6, 3,6 kbps).

For M = 2 and 10 :

HANDOVER COMMAND

Information Element	value/remarks
Mode of first channel	Arbitrary from those supported (6, 3,6 kbps).

26.6.5.3 Handover / successful / active call / finely synchronized

26.6.5.3.1 Conformance requirements

The MS shall correctly apply the handover procedure from TCH/F with frequency hopping to TCH/F without frequency hopping in the finely synchronized case when a call is in progress.

The MS shall correctly apply the handover procedure from TCH/H with frequency hopping to TCH/H without frequency hopping in the finely synchronized case when a call is in progress. This requirement does not apply to MSs not supporting TCH/H.

References

GSM 04.08 sections 3.4.4, 9.1.14, 9.1.15 and 9.1.16.

GSM 04.13 section 5.2.6.

GSM 05.05 section 4.1.1.

GSM 05.10, section 6.6.

26.6.5.3.2 Test purpose

To test that when the MS is ordered to make a finely synchronized handover to a synchronized cell, it sends 4 access bursts on the main DCCH and then activates the channel correctly, taking into account the value of any Starting Time information element, power command and correctly calculating the timing advance to use. To test the MS activates the new channel correctly and transmits the HANDOVER COMPLETE message without undue delay.

26.6.5.3.3 Method of test

Initial Conditions

System Simulator:

2 cells, A and B, with same LAI, default parameters, except:

The BCCH of cell A is sent k bit periods before the BCCH of cell B. The timing advance in cell A sent to the MS is y bit periods. k and y are selected such that $0 < (2k+y) \bmod 256 < 60$.

GSM 450:

Cell B has BCCH ARFCN = 274.

GSM 480:

Cell B has BCCH ARFCN = 321.

P-GSM 900:

Cell B has BCCH ARFCN = 40.

DCS 1 800:

Cell B has BCCH ARFCN = 764.

PCS 1900:

Cell B has BCCH ARFCN = 764.

Mobile Station:

The MS is in the active state (U10) of a call (on cell A). The MS is using a power level P . Where P is a power level within the supported range of that type of MS.

Related PICS/PIXIT Statements

Supported rate(s) of TCH: TCH/F and/or TCH/H.

Support for state U10 of the Call Control protocol.

Supported speech and data rates.

Type of Mobile Station (GSM 450 or GSM 480 or P-GSM 900 or EGSM or DCS 1 800 or PCS 1900).

Power class of Mobile Station.

Foreseen Final State of the MS

The active state (U10) of a mobile call (on cell B).

Test Procedure

This procedure is repeated for execution counter $M = 1$ to 2. (See table 26.6-1.)

The MS is in the active state (U10) of a call on cell A. The SS sends a HANOVER COMMAND on the main DCCH. The MS shall (at the time specified in the Starting Time information element, if included) send 4 access bursts, in 4 successive slots on the new DCCH to cell B. Then the MS shall establish a signalling link indicating the correct Timing Advance and power level and send a HANOVER COMPLETE message.

The MS shall be "ready to transmit" a HANOVER COMPLETE message before "x" ms after the end of the HANOVER COMMAND message, but not before a UA frame has been sent by the SS.

The term "ready to transmit" is defined in GSM 04.13. The value of "x" depends upon the target channel and is specified in the specific message contents section.

Maximum Duration of Test

5 minutes, including 1 minute for any necessary operator actions.

Expected Sequence

This sequence is performed for execution counter $M = 1$ for an MS which only supports TCH/F.

This sequence is performed for execution counter $M = 1$ to 2 for an MS which supports TCH/F and H.

Step	Direction	Message	Comments
0	MS -> SS		$M = 1$, The MS and SS are using a full rate TCH in hopping mode on cell A. $M = 2$, The MS and SS are using a half rate TCH in hopping mode on cell A.
1	SS -> MS	HANOVER COMMAND	See Specific Message Contents.
2	MS -> SS	HANOVER ACCESS	See specific message contents. Four messages.
3	MS -> SS	HANOVER ACCESS	are transmitted to Cell B in 4 successive slots.
4	MS -> SS	HANOVER ACCESS	on the new DCCH.
5	MS -> SS	HANOVER ACCESS	
6	MS -> SS	SABM	Sent without information field.
7	SS -> MS	UA	
8	MS -> SS	HANOVER COMPLETE	This message shall be ready to be transmitted before "x" ms after the completion of step 1. See specific message contents.
9	SS		The header of the next uplink SACCH is examined and the Timing Advance and Power Level indications are examined. The correct timing advance shall be indicated. A tolerance of +/- 2 bit periods is allowed. The power level indication shall indicate the power level used in the handover command.
10	MS, SS		$M = 1$, The MS and SS are using a full rate TCH in non-hopping mode on cell B $M = 2$, The MS and SS are using a half rate TCH in non-hopping mode on cell B.

Specific Message Contents

M = 1:

GSM 450

HANDOVER COMMAND

Information Element	value/remark
As default message contents, except:	
Cell Description	
- Network Colour Code	1
- Base Station Colour Code	5
- BCCH Carrier Number	274
Channel Description	
- Channel type	TCH/F + ACCHs
- Timeslot Number	Arbitrary value, but not zero.
- Training Sequence Code	Chosen arbitrarily.
- Hopping	Single RF Channel.
- ARFCN	274
Handover Reference	
- Value	Chosen arbitrarily from the range (0, 1..255).
Power command	
- Power Level	Arbitrarily chosen, but different to the one already in use and within the range supported by that type of MS.
Synchronization Indication	
- Report Observed Time Difference	Shall not be included.
- Synchronization Indication	"Synchronized".
- Normal Cell Indication	Ignore out of range timing advance.

HANDOVER ACCESS

Information Element	value/remark
As default message contents except:	
Handover Reference	
- Value	Same as HANDOVER COMMAND

Step 8: x = 650 ms.

GSM 480**HANDOVER COMMAND**

Information Element	value/remark
As default message contents, except:	
Cell Description	
- Network Colour Code	1
- Base Station Colour Code	5
- BCCH Carrier Number	321
Channel Description	
- Channel type	TCH/F + ACCHs
- Timeslot Number	Arbitrary value, but not zero.
- Training Sequence Code	Chosen arbitrarily.
- Hopping	Single RF Channel.
- ARFCN	321
Handover Reference	
- Value	Chosen arbitrarily from the range (0, 1..255).
Power command	
- Power Level	Arbitrarily chosen, but different to the one already in use and within the range supported by that type of MS.
Synchronization Indication	
- Report Observed Time Difference	Shall not be included.
- Synchronization Indication	"Synchronized".
- Normal Cell Indication	Ignore out of range timing advance.

HANDOVER ACCESS

Information Element	value/remark
As default message contents except:	
Handover Reference	
- Value	Same as HANDOVER COMMAND

Step 8: x = 650 ms.

GSM 900**HANDOVER COMMAND**

Information Element	value/remark
As default message contents, except:	
Cell Description	
- Network Colour Code	1
- Base Station Colour Code	5
- BCCH Carrier Number	40
Channel Description	
- Channel type	TCH/F + ACCHs
- Timeslot Number	Arbitrary value, but not zero.
- Training Sequence Code	Chosen arbitrarily.
- Hopping	Single RF Channel.
- ARFCN	40
Handover Reference	
- Value	Chosen arbitrarily from the range (0, 1..255).
Power command	
- Power Level	Arbitrarily chosen, but different to the one already in use and within the range supported by that type of MS.
Synchronization Indication	
- Report Observed Time Difference	Shall not be included.
- Synchronization Indication	"Synchronized".
- Normal Cell Indication	Ignore out of range timing advance.

HANDOVER ACCESS

Information Element	value/remark
As default message contents except: Handover Reference - Value	Same as HANDOVER COMMAND

Step 8: x = 650 ms.

DCS 1 800

HANDOVER COMMAND

Information Element	value/remark
As default message contents, except: Cell Description - Network Colour Code - Base Station Colour Code - BCCH Carrier Number Channel Description - Channel type - Timeslot Number - Training Sequence Code - Hopping - ARFCN Handover Reference - Value Power command - Power Level Synchronization Indication - Report Observed Time Difference - Synchronization Indication - Normal Cell Indication	1 5 764 TCH/F + ACCHs Arbitrary value, but not zero. Chosen arbitrarily. Single RF Channel. 764 Chosen arbitrarily from the range (0, 1..255). Arbitrarily chosen, but different to the one already in use and within the range supported by that type of MS. Shall not be included. "Synchronized". Ignore out of range timing advance.

HANDOVER ACCESS

Information Element	value/remark
As default message contents except: Handover Reference - Value	Same as HANDOVER COMMAND

Step 8: x = 650 ms.

PCS 1900**HANDOVER COMMAND**

Information Element	value/remark
As default message contents, except:	
Cell Description	
- Network Colour Code	1
- Base Station Colour Code	5
- BCCH Carrier Number	764
Channel Description	
- Channel type	TCH/F + ACCHs
- Timeslot Number	Arbitrary value, but not zero.
- Training Sequence Code	Chosen arbitrarily.
- Hopping	Single RF Channel.
- ARFCN	764
Handover Reference	
- Value	Chosen arbitrarily from the range (0, 1..255).
Power command	
- Power Level	Arbitrarily chosen, but different to the one already in use and within the range supported by that type of MS.
Synchronization Indication	
- Report Observed Time Difference	Shall not be included.
- Synchronization Indication	"Synchronized".
- Normal Cell Indication	Ignore out of range timing advance.

HANDOVER ACCESS

Information Element	value/remark
As default message contents except:	
Handover Reference	
- Value	Same as HANDOVER COMMAND

Step 8: x = 650 ms.

M = 2:

GSM 450

HANDOVER COMMAND

Information Element	value/remark
As default message contents, except:	
Cell Description	
- Network Colour Code	1
- Base Station Colour Code	5
- BCCH Carrier Number	274
Channel Description	
- Channel type	TCH/H + ACCHs
- TDMA offset	Chosen arbitrarily.
- Timeslot Number	Arbitrary value, but not zero.
- Training Sequence Code	Chosen arbitrarily.
- Hopping	Single RF Channel.
- ARFCN	274
Handover Reference	
- Value	Chosen arbitrarily from the range (0, 1..255).
Power command	
- Power Level	Arbitrarily chosen, but different to the one already in use and within the range supported by that type of MS.
Synchronization Indication	
- Report Observed Time Difference	Shall not be included.
- Synchronization Indication	"Synchronized".
- Normal Cell Indication	Ignore out of range timing advance.
Mode of First Channel	If speech is supported: Speech (full rate version 1 or half rate version 1). If speech is not supported: arbitrary from those supported, 12, 6, 3,6 kbps).

HANDOVER ACCESS

Information Element	value/remark
As default message contents except:	
Handover Reference	
- Value	Same as HANDOVER COMMAND

Step 8: x = 900 ms.

GSM 480**HANDOVER COMMAND**

Information Element	value/remark
As default message contents, except:	
Cell Description	
- Network Colour Code	1
- Base Station Colour Code	5
- BCCH Carrier Number	321
Channel Description	
- Channel type	TCH/H + ACCHs
- TDMA offset	Chosen arbitrarily.
- Timeslot Number	Arbitrary value, but not zero.
- Training Sequence Code	Chosen arbitrarily.
- Hopping	Single RF Channel.
- ARFCN	321
Handover Reference	
- Value	Chosen arbitrarily from the range (0, 1..255).
Power command	
- Power Level	Arbitrarily chosen, but different to the one already in use and within the range supported by that type of MS.
Synchronization Indication	
- Report Observed Time Difference	Shall not be included.
- Synchronization Indication	"Synchronized".
- Normal Cell Indication	Ignore out of range timing advance.
Mode of First Channel	If speech is supported: Speech (full rate version 1 or half rate version 1). If speech is not supported: arbitrary from those supported, 12, 6, 3,6 kbps).

HANDOVER ACCESS

Information Element	value/remark
As default message contents except:	
Handover Reference	
- Value	Same as HANDOVER COMMAND

Step 8: x = 900 ms.

GSM 900**HANDOVER COMMAND**

Information Element	value/remark
As default message contents, except:	
Cell Description	
- Network Colour Code	1
- Base Station Colour Code	5
- BCCH Carrier Number	40
Channel Description	
- Channel type	TCH/H + ACCHs
- TDMA offset	Chosen arbitrarily.
- Timeslot Number	Arbitrary value, but not zero.
- Training Sequence Code	Chosen arbitrarily.
- Hopping	Single RF Channel.
- ARFCN	40
Handover Reference	
- Value	Chosen arbitrarily from the range (0, 1..255).
Power command	
- Power Level	Arbitrarily chosen, but different to the one already in use and within the range supported by that type of MS.
Synchronization Indication	
- Report Observed Time Difference	Shall not be included.
- Synchronization Indication	"Synchronized".
- Normal Cell Indication	Ignore out of range timing advance.
Mode of First Channel	If speech is supported: Speech (full rate version 1 or half rate version 1). If speech is not supported: arbitrary from those supported, 12, 6, 3,6 kbps).

HANDOVER ACCESS

Information Element	value/remark
As default message contents except:	
Handover Reference	
- Value	Same as HANDOVER COMMAND

Step 8: x = 900 ms.

DCS 1 800**HANDOVER COMMAND**

Information Element	value/remark
As default message contents, except:	
Cell Description	
- Network Colour Code	1
- Base Station Colour Code	5
- BCCH Carrier Number	764
Channel Description	
- Channel type	TCH/H + ACCHs
- TDMA offset	Chosen arbitrarily.
- Timeslot Number	Arbitrary value, but not zero.
- Training Sequence Code	Chosen arbitrarily.
- Hopping	Single RF Channel.
- ARFCN	764
Handover Reference	
- Value	Chosen arbitrarily from the range (0, 1..255).
Power command	
- Power Level	Arbitrarily chosen, but different to the one already in use and within the range supported by that type of MS.
Synchronization Indication	
- Report Observed Time Difference	Shall not be included.
- Synchronization Indication	"Synchronized".
- Normal Cell Indication	Ignore out of range timing advance.
Mode of First Channel	If speech is supported: Speech (full rate version 1 or half rate version 1). If speech is not supported: arbitrary from those supported (12, 6, 3,6 kbps).

HANDOVER ACCESS

Information Element	value/remark
As default message contents except:	
Handover Reference	
- Value	Same as HANDOVER COMMAND

Step 8: x = 900 ms. **PCS 1900**

HANDOVER COMMAND

Information Element	value/remark
As default message contents, except:	
Cell Description	
- Network Colour Code	1
- Base Station Colour Code	5
- BCCH Carrier Number	764
Channel Description	
- Channel type	TCH/H + ACCHs
- TDMA offset	Chosen arbitrarily.
- Timeslot Number	Arbitrary value, but not zero.
- Training Sequence Code	Chosen arbitrarily.
- Hopping	Single RF Channel.
- ARFCN	764
Handover Reference	
- Value	Chosen arbitrarily from the range (0, 1..255).
Power command	
- Power Level	Arbitrarily chosen, but different to the one already in use and within the range supported by that type of MS.
Synchronization Indication	
- Report Observed Time Difference	Shall not be included.
- Synchronization Indication	"Synchronized".
- Normal Cell Indication	Ignore out of range timing advance.
Mode of First Channel	If speech is supported: Speech (full rate version 1 or half rate version 1). If speech is not supported: arbitrary from those supported (12, 6, 3,6 kbps).

HANDOVER ACCESS

Information Element	value/remark
As default message contents except:	
Handover Reference	
- Value	Same as HANDOVER COMMAND

Step 8: x = 900 ms.

26.6.5.4 Handover / successful / call under establishment / finely synchronized

This test is applicable to all MS which support at least one MO circuit switched basic service.

26.6.5.4.1 Conformance requirements

The MS shall correctly apply the handover procedure from SDCCH/8 or TCH/F with or without frequency hopping to SDCCH4, SDCCH/8 or TCH/F with or without frequency hopping in the finely synchronized case, during call establishment.

If during call establishment a Layer 3 MM or CC message just sent by the MS is not Layer 2 acknowledged before the channel change caused by the HANDOVER COMMAND message, the MS shall send the Layer 3 message to the new cell, using the same value in the N(SD) field, after the handover procedure.

References

GSM 05.10, section 6.6.

GSM 04.08, section 3.4.4.

GSM 04.08, section 3.1.4.2.

GSM 04.13, section 5.2.6.

26.6.5.4.2 Test purpose

To test that when the MS is ordered to make a finely synchronized handover to a synchronized cell, it sends 4 access bursts on the main DCCH and then activates the channel correctly, taking into account the value of any Starting Time information element, power command and correctly calculating the timing advance to use. To test that the MS correctly retransmits Layer 3 MM or CC messages that were not acknowledged by Layer 2 before the Handover, after completion of the Handover. To verify the MS transmits the HANDOVER COMPLETE message without undue delay.

26.6.5.4.3 Method of test

Initial Conditions

System Simulator:

2 cells, A and B, with same LAI, default parameters, except:

The BCCH of cell A is sent k bit periods before the BCCH of cell B. The timing advance in cell A sent to the MS is y bit periods. k and y are selected such that $0 < (2k + y) \bmod 256 < 60$.

The frame numbers of cells A and B shall be different by 100.

GSM 450:

Cell A has:

BCCH ARFCN = 263.

Cell Allocation = (259, 261, 263, 265, 267, 269, 271, 273, 275, 277, 279, 281, 283, 285, 287, 289, 291).

Cell B has:

BCCH ARFCN = 274.

Cell Allocation = (260, 262, 264, 266, 268, 270, 272, 274, 276, 279, 281, 283, 285, 287, 289, 291).

GSM 480:

Cell A has:

BCCH ARFCN = 310.

Cell Allocation = (306, 308, 310, 312, 314, 316, 318, 320, 322, 324, 326, 328, 330, 332, 334, 336, 338).

Cell B has:

BCCH ARFCN = 321.

Cell Allocation = (307, 309, 311, 313, 315, 317, 319, 321, 323, 326, 328, 330, 332, 334, 336, 338).

GSM 900:

Cell A has:

BCCH ARFCN = 20.

Cell Allocation = (10, 17, 20, 26, 34, 42, 45, 46, 52, 59, 66, 73, 74, 75, 76, 108, 114).

Cell B has:

BCCH ARFCN = 40.

Cell Allocation = (14, 18, 22, 24, 30, 31, 38, 40, 60, 66, 73, 74, 75, 76, 108, 114).

DCS 1 800:

Cell A has:

BCCH ARFCN = 747.

Cell Allocation = (734, 741, 747, 754, 759, 762, 766, 767, 773, 775, 779, 782, 791, 798, 829, 832, 844).

Cell B has:

BCCH ARFCN = 764.

Cell Allocation = (739, 743, 746, 749, 756, 758, 761, 764, 771, 779, 782, 791, 798, 829, 832, 844).

PCS 1900:

Cell A has:

BCCH ARFCN = 647.

Cell Allocation = (634, 641, 647, 654, 659, 662, 666, 667, 673, 675, 679, 682, 691, 698, 729, 732, 744).

Cell B has:

BCCH ARFCN = 664.

Cell Allocation = (639, 643, 646, 649, 656, 658, 661, 664, 671, 679, 682, 691, 698, 729, 732, 744).

Mobile Station:

The MS is in the "idle, updated" state, with a TMSI allocated and camped on cell A. The MS is using a power level P, where P is a power level within the supported range of that type of MS.

Related PICS/PIXIT Statements

Supported rate(s) of TCH: TCH/F.

Support for state MO calls.

Supported speech and data rates.

Type of Mobile Station (GSM 450 or GSM 480 or P-GSM 900 or EGSM or DCS 1 800 or PCS 1900).

Power class of Mobile Station.

Foreseen Final State of the MS

"Idle, updated" with TMSI allocated and camped on cell B.

Test Procedure

This procedure is repeated for execution counter M = 1, 2, 3, 4 (See table 26.6-1.)

A Mobile Originating Call is initiated on cell A. After the MS has sent the SETUP message (and before the last L2 frame carrying the SETUP message is acknowledged by the SS) the SS sends a HANOVER COMMAND message, ordering the MS to switch to cell B. The MS shall then (at the time specified in the Starting Time information element, if included) send 4 access bursts, in successive slots on the new DCCH to cell B. Then the MS shall establish a signalling link indicating the correct timing advance and power level and send a HANOVER COMPLETE message. The MS shall be "ready to transmit" the HANOVER COMPLETE message before "x" ms after the end of the HANOVER COMMAND message, but not before a UA frame has been sent by the SS. The MS shall then again send

the SETUP message to the SS, using the same value in the N(SD) field. Finally the SS sends a CHANNEL RELEASE to end the test.

The term "ready to transmit" is defined in GSM 04.13. The value "x" depends upon the target channel and is specified in the specific message contents section.

Maximum Duration of Test

5 minutes, including 1 minute for any necessary operator actions.

Expected Sequence

This procedure is repeated for execution counter M = 1, 2, 3, 4 (unless a particular TCH is not supported).

Step	Direction	Message	Comments
1	-----	-----	A MO call is initiated.
2	MS -> SS	CHANNEL REQUEST	Establ. Cause = "Originating call, NECI not set to 1"
3	SS -> MS	IMMEDIATE ASSIGNMENT	See Specific Message contents.
4	MS -> SS	CM SERVICE REQUEST	CM Service Type = Mobile Origina- ting Call Establishment.
5	SS -> MS	CIPHERING MODE COMMAND	
6	MS -> SS	CIPHERING MODE COMPLETE	
7	MS -> SS	SETUP	Last L2 frame not acknowledged by the SS.
8	SS -> MS	HANDOVER COMMAND	See Specific Message Contents.
9	MS -> SS	HANDOVER ACCESS	
10	MS -> SS	HANDOVER ACCESS	
11	MS -> SS	HANDOVER ACCESS	See Specific message contents. Four.
12	MS -> SS	HANDOVER ACCESS	Messages are transmitted to cell B in 4 successive slots on the new DCCH. If the HANDOVER COMMAND message includes a starting time IE then the first HANDOVER ACCESS message shall be transmitted in the indicated frame (unless the starting time has elapsed).
13	MS -> SS	SABM	Sent without information field.
14	SS -> MS	UA	
15	MS -> SS	HANDOVER COMPLETE	The message shall be ready to be transmitted before "x" ms after the completion of step 8.
16	SS		The header of the next uplink SACCH is examined and the Timing Advance and Power Level indications are examined. The correct timing advance shall be indicated. A tolerance of +/- 2 bit periods is allowed. The power level indication shall indicate the power level used in the handover command.
17	MS -> SS	SETUP	Same N(SD) as in step 7.
18	SS -> MS	CHANNEL RELEASE	

Specific Message Contents

M = 1:

DCS 1 800:

IMMEDIATE ASSIGNMENT

Information Element	value/remark
As default message contents except: Channel Description - Channel Type - TDMA offset - Timeslot number - Training Sequence Code - Hopping - MAIO - HSN Mobile Allocation	Channel Description. SDCCH/8 As default message contents. Arbitrary value, but not zero. Chosen arbitrarily. RF hopping channel. Chosen arbitrarily from the set (0, 1 to N-1), where N is the number of frequencies encoded in the Mobile Allocation. Chosen arbitrarily from the set. (1,2,..63). Indicates all of the CA of cell A except for the BCCH frequency.

HANDOVER COMMAND

Information Element	value/remark
As default message contents except: Cell Description - Network Colour Code - Base Station Colour Code - BCCH Carrier Number Channel Description - Channel Type - TDMA offset - Timeslot number - Training Sequence Code - Hopping - MAIO - HSN Frequency List after time - Frequency List Handover Reference - Value Power command - Power Level Synchronization Indication - Report Observed Time Difference - Synchronization Indication - Normal Cell Indication Mode of First Channel	1 5 764 SDCCH/8 Chosen arbitrarily. Arbitrary value, but not zero. Chosen arbitrarily. RF hopping channel. Chosen arbitrarily from the set (0, 1 to N-1), where N is the number of frequencies encoded in the Frequency List IE. Zero (this gives cyclic hopping). Use Range 512 to encode the complete CA of Cell B. Chosen arbitrarily from the range (0, 1..255). Arbitrarily chosen, but different to the one already in use and within the range supported by the MS. Shall not be included. "Synchronized". Ignore out of range timing advance. Signalling only

HANDOVER ACCESS

Information Element	value/remark
As default message contents except: Handover Reference - Value	Same as HANDOVER COMMAND

Step 15: x = 1 500 ms.

PCS 1900:**IMMEDIATE ASSIGNMENT**

Information Element	value/remark
As default message contents except: Channel Description - Channel Type - TDMA offset - Timeslot number - Training Sequence Code - Hopping - MAIO - HSN Mobile Allocation	Channel Description. SDCCH/8 As default message contents. Arbitrary value, but not zero. Chosen arbitrarily. RF hopping channel. Chosen arbitrarily from the set (0, 1 to N-1), where N is the number of frequencies encoded in the Mobile Allocation. Chosen arbitrarily from the set. (1,2,..63). Indicates all of the CA of cell A except for the BCCH frequency.

HANDOVER COMMAND

Information Element	value/remark
As default message contents except: Cell Description - Network Colour Code - Base Station Colour Code - BCCH Carrier Number Channel Description - Channel Type - TDMA offset - Timeslot number - Training Sequence Code - Hopping - MAIO - HSN Frequency List after time - Frequency List Handover Reference - Value Power command - Power Level Synchronization Indication - Report Observed Time Difference - Synchronization Indication - Normal Cell Indication Mode of First Channel	1 5 664 SDCCH/8 Chosen arbitrarily. Arbitrary value, but not zero. Chosen arbitrarily. RF hopping channel. Chosen arbitrarily from the set (0, 1 to N-1), where N is the number of frequencies encoded in the Frequency List IE. Zero (this gives cyclic hopping). Use Range 512 to encode the complete CA of Cell B. Chosen arbitrarily from the range (0, 1..255). Arbitrarily chosen, but different to the one already in use and within the range supported by the MS. Shall not be included. "Synchronized". Ignore out of range timing advance. Signalling only

HANDOVER ACCESS

Information Element	value/remark
As default message contents except: Handover Reference - Value	Same as HANDOVER COMMAND

Step 15: x = 1 500 ms.

GSM 450:**IMMEDIATE ASSIGNMENT**

Information Element	value/remark
As default message contents except: Channel Description - Channel Type - TDMA offset - Timeslot number - Training Sequence Code - Hopping - MAIO - HSN Mobile Allocation	Channel Description. SDCCH/8 As default message contents. Arbitrary value, but not zero. Chosen arbitrarily. RF hopping channel. Chosen arbitrarily from the set (0, 1 to N-1), where N is the number of frequencies encoded in the Mobile Allocation. Chosen arbitrarily from the set (1,2,..63). Indicates all of the CA of cell A except for the BCCH frequency.

HANDOVER COMMAND

Information Element	value/remark
As default message contents except: Cell Description - Network Colour Code - Base Station Colour Code - BCCH Carrier Number Channel Description - Channel Type - TDMA offset - Timeslot number - Training Sequence Code - Hopping - MAIO - HSN Frequency List after time - Frequency List Handover Reference - Value Power command - Power Level Synchronization Indication - Report Observed Time Difference - Synchronization Indication - Normal Cell Indication Mode of First Channel	1 5 274 SDCCH/8 Chosen arbitrarily. Arbitrary value, but not zero. Chosen arbitrarily. RF hopping channel. Chosen arbitrarily from the set (0, 1 to N-1), where N is the number of frequencies encoded in the Frequency List IE. Zero (this gives cyclic hopping). Use range 128 to encode the complete CA of Cell B. Chosen arbitrarily from the range (0, 1..255). Arbitrarily chosen, but different to the one already in use and within the range supported by the MS. Shall not be included. "Synchronized". Ignore out of range timing advance. Signalling only.

HANDOVER ACCESS

Information Element	value/remark
As default message contents except: Handover Reference - Value	Same as HANDOVER COMMAND

Step 15: $x = 1\ 500$ ms.

GSM 480:

IMMEDIATE ASSIGNMENT

Information Element	value/remark
As default message contents except: Channel Description - Channel Type - TDMA offset - Timeslot number - Training Sequence Code - Hopping - MAIO - HSN Mobile Allocation	Channel Description. SDCCH/8 As default message contents. Arbitrary value, but not zero. Chosen arbitrarily. RF hopping channel. Chosen arbitrarily from the set (0, 1 to N-1), where N is the number of frequencies encoded in the Mobile Allocation. Chosen arbitrarily from the set (1,2,..63). Indicates all of the CA of cell A except for the BCCH frequency.

HANDOVER COMMAND

Information Element	value/remark
As default message contents except: Cell Description - Network Colour Code - Base Station Colour Code - BCCH Carrier Number Channel Description - Channel Type - TDMA offset - Timeslot number - Training Sequence Code - Hopping - MAIO - HSN Frequency List after time - Frequency List Handover Reference - Value Power command - Power Level Synchronization Indication - Report Observed Time Difference - Synchronization Indication - Normal Cell Indication Mode of First Channel	1 5 321 SDCCH/8 Chosen arbitrarily. Arbitrary value, but not zero. Chosen arbitrarily. RF hopping channel. Chosen arbitrarily from the set (0, 1 to N-1), where N is the number of frequencies encoded in the Frequency List IE. Zero (this gives cyclic hopping). Use range 128 to encode the complete CA of Cell B. Chosen arbitrarily from the range (0, 1..255). Arbitrarily chosen, but different to the one already in use and within the range supported by the MS. Shall not be included. "Synchronized". Ignore out of range timing advance. Signalling only.

HANDOVER ACCESS

Information Element	value/remark
As default message contents except: Handover Reference - Value	Same as HANDOVER COMMAND

Step 15: x = 1 500 ms.

GSM 900:

IMMEDIATE ASSIGNMENT

Information Element	value/remark
As default message contents except: Channel Description - Channel Type - TDMA offset - Timeslot number - Training Sequence Code - Hopping - MAIO - HSN Mobile Allocation	Channel Description. SDCCH/8 As default message contents. Arbitrary value, but not zero. Chosen arbitrarily. RF hopping channel. Chosen arbitrarily from the set (0, 1 to N-1), where N is the number of frequencies encoded in the Mobile Allocation. Chosen arbitrarily from the set (1,2,..63). Indicates all of the CA of cell A except for the BCCH frequency.

HANDOVER COMMAND

Information Element	value/remark
As default message contents except: Cell Description - Network Colour Code - Base Station Colour Code - BCCH Carrier Number Channel Description - Channel Type - TDMA offset - Timeslot number - Training Sequence Code - Hopping - MAIO - HSN Frequency List after time - Frequency List Handover Reference - Value Power command - Power Level Synchronization Indication - Report Observed Time Difference - Synchronization Indication - Normal Cell Indication Mode of First Channel	1 5 40 SDCCH/8 Chosen arbitrarily. Arbitrary value, but not zero. Chosen arbitrarily. RF hopping channel. Chosen arbitrarily from the set (0, 1 to N-1), where N is the number of frequencies encoded in the Frequency List IE. Zero (this gives cyclic hopping). Use Bit Map 0 to encode the complete CA of Cell B. Chosen arbitrarily from the range (0, 1..255). Arbitrarily chosen, but different to the one already in use and within the range supported by the MS. Shall not be included. "Synchronized". Ignore out of range timing advance. Signalling only.

HANDOVER ACCESS

Information Element	value/remark
As default message contents except: Handover Reference - Value	Same as HANDOVER COMMAND

Step 15: x = 1 500 ms.

M = 2:

DCS 1 800:

IMMEDIATE ASSIGNMENT

Information Element	value/remark
As default message contents except: Channel Description - Channel Type - TDMA offset - Timeslot number - Training Sequence Code - Hopping - MAIO - HSN Mobile Allocation	Channel Description. SDCCH/8 As default message contents. zero. Chosen arbitrarily. RF hopping channel. Chosen arbitrarily from the set (0, 1 to N-1), where N is the number of frequencies encoded in the Mobile Allocation. Zero (this gives cyclic hopping). Indicates all of the CA of cell A except for the following 2 frequencies: (747 and 767).

HANDOVER COMMAND

Information Element	value/remark
As default message contents except: Cell Description - Network Colour Code - Base Station Colour Code - BCCH Carrier Number Channel Description - Channel Type - TDMA offset - Timeslot number - Training Sequence Code - Hopping - ARFCN Handover Reference - Value Power command - Power Level Synchronization Indication - Report Observed Time Difference - Synchronization Indication - Normal Cell Indication Starting Time	1 5 764 SDCCH/4 Chosen arbitrarily. zero. same as the BCCH. Single RF Channel. 764 Chosen arbitrarily from the range (0, 1..255). Arbitrarily chosen, but different to the one already in use and within the range supported by the MS. Shall not be included. "Synchronized". Ignore out of range timing advance. Indicates the frame number of cell B that will occur approximately 1,1 seconds after the HANDOVER COMMAND message is sent by cell A.

HANDOVER ACCESS

Information Element	value/remark
As default message contents except: Handover Reference - Value	Same as HANDOVER COMMAND

Step 15: x = 2 600 ms.

PCS 1900:**IMMEDIATE ASSIGNMENT**

Information Element	value/remark
As default message contents except: Channel Description - Channel Type - TDMA offset - Timeslot number - Training Sequence Code - Hopping - MAIO - HSN Mobile Allocation	Channel Description. SDCCH/8 As default message contents. zero. Chosen arbitrarily. RF hopping channel. Chosen arbitrarily from the set (0, 1 to N-1), where N is the number of frequencies encoded in the Mobile Allocation. Zero (this gives cyclic hopping). Indicates all of the CA of cell A except for the following 2 frequencies: (647 and 667).

HANDOVER COMMAND

Information Element	value/remark
As default message contents except: Cell Description - Network Colour Code - Base Station Colour Code - BCCH Carrier Number Channel Description - Channel Type - TDMA offset - Timeslot number - Training Sequence Code - Hopping - ARFCN Handover Reference - Value Power command - Power Level Synchronization Indication - Report Observed Time Difference - Synchronization Indication - Normal Cell Indication Starting Time	1 5 664 SDCCH/4 Chosen arbitrarily. zero. same as the BCCH. Single RF Channel. 664 Chosen arbitrarily from the range (0, 1..255). Arbitrarily chosen, but different to the one already in use and within the range supported by the MS. Shall not be included. "Synchronized". Ignore out of range timing advance. Indicates the frame number of cell B that will occur approximately 1,1 seconds after the HANDOVER COMMAND message is sent by cell A.

HANDOVER ACCESS

Information Element	value/remark
As default message contents except: Handover Reference - Value	Same as HANDOVER COMMAND

Step 15: $x = 2\ 600$ ms.

GSM 450:

IMMEDIATE ASSIGNMENT

Information Element	value/remark
As default message contents except: Channel Description - Channel Type - TDMA offset - Timeslot number - Training Sequence Code - Hopping - MAIO - HSN Mobile Allocation	Channel Description. SDCCH/8 As default message contents. Arbitrary value, but not zero. Chosen arbitrarily. RF hopping channel. Chosen arbitrarily from the set (0, 1 to N-1), where N is the number of frequencies encoded in the Mobile Allocation. Zero (this gives cyclic hopping). Indicates all of the CA of cell A except for the following 2 frequencies: (263 and 275).

HANDOVER COMMAND

Information Element	value/remark
As default message contents except: Cell Description - Network Colour Code - Base Station Colour Code - BCCH Carrier Number Channel Description - Channel Type - TDMA offset - Timeslot number - Training Sequence Code - Hopping - ARFCN Handover Reference - Value Power command - Power Level Synchronization Indication - Report Observed Time Difference - Synchronization Indication - Normal Cell Indication Starting Time	1 5 274 SDCCH/4 Chosen arbitrarily. zero. same as the BCCH. Single RF Channel. 274 Chosen arbitrarily from the range (0, 1..255). Arbitrarily chosen, but different to the one already in use and within the range supported by the MS. Shall not be included. "Synchronized". Ignore out of range timing advance. Indicates the frame number of cell B that will occur approximately 1,1 seconds after the HANDOVER COMMAND message is sent by cell A.

HANDOVER ACCESS

Information Element	value/remark
As default message contents except: Handover Reference - Value	Same as HANDOVER COMMAND

Step 15: $x = 2\ 600$ ms.

GSM 480:

IMMEDIATE ASSIGNMENT

Information Element	value/remark
As default message contents except: Channel Description - Channel Type - TDMA offset - Timeslot number - Training Sequence Code - Hopping - MAIO - HSN Mobile Allocation	Channel Description. SDCCH/8 As default message contents. Arbitrary value, but not zero. Chosen arbitrarily. RF hopping channel. Chosen arbitrarily from the set (0, 1 to N-1), where N is the number of frequencies encoded in the Mobile Allocation. Zero (this gives cyclic hopping). Indicates all of the CA of cell A except for the following 2 frequencies: (310 and 322).

HANDOVER COMMAND

Information Element	value/remark
As default message contents except: Cell Description - Network Colour Code - Base Station Colour Code - BCCH Carrier Number Channel Description - Channel Type - TDMA offset - Timeslot number - Training Sequence Code - Hopping - ARFCN Handover Reference - Value Power command - Power Level Synchronization Indication - Report Observed Time Difference - Synchronization Indication - Normal Cell Indication Starting Time	1 5 321 SDCCH/4 Chosen arbitrarily. zero. same as the BCCH. Single RF Channel. 321 Chosen arbitrarily from the range (0, 1..255). Arbitrarily chosen, but different to the one already in use and within the range supported by the MS. Shall not be included. "Synchronized". Ignore out of range timing advance. Indicates the frame number of cell B that will occur approximately 1,1 seconds after the HANDOVER COMMAND message is sent by cell A.

HANDOVER ACCESS

Information Element	value/remark
As default message contents except: Handover Reference - Value	Same as HANDOVER COMMAND

Step 15: x = 2 600 ms.

GSM 900:

IMMEDIATE ASSIGNMENT

Information Element	value/remark
As default message contents except: Channel Description - Channel Type - TDMA offset - Timeslot number - Training Sequence Code - Hopping - MAIO - HSN Mobile Allocation	Channel Description. SDCCH/8 As default message contents. Arbitrary value, but not zero. Chosen arbitrarily. RF hopping channel. Chosen arbitrarily from the set (0, 1 to N-1), where N is the number of frequencies encoded in the Mobile Allocation. Zero (this gives cyclic hopping). Indicates all of the CA of cell A except for the following 2 frequencies: (20 and 52).

HANDOVER COMMAND

Information Element	value/remark
As default message contents except: Cell Description - Network Colour Code - Base Station Colour Code - BCCH Carrier Number Channel Description - Channel Type - TDMA offset - Timeslot number - Training Sequence Code - Hopping - ARFCN Handover Reference - Value Power command - Power Level Synchronization Indication - Report Observed Time Difference - Synchronization Indication - Normal Cell Indication Starting Time	1 5 40 SDCCH/4 Chosen arbitrarily. zero. same as the BCCH. Single RF Channel. 40 Chosen arbitrarily from the range (0, 1..255). Arbitrarily chosen, but different to the one already in use and within the range supported by the MS. Shall not be included. "Synchronized". Ignore out of range timing advance. Indicates the frame number of cell B that will occur approximately 1,1 seconds after the HANDOVER COMMAND message is sent by cell A.

HANDOVER ACCESS

Information Element	value/remark
As default message contents except: Handover Reference - Value	Same as HANDOVER COMMAND

Step 15: x = 2 600 ms.

M = 3:

DCS 1 800:

IMMEDIATE ASSIGNMENT

Information Element	value/remark
As default message contents except: Channel Description - Channel Type - Timeslot number - Training Sequence Code - Hopping - ARFCN	Channel Description. TCH/F + ACCHs Arbitrary value, but not zero. Chosen arbitrarily. Single RF Channel. 747

HANDOVER COMMAND

Information Element	value/remark
As default message contents except: Cell Description - Network Colour Code - Base Station Colour Code - BCCH Carrier Number Channel Description - Channel Type - Timeslot number - Training Sequence Code - Hopping - MAIO - HSN Frequency Short List after time - Frequency Short List Handover Reference - Value Power command - Power Level Synchronization Indication - Report Observed Time Difference - Synchronization Indication - Normal Cell Indication	1 5 764 TCH/F + ACCHs zero Chosen arbitrarily. RF hopping channel. Chosen arbitrarily from the set (0, 1 to N-1), where N is the number of frequencies encoded in the Frequency Short list IE. Chosen arbitrarily from the set (1,2,..63). Use Range 128 to encode the following 3 frequencies: (758, 761, 771). Chosen arbitrarily from the range (0, 1..255). Arbitrarily chosen, but different to the one already in use and within the range supported by the MS. Shall not be included. "Synchronized". Ignore out of range timing advance.

HANDOVER ACCESS

Information Element	value/remark
As default message contents except: Handover Reference - Value	Same as HANDOVER COMMAND

Step 15: x = 650 ms.

PCS 1900:**IMMEDIATE ASSIGNMENT**

Information Element	value/remark
As default message contents except: Channel Description - Channel Type - Timeslot number - Training Sequence Code - Hopping - ARFCN	Channel Description. TCH/F + ACCHs Arbitrary value, but not zero. Chosen arbitrarily. Single RF Channel. 647

HANDOVER COMMAND

Information Element	value/remark
As default message contents except: Cell Description - Network Colour Code - Base Station Colour Code - BCCH Carrier Number Channel Description - Channel Type - Timeslot number - Training Sequence Code - Hopping - MAIO - HSN Frequency Short List after time - Frequency Short List Handover Reference - Value Power command - Power Level Synchronization Indication - Report Observed Time Difference - Synchronization Indication - Normal Cell Indication	1 5 664 TCH/F + ACCHs zero Chosen arbitrarily. RF hopping channel. Chosen arbitrarily from the set (0, 1 to N-1), where N is the number of frequencies encoded in the Frequency Short list IE. Chosen arbitrarily from the set (1,2,..63). Use Range 128 to encode the following 3 frequencies: (658, 661, 671). Chosen arbitrarily from the range (0, 1..255). Arbitrarily chosen, but different to the one already in use and within the range supported by the MS. Shall not be included. "Synchronized". Ignore out of range timing advance.

HANDOVER ACCESS

Information Element	value/remark
As default message contents except: Handover Reference - Value	Same as HANDOVER COMMAND

Step 15: x = 650 ms.

GSM 450:

IMMEDIATE ASSIGNMENT

Information Element	value/remark
As default message contents except: Channel Description - Channel Type - Timeslot number - Training Sequence Code - Hopping - ARFCN	Channel Description. TCH/F + ACCHs Arbitrary value, but not zero. Chosen arbitrarily. Single RF Channel. 263

HANDOVER COMMAND

Information Element	value/remark
As default message contents except: Cell Description - Network Colour Code - Base Station Colour Code - BCCH Carrier Number Channel Description - Channel Type - Timeslot number - Training Sequence Code - Hopping - MAIO - HSN Frequency List after time - Frequency List Handover Reference - Value Power command - Power Level Synchronization Indication - Report Observed Time Difference - Synchronization Indication - Normal Cell Indication	1 5 274 TCH/F + ACCHs zero. Chosen arbitrarily. RF hopping channel. Chosen arbitrarily from the set (0, 1 to N-1), where N is the number of frequencies encoded in the Frequency List IE. Chosen arbitrarily from the set (1,2,..63). Indicates (279, 285, 287, 289). Chosen arbitrarily from the range (0, 1..255). Arbitrarily chosen, but different to the one already in use and within the range supported by the MS. Shall not be included. "Synchronized". Ignore out of range timing advance.

HANDOVER ACCESS

Information Element	value/remark
As default message contents except: Handover Reference - Value	Same as HANDOVER COMMAND

Step 15: x = 650 ms.

GSM 480:**IMMEDIATE ASSIGNMENT**

Information Element	value/remark
As default message contents except: Channel Description - Channel Type - Timeslot number - Training Sequence Code - Hopping - ARFCN	Channel Description. TCH/F + ACCHs Arbitrary value, but not zero. Chosen arbitrarily. Single RF Channel. 310

HANDOVER COMMAND

Information Element	value/remark
As default message contents except: Cell Description - Network Colour Code - Base Station Colour Code - BCCH Carrier Number Channel Description - Channel Type - Timeslot number - Training Sequence Code - Hopping - MAIO - HSN Frequency List after time - Frequency List Handover Reference - Value Power command - Power Level Synchronization Indication - Report Observed Time Difference - Synchronization Indication - Normal Cell Indication	1 5 321 TCH/F + ACCHs zero. Chosen arbitrarily. RF hopping channel. Chosen arbitrarily from the set (0, 1 to N-1), where N is the number of frequencies encoded in the Frequency List IE. Chosen arbitrarily from the set (1,2,..63). Indicates (326, 332, 334, 336). Chosen arbitrarily from the range (0, 1..255). Arbitrarily chosen, but different to the one already in use and within the range supported by the MS. Shall not be included. "Synchronized". Ignore out of range timing advance.

HANDOVER ACCESS

Information Element	value/remark
As default message contents except: Handover Reference - Value	Same as HANDOVER COMMAND

Step 15: x = 650 ms.

GSM 900:**IMMEDIATE ASSIGNMENT**

Information Element	value/remark
As default message contents except: Channel Description - Channel Type - Timeslot number - Training Sequence Code - Hopping - ARFCN	Channel Description. TCH/F + ACCHs Arbitrary value, but not zero. Chosen arbitrarily. Single RF Channel. 20

HANDOVER COMMAND

Information Element	value/remark
As default message contents except: Cell Description - Network Colour Code - Base Station Colour Code - BCCH Carrier Number Channel Description - Channel Type - Timeslot number - Training Sequence Code - Hopping - MAIO - HSN Frequency Channel Sequence after time - Frequency Channel Sequence Handover Reference - Value Power command - Power Level Synchronization Indication - Report Observed Time Difference - Synchronization Indication - Normal Cell Indication	1 5 40 TCH/F + ACCHs zero. Chosen arbitrarily. RF hopping channel. Chosen arbitrarily from the set (0, 1 to N-1), where N is the number of frequencies encoded in the Frequency Channel Sequence IE. Chosen arbitrarily from the set (1,2,..63). Indicates (66, 75, 76, 108). Chosen arbitrarily from the range (0, 1..255). Arbitrarily chosen, but different to the one already in use and within the range supported by the MS. Shall not be included. "Synchronized". Ignore out of range timing advance.

HANDOVER ACCESS

Information Element	value/remark
As default message contents except: Handover Reference - Value	Same as HANDOVER COMMAND

Step 15: x = 650 ms.

M = 4:

DCS 1 800:

IMMEDIATE ASSIGNMENT

Information Element	value/remark
As default message contents except: Channel Description - Channel Type - TDMA offset - Timeslot number - Training Sequence Code - Hopping - ARFCN	Channel Description. SDCCH/8 As default message contents. As default message contents. Chosen arbitrarily. Single RF Channel. Chosen arbitrarily from the Cell Allocation of Cell A.

HANDOVER COMMAND

Information Element	value/remark
As default message contents except: Cell Description - Network Colour Code - Base Station Colour Code - BCCH Carrier Number Channel Description - Channel Type - Timeslot number - Training Sequence Code - Hopping - ARFCN Handover Reference - Value Power command - Power Level Synchronization Indication - Report Observed Time Difference - Synchronization Indication - Normal Cell Indication Channel Mode	1 5 764 TCH/F + ACCHs Arbitrary value, but not zero. Chosen arbitrarily. Single RF Channel. Chosen arbitrarily from the Cell Allocation of Cell B. Chosen arbitrarily from the range (0, 1..255). Arbitrarily chosen, but different to the one already in use and within the range supported by the MS. Shall not be included. "Synchronized". Ignore out of range timing advance. If speech is supported: Speech (full rate version 1 or half rate version 1). If speech is not supported: arbitrary from those supported (12, 6, 3,6 kbps).

HANDOVER ACCESS

Information Element	value/remark
As default message contents except: Handover Reference - Value	Same as HANDOVER COMMAND

Step 15: x = 650 ms.

PCS 1900:**IMMEDIATE ASSIGNMENT**

Information Element	value/remark
As default message contents except: Channel Description - Channel Type - TDMA offset - Timeslot number - Training Sequence Code - Hopping - ARFCN	Channel Description. SDCCH/8 As default message contents. As default message contents. Chosen arbitrarily. Single RF Channel. Chosen arbitrarily from the Cell Allocation of Cell A.

HANDOVER COMMAND

Information Element	value/remark
As default message contents except: Cell Description - Network Colour Code - Base Station Colour Code - BCCH Carrier Number Channel Description - Channel Type - Timeslot number - Training Sequence Code - Hopping - ARFCN Handover Reference - Value Power command - Power Level Synchronization Indication - Report Observed Time Difference - Synchronization Indication - Normal Cell Indication Channel Mode	1 5 664 TCH/F + ACCHs Arbitrary value, but not zero. Chosen arbitrarily. Single RF Channel. Chosen arbitrarily from the Cell Allocation of Cell B. Chosen arbitrarily from the range (0, 1..255). Arbitrarily chosen, but different to the one already in use and within the range supported by the MS. Shall not be included. "Synchronized". Ignore out of range timing advance. If speech is supported: Speech (full rate version 1 or half rate version 1). If speech is not supported: arbitrary from those supported (12, 6, 3,6 kbps).

HANDOVER ACCESS

Information Element	value/remark
As default message contents except: Handover Reference - Value	Same as HANDOVER COMMAND

Step 15: x = 650 ms.

GSM 450:**IMMEDIATE ASSIGNMENT**

Information Element	value/remark
As default message contents except: Channel Description - Channel Type - TDMA offset - Timeslot number - Training Sequence Code - Hopping - ARFCN	Channel Description. SDCCH/8 As default message contents. As default message contents. Chosen arbitrarily. Single RF Channel. Chosen arbitrarily from the Cell Allocation of Cell A.

HANDOVER COMMAND

Information Element	value/remark
As default message contents except: Cell Description - Network Colour Code - Base Station Colour Code - BCCH Carrier Number Channel Description - Channel Type - Timeslot number - Training Sequence Code - Hopping - ARFCN Handover Reference - Value Power command - Power Level Synchronization Indication - Report Observed Time Difference - Synchronization Indication - Normal Cell Indication Channel Mode	1 5 274 TCH/F + ACCHs Arbitrary value, but not zero. Chosen arbitrarily. Single RF Channel. Chosen arbitrarily from the Cell Allocation of Cell B. Chosen arbitrarily from the range (0, 1..255). Arbitrarily chosen, but different to the one already in use and within the range supported by the MS. Shall not be included. "Synchronized". Ignore out of range timing advance. If speech is supported: Speech (full rate version 1 or half rate version 1). If speech is not supported: arbitrary from those supported (12, 6, 3,6 kbps).

HANDOVER ACCESS

Information Element	value/remark
As default message contents except: Handover Reference - Value	Same as HANDOVER COMMAND

Step 15: x = 650 ms.

GSM 480:**IMMEDIATE ASSIGNMENT**

Information Element	value/remark
As default message contents except: Channel Description - Channel Type - TDMA offset - Timeslot number - Training Sequence Code - Hopping - ARFCN	Channel Description. SDCCH/8 As default message contents. As default message contents. Chosen arbitrarily. Single RF Channel. Chosen arbitrarily from the Cell Allocation of Cell A.

HANDOVER COMMAND

Information Element	value/remark
As default message contents except: Cell Description - Network Colour Code - Base Station Colour Code - BCCH Carrier Number Channel Description - Channel Type - Timeslot number - Training Sequence Code - Hopping - ARFCN Handover Reference - Value Power command - Power Level Synchronization Indication - Report Observed Time Difference - Synchronization Indication - Normal Cell Indication Channel Mode	1 5 321 TCH/F + ACCHs Arbitrary value, but not zero. Chosen arbitrarily. Single RF Channel. Chosen arbitrarily from the Cell Allocation of Cell B. Chosen arbitrarily from the range (0, 1..255). Arbitrarily chosen, but different to the one already in use and within the range supported by the MS. Shall not be included. "Synchronized". Ignore out of range timing advance. If speech is supported: Speech (full rate version 1 or half rate version 1). If speech is not supported: arbitrary from those supported (12, 6, 3,6 kbps).

HANDOVER ACCESS

Information Element	value/remark
As default message contents except: Handover Reference - Value	Same as HANDOVER COMMAND

Step 15: x = 650 ms.

GSM 900:**IMMEDIATE ASSIGNMENT**

Information Element	value/remark
As default message contents except: Channel Description - Channel Type - TDMA offset - Timeslot number - Training Sequence Code - Hopping - ARFCN	Channel Description. SDCCH/8 As default message contents. As default message contents. Chosen arbitrarily. Single RF Channel. Chosen arbitrarily from the Cell Allocation of Cell A.

HANDOVER COMMAND

Information Element	value/remark
As default message contents except: Cell Description - Network Colour Code - Base Station Colour Code - BCCH Carrier Number Channel Description - Channel Type - Timeslot number - Training Sequence Code - Hopping - ARFCN Handover Reference - Value Power command - Power Level Synchronization Indication - Report Observed Time Difference - Synchronization Indication - Normal Cell Indication Channel Mode	1 5 40 TCH/F + ACCHs Arbitrary value, but not zero. Chosen arbitrarily. Single RF Channel. Chosen arbitrarily from the Cell Allocation of Cell B. Chosen arbitrarily from the range (0, 1..255). Arbitrarily chosen, but different to the one already in use and within the range supported by the MS. Shall not be included. "Synchronized". Ignore out of range timing advance. If speech is supported: Speech (full rate version 1 or half rate version 1). If speech is not supported: arbitrary from those supported (12, 6, 3,6 kbps).

HANDOVER ACCESS

Information Element	value/remark
As default message contents except: Handover Reference - Value	Same as HANDOVER COMMAND

Step 15: $x = 650$ ms.

26.6.5.5 Pre-synchronized handovers**26.6.5.5.1 Handover / successful / active call / pre-synchronized / Timing Advance IE not included**

If an MS does not implement the pre-synchronized handover procedure correctly then calls may fail.

26.6.5.5.1.1 Conformance requirements

- 1 The MS shall correctly apply the handover procedure from TCH/F without frequency hopping to TCH/F without frequency hopping in the pre-synchronized case when a call is active.
- 2 When the Timing Advance information element is not included in the HANDOVER COMMAND, the MS shall access the new cell with the default timing advance of 1 bit period.
- 3 The MS shall be ready to transmit the HANDOVER COMPLETE message within 650 ms of the end of the HANDOVER COMMAND message.

References

Conformance requirement 1: GSM 04.08 section 3.4.4.

Conformance requirement 2: GSM 05.10, section 6.6.

Conformance requirement 3: GSM 04.13, section 5.2.6.1.

26.6.5.5.1.2 Test purpose

To verify that when the MS is ordered to make a pre-synchronized handover to another cell, it sends 4 access bursts on the main DCCH and then activates the channel correctly and correctly calculates the time to transmit.

26.6.5.5.1.3 Method of test

Initial Conditions

System Simulator:

2 cells, A and B, with same LAI, default parameters.

The BCCH of cell A is sent k bit periods before the BCCH of cell B. k is arbitrarily selected.

Mobile Station:

The MS is in the active state (U10) of a call (on cell A) using a full rate TCH in non-hopping mode.

Related PICS/PIXIT Statements

Supported rate(s) of TCH: TCH/F.

Support for state U10 of the Call Control protocol.

Type of MS (GSM 450 or GSM 480 or P-GSM 900 or EGSM or DCS 1 800 or PCS 1900).

Foreseen Final State of the MS

The active state (U10) of a mobile call (on cell B) using a full rate TCH in non-hopping mode.

Test Procedure

The MS is in the active state (U10) of a call on cell A. The SS sends a HANDOVER COMMAND for a pre-synchronized handover without the Timing Advance IE on the main DCCH. The MS shall send 4 access bursts, at the commanded power level, in 4 successive slots of the new DCCH to cell B with a Timing Advance of zero. Then the MS shall establish a signalling link using a Timing Advance of one and send a HANDOVER COMPLETE message. The MS shall be ready to transmit the HANDOVER COMPLETE message before 650 ms after the end of the HANDOVER COMMAND message, but not before a UA frame has been sent by the SS.

The term "ready to transmit" is defined in GSM 04.13.

Maximum Duration of Test

5 seconds.

Expected Sequence

Step	Direction	Message	Comments
1	SS -> MS	HANDOVER COMMAND	See specific message contents below. Handover Reference as included in the HANDOVER COMMAND.
2	MS -> SS	HANDOVER ACCESS	
3	MS -> SS	HANDOVER ACCESS	
4	MS -> SS	HANDOVER ACCESS	
5	MS -> SS	HANDOVER ACCESS	
6	MS -> SS	SABM	Sent without information field.
7	SS -> MS	UA	This message shall be ready to be transmitted before 650 ms after the completion of step 1. The SS checks that the timing advance reported in the layer 1 header of the SACCH message that is sent in the first SACCH multiframe following the SABM is 1 bit period.
8	MS -> SS	HANDOVER COMPLETE	
9	SS	-	

Specific Message Contents

HANDOVER COMMAND

As default message contents, except: Synchronization Indication	pre-synchronized; ROT=0; NCI=0.
--	---------------------------------

26.6.5.5.2 Handover / successful / call being established / pre-synchronized / timing advance IE is included / reporting of observed time difference requested

This test is applicable to all MS which support at least one MO circuit switched basic service.

If an MS does not implement the pre-synchronized handover procedure correctly then calls may fail.

If an MS does not report the observed time difference between cells correctly then pseudo synchronized handovers might not be possible for any MS.

26.6.5.5.2.1 Conformance requirements

- 1 The MS shall correctly apply the handover procedure from an SDCCH/4 to a TCH/F without frequency hopping in the pre-synchronized case while a call is being established.
- 2 If during call establishment a Layer 3 MM or CC message just sent by the MS is not Layer 2 acknowledged before the channel change caused by the HANDOVER COMMAND message, the MS shall send the Layer 3 message to the new cell, using the same value in the N(SD) field, after the handover procedure.
- 3 When the Timing Advance information element is included in the HANDOVER COMMAND, the MS shall access the new cell with the timing advance included in the Timing Advance IE.
- 4 The MS shall be ready to transmit the HANDOVER COMPLETE message within 650 ms of the end of the HANDOVER COMMAND message.
- 5 When requested to do so in the HANDOVER COMMAND message, the MS shall return the Mobile Time Difference IE in the HANDOVER COMPLETE message indicating the sum of the observed time difference between the cells and the timing advance used on the old cell.

References

- Conformance requirement 1: GSM 04.08, section 3.4.4.
- Conformance requirement 2: GSM 04.08, section 3.1.4.3.
- Conformance requirement 3: GSM 05.10, section 6.6.
- Conformance requirement 4: GSM 04.13, section 5.2.6.1.
- Conformance requirement 5: GSM 04.08, section 10.5.2.39.

26.6.5.5.2.2 Test purpose

To test that when the MS is ordered to make a pre-synchronized handover to another cell, it sends 4 access bursts on the main DCCH and then activates the channel correctly and correctly calculates the time to transmit. To test that the MS correctly retransmits Layer 3 MM or CC messages that were not acknowledged by Layer 2 before the Handover, after completion of the Handover. To test that the MS correctly reports on the time difference between the cells.

26.6.5.5.2.3 Method of test

Initial Conditions

System Simulator:

2 cells, A and B, with same LAI, default parameters.

The BCCH of cell A is sent k bit periods before the BCCH of cell B.

Mobile Station:

The MS is in the "idle, updated" state, with a TMSI allocated and camped on cell A.

Related PICS/PIXIT Statements

Supported rate(s) of TCH: TCH/F.

Support for state MO calls.

Type of MS (GSM 450 or GSM 480 or P-GSM 900 or EGSM or DCS 1 800 or PCS 1900).

Foreseen Final State of the MS

"Idle, updated" with TMSI allocated and camped on cell B.

Test Procedure

A Mobile Originating Call is initiated. The SS sends an IMMEDIATE ASSIGNMENT message allocating an SDCCH/4. The MS is commanded to use a timing advance of y bit periods on cell A. After the MS has sent the SETUP message (and before the last L2 frame carrying the SETUP message is acknowledged by the SS) the SS sends a HANDOVER COMMAND, ordering the MS to switch to cell B. The MS shall then send 4 access bursts, at the commanded power level, in 4 successive slots of the new DCCH to cell B. Then the MS shall establish a signalling link using the correct timing advance and send a HANDOVER COMPLETE message. The MS shall be ready to transmit the HANDOVER COMPLETE message before 650 ms after the end of the HANDOVER COMMAND message, but not before a UA frame has been sent by the SS.

The term "ready to transmit" is defined in GSM 04.13.

The MS shall then again send the SETUP message to the SS, using the same value in the N(SD) field. Finally the SS sends a CHANNEL RELEASE to end the test.

Maximum Duration of Test

20 seconds.

Expected Sequence

Step	Direction	Message	Comments
1	-----	-----	A MO call is initiated.
2	MS -> SS	CHANNEL REQUEST	
3	SS -> MS	IMMEDIATE ASSIGNMENT	to an SDCCH/4.
4	MS -> SS	CM SERVICE REQUEST	
5	SS -> MS	CIPHERING MODE COMMAND	
6	MS -> SS	CIPHERING MODE COMPLETE	
7	MS -> SS	SETUP	Last L2 frame not acknowledged by the SS.
8	SS -> MS	HANDOVER COMMAND	See specific message contents below.
9	MS -> SS	HANDOVER ACCESS	Handover Reference as included in the
10	MS -> SS	HANDOVER ACCESS	HANDOVER COMMAND
11	MS -> SS	HANDOVER ACCESS	
12	MS -> SS	HANDOVER ACCESS	
13	MS -> SS	SABM	Sent without information field.
14	SS -> MS	UA	
15	MS -> SS	HANDOVER COMPLETE	This message shall be ready to be transmitted before 650 ms after the completion of step 8. Shall include the Mobile Time Difference IE with value $(2k+y) \bmod 2,097,152$ half bit periods. A tolerance of ± 2 half bit periods is allowed.
16	MS -> SS	SETUP	Same N(SD) as in step 7
17	SS	-	The SS checks that the timing advance reported in the layer 1 header of the SACCH message that is sent in the first SACCH multiframe following the SABM is 9 bit periods. A tolerance of ± 2 bit periods is allowed.
18	SS -> MS	CHANNEL RELEASE	

Specific Message Contents

HANDOVER COMMAND

As default message contents, except: Synchronization Indication Timing Advance	pre-synchronized; ROT=1; NCI=0. 9 bit periods.
--	---

26.6.5.6 Handover / successful / active call / pseudo synchronized

This test only applies to MSs that claim to support the pseudo synchronized handover procedure. If MSs that claim to support this procedure do not correctly implement it, then calls may fail.

26.6.5.6.1 Conformance requirements

- 1 The MS shall correctly apply the handover procedure from TCH/F without frequency hopping to TCH/F without frequency hopping in the pseudo synchronized case when a call is in progress.
- 2 The MS shall access the new cell with the correct timing advance.
- 3 The MS shall be ready to transmit the HANDOVER COMPLETE message within 650 ms of the end of the HANDOVER COMMAND message.
- 4 When requested to do so in the HANDOVER COMMAND message, the MS shall return the Mobile Time Difference IE in the HANDOVER COMPLETE message indicating the sum of the observed time difference between the cells and the timing advance used on the old cell.

References

Conformance requirement 1: GSM 04.08 section 3.4.4.

Conformance requirement 2: GSM 05.10, section 6.6.

Conformance requirement 3: GSM 04.13, section 5.2.6.1.

Conformance requirement 4: GSM 04.08, section 10.5.2.39.

26.6.5.6.2 Test purpose

To test that when the MS is ordered to make a pseudo synchronized handover to another cell, it sends 4 access bursts on the main DCCH and then activates the channel correctly and correctly calculates the time to transmit. To test that the MS correctly reports the time difference between the cells.

26.6.5.6.3 Method of test

Initial Conditions

System Simulator:

2 cells, A and B, with same LAI, default parameters.

The BCCH of cell A is sent k bit periods before the BCCH of cell B. k is arbitrarily selected.

The MS is being commanded to use a timing advance of y bit periods on cell A, where y is arbitrarily selected from the set $\{11, 12, \dots, 62\}$.

Mobile Station:

The MS is in the active state (U10) of a call (on cell A) using a full rate TCH in non-hopping mode.

Related PICS/PIXIT Statements

Supported rate(s) of TCH: TCH/F.

Support for state U10 of the Call Control protocol.

Support for pseudo synchronization.

Type of MS (GSM 450 or GSM 480 or P-GSM 900 or EGSM or DCS 1 800 or PCS 1900).

Foreseen Final State of the MS

The active state (U10) of a mobile call (on cell B) using a full rate TCH in non-hopping mode.

Test Procedure

The MS is in the active state (U10) of a call on cell A. The SS sends a HANOVER COMMAND for a pseudo-synchronized handover with the Real Time Difference IE included. The Time Difference value is set to $(2k+10)$ modulo 256. The MS shall send 4 access bursts, at the commanded power level, in 4 successive slots of the new DCCH to cell B with a Timing Advance of zero. Then the MS shall establish a signalling link using a Timing Advance of $(y-10)$ bit periods and send a HANOVER COMPLETE message. The MS shall be ready to transmit the HANOVER COMPLETE message before 650 ms after the end of the HANOVER COMMAND message, but not before a UA frame has been sent by the SS.

The term "ready to transmit" is defined in GSM 04.13.

Maximum Duration of Test

5 seconds.

Expected Sequence

Step	Direction	Message	Comments
1	SS -> MS	HANDOVER COMMAND	See specific message contents below. Handover Reference as included in the HANDOVER COMMAND. Sent without information field.
2	MS -> SS	HANDOVER ACCESS	
3	MS -> SS	HANDOVER ACCESS	
4	MS -> SS	HANDOVER ACCESS	
5	MS -> SS	HANDOVER ACCESS	
6	MS -> SS	SABM	
7	SS -> MS	UA	
8	MS -> SS	HANDOVER COMPLETE	
9	SS	-	This message shall be ready to be transmitted before 650 ms after the completion of step 1. Shall include the Mobile Time Difference IE with value $(2k+y) \bmod 2,097,152$ half bit periods. A tolerance of ± 2 half bit periods is allowed. The SS checks that the timing advance reported in the layer 1 header of the SACCH message that is sent in the first SACCH multiframe following the SABM is $(y-10)$ bit periods. A tolerance of ± 2 bit periods is allowed.

Specific Message Contents

HANDOVER COMMAND

As default message contents, except: Synchronization Indication Time Difference	pseudo-synchronized; ROT=1; NCI=0. $(2k+10) \bmod 256$.
---	---

26.6.5.7 Handover / successful / active call / non-synchronized / reporting of observed time difference requested

If an MS does not report the observed time difference between cells correctly then pseudo synchronized handovers might not be possible for any MS.

26.6.5.7.1 Conformance requirements

- 1 The MS shall correctly apply the handover procedure from a TCH/F without frequency hopping to a TCH/F without frequency hopping in the non-synchronized case while a call is active.
- 2 When requested to do so in the HANDOVER COMMAND message, the MS shall return the Mobile Time Difference IE in the HANDOVER COMPLETE message indicating the sum of the observed time difference between the cells and the timing advance used on the old cell.

References

Conformance requirement 1: GSM 04.08, section 3.4.4.

Conformance requirement 2: GSM 04.08, section 10.5.2.39.

26.6.5.7.2 Test purpose

To verify that when the MS is ordered to make a non-synchronized handover to another cell and is ordered to report on the time difference between the cells, that it does so correctly.

26.6.5.7.3 Method of test

Initial Conditions

System Simulator:

2 cells, A and B with default parameters except the LAI of cell B has MNC = 02 (PCS 1900: MNC = 021) decimal,
MCC = 315 decimal, and LAC = 5344 H.

The BCCH of cell A is sent k bit periods before the BCCH of cell B.

The MS is commanded to use a timing advance of y bit periods on cell A.

Mobile Station:

The MS is in the active state (U10) of a call (on cell A) using a full rate TCH in non-hopping mode.

Related PICS/PIXIT Statements

Supported rate(s) of TCH: TCH/F.

Support for state U10 of the Call Control protocol.

Type of MS (GSM 450 or GSM 480 or P-GSM 900 or EGSM or DCS 1 800 or PCS 1900).

Foreseen Final State of the MS

The active state (U10) of a mobile call (on cell B) using a full rate TCH in non-hopping mode.

Test Procedure

The MS is in the active state (U10) of a call on cell A. The SS sends a HANOVER COMMAND on the main DCCH. The HANOVER COMMAND includes a Synchronization Indication IE that instructs the MS to supply the observed time difference between the cells. The MS shall begin to send access bursts on the new DCCH to cell B and the SS sends one PHYSICAL INFORMATION message. The MS shall activate the channel in sending and receiving mode and establish a signalling link using the correct timing advance. The MS shall transmit a HANOVER COMPLETE message containing the Mobile Time Difference IE with a correct value.

Maximum Duration of Test

5 seconds.

Expected Sequence

Step	Direction	Message	Comments
1	SS -> MS	HANOVER COMMAND	See specific message contents below.
2	MS -> SS	HANOVER ACCESS	Repeated on every burst of the uplink main DCCH until reception of PHYSICAL INFORMATION. Handover Reference as included in the HANOVER COMMAND.
3	SS -> MS	PHYSICAL INFORMATION	
4	MS -> SS	SABM	Sent without information field.
5	SS -> MS	UA	
6	MS -> SS	HANOVER COMPLETE	Shall include the Mobile Time Difference IE with value $(2k+y) \bmod 2,097,152$ half bit periods. A tolerance of ± 2 half bit periods is allowed.

Specific Message Contents

HANDOVER COMMAND

as default message contents, except: Synchronization Indication	"not synchronized"; ROT=1; NCI=0.
--	-----------------------------------

26.6.5.8 Handover / layer 3 failure

26.6.5.8.1 Conformance requirements

The MS shall return to the old channel in the case of an handover failure caused by the non reception of the PHYSICAL INFORMATION message. On the old channel the MS shall use the Power Level that it was previously using on that channel.

References

GSM 04.08 section 3.4.4.

26.6.5.8.2 Test purpose

To verify the function of timer T3124 and the contents in the message HANDOVER FAILURE and in the layer 1 header on the SACCH.

26.6.5.8.3 Method of test

Initial Conditions

System Simulator:

2 cells with same LAI, default parameters.

Mobile Station:

The MS is in the active state (U10) of a call (on cell A). Used power level is the maximum supported by the MS.

Related PICS/PIXIT Statements

Supported rate(s) of TCH: TCH/F.

Support for state U10 of the Call Control protocol.

Type of MS (GSM 450 or GSM 480 or P-GSM 900 or EGSM or DCS 1 800 or PCS 1900).

Foreseen Final State of the MS

The active state (U10) of a mobile call (on cell A). Used power level is the maximum supported by the MS.

Test Procedure

The MS is in the active state (U10) of a call on cell A. The SS sends a HANDOVER COMMAND with Power Command set to 8 on the main DCCH. The MS shall begin to send access bursts at the commanded power level on the new DCCH to cell B. The SS activates the SACCH, but does not send PHYSICAL INFORMATION (thus causing a time-out of T3124). The MS shall re-establish the old link on cell A and send a HANDOVER FAILURE within 3 seconds from the transmission of HANDOVER COMMAND, using the old power level.

Maximum Duration of Test

5 minutes, including 1 minute for any necessary operator actions.

Expected Sequence

Step	Direction	Message	Comments
0	SS	-	The SS records the power level in the layer 1 header of the last SACCH message sent by the MS before step 1.
1	SS -> MS	HANDOVER COMMAND	Channel description: non-hopping, full rate Power Command: 8. Synchronization Indication: non synchronized.
2	MS -> SS	HANDOVER ACCESS	Several messages are sent, all with correct Handover References.
3	MS -> SS	HANDOVER FAILURE	Sent on old channel, RR cause value = "Abnormal release, unspecified", "Abnormal release, channel unacceptable", "Abnormal release, timer expired", "Abnormal release, no activity on the radio path" or "Protocol error unspecified". Shall be sent within 3 seconds from the transmission of HANDOVER COMMAND.
4	SS	-	The SS checks that the power level reported in the layer 1 header of the SACCH message that is sent in the first SACCH multiframe following the SABM is the same as in step 0.

Specific Message Contents

None.

26.6.5.9 Handover / layer 1 failure

26.6.5.9.1 Conformance requirements

The MS shall return to the old channel in the case of an handover failure caused by a layer 1 failure on the target cell. On the old channel the MS shall use the Power Level that it was previously using on that channel.

References

GSM 04.08 section 3.4.4.

26.6.5.9.2 Test purpose

To verify the function of timer T3124 and the contents in the message HANDOVER FAILURE and in the layer 1 header on the SACCH.

26.6.5.9.3 Method of test

Initial Conditions

System Simulator:

2 cells with same LAI, default parameters.

Mobile Station:

The MS is in the active state (U10) of a call (on cell A). Used power level is the maximum supported by the MS.

Related PICS/PIXIT Statements

Supported rate(s) of TCH: TCH/F.

Support for state U10 of the Call Control protocol.

Type of MS (GSM 450 or GSM 480 or P-GSM 900 or EGSM or DCS 1 800 or PCS 1900).

Foreseen Final State of the MS

The active state (U10) of a mobile call (on cell A). Used power level is the maximum supported by the MS.

Test Procedure

The MS is in the active state (U10) of a call on cell A. The SS sends a HANOVER COMMAND on the main DCCH. The MS shall begin to send access bursts at the commanded power level on the new DCCH to cell B. With the exception of normal BCCH signalling, the SS does not transmit anything on cell B (thus causing a time-out of T3124). The MS shall re-establish the old link on cell A and send a HANOVER FAILURE within 3 seconds from the transmission of HANOVER COMMAND, using the old power level.

Maximum Duration of Test

5 minutes, including 1 minute for any necessary operator actions.

Expected Sequence

Step	Direction	Message	Comments
0	SS	-	The SS records the power level in the layer 1 header of the last SACCH message sent by the MS before step 1.
1	SS -> MS	HANOVER COMMAND	Channel description: non-hopping, full rate. Synchronization Indication: non synchronized.
2	MS -> SS	HANOVER ACCESS	Several messages are sent, all with correct Handover References.
3	MS -> SS	HANOVER FAILURE	Sent on old channel, RR cause value = "Abnormal release, unspecified", "Abnormal release, channel unacceptable", "Abnormal release, timer expired", "Abnormal release, no activity on the radio path" or "Protocol error unspecified". Shall be sent within 3 seconds from the transmission of HANOVER COMMAND.
4	SS	-	The SS checks that the power level reported in the layer 1 header of the SACCH message that is sent in the first SACCH multiframe following the SABM is the same as in step 0.

Specific Message Contents

None.

26.6.6 Test of frequency redefinition

The Frequency Redefinition procedure is used by the network to change the frequencies and hopping sequences of the allocated channels.

26.6.6.1 Frequency redefinition

26.6.6.1.1 Conformance requirements

An MS, after receiving a FREQUENCY REDEFINITION message, shall start using the new frequencies and hopping sequence in the correct time slot when the MS is allocated a dedicated channel.

The behaviour described in the test purpose is applied for each combination of the value T(k) (k = 1,2,3) and for each supported dedicated channel type.

References

GSM 04.08 sections 3.4.5, 9.1.13 and 10.5.2.13.

26.6.6.1.2 Test purpose

To verify that the MS, after receiving a Frequency Redefinition message, starts using the new frequencies and hopping sequence at the time indicated in the message.

26.6.6.1.3 Method of test

Initial Conditions

System Simulator:

1 cell, CCCH_CONF set to 1 basic physical channel used for CCCH, not combined with SDCCHs. The cell allocation is set to CA_{PGSM}(1) or CA_{DCS}(1), depending on the band of operation of the Mobile Station (See PICS/PIXIT), before each execution of this test.

Mobile Station:

The MS is in the "idle, updated" state, with a TMSI allocated.

Related PICS/PIXIT Statements

Supported rate(s) of TCH: TCH/F and/or TCH/H.

Type of MS (GSM 450 or GSM 480 or P-GSM 900 or EGSM or DCS 1 800 or PCS 1900).

Foreseen Final State of the MS

"Idle, updated", with TMSI allocated.

Test Procedure

Test parameters:

P-GSM 900:

ca_{PGSM}(1) is set to 64.

An arbitrary subset CA_{PGSM}(1) of the set {1,...,124} containing ca_{PGSM}(1) elements is drawn.

An element B of the set CA_{PGSM}(1) is arbitrarily chosen.

An arbitrary value ca_{PGSM}(2) in the range 20,...,63 is chosen.

An arbitrary subset CA_{PGSM}(2) of the set {1,...,124} with ca_{PGSM}(2) elements and containing B is chosen.

An arbitrary value ca_{PGSM}(3) in the range 4,...,19 is chosen.

An arbitrary subset CA_{PGSM}(3) of the set {1,...,124} with ca_{PGSM}(3) elements and containing B is chosen.

For j = 1,2,3, values ma_{PGSM}(j) in the range j,...,ca_{PGSM}(j)-1 and values MAIO_{PGSM}(j) in the range 0,...,ma_{PGSM}(j)-1 are arbitrarily chosen.

Subsets MA_{PGSM}(j) of CA_{PGSM}(j) not containing B and having ma(j) elements are arbitrarily chosen.

DCS 1 800:

ca_{DCS}(1) is set to 64.

An arbitrary subset CA_{DCS}(1) of the set {700,...,812} containing ca_{DCS}(1) elements is chosen.

An element B of the set CA_{DCS}(1) is arbitrarily chosen. CA_{DCS}(1) is then coded using the Variable Bit Map coding scheme.

An arbitrary value ca_{DCS}(2) in the range 17,...,63 is chosen.

An arbitrary subset $CA_{DCS}(2)$ of the set $\{700, \dots, 812\}$ with $ca_{DCS}(2)$ elements and containing B is chosen. $CA_{DCS}(2)$ is then coded using the Variable Bit Map coding scheme.

An arbitrary value $ca_{DCS}(3)$ in the range $4, \dots, 16$ is chosen.

An arbitrary subset $CA_{DCS}(3)$ of the set $\{700, \dots, 812\}$ with $ca_{DCS}(3)$ elements and containing B is chosen. $CA_{DCS}(3)$ is then coded according to the specific message contents.

For $j = 1, 2, 3$, values $ma_{DCS}(j)$ in the range $j, \dots, ca_{DCS}(j)-1$ and values $MAIO_{DCS}(j)$ in the range $0, \dots, ma_{DCS}(j)-1$ are arbitrarily chosen.

Subsets $MA_{DCS}(j)$ of $CA_{DCS}(j)$ not containing B and having $ma_{DCS}(j)$ elements are arbitrarily chosen.

PCS 1900:

$ca_{GSM1900}(1)$ is set to 64.

An arbitrary subset $CA_{GSM1900}(1)$ of the set $\{700, \dots, 810\}$ containing $ca_{GSM1900}(1)$ elements is chosen.

An element B of the set $CA_{GSM1900}(1)$ is arbitrarily chosen. $CA_{GSM1900}(1)$ is then coded using the Variable Bit Map coding scheme.

An arbitrary value $ca_{GSM1900}(2)$ in the range $17, \dots, 63$ is chosen.

An arbitrary subset $CA_{GSM1900}(2)$ of the set $\{700, \dots, 810\}$ with $ca_{GSM1900}(2)$ elements and containing B is chosen. $CA_{GSM1900}(2)$ is then coded using the Variable Bit Map coding scheme.

An arbitrary value $ca_{GSM1900}(3)$ in the range $4, \dots, 16$ is chosen.

An arbitrary subset $CA_{GSM1900}(3)$ of the set $\{700, \dots, 810\}$ with $ca_{GSM1900}(3)$ elements and containing B is chosen. $CA_{GSM1900}(3)$ is then coded according to the specific message contents.

For $j = 1, 2, 3$, values $ma_{GSM1900}(j)$ in the range $j, \dots, ca_{GSM1900}(j)-1$ and values $MAIO_{GSM1900}(j)$ in the range $0, \dots, ma_{GSM1900}(j)-1$ are arbitrarily chosen.

Subsets $MA_{GSM1900}(j)$ of $CA_{GSM1900}(j)$ not containing B and having $ma_{GSM1900}(j)$ elements are arbitrarily chosen.

GSM 450:

$ca_{450}(1)$ is set to 32.

An arbitrary subset $CA_{450}(1)$ of the set $\{259, \dots, 293\}$ containing $ca_{450}(1)$ elements is chosen.

An element B of the set $CA_{450}(1)$ is arbitrarily chosen. $CA_{450}(1)$ is then coded using the Range 128 coding scheme.

An arbitrary value $ca_{450}(2)$ in the range $17, \dots, 31$ is chosen.

An arbitrary subset $CA_{450}(2)$ of the set $\{259, \dots, 293\}$ with $ca_{450}(2)$ elements and containing B is chosen. $CA_{450}(2)$ is then coded using the Range 128 coding scheme.

An arbitrary value $ca_{450}(3)$ in the range $4, \dots, 16$ is chosen.

An arbitrary subset $CA_{450}(3)$ of the set $\{259, \dots, 293\}$ with $ca_{450}(3)$ elements and containing B is chosen. $CA_{450}(3)$ is then coded according to the specific message contents.

For $j = 1, 2, 3$, values $ma_{450}(j)$ in the range $j, \dots, ca_{450}(j)-1$ and values $MAIO_{450}(j)$ in the range $0, \dots, ma_{450}(j)-1$ are arbitrarily chosen.

Subsets $MA_{450}(j)$ of $CA_{450}(j)$ not containing B and having $ma_{450}(j)$ elements are arbitrarily chosen.

GSM 480:

$ca_{480}(1)$ is set to 32.

An arbitrary subset $CA_{480}(1)$ of the set $\{306, \dots, 340\}$ containing $ca_{480}(1)$ elements is chosen.

An element B of the set $CA_{480}(1)$ is arbitrarily chosen. $CA_{480}(1)$ is then coded using the Range 128 coding scheme.

An arbitrary value $ca_{480}(2)$ in the range $17, \dots, 31$ is chosen.

An arbitrary subset $CA_{480}(2)$ of the set $\{306, \dots, 340\}$ with $ca_{480}(2)$ elements and containing B is chosen. $CA_{480}(2)$ is then coded using the Range 128 coding scheme.

An arbitrary value $ca_{480}(3)$ in the range $4, \dots, 16$ is chosen.

An arbitrary subset $CA_{480}(3)$ of the set $\{306, \dots, 340\}$ with $ca_{480}(3)$ elements and containing B is chosen. $CA_{480}(3)$ is then coded according to the specific message contents.

For $j = 1, 2, 3$, values $ma_{480}(j)$ in the range $j, \dots, ca_{480}(j)-1$ and values $MAIO_{480}(j)$ in the range $0, \dots, ma_{480}(j)-1$ are arbitrarily chosen.

Subsets $MA_{480}(j)$ of $CA_{480}(j)$ not containing B and having $ma_{480}(j)$ elements are arbitrarily chosen.

PCS 1900, DCS 1 800, GSM 900, GSM 450 and GSM 480

Let $T(1) = 91$, $T(2) = 42\ 000$.

An arbitrary value $T(3)$ in the range $92, \dots, 29999$ is chosen.

The System Simulator pages the MS and after the MS has responded with a CHANNEL REQUEST, the simulator assigns a dedicated channel (TCH/F, TCH/H or SDCCH, as defined by the execution counter R). Then the SS sends a FREQUENCY REDEFINITION message, which modifies the frequencies/hopping sequence to be used by the MS. The MS shall then, at the TDMA frame defined by the contents of the "Starting Time" information element, use the new frequencies/hopping sequence. (The value of $T(2)$ ensures that the MS believes the Starting Time has passed and so the MS shall start transmitting immediately. Immediately being in the scope of this test no later than 73 Frames for SDCCH/8 or TCH/F and 90 Frames for TCH/H after the SS sends the last burst of the first L2 frame containing the beginning of the FREQUENCY REDEFINITION message. The range for $T(3)$ ensures that the MS has to wait until the designated frame before starting transmission on the new frequencies.)

The verification is performed at the RF burst level. The MS transmits the standard test signal C1 (annex 5), and for the TCH case, the SS checks the received pattern with the expected pattern. For the SDCCH case the MS transmits fill frames, and the SS checks for each burst whether the burst is transmitted at the right frequency.

Maximum Duration of Test

$3 * (\text{number of supported channels} * T(3) + 7)$

Expected Sequence

This sequence is performed for every combination of execution counters $K = 1, 2, 3$ and $R = 1, 2, 3$:

Step	Direction	Message	Comments
1	SS -> MS	PAGING REQUEST TYPE 1	<p>The SS checks that the MS is transmitting on the correct frequencies without delay.</p> <p>See description 1 below.</p> <p>The SS checks that the MS is transmitting on the correct frequencies and that the transmissions started in the correct frame.</p> <p>See description 2 below.</p> <p>The SS checks that the MS is transmitting on the correct frequencies and that the transmissions started in the correct frame.</p>
2	MS -> SS	CHANNEL REQUEST	
3	SS -> MS	IMMEDIATE ASSIGNMENT	
4	MS -> SS	PAGING RESPONSE	
5	-----	-----	
6	SS -> MS	FREQUENCY REDEFINITION	
7	-----	-----	
8	SS -> MS	FREQUENCY REDEFINITION	
9	-----	-----	
10	SS -> MS	CHANNEL RELEASE	

For $K=1$, $R = 1,2,3$ $T(K) = T(1)$;

$K=2$, $R = 1,2,3$ $T(K) = T(2)$;

$K=3$, $R = 1,2,3$ $T(K) = T(3)$.

Specific Message Contents

GSM 450:

IMMEDIATE ASSIGNMENT

Information Element	value/remark
L2 pseudo length	value dependent on the length of the Mobile Allocation and thus on the number of channels in CA450(1).
Channel Description	
Channel type and TDMA offset	SDCCH/8 arbitrary offset, for $R=1$ $B_m + ACCHs$ for $R=2$ $L_m + ACCHs$ arbitrary offset, for $R=3$
Timeslot number	arbitrarily selected by
TSC	arbitrarily selected
Hopping channel	RF hopping channel
MAIO	MAIO450(1)
HSN	0
Request reference	corresponds to the Channel Request
Timing advance	30 bit periods
Mobile Allocation	corresponds to set MA450(1)
Starting Time	not present
IA rest octets	all bits are set to spare

FREQUENCY REDEFINITION (Description 1)

Information Element	value/remark
Protocol Discriminator	RR Management
Skip Indicator	0000
Message Type	00101011
Channel Description	
Channel type and TDMA offset	SDCCH/8 offset not changed, for R=1 Bm + ACCHs for R=2 Lm + ACCHs offset not changed, for R=3
Timeslot number	not changed
TSC	not changed
Hopping channel	RF hopping channel
MAIO	MAIO450(2)
HSN	0
Mobile Allocation	corresponds to set MA450(2)
Starting Time	The last burst of the first L2 frame containing the beginning of this message is transmitted in frame number X. The starting time is set to frame number (X plus T(K) modulo 42 432).
Cell Channel Description	
Information element identifier contents	62H corresponds to set CA450(2) with "Format ID" set to "Range 128".

FREQUENCY REDEFINITION (Description 2)

Information Element	value/remark
Protocol Discriminator	RR Management
Skip Indicator	0000
Message Type	00101011
Channel Description	
Channel type and TDMA offset	SDCCH/8 offset not changed, for R=1 Bm + ACCHs, for R=2 Lm + ACCHs offset not changed, for R=3
Timeslot number	not changed
TSC	not changed
Hopping channel	RF hopping channel
MAIO	MAIO450(3)
HSN	0
Mobile Allocation	corresponds to set MA450M(3)
Starting Time	The last burst of the first L2 frame containing the beginning of this message is transmitted in frame number X. The starting time is set to frame number (X plus T(K) modulo 42 432).
Cell Channel Description	
Information element identifier contents	62H corresponds to set CA450(3) with "Format ID" set to "Range 128".

GSM 480:**IMMEDIATE ASSIGNMENT**

Information Element	value/remark
L2 pseudo length	value dependent on the length of the Mobile Allocation and thus on the number of channels in CA480(1).
Channel Description	
Channel type and TDMA offset	SDCCH/8 arbitrary offset, for R=1 Bm + ACCHs for R=2 Lm + ACCHs arbitrary offset, for R=3
Timeslot number	arbitrarily selected by
TSC	arbitrarily selected
Hopping channel	RF hopping channel
MAIO	MAIO480M(1)
HSN	0
Request reference	corresponds to the Channel Request
Timing advance	30 bit periods
Mobile Allocation	corresponds to set MA480(1)
Starting Time	not present
IA rest octets	all bits are set to spare

FREQUENCY REDEFINITION (Description 1)

Information Element	value/remark
Protocol Discriminator	RR Management
Skip Indicator	0000
Message Type	00101011
Channel Description	
Channel type and TDMA offset	SDCCH/8 offset not changed, for R=1 Bm + ACCHs for R=2 Lm + ACCHs offset not changed, for R=3
Timeslot number	not changed
TSC	not changed
Hopping channel	RF hopping channel
MAIO	MAIO480(2)
HSN	0
Mobile Allocation	corresponds to set MA480(2)
Starting Time	The last burst of the first L2 frame containing the beginning of this message is transmitted in frame number X. The starting time is set to frame number (X plus T(K) modulo 42 432).
Cell Channel Description	
Information element identifier contents	62H corresponds to set CA480(2) with "Format ID" set to "Range 128".

FREQUENCY REDEFINITION (Description 2)

Information Element	value/remark
Protocol Discriminator	RR Management
Skip Indicator	0000
Message Type	00101011
Channel Description	
Channel type and TDMA offset	SDCCH/8 offset not changed, for R=1 Bm + ACCHs, for R=2 Lm + ACCHs offset not changed, for R=3
Timeslot number	not changed
TSC	not changed
Hopping channel	RF hopping channel
MAIO	MAIO480(3)
HSN	0
Mobile Allocation	corresponds to set MA480(3)
Starting Time	The last burst of the first L2 frame containing the beginning of this message is transmitted in frame number X. The starting time is set to frame number (X plus T(K) modulo 42 432).
Cell Channel Description	
Information element identifier contents	62H corresponds to set CA480(3) with "Format ID" set to "Range 128".

GSM 900:

IMMEDIATE ASSIGNMENT

Information Element	value/remark
L2 pseudo length	value dependent on the length of the Mobile Allocation and thus on the number of channels in CAPGSM(1).
Channel Description	
Channel type and TDMA offset	SDCCH/8 arbitrary offset, for R=1 Bm + ACCHs for R=2 Lm + ACCHs arbitrary offset, for R=3
Timeslot number	arbitrarily selected by
TSC	arbitrarily selected
Hopping channel	RF hopping channel
MAIO	MAIOPGSM(1)
HSN	0
Request reference	corresponds to the Channel Request
Timing advance	30 bit periods
Mobile Allocation	corresponds to set MAPGSM(1)
Starting Time	not present
IA rest octets	all bits are set to spare

FREQUENCY REDEFINITION (Description 1)

Information Element	value/remark
Protocol Discriminator	RR Management
Skip Indicator	0000
Message Type	00101011
Channel Description	
Channel type and TDMA offset	SDCCH/8 offset not changed, for R=1 Bm + ACCHs for R=2 Lm + ACCHs offset not changed, for R=3
Timeslot number	not changed
TSC	not changed
Hopping channel	RF hopping channel
MAIO	MAIOPGSM(2)
HSN	0
Mobile Allocation	corresponds to set MAPGSM(2)
Starting Time	The last burst of the first L2 frame containing the beginning of this message is transmitted in frame number X. The starting time is set to frame number (X plus T(K) modulo 42 432).
Cell Channel Description	
Information element identifier contents	62H corresponds to set CAPGSM(2) with "Format ID" set to "bit map 0".

FREQUENCY REDEFINITION (Description 2)

Information Element	value/remark
Protocol Discriminator	RR Management
Skip Indicator	0000
Message Type	00101011
Channel Description	
Channel type and TDMA offset	SDCCH/8 offset not changed, for R=1 Bm + ACCHs, for R=2 Lm + ACCHs offset not changed, for R=3
Timeslot number	not changed
TSC	not changed
Hopping channel	RF hopping channel
MAIO	MAIOPGSM(3)
HSN	0
Mobile Allocation	corresponds to set MAPGSM(3)
Starting Time	The last burst of the first L2 frame containing the beginning of this message is transmitted in frame number X. The starting time is set to frame number (X plus T(K) modulo 42 432).
Cell Channel Description	
Information element identifier contents	62H corresponds to set CAPGSM(3) with "Format ID" set to "bit map 0".

DCS 1 800:

IMMEDIATE ASSIGNMENT

Information Element	value/remark
L2 pseudo length	value dependent on the length of the Mobile Allocation and thus on the number of channels in CADCS(1).
Channel Description	
Channel type and TDMA offset	SDCCH/8 arbitrary offset, for R=1 Bm + ACCHs for R=2 Lm + ACCHs arbitrary offset, for R=3
Timeslot number	arbitrarily selected
TSC	arbitrarily selected
Hopping channel	RF hopping channel
MAIO	MAIODCS(1)
HSN	0
Request reference	corresponds to the Channel Request
Timing advance	30 bit periods
Mobile Allocation	corresponds to set MADCS(1)
Starting Time	not present
IA rest octets	all bits are set to spare

FREQUENCY REDEFINITION (Description 1)

Information Element	value/remark
Protocol Discriminator	RR Management
Skip Indicator	0000
Message Type	00101011
Channel Description	
Channel type and TDMA offset	SDCCH/8 offset not changed, for R=1 Bm + ACCHs for R=2 Lm + ACCHs offset not changed, for R=3
Timeslot number	not changed
TSC	not changed
Hopping channel	RF hopping channel
MAIO	MAIODCS(2)
HSN	0
Mobile Allocation	corresponds to set MADCS(2)
Starting Time	The last burst of the first L2 frame containing the beginning of this message is transmitted in frame number X. The starting time is set to frame number (X plus T(K) modulo 42 432).
Cell Channel Description	
Information element identifier contents	62H K = 1 - corresponds to set CADCS(2) with "Format ID" set to " Variable Bit Map" K = 2- corresponds to set CADCS(2) with "Format ID" set to " Variable Bit Map" K = 3 - corresponds to set CADCS(2) with "Format ID" set to " Variable Bit Map"

FREQUENCY REDEFINITION (Description 2)

Information Element	value/remark
Protocol Discriminator	RR Management
Skip Indicator	0000
Message Type	00101011
Channel Description	
Channel type and TDMA offset	SDCCH/8 offset not changed, for R=1 Bm + ACCHs, for R=2 Lm + ACCHs offset not changed, for R=3
Timeslot number	not changed
TSC	not changed
Hopping channel	RF hopping channel
MAIO	MAIODCS(3)
HSN	0
Mobile Allocation	corresponds to set MADCS(3)
Starting Time	The last burst of the first L2 frame containing the beginning of this message is transmitted in frame number X. The starting time is set to frame number (X plus T(K) modulo 42 432).
Cell Channel Description	
Information element identifier contents	62H K = 1 - corresponds to set CADCS(3) with "Format ID" set to "Range 1024" K = 2- corresponds to set CADCS(3) with "Format ID" set to "Range 256" K = 3 - corresponds to set CADCS(3) with "Format ID" set to "Range 512"

PCS 1900:

IMMEDIATE ASSIGNMENT

Information Element	value/remark
L2 pseudo length	value dependent on the length of the Mobile Allocation and thus on the number of channels in CAGSM1900(1).
Channel Description	
Channel type and TDMA offset	SDCCH/8 arbitrary offset, for R=1 Bm + ACCHs for R=2 Lm + ACCHs arbitrary offset, for R=3
Timeslot number	arbitrarily selected
TSC	arbitrarily selected
Hopping channel	RF hopping channel
MAIO	MAIOGSM1900(1)
HSN	0
Request reference	corresponds to the Channel Request
Timing advance	30 bit periods
Mobile Allocation	corresponds to set MAGSM1900(1)
Starting Time	not present
IA rest octets	all bits are set to spare

FREQUENCY REDEFINITION (Description 1)

Information Element	value/remark
Protocol Discriminator	RR Management
Skip Indicator	0000
Message Type	00101011
Channel Description	
Channel type and TDMA offset	SDCCH/8 offset not changed, for R=1 Bm + ACCHs for R=2 Lm + ACCHs offset not changed, for R=3
Timeslot number	not changed
TSC	not changed
Hopping channel	RF hopping channel
MAIO	MAIOGSM1900(2)
HSN	0
Mobile Allocation	corresponds to set MAGSM1900(2)
Starting Time	The last burst of the first L2 frame containing the beginning of this message is transmitted in frame number X. The starting time is set to frame number (X plus T(K) modulo 42 432).
Cell Channel Description	
Information element identifier contents	62H K = 1 - corresponds to set CAGSM1900(2) with "Format ID" set to " Variable Bit Map" K = 2- corresponds to set CAGSM1900(2) with "Format ID" set to " Variable Bit Map" K = 3 - corresponds to set CAGSM1900(2) with "Format ID" set to " Variable Bit Map"

FREQUENCY REDEFINITION (Description 2)

Information Element	value/remark
Protocol Discriminator	RR Management
Skip Indicator	0000
Message Type	00101011
Channel Description	
Channel type and TDMA offset	SDCCH/8 offset not changed, for R=1 Bm + ACCHs, for R=2 Lm + ACCHs offset not changed, for R=3
Timeslot number	not changed
TSC	not changed
Hopping channel	RF hopping channel
MAIO	MAIOGSM1900(3)
HSN	0
Mobile Allocation	corresponds to set MAGSM1900(3)
Starting Time	The last burst of the first L2 frame containing the beginning of this message is transmitted in frame number X. The starting time is set to frame number (X plus T(K) modulo 42 432).
Cell Channel Description	
Information element identifier contents	62H K = 1 - corresponds to set CAGSM1900(3) with "Format ID" set to "Range 1024" K = 2- corresponds to set CAGSM1900(3) with "Format ID" set to "Range 256" K = 3 - corresponds to set CAGSM1900(3) with "Format ID" set to "Range 512"

26.6.7 Test of the channel mode modify procedure

The channel mode modify procedure allows the network to request the MS to change the channel mode for one channel. If the mobile station does not correctly respond to the CHANNEL MODE MODIFY message (with a positive acknowledgement if the new channel mode is supported, with a negative acknowledgement if the new channel mode is not supported), the network may try to repeat the procedure, release the connection, or continue to wait for the acknowledgement (the maximum time resulting from layer two re-transmissions and MS reaction time being around 5 seconds).

26.6.7.1 Test of the channel mode modify procedure / full rate

This test is only applicable to an MS supporting TCH/F.

26.6.7.1.1 Conformance requirement

When the MS has received the CHANNEL MODE MODIFY message, the mobile station changes the mode for the indicated channel and then replies by a CHANNEL MODE MODIFY ACKNOWLEDGE message indicating the new channel mode.

If the mobile station does not support the indicated mode, it shall retain the old mode and return the associated channel mode information in the CHANNEL MODE MODIFY ACKNOWLEDGE message.

References

GSM 04.08, subclauses 3.4.6.1.2 and 3.4.6.1.3

26.6.7.1.2 Test purpose

To verify that the MS, in an RR connected state, acknowledges a CHANNEL MODE MODIFY message by sending a CHANNEL MODE MODIFY ACKNOWLEDGEMENT message specifying and switching to the correct mode.

- the new mode if that mode is supported.
- the old mode if the new mode is not supported.

This shall be verified for the channel modes

- signalling only.
- speech full rate version 1.
- data 9,6 Kb/s.
- data 4,8 Kb/s full rate.
- data 2,4 Kb/s full rate.

26.6.7.1.3 Method of test

Initial Conditions

System Simulator:

1 cells, default parameters.

Mobile Station:

The MS is "idle updated", with TMSI allocated.

Related PICS/PIXIT Statements

- Type of MS (GSM 450 or GSM 480 or P-GSM 900 or EGSM or DCS 1 800 or PCS 1900).
- The MS supports TCH/F (Y/N).
- Bearer Capabilities supported by the MS.
- Channel modes supported by the MS:
 - * MS supports speech full rate version 1 (p1 = Y/N);
 - * MS supports data 9,6 Kb/s (p2 = Y/N);
 - * MS supports data 4,8 Kb/s full rate (p3 = Y/N);
 - * MS supports data 2,4 Kb/s full rate (p4 = Y/N).

Foreseen Final State of the MS

"Idle, updated", with TMSI allocated.

Test procedure

A Mobile Terminated call is initiated , however following the Channel Request received from the Mobile Station, the SS sends an Immediate Assignment to the MS commanding it to go to a TCH/F. This sets the Channel Mode automatically to "Signalling Only".

The SS then sends a series of CHANNEL MODE MODIFY messages to the MS. Each time it is checked that the MS responds with a CHANNEL MODE MODIFY ACKNOWLEDGE message specifying:

- the channel mode that has been specified in the CHANNEL MODE MODIFY message, if the MS supports that mode (this mode then becomes the "channel mode in use");
- the channel mode that was in use when the CHANNEL MODE MODIFY message has been received, if the MS does not support the channel mode specified in the CHANNEL MODE MODIFY message.

Maximum Duration of Test

30 seconds.

Expected Sequence

Step	Direction	Message	Comments
1	SS->MS	PAGING REQUEST TYPE 1	Sent on correct paging subchannel.
2	MS->SS	CHANNEL REQUEST	Establishment cause indicates "answer to paging".
3	SS->MS	IMMEDIATE ASSIGNMENT	Assignment to a non hopping TCH/F.
4	SS->MS	CHANNEL MODE MODIFY	
5	MS->SS	CHANNEL MODE MODIFY ACKNOWLEDGE	
6	SS->MS	CHANNEL MODE MODIFY	
7	MS->SS	CHANNEL MODE MODIFY ACKNOWLEDGE	
8	SS->MS	CHANNEL MODE MODIFY	
9	MS->SS	CHANNEL MODE MODIFY ACKNOWLEDGE	
10	SS->MS	CHANNEL MODE MODIFY	
11	MS->SS	CHANNEL MODE MODIFY ACKNOWLEDGE	
12	SS->MS	CHANNEL MODE MODIFY	
13	MS->SS	CHANNEL MODE MODIFY ACKNOWLEDGE	
14	SS->MS	CHANNEL RELEASE	

Specific Message Contents

CHANNEL MODE MODIFY

Information Element	value/remark
Channel description	describes the already assigned dedicated channel.
Channel mode	
Mode	in step 4: speech full rate version 1 in step 6: data 9,6 Kb/s in step 8: data 4,8 Kb/s full rate in step 10: data 2,4 Kb/s full rate in step 12 signalling only

CHANNEL MODE MODIFY ACKNOWLEDGE

Channel mode	
Mode	in step 2: signalling only in step 5: if p1 = Y: speech full rate version 1 if p1 = N: same as in step 2 in step 7: if p2= Y: data 9.6 Kb/s if p2= N: same as in step 5 in step 9: if p3= Y: data 4.8 Kb/s full rate if p3= N: same as in step 7 in step 11: if p4=Y: data 2.4 Kb/s full rate if p4= N: same as in step 9 in step 13: if p1=Y: signalling only if p1=N: same as in step 11.

26.6.7.2 Test of the channel mode modify procedure / half rate

This test is only applicable to an MS supporting TCH/H.

26.6.7.2.1 Conformance requirement

When the MS has received the CHANNEL MODE MODIFY message, the mobile station changes the mode for the indicated channel and then replies by a CHANNEL MODE MODIFY ACKNOWLEDGE message indicating the new channel mode.

If the mobile station does not support the indicated mode, it shall retain the old mode and return the associated channel mode information in the CHANNEL MODE MODIFY ACKNOWLEDGE message.

References

GSM 04.08, subclauses 3.4.6.1.2 and 3.4.6.1.3

26.6.7.2.2 Test purpose

To verify that the MS, in an RR connected state, acknowledges a CHANNEL MODE MODIFY message by sending a CHANNEL MODE MODIFY ACKNOWLEDGEMENT message specifying and switches to the correct mode:

- the new mode if that mode is supported;
- the old mode if the new mode is not supported.

This shall be verified for the channel modes:

- signalling only;
- speech half rate version 1;
- data 4,8 Kb/s half rate;

- data 2,4 Kb/s half rate.

26.6.7.2.3 Method of test

Initial Conditions

System Simulator:

1 cells, default parameters.

Mobile Station:

The MS is "idle updated", with TMSI allocated.

Related PICS/PIXIT Statements

- Type of MS (GSM 450 or GSM 480 or P-GSM 900 or EGSM or DCS 1 800 or PCS 1900).
- The MS supports TCH/H (Y/N).
- Bearer Capabilities supported by the MS.
- Channel modes supported by the MS:
 - * MS supports speech half rate version 1 (q1 = Y/N);
 - * MS supports data 4,8 Kb/s half rate (q2 = Y/N);
 - * MS supports data 2,4 Kb/s half rate (q3 = Y/N).

Foreseen Final State of the MS

"Idle, updated", with TMSI allocated.

Test procedure

A Mobile Terminated call is initiated, however following the Channel Request received from the Mobile Station, the SS sends an Immediate Assignment to the MS commanding it to go to a TCH/H. This sets the Channel Mode automatically to "Signalling Only".

The SS then sends a series of CHANNEL MODE MODIFY messages to the MS. Each time it is checked that the MS responds with a CHANNEL MODE MODIFY ACKNOWLEDGE message specifying:

- the channel mode that has been specified in the CHANNEL MODE MODIFY message, if the MS supports that mode (this mode then becomes the "channel mode in use");
- the channel mode that was in use when the CHANNEL MODE MODIFY message has been received, if the MS does not support the channel mode specified in the CHANNEL MODE MODIFY message.

Maximum Duration of Test

30 seconds.

Expected Sequence

Step	Direction	Message	Comments
1	SS->MS	PAGING REQUEST TYPE 1	Sent on the correct paging subchannel. Establishment cause indicates "answer to paging". Assignment to a non hopping TCH/H.
2	MS->SS	CHANNEL REQUEST	
3	SS->MS	IMMEDIATE ASSIGNMENT	
4	SS->MS	CHANNEL MODE MODIFY	
5	MS->SS	CHANNEL MODE MODIFY ACKNOWLEDGE	
6	SS->MS	CHANNEL MODE MODIFY	
7	MS->SS	CHANNEL MODE MODIFY ACKNOWLEDGE	
8	SS->MS	CHANNEL MODE MODIFY	
9	MS->SS	CHANNEL MODE MODIFY ACKNOWLEDGE	
10	SS->MS	CHANNEL MODE MODIFY	
11	MS->SS	CHANNEL MODE MODIFY ACKNOWLEDGE	
12	SS->MS	CHANNEL RELEASE	

Specific Message Contents

CHANNEL MODE MODIFY

Information Element	value/remark
Channel description Channel mode Mode	describes the already assigned dedicated channel. in step 4: speech half rate in step 6: data 4,8 Kb/s half rate in step 8: data 2,4 Kb/s half rate in step 10: signalling only

CHANNEL MODE MODIFY ACKNOWLEDGE

Information Element	value/remark
Channel mode Mode	in step 5: if q1 = Y: Speech half rate version 1 if q1 = N: signalling only in step 7: if q2 = Y: data 4,8 Kb/s half rate if q2 = N: same as in step 5 in step 9: if q3 = Y: data 2,4 Kb/s half rate if q3 = N: same as in step 7 in step 11: if q1 = Y: signalling only if q1 = N: same as in step 9.

26.6.8 Test of ciphering mode setting

The Ciphering Mode Setting Procedure can be used by the network to trigger the start and stop of stream ciphering.

The SS shall start and synchronize ciphering and deciphering according to GSM 03.20. The bitstream shall be generated by algorithm A5 (A5/1 or A5/2 as defined by the test case) using the encryption key Kc.

26.6.8.1 Ciphering mode / start ciphering

26.6.8.1.1 Conformance requirements

1. When the MS receives the CIPHERING MODE COMMAND message with Ciphering Mode Setting information element set to "start ciphering", the MS starts ciphering and deciphering with the algorithm indicated by the "algorithm identifier" field:
 - the MS responds with a CIPHERING MODE COMPLETE message in ciphered mode;
 - the ciphering uses the cipher key determined during the authentication procedure.
2. The MS responds to the AUTHENTICATION REQUEST message with an AUTHENTICATION RESPONSE message and continues to use the ciphering key obtained from the previous authentication procedure.

References

GSM 04.08 section 3.4.7.

26.6.8.1.2 Test purpose

To verify that the MS starts ciphering when it receives a CIPHERING MODE COMMAND message with Cipher Mode Setting = "Start Ciphering". To verify that it continues to use the old cipher key after it receives an AUTHENTICATION REQUEST whilst in ciphered mode.

26.6.8.1.3 Method of test

Initial Conditions

System Simulator:

1 cells, Radio_Link_Timeout set to 64.

Mobile Station:

The MS is in the "idle, updated" state, with a TMSI allocated.

Related PICS/PIXIT Statements

Type of MS (GSM 450 or GSM 480 or P-GSM 900 or EGSM or DCS 1 800 or PCS 1900).

Support for state U10 of the Call Control protocol.

Supported encryption algorithms: A5/1 and/or A5/2.

Foreseen Final State of the MS

"Idle, updated", with TMSI allocated.

Test Procedure

The MS is made to originate a call. It shall send at least one CHANNEL REQUEST message. The SS sends an IMMEDIATE ASSIGNMENT and the MS shall answer with a CM SERVICE REQUEST. The SS sends an AUTHENTICATION REQUEST and the MS shall answer with AUTHENTICATION RESPONSE. Then the SS sends a CIPHERING MODE COMMAND, ordering the MS to start ciphering with an algorithm supported by the MS. After

transmission of this command the SS starts deciphering. The MS shall respond with a CIPHERING MODE COMPLETE message in ciphered mode using the cipher key determined during the authentication procedure, and continue to establish the call with a SETUP message. After reception of the CIPHERING MODE COMPLETE the SS starts enciphering.

The SS then sends another AUTHENTICATION REQUEST and the MS shall respond with an AUTHENTICATION RESPONSE. The MS shall continue to use the old cipher key.

Finally the SS sends a CHANNEL RELEASE to end the test.

Maximum Duration of Test

5 minutes, including 1 minute for any necessary operator actions.

Expected Sequence

This sequence is performed for execution counter, K=1, 2.

Step	Direction	Message	Comments
1	MS -> SS	CHANNEL REQUEST	Establ. Cause = "Originating Call" NECI not set to 1
2	SS -> MS	IMMEDIATE ASSIGNMENT	
3	MS -> SS	CM SERVICE REQUEST	
4	SS -> MS	AUTHENTICATION REQUEST	Cipher Mode Setting = "Start CIPHERING; cipher with algorithm A5/K". The SS starts deciphering. Sent in ciphered mode using the cipher key determined in between steps 4&5. The SS start enciphering.
5	MS -> SS	AUTHENTICATION RESPONSE	
6	SS -> MS	CIPHERING MODE COMMAND	
7	MS -> SS	CIPHERING MODE COMPLETE	
8	MS -> SS	SETUP	
9	SS -> MS	AUTHENTICATION REQUEST	Determines a new cipher key. Sent in ciphered mode using the cipher key determined in between steps 4&5.
10	MS -> SS	AUTHENTICATION RESPONSE	
11	SS -> MS	CHANNEL RELEASE	

Specific Message Contents

CIPHERING MODE COMMAND

For	k = 1, A5/k = A5/1
For	k = 2, A5/k = A5/2

26.6.8.2 CIPHERING mode / no ciphering

26.6.8.2.1 Conformance requirements

When the MS receives a CIPHERING MODE COMMAND message with Ciphering Mode Setting information element set to "no ciphering" the MS shall respond in non ciphered mode with a CIPHERING MODE COMPLETE message.

When the CIPHERING MODE COMMAND with Ciphering Mode Setting information element set to "no ciphering" is received as a response to a CM SERVICE REQUEST, the MS shall continue the establishment of the CM service.

References

GSM 04.08 section 3.4.7.

26.6.8.2.2 Test purpose

To verify that the MS does not start ciphering when it receives a CIPHERING MODE COMMAND message with Cipher Mode Setting = "No Ciphering".

26.6.8.2.3 Method of test

Initial Conditions

System Simulator:

1 cells, Radio_Link_Timeout set to 64.

Mobile Station:

The MS is in the "idle, updated" state, with a TMSI allocated.

Related PICS/PIXIT Statements

Type of MS (GSM 450 or GSM 480 or P-GSM 900 or EGSM or DCS 1 800 or PCS 1900).

Support for state U10 of the Call Control protocol.

Foreseen Final State of the MS

"Idle, updated", with TMSI allocated.

Test Procedure

The MS is made to originate a call. It shall send at least one CHANNEL REQUEST message. The SS sends an IMMEDIATE ASSIGNMENT and the MS shall answer with a CM SERVICE REQUEST. The SS sends an AUTHENTICATION REQUEST and the MS shall answer with an AUTHENTICATION RESPONSE. Then the SS sends a CIPHERING MODE COMMAND, ordering the MS not to start ciphering. The MS shall respond with a CIPHERING MODE COMPLETE message in non-ciphered mode and continue to establish the call with a SETUP message.

Finally the SS sends a CHANNEL RELEASE to end the test.

Maximum Duration of Test

5 minutes, including 1 minute for any necessary operator actions.

Expected Sequence

Step	Direction	Message	Comments
1	MS -> SS	CHANNEL REQUEST	Establ. Cause = "Originating call; NECI not equal to 1.
2	SS -> MS	IMMEDIATE ASSIGNMENT	
3	MS -> SS	CM SERVICE REQUEST	
4	SS -> MS	AUTHENTICATION REQUEST	Cipher Mode Setting = "No Ciphering". Sent in non-ciphered mode.
5	MS -> SS	AUTHENTICATION RESPONSE	
6	SS -> MS	CIPHERING MODE COMMAND	
7	MS -> SS	CIPHERING MODE COMPLETE	
8	MS -> SS	SETUP	
11	SS -> MS	CHANNEL RELEASE	

Specific Message Contents

None.

26.6.8.3 Ciphering mode / old cipher key

26.6.8.3.1 Conformance requirements

When the MS receives the CIPHERING MODE COMMAND message with Ciphering Mode Setting information element set to "start ciphering", the MS starts ciphering and deciphering with the algorithm indicated by the "algorithm identifier" field. Also;

- the MS responds with a CIPHERING MODE COMPLETE message in the correct ciphered mode;
- the ciphering shall use the previously stored cipher key;
- in the case of a mobile originating speech call, the MS shall send a SETUP message after the completion of the ciphering procedure.

References

GSM 04.08 section 3.4.7.

26.6.8.3.2 Test purpose

To verify that the MS uses the stored cipher key when it receives a CIPHERING MODE COMMAND without a preceding authentication procedure.

26.6.8.3.3 Method of test

Initial Conditions

System Simulator:

1 cells, Radio_Link_Timeout = 64.

Mobile Station:

The MS is in the "idle, updated" state, with a TMSI allocated and a known cipher key stored.

Related PICS/PIXIT Statements

Type of MS (GSM 450 or GSM 480 or P-GSM 900 or EGSM or DCS 1 800 or PCS 1900).

Support for state U10 of the Call Control protocol.

Supported encryption algorithms: A5/1 and/or A5/2.

Foreseen Final State of the MS

"Idle, updated", with TMSI allocated.

Test Procedure

The MS is made to originate a call. It shall send at least one CHANNEL REQUEST message. The SS sends an IMMEDIATE ASSIGNMENT and the MS shall answer with a CM SERVICE REQUEST. The SS sends a CIPHERING MODE COMMAND, ordering the MS to start ciphering with a supported algorithm. After transmission of this command the SS starts deciphering. The MS shall respond with a CIPHERING MODE COMPLETE message in the commanded ciphered mode using the stored cipher key and continue to establish the call with a SETUP message. After reception of the CIPHERING MODE COMPLETE the SS starts enciphering.

Finally the SS sends a CHANNEL RELEASE to end the test.

Maximum Duration of Test

5 minutes, including 1 minute for any necessary operator actions.

Expected Sequence

Step	Direction	Message	Comments
1	MS -> SS	CHANNEL REQUEST	Establ. Cause = "Originating Call: NECI not equal to 1. Cipher Mode Setting = "Start Cipherring", algorithm arbitrarily selected from those supported by the MS. The SS starts deciphering.
2	SS -> MS	IMMEDIATE ASSIGNMENT	
3	MS -> SS	CM SERVICE REQUEST	
4	SS -> MS	CIPHERING MODE COMMAND	
5	MS -> SS	CIPHERING MODE COMPLETE	Sent in commanded ciphered mode with the stored cipher key. The SS starts enciphering.
6	MS -> SS	SETUP	
7	SS -> MS	CHANNEL RELEASE	

Specific Message Contents

None.

26.6.8.4 Cipherring mode / change of mode, algorithm and key

Networks can be implemented that do not have the same cipherring algorithms on all base stations. In such networks changes of algorithms and cipherring mode may occur and calls will fail if MSs incorrectly handle commands or use an incorrect cipher key.

26.6.8.4.1 Conformance requirements

- 1 When the MS in the "not ciphered" mode, receives a CIPHERING MODE COMMAND message with the Cipherring Mode Setting information element set to "start cipherring", the MS shall load the cipher key stored in the SIM into the ME, use this key to start cipherring and deciphering with the algorithm indicated by the "algorithm identifier" field and, respond with a CIPHERING MODE COMPLETE message.
- 2 If the last timeslot of the message block containing a CIPHERING MODE COMMAND message occurs at time T, then the MS shall be ready to transmit the CIPHERING MODE COMPLETE message before T+500 ms.
- 3 When the MS receives an ASSIGNMENT COMMAND message containing a Cipher Mode Setting IE after receipt of a CIPHERING MODE COMMAND message, the MS shall perform the assignment, use the commanded mode and/or algorithm on the new channel, and not change the cipherring key.
- 4 When the MS receives a HANDOVER COMMAND message containing a Cipher Mode Setting IE after receipt of a CIPHERING MODE COMMAND message, the MS shall perform the handover, use the commanded mode and/or algorithm on the new channel, and not change the cipherring key.
- 5 When the MS in the "ciphered" mode receives a CIPHERING MODE COMMAND message with Cipher Mode Setting IE set to "no cipherring", the MS shall load the cipher key stored in the SIM into the ME, load the cipher key stored in the SIM into the ME, stop cipherring and deciphering and, respond with a CIPHERING MODE COMPLETE message.
- 6 When the MS receives an AUTHENTICATION REQUEST message, it shall process the challenge information and send back an AUTHENTICATION RESPONSE message to the network. The new cipherring key calculated from the challenge information shall overwrite the previous one and be stored on the SIM before the AUTHENTICATION RESPONSE message is transmitted. The cipherring key stored in the SIM shall be loaded in to the ME when any valid CIPHERING MODE COMMAND is received.
- 7 When the MS in the not ciphered mode receives a CIPHERING MODE COMMAND message with Cipher Mode Setting IE set to "no cipherring", the MS shall load the cipher key stored in the SIM into the ME, stop cipherring and deciphering and, respond with a CIPHERING MODE COMPLETE message.
- 8 If a handover fails then the operational parameters used when returning to the old channel are those applied before the HANDOVER COMMAND message was received.
- 9 If an assignment fails then the operational parameters used when returning to the old channel are those applied before the ASSIGNMENT COMMAND message was received.

References

Conformance requirement 1: GSM 04.08 sections 3.4.7.2 and 4.3.2.2.

Conformance requirement 2: GSM 04.13 section 5.2.7.

Conformance requirement 3: GSM 04.08 section 3.4.3.1.

Conformance requirement 4: GSM 04.08 section 3.4.4.1.

Conformance requirement 5: GSM 04.08 sections 3.4.7.2 and 4.3.2.2.

Conformance requirement 6: GSM 04.08 section 4.3.2.2.

Conformance requirement 7: GSM 04.08 section 3.4.7.2.

Conformance requirement 8: GSM 04.08 section 3.4.4.4.

Conformance requirement 9: GSM 04.08 section 3.4.3.3.

26.6.8.4.2 Test purpose

- 1 To verify that when the MS is in the "not ciphered" mode and receives the CIPHERING MODE COMMAND message with Ciphering Mode Setting information element set to "start ciphering", the MS uses the cipher key stored in the SIM to start ciphering and deciphering with the algorithm indicated by the "algorithm identifier" field and that the MS responds with a CIPHERING MODE COMPLETE message.
- 2 To verify that the MS is ready to transmit the CIPHERING MODE COMPLETE message before 500 ms after the end of the CIPHERING MODE COMMAND message.
- 3 To verify that when the MS receives an ASSIGNMENT COMMAND message containing a Cipher Mode Setting IE after receipt of a CIPHERING MODE COMMAND message, the MS shall perform the assignment, use the commanded mode and/or algorithm on the new channel, and not change the ciphering key.
- 4 To verify that when the MS receives a HANDOVER COMMAND message containing a Cipher Mode Setting IE after receipt of a CIPHERING MODE COMMAND message, the MS shall perform the handover, use the commanded mode and/or algorithm on the new channel, and not change the ciphering key
- 5 To verify that when the MS is in the "ciphered" mode and receives the CIPHERING MODE COMMAND message with Cipher Mode Setting IE set to "no ciphering", the MS loads the cipher key stored in the SIM into the ME, stops ciphering and deciphering and, responds with a CIPHERING MODE COMPLETE message.
- 6 To verify that the MS responds to an AUTHENTICATION REQUEST message with an AUTHENTICATION RESPONSE message and continues to use the cipher key obtained from the previous authentication procedure.
- 7 To verify that when the MS is in the "not ciphered" mode and receives the CIPHERING MODE COMMAND message with Ciphering Mode Setting information element set to "no ciphering", the does not start ciphering or deciphering, but does respond with a CIPHERING MODE COMPLETE message.
- 8 To verify that when the MS receives a HANDOVER COMMAND message and the handover fails, the MS sends a HANDOVER FAILURE message on the old channel using the old ciphering mode and (if ciphered) the old algorithm and old key.
- 9 To verify that when the MS receives an ASSIGNMENT COMMAND message and the assignment fails, the MS sends an ASSIGNMENT FAILURE message on the old channel using the old ciphering mode and (if ciphered) the old algorithm and old key.

26.6.8.4.3 Method of test

Initial Conditions

System Simulator:

1 cell, with a legal combination of CCCH_CONF with SDCCH/4s or SDCCH/8s is chosen arbitrarily by the SS.

Mobile Station:

The MS is in the "idle, updated" state, with a TMSI allocated and a known cipher key, K, stored in the SIM.

Related PICS/PIXIT Statements

Type of MS (GSM 450 or GSM 480 or P-GSM 900 or EGSM or DCS 1 800 or PCS 1900).

Supported ciphering algorithms: A5/1 and/or A5/2.

Power class of mobile station.

Foreseen Final State of the MS

"Idle, updated", with TMSI allocated.

Test Procedure

The MS is paged. The MS shall send at least one CHANNEL REQUEST message. The SS sends an IMMEDIATE ASSIGNMENT and the MS shall answer with a PAGING RESPONSE message.

The SS sends a CIPHERING MODE COMMAND, ordering the MS to start ciphering with a supported algorithm. After transmission of this command the SS starts deciphering. The MS shall respond with a CIPHERING MODE COMPLETE message in the commanded ciphered mode using the cipher key K. After reception of the CIPHERING MODE COMPLETE the SS starts enciphering. The MS shall be ready to transmit the CIPHERING MODE COMPLETE message before 500 ms after the end of the CIPHERING MODE COMMAND message.

The term "ready to transmit" is defined in GSM 04.13.

The SS sends an AUTHENTICATION REQUEST message to the MS. Cipher key L is calculated. The MS shall send an AUTHENTICATION RESPONSE message to the SS.

The SS sends a HANDOVER COMMAND (for a finely synchronized intra-BTS handover) with the Cipher Mode Setting IE set to "no ciphering". The MS shall transmit the HANDOVER COMPLETE on the commanded channel in non ciphered mode.

The SS sends an ASSIGNMENT COMMAND message containing a Cipher Mode Setting IE set to "start ciphering". The MS shall start transmitting on the commanded channel using the commanded algorithm and cipher key K. The MS shall transmit the ASSIGNMENT COMPLETE message.

The SS sends a CIPHERING MODE COMMAND, ordering the MS to stop ciphering. After transmission of this command the SS stops deciphering. The MS shall respond with a CIPHERING MODE COMPLETE message in non ciphered mode. After reception of the CIPHERING MODE COMPLETE the SS stops enciphering.

The SS sends a HANDOVER COMMAND (for a finely synchronized intra-BTS handover) with the Cipher Mode Setting IE set to "start ciphering". The MS shall transmit the HANDOVER COMPLETE on the commanded channel in ciphered mode using cipher key L and command algorithm.

The SS sends a HANDOVER COMMAND (for a finely synchronized intra-BTS handover) with the Cipher Mode Setting IE set to "start ciphering" and the algorithm identifier indicating the algorithm currently in use. The MS shall transmit the HANDOVER COMPLETE on the commanded channel in ciphered mode using the same algorithm as before the handover.

The SS sends an ASSIGNMENT COMMAND message containing a Cipher Mode Setting IE set to "no ciphering". The MS shall start transmitting on the commanded channel in non-ciphered mode. The MS shall transmit the ASSIGNMENT COMPLETE message.

The SS sends a CIPHERING MODE COMMAND, containing a Cipher Mode Setting IE set to "no ciphering". The MS shall respond with a CIPHERING MODE COMPLETE message.

The SS sends an AUTHENTICATION REQUEST message to the MS. Cipher key M is calculated. The MS shall send an AUTHENTICATION RESPONSE message to the SS.

The SS sends a HANDOVER COMMAND (for a finely synchronized intra-BTS handover) with the Cipher Mode Setting IE set to "start ciphering". The MS shall transmit the HANDOVER COMPLETE on the commanded channel using the commanded algorithm and cipher key L.

The SS sends a HANOVER COMMAND (for a finely synchronized intra-BTS handover) with the Cipher Mode Setting IE set to "no ciphering". The SS does not activate the commanded channel. The MS's transmissions on the new channel need not be monitored. The MS shall transmit the HANOVER FAILURE message on the "old" channel using the "old" algorithm and cipher key L and commanded algorithm.

The SS sends an ASSIGNMENT COMMAND message containing a Cipher Mode Setting IE set to "start ciphering". The SS does not activate the commanded channel. The MS's transmissions on the new channel need not be monitored. The MS shall transmit the ASSIGNMENT FAILURE message on the "old" channel using the "old" algorithm and cipher key L.

If the MS only supports one ciphering algorithm then the SS sends a CHANNEL RELEASE message.

If the MS supports more than one ciphering algorithm then the following steps are performed:

The SS sends an ASSIGNMENT COMMAND message containing a Cipher Mode Setting IE set to "start ciphering" and the Algorithm Identifier indicating a different supported algorithm to the one in use. The MS shall start transmitting on the commanded channel using the commanded algorithm. The MS shall transmit the ASSIGNMENT COMPLETE message.

The SS sends a HANOVER COMMAND (for a finely synchronized intra-BTS handover) containing a Cipher Mode Setting IE set to "start ciphering" and the Algorithm Identifier indicating a different supported algorithm to the one in use. The MS shall transmit the HANOVER COMPLETE on the commanded channel using the commanded algorithm.

The SS sends a CHANNEL RELEASE to end the test.

Maximum Duration of Test

3 minutes.

Expected Sequence

For MSs that only support one ciphering algorithm, the SS shall use step 61A. For MSs that support more than one ciphering algorithm, the SS shall use step 61B and the subsequent steps.

NOTE: TS GSM 04.08 appears to be unclear as to whether timer T3240 shall or shall not be started as a result of the AUTHENTICATION REQUEST messages sent in steps 8 and 44. To allow a variety of test equipment implementations, the IDENTITY REQUEST messages are included in order to avoid an unexpected expiry of timer T3240 prior to the end of the expected sequence.

Step	Direction	Message	Comments
1	SS -> MS	PAGING REQUEST TYPE 1	
2	MS -> SS	CHANNEL REQUEST	
3	SS -> MS	IMMEDIATE ASSIGNMENT	To either SDCCH4 or SDCCH8 depending upon CCCH_CONF arbitrarily chosen.
4	MS -> SS	PAGING RESPONSE	
5	SS -> MS	CIPHERING MODE COMMAND	Cipher Mode Setting = "Start Ciphering", algorithm arbitrarily selected from those supported by the MS. The SS starts deciphering with the selected algorithm.
6	MS -> SS	CIPHERING MODE COMPLETE	Sent in ciphered mode using key "K", the stored cipher key, and the commanded algorithm. This message shall be ready to be transmitted before 500 ms after the completion of step 5.
7	SS		- The SS starts enciphering using key "K".
8	SS -> MS	AUTHENTICATION REQUEST	Contains a new Ciphering Key Sequence Number which is associated with the new cipher key, "L".
9	MS -> SS	AUTHENTICATION RESPONSE	
10	SS -> MS	HANOVER COMMAND	Includes Cipher Mode Setting IE set to "No Ciphering".
11	SS	-	The SS activates the new channel without ciphering.
12	MS -> SS	HANOVER ACCESS	These four HANOVER ACCESS messages are sent on the new channel in non ciphered mode.
13	MS -> SS	HANOVER ACCESS	
14	MS -> SS	HANOVER ACCESS	
15	MS -> SS	HANOVER ACCESS	
16	MS -> SS	HANOVER COMPLETE	Sent in non ciphered mode on the new channel.

Step	Direction	Message	Comments
17	SS -> MS	ASSIGNMENT COMMAND	Includes Cipher Mode Setting IE set to "Start Ciphering", with algorithm arbitrarily selected from those supported by the MS.
18	SS		The SS activates the new channel with enciphering and deciphering enabled and using cipher key "K".
19	MS -> SS	ASSIGNMENT COMPLETE	Sent on the new channel in ciphered mode using key "K" and the commanded algorithm.
20	SS -> MS	CIPHERING MODE COMMAND	Cipher Mode Setting = "No Ciphering". The SS starts receiving in non ciphered mode.
21	MS -> SS	CIPHERING MODE COMPLETE	Sent in non ciphered mode. This message shall be ready to be transmitted before 500 ms after the completion of step 20.
22	SS	-	The SS starts transmitting in non ciphered mode.
23	SS -> MS	HANDOVER COMMAND	Includes Cipher Mode Setting IE set to "Start Ciphering", with algorithm "X" arbitrarily selected from those supported by the MS.
24	SS		The SS activates the new channel with enciphering and deciphering enabled and using cipher key "L".
25	MS -> SS	HANDOVER ACCESS	These four HANDOVER ACCESS messages are sent on the new channel in the non ciphered mode.
26	MS -> SS	HANDOVER ACCESS	
27	MS -> SS	HANDOVER ACCESS	
28	MS -> SS	HANDOVER ACCESS	
29	MS -> SS	HANDOVER COMPLETE	Sent on the new channel in ciphered mode using key "L" and algorithm "X".
30	SS -> MS	IDENTITY REQUEST	
31	MS -> SS	IDENTITY RESPONSE	
32	SS -> MS	HANDOVER COMMAND	Includes Cipher Mode Setting IE set to "Start Ciphering", with algorithm identifier set to "X".
33	SS		The SS activates the new channel with enciphering and deciphering enabled.
34	MS -> SS	HANDOVER ACCESS	These four HANDOVER ACCESS messages are sent on the new channel in the non ciphered mode.
35	MS -> SS	HANDOVER ACCESS	
36	MS -> SS	HANDOVER ACCESS	
37	MS -> SS	HANDOVER ACCESS	
38	MS -> SS	HANDOVER COMPLETE	Sent on the new channel in ciphered mode using algorithm "X".
39	SS -> MS	ASSIGNMENT COMMAND	Includes Cipher Mode Setting IE set to "No Ciphering".
40	SS		The SS activates the new channel without ciphering.
41	MS -> SS	ASSIGNMENT COMPLETE	Sent in non-ciphered mode on the new channel.
42	SS -> MS	CIPHERING MODE COMMAND	Cipher Mode Setting = "No Ciphering".
43	MS -> SS	CIPHERING MODE COMPLETE	Sent in non ciphered mode. This message shall be ready to be transmitted before 500 ms after the completion of step 42.
44	SS -> MS	AUTHENTICATION REQUEST	Contains a new Ciphering Key Sequence Number which is associated with the new cipher key, "M".
45	MS -> SS	AUTHENTICATION RESPONSE	
46	SS -> MS	HANDOVER COMMAND	Includes Cipher Mode Setting IE set to "Start Ciphering", with algorithm "Y" arbitrarily selected from those supported by the MS.
47	SS		The SS activates the new channel with enciphering and deciphering enabled and using cipher key "L".
48	MS -> SS	HANDOVER ACCESS	These four HANDOVER ACCESS messages are sent on the new channel in the non ciphered mode.
49	MS -> SS	HANDOVER ACCESS	
50	MS -> SS	HANDOVER ACCESS	
51	MS -> SS	HANDOVER ACCESS	
52	MS -> SS	HANDOVER COMPLETE	Sent on the new channel in ciphered mode using key "L"
53	SS -> MS	HANDOVER COMMAND	Includes Cipher Mode Setting IE set to "No Ciphering".
54	SS, MS		The SS does not activate the new channel The MS's transmissions on the new channel need not be monitored.
55	MS -> SS	HANDOVER FAILURE	sent on old channel using algorithm "Y" and key "L".
56	SS -> MS	IDENTITY REQUEST	
57	MS -> SS	IDENTITY RESPONSE	

Step	Direction	Message	Comments
58 59	SS -> MS SS, MS	ASSIGNMENT COMMAND	Includes Cipher Mode Setting IE set to "No Ciphering". The SS does not activate the new channel The MS's transmissions on the new channel need not be monitored. sent on old channel using algorithm "Y" and key "L".
60 61A 61B	MS -> SS SS -> MS SS -> MS	ASSIGNMENT FAILURE CHANNEL RELEASE ASSIGNMENT COMMAND	
62B	SS		Includes Cipher Mode Setting IE set to "Start Ciphering", with algorithm "Z" arbitrarily selected from those supported by the MS but different to algorithm "Y". The SS activates the new channel with enciphering and deciphering enabled. Sent on the new channel in ciphered mode using key "L" and algorithm "Z".
63B	MS -> SS	ASSIGNMENT COMPLETE	
64B 65B	SS -> MS SS	HANDOVER COMMAND	Includes Cipher Mode Setting IE set to "Start Ciphering" and the algorithm identifier set to "Y". The SS activates the new channel with enciphering and deciphering enabled. These four HANDOVER ACCESS messages are sent on the new channel in the non ciphered mode.
66B 67B 68B 69B 70B	MS -> SS MS -> SS MS -> SS MS -> SS MS -> SS	HANDOVER ACCESS HANDOVER ACCESS HANDOVER ACCESS HANDOVER ACCESS HANDOVER COMPLETE	
71B	SS -> MS	CHANNEL RELEASE	Sent on the new channel in ciphered mode using key "L" and algorithm "Y".

Specific Message Contents

GSM 450:

ASSIGNMENT COMMAND

Information Element	value/remark
Protocol Discriminator	RR Management.
Skip Indicator	0000
Message Type	00101110
Channel Description	
- Channel Type	SDCCH/8 or SDCCH4 (same type as old channel)
- TDMA offset	Chosen arbitrarily, but different to the one in use (SDCCH4), otherwise arbitrary..
- Timeslot Number	Chosen arbitrarily, but different to the one in use (SDCCH8) or Timeslot zero.(SDCCH4)
- Training Sequence Code	5 (same as the BCC).
- Hopping	Single RF channel.
- ARFCN	Channel number 265.
Power Command	
- Power level	Chosen arbitrarily but within the range supported by the MS.
Cipher Mode Setting	As specified above.
All other information elements:	Not present.

HANDOVER COMMAND

Information Element	value/remark
Protocol Discriminator	RR Management.
Skip Indicator	0000
Message Type	00101011
Cell Description	
- Network Colour Code	1
- Base station Colour Code	5
- BCCH Carrier Number	Channel Number 265.
Channel Description	
- Channel Type	SDCCH/4
- TDMA offset	Chosen arbitrarily, but different to the one in use.
- Timeslot Number	Timeslot zero.
- Training Sequence Code	5 (same as the BCC).
- Hopping	Single RF channel.
- ARFCN	Channel Number 265.
Handover Reference	
- Handover Reference Value	Chosen arbitrarily.
Power Command	
- Power level	Chosen arbitrarily, but within the range supported by the MS.
Synchronization Indication	
- Synchronization indication	synchronized.
- Report observed time difference	not included.
- Normal cell indication	out of range ignored.
Cipher Mode setting	As specified above.
All other information elements:	Not present.

CIPHER MODE COMMAND

Information Element	value/remark
As default message contents, except:	
Cipher Mode Setting	
- Algorithm Identifier	As specified above.
- Cipher Mode Set	As specified above.

GSM 480:

ASSIGNMENT COMMAND

Information Element	value/remark
Protocol Discriminator	RR Management.
Skip Indicator	0000
Message Type	00101110
Channel Description	
- Channel Type	SDCCH/8 or SDCCH4 (same type as old channel)
- TDMA offset	Chosen arbitrarily, but different to the one in use (SDCCH4), otherwise arbitrary..
- Timeslot Number	Chosen arbitrarily, but different to the one in use (SDCCH8) or Timeslot zero.(SDCCH4)
- Training Sequence Code	5 (same as the BCC).
- Hopping	Single RF channel.
- ARFCN	Channel number 315.
Power Command	
- Power level	Chosen arbitrarily but within the range supported by the MS.
Cipher Mode Setting	As specified above.
All other information elements:	Not present.

HANDOVER COMMAND

Information Element	value/remark
Protocol Discriminator	RR Management.
Skip Indicator	0000
Message Type	00101011
Cell Description	
- Network Colour Code	1
- Base station Colour Code	5
- BCCH Carrier Number	Channel Number 315.
Channel Description	
- Channel Type	SDCCH/4
- TDMA offset	Chosen arbitrarily, but different to the one in use.
- Timeslot Number	Timeslot zero.
- Training Sequence Code	5 (same as the BCC).
- Hopping	Single RF channel.
- ARFCN	Channel Number 315.
Handover Reference	
- Handover Reference Value	Chosen arbitrarily.
Power Command	
- Power level	Chosen arbitrarily, but within the range supported by the MS.
Synchronization Indication	
- Synchronization indication	synchronized.
- Report observed time difference	not included.
- Normal cell indication	out of range ignored.
Cipher Mode setting	As specified above.
All other information elements:	Not present.

CIPHER MODE COMMAND

Information Element	value/remark
As default message contents, except:	
Cipher Mode Setting	
- Algorithm Identifier	As specified above.
- Cipher Mode Set	As specified above.

GSM 900:

ASSIGNMENT COMMAND

Information Element	value/remark
Protocol Discriminator	RR Management.
Skip Indicator	0000
Message Type	00101110
Channel Description	
- Channel Type	SDCCH/8 or SDCCH4 (same type as old channel)
- TDMA offset	Chosen arbitrarily, but different to the one in use (SDCCH4), otherwise arbitrary..
- Timeslot Number	Chosen arbitrarily, but different to the one in use (SDCCH8) or Timeslot zero.(SDCCH4)
- Training Sequence Code	5 (same as the BCC).
- Hopping	Single RF channel.
- ARFCN	Channel number 30.
Power Command	
- Power level	Chosen arbitrarily but within the range supported by the MS.
Cipher Mode Setting	As specified above.
All other information elements:	Not present.

HANDOVER COMMAND

Information Element	value/remark
Protocol Discriminator	RR Management.
Skip Indicator	0000
Message Type	00101011
Cell Description	
- Network Colour Code	1
- Base station Colour Code	5
- BCCH Carrier Number	Channel Number 30.
Channel Description	
- Channel Type	SDCCH/4
- TDMA offset	Chosen arbitrarily, but different to the one in use.
- Timeslot Number	Timeslot zero.
- Training Sequence Code	5 (same as the BCC).
- Hopping	Single RF channel.
- ARFCN	Channel Number 30.
Handover Reference	
- Handover Reference Value	Chosen arbitrarily.
Power Command	
- Power level	Chosen arbitrarily, but within the range supported by the MS.
Synchronization Indication	
- Synchronization indication	synchronized.
- Report observed time difference	not included.
- Normal cell indication	out of range ignored.
Cipher Mode setting	As specified above.
All other information elements:	Not present.

CIPHER MODE COMMAND

Information Element	value/remark
As default message contents, except:	
Cipher Mode Setting	
- Algorithm Identifier	As specified above.
- Cipher Mode Set	As specified above.

DCS 1 800:

ASSIGNMENT COMMAND

Information Element	value/remark
Protocol Discriminator	RR Management.
Skip Indicator	0000
Message Type	00101110
Channel	
- Channel Type	SDCCH/8 or SDCCH4(same type as old channel)
- TDMA offset	Chosen arbitrarily, but different to the one in use (SDCCH4), otherwise arbitrary..
- Timeslot Number	Chosen arbitrarily, but different to the one in use (SDCCH8) or Timeslot zero.(SDCCH4)
- Training Sequence Code	5 (same as the BCC).
- Hopping	Single RF channel.
- ARFCN	Channel number 650.
Power Command	
- Power level	Chosen arbitrarily, but within the range supported by the MS.
Cipher Mode Setting	As specified above.
All other information elements:	Not present.

HANDOVER COMMAND

Information Element	value/remark
Protocol Discriminator	RR Management.
Skip Indicator	0000
Message Type	00101011
Cell Description	
- Network Colour Code	1
- Base station Colour Code	5
- BCCH Carrier Number	Channel Number 650.
Channel Description	
- Channel Type	SDCCH/8 or SDCCH4 (same type as old channel) Chosen arbitrarily, but different to the one in use (SDCCH4), otherwise arbitrary.
- TDMA offset	Chosen arbitrarily, but different to the one in use (SDCCH8) or Timeslot zero.(SDCCH4
- Timeslot Number	5 (same as the BCC).
- Training Sequence Code	Single RF channel.
- Hopping	Channel Number 650.
- ARFCN	
Handover Reference	
- Handover Reference Value	Chosen arbitrarily.
Power Command	
- Power level	Chosen arbitrarily, but within the range supported by the MS.
Synchronization Indication	
- Synchronization indication	synchronized.
- Report observed time difference	not included.
- Normal cell indication	out of range ignored.
Cipher Mode setting	As specified above.
All other information elements:	Not present.

PCS 1900:

ASSIGNMENT COMMAND

Information Element	value/remark
Protocol Discriminator	RR Management.
Skip Indicator	0000
Message Type	00101110
Channel	
- Channel Type	SDCCH/8 or SDCCH/4 (same type as old channel) Chosen arbitrarily, but different to the one in use (SDCCH4), otherwise arbitrary.
- TDMA offset	Chosen arbitrarily, but different to the one in use (SDCCH) or Timeslot zero (SDCCH4).
- Timeslot Number	5 (same as the BCC).
- Training Sequence Code	Single RF channel.
- Hopping	Channel number 650.
- ARFCN	
Power Command	
- Power level	Chosen arbitrarily, but within the range supported by the MS.
Cipher Mode Setting	As specified above.
All other information elements:	Not present.

HANDOVER COMMAND

Information Element	value/remark
Protocol Discriminator	RR Management.
Skip Indicator	0000
Message Type	00101011
Cell Description	
- Network Colour Code	1
- Base station Colour Code	5
- BCCH Carrier Number	Channel Number 650.
Channel Description	
- Channel Type	SDCCH/8 or SDCCH/4 (same type as old channel) Chosen arbitrarily, but different to the one in use (SDCCH4), otherwise arbitrary
- TDMA offset	Chosen arbitrarily, but different to the one in use (SDCCH) or Timeslot zero (SDCCH4).
- Timeslot Number	5 (same as the BCC).
- Training Sequence Code	Single RF channel.
- Hopping	Channel Number 650.
- ARFCN	
Handover Reference	
- Handover Reference Value	Chosen arbitrarily.
Power Command	
- Power level	Chosen arbitrarily, but within the range supported by the MS.
Synchronization Indication	
- Synchronization indication	synchronized.
- Report observed time difference	not included.
- Normal cell indication	out of range ignored.
Cipher Mode setting	As specified above.
All other information elements:	Not present.

26.6.8.5 Ciphering mode / IMEISV request

If the MS does not supply the IMEISV when requested, the network will not know whether or not the MS is type approved, i.e. whether or not it has passed any tests.

If the MS supplies its IMEISV when not requested, this may cause calls to systematically fail.

26.6.8.5.1 Conformance requirements

1. When the MS receives the CIPHERING MODE COMMAND message with Cipher Response bit set to "IMEISV shall be included", the MS shall include the IMEISV in the Mobile Identity IE in the CIPHERING MODE COMPLETE message.
2. When the MS receives the CIPHERING MODE COMMAND message with Cipher Response bit set to "IMEISV shall not be included", the MS shall not include the Mobile Identity IE in the CIPHERING MODE COMPLETE message.

References

Conformance requirement 1: GSM 04.08 sections 3.4.7.2 and 9.1.10.1.

Conformance requirement 2: GSM 04.08 section 9.1.10.1.

26.6.8.5.2 Test purpose

To verify that the MS supplies its IMEISV in the CIPHERING MODE COMPLETE message when it receives a CIPHERING MODE COMMAND message with a Cipher Response bit set to "IMEISV shall be included".

To verify that the MS does not supply any Mobile Identity IE in the CIPHERING MODE COMPLETE message when it receives a CIPHERING MODE COMMAND message with a Cipher Response bit set to "IMEISV shall not be included".

26.6.8.5.3 Method of test

Initial Conditions

System Simulator:

1 cell.

Mobile Station:

The MS is in the "idle, updated" state, with a TMSI allocated.

Related PICS/PIXIT Statements

IMEISV of the MS.

Type of MS (GSM 450 or GSM 480 or P-GSM 900 or EGSM or DCS 1 800 or PCS 1900).

Foreseen Final State of the MS

"Idle, updated", with TMSI allocated.

Test Procedure

The MS is paged. It shall send at least one CHANNEL REQUEST message. The SS sends an IMMEDIATE ASSIGNMENT and the MS shall answer with a PAGING RESPONSE. Then the SS sends a CIPHERING MODE COMMAND indicating "No ciphering" and with the Cipher Response bit set to "IMEISV shall not be included". The MS shall respond with a CIPHERING MODE COMPLETE message that does not include the Mobile Identity IE.

Then the SS sends a CIPHERING MODE COMMAND indicating "No ciphering" and with the Cipher Response bit set to "IMEISV shall be included". The MS shall respond with a CIPHERING MODE COMPLETE message that carries the IMEISV in the Mobile Identity IE.

Finally the SS sends a CHANNEL RELEASE to end the test.

Maximum Duration of Test

10 seconds.

Expected Sequence

Step	Direction	Message	Comments
1	SS -> MS	PAGING REQUEST TYPE 1	
2	MS -> SS	CHANNEL REQUEST	
3	SS -> MS	IMMEDIATE ASSIGNMENT	
4	MS -> SS	PAGING RESPONSE	
5	SS -> MS	CIPHERING MODE COMMAND	Cipher Mode Setting = "No Ciphering". Cipher Response = "IMEISV shall not be included".
6	MS -> SS	CIPHERING MODE COMPLETE	Shall not include Mobile Identity IE.
7	SS -> MS	CIPHERING MODE COMMAND	Cipher Mode Setting = "No Ciphering". Cipher Response = "IMEISV shall be included".
8	MS -> SS	CIPHERING MODE COMPLETE	Shall include one Mobile Identity IE carrying the MS's IMEISV.
9	SS -> MS	CHANNEL RELEASE	

Specific Message Contents

None.

26.6.9 Test of additional assignment

The Additional Assignment procedure is used to change an MS's channel configuration from Lm + ACCH to Lm + Lm + ACCH. It is therefore only relevant to those mobiles which perform such an operation.

No tests are specified at the moment.

26.6.10 Test of partial release

The Partial Release procedure is used to change an MS's channel configuration from Lm + Lm + ACCH to Lm + ACCH. It is therefore only relevant to those mobiles which perform such an operation.

No tests are specified at the moment.

26.6.11 Test of classmark

26.6.11.1 Classmark change

This procedure allows the MS to indicate to the network that a change in the classmark (e.g. due to addition of power amplification) has taken place.

26.6.11.1.1 Conformance requirements

If the RF power capability of the MS is changed during a call, this change shall be signalled to the network.

If the RF power capability of the MS is changed in idle mode, the up to date RF power capability shall be signalled to the network during RR connection establishment.

References

GSM 04.08 section 3.4.10.

26.6.11.1.2 Test purpose

To verify that if the RF power capability or any other capability indicated in a Classmark IE of the MS is changed during a call, the change is communicated on the DCCH to the network.

To verify that if the RF power capability or any other capability indicated in a Classmark IE of the MS is changed in idle mode, the out of date capabilities are not communicated to the network during RR connection establishment.

26.6.11.1.3 Method of test

Initial Conditions

System Simulator:

1 cell, default parameters.

Mobile Station:

The MS is in the "idle, updated" state, with a TMSI allocated and with no additional power amplification applied.

Related PICS/PIXIT Statements

Type of MS (GSM 450 or GSM 480 or P-GSM 900 or EGSM or DCS 1 800 or PCS 1900).

Support for more than one RF power class: yes/no.

Support for state U10 of the Call Control protocol.

Full rate channel modes supported by the MS

Foreseen Final State of the MS

"Idle, updated", with TMSI allocated and with no additional power amplification applied.

Test Procedure

With the MS in idle mode, the RF power capability shall be changed by the addition of power amplification, after which the MS is made to originate a call. The new RF power capability shall be included in the CM SERVICE REQUEST message. After the call has reached the Call Control state U10, the RF power capability of the MS is changed by removal of the additional power amplification. The MS shall send a CLASSMARK CHANGE message indicating the new RF power capability. The RF power capability is then changed by adding the power amplification. The MS shall again send a CLASSMARK CHANGE message indicating the new RF power capability. The call is then released by the SS.

With the MS in idle mode, the power amplification is removed. The SS then pages the MS, which in the PAGING RESPONSE message shall indicate the correct RF power capability.

Finally the SS transmits a CHANNEL RELEASE to end the test.

Maximum Duration of Test

5 minutes, including 1 minute for any necessary operator actions.

Expected Sequence

Step	Direction	Message	Comments
1	-----	-----	Add power amplification.
2	-----	-----	The MS shall be made to originate a call.
3	MS -> SS	CHANNEL REQUEST	Establ. Cause = "Originating call" NECI not equal to one.
4	SS -> MS	IMMEDIATE ASSIGNMENT	
5	MS -> SS	CM SERVICE REQUEST	The "Mobile Station Classmark 2" IE shall indicate the new RF power capability.
6	SS -> MS	CM SERVICE ACCEPT	
7	MS -> SS	SETUP	
8	SS -> MS	CALL PROCEEDING	
9	SS -> MS	ALERTING	
10	SS -> MS	ASSIGNMENT COMMAND	The Channel Mode is a non-signalling mode arbitrarily selected from the full rate capabilities declared for the MS
11	MS -> SS	ASSIGNMENT COMPLETE	
12	SS -> MS	CONNECT	
13	MS -> SS	CONNECT ACKNOWLEDGE	
14	-----	-----	Remove the power amplification.
15	MS -> SS	CLASSMARK CHANGE	The "Mobile Station Classmark 2" IE shall indicate the new power capability.
16	-----	-----	Add power amplification.
17	MS -> SS	CLASSMARK CHANGE	The "Mobile Station Classmark 2" IE shall indicate the new power capability.
18	SS -> MS	CHANNEL RELEASE	
19	-----	-----	Remove the power amplification.
	-----	-----	The SS waits 12 seconds to allow the MS to perform cell reselection.
20	SS -> MS	PAGING REQUEST TYPE 1	
21	MS -> SS	CHANNEL REQUEST	Establ. Cause = "Answer to paging".
22	SS -> MS	IMMEDIATE ASSIGNMENT	
23	MS -> SS	PAGING RESPONSE	The "Mobile Station Classmark 2" IE shall indicate the new power capability.
24	SS -> MS	CHANNEL RELEASE	

Specific Message Contents

None.

26.6.11.2 Classmark interrogation

This procedure allows the network to request the MS to supply all its classmark information to the network.

Networks may systematically use this procedure (e.g. during location updating) and, if it is incorrectly implemented in the MS, the basic connection establishment procedure may systematically fail.

26.6.11.2.1 Conformance requirements

On receipt of a CLASSMARK ENQUIRY message, the MS sends a CLASSMARK CHANGE message to the network containing the Mobile Station Classmark 2 information element and depending upon the contents of this information element, possibly the Mobile Station Classmark 3 information element.

References

GSM 04.08 sections 3.4.11 and 9.1.11.1.

GSM 04.13 section 5.2.9.

26.6.11.2.2 Test purpose

To verify that if the network requests the MS to supply all its classmark information then this information is communicated on the DCCH to the network.

26.6.11.2.3 Method of test

Initial Conditions

System Simulator:

1 cell, default parameters.

Mobile Station:

"Idle, updated", with TMSI allocated.

Related PICS/PIXIT Statements

Type of MS (GSM 450 or GSM 480 or P-GSM 900 or EGSM or DCS 1 800 or PCS 1900).

Contents of Mobile Station Classmark 2 information element.

Existence of Mobile Station Classmark 3 information element: yes/no.

Contents of Mobile Station Classmark 3 information element.

Switch off button: yes/no.

Foreseen Final State of the MS

"Idle, updated", with TMSI allocated.

Test Procedure

The MS is switched off (or has its power removed).

The SS then sets the IMSI attach-detach flag in the SYSTEM INFORMATION messages so that the MS shall perform a location update when switched on.

The MS is switched on (or its power is re-applied). The MS then initiates a location update attempt. After the mobile has sent the LOCATION UPDATING REQUEST message, the SS transmits a CLASSMARK ENQUIRY message. The MS shall be ready to transmit the CLASSMARK CHANGE message before 300 ms after the end of the CLASSMARK ENQUIRY message.

The term "ready to transmit" is defined in GSM 04.13.

Then the SS transmits a LOCATION UPDATING ACCEPT message that does not contain a Mobile Identity IE.

Maximum Duration of Test

2 minutes.

Expected Sequence

Step	Direction	Message	Comments
1	MS		The MS is switched off (or has its power removed). IMSI attach-detach flag changed. The MS is switched on (or its power is re-applied). Contents as defined for default message. This message shall be ready to be transmitted before 300 ms after the completion of step 7.
2	SS		
3	MS		
4	MS -> SS	CHANNEL REQUEST	
5	SS -> MS	IMMEDIATE ASSIGNMENT	
6	MS -> SS	LOCATION UPDATING REQUEST	
7	SS -> MS	CLASSMARK ENQUIRY	
8	MS -> SS	CLASSMARK CHANGE	
9	SS -> MS	LOCATION UPDATING ACCEPT	
10	SS -> MS	CHANNEL RELEASE	

Specific Message Contents

None.

Default Message Contents

Contents of LOCATION UPDATING ACCEPT message:

Protocol Discriminator	MM message
Skip Indicator	0000
Message Type	00000010
Location Area Identification	
- Mobile Country Code	001 decimal
- Mobile Network Code	01 decimal (PCS 1900: 011 decimal)
- Location Area Code	0001H
Mobile Identity	Not present
Follow on proceed	Not present

26.6.12 Test of channel release

The purpose of this procedure is to deactivate the dedicated channels in use. When the channels are released, the MS returns to the CCCH configuration, idle mode.

26.6.12.1 Channel release / SDCCH

26.6.12.1.1 Conformance requirements

After the acknowledgement of the Layer 2 disconnection by the network, the MS shall not produce any further RF-transmission.

References

GSM 04.08 section 3.4.13.1

26.6.12.1.2 Test purpose

To verify that the MS is able to correctly release an SDCCH after having received a CHANNEL RELEASE message.

26.6.12.1.3 Method of test

Initial Conditions

System Simulator:

1 cell, default parameters.

Mobile Station:

The MS is in the "idle, updated" state, with a TMSI allocated.

Related PICS/PIXIT Statements

Type of MS (GSM 450 or GSM 480 or P-GSM 900 or EGSM or DCS 1 800 or PCS 1900).

Foreseen Final State of the MS

"Idle, updated", with TMSI allocated.

Test Procedure

The MS is paged and allocated a dedicated channel and the Layer 2 signalling link is established. The SS then sends a CHANNEL RELEASE message, after which the MS shall initiate a Layer 2 disconnection process on the main signalling link. After the acknowledgement of the Layer 2 disconnection by the SS, the MS shall stop transmission of Layer 2 messages. This is verified for 3 seconds. The MS shall return to the idle state, which is verified through the paging procedure to which the MS shall respond.

Maximum Duration of Test

20 seconds.

Expected Sequence

Step	Direction	Message	Comments
1	SS -> MS	PAGING REQUEST TYPE 1	Establ. Cause = "Answer to paging". Channel Type = SDCCH/8 With a valid RR cause value. The MS may send the DISC message without performing a layer 2 acknowledgement of the CHANNEL RELEASE message.
2	MS -> SS	CHANNEL REQUEST	
3	SS -> MS	IMMEDIATE ASSIGNMENT	
4	MS -> SS	PAGING RESPONSE	
5	SS -> MS	CHANNEL RELEASE	
6	MS -> SS	DISC	
7	SS -> MS	UA	The SS verifies for 3 seconds that the MS does not produce any Layer 2 messages. The SS waits 12 seconds to allow the MS to perform cell reselection.
	-----	-----	
	-----	-----	
8	SS -> MS	PAGING REQUEST TYPE 1	Establ. Cause = "Answer to paging".
9	MS -> SS	CHANNEL REQUEST	
10	SS -> MS	IMMEDIATE ASSIGNMENT	
11	MS -> SS	PAGING RESPONSE	
12	SS -> MS	CHANNEL RELEASE	

Specific Message Contents

None.

26.6.12.2 Channel release / SDCCH - no L2 ACK

26.6.12.2.1 Conformance requirements

After the expiry of timer T3110 the MS shall not produce any further RF-transmission.

References

GSM 04.08 section 3.4.13.1

26.6.12.2.2 Test purpose

To verify that the MS is able to correctly release a SDCCH after having received a CHANNEL RELEASE message, even if the SS does not L2 acknowledge the L2 DISC frame.

26.6.12.2.3 Method of test

Initial Conditions

System Simulator:

1 cell, default parameters.

Mobile Station:

The MS is in the "idle, updated" state, with a TMSI allocated.

Related PICS/PIXIT Statements

Type of MS (GSM 450 or GSM 480 or P-GSM 900 or EGSM or DCS 1 800 or PCS 1900).

Foreseen Final State of the MS

"Idle, updated", with TMSI allocated.

Test Procedure

The MS is paged and allocated a dedicated channel and the Layer 2 signalling link is established. The SS then sends a CHANNEL RELEASE message, after which the MS shall send at least 2 L2 DISC frames. The SS does not acknowledge any of the L2 DISC frames. After 2 seconds, the SS verifies for 3 seconds that the MS has stopped transmission of Layer 2 messages. The MS shall return to the idle state, which is verified through the paging procedure to which the MS shall respond.

Maximum Duration of Test

25 seconds.

Expected Sequence

Step	Direction	Message	Comments
1	SS -> MS	PAGING REQUEST TYPE 1	Establ. Cause = "Answer to paging". Channel Type = SDCCH/8. With a valid RR cause value. The MS may send the DISC message without performing a layer 2 acknowledgement of the CHANNEL RELEASE message. The MS shall send at least 2 L2 DISC frames, to which the SS does not respond. After a period of 2 seconds, the SS verifies for 3 seconds that the MS does not produce any further Layer 2 messages. The SS waits 12 seconds to allow the MS to perform cell reselection.
2	MS -> SS	CHANNEL REQUEST	
3	SS -> MS	IMMEDIATE ASSIGNMENT	
4	MS -> SS	PAGING RESPONSE	
5	SS -> MS	CHANNEL RELEASE	
6	MS -> SS	DISC	
	-----	-----	
7	SS -> MS	PAGING REQUEST TYPE 1	Establ. Cause = "Answer to paging".
8	MS -> SS	CHANNEL REQUEST	
9	SS -> MS	IMMEDIATE ASSIGNMENT	
10	MS -> SS	PAGING RESPONSE	
11	SS -> MS	CHANNEL RELEASE	

Specific Message Contents

None.

26.6.12.3 Channel release / TCH-F

26.6.12.3.1 Conformance requirements

After the acknowledgement of the Layer 2 disconnection by the network the MS shall not produce any further RF-transmission.

References

GSM 04.08 section 3.4.13.1

26.6.12.3.2 Test purpose

To verify that the MS is able to correctly release a full-rate TCH after having received a CHANNEL RELEASE message.

26.6.12.3.3 Method of test

Initial Conditions

System Simulator:

1 cell, default parameters.

Mobile Station:

The MS is in the "idle, updated" state, with a TMSI allocated.

Related PICS/PIXIT Statements

Type of MS (GSM 450 or GSM 480 or P-GSM 900 or EGSM or DCS 1 800 or PCS 1900).

Supported rate of TCH: TCH/F.

Foreseen Final State of the MS

"Idle, updated", with TMSI allocated.

Test Procedure

The MS is paged and allocated a dedicated channel and the Layer 2 signalling link is established. The SS then sends a CHANNEL RELEASE message, after which the MS shall initiate a Layer 2 disconnection process on the main signalling link. After the acknowledgement of the Layer 2 disconnection by the SS, the MS shall stop transmission of Layer 2 messages. This is verified for 3 seconds. The MS shall return to the idle state, which is verified through the paging procedure to which the MS shall respond.

Maximum Duration of Test

20 seconds.

Expected Sequence

Step	Direction	Message	Comments
1	SS -> MS	PAGING REQUEST TYPE 1	Establ. Cause = "Answer to paging". Channel Type = "Bm + ACCHs"
2	MS -> SS	CHANNEL REQUEST	
3	SS -> MS	IMMEDIATE ASSIGNMENT	
4	MS -> SS	PAGING RESPONSE	
5	SS -> MS	CHANNEL RELEASE	
6	MS -> SS	DISC	
7	SS -> MS	UA	With a valid RR cause value. The MS may send the DISC message without performing a layer 2 acknowledgement of the CHANNEL RELEASE message. The SS verifies for 3 seconds that the MS does not produce any Layer 2 messages. The SS waits 12 seconds to allow the MS to perform cell reselection.
	-----	-----	
	-----	-----	
8	SS -> MS	PAGING REQUEST TYPE 1	Establ. Cause = "Answer to paging".
9	MS -> SS	CHANNEL REQUEST	
10	SS -> MS	IMMEDIATE ASSIGNMENT	
11	MS -> SS	PAGING RESPONSE	
12	SS -> MS	CHANNEL RELEASE	

Specific Message Contents

None.

26.6.12.4 Channel release / TCH-F - no L2 ACK

26.6.12.4.1 Conformance requirements

After the expiry of timer T3110 the MS shall not produce any further RF-transmission.

References

GSM 04.08 section 3.4.13.1

26.6.12.4.2 Test purpose

To verify that the MS is able to correctly release a TCH/F after having received a CHANNEL RELEASE message, even if the SS does not L2 acknowledge the L2 DISC frame.

26.6.12.4.3 Method of test

Initial Conditions

System Simulator:

1 cell, default parameters.

Mobile Station:

The MS is in the "idle, updated" state, with a TMSI allocated.

Related PICS/PIXIT Statements

Type of MS (GSM 450 or GSM 480 or P-GSM 900 or EGSM or DCS 1 800 or PCS 1900).

Supported rate of TCH: TCH/F.

Foreseen Final State of the MS

"Idle, updated", with TMSI allocated.

Test Procedure

The MS is paged and allocated a dedicated channel and the Layer 2 signalling link is established. The SS then sends a CHANNEL RELEASE message (with cause "abnormal release, unspecified"), after which the MS shall send at least 2 L2 DISC frames. The SS does not acknowledge any of the L2 DISC frames. After 2 seconds, the SS verifies for 3 seconds that the MS has stopped transmission of Layer 2 messages. The MS shall return to the idle state, which is verified through the paging procedure to which the MS shall respond.

Maximum Duration of Test

25 seconds.

Expected Sequence

Step	Direction	Message	Comments
1	SS -> MS	PAGING REQUEST TYPE 1	Establ. Cause = "Answer to paging". Channel Type = "Bm + ACCHs". Cause value = "Abnormal release, unspecified". The MS may send the DISC message without performing a layer 2 acknowledgement of the CHANNEL RELEASE message. The MS shall send at least 2 L2 DISC frames, to which the SS does not respond. After a period of 2 seconds, the SS verifies for 3 seconds that the MS does not produce any further Layer 2 messages. The SS waits 12 seconds to allow the MS to perform cell reselection.
2	MS -> SS	CHANNEL REQUEST	
3	SS -> MS	IMMEDIATE ASSIGNMENT	
4	MS -> SS	PAGING RESPONSE	
5	SS -> MS	CHANNEL RELEASE	
6	MS -> SS	DISC	
	-----	-----	
7	SS -> MS	PAGING REQUEST TYPE 1	Establ. Cause = "Answer to paging". Channel Type = SDCCH/8.
8	MS -> SS	CHANNEL REQUEST	
9	SS -> MS	IMMEDIATE ASSIGNMENT	
10	MS -> SS	PAGING RESPONSE	
11	SS -> MS	CHANNEL RELEASE	

Specific Message Contents

None.

26.6.13 Test of starting time

The Assignment, Handover and immediate assignment procedures can include a delayed change of frequency list, MAIO and HSN. This series of tests checks the behaviour of the Mobile Station when receiving channel allocation messages with a starting time and channel description for both before and after the starting time. Tests checking the phase 1 usage of the starting time (that is without a channel description for before the time) are included in the series related to immediate assignment, dedicated assignment and handover.

Throughout section 26.6.13 the defaults in section 26.6.14 for GSM 900, 26.6.15 for DCS 1 800, 26.6.16 for GSM 450 and 26.6.17 for GSM 480 are used with the following exceptions:

Contents of IMMEDIATE ASSIGNMENT message, unless otherwise defined in the individual test cases:

L2 pseudo length	This is the sum of the lengths of all the information elements present in the message except for the IA rest octets and L2 pseudo length IEs. For the default message the L2 pseudo length is 11.
Protocol Discriminator	RR Management.
Skip Indicator	0000
Message Type	00111111
Page Mode	
- Page Mode	Normal Paging.
Channel Description	
- Channel Type and TDMA offset	Chosen arbitrarily (see initial conditions).
- Timeslot Number	Chosen arbitrarily by the test house;
- Training Sequence Code	Chosen arbitrarily by the test house
- Hopping	Yes.
- Hopping parameters	Chosen arbitrarily.
Request Reference	Pertaining to last Channel Request sent by the MS.
Timing Advance	
- Timing advance value	30 bit periods.
Mobile Allocation	Chosen arbitrarily, at least one frequency. In case of an MA with just one frequency, the frequency should be different from the BCCH carrier.
Starting Time	Not present.
IA rest octets	Not used (all bits set to spare).

GSM 450:

Cell A has:

BCCH ARFCN = 263.

Cell Allocation = (259, 261, 263, 265, 267, 269, 271, 273, 275, 277, 279, 281, 283, 285, 287, 289, 291).

Cell B has:

BCCH ARFCN = 274.

Cell Allocation = (260, 262, 264, 266, 268, 270, 272, 274, 276, 279, 281, 283, 285, 287, 289, 291).

Base station Colour Code = different to Cell A

The Cell Allocation of both Cell A and Cell B shall be coded using range 128 format.

(The BCCH ARFCNs are already included in the default BA-List.)

GSM 480:

Cell A has:

BCCH ARFCN = 310.

Cell Allocation = (306, 308, 310, 312, 314, 316, 318, 320, 322, 324, 326, 328, 330, 332, 334, 336, 338).

Cell B has:

BCCH ARFCN = 321.

Cell Allocation = (307, 309, 311, 313, 315, 317, 319, 321, 323, 326, 328, 330, 332, 334, 336, 338).

Base station Colour Code = different to Cell A

The Cell Allocation of both Cell A and Cell B shall be coded using range 128 format.

(The BCCH ARFCNs are already included in the default BA-List.)

GSM 900:

Cell A has:

BCCH ARFCN = 20.

Cell Allocation = (10, 17, 20, 26, 34, 42, 45, 46, 52, 59, 66, 73, 74, 75, 76, 108, 114).

Cell B has:

BCCH ARFCN = 40.

Cell Allocation = (14, 18, 22, 24, 30, 31, 38, 40, 60, 66, 73, 74, 75, 76, 108, 114).

Base station Colour Code = different to Cell A

The Cell Allocation of both Cell A and Cell B shall be coded using bit map 0 format.

(The BCCH ARFCNs are already included in the default BA-List.)

DCS 1 800:

Cell A has:

BCCH ARFCN = 747.

Cell Allocation = (737, 741, 747, 754, 759, 762, 766, 767, 773, 775, 779, 782, 791, 798, 829, 832, 844).

Base station Colour Code = different to Cell A

Cell B has:

BCCH ARFCN = 764.

Cell Allocation = (739, 743, 746, 749, 756, 758, 761, 764, 771, 779, 782, 791, 798, 829, 832, 844).

The Cell Allocation of both Cell A and Cell B shall be coded using range 256 format.

The BCCH ARFCNs shall be added to the default BA-List.

PCS 1900:

Cell A has:

BCCH ARFCN = 647.

Cell Allocation = (637, 641, 647, 654, 659, 662, 666, 667, 673, 675, 679, 682, 691, 698, 729, 732, 744).

Cell B has:

BCCH ARFCN = 664.

Cell Allocation = (639, 643, 646, 649, 656, 658, 661, 664, 671, 679, 682, 691, 698, 729, 732, 744).

The Cell Allocation of both Cell A and Cell B shall be coded using range 256 format.

The BCCH ARFCNs shall be added to the default BA-List.

26.6.13.1 Dedicated assignment with starting time / successful case / time not elapsed

26.6.13.1.1 Conformance requirement

A Mobile Station receiving an ASSIGNMENT COMMAND message with a starting time and channel descriptions for both after and before the starting time, and ready to access before the indicated time has elapsed, shall perform the assignment on the channels as described for before the starting time and shall start using the new frequency parameters (frequencies and hopping sequence, or single frequency) in the correct time slot indicated by the starting time.

The Mobile Station shall accept the ASSIGNMENT COMMAND message for different message formatting, differing by the information elements used to describe frequency lists.

Reference(s)

GSM 04.08 sub-clauses 3.4.3.1, 9.1.2.

26.6.13.1.2 Test purpose

To verify that the MS, after receiving an ASSIGNMENT COMMAND message with a starting time and channel descriptions both for before and after the starting time, and ready to access before the indicated time, performs correctly the assignment using the description for before the time, and eventually starts using the frequency parameters for after the time at the time indicated in the message.

26.6.13.1.3 Method of test

Initial condition(s)

System Simulator:

1 cell, CCCH_CONF set to 1 basic physical channel used for CCCH, not combined with SDCCHs.

Mobile Station:

The MS is in the "idle, updated" state, with a TMSI allocated.

Related PICS/PIXIT statement(s)

- TCH supported (Y/N)
- Supported rate(s) of TCH: (F/F+H).
- The supported channel mode(s) need to be declared.
- Supported frequencies (GSM 450, GSM 480, P-GSM, E-GSM, R-GSM or DCS 1 800 or PCS 1900).

Foreseen final state of the MS

"Idle, updated", with TMSI allocated.

Test procedure

The System Simulator pages the MS and after the MS has responded with a CHANNEL REQUEST, the simulator assigns a hopping SDCCH. Then the SS sends an ASSIGNMENT COMMAND message allocating a channel (TCH/F, TCH/H or SDCCH, arbitrarily chosen among the channels supported), with a starting time and channel descriptions (hopping case) for both before and after the starting time, as detailed in the "specific message contents" clause. The indicated time is such that the Mobile Station is ready to access before that time. The Mobile Station then accesses the channel as described for before the starting time. The MS shall eventually, at the TDMA frame defined by the contents of the "Starting Time" information element of the ASSIGNMENT COMMAND message, use the new frequency parameters. The verification is performed at the RF burst level.

Test parameters:

T1 is set to $T0+60$ and $T0+1000 \pmod{42\,432}$, where T0 is the frame number at which the first burst of the ASSIGNMENT COMMAND message is sent.

Maximum duration of test

45 sec.

Expected sequence

Step	Direction	Message	Comments
1	SS -> MS	PAGING REQUEST TYPE 1	
2	MS -> SS	CHANNEL REQUEST	
3	SS -> MS	IMMEDIATE ASSIGNMENT	Hopping channel.
4	MS -> SS	PAGING RESPONSE	
5	SS -> MS	ASSIGNMENT COMMAND	See specific message contents.
6	MS -> SS	ASSIGNMENT COMPLETE	Sent on the correct channel (before time parameters) after establishment of the main signalling link.
7	-----	Time T1	The SS checks that the MS is transmitting now on the correct frequencies (after time parameters) and that the transmission started in the correct frame.
8	SS -> MS	CHANNEL RELEASE	

Specific message contents

ASSIGNMENT COMMAND

Information element	Value/remark
Channel Description, after time	
Channel Type and TDMA offset	Chosen arbitrarily among that supported by the Mobile Station.
Timeslot Number	Chosen arbitrarily.
Training Sequence Code	Chosen arbitrarily.
Hopping	Yes.
Hopping parameters	Chosen arbitrarily.
Power Command	
Power level	Chosen arbitrarily.
Channel Mode	
Mode	Arbitrarily selected from capabilities declared for the MS for the chosen type of channel.
Mobile Allocation, after time	Chosen arbitrarily, at least one frequency. In case of an MA with just one frequency, the frequency should be different from the BCCH carrier.
Starting Time	T1
Channel Description, before time	
Channel Type and TDMA offset	Same as after time.
Timeslot Number	Same as after time.
Training Sequence Code	Same as after time.
Hopping	Yes.
Hopping parameters	Chosen arbitrarily, different from "after time".
Mobile Allocation, before time	Chosen arbitrarily, at least one frequency and different from "Mobile Allocation, after time". In case of an MA with just one frequency, the frequency should be different from the BCCH carrier.

26.6.13.2 Dedicated assignment with starting time / successful case / time elapsed

26.6.13.2.1 Conformance requirement

A Mobile Station receiving an ASSIGNMENT COMMAND message with a starting time and channel descriptions for both after and before the starting time, and ready to access after the indicated time has elapsed, shall perform the assignment on the channels as described for after the starting time.

The Mobile Station shall accept the ASSIGNMENT COMMAND message for different message formattings, differing by the information elements used to describe frequency lists.

Reference(s):

GSM 04.08 sub-clauses 3.4.3.1, 9.1.2.

26.6.13.2.2 Test purpose

To verify that the MS, after receiving an ASSIGNMENT COMMAND message with a starting time and channel descriptions both for before and after the starting time, performs correctly the assignment using the frequency parameters for after the time if the indicated time has already elapsed when the Mobile Station is ready to transmit.

26.6.13.2.3 Method of test

Initial condition(s)

System Simulator:

1 cell, CCCH_CONF set to 1 basic physical channel used for CCCH, not combined with SDCCHs.

Mobile Station:

The MS is in the "idle, updated" state, with a TMSI allocated.

Related PICS/PIXIT statement(s)

- TCH supported (Y/N).
- Supported rate(s) of TCH: (F/F+H).
- The supported channel mode(s) need to be declared.
- Supported frequencies (GSM 450, GSM 480, P-GSM, E-GSM, R-GSM or DCS 1 800 or PCS 1900).

Foreseen final state of the MS

"Idle, updated", with TMSI allocated.

Test procedure

The System Simulator pages the MS and after the MS has responded with a CHANNEL REQUEST, the simulator assigns a hopping SDCCH. Then the SS sends an ASSIGNMENT COMMAND message allocating a channel (TCH/F, TCH/H or SDCCH, arbitrarily chosen among the channels supported), with a starting time and channel descriptions (hopping case) for both before and after the starting time, as detailed in the "specific message contents" clause. The indicated time is such that the Mobile Station is ready to access only after that time. The Mobile Station then accesses the channel as described for after the starting time. The verification is performed at the RF burst level.

Test parameters:

T1 is set to $T0+5 \pmod{42\,432}$, where T0 is the frame number at which the first burst of the ASSIGNMENT COMMAND message is sent.

Maximum duration of test

45 sec.

Expected sequence

Step	Direction	Message	Comments
1	SS -> MS	PAGING REQUEST TYPE 1	
2	MS -> SS	CHANNEL REQUEST	Hopping channel.
3	SS -> MS	IMMEDIATE ASSIGNMENT	
4	MS -> SS	PAGING RESPONSE	
5	SS -> MS	ASSIGNMENT COMMAND	See specific message contents.
6	MS -> SS	ASSIGNMENT COMPLETE	Sent on the correct channel (after time parameters) after establishment of the main signalling link.
7	SS -> MS	CHANNEL RELEASE	

Specific message contents

ASSIGNMENT COMMAND

Information element	Value/remark
Channel Description, after time	
Channel Type and TDMA offset	Chosen arbitrarily among that supported by the Mobile Station.
Timeslot Number	Chosen arbitrarily.
Training Sequence Code	Chosen arbitrarily.
Hopping	Yes.
Hopping parameters	Chosen arbitrarily.
Power Command	
Power level	Chosen arbitrarily.
Channel Mode	
Mode	Arbitrarily selected from capabilities declared for the MS for the chosen type of channel.
Mobile Allocation, after time	Chosen arbitrarily, at least one frequency. In case of an MA with just one frequency, the frequency should be different from the BCCH carrier.
Starting Time	T1
Channel Description, before time	
Channel Type and TDMA offset	Same as after time.
Timeslot Number	Same as after time.
Training Sequence Code	Same as after time.
Hopping	Yes.
Hopping parameters	Chosen arbitrarily, different from "after time".
Mobile Allocation, before time	Chosen arbitrarily, at least one frequency and different from "Mobile Allocation, after time". In case of an MA with just one frequency, the frequency should be different from the BCCH carrier.

26.6.13.3 Dedicated assignment with starting time and frequency redefinition / failure case / time not elapsed

26.6.13.3.1 Conformance requirement

An MS, after receiving a FREQUENCY REDEFINITION message, shall keep the provided information until the time is elapsed. The Mobile Station must accept an intervening dedicated assignment, and, in case of failure of this assignment resulting in a return to the old channel before the time indicated in the FREQUENCY REDEFINITION message, shall return on the old channel with the frequency parameters in use at the moment of the reception of the FREQUENCY REDEFINITION message, and shall eventually start using the new frequency parameters in the correct time slot indicated by the starting time of the FREQUENCY REDEFINITION message.

Reference(s):

GSM 04.08 sub-clauses 3.4.3 and 3.4.5.

26.6.13.3.2 Test purpose

To verify that the MS, after receiving a FREQUENCY REDEFINITION and then an ASSIGNMENT COMMAND message with a starting time and channel descriptions both for before and after the starting time, failing the assignment and returning on the old channel, and ready to access before the time indicated in the FREQUENCY REDEFINITION, resumes transmission on the channels used at the time of the reception of the FREQUENCY REDEFINITION message and eventually starts using the new frequency parameters at the time indicated in the FREQUENCY REDEFINITION message.

26.6.13.3.3 Method of test

Initial condition(s)

System Simulator:

1 cell, CCCH_CONF set to 1 basic physical channel used for CCCH, not combined with SDCCHs.

Mobile Station:

The MS is in the "idle, updated" state, with a TMSI allocated.

Related PICS/PIXIT statement(s)

- TCH supported (Y/N).
- Supported rate(s) of TCH: (F/F+H).
- The supported channel mode(s) need to be declared.
- Supported frequencies (GSM 450, GSM 480, P-GSM, E-GSM, R-GSM or DCS 1 800 or PCS 1900).

Foreseen final state of the MS

"Idle, updated", with TMSI allocated.

Test procedure

The System Simulator pages the MS and after the MS has responded with a CHANNEL REQUEST, the simulator assigns allocating a hopping channel (TCH/F, TCH/H or SDCCH, arbitrarily chosen among the channels supported). Then the SS sends a FREQUENCY REDEFINITION message (starting time T1), which modifies the frequency parameters to be used by the MS. Then the SS sends an ASSIGNMENT COMMAND message, with a starting time (T2) and channel descriptions for both before and after the starting time. The channels and hopping sequences so allocated are distinct from those used and from those described by the FREQUENCY REDEFINITION message. The System Simulator does not activate the channels defined in the ASSIGNMENT COMMAND. The MS shall try to activate the new channel (this is not verified) and shall then reactivate the old channel and trigger the establishment of the main signalling link on the old channel. Then the MS shall send an ASSIGNMENT FAILURE message. Time T1 is chosen so it is reached only after the sending of the ASSIGNMENT FAILURE message. The MS shall eventually, at the TDMA frame defined by the contents of the "Starting Time" information element of the FREQUENCY REDEFINITION message, use the new frequency parameters. The verification is performed at the RF burst level.

Test parameters:

T1 is set to $T0+5000 \pmod{42\,432}$, where T0 is the frame number at which the first burst of the FREQUENCY REDEFINITION message is sent.

T2 is set to $T0+4000 \pmod{42\,432}$, where T0 is the frame number at which the first burst of the FREQUENCY REDEFINITION message is sent.

Maximum duration of test

180 sec.

Expected sequence

Step	Direction	Message	Comments
1	SS -> MS	PAGING REQUEST TYPE 1	
2	MS -> SS	CHANNEL REQUEST	
3	SS -> MS	IMMEDIATE ASSIGNMENT	Hopping channel.
4	MS -> SS	PAGING RESPONSE	
5	SS -> MS	FREQUENCY REDEFINITION	
6	SS -> MS	ASSIGNMENT COMMAND	Hopping channel, type among possible, signalling mode.
7	MS -> SS	ASSIGNMENT FAILURE	Sent on the correct channel (original parameters) after establishment of the main signalling link.
8	-----	Time T1	The SS checks that the MS is transmitting now on the correct frequencies (parameters of the FREQUENCY REDEFINITION message) and that the transmissions started in the correct frame.
9	SS -> MS	CHANNEL RELEASE	

Specific message contents

FREQUENCY REDEFINITION

Information element	Value/remark
Channel Description	
Channel Type and TDMA offset	Same as in IMMEDIATE ASSIGNMENT
Timeslot Number	Same as in IMMEDIATE ASSIGNMENT
Training Sequence Code	Same as in IMMEDIATE ASSIGNMENT
Hopping	Yes
Hopping parameters	Chosen arbitrarily, different than those of the IMMEDIATE ASSIGNMENT message, HSN same as in IMMEDIATE ASSIGNMENT.
Mobile Allocation	Chosen arbitrarily, at least two frequencies, different than those of the IMMEDIATE ASSIGNMENT message.
Starting Time	T1

ASSIGNMENT COMMAND:

Information element	Value/remark
Channel Description, after time	
Channel Type and TDMA offset	Chosen arbitrarily among that supported by the Mobile Station.
Timeslot Number	Chosen arbitrarily.
Training Sequence Code	Chosen arbitrarily.
Hopping	Yes.
Hopping parameters	Chosen arbitrarily.
Power Command	
Power level	Chosen arbitrarily.
Channel Mode	
Mode	Arbitrarily selected from capabilities declared for the MS for the chosen type of channel.
Mobile Allocation, after time	Chosen arbitrarily, at least two frequency.
Starting Time	T2
Channel Description, before time	
Channel Type and TDMA offset	Same as after time.
Timeslot Number	Same as after time.
Training Sequence Code	Same as after time.
Hopping	Yes.
Hopping parameters	Chosen arbitrarily, different from "after time".
Mobile Allocation, before time	Chosen arbitrarily, at least two frequencies, different from "Mobile Allocation, after time".

26.6.13.4 Dedicated assignment with starting time and frequency redefinition / failure case / time elapsed

26.6.13.4.1 Conformance requirement

An MS, after receiving a FREQUENCY REDEFINITION message, shall keep the provided information until the time is elapsed. The Mobile Station must accept an intervening dedicated assignment, and, in case of failure of this assignment resulting in a return to the old channel after the time indicated in the FREQUENCY REDEFINITION message, shall return on the old channel with the frequency parameters indicated in the FREQUENCY REDEFINITION message.

Reference(s):

GSM 04.08 sub-clauses 3.4.3 and 3.4.5.

26.6.13.4.2 Test purpose

To verify that the MS, after receiving a FREQUENCY REDEFINITION and then an ASSIGNMENT COMMAND message with a starting time and channel descriptions both for before and after the starting time, failing the assignment and returning on the old channel, and ready to access after the time indicated in the FREQUENCY REDEFINITION, resumes transmission using the new frequency parameters indicated in the FREQUENCY REDEFINITION message.

26.6.13.4.3 Method of test

Initial condition(s)

System Simulator:

1 cell, CCCH_CONF set to 1 basic physical channel used for CCCH, not combined with SDCCHs.

Mobile Station:

The MS is in the "idle, updated" state, with a TMSI allocated.

Related PICS/PIXIT statement(s)

- Supported frequencies (GSM 450, GSM 480, P-GSM, E-GSM, R-GSM or DCS 1 800 or PCS 1900).

Foreseen final state of the MS

"Idle, updated", with TMSI allocated.

Test procedure

The System Simulator pages the MS and after the MS has responded with a CHANNEL REQUEST, the simulator assigns allocating a hopping channel (SDCCH). Then the SS sends a FREQUENCY REDEFINITION message (starting time T1), which modifies the frequency parameters to be used by the MS. Then the SS sends an ASSIGNMENT COMMAND message, with a starting time (T2) and channel descriptions for both before and after the starting time. Time T1 is chosen so it is reached after the sending of the ASSIGNMENT COMMAND message, but before the return on the old channel. The System Simulator does not activate the channels defined in the ASSIGNMENT COMMAND. The MS shall try to activate the new channel (this is not verified) and shall then reactivate the old channel with the new frequency parameters as indicated by the FREQUENCY REDEFINITION message, and trigger the establishment of the main signalling link on the old channel. Then the MS shall send an ASSIGNMENT FAILURE message. The verification is performed at the RF burst level.

Test parameters:

i.e. for SDCCH

T2 is set to $T0 + 5000 \pmod{42432}$, where T0 is the frame number at which the first burst of the FREQUENCY REDEFINITION message is sent.

T1 is set to $T0 + 214 \pmod{42432}$, where T0 is the frame number at which the first burst of the FREQUENCY REDEFINITION message is sent.

NOTE: T0 + 214 is calculated for a maximum execution time of:

- FREQUENCY REDEFINITION using 1 L2 frame 51 frames
- ASSIGNMENT COMMAND using 2 L2 frames 102 frames
- + 120 ms maximum time for a channel change 25 frames
- + some frames contention (here 36)

Maximum duration of test

180 sec.

Expected sequence

Step	Direction	Message	Comments
1	SS -> MS	PAGING REQUEST TYPE 1	
2	MS -> SS	CHANNEL REQUEST	
3	SS -> MS	IMMEDIATE ASSIGNMENT	Hopping channel.
4	MS -> SS	PAGING RESPONSE	
5	SS -> MS	FREQUENCY REDEFINITION	
6	SS -> MS	ASSIGNMENT COMMAND	Hopping channel, type among possible, signalling mode.
7	MS -> SS	ASSIGNMENT FAILURE	Sent on the correct channel (parameters from the FREQUENCY REDEFINITION message) after establishment of the main signalling link.
8	SS -> MS	CHANNEL RELEASE	

Specific message contents

FREQUENCY REDEFINITION

Information element	Value/remark
Channel Description	
Channel Type and TDMA offset	Same as in IMMEDIATE ASSIGNMENT
Timeslot Number	Same as in IMMEDIATE ASSIGNMENT
Training Sequence Code	Same as in IMMEDIATE ASSIGNMENT
Hopping	Yes
Hopping parameters	Chosen arbitrarily, different than those of the IMMEDIATE ASSIGNMENT message.
Mobile Allocation	Chosen arbitrarily, at least two frequencies, different than those of the IMMEDIATE ASSIGNMENT message, HSN same as in IMMEDIATE ASSIGNMENT.
Starting Time	T1

ASSIGNMENT COMMAND

Information element	Value/remark
Channel Description, after time	
Channel Type and TDMA offset	Chosen arbitrarily among that supported by the Mobile Station.
Timeslot Number	Chosen arbitrarily.
Training Sequence Code	Chosen arbitrarily.
Hopping	Yes.
Hopping parameters	Chosen arbitrarily.
Power Command	
Power level	Chosen arbitrarily.
Channel Mode	
Mode	Arbitrarily selected from capabilities declared for the MS for the chosen type of channel.
Mobile Allocation, after time	Chosen arbitrarily, at least two frequencies.
Starting Time	T2
Channel Description, before time	
Channel Type and TDMA offset	Same as after time.
Timeslot Number	Same as after time.
Training Sequence Code	Same as after time.
Hopping	Yes.
Hopping parameters	Chosen arbitrarily, different from "after time".
Mobile Allocation, before time	Chosen arbitrarily, at least two frequencies, different from "Mobile Allocation, after time".

26.6.13.5 Handover with starting time / successful case / time not elapsed

26.6.13.5.1 Conformance requirement

A Mobile Station receiving an HANOVER COMMAND message with a starting time and channel descriptions for both after and before the starting time, and ready to access before the indicated time has elapsed, shall perform the handover on the channels as described for before the starting time and shall, if specified, use the parameters in the frequency list, MAIO and HSN, in the correct time slot indicated by the starting time.

The Mobile Station shall accept the HANOVER COMMAND message for different message formatting, differing by the information elements used to describe frequency lists.

Reference(s):

GSM 04.08 sub-clauses 3.4.4.1 and 9.1.15.

26.6.13.5.2 Test purpose

To verify that the MS, after receiving a HANOVER COMMAND message with a starting time and channel descriptions both for before and after the starting time, and ready to access before the indicated time, performs correctly the handover using the description for before the time, and then starts using the frequency parameters for after the time at the time indicated in the message.

26.6.13.5.3 Method of test

Initial condition(s)

System Simulator:

2 cells, CCCH_CONF set to 1 basic physical channel used for CCCH, not combined with SDCCHs.

Mobile Station:

The MS is in the "idle, updated" state, with a TMSI allocated.

Related PICS/PIXIT statement(s)

- TCH supported (Y/N).
- Supported rate(s) of TCH: (F/F+H).
- The supported channel mode(s) need to be declared.
- Supported frequencies (GSM 450, GSM 480, P-GSM, E-GSM, R-GSM or DCS 1 800 or PCS 1900).

Foreseen final state of the MS

"Idle, updated", with TMSI allocated, and camped on cell B.

Test procedure

The System Simulator pages the MS and after the MS has responded with a CHANNEL REQUEST, the simulator assigns a hopping SDCCH. After the SS has received measurements concerning cell B, the SS sends a HANOVER COMMAND message allocating a channel (TCH/F, TCH/H or SDCCH, arbitrarily chosen among the channels supported), with a starting time and channel descriptions (hopping case) for both before and after the starting time, as detailed in the "specific message contents" clause. The indicated time is such that the Mobile Station is ready to access before that time. The Mobile Station then accesses the channel as described for before the starting time. The MS shall eventually, at the TDMA frame defined by the contents of the "Starting Time" information element of the HANOVER COMMAND message, use the new frequency parameters. The verification is performed at the RF burst level.

Test parameters:

T1 is set to $T0+1000 \pmod{42432}$, where T0 is the frame number at which the first burst of the HANOVER COMMAND message is sent.

Maximum duration of test

120 sec.

Expected sequence

Step	Direction	Message	Comments
1	SS -> MS	PAGING REQUEST TYPE 1	
2	MS -> SS	CHANNEL REQUEST	
3	SS -> MS	IMMEDIATE ASSIGNMENT	Hopping channel.
4	MS -> SS	PAGING RESPONSE	
5	SS -> MS	HANOVER COMMAND	See specific message contents.
6	MS -> SS	HANOVER ACCESS	Repeated on every burst of the uplink main DCCH until reception of PHYSICAL INFORMATION.
7	SS -> MS	PHYSICAL INFORMATION	
8	MS -> SS	HANOVER COMPLETE	Sent on the correct channel (before time parameters) after establishment of the main signalling link.
9	-----	Time T1	The SS checks that the MS is transmitting now on the correct frequencies (after time parameters) and that the transmissions started in the correct frame.
10	SS -> MS	CHANNEL RELEASE	

Specific message contents

HANDOVER COMMAND:

Information element	Value/remark
Cell Description	As for cell B.
Channel Description, after time	
Channel Type and TDMA offset	Chosen arbitrarily among that supported by the Mobile Station.
Timeslot Number	Chosen arbitrarily.
Training Sequence Code	Chosen arbitrarily.
Hopping	Yes.
Hopping parameters	Chosen arbitrarily.
Power Command	
Power level	Chosen arbitrarily.
Synchronization indication	Non synchronized.
Cell Channel Description	As for cell B.
Channel Mode	
Mode	Arbitrarily selected from capabilities declared for the MS for the chosen type of channel.
Mobile Allocation, after time	Chosen arbitrarily, at least one frequency. In case of an MA with just one frequency, the frequency should be different from the BCCH carrier.
Starting Time	T1
Channel Description, before time	
Channel Type and TDMA offset	Same as after time.
Timeslot Number	Same as after time.
Training Sequence Code	Same as after time.
Hopping	Yes.
Hopping parameters	Chosen arbitrarily, different from "after time".
Mobile Allocation, before time	Chosen arbitrarily, at least one frequency, different from "Mobile Allocation, after time". In case of an MA with just one frequency, the frequency should be different from the BCCH carrier.

26.6.13.6 Handover with starting time / successful case / time elapsed

26.6.13.6.1 Conformance requirement

A Mobile Station receiving a HANDOVER COMMAND message with a starting time and channel descriptions for both after and before the starting time, and ready to access after the indicated time has elapsed, shall perform the handover on the channels as described for after the starting time.

The Mobile Station shall accept the HANDOVER COMMAND message for different message formattings, differing by the information elements used to describe frequency lists.

Reference(s):

GSM 04.08 sub-clauses 3.4.4.1 and 9.1.15.

26.6.13.6.2 Test purpose:

To verify that the MS, after receiving a HANDOVER COMMAND message with a starting time and channel descriptions both for before and after the starting time, and ready to transmit after the indicated time, performs correctly the handover using the frequency parameters for after the time.

26.6.13.6.3 Method of test

Initial condition(s)

System Simulator:

2 cells, CCCH_CONF set to 1 basic physical channel used for CCCH, not combined with SDCCHs.

Mobile Station:

The MS is in the "idle, updated" state, with a TMSI allocated, and camped on cell A

Related PICS/PIXIT statement(s)

- TCH supported (Y/N).
- Supported rate(s) of TCH: (F/F+H).
- The supported channel mode(s) need to be declared.
- Supported frequencies (GSM 450, GSM 480, P-GSM, E-GSM, R-GSM or DCS 1 800 or PCS 1900).

Foreseen final state of the MS

"Idle, updated", with TMSI allocated, and camped on cell B.

Test procedure

The System Simulator pages the MS and after the MS has responded with a CHANNEL REQUEST, the simulator assigns a hopping SDCCH. After the SS has received measurements concerning cell B, the SS sends a HANDOVER COMMAND message allocating a channel (TCH/F, TCH/H or SDCCH, arbitrarily chosen among the channels supported), with a starting time and channel descriptions (hopping case) for both before and after the starting time., as detailed in the "specific message contents" clause. The indicated time is such that the Mobile Station is ready to access only after that time. The Mobile Station then accesses the channel as described for after the starting time. The verification is performed at the RF burst level.

Test parameters:

T1 is set to $T0+5 \pmod{42\,432}$, where T0 is the frame number at which the first burst of the HANDOVER COMMAND message is sent.

Maximum duration of test

120 sec.

Expected sequence

Step	Direction	Message	Comments
1	SS -> MS	PAGING REQUEST TYPE 1	
2	MS -> SS	CHANNEL REQUEST	
3	SS -> MS	IMMEDIATE ASSIGNMENT	Hopping channel.
4	MS -> SS	PAGING RESPONSE	
5	SS -> MS	HANDOVER COMMAND	See specific message contents.
6	MS -> SS	HANDOVER ACCESS	Repeated on every burst of the uplink main DCCH until reception of PHYSICAL INFORMATION.
7	SS -> MS	PHYSICAL INFORMATION	
8	MS -> SS	HANDOVER COMPLETE	Sent on the correct channel (after time parameters) after establishment of the main signalling link.
9	SS -> MS	CHANNEL RELEASE	

Specific message contents

HANDOVER COMMAND:

Information element	Value/remark
Cell Description	As for cell B.
Channel Description, after time	
Channel Type and TDMA offset	Chosen arbitrarily among that supported by the Mobile Station.
Timeslot Number	Chosen arbitrarily.
Training Sequence Code	Chosen arbitrarily.
Hopping	Yes.
Hopping parameters	Chosen arbitrarily.
Power Command	
Power level	Chosen arbitrarily.
Synchronization indication	Non synchronized.
Cell Channel Description	As for cell B.
Channel Mode	
Mode	Arbitrarily selected from capabilities declared for the MS for the chosen type of channel.
Mobile Allocation, after time	Chosen arbitrarily, at least one frequency. In case of an MA with just one frequency, the frequency should be different from the BCCH carrier.
Starting Time	T1
Channel Description, before time	
Channel Type and TDMA offset	Same as after time.
Timeslot Number	Same as after time.
Training Sequence Code	Same as after time.
Hopping	Yes.
Hopping parameters	Chosen arbitrarily, different from "after time".
Mobile Allocation, before time	Chosen arbitrarily, at least one frequency and different from "Mobile Allocation, after time". In case of an MA with just one frequency, the frequency should be different from the BCCH carrier.

26.6.13.7 Handover with starting time and frequency redefinition / failure case / time not elapsed

26.6.13.7.1 Conformance requirement

An MS, after receiving a FREQUENCY REDEFINITION message, shall keep the provided information until the time is elapsed. The Mobile Station must accept an intervening handover, and, in case of failure of this handover resulting in a return to the old channel before the time indicated in the FREQUENCY REDEFINITION message, shall return on the old channel with the frequency parameters in use at the moment of the reception of the FREQUENCY REDEFINITION message, and shall eventually start using the new frequency parameters in the correct time slot indicated by the starting time of the FREQUENCY REDEFINITION message.

Reference(s):

GSM 04.08 sub-clauses 3.4.4 and 3.4.5.

26.6.13.7.2 Test purpose:

To verify that the MS, after receiving a FREQUENCY REDEFINITION and then a HANDOVER COMMAND message with a starting time and channel descriptions both for before and after the starting time, failing the handover, and ready to access on the old channel before the time indicated in the FREQUENCY REDEFINITION, resumes transmission on the channels used at the time of the reception of the FREQUENCY REDEFINITION message and eventually starts using the new frequency parameters at the time indicated in the FREQUENCY REDEFINITION message.

26.6.13.7.3 Method of test

Initial condition(s)

System Simulator:

2 cells, CCCH_CONF set to 1 basic physical channel used for CCCH, not combined with SDCCHs.

Mobile Station:

The MS is in the "idle, updated" state, with a TMSI allocated, and camped on cell A.

Related PICS/PIXIT statement(s)

- TCH supported (Y/N).
- Supported rate(s) of TCH: (F/F+H).
- The supported channel mode(s) need to be declared.
- Supported frequencies (GSM 450, GSM 480, P-GSM, E-GSM, R-GSM or DCS 1 800 or PCS 1900)

Foreseen final state of the MS

"Idle, updated", with TMSI allocated, and camped on cell A.

Test procedure

The System Simulator pages the MS and after the MS has responded with a CHANNEL REQUEST, the simulator assigns allocating a hopping channel (TCH/F, TCH/H or SDCCH, arbitrarily chosen among the channels supported). Then the SS sends a FREQUENCY REDEFINITION message (starting time T1), which modifies the frequency parameters to be used by the MS. Then the SS sends a HANDOVER COMMAND message, with a starting time (T2) and channel descriptions for both before and after the starting time. The MS shall try to activate the new channel (this is not verified) and shall then reactivate the old channel and trigger the establishment of the main signalling link on the old channel. The System Simulator does not activate the channels defined in the HANDOVER COMMAND. Then the MS shall send a HANDOVER FAILURE message. Time T1 is chosen so it is reached only after the sending of the HANDOVER FAILURE message. The MS shall eventually, at the TDMA frame defined by the contents of the "Starting Time" information element of the FREQUENCY REDEFINITION message, use the new frequency parameters. The verification is performed at the RF burst level.

Test parameters:

T1 is set to $T0+5000 \pmod{42\,432}$, where T0 is the frame number at which the first burst of the FREQUENCY REDEFINITION message is sent.

T2 is set to $T0+4000 \pmod{42\,432}$, where T0 is the frame number at which the first burst of the FREQUENCY REDEFINITION message is sent.

Maximum duration of test

180 sec.

Expected sequence

Step	Direction	Message	Comments
1	SS -> MS	PAGING REQUEST TYPE 1	
2	MS -> SS	CHANNEL REQUEST	
3	SS -> MS	IMMEDIATE ASSIGNMENT	Hopping channel.
4	MS -> SS	PAGING RESPONSE	
5	SS -> MS	FREQUENCY REDEFINITION	
6	SS -> MS	HANDOVER COMMAND	Hopping channel, type among possible, signalling mode.
7	MS -> SS	HANDOVER ACCESS	Not checked.
8	MS -> SS	HANDOVER FAILURE	Sent on the correct channel (original parameters) after establishment of the main signalling link.
9	-----	Time T1	The SS checks that the MS is transmitting now on the correct frequencies (parameters of the FREQUENCY REDEFINITION message) and that the transmissions started in the correct frame.
10	SS -> MS	CHANNEL RELEASE	

Specific message contents

FREQUENCY REDEFINITION

Information element	Value/remark
Channel Description	
Channel Type and TDMA offset	Same as in IMMEDIATE ASSIGNMENT
Timeslot Number	Same as in IMMEDIATE ASSIGNMENT
Training Sequence Code	Same as in IMMEDIATE ASSIGNMENT
Hopping	Yes
Hopping parameters	Chosen arbitrarily, different than those of the IMMEDIATE ASSIGNMENT message, HSN same as in IMMEDIATE ASSIGNMENT.
Mobile Allocation	Chosen arbitrarily, at least two frequencies, different than those of the IMMEDIATE ASSIGNMENT message.
Starting Time	T1

HANDOVER COMMAND:

Information element	Value/remark
Cell Description	As for cell B.
Channel Description, after time	
Channel Type and TDMA offset	Chosen arbitrarily among that supported by the Mobile Station.
Timeslot Number	Chosen arbitrarily.
Training Sequence Code	Chosen arbitrarily.
Hopping	Yes.
Hopping parameters	Chosen arbitrarily.
Power Command	
Power level	Chosen arbitrarily.
Synchronization indication	Non synchronized.
Cell Channel Description	As for cell B.
Channel Mode	
Mode	Arbitrarily selected from capabilities declared for the MS for the chosen type of channel.
Mobile Allocation, after time	Chosen arbitrarily, at least one frequency. In case of an MA with just one frequency, the frequency should be different from the BCCH carrier.
Starting Time	T2
Channel Description, before time	
Channel Type and TDMA offset	Same as after time.
Timeslot Number	Same as after time.
Training Sequence Code	Same as after time.
Hopping	Yes.
Hopping parameters	Chosen arbitrarily, different from "after time".
Mobile Allocation, before time	Chosen arbitrarily, at least one frequency and different from "Mobile Allocation, after time". In case of an MA with just one frequency, the frequency should be different from the BCCH carrier.

26.6.13.8 Handover with starting time and frequency redefinition / failure case / time elapsed

26.6.13.8.1 Conformance requirement

An MS, after receiving a FREQUENCY REDEFINITION message, shall keep the provided information until the time is elapsed. The Mobile Station must accept an intervening handover, and, in case of failure of this handover resulting in a return to the old channel after the time indicated in the FREQUENCY REDEFINITION message, shall return on the old channel with the frequency parameters indicated in the FREQUENCY REDEFINITION message.

Reference(s):

GSM 04.08 sub-clauses 3.4.4 and 3.4.5.

26.6.13.8.2 Test purpose:

To verify that the MS, after receiving a FREQUENCY REDEFINITION and then a HANDOVER COMMAND message with a starting time and channel descriptions both for before and after the starting time, failing the handover and returning on the old channel, and ready to access after the time indicated in the FREQUENCY REDEFINITION, resumes transmission using the new frequency parameters indicated in the FREQUENCY REDEFINITION message.

26.6.13.8.3 Method of test

Initial condition(s)

System Simulator:

2 cells, CCCH_CONF set to 1 basic physical channel used for CCCH, not combined with SDCCHs.

Mobile Station:

The MS is in the "idle, updated" state, with a TMSI allocated, and camped on cell A.

Related PICS/PIXIT statement(s)

- Supported frequencies (GSM 450, GSM 480, P-GSM, E-GSM, R-GSM or DCS 1 800 or PCS 1900).

Foreseen final state of the MS

"Idle, updated", with TMSI allocated, and camped on cell A.

Test procedure

The System Simulator pages the MS and after the MS has responded with a CHANNEL REQUEST, the simulator assigns a hopping channel (SDCCH). Then the SS sends a FREQUENCY REDEFINITION message (starting time T1), which modifies the frequency parameters to be used by the MS. Then the SS sends a HANDOVER COMMAND message, with a starting time (T2) and channel descriptions for both before and after the starting time. Time T1 is chosen so it is reached after the sending of the HANDOVER COMMAND message, but before the return on the old channel. The System Simulator does not activate the channels defined in the HANDOVER COMMAND. The MS shall try to activate the new channel (this is not verified) and shall then reactivate the old channel with the new frequency parameters as indicated by the FREQUENCY REDEFINITION message, and trigger the establishment of the main signalling link on the old channel. Then the MS shall send a HANDOVER FAILURE message. The verification is performed at the RF burst level.

Test parameters:

i.e. for SDCCH

T2 is set to $T0+5000 \pmod{42\,432}$, where T0 is the frame number at which the first burst of the FREQUENCY REDEFINITION message is sent.

T1 is set to $T0+265 \pmod{42\,432}$, where T0 is the frame number at which the first burst of the FREQUENCY REDEFINITION message is sent.

NOTE: T0 + 265 is calculated for a maximum execution time of:

FREQUENCY REDEFINITION	using 1 L2 frame	51 frames
HANDOVER COMMAND	using 3 L2 frames	153 frames
+ 120 ms maximum time for a channel change		25 frames
+ some frames contention (here 36)		

Maximum duration of test

180 sec.

Expected sequence

Step	Direction	Message	Comments
1	SS -> MS	PAGING REQUEST TYPE 1	
2	MS -> SS	CHANNEL REQUEST	
3	SS -> MS	IMMEDIATE ASSIGNMENT	Hopping channel.
4	MS -> SS	PAGING RESPONSE	
5	SS -> MS	FREQUENCY REDEFINITION	
6	SS -> MS	HANDOVER COMMAND	Hopping channel, type among possible, signalling mode.
7	MS -> SS	HANDOVER ACCESS	Not checked.
8	MS -> SS	HANDOVER FAILURE	Sent on the correct channel (parameters from the FREQUENCY REDEFINITION message) after establishment of the main signalling link.
9	SS -> MS	CHANNEL RELEASE	

Specific message contents

FREQUENCY REDEFINITION

Information element	Value/remark
Channel Description	
Channel Type and TDMA offset	Same as in IMMEDIATE ASSIGNMENT
Timeslot Number	Same as in IMMEDIATE ASSIGNMENT
Training Sequence Code	Same as in IMMEDIATE ASSIGNMENT
Hopping	Yes.
Hopping parameters	Chosen arbitrarily, different than those of the IMMEDIATE ASSIGNMENT message, HSN same as in IMMEDIATE ASSIGNMENT.
Mobile Allocation	Chosen arbitrarily, at least two frequencies, different than those of the IMMEDIATE ASSIGNMENT message
Starting Time	T1

HANDOVER COMMAND

Information element	Value/remark
Cell Description	As for cell B.
Channel Description, after time	
Channel Type and TDMA offset	Chosen arbitrarily among that supported by the Mobile Station.
Timeslot Number	Chosen arbitrarily.
Training Sequence Code	Chosen arbitrarily.
Hopping	Yes.
Hopping parameters	Chosen arbitrarily.
Power Command	
Power level	Chosen arbitrarily.
Synchronization indication	Non synchronized.
Cell Channel Description	As for cell B.
Channel Mode	
Mode	Arbitrarily selected from capabilities declared for the MS for the chosen type of channel.
Mobile Allocation, after time	Chosen arbitrarily, at least one frequency. In case of an MA with just one frequency, the frequency should be different from the BCCH carrier.
Starting Time	T2
Channel Description, before time	
Channel Type and TDMA offset	Same as after time.
Timeslot Number	Same as after time.
Training Sequence Code	Same as after time.
Hopping	Yes.
Hopping parameters	Chosen arbitrarily, different from "after time".
Mobile Allocation, before time	Chosen arbitrarily, at least one frequency and different from "Mobile Allocation, after time". In case of an MA with just one frequency, the frequency should be different from the BCCH carrier.

26.6.13.9 Immediate assignment with starting time / successful case / time not elapsed

26.6.13.9.1 Conformance requirement

A Mobile Station receiving an IMMEDIATE ASSIGNMENT message with a starting time and channel descriptions for both after and before the starting time, and ready to access before the indicated time has elapsed, shall perform the assignment on the channels as described for before the starting time and shall start using the new frequencies and hopping sequence in the correct time slot when the MS is allocated a dedicated channel.

Reference(s):

GSM 04.08 sub-clauses 3.3.1.1.3.1 and 9.1.18.

26.6.13.9.2 Test purpose

To verify that the MS, after receiving an IMMEDIATE ASSIGNMENT message with a starting time and channel descriptions both for before and after the starting time, and ready to access before the indicated time, performs correctly the assignment using the description for before the time, and then starts using the frequency parameters for after the time at the time indicated in the message.

26.6.13.9.3 Method of test

Initial condition(s)

System Simulator:

1 cell, CCCH_CONF set to 1 basic physical channel used for CCCH, not combined with SDCCHs.

Mobile Station:

The MS is in the "idle, updated" state, with a TMSI allocated.

Related PICS/PIXIT statement(s)

- TCH supported (Y/N).
- Supported rate(s) of TCH: (F/F+H).
- The supported channel mode(s) need to be declared.
- Supported frequencies (GSM 450, GSM 480, P-GSM, E-GSM,R-GSM or DCS 1 800 or PCS 1900).

Foreseen final state of the MS

"Idle, updated", with TMSI allocated.

Test procedure

The System Simulator pages the MS and after the MS has responded with a CHANNEL REQUEST, the simulator sends an IMMEDIATE ASSIGNMENT message allocating a hopping channel (TCH/F, TCH/H or SDCCH, arbitrarily chosen among the channels supported), with a starting time and channel descriptions for both before and after the starting time. The indicated time is such that the Mobile Station is ready to access before that time. The Mobile Station then accesses the channel as described for before the starting time. The MS shall eventually, at the TDMA frame defined by the contents of the "Starting Time" information element of the IMMEDIATE ASSIGNMENT message, use the new frequency parameters. The verification is performed at the RF burst level.

Test parameters:

T1 is chosen arbitrarily to be between T0+60 and T0+100 (mod 42 432), where T0 is the frame number at which the first burst of the IMMEDIATE ASSIGNMENT COMMAND message is sent.

Maximum duration of test

45 sec.

Expected sequence

Step	Direction	Message	Comments
1	SS -> MS	PAGING REQUEST TYPE 1	
2	MS -> SS	CHANNEL REQUEST	
3	SS -> MS	IMMEDIATE ASSIGNMENT	See specific message contents.
4	MS -> SS	PAGING RESPONSE	
5	-----	Time T1	The SS checks that the MS is transmitting now on the correct frequencies (after time parameters) and that the transmissions started in the correct frame.
6	SS -> MS	CHANNEL RELEASE	

Specific message contents

IMMEDIATE ASSIGNMENT

Information element	Value/remark
Page Mode	Normal.
Channel Description	
Channel Type and TDMA offset	Chosen arbitrarily among that supported by the Mobile Station.
Timeslot Number	Chosen arbitrarily.
Training Sequence Code	Chosen arbitrarily.
Hopping	Yes.
Hopping parameters	Chosen arbitrarily.
Timing Advance	As needed.
Mobile Allocation (after time)	Chosen arbitrarily, at least one frequency. In case of an MA with just one frequency, the frequency should be different from the BCCH carrier.
Starting Time	T1
IA Rest Octet	
MAIO	Chosen arbitrarily, different from "after time".
Mobile Allocation (before time)	Chosen arbitrarily, at least one frequency and different from "Mobile Allocation, after time". In case of an MA with just one frequency, the frequency should be different from the BCCH carrier.

26.6.13.10 Immediate assignment with starting time / successful case / time elapsed

26.6.13.10.1 Conformance requirement

A Mobile Station receiving an IMMEDIATE ASSIGNMENT message with a starting time and channel descriptions for both after and before the starting time, and ready to access after the indicated time has elapsed, shall perform the assignment on the channels as described for after the starting time.

Reference(s):

GSM 04.08 sub-clauses 3.3.1.1.3.1 and 9.1.18.

26.6.13.10.2 Test purpose

To verify that the MS, after receiving an IMMEDIATE ASSIGNMENT message with a starting time and channel descriptions both for before and after the starting time, performs correctly the assignment using the frequencies and hopping sequence for after the time if the indicated time has already elapsed when the Mobile Station is ready to transmit.

26.6.13.10.3 Method of test

Initial condition(s)

System Simulator:

1 cell, CCCH_CONF set to 1 basic physical channel used for CCCH, not combined with SDCCHs.

Mobile Station:

The MS is in the "idle, updated" state, with a TMSI allocated.

Related PICS/PIXIT statement(s)

- Type of MS (GSM 450, GSM 480, P-GSM 900 or EGSM or DCS 1 800 or PCS 1900).
- TCH supported (Y/N).

- Supported rate(s) of TCH: (F/F+H).
- The supported channel mode(s) need to be declared.

Foreseen final state of the MS

"Idle, updated", with TMSI allocated.

Test procedure

The System Simulator pages the MS and after the MS has responded with a CHANNEL REQUEST, the simulator sends an IMMEDIATE ASSIGNMENT message allocating a hopping channel (TCH/F, TCH/H or SDCCH, arbitrarily chosen among the channels supported), with a starting time and channel descriptions for both before and after the starting time. The indicated time is such that the Mobile Station is ready to access only after that time. The Mobile Station then accesses the channel as described for after the starting time. The verification is performed at the RF burst level.

Test parameters:

T1 is set to $T0+5 \pmod{42\,432}$, where T0 is the frame number at which the first burst of the IMMEDIATE ASSIGNMENT COMMAND message is sent.

Maximum duration of test

45 sec

Expected sequence

Step	Direction	Message	Comments
1	SS -> MS	PAGING REQUEST TYPE 1	See specific message contents. The SS checks that the MS is transmitting now on the correct frequencies (after time parameters).
2	MS -> SS	CHANNEL REQUEST	
3	SS -> MS	IMMEDIATE ASSIGNMENT	
4	MS -> SS	PAGING RESPONSE	
5	SS -> MS	CHANNEL RELEASE	

Specific message contents

IMMEDIATE ASSIGNMENT:

Information element	Value/remark
Page Mode	Normal.
Channel Description	
Channel Type and TDMA offset	Chosen arbitrarily among that supported by the Mobile Station.
Timeslot Number	Chosen arbitrarily.
Training Sequence Code	Chosen arbitrarily.
Hopping	Yes.
Hopping parameters	Chosen arbitrarily.
Timing Advance	As needed.
Mobile Allocation (after time)	Chosen arbitrarily, at least one frequency. In case of an MA with just one frequency, the frequency should be different from the BCCH carrier.
Starting Time	T1
IA Rest Octet	
MAIO	Chosen arbitrarily, different from "after time".
Mobile Allocation (before time)	Chosen arbitrarily, at least one frequency and different from "Mobile Allocation, after time". In case of an MA with just one frequency, the frequency should be different from the BCCH carrier.

26.6.14 Default contents of GSM 900 layer 3 messages for RR tests

This section contains the default values of GSM 900 L3 messages, which unless indicated otherwise in section 26.6 shall be transmitted by the system simulator and which are required to be received from the GSM 900 MS under test. These values are used in order to be consistent with the phase 2 version of 26.6.

The necessary L3 messages are listed in alphabetic order, with the exception of the SYSTEM INFORMATION messages, where it is the information elements which are listed in alphabetic order (this is because some information elements occur in several SYSTEM INFORMATION types).

In this section, decimal values are normally used. However, sometimes a hexadecimal value, indicated by an "H", or a binary value, indicated by a "B" is used.

Default SYSTEM INFORMATION:

NOTE 1: SYSTEM INFORMATION 2 bis, SYSTEM INFORMATION 5 bis, SYSTEM INFORMATION 7, and SYSTEM INFORMATION 8 messages are not used.

Cell A

Contents of information elements in SYSTEM INFORMATION TYPE 1 to 6 messages for cell A.

(CBCH) Channel Description	Not present.
(CBCH) Mobile Allocation	Not present.
Cell Channel Description	
- Format identifier	bit map 0.
- Cell Allocation ARFCN	Channel Numbers 20, 30, 50 and 70.
Cell Identity	
- Cell Identity Value	0001H
Cell Options	
- Power Control Indicator	Power Control Indicator is not set.
- DTX Indicator	MS shall not use DTX.
- Radio_Link_Timeout	8 SACCH blocks.
Cell Selection Parameters	
- Cell_Reselect_Hysteresis	12 dB.
- MX_TXPWR_MAX_CCH	Minimum level.
- ACS	No addition cell parameters are present in SYSTEM INFORMATION messages 7 and 8.
- NECI	New establishment causes not supported.
- RXLEV_ACCESS_MIN	Minimum level.
Control Channel Description	
- Attach-Detach allowed	No Attach/Detach.
- BS_AG_BLK_RES	0 blocks reserved for access grant.
- CCCH_CONF	1 basic physical channel used for CCCH, combined with SDCCHs.
- BS_PA_MFRMS	5 multiframe periods for transmission of paging messages.
- T3212 Time-out value	Infinite.
L2 pseudo length	
- System information 1	21
- System information 2	22
- System information 3	18
- System information 4	12
Location Area Identification	
- Mobile Country Code	001 decimal
- Mobile Network Code	01 decimal
- Location Area Code	0001H
Message Type	
- System information 1	00011001
- System information 2	00011010
- System information 3	00011011
- System information 4	00011100
- System information 5	00011101
- System information 6	00011110
Neighbour Cells Description	
- Format identifier	bit map 0.
- BCCH Allocation Sequence	0
- BCCH Allocation ARFCN	Channels numbers 10, 20, 40, 80, 90, 100, 110 and 120.
- EXT-IND	This IE carries the complete BA.
NCC Permitted	0000 0010
RACH Control Parameters	
- Max Retrans	Max 1 retrans.
- Tx-integer	5 slots used.
- Cell Barred for Access	Cell is not barred.
- Call Reestablishment Allowed	Not allowed.
- Access Control Class	Access is not barred.
- Emergency Call allowed	Yes.
SI 1 rest octets	Not used (all bits are set to spare).
SI 2 rest octets	Not used (all bits are set to spare).
SI 3 rest octets	Not used (all bits are set to spare).
SI 4 rest octets	Not used (all bits are set to spare).

Default settings for cell A:

Downlink input level Uplink output power Propagation profile BCCH/CCCH carrier number	63 dBmicroVolt emf. minimum supported by the MS's power class. static. 20
--	--

Cell B

The contents of SYSTEM INFORMATION TYPE 1 to 6 messages for cell B are identical to those of cell A with the following exceptions:

Cell Channel Description - Format Identifier - Cell Allocation ARFCN	Bit map 0. Channel Number 10.
--	----------------------------------

NOTE 2: This IE needs modification when used in handover tests which command the MS to go to a frequency hopping channel in cell B.

Cell Identity

- Cell Identity Value 0002H

Default settings for cell B:

Downlink input level Uplink output power Propagation profile BCCH/CCCH carrier number	53 dBmicroVolt emf. minimum supported by the MS's power class. static. 10
--	--

Contents of ALERTING message (SS to MS):

Protocol Discriminator Transaction Identifier TI value TI flag Message Type All other information elements	Call Control. As used in the SETUP message. 1 (destination side). 00000001 Not present.
---	---

Contents of ASSIGNMENT COMMAND message:

Protocol Discriminator Skip Indicator Message Type Channel Description - Channel Type and TDMA offset - Timeslot Number - Training Sequence Code - Hopping - ARFCN Power Command - Power level All other information elements	RR Management. 0000 00101110 Bm + ACCHs Chosen arbitrarily by the test house. Chosen arbitrarily by the test house. Single RF channel. Channel number 30. Chosen arbitrarily by the test house. Not present.
--	---

Contents of ASSIGNMENT COMPLETE message:

Protocol Discriminator	RR Management.
Skip Indicator	0000
Message Type	00101001
RR Cause	
- RR Cause Value	Normal event.

Contents of ASSIGNMENT FAILURE message:

Protocol Discriminator	RR Management.
Skip Indicator	0000
Message Type	00101111
RR Cause	
- RR Cause Value	Depending on test.

Contents of AUTHENTICATION REQUEST message:

Protocol Discriminator	MM message.
Skip Indicator	0000
Message Type	00010010
Ciphering Key Sequence Number	
- Key Sequence	Chosen arbitrarily by the test house from the range 0 to 6.
Authentication Parameter RAND	
- RAND value	Chosen arbitrarily by the test house.

Contents of AUTHENTICATION RESPONSE message:

Protocol Discriminator	MM message.
Skip Indicator	0000
Message Type	0X010100
Other information element(s)	Not checked.

Contents of CALL PROCEEDING message:

Protocol Discriminator	Call Control.
Transaction Identifier	
TI value	As used in the SETUP message.
TI flag	1 (destination side).
Message Type	00000010
All other information elements	Not present.

Contents of CHANNEL MODE MODIFY message:

Protocol Discriminator	RR Management.
Skip Indicator	0000
Message Type	00010000
Channel Description	
- Channel Type and TDMA offset	Depending on test.
- Timeslot Number	Chosen arbitrarily by the test house.
- Training Sequence Code	Chosen arbitrarily by the test house.
- Hopping	Single RF channel.
- ARFCN	Channel number 30.
Channel Mode	
- Mode	Depending on test.

Contents of CHANNEL MODE MODIFY ACKNOWLEDGE message:

Protocol Discriminator	RR Management.
Skip Indicator	0000
Message Type	00010111
Channel Description	Depending on test.
- Channel Type and TDMA offset	Same as in the CHANNEL MODE MODIFY message.
- Timeslot Number	Same as in the CHANNEL MODE MODIFY message.
- Training Sequence Code	Single RF channel.
- Hopping	Band number 0.
- Frequency Band	Channel number 30.
- ARFCN	
Channel Mode	
- Mode	Same as in the CHANNEL MODE MODIFY message.

Contents of CHANNEL RELEASE message:

Protocol Discriminator	RR Management.
Skip Indicator	0000
Message Type	00001101
RR Cause	
- RR Cause Value	Normal event.

Contents of CHANNEL REQUEST message

Establishment Cause	Not checked.
Random Reference	Not checked.

Contents of CIPHERING MODE COMMAND message:

Protocol Discriminator	RR Management.
Skip Indicator	0000
Message Type	00110101
Cipher Mode Setting	
- algorithm identifier	cipher with A5/1.
- SC	Start ciphering.
Cipher Response	IMEI shall not be included.

Contents of CIPHERING MODE COMPLETE message:

Protocol Discriminator	RR Management.
Skip Indicator	0000
Message Type	00110010
Mobile Identity	Not present.

Contents of the CLASSMARK CHANGE message:

Protocol Discriminator	RR Management.
Skip Indicator	0000
Message Type	000100110
Mobile Station Classmark 2	See PICS/PIXIT.
Mobile Station Classmark 3	For presence and contents see PICS/PIXIT.

Contents of CM SERVICE ACCEPT message:

Protocol Discriminator	Mobility Management.
Skip Indicator	0000
Message Type	00100001

Contents of CM SERVICE REQUEST message

Protocol Discriminator	Mobility Management.
Skip Indicator	0000
Message Type	0X100100
Other information elements	Not checked.

Contents of CONNECT message (SS to MS)

Protocol Discriminator	Call Control.
Transaction Identifier	
TI value	As used in the SETUP message.
TI flag	1
Message Type	00000111
All other information elements	Not present.

Contents of CONNECT ACKNOWLEDGE message (MS to SS)

Protocol Discriminator	Call Control.
Transaction Identifier	
TI value	As used in the SETUP message.
TI flag	0
Message Type	0X001111

Contents of HANDOVER ACCESS message:

Handover Reference	Equal to the value included in the Handover Command message.
--------------------	--

Contents of HANDOVER COMMAND message:

Protocol Discriminator	RR Management.
Skip Indicator	0000
Message Type	00101011
Cell Description	
- Network Colour Code	1
- Base station Colour Code	Corresponding to target cell
- BCCH Carrier Number	Set to the BCCH carrier number of cell B. (one of 10, 20, 80, 90, 100, 110 or 120).
Channel Description	
- Channel Type and TDMA offset	Bm + ACCHs.
- Timeslot Number	Chosen arbitrarily by the test house.
- Training Sequence Code	Chosen arbitrarily by the test house.
- Hopping	Single RF channel.
- ARFCN	Chosen arbitrarily by the test house from those supported on the target cell.
Handover Reference	
- Handover Reference Value	Chosen arbitrarily by the test house.
Power Command	
- Power level	Chosen arbitrarily by the test house.
All other information elements	Not present.

Contents of HANDOVER COMPLETE message:

Protocol Discriminator	RR Management.
Skip Indicator	0000
Message Type	00101100
RR cause	Normal event.
Time difference	Not present.

Contents of HANDOVER FAILURE message:

Protocol Discriminator	RR Management.
Skip Indicator	0000
Message Type	00101000
RR cause	Dependent on the test.

IDENTITY REQUEST

Information element	Value/remark
Identity type	IMEI
Spare half octet	0000

IDENTITY RESPONSE

Information element	Value/remark
Mobile identity	not checked

Contents of IMMEDIATE ASSIGNMENT message:

L2 pseudo length	This is the sum of the lengths of all the information elements present in the message except for the IA rest octets and L2 pseudo length IEs. For the default message the L2 pseudo length is 11.
Protocol Discriminator	RR Management.
Skip Indicator	0000
Message Type	00111111
Page Mode	
- Page Mode	Normal Paging.
Channel Description	
- Channel Type and TDMA offset	For non-combined CCCH/SDCCH (see initial conditions), SDCCH/8, with subchannel chosen arbitrarily by the test house For combined CCCH/SDCCH (default SS conditions), SDCCH/4, with subchannel chosen arbitrarily by the test house.
- Timeslot Number	For non-combined CCCH/SDCCH (see initial conditions), chosen arbitrarily by the test house; For combined CCCH/SDCCH (default SS conditions), SDCCH/4, timeslot zero.
- Training Sequence Code	For non-combined CCCH/SDCCH (see initial conditions), chosen arbitrarily by the test house; For combined CCCH/SDCCH (default SS conditions), SDCCH/4, TSC=5 (same as the BCC).
- Hopping	Single RF channel.
- ARFCN	For non-combined CCCH/SDCCH (see initial conditions), Channel number 30; For combined CCCH/SDCCH (default SS conditions), SDCCH/4, Channel number 20.
Request Reference	Pertaining to last Channel Request sent by the MS.
Timing Advance	
- Timing advance value	30 bit periods.
Mobile Allocation	
- Length	0
Starting Time	Not present.
IA rest octets	Not used (all bits set to spare).

Contents of IMMEDIATE ASSIGNMENT EXTENDED message:

L2 pseudo length	This is the sum of the lengths of all the information elements present in the message except for the IAX rest octets and L2 pseudo length IEs. For the default message the L2 pseudo length is 18.
Protocol Discriminator	RR Management.
Skip Indicator	0000
Message Type	00111001
Page Mode	
- Page Mode	Normal Paging.
Channel Description 1	
- Channel Type and TDMA offset	For non-combined CCCH/SDCCH (see test conditions), SDCCH/8, with subchannel chosen arbitrarily by the test house; For combined CCCH/SDCCH (default SS conditions), SDCCH/4, with subchannel chosen arbitrarily by the test house.
- Timeslot Number	For non-combined CCCH/SDCCH (see test conditions), chosen arbitrarily by the test house; For combined CCCH/SDCCH (default SS conditions), SDCCH/4, timeslot zero.
- Training Sequence Code	For non-combined CCCH/SDCCH (see initial conditions), chosen arbitrarily by the test house; For combined CCCH/SDCCH (default SS conditions), SDCCH/4, TSC=5 (same as the BCC).
- Hopping	Single RF channel.
- ARFCN	For non-combined CCCH/SDCCH (see initial conditions), Channel number 30; For combined CCCH/SDCCH (default SS conditions), SDCCH/4, Channel number 20.
Request Reference 1	Pertaining to last Channel Request sent by the MS.
Timing Advance 1	
- Timing advance value	Chosen arbitrarily by the test house.
Channel Description 2	
- Channel Type and TDMA offset	Same channel type as in Channel Description 1, but different TDMA offset to that in Channel Description 1.
- Timeslot Number	equal to the value in Channel Description 1.
- Training Sequence Code	equal to the value in Channel Description 1.
- Hopping	Single RF channel.
- ARFCN	equal to the value in Channel Description 1.
Request Reference 2	Not pertaining to any Channel Requests sent by the MS.
Timing Advance 2	
- Timing advance value	Chosen arbitrarily by the test house.
Mobile Allocation	
- Length	0
Starting Time	Not present.
IAX rest octets	Not used (all bits set to spare).

Contents of IMMEDIATE ASSIGNMENT REJECT message:

L2 pseudo length	19
Protocol Discriminator	RR Management.
Skip Indicator	0000
Message Type	00111010
Page Mode	
- Page Mode	Normal Paging.
Request Reference	Pertaining to last Channel Request sent by the MS.
Wait Indication	0 seconds.
Request Reference	Not pertaining to the MS under test.
Wait Indication	0 seconds.
Request Reference	Not pertaining to the MS under test.
Wait Indication	0 seconds.
Request Reference	Not pertaining to the MS under test.
Wait Indication	0 seconds.
IAR rest octets	Not used (all bits set to spare).

Contents of LOCATION UPDATING REQUEST message:

Protocol Discriminator	MM message.
Skip Indicator	0000
Message Type	0X001000
Other information elements	Not checked.

Contents of PAGING REQUEST TYPE 1 message:

L2 pseudo length	This is the sum of the lengths of all the information elements present in the message except for the P1 rest octets and L2 pseudo length IEs. For the default message the L2 pseudo length is 9.
Protocol Discriminator	RR Management.
Skip Indicator	0000
Message Type	00100001
Page Mode	
- Page Mode	Normal Paging.
Channels needed	
- first channel	any channel.
- second channel	any channel.
Mobile Identity 1	
- odd/even indication	Even.
- Type of Identity	TMSI.
- Identity Digits	TMSI previously allocated to MS.
Mobile Identity 2	Not present.
P1 rest octets	Not used (all bits set to spare).

Contents of PAGING REQUEST TYPE 2 message:

L2 pseudo length	This is the sum of the lengths of all the information elements present in the message except for the P2 rest octets and L2 pseudo length IEs. For the default message the L2 pseudo length is 11.
Protocol Discriminator	RR Management..
Skip Indicator	0000
Message Type	00100010
Page Mode	
- Page Mode	Normal Paging.
Channels needed	
- first channel	any channel.
- second channel	any channel.
Mobile Identity 1	
- TMSI value	TMSI previously allocated to MS.
Mobile Identity 2	
- TMSI value	TMSI not allocated to MS.
Mobile Identity	Not present.
P2 rest octets	Not used (all bits set to spare).

Contents of PAGING REQUEST TYPE 3 message:

L2 pseudo length	19
Protocol Discriminator	RR Management.
Skip Indicator	0000
Message Type	00100100
Page Mode	
- Page Mode	Normal Paging.
Channels needed	
- first channel	any channel.
- second channel	any channel.
Mobile identity 1	
- TMSI value	TMSI previously allocated to MS.
Mobile identity 2	
- TMSI value	TMSI not allocated to MS.
Mobile identity 3	
- TMSI value	TMSI not allocated to MS.
Mobile identity 4	
- TMSI value	TMSI not allocated to MS.
P3 rest octets	Not used (all bits set to spare).

Contents of PAGING RESPONSE message:

Protocol Discriminator	RR Management.
Skip Indicator	0000
Message Type	00100111
Ciphering Key Sequence Number	
- Key Sequence	Key sequence number previously allocated to MS, or "111" if no key is available.
Mobile Station Classmark 2	
Mobile Identity	
- odd/even indication	Even
- Type of identity	TMSI
- Identity Digits	TMSI previously allocated to MS.

Contents of PHYSICAL INFORMATION message:

Protocol Discriminator	RR Management.
Skip Indicator	0000
Message Type	00101101
Timing advance	20 bit periods.

Contents of SETUP message; (MS to SS):

Protocol Discriminator	Call Control.
Transaction Identifier	
TI value	any value from the set {0, ..., 6}.
TI flag	0
Message Type	0X000101
Other information elements	Not checked.

26.6.15 Default contents of DCS 1 800 layer 3 messages for RR tests

This section contains the default values of DCS 1 800 L3 messages, which unless indicated otherwise in section 26.6 shall be transmitted by the system simulator and which are required to be received from the DCS 1 800 MS under test. These values are used in order to be consistent with the phase 2 version of 26.6.

The necessary L3 messages are listed in alphabetic order, with the exception of the SYSTEM INFORMATION messages, where it is the information elements which are listed in alphabetic order (this is because some information elements occur in several SYSTEM INFORMATION types).

In this section, decimal values are normally used. However, sometimes a hexadecimal value, indicated by an "H", or a binary value, indicated by a "B" is used.

Default SYSTEM INFORMATION:

NOTE 1: SYSTEM INFORMATION 2 bis, SYSTEM INFORMATION 7, and SYSTEM INFORMATION 8 messages are not used.

SYSTEM INFORMATION 5 bis is not sent as a default message. For those tests which require SYSTEM INFORMATION 5 bis see the specific message contents for that test.

Cell A

Contents of information elements in SYSTEM INFORMATION TYPE 1 to 6 messages for cell A.

(CBCH) Channel Description	Not present.
(CBCH) Mobile Allocation	Not present.
Cell Channel Description	
- Format identifier	Range 512.
- Cell Allocation ARFCN	Channel Numbers, 590, 650, 750 and 850.
Cell Identity	
- Cell Identity Value	0001H
Cell Options	
- Power Control Indicator	Power Control Indicator is not set, 0
- DTX Indicator	MS shall not use DTX.
- Radio_Link_Timeout	8 SACCH blocks.
Cell Selection Parameters	
- Cell_Reselect_Hysteresis	12 dB
- MX_TXPWR_MAX_CCH	Minimum level.
- ACS	No addition cell parameters are present in SYSTEM INFORMATION messages 7 and 8.
- NECI	New establishment causes not supported.
- RXLEV_ACCESS_MIN	Minimum level.
Control Channel Description	
- Attach-Detach allowed	MS shall not apply.
- BS_AG_BLK_RES	0 blocks reserved for access grant.
- CCCH_CONF	1 basic physical channel used for CCCH, combined with SDCCHs.
- BS_PA_MFRMS	5 multiframe periods for transmission of paging messages.
- T3212 Time-out value	Infinite.
L2 pseudo length	
- System information 1	21
- System information 2	22
- System information 3	18
- System information 4	12
Location Area Identification	
- Mobile Country Code	001 decimal.
- Mobile Network Code	01 decimal.
- Location Area Code	0001H
Message Type	
- System information 1	00011001
- System information 2	00011010
- System information 3	00011011
- System information 4	00011100
- System information 5	00011101
- System information 6	00011110
Neighbour Cells Description	
- Format identifier	Range 512.
- BCCH Allocation Sequence	0
- BCCH Allocation ARFCN	Channels numbers, 520, 590, 600, 700, 747, 764, 780, 810, 870.
- EXT-IND	This IE carries the complete BA. EXT-IND is 0.
NCC Permitted	0000 0010
RACH Control Parameters	
- Max Retrans	Max 1 retrans.
- Tx-integer	5 slots used.
- Cell Barred for Access	Cell is not barred.
- Call Reestablishment Allowed	Not Allowed.
- Access Control Class	Access is not barred.
- Emergency Call allowed	Yes.
SI 1 rest octets	Not used (all bits are set to spare).
SI 2 rest octets	Not used (all bits are set to spare).
SI 3 rest octets	Not used (all bits are set to spare).
SI 4 rest octets	Not used (all bits are set to spare).

Default settings for cell A:

Downlink input level Uplink output power Propagation profile BCCH/CCCH carrier number	63 dBmicroVolt emf(). minimum supported by the MS's power class static. ARFN 590.
--	--

Cell B

The contents of SYSTEM INFORMATION TYPE 1 to 6 messages for cell B are identical to those of cell A with the following exceptions:

Cell Channel Description - Format Identifier - Cell Allocation ARFCN	Range 512. Channel Number 520.
--	-----------------------------------

NOTE 2: This IE needs modification when used in handover tests which command the MS to go to a frequency hopping channel in cell B.

Cell Identity - Cell Identity Value	0002H
--	-------

Default settings for cell B:

Downlink input level Uplink output power Propagation profile BCCH/CCCH carrier number	53 dBmicroVolt emf(). minimum supported by the MS's power class static. 520
--	--

Contents of ALERTING message (SS to MS):

Protocol Discriminator Transaction Identifier TI value TI flag Message Type All other information elements	Call Control. As used in the SETUP message. 1 (destination side). 00000001 Not present.
---	---

Contents of ASSIGNMENT COMMAND message:

Protocol Discriminator Skip Indicator Message Type Channel Description - Channel Type and TDMA offset - Timeslot Number - Training Sequence Code - Hopping - ARFCN Power Command - Power level All other information elements	RR Management. 0000 00101110 Bm + ACCHs. Chosen arbitrarily by the test house. Chosen arbitrarily by the test house. Single RF channel. Channel number 650. Chosen arbitrarily by the test house. Not present.
--	---

Contents of ASSIGNMENT COMPLETE message:

Protocol Discriminator	RR Management.
Skip Indicator	0000
Message Type	00101001
RR Cause	
- RR Cause Value	Normal event.

Contents of ASSIGNMENT FAILURE message:

Protocol Discriminator	RR Management.
Skip Indicator	0000
Message Type	00101111
RR Cause	
- RR Cause Value	Depending on test.

Contents of AUTHENTICATION REQUEST message:

Protocol Discriminator	MM message.
Skip Indicator	0000
Message Type	00010010
Ciphering Key Sequence Number	
- Key Sequence	Chosen arbitrarily by the test house from the range 0 to 6.
Authentication Parameter RAND	
- RAND value	Chosen arbitrarily by the test house.

Contents of AUTHENTICATION RESPONSE message:

Protocol Discriminator	MM message.
Skip Indicator	0000
Message Type	0X010100
Other information element(s)	Not checked.

Contents of CALL PROCEEDING message:

Protocol Discriminator	Call Control.
Transaction Identifier	
TI value	As used in the SETUP message.
TI flag	1 (destination side).
Message Type	00000010
All other information elements	Not present.

Contents of CHANNEL MODE MODIFY message:

Protocol Discriminator	RR Management.
Skip Indicator	0000
Message Type	00010000
Channel Description	
- Channel Type and TDMA offset	Depending on test.
- Timeslot Number	Chosen arbitrarily by the test house.
- Training Sequence Code	Chosen arbitrarily by the test house.
- Hopping	Single RF channel.
- ARFCN	Channel number 650.
Channel Mode	
- Mode	Depending on test.

Contents of CHANNEL MODE MODIFY ACKNOWLEDGE message:

Protocol Discriminator	RR Management.
Skip Indicator	0000
Message Type	00010111
Channel Description	Depending on test.
- Channel Type and TDMA offset	Same as in the CHANNEL MODE MODIFY message.
- Timeslot Number	Same as in the CHANNEL MODE MODIFY message.
- Training Sequence Code	Single RF channel.
- Hopping	Band number 0.
- Frequency Band	Channel number 650.
- ARFCN	
Channel Mode	
- Mode	Same as in the CHANNEL MODE MODIFY message.

Contents of CHANNEL RELEASE message:

Protocol Discriminator	RR Management.
Skip Indicator	0000
Message Type	00001101
RR Cause	
- RR Cause Value	Normal event.

Contents of CHANNEL REQUEST message:

Establishment Cause	Not checked.
Random Reference	Not checked.

Contents of CIPHERING MODE COMMAND message:

Protocol Discriminator	RR Management.
Skip Indicator	0000
Message Type	00110101
Cipher Mode Setting	
- algorithm identifier	cipher with A5/1.
- SC	Start ciphering.
Cipher Response	IMEI shall not be included.

Contents of CIPHERING MODE COMPLETE message:

Protocol Discriminator	RR Management.
Skip Indicator	0000
Message Type	00110010
Mobile Identity	Not present.

Contents of the CLASSMARK CHANGE message:

Protocol Discriminator	RR Management.
Skip Indicator	0000
Message Type	000100110
Mobile Station Classmark 2	
- RF Power Capability	See PICS/PIXIT.
- Frequency Capability	Set to 0.
Mobile Station Classmark 3	For presence and contents see PICS/PIXIT.

Contents of CM SERVICE ACCEPT message:

Protocol Discriminator	Mobility Management.
Skip Indicator	0000
Message Type	00100001

Contents of CM SERVICE REQUEST message:

Protocol Discriminator	Mobility Management.
Skip Indicator	0000
Message Type	0X100100
Other information elements	Not checked.

Contents of CONNECT message (SS to MS):

Protocol Discriminator	Call Control.
Transaction Identifier	
TI value	As used in the SETUP message.
TI flag	1
Message Type	00000111
All other information elements	Not present.

Contents of CONNECT ACKNOWLEDGE message (MS to SS):

Protocol Discriminator	Call Control.
Transaction Identifier	
TI value	As used in the SETUP message.
TI flag	0
Message Type	0X001111

Contents of HANDOVER ACCESS message:

Handover Reference	Equal to the value included in the Handover Command message.
--------------------	--

Contents of HANDOVER COMMAND message:

Protocol Discriminator	RR Management.
Skip Indicator	0000
Message Type	00101011
Cell Description	
- Network Colour Code	1
- Base station Colour Code	Corresponding to target cell
- BCCH Carrier Number	Set to the BCCH carrier number of cell B. (one of 520, 590, 600, 700, 780, 810 or 870).
Channel Description	
- Channel Type and TDMA offset	Bm + ACCHs.
- Timeslot Number	Chosen arbitrarily by the test house.
- Training Sequence Code	Chosen arbitrarily by the test house.
- Hopping	Single RF channel.
- ARFCN	Chosen arbitrarily by the test house from those supported on the target cell.
Handover Reference	
- Handover Reference Value	Chosen arbitrarily by the test house.
Power Command	
- Power level	Chosen arbitrarily by the test house.
All other information elements	Not present.

Contents of HANDOVER COMPLETE message:

Protocol Discriminator	RR Management.
Skip Indicator	0000
Message Type	00101100
RR cause	Normal event.
Time difference	Not present.

Contents of HANDOVER FAILURE message:

Protocol Discriminator	RR Management.
Skip Indicator	0000
Message Type	00101000
RR cause	Dependent on the test.

IDENTITY REQUEST

Information element	Value/remark
Identity type	IMEI
Spare half octet	0000

IDENTITY RESPONSE

Information element	Value/remark
Mobile identity	not checked

Contents of IMMEDIATE ASSIGNMENT message:

L2 pseudo length	This is the sum of the lengths of all the information elements present in the message except for the IA rest octets and L2 pseudo length IEs. For the default message the L2 pseudo length is 11.
Protocol Discriminator	RR Management.
Skip Indicator	0000
Message Type	00111111
Page Mode	
- Page Mode	Normal Paging.
Channel Description	
- Channel Type and TDMA offset	For non-combined CCCH/SDCCH (see initial conditions), SDCCH/8, with subchannel chosen arbitrarily by the test house For combined CCCH/SDCCH (default SS conditions), SDCCH/4, with subchannel chosen arbitrarily by the test house.
- Timeslot Number	For non-combined CCCH/SDCCH (see initial conditions), chosen arbitrarily by the test house; For combined CCCH/SDCCH (default SS conditions), SDCCH/4, timeslot zero.
- Training Sequence Code	For non-combined CCCH/SDCCH (see initial conditions), chosen arbitrarily by the test house; For combined CCCH/SDCCH (default SS conditions), SDCCH/4, TSC=5 (same as the BCC).
- Hopping	Single RF channel.
- ARFCN	For non-combined CCCH/SDCCH (see initial conditions), Channel number 650; For combined CCCH/SDCCH (default SS conditions), SDCCH/4, Channel number 590.
Request Reference	Pertaining to last Channel Request sent by the MS.
Timing Advance	
- Timing advance value	30 bit periods.
Mobile Allocation	
- Length	0
Starting Time	Not present.
IA rest octets	Not used (all bits set to spare).

Contents of IMMEDIATE ASSIGNMENT EXTENDED message:

L2 pseudo length	This is the sum of the lengths of all the information elements present in the message except for the IAX rest octets and L2 pseudo length IEs. For the default message the L2 pseudo length is 18.
Protocol Discriminator	RR Management.
Skip Indicator	0000
Message Type	00111001
Page Mode	
- Page Mode	Normal Paging.
Channel Description 1	
- Channel Type and TDMA offset	For non-combined CCCH/SDCCH (see test conditions), SDCCH/8, with subchannel chosen arbitrarily by the test house; For combined CCCH/SDCCH (default SS conditions), SDCCH/4, with subchannel chosen arbitrarily by the test house.
- Timeslot Number	For non-combined CCCH/SDCCH (see test conditions), chosen arbitrarily by the test house; For combined CCCH/SDCCH (default SS conditions), SDCCH/4, timeslot zero.
- Training Sequence Code	For non-combined CCCH/SDCCH (see initial conditions), chosen arbitrarily by the test house; For combined CCCH/SDCCH (default SS conditions), SDCCH/4, TSC=5 (same as the BCC).
- Hopping	Single RF channel.
- ARFCN	For non-combined CCCH/SDCCH (see initial conditions), Channel number 650; For combined CCCH/SDCCH (default SS conditions), SDCCH/4, Channel number 590.
Request Reference 1	Pertaining to last Channel Request sent by the MS.
Timing Advance 1	
- Timing advance value	Chosen arbitrarily by the test house.
Channel Description 2	
- Channel Type and TDMA offset	Same channel type as in Channel Description 1, but different TDMA offset to that in Channel Description 1.
- Timeslot Number	equal to the value in Channel Description 1.
- Training Sequence Code	equal to the value in Channel Description 1.
- Hopping	Single RF channel.
- ARFCN	equal to the value in Channel Description 1.
Request Reference 2	Not pertaining to any Channel Requests sent by the MS.
Timing Advance 2	
- Timing advance value	Chosen arbitrarily by the test house.
Mobile Allocation	
- Length	0
Starting Time	Not present.
IAX rest octets	Not used (all bits set to spare).

Contents of IMMEDIATE ASSIGNMENT REJECT message:

L2 pseudo length	19
Protocol Discriminator	RR Management.
Skip Indicator	0000
Message Type	00111010
Page Mode	
- Page Mode	Normal Paging.
Request Reference	Pertaining to last Channel Request sent by the MS.
Wait Indication	0 seconds.
Request Reference	Not pertaining to the MS under test.
Wait Indication	0 seconds.
Request Reference	Not pertaining to the MS under test.
Wait Indication	0 seconds.
Request Reference	Not pertaining to the MS under test.
Wait Indication	0 seconds.
IAR rest octets	Not used (all bits set to spare).

Contents of LOCATION UPDATING REQUEST message:

Protocol Discriminator	MM message.
Skip Indicator	0000
Message Type	0X001000
Other information elements	Not checked.

Contents of PAGING REQUEST TYPE 1 message:

L2 pseudo length	This is the sum of the lengths of all the information elements present in the message except for the P1 rest octets and L2 pseudo length IEs. For the default message the L2 pseudo length is 9.
Protocol Discriminator	RR Management.
Skip Indicator	0000
Message Type	00100001
Page Mode	
- Page Mode	Normal Paging.
Channels needed	
- first channel	any channel.
- second channel	any channel.
Mobile Identity 1	
- odd/even indication	Even.
- Type of Identity	TMSI.
- Identity Digits	TMSI previously allocated to MS.
Mobile Identity 2	Not present.
P1 rest octets	Not used (all bits set to spare).

Contents of PAGING REQUEST TYPE 2 message:

L2 pseudo length	This is the sum of the lengths of all the information elements present in the message except for the P2 rest octets and L2 pseudo length IEs. For the default message the L2 pseudo length is 11.
Protocol Discriminator	RR Management.
Skip Indicator	0000
Message Type	00100010
Page Mode	
- Page Mode	Normal Paging.
Channels needed	
- first channel	any channel.
- second channel	any channel.
Mobile Identity 1	
- TMSI value	TMSI previously allocated to MS.
Mobile Identity 2	
- TMSI value	TMSI not allocated to MS.
Mobile Identity	Not present.
P2 rest octets	Not used (all bits set to spare).

Contents of PAGING REQUEST TYPE 3 message:

L2 pseudo length	19
Protocol Discriminator	RR Management.
Skip Indicator	0000
Message Type	00100100
Page Mode	
- Page Mode	Normal Paging.
Channels needed	
- first channel	any channel.
- second channel	any channel.
Mobile identity 1	
- TMSI value	TMSI previously allocated to MS.
Mobile identity 2	
- TMSI value	TMSI not allocated to MS.
Mobile identity 3	
- TMSI value	TMSI not allocated to MS.
Mobile identity 4	
- TMSI value	TMSI not allocated to MS.
P3 rest octets	Not used (all bits set to spare).

Contents of PAGING RESPONSE message:

Protocol Discriminator	RR Management.
Skip Indicator	0000
Message Type	00100111
Ciphering Key Sequence Number	
- Key Sequence	Key sequence number previously allocated to MS, or "111" if no key is available.
Mobile Station Classmark 2	
Mobile Identity	
- odd/even indication	Even.
- Type of identity	TMSI
- Identity Digits	TMSI previously allocated to MS.

Contents of PHYSICAL INFORMATION message:

Protocol Discriminator	RR Management.
Skip Indicator	0000
Message Type	00101101
Timing advance	20 bit periods.

Contents of SETUP message; (MS to SS):

Protocol Discriminator	Call Control.
Transaction Identifier	
TI value	any value from the set {0, ..., 6}.
TI flag	0
Message Type	0X000101
Other information elements	Not checked.

26.6.16 Default contents of GSM 450 layer 3 messages for RR tests

This section contains the default values of GSM 450 L3 messages, which unless indicated otherwise in section 26.6 shall be transmitted by the system simulator and which are required to be received from the GSM 450 MS under test. These values are used in order to be consistent with the phase 2 version of 26.6.

The necessary L3 messages are listed in alphabetic order, with the exception of the SYSTEM INFORMATION messages, where it is the information elements which are listed in alphabetic order (this is because some information elements occur in several SYSTEM INFORMATION types).

In this section, decimal values are normally used. However, sometimes a hexadecimal value, indicated by an "H", or a binary value, indicated by a "B" is used.

Default SYSTEM INFORMATION:

NOTE 1: SYSTEM INFORMATION 2 bis, SYSTEM INFORMATION 5 bis, SYSTEM INFORMATION 7, and SYSTEM INFORMATION 8 messages are not used.

Cell A

Contents of information elements in SYSTEM INFORMATION TYPE 1 to 6 messages for cell A.

(CBCH) Channel Description	Not present.
(CBCH) Mobile Allocation	Not present.
Cell Channel Description	
- Format identifier	Range 128.
- Cell Allocation ARFCN	Channel Numbers 263, 267, 275 and 279.
Cell Identity	
- Cell Identity Value	0001H
Cell Options	
- Power Control Indicator	Power Control Indicator is not set.
- DTX Indicator	MS shall not use DTX.
- Radio_Link_Timeout	8 SACCH blocks.
Cell Selection Parameters	
- Cell_Reselect_Hysteresis	12 dB.
- MX_TXPWR_MAX_CCH	Minimum level.
- ACS	No addition cell parameters are present in SYSTEM INFORMATION messages 7 and 8.
- NECI	New establishment causes not supported.
- RXLEV_ACCESS_MIN	Minimum level.
Control Channel Description	
- Attach-Detach allowed	No Attach/Detach.
- BS_AG_BLK_RES	0 blocks reserved for access grant.
- CCCH_CONF	1 basic physical channel used for CCCH, combined with SDCCHs.
- BS_PA_MFRMS	5 multiframe periods for transmission of paging messages.
- T3212 Time-out value	Infinite.
L2 pseudo length	
- System information 1	21
- System information 2	22
- System information 3	18
- System information 4	12
Location Area Identification	
- Mobile Country Code	001 decimal
- Mobile Network Code	01 decimal
- Location Area Code	0001H
Message Type	
- System information 1	00011001
- System information 2	00011010
- System information 3	00011011
- System information 4	00011100
- System information 5	00011101
- System information 6	00011110
Neighbour Cells Description	
- Format identifier	128 range.
- BCCH Allocation Sequence	0
- BCCH Allocation ARFCN	Channels numbers 262, 263, 274, 282, 284, 287, 290 and 293.
- EXT-IND	This IE carries the complete BA.
NCC Permitted	0000 0010
RACH Control Parameters	
- Max Retrans	Max 1 retrans.
- Tx-integer	5 slots used.
- Cell Barred for Access	Cell is not barred.
- Call Reestablishment Allowed	Not allowed.
- Access Control Class	Access is not barred.
- Emergency Call allowed	Yes.
SI 1 rest octets	Not used (all bits are set to spare).
SI 2 rest octets	Not used (all bits are set to spare).
SI 3 rest octets	Not used (all bits are set to spare).
SI 4 rest octets	Not used (all bits are set to spare).

Default settings for cell A:

Downlink input level Uplink output power Propagation profile BCCH/CCCH carrier number	63 dBmicroVolt emf. minimum supported by the MS's power class. static. 263
--	---

Cell B

The contents of SYSTEM INFORMATION TYPE 1 to 6 messages for cell B are identical to those of cell A with the following exceptions:

Cell Channel Description - Format Identifier - Cell Allocation ARFCN	128 range. Channel Number 261.
--	-----------------------------------

NOTE 2: This IE needs modification when used in handover tests which command the MS to go to a frequency hopping channel in cell B.

Cell Identity

- Cell Identity Value 0002H

Default settings for cell B:

Downlink input level Uplink output power Propagation profile BCCH/CCCH carrier number	53 dBmicroVolt emf. minimum supported by the MS's power class. static. 261
--	---

Contents of ALERTING message (SS to MS):

Protocol Discriminator Transaction Identifier TI value TI flag Message Type All other information elements	Call Control. As used in the SETUP message. 1 (destination side). 00000001 Not present.
---	---

Contents of ASSIGNMENT COMMAND message:

Protocol Discriminator Skip Indicator Message Type Channel Description - Channel Type and TDMA offset - Timeslot Number - Training Sequence Code - Hopping - ARFCN Power Command - Power level All other information elements	RR Management. 0000 00101110 Bm + ACCHs Chosen arbitrarily by the test house. Chosen arbitrarily by the test house. Single RF channel. Channel number 267. Chosen arbitrarily by the test house. Not present.
--	--

Contents of ASSIGNMENT COMPLETE message:

Protocol Discriminator	RR Management.
Skip Indicator	0000
Message Type	00101001
RR Cause	
- RR Cause Value	Normal event.

Contents of ASSIGNMENT FAILURE message:

Protocol Discriminator	RR Management.
Skip Indicator	0000
Message Type	00101111
RR Cause	
- RR Cause Value	Depending on test.

Contents of AUTHENTICATION REQUEST message:

Protocol Discriminator	MM message.
Skip Indicator	0000
Message Type	00010010
Ciphering Key Sequence Number	
- Key Sequence	Chosen arbitrarily by the test house from the range 0 to 6.
Authentication Parameter RAND	
- RAND value	Chosen arbitrarily by the test house.

Contents of AUTHENTICATION RESPONSE message:

Protocol Discriminator	MM message.
Skip Indicator	0000
Message Type	0X010100
Other information element(s)	Not checked.

Contents of CALL PROCEEDING message:

Protocol Discriminator	Call Control.
Transaction Identifier	
TI value	As used in the SETUP message.
TI flag	1 (destination side).
Message Type	00000010
All other information elements	Not present.

Contents of CHANNEL MODE MODIFY message:

Protocol Discriminator	RR Management.
Skip Indicator	0000
Message Type	00010000
Channel Description	
- Channel Type and TDMA offset	Depending on test.
- Timeslot Number	Chosen arbitrarily by the test house.
- Training Sequence Code	Chosen arbitrarily by the test house.
- Hopping	Single RF channel.
- ARFCN	Channel number 267.
Channel Mode	
- Mode	Depending on test.

Contents of CHANNEL MODE MODIFY ACKNOWLEDGE message:

Protocol Discriminator	RR Management.
Skip Indicator	0000
Message Type	00010111
Channel Description	Depending on test.
- Channel Type and TDMA offset	Same as in the CHANNEL MODE MODIFY message.
- Timeslot Number	Same as in the CHANNEL MODE MODIFY message.
- Training Sequence Code	Single RF channel.
- Hopping	Band number 0.
- Frequency Band	Channel number 267.
- ARFCN	
Channel Mode	
- Mode	Same as in the CHANNEL MODE MODIFY message.

Contents of CHANNEL RELEASE message:

Protocol Discriminator	RR Management.
Skip Indicator	0000
Message Type	00001101
RR Cause	
- RR Cause Value	Normal event.

Contents of CHANNEL REQUEST message

Establishment Cause	Not checked.
Random Reference	Not checked.

Contents of CIPHERING MODE COMMAND message:

Protocol Discriminator	RR Management.
Skip Indicator	0000
Message Type	00110101
Cipher Mode Setting	
- algorithm identifier	cipher with A5/1.
- SC	Start ciphering.
Cipher Response	IMEI shall not be included.

Contents of CIPHERING MODE COMPLETE message:

Protocol Discriminator	RR Management.
Skip Indicator	0000
Message Type	00110010
Mobile Identity	Not present.

Contents of the CLASSMARK CHANGE message:

Protocol Discriminator	RR Management.
Skip Indicator	0000
Message Type	000100110
Mobile Station Classmark 2	See PICS/PIXIT.
Mobile Station Classmark 3	For presence and contents see PICS/PIXIT.

Contents of CM SERVICE ACCEPT message:

Protocol Discriminator	Mobility Management.
Skip Indicator	0000
Message Type	00100001

Contents of CM SERVICE REQUEST message

Protocol Discriminator	Mobility Management.
Skip Indicator	0000
Message Type	0X100100
Other information elements	Not checked.

Contents of CONNECT message (SS to MS)

Protocol Discriminator	Call Control.
Transaction Identifier	
TI value	As used in the SETUP message.
TI flag	1
Message Type	00000111
All other information elements	Not present.

Contents of CONNECT ACKNOWLEDGE message (MS to SS)

Protocol Discriminator	Call Control.
Transaction Identifier	
TI value	As used in the SETUP message.
TI flag	0
Message Type	0X001111

Contents of HANDOVER ACCESS message:

Handover Reference	Equal to the value included in the Handover Command message.
--------------------	--

Contents of HANDOVER COMMAND message:

Protocol Discriminator	RR Management.
Skip Indicator	0000
Message Type	00101011
Cell Description	
- Network Colour Code	1
- Base station Colour Code	Corresponding to target cell
- BCCH Carrier Number	Set to the BCCH carrier number of cell B. (one of 261, 263, 282, 284, 287, 290 or 293).
Channel Description	
- Channel Type and TDMA offset	Bm + ACCHs.
- Timeslot Number	Chosen arbitrarily by the test house.
- Training Sequence Code	Chosen arbitrarily by the test house.
- Hopping	Single RF channel.
- ARFCN	Chosen arbitrarily by the test house from those supported on the target cell.
Handover Reference	
- Handover Reference Value	Chosen arbitrarily by the test house.
Power Command	
- Power level	Chosen arbitrarily by the test house.
All other information elements	Not present.

Contents of HANDOVER COMPLETE message:

Protocol Discriminator	RR Management.
Skip Indicator	0000
Message Type	00101100
RR cause	Normal event.
Time difference	Not present.

Contents of HANDOVER FAILURE message:

Protocol Discriminator	RR Management.
Skip Indicator	0000
Message Type	00101000
RR cause	Dependent on the test.

IDENTITY REQUEST

Information element	Value/remark
Identity type	IMEI
Spare half octet	0000

IDENTITY RESPONSE

Information element	Value/remark
Mobile identity	not checked

Contents of IMMEDIATE ASSIGNMENT message:

L2 pseudo length	This is the sum of the lengths of all the information elements present in the message except for the IA rest octets and L2 pseudo length IEs. For the default message the L2 pseudo length is 11.
Protocol Discriminator	RR Management.
Skip Indicator	0000
Message Type	00111111
Page Mode	
- Page Mode	Normal Paging.
Channel Description	
- Channel Type and TDMA offset	For non-combined CCCH/SDCCH (see initial conditions), SDCCH/8, with subchannel chosen arbitrarily by the test house For combined CCCH/SDCCH (default SS conditions), SDCCH/4, with subchannel chosen arbitrarily by the test house.
- Timeslot Number	For non-combined CCCH/SDCCH (see initial conditions), chosen arbitrarily by the test house; For combined CCCH/SDCCH (default SS conditions), SDCCH/4, timeslot zero.
- Training Sequence Code	For non-combined CCCH/SDCCH (see initial conditions), chosen arbitrarily by the test house; For combined CCCH/SDCCH (default SS conditions), SDCCH/4, TSC=5 (same as the BCC).
- Hopping	Single RF channel.
- ARFCN	For non-combined CCCH/SDCCH (see initial conditions), Channel number 30; For combined CCCH/SDCCH (default SS conditions), SDCCH/4, Channel number 263.
Request Reference	Pertaining to last Channel Request sent by the MS.
Timing Advance	
- Timing advance value	30 bit periods.
Mobile Allocation	
- Length	0
Starting Time	Not present.
IA rest octets	Not used (all bits set to spare).

Contents of IMMEDIATE ASSIGNMENT EXTENDED message:

L2 pseudo length	This is the sum of the lengths of all the information elements present in the message except for the IAX rest octets and L2 pseudo length IEs. For the default message the L2 pseudo length is 18.
Protocol Discriminator	RR Management.
Skip Indicator	0000
Message Type	00111001
Page Mode	
- Page Mode	Normal Paging.
Channel Description 1	
- Channel Type and TDMA offset	For non-combined CCCH/SDCCH (see test conditions), SDCCH/8, with subchannel chosen arbitrarily by the test house; For combined CCCH/SDCCH (default SS conditions), SDCCH/4, with subchannel chosen arbitrarily by the test house.
- Timeslot Number	For non-combined CCCH/SDCCH (see test conditions), chosen arbitrarily by the test house; For combined CCCH/SDCCH (default SS conditions), SDCCH/4, timeslot zero.
- Training Sequence Code	For non-combined CCCH/SDCCH (see initial conditions), chosen arbitrarily by the test house; For combined CCCH/SDCCH (default SS conditions), SDCCH/4, TSC=5 (same as the BCC).
- Hopping	Single RF channel.
- ARFCN	For non-combined CCCH/SDCCH (see initial conditions), Channel number 30; For combined CCCH/SDCCH (default SS conditions), SDCCH/4, Channel number 263.
Request Reference 1	Pertaining to last Channel Request sent by the MS.
Timing Advance 1	
- Timing advance value	Chosen arbitrarily by the test house.
Channel Description 2	
- Channel Type and TDMA offset	Same channel type as in Channel Description 1, but different TDMA offset to that in Channel Description 1.
- Timeslot Number	equal to the value in Channel Description 1.
- Training Sequence Code	equal to the value in Channel Description 1.
- Hopping	Single RF channel.
- ARFCN	equal to the value in Channel Description 1.
Request Reference 2	Not pertaining to any Channel Requests sent by the MS.
Timing Advance 2	
- Timing advance value	Chosen arbitrarily by the test house.
Mobile Allocation	
- Length	0
Starting Time	Not present.
IAX rest octets	Not used (all bits set to spare).

Contents of IMMEDIATE ASSIGNMENT REJECT message:

L2 pseudo length	19
Protocol Discriminator	RR Management.
Skip Indicator	0000
Message Type	00111010
Page Mode	
- Page Mode	Normal Paging.
Request Reference	Pertaining to last Channel Request sent by the MS.
Wait Indication	0 seconds.
Request Reference	Not pertaining to the MS under test.
Wait Indication	0 seconds.
Request Reference	Not pertaining to the MS under test.
Wait Indication	0 seconds.
Request Reference	Not pertaining to the MS under test.
Wait Indication	0 seconds.
IAR rest octets	Not used (all bits set to spare).

Contents of LOCATION UPDATING REQUEST message:

Protocol Discriminator	MM message.
Skip Indicator	0000
Message Type	0X001000
Other information elements	Not checked.

Contents of PAGING REQUEST TYPE 1 message:

L2 pseudo length	This is the sum of the lengths of all the information elements present in the message except for the P1 rest octets and L2 pseudo length IEs. For the default message the L2 pseudo length is 9.
Protocol Discriminator	RR Management.
Skip Indicator	0000
Message Type	00100001
Page Mode	
- Page Mode	Normal Paging.
Channels needed	
- first channel	any channel.
- second channel	any channel.
Mobile Identity 1	
- odd/even indication	Even.
- Type of Identity	TMSI.
- Identity Digits	TMSI previously allocated to MS.
Mobile Identity 2	Not present.
P1 rest octets	Not used (all bits set to spare).

Contents of PAGING REQUEST TYPE 2 message:

L2 pseudo length	This is the sum of the lengths of all the information elements present in the message except for the P2 rest octets and L2 pseudo length IEs. For the default message the L2 pseudo length is 11.
Protocol Discriminator	RR Management..
Skip Indicator	0000
Message Type	00100010
Page Mode	
- Page Mode	Normal Paging.
Channels needed	
- first channel	any channel.
- second channel	any channel.
Mobile Identity 1	
- TMSI value	TMSI previously allocated to MS.
Mobile Identity 2	
- TMSI value	TMSI not allocated to MS.
Mobile Identity	Not present.
P2 rest octets	Not used (all bits set to spare).

Contents of PAGING REQUEST TYPE 3 message:

L2 pseudo length	19
Protocol Discriminator	RR Management.
Skip Indicator	0000
Message Type	00100100
Page Mode	
- Page Mode	Normal Paging.
Channels needed	
- first channel	any channel.
- second channel	any channel.
Mobile identity 1	
- TMSI value	TMSI previously allocated to MS.
Mobile identity 2	
- TMSI value	TMSI not allocated to MS.
Mobile identity 3	
- TMSI value	TMSI not allocated to MS.
Mobile identity 4	
- TMSI value	TMSI not allocated to MS.
P3 rest octets	Not used (all bits set to spare).

Contents of PAGING RESPONSE message:

Protocol Discriminator	RR Management.
Skip Indicator	0000
Message Type	00100111
Ciphering Key Sequence Number	
- Key Sequence	Key sequence number previously allocated to MS, or "111" if no key is available.
Mobile Station Classmark 2	
Mobile Identity	
- odd/even indication	Even
- Type of identity	TMSI
- Identity Digits	TMSI previously allocated to MS.

Contents of PHYSICAL INFORMATION message:

Protocol Discriminator	RR Management.
Skip Indicator	0000
Message Type	00101101
Timing advance	20 bit periods.

Contents of SETUP message; (MS to SS):

Protocol Discriminator	Call Control.
Transaction Identifier	
TI value	any value from the set {0, ..., 6}.
TI flag	0
Message Type	0X000101
Other information elements	Not checked.

26.6.17 Default contents of GSM 480 layer 3 messages for RR tests

This section contains the default values of GSM 480 L3 messages, which unless indicated otherwise in section 26.6 shall be transmitted by the system simulator and which are required to be received from the GSM 480 MS under test. These values are used in order to be consistent with the phase 2 version of 26.6.

The necessary L3 messages are listed in alphabetic order, with the exception of the SYSTEM INFORMATION messages, where it is the information elements which are listed in alphabetic order (this is because some information elements occur in several SYSTEM INFORMATION types).

In this section, decimal values are normally used. However, sometimes a hexadecimal value, indicated by an "H", or a binary value, indicated by a "B" is used.

Default SYSTEM INFORMATION:

NOTE 1: SYSTEM INFORMATION 2 bis, SYSTEM INFORMATION 5 bis, SYSTEM INFORMATION 7, and SYSTEM INFORMATION 8 messages are not used.

Cell A

Contents of information elements in SYSTEM INFORMATION TYPE 1 to 6 messages for cell A.

(CBCH) Channel Description	Not present.
(CBCH) Mobile Allocation	Not present.
Cell Channel Description	
- Format identifier	128 range.
- Cell Allocation ARFCN	Channel Numbers 310, 315, 322 and 326.
Cell Identity	
- Cell Identity Value	0001H
Cell Options	
- Power Control Indicator	Power Control Indicator is not set.
- DTX Indicator	MS shall not use DTX.
- Radio_Link_Timeout	8 SACCH blocks.
Cell Selection Parameters	
- Cell_Reselect_Hysteresis	12 dB.
- MX_TXPWR_MAX_CCH	Minimum level.
- ACS	No addition cell parameters are present in SYSTEM INFORMATION messages 7 and 8.
- NECI	New establishment causes not supported.
- RXLEV_ACCESS_MIN	Minimum level.
Control Channel Description	
- Attach-Detach allowed	No Attach/Detach.
- BS_AG_BLK_RES	0 blocks reserved for access grant.
- CCCH_CONF	1 basic physical channel used for CCCH, combined with SDCCHs.
- BS_PA_MFRMS	5 multiframe periods for transmission of paging messages.
- T3212 Time-out value	Infinite.
L2 pseudo length	
- System information 1	21
- System information 2	22
- System information 3	18
- System information 4	12
Location Area Identification	
- Mobile Country Code	001 decimal
- Mobile Network Code	01 decimal
- Location Area Code	0001H
Message Type	
- System information 1	00011001
- System information 2	00011010
- System information 3	00011011
- System information 4	00011100
- System information 5	00011101
- System information 6	00011110
Neighbour Cells Description	
- Format identifier	128 range.
- BCCH Allocation Sequence	0
- BCCH Allocation ARFCN	Channels numbers 308, 310, 321, 329, 331, 334, 337 and 340.
- EXT-IND	This IE carries the complete BA.
NCC Permitted	0000 0010
RACH Control Parameters	
- Max Retrans	Max 1 retrans.
- Tx-integer	5 slots used.
- Cell Barred for Access	Cell is not barred.
- Call Reestablishment Allowed	Not allowed.
- Access Control Class	Access is not barred.
- Emergency Call allowed	Yes.
SI 1 rest octets	Not used (all bits are set to spare).
SI 2 rest octets	Not used (all bits are set to spare).
SI 3 rest octets	Not used (all bits are set to spare).
SI 4 rest octets	Not used (all bits are set to spare).

Default settings for cell A:

Downlink input level Uplink output power Propagation profile BCCH/CCCH carrier number	63 dBmicroVolt emf. minimum supported by the MS's power class. static. 310
--	---

Cell B

The contents of SYSTEM INFORMATION TYPE 1 to 6 messages for cell B are identical to those of cell A with the following exceptions:

Cell Channel Description - Format Identifier - Cell Allocation ARFCN	128 range. Channel Number 308.
--	-----------------------------------

NOTE 2: This IE needs modification when used in handover tests which command the MS to go to a frequency hopping channel in cell B.

Cell Identity

- Cell Identity Value 0002H

Default settings for cell B:

Downlink input level Uplink output power Propagation profile BCCH/CCCH carrier number	53 dBmicroVolt emf. minimum supported by the MS's power class. static. 308
--	---

Contents of ALERTING message (SS to MS):

Protocol Discriminator Transaction Identifier TI value TI flag Message Type All other information elements	Call Control. As used in the SETUP message. 1 (destination side). 00000001 Not present.
---	---

Contents of ASSIGNMENT COMMAND message:

Protocol Discriminator Skip Indicator Message Type Channel Description - Channel Type and TDMA offset - Timeslot Number - Training Sequence Code - Hopping - ARFCN Power Command - Power level All other information elements	RR Management. 0000 00101110 Bm + ACCHs Chosen arbitrarily by the test house. Chosen arbitrarily by the test house. Single RF channel. Channel number 315. Chosen arbitrarily by the test house. Not present.
--	--

Contents of ASSIGNMENT COMPLETE message:

Protocol Discriminator	RR Management.
Skip Indicator	0000
Message Type	00101001
RR Cause	
- RR Cause Value	Normal event.

Contents of ASSIGNMENT FAILURE message:

Protocol Discriminator	RR Management.
Skip Indicator	0000
Message Type	00101111
RR Cause	
- RR Cause Value	Depending on test.

Contents of AUTHENTICATION REQUEST message:

Protocol Discriminator	MM message.
Skip Indicator	0000
Message Type	00010010
Ciphering Key Sequence Number	
- Key Sequence	Chosen arbitrarily by the test house from the range 0 to 6.
Authentication Parameter RAND	
- RAND value	Chosen arbitrarily by the test house.

Contents of AUTHENTICATION RESPONSE message:

Protocol Discriminator	MM message.
Skip Indicator	0000
Message Type	0X010100
Other information element(s)	Not checked.

Contents of CALL PROCEEDING message:

Protocol Discriminator	Call Control.
Transaction Identifier	
TI value	As used in the SETUP message.
TI flag	1 (destination side).
Message Type	00000010
All other information elements	Not present.

Contents of CHANNEL MODE MODIFY message:

Protocol Discriminator	RR Management.
Skip Indicator	0000
Message Type	00010000
Channel Description	
- Channel Type and TDMA offset	Depending on test.
- Timeslot Number	Chosen arbitrarily by the test house.
- Training Sequence Code	Chosen arbitrarily by the test house.
- Hopping	Single RF channel.
- ARFCN	Channel number 315.
Channel Mode	
- Mode	Depending on test.

Contents of CHANNEL MODE MODIFY ACKNOWLEDGE message:

Protocol Discriminator	RR Management.
Skip Indicator	0000
Message Type	00010111
Channel Description	Depending on test.
- Channel Type and TDMA offset	Same as in the CHANNEL MODE MODIFY message.
- Timeslot Number	Same as in the CHANNEL MODE MODIFY message.
- Training Sequence Code	Single RF channel.
- Hopping	Band number 0.
- Frequency Band	Channel number 315.
- ARFCN	
Channel Mode	
- Mode	Same as in the CHANNEL MODE MODIFY message.

Contents of CHANNEL RELEASE message:

Protocol Discriminator	RR Management.
Skip Indicator	0000
Message Type	00001101
RR Cause	
- RR Cause Value	Normal event.

Contents of CHANNEL REQUEST message

Establishment Cause	Not checked.
Random Reference	Not checked.

Contents of CIPHERING MODE COMMAND message:

Protocol Discriminator	RR Management.
Skip Indicator	0000
Message Type	00110101
Cipher Mode Setting	
- algorithm identifier	cipher with A5/1.
- SC	Start ciphering.
Cipher Response	IMEI shall not be included.

Contents of CIPHERING MODE COMPLETE message:

Protocol Discriminator	RR Management.
Skip Indicator	0000
Message Type	00110010
Mobile Identity	Not present.

Contents of the CLASSMARK CHANGE message:

Protocol Discriminator	RR Management.
Skip Indicator	0000
Message Type	000100110
Mobile Station Classmark 2	See PICS/PIXIT.
Mobile Station Classmark 3	For presence and contents see PICS/PIXIT.

Contents of CM SERVICE ACCEPT message:

Protocol Discriminator	Mobility Management.
Skip Indicator	0000
Message Type	00100001

Contents of CM SERVICE REQUEST message

Protocol Discriminator	Mobility Management.
Skip Indicator	0000
Message Type	0X100100
Other information elements	Not checked.

Contents of CONNECT message (SS to MS)

Protocol Discriminator	Call Control.
Transaction Identifier	
TI value	As used in the SETUP message.
TI flag	1
Message Type	00000111
All other information elements	Not present.

Contents of CONNECT ACKNOWLEDGE message (MS to SS)

Protocol Discriminator	Call Control.
Transaction Identifier	
TI value	As used in the SETUP message.
TI flag	0
Message Type	0X001111

Contents of HANDOVER ACCESS message:

Handover Reference	Equal to the value included in the Handover Command message.
--------------------	--

Contents of HANDOVER COMMAND message:

Protocol Discriminator	RR Management.
Skip Indicator	0000
Message Type	00101011
Cell Description	
- Network Colour Code	1
- Base station Colour Code	Corresponding to target cell
- BCCH Carrier Number	Set to the BCCH carrier number of cell B. (one of 308, 310, 329, 331, 334, 337 or 340).
Channel Description	
- Channel Type and TDMA offset	Bm + ACCHs.
- Timeslot Number	Chosen arbitrarily by the test house.
- Training Sequence Code	Chosen arbitrarily by the test house.
- Hopping	Single RF channel.
- ARFCN	Chosen arbitrarily by the test house from those supported on the target cell.
Handover Reference	
- Handover Reference Value	Chosen arbitrarily by the test house.
Power Command	
- Power level	Chosen arbitrarily by the test house.
All other information elements	Not present.

Contents of HANDOVER COMPLETE message:

Protocol Discriminator	RR Management.
Skip Indicator	0000
Message Type	00101100
RR cause	Normal event.
Time difference	Not present.

Contents of HANDOVER FAILURE message:

Protocol Discriminator	RR Management.
Skip Indicator	0000
Message Type	00101000
RR cause	Dependent on the test.

IDENTITY REQUEST

Information element	Value/remark
Identity type	IMEI
Spare half octet	0000

IDENTITY RESPONSE

Information element	Value/remark
Mobile identity	not checked

Contents of IMMEDIATE ASSIGNMENT message:

L2 pseudo length	This is the sum of the lengths of all the information elements present in the message except for the IA rest octets and L2 pseudo length IEs. For the default message the L2 pseudo length is 11.
Protocol Discriminator	RR Management.
Skip Indicator	0000
Message Type	00111111
Page Mode	
- Page Mode	Normal Paging.
Channel Description	
- Channel Type and TDMA offset	For non-combined CCCH/SDCCH (see initial conditions), SDCCH/8, with subchannel chosen arbitrarily by the test house For combined CCCH/SDCCH (default SS conditions), SDCCH/4, with subchannel chosen arbitrarily by the test house.
- Timeslot Number	For non-combined CCCH/SDCCH (see initial conditions), chosen arbitrarily by the test house; For combined CCCH/SDCCH (default SS conditions), SDCCH/4, timeslot zero.
- Training Sequence Code	For non-combined CCCH/SDCCH (see initial conditions), chosen arbitrarily by the test house; For combined CCCH/SDCCH (default SS conditions), SDCCH/4, TSC=5 (same as the BCC).
- Hopping	Single RF channel.
- ARFCN	For non-combined CCCH/SDCCH (see initial conditions), Channel number 30; For combined CCCH/SDCCH (default SS conditions), SDCCH/4, Channel number 310.
Request Reference	Pertaining to last Channel Request sent by the MS.
Timing Advance	
- Timing advance value	30 bit periods.
Mobile Allocation	
- Length	0
Starting Time	Not present.
IA rest octets	Not used (all bits set to spare).

Contents of IMMEDIATE ASSIGNMENT EXTENDED message:

L2 pseudo length	This is the sum of the lengths of all the information elements present in the message except for the IAX rest octets and L2 pseudo length IEs. For the default message the L2 pseudo length is 18.
Protocol Discriminator	RR Management.
Skip Indicator	0000
Message Type	00111001
Page Mode	
- Page Mode	Normal Paging.
Channel Description 1	
- Channel Type and TDMA offset	For non-combined CCCH/SDCCH (see test conditions), SDCCH/8, with subchannel chosen arbitrarily by the test house; For combined CCCH/SDCCH (default SS conditions), SDCCH/4, with subchannel chosen arbitrarily by the test house.
- Timeslot Number	For non-combined CCCH/SDCCH (see test conditions), chosen arbitrarily by the test house; For combined CCCH/SDCCH (default SS conditions), SDCCH/4, timeslot zero.
- Training Sequence Code	For non-combined CCCH/SDCCH (see initial conditions), chosen arbitrarily by the test house; For combined CCCH/SDCCH (default SS conditions), SDCCH/4, TSC=5 (same as the BCC).
- Hopping	Single RF channel.
- ARFCN	For non-combined CCCH/SDCCH (see initial conditions), Channel number 30; For combined CCCH/SDCCH (default SS conditions), SDCCH/4, Channel number 310.
Request Reference 1	Pertaining to last Channel Request sent by the MS.
Timing Advance 1	
- Timing advance value	Chosen arbitrarily by the test house.
Channel Description 2	
- Channel Type and TDMA offset	Same channel type as in Channel Description 1, but different TDMA offset to that in Channel Description 1.
- Timeslot Number	equal to the value in Channel Description 1.
- Training Sequence Code	equal to the value in Channel Description 1.
- Hopping	Single RF channel.
- ARFCN	equal to the value in Channel Description 1.
Request Reference 2	Not pertaining to any Channel Requests sent by the MS.
Timing Advance 2	
- Timing advance value	Chosen arbitrarily by the test house.
Mobile Allocation	
- Length	0
Starting Time	Not present.
IAX rest octets	Not used (all bits set to spare).

Contents of IMMEDIATE ASSIGNMENT REJECT message:

L2 pseudo length	19
Protocol Discriminator	RR Management.
Skip Indicator	0000
Message Type	00111010
Page Mode	
- Page Mode	Normal Paging.
Request Reference	Pertaining to last Channel Request sent by the MS.
Wait Indication	0 seconds.
Request Reference	Not pertaining to the MS under test.
Wait Indication	0 seconds.
Request Reference	Not pertaining to the MS under test.
Wait Indication	0 seconds.
Request Reference	Not pertaining to the MS under test.
Wait Indication	0 seconds.
IAR rest octets	Not used (all bits set to spare).

Contents of LOCATION UPDATING REQUEST message:

Protocol Discriminator	MM message.
Skip Indicator	0000
Message Type	0X001000
Other information elements	Not checked.

Contents of PAGING REQUEST TYPE 1 message:

L2 pseudo length	This is the sum of the lengths of all the information elements present in the message except for the P1 rest octets and L2 pseudo length IEs. For the default message the L2 pseudo length is 9.
Protocol Discriminator	RR Management.
Skip Indicator	0000
Message Type	00100001
Page Mode	Normal Paging.
- Page Mode	
Channels needed	any channel.
- first channel	any channel.
- second channel	
Mobile Identity 1	Even.
- odd/even indication	TMSI.
- Type of Identity	TMSI previously allocated to MS.
- Identity Digits	
Mobile Identity 2	Not present.
P1 rest octets	Not used (all bits set to spare).

Contents of PAGING REQUEST TYPE 2 message:

L2 pseudo length	This is the sum of the lengths of all the information elements present in the message except for the P2 rest octets and L2 pseudo length IEs. For the default message the L2 pseudo length is 11.
Protocol Discriminator	RR Management..
Skip Indicator	0000
Message Type	00100010
Page Mode	Normal Paging.
- Page Mode	
Channels needed	any channel.
- first channel	any channel.
- second channel	
Mobile Identity 1	TMSI previously allocated to MS.
- TMSI value	
Mobile Identity 2	TMSI not allocated to MS.
- TMSI value	
Mobile Identity	Not present.
P2 rest octets	Not used (all bits set to spare).

Contents of PAGING REQUEST TYPE 3 message:

L2 pseudo length	19
Protocol Discriminator	RR Management.
Skip Indicator	0000
Message Type	00100100
Page Mode	
- Page Mode	Normal Paging.
Channels needed	
- first channel	any channel.
- second channel	any channel.
Mobile identity 1	
- TMSI value	TMSI previously allocated to MS.
Mobile identity 2	
- TMSI value	TMSI not allocated to MS.
Mobile identity 3	
- TMSI value	TMSI not allocated to MS.
Mobile identity 4	
- TMSI value	TMSI not allocated to MS.
P3 rest octets	Not used (all bits set to spare).

Contents of PAGING RESPONSE message:

Protocol Discriminator	RR Management.
Skip Indicator	0000
Message Type	00100111
Ciphering Key Sequence Number	
- Key Sequence	Key sequence number previously allocated to MS, or "111" if no key is available.
Mobile Station Classmark 2	
Mobile Identity	
- odd/even indication	Even
- Type of identity	TMSI
- Identity Digits	TMSI previously allocated to MS.

Contents of PHYSICAL INFORMATION message:

Protocol Discriminator	RR Management.
Skip Indicator	0000
Message Type	00101101
Timing advance	20 bit periods.

Contents of SETUP message; (MS to SS):

Protocol Discriminator	Call Control.
Transaction Identifier	
TI value	any value from the set {0, ..., 6}.
TI flag	0
Message Type	0X000101
Other information elements	Not checked.

26.6.18 Default contents of PCS 1900 layer 3 messages for RR tests

This section contains the default values of PCS 1900 L3 messages, which unless indicated otherwise in section 26.6 shall be transmitted by the system simulator and which are required to be received from the PCS 1900 MS under test. These values are used in order to be consistent with the phase 2 version of 26.6.

The necessary L3 messages are listed in alphabetic order, with the exception of the SYSTEM INFORMATION messages, where it is the information elements which are listed in alphabetic order (this is because some information elements occur in several SYSTEM INFORMATION types).

In this section, decimal values are normally used. However, sometimes a hexadecimal value, indicated by an "H", or a binary value, indicated by a "B" is used.

Default SYSTEM INFORMATION:

NOTE 1: SYSTEM INFORMATION 2 bis, SYSTEM INFORMATION 7, and SYSTEM INFORMATION 8 messages are not used.

SYSTEM INFORMATION 5 bis is not sent as a default message. For those tests which require SYSTEM INFORMATION 5 bis see the specific message contents for that test.

Cell A

Contents of information elements in SYSTEM INFORMATION TYPE 1 to 6 messages for cell A.

(CBCH) Channel Description	Not present.
(CBCH) Mobile Allocation	Not present.
Cell Channel Description	
- Format identifier	Range 512.
- Cell Allocation ARFCN	Channel Numbers, 590, 650, 750 and 780.
Cell Identity	
- Cell Identity Value	0001H
Cell Options	
- Power Control Indicator	Power Control Indicator is not set, 0
- DTX Indicator	MS shall not use DTX.
- Radio_Link_Timeout	8 SACCH blocks.
Cell Selection Parameters	
- Cell_Reselect_Hysteresis	12 dB
- MX_TXPWR_MAX_CCH	Minimum level.
- ACS	No addition cell parameters are present in SYSTEM INFORMATION messages 7 and 8.
- NECI	New establishment causes not supported.
- RXLEV_ACCESS_MIN	Minimum level.
Control Channel Description	
- Attach-Detach allowed	MS shall not apply.
- BS_AG_BLK_RES	0 blocks reserved for access grant.
- CCCH_CONF	1 basic physical channel used for CCCH, combined with SDCCHs.
- BS_PA_MFRMS	5 multiframe periods for transmission of paging messages.
- T3212 Time-out value	Infinite.
L2 pseudo length	
- System information 1	21
- System information 2	22
- System information 3	18
- System information 4	12
Location Area Identification	
- Mobile Country Code	001 decimal.
- Mobile Network Code	011 decimal.
- Location Area Code	0001H
Message Type	
- System information 1	00011001
- System information 2	00011010
- System information 3	00011011
- System information 4	00011100
- System information 5	00011101
- System information 6	00011110
Neighbour Cells Description	
- Format identifier	Range 512.
- BCCH Allocation Sequence	0
- BCCH Allocation ARFCN	Channels numbers, 520, 590, 600, 647, 664, 700, 720, 760, 780.
- EXT-IND	This IE carries the complete BA. EXT-IND is 0.
NCC Permitted	0000 0010
RACH Control Parameters	
- Max Retrans	Max 1 retrans.
- Tx-integer	5 slots used.
- Cell Barred for Access	Cell is not barred.
- Call Reestablishment Allowed	Not Allowed.
- Access Control Class	Access is not barred.
- Emergency Call allowed	Yes.
SI 1 rest octets	Not used (all bits are set to spare).
SI 2 rest octets	Not used (all bits are set to spare).
SI 3 rest octets	Not used (all bits are set to spare).
SI 4 rest octets	Not used (all bits are set to spare).

Default settings for cell A:

Downlink input level Uplink output power Propagation profile BCCH/CCCH carrier number	63 dBmicroVolt emf(). minimum supported by the MS's power class. static. ARFN 590.
--	---

Cell B

The contents of SYSTEM INFORMATION TYPE 1 to 6 messages for cell B are identical to those of cell A with the following exceptions:

Cell Channel Description - Format Identifier - Cell Allocation ARFCN	Range 512. Channel Number 520.
--	-----------------------------------

NOTE 2: This IE needs modification when used in handover tests which command the MS to go to a frequency hopping channel in cell B.

Cell Identity - Cell Identity Value	0002H
--	-------

Default settings for cell B:

Downlink input level Uplink output power Propagation profile BCCH/CCCH carrier number	53 dBmicroVolt emf(). minimum supported by the MS's power class. static. 520
--	---

Contents of ALERTING message (SS to MS):

Protocol Discriminator Transaction Identifier TI value TI flag Message Type All other information elements	Call Control. As used in the SETUP message. 1 (destination side). 00000001 Not present.
---	---

Contents of ASSIGNMENT COMMAND message:

Protocol Discriminator Skip Indicator Message Type Channel Description - Channel Type and TDMA offset - Timeslot Number - Training Sequence Code - Hopping - ARFCN Power Command - Power level All other information elements	RR Management. 0000 00101110 Bm + ACCHs. Chosen arbitrarily by the test house. Chosen arbitrarily by the test house. Single RF channel. Channel number 650. Chosen arbitrarily by the test house. Not present.
--	---

Contents of ASSIGNMENT COMPLETE message:

Protocol Discriminator	RR Management.
Skip Indicator	0000
Message Type	00101001
RR Cause	
- RR Cause Value	Normal event.

Contents of ASSIGNMENT FAILURE message:

Protocol Discriminator	RR Management.
Skip Indicator	0000
Message Type	00101111
RR Cause	
- RR Cause Value	Depending on test.

Contents of AUTHENTICATION REQUEST message:

Protocol Discriminator	MM message.
Skip Indicator	0000
Message Type	00010010
Ciphering Key Sequence Number	
- Key Sequence	Chosen arbitrarily by the test house from the range 0 to 6.
Authentication Parameter RAND	
- RAND value	Chosen arbitrarily by the test house.

Contents of AUTHENTICATION RESPONSE message:

Protocol Discriminator	MM message.
Skip Indicator	0000
Message Type	0X010100
Other information element(s)	Not checked.

Contents of CALL PROCEEDING message:

Protocol Discriminator	Call Control.
Transaction Identifier	
TI value	As used in the SETUP message.
TI flag	1 (destination side).
Message Type	00000010
All other information elements	Not present.

Contents of CHANNEL MODE MODIFY message:

Protocol Discriminator	RR Management.
Skip Indicator	0000
Message Type	00010000
Channel Description	
- Channel Type and TDMA offset	Depending on test.
- Timeslot Number	Chosen arbitrarily by the test house.
- Training Sequence Code	Chosen arbitrarily by the test house.
- Hopping	Single RF channel.
- ARFCN	Channel number 650.
Channel Mode	
- Mode	Depending on test.

Contents of CHANNEL MODE MODIFY ACKNOWLEDGE message:

Protocol Discriminator	RR Management.
Skip Indicator	0000
Message Type	00010111
Channel Description	Depending on test.
- Channel Type and TDMA offset	Same as in the CHANNEL MODE MODIFY message.
- Timeslot Number	Same as in the CHANNEL MODE MODIFY message.
- Training Sequence Code	Single RF channel.
- Hopping	Band number 0.
- Frequency Band	Channel number 650.
- ARFCN	
Channel Mode	
- Mode	Same as in the CHANNEL MODE MODIFY message.

Contents of CHANNEL RELEASE message:

Protocol Discriminator	RR Management.
Skip Indicator	0000
Message Type	00001101
RR Cause	
- RR Cause Value	Normal event.

Contents of CHANNEL REQUEST message:

Establishment Cause	Not checked.
Random Reference	Not checked.

Contents of CIPHERING MODE COMMAND message:

Protocol Discriminator	RR Management.
Skip Indicator	0000
Message Type	00110101
Cipher Mode Setting	
- algorithm identifier	cipher with A5/1.
- SC	Start ciphering.
Cipher Response	IMEI shall not be included.

Contents of CIPHERING MODE COMPLETE message:

Protocol Discriminator	RR Management.
Skip Indicator	0000
Message Type	00110010
Mobile Identity	Not present.

Contents of the CLASSMARK CHANGE message:

Protocol Discriminator	RR Management.
Skip Indicator	0000
Message Type	000100110
Mobile Station Classmark 2	
- RF Power Capability	See PICS/PIXIT.
- Frequency Capability	Set to 0.
Mobile Station Classmark 3	For presence and contents see PICS/PIXIT.

Contents of CM SERVICE ACCEPT message:

Protocol Discriminator	Mobility Management.
Skip Indicator	0000
Message Type	00100001

Contents of CM SERVICE REQUEST message:

Protocol Discriminator	Mobility Management.
Skip Indicator	0000
Message Type	0X100100
Other information elements	Not checked.

Contents of CONNECT message (SS to MS):

Protocol Discriminator	Call Control.
Transaction Identifier	
TI value	As used in the SETUP message.
TI flag	1
Message Type	00000111
All other information elements	Not present.

Contents of CONNECT ACKNOWLEDGE message (MS to SS):

Protocol Discriminator	Call Control.
Transaction Identifier	
TI value	As used in the SETUP message.
TI flag	0
Message Type	0X001111

Contents of HANDOVER ACCESS message:

Handover Reference	Equal to the value included in the Handover Command message.
--------------------	--

Contents of HANDOVER COMMAND message:

Protocol Discriminator	RR Management.
Skip Indicator	0000
Message Type	00101011
Cell Description	
- Network Colour Code	1
- Base station Colour Code	5
- BCCH Carrier Number	Set to the BCCH carrier number of cell B. (one of 520, 590, 600, 700, 720, 760 or 780).
Channel Description	
- Channel Type and TDMA offset	Bm + ACCHs.
- Timeslot Number	Chosen arbitrarily by the test house.
- Training Sequence Code	Chosen arbitrarily by the test house.
- Hopping	Single RF channel.
- ARFCN	Chosen arbitrarily by the test house from those supported on the target cell.
Handover Reference	
- Handover Reference Value	Chosen arbitrarily by the test house.
Power Command	
- Power level	Chosen arbitrarily by the test house.
All other information elements	Not present.

Contents of HANDOVER COMPLETE message:

Protocol Discriminator	RR Management.
Skip Indicator	0000
Message Type	00101100
RR cause	Normal event.
Time difference	Not present.

Contents of HANDOVER FAILURE message:

Protocol Discriminator	RR Management.
Skip Indicator	0000
Message Type	00101000
RR cause	Dependent on the test.

Contents of IMMEDIATE ASSIGNMENT message:

L2 pseudo length	This is the sum of the lengths of all the information elements present in the message except for the IA rest octets and L2 pseudo length IEs. For the default message the L2 pseudo length is 11.
Protocol Discriminator	RR Management.
Skip Indicator	0000
Message Type	00111111
Page Mode	
- Page Mode	Normal Paging.
Channel Description	
- Channel Type and TDMA offset	For non-combined CCCH/SDCCH (see initial conditions), SDCCH/8, with subchannel chosen arbitrarily by the test house For combined CCCH/SDCCH (default SS conditions), SDCCH/4, with subchannel chosen arbitrarily by the test house.
- Timeslot Number	For non-combined CCCH/SDCCH (see initial conditions), chosen arbitrarily by the test house; For combined CCCH/SDCCH (default SS conditions), SDCCH/4, timeslot zero.
- Training Sequence Code	For non-combined CCCH/SDCCH (see initial conditions), chosen arbitrarily by the test house; For combined CCCH/SDCCH (default SS conditions), SDCCH/4, TSC=5 (same as the BCC). Single RF channel.
- Hopping	For non-combined CCCH/SDCCH (see initial conditions), Channel number 650; For combined CCCH/SDCCH (default SS conditions), SDCCH/4, Channel number 590.
- ARFCN	Pertaining to last Channel Request sent by the MS.
Request Reference	
Timing Advance	
- Timing advance value	30 bit periods.
Mobile Allocation	
- Length	0
Starting Time	Not present.
IA rest octets	Not used (all bits set to spare).

Contents of IMMEDIATE ASSIGNMENT EXTENDED message:

L2 pseudo length	This is the sum of the lengths of all the information elements present in the message except for the IAX rest octets and L2 pseudo length IEs. For the default message the L2 pseudo length is 18.
Protocol Discriminator	RR Management.
Skip Indicator	0000
Message Type	00111001
Page Mode	
- Page Mode	Normal Paging.
Channel Description 1	
- Channel Type and TDMA offset	For non-combined CCCH/SDCCH (see test conditions), SDCCH/8, with subchannel chosen arbitrarily by the test house; For combined CCCH/SDCCH (default SS conditions), SDCCH/4, with subchannel chosen arbitrarily by the test house.
- Timeslot Number	For non-combined CCCH/SDCCH (see test conditions), chosen arbitrarily by the test house; For combined CCCH/SDCCH (default SS conditions), SDCCH/4, timeslot zero.
- Training Sequence Code	For non-combined CCCH/SDCCH (see initial conditions), chosen arbitrarily by the test house; For combined CCCH/SDCCH (default SS conditions), SDCCH/4, TSC=5 (same as the BCC).
- Hopping	Single RF channel.
- ARFCN	For non-combined CCCH/SDCCH (see initial conditions), Channel number 650; For combined CCCH/SDCCH (default SS conditions), SDCCH/4, Channel number 590.
Request Reference 1	Pertaining to last Channel Request sent by the MS.
Timing Advance 1	
- Timing advance value	Chosen arbitrarily by the test house.
Channel Description 2	
- Channel Type and TDMA offset	Same channel type as in Channel Description 1, but different TDMA offset to that in Channel Description 1.
- Timeslot Number	equal to the value in Channel Description 1.
- Training Sequence Code	equal to the value in Channel Description 1.
- Hopping	Single RF channel.
- ARFCN	equal to the value in Channel Description 1.
Request Reference 2	Not pertaining to any Channel Requests sent by the MS.
Timing Advance 2	
- Timing advance value	Chosen arbitrarily by the test house.
Mobile Allocation	
- Length	0
Starting Time	Not present.
IAX rest octets	Not used (all bits set to spare).

Contents of IMMEDIATE ASSIGNMENT REJECT message:

L2 pseudo length	19
Protocol Discriminator	RR Management.
Skip Indicator	0000
Message Type	00111010
Page Mode	
- Page Mode	Normal Paging.
Request Reference	Pertaining to last Channel Request sent by the MS.
Wait Indication	0 seconds.
Request Reference	Not pertaining to the MS under test.
Wait Indication	0 seconds.
Request Reference	Not pertaining to the MS under test.
Wait Indication	0 seconds.
Request Reference	Not pertaining to the MS under test.
Wait Indication	0 seconds.
IAR rest octets	Not used (all bits set to spare).

Contents of LOCATION UPDATING REQUEST message:

Protocol Discriminator	MM message.
Skip Indicator	0000
Message Type	0X001000
Other information elements	Not checked.

Contents of PAGING REQUEST TYPE 1 message:

L2 pseudo length	This is the sum of the lengths of all the information elements present in the message except for the P1 rest octets and L2 pseudo length IEs. For the default message the L2 pseudo length is 9.
Protocol Discriminator	RR Management.
Skip Indicator	0000
Message Type	00100001
Page Mode	
- Page Mode	Normal Paging.
Channels needed	
- first channel	any channel.
- second channel	any channel.
Mobile Identity 1	
- odd/even indication	Even.
- Type of Identity	TMSI.
- Identity Digits	TMSI previously allocated to MS.
Mobile Identity 2	Not present.
P1 rest octets	Not used (all bits set to spare).

Contents of PAGING REQUEST TYPE 2 message:

L2 pseudo length	This is the sum of the lengths of all the information elements present in the message except for the P2 rest octets and L2 pseudo length IEs. For the default message the L2 pseudo length is 11.
Protocol Discriminator	RR Management.
Skip Indicator	0000
Message Type	00100010
Page Mode	
- Page Mode	Normal Paging.
Channels needed	
- first channel	any channel.
- second channel	any channel.
Mobile Identity 1	
- TMSI value	TMSI previously allocated to MS.
Mobile Identity 2	
- TMSI value	TMSI not allocated to MS.
Mobile Identity	Not present.
P2 rest octets	Not used (all bits set to spare).

Contents of PAGING REQUEST TYPE 3 message:

L2 pseudo length	19
Protocol Discriminator	RR Management.
Skip Indicator	0000
Message Type	00100100
Page Mode	
- Page Mode	Normal Paging.
Channels needed	
- first channel	any channel.
- second channel	any channel.
Mobile identity 1	
- TMSI value	TMSI previously allocated to MS.
Mobile identity 2	
- TMSI value	TMSI not allocated to MS.
Mobile identity 3	
- TMSI value	TMSI not allocated to MS.
Mobile identity 4	
- TMSI value	TMSI not allocated to MS.
P3 rest octets	Not used (all bits set to spare).

Contents of PAGING RESPONSE message:

Protocol Discriminator	RR Management.
Skip Indicator	0000
Message Type	00100111
Ciphering Key Sequence Number	
- Key Sequence	Key sequence number previously allocated to MS, or "111" if no key is available.
Mobile Station Classmark 2	
Mobile Identity	
- odd/even indication	Even.
- Type of identity	TMSI
- Identity Digits	TMSI previously allocated to MS.

Contents of PHYSICAL INFORMATION message:

Protocol Discriminator	RR Management.
Skip Indicator	0000
Message Type	00101101
Timing advance	20 bit periods.

Contents of SETUP message; (MS to SS):

Protocol Discriminator	Call Control.
Transaction Identifier	
TI value	any value from the set {0, ..., 6}.
TI flag	0
Message Type	0X000101
Other information elements	Not checked.

26.7 Elementary procedures of mobility management

The tests are based on GSM 04.08 and GSM 03.03.

In this section, when the expected sequence require that "a mobile originated CM connection is attempted", it shall be for a service other than emergency call.

In this section, a initial CM message is either a SETUP message, a REGISTER message or a CP-DATA message (in that case the acknowledged mode of operation on SAPI 3 will have be established and this message will be sent on SAPI 3).

26.7.1 TMSI reallocation

The intention of the TMSI Reallocation procedure is to assign a new temporary identity for the MS. If the message is not understood by the MS, the network could not establish a link to the MS. As this is a common MM procedure, it can be initiated at any time.

26.7.1.1 Conformance requirement

- 1) A Mobile Station shall acknowledge a new TMSI when explicitly allocated during a location updating procedure or an incoming call.
- 2) The TMSI shall be updated on the SIM when the Mobile Station is correctly deactivated in accordance with the manufacturer's instructions.
- 3) A Mobile Station shall answer paging with this TMSI and includes it in the Paging Response message.

Reference(s):

GSM 04.08 section 4.3.1, GSM 03.03 section 2, GSM 02.17 section 6.1.

26.7.1.2 Test purpose

To verify that the MS is able to receive and acknowledge a new TMSI by means of an explicit TMSI reallocation procedure.

To verify that the MS has stored the TMSI in a non-volatile memory.

The implicit reallocation procedure is tested in section 26.7.4.1.

26.7.1.3 Method of test

Initial conditions

System Simulator:

Two cells A and B, belonging to different location areas a and b, default parameters.

Mobile Station:

The MS has valid TMSI (= TMSI1), CKSN, Kc. It is "idle updated" on cell B.

Related PICS/PIXIT statement(s)

Switch off button Yes/No.

Way to bring the MS into service.

Foreseen final state of the MS

The MS has a valid TMSI (= TMSI1), CKSN, Kc. It is "idle updated" on cell A.

Test Procedure

The MS is paged in cell B and the ciphering mode is established. An explicit TMSI reallocation procedure is performed. The channel is released. The MS is switched off and then its power supply is interrupted for 10 seconds. The power supply is resumed and then the MS is switched on and allowed sufficient time to guarantee that the MS is in service (listening to its paging subchannel). The system simulator then checks, by paging, whether the MS has stored the received TMSI.

The MS is made to select cell A. A normal location updating procedure is performed in cell A. An explicit TMSI reallocation procedure is performed and then the location updating procedure is accepted by the SS. The system simulator checks, by paging, whether the MS has stored the allocated TMSI.

Maximum duration of test

2 minutes.

Expected sequence

Step	Direction	Message	Comments
1	SS -> MS	PAGING REQUEST TYPE 1	<p>The following messages are sent and shall be received on cell B. "Mobile identity" = TMSI1. Establishment Cause: Answer to paging.</p> <p>The SS starts deciphering. The SS starts enciphering. "Mobile identity" = new TMSI (TMSI2) different from TMSI 1.</p> <p>After the sending of this message, the SS waits for the disconnection of the main signalling link. If possible (see PICS), the MS is switched off. The power supply is interrupted for 10 seconds. The MS is switched on. The SS waits an amount of time which is enough to guarantee that the MS is in service (listening to its paging subchannel).</p> <p>"Mobile identity" = TMSI2. Establishment Cause: Answer to paging.</p> <p>"Mobile identity" = TMSI2. After the sending of this message, the SS waits for the disconnection of the main signalling link. The following messages are sent and shall be received on cell A The RF level of cell B is lowered until the MS selects cell A. The RF level of cell B is set sufficiently low to ensure that cell B is not suitable as defined in GSM 05.08 section 6.6.2.</p> <p>Establishment cause: Location updating.</p> <p>location updating type = normal, "ciphering key sequence number" = CKSN, LAI = b, "mobile identity" = TMSI2. TMSI = TMSI1.</p> <p>This message does not contain the optional Mobile Identity field.</p> <p>After the sending of this message, the SS waits for the disconnection of the main signalling link. The SS waits an amount of time which is enough to guarantee that the MS is "idle updated" on cell A.</p> <p>"Mobile identity" IE contains the new TMSI (= TMSI1). "Establishment cause": Answer to paging.</p> <p>"Mobile identity" IE contains the new TMSI (= TMSI1). After the sending of this message, the SS waits for the disconnection of the main signalling link.</p>
2	MS -> SS	CHANNEL REQUEST	
3	SS -> MS	IMMEDIATE ASSIGNMENT	
4	MS -> SS	PAGING RESPONSE	
5	SS -> MS	CIPHERING MODE COMMAND	
6	MS -> SS	CIPHERING MODE COMPLETE	
7	SS -> MS	TMSI REALLOCATION COMMAND	
8	MS -> SS	TMSI REALLOCATION COMPLETE	
9	SS -> MS	CHANNEL RELEASE	
10	MS		
10a	MS		
11	MS		
12	SS		
13	SS -> MS	PAGING REQUEST TYPE 1	
14	MS -> SS	CHANNEL REQUEST	
15	SS -> MS	IMMEDIATE ASSIGNMENT	
16	MS -> SS	PAGING RESPONSE	
17	SS -> MS	CHANNEL RELEASE	
18	SS		
19	MS -> SS	CHANNEL REQUEST	
20	SS -> MS	IMMEDIATE ASSIGNMENT	
21	MS -> SS	LOCATION UPDATING REQUEST	
22	SS -> MS	TMSI REALLOCATION COMMAND	
23	MS -> SS	TMSI REALLOCATION COMPLETE	
24	SS -> MS	LOCATION UPDATING ACCEPT	
25	SS -> MS	CHANNEL RELEASE	
26	SS -> MS	PAGING REQUEST TYPE 1	
27	MS -> SS	CHANNEL REQUEST	
28	SS -> MS	IMMEDIATE ASSIGNMENT	
29	MS -> SS	PAGING RESPONSE	
30	SS -> MS	CHANNEL RELEASE	

Specific message contents:

None.

26.7.2 Authentication

The purpose of this procedure is to verify the user identity. A correct response is essential to guarantee the establishment of the connection. If not, the connection will drop.

The SS shall be able to handle vectors of Kc, RAND, and SRES in a similar way as the MSC/BSS entities. The SS shall incorporate a test algorithm for generating SRES and Kc from RAND and Ki which operates as described in annex 4.

26.7.2.1 Authentication accepted

26.7.2.1.1 Conformance requirement

- 1) A Mobile Station shall correctly respond to an Authentication Request message by sending an Authentication Response message with the SRES information field set to the same value as the one produced by the authentication algorithm in the network.
- 2) A Mobile Station shall indicate in a Paging Response message the ciphering key sequence number which was allocated to it through the authentication procedure.

Reference(s)

GSM 04.08 section 4.3.2, GSM 03.03 section 2.

26.7.2.1.2 Test purpose

- 1) To check that a Mobile Station correctly responds to an Authentication Request message by sending an Authentication Response message with the SRES information field set to the same value as the one produced by the authentication algorithm in the network.
- 2) To check that a Mobile Station indicates in a Paging Response message the ciphering key sequence number which was allocated to it through the authentication procedure.

26.7.2.1.3 Method of test

Initial conditions

System Simulator:

1 cell, default parameters.

Mobile Station:

The MS has valid TMSI, CKSN (CKSN1), Kc. It is "idle updated" on the cell.

Related PICS/PIXIT statement(s)

None.

Foreseen final state of the MS

The MS has valid TMSI, CKSN and Kc. It is "idle updated" on the cell.

Test Procedure

The MS is paged. After the MS has sent a PAGING RESPONSE message to the SS, the SS initiates an authentication procedure and checks the value SRES sent by the MS in the AUTHENTICATION RESPONSE message. The channel

is released. The MS is paged and the SS checks the value of the ciphering key sequence number sent by the MS in the PAGING RESPONSE message.

Maximum duration of test

1 minute.

Expected sequence

Step	Direction	Message	Comments
1	SS -> MS	PAGING REQUEST TYPE 1	Establishment Cause: Answer to paging.
2	MS -> SS	CHANNEL REQUEST	
3	SS -> MS	IMMEDIATE ASSIGNMENT	CKSN = CKSN1 The SS initiates authentication with CKSN2 different from CKSN1.
4	MS -> SS	PAGING RESPONSE	
5	SS -> MS	AUTHENTICATION REQUEST	
6	MS -> SS	AUTHENTICATION RESPONSE	"Auth. parameter SRES" IE shall be bit exact with the value as produced by the authentication algorithm.
7	SS -> MS	CHANNEL RELEASE	After the sending of this message, the SS waits for the disconnection of the main signalling link. The SS waits an amount of time which is enough to guarantee that the MS is in service.
8	SS -> MS	PAGING REQUEST TYPE 1	Establishment Cause: Answer to paging.
9	MS -> SS	CHANNEL REQUEST	
10	SS -> MS	IMMEDIATE ASSIGNMENT	"Ciphering key sequence number" shall be the same as the value that was sent in the last AUTHENTICATION REQUEST message (= CKSN2).
11	MS -> SS	PAGING RESPONSE	
12	SS -> MS	CHANNEL RELEASE	After the sending of this message, the SS waits for the disconnection of the main signalling link.

Specific message contents:

None.

26.7.2.2 Authentication rejected

26.7.2.2.1 Conformance requirement

- 1) After reception of an Authentication Reject message the Mobile Station shall:
 - 1.1 not perform normal location updating.
 - 1.2 not perform periodic location updating.
 - 1.3 not respond to paging with TMSI.
 - 1.4 reject any request from CM entity for MM connection except for emergency call.
 - 1.5 not perform IMSI detach if deactivated.
- 2) After reception of an Authentication Reject message the Mobile Station, if it supports speech, shall accept a request for an emergency call by sending a CHANNEL REQUEST message with the establishment cause set to "emergency call" and include an IMEI as mobile identity in the CM SERVICE REQUEST message.
- 3) After reception of an Authentication Reject message the Mobile Station shall delete the stored LAI, CKSN and TMSI.

Reference(s)

GSM 04.08 sections 4.3.2.5.

26.7.2.2.2 Test purpose

- 1) To check that ,after reception of an Authentication Reject message, the Mobile Station:
 - 1.1 does not perform normal location updating.
 - 1.2 does not perform periodic location updating.
 - 1.3 does not respond to paging with TMSI.
 - 1.4 rejects any request from CM entity for MM connection except for emergency call.
 - 1.5 does not perform IMSI detach if deactivated.
- 2) To check that, after reception of an Authentication Reject message the Mobile Station, if it supports speech, accepts a request for an emergency call by sending a CHANNEL REQUEST message with the establishment cause set to "emergency call" and includes an IMEI as mobile identity in the CM SERVICE REQUEST message.
- 3) To check that, after reception of an Authentication Reject message and after having been deactivated and reactivated, the MS performs location updating using its IMSI as mobile identity and indicates deleted LAI and CKSN.

26.7.2.2.3 Method of test

Initial conditions

System Simulator:

Two cells: A and B, belonging to different location areas a and b.

IMSI attach/detach is allowed in both cells.

The T3212 time-out value is 1/10 hour in both cells.

Mobile Station:

The MS has valid TMSI, CKSN (CKSN2) and Kc. It is "idle updated" on cell B.

Related PICS/PIXIT statement(s)

SIM removal possible while MS is powered Yes/No.

Switch off on button Yes/No.

Support of speech Yes/No.

Foreseen final state of the MS

The MS has valid TMSI, CKSN (CKSN1) and Kc. It is "idle updated" on cell A.

Test procedure

The SS rejects an authentication. The channel is released. The SS checks that the MS has entered the state MM IDLE substate NO IMSI, i.e. does not perform normal location updating, does not perform periodic updating, does not respond to paging, rejects any requests from CM entities except emergency calls and does not perform IMSI detach if SIM detachment is performed, switch off is performed, or the power is removed, depending on the MS (see PICS/PIXIT).

Maximum duration of test

10 minutes.

Expected sequence

Step	Direction	Message	Comments	
The following messages are sent and shall be received on cell B				
1	SS -> MS	PAGING REQUEST TYPE 1	Establishment Cause: Answer to paging. "Ciphering key sequence number" shall be the same as the value that was sent in the last AUTHENTICATION REQUEST message (= CKSN2).	
2	MS -> SS	CHANNEL REQUEST		
3	SS -> MS	IMMEDIATE ASSIGNMENT		
4	MS -> SS	PAGING RESPONSE		
5	SS -> MS	AUTHENTICATION REQUEST	After the sending of this message, the SS waits for the disconnection of the main signalling link. The MS is paged in cell B. "Mobile identity" IE contains TMSI. The MS shall ignore this message. This is verified during 3 seconds. The SS waits for at least for 15 s. A MO CM connection is attempted. The MS shall not initiate an RR connection establishment on cell A or cell B. This is checked during 3 seconds. If the MS supports speech (see PICS), an emergency call is attempted. "Establishment cause": Emergency call. "CM service type": Emergency call establishment. "Mobile identity": type of identity is set to IMEI. "Cause" = unassigned number. After the sending of this message, the SS waits for the disconnection of the main signalling link.	
6	MS -> SS	AUTHENTICATION RESPONSE		
7	SS -> MS	AUTHENTICATION REJECT		
8	SS -> MS	CHANNEL RELEASE		
9	SS -> MS	PAGING REQUEST TYPE 1		
10	MS			
11	SS			
12	MS			
13	MS			
14	MS			
15	MS -> SS	CHANNEL REQUEST	"Establishment cause": Emergency call. "CM service type": Emergency call establishment. "Mobile identity": type of identity is set to IMEI. "Cause" = unassigned number. After the sending of this message, the SS waits for the disconnection of the main signalling link.	
16	SS -> MS	IMMEDIATE ASSIGNMENT		
17	MS -> SS	CM SERVICE REQUEST		
18	SS -> MS	CM SERVICE ACCEPT		
19	MS -> SS	EMERGENCY SETUP		
20	SS -> MS	RELEASE COMPLETE		
21	SS -> MS	CHANNEL RELEASE		
The following messages are sent and shall be received on cell A.				
22	SS			The RF levels are changed to make the MS reselect the cell A. The MS performs cell reselection according to procedure as specified in GSM 05.08 (this however is not checked until step 29). The MS shall not initiate an RR connection establishment on cell A or on cell B. The SS waits at least 7 minutes for a possible periodic updating. The MS shall not initiate an RR connection establishment on cell A or on cell B. If possible (see PICS) SIM detachment is performed. Otherwise if possible (see PICS) switch off is performed. Otherwise the power is removed. The MS shall not initiate an RR connection establishment on cell A or on cell B. This is checked during 3 seconds. Depending on what has been performed in step 26 the MS is brought back to operation. "Establishment cause": Location updating. "location updating type" = normal, "CKSN" = no key available, "Mobile Identity" = IMSI, "LAI" = deleted LAI (the MCC and MNC hold the previous values, the LAC is coded FFFE). "CKSN" = CKSN1. "Mobile Identity" = TMSI. After the sending of this message, the SS waits for the disconnection of the main signalling link.
23	MS			
24	SS			
25	MS			
26	MS			
27	MS			
28	MS			
29	MS -> SS	CHANNEL REQUEST		
30	SS -> MS	IMMEDIATE ASSIGNMENT		
31	MS -> SS	LOCATION UPDATING REQUEST		
32	SS -> MS	AUTHENTICATION REQUEST		
33	MS -> SS	AUTHENTICATION RESPONSE		
34	SS -> MS	LOCATION UPDATING ACCEPT		
35	MS -> SS	TMSI REALLOCATION COMPLETE		
36	SS -> MS	CHANNEL RELEASE		

Specific message contents

None.

26.7.3 Identification

The purpose of this procedure is to check that the MS gives its identity as requested by the network. If this procedure does not work, it will not be possible for the network to rely on the identity claimed by the MS.

26.7.3.1 General Identification

26.7.3.1.1 Conformance requirement

- 1) When requested by the network the Mobile Station shall send its IMSI.
- 2) When requested by the network the Mobile Station shall send the TMSI which it was previously allocated.
- 3) When requested by the network the Mobile Station shall send its IMEI as stored in the Mobile Equipment.
- 4) When requested by the network the Mobile Station shall send its IMEISV as stored in the Mobile Equipment.

Reference(s)

GSM 04.08 sections 4.3.3.

26.7.3.1.2 Test purpose

- 1) To verify that the MS sends identity information as requested by the system in the following cases: IMSI and TMSI are requested in non-ciphered mode, IMEI is requested in ciphered mode.
- 2) To verify that the MS sends its IMEI, when requested to do so, in non-ciphered mode.
- 3) To verify that the MS sends its IMEISV, when requested to do so, in non-ciphered mode.

26.7.3.1.3 Method of test

26.7.3.1.3.1 Identification / test 1

Initial conditions

System Simulator:

1 cell, default values.

Mobile Station:

The MS has a valid TMSI. It is "idle updated" on the cell.

Related PICS/PIXIT statement(s)

IMEI of the ME.

Foreseen final state of the MS

The MS has a valid TMSI. It is "idle updated" on the cell.

Test Procedure

The SS requests identity information from the MS:

- IMSI in non ciphering mode,

- allocated TMSI in non ciphering mode,
- IMEI in ciphering mode.

Maximum duration of test

30 seconds.

Expected sequence

Step	Direction	Message	Comments
1	SS -> MS	PAGING REQUEST TYPE 1	Establishment Cause: Answer to paging. "Identity type" IE is IMSI. "Mobile identity" IE specifies the IMSI of the MS. "Identity type" IE is TMSI. "Mobile identity" IE specifies the allocated TMSI of the MS.
2	MS -> SS	CHANNEL REQUEST	
3	SS -> MS	IMMEDIATE ASSIGNMENT	
4	MS -> SS	PAGING RESPONSE	
5	SS -> MS	IDENTITY REQUEST	
6	MS -> SS	IDENTITY RESPONSE	
7	SS -> MS	IDENTITY REQUEST	
8	MS -> SS	IDENTITY RESPONSE	
9	SS -> MS	CIPHERING MODE COMMAND	"Identity type" IE is IMEI. "Mobile identity" IE specifies the IMEI stored in the Mobile Equipment. After the sending of this message, the SS waits for the disconnection of the main signalling link.
10	MS -> SS	CIPHERING MODE COMPLETE	
11	SS -> MS	IDENTITY REQUEST	
12	MS -> SS	IDENTITY RESPONSE	
13	SS -> MS	CHANNEL RELEASE	

Specific message contents:

None.

26.7.3.1.3.2 Identification / test 2

Initial conditions

System Simulator:

1 cell, default values.

Mobile Station:

The MS has a valid TMSI. It is in "idle updated".

Related PICS/PIXIT statement(s)

IMEI of the ME.

IMEISV of the ME.

Foreseen final state of the MS

The MS has a valid TMSI. It is "idle updated".

Test Procedure

The SS requests identity information from the MS:

- IMEI in non ciphering mode;
- IMEISV in non ciphering mode.

Maximum duration of test

30 second;

Expected sequence

Step	Direction	Message	Comments
1	SS -> MS	PAGING REQUEST TYPE 1	Establishment Cause: Answer to paging. "Identity type" IE is IMEI. "Mobile identity" IE specifies the IMEI of the MS. "Identity type" IE is IMEIS. "Mobile identity" IE specifies the IMEISV of the MS. After the sending of this message, the SS waits for the disconnection of the main signalling link.
2	MS -> SS	CHANNEL REQUEST	
3	SS -> MS	IMMEDIATE ASSIGNMENT	
4	MS -> SS	PAGING RESPONSE	
5	SS -> MS	IDENTITY REQUEST	
6	MS -> SS	IDENTITY RESPONSE	
7	SS -> MS	IDENTITY REQUEST	
8	MS -> SS	IDENTITY RESPONSE	
9	SS -> MS	CHANNEL RELEASE	

Specific message contents:

None.

26.7.3.2 Handling of IMSI shorter than the maximum length

26.7.3.2.1 Conformance requirement

The MS shall be capable of handling an IMSI that is not of the maximum length.

Reference(s)

GSM 04.08 clause 10.5.1.4.

26.7.3.2.2 Test purpose

To check that the MS behaves correctly when activated with an IMSI of length less than the maximum length.

In this condition, the MS shall:

- perform location updating;
- answer to paging with IMSI;
- give the correct IMSI when asked by an IDENTITY REQUEST;
- attempt CM connection establishment when requested to;
- attempt call re-establishment when needed;
- attempt IMSI detach when needed;
- erase its TMSI when the IMSI is sent by the network in a LOCATION UPDATING ACCEPT or a TMSI REALLOCATION COMMAND message.

26.7.3.2.3 Method of test

Initial conditions

System Simulator:

1 cell, default values.

IMSI attach/detach bit set to "1".

Mobile Station:

The MS has no valid TMSI.

It is "idle updated".

The IMSI has the value 001011234.

Related PICS/PIXIT statement(s)

On/Off switch - Yes/No.

Foreseen final state of MS

The MS has no valid TMSI. It is in "idle, updated".

Test Procedure

The MS is paged with its IMSI. The MS shall answer to paging and include the correct IMSI in the PAGING RESPONSE message. During call establishment, the SS asks for the IMSI of the MS. The MS shall answer by an IDENTITY RESPONSE message including the correct IMSI. During the active phase of the call, the SS stops sending valid SACCH frames. The MS performs call re-establishment. The MS shall include the correct IMSI in the CM RE-ESTABLISHMENT message. a TMSI REALLOCATION COMMAND including a TMSI is sent to the MS. The MS acknowledges this message. The call is release.

The MS is paged with its TMSI. The MS shall answer to paging and includes its TMSI in the PAGING RESPONSE message. During call establishment, the SS sends a TMSI REALLOCATION COMMAND including the IMSI to the MS. The MS shall acknowledge this message. The MS shall erase its TMSI. The call is released.

The MS is switched off or has its power source removed. The MS performs IMSI detach. The MS shall include the correct IMSI in the IMSI DETACH INDICATION message.

The MS is switched on or powered on. The MS performs IMSI attach. The MS shall include the correct IMSI in the LOCATION UPDATING REQUEST message. A TMSI is allocated to the MS.

The LAC of the cell is changed. The MS performs location updating. The SS includes the IMSI in the LOCATION UPDATING ACCEPT message.

A mobile originated CM connection is attempted. The MS shall include the correct IMSI in the CM SERVICE REQUEST message.

Maximum duration of test

5 minutes.

Expected sequence

Step	Direction	Message	Comments
1	SS -> MS	PAGING REQUEST TYPE 1	"mobile identity 1" contains IMSI of MS.
2	MS -> SS	CHANNEL REQUEST	Establishment cause: Answer to paging.
3	SS -> MS	IMMEDIATE ASSIGNMENT	
4	MS -> SS	PAGING RESPONSE	"mobile identity" contains the IMSI of the MS.
5	SS -> MS	IDENTITY REQUEST	"identity type" IE is IMSI.
6	MS -> SS	IDENTITY RESPONSE	"mobile identity" IE contains the IMSI of the MS.
7			The call is established using the sequence of the generic terminating call set-up procedure.
8	SS		The SS stops sending valid SACCH frames.
9	MS -> SS	CHANNEL REQUEST	
10	SS -> MS	IMMEDIATE ASSIGNMENT	
11	MS -> SS	CM REESTABLISHMENT REQUEST	"mobile identity" IE contains IMSI of the MS.
12	SS -> MS	TMSI REALLOCATION COMMAND	"mobile identity" contains a TMSI.
13	MS -> SS	TMSI REALLOCATION COMPLETE	
14	SS -> MS	CHANNEL RELEASE	After sending this message, the SS waits for the disconnection of the main signalling link.
15	SS -> MS	PAGING REQUEST TYPE 1	"mobile identity 1" contains TMSI of MS.
16	MS -> SS	CHANNEL REQUEST	Establishment cause: Answer to paging.
17	SS -> MS	IMMEDIATE ASSIGNMENT	
18	MS -> SS	PAGING RESPONSE	"mobile identity" contains the TMSI of the MS.
19	SS -> MS	AUTHENTICATION REQUEST	
20	MS -> SS	AUTHENTICATION RESPONSE	
21	SS -> MS	TMSI REALLOCATION COMMAND	"mobile identity" contains a IMSI of MS.
22	MS -> SS	TMSI REALLOCATION COMPLETE	
23	SS -> MS	CHANNEL RELEASE	
24	MS		If possible (see PICS) the MS is switched off, otherwise the MS has its power source removed. If the MS was switched off it performs IMSI detach.
25	MS -> SS	CHANNEL REQUEST	
26	SS -> MS	IMMEDIATE ASSIGNMENT	
27	MS -> SS	IMSI DETACH INDICATION	"mobile identity" contains IMSI of MS.
28	SS -> MS	CHANNEL RELEASE	
29	MS		The MS is switched on or has power restored.
30	MS -> SS	CHANNEL REQUEST	
31	SS -> MS	IMMEDIATE ASSIGNMENT	
32	MS -> SS	LOCATION UPDATING REQUEST	"mobile identity" contains IMSI of MS.
33	SS -> MS	LOCATION UPDATING ACCEPT	"mobile identity" contains a TMSI.
34	MS -> SS	TMSI REALLOCATION COMPLETE	
35	SS -> MS	CHANNEL RELEASE	
36	SS		The SS changes the LAC of the cell.
37	MS -> SS	CHANNEL REQUEST	Shall be sent within 35s of the LAC being changed.
38	SS -> MS	IMMEDIATE ASSIGNMENT	
39	MS -> SS	LOCATION UPDATING REQUEST	"mobile identity" contains TMSI of the MS.
40	SS -> MS	LOCATION UPDATING ACCEPT	"mobile identity" contains IMSI of the MS.
41	SS -> MS	CHANNEL RELEASE	
42	MS		a mobile originated CM connection is attempted.
43	MS -> SS	CHANNEL REQUEST	
44	SS -> MS	IMMEDIATE ASSIGNMENT	
45	MS -> SS	CM SERVICE REQUEST	"mobile identity" contains IMSI of the MS.
46	SS -> MS	CHANNEL RELEASE	

Specific message contents

None.

26.7.4 Location updating

This procedure is used to register the MS in the network. If it is not performed correctly, no call can be established.

26.7.4.1 Location updating / accepted

26.7.4.1.1 Conformance requirement

1.
 - 1.1 If the network accepts a location updating from the Mobile Station and reallocates a TMSI in the Location Updating Accept message the Mobile Station shall acknowledge the reception of the new TMSI.
 - 1.2 The Mobile Station shall answer to paging with this TMSI and include it in a Paging Response message.
- 2 If the network accepts a location updating from the Mobile Station and the Location Updating Accept message contains neither TMSI nor IMSI, the Mobile Station shall answer to paging when addressed with the last allocated TMSI and include it in the Paging Response message.
3.
 - 3.1 If the network accepts a location updating from the Mobile Station by use of a Location Updating Accept message containing the IMSI of the Mobile Station, the Mobile Station shall not answer paging with the last allocated TMSI.
 - 3.2 The Mobile Station shall still answer paging with IMSI.
4. A mobile station that supports:
 - only the GSM 450 band (cf. GSM 05.05), or
 - only the GSM 480 band (cf. GSM 05.05), or
 - only the primary GSM band P-GSM 900 (cf. GSM 05.05), or
 - only the DCS 1800 band (cf. GSM 05.05)

may ignore SYSTEM INFORMATION TYPE 2ter messages ; if it does so it shall assume that the SYSTEM INFORMATION TYPE 2 carries the complete BA, for selection of the cell , where it performs the location updating procedure .

This SYSTEM INFORMATION TYPE 2ter message may be sent by the network with either a L2 pseudo length of 18 or some other value.

see 04.08, section 9.1.34, and 3.2.2.1.

Reference(s)

GSM 04.08 section 4.4.4.6.

26.7.4.1.2 Test purpose

1) To test the behaviour of the MS if the network accepts the location updating of the MS.

For the network response three different cases are identified:

- 1.1) TMSI is allocated,
- 1.2) Location updating accept contains neither TMSI nor IMSI,
- 1.3) Location updating accept contains IMSI.

2) To verify that the MS , that supports only the GSM 450 band or only the GSM 480 band or only the primary GSM900 band or only the DCS1800 band is not disturbed by SYSTEM INFORMATION 2ter messages , with different values of L2pseudolength.

26.7.4.1.3 Method of test

26.7.4.1.3.1 Location Updating/accepted/test1

Initial conditions:

System Simulator:

Two cells, A and B, belonging to different location areas with location area identification a and b of the same PLMN.

IMSI attach/detach is allowed in both cells.

The T3212 time-out value is 1/10 hour in both cells.

Mobile Station:

The MS has a valid TMSI (=TMSI1) and CKSN (=CKSN1). It is "idle updated" on cell A.

Related PICS/PIXIT statement(s)

None.

Foreseen final state of the MS

The MS has no valid TMSI. It has valid CKSN and Kc. It is "idle, updated" on cell B.

Test Procedure

The MS is made to select cell B. A normal location updating with TMSI reallocation is performed in cell B. The channel is released. The SS checks, by paging, that the MS has stored the newly allocated TMSI. The channel is released. The MS is made to select cell A. A normal location updating is performed in cell A. The LOCATION UPDATING ACCEPT message contains neither IMSI nor TMSI. The SS checks, by paging, that the MS has kept the old TMSI. The channel is released. The MS is made to select cell B. A normal location updating is performed in cell B. The LOCATION UPDATING ACCEPT message contains an IMSI. The SS checks, by paging, that the MS has deleted its TMSI and responds to paging with IMSI.

Maximum duration of test

4 minutes.

Expected sequence

Step	Direction	Message	Comments
1	SS		The RF level of cell A is lowered until the MS selects cell B.
2	MS -> SS	CHANNEL REQUEST	"Establishment cause": Location updating.
3	SS -> MS	IMMEDIATE ASSIGNMENT	
4	MS -> SS	LOCATION UPDATING REQUEST	"location updating type" = normal, "CKSN" = CKSN1, "location area identification" = a, "mobile station classmark 1" as given by the PICS and "mobile identity" = TMSI1.
5	SS -> MS	LOCATION UPDATING ACCEPT	"Mobile identity" = new TMSI (=TMSI2), LAI = b.
6	MS -> SS	TMSI REALLOCATION COMPLETE	
7	SS -> MS	CHANNEL RELEASE	After the sending of this message, the SS waits for the disconnection of the main signalling link. The SS waits an amount of time which is enough to guarantee that the MS is in service.
8	SS -> MS	PAGING REQUEST TYPE 1	"Mobile identity" IE contains the new TMSI (= TMSI2).
9	MS -> SS	CHANNEL REQUEST	
10	SS -> MS	IMMEDIATE ASSIGNMENT	
11	MS -> SS	PAGING RESPONSE	"Mobile identity" IE contains the new TMSI (= TMSI2).
12	SS -> MS	CHANNEL RELEASE	After the sending of this message, the SS waits for the disconnection of the main signalling link.
13	SS		The RF level of cell B is lowered until the MS selects cell A.
14	MS -> SS	CHANNEL REQUEST	"Establishment cause": Location updating
15	SS -> MS	IMMEDIATE ASSIGNMENT	
16	MS -> SS	LOCATION UPDATING REQUEST	"location updating type" = normal, "CKSN" = CKSN1, "location area identification" = b, "mobile station classmark 1" as given by the PICS and "mobile identity" = TMSI2.
17	SS -> MS	LOCATION UPDATING ACCEPT	"Mobile identity" IE not included.
18	SS -> MS	CHANNEL RELEASE	After the sending of this message, the SS waits for the disconnection of the main signalling link. The SS waits an amount of time which is enough to guarantee that the MS is in service.
19	SS -> MS	PAGING REQUEST TYPE 1	"Mobile identity" IE contains the TMSI (= TMSI2).
20	MS -> SS	CHANNEL REQUEST	
21	SS -> MS	IMMEDIATE ASSIGNMENT	
22	MS -> SS	PAGING RESPONSE	"Mobile identity" IE contains the TMSI (=TMSI2).
23	SS -> MS	CHANNEL RELEASE	After the sending of this message, the SS waits for the disconnection of the main signalling link.
24	SS		The RF level of cell A is lowered until the MS selects cell B.
25	MS -> SS	CHANNEL REQUEST	"Establishment cause": Location updating.
26	SS -> MS	IMMEDIATE ASSIGNMENT	
27	MS -> SS	LOCATION UPDATING REQUEST	"location updating type" = normal, "CKSN" = CKSN1, "location area identification" = a, "mobile station classmark 1" as given by the PICS and "mobile identity" = TMSI2.
28	SS -> MS	LOCATION UPDATING ACCEPT	"Mobile identity" IE contains IMSI.
29	SS -> MS	CHANNEL RELEASE	After the sending of this message, the SS waits for the disconnection of the main signalling link. The SS waits an amount of time which is enough to guarantee that the MS is in service.
30	SS -> MS	PAGING REQUEST TYPE 1	"Mobile identity" IE contains the old TMSI (= TMSI2).
31	MS		The MS shall ignore this message. This is checked during 5 seconds.
32	SS -> MS	PAGING REQUEST TYPE 1	"Mobile identity" IE contains the IMSI.
33	MS -> SS	CHANNEL REQUEST	
34	SS -> MS	IMMEDIATE ASSIGNMENT	
35	MS -> SS	PAGING RESPONSE	"Mobile identity" IE contains the IMSI.
36	SS -> MS	CHANNEL RELEASE	After the sending of this message, the SS waits for the disconnection of the main signalling link.

Specific message contents:

None.

26.7.4.1.3.2 Location Updating/accepted/test2

Initial conditions:

System Simulator:

Two cells, A and B, belonging to different location areas with location area identification a and b of the same PLMN.

System information 2ter is broadcasted on the two cells (Cell A with L2pseudolength=18, Cell B with L2pseudolength=0) .

IMSI attach/detach is allowed in both cells.

The T3212 time-out value is 1/10 hour in both cells.

Mobile Station:

The MS has a valid TMSI (=TMSI1) and CKSN (=CKSN1). It is "idle updated" on cell A.

Related PICS/PIXIT statement(s)

None.

Foreseen final state of the MS

The MS has no valid TMSI. It has valid CKSN and Kc. It is "idle, updated" on cell B.

Test Procedure

The MS is made to select cell B. A normal location updating with TMSI reallocation is performed in cell B. The channel is released. The SS checks, by paging, that the MS has stored the newly allocated TMSI. The channel is released. The MS is made to select cell A. A normal location updating is performed in cell A. The LOCATION UPDATING ACCEPT message contains neither IMSI nor TMSI. The SS checks, by paging, that the MS has kept the old TMSI. The channel is released. The MS is made to select cell B. A normal location updating is performed in cell B. The LOCATION UPDATING ACCEPT message contains an IMSI. The SS checks, by paging, that the MS has deleted its TMSI and responds to paging with IMSI.

Maximum duration of test

4 minutes.

Expected sequence

Step	Direction	Message	Comments
1	SS		The RF level of cell A is lowered until the MS selects cell B.
2	MS -> SS	CHANNEL REQUEST	"Establishment cause": Location updating.
3	SS -> MS	IMMEDIATE ASSIGNMENT	
4	MS -> SS	LOCATION UPDATING REQUEST	"location updating type" = normal, "CKSN" = CKSN1, "location area identification" = a, "mobile station classmark 1" as given by the PICS and "mobile identity" = TMSI1.
5	SS -> MS	LOCATION UPDATING ACCEPT	"Mobile identity" = new TMSI (=TMSI2), LAI = b.
6	MS -> SS	TMSI REALLOCATION COMPLETE	
7	SS -> MS	CHANNEL RELEASE	After the sending of this message, the SS waits for the disconnection of the main signalling link. The SS waits an amount of time which is enough to guarantee that the MS is in service.
8	SS -> MS	PAGING REQUEST TYPE 1	"Mobile identity" IE contains the new TMSI (= TMSI2).
9	MS -> SS	CHANNEL REQUEST	
10	SS -> MS	IMMEDIATE ASSIGNMENT	
11	MS -> SS	PAGING RESPONSE	"Mobile identity" IE contains the new TMSI (= TMSI2).
12	SS -> MS	CHANNEL RELEASE	After the sending of this message, the SS waits for the disconnection of the main signalling link.
13	SS		The RF level of cell B is lowered until the MS selects cell A.
14	MS -> SS	CHANNEL REQUEST	"Establishment cause": Location updating
15	SS -> MS	IMMEDIATE ASSIGNMENT	
16	MS -> SS	LOCATION UPDATING REQUEST	"location updating type" = normal, "CKSN" = CKSN1, "location area identification" = b, "mobile station classmark 1" as given by the PICS and "mobile identity" = TMSI2.
17	SS -> MS	LOCATION UPDATING ACCEPT	"Mobile identity" IE not included.
18	SS -> MS	CHANNEL RELEASE	After the sending of this message, the SS waits for the disconnection of the main signalling link. The SS waits an amount of time which is enough to guarantee that the MS is in service.
19	SS -> MS	PAGING REQUEST TYPE 1	"Mobile identity" IE contains the TMSI (= TMSI2).
20	MS -> SS	CHANNEL REQUEST	
21	SS -> MS	IMMEDIATE ASSIGNMENT	
22	MS -> SS	PAGING RESPONSE	"Mobile identity" IE contains the TMSI (=TMSI2).
23	SS -> MS	CHANNEL RELEASE	After the sending of this message, the SS waits for the disconnection of the main signalling link.
24	SS		The RF level of cell A is lowered until the MS selects cell B.
25	MS -> SS	CHANNEL REQUEST	"Establishment cause": Location updating.
26	SS -> MS	IMMEDIATE ASSIGNMENT	
27	MS -> SS	LOCATION UPDATING REQUEST	"location updating type" = normal, "CKSN" = CKSN1, "location area identification" = a, "mobile station classmark 1" as given by the PICS and "mobile identity" = TMSI2.
28	SS -> MS	LOCATION UPDATING ACCEPT	"Mobile identity" IE contains IMSI.
29	SS -> MS	CHANNEL RELEASE	After the sending of this message, the SS waits for the disconnection of the main signalling link. The SS waits an amount of time which is enough to guarantee that the MS is in service.
30	SS -> MS	PAGING REQUEST TYPE 1	"Mobile identity" IE contains the old TMSI (= TMSI2).
31	MS		The MS shall ignore this message. This is checked during 5 seconds.
32	SS -> MS	PAGING REQUEST TYPE 1	"Mobile identity" IE contains the IMSI.
33	MS -> SS	CHANNEL REQUEST	
34	SS -> MS	IMMEDIATE ASSIGNMENT	
35	MS -> SS	PAGING RESPONSE	"Mobile identity" IE contains the IMSI.
36	SS -> MS	CHANNEL RELEASE	After the sending of this message, the SS waits for the disconnection of the main signalling link.

Specific message contents:

SYSTEM INFORMATION TYPE 2ter Cell A :

Information Element	Value/remark
L2 Pseudolength	18
Neighbour Cells Description 2	0
Multiband reporting For Cell A	
- Format notation	Range 512
- BA_IND	0
- BCCH Allocation ARFCN	ARFCN 520, 870 (for GSM 400 and GSM 900 tests), ARFCN 43,85 (For GSM 1800 tests)
SI 2ter rest octets	Not used (All bits set to spare)

SYSTEM INFORMATION TYPE 2ter Cell B :

Information Element	Value/remark
L2 Pseudolength	0
Neighbour Cells Description 2	0
Multiband reporting For Cell B	
- Format notation	Range 512
- BA_IND	0
- BCCH Allocation ARFCN	ARFCN 590, 810 (for GSM 400 and GSM 900 tests), ARFCN 44,86 (for GSM 1800 tests),
SI 2ter rest octets	Not used (All bits set to spare)

SYSTEM INFORMATION TYPE 3 Cell A and cell B :

Same as default content in 26.7.6 except :

Information Element	Value/remark
SI3 rest octets SI 2ter Indicator	All bits are set to spare except, System Information 2ter is available

26.7.4.2 Location updating / rejected

26.7.4.2.1 Location updating / rejected / IMSI invalid

26.7.4.2.1.1 Conformance requirement

- 1) If the network rejects a location updating from the Mobile Station with the cause "IMSI unknown in HLR", "Illegal MS" or "Illegal ME" the Mobile Station shall:
 - 1.1 not perform normal location updating;
 - 1.2 not perform periodic location updating;
 - 1.3 not respond to paging with IMSI;
 - 1.4 not respond to paging with TMSI;
 - 1.5 reject any request from CM entity for MM connection other than for emergency call;
 - 1.6 not perform IMSI detach if it is switched off or has its power source removed.
- 2) If the network rejects a location updating from the Mobile Station with the cause "IMSI unknown in HLR", "Illegal MS" or "Illegal ME" the Mobile Station, if it supports speech, shall accept a request for an emergency call by sending a Channel Request message with the establishment cause set to "emergency call" and include an IMEI as mobile identity in the CM SERVICE REQUEST message.

- 3) If the network rejects a location updating from the Mobile Station with the cause "IMSI unknown in HLR", "Illegal MS" or "Illegal ME" the Mobile Station shall delete the stored LAI, CKSN and TMSI.

Reference(s)

GSM 04.08 sections 4.4.4.7.

26.7.4.2.1.2 Test purpose

To test the behaviour of the MS if the network rejects the location updating of the MS with the cause "IMSI unknown in HLR", "illegal MS" or "Illegal ME".

26.7.4.2.1.3 Method of test

Initial conditions

System Simulator:

Two cells: A and B, belonging to different location areas of the same PLMN.

IMSI attach/detach is allowed in both cells.

The T3212 time-out value is 1/10 hour in both cells.

Mobile Station:

The MS has valid TMSI, CKSN and Kc. It is "idle updated" on cell A.

Related PICS/PIXIT statement(s)

SIM removal possible while the MS is powered Yes/No.

Switch off on button Yes/No.

Support for speech Yes/No.

Foreseen final state of the MS

The MS has valid TMSI, CKSN and Kc. It is "idle updated" on cell A.

Test Procedure

The SS rejects a normal location updating with the cause value "IMSI unknown in HLR". The channel is released. The SS checks that the MS has entered the state MM IDLE and the substate NO IMSI, i.e. does not perform normal location updating when a new cell of the same or another PLMN is entered, does not perform periodic updating, does not respond to paging, rejects any requests from CM entities except emergency calls and does not perform IMSI detach if it is switched off or has its power source removed.

The test is repeated with cause value "Illegal MS" and with cause value "Illegal ME".

Maximum duration of test

35 minutes.

Expected sequence

The sequence is executed for execution counter k = 1, 2, 3.

Step	Direction	Message	Comments
1	SS		The following messages are sent and shall be received on cell B.
2	MS -> SS	CHANNEL REQUEST	The RF level of cell A is lowered until the MS selects cell B.
3	SS -> MS	IMMEDIATE ASSIGNMENT	"Establishment cause": Location updating.
4	MS -> SS	LOCATION UPDATING REQUEST	
5	SS -> MS	LOCATION UPDATING REJECT	"Reject cause" IE is "IMSI unknown in HLR" for k = 1, "Illegal MS" for k = 2, "Illegal ME" for k = 3.
6	SS -> MS	CHANNEL RELEASE	After the sending of this message, the SS waits for the disconnection of the main signalling link.
7	SS		The following messages are sent and shall be received on cell A.
8	MS		The RF levels are then changed again to make the MS reselect the cell A.
			The MS performs cell reselection according to procedure as specified in GSM 05.08 (this however is not checked until step 18). The MS shall not initiate an RR connection establishment on cell A or on cell B.
9	SS		The SS waits at least 7 minutes for a possible periodic updating.
10	MS		The MS shall not initiate an RR connection establishment on cell A or on cell B.
11	SS -> MS	PAGING REQUEST TYPE 1	The MS is paged in cell A. "Mobile identity" IE contains IMSI.
12	MS		The MS shall ignore this message. This is verified during 3 seconds.
13	SS -> MS	PAGING REQUEST TYPE 1	The MS is paged in cell A. "Mobile identity" IE contains TMSI.
14	MS		The MS shall ignore this message. This is verified during 3 seconds.
15	MS		A MO CM connection is attempted.
16	MS		The MS shall not initiate an RR connection establishment on cell A or on cell B. This is checked during 3 seconds.
17	MS		If the MS supports speech (see PICS), it is made to perform an emergency call.
18	MS -> SS	CHANNEL REQUEST	"Establishment cause": Emergency call. This message is sent in cell A.
19	SS -> MS	IMMEDIATE ASSIGNMENT	
20	MS -> SS	CM SERVICE REQUEST	"CM service type": Emergency call establishment. "Mobile identity": type of identity is set to IMEI.
21	SS -> MS	CM SERVICE ACCEPT	
22	MS -> SS	EMERGENCY SETUP	
23	SS -> MS	RELEASE COMPLETE	"Cause" = unassigned number.
24	SS -> MS	CHANNEL RELEASE	After the sending of this message, the SS waits for the disconnection of the main signalling link.
25	MS		If possible (see PICS) SIM detachment is performed. Otherwise if possible (see PICS) switch off is performed. Otherwise the power is removed.
26	MS		The MS shall not initiate an RR connection establishment on cell A or on cell B. This is checked during 3 seconds.
27	MS		Depending on what has been performed in step 25 the MS is brought back to operation.
28	MS -> SS	CHANNEL REQUEST	"Establishment cause": Location updating.
29	SS -> MS	IMMEDIATE ASSIGNMENT	
30	MS -> SS	LOCATION UPDATING REQUEST	"location updating type" = normal, "CKSN" = no key available, "mobile station classmark 1" as given by the PICS, "Mobile Identity" = IMSI, "LAI" = deleted LAI (the MCC and MNC hold the previous values, the LAC is coded FFFE).
31	SS -> MS	AUTHENTICATION REQUEST	"CKSN" = CKSN1.
32	MS -> SS	AUTHENTICATION RESPONSE	
33	SS -> MS	LOCATION UPDATING ACCEPT	"Mobile Identity" = TMSI.
32	MS -> SS	TMSI REALLOCATION COMPLETE	
33	SS -> MS	CHANNEL RELEASE	After the sending of this message, the SS waits for the disconnection of the main signalling link.

Specific message contents:

None.

26.7.4.2.2 Location updating / rejected / PLMN not allowed

26.7.4.2.2.1 Conformance requirement

- 1) If the network reject a location updating from the Mobile Station with the cause "PLMN not allowed" the Mobile Station shall:
 - 1.1 not perform periodic updating;
 - 1.2 not perform IMSI detach when switched off;
 - 1.3 not perform IMSI attach when switched on in the same location area;
 - 1.4 not perform normal location updating when in the same PLMN and when that PLMN is not selected manually;
 - 1.5 reject any request from CM entity for MM connection other than for emergency call.
- 2) If the network rejects a location updating from the Mobile Station with the cause "PLMN not allowed" the Mobile Station shall:
 - 2.1 perform normal location updating when a new PLMN is entered;
 - 2.2 accept a request for an emergency call, if it supports speech, by sending a Channel Request message with the establishment cause set to "emergency call".
- 3) If the network rejects a location updating from the Mobile Station with the cause "PLMN not allowed" and if after that the PLMN from which this rejection was received, is manually selected, the Mobile Station shall perform a normal location updating procedure.

Reference(s)

GSM 04.08 section 4.4.4.7.

26.7.4.2.2.2 Test purpose

To test the behaviour of the MS if the network rejects the location updating of the MS with the cause "PLMN not allowed".

26.7.4.2.2.3 Method of test

26.7.4.2.2.3.1 Location updating / rejected / PLMN not allowed / test 1

Initial conditions

System Simulator:

One cell: C, belonging to PLMN1.

Two cells: A and B, belonging to different location areas a and b and belonging to PLMN2. PLMN2 is different from HPLMN and from PLMN1.

IMSI attach/detach is allowed in cells A and B but not in cell C.

The T3212 time-out value is 1/10 hour in cells A and B.

Mobile Station:

The MS has a valid TMSI. It is "idle updated" on cell C.

The MS is in manual mode for PLMN selection.

Related PICS/PIXIT statement(s)

SIM removal possible while the MS is powered Yes/No.

Switch off on button Yes/No.

The MS is automatically in automatic mode after switch on Yes/No.

Support for speech Yes/No.

Foreseen final state of the MS

The MS has a valid TMSI. It is "idle updated" on cell C. The MS is in automatic mode for PLMN selection.

Test Procedure

The SS rejects a normal location updating with the cause value "PLMN not allowed". The channel is released. The SS checks that the MS does not perform periodic updating, does not perform IMSI detach, does not perform IMSI attach if activated in the same location area, rejects any request for CM connection establishment other than emergency call, accepts a request for an emergency call and performs normal location updating only when a new PLMN is entered.

Maximum duration of test

12 minutes.

Expected sequence

Step	Direction	Message	Comments
1	MS		The following messages are sent and shall be received on cell B.
2	SS		The MS is switched off (or power is removed).
3	MS		The SS activates cells A and B and deactivates cell C. Cell B has a level higher by at least 5 dB than cell A.
4	MS -> SS	CHANNEL REQUEST	The MS is switched on. (or power is reapplied) If necessary the MS is put in manual selection mode. The MS shall offer the new PLMN as available to the user. The PLMN is manually selected.
5	SS -> MS	IMMEDIATE ASSIGNMENT	"Establishment cause": Location updating.
6	MS -> SS	LOCATION UPDATING REQUEST	
7	SS -> MS	LOCATION UPDATING REJECT	"Reject cause" = PLMN not allowed.
8	SS -> MS	CHANNEL RELEASE	After the sending of this message, the SS waits for the disconnection of the main signalling link.
9	SS		The SS waits for a possible periodic updating for 7 minutes.
10	MS		The MS shall not initiate an RR connection establishment on cell A or on cell B.
11	MS		If possible (see PICS) SIM detachment is performed. Otherwise if possible (see PICS) switch off is performed. Otherwise the power is removed.
12	MS		The MS shall not initiate an RR connection establishment on cell A or on cell B. This is checked during 3 seconds.
13	MS		Depending on what has been performed in step 11 the MS is brought back to operation. The MS is not made to select PLMN 2.
14	MS		The MS shall not initiate an RR connection establishment. This is checked during 3 seconds.
15	SS		The following message are sent and shall be received on cell A.
16	MS		The RF level of cell B is lowered to make the MS reselect cell A. No access to the network shall be registered by the SS within one minute.
17	MS		If the MS supports speech (see PICS) it is made to perform an emergency.
18	MS -> SS	CHANNEL REQUEST	"Establishment cause": Emergency call.
19	SS -> MS	IMMEDIATE ASSIGNMENT	
20	MS -> SS	CM SERVICE REQUEST	"CM service type" = Emergency call establishment.
21	SS -> MS	CM SERVICE ACCEPT	
22	MS -> SS	EMERGENCY SETUP	
23	SS -> MS	RELEASE COMPLETE	Cause IE: "unassigned number".
24	SS -> MS	CHANNEL RELEASE	After the sending of this message, the SS waits for the disconnection of the main signalling link.
25	MS		A MO CM connection is attempted.
26	MS		The MS shall not initiate an RR connection establishment. This is checked during 3 seconds.
27	MS		The following messages are sent and shall be received on cell C.
28	SS		The MS is switched off.
29	MS		The SS activates cell C and deactivates cells A and B.
30	MS -> SS	CHANNEL REQUEST	The MS is switched on. If necessary the MS is placed into the automatic mode.
31	SS -> MS	IMMEDIATE ASSIGNMENT	"Establishment cause": Location updating.
32	MS -> SS	LOCATION UPDATING REQUEST	"location updating type" = normal, "CKSN" = no key available, "LAI" = deleted LAI (the MCC and MNC hold the values of PLMN1, the LAC is coded FFFE) "mobile identity" = IMSI.
33	SS -> MS	LOCATION UPDATING ACCEPT	"Mobile identity" = TMSI.
34	MS -> SS	TMSI REALLOCATION COMPLETE	
35	SS -> MS	CHANNEL RELEASE	After the sending of this message, the SS waits for the disconnection of the main signalling link.

Specific message contents:

None.

26.7.4.2.2.3.2 Location updating / rejected / PLMN not allowed / test 2

Initial conditions

System Simulator:

One cell C, belonging to PLMN1.

Two cells A and B, belonging to different location areas a and b and belonging to PLMN2. PLMN2 is different from HPLMN.

IMSI attach/detach is allowed in cells A and B but not in cell C.

The T3212 time-out value is 1/10 hour in cells A and B.

Mobile Station:

The MS has a valid TMSI. It is "idle updated" on cell C.

Related PICS/PIXIT statement(s)

SIM removal possible while MS is powered Yes/No.

Switch off on button Yes/No.

The MS is automatically in automatic mode after switch on Yes/No.

Foreseen final state of the MS

The MS has a valid TMSI. It is "idle, updated" on cell C.

The MS is in automatic mode for PLMN selection.

Test Procedure

The SS rejects a normal location updating with the cause value "PLMN not allowed". The channel is released. Then the PLMN from which this rejection was received is manually selected and the SS checks that a normal location updating is performed.

Maximum duration of test

5 minutes.

Expected sequence

Step	Direction	Message	Comments
1	MS		The following messages are sent and shall be received on cell B.
2	SS		The MS is switched off (or power is removed).
3	MS		The SS activates cells A and B and deactivates cell C.
3a	MS		Cell B has a level higher by at least 5 dB than cell A.
			The MS is switched on (or power is reapplied).
			If the MS is in manual mode, it shall offer the new PLMN as available to the user. In this case the PLMN is manually selected.
4	MS -> SS	CHANNEL REQUEST	"Establishment cause": Location updating.
5	SS -> MS	IMMEDIATE ASSIGNMENT	
6	MS -> SS	LOCATION UPDATING REQUEST	
7	SS -> MS	LOCATION UPDATING REJECT	"Reject cause" = PLMN not allowed.
8	SS -> MS	CHANNEL RELEASE	After the sending of this message, the SS waits for the disconnection of the main signalling link.
9	MS		The MS is made to search for PLMNs and the PLMN indicated by the SS is manually selected.
10	MS -> SS	CHANNEL REQUEST	"Establishment cause": Location updating.
11	SS -> MS	IMMEDIATE ASSIGNMENT	
12	MS -> SS	LOCATION UPDATING REQUEST	"location updating type" = normal, "CKSN" = no key available, "LAI" = deleted LAI (the MCC and MNC hold the values of PLMN1, the LAC is coded FFFE) "mobile identity" = IMSI.
13	SS -> MS	CHANNEL RELEASE	After the sending of this message, the SS waits for the disconnection of the main signalling link. The following messages are sent and shall be received on cell C.
14	MS		The MS is switched off.
15	SS		The SS activates cell C and deactivates cells A and B.
16	MS		The MS is switched on. If necessary, the MS is put into the automatic mode.
17	MS -> SS	CHANNEL REQUEST	"Establishment cause": Location updating.
18	SS -> MS	IMMEDIATE ASSIGNMENT	
19	MS -> SS	LOCATION UPDATING REQUEST	"location updating type" = normal, "CKSN" = no key available, "LAI" = deleted LAI (the MCC and MNC hold the values of PLMN1, the LAC is coded FFFE) "mobile identity" = IMSI.
20	SS -> MS	LOCATION UPDATING ACCEPT	"Mobile identity" = TMSI.
21	MS -> SS	TMSI REALLOCATION COMPLETE	
22	SS -> MS	CHANNEL RELEASE	After the sending of this message, the SS waits for the disconnection of the main signalling link.

Specific message contents:

None.

26.7.4.2.3 Location updating / rejected / location area not allowed

26.7.4.2.3.1 Conformance requirement

- 1) If the network rejects a location updating from the Mobile Station with the cause "Location Area not allowed" the Mobile Station shall:
 - 1.1 not perform periodic updating;
 - 1.2 not respond to paging with TMSI;
 - 1.3 reject any request from CM entity for MM connection other than for emergency call;
 - 1.4 not perform IMSI detach.

- 2) If the network rejects a location updating from the Mobile Station with the cause "Location Area not allowed" the Mobile Station shall:
 - 2.1 perform normal location updating when a new location area is entered;
 - 2.2 accept a request for an emergency call, if it supports speech, by sending a Channel Request message with the establishment cause set to "emergency call";
 - 2.3 delete the list of forbidden LAs after switch off (power off).

Reference(s)

GSM 04.08 sections 4.4.4.7.

26.7.4.2.3.2 Test purpose

To test the behaviour of the MS if the network rejects the location updating of the MS with the cause "Location Area not allowed".

To test that the MS deletes the list of forbidden LAs after switch off (power off).

26.7.4.2.3.3 Method of test

Initial conditions

System Simulator:

Two cells: A and B, belonging to different location areas a and b.

IMSI attach/detach is allowed in both cells.

The T3212 time-out value is 1/10 hour in both cells.

Mobile Station:

The MS has a valid TMSI. It is "idle updated" on cell A.

Related PICS/PIXIT statement(s)

Switch off on button Yes/No.

Support for speech Yes/No.

Method to clear the list of forbidden location areas periodically.

Foreseen final state of the MS

The MS has a valid TMSI. It is "idle updated" on cell A.

Test Procedure

The SS rejects a normal location updating with the cause value "Location Area not allowed". The channel is released. The SS checks that the MS does not perform periodic updating, does not respond to paging with TMSI, rejects any requests from CM entities for MM-connections except emergency calls, does not perform IMSI detach, performs normal location updating when a new location area is entered and deletes the list of forbidden LAs when switched off.

Different types of MS may use different methods to periodically clear the list of forbidden location areas (e.g. every day at 12am). If the list is cleared while the test is being run, it may be necessary to re-run the test.

Maximum duration of test

12 minutes.

Expected sequence

Step	Direction	Message	Comments
1	SS		The following messages are sent and shall be received on cell B. The RF level of cell A is lowered so that cell B is selected, while keeping the C1 and C2 of cell A greater than 10.
2	MS -> SS	CHANNEL REQUEST	"Establishment cause": Location updating.
3	SS -> MS	IMMEDIATE ASSIGNMENT	
4	MS -> SS	LOCATION UPDATING REQUEST	
5	SS -> MS	LOCATION UPDATING REJECT	"Reject cause" = "Location Area not allowed".
6	SS -> MS	CHANNEL RELEASE	After the sending of this message, the SS waits for the disconnection of the mainsignalling link. The SS waits for a possible location updating for 7 minutes.
7	SS		
8	MS		The MS shall not initiate an RR-connection establishment either on cell A or cell B.
9	SS -> MS	PAGING REQUEST TYPE 1	The MS is paged in cell B. "Mobile identity" = TMSI.
10	MS		The MS shall ignore this message. This is checked during 3 seconds.
11	MS		A MO CM connection is attempted.
12	MS		The MS shall not initiate an RR connection establishment on cell A or cell B. This is checked during 3 seconds.
13	MS		If the MS supports speech (see PICS), it is made to perform an emergency call.
14	MS -> SS	CHANNEL REQUEST	"Establishment cause": Emergency call.
15	SS -> MS	IMMEDIATE ASSIGNMENT	
16	MS -> SS	CM SERVICE REQUEST	"CM service type": Emergency call establishment.
17	SS -> MS	CM SERVICE ACCEPT	
18	MS -> SS	EMERGENCY SETUP	
19	SS -> MS	RELEASE COMPLETE	Cause: "unassigned number".
20	SS -> MS	CHANNEL RELEASE	After the sending of this message, the SS waits for the disconnection of the main signalling link.
21	MS		If possible (see PICS) switch off is performed. Otherwise the power is removed.
22	MS		The MS shall not initiate an RR connection establishment on cell A or on cell B (check for IMSI detach) This is checked during 3 seconds.
23	MS		Depending on what has been performed in step 21 the MS is brought back to operation.
24	MS -> SS	CHANNEL REQUEST	"Establishment cause": Location updating.
25	SS -> MS	IMMEDIATE ASSIGNMENT	
26	MS -> SS	LOCATION UPDATING REQUEST	"location updating type" = normal, "CKSN" = no key available, "LAI" = deleted LAI, "mobile identity" = IMSI (This checks the deletion of the forbidden lists)
27	SS -> MS	LOCATION UPDATING REJECT	"Reject cause" = "Location Area not allowed".
28	SS -> MS	CHANNEL RELEASE	After the sending of this message, the SS waits for the disconnection of the main signalling link. The following messages are sent and shall be received on cell A.
29	SS		The RF level of cell B is lowered until the MS selects cell A.
30	MS -> SS	CHANNEL REQUEST	"Establishment cause": Location updating.
31	SS -> MS	IMMEDIATE ASSIGNMENT	
32	MS -> SS	LOCATION UPDATING REQUEST	
33	SS -> MS	AUTHENTICATION REQUEST	
34	MS -> SS	AUTHENTICATION RESPONSE	
35	SS -> MS	LOCATION UPDATING ACCEPT	Mobile identity = TMSI.
36	MS -> SS	TMSI REALLOCATION COMPLETE	
37	SS -> MS	CHANNEL RELEASE	After the sending of this message, the SS waits for the disconnection of the main signalling link.

Specific message contents:

None.

26.7.4.2.4 Location updating / rejected / roaming not allowed in this location area

26.7.4.2.4.1 Conformance requirement

- 1) If the network rejects a location updating from the Mobile Station with the cause "Roaming not allowed in this area" the Mobile Station shall:
 - 1.1 not perform periodic updating;
 - 1.2 not respond to paging with TMSI;
 - 1.3 reject any request from CM entity for MM connection other than for emergency call;
 - 1.4 not perform IMSI detach.
- 2) If the network rejects a location updating from the Mobile Station with the cause "Roaming not allowed in this area" the Mobile Station shall:
 - 2.1 perform normal location updating when a new location area is entered;
 - 2.2 accept a request for an emergency call, if it supports speech, by sending a Channel Request message with the establishment cause set to "emergency call";
 - 2.3 periodically search for its HPLMN.
- 3) The mobile station shall reset the list of "Forbidden location areas for roaming" when it is switched off or has its power source removed or when the SIM is removed.
- 4) The MS shall be capable of storing at least 6 entries in the list of "Forbidden location areas for roaming".

Reference(s)

GSM 04.08 section 4.4.4.7.

26.7.4.2.4.2 Test purposes

Test purpose 1

To test that on receipt of a rejection using the Roaming cause code, the MS ceases trying to update on that cell, that this situation continues for at least one periodic location interval period, and that the corresponding list is re-set by switching off the MS or removing its power source.

Test purpose 2

To test that if no cell is available, the MS does not answer to paging with TMSI, rejects a request from CM entity other than for emergency calls.

Test purpose 3

To test that at least 6 entries can be held in the list of "forbidden location areas for roaming" (the requirement in GSM 04.08 is to store at least 10 entries. This is not fully tested by the third procedure).

Test purpose 4

To test that if a cell of the Home PLMN is available then the MS returns to it in preference to any other available cell.

Test purpose 5

To test that if the SIM is removed the list of "forbidden location areas for roaming" is cleared.

26.7.4.2.4.3 Method of test

Initial conditions

The initial conditions shall be met before each of the different procedures.

System Simulator:

For procedures 1, 2, 3 and 5: Two cells A and B, belonging to different location areas of the same PLMN with LAI a and b. The MCC of that PLMN is the same as that of the HPLMN. The MNC of that PLMN is different from that of the HPLMN.

For procedure 4: three cells A, B, C of the same PLMN which is not the HPLMN with 3 different location area codes. Cells should differ in signal strength by 10 dB with cell A being the strongest and cell C the weakest. There should be a 20 dB range between A and C. A should be set to a level of - 40 dBm.

IMSI attach/detach is allowed in every cell.

The T3212 time-out value is 1/10 hour in every cell.

Mobile Station:

Procedures 1, 2, 3 and 5: The MS has valid TMSI, CKSN and Kc. It is "idle updated" on cell B.

Procedure 4: The MS has valid TMSI, CKSN and Kc. It is "idle updated" on cell A.

The list of "forbidden location areas for roaming" shall be empty (this may be achieved by either removing the SIM or switching the MS OFF then ON or removing the MS power source depending on PICS).

Related PICS/PIXIT statement(s)

SIM removal possible while MS is powered Yes/No.

Switch off on button Yes/No.

Support of speech Yes/No.

Method to clear the list of location areas for roaming periodically.

The MS is automatically in automatic mode after switch on Yes/No.

Foreseen final state of the MS

Procedures 1 and 5: The MS has no valid TMSI and no CKSN. It is "idle updated" on cell A.

Procedure 2 and 3: The MS has no valid TMSI and no CKSN. It is in the "limited service" state on cell A.

Procedure 4: The MS has no valid TMSI and no CKSN. It is "idle updated" on cell C.

Test Procedures

Procedure 1:

The SS rejects a normal location updating with the cause value "Roaming not allowed in this area". The channel is released. The SS checks that the MS does not perform periodic location updating procedure. The MS is turned off and then on. The SS checks that the MS performs location updating on the cell on which its location update request had been rejected (this checks that the LA is not the forbidden list after switch on). This procedure is performed another time but the deletion of the list is checked while removing the SIM (instead of turning off the MS).

Procedure 2:

The SS rejects a normal location updating with the cause value "Roaming not allowed in this area". The channel is released. The SS checks that the MS does not answer to a paging message with TMSI, rejects a request from CM entity but supports an emergency call.

Procedure 3:

The SS rejects a normal location updating with the cause value "Roaming not allowed in this area". This is done for 6 different location areas. Then the SS checks that the MS does not attempt to begin a location updating procedure on the non-allowed location areas.

Procedure 4:

The SS accepts a periodic location updating on a cell not belonging to the HPLMN. Then when the MS attempts to perform a periodic location updating to this cell, the SS rejects this location updating with the cause value "Roaming not allowed in this area". Two cells are then available, one belonging to the HPLMN but with the weakest level. It is checked that the MS returns to its HPLMN.

Procedure 5: If SIM removal is possible while MS is powered:

The SS rejects a normal location updating with the cause value "Roaming not allowed in this area". The channel is released. The SS checks that the MS does not perform periodic location updating procedure. The SIM is removed and inserted in the MS. The SS checks that the MS performs location updating on the cell on which its location update request had been rejected (this checks that the LA is not the forbidden list after switch on).

Different types of MS may use different methods to periodically clear the list of forbidden areas (e.g. every day at 12am) for roaming. If the list is cleared while the test is being run, it may be necessary to re-run the test.

Maximum duration of test

Procedures 1 and 5: 12 minutes each.

Procedure 2: 6 minutes.

Procedure 3: 17 minutes.

Procedure 4: 16 minutes.

Expected sequence

The following procedure is used during the test:

Change_LAI (x):

- The purpose of this procedure is to change the value of Location Area Identifier of cell x.
- The Location Area Identifier of cell x shall be changed. The code shall be chosen arbitrarily but shall be different from any previously used in this procedure. The code shall have the same MCC as the Home PLMN and shall not have the same MNC as the Home PLMN.

Procedure 1

Step	Direction	Message	Comments
1	SS		The following messages are sent and shall be received on cell A.
2	MS -> SS	CHANNEL REQUEST	The RF level of cell B is lowered until cell B is no more suitable and the MS selects cell A.
3	SS -> MS	IMMEDIATE ASSIGNMENT	"Establishment cause": Location updating.
4	MS -> SS	LOCATION UPDATING REQUEST	
5	SS -> MS	LOCATION UPDATING REJECT	"Reject cause" IE is "Roaming not allowed in this location area".
6	SS -> MS	CHANNEL RELEASE	After the sending of this message, the SS waits for the disconnection of the main signalling link.
7	SS		The SS waits at least 7 minutes for a possible location updating.
8	MS		The MS shall not initiate an RR connection establishment on cell A or on cell B.
9	MS		If possible (see PICS) the MS is switched off. Otherwise if possible the power is removed.
10	MS		Depending on what has been performed in step 9 the MS is brought back to operation and placed in a automatic mode.
11	MS -> SS	CHANNEL REQUEST	"Establishment cause": Location updating.
12	SS -> MS	IMMEDIATE ASSIGNMENT	
13	MS -> SS	LOCATION UPDATING REQUEST	Location Updating Type = normal.
14	SS -> MS	LOCATION UPDATING ACCEPT	IE Mobile Identity not present.
15	SS -> MS	CHANNEL RELEASE	After the sending of this message, the SS waits for the disconnection of the main signalling link.

Procedure 2

Step	Direction	Message	Comments
1	SS		The following messages are sent and shall be received on cell A. The RF level of cell B is lowered until the MS selects cell A. The level of cell B shall be such that cell B is suitable for cell selection.
2	MS -> SS	CHANNEL REQUEST	"Establishment cause": Location updating This message is sent on cell A.
3	SS -> MS	IMMEDIATE ASSIGNMENT	
4	MS -> SS	LOCATION UPDATING REQUEST	
5	SS -> MS	LOCATION UPDATING REJECT	"Reject cause" IE is "Roaming not allowed in this location area".
6	SS -> MS	CHANNEL RELEASE	After the sending of this message, the SS waits for the disconnection of the main signalling link.
7	MS -> SS	CHANNEL REQUEST	The following messages are sent and shall be received on cell B. "Establishment cause": Location updating.
8	SS -> MS	IMMEDIATE ASSIGNMENT	
9	MS -> SS	LOCATION UPDATING REQUEST	
10	SS -> MS	LOCATION UPDATING REJECT	"Reject cause" IE is "Roaming not allowed in this location area".
11	SS -> MS	CHANNEL RELEASE	After the sending of this message, the SS waits for the disconnection of the main signalling link.
12	SS		The SS waits for a possible location updating procedure on both cells A and B for 2 minutes.
13	MS		The MS shall not initiate an RR connection establishment on cell A or on cell B within 2 minutes after the end of step 11.
14	SS -> MS	PAGING REQUEST TYPE 1	"Mobile identity" = TMSI. This message is sent on cell A and on cell B.
15	MS		The MS shall not initiate an RR connection on cell A or on cell B. This is checked during 3 seconds.
16	MS		A MO CM connection is attempted.
17	MS		The MS shall not initiate an RR connection establishment on cell A or on cell B. This is checked during 3 seconds.
18	MS		The following messages are sent and shall be received on cell A Steps 20 to 27 are performed if the MS supports speech. An emergency call is attempted.
19	MS -> SS	CHANNEL REQUEST	"Establishment cause":
20	SS -> MS	IMMEDIATE ASSIGNMENT	
21	MS -> SS	CM SERVICE REQUEST	"CM service type": Emergency call establishment.
22	SS -> MS	CM SERVICE ACCEPT	
23	MS -> SS	EMERGENCY SETUP	
24	SS -> MS	RELEASE COMPLETE	"Cause" = unassigned number.
25	SS -> MS	CHANNEL RELEASE	After the sending of this message, the SS waits for the disconnection of the main signalling link.

Procedure 3

Step	Direction	Message	Comments
1	SS		The following messages are sent and shall be received on cell A The RF level of cell B is lowered until the MS selects cell A. The level of cell B shall be such that cell B is suitable for cell selection.
2	MS -> SS	CHANNEL REQUEST	"Establishment cause": Location updating. "Reject cause" IE is "Roaming not allowed in this location area". After the sending of this message, the SS waits for the disconnection of the main signalling link.
3	SS -> MS	IMMEDIATE ASSIGNMENT	
4	MS -> SS	LOCATION UPDATING REQUEST	
5	SS -> MS	LOCATION UPDATING REJECT	
6	SS -> MS	CHANNEL RELEASE	
9	MS -> SS	CHANNEL REQUEST	The following messages are sent and shall be received on cell B.
10	SS -> MS	IMMEDIATE ASSIGNMENT	"Establishment cause": Location updating.
11	MS -> SS	LOCATION UPDATING REQUEST	"Reject cause" IE is "Roaming not allowed in this location area". After the sending of this message, the SS waits for the disconnection of the main signalling link.
12	SS -> MS	LOCATION UPDATING REJECT	
13	SS -> MS	CHANNEL RELEASE	
14	SS		
17	MS -> SS	CHANNEL REQUEST	The following messages are sent and shall be received on cell A.
18	SS -> MS	IMMEDIATE ASSIGNMENT	"Establishment cause": Location updating.
19	MS -> SS	LOCATION UPDATING REQUEST	"Reject cause" IE is "Roaming not allowed in this location area". After the sending of this message, the SS waits for the disconnection of the main signalling link.
20	SS -> MS	LOCATION UPDATING REJECT	
21	SS -> MS	CHANNEL RELEASE	
22	SS		
25	MS -> SS	CHANNEL REQUEST	The following messages are sent and shall be received on cell B.
26	SS -> MS	IMMEDIATE ASSIGNMENT	"Establishment cause": Location updating.
27	MS -> SS	LOCATION UPDATING REQUEST	"Reject cause" IE is "Roaming not allowed in this location area". After the sending of this message, the SS waits for the disconnection of the main signalling link.
28	SS -> MS	LOCATION UPDATING REJECT	
29	SS -> MS	CHANNEL RELEASE	
30	SS		
33	MS -> SS	CHANNEL REQUEST	The following messages are sent and shall be received on cell A.
34	SS -> MS	IMMEDIATE ASSIGNMENT	"Establishment cause": Location updating.
35	MS -> SS	LOCATION UPDATING REQUEST	"Reject cause" IE is "Roaming not allowed in this location area". After the sending of this message, the SS waits for the disconnection of the main signalling link.
36	SS -> MS	LOCATION UPDATING REJECT	
37	SS -> MS	CHANNEL RELEASE	
38	SS		
41	MS -> SS	CHANNEL REQUEST	The following messages are sent and shall be received on cell B.
42	SS -> MS	IMMEDIATE ASSIGNMENT	"Establishment cause": Location updating.
43	MS -> SS	LOCATION UPDATING REQUEST	"Reject cause" IE is "Roaming not allowed in this location area". After the sending of this message, the SS waits for the disconnection of the main signalling link.
44	SS -> MS	LOCATION UPDATING REJECT	
45	SS -> MS	CHANNEL RELEASE	
46	SS		
47	MS		The MS shall not initiate an RR connection establishment on cell A or on cell B within 7 minutes after the end of step 45.

Procedure 4

Step	Direction	Message	Comments
1	SS		The following messages are sent and shall be received on cell A. The SS waits for a periodic location updating procedure on cell A for 7 minutes after the initial conditions have been established.
2	MS -> SS	CHANNEL REQUEST	"Establishment cause": Location updating.
3	SS -> MS	IMMEDIATE ASSIGNMENT	
4	MS -> SS	LOCATION UPDATING REQUEST	Location Updating Type = periodic.
5	SS -> MS	LOCATION UPDATING ACCEPT	IE Mobile Identity not present.
6	SS -> MS	CHANNEL RELEASE	After the sending of this message, the SS waits for the disconnection of the main signalling link.
7	SS		The location area identity of cell C shall be changed to that of a location area in the Home PLMN.
8	SS		The SS waits for a periodic location updating procedure on cell A for 7 minutes.
9	MS -> SS	CHANNEL REQUEST	"Establishment cause": Location updating This message is sent on cell A within 7 minutes after the end of step 6.
10	SS -> MS	IMMEDIATE ASSIGNMENT	
11	MS -> SS	LOCATION UPDATING REQUEST	"Location updating type" = periodic.
12	SS -> MS	LOCATION UPDATING REJECT	"Reject cause" IE is "Roaming not allowed in this location area".
13	SS -> MS	CHANNEL RELEASE	After the sending of this message, the SS waits for the disconnection of the main signalling link.
16	MS -> SS	CHANNEL REQUEST	The following messages are sent and shall be received on cell C. "Establishment cause": Location updating.
17	SS -> MS	IMMEDIATE ASSIGNMENT	
18	MS -> SS	LOCATION UPDATING REQUEST	
19	SS -> MS	LOCATION UPDATING ACCEPT	IE Mobile Identity not present.
20	SS -> MS	CHANNEL RELEASE	After the sending of this message, the SS waits for the disconnection of the main signalling link.

Procedure 5

Step	Direction	Message	Comments
1	SS		The following messages are sent and shall be received on cell A.
2	MS -> SS	CHANNEL REQUEST	The RF level of cell B is lowered until cell B is no longer suitable and the MS selects cell A.
3	SS -> MS	IMMEDIATE ASSIGNMENT	"Establishment cause": Location updating.
4	MS -> SS	LOCATION UPDATING REQUEST	
5	SS -> MS	LOCATION UPDATING REJECT	"Reject cause" IE is "Roaming not allowed in this location area".
6	SS -> MS	CHANNEL RELEASE	After the sending of this message, the SS waits for the disconnection of the main signalling link.
7	SS		The SS waits at least 7 minutes for a possible location updating.
8	MS		The MS shall not initiate an RR connection establishment on cell A or on cell B.
9	MS		The SIM is removed.
10	MS		The SIM is inserted into the ME.
11	MS -> SS	CHANNEL REQUEST	"Establishment cause": Location updating.
12	SS -> MS	IMMEDIATE ASSIGNMENT	
13	MS -> SS	LOCATION UPDATING REQUEST	Location Updating Type = normal.
14	SS -> MS	LOCATION UPDATING ACCEPT	IE Mobile Identity not present.
15	SS -> MS	CHANNEL RELEASE	After the sending of this message, the SS waits for the disconnection of the main signalling link.

Specific message contents:

None.

26.7.4.3 Location updating / abnormal cases

26.7.4.3.1 Location updating / abnormal cases / random access fails

26.7.4.3.1.1 Conformance requirement

If during the RR connection establishment phase of a normal location updating procedure, channel requests are not answered by the network, the Mobile Station shall:

1. send (Max-Retrans+1) Channel Request messages;
2. not try to establish a connection during a period of T3213;
3. then perform a normal location updating procedure as it is still necessary;
4. not repeat the complete procedure if the original cause of the location updating procedure has disappeared.

Reference(s):

GSM 04.08 section 4.4.4.9 and GSM 05.08 section 6.6.2.

26.7.4.3.1.2 Test purpose

To verify that when during the RR connection establishment phase of a location updating procedure, channel requests are not answered by the network, after expiry of T3213 (= 4s in Phase 2) and when the cell reselection procedure is finished the complete procedure is repeated if still necessary.

26.7.4.3.1.3 Method of test

Initial conditions

System Simulator:

Two cells: A and B of the same PLMN, belonging to different location areas with LAI a and b.

The RF power level of cell B is higher than the one of cell A.

IMSI attach/detach is not allowed in both cells.

The T3212 time-out value is set to infinite in both cells.

Mobile Station:

The MS has a valid TMSI, CKSN and Kc. It is "Idle updated" on cell B.

Related PICS/PIXIT statement(s)

None.

Foreseen final state of the MS

The MS is "Idle updated" on cell A.

Test Procedure

The SS causes a random access failure in the MS during a normal location updating procedure. After the expiry of T3213 and when the cell reselection procedure is finished the MS will try to restart the normal location updating procedure.

The test is repeated but the original cause of the location updating procedure has disappeared. The SS then checks that the MS will not restart the location updating procedure.

Maximum duration of test

1 minute.

Expected sequence

Step	Direction	Message	Comments
1	MS		The following messages are sent and shall be received on cell A. The RF level of cell B is lowered until the MS selects cell A. The RF level of cell B is set sufficiently low to ensure that cell B is not suitable as defined in GSM 05.08 section 6.6.2..
2	MS -> SS	CHANNEL REQUEST	Establishment cause: Location updating. This message is sent by the MS (Max_Retrans + 1) times.
3	SS		The SS waits for 4 seconds.
4	MS		The MS shall not send any layer 3 message during this time.
5	MS -> SS	CHANNEL REQUEST	Establishment cause: Location updating. The time difference between this message and the last CHANNEL REQUEST sent in step 2 shall be in the range 4 s - 9 s.
6	SS -> MS	IMMEDIATE ASSIGNMENT	
7	MS -> SS	LOCATION UPDATING REQUEST	location updating type = normal, CKSN = initial value, LAI = b, mobile station classmark 1 and mobile identity = TMSI.
8	SS -> MS	LOCATION UPDATING ACCEPT	Optional IE Mobile Identity not included
9	SS -> MS	CHANNEL RELEASE	After the sending of this message, the SS waits for the disconnection of the main signalling link.
10	SS		The RF level of cell B is set to the same value as for cell A.
11	SS		The RF level of cell A is lowered until the MS selects cell B. The RF level of cell A is kept sufficiently high to ensure that cell A is still suitable as defined in GSM 05.08 section 6.6.2.
12	MS -> SS	CHANNEL REQUEST	The following messages are sent and shall be received on cell B. Establishment cause: Location updating. This message is sent by the MS (Max_Retrans + 1) times.
13	SS		Immediately after the end of step 12 the RF level of cell A is set to the same value as for cell B.
14	MS		The MS shall not initiate an RR connection establishment on cell A or on cell B. This is checked during 15 s.

Specific message contents:

None.

26.7.4.3.2 Location updating / abnormal cases / attempt counter less or equal to 4, LAI different

26.7.4.3.2.1 Conformance requirement

- 1) When a failure such as cases d), f) and g) of section 4.4.4.9 of GSM 04.08 has occurred during a normal location updating procedure, if the attempt counter is smaller than 4 and after expiry of T3211, the Mobile Station shall resend its Location Updating Request message with the Mobile Identity IE set to its IMSI, CKSN IE set to "no key is available" and the Location Updating type set to "normal location updating".
- 2) When a failure such as cases d), f) and g) of section 4.4.4.9 of GSM 04.08 has occurred during a normal location updating procedure the Mobile Station shall:
 - 2.1 not answer to paging with the previously allocated TMSI;
 - 2.2 not perform the IMSI detach procedure, when switched off.
- 3) When a failure such as case e) of section 4.4.4.9 of GSM 04.08 has occurred during a normal location updating procedure and when an emergency call establishment is requested by the user the Mobile Station, if it supports speech, shall send a CM Service Request message with CM Service Type IE set to "emergency call"

establishment", CKSN IE set to "no key available" and Mobile Identity IE set to its IMSI and after acceptance by the network it shall send an Emergency Setup message.

- 4) When a failure such as cases d), f) and g) of section 4.4.4.9 of GSM 04.08 has occurred during a normal location updating procedure the Mobile Station shall use a request from CM entity other than emergency call as a trigger for a normal location updating procedure and shall send a Location Updating Request message with the Mobile Identity IE set to its IMSI, CKSN IE set to "no key is available" and the Location Updating type IE set to "normal location updating".
- 5) When a failure such as cases d), f) and g) of section 4.4.4.9 of GSM 04.08 has occurred during a normal location updating procedure the Mobile Station shall answer to paging with IMSI and shall send a Paging Response message with CKSN IE set to "no key available" and Mobile Identity IE set to its IMSI.
- 6) When a failure such as cases d), f) and g) of section 4.4.4.9 of GSM 04.08 has occurred during a normal location updating procedure the Mobile Station shall perform a normal location updating procedure as soon as it enters a new cell.

References

GSM 04.08 section 4.4.4.2 and 4.4.4.9 and GSM 05.08 section 6.6.2.

26.7.4.3.2.2 Test purpose

To verify that the MS performs normal location updating procedures when its attempt counter is smaller than 4.

To check that the MS does not perform the IMSI detach procedure when "idle not updated".

To verify that when "idle not updated" the MS can perform an emergency call.

To verify that when "idle not updated" the MS uses requests from CM layer other than emergency call as triggering of a normal location updating procedure.

To verify that the MS performs a normal location updating procedure if it enters a new cell while being "idle not updated".

26.7.4.3.2.3 Method of test

Initial conditions

System Simulator:

Two cells: A and B of the same PLMN, belonging to different location areas with LAI a and b.

ATT flag shall be set to IMSI attach/detach allowed.

Mobile Station:

The MS is "idle updated" on cell A. A valid CKSN value is stored in the SIM and is noted "initial CKSN". A TMSI is allocated.

Related PICS/PIXIT statements

SIM removal possible while MS is powered Yes/No.

Switch off on button Yes/No.

Support for speech Yes/No.

Foreseen final state of the MS

The MS is "Idle updated" on cell A with a valid CKSN and a TMSI.

Test Procedure

The MS is made to perform a normal location updating procedure. Four types of failure cases are triggered:

- sending of a Location Updating Reject with cause randomly chosen between all defined cause values except 2, 3, 6, 11, 12 and 13 (which trigger a different action) (case g of GSM 04.08 section 4.4.4.9);
- RR-connection failure (case d);
- sending of a CHANNEL RELEASE message before the normal end of the procedure (case f);
- T3210 time-out (case e).

As there is no stored LAI or the stored LAI is different from the broadcast LAI, and the attempt counter in the MS shall be lower than 4, the MS enters the state MM IDLE and substate ATTEMPTING TO UPDATE and waits for T3211 seconds before trying again a location updating procedure.

Then the behaviour of the MS in the MM IDLE ATTEMPTING TO UPDATE SERVICE state is checked, that is:

- not answer to paging with TMSI;
- not perform an IMSI detach procedure;
- support request for emergency call;
- use requests from CM layer other than emergency call as triggering of a normal location updating procedure;
- perform normal location updating procedure when a new cell is entered.

Maximum duration of test

9 minutes.

Expected sequence

Step	Direction	Message	Comments
The following messages are sent and shall be received on cell B.			
1	MS		The RF level of cell A is lowered until the MS selects cell B. The RF level of cell A is set sufficiently low to ensure that cell A is not suitable as defined in GSM 05.08 section 6.6.2.
2	MS -> SS	CHANNEL REQUEST	Establishment cause: Location updating.
3	SS -> MS	IMMEDIATE ASSIGNMENT	
4	MS -> SS	LOCATION UPDATING REQUEST	location updating type = normal, CKSN = initial value, LAI = a, mobile station classmark 1 as given by the PICS and mobile identity = TMSI.
5	SS -> MS	LOCATION UPDATING REJECT	IE Reject cause is set to a value arbitrarily chosen: * in table 10.66 of GSM 04.08, causes #2, #3, #6, #11, #12 and #13 being excluded.
6	SS -> MS	CHANNEL RELEASE	After the sending of this message, the SS waits for the disconnection of the main signalling link.
7	MS		The MS shall not initiate an RR connection establishment on cell A or on cell B during T3211 seconds at least after the channel release.
8	MS -> SS	CHANNEL REQUEST	Establishment cause: Location updating.
9	SS -> MS	IMMEDIATE ASSIGNMENT	
10	MS -> SS	LOCATION UPDATING REQUEST	location updating type = normal, CKSN = no key available, LAI = deleted LAI (the MCC and MNC hold the previous values, the LAC is coded FFFE), Mobile Identity = IMSI.
11	SS		The SS deactivates the SACCH on the dedicated channel. The SS waits until there are no more SACCH frames in the uplink direction. This release connection is done within 8 SACCH frames.
12	MS		The MS shall not initiate an RR connection establishment on cell A or on cell B within T3211 + RadioLinkTimeout after the SS deactivates the SACCH.
13	MS -> SS	CHANNEL REQUEST	Establishment cause: Location updating.
14	SS -> MS	IMMEDIATE ASSIGNMENT	
15	MS -> SS	LOCATION UPDATING REQUEST	location updating type = normal, CKSN = no key available, LAI = deleted LAI (the MCC and MNC hold the previous values, the LAC is coded FFFE), Mobile Identity = IMSI.
16	SS -> MS	CHANNEL RELEASE	After the sending of this message, the SS waits for the disconnection of the main signalling link.
17	MS		The MS shall not initiate an RR connection establishment on cell A or on cell B during T3211 seconds at least after the channel release.
18	MS -> SS	CHANNEL REQUEST	Establishment cause: Location updating.
19	SS -> MS	IMMEDIATE ASSIGNMENT	
20	MS -> SS	LOCATION UPDATING REQUEST	location updating type = normal, CKSN = no key available, LAI = deleted LAI (the MCC and MNC hold the previous values, the LAC is coded FFFE), Mobile Identity = IMSI.
21	SS -> MS	AUTHENTICATION REQUEST	CKSN = initial CKSN.
22	MS -> SS	AUTHENTICATION RESPONSE	
23	SS -> MS	LOCATION UPDATING ACCEPT	IE mobile Identity = new TMSI.
24	MS -> SS	TMSI REALLOCATION COMPLETE	
25	SS -> MS	CHANNEL RELEASE	After the sending of this message, the SS waits for the disconnection of the main signalling link. MS is now "idle updated" in cell B.
The following messages are sent and shall be received on cell A.			
26	MS		The RF level of cell B is lowered until the MS selects cell A. The RF level of cell B is set sufficiently low to ensure that cell B is not suitable as defined in GSM 05.08 section 6.6.2.
27	MS -> SS	CHANNEL REQUEST	Establishment cause: Location updating.
28	SS -> MS	IMMEDIATE ASSIGNMENT	

Step	Direction	Message	Comments
29	MS -> SS	LOCATION UPDATING REQUEST	location updating type = normal, CKSN = initial value, LAI = b, mobile station classmark 1 as given by the PICS and mobile identity = TMSI.
30	SS		performs step 5 with reject cause #100 and step 6.
31	SS -> MS	PAGING REQUEST TYPE 1	Mobile identity = old TMSI of the MS. This message is sent continuously to the MS during 8 seconds.
32	SS		The SS checks that there is no answer from the MS during 12 seconds.
33	SS		If during steps 31 and 32 the MS attempts to perform a location updating procedure the SS will perform step 30 and then continue the procedure.
34	MS		If possible (see PICS) SIM detachment is performed. Otherwise if possible (see PICS) mobile switch off is performed. Otherwise the power is removed.
35	MS		The MS shall not initiate an RR connection establishment on cell A or on cell B. This is checked during 30 seconds.
36	MS		Depending on what has been performed in step 34 the MS is brought back to operation.
37	MS -> SS	CHANNEL REQUEST	Establishment cause: Location updating.
38	SS -> MS	IMMEDIATE ASSIGNMENT	
39	MS -> SS	LOCATION UPDATING REQUEST	location updating type = normal, CKSN = no key available, LAI = deleted LAI (the MCC and MNC hold the previous values, the LAC is coded FFFE), Mobile Identity = IMSI.
40	SS -> MS	AUTHENTICATION REQUEST	CKSN = initial CKSN.
41	MS -> SS	AUTHENTICATION RESPONSE	
42	SS -> MS	LOCATION UPDATING ACCEPT	IE mobile Identity = new TMSI.
43	MS -> SS	TMSI REALLOCATION COMPLETE	
44	SS -> MS	CHANNEL RELEASE	After the sending of this message, the SS waits for the disconnection of the main signalling link. MS is now "idle updated" in cell A.
45	MS		The RF level of cell A is lowered until the MS selects cell B. The RF level of cell A is set sufficiently low to ensure that cell A is not suitable as defined in GSM 05.08 section 6.6.2.
46	MS -> SS	CHANNEL REQUEST	Establishment cause: Location updating.
47	SS -> MS	IMMEDIATE ASSIGNMENT	
48	MS -> SS	LOCATION UPDATING REQUEST	location updating type = normal, CKSN = initial value, LAI = a, mobile station classmark 1 as given by the PICS and mobile identity = TMSI.
49	SS -> MS	AUTHENTICATION REQUEST	
50	MS->SS	AUTHENTICATION RESPONSE	steps 49 and 50 are performed N times. N shall be chosen in such a way that T3210 expires. Depending on when T3210 expires in the MS, it is possible that on the Nth occurrence of step 50 the MS may send a L2 DISC rather than the AUTHENTICATION RESPONSE message.
51	SS		The SS checks that there is no more activity from the MS on the channel after the DISC/UA exchange has been completed.
52	MS		If the MS supports speech it is made to perform an emergency call.
53	MS -> SS	CHANNEL REQUEST	Establishment cause: Emergency call.
54	SS -> MS	IMMEDIATE ASSIGNMENT	
55	MS -> SS	CM SERVICE REQUEST	CM service type = Emergency call establishment; CKSN = no key available; Mobile Identity = IMSI.
56	SS -> MS	CM SERVICE ACCEPT	
57	MS -> SS	EMERGENCY SETUP	
58	SS -> MS	RELEASE COMPLETE	Cause = unassigned number.
59	SS -> MS	CHANNEL RELEASE	
60	MS -> SS	CHANNEL REQUEST	Establishment cause: Location updating The SS will wait at most 15 seconds for this message.
61	SS -> MS	IMMEDIATE ASSIGNMENT	

Step	Direction	Message	Comments
62	MS -> SS	LOCATION UPDATING REQUEST	location updating type = normal, CKSN = no key available, LAI = deleted LAI (the MCC and MNC hold the previous values, the LAC is coded FFFE), Mobile Identity = IMSI.
63	SS -> MS	AUTHENTICATION REQUEST	CKSN = initial CKSN.
64	MS -> SS	AUTHENTICATION RESPONSE	
65	SS -> MS	LOCATION UPDATING ACCEPT	IE mobile Identity = new TMSI.
66	MS -> SS	TMSI REALLOCATION COMPLETE	
67	SS -> MS	CHANNEL RELEASE	After the sending of this message, the SS waits for the disconnection of the main signalling link. MS is now "idle updated" in cell B.
68	MS		The RF level of cell B is lowered until the MS selects cell A. The RF level of cell B is set sufficiently low to ensure that cell B is not suitable as defined in GSM 05.08 section 6.6.2.
69	MS -> SS	CHANNEL REQUEST	Establishment cause: Location updating.
70	SS -> MS	IMMEDIATE ASSIGNMENT	
71	MS -> SS	LOCATION UPDATING REQUEST	location updating type = normal, CKSN = initial value, LAI = b, mobile station classmark 1 as given by the PICS and mobile identity = TMSI.
72	SS		performs step 11.
73	MS		A MO CM connection is attempted before T3211 expiry.
74	MS -> SS	CHANNEL REQUEST	Establishment cause: Location updating.
75	SS -> MS	IMMEDIATE ASSIGNMENT	
76	MS -> SS	LOCATION UPDATING REQUEST	location updating type = normal, CKSN = no key available, LAI = deleted LAI (the MCC and MNC hold the previous values, the LAC is coded FFFE), Mobile Identity = IMSI.
77	SS -> MS	LOCATION UPDATING ACCEPT	IE mobile Identity = new TMSI.
78	MS -> SS	TMSI REALLOCATION COMPLETE	
79	SS -> MS	CHANNEL RELEASE	Steps 80 to 83 are optional as the MS may have memorized the request for CM connection attempt Wait 10 s to decide whether to go directly to step 84.
80	MS -> SS	CHANNEL REQUEST	Establishment cause: Not checked.
81	SS -> MS	IMMEDIATE ASSIGNMENT	
82	MS -> SS	CM SERVICE REQUEST	CKSN = no key available, Mobile identity = TMSI.
83	SS -> MS	CHANNEL RELEASE	After the sending of this message, the SS waits for the disconnection of the main signalling link. MS is now "idle updated" in cell A.
84	MS		The RF level of cell A is lowered until the MS selects cell B. The RF level of cell A is set sufficiently low to ensure that cell A is not suitable as defined in GSM 05.08 section 6.6.2.
85	MS -> SS	CHANNEL REQUEST	Establishment cause: Location updating.
86	SS -> MS	IMMEDIATE ASSIGNMENT	
87	MS -> SS	LOCATION UPDATING REQUEST	location updating type = normal, CKSN = no key available LAI = a, mobile station classmark 1 as given by the PICS and mobile identity = TMSI.
88	SS		performs step 16.
89	MS		The RF level of cell B is lowered until the MS selects cell A. The RF level of cell B is set sufficiently low to ensure that cell B is not suitable as defined in GSM 05.08 section 6.6.2.
90	MS -> SS	CHANNEL REQUEST	Establishment cause: Location updating. The time interval between Cell B being set sufficiently low to ensure that Cell B is not suitable and this message shall be less than 20s.
91	SS -> MS	IMMEDIATE ASSIGNMENT	
92	MS -> SS	LOCATION UPDATING REQUEST	location updating type = normal, CKSN = no key available , LAI = deleted LAI (the MCC and MNC hold the previous values, the LAC is coded FFFE), mobile station classmark 1 as given by the PICS and mobile identity = IMSI.
93	SS -> MS	AUTHENTICATION REQUEST	CKSN = initial CKSN.
94	MS -> SS	AUTHENTICATION RESPONSE	

Step	Direction	Message	Comments
95	SS -> MS	LOCATION UPDATING ACCEPT	Mobile identity = TMSI. After the sending of this message, the SS waits for the disconnection of the main signalling link. MS is now "Idle, updated" in cell A.
96	MS -> SS	TMSI REALLOCATION COMPLETE	
97	SS -> MS	CHANNEL RELEASE	

Specific message contents

None.

26.7.4.3.3 Location updating / abnormal cases / attempt counter equal to 4

26.7.4.3.3.1 Conformance requirement

- 1) When four failures such as cases d) to g) of section 4.4.4.9 of GSM 04.08 have occurred during a normal location updating procedure the Mobile Station shall:
 - 1.1 perform location updating after T3212 expiry by sending a Location Updating Request message with the Mobile Identity IE set to its IMSI, CKSN IE set to "no key is available" and the Location Updating type set to "normal updating".
 - 1.2 if the T3212 initiated location updating was unsuccessful, then after T3211 expiry the Mobile Station shall send a Location Updating Request message with the Mobile Identity IE set to its IMSI, CKSN IE set to "no key is available" and the Location Updating type IE set to "normal location updating".
- 2) When four failures such as cases d), f), g) of section 4.4.4.9 of GSM 04.08 have occurred during a normal location updating procedure the Mobile Station, if it supports speech, shall be able to perform an emergency call i.e. the Mobile Station is able to send a CM Service Request message with the CM Service Type IE set to "emergency call establishment", CKSN IE set to "no key is available" and Mobile Identity IE set to its IMSI and then send an Emergency Setup message.
- 3) When four failures such as cases d), f), g) of section 4.4.4.9 of GSM 04.08 have occurred during a normal location updating procedure:
 - 3.1 the Mobile Station shall use a request from CM entity for MM connection for a service other than emergency call as a trigger for a normal location updating procedure and shall send a Location Updating Request message with the Mobile Identity IE set to its IMSI, CKSN IE set to "no key is available" and the Location Updating type IE set to "normal location updating".
 - 3.2 after a location updating triggered by a request from the CM layer which was .unsuccessful, after T3211 expiry the Mobile Station shall send a Location Updating Request message with the Mobile Identity IE set to its IMSI, CKSN IE set to "no key is available" and the Location Updating type IE set to "normal location updating".
- 4) When four failures such as cases d), f), g) of section 4.4.4.9 of GSM 04.08 have occurred during a normal location updating procedure:
 - 4.1 the Mobile Station shall perform a normal location updating procedure if it enters a new cell.
 - 4.2 if this location updating is unsuccessful, after T3211 expiry the Mobile Station shall send a Location Updating Request message with the Mobile Identity IE set to its IMSI, CKSN IE set to "no key is available" and the Location Updating type IE set to "normal location updating".

References

GSM 04.08 section 4.4.4.9 and GSM 05.08 section 6.6.2.

26.7.4.3.3.2 Test purpose

To verify that the MS performs normal location updating procedures after T3212 expiry, when its attempt counter has reached value 4 and that the MS reset its attempt counter after a timer T3212 expiry.

To verify that the MS still follows the MM IDLE ATTEMPTING TO UPDATE state requirements after its attempt counter has reached value 4.

To verify that the attempt counter is reset in the cases where it has to be done.

26.7.4.3.3.3 Method of test

Initial conditions

System Simulator:

Two cells: A and B, belonging to different location areas a and b.

IMSI attach/detach is allowed in both cells.

T3212 is set to 6 minutes.

Mobile Station:

The MS is "Idle updated" on cell B with a valid CKSN and a TMSI.

Related PICS/PIXIT statements

SIM removal possible while MS is powered Yes/No.

Switch off on button Yes/No.

Support of speech Yes/No.

Foreseen final state of the MS

The MS is "Idle updated" on cell A with a valid CKSN and a TMSI.

Test Procedure

The MS is made to perform a normal location updating. The SS triggers a failure in this procedure. After T3211 expiry the MS will try again the location updating procedure. The SS triggers again a failure. This is done again 2 times. At this point the attempt counter shall be equal to 4. It is then checked that T3212 has been started and that at its expiry the MS will try a normal location updating procedure. It is verified that the MS has reset its attempt counter after timer T3212 expiry.

Then it is checked that, when the attempt counter has reached the value of 4, the MS is in the MM IDLE state and ATTEMPTING TO UPDATE substate, that is:

- not perform an IMSI detach procedure;
- support request for emergency call;
- use requests from CM layer other than emergency call as triggering of a normal location updating procedure;
- perform normal location updating procedure when a new cell is entered.

Maximum duration of test

20 minutes.

Expected sequence

Step	Direction	Message	Comments
1	MS		The following messages are sent and shall be received on cell A. The RF level of cell B is lowered until the MS selects cell A. The RF level of cell B is set sufficiently low to ensure that cell B is not suitable as defined in GSM 05.08 section 6.6.2.
2	MS -> SS	CHANNEL REQUEST	Establishment cause: Location updating. location updating type = normal, CKSN = initial value, LAI = b, mobile station classmark 1 as given by the PICS and mobile identity = TMSI.
3	SS -> MS	IMMEDIATE ASSIGNMENT	
4	MS -> SS	LOCATION UPDATING REQUEST	
5	SS -> MS	LOCATION UPDATING REJECT	
6	SS -> MS	CHANNEL RELEASE	IE Reject cause is set to #22 * in table 10.66 of GSM 04.08, causes #2, #3, #6, #11, #12 and #13 being excluded. The SS waits for the disconnection of the main signalling link.
7	MS		The MS shall not initiate an RR connection establishment on cell A or on cell B within T3211.
8	MS -> SS	CHANNEL REQUEST	Establishment cause: Location updating. location updating type = normal, CKSN = no key available, LAI = deleted LAI (the MCC and MNC hold the previous values, the LAC is coded FFFE), Mobile Identity = IMSI.
9	SS -> MS	IMMEDIATE ASSIGNMENT	
10	MS -> SS	LOCATION UPDATING REQUEST	
11	SS		The SS deactivates the SACCH on the dedicated channel and waits until there are no more SACCH frames in the uplink. This is done within 8 SACCH frames.
12	MS		The MS shall not initiate an RR connection establishment on cell A or on cell B with T3211 + RadioLinkTimeout after the SS deactivates the SACCH.
13	MS -> SS	CHANNEL REQUEST	Establishment cause: Location updating. location updating type = normal, CKSN = no key available, LAI = deleted LAI (the MCC and MNC hold the previous values, the LAC is coded FFFE), Mobile Identity = IMSI.
14	SS -> MS	IMMEDIATE ASSIGNMENT	
15	MS -> SS	LOCATION UPDATING REQUEST	
16	SS -> MS	AUTHENTICATION REQUEST	these steps (16 and 17) are performed N times. N shall be chosen in such a way that T3210 expires. Depending on when T3210 expires in the MS, it is possible that on the Nth occurrence of step 50 the MS may send a L2 DISC rather than the AUTHENTICATION RESPONSE message.
17	MS -> SS	AUTHENTICATION RESPONSE	
18	MS		The MS shall cease transmission (after the DISC/UA exchange has been completed) and then shall not initiate an RR connection establishment on cell A or on cell B during T3211 seconds at least after the expiry of T3210.
19	MS -> SS	CHANNEL REQUEST	Establishment cause: Location updating. location updating type = normal, CKSN = no key available, LAI = deleted LAI (the MCC and MNC hold the previous values, the LAC is coded FFFE), Mobile Identity = IMSI.
20	SS -> MS	IMMEDIATE ASSIGNMENT	
21	MS -> SS	LOCATION UPDATING REQUEST	
22	SS -> MS	CHANNEL RELEASE	The SS waits for the disconnection of the main signalling link.
23	MS		The MS shall not initiate an RR connection establishment on cell A or on cell B during T3212 (tolerance -15s; 45s) at least after the channel release.
24	MS -> SS	CHANNEL REQUEST	Establishment cause: Location updating. location updating type: "normal location update" CKSN = no key available, LAI = deleted LAI (the MCC and MNC hold the previous values, the LAC is coded FFFE) mobile station classmark 1 as given by the PICS and mobile identity = IMSI.
25	SS -> MS	IMMEDIATE ASSIGNMENT	
26	MS -> SS	LOCATION UPDATING REQUEST	

Step	Direction	Message	Comments
27	SS -> MS	LOCATION UPDATING REJECT	IE Reject cause = #17 "network failure".
28	SS -> MS	CHANNEL RELEASE	The SS waits for the disconnection of the main signalling link.
29	MS		The MS shall not initiate an RR connection establishment on cell A or on cell B during T3211 seconds at least after the channel release.
30	MS -> SS	CHANNEL REQUEST	Establishment cause: Location updating.
31	SS -> MS	IMMEDIATE ASSIGNMENT	
32	MS -> SS	LOCATION UPDATING REQUEST	location updating type = normal, CKSN = no key available, LAI = deleted LAI (the MCC and MNC hold the previous values, the LAC is coded FFFE) mobile station classmark 1 as given by the PICS and mobile identity = IMSI.
33	SS -> MS	AUTHENTICATION REQUEST	CKSN = initial CKSN.
34	MS -> SS	AUTHENTICATION RESPONSE	
35	SS -> MS	LOCATION UPDATING ACCEPT	IE mobile Identity = new TMSI.
36	MS -> SS	TMSI REALLOCATION COMPLETE	
37	SS -> MS	CHANNEL RELEASE	After the sending of this message, the SS waits for the disconnection of the main signalling link. MS is now "idle, updated" in cell A.
38	MS		The RF level of cell A is lowered until the MS selects cell B. The RF level of cell A is set sufficiently low to ensure that cell A is not suitable as defined in GSM 05.08 section 6.6.2.
39	MS -> SS	CHANNEL REQUEST	Establishment cause: Location updating.
40	SS -> MS	IMMEDIATE ASSIGNMENT	
41	MS -> SS	LOCATION UPDATING REQUEST	location updating type = normal, CKSN = initial value, LAI = a, mobile station classmark 1 as given by the PICS and mobile identity = TMSI.
42	SS -> MS	LOCATION UPDATING REJECT	IE Reject cause is set to #42 * in table 10.66 of GSM 04.08, causes #2, #3, #6, #11, #12 and #13 being excluded.
43	SS -> MS	CHANNEL RELEASE	The SS waits for the disconnection of the main signalling link.
44	MS		The MS shall not initiate an RR connection establishment on cell A or on cell B during T3211 seconds at least after the channel release.
45	MS -> SS	CHANNEL REQUEST	Establishment cause: Location updating.
46	SS -> MS	IMMEDIATE ASSIGNMENT	
47	MS -> SS	LOCATION UPDATING REQUEST	location updating type = normal, CKSN = no key available, LAI = deleted LAI (the MCC and MNC hold the previous values, the LAC is coded FFFE), Mobile Identity = IMSI.
48	SS		The SS deactivates the SACCH on the dedicated channel and waits until there is no more SACCH frames in the uplink. This is done within 8 SACCH frames.
48a	MS		The MS shall not initiate an RR connection establishment on cell A or on cell B within T3211 + RadioLinkTimeOut after the SS deactivates the SACCH.
49	MS -> SS	CHANNEL REQUEST	Establishment cause: Location updating.
50	SS -> MS	IMMEDIATE ASSIGNMENT	
51	MS -> SS	LOCATION UPDATING REQUEST	location updating type = normal, CKSN = no key available, LAI = deleted LAI (the MCC and MNC hold the previous values, the LAC is coded FFFE), Mobile Identity = IMSI.
52	SS -> MS	CHANNEL RELEASE	The SS waits for the disconnection of the main signalling link.
53	MS		The MS shall not initiate an RR connection establishment on cell A or on cell B during T3211 seconds at least after the channel release.
54	MS -> SS	CHANNEL REQUEST	Establishment cause: Location updating.
55	SS -> MS	IMMEDIATE ASSIGNMENT	

Step	Direction	Message	Comments
56	MS -> SS	LOCATION UPDATING REQUEST	location updating type = normal, CKSN = no key available, LAI = deleted LAI (the MCC and MNC hold the previous values, the LAC is coded FFFE) mobile station classmark 1 as given by the PICS and mobile identity = IMSI.
57	SS		performs step 42 with cause #38 and step 43.
58	MS		If the MS supports speech, it is made to perform an emergency call.
59	MS -> SS	CHANNEL REQUEST	Establishment cause: Emergency call.
60	SS -> MS	IMMEDIATE ASSIGNMENT	
61	MS -> SS	CM SERVICE REQUEST	CM service type = Emergency call establishment; CKSN = no key available; Mobile Identity = IMSI.
62	SS -> MS	CM SERVICE ACCEPT	
63	MS -> SS	EMERGENCY SETUP	
64	SS -> MS	RELEASE COMPLETE	Cause = unassigned number.
65	SS -> MS	CHANNEL RELEASE	The SS waits for the disconnection of the main signalling link.
66	MS		If possible (see PICS) SIM detachment is performed. Otherwise if possible (see PICS) switch off is performed. Otherwise the power is removed.
67	MS		The MS shall not initiate an RR connection establishment on cell A or on cell B. This is checked during 3 seconds.
68	MS		Depending on what has been performed in step 66 the MS is brought back to operation.
69	MS -> SS	CHANNEL REQUEST	Establishment cause: Location updating.
70	SS -> MS	IMMEDIATE ASSIGNMENT	
71	MS -> SS	LOCATION UPDATING REQUEST	location updating type = normal, CKSN = no key available, LAI = deleted LAI (the MCC and MNC hold the previous values, the LAC is coded FFFE), Mobile Identity = IMSI.
72	SS -> MS	AUTHENTICATION REQUEST	CKSN = initial CKSN.
73	MS -> SS	AUTHENTICATION RESPONSE	
74	SS -> MS	LOCATION UPDATING ACCEPT	IE mobile Identity = new TMSI.
75	MS -> SS	TMSI REALLOCATION COMPLETE	
76	SS -> MS	CHANNEL RELEASE	After the sending of this message, the SS waits for the disconnection of the main signalling link. MS is now "idle, updated" in cell B.
77	MS		The RF level of cell B is lowered until the MS selects cell A. The RF level of cell B is set sufficiently low to ensure that cell B is not suitable as defined in GSM 05.08 section 6.6.2.
78	MS -> SS	CHANNEL REQUEST	Establishment cause: Location updating.
79	SS -> MS	IMMEDIATE ASSIGNMENT	
80	MS -> SS	LOCATION UPDATING REQUEST	location updating type = normal, CKSN = initial value, LAI = b, mobile station classmark 1 as given by the PICS and mobile identity = TMSI.
81	SS -> MS	LOCATION UPDATING REJECT	IE Reject cause is set to #38 * in table 10.66 of GSM 04.08, causes #2, #3, #6, #11, #12, and #13 being excluded.
82	SS -> MS	CHANNEL RELEASE	The SS waits for the disconnection of the main signalling link.
83	MS		The MS shall not initiate an RR connection establishment on cell A or on cell B during T3211 seconds at least after the channel release.
84	MS -> SS	CHANNEL REQUEST	Establishment cause: Location updating.
85	SS -> MS	IMMEDIATE ASSIGNMENT	
86	MS -> SS	LOCATION UPDATING REQUEST	location updating type = normal, CKSN = no key available, LAI = deleted LAI (the MCC and MNC hold the previous values, the LAC is coded FFFE), Mobile Identity = IMSI.
87	SS		The SS deactivates the SACCH on the dedicated channel and waits until there is no more SACCH frames in the uplink. This is done within 8 SACCH frames.
88	MS		The MS shall not initiate an RR connection establishment on cell A or on cell B within T3211 +RadioLinkTimeout seconds after the SS deactivates the SACCH.

Step	Direction	Message	Comments
89	MS -> SS	CHANNEL REQUEST	Establishment cause: Location updating.
90	SS -> MS	IMMEDIATE ASSIGNMENT	
91	MS -> SS	LOCATION UPDATING REQUEST	location updating type = normal, CKSN = no key available, LAI = deleted LAI (the MCC and MNC hold the previous values, the LAC is coded FFFE), Mobile Identity = IMSI.
92	SS -> MS	CHANNEL RELEASE	The SS waits for the disconnection of the main signalling link.
93	MS		The MS shall not initiate an RR connection establishment on cell A or on cell B during T3211 seconds at least after the channel release.
94	MS -> SS	CHANNEL REQUEST	Establishment cause: Location updating.
95	SS -> MS	IMMEDIATE ASSIGNMENT	
96	MS -> SS	LOCATION UPDATING REQUEST	location updating type = normal, CKSN = no key available, LAI = deleted LAI (the MCC and MNC hold the previous values, the LAC is coded FFFE) mobile station classmark 1 as given by the PICS and mobile identity = IMSI.
97	SS		performs step 48.
98	MS		A MO CM connection is attempted.
99	MS -> SS	CHANNEL REQUEST	Establishment cause: Location updating.
100	SS -> MS	IMMEDIATE ASSIGNMENT	
101	MS -> SS	LOCATION UPDATING REQUEST	location updating type = normal, CKSN = no key available, LAI = deleted LAI (the MCC and MNC hold the previous values, the LAC is coded FFFE), Mobile Identity = IMSI.
102	SS		performs step 52.
103	MS		The MS shall not initiate an RR connection establishment on cell A or on cell B during T3211 seconds at least after the channel release.
104	MS -> SS	CHANNEL REQUEST	Establishment cause: Location updating.
105	SS -> MS	IMMEDIATE ASSIGNMENT	
106	MS -> SS	LOCATION UPDATING REQUEST	location updating type = normal, CKSN = no key available, LAI = deleted LAI (the MCC and MNC hold the previous values, the LAC is coded FFFE), Mobile Identity = IMSI.
107	SS -> MS	AUTHENTICATION REQUEST	CKSN = initial CKSN.
108	MS -> SS	AUTHENTICATION RESPONSE	
109	SS -> MS	LOCATION UPDATING ACCEPT	IE mobile Identity = new TMSI.
110	MS -> SS	TMSI REALLOCATION COMPLETE	
111	SS -> MS	CHANNEL RELEASE	MS is now "idle, updated" in cell A The MS may or may not have memorized the request for CM connection. The steps 112 to 116 are therefore optional for the MS. The SS waits 10 second whether to decide to go directly to step 117.
112	MS -> SS	CHANNEL REQUEST	
113	SS -> MS	IMMEDIATE ASSIGNMENT	
114	MS -> SS	CM SERVICE REQUEST	CKSN = initial value, Mobile identity = TMSI.
115	SS -> MS	CM SERVICE REJECT	cause #17 (network failure).
116	SS -> MS	CHANNEL RELEASE	The SS waits for the disconnection of the main signalling link.
117	MS		The RF level of cell A is lowered until the MS selects cell B. The RF level of cell A is set sufficiently low to ensure that cell A is not suitable as defined in GSM 05.08 section 6.6.2.
118	MS -> SS	CHANNEL REQUEST	Establishment cause: Location updating.
119	SS -> MS	IMMEDIATE ASSIGNMENT	
120	MS -> SS	LOCATION UPDATING REQUEST	location updating type = normal, CKSN = initial value, LAI = a, mobile station classmark 1 as given by the PICS and mobile identity = TMSI.
121	SS -> MS	LOCATION UPDATING REJECT	IE Reject cause is set to #38 * in table 10.66 of GSM 04.08, causes #2, #3, #6, #11, #12 and #13 being excluded.
122	SS -> MS	CHANNEL RELEASE	The SS waits for the disconnection of the main signalling link

Step	Direction	Message	Comments
123	MS		The MS shall not initiate an RR connection establishment on cell A or on cell B during T3211 seconds at least after the channel release.
124	MS -> SS	CHANNEL REQUEST	Establishment cause: Location updating.
125	SS -> MS	IMMEDIATE ASSIGNMENT	
126	MS -> SS	LOCATION UPDATING REQUEST	location updating type = normal, CKSN = no key available, LAI = deleted LAI (the MCC and MNC hold the previous values, the LAC is coded FFFE), Mobile Identity = IMSI.
127	SS		The SS stops any RF transmission on the dedicated channel and waits until there is no more SACCH in the uplink.
128	MS		The MS shall not initiate an RR connection establishment on cell A or on cell B within T3211 + RadioLinkTimeOut seconds after the SS stops RF transmission.
129	MS -> SS	CHANNEL REQUEST	Establishment cause: Location updating.
130	SS -> MS	IMMEDIATE ASSIGNMENT	
131	MS -> SS	LOCATION UPDATING REQUEST	location updating type = normal, CKSN = no key available, LAI = deleted LAI (the MCC and MNC hold the previous values, the LAC is coded FFFE), Mobile Identity = IMSI.
132	SS -> MS	CHANNEL RELEASE	The SS waits for the disconnection of the main signalling link.
133	MS		The MS shall not initiate an RR connection establishment on cell A or on cell B during T3211 seconds at least after the channel release.
134	MS -> SS	CHANNEL REQUEST	Establishment cause: Location updating.
135	SS -> MS	IMMEDIATE ASSIGNMENT	
136	MS -> SS	LOCATION UPDATING REQUEST	location updating type = normal, CKSN = no key available, LAI = deleted LAI (the MCC and MNC hold the previous values, the LAC is coded FFFE) mobile station classmark 1 as given by the PICS and mobile identity = IMSI.
137	SS		performs steps 42 and 43.
138	MS		The RF level of cell B is lowered until the MS selects cell A. The RF level of cell B is set sufficiently low to ensure that cell B is not suitable as defined in GSM 05.08 section 6.6.2.
139	MS -> SS	CHANNEL REQUEST	Establishment cause: Location updating.
140	SS -> MS	IMMEDIATE ASSIGNMENT	
141	MS -> SS	LOCATION UPDATING REQUEST	location updating type = normal, CKSN = no key available, LAI = deleted LAI (the MCC and MNC hold the previous values, the LAC is coded FFFE) mobile station classmark 1 as given by the PICS and mobile identity = IMSI.
142	SS		performs the step 48.
143	MS		The MS shall not initiate an RR connection establishment on cell A or on cell B until T3211 + RadioLinkTimeout after the SS deactivates the SACCH.
144	MS -> SS	CHANNEL REQUEST	Establishment cause: Location updating.
145	SS -> MS	IMMEDIATE ASSIGNMENT	
146	MS -> SS	LOCATION UPDATING REQUEST	location updating type = normal, CKSN = no key available, LAI = deleted LAI (the MCC and MNC hold the previous values, the LAC is coded FFFE), Mobile Identity = IMSI.
147	SS -> MS	AUTHENTICATION REQUEST	CKSN = initial CKSN.
148	MS -> SS	AUTHENTICATION RESPONSE	
149	SS -> MS	LOCATION UPDATING ACCEPT	IE mobile Identity = new TMSI.
150	MS -> SS	TMSI REALLOCATION COMPLETE	
151	SS -> MS	CHANNEL RELEASE	After the sending of this message, the SS waits for the disconnection of the main signalling link. MS is now "idle, updated" in cell A.

Specific message contents

None.

26.7.4.3.4 Location updating / abnormal cases / attempt counter less or equal to 4, stored LAI equal to broadcast LAI

26.7.4.3.4.1 Conformance requirement

- 1) When a failure such as cases d), f) and g) of section 4.4.4.9 of GSM 04.08 has occurred during a periodic location updating procedure (the broadcast LAI is equal to the stored LAI):
 - 1.1 the Mobile Station shall be able to establish an MM connection i.e. send a Channel Request and then a CM Service Request message, CKSN and LAI set to those which have been allocated to the Mobile Station, Mobile Identity IE set to the TMSI which has been allocated to the Mobile Station;
 - 1.2 then the Mobile Station shall not attempt a location updating procedure.
- 2) When a failure such as cases d), f) and g) of section 4.4.4.9 of GSM 04.08 has occurred during an IMSI attach procedure (the broadcast LAI is equal to the stored LAI):
 - 2.1 the Mobile Station shall be able to establish an MM connection i.e. send a Channel Request and then a CM Service Request message, CKSN and LAI set to those which have been allocated to the Mobile Station, Mobile Identity IE set to the TMSI which has been allocated to the Mobile Station;
 - 2.2 then the Mobile Station shall not attempt a location updating procedure.
- 3) When a failure such as cases d), f) and g) of section 4.4.4.9 of GSM 04.08 has occurred during a periodic location updating procedure and the attempt counter is smaller than 4 the Mobile Station shall send, after T3211 expiry, a Location Updating Request message with the Mobile Identity IE set to the TMSI which has been allocated to the Mobile Station, CKSN IE and LAI set to those which have been allocated to the Mobile Station and the Location Updating type set to "periodic updating".

When the Mobile Station's attempt counter reaches the value 4 (four failures such as cases d), f) and g) of section 4.4.4.9 of GSM 04.08 have occurred during a periodic location updating procedure) after T3212 expiry it shall send a Location Updating Request message with the Mobile Identity IE set to its IMSI, CKSN IE set to "no key is available" and the Location Updating type set to "normal".
- 4) When the Mobile Station's attempt counter reaches the value 4 (four failures such as cases d), f) and g) of section 4.4.4.9 of GSM 04.08 have occurred during a periodic location updating procedure) it shall use a request for a CM connection other than emergency call as a trigger for a location updating procedure.
- 5) When a failure such as cases d), f) and g) of section 4.4.4.9 of GSM 04.08 has occurred during an IMSI attach procedure and the attempt counter is smaller than 4 the Mobile Station shall send, after T3211 expiry, a Location Updating Request message with the Mobile Identity IE set to the TMSI which has been allocated to the Mobile Station, CKSN IE and LAI set to those which have been allocated to the Mobile Station and the Location Updating type set to "IMSI attach".

When the Mobile Station's attempt counter reaches the value 4 (four failures such as cases d), f) and g) of section 4.4.4.9 of GSM 04.08 have occurred during an IMSI attach procedure) after T3212 expiry it shall send a Location Updating Request message with the Mobile Identity IE set to its IMSI, CKSN IE set to "no key is available" and the Location Updating type set to "normal".
- 6) When the Mobile Station's attempt counter reaches the value 4 (four failures such as cases d), f) and g) of section 4.4.4.9 of GSM 04.08 have occurred during an IMSI attach procedure) it shall use a request for a CM connection other than emergency call as a trigger for a location updating procedure.

References

GSM 04.08 section 4.4.4.9.

26.7.4.3.4.2 Test purpose

To verify that in the case when the attempt counter is smaller than 4 and the broadcast LAI is equal to the stored LAI, the MS is in the MM IDLE state and NORMAL SERVICE substate. To verify that timer T3211 is stopped after a MM connection establishment.

To verify that the MS uses the T3211 timer, and that it enters the MM IDLE state and NORMAL SERVICE substate when its attempt counter reaches value 4 even in the case where the stored LAI is equal to the broadcast LAI.

26.7.4.3.4.3 Method of test

Initial conditions

System Simulator:

One cell: B, belonging to location area b.

IMSI attach/detach is allowed.

T3212 is set to 6 minutes.

Mobile Station:

The MS is "Idle updated" on cell B with a valid CKSN and a TMSI.

Related PICS/PIXIT statements

SIM removal possible while MS is powered Yes/No.

Switch off on button Yes/No.

Foreseen final state of the MS

The MS is "idle updated" on cell B with a valid CKSN and a TMSI.

Test Procedure

A failure during the periodic location updating is triggered: as the broadcast LAI is equal to the stored LAI, the MS is still in the MM IDLE state and NORMAL SERVICE substate and timer T3211 is started. A CM connection other than for emergency call is attempted. It is checked that this is possible and that T3211 is stopped. Same test is performed with a failure during an IMSI attach procedure.

Then failures are triggered during the periodic location updating to let the attempt counter to reach the value of 4. The MS shall enter the MM IDLE LIMITED SERVICE state and delete any TMSI, stored LAI, ciphering key sequence number and ciphering key. When the attempt counter reaches the value of 4, timer T3212 shall be started. At timer T3212 expiry a location updating procedure is started. A request for CM connection other for than emergency call shall trigger a location updating procedure.

Same tests are performed when the failures are triggered during an IMSI attach procedure.

Maximum duration of test

40 minutes.

Expected sequence

Step	Direction	Message	Comments
1	SS		The SS shall wait at most T3212 + 45 seconds.
2	MS -> SS	CHANNEL REQUEST	Establishment cause: Location updating.
3	SS -> MS	IMMEDIATE ASSIGNMENT	
4	MS -> SS	LOCATION UPDATING REQUEST	location updating type = periodic, CKSN = initial value, LAI = b, mobile station classmark 1 as given by the PICS and mobile identity = TMSI.
5	SS		performs step 5, of 26.7.4.3.2 with cause #17 and step 6 of 26.7.4.3.2.
6	MS		A MO CM connection is attempted.
7	MS -> SS	CHANNEL REQUEST	
8	SS -> MS	IMMEDIATE ASSIGNMENT	
9	MS -> SS	CM SERVICE REQUEST	CKSN = initial CKSN, Mobile Identity = TMSI.
10	SS -> MS	CM SERVICE ACCEPT	
11	MS -> SS	An initial CM message	
12	SS -> MS	CHANNEL RELEASE	The SS waits for the disconnection of the main signalling link.
13	SS		The MS shall not initiate an RR connection establishment. This is checked during 2*T3211.
14	MS		If possible (see PICS) SIM detachment is performed. Otherwise if possible (see PICS) switch off is performed. Otherwise the power is removed.
15	MS -> SS	CHANNEL REQUEST	Steps 15 to 19 are optional.
16	SS -> MS	IMMEDIATE ASSIGNMENT	
17	MS -> SS	IMSI DETACH INDICATION	
18	SS -> MS	CHANNEL RELEASE	
19	MS		Depending on what has been performed in step 14 the MS is brought back to operation.
20	MS -> SS	CHANNEL REQUEST	Establishment cause: Location updating.
21	SS -> MS	IMMEDIATE ASSIGNMENT	
22	MS -> SS	LOCATION UPDATING REQUEST	location updating type = IMSI attach, CKSN = initial value, LAI = b, mobile station classmark 1 as given by the PICS and mobile identity = TMSI.
23	SS		performs step 11 of 26.7.4.3.2.
24	MS		A MO CM connection is attempted.
25	MS -> SS	CHANNEL REQUEST	
26	SS -> MS	IMMEDIATE ASSIGNMENT	
27	MS -> SS	CM SERVICE REQUEST	CKSN = initial CKSN, Mobile Identity = TMSI.
28	SS -> MS	CIPHERING MODE COMMAND	
29	MS -> SS	CIPHERING MODE COMPLETE	
30	MS -> SS	An initial CM message	
31	SS -> MS	CHANNEL RELEASE	The SS waits for the disconnection of the main signalling link.
32	SS		The MS shall not initiate an RR connection establishment. This is checked during 2*T3211 MS is "idle, updated" in cell B.
32/1	MS		If possible (see PICS) SIM detachment is performed. Otherwise if possible (see PICS) switch off is performed. Otherwise the power is removed.
32/2	MS -> SS	CHANNEL REQUEST	Steps 32/2 to 32/5 are optional.
32/3	SS -> MS	IMMEDIATE ASSIGNMENT	
32/4	MS -> SS	IMSI DETACH INDICATION	
32/5	SS -> MS	CHANNEL RELEASE	
32/6	MS		Depending on what has been performed in step 32/1, the MS is brought back to operation.
32/7	MS -> SS	CHANNEL REQUEST	Establishment cause: Location updating.
32/8	SS -> MS	IMMEDIATE ASSIGNMENT	
32/9	MS -> SS	LOCATION UPDATING REQUEST	location updating type = IMSI attach, CKSN = initial value, LAI = b, mobile station classmark 1 as given by the PICS and mobile identity = TMSI.
32/10	SS -> MS	LOCATION UPDATING ACCEPT	without mobile identity
32/11	SS -> MS	CHANNEL RELEASE	
33	SS		The SS shall wait at most T3212 + 15 seconds.
34	MS -> SS	CHANNEL REQUEST	Establishment cause: Location updating.

Step	Direction	Message	Comments
35	SS -> MS	IMMEDIATE ASSIGNMENT	<p>location updating type = periodic, CKSN = initial value, LAI = b, mobile station classmark 1 as given by the PICS and mobile identity = TMSI.</p> <p>performs step 16 of 26.7.4.3.2.</p> <p>The MS shall not initiate an RR connection establishment during T3211 at least after the channel release.</p> <p>Establishment cause: Location updating.</p>
36	MS -> SS	LOCATION UPDATING REQUEST	
37	SS		
38	MS		
39	MS -> SS	CHANNEL REQUEST	
40	SS -> MS	IMMEDIATE ASSIGNMENT	
41	MS -> SS	LOCATION UPDATING REQUEST	
42	SS		
43	MS		
44	MS -> SS	CHANNEL REQUEST	
45	SS -> MS	IMMEDIATE ASSIGNMENT	<p>location updating type = periodic, CKSN = initial value, LAI = b, mobile station classmark 1 as given by the PICS and mobile identity = TMSI.</p> <p>performs step 5 of 26.7.4.3.2 with cause #17 and step 6 of 26.7.4.3.2.</p> <p>The MS shall not initiate an RR connection establishment during T3211 at least after the channel release.</p> <p>Establishment cause: Location updating.</p>
46	MS -> SS	LOCATION UPDATING REQUEST	
47	SS		
48	MS		
49	MS -> SS	CHANNEL REQUEST	
50	SS -> MS	IMMEDIATE ASSIGNMENT	
51	MS -> SS	LOCATION UPDATING REQUEST	
52	SS		
53	MS		
54	MS -> SS	CHANNEL REQUEST	
55	SS -> MS	IMMEDIATE ASSIGNMENT	<p>location updating type = periodic, CKSN = initial value, LAI = b, mobile station classmark 1 as given by the PICS and mobile identity = TMSI.</p> <p>performs step 16 of 26.7.4.3.2.</p> <p>The MS shall not initiate an RR connection establishment during T3212 - 15 seconds at least after the channel release.</p> <p>Establishment cause: Location updating.</p>
56	MS -> SS	LOCATION UPDATING REQUEST	
57	SS -> MS	AUTHENTICATION REQUEST	
58	MS -> SS	AUTHENTICATION RESPONSE	
59a	SS -> MS	LOCATION UPDATING ACCEPT TMSI REALLOCATION	
59b	MS -> SS	COMPLETE	
60	SS -> MS	CHANNEL RELEASE	
61	MS		
62	MS -> SS	CHANNEL REQUEST	
63	SS -> MS	IMMEDIATE ASSIGNMENT	
64	MS -> SS	LOCATION UPDATING REQUEST	
65	SS		<p>location updating type = periodic or normal (see Note 1), CKSN = no key available, LAI = deleted LAI (the MCC and MNC hold the previous values, the LAC is coded FFFE) mobile station classmark 1 as given by the PICS and mobile identity = IMSI.</p>
66	MS		
67	MS -> SS	CHANNEL REQUEST	
68	SS -> MS	IMMEDIATE ASSIGNMENT	
69	MS -> SS	LOCATION UPDATING REQUEST	
70	SS		

Step	Direction	Message	Comments
71	MS		The MS shall not initiate an RR connection establishment within T3211 + RadioLinkTimeout after the SS deactivates the SACCH.
72	MS -> SS	CHANNEL REQUEST	Establishment cause: Location updating. location updating type = periodic, CKSN = initial value, LAI = b, mobile station classmark 1 as given by the PICS and mobile identity = TMSI. performs step 16 of 26.7.4.3.2. The MS shall not initiate an RR connection establishment during T3211 at least after the channel release. Establishment cause: Location updating. location updating type = periodic, CKSN = initial value, LAI = b, mobile station classmark 1 as given by the PICS and mobile identity = TMSI. performs step 5 of 26.7.4.3.2 with cause #17 and step 6 of 26.7.4.3.2. A MO CM connection is attempted. Establishment cause: Location updating. location updating type = normal, CKSN = no key available, LAI = deleted LAI (the MCC and MNC hold the previous values, the LAC is coded FFFE) mobile station classmark 1 as given by the PICS and mobile identity = IMSI. IE mobile identity = TMSI.
73	SS -> MS	IMMEDIATE ASSIGNMENT	
74	MS -> SS	LOCATION UPDATING REQUEST	
75	SS		
76	MS		
77	MS -> SS	CHANNEL REQUEST	
78	SS -> MS	IMMEDIATE ASSIGNMENT	
79	MS -> SS	LOCATION UPDATING REQUEST	
80	SS		
81	MS		
82	MS -> SS	CHANNEL REQUEST	
83	SS -> MS	IMMEDIATE ASSIGNMENT	
84	MS -> SS	LOCATION UPDATING REQUEST	
85	SS -> MS	LOCATION UPDATING ACCEPT	
86	MS -> SS	TMSI REALLOCATION COMPLETE	
87	SS -> MS	CHANNEL RELEASE	
88	MS -> SS	CHANNEL REQUEST	
89	SS -> MS	IMMEDIATE ASSIGNMENT	CKSN = no key available, Mobile identity = TMSI cause #17 (network failure).
90	MS -> SS	CM SERVICE REQUEST	
91	SS -> MS	CM SERVICE REJECT	
92	SS -> MS	CHANNEL RELEASE	
93	MS		
94	MS -> SS	CHANNEL REQUEST	Steps 94 to 97 are optional.
95	SS -> MS	IMMEDIATE ASSIGNMENT	Depending on what has been performed in step 97 the MS is brought back to operation. Establishment cause: Location updating. location updating type = IMSI attach, CKSN = no key available, LAI = b, mobile station classmark 1 as given by the PICS and mobile identity = TMSI. performs step 11 of 26.7.4.3.2. The MS shall not initiate an RR connection establishment within T3211 + RadioLinkTimeout after the SS deactivates the SACCH. Establishment cause: Location updating. location updating type = IMSI attach, CKSN = no key available, LAI = b, mobile station classmark 1 as given by the PICS and mobile identity = TMSI. After the sending of the message the SS waits for the disconnection of the main signalling link. The MS shall not initiate an RR connection establishment during T3211 at least after the channel release. Establishment cause: Location updating.
96	MS -> SS	IMSI DETACH INDICATION	
97	SS -> MS	CHANNEL RELEASE	
98	MS		
99	MS -> SS	CHANNEL REQUEST	
100	SS -> MS	IMMEDIATE ASSIGNMENT	
101	MS -> SS	LOCATION UPDATING REQUEST	
102	SS		
103	MS		
104	MS -> SS	CHANNEL REQUEST	
105	SS -> MS	IMMEDIATE ASSIGNMENT	
106	MS -> SS	LOCATION UPDATING REQUEST	
107	SS -> MS	CHANNEL RELEASE	
108	MS		
109	MS -> SS	CHANNEL REQUEST	
110	SS -> MS	IMMEDIATE ASSIGNMENT	

Step	Direction	Message	Comments
111	MS -> SS	LOCATION UPDATING REQUEST	location updating type = IMSI attach, CKSN = no key available, LAI = b, mobile station classmark 1 as given by the PICS and mobile identity = TMSI. IE Reject cause is set to a value arbitrarily chosen: * in table 10.66 of GSM 04.08, causes #2, #3, #6, #11, #12, and #13 being excluded. After the sending of this message, the SS waits for the disconnection of the main signalling link. The MS shall not initiate an RR connection establishment during T3211 at least after the channel release. Establishment cause: Location updating.
112a	SS -> MS	LOCATION UPDATING REJECT	
112b	MS -> SS	CHANNEL RELEASE	
113	MS		
114	MS -> SS	CHANNEL REQUEST	
115	SS -> MS	IMMEDIATE ASSIGNMENT	
116	MS -> SS	LOCATION UPDATING REQUEST	
117	SS		
118	MS		
119	MS -> SS	CHANNEL REQUEST	
120	SS -> MS	IMMEDIATE ASSIGNMENT	location updating type = IMSI attach, CKSN = no key available, LAI = b, mobile station classmark 1 as given by the PICS and mobile identity = TMSI. performs step 11 of 26.7.4.3.2. The MS shall not initiate an RR connection establishment during T3212 - 15 seconds at least after the channel release. Establishment cause: Location updating.
121	MS -> SS	LOCATION UPDATING REQUEST	
122	SS -> MS	AUTHENTICATION REQUEST	
123	MS -> SS	AUTHENTICATION RESPONSE	
124	SS -> MS	LOCATION UPDATING ACCEPT	
125	MS -> SS	TMSI REALLOCATION COMPLETE	
126	SS -> MS	CHANNEL RELEASE	location updating type = periodic or normal or IMSI attach (see Note 2), CKSN = no key available, LAI = deleted LAI (the MCC and MNC hold the previous values, the LAC is coded FFFE) mobile station classmark 1 as given by the PICS and mobile identity = IMSI. IE mobile Identity = TMSI.
127	MS		
128	MS -> SS	CHANNEL REQUEST	If possible (see PICS) SIM detachment is performed. Otherwise if possible (see PICS) switch off is performed. Otherwise the power is removed. Steps 128 to 131 are optional.
129	SS -> MS	IMMEDIATE ASSIGNMENT	
130	MS -> SS	IMSI DETACH INDICATION	
131	SS -> MS	CHANNEL RELEASE	
132	MS		Depending on what has been performed in step 130 the MS is brought back to operation. Establishment cause: Location updating. location updating type = IMSI attach, CKSN = initial value, LAI = b, mobile station classmark 1 as given by the PICS and mobile identity = TMSI. performs step 16 of 26.7.4.3.2. The MS shall not initiate an RR connection establishment during T3211 at least after the channel release.
133	MS -> SS	CHANNEL REQUEST	
134	SS -> MS	IMMEDIATE ASSIGNMENT	
135	MS -> SS	LOCATION UPDATING REQUEST	
136	SS		
137	MS		
138	MS -> SS	CHANNEL REQUEST	Establishment cause: Location updating. location updating type = IMSI attach, CKSN = initial value, LAI = b, mobile station classmark 1 as given by the PICS and mobile identity = TMSI. performs step 5 of 26.7.4.3.2 with cause #17 and step 6 of 26.7.4.3.2. The MS shall not initiate an RR connection establishment during T3211 at least after the channel release. Establishment cause: Location updating.
139	SS -> MS	IMMEDIATE ASSIGNMENT	
140	MS -> SS	LOCATION UPDATING REQUEST	
141	SS		
142	MS		
143	MS -> SS	CHANNEL REQUEST	
144	SS -> MS	IMMEDIATE ASSIGNMENT	
145	MS -> SS	LOCATION UPDATING REQUEST	
146	SS		

Step	Direction	Message	Comments
147	MS		The MS shall not initiate an RR connection establishment within T3211 + RadioLinkTimeout after the SS deactivates the SACCH.
148	MS -> SS	CHANNEL REQUEST	Establishment cause: Location updating.
149	SS -> MS	IMMEDIATE ASSIGNMENT	
150	MS -> SS	LOCATION UPDATING REQUEST	
151	SS		location updating type = IMSI attach, CKSN = initial value, LAI = b, mobile station classmark 1 as given by the PICS and mobile identity = TMSI.
152	MS		
153	MS -> SS	CHANNEL REQUEST	performs step 16 of 26.7.4.3.2. The MS is made to perform a MO call. Establishment cause: Location updating.
154	SS -> MS	IMMEDIATE ASSIGNMENT	
155	MS -> SS	LOCATION UPDATING REQUEST	
156	SS -> MS	AUTHENTICATION REQUEST	location updating type = normal, CKSN = no key available, LAI = deleted LAI (the MCC and MNC hold the previous values, the LAC is coded FFFE) mobile station classmark 1 as given by the PICS and mobile identity = IMSI.
157	MS -> SS	AUTHENTICATION RESPONSE	
158	SS -> MS	LOCATION UPDATING ACCEPT	
159	MS -> SS	TMSI REALLOCATION COMPLETE	
160	SS -> MS	CHANNEL RELEASE	
161	MS		Steps 161 to 166 are optional. An MO CM connection is attempted.
162	MS -> SS	CHANNEL REQUEST	
163	SS -> MS	IMMEDIATE ASSIGNMENT	CKSN = initial value, Mobile identity = TMSI. cause #17 (network failure).
164	MS -> SS	CM SERVICE REQUEST	
165	SS -> MS	CM SERVICE REJECT	
166	SS -> MS	CHANNEL RELEASE	

NOTE 1: the MS can include both types of Location updating. As T3212 expires it can be a periodic location updating procedure and as there is no stored LAI it can be a normal one.

NOTE 2: same problem as in note 1. Three types of location updating procedures should be allowed.

Specific message contents

None.

26.7.4.4 Location updating / release / expiry of T3240

26.7.4.4.1 Conformance requirement

The mobile station receiving a LOCATION UPDATING REJECT message shall start T3240: it shall abort the RR connection at the expiry of timer T3240.

References

GSM 04.08 section 4.4.4.8, 11.2.

26.7.4.4.2 Test purpose

To verify that the MS aborts the RR-connection at the expiry of timer T3240.

26.7.4.4.3 Method of test

Initial conditions

System Simulator:

Two cells: A and B, belonging to different location areas a and b.

Mobile Station:

The MS has a valid TMSI. It is "idle updated" on cell A.

Related PICS/PIXIT statements

None.

Foreseen final state of the MS

The MS is "idle updated" on cell B.

Test Procedure

A normal location updating procedure is performed. The RR-connection is not released by the SS within the timer T3240. It is checked that the MS aborts the RR-connection.

Maximum duration of test

1 minute.

Expected sequence

Step	Direction	Message	Comments
1	SS		The RF level of cell A is lowered until the MS selects cell B.
2	MS -> SS	CHANNEL REQUEST	"Establishment cause": Location updating.
3	SS -> MS	IMMEDIATE ASSIGNMENT	
4	MS -> SS	LOCATION UPDATING REQUEST	
5	SS -> MS	LOCATION UPDATING ACCEPT	
6	SS		The SS waits T3240 expiry.
7	MS		The MS shall abort the RR connection (disconnection of layer 2).

Specific message contents

None.

26.7.4.5 Location updating / periodic

26.7.4.5.1 Location updating / periodic spread

26.7.4.5.1.1 Conformance requirement

- 1) The Mobile Stations shall perform spreading of the time before performing a periodic location updating when the location updating timer value is reduced.
- 2) The Mobile Station shall reset timer T3212 when the Mobile Station is deactivated, and shall start with a value between zero and the broadcasted value when reactivated in the same cell, IMSI attach being forbidden.
- 3) When activated the Mobile Station shall start timer T3212 with a value randomly drawn in the allowed range.

NOTE: This conformance requirement is not covered by a test purpose. It is intended to be covered by a manufacturer declaration.

References

GSM 04.08 section 4.4.2.

26.7.4.5.1.2 Test purpose

- 1) To check that when the location updating timer is reduced, the timer running in the MS is started with a value depending on the current timer value and the new broadcasted T3212 value.
- 2) To verify that when the MS is reactivated in the same cell (as the one in which it was deactivated), IMSI attach being forbidden, the MS starts the timer T3212 with a value between zero and the broadcasted value.

NOTE: It is not tested that the value is random.

26.7.4.5.1.3 Method of test

Initial conditions

System Simulator:

One cell, T3212 is set to 30 minutes.

IMSI attach is allowed in the cell.

Mobile Station:

The MS is deactivated. The stored MCC, MNC and LAC correspond to the broadcasted values. The stored update status is "updated".

Related PICS/PIXIT statements

None.

Foreseen final state of the MS

The MS has a valid TMSI. It is "idle updated".

Test procedure

The MS is activated. It performs IMSI attach. 3 minutes after the end of the IMSI attach procedure, the value of T3212 is set to 6 minutes. The MS shall perform periodic location updating 6 minutes after the end of the IMSI attach procedure.

Then, the IMSI attach/detach is forbidden. T3212 is still set to 6 minutes.

The MS is deactivated. The MS is reactivated. It is checked that the MS performs a periodic location updating during the 6 minutes following activation.

Maximum duration of test

20 minutes.

Expected sequence

Step	Direction	Message	Comments
1	MS		The MS is activated.
2	MS -> SS	CHANNEL REQUEST	"Establishment cause": Location updating.
3	SS -> MS	IMMEDIATE ASSIGNMENT	
4	MS -> SS	LOCATION UPDATING REQUEST	"location updating type": IMSI attach.
5	SS -> MS	LOCATION UPDATING ACCEPT	
6	SS -> MS	CHANNEL RELEASE	After the sending of this message, the SS waits for the disconnection of the main signalling link.
7	SS		3 minutes after step 6 the value of T3212 is set to 6 minutes.
8	MS -> SS	CHANNEL REQUEST	"Establishment cause": Location updating This message shall be sent by the MS between 5minutes 45s and 6minutes 15s after step 6.
9	SS -> MS	IMMEDIATE ASSIGNMENT	
10	MS -> SS	LOCATION UPDATING REQUEST	"location updating type": periodic updating.
11	SS -> MS	LOCATION UPDATING ACCEPT	
12	SS -> MS	CHANNEL RELEASE	After the sending of this message, the SS waits for the disconnection of the main signalling link.
13	SS		IMSI attach/detach is not allowed.
14	MS		The MS is deactivated.
15	MS		The MS is activated.
16	SS		The SS waits until the periodic location updating.
17	MS -> SS	CHANNEL REQUEST	"Establishment cause": Location updating This message shall arrive during the 7 minutes following the MS activation.
18	SS -> MS	IMMEDIATE ASSIGNMENT	
19	MS -> SS	LOCATION UPDATING REQUEST	"Location updating type" = periodic.
20	SS -> MS	LOCATION UPDATING ACCEPT	
21	SS -> MS	CHANNEL RELEASE	After the sending of this message, the SS waits for the disconnection of the main signalling link.

Specific message contents

None.

26.7.4.5.2 Location updating / periodic normal / test 1

26.7.4.5.2.1 Conformance requirement

- 1 The Mobile Station shall stop and reset the timer T3212 of the periodic location updating procedure when the first MM message is received or ciphering mode setting is completed in the case of MM connection establishment.
- 2 The Mobile Station shall stop and reset the timer T3212 of the periodic location updating procedure when the Mobile Station has responded to paging and thereafter has received the first correct L3 message that is not an RR message.

References

GSM 04.08 section 4.4.2.

26.7.4.5.2.2 Test purpose

To verify that the MS stops and resets the timer T3212 of the periodic location updating procedure when:

- the first MM-message is received in the case of MM-connection establishment, ciphering mode being not set;
- the MS has responded to paging and the first correct L3 message that is not an RR message is received.

NOTE: T3212 is stopped when the MM-idle state is left and restarted when the MM sublayer returns to that state, substate NORMAL SERVICE or ATTEMPTING TO UPDATE. As a consequence, the exact time when T3212 is reset between those two events cannot be tested.

26.7.4.5.2.3 Method of test

Initial conditions

System Simulator:

1 cell, default parameters.

IMSI attach/detach is not allowed.

The T3212 time-out value is 2/10 hour.

Mobile Station:

The MS has a valid TMSI. It is "idle updated".

Related PICS/PIXIT statements

None.

Foreseen final state of the MS

The MS has a valid TMSI. It is "idle updated".

Test procedure

An MS originated MM connection is established and cleared. The channel is released. It is checked that the MS performs a periodic location updating 12 minutes after the release of the channel.

One minute after the periodic location updating, the MS is paged, it sends a CHANNEL REQUEST message and the SS responds with an IMMEDIATE ASSIGNMENT message, a call is established and then cleared. It is checked that the MS performs a periodic location updating 12 minutes after the release of the link.

Maximum duration of test

30 minutes.

Expected sequence

Step	Direction	Message	Comments
1	MS		A MO CM connection is attempted.
2	MS -> SS	CHANNEL REQUEST	
3	SS -> MS	IMMEDIATE ASSIGNMENT	
4	MS -> SS	CM SERVICE REQUEST	
5	SS -> MS	CM SERVICE REJECT	cause #17 (network failure).
6	SS -> MS	CHANNEL RELEASE	After the sending of this message, the SS waits for the disconnection of the main signalling link.
7	SS		The SS waits until the periodic location updating.
8	MS -> SS	CHANNEL REQUEST	"Establishment cause": Location updating This message shall arrive between 11 minutes 45 s and 12 minutes 15 s after the last release of the RR connection by the SS.
9	SS -> MS	IMMEDIATE ASSIGNMENT	
10	MS -> SS	LOCATION UPDATING REQUEST	"Location updating type" = periodic.
11	SS -> MS	LOCATION UPDATING ACCEPT	
12	SS -> MS	CHANNEL RELEASE	After the sending of this message, the SS waits for the disconnection of the main signalling link.
13	SS		The SS waits 1 minute.
14	SS -> MS	PAGING REQUEST TYPE 1	"Mobile identity" = IMSI.
15	MS -> SS	CHANNEL REQUEST	"Establishment cause": Answer to paging.
16	SS -> MS	IMMEDIATE ASSIGNMENT	
17	MS -> SS	PAGING RESPONSE	
18	SS -> MS	AUTHENTICATION REQUEST	
19	MS -> SS	AUTHENTICATION RESPONSE	
20	SS - MS	CHANNEL RELEASE	After the sending of this message, the SS waits for the disconnection of the main signalling link.
21	SS		The SS waits until the periodic location updating.
22	MS -> SS	CHANNEL REQUEST	"Establishment cause": Location updating This message shall arrive between 11 minutes 45 s and 12 minutes 15 s after the last release of the RR connection by the SS.
23	SS -> MS	IMMEDIATE ASSIGNMENT	
24	MS -> SS	LOCATION UPDATING REQUEST	"Location updating type" = periodic.
25	SS -> MS	LOCATION UPDATING ACCEPT	
26	SS -> MS	CHANNEL RELEASE	After the sending of this message, the SS waits for the disconnection of the main signalling link.

Specific message contents

None.

26.7.4.5.3 Location updating / periodic normal / test 2

26.7.4.5.3.1 Conformance requirement

When a LOCATION UPDATING ACCEPT or a LOCATION UPDATING REJECT message is received, the timer T3212 is stopped and reset and the Mobile Station shall perform a periodic location updating after T3212 expiry.

References

GSM 04.08 section 4.4.2.

26.7.4.5.3.2 Test purpose

To verify that the MS stops and resets the timer T3212 of the periodic location updating procedure when a LOCATION UPDATING ACCEPT message is received.

NOTE: T3212 is stopped when the MM-idle state is left and restarted when the MM sublayer returns to that state, substate NORMAL SERVICE or ATTEMPTING TO UPDATE. As a consequence, the exact time when T3212 is reset between those two events cannot be tested.

26.7.4.5.3.3 Method of test

Initial conditions

System Simulator:

2 cells, IMSI attach/detach is allowed in both cells.

T3212 is set to 6 minutes.

Mobile Station:

The MS has a valid TMSI. It is "idle updated" on cell A.

Related PICS/PIXIT statements

SIM removal possible while MS is powered Yes/No

Switch off on button yes/No

Foreseen final state of the MS

The MS has a valid TMSI. It is "idle updated" on cell B.

Test procedure

A normal location updating is performed. The channel is released. One minute later, the MS is deactivated, then reactivated in the same cell. It is checked that the MS performs an IMSI attach and a periodic location updating 6 minutes after the IMSI attach.

Maximum duration of test

20 minutes.

Expected sequence

Step	Direction	Message	Comments
1	SS		The following messages are sent and shall be received on cell B. The RF level of cell A is lowered until the MS selects cell B.
2	MS -> SS	CHANNEL REQUEST	"establishment cause": Location updating.
3	SS -> MS	IMMEDIATE ASSIGNMENT	
4	MS -> SS	LOCATION UPDATING REQUEST	"location updating type" = normal.
5	SS -> MS	LOCATION UPDATING ACCEPT	
6	SS -> MS	CHANNEL RELEASE	After the sending of this message, the SS waits for the disconnection of the main signalling link.
7	SS		The SS waits until the periodic location updating.
8	MS -> SS	CHANNEL REQUEST	"Establishment cause": Location updating This message shall arrive between 5 minutes 45s and 6 minutes 15 s after the last release of the RR connection by the SS.
9	SS -> MS	IMMEDIATE ASSIGNMENT	
10	MS -> SS	LOCATION UPDATING REQUEST	"Location updating type" = periodic.
11	SS -> MS	LOCATION UPDATING ACCEPT	
12	SS -> MS	CHANNEL RELEASE	After the sending of this message, the SS waits for the disconnection of the main signalling link.
13	MS		If possible (see PICS) SIM removal is performed. Otherwise if possible (see PICS) switch off is performed. Otherwise the power is removed. steps 14 to 17 may be performed or not depending on the action made in step 13.
14	MS -> SS	CHANNEL REQUEST	
15	SS -> MS	IMMEDIATE ASSIGNMENT	
16	MS -> SS	IMSI DETACH INDICATION	
17	SS -> MS	CHANNEL RELEASE	After the sending of this message, the SS waits for the disconnection of the main signalling link.
18	MS		Depending on what has been performed in step 13 the MS is brought back to operation.
19	MS -> SS	CHANNEL REQUEST	"Establishment cause": Location updating.
20	SS -> MS	IMMEDIATE ASSIGNMENT	
21	MS -> SS	LOCATION UPDATING REQUEST	"Location updating type" = IMSI attach.
22	SS -> MS	LOCATION UPDATING ACCEPT	
23	SS -> MS	CHANNEL RELEASE	After the sending of this message, the SS waits for the disconnection of the main signalling link.
24	SS		The SS waits until the periodic location updating.
25	MS -> SS	CHANNEL REQUEST	"Establishment cause": Location updating This message shall arrive between 5 minutes 45 s and 6 minutes 15s after the last release of the RR connection by the SS.
26	SS -> MS	IMMEDIATE ASSIGNMENT	
27	MS -> SS	LOCATION UPDATING REQUEST	"Location updating type" = periodic.
28	SS -> MS	LOCATION UPDATING ACCEPT	
29	SS -> MS	CHANNEL RELEASE	After the sending of this message, the SS waits for the disconnection of the main signalling link.

Specific message contents

None.

26.7.4.5.4 Location updating / periodic HPLMN search

26.7.4.5.4.1 Location updating / periodic HPLMN search / MS waits time T

26.7.4.5.4.1.1 Conformance requirement

When in automatic mode and roaming in the home country, the MS shall make an attempt to access the HPLMN, if the MS is on the VPLMN at time T after since the last attempt.

NOTE: This test is not intended to test every value in the range 6 minutes to 8 hours or the default of 30 minutes, but is intended to check that the mobile is capable of using the value stored on the SIM.

References

GSM 02.11 section 3.2.2.5.2.

GSM 03.22 section 4.4.3.3.

26.7.4.5.4.1.2 Test purpose

To verify that when a cell of the HPLMN becomes available, following the successful location request on the VPLMN of the home country and after the first search the mobile has failed to find its HPLMN, that the MS shall perform a location update request on the HPLMN after time T. Where T is the HPLMN Search Period stored in the SIM.

26.7.4.5.4.1.3 Method of test

Initial conditions

System Simulator:

Two cells A and B, belonging to different location areas with location identification a and b. Cell A shall be a cell of the HPLMN and Cell B shall be a cell of the VPLMN with a Country Code the same as that of Cell A. Initially Cell A shall not be broadcasting. IMSI attach/detach is not allowed on either cell.

Mobile Station:

The MS is switched off. The HPLMN Search Period on the SIM shall be set to 6 minutes. The location area information on the SIM is "deleted".

Related PICS/PIXIT statements

Switch on/off button Yes/No.

Foreseen final state of the MS

The MS is "idle updated" on Cell A.

Test Procedure

Only Cell B shall be broadcasting. The MS shall be switched on either by using the Power Switch or by applying power. A normal location updating is performed on Cell B. Cell A shall be made available after 8 minutes, thus ensuring the MS fails to find the HPLMN during its first attempt. It is verified that the MS performs a location update request on Cell A, within 6 minutes after broadcasting of Cell A.

Maximum duration of test

17 minutes.

Expected sequence

Step	Direction	Message	Contents
1	MS		The following messages shall be sent and received on Cell B. The MS is switched on by either using the Power Switch or by applying power.
2	MS -> SS	CHANNEL REQUEST	"Establishment cause": Location updating.
3	SS -> MS	IMMEDIATE ASSIGNMENT	
4	MS -> SS	LOCATION UPDATING REQUEST	"Location Update Type": Normal.
5	SS -> MS	LOCATION UPDATING ACCEPT	
6	SS -> MS	CHANNEL RELEASE	After sending this message the SS waits for the disconnection of the main signalling link. The SS waits a period of 8 minutes, this allowing the MS to make its first periodic search.
8	SS		Cell A is made available. Within 8 minutes after step 8 the following messages shall be sent and received on Cell A.
9	MS -> SS	CHANNEL REQUEST	"Establishment cause": Location updating.
10	SS -> MS	IMMEDIATE ASSIGNMENT	
11	MS -> SS	LOCATION UPDATING REQUEST	"Location Update Type": normal.
12	SS -> MS	LOCATION UPDATING ACCEPT	
13	SS -> MS	CHANNEL RELEASE	After sending this message the SS waits for the disconnection of the main signalling link.

Specific message contents

None.

26.7.4.5.4.2 Location updating / periodic HPLMN search / MS in manual mode

26.7.4.5.4.2.1 Conformance requirement

The periodic attempts shall only be performed if in automatic mode when the MS is roaming in its home country.

References

GSM 02.11 section 3.2.2.5.2.

GSM 03.22 section 4.4.3.3.

26.7.4.5.4.2.2 Test purpose

To verify that no HPLMN Search is performed when the MS is not in automatic mode.

26.7.4.5.4.2.3 Method of test

Initial conditions

System Simulator:

Two cells A and B, belonging to different location areas with location identification a and b. Cell A shall be a cell of the HPLMN and Cell B shall be a cell of the VPLMN with a Country Code the same as that of Cell A. Initially Cell A shall not be broadcasting. IMSI attach/detach is not allowed on either cell.

Mobile Station:

The MS is switched off. The HPLMN Search Period on the SIM shall be set to 6 minutes. The location area information on the SIM is "deleted".

Related PICS/PIXIT statements

Switch on/off button Yes/No.

Foreseen final state of the MS

The MS is "idle updated" on Cell B.

Test Procedure

Only Cell B shall be broadcasting. The MS shall be switched on either by using the Power Switch or by applying power. A normal location updating is performed on Cell B. The MS is forced into manual selection mode. Cell A is made available. It is verified that the MS does not attempt to perform a location update on Cell A.

Maximum duration of test

7 minutes.

Expected sequence

Step	Direction	Message	Contents
1	MS		The following messages shall be sent and received on Cell B. The MS is switched on by either using the Power Switch or by applying power.
2	MS -> SS	CHANNEL REQUEST	"Establishment cause": Location updating.
3	SS -> MS	IMMEDIATE ASSIGNMENT	
4	MS -> SS	LOCATION UPDATING REQUEST	"Location Update Type": Normal.
5	SS -> MS	LOCATION UPDATING ACCEPT	
6	SS -> MS	CHANNEL RELEASE	After sending this message the SS waits for the disconnection of the main signalling link.
8	MS		The MS is forced into manual selection mode.
9	SS		Cell A is made available.
10	SS		The SS waits a period of 7 minutes. During this time no messages shall be received on Cell A.

Specific message contents

None.

26.7.4.5.4.3 Location updating / periodic HPLMN search / MS waits at least two minutes and at most T minutes

26.7.4.5.4.3.1 Conformance requirement

After switch on, the MS waits at least 2 minutes and at most T minutes before the first HPLMN Search is attempted.

References

GSM 02.11 section 3.2.2.5.2.

GSM 03.22 section 4.4.3.3.

26.7.4.5.4.3.2 Test purpose

To verify that the MS waits at least 2 minutes and at most T minutes before attempting its first HPLMN Search.

26.7.4.5.4.3.3 Method of test

Initial Conditions

System Simulator:

Two cells A and B, belonging to different location areas with location identification a and b. Cell A shall be a cell of the HPLMN and Cell B shall be a cell of the VPLMN with a Country Code the same as that of Cell A. Initially Cell A shall not be broadcasting. IMSI attach/detach is not allowed on either cell.

Mobile Station:

The MS is switched off. The HPLMN Search Period on the SIM shall be set to 6 minutes. The location area information on the SIM is "deleted".

Related PICS/PIXIT statements

Switch on/off button Yes/No.

Foreseen final state of the MS

The MS is "idle updated" on Cell A.

Test Procedure

Only Cell B shall be broadcasting. The MS shall be switched on either by using the Power Switch or by applying power. A normal location updating is performed on Cell B. Cell A is made available. It is verified that the MS attempts to perform a location update on Cell A, after at least 2 minutes and at most T minutes have passed following power on.

Maximum duration of test

8 minutes.

Expected sequence

Step	Direction	Message	Contents
1	MS		The following messages shall be sent and received on Cell B. The MS is switched on by either using the Power Switch or by applying power.
2	MS -> SS	CHANNEL REQUEST	"Establishment cause": Location updating.
3	SS -> MS	IMMEDIATE ASSIGNMENT	
4	MS -> SS	LOCATION UPDATING REQUEST	"Location Update Type": Normal.
5	SS -> MS	LOCATION UPDATING ACCEPT	
6	SS -> MS	CHANNEL RELEASE	After sending this message the SS waits for the disconnection of the main signalling link.
8	SS		Cell A is made available.
9	SS		The SS waits a period of 2 minutes after the MS is switched on. During this time no messages shall be received on Cell A. The following messages shall be sent and received on cell A. Within T minutes after the MS is switched on the following messages shall be sent and received on cell A.
10	MS -> SS	CHANNEL REQUEST	"Establishment cause": Location updating This message shall be sent between 2 and 7 minutes after step 1
11	SS -> MS	IMMEDIATE ASSIGNMENT	
12	MS -> SS	LOCATION UPDATING REQUEST	"Location Update Type": normal.
13	SS -> MS	LOCATION UPDATING ACCEPT	
14	SS -> MS	CHANNEL RELEASE	After sending this message the SS waits for the disconnection of the main signalling link.

Specific message contents

None.

26.7.4.6 Location updating / interworking of attach and periodic

26.7.4.6.1 Conformance requirement

- 1) If the Mobile Station is in service state NO CELL AVAILABLE, LIMITED SERVICE, PLMN SEARCH or PLMN SEARCH-NORMAL SERVICE when the timer expires the location updating procedure is delayed until this service state is left.
- 2) The T3212 time-out value shall not be changed in the NO CELL AVAILABLE, LIMITED SERVICE, PLMN SEARCH and PLMN SEARCH-NORMAL SERVICE states.
- 3) If the selected cell is in the location area where the mobile station is registered and IMSI ATTACH is not required and timer T3212 has not expired, then the state is NORMAL SERVICE.

References

- 1 GSM 04.08 section 4.4.2.
- 2 GSM 04.08 section 4.4.2.
- 3 GSM 04.08 section 4.2.1.1

26.7.4.6.2 Test purpose

- 1) To check that if the PLU timer expires while the MS is out of coverage, the MS informs the network of its return to coverage.
- 2) To check that the PLU timer is not disturbed by cells of forbidden PLMNs.
- 3) To check that if the PLU timer does not expire while out of coverage and if the mobile returns to the LA where it is updated, the mobile does not inform the network of its return to coverage.

26.7.4.6.3 Method of test

Initial conditions

System Simulator:

Two cells, a and b, of different PLMNs.

T3212 is set to 12 minutes on cell a.

T3212 is set to 6 minutes on cell b.

IMSI attach is allowed in both cells.

Mobile Station:

The MS is deactivated. The PLMN of cell b is entered in the SIM's forbidden PLMN list.

Related PICS/PIXIT statements

None.

Foreseen final state of the MS

The MS is "idle updated". The PLMN of cell b is entered in the SIM's forbidden PLMN list.

Test procedure

The MS is activated and placed in automatic network selection mode. It performs IMSI attach. 1 minute after the end of the IMSI attach procedure, cell a is switched off. The MS shall not location update on cell b. 8 minutes after the end of the IMSI attach procedure, cell a is switched on. The MS shall not location update on cell a before 11,75 minutes after the end of the IMSI attach procedure. The MS shall perform a periodic location update on cell a between 11,75 minutes and 12,25 minutes after the end of the IMSI attach procedure.

3 minutes after the end of the periodic location updating procedure, cell a is switched off. The MS shall not location update on cell b. 14 minutes after the end of the periodic location updating procedure, cell a is switched on and cell b is switched off. The MS shall perform a location update on cell a before 17 minutes after the end of the periodic location updating procedure.

Maximum duration of test

35 minutes.

Expected sequence

Step	Direction	Message	Comments
1	MS		The MS is activated in automatic network selection mode.
2	MS -> SS	CHANNEL REQUEST	
3	SS -> MS	IMMEDIATE ASSIGNMENT	
4	MS -> SS	LOCATION UPDATING REQUEST	"location updating type": IMSI attach.
5	SS -> MS	LOCATION UPDATING ACCEPT	
6	SS -> MS	CHANNEL RELEASE	After the sending of this message, the SS waits for the disconnection of the main signalling link.
7	SS		1 minute after step 6, cell a is switched off.
8	SS		8 minutes after step 6, cell a is switched on.
9	MS -> SS	CHANNEL REQUEST	This message shall be sent by the MS between 11 minutes 45s and 12 minutes 15s after step 6.
10	SS -> MS	IMMEDIATE ASSIGNMENT	
11	MS -> SS	LOCATION UPDATING REQUEST	"location updating type": periodic updating.
12	SS -> MS	LOCATION UPDATING ACCEPT	
13	SS -> MS	CHANNEL RELEASE	After the sending of this message, the SS waits for the disconnection of the main signalling link.
14	SS		3 minutes after step 13, cell a is switched off.
15	SS		14 minutes after step 13, cell a is switched on and cell b is switched off.
16	MS -> SS	CHANNEL REQUEST	This message shall be sent by the MS before 17 minutes after step 13.
17	SS -> MS	IMMEDIATE ASSIGNMENT	
18	MS -> SS	LOCATION UPDATING REQUEST	"Location updating type" = periodic.
19	SS -> MS	LOCATION UPDATING ACCEPT	
22	SS -> MS	CHANNEL RELEASE	After the sending of this message, the SS waits for the disconnection of the main signalling link.

Specific message contents

None.

26.7.5 MM connection

26.7.5.1 Introduction

[tbd]

26.7.5.2 MM connection / establishment with cipher

26.7.5.2.1 Conformance requirement

- 1) The Mobile Station shall be able to correctly set up an MM connection in a Mobile Originating CM connection attempt and send a CM Service Request message with CKSN information element as stored in the SIM and Mobile Identity information element set to the TMSI.
- 2) The Mobile Station shall be able to interpret cipher mode setting as acceptance of its CM service request i.e. send a CM message.

References

GSM 04.08 sections 4.5.1.1.

26.7.5.2.2 Test purpose

To verify that the MS can correctly set up an MM connection in an origination and interpret cipher mode setting as acceptance of its CM service request.

26.7.5.2.3 Method of test

Initial conditions

System Simulator:

1 cell, default parameters.

Mobile Station:

The MS has a valid TMSI. It is "idle updated".

Related PICS/PIXIT statements

None.

Foreseen final state of the MS

The MS has valid TMSI, CKSN. It is "idle updated".

Test Procedure

A mobile originating CM connection is initiated. After the MS has sent the CM SERVICE REQUEST message to the SS, an authentication procedure and a ciphering mode setting procedure are performed. Then, the MS sends a CM message and the SS clears the call and releases the channel.

Maximum duration of test

One minute.

Expected sequence

Step	Direction	Message	Comments
1	MS		A MO CM connection is attempted.
2	MS -> SS	CHANNEL REQUEST	
3	SS -> MS	IMMEDIATE ASSIGNMENT	
4	MS -> SS	CM SERVICE REQUEST	
5	SS -> MS	AUTHENTICATION REQUEST	
6	MS -> SS	AUTHENTICATION RESPONSE	
7	SS -> MS	CIPHERING MODE COMMAND	The SS starts deciphering.
8	MS -> SS	CIPHERING MODE COMPLETE	The SS starts enciphering.
A9	MS -> SS	SETUP	
A10	SS -> MS	RELEASE COMPLETE	"Cause" IE: "unassigned number".
B9	MS -> SS	REGISTER	
B10	SS -> MS	RELEASE COMPLETE	
C9	MS -> SS	CP-DATA	
C10	SS -> MS	CP-ACK	
C11	SS -> MS	CP-DATA	
C12	MS -> SS	CP-ACK	
13	SS -> MS	CHANNEL RELEASE	After the sending of this message, the SS waits for the disconnection of the main signalling link.

Specific message contents

None.

26.7.5.3 MM connection / establishment without cipher

26.7.5.3.1 Conformance requirement

Upon reception of the CM SERVICE ACCEPT message, the MS shall send a CM message.

References

GSM 04.08 sections 4.5.1.1.

26.7.5.3.2 Test purpose

To verify that the MS can correctly set up an MM connection in an originating CM connection establishment when ciphering mode setting is not required.

26.7.5.3.3 Method of test

Initial conditions

System Simulator:

1 cell, default parameters.

Mobile Station:

The MS has a valid TMSI. It is "idle updated".

Related PICS/PIXIT statements

None.

Foreseen final state of the MS

The MS has a valid TMSI. It is "idle updated".

Test Procedure

A mobile originating CM connection is attempted. The MM-connection is established without invoking the ciphering mode setting procedure.

Then, the MS sends a CM message and the SS releases the channel.

Maximum duration of test

one minute.

Expected sequence

Step	Direction	Message	Comments
1	MS		A MO CM connection is attempted.
2	MS -> SS	CHANNEL REQUEST	
3	SS -> MS	IMMEDIATE ASSIGNMENT	
4	MS -> SS	CM SERVICE REQUEST	
5	SS -> MS	CM SERVICE ACCEPT	
A6	MS -> SS	SETUP	
B6	MS -> SS	REGISTER	
C6	MS -> SS	CP-DATA	
C7	SS -> MS	CP-ACK	
C8	SS -> MS	CP-DATA	
C9	MS -> SS	CP-ACK	
10	SS -> MS	CHANNEL RELEASE	After the sending of this message, the SS waits for the disconnection of the main signalling link.

Specific message contents

None.

26.7.5.4 MM connection / establishment rejected

26.7.5.4.1 Conformance requirement

Upon reception of a CM SERVICE REJECT message, the MS shall not send any layer 3 message, start timer T3240 and enter the "wait for network command" state.

References

GSM 04.08 sections 4.5.1.1.

26.7.5.4.2 Test purpose

To verify that the MS does not send a layer 3 message when the service request is rejected by the SS.

26.7.5.4.3 Method of test

Initial conditions

System Simulator:

1 cell, default parameters.

Mobile Station:

The MS has a valid TMSI. It is "idle updated".

Related PICS/PIXIT statements

None.

Foreseen final state of the MS

The MS has a valid TMSI; It is "idle updated".

Test Procedure

A mobile originating CM connection is attempted. After the MS has sent the CM SERVICE REQUEST message to the SS, the SS responds with a CM SERVICE REJECT message with reject cause "requested service option not subscribed". It is checked that the MS does not send a layer 3 message.

Maximum duration of test

1 minute.

Expected sequence

Step	Direction	Message	Comments
1	MS		A MO CM connection is attempted
2	MS -> SS	CHANNEL REQUEST	
3	SS -> MS	IMMEDIATE ASSIGNMENT	
4	MS -> SS	CM SERVICE REQUEST	
5	SS -> MS	CM SERVICE REJECT	"Reject cause" IE: "requested service option not subscribed".
6	SS		The MS shall not send a layer 3 message. This is checked during 5 seconds.
7	SS -> MS	CHANNEL RELEASE	After the sending of this message, the SS waits for the disconnection of the main signalling link.

Specific message contents

None.

26.7.5.5 MM connection / establishment rejected cause 4

26.7.5.5.1 Conformance requirement

- 1) The Mobile Station shall be able to correctly set up an MM connection in a Mobile Originating CM connection attempt and send a CM Service Request message with CKSN information element as stored in the SIM and Mobile Identity information element set to the TMSI.
- 2) The Mobile Station, when receiving a CM SERVICE REJECT message with reject cause "IMSI unknown in VLR" shall wait for the network to release the RR connection.
- 3) The Mobile Station shall then be able to perform a location updating procedure.

References

GSM 04.08 sections 4.5.1.1.

26.7.5.5.2 Test purpose

To verify that the MS can correctly accept a CM SERVICE REJECT message with reject cause "IMSI unknown in VLR".

26.7.5.5.3 Method of test

Initial conditions

System Simulator:

1 cell, default parameters.

Mobile Station:

The MS has a valid TMSI. It is "idle updated".

Related PICS/PIXIT statements

None.

Foreseen final state of the MS

The MS has valid TMSI, CKSN. It is "idle updated".

Test Procedure

A mobile originating CM connection is attempted. After the MS has sent the CM SERVICE REQUEST message to the SS, the SS responds with a CM SERVICE REJECT message with reject cause "IMSI unknown in VLR". On receipt of this message, the MS shall delete any TMSI, LAI, cipher key and cipher key sequence number. The channel is released. It is checked that the MS performs a normal location updating procedure.

Maximum duration of test

One minute.

Expected sequence

Step	Direction	Message	Comments
1	MS		A MO CM connection is attempted.
2	MS -> SS	CHANNEL REQUEST	
3	SS -> MS	IMMEDIATE ASSIGNMENT	
4	MS -> SS	CM SERVICE REQUEST	
5	SS -> MS	CM SERVICE REJECT	"Reject cause" = "IMSI unknown in VLR".
6	SS -> MS	CHANNEL RELEASE	After the sending of this message, the SS waits for the disconnection of the main signalling link.
7	MS -> SS	CHANNEL REQUEST	"Establishment cause": Location updating.
8	SS -> MS	IMMEDIATE ASSIGNMENT	
9	MS -> SS	LOCATION UPDATING REQUEST	"Ciphering key sequence number" = "No key is available". "Mobile identity" = IMSI. "Location area identification" = deleted LAI (the MCC and MNC hold the previous values, the LAC is coded FFFE).
10	SS -> MS	AUTHENTICATION REQUEST	
11	MS -> SS	AUTHENTICATION RESPONSE	
12	SS -> MS	LOCATION UPDATING ACCEPT	"Mobile identity" = new TMSI.
13	MS -> SS	TMSI REALLOCATION COMPLETE	
14	SS -> MS	CHANNEL RELEASE	After the sending of this message, the SS waits for the disconnection of the main signalling link.

Specific message contents

None.

26.7.5.6 MM connection / expiry T3230

26.7.5.6.1 Conformance requirement

At T3230 expiry (i.e. no response is given but an RR connection is available) the MM connection establishment shall be aborted.

References

GSM 04.08 sections 4.5.1.2 and 11.2.

26.7.5.6.2 Test purpose

To verify that at T3230 expiry, the MS aborts the MM-connection establishment.

26.7.5.6.3 Method of test

Initial conditions

System Simulator:

1 cell, default parameters.

Mobile Station:

The MS has a valid TMSI. It is "idle updated".

Related PICS/PIXIT statements

None.

Foreseen final state of the MS

The MS has a valid TMSI. It is "idle updated".

Test Procedure

A mobile originating CM connection is attempted. After the MS has sent the CM SERVICE REQUEST message to the SS, the SS waits for expiry of timer T3230. It is checked that the MS does not send a layer 3 message but waits for the release of the RR-connection.

Maximum duration of test

1 minute.

Expected sequence

Step	Direction	Message	Comments
1	MS		A MO CM connection is attempted.
2	MS -> SS	CHANNEL REQUEST	
3	SS -> MS	IMMEDIATE ASSIGNMENT	
4	MS -> SS	CM SERVICE REQUEST	
5	SS		The SS waits for expiry of timer T3230.
6	SS -> MS	CM SERVICE ACCEPT	
7	MS -> SS	MM STATUS	"Reject cause " IE is "message not compatible with the call state or not implemented".
8	SS -> MS	CHANNEL RELEASE	After the sending of this message, the SS waits for the disconnection of the main signalling link.

Specific message contents

None.

26.7.5.7 MM connection / abortion by the network

26.7.5.7.1 MM connection / abortion by the network / cause #6

26.7.5.7.1.1 Conformance requirement

- 1) Upon reception of an ABORT message, the MS shall release any ongoing MM connection and enter the "wait for network command" state.
- 2) If the cause in the ABORT message was cause #6, the Mobile Station shall:
 - 2.1 not perform normal location updating;
 - 2.2 not perform periodic location updating;
 - 2.3 not respond to paging with TMSI;
 - 2.4 reject any request for Mobile Originating call establishment except Emergency call;
 - 2.5 not perform IMSI detach if deactivated.
- 3) After reception of an ABORT message with cause #6, the Mobile Station, if it supports speech, shall accept a request for an emergency call by sending a Channel Request message with the establishment cause set to "emergency call".
- 4) After reception of an ABORT message with cause #6, the Mobile Station shall delete the stored LAI, CKSN and TMSI.

Reference(s)

GSM 04.08 section 4.3.5.

26.7.5.7.1.2 Test purpose

To check that upon reception of an ABORT message with cause #6 during call establishment:

- the MS does not send any layer 3 message;
- after reception of an ABORT message and after having been deactivated and reactivated, the MS performs location updating using its IMSI as mobile identity and indicates deleted LAI and CKSN;
- the MS does not perform location updating, does not answer to paging with TMSI, rejects any request for mobile originating call except emergency call, does not perform IMSI detach;
- the MS accepts a request for emergency call.

26.7.5.7.1.3 Method of test

Initial Conditions

System Simulator:

2 cells, default parameters.

Mobile Station:

The MS has a valid TMSI, CKSN and Kc. It is "idle updated" on cell B.

Related PICS/PIXIT Statement(s)

SIM removal possible while MS is powered Yes/No.

Switch off on button Yes/No.

Support of speech Yes/No.

Foreseen final state of the MS

The MS has a valid TMSI. It is "idle updated" on cell A.

Test procedure

A mobile originating CM connection is attempted. Upon reception of the AUTHENTICATION RESPONSE message, the SS sends an ABORT message with cause #6. The SS waits for 5 seconds. The MS shall not send any layer 3 message. The SS releases the RR connection.

The SS checks that the MS has entered the state MM IDLE substate NO IMSI, i.e. does not perform normal location updating, does not perform periodic updating, does not respond to paging, rejects any requests from CM entities except emergency calls and does not perform IMSI detach if deactivated.

Maximum Duration Of Test

10 minutes.

Expected Sequence

Step	Direction	Message	Comments
The following messages are sent and shall be received on cell B			
1	MS		A mobile originating CM connection is attempted.
2	MS -> SS	CHANNEL REQUEST	
3	SS -> MS	IMMEDIATE ASSIGNMENT	
4	MS -> SS	CM SERVICE REQUEST	
5	SS -> MS	AUTHENTICATION REQUEST	
6	MS -> SS	AUTHENTICATION RESPONSE	
7	SS -> MS	ABORT	"reject cause" = #6.
8	SS		The SS waits for 5 seconds.
9	MS		The MS shall not send any layer 3 message during that time.
10	SS -> MS	CHANNEL RELEASE	After the sending of this message, the SS waits for the disconnection of the main signalling link.
The following messages are sent and shall be received on cell A.			
11	SS		The RF levels are changed to make the MS reselect cell A.
12	MS		The MS performs cell reselection according to procedure as specified in GSM 05.08 (this however is not checked until step 22). The MS shall not initiate an RR connection establishment on cell A or on cell B.
13	SS		The SS waits at least 7 minutes for a possible periodic updating.
14	MS		The MS shall not initiate an RR connection establishment on cell A or on cell B.
15	SS -> MS	PAGING REQUEST TYPE 1	"Mobile identity" IE contains TMSI.
16	MS		The MS shall not initiate an RR connection establishment on cell A or on cell B. This is verified during 3 seconds.
17	MS		A MO CM connection is attempted.
18	MS		The MS shall not initiate an RR connection establishment on cell A or on cell B. This is checked during 3 seconds.
19	MS		If the MS supports speech (see PICS), an emergency call is attempted.
20	MS -> SS	CHANNEL REQUEST	"Establishment cause": Emergency call.
21	SS -> MS	IMMEDIATE ASSIGNMENT	
22	MS -> SS	CM SERVICE REQUEST	"CM service type": Emergency call establishment.
23	SS -> MS	CM SERVICE ACCEPT	
24	MS -> SS	EMERGENCY SETUP	
25	SS -> MS	RELEASE COMPLETE	"Cause" = unassigned number.
26	SS -> MS	CHANNEL RELEASE	After the sending of this message, the SS waits for the disconnection of the main signalling link.
27	MS		If possible (see PICS) SIM detachment is performed. Otherwise if possible (see PICS) switch off is performed. Otherwise the power is removed.
28	MS		The MS shall not initiate an RR connection establishment on cell A or on cell B. This is checked during 3 seconds.
29	MS		Depending on what has been performed in step 29 the MS is brought back to operation.
30	MS -> SS	CHANNEL REQUEST	"Establishment cause": Location updating.
31	SS -> MS	IMMEDIATE ASSIGNMENT	
32	MS -> SS	LOCATION UPDATING REQUEST	"location updating type" = normal, "CKSN" = no key available, "Mobile Identity" = IMSI, "LAI" = deleted LAI (the MCC and MNC hold the previous values, the LAC is coded FFFE).
33	SS -> MS	AUTHENTICATION REQUEST	"CKSN" = CKSN1.
34	MS -> SS	AUTHENTICATION RESPONSE	
35	SS -> MS	LOCATION UPDATING ACCEPT	"Mobile Identity" = TMSI.
36	MS -> SS	TMSI REALLOCATION COMPLETE	
37	SS -> MS	CHANNEL RELEASE	After the sending of this message, the SS waits for the disconnection of the main signalling link.

Specific message contents

None.

26.7.5.7.2 MM connection / abortion by the network / cause not equal to #6

26.7.5.7.2.1 Conformance requirement

Upon reception of an ABORT message, the MS shall release any ongoing MM connection and enter the "wait for network command" state.

Reference(s)

GSM 04.08 section 4.3.5.

26.7.5.7.2.2 Test purpose

To check that when multiple MM connections are established, the MS releases all MM connections upon reception of an ABORT message, in the case when the two MM connections are established for a mobile terminating call and a non call related supplementary service operation.

26.7.5.7.2.3 Method of test

Initial Conditions

System Simulator:

1 cell, default parameters.

Mobile Station:

The MS is in state U10 of a mobile terminating call.

Related PICS/PIXIT Statement(s)

The MS supports a non call related supplementary service operation during an active call Yes/No.

Foreseen final state of the MS

The MS has a valid TMSI. It is "idle updated".

Test procedure

A non call related supplementary service operation is attempted at the MS. Upon reception of the REGISTER message, the SS sends an ABORT message with cause # 17. The SS sends a DISCONNECT using the TI of the mobile terminating call. The MS shall send a RELEASE COMPLETE message with the PD and TI of the DISCONNECT message and with cause #81. The SS releases the RR connection.

Maximum Duration Of Test

15 seconds.

Expected Sequence

This procedure is performed if the MS supports non call related supplementary service operation.

Step	Direction	Message	Comments
1	MS		A non call related supplementary service operation is attempted at the MS.
2	MS -> SS	CM SERVICE REQUEST	
3	SS -> MS	CM SERVICE ACCEPT	
4	MS -> SS	REGISTER	
5	SS -> MS	ABORT	"reject cause" = #17.
6	SS -> MS	DISCONNECT	with the TI of the mobile terminating call.
7	MS -> SS	RELEASE COMPLETE	"cause" = #81. Same PD and TI as the DISCONNECT message.
8	SS -> MS	CHANNEL RELEASE	After the sending of this message, the SS waits for the disconnection of the main signalling link.

Specific message contents

None.

26.7.5.8 MM connection / follow-on request pending

26.7.5.8.1 MM connection / follow-on request pending / test 1

26.7.5.8.1.1 Conformance requirement

The MS shall not attempt to establish a new MM connection after location updating on the same RR connection if not allowed by the network.

Reference(s)

GSM 04.08 section 4.4.4.6.

26.7.5.8.1.2 Test purpose

To check that when the network does not include the follow on proceed IE in a LOCATION UPDATING ACCEPT message, a MS that has a CM application request pending does not attempt to establish a new MM connection on that RR connection.

26.7.5.8.1.3 Method of test

Initial Conditions

System Simulator:

1 cell, ATT flag is set to "MSs in the cell shall apply IMSI attach and detach procedure".

Mobile Station:

The MS has a valid TMSI and is deactivated.

Related PICS/PIXIT Statement(s)

None.

Foreseen final state of the MS

The MS has a valid TMSI. It is "idle updated".

Test procedure

The MS is activated and a CM connection is attempted during the location updating procedure. The SS does not include the follow on proceed information element in the LOCATION UPDATING ACCEPT message. The SS waits for at least 8 seconds. The MS shall not send any layer 3 message for 8 seconds.

Maximum Duration of Test

60 s.

Expected Sequence

Step	Direction	Message	Comments
1	MS		The MS is activated.
2	MS -> SS	CHANNEL REQUEST	
3	SS -> MS	IMMEDIATE ASSIGNMENT	
4	MS -> SS	LOCATION UPDATING REQUEST	location updating type = IMSI attach. Then the SS waits for 15 s. During this delay a CM connection is attempted.
5	SS -> MS	LOCATION UPDATING ACCEPT	follow on proceed IE not included.
6	SS		The SS wait for at least 8 seconds.
7	MS		The MS shall not send any layer 3 message for 8 seconds after reception of the LOCATION UPDATING ACCEPT message.
8	SS -> MS	CHANNEL RELEASE	After the sending of this message, the SS waits for the disconnection of the main signalling link.

Specific message contents

None.

26.7.5.8.2 MM connection / follow-on request pending / test 2

26.7.5.8.2.1 Conformance requirement

A MS supporting the follow-on request procedure and having a CM connection request pending shall correctly establish an MM connection following a location update when allowed by the network.

Reference(s)

GSM 04.08 section 4.4.4.6.

26.7.5.8.2.2 Test purpose

To check that when the network includes the follow on proceed IE in a LOCATION UPDATING ACCEPT message, a MS that supports the follow on request procedure and that has a CM application request pending establishes successfully a new MM connection on that RR connection.

26.7.5.8.2.3 Method of test

Initial Conditions

System Simulator:

1 cell, ATT flag is set to "MSs in the cell shall apply IMSI attach and detach procedure".

Mobile Station:

The MS has a valid TMSI and is deactivated.

Related PICS/PIXIT Statement(s)

MS supports the follow on request procedure Yes/No.

Foreseen final state of the MS

The MS has a valid TMSI. It is "idle updated".

Test procedure

The MS is activated and a CM connection is attempted during the location updating procedure. The SS includes the follow on proceed information element in the LOCATION UPDATING ACCEPT message. The SS waits for at least 8 seconds.

If the MS supports the follow on request procedure:

The MS shall send a CM SERVICE REQUEST. Upon reception of that message, the SS sends a CM SERVICE ACCEPT message. The MS shall send an initial CM message. Upon reception of that message, the SS releases the RR connection.

If the MS does not support the follow on request procedure:

The MS shall not send any layer 3 message for 8 seconds.

Maximum Duration of Test

60 s.

Expected Sequence

Step	Direction	Message	Comments
1	MS		The MS is activated.
2	MS -> SS	CHANNEL REQUEST	
3	SS -> MS	IMMEDIATE ASSIGNMENT	
4	MS -> SS	LOCATION UPDATING REQUEST	Location updating type = IMSI attach. Then the SS waits for 15 s. During this delay a CM connection is attempted.
5	SS -> MS	LOCATION UPDATING ACCEPT	follow on proceed IE included.
			If the MS supports the follow on request procedure (see PICS) steps A6 to A8 are performed, otherwise steps B6 to B7 are performed.
A6	MS -> SS	CM SERVICE REQUEST	
A7	SS ->MS	CM SERVICE ACCEPT	
A8	MS -> SS	An initial CM message	
B6	SS		The SS wait for at least 8 seconds.
B7	MS		The MS shall not send any layer 3 message for 8 seconds after reception of the LOCATION UPDATING ACCEPT message.
9	SS -> MS	CHANNEL RELEASE	After the sending of this message, the SS waits for the disconnection of the main signalling link.

Specific message contents

None.

26.7.5.8.3 MM connection / follow-on request pending / test 3

26.7.5.8.3.1 Conformance requirement

- 1) The MS shall not set the follow on request bit in a LOCATION UPDATING REQUEST message if no MM connection request is pending.
- 2) When the network includes the follow on proceed IE in a LOCATION UPDATING ACCEPT message, a MS that has no CM application request pending shall not attempt to establish a new MM connection on that RR connection.
- 3) The MS shall correctly handle a CM connection established by the network on the RR connection that was used for the location updating procedure.

Reference(s)

GSM 04.08 section 4.4.4.6.

26.7.5.8.3.2 Test purpose

- 1) To check that a MS that has no CM application request pending sets the Follow-On-Request bit to No follow-on request pending in a LOCATION UPDATING REQUEST message.
- 2) To check that when the network includes the follow on proceed IE in a LOCATION UPDATING ACCEPT message, a MS that has no CM application request pending does not attempt to establish a new MM connection on that RR connection.
- 3) To check that the MS accepts establishment by the network of a new MM connection on the existing RR connection.

26.7.5.8.3.3 Method of test

Initial Conditions

System Simulator:

1 cell, ATT flag is set to "MSs in the cell shall apply IMSI attach and detach procedure".

Mobile Station:

The MS has a valid TMSI and is deactivated.

Related PICS/PIXIT Statement(s)

Supported services on TCH.

Foreseen final state of the MS

The MS has a valid TMSI. It is "idle updated".

Test procedure

The MS is activated. The MS performs location updating. The MS shall set the FOR bit to No follow-on request pending in the LOCATION UPDATING REQUEST message. The SS includes the follow on proceed information element in the LOCATION UPDATING ACCEPT message. The SS waits for 5 seconds. The MS shall not send any layer 3 message for 5 seconds. The SS sends a SETUP message to the MS requesting a basic service supported by the MS. The MS shall send either a CALL CONFIRMED message if it supports a service on TCH or a RELEASE COMPLETE with cause #88.

Maximum Duration of Test

20 s.

Expected Sequence

Step	Direction	Message	Comments
1	MS		The MS is activated.
2	MS -> SS	CHANNEL REQUEST	
3	SS -> MS	IMMEDIATE ASSIGNMENT	
4	MS -> SS	LOCATION UPDATING REQUEST	"Location updating type" = IMSI attach. The FOR bit is set to No follow-on request pending.
5	SS -> MS	LOCATION UPDATING ACCEPT	follow on proceed IE is included.
6	SS		The SS wait for 5 seconds.
7	MS		The MS shall not send any layer 3 message for 5 seconds after reception of the LOCATION UPDATING ACCEPT message.
8	SS -> MS	SETUP	
A9	MS -> SS	CALL CONFIRMED	If the MS supports a basic service on TCH.
B9	MS -> SS	RELEASE COMPLETE	If the MS does not support any basic service on TCH. cause #88.
10	SS -> MS	CHANNEL RELEASE	After the sending of this message, the SS waits for the disconnection of the main signalling link.

Specific message contents

None.

26.7.6 Default contents of messages

Default contents SYSTEM INFORMATION messages and default settings

For cell A and B For GSM use 26.6.14.

For DCS use 26.6.15, for PCS 1900 use 26.6.18, for GSM 450 use 26.6.16 and for GSM 480 use 26.6.17.

Cell C

The contents of SYSTEM INFORMATION TYPE 1 to 6 messages for cell C are identical to those of cell A with the following exceptions:

Cell Channel Description - Format Identifier - Cell Allocation ARFCN	Range 128 for GSM 450 and GSM 480 Bit map 0 for GSM Range 512 for DCS and PCS 1900. Channel number 267 for GSM 450, Channel number 315 for GSM 480, Channel Number 30 for GSM, Channel Number 700 for DCS and PCS 1900.
Cell Identity - Cell Identity Value	0003H

Default settings for cell C:

Downlink input level Uplink output power	53 dBmicroVolt emf minimum supported by the MS's power class for GSM and DCS, Power Control Level = 10 for PCS 1900 static.
Propagation profile BCCH/CCCH carrier number	267 for GSM 450 315 for GSM 480 30 for GSM 700 for DCS and PCS 1900.

ABORT

Information element	Value/remark
Reject cause	Depending on the test one of either: #6 - Illegal ME #17 - Network Failure.

AUTHENTICATION REQUEST

Information element	Value/remark
Cipher Key Sequence Number Authentication parameter RAND	Arbitrary Arbitrarily chosen by the test house

AUTHENTICATION RESPONSE

Information element	Value/remark
Authentication parameter SRES	As applicable

AUTHENTICATION REJECT

Information element	Value/remark
None but message head	

CHANNEL RELEASE

Information element	Value/remark
RR cause	Normal release

CIPHERING MODE COMMAND

Information element	Value/remark
Cipher mode setting Cipher Response	Start ciphering IMEI must not be included

CM RE-ESTABLISHMENT REQUEST

Information element	Value/remark
Cipher Key Sequence Number Mobile station classmark 2 Mobile Identity Location area identification	According to SIM contents See PICS/PIXIT IMSI of MS under test As in section 26.1.1

CM SERVICE ACCEPT

Information element	Value/remark
None but message head	Omitted

CM SERVICE REQUEST

Information element	Value/remark
CM service type Ciphering key sequence number Mobile station classmark 2 Mobile identity	Mobile originating call establishment unless otherwise specified in test. According to SIM contents See PICS/PIXIT TMSI of the MS under test

CM SERVICE REJECT

Information element	Value/remark
Reject cause	Depending on test

IDENTITY REQUEST

Information element	Value/remark
Identity type Spare half octet	Depending on test 0000

IDENTITY RESPONSE

Information element	Value/remark
Mobile identity	Depending on test

IMMEDIATE ASSIGNMENT

Information element	Value/remark
L2 pseudo length Page mode Spare half octet Channel description - Channel type and TDMA offset - Time slot number - Subsequent fields of the Channel description IE depend upon the Type of MS under test (GSM 450 or GSM 480 or DCS 1 800 or PCS 1900 or GSM 900), as specified in section 26.1.1 Request reference - Random access information - N51,N32,N26 Timing advance Mobile allocation Starting time IA rest octets	Normal Paging 0000 SDCCH/4 or SDCCH/8 Arbitrary legal value As received from MS Corresponding to the frame in which the Channel Request was sent 0 Empty (L=0) Omitted all bits set to spare

IMSI DETACH INDICATION

Information element	Value/remark
Mobile station classmark 1 Mobile identity	See PICS/PIXIT TMSI of the MS under test

LOCATION UPDATING ACCEPT

Information element	Value/remark
Location area identification Mobile identity Follow on proceed	As in section 26.1.1 Omitted Omitted

LOCATION UPDATING REJECT

Information element	Value/remark
Reject cause	As specified in test

LOCATION UPDATING REQUEST

Information element	Value/remark
Location updating type	Normal location updating
Cipher Key Sequence Number	According to SIM contents
Location area identification	As in section 26.1.1
Mobile station classmark	See PICS/PIXIT
Mobile identity	TMSI of the MS

PAGING REQUEST TYPE 1

Information element	Value/remark
L2 pseudo length	Normal paging
Page Mode	
Channels needed	"any channel" spare
- mobile 1	
- mobile 2	TMSI of MS under test
Mobile identity 1	
Mobile identity 2	Omitted
P1 rest octets	All bits set to spare

PAGING RESPONSE

Information element	Value/remark
Ciphering key sequence number	According to SIM contents
Spare half octet	0000
Mobile station classmark 2	See PICS/PIXIT
Mobile identity	TMSI of the MS under test

TMSI REALLOCATION COMMAND

Information element	Value/remark
Location area identification	As in section 26.1.1
Mobile identity	TMSI of the MS under test

TMSI REALLOCATION COMPLETE

Information element	Value/remark
None but message head	omitted

26.8 Tests related to circuit switched call control

26.8.1 Circuit switched Call Control (CC) state machine verification

26.8.1.1 General on CC state machine verification

The principle of checking the call control functions consists in the validation of each call control identified state.

State U0 as an initial state is not verified in the tests of 26.8.1.2 (establishment of an outgoing call).

State U0.1 is never verified.

The steps to be followed within each performed test are:

- bring the MS into the required state;
- trigger the tested event;

- check the MS response and new state.

In sections 26.8.1.2 and 26.8.1.3 different tables are defined to bring the MS into the required initial state. The exact table to be chosen is specified individually in section "Initial conditions" of "Method of test" for each test case.

For each test, unless otherwise specified, a circuit switched basic service among those supported by the MS but excluding the emergency call teleservice shall be chosen arbitrarily, and the test shall be performed according to that basic service. If the only circuit switched basic service supported by the mobile is emergency call, then the incoming call tests shall not be performed and the other call control tests shall be performed with the EMERGENCY SETUP message replacing the SETUP message.

The initial states are to be checked through STATUS ENQUIRY messages sent by the SS, when feasible. This is not explicitly stated in the tables of expected sequences of signalling messages. The checking of final states are explicitly included into the expected sequences of signalling messages.

The following postamble may be used by the SS to bring MS back to idle mode in those test cases, in which it is not already included into expected sequence of signalling messages:

Table 26.8.1.1/1: A postamble to bring the MS back to idle mode.

Step	Direction	Message	Comments
n	SS -> MS	CHANNEL RELEASE	
n+1	MS		the MS shall release the main signalling link (DISC/UA)

The postamble has not been included into the all of the tests in order to leave an option to concatenate the procedures in the future by using a final state of a test case as an initial state to another one.

For the special case of U0, the state is checked by sending STATUS ENQUIRY message with all possible values of transaction identifier (seven values) as U0 is the only state in which for every TI the MS will answer with release complete with cause #81. If U0 is to be verified when no RR connection exists, first a mobile terminating radio connection must be established.

The MS responses are either call management messages received by the SS or lower layers functions activated within the MS or MMI actions (e.g. the buzzing of an alerting tone).

A time-out within the MS is triggered by the SS when it does not answer back an MS expected response.

The test sequences may be split in 3 main groups:

- establishment and release of an outgoing call;
- establishment and release of an incoming call;
- in-call functions.

Remark on verification of transient states:

Some call control states of the mobile station may be transient, depending on implementation, configuration of the MS and previous messages (see annex 3, subclause 3.1.6).

If a test starts in a transient state, then the test is executed without verification of the starting state.

26.8.1.2 Establishment of an outgoing call

Initial conditions

As a minimum requirement the MS is updated and has been given a TMSI, a ciphering key and cipher key sequence number, and the layer 2, RR and MM functionalities have been verified.

There are as many CM initial conditions as states to be checked.

The tables below describe message exchanges which bring the MS in the requested initial states.

A state may be taken as initial only when all the states which lead to this initial states have been validated. The order followed in the test procedure will be U0, U0.1, U1, U3, U4, U10, U12, U19, U11 as seen in the table underneath.

The MS is brought again in the initial state starting with U0 at each new test performed.

Table 26.8.1.2/1: Establishment of an outgoing call, procedure 1 (late assignment)

Step	Direction	Message	Comments/actions/next state
1	MS -> SS	CHANNEL REQUEST	initiate outgoing call
2	SS -> MS	IMMEDIATE ASSIGNMENT	SDCCH, U0
3	MS -> SS	CM SERVICE REQUEST	U0.1
4	SS -> MS	CIPHERING MODE COMMAND	
5	MS -> SS	CIPHERING MODE COMPLETE	
6	MS -> SS	SETUP	U1
7	SS -> MS	CALL PROCEEDING	U3
8	SS -> MS	ALERTING	U4
9	SS -> MS	ASSIGNMENT COMMAND	TCH
10	MS -> SS	ASSIGNMENT COMPLETE	
11	SS -> MS	CONNECT	
12	MS -> SS	CONNECT ACKNOWLEDGE	U10
A13	SS -> MS	DISCONNECT	U12 (note 1)
B13	SS -> MS	DISCONNECT	U12 (note 2)
B14	MS -> SS	RELEASE	U19
C13			MMI action, terminate call
C14	MS -> SS	DISCONNECT	U11

NOTE 1: The Progress Indicator IE with progress description #8 "in band information or appropriate pattern now available" is included.

NOTE 2: The Progress Indication IE is not included.

Table 26.8.1.2/2: Establishment of an outgoing call, procedure 2

Step	Direction	Message	Comments/actions/next state
1	MS -> SS	CHANNEL REQUEST	initiate outgoing call
2	SS -> MS	IMMEDIATE ASSIGNMENT	TCH, U0
3	MS -> SS	CM SERVICE REQUEST	U0.1
4	SS -> MS	CHANNEL MODE MODIFY	(note 3)
5	MS -> SS	CHANNEL MODE MODIFY ACKNOWLEDGE	
6	SS -> MS	CIPHERING MODE COMMAND	
7	MS -> SS	CIPHERING MODE COMPLETE	
8	MS -> SS	SETUP	U1
9	SS -> MS	CALL PROCEEDING	U3
10	SS -> SS	ALERTING	U4
11	SS -> MS	CONNECT	
12	MS -> SS	CONNECT ACKNOWLEDGE	U10
A13	SS -> MS	DISCONNECT	U12 (note 4)
B13	SS -> MS	DISCONNECT	U12 (note 5)
B14	MS -> SS	RELEASE	U19
C13			MMI action, terminate call
C14	MS -> SS	DISCONNECT	U11

NOTE 3: Assigned channel is appropriate for the chosen bearer capability (see 26.8.1).

NOTE 4: The Progress Indicator IE with progress description #8 "in band information or appropriate pattern now available" is included.

NOTE 5: The Progress Indicator IE is not included.

Table 26.8.1.2/3: Establishment of an outgoing call, procedure 3

Step	Direction	Message	Comments/actions/next state
1	MS -> SS	CHANNEL REQUEST	initiate outgoing call
2	SS -> MS	IMMEDIATE ASSIGNMENT	SDCCH, U0
3	MS -> SS	CM SERVICE REQUEST	U0.1
4	SS -> MS	CIPHERING MODE COMMAND	
5	MS -> SS	CIPHERING MODE COMPLETE	
6	MS -> SS	SETUP	U1
7	SS -> MS	AUTHENTICATION REQUEST	
8	MS -> SS	AUTHENTICATION RESPONSE	
9	SS -> MS	CALL PROCEEDING	U3
10	SS -> MS	ASSIGNMENT COMMAND	TCH
11	MS -> SS	ASSIGNMENT COMPLETE	
12	SS -> MS	ALERTING	U4
13	SS -> MS	CONNECT	
14	MS -> SS	CONNECT ACKNOWLEDGE	U10
A15	SS -> MS	DISCONNECT	U12 (note 6)
B15	SS -> MS	DISCONNECT	U12 (note 7)
B16	MS -> SS	RELEASE	U19
C15			MMI action, terminate call
C16	MS -> SS	DISCONNECT	U11

NOTE 6: The Progress Indicator IE with progress description #8 "in band information or appropriate pattern now available" is included.

NOTE 7: The Progress indicator IE is not included.

Table 26.8.1.2/4: Establishment of an outgoing call, procedure 4

Step	Direction	Message	Comments
1	MS -> SS	CHANNEL REQUEST	initiate outgoing call
2	SS -> MS	IMMEDIATE ASSIGNMENT	TCH, U0
3	MS -> SS	CM SERVICE REQUEST	U0.1
4	SS -> MS	IDENTITY REQUEST	
5	MS -> SS	IDENTITY RESPONSE	
6	SS -> MS	CIPHERING MODE COMMAND	
7	MS -> SS	CIPHERING MODE COMPLETE	
8	MS -> SS	SETUP	U1
9	SS -> MS	CHANNEL MODE MODIFY	(note 8)
10	MS -> SS	CHANNEL MODE MODIFY ACKNOWLEDGE	
11	SS -> MS	CALL PROCEEDING	U3
12	SS -> MS	ALERTING	U4
13	SS -> MS	CONNECT	
14	MS -> SS	CONNECT ACKNOWLEDGE	U10
A15	SS -> MS	DISCONNECT	U12 (note 9)
B15	SS -> MS	DISCONNECT	U12 (note 10)
B16	MS -> SS	RELEASE	U19
C15			MMI action, terminate call
C16	MS -> SS	DISCONNECT	U11

NOTE 8: Assigned channel is appropriate for the chosen bearer capability (see 26.8.1).

NOTE 9: The Progress Indicator IE with progress description #8 "in band information or appropriate pattern now available" is included.

NOTE 10: The Progress Indicator IE is not included.

26.8.1.2.1 Outgoing call / U0 null state

26.8.1.2.1.1 Outgoing call / U0 null state / MM connection requested

26.8.1.2.1.1.1 Definition and applicability

The call control entity of the Mobile Station requests the MM-sublayer to establish a mobile originating MM-connection. This test is applicable for any equipment supporting at least one mobile originated circuit switched basic service.

26.8.1.2.1.1.2 Conformance requirement

- 1) Upon initiation of an outgoing basic call by user the MS shall initiate establishment of an MM connection, using as first MM message a CM SERVICE REQUEST message with CM service type "Mobile originating call establishment or packet mode connection establishment".

References

GSM 04.08 section 5.2.1.1, GSM 04.08 section 4.5.1.1, GSM 04.08 section 3.3.1.1

26.8.1.2.1.1.3 Test purpose

To verify that upon initiation of an outgoing basic call by user the MS initiates establishment of an MM connection, using as first MM message a CM SERVICE REQUEST message with CM service type "Mobile originating call establishment or packet mode connection establishment".

26.8.1.2.1.1.4 Method of test

Related PICS/PIXIT statements

- supported MO circuit switched basic services.

Initial conditions

System Simulator:

1 cell, default parameters.

Mobile Station:

The MS is in MM-state "idle, updated" with valid TMSI and CKSN.

Foreseen final state of the MS

U0, null.

Test procedure

An MO circuit switched basic service is selected that is supported by the MS; if the MS supports MO telephony, the selected basic service is telephony. If necessary, the MS is configured for that basic service. Then, the MS is made to initiate a call. When the SS receives CM SERVICE REQUEST, the contents of it shall be checked.

Maximum duration of test

30 s.

Expected sequence

Step	Direction	Message	Comments
1	MS -> SS	CHANNEL REQUEST	initiate outgoing call
2	SS -> MS	IMMEDIATE ASSIGNMENT	TCH
3	MS -> SS	CM SERVICE REQUEST	verify the type of call which is asked for "basic" or "emergency by the MS
4	SS -> MS	CHANNEL RELEASE	
5	MS		the MS shall release the main signalling link (DISC/UA)

Specific message contents:

None.

26.8.1.2.2 Outgoing call / U0.1 MM connection pending

26.8.1.2.2.1 Outgoing call / U0.1 MM connection pending / CM service rejected

26.8.1.2.2.1.1 Definition and applicability

A request for MM connection is rejected by the SS. This test is applicable for any equipment supporting at least one mobile originated circuit switched basic service.

26.8.1.2.2.1.2 Conformance requirement

Upon receiving indication of an MM-connection establishment being rejected, CC entity should inform upper layer of this rejection.

References

GSM 04.08, section 4.5.1.1 , GSM 04.07, section 6.2.2.

26.8.1.2.2.1.3 Test purpose

To verify that a CC entity of the MS in CC-state U0.1, "MM-connection pending", upon the MS receiving a CM SERVICE REJECT message, returns to CC state U0, "Null".

26.8.1.2.2.1.4 Method of test

Related PICS/PIXIT statements

- supported MO circuit switched basic services.

Initial conditions

System Simulator:

1 cell, default parameters.

Mobile Station:

The MS is in MM-state "idle, updated" with valid TMSI and CKSN.

The MS is brought into the state U0.1 by using table 26.8.1.2/1.

Foreseen final state of the MS

U0, null.

Maximum duration of test

30 s.

Test procedure

An MO circuit switched basic service is selected that is supported by the MS; if the MS supports MO telephony, the selected basic service is telephony. If necessary, the MS is configured for that basic service. Then, the MS is made to initiate a call. When the SS receives CM SERVICE REQUEST, the contents of it shall be checked. The SS rejects it by CM SERVICE REJECT. Then the SS will check the state of the MS by using STATUS ENQUIRY with all the relevant transaction identifiers.

Expected sequence

Step	Direction	Message	Comments
1	SS -> MS	CM SERVICE REJECT	
2	SS -> MS	STATUS ENQUIRY	
3	MS -> SS	RELEASE COMPLETE	cause shall be 81# (invalid T1 value)
4	SS		repeat steps 2-3 to cover all the transaction identifiers from 000 ...110
5	SS -> MS	CHANNEL RELEASE	
6	MS		the MS shall release the main signalling link (DISC/UA)

Specific message contents:

None.

26.8.1.2.2.2 Outgoing call / U0.1 MM connection pending / CM service accepted

26.8.1.2.2.2.1 Definition and applicability

A CM request is accepted for the MM-connection by the SS. This test is applicable for any equipment supporting at least one mobile originated circuit switched basic service.

26.8.1.2.2.2.2 Conformance requirement

A CC entity of the MS in CC-state U0.1, "MM-connection pending", upon the MS receiving a CM SERVICE ACCEPT message, shall send a SETUP message specifying the Called party BCD number that was entered into the MS and then enter CC state U1, "Call initiated".

References

GSM 04.08, section 4.5.1.1, GSM 04.08, section 5.2.1.1.

26.8.1.2.2.2.3 Test purpose

To verify that a CC entity of the MS in CC-state U0.1, "MM-connection pending", upon the MS receiving a CM SERVICE ACCEPT message, sends a SETUP message specifying the Called party BCD number that was entered into the MS and then enters CC state U1, "Call initiated".

26.8.1.2.2.2.4 Method of test

Related PICS/PIXIT statements

- supported MO circuit switched basic services.

Initial conditions

System Simulator:

1 cell, default parameters.

Mobile Station:

The MS is in MM-state "idle, updated" with valid TMSI and CKSN.

The MS is brought into the state U0.1 by using table 26.8.1.2/1.

Foreseen final state of the MS

U1, call initiated.

Maximum duration of test

30 s.

Test procedure

An MO circuit switched basic service is selected that is supported by the MS; if the MS supports MO telephony, the selected basic service is telephony. If necessary, the MS is configured for that basic service. Then, the MS is made to initiate a call. When the MS is requesting a MM-connection, the SS will indicate acceptance by sending a CM SERVICE ACCEPT message. The MS shall respond with SETUP. Then the SS will check the state of the call control entity by STATUS ENQUIRY with the relevant transaction identifiers.

Expected sequence

Step	Direction	Message	Comments
1	SS -> MS	CM SERVICE ACCEPT	
2	MS -> SS	SETUP	with called party BCD number.
3	SS -> MS	STATUS ENQUIRY	
4	MS -> SS	STATUS	cause shall be 30# (response to enq.) and state U1 call initiated.

Specific message contents:

None.

26.8.1.2.2.3 Outgoing call / U0.1 MM connection pending / lower layer failure

26.8.1.2.2.3.1 Definition and applicability

The call control entity of the MS being in the state, U0.1, a lower layer failure is accomplished at the MS and consequently, communication at layer 3 level with the peer entity is terminated. This test is applicable for any equipment supporting at least one mobile originated circuit switched basic service.

26.8.1.2.2.3.2 Conformance requirement

- 1) Upon a lower layer failure the MS releases the MM connection in progress and returns to idle mode. In that state no call exists, and the CC entities relating to the seven mobile originating transaction identifiers are in state U0, "Null".

References

GSM 04.08, section 4.5.1.2, GSM 04.08, section 5.2.1.1., GSM 04.08 section 5.5.3.2. and GSM 04.08 section 8.3.

26.8.1.2.2.3.3 Test purpose

To verify that after the MS with a CC entity in state U0.1, "MM-connection pending", has detected a lower layer failure and has returned to idle mode, the CC entities relating to the seven mobile originating transaction identifiers are in state U0, "Null".

26.8.1.2.2.3.4 Method of test

Related PICS/PIXIT statements

- supported MO circuit switched basic services.

Initial conditions

System Simulator:

1 cell, default parameters.

Mobile Station:

The MS is in MM-state "idle, updated" with valid TMSI and CKSN.

The MS is brought into the state U0.1 by using table 26.8.1.2/1.

Foreseen final state of the MS

U0, null.

Maximum duration of test

1 min.

Test procedure

An MO circuit switched basic service is selected that is supported by the MS; if the MS supports MO telephony, the selected basic service is telephony. If necessary, the MS is configured for that basic service. Then, the MS is made to initiate a call. When the MS has sent a CM SERVICE REQUEST message, the SS generates a lower layer failure at the MS. The SS waits long enough to enable the MS to return to idle state listening to paging, and then pages MS to create RR-connection. Finally, the SS will check the state of the MS by using STATUS ENQUIRY with the relevant transaction identifiers.

Expected sequence

Step	Direction	Message	Comments
1	SS		SS generates lower layer failure.
2	SS		SS waits 20 s for the MS to return to listening to paging.
3	SS -> MS	PAGING REQUEST	
4	MS -> SS	CHANNEL REQUEST	
5	SS -> MS	IMMEDIATE ASSIGNMENT	
6	MS -> SS	PAGING RESPONSE	
7	SS -> MS	STATUS ENQUIRY	
8	MS -> SS	RELEASE COMPLETE	cause shall be 81# (invalid TI value).
9	SS		repeat steps 7-8 to cover all the transaction identifiers from 000 ...110.
10	SS -> MS	CHANNEL RELEASE	the main signalling link shall be released by the MS (L2: DISC/UA).

Specific message contents:

None.

26.8.1.2.3 Outgoing call / U1 call initiated

26.8.1.2.3.1 Outgoing call / U1 call initiated / receiving CALL PROCEEDING

26.8.1.2.3.1.1 Definition and applicability

The call control entity of the MS being in the state, U1, a CALL PROCEEDING message is sent by the SS. This test is applicable for any equipment supporting at least one mobile originated circuit switched basic service.

26.8.1.2.3.1.2 Conformance requirement

- 1) A CC entity of the MS in CC-state U1, "Call initiated", upon receipt of a CALL PROCEEDING message, shall enter CC state U3, "Mobile originating call proceeding".

References

GSM 04.08, sections 5.2.1.1, 5.2.1.2 and 5.2.1.3.

26.8.1.2.3.1.3 Test purpose

To verify that a CC entity of the MS in CC-state U1, "Call initiated", upon receipt of a CALL PROCEEDING message, enters CC state U3, "Mobile originating call proceeding".

26.8.1.2.3.1.4 Method of test

Related PICS/PIXIT statements

- supported MO circuit switched basic services.

Initial conditions

System Simulator:

1 cell, default parameters.

Mobile Station:

The MS is in MM-state "idle, updated" with valid TMSI and CKSN.

The MS is brought into the state U1 by using table 26.8.1.2/2.

Foreseen final state of the MS

U3, Mobile originating call proceeding.

Maximum duration of test

30 s.

Test procedure

An MO circuit switched basic service is selected that is supported by the MS; if the MS supports MO telephony, the selected basic service is telephony. If necessary, the MS is configured for that basic service. Then, the MS is made to initiate a call. The CC entity of the MS is brought to the state U1. The SS sends a CALL PROCEEDING message to the MS. The SS checks by using the status enquiry procedure that the CC entity has entered the state U3.

Expected sequence

Step	Direction	Message	Comments
1	SS -> MS	CALL PROCEEDING	tone generation not mandatory
2	SS -> MS	STATUS ENQUIRY	
3	MS -> SS	STATUS	cause 30#, state U3

Specific message contents:

None.

26.8.1.2.3.2 Outgoing call / U1 call initiated / rejecting with RELEASE COMPLETE

26.8.1.2.3.2.1 Definition and applicability

The call control entity of the MS being in the state, U1, the call is rejected by a RELEASE COMPLETE message sent by the SS. This test is applicable for any equipment supporting at least one mobile originated circuit switched basic service.

26.8.1.2.3.2.2 Conformance requirement

- 1) A CC entity of the MS in CC-state U1, "Call initiated", upon receipt of a RELEASE COMPLETE message with valid cause value, shall enter CC state U0, "Null".
- 2) On returning to idle mode, the CC entities relating to the seven mobile originating transaction identifiers shall be in state U0, "Null".
- 3) On releasing the MM-connection, the MS shall wait for MM layer release initiated by the network.

References

Conformance requirement 1: GSM 04.08, section 5.4.2, GSM 04.08, section 5.4.4.

Conformance requirement 2: GSM 04.08, section 5.5.3.2.

Conformance requirement 3: GSM 04.08, section 5.4.4.3, GSM 04.08, section 4.5.3, GSM 04.08, section 3.4.13.1

26.8.1.2.3.2.3 Test purpose

- 1) To verify that a CC entity of the MS in CC-state U1, "Call initiated", upon receipt of a RELEASE COMPLETE message with valid cause value, enters CC state U0, "Null".
- 2) To verify that in returning to idle mode, the CC entities relating to the seven mobile originating transaction identifiers are in state U0, "Null".
- 3) To verify that in releasing the MM-connection, the MS shall wait for MM layer release initiated by SS.

26.8.1.2.3.2.4 Method of test

Related PICS/PIXIT statements

- supported MO circuit switched basic services.

Initial conditions

System Simulator:

1 cell, default parameters.

Mobile Station:

The MS is in MM-state "idle, updated" with valid TMSI and CKSN.

The MS is brought into the state U1 by using table 26.8.1.2/2.

Foreseen final state of the MS

U0, null.

Maximum duration of test

30 s.

Test procedure

An MO circuit switched basic service is selected that is supported by the MS; if the MS supports MO telephony, the selected basic service is telephony. If necessary, the MS is configured for that basic service. Then, the MS is made to initiate a call. The CC entity of the MS is brought to the state U1. The SS sends a RELEASE COMPLETE message to the MS. The SS checks by using the status enquiry procedure that the CC entity has entered the state U0 with all the relevant transaction identifiers.

Expected sequence

Step	Direction	Message	Comments
1	SS -> MS	RELEASE COMPLETE	See specific message content below.
2	SS -> MS	STATUS ENQUIRY	
3	MS -> SS	RELEASE COMPLETE	cause 81# (invalid TI value)
4	SS		repeat steps 2-3 to cover all the transaction identifiers from 000...110
5	SS -> MS	CHANNEL RELEASE	the main signalling link shall be released by the MS (L2: DISC/UA).

Specific message contents:

RELEASE COMPLETE

1) With a valid cause value among:

related to numbering,

#1 unallocated number

#3 no route to destination

#22 number changed

#28 invalid number format

related to bearer capabilities,

#8 operator determined barring

#57 bearer capability not authorized

#58 bearer capability not presently available

#63 service or option not available

#65 bearer service not implemented

#34 no circuit/channel available (call queuing).

26.8.1.2.3.3 Outgoing call / U1 call initiated / T303 expiry

26.8.1.2.3.3.1 Definition and applicability

The call control entity of the MS being in the state, U1, if no response is then received from the SS, timer T303 expires at the MS side. This test is applicable for any equipment supporting at least one mobile originated circuit switched basic service.

26.8.1.2.3.3.2 Conformance requirement

- 1) A CC entity of the MS in CC-state U1, "Call initiated", upon expiry of T303 shall send a DISCONNECT message to its peer entity and enter state U11, "Disconnect request".

References

GSM 04.08, section 5.2.1.1, GSM 04.08, section 5.4.

26.8.1.2.3.3.3 Test purpose

- 1) To verify that a CC entity of the MS in CC-state U1, "Call initiated", upon expiry of T303 (accuracy +/-20 % between reception of CM SERVICE REQUEST and DISCONNECT by SS) sends a DISCONNECT message to its peer entity and enters state U11, "Disconnect request".

26.8.1.2.3.3.4 Method of test

Related PICS/PIXIT statements

- supported MO circuit switched basic services.

Initial conditions

System Simulator:

1 cell, default parameters.

Mobile Station:

The MS is in MM-state "idle, updated" with valid TMSI and CKSN.

The MS is brought into the state U1 by using table 26.8.1.2/2.

Foreseen final state of the MS

U11, disconnect request.

Maximum duration of test

1 minute.

Test procedure

An MO circuit switched basic service is selected that is supported by the MS; if the MS supports MO telephony, the selected basic service is telephony. If necessary, the MS is configured for that basic service. Then, the MS is made to initiate a call. The CC entity of the MS is brought to the state U1. When T303 expires at the MS, the MS shall send DISCONNECT. The SS checks by using the status enquiry procedure that the CC entity has entered the state U11, disconnect request.

Expected sequence

Step	Direction	Message	Comments
1	SS		SS waits for T303 expiry.
2	MS -> SS	DISCONNECT	Shall be transmitted between 24 s and 36 s after the CM SERVICE REQUEST.
3	SS -> MS	STATUS ENQUIRY	
4	MS -> SS	STATUS	cause 30#, status U11

Specific message contents:

None.

26.8.1.2.3.4 Outgoing call / U1 call initiated / lower layer failure

26.8.1.2.3.4.1 Definition and applicability

The call control entity of the MS being in the state, U1, a lower layer failure is accomplished at the MS and consequently, communication at layer 3 level with the peer entity is terminated. This test is applicable for any equipment supporting at least one mobile originated circuit switched basic service.

26.8.1.2.3.4.2 Conformance requirement

Upon a lower layer failure MM informs the relevant CM entities that the MM connection has been interrupted. As call re-establishment is not allowed, the CC entity must perform a local release. The MS returns to idle mode. In that state no call exists, and the CC entities relating to the seven mobile originating transaction identifiers are in state U0, "Null".

References

GSM 04.08, section 4.5.2.3, GSM 04.08, section 5.2.1.1, GSM 04.08 section 5.5.3.2.

26.8.1.2.3.4.3 Test purpose

To verify that after the MS with a CC entity in state U1 "Call initiated", has detected a lower layer failure and has returned to idle mode, the CC entities relating to the seven mobile originating transaction identifiers are in state U0, "Null".

26.8.1.2.3.4.4 Method of test

Related PICS/PIXIT statements

- supported MO circuit switched basic services.

Initial conditions

System Simulator:

1 cell, default parameters.

Mobile Station:

The MS is in MM-state "idle, updated" with valid TMSI and CKSN.

The MS is brought into the state U1 by using table 26.8.1.2/4.

Foreseen final state of the MS

U0, null.

Maximum duration of test

1 min.

Test procedure

An MO circuit switched basic service is selected that is supported by the MS; if the MS supports MO telephony, the selected basic service is telephony. If necessary, the MS is configured for that basic service. Then, the MS is made to initiate a call. The MS is brought to the state U1. The SS generates a lower layer failure at the MS. The SS waits long enough to enable the MS to return to idle state listening to paging, and then pages MS to create RR-connection. Finally, the SS will check the state of the MS by using STATUS ENQUIRY with the relevant transaction identifiers.

Expected sequence

Step	Direction	Message	Comments
1	SS		SS generates lower layer failure.
2	SS		SS waits 20 s for the MS to return to listening to paging.
3	SS -> MS	PAGING REQUEST	
4	MS -> SS	CHANNEL REQUEST	
5	SS -> MS	IMMEDIATE ASSIGNMENT	
6	MS -> SS	PAGING RESPONSE	
7	SS -> MS	STATUS ENQUIRY	
8	MS -> SS	RELEASE COMPLETE	cause 81# (invalid TI value).
9	SS		repeat steps 7-8 to cover all the transaction identifiers from 000...110.
10	SS -> MS	CHANNEL RELEASE	
11	MS		the MS shall release the main signalling link (DISC/UA).

Specific message contents:

None.

26.8.1.2.3.5 Outgoing call / U1 call initiated / receiving ALERTING

26.8.1.2.3.5.1 Definition and applicability

The call control entity of the MS being in the state, U1, an ALERTING message is sent to the MS as a indication that a call is being alerted at a called end. This test is applicable for any equipment supporting at least one mobile originated circuit switched basic service.

26.8.1.2.3.5.2 Conformance requirement

- 1) A CC entity of the MS in CC-state U1, "Call initiated", upon receipt of an ALERTING message, shall enter CC state U4, "Call delivered".

References

GSM 04.08, section 5.2.1.1.

26.8.1.2.3.5.3 Test purpose

To verify that a CC entity of the MS in CC-state U1, "Call initiated", upon receipt of an ALERTING message, enters CC state U4, "Call delivered".

26.8.1.2.3.5.4 Method of test

Related PICS/PIXIT statements

- supported MO circuit switched basic services.

Initial conditions

System Simulator:

1 cell, default parameters.

Mobile Station:

The MS is in MM-state "idle, updated" with valid TMSI and CKSN.

The MS is brought into the state U1 by using table 26.8.1.2/4.

Foreseen final state of the MS

U4, call delivered.

Maximum duration of test

30 s.

Test procedure

An MO circuit switched basic service is selected that is supported by the MS; if the MS supports MO telephony, the selected basic service is telephony. If necessary, the MS is configured for that basic service. Then, the MS is made to initiate a call. The CC entity of the MS is brought to the state U1. The SS sends an ALERTING message to the MS. The SS checks by using the status enquiry procedure that the CC entity has entered the state U4, call delivered.

Expected sequence

Step	Direction	Message	Comments
1	SS -> MS	ALERTING	
2	SS -> MS	STATUS ENQUIRY	
3	MS -> SS	STATUS	cause 30#, state U4

Specific message contents:

None.

26.8.1.2.3.6 Outgoing call / U1 call initiated / entering state U10

26.8.1.2.3.6.1 Definition and applicability

The call control entity of the MS being in the state, U1, a CONNECT message is received by the MS. This test is applicable for any equipment supporting at least one mobile originated circuit switched basic service.

26.8.1.2.3.6.2 Conformance requirement

- 1) A CC entity of the MS in CC-state U1, "Call initiated", upon receipt of a CONNECT message, shall send a CONNECT ACKNOWLEDGE message to its peer entity and enter CC state U10, "Active".

References

GSM 04.08, section 5.2.1.1, GSM 04.08, section 5.2.1.6.

26.8.1.2.3.6.3 Test purpose

To verify that a CC entity of the MS in CC-state U1, "Call initiated", upon receipt of a CONNECT message, sends a CONNECT ACKNOWLEDGE message to its peer entity and enters CC state U10, "Active".

26.8.1.2.3.6.4 Method of test

Related PICS/PIXIT statements

- supported MO circuit switched basic services.

Initial conditions

System Simulator:

1 cell, default parameters.

Mobile Station:

The MS is in MM-state "idle, updated" with valid TMSI and CKSN.

The MS is brought into the state U1 by using table 26.8.1.2/4.

Foreseen final state of the MS

U10, call active.

Maximum duration of test

30 s.

Test procedure

An MO circuit switched basic service is selected that is supported by the MS; if the MS supports MO telephony, the selected basic service is telephony. If necessary, the MS is configured for that basic service. Then, the MS is made to initiate a call. The CC entity of the MS is brought to the state U1. The SS sends a CONNECT message to the MS. The MS shall respond by sending a CONNECT ACKNOWLEDGE message. The SS checks by using the status enquiry procedure that the CC entity has entered the state U10, active.

Expected sequence

Step	Direction	Message	Comments
1	SS -> MS	CONNECT	
2	MS -> SS	CONNECT ACKNOWLEDGE	
3	SS -> MS	STATUS ENQUIRY	
4	MS -> SS	STATUS	cause 30#, state U10

Specific message contents:

None.

26.8.1.2.3.7 Outgoing call / U1 call initiated / unknown message received

26.8.1.2.3.7.1 Definition and applicability

The call control entity of the MS being in the state, U1, an unknown message is received by the MS. This test is applicable for any equipment supporting at least one mobile originated circuit switched basic service.

26.8.1.2.3.7.2 Conformance requirement

- 1) A CC entity of the MS in CC-state U1, "Call initiated", upon receipt of a message with message type not defined for the protocol discriminator from its peer entity shall return a STATUS message.

References

GSM 04.08 section 8.4.

26.8.1.2.3.7.3 Test purpose

To verify that a CC entity of the MS in CC-state U1, "Call initiated", upon receipt of a message with message type not defined for the protocol discriminator unknown message from its peer entity returns a STATUS message.

26.8.1.2.3.7.4 Method of test

Related PICS/PIXIT statements

- supported MO circuit switched basic services.

Initial conditions

System Simulator:

1 cell, default parameters.

Mobile Station:

The MS is in MM-state "idle, updated" with valid TMSI and CKSN.

The MS is brought into the state U1 by using table 26.8.1.2/1.

Foreseen final state of the MS

U1, call initiated.

Maximum duration of test

30 s.

Test procedure

An MO circuit switched basic service is selected that is supported by the MS; if the MS supports MO telephony, the selected basic service is telephony. If necessary, the MS is configured for that basic service. Then, the MS is made to initiate a call. The CC entity of the MS is brought to the state U1. The SS sends a message with message type not defined for the protocol discriminator to the MS. The MS shall respond with a STATUS message, and finally the SS checks by using the status enquiry procedure that the state of the CC entity has remained unchanged.

Expected sequence

Step	Direction	Message	Comments
1	SS -> MS	unknown message	message type not defined for PD
2	MS -> SS	STATUS	cause 97#, state U1
3	SS -> MS	STATUS ENQUIRY	
4	MS -> SS	STATUS	cause 30#, state U1

Specific message contents:

None.

26.8.1.2.4 Outgoing call / U3 MS originating call proceeding

26.8.1.2.4.1 Outgoing call / U3 MS originating call proceeding / ALERTING received

26.8.1.2.4.1.1 Definition and applicability

The call control entity of the MS being in the state, U3, an ALERTING message is sent to the MS as a indication that a call is being alerted at a called end. This test is applicable for any equipment supporting at least one mobile originated circuit switched basic service.

26.8.1.2.4.1.2 Conformance requirement

- 1) A CC-entity of the MS in CC-state U3, "Mobile Originating Call Proceeding", upon receipt of a ALERTING message shall enter CC-state U4, "Call Delivered".

References

GSM 04.08 section 5.2.1.5.

26.8.1.2.4.1.3 Test purpose

To verify that a CC-entity of the MS in CC-state U3, "Mobile Originating Call Proceeding", upon receipt of a ALERTING message enters CC-state U4, "Call Delivered".

26.8.1.2.4.1.4 Method of test

Related PICS/PIXIT statements

- supported MO circuit switched basic services.

Initial conditions

System Simulator:

1 cell, default parameters.

Mobile Station:

The MS is in MM-state "idle, updated" with valid TMSI and CKSN.

The MS is brought into the state U3 by using table 26.8.1.2/2.

Foreseen final state of the MS

U4, call delivered.

Maximum duration of test

30 s.

Test procedure

An MO circuit switched basic service is selected that is supported by the MS; if the MS supports MO telephony, the selected basic service is telephony. If necessary, the MS is configured for that basic service. Then, the MS is made to initiate a call. The CC entity of the MS is brought to the state U3. The SS sends an ALERTING message to the MS. The SS checks by using the status enquiry procedure that the CC entity has entered the state U4, call delivered.

Expected sequence

Step	Direction	Message	Comments
1	SS -> MS	ALERTING	
2	SS -> MS	STATUS ENQUIRY	
3	MS -> SS	STATUS	cause 30#, state U4

Specific message contents:

None.

26.8.1.2.4.2 Outgoing call / U3 MS originating call proceeding / CONNECT received

26.8.1.2.4.2.1 Definition and applicability

The call control entity of the MS being in the state, U3, a CONNECT message is received by the MS. This test is applicable for any equipment supporting at least one mobile originated circuit switched basic service.

26.8.1.2.4.2.2 Conformance requirement

- 1) A CC-entity of the MS in CC-state U3, "Mobile Originating Call Proceeding", upon receipt of a CONNECT message shall return a "CONNECT ACKNOWLEDGE" message to its peer entity and enter the CC state U10, "Active".
- 2) The MS shall then stop any locally generated indication.

References

Conformance requirement 1: GSM 04.08 section 5.2.1.6.

Conformance requirement 2: GSM 04.08 section 5.2.1.6.

26.8.1.2.4.2.3 Test purpose

- 1) To verify that a CC-entity of the MS in CC-state U3, "Mobile Originating Call Proceeding", upon receipt of a CONNECT message returns a "CONNECT ACKNOWLEDGE" message to its peer entity and enters the CC state U10, "Active".
- 2) To verify that the MS stops locally generated indication, if any.

26.8.1.2.4.2.4 Method of test

Related PICS/PIXIT statements

- supported MO circuit switched basic services.

Initial conditions

System Simulator:

1 cell, default parameters.

Mobile Station:

The MS is in MM-state "idle, updated" with valid TMSI and CKSN.

The MS is brought into the state U3 by using table 26.8.1.2/2.

Foreseen final state of the MS

U10, active.

Maximum duration of test

30 s.

Test procedure

An MO circuit switched basic service is selected that is supported by the MS; if the MS supports MO telephony, the selected basic service is telephony. If necessary, the MS is configured for that basic service. Then, the MS is made to initiate a call. The CC entity of the MS is brought to the state U3. The SS sends a CONNECT message to the MS. The MS shall respond by sending a CONNECT ACKNOWLEDGE message. The SS checks by using the status enquiry procedure that the CC entity has entered the state U10, active.

Expected sequence

Step	Direction	Message	Comments
1	SS -> MS	CONNECT	the MS shall stop tone generation, if any cause 30#, state U10
2	MS -> SS	CONNECT ACKNOWLEDGE	
3	SS -> MS	STATUS ENQUIRY	
4	MS -> SS	STATUS	

Specific message contents:

None.

26.8.1.2.4.3 Outgoing call / U3 MS originating call proceeding / PROGRESS received without in band information

26.8.1.2.4.3.1 Definition and applicability

The call control entity of the MS being in the state, U3, a PROGRESS message is received by the MS. The PROGRESS message does not contain indication of in-band information availability. This test is applicable for any equipment supporting at least one mobile originated circuit switched basic service.

26.8.1.2.4.3.2 Conformance requirement

- 1) A CC-entity of the MS in CC-state U3, "Mobile Originating Call Proceeding", upon receipt of a PROGRESS message with valid cause values shall stay in CC-state U3.

- 2) After receipt of the PROGRESS message timer T310 shall be stopped.

References

Conformance requirement 1: GSM 04.08 section 5.2.1.4.

Conformance requirement 2: GSM 04.08 section 11.3.

26.8.1.2.4.3.3 Test purpose

- 1) To verify that a CC-entity of the MS in CC-state U3, "Mobile Originating Call Proceeding", upon receipt of a PROGRESS message with valid cause values stays in CC-state U3.
- 2) To verify that after receipt of the PROGRESS message timer T310 is stopped.

26.8.1.2.4.3.4 Method of test

Related PICS/PIXIT statements

- supported MO circuit switched basic services.

Initial conditions

System Simulator:

1 cell, default parameters.

Mobile Station:

The MS is in MM-state "idle, updated" with valid TMSI and CKSN.

The MS is brought into the state U3 by using table 26.8.1.2/2.

Foreseen final state of the MS

U3, mobile originating call proceeding.

Maximum duration of test

1 min.

Test procedure

An MO circuit switched basic service is selected that is supported by the MS; if the MS supports MO telephony, the selected basic service is telephony. If necessary, the MS is configured for that basic service. Then, the MS is made to initiate a call. The CC entity of the MS is brought to the state U3. The SS sends a PROGRESS message not containing indication of in-band information availability to the MS. The SS checks that the MS has stopped T310, i.e. at T310 time-out no DISCONNECT message is sent by the MS. Then the SS checks by using the status enquiry procedure that the state of the CC entity has remained unchanged.

Expected sequence

Step	Direction	Message	Comments
1	SS -> MS	PROGRESS	(note)
2	SS -> MS	STATUS ENQUIRY	
3	MS -> SS	STATUS	cause 30#, state U3
4	SS		SS waits at least 45 seconds and checks no DISCONNECT is sent by the MS
5	SS -> MS	STATUS ENQUIRY	
6	MS -> SS	STATUS	cause 30#, state U3

NOTE: Tested with a valid cause value among:

- #4 call has returned to PLMN/ISDN
- #32 call is end-to-end PLMN/ISDN or
- any value in the set #(21-127)

Specific message contents:

None.

26.8.1.2.4.4 Outgoing call / U3 MS originating call proceeding / PROGRESS with in band information

26.8.1.2.4.4.1 Definition and applicability

The call control entity of the MS being in the state, U3, a PROGRESS message indicating availability of in band information is received by the MS. This test is applicable for any equipment supporting at least one mobile originated circuit switched basic service.

26.8.1.2.4.4.2 Conformance requirement

- 1) A CC-entity of the MS in CC-state U3, "Mobile Originating Call Proceeding", upon receipt of a PROGRESS message indicating in-band announcement shall through-connect the traffic channel for speech, if TCH is in a speech mode. If TCH is not in speech mode, the MS shall not through-connect the TCH.
- 2) After receipt of the PROGRESS message, T310 shall be stopped.

References

GSM 04.08 section 3.4.3., GSM 04.08 section 5.1.3, GSM 04.08 section 5.2.1.4., GSM 04.08 section 5.2.1.9, GSM 04.08 section 5.5.1., GSM 04.08 section 11.3.

26.8.1.2.4.4.3 Test purpose

- 1) To verify that a CC-entity of the MS in CC-state U3, "Mobile Originating Call Proceeding", upon receipt of a PROGRESS message indicating in-band announcement through-connects the traffic channel for speech, if TCH is in speech mode. If TCH is not in a speech mode, the MS does not through-connect the TCH.
- 2) To verify that after receipt of the PROGRESS message, T310 is stopped.

26.8.1.2.4.4.4 Method of test

Related PICS/PIXIT statements

- supported MO circuit switched basic services.

Initial conditions

System Simulator:

1 cell, default parameters.

Mobile Station:

The MS is in MM-state "idle, updated" with valid TMSI and CKSN.

The MS is brought into the state U3 by using table 26.8.1.2/2.

Foreseen final state of the MS

U3, mobile originating call proceeding.

Maximum duration of test

1 minute.

Test procedure

An MO circuit switched basic service is selected that is supported by the MS; if the MS supports MO telephony, the selected basic service is telephony. If necessary, the MS is configured for that basic service. Then, the MS is made to initiate a call. The CC entity of the MS is brought to the state U3. The SS sends a PROGRESS message containing indication of in-band information availability to the MS. The SS checks that if channel mode is speech, the TCH shall be through connected. If channel mode is not speech, the TCH shall not be through connected. Also the SS checks that the MS has stopped T310, i.e. at T310 time-out no DISCONNECT message is sent by the MS. Then the SS checks by using the status enquiry procedure that the state of the CC entity has remained unchanged.

Expected sequence

Step	Direction	Message	Comments
1	SS -> MS	PROGRESS 1)	the MS shall stop all the CC timers (note), if channel mode is speech, the TCH shall be through connected. If channel mode is not speech, the TCH shall not be through connected.
2	SS -> MS	STATUS ENQUIRY	cause 30#, state U3
3	MS -> SS	STATUS	
4	SS		SS waits at least 45 seconds and checks no DISCONNECT is sent by the MS.
5	SS -> MS	STATUS ENQUIRY	cause 30#, state U3
6	MS -> SS	STATUS	
7	SS		If the channel mode is speech the SS will check that the user connection for speech is attached (both downlink and uplink).

Specific message contents:

NOTE: Tested with a valid cause value among:

#1 call is not end to end PLMN/ISDN

#2 destination address is non PLMN/ISDN

#3 originating address is non PLMN/ISDN

#8 in band information or appropriate pattern now available or any value in the set #(6-20).

26.8.1.2.4.5 Outgoing call / U3 MS originating call proceeding / DISCONNECT with in band tones

26.8.1.2.4.5.1 Definition and applicability

The call control entity of the MS being in the state, U3, a DISCONNECT message indicating availability of in band information is received by the MS. This test is applicable for any equipment supporting at least one mobile originated circuit switched basic service.

26.8.1.2.4.5.2 Conformance requirement

- 1) A CC-entity of the MS in CC-state U3, "Mobile Originating Call Proceeding", upon receipt of a DISCONNECT with progress indicator #8, shall through-connect the speech channel to make in-band announcements available, if traffic channel is in speech mode. If TCH is not in speech mode, the MS shall send a RELEASE message.

References

GSM 04.08 section 5.2.1.4., GSM 04.08 section 5.4.4.

26.8.1.2.4.5.3 Test purpose

To verify that a CC-entity of the MS in CC-state U3, "Mobile Originating Call Proceeding", upon receipt of a DISCONNECT with progress indicator #8 through-connects the speech channel to make in-band announcements available, if traffic channel is in speech mode. If TCH is not in speech mode, the MS sends a RELEASE message.

26.8.1.2.4.5.4 Method of test

Related PICS/PIXIT statements

- supported MO circuit switched basic services.

Initial conditions

System Simulator:

1 cell, default parameters.

Mobile Station:

The MS is in MM-state "idle, updated" with valid TMSI and CKSN.

The MS is brought into the state U3 by using table 26.8.1.2/2.

Foreseen final state of the MS

U12, disconnect indication.

Maximum duration of test

30 s.

Test procedure

An MO circuit switched basic service is selected that is supported by the MS; if the MS supports MO telephony, the selected basic service is telephony. If necessary, the MS is configured for that basic service. Then, the MS is made to initiate a call. The CC entity of the MS is brought to the state U3. The SS sends a DISCONNECT message containing indication of in-band information availability to the MS. The SS checks that if channel mode is speech, the TCH shall be through connected and the MS enters state U12, disconnect indication. If channel mode is not speech, the TCH shall not be through connected and the MS shall enter state U19, release request.

Expected sequence

Step	Direction	Message	Comments
1	SS -> MS	DISCONNECT	(note)
B2	SS		TCH in speech mode: the SS will check that the audio path for in band tones is attached.
B3	SS -> MS	STATUS ENQUIRY	
B4	MS -> SS	STATUS	cause 30#, state U12
C2	MS -> SS	RELEASE	TCH is not in speech mode:
C3	SS -> MS	STATUS ENQUIRY	
C4	MS -> SS	STATUS	cause 30#, state U19

Specific message contents:

NOTE: the cause value:

#8 in band information or appropriate pattern now available.

26.8.1.2.4.6 Outgoing call / U3 MS originating call proceeding / DISCONNECT without in band tones

26.8.1.2.4.6.1 Definition and applicability

The call control entity of the MS being in the state, U3, a DISCONNECT message is received by the MS. The DISCONNECT message does not contain indication of in-band information availability. This test is applicable for any equipment supporting at least one mobile originated circuit switched basic service.

26.8.1.2.4.6.2 Conformance requirement

- 1) A CC-entity of the MS in CC-state U3, "Mobile Originating Call Proceeding", upon receipt of a DISCONNECT without progress indicator shall return a RELEASE message and enter the CC-state U19, "Release Request"

References

GSM 04.08 section 5.4.4.

26.8.1.2.4.6.3 Test purpose

To verify that a CC-entity of the MS in CC-state U3, "Mobile Originating Call Proceeding", upon receipt of a DISCONNECT without progress indicator returns a RELEASE message and enters the CC-state U19, "Release Request".

26.8.1.2.4.6.4 Method of test

Related PICS/PIXIT statements

- supported MO circuit switched basic services.

Initial conditions

System Simulator:

1 cell, default parameters.

Mobile Station:

The MS is in MM-state "idle, updated" with valid TMSI and CKSN.

The MS is brought into the state U3 by using table 26.8.1.2/2.

Foreseen final state of the MS

U19, release request.

Maximum duration of test

30 s.

Test procedure

An MO circuit switched basic service is selected that is supported by the MS; if the MS supports MO telephony, the selected basic service is telephony. If necessary, the MS is configured for that basic service. Then, the MS is made to initiate a call. The CC entity of the MS is brought to the state U3. The SS sends a DISCONNECT message not containing indication of in-band information availability to the MS. The MS shall respond with a RELEASE message. The SS checks by using the status enquiry procedure that the CC entity of the MS has entered the state U19, release request.

Expected sequence

Step	Direction	Message	Comments
1	SS -> MS	DISCONNECT	
2	MS -> SS	RELEASE	
3	SS -> MS	STATUS ENQUIRY	
4	MS -> SS	STATUS	cause 30#, state U19

Specific message contents:

None.

26.8.1.2.4.7 Outgoing call / U3 MS originating call proceeding / RELEASE received

26.8.1.2.4.7.1 Definition and applicability

The call control entity of the MS being in the state, U3, a RELEASE message is received by the MS. This test is applicable for any equipment supporting at least one mobile originated circuit switched basic service.

26.8.1.2.4.7.2 Conformance requirement

- 1) A CC-entity of the MS in CC-state U3, "Mobile Originating Call Proceeding", upon receipt of a RELEASE will return a RELEASE COMPLETE and enter the CC-state U0, "Null".
- 2) The MS on returning to the idle mode shall release the MM-connection and the CC-entities relating to the seven mobile originating transaction identifiers shall be in CC-state U0, "Null".
- 3) On releasing the MM-connection, the MS shall wait for MM layer release initiated by the network.

References

Conformance requirement 1: GSM 04.08 section 5.4.2., GSM 04.08 section 5.4.4.

Conformance requirement 2: GSM 04.08 section 4.5.3., GSM 04.08 section 5.5.3.2.

Conformance requirement 3: GSM 04.08, section 5.4.4.3, GSM 04.08, section 4.5.3, GSM 04.08, section 3.4.13.1

26.8.1.2.4.7.3 Test purpose

- 1) To verify that a CC-entity of the MS in CC-state U3, "Mobile Originating Call Proceeding", upon receipt of a RELEASE will return a RELEASE COMPLETE and enter the CC-state U0, "Null".
- 2) To verify that the MS on returning to the idle mode releases the MM-connection and that the CC-entities relating to the seven mobile originating transaction identifiers are in CC-state U0, "Null".
- 3) To verify that in releasing the MM-connection, the MS shall wait for MM layer release initiated by SS.

26.8.1.2.4.7.4 Method of test

Related PICS/PIXIT statements

- supported MO circuit switched basic services.

Initial conditions

System Simulator:

1 cell, default parameters.

Mobile Station:

The MS is in MM-state "idle, updated" with valid TMSI and CKSN.

The MS is brought into the state U3 by using table 26.8.1.2/2.

Foreseen final state of the MS

U0, null.

Maximum duration of test

1 min 30 s.

Test procedure

An MO circuit switched basic service is selected that is supported by the MS; if the MS supports MO telephony, the selected basic service is telephony. If necessary, the MS is configured for that basic service. Then, the MS is made to initiate a call. The CC entity of the MS is brought to the state U3. The SS sends a RELEASE message to the MS. The MS shall respond with a RELEASE COMPLETE message. The SS checks by using the status enquiry procedure that the CC entity has entered the state U0 with all the relevant transaction identifiers.

Expected sequence

Step	Direction	Message	Comments
1	SS -> MS	RELEASE	with cause "Normal, unspecified"
2	MS -> SS	RELEASE COMPLETE	
3	SS -> MS	STATUS ENQUIRY	cause 81# (invalid TI value) repeat steps 3-4 to cover all the transaction identifiers from 000...110
4	MS -> SS	RELEASE COMPLETE	
5	SS		
6	SS -> MS	CHANNEL RELEASE	the main signalling link shall be released by the MS (L2: DISC/UA).

Specific message contents:

None.

26.8.1.2.4.8 Outgoing call / U3 MS originating call proceeding / termination requested by the user

26.8.1.2.4.8.1 Definition and applicability

The call control entity of the MS being in the state, U3, the user requests to terminate the call. This test is applicable for any equipment supporting at least one mobile originated circuit switched basic service.

26.8.1.2.4.8.2 Conformance requirement

- 1) A CC-entity of the MS in CC-state U3, "Mobile Originating Call Proceeding", upon request by the user to terminate will send a DISCONNECT message and enter the CC-state U11, "Disconnect Request".

References

GSM 04.07 section 6.2.2., GSM 04.08 section 5.4.3.

26.8.1.2.4.8.3 Test purpose

To verify that a CC-entity of the MS in CC-state U3, "Mobile Originating Call Proceeding", upon request by the user to terminate will send a DISCONNECT message and enter the CC-state U11, "Disconnect Request".

26.8.1.2.4.8.4 Method of test

Related PICS/PIXIT statements

- supported MO circuit switched basic services.

Initial conditions

System Simulator: 1 cell, default parameters.

Mobile Station: The MS is in MM-state "idle, updated" with valid TMSI and CKSN.

The MS is brought into the state U3 by using table 26.8.1.2/3.

Foreseen final state of the MS

U11, disconnect request.

Maximum duration of test

30 s.

Test procedure

An MO circuit switched basic service is selected that is supported by the MS; if the MS supports MO telephony, the selected basic service is telephony. If necessary, the MS is configured for that basic service. Then, the MS is made to initiate a call. The CC entity of the MS is brought to the state U3. The user requests termination of the call. The MS shall send a DISCONNECT message. The SS checks by using the status enquiry procedure that the CC entity has entered the state U11, disconnect request.

Expected sequence

Step	Direction	Message	Comments
1			MMI action, terminate call
2	MS -> SS	DISCONNECT	
3	SS -> MS	STATUS ENQUIRY	
4	MS -> SS	STATUS	cause 30#, state U11

Specific message contents:

None.

26.8.1.2.4.9 Outgoing call / U3 MS originating call proceeding / traffic channel allocation

26.8.1.2.4.9.1 Definition and applicability

The call control entity of the MS being in the state, U3, a traffic channel assignment procedure is performed. This test is applicable for any equipment supporting at least one mobile originated circuit switched basic service.

26.8.1.2.4.9.2 Conformance requirement

- 1) A CC-entity of the MS in CC-state U3, "Mobile Originating Call Proceeding", when allocated a traffic channel by the network performing the assignment procedure, shall perform a layer 2 establishment on the FACCH without changing the state of the call in progress.

References

GSM 04.08 section 3.4.3., GSM 04.08 section 5.2.1.9.

26.8.1.2.4.9.3 Test purpose

To verify that a CC-entity of the MS in CC-state U3, "Mobile Originating Call Proceeding", when allocated a traffic channel by the network performing the assignment procedure, performs a layer 2 establishment on the FACCH without changing the state of the call in progress.

26.8.1.2.4.9.4 Method of test

Related PICS/PIXIT statements

- supported MO circuit switched basic services.

Initial conditions

System Simulator:

1 cell, default parameters.

Mobile Station:

The MS is in MM-state "idle, updated" with valid TMSI and CKSN.

The MS is brought into the state U3 by using table 26.8.1.2/3.

Foreseen final state of the MS

U3, mobile originating call proceeding.

Maximum duration of test

30 s.

Test procedure

An MO circuit switched basic service is selected that is supported by the MS; if the MS supports MO telephony, the selected basic service is telephony. If necessary, the MS is configured for that basic service. Then, the MS is made to initiate a call. The CC entity of the MS is brought to the state U3. The SS sends an ASSIGNMENT COMMAND for traffic channel to the MS. The MS shall establish layer 2 link on the newly allocated channel and respond with an ASSIGNMENT COMPLETE message. The SS checks by using the status enquiry procedure that the state of the CC entity has remained unchanged.

Expected sequence

Step	Direction	Message	Comments
1	SS -> MS	ASSIGNMENT COMMAND	(TCH) the MS shall perform L2 establishment on the FACCH cause 30#, state U3
2	MS -> SS	ASSIGNMENT COMPLETE	
3	SS -> MS	STATUS ENQUIRY	
4	MS -> SS	STATUS	

Specific message contents:

None.

26.8.1.2.4.10 Outgoing call / U3 MS originating call proceeding / timer T310 time-out

26.8.1.2.4.10.1 Definition and applicability

The call control entity of the MS being in the state, U3, if no response is then received from the SS, timer T310 expires at the MS side. This test is applicable for any equipment supporting at least one mobile originated circuit switched basic service.

26.8.1.2.4.10.2 Conformance requirement

- 1) A CC-entity of the MS in CC-state U3, "Mobile Originating Call Proceeding" shall, upon expiry of timer T310, and not before, initiate call release by sending DISCONNECT and enter the CC-state U11, "Disconnect Request".

References

GSM 04.08 section 5.2.1.3./Abnormal case, GSM 04.08 section 5.4.3, GSM 04.08 section 11.3.

26.8.1.2.4.10.3 Test purpose

To verify that a CC-entity of the MS in CC-state U3, "Mobile Originating Call Proceeding" will, upon expiry of timer T310 (accuracy minus 2 %, plus 50 %), initiate call release by sending DISCONNECT and enter the CC-state U11, "Disconnect Request".

26.8.1.2.4.10.4 Method of test

Related PICS/PIXIT statements

- supported MO circuit switched basic services.

Initial conditions

System Simulator:

1 cell, default parameters.

Mobile Station:

The MS is in MM-state "idle, updated" with valid TMSI and CKSN.

The MS is brought into the state U3 by using table 26.8.1.2/3.

Foreseen final state of the MS

U11, disconnect request.

Maximum duration of test

1 min.

Test procedure

An MO circuit switched basic service is selected that is supported by the MS; if the MS supports MO telephony, the selected basic service is telephony. If necessary, the MS is configured for that basic service. Then, the MS is made to initiate a call. The CC entity of the MS is brought to the state U3. The T310 expires at the MS and the MS shall send DISCONNECT. The SS checks timer T310 accuracy and that the CC entity has entered the state U11, disconnect request.

Expected sequence

Step	Direction	Message	Comments
1	SS		the SS waits for T310 time-out
2	MS -> SS	DISCONNECT	check the timer T310 accuracy (minus 2 % to plus 50 %)
3	SS -> MS	STATUS ENQUIRY	
4	MS -> SS	STATUS	cause 30#, state U11

Specific message contents:

None.

26.8.1.2.4.11 Outgoing call / U3 MS originating call proceeding / lower layer failure

26.8.1.2.4.11.1 Definition and applicability

The call control entity of the MS being in the state, U3, a lower layer failure is accomplished at the MS and consequently, communication at layer 3 level with the peer entity is terminated. This test is applicable for any equipment supporting at least one mobile originated circuit switched basic service.

26.8.1.2.4.11.2 Conformance requirement

- 1) If a CC-entity of the MS in CC-state U3, "Mobile Originating Call Proceeding" has detected a lower layer failure and has returned to idle mode, the CC entities relating to the seven mobile originating transaction identifiers shall be in state U0, "Null".

References

GSM 04.08 section 4.5.2.3., GSM 04.08 section 4.5.3., GSM 04.08 section 5.5.3.2., GSM 04.08 section 3.4.13.2.1

26.8.1.2.4.11.3 Test purpose

To verify that a CC-entity of the MS in CC-state U3, "Mobile Originating Call Proceeding" having detected a lower layer failure and having returned to idle mode, the CC entities relating to the seven mobile originating transaction identifiers are in state U0, "Null".

26.8.1.2.4.11.4 Method of test

Related PICS/PIXIT statements

- supported MO circuit switched basic services.

Initial conditions

System Simulator:

1 cell, default parameters.

Mobile Station:

The MS is in MM-state "idle, updated" with valid TMSI and CKSN.

The MS is brought into the state U3 by using table 26.8.1.2/4.

Foreseen final state of the MS

U0, null.

Maximum duration of test

1 min 30 s.

Test procedure

An MO circuit switched basic service is selected that is supported by the MS; if the MS supports MO telephony, the selected basic service is telephony. If necessary, the MS is configured for that basic service. Then, the MS is made to initiate a call. The MS is brought to the state U3. The SS generates a lower layer failure at the MS. The SS waits long enough to enable the MS to return to idle state listening to paging, and then pages MS to create RR-connection. Finally, the SS will check the state of the MS by using STATUS ENQUIRY with the relevant transaction identifiers.

Expected sequence

Step	Direction	Message	Comments
1	SS		SS generates lower layer failure
2	SS		SS waits 20 s for the MS to return to listening to paging
3	SS -> MS	PAGING REQUEST	
4	MS -> SS	CHANNEL REQUEST	
5	SS -> MS	IMMEDIATE ASSIGNMENT	
6	MS -> SS	PAGING RESPONSE	
7	SS -> MS	STATUS ENQUIRY	
8	MS -> SS	RELEASE COMPLETE	cause 81# (invalid TI value)
9	SS		repeat steps 18-19 to cover all the transaction identifiers from 000...110
10	SS -> MS	CHANNEL RELEASE	the main signalling link shall be released by the MS (L2: DISC/UA).

Specific message contents:

None.

26.8.1.2.4.12 Outgoing call / U3 MS originating call proceeding / unknown message received

26.8.1.2.4.12.1 Definition and applicability

The call control entity of the MS being in the state, U3, an unknown message is received by the MS. This test is applicable for any equipment supporting at least one mobile originated circuit switched basic service.

26.8.1.2.4.12.2 Conformance requirement

- 1) A CC-entity of the MS in CC-state U3, "Mobile Originating Call Proceeding" having received an unknown message from its peer entity shall return a STATUS message.

References

GSM 04.08 section 8.5.

26.8.1.2.4.12.3 Test purpose

To verify that a CC-entity of the MS in CC-state U3, "Mobile Originating Call Proceeding" having received an unknown message from its peer entity returns a STATUS message.

26.8.1.2.4.12.4 Method of test

Related PICS/PIXIT statements

- supported MO circuit switched basic services.

Initial conditions

System Simulator:

1 cell, default parameters.

Mobile Station:

The MS is in MM-state "idle, updated" with valid TMSI and CKSN.

The MS is brought into the state U3 by using table 26.8.1.2/1.

Foreseen final state of the MS

U3, mobile originating call proceeding.

Maximum duration of test

30 s.

Test procedure

An MO circuit switched basic service is selected that is supported by the MS; if the MS supports MO telephony, the selected basic service is telephony. If necessary, the MS is configured for that basic service. Then, the MS is made to initiate a call. The CC entity of the MS is brought to the state U3. The SS sends a message with message type not defined for the protocol discriminator to the MS. The MS shall respond with a STATUS message, and finally the SS checks by using the status enquiry procedure that the state of the CC entity has remained unchanged.

Expected sequence

Step	Direction	Message	Comments
1	SS -> MS	unknown message	message type not defined for PD
2	MS -> SS	STATUS	cause 97#, state U3
3	SS -> MS	STATUS ENQUIRY	
4	MS -> SS	STATUS	cause 30#, state U3

Specific message contents:

None.

26.8.1.2.4.13 Outgoing call / U3 MS originating call proceeding / Internal alerting indication

26.8.1.2.4.13.1 Definition and applicability

The call control entity of the MS being in the state, U3, an ALERTING message is sent to the MS when the user connection is not attached to the radio path. This test is applicable for any equipment supporting mobile originated circuit switched basic service for telephony.

26.8.1.2.4.13.2 Conformance requirement

- 1) When the call control entity of the MS in the "mobile originating call proceeding" state receives an ALERTING message then it shall enter "call delivered" state and, for speech calls, if the user connection is not attached to the radio path, the MS shall internally generate an alerting indication.

References

GSM 04.08 section 5.2.1.5.

26.8.1.2.4.13.3 Test purpose

When the call control entity of the MS in the "mobile originating call proceeding" state receives an ALERTING message then it enters "call delivered" state and, for speech calls, if the user connection is not attached to the radio path, the MS generates internally an alerting indication.

26.8.1.2.4.13.4 Method of test

Related PICS/PIXIT statements

- supported MO circuit switched basic services.
- way to give internally generated alerting indication for outgoing calls

Initial conditions

System Simulator:

1 cell, default parameters.

Mobile Station:

The MS is in MM-state "idle, updated" with valid TMSI and CKSN.

The MS is brought into the state U3 by using table 26.8.1.2/1.

Foreseen final state of the MS

U4, call delivered.

Maximum duration of test

30 s.

Test procedure

The SS sends an ALERTING message to the MS. The SS checks by using the status enquiry procedure that the CC entity has entered the state U4, call delivered. Also it is checked that the MS generates internally alerting indication to the user in the way described in the PICX/PIXIT statements.

Expected sequence

Step	Direction	Message	Comments
1	SS -> MS	ALERTING	the MS shall generate an alerting indication to the user in the way described in the PICS/PIXIT statements cause 30#, state U4
2	SS -> MS	STATUS ENQUIRY	
3	MS -> SS	STATUS	

Specific message contents:

None.

26.8.1.2.5 Outgoing call / U4 call delivered

26.8.1.2.5.1 Outgoing call / U4 call delivered / CONNECT received

26.8.1.2.5.1.1 Definition and applicability

The call control entity of the MS being in the state, U4, a CONNECT message is received by the MS. This test is applicable for any equipment supporting at least one mobile originated circuit switched basic service.

26.8.1.2.5.1.2 Conformance requirement

- 1) A CC-entity of the MS in CC-state U4, "Call Delivered", upon receipt of the CONNECT message shall return a CONNECT ACKNOWLEDGE to its peer entity and enter the CC-state U10, "Active".

References

GSM 04.08 section 5.2.1.6.

26.8.1.2.5.1.3 Test purpose

To verify that a CC-entity of the MS in CC-state U4, "Call Delivered", upon receipt of the CONNECT message returns a CONNECT ACKNOWLEDGE to its peer entity and enters the CC-state U10, "Active".

26.8.1.2.5.1.4 Method of test

Related PICS/PIXIT statements

- supported MO circuit switched basic services.

Initial conditions

System Simulator:

1 cell, default parameters.

Mobile Station:

The MS is in MM-state "idle, updated" with valid TMSI and CKSN.

The MS is brought into the state U4 by using table 26.8.1.2/3.

Foreseen final state of the MS

U10, active.

Maximum duration of test

30 s.

Test procedure

An MO circuit switched basic service is selected that is supported by the MS; if the MS supports MO telephony, the selected basic service is telephony. If necessary, the MS is configured for that basic service. Then, the MS is made to initiate a call. The CC entity of the MS is brought to the state U4. The SS sends a CONNECT message to the MS. The MS shall respond by sending a CONNECT ACKNOWLEDGE message. The SS checks by using the status enquiry procedure that the CC entity has entered the state U10, active.

Expected sequence

Step	Direction	Message	Comments
1	SS -> MS	CONNECT	
2	MS -> SS	CONNECT ACKNOWLEDGE	MS stops alerting, if applicable
3	SS -> MS	STATUS ENQUIRY	
4	MS -> SS	STATUS	cause 30#, state U10

Specific message contents:

None.

26.8.1.2.5.2 Outgoing call / U4 call delivered / termination requested by the user

26.8.1.2.5.2.1 Definition and applicability

The call control entity of the MS being in the state, U4, the user requests to terminate the call. This test is applicable for any equipment supporting at least one mobile originated circuit switched basic service.

26.8.1.2.5.2.2 Conformance requirement

- 1) A CC-entity of the MS in CC-state U4, "Call Delivered", upon request by the user to terminate shall send a DISCONNECT message and enter the CC-state U11, "Disconnect Request".

References

GSM 04.07 section 6.2.2., GSM 04.08 section 5.4.3.

26.8.1.2.5.2.3 Test purpose

To verify that a CC-entity of the MS in CC-state U4, "Call Delivered", upon request by the user to terminate will send a DISCONNECT message and enter the CC-state U11, "Disconnect Request".

26.8.1.2.5.2.4 Method of test

Related PICS/PIXIT statements

- supported MO circuit switched basic services.

Initial conditions

System Simulator:

1 cell, default parameters.

Mobile Station:

The MS is in MM-state "idle, updated" with valid TMSI and CKSN.

The MS is brought into the state U4 by using table 26.8.1.2/3.

Foreseen final state of the MS

U11, disconnect request.

Maximum duration of test

30 s.

Test procedure

An MO circuit switched basic service is selected that is supported by the MS; if the MS supports MO telephony, the selected basic service is telephony. If necessary, the MS is configured for that basic service. Then, the MS is made to initiate a call. The CC entity of the MS is brought to the state U4. The user requests termination of the call. The MS shall send a DISCONNECT message. The SS checks by using the status enquiry procedure that the CC entity has entered the state U11, disconnect request.

Expected sequence

Step	Direction	Message	Comments
1			MMI action, terminate call
2	MS -> SS	DISCONNECT	
3	SS -> MS	STATUS ENQUIRY	
4	MS -> SS	STATUS	cause 30#, state U11

Specific message contents:

None.

26.8.1.2.5.3 Outgoing call / U4 call delivered / DISCONNECT with in band tones

26.8.1.2.5.3.1 Definition and applicability

The call control entity of the MS being in the state, U4, a DISCONNECT message indicating availability of in band information is received by the MS. This test is applicable for any equipment supporting at least one mobile originated circuit switched basic service.

26.8.1.2.5.3.2 Conformance requirement

- 1) A CC-entity of the MS in CC-state U4, "Call Delivered" shall, upon receipt of a DISCONNECT with a progress indicator indicating in-band information, shall through-connect the speech channel to make in-band announcements available, if traffic channel is in speech mode. If TCH is not in speech mode, the MS shall send a RELEASE message.

References

GSM 04.08 section 3.4.3, GSM 04.08 section 5.4.4.1., GSM 04.08 section 5.5.1., GSM 04.08 section 5.2.1.9.

26.8.1.2.5.3.3 Test purpose

To verify that a CC-entity of the MS in CC-state U4, "Call Delivered", upon receipt of a DISCONNECT with a progress indicator indicating in-band information, through-connects the speech channel to make in-band announcements available, if traffic channel is in speech mode. If TCH is not in speech mode, the MS shall send a RELEASE message.

26.8.1.2.5.3.4 Method of test

Related PICS/PIXIT statements

- supported MO circuit switched basic services.

Initial conditions

System Simulator:

1 cell, default parameters.

Mobile Station:

The MS is in MM-state "idle, updated" with valid TMSI and CKSN.

The MS is brought into the state U4 by using table 26.8.1.2/2.

Foreseen final state of the MS

U12, disconnect indication.

Maximum duration of test

30 s.

Test procedure

An MO circuit switched basic service is selected that is supported by the MS; if the MS supports MO telephony, the selected basic service is telephony. If necessary, the MS is configured for that basic service. Then, the MS is made to initiate a call. The CC entity of the MS is brought to the state U4. The SS sends a DISCONNECT message containing indication of in-band information availability to the MS. The SS checks that if channel mode is MO telephony, the TCH shall be through connected and the MS enters state U12, disconnect indication. If channel mode is not speech, the TCH shall not be through connected and the MS shall enter state U19, release request.

Expected sequence

Step	Direction	Message	Comments
1	SS -> MS	DISCONNECT	(note)
A2	SS		TCH in speech mode: the SS will check that the audio path for in band tones is attached.
A3	SS -> MS	STATUS ENQUIRY	
A4	MS -> SS	STATUS	cause 30#, state U12
B2	MS -> SS	RELEASE	TCH is not in speech mode:
B3	SS -> MS	STATUS ENQUIRY	
B4	MS -> SS	STATUS	cause 30#, state U19

Specific message contents:

NOTE: the Progress Indicator, Progress Description:

#8 in band information or appropriate pattern now available.

26.8.1.2.5.4 Outgoing call / U4 call delivered / DISCONNECT without in band tones

26.8.1.2.5.4.1 Definition and applicability

The call control entity of the MS being in the state, U4, a DISCONNECT message is received by the MS. The DISCONNECT message does not contain indication of in-band information availability. This test is applicable for any equipment supporting at least one mobile originated circuit switched basic service.

26.8.1.2.5.4.2 Conformance requirement

- 1) A CC-entity of the MS in CC-state U4, "Call Delivered", upon receipt of a DISCONNECT without progress indicator, shall return a RELEASE message and enter the CC-state U19, "Release Request".

References

GSM 04.08 section 5.4.4.

26.8.1.2.5.4.3 Test purpose

To verify that a CC-entity of the MS in CC-state U4, "Call Delivered", upon receipt of a DISCONNECT without progress indicator, returns a RELEASE message and enters the CC-state U19, "Release Request".

26.8.1.2.5.4.4 Method of test

Related PICS/PIXIT statements

- supported MO circuit switched basic services.

Initial conditions

System Simulator:

1 cell, default parameters.

Mobile Station:

The MS is in MM-state "idle, updated" with valid TMSI and CKSN.

The MS is brought into the state U4 by using table 26.8.1.2/2.

Foreseen final state of the MS

U19, release request.

Maximum duration of test

30 s.

Test procedure

An MO circuit switched basic service is selected that is supported by the MS; if the MS supports MO telephony, the selected basic service is telephony. If necessary, the MS is configured for that basic service. Then, the MS is made to initiate a call. The CC entity of the MS is brought to the state U4. The SS sends a DISCONNECT message not containing indication of in-band information availability to the MS. The MS shall respond with a RELEASE message. The SS checks by using the status enquiry procedure that the CC entity of the MS has entered the state U19, release request.

Expected sequence

Step	Direction	Message	Comments
1	SS -> MS	DISCONNECT	
2	MS -> SS	RELEASE	
3	SS -> MS	STATUS ENQUIRY	
4	MS -> SS	STATUS	cause 30#, state U19

Specific message contents:

None.

26.8.1.2.5.5 Outgoing call / U4 call delivered / RELEASE received

26.8.1.2.5.5.1 Definition and applicability

The call control entity of the MS being in the state, U4, a RELEASE message is received by the MS. This test is applicable for any equipment supporting at least one mobile originated circuit switched basic service.

26.8.1.2.5.5.2 Conformance requirement

- 1) A CC-entity of the MS in CC-state U4, "Call Delivered", upon receipt of the RELEASE message shall respond with the RELEASE COMPLETE message and enter the CC-state U0, "Null".
- 2) The MS on returning to idle mode shall release the MM-connection and the CC-entities relating to the seven mobile originating transaction identifiers shall be in CC-state U0, "Null".

References

Conformance requirement 1: GSM 04.08 section 5.4.2., GSM 04.08 section 5.4.4.

Conformance requirement 2: GSM 04.08 section 4.5.3., GSM 04.08 section 5.5.3.2.

26.8.1.2.5.5.3 Test purpose

- 1) To verify that a CC-entity of the MS in CC-state U4, "Call Delivered", upon receipt of the RELEASE message will respond with the RELEASE COMPLETE message and enter the CC-state U0, "Null".
- 2) To verify that the MS on returning the idle mode releases the MM-connection and that the CC-entities relating to the seven mobile originating transaction identifiers are in CC-state U0, "Null".

26.8.1.2.5.5.4 Method of test

Related PICS/PIXIT statements

- supported MO circuit switched basic services.

Initial conditions

System Simulator:

1 cell, default parameters.

Mobile Station:

The MS is in MM-state "idle, updated" with valid TMSI and CKSN.

The MS is brought into the state U4 by using table 26.8.1.2/2.

Foreseen final state of the MS

U0, null.

Maximum duration of test

1 min 30 s.

Test procedure

An MO circuit switched basic service is selected that is supported by the MS; if the MS supports MO telephony, the selected basic service is telephony. If necessary, the MS is configured for that basic service. Then, the MS is made to initiate a call. The CC entity of the MS is brought to the state U4. The SS sends a RELEASE message to the MS. The MS shall respond with a RELEASE COMPLETE message. The SS checks by using the status enquiry procedure that the CC entity has entered the state U0 with all the relevant transaction identifiers.

Expected sequence

Step	Direction	Message	Comments
1	SS -> MS	RELEASE	with cause "Normal, unspecified"
2	MS -> SS	RELEASE COMPLETE	
3	SS -> MS	STATUS ENQUIRY	cause 81# (invalid TI value) repeat steps 19-20 to cover all the transaction identifiers from 000...110
4	MS -> SS	RELEASE COMPLETE	
5	SS		
6	SS -> MS	CHANNEL RELEASE	the main signalling link shall be released by the MS (L2: DISC/UA).

Specific message contents:

None.

26.8.1.2.5.6 Outgoing call / U4 call delivered / lower layer failure

26.8.1.2.5.6.1 Definition and applicability

The call control entity of the MS being in the state, U4, a lower layer failure is accomplished at the MS and consequently, communication at layer 3 level with the peer entity is terminated. This test is applicable for any equipment supporting at least one mobile originated circuit switched basic service.

26.8.1.2.5.6.2 Conformance requirement

- 1) When CC-entity of the MS in CC-state U4, "Call Delivered" has detected a lower layer failure and has returned to idle mode, the CC-entities relating to the seven mobile originating transaction identifiers shall be in CC-state U0, "Null".

References

GSM 04.08 section 4.5.2.3., GSM 04.08 section 4.5.3., GSM 04.08 section 5.5.3.2., GSM 04.08 section 3.4.13.2.1

26.8.1.2.5.6.3 Test purpose

To verify that a CC-entity of the MS in CC-state U4, "Call Delivered" having detected a lower layer failure and has returned to idle mode, the CC-entities relating to the seven mobile originating transaction identifiers are in CC-state U0, "Null".

26.8.1.2.5.6.4 Method of test

Related PICS/PIXIT statements

- supported MO circuit switched basic services.

Initial conditions

System Simulator:

1 cell, default parameters.

Mobile Station:

The MS is in MM-state "idle, updated" with valid TMSI and CKSN.

The MS is brought into the state U4 by using table 26.8.1.2/2.

Foreseen final state of the MS

U0, null.

Maximum duration of test

1 min 30 s.

Test procedure

An MO circuit switched basic service is selected that is supported by the MS; if the MS supports MO telephony, the selected basic service is telephony. If necessary, the MS is configured for that basic service. Then, the MS is made to initiate a call. The MS is brought to the state U4. The SS generates a lower layer failure at the MS. The SS waits long enough to enable the MS to return to idle state listening to paging, and then pages MS to create RR-connection. Finally, the SS will check the state of the MS by using STATUS ENQUIRY with the relevant transaction identifiers.

Expected sequence

Step	Direction	Message	Comments
1	SS		SS generates lower layer failure
2	SS		SS waits 20 s for the MS to return to listening to paging
3	SS -> MS	PAGING REQUEST	
4	MS -> SS	CHANNEL REQUEST	
5	SS -> MS	IMMEDIATE ASSIGNMENT	
6	MS -> SS	PAGING RESPONSE	
7	SS -> MS	STATUS ENQUIRY	
8	MS -> SS	RELEASE COMPLETE	cause 81# (invalid TI value)
9	SS		repeat steps 7-8 to cover all the transaction identifiers from 000...110
10	SS -> MS	CHANNEL RELEASE	the main signalling link shall be released by the MS (L2: DISC/UA).

Specific message contents:

None.

26.8.1.2.5.7 Outgoing call / U4 call delivered / traffic channel allocation

26.8.1.2.5.7.1 Definition and applicability

The call control entity of the MS being in the state, U4, a traffic channel assignment procedure is performed. This test is applicable for any equipment supporting at least one mobile originated circuit switched basic service.

26.8.1.2.5.7.2 Conformance requirement

- 1) A CC-entity of the MS in CC-state U4, "Call Delivered", when allocated a traffic channel by the network performing the assignment procedure, shall perform a layer 2 establishment on the FACCH without changing the state of the call in progress.

References

GSM 04.08 section 3.4.3., GSM 04.08 section 5.2.1.9.

26.8.1.2.5.7.3 Test purpose

To verify that a CC-entity of the MS in CC-state U4, "Call Delivered", when allocated a traffic channel by the network performing the assignment procedure, shall perform a layer 2 establishment on the FACCH without changing the state of the call in progress.

26.8.1.2.5.7.4 Method of test

Related PICS/PIXIT statements

- supported MO circuit switched basic services.

Initial conditions

System Simulator:

1 cell, default parameters.

Mobile Station:

The MS is in MM-state "idle, updated" with valid TMSI and CKSN.

The MS is brought into the state U4 by using table 26.8.1.2/1.

Foreseen final state of the MS

U4, call delivered.

Maximum duration of test

30 s.

Test procedure

An MO circuit switched basic service is selected that is supported by the MS; if the MS supports MO telephony, the selected basic service is telephony. If necessary, the MS is configured for that basic service. Then, the MS is made to initiate a call. The CC entity of the MS is brought to the state U4. The SS sends an ASSIGNMENT COMMAND for traffic channel to the MS. The MS shall establish layer 2 link on the newly allocated channel and respond with an ASSIGNMENT COMPLETE message. The SS checks by using the status enquiry procedure that the state of the CC entity has remained unchanged.

Expected sequence

Step	Direction	Message	Comments
1	SS -> MS	ASSIGNMENT COMMAND	TCH, the MS shall perform L2 establishment on the FACCH
2	MS -> SS	ASSIGNMENT COMPLETE	
3	SS -> MS	STATUS ENQUIRY	
4	MS -> SS	STATUS	cause 30#, state U4

Specific message contents:

None.

26.8.1.2.5.8 Outgoing call / U4 call delivered / unknown message received

26.8.1.2.5.8.1 Definition and applicability

The call control entity of the MS being in the state, U4, an unknown message is received by the MS. This test is applicable for any equipment supporting at least one mobile originated circuit switched basic service.

26.8.1.2.5.8.2 Conformance requirement

- 1) A CC-entity of the MS in CC-state U4, "Call Delivered", having received an unknown message from its peer entity shall return a STATUS message.

References

GSM 04.08 section 8.4.

26.8.1.2.5.8.3 Test purpose

To verify that a CC-entity of the MS in CC-state U4, "Call Delivered", having received an unknown message from its peer entity returns a STATUS message.

26.8.1.2.5.8.4 Method of test

Related PICS/PIXIT statements

- supported MO circuit switched basic services.

Initial conditions

System Simulator:

1 cell, default parameters.

Mobile Station:

The MS is in MM-state "idle, updated" with valid TMSI and CKSN.

The MS is brought into the state U4 by using table 26.8.1.2/4.

Foreseen final state of the MS

U4, call delivered.

Maximum duration of test

30 s.

Test procedure

An MO circuit switched basic service is selected that is supported by the MS; if the MS supports MO telephony, the selected basic service is telephony. If necessary, the MS is configured for that basic service. Then, the MS is made to initiate a call. The CC entity of the MS is brought to the state U4. The SS sends a message with message type not defined for the protocol discriminator to the MS. The MS shall respond with a STATUS message, and finally the SS checks by using the status enquiry procedure that the state of the CC entity has remained unchanged.

Expected sequence

Step	Direction	Message	Comments
1	SS -> MS	unknown message	message type not defined for PD
2	MS -> SS	STATUS	cause 97#, state U4
3	SS -> MS	STATUS ENQUIRY	
4	MS -> SS	STATUS	cause 30#, state U4

Specific message contents:

None.

26.8.1.2.6 U10 call active

26.8.1.2.6.1 U10 call active / termination requested by the user

26.8.1.2.6.1.1 Definition and applicability

The call control entity of the MS being in the state, U10, the user requests to terminate the call. This test is applicable for any equipment supporting at least one mobile originated circuit switched basic service.

26.8.1.2.6.1.2 Conformance requirement

- 1) A CC-entity of the MS in CC-state U10, "Call Active", upon request by the user to terminate shall send a DISCONNECT message and enter the CC-state U11, "Disconnect Request".

References

GSM 04.07 section 6.2.2., GSM 04.08 section 5.4.3.

26.8.1.2.6.1.3 Test purpose

To verify that the a CC-entity of the MS in CC-state U10, "Call Active", upon request by the user to terminate will send a DISCONNECT message and enter the CC-state U11, "Disconnect Request".

26.8.1.2.6.1.4 Method of test

Related PICS/PIXIT statements

- supported MO circuit switched basic services.

Initial conditions

System Simulator:

1 cell, default parameters.

Mobile Station:

The MS is in MM-state "idle, updated" with valid TMSI and CKSN.

The MS is brought into the state U10 by using table 26.8.1.2/1.

Foreseen final state of the MS

U11, disconnect request.

Maximum duration of test

30 s.

Test procedure

An MO circuit switched basic service is selected that is supported by the MS; if the MS supports MO telephony, the selected basic service is telephony. If necessary, the MS is configured for that basic service. Then, the MS is made to initiate a call. The CC entity of the MS is brought to the state U10. The user requests termination of the call. The MS shall send a DISCONNECT message. The SS checks by using the status enquiry procedure that the CC entity has entered the state U11, disconnect request.

Expected sequence

Step	Direction	Message	Comments
1			MMI action, terminate call
2	MS -> SS	DISCONNECT	U11
3	SS -> MS	STATUS ENQUIRY	
4	MS -> SS	STATUS	cause 30#, state U11

Specific message contents:

None.

26.8.1.2.6.2 U10 call active / RELEASE received

26.8.1.2.6.2.1 Definition and applicability

The call control entity of the MS being in the state, U10, a RELEASE message is received by the MS. This test is applicable for any equipment supporting at least one mobile originated circuit switched basic service.

26.8.1.2.6.2.2 Conformance requirement

- 1) A CC-entity of the MS in CC-state U10, "Call Active", upon receipt of the RELEASE shall respond with the RELEASE COMPLETE message and enter the CC-state U0, "Null"
- 2) When the MS returns to the idle mode it shall release the MM-connection and the CC-entities relating to the seven mobile originating transaction identifiers shall be in CC-state U0, "Null"

References

Conformance requirement 1: GSM 04.08 section 5.4.2., GSM 04.08 section 5.4.4.

Conformance requirement 2: GSM 04.08 section 4.5.3., GSM 04.08 section 5.5.3.2.

26.8.1.2.6.2.3 Test purpose

- 1) To verify that the a CC-entity of the MS in CC-state U10, "Call Active", upon receive of the RELEASE will respond with the RELEASE COMPLETE message and enter the CC-state U0, "Null"
- 2) To verify that the MS on returning to the idle mode releases the MM-connection and that the CC-entities relating to the seven mobile originating transaction identifiers are in CC-state U0, "Null"

26.8.1.2.6.2.4 Method of test

Related PICS/PIXIT statements

- supported MO circuit switched basic services.

Initial conditions

System Simulator:

1 cell, default parameters.

Mobile Station:

The MS is in MM-state "idle, updated" with valid TMSI and CKSN.

The MS is brought into the state U10 by using table 26.8.1.2/1.

Foreseen final state of the MS

U0, null.

Maximum duration of test

1 min 30 s.

Test procedure

An MO circuit switched basic service is selected that is supported by the MS; if the MS supports MO telephony, the selected basic service is telephony. If necessary, the MS is configured for that basic service. Then, the MS is made to initiate a call. The CC entity of the MS is brought to the state U10. The SS sends a RELEASE message to the MS. The MS shall respond with a RELEASE COMPLETE message. The SS checks by using the status enquiry procedure that the CC entity has entered the state U0 with all the relevant transaction identifiers.

Expected sequence

Step	Direction	Message	Comments
1	SS -> MS	RELEASE	with cause "Normal, unspecified"
2	MS -> SS	RELEASE COMPLETE	the MS starts T3240
3	SS -> MS	STATUS ENQUIRY	
4	MS -> SS	RELEASE COMPLETE	cause 81# (invalid TI value)
5	SS		repeat steps 3-4 to cover all the transaction identifiers from 000...110
6	SS -> MS	CHANNEL RELEASE	the main signalling link shall be released by the MS (L2: DISC/UA)

Specific message contents:

None.

26.8.1.2.6.3 U10 call active / DISCONNECT with in band tones

26.8.1.2.6.3.1 Definition and applicability

The call control entity of the MS being in the state, U10, a DISCONNECT message indicating availability of in band information is received by the MS. This test is applicable for any equipment supporting at least one mobile originated circuit switched basic service.

26.8.1.2.6.3.2 Conformance requirement

- 1) A CC-entity of the MS in CC-state U10, "Call Active", upon receipt of a DISCONNECT message with a Progress Indicator indicating in-band information, shall through-connect the speech channel to make in-band announcements available, if traffic channel is in speech mode. If TCH is not in speech mode, the MS shall send a RELEASE message.

References

GSM 04.08 section 5.4.4.1., GSM 04.08 section 5.5.1.

26.8.1.2.6.3.3 Test purpose

To verify that a CC-entity of the MS in CC-state U10, "Call Active", upon receipt of a DISCONNECT message with a Progress Indicator indicating in-band information, through-connects the speech channel to make in-band announcements available, if traffic channel is in speech mode. If TCH is not in speech mode, the MS sends a RELEASE message.

26.8.1.2.6.3.4 Method of test

Related PICS/PIXIT statements

- supported MO circuit switched basic services.

Initial conditions

System Simulator:

1 cell, default parameters.

Mobile Station:

The MS is in MM-state "idle, updated" with valid TMSI and CKSN.

The MS is brought into the state U10 by using table 26.8.1.2/2.

Foreseen final state of the MS

U12, disconnect indication.

Maximum duration of test

30 s.

Test procedure

An MO circuit switched basic service is selected that is supported by the MS; if the MS supports MO telephony, the selected basic service is telephony. If necessary, the MS is configured for that basic service. Then, the MS is made to initiate a call. The CC entity of the MS is brought to the state U10. The SS sends a DISCONNECT message containing

indication of in-band information availability to the MS. The SS checks that if channel mode is speech, the TCH shall be through connected and the MS enters state U12, disconnect indication. If channel mode is not speech, the TCH shall not be through connected and the MS enters state U19, release request.

Expected sequence

Step	Direction	Message	Comments
1	SS -> MS	DISCONNECT	(note)
A2	SS		TCH in speech mode: the SS will check that the audio path for in band tones is attached.
A3	SS -> MS	STATUS ENQUIRY	
A4	MS -> SS	STATUS	cause 30#, state U12
B2	MS -> SS	RELEASE	TCH is not in speech mode:
B3	SS -> MS	STATUS ENQUIRY	
B4	MS -> SS	STATUS	cause 30#, state U19

Specific message contents:

NOTE: the Progress Indicator, Progress Description:

#8 in band information or appropriate pattern now available.

26.8.1.2.6.4 U10 call active / DISCONNECT without in band tones

26.8.1.2.6.4.1 Definition and applicability

The call control entity of the MS being in the state, U10, a DISCONNECT message is received by the MS. The DISCONNECT message does not contain indication of in-band information availability. This test is applicable for any equipment supporting at least one mobile originated circuit switched basic service.

26.8.1.2.6.4.2 Conformance requirement

- 1) A CC-entity of the MS in CC-state U10, "Call Active", upon receipt of a DISCONNECT message without progress indicator, shall return a RELEASE message and enter the CC-state U19, "Release Request".

References

GSM 04.08 section 5.4.4.

26.8.1.2.6.4.3 Test purpose

To verify that the a CC-entity of the MS in CC-state U10, "Call Active", upon receipt of a DISCONNECT message without progress indicator, returns a RELEASE message and enters the CC-state U19, "Release Request".

26.8.1.2.6.4.4 Method of test

Related PICS/PIXIT statements

- supported MO circuit switched basic services.

Initial conditions

System Simulator:

1 cell, default parameters.

Mobile Station:

The MS is in MM-state "idle, updated" with valid TMSI and CKSN.

The MS is brought into the state U10 by using table 26.8.1.2/2.

Foreseen final state of the MS

U19, release request.

Maximum duration of test

30 s.

Test procedure

An MO circuit switched basic service is selected that is supported by the MS; if the MS supports MO telephony, the selected basic service is telephony. If necessary, the MS is configured for that basic service. Then, the MS is made to initiate a call. The CC entity of the MS is brought to the state U10. The SS sends a DISCONNECT message not containing indication of in-band information availability to the MS. The MS shall respond with a RELEASE message. The SS checks by using the status enquiry procedure that the CC entity of the MS has entered the state U19, release request.

Expected sequence

Step	Direction	Message	Comments
1	SS -> MS	DISCONNECT	
2	MS -> SS	RELEASE	
3	SS -> MS	STATUS ENQUIRY	
4	MS -> SS	STATUS	cause 30#, state U19

Specific message contents:

None.

26.8.1.2.6.5 U10 call active / RELEASE COMPLETE received

26.8.1.2.6.5.1 Definition and applicability

The call control entity of the MS being in the state, U10, the call is cleared by a RELEASE COMPLETE message sent by the SS. This test is applicable for any equipment supporting at least one mobile originated circuit switched basic service.

26.8.1.2.6.5.2 Conformance requirement

- 1) A CC entity of the MS in CC-state U10, "active", upon receipt of a RELEASE COMPLETE message with valid cause value, shall enter CC state U0, "Null".
- 2) On returning to idle mode, the CC entities relating to the seven mobile originating transaction identifiers shall be in state U0, "Null".

References

Conformance requirement 1: GSM 04.08, section 5.4.2, GSM 04.08, section 5.4.4.

Conformance requirement 2: GSM 04.08, section 5.4.4.3.

26.8.1.2.6.5.3 Test purpose

- 1) To verify that a CC entity of the MS in CC-state U10, "Call active" upon receipt of a RELEASE COMPLETE message with valid cause value, enters CC state U0, "Null".
- 2) To verify that in returning to idle mode, the CC entities relating to the seven mobile originating transaction identifiers are in state U0, "Null".

26.8.1.2.6.5.4 Method of test

Related PICS/PIXIT statements

- supported MO circuit switched basic services.

Initial conditions

System Simulator:

1 cell, default parameters.

Mobile Station:

The MS is in MM-state "idle, updated" with valid TMSI and CKSN.

The MS is brought into the state U10 by using table 26.8.1.2/2.

Foreseen final state of the MS

U0, null.

Maximum duration of test

30 s.

Test procedure

The SS sends a RELEASE COMPLETE message to the MS. The SS checks by using the status enquiry procedure that the CC entity has entered the state U0 with all the relevant transaction identifiers.

Expected sequence

Step	Direction	Message	Comments
1	SS -> MS	RELEASE COMPLETE	note 1
2	SS -> MS	STATUS ENQUIRY	note 2
3	MS -> SS	RELEASE COMPLETE	cause 81# (invalid TI value),
4	SS		repeat steps 2-3 to cover all the transaction identifiers from 000...110
5	SS -> MS	CHANNEL RELEASE	the main signalling link shall be released by the MS (L2: DISC/UA).

Specific message contents:

NOTE 1: With the cause value chosen arbitrarily.

NOTE 2: TI flag has the value indicating the MS as a originator of the call.

26.8.1.2.6.6 U10 call active / SETUP received

26.8.1.2.6.6.1 Definition and applicability

If the MS does not react correctly when receiving a SETUP message on a new Transaction Identifier during an active call, the active call may be lost.

This test is applicable for all GSM 400, GSM 900 and DCS 1 800 MS supporting at least one mobile originated circuit switched basic service.

26.8.1.2.6.6.2 Conformance requirement

- 1) A Mobile Station that has a call established when receiving a SETUP message shall respond either with a CALL CONFIRMED message or a RELEASE COMPLETE message, both with cause #17 "user busy".
- 2) The call control state of the existing transaction shall not be affected by the incoming SETUP message.

Reference(s):

Conformance requirement 1: GSM 04.08, section 5.2.2.3.1.

Conformance requirement 2: GSM 04.08, section 5.1.1.

26.8.1.2.6.6.3 Test purpose

- 1) To verify that a Mobile Station that has a call established and receives a SETUP message answers either with a CALL CONFIRMED message with cause "user busy" if it supports call waiting, or with a RELEASE COMPLETE message with cause "user busy" otherwise.
- 2) To verify that after having sent this message, the MS is still in state U10 for the established call.

26.8.1.2.6.6.4 Method of test

Initial conditions

System Simulator:

1 cell, default parameters.

Mobile Station:

The MS is idle updated with valid TMSI and CKSN.

The MS is brought into the state U10 by using table 26.8.1.2/14.

Related PICS/PIXIT statement(s)

- supported MO circuit switched basic services.
- support of call waiting Y/N.

Foreseen final state of the MS

U10, call active.

Maximum duration of test

30 s.

Test Procedure

The MS has a mobile originated call in the U10 state.

The SS sends a SETUP message to the MS (with signal IE indicating "call waiting tone on").

If the MS does not support call waiting it shall answer by a RELEASE COMPLETE message.

If the MS supports call waiting it shall answer by a CALL CONFIRMED message followed by an ALERTING. The second transaction is then released by the SS with a RELEASE COMPLETE message.

In both cases the SS checks by using the status enquiry procedure that the CC entity of the MS is still in state U10, active call for the original call.

Expected sequence

Step	Direction	Message	Comments
1	SS -> MS	SETUP	this message establishes a second transaction The TI value shall be the same as the one that is in use for the MO call. The TI flag shall have the value specified for an MT call.
A2	MS -> SS	RELEASE COMPLETE	if the MS does not support call waiting with cause user busy" with the TI of the second transaction
B2	MS -> SS	CALL CONFIRMED	if the MS supports call waiting with cause user busy" with the TI of the second transaction
B3	MS -> SS	ALERTING	with the TI of the second transaction
B4	SS -> MS	RELEASE COMPLETE	with the TI of the second transaction
5	SS -> MS	STATUS ENQUIRY	with the TI of the original transaction
6	MS -> SS	STATUS	cause 30#, state U10 with the TI of the original transaction

NOTE: The Transaction Identifier of the second transaction shall be different from the one of the already established transaction.

Specific message contents

SETUP message contains a Signal IE with value "call waiting tone on" (H'07).

26.8.1.2.7 U11 disconnect request

26.8.1.2.7.1 U11 disconnect request / clear collision

26.8.1.2.7.1.1 Definition and applicability

The call control entity of the MS being in the state, U11, a DISCONNECT message is received by the MS. This test is applicable for any equipment supporting at least one mobile originated circuit switched basic service.

26.8.1.2.7.1.2 Conformance requirement

- 1) A CC-entity of the MS in CC-state U11, "Disconnect Request", upon receipt of a DISCONNECT message, shall return to its peer entity the RELEASE message and enter the CC-state U19, "Release Request".

References

GSM 04.08 section 5.4.5.

26.8.1.2.7.1.3 Test purpose

To verify that the a CC-entity of the MS in CC-state U11, "Disconnect Request", upon receipt of a DISCONNECT message, returns to its peer entity the RELEASE message and enters the CC-state U19, "Release Request".

26.8.1.2.7.1.4 Method of test

Related PICS/PIXIT statements

- supported MO circuit switched basic services.

Initial conditions

System Simulator:

1 cell, default parameters.

Mobile Station:

The MS is in MM-state "idle, updated" with valid TMSI and CKSN.

The MS is brought into the state U11 by using table 26.8.1.2/3.

Foreseen final state of the MS

U19, release request.

Maximum duration of test

30 s.

Test procedure

An MO circuit switched basic service is selected that is supported by the MS; if the MS supports MO telephony, the selected basic service is telephony. If necessary, the MS is configured for that basic service. Then, the MS is made to initiate a call. The CC entity of the MS is brought to the state U11. The SS sends a DISCONNECT message to the MS. The MS shall respond with a RELEASE message. The SS checks by using the status enquiry procedure that the CC entity of the MS has entered the state U19, release request.

Expected sequence

Step	Direction	Message	Comments
1	SS -> MS	DISCONNECT	
2	MS -> SS	RELEASE	
3	SS -> MS	STATUS ENQUIRY	
4	MS -> SS	STATUS	cause 30#, state U19

Specific message contents:

None.

26.8.1.2.7.2 U11 disconnect request / RELEASE received

26.8.1.2.7.2.1 Definition and applicability

The call control entity of the MS being in the state, U11, a RELEASE message is received by the MS. This test is applicable for any equipment supporting at least one mobile originated circuit switched basic service.

26.8.1.2.7.2.2 Conformance requirement

- 1) A CC-entity of the MS in CC-state U11, "Disconnect Request", upon receipt of the RELEASE message shall return RELEASE COMPLETE and enter the CC-state U0, "Null".
- 2) On returning to the idle mode the MS shall release the MM-connection and the CC-entities relating to the seven mobile originating transaction identifiers shall be in CC-state U0, "Null".

References

Conformance requirement 1: GSM 04.08 section 5.4.3.

Conformance requirement 2: GSM 04.08 section 4.5.3., GSM 04.08 section 5.5.3.2., GSM 04.08 section 8.3.

26.8.1.2.7.2.3 Test purpose

- 1) To verify that the a CC-entity of the MS in CC-state U11, "Disconnect Request", upon receipt of the RELEASE message shall return RELEASE COMPLETE and enter the CC-state U0, "Null".

- 2) To verify that the MS on returning to the idle mode releases the MM-connection and that the CC-entities relating to the seven mobile originating transaction identifiers are in CC-state U0, "Null".

26.8.1.2.7.2.4 Method of test

Related PICS/PIXIT statements

- supported MO circuit switched basic services.

Initial conditions

System Simulator:

1 cell, default parameters.

Mobile Station:

The MS is in MM-state "idle, updated" with valid TMSI and CKSN.

The MS is brought into the state U11 by using table 26.8.1.2/3.

Foreseen final state of the MS

U0, null.

Maximum duration of test

1 min 30 s.

Test procedure

An MO circuit switched basic service is selected that is supported by the MS; if the MS supports MO telephony, the selected basic service is telephony. If necessary, the MS is configured for that basic service. Then, the MS is made to initiate a call. The CC entity of the MS is brought to the state U11. The SS sends a RELEASE message to the MS. The MS shall respond with a RELEASE COMPLETE message. The SS checks by using the status enquiry procedure that the CC entity has entered the state U0 with all the relevant transaction identifiers.

Expected sequence

Step	Direction	Message	Comments
1	SS -> MS	RELEASE	
2	MS -> SS	RELEASE COMPLETE	
3	SS -> MS	STATUS ENQUIRY	
4	MS -> SS	RELEASE COMPLETE	cause 81# (invalid TI value)
5	SS		repeat steps 3-4 to cover all the transaction identifiers from 000...110
6	SS -> MS	CHANNEL RELEASE	the main signalling link shall be released by the MS (L2: DISC/UA).

Specific message contents:

None.

26.8.1.2.7.3 U11 disconnect request / timer T305 time-out

26.8.1.2.7.3.1 Definition and applicability

The call control entity of the MS being in the state, U11, if no response is then received from the SS, timer T305 expires at the MS side. This test is applicable for any equipment supporting at least one mobile originated circuit switched basic service.

26.8.1.2.7.3.2 Conformance requirement

- 1) A CC-entity of the MS in CC-state U11, "Disconnect Request" shall on expiry of T305, proceed with the connection release procedure by sending the RELEASE message to its peer entity and shall enter the CC-state U19, "Release Request".

References

GSM 04.08 section 5.4.3., GSM 04.08 section 11.3.

26.8.1.2.7.3.3 Test purpose

To verify that the CC-entity of the MS in CC-state U11, "Disconnect Request" shall on expiry of T305 (accuracy +/- 10 %), proceed with the connection release procedure by sending the RELEASE message to its peer entity and enters the CC-state U19, "Release Request".

26.8.1.2.7.3.4 Method of test

Related PICS/PIXIT statements

- supported MO circuit switched basic services.

Initial conditions

System Simulator:

1 cell, default parameters.

Mobile Station:

The MS is in MM-state "idle, updated" with valid TMSI and CKSN.

The MS is brought into the state U11 by using table 26.8.1.2/3.

Foreseen final state of the MS

U19, release request.

Maximum duration of test

1 minute.

Test procedure

An MO circuit switched basic service is selected that is supported by the MS; if the MS supports MO telephony, the selected basic service is telephony. If necessary, the MS is configured for that basic service. Then, the MS is made to initiate a call. The CC entity of the MS is brought to the state U11. Then T305 expires at the MS and the MS shall send a RELEASE message. The SS checks timer T305 accuracy and that the CC entity has entered the state U19, release request.

Expected sequence

Step	Direction	Message	Comments
1	SS		SS waits until T305 expires at the MS
2	MS -> SS	RELEASE	SS checks the time between DISCONNECT and RELEASE (note), (T305 +/- 10 %)
3	SS -> MS	STATUS ENQUIRY	
4	MS -> SS	STATUS	cause 30#, state U19

Specific message contents:

NOTE: With the same cause value as originally contained in the DISCONNECT message. An additional cause information element (#102 recovery on timer expiry) may be included.

26.8.1.2.7.4 U11 disconnect request / lower layer failure

26.8.1.2.7.4.1 Definition and applicability

The call control entity of the MS being in the state, U11, a lower layer failure is accomplished at the MS and consequently, communication at layer 3 level with the peer entity is terminated. This test is applicable for any equipment supporting at least one mobile originated circuit switched basic service.

26.8.1.2.7.4.2 Conformance requirement

- 1) A CC-entity of the MS in CC-state U11, "Disconnect Request" having detected a lower layer failure shall return to the idle mode. The CC entities relating to the seven mobile originating transaction identifiers shall be in state U0, "Null".

References

GSM 04.08 section 4.5.2.3., GSM 04.08 section 4.5.3., GSM 04.08 section 5.5.3.2., GSM 04.08 section 3.4.13.2.1., GSM 04.08 section 8.3.

26.8.1.2.7.4.3 Test purpose

To verify that the a CC-entity of the MS in CC-state U11, "Disconnect Request" having detected a lower layer failure returns to the idle mode. The CC entities relating to the seven mobile originating transaction identifiers are thus in state U0, "Null".

26.8.1.2.7.4.4 Method of test

Related PICS/PIXIT statements

- supported MO circuit switched basic services.

Initial conditions

System Simulator:

1 cell, default parameters.

Mobile Station:

The MS is in MM-state "idle, updated" with valid TMSI and CKSN.

The MS is brought into the state U11 by using table 26.8.1.2/4.

Foreseen final state of the MS

U0, null.

Maximum duration of test

1 min 30 s.

Test procedure

An MO circuit switched basic service is selected that is supported by the MS; if the MS supports MO telephony, the selected basic service is telephony. If necessary, the MS is configured for that basic service. Then, the MS is made to initiate a call. The MS is brought to the state U11. The SS generates a lower layer failure at the MS. The SS waits long

enough to enable the MS to return to idle state listening to paging, and then pages MS to create RR-connection. Finally, the SS will check the state of the MS by using STATUS ENQUIRY with the relevant transaction identifiers.

Expected sequence

Step	Direction	Message	Comments
1	SS		SS generates lower layer failure
2	SS		SS waits 20 s for the MS to return to listening to paging
3	SS -> MS	PAGING REQUEST	
4	MS -> SS	CHANNEL REQUEST	
5	SS -> MS	IMMEDIATE ASSIGNMENT	
6	MS -> SS	PAGING RESPONSE	
7	SS -> MS	STATUS ENQUIRY	
8	MS -> SS	RELEASE COMPLETE	cause 81# (invalid TI value)
9	SS		repeat steps 7-8 to cover all the transaction identifiers from 000...110
10	SS -> MS	CHANNEL RELEASE	the main signalling link shall be released by the MS (L2: DISC/UA).

Specific message contents:

None.

26.8.1.2.7.5 U11 disconnect request / unknown message received

26.8.1.2.7.5.1 Definition and applicability

The call control entity of the MS being in the state, U4, an unknown message is received by the MS. This test is applicable for any equipment supporting at least one mobile originated circuit switched basic service.

26.8.1.2.7.5.2 Conformance requirement

- 1) A CC-entity of the MS in CC-state U100, "Call Delivered", having received an unknown message from its peer entity shall return a STATUS message.

References

GSM 04.08 section 8.4.

26.8.1.2.7.5.3 Test purpose

To verify that a CC-entity of the MS in CC-state U11, "Call Delivered", having received an unknown message from its peer entity returns a STATUS message.

26.8.1.2.7.5.4 Method of test

Related PICS/PIXIT statements

- supported MO circuit switched basic services.

Initial conditions

System Simulator:

1 cell, default parameters.

Mobile Station:

The MS is in MM-state "idle, updated" with valid TMSI and CKSN.

The MS is brought into the state U11 by using table 26.8.1.2/4.

Foreseen final state of the MS

U11, disconnect request.

Maximum duration of test

30 s.

Test procedure

An MO circuit switched basic service is selected that is supported by the MS; if the MS supports MO telephony, the selected basic service is telephony. If necessary, the MS is configured for that basic service. Then, the MS is made to initiate a call. The CC entity of the MS is brought to the state U11. The SS sends a message with message type not defined for the protocol discriminator to the MS. The MS shall respond with a STATUS message, and finally the SS checks by using the status enquiry procedure that the state of the CC entity has remained unchanged.

Expected sequence

Step	Direction	Message	Comments
1	SS -> MS	unknown message	message type not defined for PD
2	MS -> SS	STATUS	cause 97#, state U11
3	SS -> MS	STATUS ENQUIRY	
4	MS -> SS	STATUS	cause 30#, state U11

Specific message contents:

None.

26.8.1.2.8 U12 disconnect indication

26.8.1.2.8.1 U12 disconnect indication / call releasing requested by the user

26.8.1.2.8.1.1 Definition and applicability

The call control entity of the MS being in the state, U12, the user requests to terminate the call. This test is applicable only for mobile stations supporting bearer capability for speech.

26.8.1.2.8.1.2 Conformance requirement

- 1) A CC-entity of the MS in CC-state U12, "Disconnect Indication" being in network initiated call release phase, shall, upon receiving a call release request from the user send a RELEASE to its peer entity and enter CC-state U19, "Release Request".

References

GSM 04.07 section 6.2.2., GSM 04.08 section 5.4.4.

26.8.1.2.8.1.3 Test purpose

To verify that a CC-entity of the MS in CC-state U12, "Disconnect Indication" being in network initiated call release phase, shall, upon receiving a call release request from the user sends a RELEASE to its peer entity and enters CC-state U19, "Release Request"

26.8.1.2.8.1.4 Method of test

Related PICS/PIXIT statements

- supported MO circuit switched basic services.

Initial conditions

System Simulator:

1 cell, default parameters.

Mobile Station:

The MS is in MM-state "idle, updated" with valid TMSI and CKSN.

The MS is brought into the state U12 by using Option A of table 26.8.1.2/1.

Foreseen final state of the MS

U19, release request.

Maximum duration of test

30 s.

Test procedure

An MO circuit switched basic service is selected that is supported by the MS; if the MS supports MO telephony, the selected basic service is telephony. If necessary, the MS is configured for that basic service. Then, the MS is made to initiate a call. The CC entity of the MS is brought to the state U12. The user requests termination of the call. The MS shall send a RELEASE message. The SS checks by using the status enquiry procedure that the CC entity has entered the state U19, release request.

Expected sequence

Step	Direction	Message	Comments
1			MMI action, "on hook" cause 30#, state U19
2	MS -> SS	RELEASE	
3	SS -> MS	STATUS ENQUIRY	
4	MS -> SS	STATUS	

Specific message contents:

None.

26.8.1.2.8.2 U12 disconnect indication / RELEASE received

26.8.1.2.8.2.1 Definition and applicability

The call control entity of the MS being in the state, U12, a RELEASE message is received by the MS. This test is applicable only for mobile stations supporting bearer capability for speech.

26.8.1.2.8.2.2 Conformance requirement

- 1) A CC-entity of the MS in CC-state U12, "Disconnect Indication", upon receipt of a RELEASE message shall return to its peer entity the RELEASE COMPLETE message and enter the CC-state U0, "Null".
- 2) On returning to the idle mode the MS shall release the MM-connection and the CC-entities relating to the seven mobile originating transaction identifiers shall be in CC-state U0, "Null".

References

Conformance requirement 1: GSM 04.08 section 5.4.2

Conformance requirement 2: GSM 04.08 section 4.5.3., GSM 04.08 section 5.5.3.2., GSM 04.08 section 8.3.

26.8.1.2.8.2.3 Test purpose

- 1) To verify that a CC-entity of the MS in CC-state U12, "Disconnect Indication", upon receipt of a RELEASE message returns to its peer entity the RELEASE COMPLETE message and enters the CC-state U0, "Null".
- 2) To verify that the MS on returning to the idle mode releases the MM-connection and that the CC-entities relating to the seven mobile originating transaction identifiers are in CC-state U0, "Null".

26.8.1.2.8.2.4 Method of test

Related PICS/PIXIT statements

- supported MO circuit switched basic services.

Initial conditions

System Simulator:

1 cell, default parameters.

Mobile Station:

The MS is in MM-state "idle, updated" with valid TMSI and CKSN.

The MS is brought into the state U12 by using Option A of table 26.8.1.2/1.

Foreseen final state of the MS

U0, null.

Maximum duration of test

1 min.

Test procedure

An MO circuit switched basic service is selected that is supported by the MS; if the MS supports MO telephony, the selected basic service is telephony. If necessary, the MS is configured for that basic service. Then, the MS is made to initiate a call. The CC entity of the MS is brought to the state U12. The SS sends a RELEASE message to the MS. The MS shall respond with a RELEASE COMPLETE message. The SS checks by using the status enquiry procedure that the CC entity has entered the state U0 with all the relevant transaction identifiers.

Expected sequence

Step	Direction	Message	Comments
1	SS -> MS	RELEASE	
2	MS -> SS	RELEASE COMPLETE	
3	SS -> MS	STATUS ENQUIRY	
4	MS -> SS	RELEASE COMPLETE	
5	SS		cause 81# (invalid TI value) repeat steps 3-4 to cover all the transaction identifiers from 000...110
6	SS -> MS	CHANNEL RELEASE	the main signalling link shall be released by the MS (L2: DISC/UA).

Specific message contents:

None.

26.8.1.2.8.3 U12 disconnect indication / lower layer failure

26.8.1.2.8.3.1 Definition and applicability

The call control entity of the MS being in the state, U12, a lower layer failure is accomplished at the MS and consequently, communication at layer 3 level with the peer entity is terminated. This test is applicable only for mobile stations supporting bearer capability for speech.

26.8.1.2.8.3.2 Conformance requirement

- 1) A CC-entity of the MS in CC-state U12, "Disconnect Indication" having detected a lower layer failure shall return to idle mode. The CC-entities relating to the seven mobile originating transaction identifiers shall be in state U0, "Null".

References

GSM 04.08 section 4.5.3.2., GSM 04.08 section 4.5.3., GSM 04.08 section 5.5.3.2., GSM 04.08 section 3.4.13.2.1., GSM 04.08 section 8.3.

26.8.1.2.8.3.3 Test purpose

To verify that a CC-entity of the MS in CC-state U12, "Disconnect Indication" having detected a lower layer failure returns to idle mode. The CC-entities relating to the seven mobile originating transaction identifiers are thus in state U0, "Null".

26.8.1.2.8.3.4 Method of test

Related PICS/PIXIT statements

- supported MO circuit switched basic services.

Initial conditions

System Simulator:

1 cell, default parameters.

Mobile Station:

The MS is in MM-state "idle, updated" with valid TMSI and CKSN.

The MS is brought into the state U12 by using Option A of table 26.8.1.2/2.

Foreseen final state of the MS

U0, null.

Maximum duration of test

1 min 30 s.

Test procedure

An MO circuit switched basic service is selected that is supported by the MS; if the MS supports MO telephony, the selected basic service is telephony. If necessary, the MS is configured for that basic service. Then, the MS is made to initiate a call. The MS is brought to the state U12. The SS generates a lower layer failure at the MS. The SS waits long enough to enable the MS to return to idle state listening to paging, and then pages MS to create RR-connection. Finally, the SS will check the state of the MS by using STATUS ENQUIRY with the relevant transaction identifiers.

Expected sequence

Step	Direction	Message	Comments
1	SS		SS generates lower layer failure
2	SS		SS waits 20 s for the MS to return to listening to paging
3	SS -> MS	PAGING REQUEST	
4	MS -> SS	CHANNEL REQUEST	
5	SS -> MS	IMMEDIATE ASSIGNMENT	
6	MS -> SS	PAGING RESPONSE	
7	SS -> MS	STATUS ENQUIRY	
8	MS -> SS	RELEASE COMPLETE	cause 81# (invalid TI value)
9	SS		repeat steps 7-8 to cover all the transaction identifiers from 000...110
10	SS -> MS	CHANNEL RELEASE	the main signalling link shall be released by the MS (L2: DISC/UA).

Specific message contents:

None.

26.8.1.2.8.4 U12 disconnect indication / unknown message received

26.8.1.2.8.4.1 Definition and applicability

The call control entity of the MS being in the state, U12, an unknown message is received by the MS. This test is applicable only for mobile stations supporting bearer capability for speech.

26.8.1.2.8.4.2 Conformance requirement

A CC-entity of the MS in CC-state U12, "Disconnect Indication" having received an unknown message from its peer entity shall return a STATUS message.

References

GSM 04.08 section 8.4.

26.8.1.2.8.4.3 Test purpose

To verify that a CC-entity of the MS in CC-state U12, "Disconnect Indication" having received an unknown message from its peer entity returns a STATUS message.

26.8.1.2.8.4.4 Method of test

Related PICS/PIXIT statements

- supported MO circuit switched basic services.

Initial conditions

System Simulator:

1 cell, default parameters.

Mobile Station:

The MS is in MM-state "idle, updated" with valid TMSI and CKSN.

The MS is brought into the state U12 by using Option A of table 26.8.1.2/3.

Foreseen final state of the MS

U12, disconnect indication.

Maximum duration of test

30 s.

Test procedure

An MO circuit switched basic service is selected that is supported by the MS; if the MS supports MO telephony, the selected basic service is telephony. If necessary, the MS is configured for that basic service. Then, the MS is made to initiate a call. The CC entity of the MS is brought to the state U12. The SS sends a message with message type not defined for the protocol discriminator to the MS. The MS shall respond with a STATUS message, and finally the SS checks by using the status enquiry procedure that the state of the CC entity has remained unchanged.

Expected sequence

Step	Direction	Message	Comments
1	SS -> MS	unknown message	message type not defined for PD
2	MS -> SS	STATUS	cause 97#, state U12
3	SS -> MS	STATUS ENQUIRY	
4	MS -> SS	STATUS	cause 30#, state U12

Specific message contents:

None.

26.8.1.2.9 Outgoing call / U19 release request

26.8.1.2.9.1 Outgoing call / U19 release request / timer T308 time-out

26.8.1.2.9.1.1 Definition and applicability

The call control entity of the MS being in the state, U19, if no response is then received from the SS, timer T308 expires at the MS side. This test is applicable for any equipment supporting at least one mobile originated circuit switched basic service.

26.8.1.2.9.1.2 Conformance requirement

- 1) A CC-entity of the MS in CC-state U19, "Release Request" will, upon the first expiry of timer T308 send the RELEASE message to its peer entity and remain in the CC-state U19.

References

GSM 04.08 section 5.4.4.3.1, GSM 04.08 section 11.3.

26.8.1.2.9.1.3 Test purpose

To verify that a CC-entity of the MS in CC-state U19, "Release Request" will, upon the first expiry of timer T308 (accuracy +/- 10 %) send the RELEASE message to its peer entity and remain in the CC-state U19.

26.8.1.2.9.1.4 Method of test

Related PICS/PIXIT statements

- supported MO circuit switched basic services.

Initial conditions

System Simulator:

1 cell, default parameters.

Mobile Station:

The MS is in MM-state "idle, updated" with valid TMSI and CKSN.

The MS is brought into the state U19 by using table 26.8.1.2/4.

Foreseen final state of the MS

U19, release request.

Maximum duration of test

1 min.

Test procedure

An MO circuit switched basic service is selected that is supported by the MS; if the MS supports MO telephony, the selected basic service is telephony. If necessary, the MS is configured for that basic service. Then, the MS is made to initiate a call. The CC entity of the MS is brought to the state U19. When T308 expires at the MS, the MS shall send a RELEASE message. The SS checks timer T308 accuracy and that the state of the CC entity has remained unchanged.

Expected sequence

Step	Direction	Message	Comments
1	SS		SS waits until T308 at the MS
2	MS -> SS	RELEASE	SS checks the time between the two RELEASE messages (T308 +/- 10 %)
3	SS -> MS	STATUS ENQUIRY	
4	MS -> SS	STATUS	cause 30#, state U19

Specific message contents:

None.

26.8.1.2.9.2 Outgoing call / U19 release request / 2nd timer T308 time-out

26.8.1.2.9.2.1 Definition and applicability

The call control entity of the MS being in the state, U19, if no response is then received after timer T308 has expired two times in success at the MS. This test is applicable for any equipment supporting at least one mobile originated circuit switched basic service.

26.8.1.2.9.2.2 Conformance requirement

- 1) A CC-entity of the MS in CC-state U19, "Release Request", upon the 2nd expiry of the timer T308, shall enter the CC-state U0, "Null".
- 2) Subsequently the MS shall proceed with releasing the MM-connection and enter the idle mode with the CC entities relating to the seven mobile originating transaction identifiers in state U0, "Null".

References

Conformance requirement 1: GSM 04.08 section 5.4.4.3.1., GSM 04.08 section 11.3.

Conformance requirement 2: GSM 04.08 section 4.5.3., GSM 04.08 section 5.5.3.2.

26.8.1.2.9.2.3 Test purpose

- 1) To verify that a CC-entity of the MS in CC-state U19, "Release Request", upon the 2nd expiry of the timer T308, enters the CC-state U0, "Null".

- 2) To verify that subsequently the MS proceeds with releasing the MM-connection and enters the idle mode with the CC entities relating to the seven mobile originating transaction identifiers in state U0, "Null".

26.8.1.2.9.2.4 Method of test

Related PICS/PIXIT statements

- supported MO circuit switched basic services.

Initial conditions

System Simulator:

1 cell, default parameters.

Mobile Station:

The MS is in MM-state "idle, updated" with valid TMSI and CKSN.

The MS is brought into the state U19 by using table 26.8.1.2/4.

Foreseen final state of the MS

U0, null.

Maximum duration of test

2 min 30 s.

Test procedure

An MO circuit switched basic service is selected that is supported by the MS; if the MS supports MO telephony, the selected basic service is telephony. If necessary, the MS is configured for that basic service. Then, the MS is made to initiate a call. The CC entity of the MS is brought to the state U19. The SS allows T308 expiry at the MS, and the MS shall repeat sending the RELEASE message and start timer T308 again. The SS allows again T308 expiry at the MS. The MS shall abort the RR-connection (DISC/UA). The SS waits long enough to enable the MS to return to idle state listening to paging, and then pages MS to create RR-connection. Finally, the SS will check the state of the MS by using STATUS ENQUIRY with the relevant transaction identifiers.

Expected sequence

Step	Direction	Message	Comments
1	SS		SS waits until T308 expiry at the MS
2	MS -> SS	RELEASE	
3	SS -> MS	STATUS ENQUIRY	
4	MS -> SS	STATUS	cause 30#, state U19
5	SS		SS waits until the second T308 expiry at the MS
6	SS		SS waits T3240 expiry at the MS
7	MS		the main signalling link shall be released by the MS (L2: DISC/UA).
8	SS		SS waits 10 s for the MS to return to listening to paging
9	SS -> MS	PAGING REQUEST	
10	MS -> SS	CHANNEL REQUEST	
11	SS -> MS	IMMEDIATE ASSIGNMENT	
12	MS -> SS	PAGING RESPONSE	
13	SS -> MS	STATUS ENQUIRY	
14	MS -> SS	RELEASE COMPLETE	cause 81# (invalid TI value)
15	SS		repeat steps 13-14 to cover all the transaction identifiers from 000...110
16	SS -> MS	CHANNEL RELEASE	the main signalling link shall be released by the MS (L2: DISC/UA).

Specific message contents:

None.

26.8.1.2.9.3 Outgoing call / U19 release request / RELEASE received

26.8.1.2.9.3.1 Definition and applicability

The call control entity of the MS being in the state, U19, a RELEASE message is received by the MS. This test is applicable for any equipment supporting at least one mobile originated circuit switched basic service.

26.8.1.2.9.3.2 Conformance requirement

- 1) A CC-entity of the MS in CC-state U19, "Release Request", upon receipt of a RELEASE, shall release the MM-connection and enter the CC-state U0, "Null" with the CC entities relating to the seven mobile originating transaction identifiers in state U0, "Null".

References

GSM 04.08 section 5.4.5., GSM 04.08 section 11.3, GSM 04.08 section 5.5.3.2.

26.8.1.2.9.3.3 Test purpose

To verify that a CC-entity of the MS in CC-state U19, "Release Request", upon receipt of a RELEASE, shall release the MM-connection and enters the CC-state U0, "Null" with the CC entities relating to the seven mobile originating transaction identifiers in state U0, "Null".

26.8.1.2.9.3.4 Method of test

Related PICS/PIXIT statements

- supported MO circuit switched basic services.

Initial conditions

System Simulator:

1 cell, default parameters.

Mobile Station:

The MS is in MM-state "idle, updated" with valid TMSI and CKSN.

The MS is brought into the state U19 by using table 26.8.1.2/4.

Foreseen final state of the MS

U0, null.

Maximum duration of test

1 min 30 s.

Test procedure

An MO circuit switched basic service is selected that is supported by the MS; if the MS supports MO telephony, the selected basic service is telephony. If necessary, the MS is configured for that basic service. Then, the MS is made to initiate a call. The CC entity of the MS is brought to the state U19. The SS sends a RELEASE message to the MS. The MS shall release the MM-connection. The SS checks by using the status enquiry procedure that the CC entity has entered the state U0 with all the relevant transaction identifiers.

Expected sequence

Step	Direction	Message	Comments
1	SS -> MS	RELEASE	(note)
2	SS -> MS	STATUS ENQUIRY	
3	MS -> SS	RELEASE COMPLETE	cause 81# (invalid TI value)
4	SS		repeat steps 2-3 to cover all the transaction identifiers from 000...110
5	SS -> MS	CHANNEL RELEASE	the main signalling link shall be released by the MS (L2: DISC/UA).

Specific message contents:

NOTE: With the same cause number as originally contained in DISC and optional cause #102 recovery on timer expiry.

26.8.1.2.9.4 Outgoing call / U19 release request / RELEASE COMPLETE received

26.8.1.2.9.4.1 Definition and applicability

The call control entity of the MS being in the state, U19, a RELEASE COMPLETE message is received by the MS. This test is applicable for any equipment supporting at least one mobile originated circuit switched basic service.

26.8.1.2.9.4.2 Conformance requirement

- 1) A CC-entity of the MS in CC-state U19, "Release Request", upon receipt of a RELEASE COMPLETE, shall release the MM-connection and enter the CC-state U0, "Null" with the CC entities relating to the seven mobile originating transaction identifiers in state U0, "Null".

References

GSM 04.08 section 5.4.4.3., GSM 04.08 section 4.5.3, GSM 04.08 section 8.3.

26.8.1.2.9.4.3 Test purpose

To verify that a CC-entity of the MS in CC-state U19, "Release Request", upon receipt of a RELEASE COMPLETE, shall release the MM-connection and enters the CC-state U0, "Null" with the CC entities relating to the seven mobile originating transaction identifiers in state U0, "Null".

26.8.1.2.9.4.4 Method of test

Related PICS/PIXIT statements

- supported MO circuit switched basic services.

Initial conditions

System Simulator:

1 cell, default parameters.

Mobile Station:

The MS is in MM-state "idle, updated" with valid TMSI and CKSN.

The MS is brought into the state U19 by using table 26.8.1.2/1.

Foreseen final state of the MS

U0, null.

Maximum duration of test

1 min 30 s.

Test procedure

An MO circuit switched basic service is selected that is supported by the MS; if the MS supports MO telephony, the selected basic service is telephony. If necessary, the MS is configured for that basic service. Then, the MS is made to initiate a call. The CC entity of the MS is brought to the state U19. The SS sends a RELEASE COMPLETE message to the MS. The MS shall release the MM-connection. The SS checks by using the status enquiry procedure that the CC entity has entered the state U0 with all the relevant transaction identifiers.

Expected sequence

Step	Direction	Message	Comments
1	SS -> MS	RELEASE COMPLETE	
2	SS -> MS	STATUS ENQUIRY	
3	MS -> SS	RELEASE COMPLETE	cause 81# (invalid TI value)
4	SS		repeat steps 2-3 to cover all the transaction identifiers from 000...110
5	SS -> MS	CHANNEL RELEASE	the main signalling link shall be released by the MS (L2: DISC/UA).

Specific message contents:

None.

26.8.1.2.9.5 Outgoing call / U19 release request / lower layer failure

26.8.1.2.9.5.1 Definition and applicability

The call control entity of the MS being in the state, U19, a lower layer failure is accomplished at the MS and consequently, communication at layer 3 level with the peer entity is terminated. This test is applicable for any equipment supporting at least one mobile originated circuit switched basic service.

26.8.1.2.9.5.2 Conformance requirement

A CC-entity of the MS in CC-state U19, "Release Request", having detected a lower layer failure, shall return to the idle mode, the CC entities relating to the seven mobile originating transaction identifiers shall be in state U0, "Null".

References

GSM 04.08 section 4.5.2.3., GSM 04.08 section 4.5.3., GSM 04.08 section 5.5.3.2., GSM 04.08 section 8.3.

26.8.1.2.9.5.3 Test purpose

To verify that a CC-entity of the MS in CC-state U19, "Release Request", having detected a lower layer failure, returns to the idle mode, the CC entities relating to the seven mobile originating transaction identifiers are in state U0, "Null".

26.8.1.2.9.5.4 Method of test

Related PICS/PIXIT statements

- supported MO circuit switched basic services.

Initial conditions

System Simulator:

1 cell, default parameters.

Mobile Station:

The MS is in MM-state "idle, updated" with valid TMSI and CKSN.

The MS is brought into the state U19 by using table 26.8.1.2/1.

Foreseen final state of the MS

U0, null.

Maximum duration of test

1 min 30 s.

Test procedure

An MO circuit switched basic service is selected that is supported by the MS; if the MS supports MO telephony, the selected basic service is telephony. If necessary, the MS is configured for that basic service. Then, the MS is made to initiate a call. The MS is brought to the state U19. The SS generates a lower layer failure at the MS. The SS waits long enough to enable the MS to return to idle state listening to paging, and then pages MS to create RR-connection. Finally, the SS will check the state of the MS by using STATUS ENQUIRY with the relevant transaction identifiers.

Expected sequence

Step	Direction	Message	Comments
1	SS		SS generates lower layer failure
2	SS		SS waits 20 s for the MS to return to listening to paging
3	SS -> MS	PAGING REQUEST	
4	MS -> SS	CHANNEL REQUEST	
5	SS -> MS	IMMEDIATE ASSIGNMENT	
6	MS -> SS	PAGING RESPONSE	
7	SS -> MS	STATUS ENQUIRY	
8	MS -> SS	RELEASE COMPLETE	cause 81# (invalid TI value)
9	SS		repeat steps 7-8 to cover all the transaction identifiers from 000...110
10	SS -> MS	CHANNEL RELEASE	the main signalling link shall be released by the MS (L2: DISC/UA).

Specific message contents:

None.

26.8.1.3 Establishment of an incoming call / Initial conditions

The tables below describe message exchanges which bring the MS in the requested initial states in case of an incoming call.

A state may be taken as initial only when all the states which lead to this initial states have been validated. The order will be U0, U6, U9, U7, U8, U10, U26 etc. as in the following tables.

Table 26.8.1.3/1: Establishment of an incoming call, procedure 1

Step	Direction	Message	Comments	
1	SS -> MS	PAGING REQUEST	U0, SDCCH	
2	MS -> SS	CHANNEL REQUEST		
3	SS -> MS	IMMEDIATE ASSIGNMENT		
4	MS -> SS	PAGING RESPONSE		
5	SS -> MS	AUTHENTICATION REQUEST		
6	MS -> SS	AUTHENTICATION RESPONSE		
7	SS -> MS	CIPHERING MODE COMMAND		
8	MS -> SS	CIPHERING MODE COMPLETE		
9	SS -> MS	SETUP		U6, (note 1)
10	MS -> SS	CALL CONFIRMED		U9
A11	MS -> SS	CONNECT	U8, p = Y, (note 2)	
B11	MS -> SS	ALERTING	U7, p = N, (note 2)	
B12	MS		(note 3)	
B13	MS -> SS	CONNECT	U8	
14	SS -> MS	ASSIGNMENT COMMAND	TCH	
15	MS -> SS	ASSIGNMENT COMPLETE		
16	SS -> MS	CONNECT ACKNOWLEDGE	U10	

NOTE 1: With signal information included in the SETUP message.

NOTE 2: The MS is supporting immediate connect (p = Y/N). See PICS/PIXIT statement.

NOTE 3: If necessary (see PICS/PIXIT statement), the MS is made to accept the call in the way described in a PICS/PIXIT statement.

Table 26.8.1.3/2: Establishment of an incoming call, procedure 2

Step	Direction	Message	Comments	
1	SS -> MS	PAGING REQUEST	U0, SDCCH	
2	MS -> SS	CHANNEL REQUEST		
3	SS -> MS	IMMEDIATE ASSIGNMENT		
4	MS -> SS	PAGING RESPONSE		
5	SS -> MS	CIPHERING MODE COMMAND		
6	MS -> SS	CIPHERING MODE COMPLETE		
7	SS -> MS	SETUP		U6, (note 4)
8	MS -> SS	CALL CONFIRMED		U9
A9	MS -> SS	CONNECT	U8, p = Y, (note 5)	
A10	SS -> MS	ASSIGNMENT COMMAND	TCH	
A11	MS -> SS	ASSIGNMENT COMPLETE		
B9	MS -> SS	ALERTING	U7, p = N, (note 5)	
B10	SS -> MS	ASSIGNMENT COMMAND	TCH	
B11	MS -> SS	ASSIGNMENT COMPLETE		
B12	MS		(note 6)	
B13	MS -> SS	CONNECT	U8	
14	SS -> MS	AUTHENTICATION REQUEST	U10	
15	MS -> SS	AUTHENTICATION RESPONSE		
16	SS -> MS	CONNECT ACKNOWLEDGE		

NOTE 4: With signal information included in the SETUP message.

NOTE 5: The MS is supporting immediate connect (p = Y/N). See PICS/PIXIT statement.

NOTE 6: If necessary (see PICS/PIXIT statement), the MS is made to accept the call in the way described in a PICS/PIXIT statement.

Table 26.8.1.3/3: Establishment of an incoming call, procedure 3

Step	Direction	Message	Comments
1	SS -> MS	PAGING REQUEST	
2	MS -> SS	CHANNEL REQUEST	
3	SS -> MS	IMMEDIATE ASSIGNMENT	U0, TCH
4	MS -> SS	PAGING RESPONSE	
5	SS -> MS	AUTHENTICATION REQUEST	
6	MS -> SS	AUTHENTICATION RESPONSE	
7	SS -> MS	CIPHERING MODE COMMAND	
8	MS -> SS	CIPHERING MODE COMPLETE	
9	SS -> MS	CHANNEL MODE MODIFY	(note 7)
10	MS -> SS	CHANNEL MODE MODIFY ACKNOWLEDGE	
11	SS -> MS	SETUP	U6, (note 8)
12	MS -> SS	CALL CONFIRMED	U9
A13	MS -> SS	CONNECT	U8, p = Y, (note 9)
B13	MS -> SS	ALERTING	U7, p = N, (note 9)
B14	MS		(note 10)
B15	MS -> SS	CONNECT	U8
16	SS -> MS	CONNECT ACKNOWLEDGE	U10

NOTE 7: Assigned channel is appropriate for the chosen mobile originated circuit switched basic service.

NOTE 8: With signal information included in the SETUP message.

NOTE 9: The MS is supporting immediate connect (p = Y/N). See PICS/PIXIT statement.

NOTE 10: If necessary (see PICS/PIXIT statement), the MS is made to accept the call in the way described in a PICS/PIXIT statement.

Table 26.8.1.3/4: Establishment of an incoming call, procedure 4

Step	Direction	Message	Comments
1	SS -> MS	PAGING REQUEST	
2	MS -> SS	CHANNEL REQUEST	
3	SS -> MS	IMMEDIATE ASSIGNMENT	U0, SDCCH
4	MS -> SS	PAGING RESPONSE	
5	SS -> MS	CIPHERING MODE COMMAND	
6	MS -> SS	CIPHERING MODE COMPLETE	
7	SS -> MS	SETUP	U6, (note 11)
8	MS -> SS	CALL CONFIRMED	U9
9	SS -> MS	ASSIGNMENT COMMAND	TCH
10	MS -> SS	ASSIGNMENT COMPLETE	
A11	MS -> SS	CONNECT	U8, p = Y, (note 12)
B11	MS -> SS	ALERTING	U7, p = N, (note 12)
B12	MS		(note 13)
B13	MS -> SS	CONNECT	U8
14	SS -> MS	AUTHENTICATION REQUEST	
15	MS -> SS	AUTHENTICATION RESPONSE	
16	SS -> MS	CONNECT ACKNOWLEDGE	U10

NOTE 11: The signal information element is not included in the SETUP message.

NOTE 12: The MS is supporting immediate connect (p = Y/N). See PICS/PIXIT statement.

NOTE 13: If necessary (see PICS/PIXIT statement), the MS is made to accept the call in the way described in a PICS/PIXIT statement.

26.8.1.3.1 Incoming call / U0 null state

26.8.1.3.1.1 Incoming call / U0 null state / SETUP received with a non supported bearer capability

26.8.1.3.1.1.1 Definition and applicability

The call control entity of the MS being in the state, U0, a SETUP message is received with only one bearer capability and this bearer capability is not supported by the MS. This test is applicable for all equipment.

26.8.1.3.1.1.2 Conformance requirement

- 1) A CC entity of the MS, upon receipt of SETUP containing one bearer capability and this bearer capability is not supported, shall return a RELEASE COMPLETE with correct cause value to its peer entity and return to the idle mode. The CC-entities relating to the seven mobile terminating transaction identifiers shall be in the state U0,"Null".

References

GSM 04.08 section 5.2.2.2., GSM 04.08 annex B.

26.8.1.3.1.1.3 Test purpose

To verify that a CC entity of the MS, upon receipt of SETUP containing one bearer capability and this bearer capability is not supported, returns a RELEASE COMPLETE with correct cause value to its peer entity, and returns to the idle mode. To verify that the CC-entities relating to the seven mobile terminating transaction identifiers are then in the state U0,"Null".

26.8.1.3.1.1.4 Method of test

Related PICS/PIXIT statements

- supported MO circuit switched basic services.

Initial conditions

System Simulator:

1 cell, default parameters.

Mobile Station:

The MS is in MM-state "idle, updated" with valid TMSI and CKSN.

Foreseen final state of the MS

U0, null.

Maximum duration of test

30 s.

Test procedure

A mobile terminated call is initiated. The MS receives a SETUP message that contains a bearer capability not supported by the MS. The MS returns a RELEASE COMPLETE message. The SS checks by using the status enquiry procedure that the CC entity is still in the state U0 with all the relevant transaction identifiers.

Expected sequence

Step	Direction	Message	Comments
1	SS -> MS	PAGING REQUEST	SS sends paging
2	MS -> SS	CHANNEL REQUEST	
3	SS -> MS	IMMEDIATE ASSIGNMENT	(SDCCH)
4	MS -> SS	PAGING RESPONSE	
5	SS -> MS	AUTHENTICATION REQUEST	
6	MS -> SS	AUTHENTICATION RESPONSE	
7	SS -> MS	CIPHERING MODE COMMAND	
8	MS -> SS	CIPHERING MODE COMPLETE	
9	SS -> MS	SETUP	(note 1)
10	MS -> SS	RELEASE COMPLETE	(note 2)
11	SS -> MS	STATUS ENQUIRY	Cause #81 (invalid TI value). Repeat steps 11-12 to cover all the transaction identifiers from 000... 110.
12	MS -> SS	RELEASE COMPLETE	
13	SS		

Specific message contents:

NOTE 1: With one bearer capability and that bearer capability is not supported by the MS.

NOTE 2: With cause #88 incompatible destination.

26.8.1.3.2 Incoming call / U6 call present

26.8.1.3.2.1 Incoming call / U6 call present / automatic call rejection

26.8.1.3.2.1.1 Definition and applicability

Although the state U6 is transient, the ability to refuse a call (automatically) in this state is tested, if it is implemented at the MS. The test is applicable for those equipments described above supporting at least one mobile terminating circuit switched basic service.

26.8.1.3.2.1.2 Conformance requirement

- 1) A CC entity of the MS in CC-state U6, "Call Present", upon receipt of a rejection indication of the incoming call from the user, send RELEASE COMPLETE with the appropriate cause value to its peer entity and enter the CC-state U0, "Null". The CC entities relating to the seven mobile terminating transaction identifiers shall be in state U0, "Null".

References

GSM 11.10, annex B (for PICS/PIXIT statement), GSM 04.07 section 6.2.2., GSM 04.08 section 5.2.2.3.1., GSM 04.08 section 5.5.3.2, GSM 04.08 section 8.3.

26.8.1.3.2.1.3 Test purpose

To verify that a CC entity of the MS in CC-state U6, "Call Present", shall upon receipt of a rejection indication of the incoming call from the user, shall send RELEASE COMPLETE with the appropriate cause value to its peer entity and enter the CC-state U0, "Null". The CC entities relating to the seven mobile terminating transaction identifiers are then in state U0, "Null".

26.8.1.3.2.1.4 Method of test

Related PICS/PIXIT statements

- supported teleservices;
- the MS supports an ability to refuse a call after receipt of a SETUP message.

Initial conditions

System Simulator:

1 cell, default parameters.

Mobile Station:

The MS is in MM-state "idle, updated" with valid TMSI and CKSN.

The MS is brought into the state U6 by using table 26.8.1.3/2.

Foreseen final state of the MS

U0, null.

Maximum duration of test

1 min 30 s.

Test procedure

A teleservice is selected that is supported by the MS; if the MS supports speech, the selected teleservice is speech. If necessary, the MS is configured for that teleservice. Then a mobile terminated call is initiated. The call control entire of the MS is brought to the state U6 (Note: The state U6 is not checked, since it is not stable). The MS is made to refuse the call (the refusal may require some preliminary preparations in order to achieve refusal at this point). The MS shall send a RELEASE COMPLETE message and enter a call control state U0. The SS checks by using the status enquiry procedure that the CC entity has entered the state U0 with all the relevant transaction identifiers.

Expected sequence

Step	Direction	Message	Comments
1			the MS is made to refuse the call
2	MS -> SS	RELEASE COMPLETE	(note)
3	SS -> MS	STATUS ENQUIRY	
4	MS -> SS	RELEASE COMPLETE	cause 81# (invalid TI value)
5	SS		repeat steps 3-4 to cover all the transaction identifiers from 000...110
6	SS -> MS	CHANNEL RELEASE	the main signalling link shall be released by the MS (L2: DISC/UA).

Specific message contents:

NOTE: With cause value #21 call rejected.

26.8.1.3.3 Incoming call / U9 mobile terminating call confirmed

26.8.1.3.3.1 Incoming call / U9 mobile terminating call confirmed / alerting or immediate connecting

26.8.1.3.3.1.1 Definition and applicability

The call control entity of the MS having entered the state, U9, with signal information received in the preceding SETUP message, the subsequent behaviour of the MS is tested. This test is applicable for any equipment supporting at least one mobile terminating circuit switched basic service.

26.8.1.3.3.1.2 Conformance requirement

- 1) A CC entity in CC-state U9, "MS Terminating Call Confirmed", (if signalled by the network in previous SETUP message that it may alert) shall either send a ALERTING message to its peer entity and enter state U7, or send a CONNECT message to its peer entity and enter U8.

References

GSM 04.08 section 5.2.2.3.2., GSM 11.10, annex 3 - section 2.2.

26.8.1.3.3.1.3 Test purpose

To verify that a CC entity in CC-state U9, "MS Terminating Call Confirmed", (if signalled by the network in previous SETUP message that it may alert) will either send a ALERTING message to its peer entity and enter state U7, or send a CONNECT message to its peer entity and enter U8.

26.8.1.3.3.1.4 Method of test

Related PICS/PIXIT statements

- supported MT circuit switched basic services;
- MT circuit switched basic services for which immediate connect is not used.

Initial conditions

System Simulator:

1 cell, default parameters.

Mobile Station:

The MS is in MM-state "idle, updated" with valid TMSI and CKSN.

The MS is brought into the state U9 by using table 26.8.1.3/2.

Foreseen final state of the MS

- U8, connect request, if the MS supports immediate connect for the selected basic service;
- otherwise U7, call received.

Maximum duration of test

30 s.

Test procedure

An MT circuit switched basic service is selected that is supported by the MS; if the MS supports MT telephony, the selected basic service is telephony. If necessary, the MS is configured for that basic service. Then a mobile terminated call is initiated. The CC entity of the MS is brought to the state U9 by using a SETUP message containing signalling

information element. (The state U9 is not a stable state in this case, and consequently it is not checked as an initial state.) If the MS supports immediate connect for the selected basic service ($p = Y$), it sends a CONNECT message and enters the state U8, connect request. Otherwise ($p = N$) the MS sends an ALERTING message and enters the state U7, call receiving. The SS checks by using the status enquiry procedure that the CC entity has entered its state as described.

Expected sequence

Step	Direction	Message	Comments
A11	MS -> SS	CONNECT	$p = Y$ cause 30#, state U8
A12	SS -> MS	STATUS ENQUIRY	
A13	MS -> SS	STATUS	
B11	MS -> SS	ALERTING	$p = N$ cause 30#, state U7
B12	SS -> MS	STATUS ENQUIRY	
B13	MS -> SS	STATUS	

Specific message contents:

None.

26.8.1.3.3.2 Incoming call / U9 mobile terminating call confirmed / TCH assignment

26.8.1.3.3.2.1 Definition and applicability

The call control entity of the MS being in the state, U9, an assignment procedure is performed for traffic channel. This test is applicable for any equipment supporting at least one MT circuit switched basic service, for which immediate connect is not used.

26.8.1.3.3.2.2 Conformance requirement

- 1) A CC-entity of the MS in CC-state U9, "MS Terminating Call Confirmed", when allocated a traffic channel by the network performing the assignment procedure, shall perform a layer 2 establishment on the FACCH, send a ALERTING message and enter state U7.

References

GSM 04.08 section 3.4.3., GSM 04.08 section 5.2.2.7., GSM 04.08 section 5.2.2.3.2.

26.8.1.3.3.2.3 Test purpose

To verify that a CC-entity of the MS in CC-state U9, "MS Terminating Call Confirmed", when allocated a traffic channel by the network performing the assignment procedure, performs a layer 2 establishment on the FACCH, sends a ALERTING message and enters state U7.

26.8.1.3.3.2.4 Method of test

Related PICS/PIXIT statements

- supported MT circuit switched basic services;
- MT circuit switched basic services for which immediate connect is not used.

Initial conditions

System Simulator:

1 cell, default parameters.

Mobile Station:

The MS is in MM-state "idle, updated" with valid TMSI and CKSN.

The MS is brought into the state U9 by using table 26.8.1.3/4.

Foreseen final state of the MS

U9, mobile terminating call confirmed.

Maximum duration of test

30 s.

Test procedure

An MT circuit switched basic service is selected that is supported by the MS and for which the MS does not use immediate connection; if the MS supports MT telephony without immediate connection, the selected basic service is telephony. If necessary, the MS is configured for that basic service. Then a mobile terminated call is initiated. The CC entity of the MS is brought to the state U9 (by using a SETUP message not containing the signal information element). The SS sends an ASSIGNMENT COMMAND for traffic channel to the MS. The MS shall establish layer 2 link on the newly allocated channel and respond with an ASSIGNMENT COMPLETE message. The MS sends an ALERTING message and enters state U7, call received. The SS verifies by using the status enquiry procedure that the MS has entered the correct state.

Expected sequence

Step	Direction	Message	Comments
1	SS -> MS	ASSIGNMENT COMMAND	TCH, an appropriate non-signalling mode the MS shall establish L2 link
2	MS		
3	MS -> SS	ASSIGNMENT COMPLETE	
4	MS -> SS	ALERTING	
5	SS -> MS	STATUS ENQUIRY	
6	MS -> SS	STATUS	cause 30#, state U7

Specific message contents:

None.

26.8.1.3.3.3 Incoming call / U9 mobile terminating call confirmed / termination requested by the user

26.8.1.3.3.3.1 Definition and applicability

The call control entity of the MS being in the state, U9, the user requests for releasing of the call. This test is applicable for any equipment supporting at least one MT circuit switched basic service for which immediate connection is not used and, in addition to this, the facility to send a DISCONNECT message in state U9.

26.8.1.3.3.3.2 Conformance requirement

- 1) A CC-entity of the MS in CC-state U9, "MS Terminating Call Confirmed", upon request by the user to terminate shall send a DISCONNECT message and enter the CC-state U11, "Disconnect Request".

References

GSM 04.07 section 6.2.2., GSM 04.08 section 5.4.3.

26.8.1.3.3.3.3 Test purpose

To verify that a CC-entity of the MS in CC-state U9, "MS Terminating Call Confirmed", upon request by the user to terminate will send a DISCONNECT message and enter the CC-state U11, "Disconnect Request".

26.8.1.3.3.3.4 Method of test

Related PICS/PIXIT statements

- supported MT circuit switched basic services;
- MT circuit switched basic services for which immediate connect is not used;
- the MS supports user requested call clearing in the state U9.

Initial conditions

System Simulator:

1 cell, default parameters.

Mobile Station:

The MS is in MM-state "idle, updated" with valid TMSI and CKSN.

The MS is brought into the state U9 by using table 26.8.1.3/4.

Foreseen final state of the MS

U11, disconnect request.

Maximum duration of test

30 s.

Test procedure

An MT circuit switched basic service is selected that is supported by the MS and for which the MS does not use immediate connection; if the MS supports MT telephony without immediate connection, the selected basic service is telephony. If necessary, the MS is configured for that basic service. Then a mobile terminated call is initiated. The CC entity of the MS is brought to the state U9 (by using a SETUP message not containing the signal information element). Then the user requests termination of the call, if possible. The MS sends a DISCONNECT message and enters state U11, disconnect request. The SS verifies by using the status enquiry procedure that the MS has entered the correct state.

Expected sequence

Step	Direction	Message	Comments
1			the MS is made to clear the call cause 30#, state U11
2	MS -> SS	DISCONNECT	
3	SS -> MS	STATUS ENQUIRY	
4	MS -> SS	STATUS	

Specific message contents:

None.

26.8.1.3.3.4 Incoming call / U9 mobile terminating call confirmed / DISCONNECT received

26.8.1.3.3.4.1 Definition and applicability

The call control entity of the MS being in the state, U9, a DISCONNECT message is received by the MS. This test is applicable for any equipment supporting at least one MT circuit switched basic service, for which immediate connect is not used.

26.8.1.3.3.4.2 Conformance requirement

- 1) A CC-entity of the MS in CC-state U9, "MS Terminating Call Confirmed", upon receipt of a DISCONNECT shall return a RELEASE message and enter the CC-state U19, "Release Request".

References

GSM 04.08 section 5.4.4.

26.8.1.3.3.4.3 Test purpose

To verify that a CC-entity of the MS in CC-state U9, "MS Terminating Call Confirmed", upon receipt of a DISCONNECT returns a RELEASE message and enters the CC-state U19, "Release Request".

26.8.1.3.3.4.4 Method of test

Related PICS/PIXIT statements

- supported MT circuit switched basic services;
- MT circuit switched basic services for which immediate connect is not used.

Initial conditions

System Simulator:

1 cell, default parameters.

Mobile Station:

The MS is in MM-state "idle, updated" with valid TMSI and CKSN.

The MS is brought into the state U9 by using table 26.8.1.3/4.

Foreseen final state of the MS

U19, release request.

Maximum duration of test

30 s.

Test procedure

An MT circuit switched basic service is selected that is supported by the MS and for which the MS does not use immediate connection; if the MS supports MT telephony without immediate connection, the selected basic service is telephony. If necessary, the MS is configured for that basic service. Then a mobile terminated call is initiated. The CC entity of the MS is brought to the state U9. The SS sends a DISCONNECT message to the MS. The MS responds by sending a RELEASE message and enters state U19, release request. The SS verifies by using the status enquiry procedure that the MS has entered the correct state.

Expected sequence

Step	Direction	Message	Comments
1	SS -> MS	DISCONNECT	
2	MS -> SS	RELEASE	
3	SS -> MS	STATUS ENQUIRY	
4	MS -> SS	STATUS	cause 30#, state U19

Specific message contents:

None.

26.8.1.3.3.5 Incoming call / U9 mobile terminating call confirmed / RELEASE received

26.8.1.3.3.5.1 Definition and applicability

The call control entity of the MS being in the state, U9, a RELEASE message is received by the MS. This test is applicable for any equipment supporting at least one MT circuit switched basic service, for which immediate connect is not used.

26.8.1.3.3.5.2 Conformance requirement

- 1) A CC-entity of the MS in CC-state U9, "MS Terminating Call Confirmed", upon receipt of a RELEASE shall return a RELEASE COMPLETE and enter the CC-state U0, "Null".

GSM 04.08 section 5.4.4.

- 2) On returning to the idle mode the MS shall release the MM-connection and the CC-entities relating to the seven mobile terminating transaction identifiers shall be in CC-state U0, "Null".

References

Conformance requirement 1: GSM 04.08 section 5.4.4.

Conformance requirement 2: GSM 04.08 section 4.5.3., GSM 04.08 section 5.5.3.2.,
GSM 04.08 section 8.3.

26.8.1.3.3.5.3 Test purpose

- 1) To verify that a CC-entity of the MS in CC-state U9, "MS Terminating Call Confirmed", upon receipt of a RELEASE will return a RELEASE COMPLETE and enter the CC-state U0, "Null".
- 2) To verify that the MS on returning to the idle mode releases the MM-connection and that the CC-entities relating to the seven mobile terminating transaction identifiers are in CC-state U0, "Null".

26.8.1.3.3.5.4 Method of test

Related PICS/PIXIT statements

- supported MT circuit switched basic services;
- MT circuit switched basic services for which immediate connect is not used.

Initial conditions

System Simulator:

1 cell, default parameters.

Mobile Station:

The MS is in MM-state "idle, updated" with valid TMSI and CKSN.

The MS is brought into the state U9 by using table 26.8.1.3/4.

Foreseen final state of the MS

U0, null.

Maximum duration of test

1 min 30 s.

Test procedure

An MT circuit switched basic service is selected that is supported by the MS and for which the MS does not use immediate connection; if the MS supports MT telephony without immediate connection, the selected basic service is telephony. If necessary, the MS is configured for that basic service. Then a mobile terminated call is initiated. The CC entity of the MS is brought to the state U9. The SS sends a RELEASE message to the MS. The MS responds by sending a RELEASE COMPLETE message and enters state U0, null. The SS verifies by using the status enquiry procedure that the MS has entered the correct state with the relevant transaction identifiers.

Expected sequence

Step	Direction	Message	Comments
1	SS -> MS	RELEASE	with cause "Normal, unspecified"
2	MS -> SS	RELEASE COMPLETE	
3	SS -> MS	STATUS ENQUIRY	cause 81# (invalid TI value) repeat steps 3-4 to cover all the transaction identifiers from 000...110
4	MS -> SS	RELEASE COMPLETE	
5	SS		
6	SS -> MS	CHANNEL RELEASE	the main signalling link shall be released by the MS (L2: DISC/UA).

Specific message contents:

None.

26.8.1.3.3.6 Incoming call / U9 mobile terminating call confirmed / lower layer failure

26.8.1.3.3.6.1 Definition and applicability

The call control entity of the MS being in the state, U9, a lower layer failure is accomplished at the MS and consequently, communication at layer 3 level with the peer entity is terminated. This test is applicable for any equipment supporting at least one MT circuit switched basic service, for which immediate connect is not used.

26.8.1.3.3.6.2 Conformance requirement

- 1) A CC entity of the MS in CC-state U9, "MS Terminating Call Confirmed", having detected a lower layer failure shall return to idle mode with the CC entities relating to the seven mobile terminating transaction identifiers in CC-state U0, "Null".

References

GSM 04.08 section 4.5.2.3., GSM 04.08 section 4.5.3., GSM 04.08 section 5.5.3.2., GSM 04.08 section 8.3.

26.8.1.3.3.6.3 Test purpose

To verify that a CC entity of the MS in CC-state U9, "MS Terminating Call Confirmed", having detected a lower layer failure returns to idle mode with the CC entities relating to the seven mobile terminating transaction identifiers in CC-state U0, "Null".

26.8.1.3.3.6.4 Method of test

Related PICS/PIXIT statements

- supported MT circuit switched basic services;

- MT circuit switched basic services for which immediate connect is not used.

Initial conditions

System Simulator:

1 cell, default parameters.

Mobile Station:

The MS is in MM-state "idle, updated" with valid TMSI and CKSN.

The MS is brought into the state U9 by using table 26.8.1.3/4.

Foreseen final state of the MS

U0, null.

Maximum duration of test

1 min 30 s.

Test procedure

An MT circuit switched basic service is selected that is supported by the MS and for which the MS does not use immediate connection; if the MS supports MT telephony without immediate connection, the selected basic service is telephony. If necessary, the MS is configured for that basic service. Then a mobile terminated call is initiated. The MS is brought to the state U9. The SS generates a lower layer failure at the MS. The SS waits long enough to enable the MS to return to idle state listening to paging, and then pages MS to create RR-connection. Finally, the SS will check the state of the MS by using STATUS ENQUIRY with the relevant transaction identifiers.

Expected sequence

Step	Direction	Message	Comments
1	SS		SS generates lower layer failure
2	SS		SS waits 20 s for the MS to return to listening to paging
3	SS -> MS	PAGING REQUEST	
4	MS -> SS	CHANNEL REQUEST	
5	SS -> MS	IMMEDIATE ASSIGNMENT	
6	MS -> SS	PAGING RESPONSE	
7	SS -> MS	STATUS ENQUIRY	
8	MS -> SS	RELEASE COMPLETE	cause 81# (invalid TI value)
9	SS		repeat steps 7-8 to cover all the transaction identifiers from 000...110
10	SS -> MS	CHANNEL RELEASE	the main signalling link shall be released by the MS (L2: DISC/UA).

Specific message contents:

None.

26.8.1.3.3.7 Incoming call / U9 mobile terminating call confirmed / unknown message received

26.8.1.3.3.7.1 Definition and applicability

The call control entity of the MS being in the state, U9, an unknown message is received by the MS. This test is applicable for any equipment supporting at least MT circuit switched basic service, for which immediate connect is not used.

26.8.1.3.3.7.2 Conformance requirement

- 1) A CC-entity of the MS in CC-state U9, "MS Terminating Call Confirmed" having received an unknown message from its peer entity shall return a STATUS message.

References

GSM 04.08 section 8.4.

26.8.1.3.3.7.3 Test purpose

To verify that a CC-entity of the MS in CC-state U9, "MS Terminating Call Confirmed" having received an unknown message from its peer entity returns a STATUS message.

26.8.1.3.3.7.4 Method of test

Related PICS/PIXIT statements

- supported MT circuit switched basic services;
- MT circuit switched basic services for which immediate connect is not used.

Initial conditions

System Simulator:

1 cell, default parameters.

Mobile Station:

The MS is in MM-state "idle, updated" with valid TMSI and CKSN.

The MS is brought into the state U9 by using table 26.8.1.3/4.

Foreseen final state of the MS

U9, mobile terminating call proceeding.

Maximum duration of test

30 s.

Test procedure

A MT circuit switched basic service is selected that is supported by the MS and for which the MS does not use immediate connection; if the MS supports MT telephony without immediate connection, the selected basic service is telephony. If necessary, the MS is configured for that basic service. Then a mobile terminated call is initiated. The CC entity of the MS is brought to the state U9. The SS sends a message with message type not defined for the protocol discriminator to the MS. The MS shall respond with a STATUS message, and finally the SS checks by using the status enquiry procedure that the state of the CC entity has remained unchanged.

Expected sequence

Step	Direction	Message	Comments
1	SS -> MS	unknown message	message type not defined for PD
2	MS -> SS	STATUS	cause 97#, state U9
3	SS -> MS	STATUS ENQUIRY	
4	MS -> SS	STATUS	cause 30#, state U9

Specific message contents:

None.

26.8.1.3.4 Incoming call / U7 call received

26.8.1.3.4.1 Incoming call / U7 call received / call accepted

26.8.1.3.4.1.1 Definition and applicability

The call control entity of the MS being in the state, U7, a user accepts the incoming call. This test is applicable for any equipment supporting at least one mobile terminating circuit switched basic service for which immediate connect is not used.

26.8.1.3.4.1.2 Conformance requirement

- 1) A CC entity of a MS in CC-state U7, "Call Received", upon a user accepting the incoming call, shall send a CONNECT message to its peer entity and enter the CC-state U8, "Connect Request".

References

GSM 04.07 section 6.2.2., GSM 04.08 section 5.2.2.5.

26.8.1.3.4.1.3 Test purpose

To verify that a CC entity of a MS in CC-state U7, "Call Received", upon a user accepting the incoming call, shall send a CONNECT message to its peer entity and enter the CC-state U8, "Connect Request"

26.8.1.3.4.1.4 Method of test

Related PICS/PIXIT statements

- supported MT circuit switched basic services;
- MT circuit switched basic services for which immediate connect is not used.

Initial conditions

System Simulator:

1 cell, default parameters.

Mobile Station:

The MS is in MM-state "idle, updated" with valid TMSI and CKSN.

The MS is brought into the state U7 by using table 26.8.1.3/3.

Foreseen final state of the MS

U8, connect request.

Maximum duration of test

30 s.

Test procedure

An MT circuit switched basic service is selected that is supported by the MS and for which the MS does not use immediate connection; if the MS supports MT telephony without immediate connection, the selected basic service is telephony. If necessary, the MS is configured for that basic service. Then a mobile terminated call is initiated. The CC

entity of the MS is brought to the state U7. The user accepts the incoming call. The MS sends a CONNECT message. The SS checks by using the status enquiry procedure that the CC entity has entered state U8, connect request.

Expected sequence

Step	Direction	Message	Comments
1			the MS is made to accept the call by the user cause 30#, state U8
2	MS -> SS	CONNECT	
3	SS -> MS	STATUS ENQUIRY	
4	MS -> SS	STATUS	

Specific message contents:

None.

26.8.1.3.4.2 Incoming call / U7 call received / termination requested by the user

26.8.1.3.4.2.1 Definition and applicability

The call control entity of the MS being in the state, U7, a user requests to terminate incoming call. This test is applicable for any equipment supporting at least one mobile terminating circuit switched basic service for which immediate connect is not used.

26.8.1.3.4.2.2 Conformance requirement

- 1) A CC entity of a MS in CC-state U7, "Call Received", upon request by the user to terminate shall send a DISCONNECT message and enter the CC-state U11, "Disconnect Request".

References

GSM 04.07 section 6.2.2., GSM 04.08 section 5.4.3.

26.8.1.3.4.2.3 Test purpose

To verify that a CC entity of a MS in CC-state U7, "Call Received", upon request by the user to terminate will send a DISCONNECT message and enter the CC-state U11, "Disconnect Request".

26.8.1.3.4.2.4 Method of test

Related PICS/PIXIT statements

- supported MT circuit switched basic services;
- MT circuit switched basic services for which immediate connect is not used.

Initial conditions

System Simulator:

1 cell, default parameters.

Mobile Station:

The MS is in MM-state "idle, updated" with valid TMSI and CKSN.

The MS is brought into the state U7 by using table 26.8.1.3/3.

Foreseen final state of the MS

U11, disconnect request.

Maximum duration of test

30 s.

Test procedure

An MT circuit switched basic service is selected that is supported by the MS and for which the MS does not use immediate connection; if the MS supports MT telephony without immediate connection, the selected basic service is telephony. If necessary, the MS is configured for that basic service. Then a mobile terminated call is initiated. The CC entity of the MS is brought to the state U7. The user initiates clearing the incoming call. The MS sends a DISCONNECT message. The SS checks by using the status enquiry procedure that the CC entity has entered state U11, disconnect request.

Expected sequence

Step	Direction	Message	Comments
1			the MS is made to terminate/reject the call
2	MS -> SS	DISCONNECT	
3	SS -> MS	STATUS ENQUIRY	
4	MS -> SS	STATUS	cause 30#, state U11

Specific message contents:

None.

26.8.1.3.4.3 Incoming call / U7 call received / DISCONNECT received

26.8.1.3.4.3.1 Definition and applicability

The call control entity of the MS being in the state, U7, a DISCONNECT message is received by the MS. This test is applicable for any equipment supporting at least one mobile terminating circuit switched basic service for which immediate connect is not used.

26.8.1.3.4.3.2 Conformance requirement

- 1) A CC entity of a MS in CC-state U7, "Call Received", upon receipt of a DISCONNECT with a progress indicator indicating in-band information from network, if a TCH was not assigned, shall return a RELEASE message and enter the CC-state U19, "Release Request".

References

GSM 04.08 section 5.4.4.

26.8.1.3.4.3.3 Test purpose

To verify that a CC entity of a MS in CC-state U7, "Call Received", upon receipt of a DISCONNECT with a progress indicator indicating in-band information from network, if a TCH was not assigned, returns a RELEASE message and enters the CC-state U19, "Release Request".

26.8.1.3.4.3.4 Method of test

Related PICS/PIXIT statements

- supported MT circuit switched basic services;
- MT circuit switched basic services for which immediate connect is not used.

Initial conditions

System Simulator:

1 cell, default parameters.

Mobile Station:

The MS is in MM-state "idle, updated" with valid TMSI and CKSN.

The MS is brought into the state U7 by using table 26.8.1.3/1.

Foreseen final state of the MS

U19, release request.

Maximum duration of test

30 s.

Test procedure

An MT circuit switched basic service is selected that is supported by the MS and for which the MS does not use immediate connection; if the MS supports MT telephony without immediate connection, the selected basic service is telephony. If necessary, the MS is configured for that basic service. Then a mobile terminated call is initiated. The CC entity of the MS is brought to the state U7. The SS sends a DISCONNECT message. The MS responds with a RELEASE message. The SS checks by using the status enquiry procedure that the CC entity has entered state U19, release request.

Expected sequence

Step	Direction	Message	Comments
1	SS -> MS	DISCONNECT	(note)
2	MS -> SS	RELEASE	
3	SS -> MS	STATUS ENQUIRY	
4	MS -> SS	STATUS	cause 30#, state U19

Specific message contents:

NOTE: With a progress indicator indicating in-band information; Progress Indicator, Progress Description #8.

26.8.1.3.4.4 Incoming call / U7 call received / RELEASE received

26.8.1.3.4.4.1 Definition and applicability

The call control entity of the MS being in the state, U7, a RELEASE message is received by the MS. This test is applicable for any equipment supporting at least one mobile terminating circuit switched basic service for which immediate connect is not used.

26.8.1.3.4.4.2 Conformance requirement

- 1) A CC entity of a MS in CC-state U7, "Call Received", upon receipt of a RELEASE shall return a RELEASE COMPLETE and enter the CC-state U0, "Null".
- 2) On returning to the idle mode the MS shall release the MM-connection and the CC-entities relating to the seven mobile terminating transaction identifiers shall be in CC-state U0, "Null".

References

Conformance requirement 1: GSM 04.08 section 5.4.4.

Conformance requirement 2: GSM 04.08 section 4.5.3., GSM 04.08 section 5.5.3.2.

26.8.1.3.4.4.3 Test purpose

- 1) To verify that a CC entity of a MS in CC-state U7, "Call Received", upon receipt of a RELEASE will return a RELEASE COMPLETE and enter the CC-state U0, "Null".
- 2) To verify that the MS on returning to the idle mode releases the MM-connection and that the CC-entities relating to the seven mobile terminating transaction identifiers are in CC-state U0, "Null".

26.8.1.3.4.4.4 Method of test

Related PICS/PIXIT statements

- supported MT circuit switched basic services;
- MT circuit switched basic services for which immediate connect is not used.

Initial conditions

System Simulator:

1 cell, default parameters.

Mobile Station:

The MS is in MM-state "idle, updated" with valid TMSI and CKSN.

The MS is brought into the state U7 by using table 26.8.1.3/1.

Foreseen final state of the MS

U0, null.

Maximum duration of test

1 min.

Test procedure

An MT circuit switched basic service is selected that is supported by the MS and for which the MS does not use immediate connection; if the MS supports MT telephony without immediate connection, the selected basic service is telephony. If necessary, the MS is configured for that basic service. Then a mobile terminated call is initiated. The CC entity of the MS is brought to the state U7. The SS sends a RELEASE message. The MS responds with a RELEASE COMPLETE message. The SS checks by using the status enquiry procedure that the CC entity has entered state U0, null, with the relevant transaction identifiers.

Expected sequence

Step	Direction	Message	Comments
1	SS -> MS	RELEASE	with cause "Normal, unspecified"
2	MS -> SS	RELEASE COMPLETE	
3	SS -> MS	STATUS ENQUIRY	cause 81# (invalid TI value) repeat steps 3-4 to cover all the transaction identifiers from 000...110
4	MS -> SS	RELEASE COMPLETE	
5	SS		
6	SS -> MS	CHANNEL RELEASE	the main signalling link shall be released by the MS (L2: DISC/UA).

Specific message contents:

None.

26.8.1.3.4.5 Incoming call / U7 call received / lower layer failure

26.8.1.3.4.5.1 Definition and applicability

The call control entity of the MS being in the state, U7, a lower layer failure is accomplished at the MS and consequently, communication at layer 3 level with the peer entity is terminated. This test is applicable for any equipment supporting at least one mobile terminating circuit switched basic service for which immediate connect is not used.

26.8.1.3.4.5.2 Conformance requirement

- 1) A CC entity of a MS in CC-state U7, "Call Received", having detected a lower layer failure shall return to idle mode with the CC entities relating to the seven mobile terminating transaction identifiers in CC-state U0, "Null".

References

GSM 04.08 section 4.5.2.3., GSM 04.08 section 4.5.3., GSM 04.08 section 5.5.3.2., GSM 04.08 section 8.3.

26.8.1.3.4.5.3 Test purpose

To verify that a CC entity of a MS in CC-state U7, "Call Received", having detected a lower layer failure returns to idle mode with the CC entities relating to the seven mobile terminating transaction identifiers in CC-state U0, "Null".

26.8.1.3.4.5.4 Method of test

Related PICS/PIXIT statements

- supported MT circuit switched basic services;
- MT circuit switched basic services for which immediate connect is not used.

Initial conditions

System Simulator:

1 cell, default parameters.

Mobile Station:

The MS is in MM-state "idle, updated" with valid TMSI and CKSN.

The MS is brought into the state U7 by using table 26.8.1.3/2.

Foreseen final state of the MS

U0, null.

Maximum duration of test

1 min 30 s.

Test procedure

An MT circuit switched basic service is selected that is supported by the MS and for which the MS does not use immediate connection; if the MS supports MT telephony without immediate connection, the selected basic service is telephony. If necessary, the MS is configured for that basic service. Then a mobile terminated call is initiated. The MS is brought to the state U7. The SS generates a lower layer failure at the MS. The SS waits long enough to enable the MS to return to idle state listening to paging, and then pages MS to create RR-connection. Finally, the SS will check the state of the MS by using STATUS ENQUIRY with the relevant transaction identifiers.

Expected sequence

Step	Direction	Message	Comments
1	SS		SS generates lower layer failure
2	SS		SS waits 20 s for the MS to return to listening to paging
3	SS -> MS	PAGING REQUEST	
4	MS -> SS	CHANNEL REQUEST	
5	SS -> MS	IMMEDIATE ASSIGNMENT	
6	MS -> SS	PAGING RESPONSE	
7	SS -> MS	STATUS ENQUIRY	
8	MS -> SS	RELEASE COMPLETE	cause 81# (invalid TI value)
9	SS		repeat steps 7-8 to cover all the transaction identifiers from 000...110
10	SS -> MS	CHANNEL RELEASE	the main signalling link shall be released by the MS (L2: DISC/UA).

Specific message contents:

None.

26.8.1.3.4.6 Incoming call / U7 call received / unknown message received

26.8.1.3.4.6.1 Definition and applicability

The call control entity of the MS being in the state, U7, an unknown message is received by the MS. This test is applicable for any equipment supporting at least one mobile terminating circuit switched basic service for which immediate connect is not used.

26.8.1.3.4.6.2 Conformance requirement

- 1) A CC entity of a MS in CC-state U7, "Call Received", having received an unknown message from its peer entity shall return a STATUS message.

References

GSM 04.08 section 8.4.

26.8.1.3.4.6.3 Test purpose

To verify that a CC entity of a MS in CC-state U7, "Call Received", having received an unknown message from its peer entity returns a STATUS message.

26.8.1.3.4.6.4 Method of test

Related PICS/PIXIT statements

- supported MT circuit switched basic services;
- MT circuit switched basic services for which immediate connect is not used.

Initial conditions

System Simulator:

1 cell, default parameters.

Mobile Station:

The MS is in MM-state "idle, updated" with valid TMSI and CKSN.

The MS is brought into the state U7 by using table 26.8.1.3/3.

Foreseen final state of the MS

U7, call received.

Maximum duration of test

30 s.

Test procedure

An MT circuit switched basic service is selected that is supported by the MS and for which the MS does not use immediate connection; if the MS supports MT telephony without immediate connection, the selected basic service is telephony. If necessary, the MS is configured for that basic service. Then a mobile terminated call is initiated. The CC entity of the MS is brought to the state U7. The SS sends a message with message type not defined for the protocol discriminator to the MS. The MS shall respond with a STATUS message, and finally the SS checks by using the status enquiry procedure that the state of the CC entity has remained unchanged.

Expected sequence

Step	Direction	Message	Comments
1	SS -> MS	unknown message	message type not defined for PD
2	MS -> SS	STATUS	cause 97#, state U7
3	SS -> MS	STATUS ENQUIRY	
4	MS -> SS	STATUS	cause 30#, state U7

Specific message contents:

None.

26.8.1.3.4.7 Incoming call / U7 call received / TCH assignment

26.8.1.3.4.7.1 Definition and applicability

The call control entity of the MS being in the state, U7, an assignment procedure is performed for traffic channel. This test is applicable for any equipment supporting at least one mobile terminating circuit switched basic service for which immediate connect is not used.

26.8.1.3.4.7.2 Conformance requirement

- 1) A CC entity of a MS in CC-state U7, "Call Received", when allocated a traffic channel by the network performing the assignment procedure, shall perform a layer 2 establishment on the FACCH without changing the state of the call in progress.

References

GSM 04.08 section 3.4.3., GSM 04.08 section 5.2.2.7.

26.8.1.3.4.7.3 Test purpose

To verify that a CC entity of a MS in CC-state U7, "Call Received", when allocated a traffic channel by the network performing the assignment procedure, shall perform a layer 2 establishment on the FACCH without changing the state of the call in progress.

26.8.1.3.4.7.4 Method of test

Related PICS/PIXIT statements

- supported MT circuit switched basic services;
- MT circuit switched basic services for which immediate connect is not used.

Initial conditions

System Simulator:

1 cell, default parameters.

Mobile Station:

The MS is in MM-state "idle, updated" with valid TMSI and CKSN.

The MS is brought into the state U7 by using table 26.8.1.3/1.

Foreseen final state of the MS

U7, call received.

Maximum duration of test

30 s.

Test procedure

An MT circuit switched basic service is selected that is supported by the MS and for which the MS does not use immediate connection; if the MS supports MT telephony without immediate connection, the selected basic service is telephony. If necessary, the MS is configured for that basic service. Then a mobile terminated call is initiated. The CC entity of the MS is brought to the state U7. The SS sends an ASSIGNMENT COMMAND for traffic channel to the MS. The MS shall establish layer 2 link on the newly allocated channel and respond with an ASSIGNMENT COMPLETE message. The SS verifies by using the status enquiry procedure that the state of the CC entity has remained unchanged.

Expected sequence

Step	Direction	Message	Comments
1	SS -> MS	ASSIGNMENT COMMAND	TCH
2	MS		the MS shall establish L2 link
3	MS -> SS	ASSIGNMENT COMPLETE	
4	SS -> MS	STATUS ENQUIRY	
5	MS -> SS	STATUS	cause 30#, state U7

Specific message contents:

None.

26.8.1.3.4.8 Incoming call / U7 call received / RELEASE COMPLETE received

26.8.1.3.4.8.1 Definition and applicability

The call control entity of the MS being in the state, U7, the call is cleared by a RELEASE COMPLETE message sent by the SS. This test is applicable for any equipment supporting at least one mobile terminating circuit switched basic service, for which immediate connect is not used.

26.8.1.3.4.8.2 Conformance requirement

- 1) A CC entity of the MS in CC-state U7, "call received", upon receipt of a RELEASE COMPLETE message with valid cause value, shall enter CC state U0, "Null".
- 2) On returning to idle mode, the CC entities relating to the seven mobile terminating transaction identifiers shall be in state U0, "Null".

References

Conformance requirement 1: GSM 04.08, section 5.4.2, GSM 04.08, section 5.4.4.

Conformance requirement 2: GSM 04.08, section 5.4.4.3.

26.8.1.3.4.8.3 Test purpose

- 1) To verify that a CC entity of the MS in CC-state U7, "Call received", upon receipt of a RELEASE COMPLETE message with valid cause value, enters CC state U0, "Null".
- 2) To verify that in returning to idle mode, the CC entities relating to the seven mobile terminating transaction identifiers are in state U0, "Null".

26.8.1.3.4.8.4 Method of test

Related PICS/PIXIT statements

- supported MT circuit switched basic services;
MT circuit switched basic services for which immediate connect is not used.

Initial conditions

System Simulator:

1 cell, default parameters.

Mobile Station:

The MS is in MM-state "idle, updated" with valid TMSI and CKSN.

The MS is brought into the state U7 by using table 26.8.1.3/1.

Foreseen final state of the MS

U0, null.

Maximum duration of test

30 s.

Test procedure

An MT circuit switched basic service is selected that is supported by the MS and for which the MS does not use immediate connection; if the MS supports MT telephony without immediate connection, the selected service is telephony. If necessary, the MS is configured for that basic service. The a mobile terminated call is initiated. the CC entity of the MS is brought to U7. The SS sends a RELEASE COMPLETE message to the MS. The SS checks by using the status enquiry procedure that the CC entity has entered the state U0 with all the relevant transaction identifiers.

Expected sequence

Step	Direction	Message	Comments
1	SS -> MS	RELEASE COMPLETE	note 1
2	SS -> MS	STATUS ENQUIRY	
3	MS -> SS	RELEASE COMPLETE	cause 81# (invalid TI value), note 2
4	SS		repeat steps 2-3 to cover all the transaction identifiers from 000...110
5	SS -> MS	CHANNEL RELEASE	the main signalling link shall be released by the MS (L2: DISC/UA).

Specific message contents:

NOTE 1: With the cause value chosen arbitrarily.

NOTE 2: TI flag has the value indicating the SS as a originator of the call.

26.8.1.3.5 Incoming call / U8 connect request

26.8.1.3.5.1 Incoming call / U8 connect request / CONNECT acknowledged

26.8.1.3.5.1.1 Definition and applicability

The call control entity of the MS being in the state, U8, a CONNECT ACKNOWLEDGE message is received by the MS. This test is applicable for any equipment supporting at least one mobile terminating circuit switched basic service.

26.8.1.3.5.1.2 Conformance requirement

A CC entity of a MS in CC-state U8, "Connect Request", upon receipt of CONNECT ACKNOWLEDGE shall enter the CC-state U10, "Call Active".

References

GSM 04.08 section 5.2.2.6.

26.8.1.3.5.1.3 Test purpose

To verify that a CC entity of a MS in CC-state U8, "Connect Request", upon receipt of CONNECT ACKNOWLEDGE shall enter the CC-state U10, "Call Active".

26.8.1.3.5.1.4 Method of test

Related PICS/PIXIT statements

- supported MT circuit switched basic services;
- MT circuit switched basic services for which immediate connect is not used.

Initial conditions

System Simulator:

1 cell, default parameters.

Mobile Station:

The MS is in MM-state "idle, updated" with valid TMSI and CKSN.

The MS is brought into the state U8 by using table 26.8.1.3/2.

Foreseen final state of the MS

U10, active.

Maximum duration of test

30 s.

Test procedure

An MT circuit switched basic service is selected that is supported by the MS; if the MS supports MT telephony, the selected basic service is telephony. If necessary the MS is configured for that basic service. Then a mobile terminated call is initiated. The CC entity of the MS is brought to the state U8 (if the MS uses immediate connection for the selected basic service then p = Y, otherwise p = N). The SS sends a CONNECT ACKNOWLEDGE message. The SS checks by using the status enquiry procedure that the CC entity of the MS has entered state U10, active.

Expected sequence

Step	Direction	Message	Comments
A1	SS -> MS	ASSIGNMENT COMMAND	p = Y
A2	MS -> SS	ASSIGNMENT COMPLETE	
3	SS -> MS	CONNECT ACKNOWLEDGE	cause 30#, state U10
4	SS -> MS	STATUS ENQUIRY	
5	MS -> SS	STATUS	

Specific message contents:

None.

26.8.1.3.5.2 Incoming call / U8 connect request / timer T313 time-out

26.8.1.3.5.2.1 Definition and applicability

The call control entity of the MS being in the state, U8, if no response is then received from the SS, timer T313 expires at the MS side. This test is applicable for any equipment supporting at least one mobile terminating circuit switched basic service.

26.8.1.3.5.2.2 Conformance requirement

A CC entity of a MS in CC-state U8, "Connect Request", having waited for a reasonable length of time (e.g. expiry of timer T313) without receiving the appropriate protocol message to complete the incoming call, shall initiate the clearing of that incoming call by sending the CC message DISCONNECT and enter the CC-state U11, "Disconnect Request".

If an MS disconnects too early then, in the case of very late assignment of a traffic channel, systematic waste of radio resources may occur.

References

GSM 04.08 section 5.2.2.6., GSM 04.08 section 5.4.3.

26.8.1.3.5.2.3 Test purpose

To verify that a CC entity of a MS in CC-state U8, "Connect Request", having waited for a reasonable length of time (e.g. expiry of timer T313) without receiving the appropriate protocol message to complete the incoming call, shall initiate the clearing of that incoming call by sending the CC message DISCONNECT and enter the CC-state U11, "Disconnect Request"

26.8.1.3.5.2.4 Method of test

Related PICS/PIXIT statements

- supported MT circuit switched basic services;
- MT circuit switched basic services for which immediate connect is not used.

Initial conditions

System Simulator:

1 cell, default parameters.

Mobile Station:

The MS is in MM-state "idle, updated" with valid TMSI and CKSN.

The MS is brought into the state U8 by using table 26.8.1.3/2.

Foreseen final state of the MS

U11, disconnect request.

Maximum duration of test

45 s.

Test procedure

An MT circuit switched basic service is selected that is supported by the MS; if the MS supports MT telephony, the selected basic service is telephony. If necessary the MS is configured for that basic service. Then a mobile terminated call is initiated. The CC entity of the MS is brought to the state U8 (if the MS uses immediate connection for the selected basic service then $p = Y$, otherwise $p = N$). The T313 expires at the MS and the MS sends a DISCONNECT message and enters state U11, disconnect request. The SS checks by using the status enquiry procedure that the MS has entered the correct state.

Expected sequence

Step	Direction	Message	Comments
A1	SS -> MS	ASSIGNMENT COMMAND	$p = Y$
A2	MS -> SS	ASSIGNMENT COMPLETE	
3	MS -> SS	DISCONNECT	Shall not be sent before 15 seconds after entry into state U8. But, shall be sent before $1,1 * T313$ after entry into state U8. cause 30#, state U11
4	SS -> MS	STATUS ENQUIRY	
5	MS -> SS	STATUS	

Specific message contents:

None.

26.8.1.3.5.3 Incoming call / U8 connect request / termination requested by the user

26.8.1.3.5.3.1 Definition and applicability

The call control entity of the MS being in the state, U10, the user requests for releasing of the call. This test is applicable for any equipment supporting at least one mobile terminating circuit switched basic service.

26.8.1.3.5.3.2 Conformance requirement

- 1) A CC entity of a MS in CC-state U8, "Connect Request", upon request by the user to terminate shall send a DISCONNECT message and enter the CC-state U11, "Disconnect Request".

References

GSM 04.07 section 6.2.2., GSM 04.08 section 5.4.3., GSM 11.10, annex 3 - section 2.2.

26.8.1.3.5.3.3 Test purpose

To verify that a CC entity of a MS in CC-state U8, "Connect Request", upon request by the user to terminate will send a DISCONNECT message and enter the CC-state U11, "Disconnect Request".

26.8.1.3.5.3.4 Method of test

Related PICS/PIXIT statements

- supported MT circuit switched basic services;
- MT circuit switched basic services for which immediate connect is not used.

Initial conditions

System Simulator:

1 cell, default parameters.

Mobile Station:

The MS is in MM-state "idle, updated" with valid TMSI and CKSN.

The MS is brought into the state U8 by using table 26.8.1.3/2.

Foreseen final state of the MS

U11, disconnect request.

Maximum duration of test

30 s.

Test procedure

An MT circuit switched basic service is selected that is supported by the MS; if the MS supports MT telephony, the selected basic service is telephony. If necessary the MS is configured for that basic service. Then a mobile terminated call is initiated. The CC entity of the MS is brought to the state U8 (if the MS uses immediate connection for the selected basic service then $p = Y$, otherwise $p = N$). Then the user requests termination of the call. The MS sends a DISCONNECT message and enters state U11, disconnect request. The SS verifies by using the status enquiry procedure that the MS has entered the correct state.

Expected sequence

Step	Direction	Message	Comments
A1	SS -> MS	ASSIGNMENT COMMAND	$p = Y$
A2	MS -> SS	ASSIGNMENT COMPLETE	
3			the user requests to clear the call
4	MS -> SS	DISCONNECT	
5	SS -> MS	STATUS ENQUIRY	
6	MS -> SS	STATUS	
			cause 30#, state U11

Specific message contents:

None.

26.8.1.3.5.4 Incoming call / U8 connect request / DISCONNECT received with in-band information

26.8.1.3.5.4.1 Definition and applicability

The call control entity of the MS being in the state, U8, a DISCONNECT message indicating availability of in band information is received by the MS. This test is applicable for any equipment supporting at least one mobile terminating circuit switched basic service.

26.8.1.3.5.4.2 Conformance requirement

A CC entity of a MS in CC-state U8, "Connect Request", upon receipt of a DISCONNECT with progress indicator #8 shall enter CC-state U12, if the traffic channel is in speech mode. If the TCH is not in speech mode, the MS shall send a RELEASE message and enter CC-state U19.

References

GSM 04.08 section 5.4.4., GSM 04.08 section 5.5.1.

26.8.1.3.5.4.3 Test purpose

To verify that a CC entity of a MS in CC-state U8, "Connect Request", upon receipt of a DISCONNECT with progress indicator #8 enters CC-state U12, if the traffic channel is in speech mode, and that the MS sends a RELEASE message and enters CC-state U19 if the TCH is not in speech mode.

26.8.1.3.5.4.4 Method of test

Related PICS/PIXIT statements

- supported MT circuit switched basic services.

Initial conditions

System Simulator:

1 cell, default parameters.

Mobile Station:

The MS is in MM-state "idle, updated" with valid TMSI and CKSN. The MS is brought into the state U8 by using table 26.8.1.3/3.

Foreseen final state of the MS

U12, disconnect indication or U19 depending on the bearer capabilities.

Maximum duration of test

30 s.

Test procedure

An MT circuit switched basic service is selected that is supported by the MS; if the MS supports MT telephony, the selected basic service is telephony. If necessary the MS is configured for that basic service. Then a mobile terminated call is initiated. The CC entity of the MS is brought to the state U8. The SS sends a DISCONNECT message containing indication of in-band information availability to the MS. If channel mode is speech, the MS enters state U12, disconnect indication. If channel mode is not speech, the MS sends a RELEASE message and enters state U19, release request.

Expected sequence

Step	Direction	Message	Comments
1	SS -> MS	DISCONNECT	(note)
A2	SS -> MS	STATUS ENQUIRY	TCH in speech mode:
A3	MS -> SS	STATUS	cause 30#, state U12
B2	MS -> SS	RELEASE	TCH is not in speech mode:
B3	SS -> MS	STATUS ENQUIRY	
B4	MS -> SS	STATUS	cause 30#, state U19

Specific message contents:

NOTE: With a progress indicator indicating in-band information; Progress Indicator, Progress description #8.

26.8.1.3.5.5 Incoming call / U8 connect request / DISCONNECT received without in-band information

26.8.1.3.5.5.1 Definition and applicability

The call control entity of the MS being in the state, U8, a DISCONNECT message is received by the MS. The DISCONNECT message does not contain indication of in-band information availability. This test is applicable for any equipment supporting at least one mobile terminating circuit switched basic service.

26.8.1.3.5.5.2 Conformance requirement

- 1) A CC entity of a MS in CC-state U8, "Connect Request", upon receipt of a DISCONNECT without progress indicator, shall return a RELEASE message and enter the CC-state U19, "Release Request".

References

GSM 04.08 section 5.4.4., GSM 04.08 section 5.4.4.2.

26.8.1.3.5.5.3 Test purpose

To verify that a CC entity of a MS in CC-state U8, "Connect Request", upon receipt of a DISCONNECT without progress indicator, returns a RELEASE message and enters the CC-state U19, "Release Request".

26.8.1.3.5.5.4 Method of test

Related PICS/PIXIT statements

- supported MT circuit switched basic services.

Initial conditions

System Simulator:

1 cell, default parameters.

Mobile Station:

The MS is in MM-state "idle, updated" with valid TMSI and CKSN.

The MS is brought into the state U8 by using table 26.8.1.3/3.

Foreseen final state of the MS

U19, release request.

Maximum duration of test

30 s.

Test procedure

An MT circuit switched basic service is selected that is supported by the MS; if the MS supports MT telephony, the selected basic service is telephony. If necessary the MS is configured for that basic service. Then a mobile terminated call is initiated. The CC entity of the MS is brought to the state U8. The SS sends a DISCONNECT message not containing indication of in-band information availability to the MS. The MS shall respond with a RELEASE message. The SS checks by using the status enquiry procedure that the CC entity of the MS has entered the state U19, release request.

Expected sequence

Step	Direction	Message	Comments
1	SS -> MS	DISCONNECT	(note) cause 30#, state U19
2	MS -> SS	RELEASE	
3	SS -> MS	STATUS ENQUIRY	
4	MS -> SS	STATUS	

Specific message contents:

NOTE: Without a progress indicator indicating in-band information.

26.8.1.3.5.6 Incoming call / U8 connect request / RELEASE received

26.8.1.3.5.6.1 Definition and applicability

The call control entity of the MS being in the state, U8, a RELEASE message is received by the MS. This test is applicable for any equipment supporting at least one mobile terminating circuit switched basic service.

26.8.1.3.5.6.2 Conformance requirement

- 1) A CC entity of a MS in CC-state U8, "Connect Request", upon receipt of a RELEASE shall return a RELEASE COMPLETE and enter the CC-state U0, "Null".
- 2) On returning to the idle mode the MS shall release the MM-connection and the CC-entities relating to the seven mobile terminating transaction identifiers shall be in CC-state U0, "Null".

References

Conformance requirement 1: GSM 04.08 section 5.4.4.

Conformance requirement 2: GSM 04.08 section 4.5.3., GSM 04.08 section 5.5.3.2.

26.8.1.3.5.6.3 Test purpose

- 1) To verify that a CC entity of a MS in CC-state U8, "Connect Request", upon receipt of a RELEASE will return a RELEASE COMPLETE and enter the CC-state U0, "Null".
- 2) To verify that the MS on returning to the idle mode releases the MM-connection and that the CC-entities relating to the seven mobile terminating transaction identifiers are in CC-state U0, "Null".

26.8.1.3.5.6.4 Method of test

Related PICS/PIXIT statements

- supported MT circuit switched basic services.

Initial conditions

System Simulator:

1 cell, default parameters.

Mobile Station:

The MS is in MM-state "idle, updated" with valid TMSI and CKSN.

The MS is brought into the state U8 by using table 26.8.1.3/3.

Foreseen final state of the MS

U0, null.

Maximum duration of test

1 min.

Test procedure

An MT circuit switched basic service is selected that is supported by the MS; if the MS supports MT telephony, the selected basic service is telephony. If necessary the MS is configured for that basic service. Then a mobile terminated call is initiated. The CC entity of the MS is brought to the state U8. The SS sends a RELEASE message. The MS responds with a RELEASE COMPLETE message. The SS checks by using the status enquiry procedure that the CC entity has entered state U0, null, with the relevant transaction identifiers.

Expected sequence

Step	Direction	Message	Comments
1	SS -> MS	RELEASE	with cause "Normal, unspecified"
2	MS -> SS	RELEASE COMPLETE	
3	SS -> MS	STATUS ENQUIRY	cause 81# (invalid TI value) repeat steps 3-4 to cover all the transaction identifiers from 000...110
4	MS -> SS	RELEASE COMPLETE	
5	SS		
6	SS -> MS	CHANNEL RELEASE	the main signalling link shall be released by the MS (L2: DISC/UA).

Specific message contents:

None.

26.8.1.3.5.7 Incoming call / U8 connect request / lower layer failure

26.8.1.3.5.7.1 Definition and applicability

The call control entity of the MS being in the state, U8, a lower layer failure is accomplished at the MS and consequently, communication at layer 3 level with the peer entity is terminated. This test is applicable for any equipment supporting at least one mobile terminating circuit switched basic service.

26.8.1.3.5.7.2 Conformance requirement

- 1) A CC entity of a MS in CC-state U8, "Connect Request", having detected a lower layer failure shall return to idle mode with the CC entities relating to the seven mobile terminating transaction identifiers in CC-state U0, "Null".

References

GSM 04.08 section 4.5.2.3., GSM 04.08 section 4.5.3., GSM 04.08 section 5.5.3.2.

26.8.1.3.5.7.3 Test purpose

To verify that a CC entity of a MS in CC-state U8, "Connect Request", having detected a lower layer failure returns to idle mode with the CC entities relating to the seven mobile terminating transaction identifiers in CC-state U0, "Null".

26.8.1.3.5.7.4 Method of test

Related PICS/PIXIT statements

- supported MT circuit switched basic services.

Initial conditions

System Simulator:

1 cell, default parameters.

Mobile Station:

The MS is in MM-state "idle, updated" with valid TMSI and CKSN.

The MS is brought into the state U8 by using table 26.8.1.3/1.

Foreseen final state of the MS

U0, null.

Maximum duration of test

1 min 30 s.

Test procedure

An MT circuit switched basic service is selected that is supported by the MS; if the MS supports MT telephony, the selected basic service is telephony. If necessary the MS is configured for that basic service. Then a mobile terminated call is initiated. The MS is brought to the state U8. The SS generates a lower layer failure at the MS. The SS waits long enough to enable the MS to return to idle state listening to paging, and then pages MS to create RR-connection. Finally, the SS will check the state of the MS by using STATUS ENQUIRY with the relevant transaction identifiers.

Expected sequence

Step	Direction	Message	Comments
1	SS		SS generates lower layer failure
2	SS		SS waits 20 s for the MS to return to listening to paging
3	SS -> MS	PAGING REQUEST	
4	MS -> SS	CHANNEL REQUEST	
5	SS -> MS	IMMEDIATE ASSIGNMENT	
6	MS -> SS	PAGING RESPONSE	
7	SS -> MS	STATUS ENQUIRY	
8	MS -> SS	RELEASE COMPLETE	cause 81# (invalid TI value)
9	SS		repeat steps 7-8 to cover all the transaction identifiers from 000...110
10	SS -> MS	CHANNEL RELEASE	the main signalling link shall be released by the MS (L2: DISC/UA).

Specific message contents:

None.

26.8.1.3.5.8 Incoming call / U8 connect request / TCH assignment

26.8.1.3.5.8.1 Definition and applicability

The call control entity of the MS being in the state, U8, an assignment procedure is performed for traffic channel. This test is applicable for any equipment supporting at least one mobile terminating circuit switched basic service.

26.8.1.3.5.8.2 Conformance requirement

- 1) A CC entity of a MS in CC-state U8, "Connect Request", when allocated a traffic channel by the network performing the assignment procedure, shall perform a layer 2 establishment on the FACCH without changing the state of the call in progress.

References

GSM 04.08 section 3.4.3., GSM 04.08 section 5.2.2.7.

26.8.1.3.5.8.3 Test purpose

To verify that a CC entity of a MS in CC-state U8, "Connect Request", when allocated a traffic channel by the network performing the assignment procedure, shall perform a layer 2 establishment on the FACCH without changing the state of the call in progress.

26.8.1.3.5.8.4 Method of test

Related PICS/PIXIT statements

- supported MT circuit switched basic services.

Initial conditions

System Simulator:

1 cell, default parameters.

Mobile Station:

The MS is in MM-state "idle, updated" with valid TMSI and CKSN.

The MS is brought into the state U8 by using table 26.8.1.3/1.

Foreseen final state of the MS

U8, connect request.

Maximum duration of test

30 s.

Test procedure

An MT circuit switched basic service is selected that is supported by the MS; if the MS supports MT telephony, the selected basic service is telephony. If necessary the MS is configured for that basic service. Then a mobile terminated call is initiated. The CC entity of the MS is brought to the state U8. The SS sends an ASSIGNMENT COMMAND for traffic channel to the MS. The MS shall establish layer 2 link on the newly allocated channel and respond with an ASSIGNMENT COMPLETE message. The SS verifies by using the status enquiry procedure that the state of the CC entity has remained unchanged.

Expected sequence

Step	Direction	Message	Comments
1	SS -> MS	ASSIGNMENT COMMAND	TCH
2	MS -> SS	ASSIGNMENT COMPLETE	
3	SS -> MS	STATUS ENQUIRY	
4	MS -> SS	STATUS	cause 30#, state U8

Specific message contents:

None.

26.8.1.3.5.9 Incoming call / U8 connect request / unknown message received

26.8.1.3.5.9.1 Definition and applicability

The call control entity of the MS being in the state, U8, an unknown message is received by the MS. This test is applicable for any equipment supporting at least one mobile terminating circuit switched basic service.

26.8.1.3.5.9.2 Conformance requirement

- 1) A CC entity of a MS in CC-state U8, "Connect Request", having received an unknown message from its peer entity shall return a STATUS message.

References

GSM 04.08 section 8.4.

26.8.1.3.5.9.3 Test purpose

To verify that a CC entity of a MS in CC-state U8, "Connect Request", having received an unknown message from its peer entity returns a STATUS message.

26.8.1.3.5.9.4 Method of test

Related PICS/PIXIT statements

- supported MT circuit switched basic services.

Initial conditions

System Simulator:

1 cell, default parameters.

Mobile Station:

The MS is in MM-state "idle, updated" with valid TMSI and CKSN.

The MS is brought into the state U8 by using table 26.8.1.3/1.

Foreseen final state of the MS

U8, connect request.

Maximum duration of test

30 s.

Test procedure

An MT circuit switched basic service is selected that is supported by the MS; if the MS supports MT telephony, the selected basic service is telephony. If necessary the MS is configured for that basic service. Then a mobile terminated call is initiated. The CC entity of the MS is brought to the state U8. The SS sends a message with message type not defined for the protocol discriminator to the MS. The MS shall respond with a STATUS message, and finally the SS checks by using the status enquiry procedure that the state of the CC entity has remained unchanged.

Expected sequence

Step	Direction	Message	Comments
1	SS -> MS	unknown message	message type not defined for PD
2	MS -> SS	STATUS	cause 97#, state U8
3	SS -> MS	STATUS ENQUIRY	
4	MS -> SS	STATUS	cause 30#, state U8

Specific message contents:

None.

26.8.1.4 In call functions

26.8.1.4.1 In-call functions / DTMF information transfer

26.8.1.4.1.1 In-call functions / DTMF information transfer / basic procedures

26.8.1.4.1.1.1 Definition and applicability

Dual Tone Multi Frequency (DTMF) is an inband one out of four plus one out of four signalling system primarily used from terminal instruments in telecommunication networks.

The support of DTMF is only permitted when a bearer capability for speech is in use or during the speech phase of alternate speech/data and alternate speech/facsimile teleservices.

26.8.1.4.1.1.2 Conformance requirement

- 1) An MS supporting the Mobile originating DTMF protocol control procedure, having a CC entity for speech in state U10, "Active": when made to send a DTMF tone, shall send a START DTMF message on the correct DCCH.

References

GSM 04.08, 5.3.3.

- 2) An MS supporting the Mobile originating DTMF protocol control procedure, having a CC entity for speech in state U10, "Active": when made to send a DTMF tone (the corresponding IA5 character being selected from among the ones supported), shall send a START DTMF message specifying the correct IA5 character in the "keypad information" field of the keypad facility information element.

2.1 GSM 04.08, 5.3.3.

26.8.1.4.1.1.3 Test purpose

- 1) To verify that an MS supporting the Mobile originating DTMF protocol control procedure, having a CC entity for speech in state U10, "Active": when made to send a DTMF tone, sends a START DTMF message on the correct DCCH.
- 2) To verify that an MS supporting the Mobile originating DTMF protocol control procedure, having a CC entity for speech in state U10, "Active": when made to send a DTMF tone (the corresponding IA5 character being selected from among the ones supported), sends a START DTMF message specifying the correct IA5 character in the "keypad information" field of the keypad facility information element.

26.8.1.4.1.1.4 Method of test

Related PICS/PIXIT statements

- supported teleservices;

- supported character set (e.g. 0-9, #, *, A, B, C, D);
- if and how DTMF tone is indicated to the user.

Initial conditions

System Simulator:

1 cell, default parameters.

Mobile Station:

The MS is in CC-state "active".

Foreseen final state of the MS

CC-state "active".

Maximum duration of test

1 min.

Test procedure

The MS being in the call active state, a user causes a DTMF tone to be generated e.g. by depression of a key in the MS. A DTMF digit corresponding to the digit indicated by the user is sent in a START DTMF message by the MS. The SS will return a START DTMF ACKNOWLEDGE message to the MS. This acknowledgement may be used in the MS to generate an indication as a feedback for a successful transmission. Then the user indicates that the DTMF sending should cease e.g. by releasing the key. The MS will send a STOP DTMF message to the network which is acknowledged with STOP DTMF ACKNOWLEDGE by the SS.

The sequence described above is repeated for each of the applicable characters 0-9, #, *, A, B, C, and D.

Then a case of rejecting a DTMF tone is tested and the state of the MS is verified.

Expected sequence

Step	Direction	Message	Comments
1	MS -> SS SS	START DTMF	the user causes DTMF tone to be generated the SS will verify that the transmitted information corresponds to the digit pressed
2	SS -> MS	START DTMF ACKNOWLEDGE	
3	SS -> MS	STATUS ENQUIRY	possible indication of a DTMF tone depending the PICS/PIXIT statements
4	MS -> SS	STATUS	
5	MS -> SS	STOP DTMF	cause 30#, state U10
6	SS -> MS	STOP DTMF ACKNOWLEDGE	
7			the DTMF tone indication shall be stopped the steps 1-4 shall be repeated for each of the applicable characters 0-9, #, *, A, B, C, D.
8	SS -> MS	STATUS ENQUIRY	
9	MS -> SS	STATUS	cause 30#, state U10
10	MS -> SS	START DTMF	
11	SS -> MS	START DTMF REJECT	
12	SS -> MS	STATUS ENQUIRY	
13	MS -> SS	STATUS	

Specific message contents:

None.

26.8.1.4.2 In-call functions / user notification

User notification procedure allows the network to notify a MS of any call-related event during the "active" state of a call. It also may allow a MS to notify the remote user of any appropriate call-related event during the "active" state of a call by sending a NOTIFY message containing a notification indicator to the network. No state change occurs at any of the interface sides during this procedure.

26.8.1.4.2.1 In-call functions / User notification / MS terminated

26.8.1.4.2.1.1 Definition and applicability

This is a case for testing user notification procedure terminated by the mobile station. The test is applicable for those equipments supporting at least one circuit switched basic service.

26.8.1.4.2.1.2 Conformance requirement

- 1) A CC entity of a MS in CC-state U10, "active", upon receiving of a NOTIFY message shall remain in the active state.

References

GSM 04.08, 5.3.1.

26.8.1.4.2.1.3 Test purpose

To verify that a CC entity of a MS in CC-state U10, "active", upon receiving of a NOTIFY message remains in the active state.

26.8.1.4.2.1.4 Method of test

Related PICS/PIXIT statements

- supported circuit switched basic services.

Initial conditions

System Simulator:

1 cell, default parameters.

Mobile Station:

The MS is in CC-state "active".

Foreseen final state of the MS

CC-state "active".

Maximum duration of test

10 s.

Test procedure

The MS being in the call active state, the SS will send a NOTIFY message to the MS. The state of the MS is checked after that.

Expected sequence

Step	Direction	Message	Comments
1	SS -> MS	NOTIFY	
2	SS -> MS	STATUS ENQUIRY	
3	MS -> SS	STATUS	cause 30#, state U10

Specific message contents:

None.

26.8.1.4.3 In-call functions / channel changes

The two following test cases are for testing some elementary radio resource level procedures during an active state of a call to ensure call maintenance also during physical channel changes.

26.8.1.4.3.1 In-call functions / channel changes / a successful channel change in active state/ Handover and Assignment Command

26.8.1.4.3.1.1 Definition and applicability

This is a case to test a change of a physical channel during active state of a call. This test is applicable for any equipment supporting at least one mobile terminating circuit switched basic service.

26.8.1.4.3.1.2 Conformance requirement

- 1) The MS being in the call active state after having successfully completed a channel assignment or a handover command, shall remain in the call active state.

References

GSM 04.08, section 5.3.4.3.2, GSM 04.08, section 3.4.6.1

26.8.1.4.3.1.3 Test purpose

To verify that the MS being in the call active state after having successfully completed a channel assignment or having completed a handover command remains in the call active state.

26.8.1.4.3.1.4 Method of test

Related PICS/PIXIT statements

- supported MT circuit switched basic services;
- Type of MS (GSM 450 or GSM 480 or P-GSM 900 or EGSM or DCS 1 800 or PCS 1900).

Initial conditions

System Simulator:

1 cell, default parameters.

Mobile Station:

The MS is in CC-state "active".

Foreseen final state of the MS

CC-state "active".

Maximum duration of test

10 s.

Test procedure

The SS initiates a call to the Mobile Station, using an arbitrarily chosen MT circuit switched basic service (see section 10 for generic call set up procedures).

The MS being in the call active state, th SS initiated channel assignment procedure causing an intracell change of channel by sending ASSIGNMENT COMMAND message to the MS. The MS performs channel assignment procedure and after the main signalling link is successfully established, the MS returns an ASSIGNMENT COMPLETE message. The state of the MS is then checked.

The SS then initiates a Finely Synchronized handover intra cell procedure. On the successful completion of this procedure the state of the MS is checked.

Expected sequence

Step	Direction	Message	Comments
0			Generic call set up procedure defined in sections 10.1 and 10.3, depending on choice of Bearer Capability.
1	SS -> MS	ASSIGNMENT COMMAND	
2	MS -> SS	ASSIGNMENT COMPLETE	
3	SS -> MS	STATUS ENQUIRY	
4	MS -> SS	STATUS	cause 30#, state U10
5	SS -> MS	HANDOVER COMMAND	See Specific message contents.
6	MS -> SS	HANDOVER ACCESS	Four HANDOVER ACCESS
7	MS -> SS	HANDOVER ACCESS	
8	MS -> SS	HANDOVER ACCESS	
9	MS -> SS	HANDOVER ACCESS	
10	MS -> SS	HANDOVER COMPLETE	
11	SS -> MS	STATUS ENQUIRY	
12	MS -> SS	STATUS	cause 30#, state U10

Specific message contents:

ASSIGNMENT COMMAND

Information Element	value/remark
Channel Description As used in Assignment Command when setting up the call, except: - Timeslot Number	Arbitrary value, but different to originally used.

HANDOVER COMMAND

Information Element	value/remark
Cell Description - Network Colour Code - Base Station Colour Code - BCCH Carrier Number	1 5 GSM 450 – ARFCN 263 GSM 480 – ARFCN 310 P-GSM 900 - ARFCN 20 DCS 1 800 - ARFCN 590 – PCS 1900 – ARFCN 650
Channel Description As used in Assignment Command when setting up the call, except: - Timeslot Number	Arbitrary value, but different to originally used.
Synchronization Indication - Report Observed Time Difference - Synchronization Indication - Normal Cell Indication	Shall not be included. "Synchronized". Ignore out of range timing advance.

STATUS

Information Element	value/remark
cause	#30, statue U10.

26.8.1.4.3.2 In-call functions / channel changes / an unsuccessful channel change in active mode/
Handover and Assignment Command

26.8.1.4.3.2.1 Definition and applicability

This is a case to test an unsuccessful change of a physical channel during active state of a call. This test is applicable for any equipment supporting at least one mobile terminating circuit switched basic service.

26.8.1.4.3.2.2 Conformance requirement

- 1) The MS, when returning to the old channel after handover or Assignment failure and having established the link, shall remain in the call active state.

References

GSM 04.08, section 5.3.4.3.

26.8.1.4.3.2.3 Test purpose

To verify that the MS, when returning to the old channel after handover or Assignment failure and correctly establishing the link, will remain in the call active state.

26.8.1.4.3.2.4 Method of test

Related PICS/PIXIT statements

- supported MT circuit switched basic services;
- Type of Mobile Station (GSM 450 or GSM 480 or P-GSM 900 or EGSM or DCS 1 800 or PCS 1900).

Initial conditions

System Simulator:

1 cell, default parameters.

Mobile Station:

The MS is in CC-state "active".

Foreseen final state of the MS

CC-state "active".

Maximum duration of test

30 s.

Test procedure

The SS initiates a call to the Mobile Station, using an arbitrarily chosen circuit switched basic service (see section 10 for generic call set up procedures).

The MS being in the call active state, the SS initiates non synchronized handover procedure to cell B. The MS begins to send access bursts on the new DCCH. The SS activates the SACCH, but does not send a PHYSICAL INFORMATION

MESSAGE, thus causing timer T3124 to time-out. Then the MS shall return back to the old channel and re-establish the signalling link on cell A and send a HANDOVER FAILURE message. The state of the MS is then checked.

The SS sends an Assignment command message allocating a hopping TCH/F, but does not activate the assigned channel. The MS shall attempt try to activate the new channel (this is not verified) and shall then reactivate the "old" channel and trigger the establishment of the main signalling link on the old channel. The MS shall send an ASSIGNMENT FAILURE message. The state of the MS is then checked.

Expected sequence

Step	Direction	Message	Comments
0			Generic call set up procedure defined in sections 10.1 and 10.3, depending on choice of Bearer Capability.
1	SS -> MS	HANDOVER COMMAND	Several messages are sent, all with the handover reference sent in the HANDOVER COMMAND message.
2	MS -> SS	HANDOVER ACCESS	
3	MS -> SS	HANDOVER FAILURE	cause 30#, state U10 Channel type = TCH/F, hopping. The MS attempts and fails to establish a signalling link on the new channel. The MS re-establishes the signalling link on the "old" channel. RR cause value = "protocol error unspecified"
4	SS -> MS	STATUS ENQUIRY	
5	MS -> SS	STATUS	
6	SS -> MS	ASSIGNMENT COMMAND	
7			
8	MS -> SS	ASSIGNMENT FAILURE	
9	SS -> MS	STATUS ENQUIRY	
10	MS -> SS	STATUS	cause 30#, state U10

Specific message contents:

ASSIGNMENT FAILURE

Information Element	value/remark
RR cause	"protocol error unspecified"

HANDOVER FAILURE

Information Element	value/remark
RR cause	Not checked, as tested elsewhere.

STATUS

Information Element	value/remark
cause	#30, statue U10.

26.8.1.4.4 In-call functions / MS terminated in-call modification

26.8.1.4.4.1 In-call functions / MS terminated in-call modification / modify when new mode is not supported

26.8.1.4.4.1.1 Definition and applicability

This is to test a special case of a in-call modification procedure, in which the new mode is not supported (and consequently not one of those negotiated and agreed during the establishment phase of the call). This test is applicable for any equipment supporting at least one circuit switched basic service.

26.8.1.4.4.1.2 Conformance requirement

- 1) In the case that the MS supports the network originated in-call modification procedure, the MS after having received a MODIFY message with a new mode which is not the actual one and cannot be supported by the MS shall reject it by sending a MODIFY REJECT message or a STATUS message.
- 2) In the case that the MS does not support the network originated in-call modification procedure, the MS shall, when receiving a MODIFY message, treat the message as unknown and respond with a STATUS message.

References

- 1) GSM 04.08, sections 5.3.4.3.4.2 and 5.3.4.4.
- 2) GSM 04.08, section 5.3.4.

26.8.1.4.4.1.3 Test purpose

- 1) To verify that an MS supporting the network originated in-call modification procedure, after having received a MODIFY message with a new mode which is not the actual one and cannot be supported by the MS, rejects it by sending a MODIFY REJECT.
- 2) To verify that an MS not supporting the network originated in-call modification procedure, after having received a MODIFY message, responds with a STATUS message.

26.8.1.4.4.1.4 Method of test

Related PICS/PIXIT statements

- supported circuit switched basic services;
- the MS supports the network originated in-call modification procedure (p = Yes/No).

Initial conditions

System Simulator:

1 cell, default parameters.

Mobile Station:

The MS is in CC-state "active".

Foreseen final state of the MS

CC-state "active".

Maximum duration of test

10 s.

Test procedure

The MS being in the call active state, the SS initiates in-call modification procedure by sending a MODIFY message with new mode different from actual mode and one of those not supported by the MS. The MS either returns a MODIFY REJECT message with the old bearer capability or a STATUS message with reject cause #97, depending on the PICS/PIXIT statement. The state of the MS is then checked.

Expected sequence

Step	Direction	Message	Comments
1	SS -> MS	MODIFY	with new mode different from actual one
2a	MS -> SS	MODIFY REJECT	with the old call mode included OR, p = Yes
2b	MS -> SS	STATUS	cause #97, state U10, p = No
3	SS -> MS	STATUS ENQUIRY	
4	MS -> SS	STATUS	cause 30#, state U10

Specific message contents:

None.

26.8.1.4.5 In-call functions / MS originated in-call modification

26.8.1.4.5.1 In-call functions / MS originated in-call modification / a successful case of modifying

26.8.1.4.5.1.1 Definition and applicability

This test is to test a successful case of in-call modification, which is triggered by the calling tone identification (CNG) received by the MS. This test is applicable for any equipment supporting any dual mode bearer capability service (BS61 - Alternate Speech/Data, BS81 - Speech followed by Data, Teleservice 61 - Alternate Speech/Group 3 fax).

26.8.1.4.5.1.2 Conformance requirement

- 1) The procedure shall be initiated by the MS in the "active" state of the call. It shall send a MODIFY message including the new mode to be changed to; and enter the "mobile originating modify" state. The new mode given in the MODIFY message shall be one of those already negotiated and agreed during the establishment phase of the call. The MS shall stop sending Bm-channel information according to the old mode and enter the state U26 "Mobile Originating Modify".
- 2) Upon receipt of the MODIFY COMPLETE message the MS shall start sending channel information according to the new call mode and enter the "active" state.

References

Conformance requirement 1: GSM 04.08, section 5.3.4.3.1.

Conformance requirement 2: GSM 04.08, section 5.3.4.3.2.

26.8.1.4.5.1.3 Test purpose

- 1) To verify that the procedure is initiated by the MS in the "active" state of the call. It sends a MODIFY message including the new mode to be changed to; and enters the "mobile originating modify" state. The new mode given in the MODIFY message is one of those already negotiated and agreed during the establishment phase of the call. The MODIFY originating side stops sending Bm-channel information.
- 2) To verify that upon receipt of the MODIFY COMPLETE message the MS starts sending channel information according to the new call mode and enters the "active" state.

26.8.1.4.5.1.4 Method of test

Related PICS/PIXIT statements

- a way to activate a dual mode call;
- a way to activate in-call modification;
- support of dual bearer capability services.

Initial conditions

System Simulator:

1 cell, default parameters.

Mobile Station:

The MS is in MM-state "idle, updated" with valid TMSI and CKSN.

Foreseen final state of the MS

CC-state "active".

Maximum duration of test

10 s.

Test procedure

The MS initiates a call for one of the supported dual mode services. The MS being in the call active state, in-call modification procedure is initiated for the selected service from the MS side. The MS shall send a MODIFY message with the new mode to the SS and the state of the MS is checked. The channel mode is modified with the CHANNEL MODE MODIFY message including the appropriate channel mode for the new service. The SS then returns a MODIFY COMPLETE message. The state of the MS is then checked.

NOTE: ICM can be initiated by manual intervention at the MS.

Expected sequence

Step	Direction	Message	Comments
1	MS		The MS is made to initiate a dual mode call
2	MS -> SS	CHANNEL REQUEST	
3	SS -> MS	IMMEDIATE ASSIGNMENT	SDCCH
4	MS -> SS	CM SERVICE REQUEST	
5	SS -> MS	CIPHERING MODE COMMAND	
6	MS -> SS	CIPHERING MODE COMPLETE	
7	MS -> SS	SETUP	as specified in specific message contents
8	SS -> MS	AUTHENTICATION REQUEST	
9	MS -> SS	AUTHENTICATION RESPONSE	
10	SS -> MS	CALL PROCEEDING	as specified in specific message contents
11	SS -> MS	ASSIGNMENT COMMAND	channel mode: see section 10.4
12	MS -> SS	ASSIGNMENT COMPLETE	
13	SS -> MS	ALERTING	
14	SS -> MS	CONNECT	
15	MS -> SS	CONNECT ACKNOWLEDGE	
16	MS -> SS	MODIFY	as specified in specific message contents
17	SS -> MS	STATUS ENQUIRY	
18	MS -> SS	STATUS	cause 30#, state U26
19	SS -> MS	CHANNEL MODE MODIFY	as specified in specific message contents
20	MS -> SS	CHANNEL MODE MODIFY ACKNOWLEDGE	
21	SS -> MS	MODIFY COMPLETE	contains the new mode as bearer capability
22	SS		allow at least 2 seconds for the MS to adapt for the new mode
23	SS -> MS	STATUS ENQUIRY	
24	MS -> SS	STATUS	cause 30#, state U10
25	SS		verify that the MS starts sending Bm channel information according to the new mode

Specific message contents:

As specified in 26.8.1.4.5.10.

26.8.1.4.5.2 In-call functions / MS originated in-call modification / modify rejected

26.8.1.4.5.2.1 Definition and applicability

This is to test a special case of a in-call modification procedure, in which the in-call modification is rejected. This test is applicable for any equipment supporting any dual mode bearer capability service (BS61 - Alternate Speech/Data, BS81 - Speech followed by Data, Teleservice 61 - Alternate Speech/Group 3 fax).

26.8.1.4.5.2.2 Conformance requirement

- 1) Upon receipt of the MODIFY REJECT message with the old bearer capability the MS shall: resume sending Bm-channel information according to the present call mode; resume interpreting received Bm-channel information according to the present call mode; and enter the "active" state.

References

GSM 04.08, section 5.3.4.3.4.1.

26.8.1.4.5.2.3 Test purpose

To verify that upon receipt of the MODIFY REJECT message with the old bearer capability the MS resumes sending Bm-channel information according to the present call mode; resumes interpreting received Bm-channel information according to the present call mode; and enters the "active" state.

26.8.1.4.5.2.4 Method of test

Related PICS/PIXIT statements

- supported teleservices;
- support of dual bearer capability services.

Initial conditions

System Simulator:

1 cell, default parameters.

Mobile Station:

The MS is in MM-state "idle, updated" with valid TMSI and CKSN.

Foreseen final state of the MS

CC-state "active".

Maximum duration of test

10 s.

Test procedure

The MS initiates a call for one of the supported dual mode services. The MS being in the call active state, in-call modification procedure is initiated for the selected service from the MS side. The MS shall send a MODIFY message with new mode to the SS. The SS returns a MODIFY REJECT message. The state of the MS is then checked.

Expected sequence

Step	Direction	Message	Comments	
1	MS -> SS	CHANNEL REQUEST	MMI action to initiate a dual mode call SDCCH	
2	SS -> MS	IMMEDIATE ASSIGNMENT		
3	MS -> SS	CM SERVICE REQUEST	as specified in specific message contents	
4	SS -> MS	CIPHERING MODE COMMAND		
5	MS -> SS	CIPHERING MODE COMPLETE		
6	MS -> SS	SETUP		
7	SS -> MS	AUTHENTICATION REQUEST		
8	MS -> SS	AUTHENTICATION RESPONSE		
9	SS -> MS	CALL PROCEEDING		
10	SS -> MS	ASSIGNMENT COMMAND		agreeing bearer capabilities for dual mode call TCH
11	MS -> SS	ASSIGNMENT COMPLETE		
12	SS -> SS	ALERTING		
13	SS -> MS	CONNECT		
14	MS -> SS	CONNECT ACKNOWLEDGE		
15	MS -> SS	MODIFY		MMI action to change the mode with cause #58 bearer capability not available and with old bearer capabilities
16	SS -> MS	MODIFY REJECT		
17	SS -> MS	STATUS ENQUIRY		cause 30#, state U10
18	MS -> SS	STATUS		

Specific message contents:

As specified in 26.8.1.4.5.10.

26.8.1.4.5.3 In-call functions / MS originated in-call modification / an abnormal case of acceptance

26.8.1.4.5.3.1 Definition and applicability

This is to test a special case of a in-call modification procedure, in which the in-call modification is accepted incorrectly. This test is applicable for any equipment supporting any dual mode bearer capability service (BS61 - Alternate Speech/Data, BS81 - Speech followed by Data, Teleservice 61 - Alternate Speech/Group 3 fax).

26.8.1.4.5.3.2 Conformance requirement

- 1) Upon receipt of the MODIFY COMPLETE message indicating a call mode which does not correspond to the requested one the MS shall discard it and take no action.

References

GSM 04.08, section 5.3.4.4.

26.8.1.4.5.3.3 Test purpose

To verify that upon receipt of the MODIFY COMPLETE message indicating a call mode which does not correspond to the requested one the MS discards it and takes no action.

26.8.1.4.5.3.4 Method of test

Related PICS/PIXIT statements

- supported teleservices;
- support of dual bearer capability services.

Initial conditions

System Simulator:

1 cell, default parameters.

Mobile Station:

The MS is in MM-state "idle, updated" with valid TMSI and CKSN.

Foreseen final state of the MS

CC-state U26 "Mobile Originating Modify".

Maximum duration of test

10 s.

Test procedure

The MS initiates a call for one of the supported dual mode services. The MS being in the call active state, in-call modification procedure is initiated for the selected service from the MS side. The MS shall send a MODIFY message with new mode to the SS. The SS returns a MODIFY COMPLETE message specifying a mode that does not correspond to the requested one. It will be verified then that the MS shall not take any action and the state of the MS will be checked.

Expected sequence

Step	Direction	Message	Comments	
1	MS -> SS	CHANNEL REQUEST	MMI action to initiate a dual mode call	
2	SS -> MS	IMMEDIATE ASSIGNMENT		
3	MS -> SS	CM SERVICE REQUEST	SDCCH	
4	SS -> MS	CIPHERING MODE COMMAND		
5	MS -> SS	CIPHERING MODE COMPLETE		
6	MS -> SS	SETUP		
7	SS -> MS	AUTHENTICATION REQUEST		
8	MS -> SS	AUTHENTICATION RESPONSE		
9	SS -> MS	CALL PROCEEDING		
10	SS -> MS	ASSIGNMENT COMMAND		
11	MS -> SS	ASSIGNMENT COMPLETE		
12	SS -> SS	ALERTING		
13	SS -> MS	CONNECT		
14	MS -> SS	CONNECT ACKNOWLEDGE		
15	MS -> SS	MODIFY		
16	SS -> MS	MODIFY COMPLETE		
17	SS -> MS	STATUS ENQUIRY		as specified in specific message contents
18	MS -> SS	STATUS		agreeing bearer capabilities for dual mode call TCH
			MMI action to change the mode with a mode that does not correspond to the requested one	
			cause 30#, state U26	

Specific message contents:

As specified in 26.8.1.4.5.10.

26.8.1.4.5.4 In-call functions / MS originated in-call modification / an abnormal case of rejection

26.8.1.4.5.4.1 Definition and applicability

This is to test a special case of a in-call modification procedure, in which the in-call modification is rejected incorrectly. This test is applicable for any equipment supporting any dual mode bearer capability service (BS61 - Alternate Speech/Data, BS81 - Speech followed by Data, Teleservice 61 - Alternate Speech/Group 3 fax).

26.8.1.4.5.4.2 Conformance requirement

- 1) Upon receipt of the MODIFY REJECT message indicating a call mode which does not correspond to the actual one the MS shall discard it and take no action.

References

GSM 04.08, section 5.3.4.4.

26.8.1.4.5.4.3 Test purpose

To verify that upon receipt of the MODIFY REJECT message indicating a call mode which does not correspond to the actual one the MS discards it and takes no action.

26.8.1.4.5.4.4 Method of test

Related PICS/PIXIT statements

- supported teleservices;
- support of dual bearer capability services.

Initial conditions

System Simulator:

1 cell, default parameters.

Mobile Station:

The MS is in MM-state "idle, updated" with valid TMSI and CKSN.

Foreseen final state of the MS

CC-state U26 "Mobile Originating Modify".

Maximum duration of test

10 s.

Test procedure

The MS initiates a call for one of the supported dual mode services. The MS being in the call active state, in-call modification procedure is initiated for the selected service from the MS side. The MS shall send a MODIFY message with new mode to the SS. The SS returns a MODIFY REJECT message specifying a mode that does not correspond to the actual one. The state of the MS is then checked.

Expected sequence

Step	Direction	Message	Comments
1	MS -> SS	CHANNEL REQUEST	MMI action to initiate a dual mode call
2	SS -> MS	IMMEDIATE ASSIGNMENT	SDCCH
3	MS -> SS	CM SERVICE REQUEST	
4	SS -> MS	CIPHERING MODE COMMAND	
5	MS -> SS	CIPHERING MODE COMPLETE	
6	MS -> SS	SETUP	as specified in specific message contents
7	SS -> MS	AUTHENTICATION REQUEST	
8	MS -> SS	AUTHENTICATION RESPONSE	
9	SS -> MS	CALL PROCEEDING	agreeing bearer capabilities for dual mode call
10	SS -> MS	ASSIGNMENT COMMAND	TCH
11	MS -> SS	ASSIGNMENT COMPLETE	
12	SS -> SS	ALERTING	
13	SS -> MS	CONNECT	
14	MS -> SS	CONNECT ACKNOWLEDGE	
15	MS -> SS	MODIFY	MMI action to change the mode
16	SS -> MS	MODIFY REJECT	with a mode that does not correspond to the actual one
17	SS -> MS	STATUS ENQUIRY	
18	MS -> SS	STATUS	cause 30#, state U26

Specific message contents:

As specified in 26.8.1.4.5.10.

26.8.1.4.5.5 In-call functions / MS originated in-call modification / time-out of timer T323

26.8.1.4.5.5.1 Definition and applicability

This is to test a special case of a in-call modification procedure, in which timer T323 expires in state U26, mobile originating modify. This test is applicable for any equipment supporting any dual mode bearer capability service (BS61 - Alternate Speech/Data, BS81 - Speech followed by Data, Teleservice 61 - Alternate Speech/Group 3 fax).

26.8.1.4.5.5.2 Conformance requirement

- 1) Upon expiration of T323 the MS shall initiate the procedures for call clearing with cause #102 "recovery on timer expiry".

References

GSM 04.08, section 5.3.4.3.4.3.

26.8.1.4.5.5.3 Test purpose

To verify that upon expiration of T323 (accuracy +/- 10 %) the MS shall initiate the procedures for call clearing with cause #102 "recovery on timer expiry".

26.8.1.4.5.5.4 Method of test

Related PICS/PIXIT statements

- supported circuit switched basic services;
- support of dual bearer capability services.

Initial conditions

System Simulator:

1 cell, default parameters.

Mobile Station:

The MS is in MM-state "idle, updated" with valid TMSI and CKSN.

Foreseen final state of the MS

CC-state U11 "disconnect request".

Maximum duration of test

1 minute.

Test procedure

The MS initiates a call for one of the supported dual mode services. The MS being in the call active state, in-call modification procedure is initiated for the selected service from the MS side. The MS shall send a MODIFY message with new mode to the SS. The SS does not respond until timer T323 expires at the MS. The MS is expected to respond with a DISCONNECT message. The SS checks timer T323 accuracy between emission of MODIFY and reception of DISCONNECT messages, the state of the MS and a cause value from the DISCONNECT message.

Expected sequence

Step	Direction	Message	Comments
1	MS -> SS	CHANNEL REQUEST	MMI action to initiate a dual mode call
2	SS -> MS	IMMEDIATE ASSIGNMENT	SDCCH
3	MS -> SS	CM SERVICE REQUEST	
4	SS -> MS	CIPHERING MODE COMMAND	
5	MS -> SS	CIPHERING MODE COMPLETE	
6	MS -> SS	SETUP	as specified in specific message contents
7	SS -> MS	AUTHENTICATION REQUEST	
8	MS -> SS	AUTHENTICATION RESPONSE	
9	SS -> MS	CALL PROCEEDING	agreeing bearer capabilities for dual mode call
10	SS -> MS	ASSIGNMENT COMMAND	TCH
11	MS -> SS	ASSIGNMENT COMPLETE	
12	SS -> MS	ALERTING	
13	SS -> MS	CONNECT	
14	MS -> SS	CONNECT ACKNOWLEDGE	
15	MS -> SS	MODIFY	MMI action to change the mode
16	SS		the SS waits for the timer T323 expiry
17	MS -> SS	DISCONNECT	cause value #102, the SS checks timer T323 accuracy (+/- 10 %) between MODIFY and DISCONNECT messages
18	SS -> MS	STATUS ENQUIRY	
19	MS -> SS	STATUS	cause 30#, state U11

Specific message contents:

As specified in 26.8.1.4.5.10.

26.8.1.4.5.6 In-call functions / MS originated in-call modification / a successful channel change in state mobile originating modify

26.8.1.4.5.6.1 Definition and applicability

This is to test a special case of a in-call modification procedure, in which a change of a physical channel occurs in state U26, mobile originating modify. This test is applicable for any equipment supporting any dual mode bearer capability service (BS61 - Alternate Speech/Data, BS81 - Speech followed by Data, Teleservice 61 - Alternate Speech/Group 3 fax).

26.8.1.4.5.6.2 Conformance requirement

- 1) A CC-entity of the MS in CC-state U26, "Mobile Originating Modify", after successful completion of a channel assignment procedure or channel mode modify procedure shall remain in the call state U26.
- 2) Upon receipt of the MODIFY COMPLETE message the MS shall start sending channel information according to the new call mode and enter the "active" state.

References

- 1) GSM 04.08, section 5.3.4.3.2, GSM 04.08, section 3.4.6.1
- 2) GSM 04.08, section 5.3.4.3.2.

26.8.1.4.5.6.3 Test purpose

- 1) To verify that a CC-entity of the MS in CC-state U26, "Mobile Originating Modify", after successful completion of a channel assignment procedure remains in the call state U26.
- 2) To verify that upon receipt of the MODIFY COMPLETE message the MS starts sending channel information according to the new call mode and enters the "active" state.

26.8.1.4.5.6.4 Method of test

Related PICS/PIXIT statements

- supported circuit switched basic services;
- support of dual bearer capability services.

Initial conditions

System Simulator:

1 cell, default parameters.

Mobile Station:

The MS is in MM-state "idle, updated" with valid TMSI and CKSN.

Foreseen final state of the MS

CC-state U10, active.

Maximum duration of test

10 s.

Test procedure

The MS initiates a call for one of the supported dual mode services. The MS being in the call active state, in-call modification procedure is initiated for the selected service from the MS side. The MS shall send a MODIFY message with a new mode to the SS. The SS does not respond immediately, but performs channel assignment procedure including the appropriate channel mode for the new service. The state of the MS is then checked. The SS then returns a MODIFY COMPLETE message. The state of the MS is checked finally.

Expected sequence

Step	Direction	Message	Comments
1	MS -> SS	CHANNEL REQUEST	MMI action to initiate a dual mode call
2	SS -> MS	IMMEDIATE ASSIGNMENT	SDCCH
3	MS -> SS	CM SERVICE REQUEST	
4	SS -> MS	CIPHERING MODE COMMAND	
5	MS -> SS	CIPHERING MODE COMPLETE	
6	MS -> SS	SETUP	as specified in specific message contents
7	SS -> MS	AUTHENTICATION REQUEST	
8	MS -> SS	AUTHENTICATION RESPONSE	
9	SS -> MS	CALL PROCEEDING	agreeing bearer capabilities for dual mode call
10	SS -> MS	ASSIGNMENT COMMAND	TCH
11	MS -> SS	ASSIGNMENT COMPLETE	
12	SS -> MS	ALERTING	
13	SS -> MS	CONNECT	
14	MS -> SS	CONNECT ACKNOWLEDGE	
15	MS -> SS	MODIFY	MMI action to change the mode
16	SS -> MS	ASSIGNMENT COMMAND	channel mode implied by the MODIFY message
17	MS -> SS	ASSIGNMENT COMPLETE	
18	SS -> MS	STATUS ENQUIRY	
19	MS -> SS	STATUS	cause 30#, state U26
20	SS -> MS	MODIFY COMPLETE	
21	SS -> MS	STATUS ENQUIRY	
22	MS -> SS	STATUS	cause 30#, state U10

Specific message contents:

As specified in 26.8.1.4.5.10.

26.8.1.4.5.7 In-call functions / MS originated in-call modification / an unsuccessful channel change in state mobile originating modify

26.8.1.4.5.7.1 Definition and applicability

This is to test a special case of a in-call modification procedure, in which an unsuccessful change of a physical channel occurs in state U26, mobile originating modify. This test is applicable for any equipment supporting any dual mode bearer capability service (BS61 - Alternate Speech/Data, BS81 - Speech followed by Data, Teleservice 61 - Alternate Speech/Group 3 fax).

26.8.1.4.5.7.2 Conformance requirement

- 1) A CC-entity of the MS in CC-state U26, "Mobile Originating Modify", when returning to the old channel after handover failure and having established the link, shall remain in the call state U26.

References

GSM 04.08, section 5.3.4.3.2.

26.8.1.4.5.7.3 Test purpose

To verify that a CC-entity of the MS in CC-state U26, "Mobile Originating Modify", when returning to the old channel after handover failure and having established the link, remains in the call state U26.

26.8.1.4.5.7.4 Method of test

Related PICS/PIXIT statements

- supported teleservices;
- support of dual bearer capability services.

Initial conditions

System Simulator:

1 cell, default parameters.

Mobile Station:

The MS is in MM-state "idle, updated" with valid TMSI and CKSN.

Foreseen final state of the MS

CC-state U26, mobile originating modify.

Maximum duration of test

10 s.

Test procedure

The MS initiates a call for one of the supported dual mode services. The MS being in the call active state, in-call modification procedure is initiated for the selected service from the MS side. The MS shall send a MODIFY message with a new mode to the SS. The SS initiates handover procedure. When the MS tries to establish the main signalling link, it is prohibited by the SS. Then the MS shall return back to the old channel and re-establish correctly the link. The state of the MS is then checked.

Expected sequence

Step	Direction	Message	Comments	
1	MS -> SS	CHANNEL REQUEST	MMI action to initiate a dual mode call SDCCH	
2	SS -> MS	IMMEDIATE ASSIGNMENT		
3	MS -> SS	CM SERVICE REQUEST	as specified in specific message contents	
4	SS -> MS	CIPHERING MODE COMMAND		
5	MS -> SS	CIPHERING MODE COMPLETE		
6	MS -> SS	SETUP		
7	SS -> MS	AUTHENTICATION REQUEST		
8	MS -> SS	AUTHENTICATION RESPONSE		
9	SS -> MS	CALL PROCEEDING		
10	SS -> MS	ASSIGNMENT COMMAND		agreeing bearer capabilities for dual mode call TCH
11	MS -> SS	ASSIGNMENT COMPLETE		
12	SS -> SS	ALERTING		
13	SS -> MS	CONNECT		
14	MS -> SS	CONNECT ACKNOWLEDGE		
15	MS -> SS	MODIFY		MMI action to change the mode
16	SS -> MS	HANDOVER COMMAND		
17	MS -> SS	HANDOVER ACCESS		the SS does not respond
18	MS -> SS	HANDOVER FAILURE		after the MS has re-established the main signalling link in the old channel
19	SS -> MS	STATUS ENQUIRY		cause 30#, state U26
20	MS -> SS	STATUS		

Specific message contents:

As specified in 26.8.1.4.5.10.

26.8.1.4.5.8 In-call functions / MS originated in-call modification / unknown message received

26.8.1.4.5.8.1 Definition and applicability

This is to test a special case of a in-call modification procedure, in which an unknown message is received in state U26, mobile originating modify. This test is applicable for any equipment supporting any dual mode bearer capability service (BS61 - Alternate Speech/Data, BS81 - Speech followed by Data, Teleservice 61 - Alternate Speech/Group 3 fax).

26.8.1.4.5.8.2 Conformance requirement

A CC entity of a MS in CC-state U26, "Mobile Originating Modify", having received an unknown message from its peer entity shall return a STATUS message.

References

GSM 04.08, section 8.4.

26.8.1.4.5.8.3 Test purpose

To verify that a CC entity of a MS in CC-state U26, "Mobile Originating Modify", having received an unknown message from its peer entity returns a STATUS message.

26.8.1.4.5.8.4 Method of test

Related PICS/PIXIT statements

- supported teleservices;
- support of dual bearer capability services.

Initial conditions

System Simulator:

1 cell, default parameters.

Mobile Station:

The MS is in MM-state "idle, updated" with valid TMSI and CKSN.

Foreseen final state of the MS

CC-state U26, mobile originating modify.

Maximum duration of test

10 s.

Test procedure

The MS initiates a call for one of the supported dual mode services. The MS being in the call active state, in-call modification procedure is initiated for the selected service from the MS side. The MS shall send a MODIFY message with a new mode to the SS. The SS sends a message with message type not defined for the protocol discriminator. The state of the MS is then checked.

Expected sequence

Step	Direction	Message	Comments
1	MS -> SS	CHANNEL REQUEST	MMI action to initiate a dual mode call SDCCH
2	SS -> MS	IMMEDIATE ASSIGNMENT	
3	MS -> SS	CM SERVICE REQUEST	as specified in specific message contents
4	SS -> MS	CIPHERING MODE COMMAND	
5	MS -> SS	CIPHERING MODE COMPLETE	
6	MS -> SS	SETUP	
7	SS -> MS	AUTHENTICATION REQUEST	
8	MS -> SS	AUTHENTICATION RESPONSE	
9	SS -> MS	CALL PROCEEDING	agreeing bearer capabilities for dual mode call TCH
10	SS -> MS	ASSIGNMENT COMMAND	
11	MS -> SS	ASSIGNMENT COMPLETE	MMI action to change the mode message type not defined for PD cause 30#, state U26
12	SS -> SS	ALERTING	
13	SS -> MS	CONNECT	
14	MS -> SS	CONNECT ACKNOWLEDGE	
15	MS -> SS	MODIFY	
16	SS -> MS	unknown message	
17	MS -> SS	STATUS	

Specific message contents:

As specified in 26.8.1.4.5.10.

26.8.1.4.5.9 In-call functions / MS originated in-call modification / a release complete received

26.8.1.4.5.9.1 Definition and applicability

The call control entity of the MS being in the state, U26, the call is cleared by a RELEASE COMPLETE message sent by the SS. This test is applicable for any equipment supporting any dual mode bearer capability service (BS61 - Alternate Speech / Data, BS81 - Speech followed by Data, Teleservice 61 - Alternate Speech / Group 3 fax).

26.8.1.4.5.9.2 Conformance requirement

- 1) A CC entity of the MS in CC-state U26, "mobile originating modify", upon receipt of a RELEASE COMPLETE message with valid cause value, shall enter CC state U0, "Null".
- 2) On returning to idle mode, the CC entities relating to the seven mobile originating transaction identifiers shall be in state U0, "Null".

Reference(s)

Conformance requirement 1: GSM 04.08 section 5.4.2, GSM 04.08 section 5.4.4.

Conformance requirement 2: GSM 04.08 section 5.4.4.3.

26.8.1.4.5.9.3 Test purpose

- 1) To verify that a CC entity of the MS in CC-state U26, "mobile originating modify", upon receipt of a RELEASE COMPLETE message with valid cause value, enters CC state U0, "Null".
- 2) To verify that on returning to idle mode, the CC entities relating to the seven mobile originating transaction identifiers are in state U0, "Null".

26.8.1.4.5.9.4 Method of test

Related PICS/PIXIT statements

- a way to activate a dual mode call;
- a way to activate in-call modification;
- support of dual bearer capability services.

Initial conditions

System Simulator:

1 cell, default parameters.

Mobile Station:

The MS is in MM-state "idle, updated" with valid TMSI and CKSN.

Foreseen final state of the MS

The MS is in MM-state "idle, updated" with valid TMSI and CKSN.

Maximum duration of test

30 seconds.

Test Procedure

The MS initiates a call for one of the supported dual mode services. The MS being in the call active state, in-call modification procedure is initiated for the selected service from the MS side. The MS shall send a MODIFY message with the new mode to the SS and the state of the MS is checked. The SS sends a RELEASE COMPLETE message to the MS. The SS checks by using the status enquiry procedure that the CC entity has entered the state U0 with all the relevant transaction identifiers.

NOTE: ICM can be initiated by manual intervention at the MS.

Expected sequence

Step	Direction	Message	Comments
1	MS		The MS is made to initiate a dual mode call
2	MS -> SS	CHANNEL REQUEST	
3	SS -> MS	IMMEDIATE ASSIGNMENT	SDCCH
4	MS -> SS	CM SERVICE REQUEST	
5	SS -> MS	CIPHERING MODE COMMAND	
6	MS -> SS	CIPHERING MODE COMPLETE	
7	MS -> SS	SETUP	as specified in specific message contents
8	SS -> MS	AUTHENTICATION REQUEST	
9	MS -> SS	AUTHENTICATION RESPONSE	
10	SS -> MS	CALL PROCEEDING	as specified in specific message contents
11	SS -> MS	ASSIGNMENT COMMAND	channel mode: see section 10.4
12	MS -> SS	ASSIGNMENT COMPLETE	
13	SS -> MS	ALERTING	
14	SS -> MS	CONNECT	
15	MS -> SS	CONNECT ACKNOWLEDGE	
16	MS -> SS	MODIFY	as specified in specific message contents
17	SS -> MS	STATUS ENQUIRY	
18	MS -> SS	STATUS	cause #30, state U26
19	SS -> MS	RELEASE COMPLETE	
20	SS -> MS	STATUS ENQUIRY	
21	MS -> SS	RELEASE COMPLETE	cause #81 (invalid TI value)
22	SS		repeat steps 20 - 21 to cover all the transaction identifiers from 000 ... 110
23	SS -> MS	CHANNEL RELEASE	the main signalling link shall be released by the MS (L2: DISC/UA)

Specific message contents:

As specified in 26.8.1.4.5.10.

26.8.1.4.5.10 In-call functions/MS originated in-call modification/contents of some of the messages

The following messages are used for testing in-call modification procedures, test cases 26.8.1.4.5.*, as default messages for those ones defined below. If any other values are defined in the expected sequence of the actual test cases, those values take precedence over the ones defined hereafter.

SETUP (MS to SS)

Information element	Value/remark
BC Repeat indicator	Sequential, if BS81 is being tested, otherwise circular for successive selection
Repeat indication	
Bearer capability 1	Appropriate for the teleservice/Bearer Service selected as an initial call mode
Bearer capability 2	Appropriate for the teleservice/Bearer Service to be selected as a new call mode
Facility	Omitted
Calling party subaddress	Omitted
Called party BCD number	As entered
Called party subaddress	Omitted
LLC repeat indicator	The same repeat indication as the one for BC. Present if and only if LLC I and LLC II are present
Low layer compatibility I	See note 1
Low layer compatibility II	See note 1
HLC repeat indicator	The same repeat indication as the one for BC. Present if and only if HLC i and HLC ii are present.
High layer compatibility i	See note
High layer compatibility ii	See note
User-user	Omitted
SS version	Omitted
CLIR suppression	Omitted
CC Capabilities	present, but contents not checked

NOTE 1: HLC/LLC may or may not be present. The contents of HLC/LLC are not verified. If LLC I is present then LLC II shall be present. If HLC i is present then HLC ii shall be present.

CALL PROCEEDING

If the MS offers a choice in a SETUP message with respect to its bearer capabilities (this choice is restricted to the connection element), the bearer capabilities 1 and 2 and BC repeat indicator must all be present in this message. Otherwise, all three IEs are omitted.

Information element	Value/remark
Repeat Indicator	See above
Repeat indication	As received in the SETUP message
Bearer Capability 1	Same as in section 10.4
Bearer Capability 2	Same as in section 10.4
Facility	Omitted
Progress indicator	Omitted

MODIFY

Information element	Value/remark
Bearer capability	If the bearer capability IEs were present in the CALL PROCEEDING message, then as it was specified in the bearer capability 2 of the CALL PROCEEDING message. Otherwise as in the bearer capability 2 of the SETUP message.
Reverse Call Setup Direction	Presence and value not checked
Low layer compatibility	See note 2
High layer compatibility	See note 2

NOTE 2: HLC (LLC) shall be included if the HLC (LLC) was included in the SETUP message. The contents of LLC/HLC are not verified.

MODIFY COMPLETE

Information element	Value/remark
Bearer capability	If the bearer capability IEs were present in the CALL PROCEEDING message, then as it was specified in the bearer capability 2 of the CALL PROCEEDING message. Otherwise as in the bearer capability 2 of the SETUP message.
Reverse Call Setup Direction	Same as in MODIFY
Low layer compatibility	See note 3
High layer compatibility	See note 3

NOTE 3: HLC (LLC) shall be included if the HLC (LLC) was included in the SETUP message. The contents of LLC/HLC are not verified.

MODIFY REJECT

Information element	Value/remark
Bearer capability	If the bearer capability IEs were present in the CALL PROCEEDING message, then as it was specified in the bearer capability 1 of the CALL PROCEEDING message. Otherwise as in the bearer capability 1 of the SETUP message.
Cause	#58 "bearer capability not presently available".
Low layer compatibility	See note 4
High layer compatibility	See note 4

NOTE 4: HLC (LLC) shall be included if the HLC (LLC) was included in the SETUP message. The contents of LLC/HLC are not verified.

CHANNEL MODE MODIFY

Information element	Value/remark
Channel description	describes non-hopping Bm+ACCHs or Lm+ACCHs as appropriate for the test
Channel Mode	appropriate for the BC in the MODIFY

CHANNEL MODE MODIFY ACKNOWLEDGE

Information element	Value/remark
Channel description	as sent by the SS in the corresponding CHANNEL MODE MODIFY message
Channel mode	as sent by the SS in the corresponding CHANNEL MODE MODIFY message

26.8.2 Call Re-establishment

26.8.2.1 Call Re-establishment/call present, re-establishment allowed

26.8.2.1.1 Definition and applicability

This is to test a successful case of a call re-establishment procedure. This test is applicable for any equipment supporting at least one bearer capability. If the MS does not perform call re-establishment procedure correctly, the network will waste resources.

26.8.2.1.2 Conformance requirement

- 1) If the call is in the "active" state or "mobile originating modify" state, the indication from MM that re-establishment is possible shall cause call control to request re-establishment from the MM-connection, suspend any further message to be sent and await the completion of the re-establishment procedure.
- 2) When the call control entity is notified that the MM-connection is re-established, it shall then resume the transmission of possibly suspended messages and resume user data exchange when an appropriate channel is available.

References

- 1) GSM 04.08, subclauses 4.5.1.6 and 5.5.4.2.
- 2) GSM 04.08, subclauses 4.5.1.6 and 5.5.4.3.

26.8.2.1.3 Test purpose

The purpose of this test is to verify that the MS can correctly perform a call re-establishment procedure.

26.8.2.1.4 Method of test

Related PICS/PIXIT statements

- supported teleservices.

Initial conditions

System Simulator:

The SS simulates cells A and B. The LAC of cell A is different from the LAC of cell B. The PLMN identities of cell A and B are equal.

The call re-establishment parameter concerning cell A is set to an arbitrary value.

Cell B is not barred, the RACH control parameters information element sent in SYSTEM INFORMATION TYPE 1 to 4 messages of cell A and B specifies "call reestablishment allowed in the cell", the NCC of cell B is indicated as permitted in the PLMN permitted information element of SYSTEM INFORMATION TYPE 2 and 6 messages of cell A. Cell B is indicated as a neighbour cell of cell A in SYSTEM INFORMATION TYPE 2 and 5 messages of cell A. Cell reselect hysteresis parameter of cell A is set to zero.

Mobile Station:

The MS is in MM-state "idle, updated" with valid TMSI and CKSN on cell A.

Foreseen final state of the MS

The MS is in MM-state "idle, updated" with valid TMSI and CKSN.

Maximum duration of test

1 minute.

Test procedure

The MS is brought to active state by using procedure 26.9.2, "structured procedures, MS originated call, early assignment". The RF level of cell A is lowered so that cell B is to be selected (when the MS performs re-establishment after radio link failure), while keeping the C1 and C2 of cell A greater than zero. SS waits for at least 5 seconds. Then the SS stops transmission on the TCH/SACCH. The MS shall re-establish the call on cell B using a CM RE-ESTABLISHMENT message. The SS performs ciphering mode setting and assignment procedures. The MS shall through-connect the appropriate bearer channel. Then, the call is cleared by the SS.

Expected sequence

Step	Direction	Message	Comments
1			Steps 1-19 of test case 26.9.2 are performed (the appropriate bearer channel is through connected in both directions in TCH)
2	SS		The RF level of cell A is lowered. The SS waits at least 5 seconds. The SS stops transmission on the TCH/SACCH.
3	MS -> SS	CHANNEL REQUEST	this is sent on cell B. Establ. cause shall be "call re-establishment; TCH/F was in use,..."
4	SS -> MS	IMMEDIATE ASSIGNMENT	
5	MS -> SS	CM REESTABLISHMENT REQUEST	note specific message contents
6	SS -> MS	CIPHERING MODE COMMAND	SS starts deciphering after sending the message.
7	MS -> SS	CIPHERING MODE COMPLETE	Shall be sent enciphered. All following messages shall be sent enciphered.
8	SS		SS starts ciphering.
9	SS -> MS	ASSIGNMENT COMMAND	
10	MS -> SS	ASSIGNMENT COMPLETE	
11	MS		The appropriate bearer channel is through connected in both directions.
12	SS -> MS	DISCONNECT	with cause value "Normal"
13	MS -> SS	RELEASE	
14	SS -> MS	RELEASE COMPLETE	
15	SS -> MS	CHANNEL RELEASE	The main signalling link is released.

Specific message contents:

CM RE-ESTABLISHMENT REQUEST

Information element	Value/remark
Protocol discriminator	Mobility Management
Skip indicator	Encoded as zeroes
Message type	CM RE-ESTABLISHMENT REQUEST
Ciphering key sequence number	The CKSN which the MS was allocated in step 6 of the procedure of section 26.9.2.
Spare half octet	zero
Mobile station classmark 2	as declared in the PICS/PIXIT
Mobile identity	The TMSI that the MS is having initially
Location area identification	Corresponding the LAI of cell A

26.8.2.2 Call Re-establishment/call present, re-establishment not allowed

26.8.2.2.1 Definition and applicability

This is to test a special case of a call re-establishment, in which it is not allowed for a MS to attempt re-establishment of a call. This test is applicable for any equipment supporting at least one mobile originated circuit switched basic service.

26.8.2.2.2 Conformance requirement

When a lower layer failure occurs while an MM-connection is active, if a cell allowing call re-establishment is not available, the MS shall release the MM-connection and shall not attempt call re-establishment.

References

GSM 04.08, subclauses 4.5.1.6 and 5.5.4.

26.8.2.2.3 Test purpose

The purpose of this test is to verify that the MS does not attempt call re-establishment when it is not allowed to take place because of the unavailability of a cell allowing call re-establishment.

26.8.2.2.4 Method of test

Related PICS/PIXIT statements

- supported MO circuit switched basic services.

Initial conditions

System Simulator:

The SS simulates cell A.

Cell A is not barred, the NCC of cell A is indicated as permitted in the PLMN permitted information element of SYSTEM INFORMATION TYPE 2 and 6 messages. The RE field of the RACH control parameters information element broadcast in messages SYSTEM INFORMATION TYPE 1, 2, 3 and 4 of cell A are set to "call reestablishment not allowed in the cell".

Mobile Station:

The MS is in MM-state "idle, updated" with valid TMSI and CKSN.

Foreseen final state of the MS

The MS is in MM-state "idle, updated" with valid TMSI and CKSN.

Maximum duration of test

1 minute.

Test procedure

The MS is brought to active state by using procedure 26.9.2, "structured procedures, MS originated call, early assignment". The SS stops transmission on the TCH/SACCH. The MS shall not require re-establishment of the call.

Expected sequence

Step	Direction	Message	Comments
1			Steps 1-19 of test case 26.9.2 are performed (the appropriate bearer channel is through connected in both directions in TCH)
2	SS		the SS stops transmission on the TCH/SACCH
3	MS		the MS shall not attempt re-establishment on cell A. This is checked for 30 seconds after the radio link failure.

Specific message contents:

None.

26.8.2.3 Call Re-establishment/call under establishment, transmission stopped

26.8.2.3.1 Definition and applicability

This is to test a special case of a call re-establishment, in which it is not allowed for a MS to attempt re-establishment of a call, since the call has not been established yet. This test is applicable for any equipment supporting at least one mobile originated circuit switched basic service.

26.8.2.3.2 Conformance requirement

When a lower layer failure occurs while an MM-connection is active, if the state of the call control entity is not "active", the MS shall release the MM-connection and shall not attempt call re-establishment.

References

GSM 04.08, subclauses 4.5.1.6 and 5.5.4.2.

26.8.2.3.3 Test purpose

The purpose of this test is to verify that the MS does not attempt call re-establishment when it is not allowed to take place because of the call control state.

26.8.2.3.4 Method of test

Related PICS/PIXIT statements

- supported MO circuit switched basic services.

Initial conditions

System Simulator:

The SS simulates cell A.

Cell A is not barred, the RACH control parameters information element sent in SYSTEM INFORMATION TYPE 1 to 4 messages of cell A specifies "call reestablishment allowed in the cell", the NCC of cell A is indicated as permitted in the PLMN permitted information element of SYSTEM INFORMATION TYPE 2 and 6 messages.

Mobile Station:

The MS is in MM-state "idle, updated" with valid TMSI and CKSN.

Foreseen final state of the MS

The MS is in MM-state "idle, updated" with valid TMSI and CKSN.

Maximum duration of test

1 minute.

Test procedure

The call control entity of the MS is brought to state U4, "call delivered" by using initial part of procedure 26.9.2, "structured procedures, MS originated call, early assignment". The SS stops transmission on the TCH/SACCH. The MS shall not require re-establishment of the call on cell A.

Expected sequence

Step	Direction	Message	Comments
1			the MS is made to initiate a call
2	MS -> SS	CHANNEL REQUEST	
3	SS -> MS	IMMEDIATE ASSIGNMENT	
4	MS -> SS	CM SERVICE REQUEST	
5	SS -> MS	AUTHENTICATION REQUEST	
6	MS -> SS	AUTHENTICATION RESPONSE	
7	SS -> MS	CIPHERING MODE COMMAND	SS starts deciphering after sending the message.
8	MS -> SS	CIPHERING MODE COMPLETE	All following messages shall be sent enciphered.
9	SS		SS starts ciphering.
10	MS -> SS	SETUP	
11	SS -> MS	CALL PROCEEDING	
12	SS -> MS	ASSIGNMENT COMMAND	
13	MS -> SS	ASSIGNMENT COMPLETE	
14	SS -> MS	ALERTING	
15	SS		the SS stops transmission on the TCH/SACCH
16	MS		the MS shall not attempt re-establishment on cell A. This is checked for 30 seconds after the radio link failure.

Specific message contents:

None.

26.8.3 User to user signalling

26.8.3.1 Definition and applicability

The "user to user" information element is used to convey information between the mobile user and a remote ISDN user. This test is therefore applicable for any equipment supporting at least one mobile terminating circuit switched basic service.

NOTE: There is no test for an MS originating call including a "user-user" information element since it is not a mandatory MS feature.

26.8.3.2 Conformance requirement

The inclusion of the "user-user" information element in downlink call control messages shall cause no adverse effects on the operation of the MS.

References

GSM 04.08 sections 5.2.2, 9.3.7, 9.3.23.1 and 10.5.4.25

26.8.3.3 Purpose of the test

The purpose of this test is to verify that inclusion of the "user-user" information element in either of the down link messages, SETUP or DISCONNECT causes no adverse effects on the operation of the MS.

26.8.3.4 Method of test

Related PICS/PIXIT statement(s)

Supported MT circuit switched basic services.

Support of user-user information element, and details of suitable codings.

Initial conditions.

System Simulator:

The SS simulates 1 cell, with default parameters.

Mobile Station:

The MS is in MM-state "idle updated", with a valid TMSI and CKSN.

Foreseen final state of the MS

The MS is in MM-state "idle updated", with a valid TMSI and CKSN.

Maximum duration of test

2 minutes.

Test procedure

The SS attempts to set up a mobile terminated call, with one of the supported circuit switched basic services which has been arbitrarily chosen, using one of the generic call set up procedures,(either speech or data) as specified in section 10. The default SETUP message contents are modified to include the user-user Information Element. The MS shall not respond adversely to the inclusion of the user-user information element.

After 30 seconds the SS sends a DISCONNECT message, again the MS shall not respond adversely to the inclusion of the user-user information element, but shall continue to clear down the call normally.

Expected sequence

Step	Direction	Message	Comments
1			Generic Call Setup procedure defined in sections in 10.1 or 10.3, depending on choice of Bearer Capability. The SETUP message in either case contains the user-user IE, see Specific message contents.
2			The SS waits 30 seconds.
3	SS -> MS	DISCONNECT	Message contains the user-user IE, see Specific message contents
4	MS -> SS	RELEASE	As defined in section 26.8.4
5	SS-> MS	RELEASE COMPLETE	As defined in section 26.8.4
6	SS-> MS	CHANNEL RELEASE	As defined in section 26.8.4

Specific message contents:

SETUP

As default message contents as defined in the Generic Call setup procedures section 10.1 or 10.3 except:

Information Element	value/remark
Bearer Capability	Bearer capability arbitrarily chosen from those supported by the Mobile Station under test.
user-user	
- length	Length of user-user contents (note)
- PD	IA5 characters (note)
- user-user	The following string coded in IA5 characters: "Call Setup" (note)

DISCONNECT

As default message contents as defined in section 26.8.4, except:

Information Element	value/remark
user-user - length - PD - user-user	Length of user-user contents (note) IA5 characters (note) The following string coded in IA5 characters: "Call Disconnect" (note)

NOTE: The codings above are for example only. For the case of an MS which supports "user-user" signalling it may be necessary to add meaning to the data fields, see PICS/PIXIT statement(s).

26.8.4 Default contents of message

ALERTING (mobile station to network direction)

No default requirements defined for this message.

ALERTING (network to mobile station direction)

Information element	Value/remark
Facility	Omitted
Progress indicator	Omitted
User-user	Omitted

ASSIGNMENT COMMAND

Information element	Value/remark
Description of the first channel	describes non-hopping Bm+ACCHs or Lm+ACCHs as appropriate for the test
Power Command	As in section 6.3
Frequency list	Omitted
Cell channel description	Omitted
Mode of the first channel	appropriate for the bearer capability chosen for the test
Description of the second channel	Omitted
Mode of the second channel	Omitted
Mobile allocation	Omitted
Starting time	Omitted
Cipher mode setting	Omitted

ASSIGNMENT COMPLETE

Information element	Value/remark
RR cause	not checked

AUTHENTICATION REQUEST

Information element	Value/remark
Ciphering key sequence number	Arbitrary excluding 111B
Spare half octet	(spare bits)
Authentication parameter RAND	Arbitrary

AUTHENTICATION RESPONSE

Information element	Value/remark
Authentication parameter SRES	not checked

CALL CONFIRMED

No default requirements defined for this message.

CALL PROCEEDING

Information element	Value/remark
Repeat Indicator	Omitted
Bearer Capability 1	Omitted if the SETUP message did not specify in the bearer capability 1 IE a connection element value "both, transparent preferred" or "both, non-transparent preferred". Otherwise included; in that case the connection element specifies the value that is appropriate for the selected basic service (either value "transparent" or value "non transparent (RLP)"), all other parameters are same as in the bearer capability 1 IE of the received SETUP message.
Bearer Capability 2	Omitted
Facility	Omitted
Progress indicator	Omitted

CHANNEL MODE MODIFY

Information element	Value/remark
Channel description	describes non-hopping Bm+ACCHs or Lm+ACCHs as appropriate for the test
Channel mode	appropriate for the bearer capability chosen for the test

CHANNEL MODE MODIFY ACKNOWLEDGE

Information element	Value/remark
Channel description	as sent by the SS in the corresponding CHANNEL MODE MODIFY message
Channel mode	as sent by the SS in the corresponding CHANNEL MODE MODIFY message

CHANNEL RELEASE

Information element	Value/remark
RR cause	Normal event

CHANNEL REQUEST

Information element	Value/remark
Establishment cause	If in response to paging, then "100"; if a mobile originating call, then "111"
Random reference	Arbitrary value of 5 bits length

CIPHERING MODE COMMAND

Information element	Value/remark
Cipher mode setting algorithm identifier SC	indicates a supported algorithm Start ciphering
Cipher response CR	IMEI must not be included

CIPHERING MODE COMPLETE

No default requirements defined for this message.

CM SERVICE ACCEPT

No default values defined for this message.

CM SERVICE REJECT

Information element	Value/remark
Reject cause	Service or option not available, unspecified

CM SERVICE REQUEST

No default requirements defined for this message.

CONNECT (network to mobile station direction)

Information element	Value/remark
Facility	Omitted
Progress indicator	Omitted
Connected number	Omitted
Connected subaddress	Omitted
User-user	Omitted

CONNECT (mobile station to network direction)

No default requirements defined for this message.

CONNECT ACKNOWLEDGE

No default requirements defined for this message.

DISCONNECT (network to mobile station direction)

Information element	Value/remark
Cause	
Coding standard	GSM
Location	User
Cause value	Normal clearing
Facility	Omitted
Progress indicator	Omitted
User-user	Omitted

DISCONNECT (mobile station to network direction)

Information element	Value/remark
Cause	Shall be present, contents not checked
Facility	Omitted
User-user	Omitted
SS version	Omitted

HANDOVER ACCESS

No default requirements defined for this message.

HANDOVER COMMAND

Information element	Value/remark
Cell Description	a BCCH frequency, which is one of the neighbour cells
Description of the first channel	describes non-hopping Bm+ACCHs or Lm+ACCHs as appropriate for the test
Handover Reference	an arbitrary value
Power Command	as in 6.3
Synchronization indication	Omitted
Frequency short list	Omitted
Frequency List	Omitted
Cell Channel Description	Omitted
Channel Mode	Omitted
Channel Description	Omitted
Channel Mode 2	Omitted
Frequency Channel Sequence	Omitted
Mobile Allocation	Omitted
Starting Time	Omitted
Real time difference	Omitted
Timing advance	Omitted
Cipher Mode setting	Omitted

HANDOVER FAILURE

No default requirements defined for this message.

IMMEDIATE ASSIGNMENT

Information element	Value/remark
Page mode	Normal paging
Channel description	describes a valid SDCCH+SACCH in non-hopping mode
Request reference	
Random access information	As received from MS
T1', T2, T3	Corresponding to frame number of the CHANNEL REQUEST
Timing advance	corresponding the timing difference between the MS and the SS
Mobile allocation	Empty (L=0)
Starting time	Omitted

MODIFY

No default values defined for this message.

MODIFY COMPLETE

No default requirements defined for this message.

MODIFY REJECT

No default values defined for this message.

NOTIFY (network to mobile station direction)

Information element	Value/remark
Notification indicator	one of the valid values chosen arbitrarily

PAGING REQUEST TYPE 1

Information element	Value/remark
L2 pseudo length	L2 pseudo length of the message
Page Mode	Normal Paging
Channels needed for Mobiles 1 and 2	
channel (first)	any channel
channel (second)	any channel
Mobile identity 1	TMSI of MS under test
Mobile identity 2	Omitted
P1 rest octets	(spare octets)

PAGING RESPONSE

No default requirements defined for this message.

PROGRESS

No default values defined for this message.

RELEASE (network to mobile station direction)

Information element	Value/remark
Cause	Omitted
Second cause	Omitted
Facility	Omitted
User-user	Omitted

RELEASE (mobile station to network direction)

No default requirements defined for this message.

RELEASE COMPLETE (network to mobile station direction)

Information element	Value/remark
Cause	Omitted
Facility	Omitted
User-user	Omitted

RELEASE COMPLETE (mobile station to network direction)

No default requirements defined for this message.

SETUP (mobile station to network direction)

Information element	Value/remark
BC Repeat indicator	Omitted
Bearer capability 1	Appropriate for the basic service selected for the test
Bearer capability 2	Omitted
Facility	Omitted
Calling party subaddress	Omitted
Called party BCD number	As entered
Called party subaddress	Omitted
LLC repeat indicator	Omitted
Low layer compatibility I	Appropriate for the basic service selected for the test
Low layer compatibility II	Omitted
HLC repeat indicator	Omitted
High layer compatibility i	Appropriate for the basic service selected for the test
High layer compatibility ii	Omitted
User-user	Omitted
SS version	Omitted
CLIR suppression	Omitted
CC Capabilities	present, shall indicate support for DTMF as per section 5.5.7 of GSM 04.08

SETUP (network to mobile station direction)

Information element	Value/remark
BC repeat indicator	Omitted
Bearer capability 1	Appropriate for the basic service selected for the test
Bearer capability 2	Omitted
Facility	Omitted
Progress indicator	Omitted
Signal	Any defined value as described for Signal IE in GSM 04.08
Calling party BCD number	Omitted
Calling party subaddress	Omitted
Called party BCD number	Omitted
Called party subaddress	Omitted
LLC repeat indicator	Omitted
Low layer compatibility I	Appropriate for the basic service selected for the test
Low layer compatibility II	Omitted
HLC repeat indicator	Omitted
High layer compatibility i	Appropriate for the basic service selected for the test
High layer compatibility ii	Omitted
User-user	Omitted

START DTMF

No default requirements defined for this message.

START DTMF ACKNOWLEDGE

Information element	Value/remark
Keypad facility	corresponding to the DTMF digit indicated in the START DTMF message

START DTMF REJECT

Information element	Value/remark
Cause	value "Resources unavailable, unspecified"

STATUS

Information element	Value/remark
Cause	Value "Response to STATUS ENQUIRY" Specified separately in each test case Omitted
Call state	
Auxiliary states	

STATUS ENQUIRY

No default values defined for this message, except that when this message is used to check that "all the transaction identifiers from 000 to 110" are in the null state, the TI flag shall take the value "1" in mobile originating call tests and shall take the value "0" in mobile terminating call tests.

STOP DTMF

No default requirements defined for this message.

STOP DTMF ACKNOWLEDGE

No default values defined for this message.

Unknown Message

Protocol Discriminator	Call Control; Call Related SS same as in use in the test 0000 0100
Transaction Identifier	
Message Type	

26.9 Structured procedures

26.9.1 Structured procedures / general

The purpose of these tests is to verify that the MS performs certain elementary procedures of the RR, MM, and CC protocol correctly within a structured procedure. The term "structured procedure" is defined in GSM 04.08, section 7, where also examples of structured procedures are given.

The reason for this test purposes is twofold:

- The behaviour of the MS in an elementary procedure may depend on the preamble which precedes the elementary procedure.
- Structured procedures tested in this section are used in other parts of this Technical Specification as preambles to establish the initial conditions for other tests; correct behaviour of an implementation under test in a preamble is essential for the validity of a test.

Mobile originating and terminating calls are tested in cases of both early and late assignment of the traffic channel; in one of the cases call release initiated by the network is tested, in another one, call release initiated by the MS.

The feature Directed Retry is tested in both Mobile Originated and Mobile Terminated Call. The configuration of the assigned channels is described in table 26.9-1:

Table 26.9-1

Directed Retry from	To	Call direction	Start Time	Sync.	Section	Exec. Counter
SDCCH/4	TCH/F, cycl. FH	MOC	None	No	26.9.7	1
SDCCH/8, cycl. FH	TCH/H, rand. FH	MOC	None	No	26.9.7	2
SDCCH/4	TCH/F, no FH	MTC	None	No	26.9.8	1
SDCCH/8, rand. FH	TCH/H, cycl. FH	MTC	1.1 sec.	No	26.9.8	2

The tests in this section only cover the successful outcome of elementary procedures (i.e. they do not deal with abnormal cases).

In this section, the emergency call service is tested for mobile stations that do not support the full rate speech version 2 in the following cases:

- emergency call initiated in the idle, updated state with authentication and ciphering, for speech full rate version 1 and if supported, speech half rate version 1;
- emergency call initiated in the idle, no IMSI state (hence without authentication and without ciphering), the network accepting the call, for either speech full rate version 1 or, provided it is supported, speech half rate version 1;
- emergency call initiated in the idle, no IMSI state (hence without authentication and without ciphering), the network rejecting the call, for either speech full rate version 1 or, provided it is supported, speech half rate version 1.

These tests on emergency calls are only applicable to an MS supporting speech.

For an MS supporting speech the test procedures in 26.9.2, 26.9.3, 26.9.4, 26.9.5, 26.9.7 and 26.9.8 are performed for speech (teleservice 11, telephony), once for speech full rate version 1 and, if supported, once for speech half rate version 1.

For an MS not supporting speech but supporting at least one teleservice, for each of the test procedures in 26.9.2, 26.9.3, 26.9.4, 26.9.5, 26.9.7 and 26.9.8 and each supported rate (full rate/half rate) a teleservice supported by the MS (see PICS/PIXIT statement) is chosen, and the test is performed corresponding to that teleservice (note that this teleservice is never a dual service).

In cases where a mobile originated call for the tested teleservice can be initiated both

- via the MMI and
- via the R or S interface,

procedures 26.9.2 and 26.9.7 (m = 1) shall be performed when initiating the mobile originated call via the MMI and procedures 26.9.3 and 26.9.7 (m = 2) shall be performed when initiating the mobile originated call via an appropriate interface (R or S).

26.9.2 Structured procedures / MS originated call / early assignment

26.9.2.1 Conformance requirements

- 1) An MS in MM state "idle, updated" and in RR idle mode, when made to initiate a call, if it provides a human interface, shall display the dialled number.
- 2) An MS in MM state "idle, updated" and in RR idle mode, when made to initiate a call for a selected teleservice that is supported by the MS, shall start to initiate the immediate assignment procedure by sending a CHANNEL REQUEST message with correct establishment cause.
- 3) Subsequently after establishment of an MM connection, the MS shall send a SETUP message with correct parameters.
- 4) The call control entity of the Mobile Station in the "call initiated" state, in the "mobile originating call proceeding" state or in the "call delivered" state, shall, upon receipt of a CONNECT message:
 - attach the user connection to the radio path;
 - return a CONNECT ACKNOWLEDGE message.
- 5) Subsequently when the network initiates call clearing by sending a DISCONNECT message, the MS shall proceed to release the call by sending a RELEASE message.
- 6) On receipt of a CHANNEL RELEASE message, the MS shall disconnect the main signalling link.

References

- Conformance requirement 1: GSM 02.07.
- Conformance requirement 2: GSM 04.08 section 3.3.1.1
- Conformance requirement 3: GSM 04.08 section 5.2.1.1.
- Conformance requirement 4: GSM 04.08 section 5.2.1.6.
- Conformance requirement 5: GSM 04.08 section 5.4.4.
- Conformance requirement 6: GSM 04.08, section 3.4.13.1

26.9.2.2 Test purpose

- 1) To verify that the MS in MM state "idle, updated" with a TMSI assigned, when made to initiate a call for a selected teleservice that is supported by the MS as declared in a PICS/PIXIT statement, displays the dialled number in the way described in a PICS/PIXIT statement.
- 2) To verify that the MS in MM state "idle, updated" and in RR idle mode, with a TMSI assigned, when made to initiate a call for a selected teleservice that is supported by the MS as declared in a PICS/PIXIT statement, starts to initiate an immediate assignment procedure by sending the CHANNEL REQUEST message with correct establishment cause.
- 3) To verify that subsequently after receipt of an IMMEDIATE ASSIGNMENT message allocating an SDCCH, after completion of establishment of the main signalling link, after having sent a CM SERVICE REQUEST message, after having successfully performed the authentication and cipher mode setting procedures, the MS sends a SETUP message with correct parameters.
- 4) To verify that subsequently, after receipt of a CALL PROCEEDING message and of an ASSIGNMENT COMMAND message allocating an appropriate TCH, after having completed the traffic channel early assignment procedure by replying with the ASSIGNMENT COMPLETE message, after receipt of an ALERTING message and a CONNECT message, the MS returns a CONNECT ACKNOWLEDGE message.
- 5) To verify that subsequently the MS has attached the user connection to the radio path. (This is checked by verifying that there is a point in time after transmission of the first L2 frame containing the (complete) CONNECT message, where the MS is sending appropriate speech or data frames whenever it does not have to transmit or acknowledge an I frame on layer 2 of the FACCH.)
- 6) To verify that subsequently upon the network initiating call clearing by sending a DISCONNECT message, the MS proceed to release the call with RELEASE.
- 7) To verify that subsequently, on receipt of a RELEASE COMPLETE message followed by a CHANNEL RELEASE message, the MS disconnects the main signalling link.

These test purposes are tested for all rates supported by the MS (full rate/half rate).

26.9.2.3 Method of test

Related PICS/PIXIT Statements

- Supported rates (full rate/half rate).
- Supported speech versions (full rate version 1, full rate version 2, half rate version 1)
- Interface to the human user (p1 = Y/N).
- Way to display the called number (only applicable if the MS has an interface to the human user).
- Way to indicate alerting (only applicable if the MS supports the feature).
- SS version
- Supported teleservices.

- Classmark.

Initial Conditions

System Simulator:

1 cell, default parameters.

Mobile Station:

The MS is in MM-state "idle, updated" with valid TMSI and CKSN.

Foreseen Final State of the MS

The MS is in MM-state "idle, updated" with valid TMSI and CKSN.

Test procedure

The following test is performed for all rates (full rate/half rate) supported by the MS:

A teleservice is selected that is supported by the MS; if the MS supports speech, the selected teleservice is speech. If necessary, the MS is configured for that teleservice.

The MS is made to initiate a call. The call is established with early assignment. Having reached the active state, the call is cleared by the SS.

Maximum Duration of Test

1 minute.

Expected Sequence

Step	Direction	Message	Comments
1	MS		The "called number" is entered.
2	MS		If p1 = Y, the MS must display the called number in the way defined in PICS/PIXIT.
3	MS -> SS	CHANNEL REQUEST	Establishment cause is "originating call and the network does not set the NECl bit to 1".
4	SS -> MS	IMMEDIATE ASSIGNMENT	
5	MS -> SS	CM SERVICE REQUEST	Message is contained in SABM.
6	SS -> MS	AUTHENTICATION REQUEST	
7	MS -> SS	AUTHENTICATION RESPONSE	SRES specifies correct value.
8	SS -> MS	CIPHERING MODE COMMAND	SS starts deciphering after sending the message.
9	MS -> SS	CIPHERING MODE COMPLETE	Shall be sent enciphered. All following messages shall be sent enciphered.
10	SS		SS starts ciphering.
11	MS -> SS	SETUP	
12	SS -> MS	CALL PROCEEDING	
13	SS -> MS	ASSIGNMENT COMMAND	
14	MS -> SS	ASSIGNMENT COMPLETE	
15	SS -> MS	ALERTING	
16	MS		Depending on the PICS, an alerting indication is given.
17	SS -> MS	CONNECT	
18	MS -> SS	CONNECT ACKNOWLEDGE	
19	MS		The appropriate bearer channel is through connected in both directions.
20	SS -> MS	DISCONNECT	
21	MS -> SS	RELEASE	
22	SS -> MS	RELEASE COMPLETE	
23	SS -> MS	CHANNEL RELEASE	The main signalling link is released.

Specific Message Contents:

None.

26.9.3 Structured procedures / MS originated call / late assignment

26.9.3.1 Conformance requirement

- 1) An MS in MM state "idle, updated" and in RR idle mode with a TMSI assigned, when made to initiate a call for a selected teleservice that is supported by the MS, shall start to initiate an immediate assignment procedure by sending the CHANNEL REQUEST message with correct establishment cause.
- 2) Upon receipt of the ASSIGNMENT COMMAND message, the Mobile Station initiates a local end release of link layer connections, disconnects the physical channels, commands the switching to the assigned channels and initiates the establishment of lower layer connections (this includes the activation of the channels, their connection and the establishment of the data links). After the main signalling link is successfully established, the MS returns an ASSIGNMENT COMPLETE message, specifying cause "normal event", to the network on the main DCCH.
- 3, 4) The call control entity of the Mobile Station in the "call initiated" state, in the "mobile originating call proceeding" state or in the "call delivered" state, shall, upon receipt of a CONNECT message:
 - attach the user connection to the radio path;
 - return a CONNECT ACKNOWLEDGE message.

References

Conformance requirement 1: GSM 04.08 section 3.3.1.1

Conformance requirement 2: GSM 04.08 sections 3.4.3.1 and 3.4.3.2.

Conformance requirement 3: GSM 04.08 section 5.2.1.6.

26.9.3.2 Test purpose

- 1) To verify that the MS in MM state "idle, updated" and in RR idle mode with a TMSI assigned, when made to initiate a call for a selected teleservice that is supported by the MS as declared in a PICS/PIXIT statement, starts to initiate an immediate assignment procedure by sending the CHANNEL REQUEST message.
- 2) To verify that subsequently after receipt of an IMMEDIATE ASSIGNMENT message allocating an SDCCH, after completion of establishment of the main signalling link, after having sent a CM SERVICE REQUEST message, after having successfully performed authentication and cipher mode setting procedures, after having sent a SETUP message, after having received a CALL PROCEEDING message followed by an ALERTING message and an ASSIGNMENT COMMAND message allocating an appropriate TCH, the MS sends an ASSIGNMENT COMPLETE message.
- 3) To verify that subsequently, after the suite of actions specified in test purposes 1 and 2, the MS after receiving a CONNECT message returns a CONNECT ACKNOWLEDGE message.
- 4) To verify that after the suite of actions specified in test purposes 1 and 2, the MS after receiving a CONNECT message attaches the user connection to the radio path. (This is checked by verifying that there is a point in time after transmission of the first L2 frame containing the (complete) CONNECT message, where the MS is sending appropriate speech or data frames whenever it does not have to transmit or acknowledge an I frame on layer 2 of the FACCH.)

These test purposes are tested for all rates supported by the MS (full rate/half rate).

26.9.3.3 Method of test

Related PICS/PIXIT statements

- Supported rates (full rate/half rate).
- Interface to the human user (p1 = Y/N).
- Way to display the called number (only applicable if the MS has an interface to the human user).

- Way to indicate alerting (only applicable if the MS supports the feature).
- Supported teleservices.
- Classmark.

Initial Conditions

System Simulator:

1 cell, default parameters.

Mobile Station:

The MS is in MM-state "idle, updated" with valid TMSI and CKSN.

Foreseen Final State of the MS

The MS has a MO call in state U10, "active".

Test procedure

The following test is performed for all rates (full rate/half rate) supported by the MS:

A teleservice is selected that is supported by the MS; if the MS supports speech, the selected teleservice is speech. If necessary, the MS is configured for that teleservice.

The MS is made to initiate a call. The call is established with late assignment.

Maximum Duration of Test

30 seconds.

Expected Sequence

Step	Direction	Message	Comments
1	MS		The "called number" is entered.
2	MS		
3	MS -> SS	CHANNEL REQUEST	Establishment cause is "originating call and the network does not set the NECl bit to 1".
4	SS -> MS	IMMEDIATE ASSIGNMENT	
5	MS -> SS	CM SERVICE REQUEST	Message is contained in SABM.
6	SS -> MS	AUTHENTICATION REQUEST	
7	MS -> SS	AUTHENTICATION RESPONSE	SRES specifies correct value.
8	SS -> MS	CIPHERING MODE COMMAND	SS starts deciphering after sending the message.
9	MS -> SS	CIPHERING MODE COMPLETE	Shall be sent enciphered. All following messages shall be sent enciphered.
10	SS		SS starts ciphering.
11	MS -> SS	SETUP	
12	SS -> MS	CALL PROCEEDING	
13	SS -> MS	ALERTING	
14	MS		Depending on the PICS, an alerting indication is given.
15	SS -> MS	ASSIGNMENT COMMAND	
16	MS -> SS	ASSIGNMENT COMPLETE	
17	SS -> MS	CONNECT	
18	MS -> SS	CONNECT ACKNOWLEDGE	
19	MS		The appropriate bearer channel is through connected in both directions.

Specific Message Contents:

None.

26.9.4 Structured procedures / MS terminated call / early assignment

26.9.4.1 Conformance requirements

- 1) The MS shall acknowledge the SETUP message with a CALL CONFIRMED message, if compatibility checking was successful, the MS is not busy, and the user does not refuse the call.
- 2, 3) Upon receipt of the ASSIGNMENT COMMAND message the MS continues a mobile terminating call establishment with early establishment of the traffic channel
 - a) by replying to the ASSIGNMENT COMMAND with an ASSIGNMENT COMPLETE message, and
 - b) if the MS supports immediate connect, by continuing the call establishment by through-connecting the traffic channel in both directions, or if the MS does not support immediate connect, by sending an ALERTING message
- 4) An MS indicates acceptance of a MT call by sending CONNECT.
- 5)

For speech calls:

The mobile station shall attach the user connection at latest when sending the connect message, except if there is no compatible radio resource available at this time. In this case the attachment shall be delayed until such a resource becomes available.

For data calls:

The mobile station shall attach the user connection when receiving the CONNECT ACKNOWLEDGE message from the network.

- 6) The MS initiates call clearing of an active call by sending a DISCONNECT message.
- 7) The MS in this phase of call release, upon receipt of a RELEASE message, shall return a RELEASE COMPLETE message.
- 8) Subsequently the MS, upon receipt of a CHANNEL RELEASE message, shall disconnect the main signalling link.

References

- Conformance requirement 1: GSM 04.08, section 5.2.2.3.1.
- Conformance requirements 2, 3: GSM 04.08, sections 5.2.2.3.2 and 3.4.3.1.
- Conformance requirement 4: GSM 04.08 section 5.2.2.5.
- Conformance requirement 5: GSM 04.08, sections 5.2.2.6 and 5.2.2.9.
- Conformance requirements 6, 7, 8: GSM 04.08, section 5.4.

26.9.4.2 Test purpose

- 1) To verify that the MS in MM state "idle, updated" and in RR idle mode with a TMSI assigned, after being paged by the network on the correct paging subchannel, after initiating the immediate assignment procedure by sending the CHANNEL REQUEST message, after receipt of an IMMEDIATE ASSIGNMENT message allocating an SDCCH, after having sent a PAGING RESPONSE message on the allocated SDCCH, after having performed successful authentication and cipher mode setting procedures, after receipt of a SETUP message not containing a signal information element, returns a CALL CONFIRMED message.
- 2) To verify that subsequently, the SS sending an ASSIGNMENT COMMAND message, the MS successfully continues a mobile terminating call establishment with early assignment of traffic channel:
 - a) by replying to the ASSIGNMENT COMMAND with an ASSIGNMENT COMPLETE message, and

- b) by continuing the call establishment by either
- sending a CONNECT messages and through connecting the TCH in both directions, or
 - sending an ALERTING message.
- 3) To verify that if after sending a CALL PROCEEDING message, the MS sends an ALERTING message during MTC establishment with early assignment, it generates an alerting indication.
- 4) To verify that if an ALERTING had been sent, subsequently, when the user accepts the call (possibly internal action as declared in PICS/PIXIT statement), the MS returns a CONNECT message.
- 5) To verify that the MS:
- if the call is a speech call: after sending the CONNECT message has through connected the TCH in both directions (this is checked by verifying that after transmission of the first L2 frame containing the (complete) CONNECT message, the MS is sending appropriate speech or data frames whenever it does not have to transmit or acknowledge an I frame on layer 2 of the FACCH.)
 - if the call is a data call: after receipt of a subsequent CONNECT ACKNOWLEDGE message through connects the TCH in both directions (this is checked by verifying that there is a point in time after transmission of the first L2 frame containing the (complete) CONNECT ACKNOWLEDGE message, where the MS is sending appropriate speech or data frames whenever it does not have to transmit or acknowledge an I frame on layer 2 of the FACCH.)
- 6) To verify that subsequently, the MS can initiate call clearing by sending a DISCONNECT message.
- 7) To verify that the MS in this phase of call release, upon receipt of a RELEASE message, returns a RELEASE COMPLETE message.
- 8) To verify that subsequently the MS, upon receipt of a CHANNEL RELEASE message, disconnects the main signalling link.

These test purposes are tested for all rates supported by the MS (full rate/half rate).

26.9.4.3 Method of test

Related PICS/PIXIT statements

- Supported rates (full rate/half rate).
- Supported speech versions (full rate version 1, full rate version 2, half rate version 1)
- Interface to the human user (p1 = Y/N).
- Way to display the called number (only applicable if the MS has an interface to the human user).
- Way to indicate alerting (only applicable if the MS supports the feature).
- Way to make the MS accept an incoming call after alerting (possibly dependent on teleservice and configuration).
- Supported teleservices.
- Classmark.
- Immediate connect supported (Y/N).

Initial Conditions

System Simulator:

1 cell, default parameters.

Mobile Station:

The MS is in MM-state "idle, updated" with valid TMSI and CKSN.

Foreseen Final State of the MS

The MS is in MM-state "idle, updated" with valid TMSI and CKSN.

Test procedure

The following test is performed for all rates (full rate/half rate) supported by the MS:

A teleservice is selected that is supported by the MS; if the MS supports speech, the selected teleservice is speech. If necessary, the MS is configured for that teleservice.

The MS is paged and the resulting call is established. Having reached the active state, the MS is made to clear the call.

Maximum Duration of Test

1 minute.

Expected Sequence

Step	Direction	Message	Comments
1	SS -> MS	PAGING REQUEST TYPE 1	Sent on the correct paging subchannel.
2	MS -> SS	CHANNEL REQUEST	
3	SS -> MS	IMMEDIATE ASSIGNMENT	
4	MS -> SS	PAGING RESPONSE	Message is contained in SABM.
5	SS -> MS	AUTHENTICATION REQUEST	
6	MS -> SS	AUTHENTICATION RESPONSE	SRES specifies correct value.
7	SS -> MS	CIPHERING MODE COMMAND	SS starts deciphering after sending the message.
8	MS -> SS	CIPHERING MODE COMPLETE	Shall be sent enciphered. All following messages shall be sent enciphered.
9	SS		SS starts ciphering.
10	SS -> MS	SETUP	Message does not contain the signal IE.
11	MS -> SS	CALL CONFIRMED	
			If the MS supports immediate connect then branch A applies. If the MS does not support immediate connect then branch B applies
A12	MS -> SS	CONNECT	sent on the old channel
A13	SS -> MS	ASSIGNMENT COMMAND	
A14	MS -> SS	ASSIGNMENT COMPLETE	
B12	SS -> MS	ASSIGNMENT COMMAND	
B13	MS -> SS	ASSIGNMENT COMPLETE	sent on the new channel
B14	MS -> SS	ALERTING	
B15	MS		An alerting indication as defined in a PICS/PIXIT statement is given by the MS
B16	MS		The MS is made to accept the call in the way described in a PICS/PIXIT statement
B17	MS -> SS	CONNECT	
18	MS		If the call is a speech call, the TCH shall be through connected in both directions.
19	SS -> MS	CONNECT ACKNOWLEDGE	
20	MS		If the call is a data call, the TCH shall be through connected in both directions.
21	MS		The MS is made to release the call.
22	MS -> SS	DISCONNECT	
23	SS -> MS	RELEASE	
24	MS -> SS	RELEASE COMPLETE	
25	SS -> MS	CHANNEL RELEASE	The main signalling link is released.

Specific Message Contents:

None.

26.9.5 Structured procedures / MS terminated call / late assignment

26.9.5.1 Conformance requirement

TP1,TP2: The MS shall acknowledge the SETUP message with a CALL CONFIRMED message, if compatibility checking was successful, the MS is not busy, and the user does not refuse the call. The MS on acceptance of the call sends a CONNECT, otherwise user alerting is initiated.

TP3: The MS indicates acceptance of a call by sending a CONNECT message.

TP4: ASSIGNMENT COMMAND is answered by ASSIGNMENT COMPLETE.

TP5:

For speech calls:

The mobile station shall attach the user connection at latest when sending the connect message, except if there is no compatible radio resource available at this time. In this case the attachment shall be delayed until such a resource becomes available.

For data calls:

The mobile station shall attach the user connection when receiving the CONNECT ACKNOWLEDGE message from the network.

Requirement reference:

Conformance requirements 1, 2, 3: GSM 04.08, sections 5.2.2.3.1, 5.2.2.3.2 and 5.2.2.5.

Conformance requirement 4: GSM 04.08, section 3.4.3.1.

Conformance requirement 5: GSM 04.08, section 5.2.2.9.

26.9.5.2 Test purpose

- 1) To verify that the MS in "Idle, Updated" state with a TMSI assigned, after being paged by the network on the correct paging subchannel, after initiating the immediate assignment procedure by sending the CHANNEL REQUEST message, after receipt of an IMMEDIATE ASSIGNMENT message allocating an SDCCH, after having established the main signalling link, after having sent a PAGING RESPONSE message, after having performed successful authentication and cipher mode setting procedures, after receipt of a SETUP message containing a signal information element, returns a CALL CONFIRMED message followed by:
 - an ALERTING message;
 - or a CONNECT message.
- 2) To verify that in the situation of test purpose 1, if the MS sends an ALERTING message, the MS generates an alerting indication in the way described in a PICS/PIXIT statement.
- 3) To verify that subsequently the MS, if it had not yet sent a CONNECT message, upon acceptance of the call, sends a CONNECT message.
- 4) To verify that subsequently after receipt of an ASSIGNMENT COMMAND, the MS sends an ASSIGNMENT COMPLETE message.

5) To verify that subsequently the MS:

- if the call is a speech call: after sending the ASSIGNMENT COMPLETE message has through connected the TCH in both directions (this is checked by verifying that after transmission of the first L2 frame containing the (complete) ASSIGNMENT COMPLETE message, the MS is sending appropriate speech or data frames whenever it does not have to transmit or acknowledge an I frame on layer 2 of the FACCH.)
- if the call is a data call: after receipt of a subsequent CONNECT ACKNOWLEDGE message through connects the TCH in both directions (this is checked by verifying that there is a point in time after transmission of the first L2 frame containing the (complete) CONNECT ACKNOWLEDGE message, where the MS is sending appropriate speech or data frames whenever it does not have to transmit or acknowledge an I frame on layer 2 of the FACCH.)

These test purposes are tested for all rates supported by the MS (full rate/half rate).

26.9.5.3 Method of test

Related PICS/PIXIT statements

- Supported rates (full rate/half rate).
- Supported speech versions (full rate version 1, full rate version 2, half rate version 1)
- Interface to the human user (p1 = Y/N).
- Way to display the called number (only applicable if the MS has an interface to the human user).
- Way to indicate alerting (only applicable if the MS supports the feature).
- Way to make the MS accept an incoming call after alerting (possibly dependent on teleservice and configuration).
- Supported teleservices.
- Classmark.
- Immediate connect supported (Y/N).

Initial Conditions

System Simulator:

1 cell, default parameters.

Mobile Station:

The MS is in MM-state "idle, updated" with valid TMSI and CKSN.

Foreseen Final State of the MS

CC state U10-call active.

Test procedure

The following test is performed for all rates (full rate/half rate) supported by the MS:

A teleservice is selected that is supported by the MS; if the MS supports speech, the selected teleservice is speech. If necessary, the MS is configured for that teleservice.

The MS is paged and a MT call is established with late assignment (after CONNECT).

Maximum Duration of Test

40 seconds.

Expected Sequence

Step	Direction	Message	Comments
1	SS -> MS	PAGING REQUEST TYPE 1	Sent on the correct paging subchannel. Establishment cause indicates "answer to paging".
2	MS -> SS	CHANNEL REQUEST	
3	SS -> MS	IMMEDIATE ASSIGNMENT	Message is contained in SABM.
4	MS -> SS	PAGING RESPONSE	
5	SS -> MS	AUTHENTICATION REQUEST	SRES specifies correct value.
6	MS -> SS	AUTHENTICATION RESPONSE	
7	SS -> MS	CIPHERING MODE COMMAND	SS starts deciphering after sending the message. Shall be sent enciphered. All following messages shall be sent enciphered.
8	MS -> SS	CIPHERING MODE COMPLETE	
9	SS		SS starts ciphering.
10	SS -> MS	SETUP	Message contains the signal IE.
11	MS -> SS	CALL CONFIRMED	
A12	MS -> SS	CONNECT	
B12	MS -> SS	ALERTING	An alerting indication as defined in an PICS/PIXIT statement is given by the MS. The MS is made to accept the call in the way described in a PICS/PIXIT statement.
B13	MS		
B14	MS		
B15	MS -> SS	CONNECT	
16	SS -> MS	ASSIGNMENT COMMAND	If the call is a speech call, the TCH shall be through connected in both directions.
17	MS -> SS	ASSIGNMENT COMPLETE	
18	MS		If the call is a data call, the MS shall through connect the TCH in both directions.
19	SS -> MS	CONNECT ACKNOWLEDGE	
20	MS		

Specific Message Contents:

None.

26.9.6 Structured procedures / emergency call

Emergency call establishment can be initiated by an MS whether location updating has been successful or not and whether a SIM is inserted into the MS or not; but only if the MS is equipped for speech.

If the procedures tested in this section are not correctly implemented in the MS, establishment, maintenance and clearing of connections might fail in the essential case of emergency calls.

The tests of this section are only applicable to an MS supporting speech.

26.9.6.1 Structured procedures / emergency call / idle updated

26.9.6.1.1 Structured procedures / emergency call / idle updated / preferred channel rate

26.9.6.1.1.1 Conformance requirement

- 1) The MS in the "idle, updated" state, as after a successful location update, after the number 112 (for GSM 900 and 1800 MS), or 911 (for PCS 1900 MS in USA and Canada), or 08 (for PCS 1900 MS in Mexico) has been entered by user, shall send a CHANNEL REQUEST message with correct establishment cause ("emergency call").
- 2) After assignment of a dedicated channel the first layer message sent by the MS on the assigned dedicated channel shall be a CM SERVICE REQUEST message specifying the correct CKSN and TMSI, with CM Service Type "emergency call establishment".
- 3) Authentication and cipher mode setting shall be performed successfully.
- 4) After cipher mode setting acceptance by the network, the MS shall send an EMERGENCY SETUP message.

- 5), 6) The emergency call shall be correctly established. The assignment procedure shall be correctly performed.
- 7) After receipt of a CONNECT ACKNOWLEDGE message during correct establishment of the emergency call the TCH shall be through connected in both directions if an appropriate TCH is available.
- 8) The call shall be cleared correctly.

Requirement Reference:

For conformance requirement 1 and 2:

GSM 04.08 section 3.3.1.1, GSM 04.08 section 5.2.1, GSM 04.08 section 4.5.1.5., GSM 02.30 section 4.

For conformance requirement 3:

GSM 04.08, section 3.4.7, GSM 04.08 section 4.3.2.

For conformance requirement 4:

GSM 04.08, section 5.2.1.1.

For conformance requirement 5 and 6:

GSM 04.08, sections 5.2.1.1 and 3.4.3.

For conformance requirement 7:

GSM 04.08, sections 5.2.1.6 and 5.1.3.

For conformance requirement 8:

GSM 04.08, section 5.4.

26.9.6.1.1.2 Test purpose

- 1) To verify that an MS supporting speech in the MM state "idle, updated", when made to call the number 112 (for GSM 900 and 1800 MS), or 911 (for PCS 1900 MS in USA and Canada), or 08 (for PCS 1900 MS in Mexico), sends a CHANNEL REQUEST message with establishment cause "emergency call".
- 2) To verify that after assignment of a dedicated channel the first layer message sent by the MS on the assigned dedicated channel is a CM SERVICE REQUEST message specifying the correct CKSN and TMSI, with CM Service Type "emergency call establishment".
- 3) To verify that authentication and cipher mode setting are performed successfully.
- 4) To verify that after cipher mode setting acceptance by the SS, the MS sends an EMERGENCY SETUP message.
- 5) To verify that subsequently, the SS having sent a CALL PROCEEDING message and then an ALERT message and having initiated the assignment procedure of an appropriate speech traffic channel, which, if the MS supports both TCH/FS and TCH/HS, is at the preferred rate, the MS performs correctly that assignment procedure.
- 6) To verify subsequent correct performance of a connect procedure.
- 7) To verify that subsequently the MS has through connected the TCH in both directions.
- 8) To verify that the call is cleared correctly.

26.9.6.1.1.3 Method of test

Related PICS/PIXIT Statements

- Speech supported (Y/N).
- Supported rate for speech: (p1 = F/H, F).

- Classmark.

Initial Conditions

System Simulator:

1 cell, default parameters.

Mobile Station:

The MS is in MM-state "idle, updated" with valid TMSI and CKSN.

Foreseen Final State of the MS

The MS is in MM-state "idle, updated" with valid TMSI and CKSN.

Test procedure

The MS is made to initiate an emergency call. The call is established with late assignment. Having reached the active state, the call is cleared by the SS.

Maximum Duration of Test

1 minute.

Expected Sequence

Step	Direction	Message	Comments
1	MS		The appropriate emergency call number is entered.
3	MS -> SS	CHANNEL REQUEST	Establishment cause is emergency call establishment.
4	SS -> MS	IMMEDIATE ASSIGNMENT	
5	MS -> SS	CM SERVICE REQUEST	Message is contained in SABM. The CM service type IE indicates "emergency call establishment".
6	SS -> MS	AUTHENTICATION REQUEST	
7	MS -> SS	AUTHENTICATION RESPONSE	SRES specifies correct value.
8	SS -> MS	CIPHERING MODE COMMAND	SS starts deciphering after sending the message.
9	MS -> SS	CIPHERING MODE COMPLETE	Shall be sent enciphered. All following messages shall be sent enciphered.
10	SS		SS starts ciphering.
11	MS -> SS	EMERGENCY SETUP	If p1 = F/H, the message must contain one bearer capability IE indicating in the radio channel requirement field "dual rate/half rate preferred" or "dual rate/full rate preferred". If p1 = F, the message must either contain no bearer capability IE or contain one bearer capability IE indicating in the radio channel requirement field "full rate channel".
12	SS -> MS	CALL PROCEEDING	
13	SS -> MS	ALERTING	
14	SS -> MS	ASSIGNMENT COMMAND	The rate of the channel is that one indicated by the EMERGENCY SETUP message, if that message did not offer a choice, and the rate is the preferred one else.
15	MS -> SS	ASSIGNMENT COMPLETE	
16	SS -> MS	CONNECT	
17	MS -> SS	CONNECT ACKNOWLEDGE	
18	MS		The TCH is through connected in both directions.
19	SS -> MS	DISCONNECT	
20	MS -> SS	RELEASE	
21	SS -> MS	RELEASE COMPLETE	
23	SS -> MS	CHANNEL RELEASE	The main signalling link is released.

Specific Message Contents:

None.

26.9.6.1.2 Structured procedures / emergency call / idle updated, non-preferred channel rate

The test is performed if the MS supports both TCH/HS and TCH/FS (see PICS/PIXIT statement).

It is identical to the test in 26.9.6.1.1 except that in step 14 the assigned TCH has the non-preferred rate.

26.9.6.2 Structured procedures / emergency call / idle, no IMSI

26.9.6.2.1 Structured procedures / emergency call / idle, no IMSI / accept case

26.9.6.2.1.1 Conformance requirement

- 1) The MS in the "idle, updated" state, as after a successful location update, after the number 112 (for GSM 900 and 1800 MS), or 911 (for PCS 1900 MS in USA and Canada), or 08 (for PCS 1900 MS in Mexico) has been entered by user, shall send a CHANNEL REQUEST message with correct establishment cause ("emergency call").
- 2) After assignment of a dedicated channel the first layer message sent by the MS on the assigned dedicated channel shall be a CM SERVICE REQUEST message specifying the correct IMEI and a non-available CKSN, with CM Service Type "emergency call establishment".
- 3) After cipher mode setting acceptance by the network, the MS shall send an EMERGENCY SETUP message.
- 4),5) The emergency call shall be correctly established. The assignment procedure shall be correctly performed.
- 6) After receipt of a CONNECT ACKNOWLEDGE message during correct establishment of the emergency call the TCH shall be through connected in both directions if an appropriate TCH is available.
- 7) The call shall be cleared correctly.

Requirement Reference:

For conformance requirement 1 and 2:

GSM 04.08 section 3.3.1.1, GSM 04.08 section 5.2.1, GSM 04.08 section 4.5.1.5., GSM 02.30 section 4.

For conformance requirement 3:

GSM 04.08, section 5.2.1.1.

For conformance requirements 4 and 5:

GSM 04.08, sections 5.2.1.1 and 3.4.3.

For conformance requirement 6:

GSM 04.08, sections 5.2.1.6 and 5.1.3.

For conformance requirement 7:

GSM 04.08, section 5.4.

26.9.6.2.1.2 Test purpose

- 1) To verify that the MS in the "idle, no IMSI" state (no SIM inserted) when made to call the number 112 (for GSM 900 and 1800 MS), or 911 (for PCS 1900 MS in USA and Canada), or 08 (for PCS 1900 MS in Mexico), sends a CHANNEL REQUEST message with establishment cause "emergency call".
- 2) To verify that after assignment of a dedicated channel the first layer message sent by the MS on the assigned dedicated channel is a CM SERVICE REQUEST message in which the cipher key sequence number IE indicates "no key is available", the CM service type IE indicates "emergency number establishment", and the mobile identity IE specifies the IMEI of the MS.

- 3) To verify that after receipt of a CM SERVICE ACCEPT message from the SS, the MS sends an EMERGENCY SETUP message.
- 4) To verify that subsequently, the SS having sent a CALL PROCEEDING message and then an ALERT message and having initiated the assignment procedure of an appropriate speech traffic channel, which, if the MS supports both TCH/FS and TCH/HS, is at the preferred rate, the MS performs correctly that assignment procedure.
- 5) To verify subsequent correct performance of a connect procedure.
- 6) To verify that subsequently the MS has through connected the TCH in both directions.
- 7) To verify that the call is cleared correctly.

26.9.6.2.1.3 Method of test

Related PICS/PIXIT Statements

- Speech supported (Y/N).
- Classmark.

Initial Conditions

System Simulator:

1 cell, default parameters.

Mobile Station:

The MS is in MM-state "idle, no IMSI", no SIM inserted.

Foreseen Final State of the MS

The MS is in MM-state "idle, no IMSI", no SIM inserted.

Test procedure

The MS is made to initiate an emergency call. The call is established without authentication, without ciphering, with late assignment. Having reached the active state, the call is cleared by the SS.

Maximum Duration of Test

1 minute.

Expected Sequence

Step	Direction	Message	Comments
1	MS		
3	MS -> SS	CHANNEL REQUEST	The appropriate emergency call number is entered. Establishment cause is "emergency call".
4	SS -> MS	IMMEDIATE ASSIGNMENT	
5	MS -> SS	CM SERVICE REQUEST	Message is contained in SABM. The CM service type IE indicates "emergency call establishment". The mobile identity IE specifies the IMEI of the MS. The cipher key sequence number IE indicates "no key is available". The mobile station classmark IE is as specified by the manufacturer in a PICS/PIXIT statement.
4	SS -> MS	CM SERVICE ACCEPT	
11	MS -> SS	EMERGENCY SETUP	
12	SS -> MS	CALL PROCEEDING	
13	SS -> MS	ALERTING	
14	SS -> MS	ASSIGNMENT COMMAND	The rate of the channel is one indicated by the EMERGENCY SETUP message.
15	MS -> SS	ASSIGNMENT COMPLETE	
16	SS -> MS	CONNECT	
17	MS -> SS	CONNECT ACKNOWLEDGE	
18	MS		The TCH is through connected in both directions.
19	SS -> MS	DISCONNECT	
20	MS -> SS	RELEASE	
21	SS -> MS	RELEASE COMPLETE	
23	SS -> MS	CHANNEL RELEASE	The main signalling link is released.

Specific Message Contents:

None.

26.9.6.2.2 Structured procedures / emergency call / idle, no IMSI / reject case

26.9.6.2.2.1 Conformance requirement

- 1) The MS in the "idle, no IMSI" state (no SIM inserted), after the number 112 (for GSM 900 and 1800 MS), or 911 (for PCS 1900 MS in USA and Canada), or 08 (for PCS 1900 MS in Mexico) has been entered, shall send a CHANNEL REQUEST message with correct establishment cause ("emergency call").
- 2) After assignment of a dedicated channel the first layer message sent by the MS on the assigned dedicated channel shall be a CM SERVICE REQUEST message specifying the correct IMEI and a non-available CKSN, with CM Service Type "emergency call establishment".
- 3) In the situation at the end of test purpose 2, when the MS receives a CM SERVICE REJECT message, it shall abandon the emergency call.

Requirement Reference:

For conformance requirement 1 and 2:

GSM 04.08 section 3.3.1.1, GSM 04.08 section 5.2.1, GSM 04.08 section 4.5.1.5., GSM 02.30 section 4.

For conformance requirement 3:

GSM 04.08 section 3.4.7, GSM 04.08 section 4.5.1.1.

26.9.6.2.2.2 Test purpose

- 1) To verify that the MS in the "idle, no IMSI" state (no SIM inserted) when made to call the number 112, (for GSM 900 and 1800 MS), or 911 (for PCS 1900 MS in USA and Canada), or 08 (for PCS 1900 MS in Mexico) sends a CHANNEL REQUEST message with establishment cause "emergency call".
- 2) To verify that after assignment of a dedicated channel the first layer message sent by the MS on the assigned dedicated channel is a CM SERVICE REQUEST message in which the cipher key sequence number IE indicates "no key is available", the CM service type IE indicates "emergency call establishment", and the mobile identity IE specifies the IMEI of the MS.
- 3) To verify that after receipt of a CM SERVICE REJECT message from the SS, the MS abandons the emergency call establishment.

26.9.6.2.2.3 Method of test

Related PICS/PIXIT statements

- Speech supported (Y/N).
- Classmark.

Initial Conditions

System Simulator:

1 cell, default parameters.

Mobile Station:

The MS is in MM-state "idle, no IMSI", no SIM inserted.

Foreseen Final State of the MS

The MS is in MM-state "idle, no IMSI", no SIM inserted.

Test procedure

The MS is made to initiate an emergency call. The call is established without authentication, without ciphering, with early assignment. The SS responds to the CM SERVICE REQUEST from the MS with a CM SERVICE REJECT message specifying in the reject cause IE the reject cause value "IMEI not accepted". The SS then verifies for during 5 seconds that the MS does not send a layer 3 message. Then the call is cleared by the SS. The SS verifies during 20 seconds after disconnection of the main signalling link that the MS does not initiate an RR connection establishment.

Maximum Duration of Test

1 minute.

Expected Sequence

Step	Direction	Message	Comments
1	MS		The appropriate call number is entered.
3	MS -> SS	CHANNEL REQUEST	Establishment cause is "emergency call".
4	SS -> MS	IMMEDIATE ASSIGNMENT	
5	MS -> SS	CM SERVICE REQUEST	Message is contained in SABM. The CM service type IE indicates "emergency call establishment". The mobile identity IE specifies the IMEI of the MS. The cipher key sequence number IE indicates "no key is available". The mobile station classmark IE is as specified by the manufacturer in a PICS/PIXIT statement.
4	SS -> MS	CM SERVICE REJECT	the reject cause IE specifies reject cause value #5, "IMEI not accepted".
5	SS		During 5 seconds, the SS verifies that the MS does not send L3 messages.
6	SS -> MS	CHANNEL RELEASE	The main signalling link is released.
7	SS		During 20 seconds, the SS verifies that the MS does not initiate an RR connection establishment.

Specific Message Contents:

-

26.9.7 Directed Retry / Mobile Originated Call

This test is applicable to all MS which support at least one MO circuit switched basic service.

26.9.7.1 Conformance requirements

The MS shall correctly apply the Directed Retry procedure from SDCCH/8 (with frequency hopping) or SDCCH/4 to TCH/F or TCH/H with or without frequency hopping in the non-synchronized case during call establishment. The call control entity of the Mobile Station in the "mobile originating call proceeding" state shall, upon receipt of a CONNECT message, attach the appropriate user connection to the radio path and return a CONNECT ACKNOWLEDGE message to the SS.

References

GSM 04.08, sections 3.4.4, 5.2.1.6. and 9.1.15.

GSM 04.13, section 5.2.6.2.

26.9.7.2 Test purpose

To test that, when the MS is ordered to perform a non-synchronized handover after the CALL PROCEED message, it continuously sends access bursts on the main DCCH until it receives a PHYSICAL INFORMATION message from the SS. To test that the MS correctly takes the values of the Timing Advance information element in the PHYSICAL INFORMATION message into account. To test that the MS activates the new channel correctly and transmits the HANDOVER COMPLETE message without undue delay. To test that the call control entity of the Mobile Station in the "mobile originating call proceeding" state, upon receipt of a CONNECT message, attaches the appropriate user connection to the radio path and returns a CONNECT ACKNOWLEDGE message to the SS.

26.9.7.3 Method of test

Initial Conditions

System Simulator:

2 cells A and B with same LAI, default parameters, except:

GSM 450:

Cell A has:

BCCH ARFCN = 263.

Cell Allocation = (259, 261, 263, 265, 267, 269, 271, 273, 275, 277, 279, 281, 283, 285, 287, 289, 291).

PLMN colour code, NCC = as defaults.

BS colour code, BCC = as defaults.

PLMN_PERM = 00001010.

Cell B has:

BCCH ARFCN = 274

Cell Allocation = (260, 262, 264, 266, 268, 270, 272, 274, 276, 279, 281, 283, 285, 287, 289, 291).

PLMN colour code, NCC = 3.

BS colour code, BCC = 0.

Both cells send SYSTEM INFORMATION TYPE 1 messages containing the complete Cell Allocation of the cell, using range 128 format.

The timebase of Cells A and B shall be such that the edges of their timeslots are not coincident at the antenna connector.

For execution counter M = 1 a combined CCH/SDCCH is used.

For execution counter M = 2 a non-combined SDCCH is used.

GSM 480:

Cell A has:

BCCH ARFCN = 310.

Cell Allocation = (306, 308, 310, 312, 314, 316, 318, 320, 322, 324, 326, 328, 330, 332, 334, 336, 338).

PLMN colour code, NCC = as defaults.

BS colour code, BCC = as defaults.

PLMN_PERM = 00001010.

Cell B has:

BCCH ARFCN = 321.

Cell Allocation = (307, 309, 311, 313, 315, 317, 319, 321, 323, 326, 328, 330, 332, 334, 336, 338).

PLMN colour code, NCC = 3.

BS colour code, BCC = 0.

Both cells send SYSTEM INFORMATION TYPE 1 messages containing the complete Cell Allocation of the cell, using range 128 format.

The timebase of Cells A and B shall be such that the edges of their timeslots are not coincident at the antenna connector.

For execution counter M = 1 a combined CCH/SDCCH is used.

For execution counter $M = 2$ a non-combined SDCCH is used.

GSM 900:

Cell A has:

BCCH ARFCN = 20.

Cell Allocation = (10, 17, 20, 26, 34, 42, 45, 46, 52, 59, 66, 73, 74, 75, 76, 108, 114).

PLMN colour code, NCC = as defaults.

BS colour code, BCC = as defaults.

PLMN_PERM = 00001010.

Cell B has:

BCCH ARFCN = 40.

Cell Allocation = (14, 18, 22, 24, 30, 31, 38, 40, 60, 66, 73, 74, 75, 76, 108, 114).

PLMN colour code, NCC = 3.

BS colour code, BCC = 0.

Both cells send SYSTEM INFORMATION TYPE 1 messages containing the complete Cell Allocation of the cell, using bit map 0 format.

The timebase of Cells A and B shall be such that the edges of their timeslots are not coincident at the antenna connector.

For execution counter $M = 1$ a combined CCH/SDCCH is used.

For execution counter $M = 2$ a non-combined SDCCH is used.

DCS 1 800:

Cell A has:

BCCH ARFCN = 747.

Cell Allocation = (734, 741, 747, 754, 759, 762, 766, 767, 773, 775, 779, 782, 791, 798, 829, 832, 844).

PLMN colour code, NCC = as defaults.

BS colour code, BCC = as defaults.

PLMN_PERM = 00001010.

Cell B has:

BCCH ARFCN = 764.

Cell Allocation = (739, 743, 746, 749, 756, 758, 761, 764, 771, 779, 782, 791, 798, 829, 832, 844).

PLMN colour code, NCC = 3.

BS colour code, BCC = 0.

Both cells send SYSTEM INFORMATION TYPE 1 messages containing the complete Cell Allocation of the cell, using Range 512 format.

The timebase of Cells A and B shall be such that the edges of their timeslots are not coincident at the antenna connector.

For execution counter $M = 1$ a combined CCH/SDCCH is used.

For execution counter $M = 2$ a non combined SDCCH is used.

Mobile Station:

The MS is in the "idle, updated" state, with a TMSI allocated and camped on cell A.

Related PICS/PIXIT Statements

Supported rate(s) of TCH: TCH/F and/or TCH/H.

Support for MO calls.

Supported teleservices.

Way to indicate alerting (only applicable if the MS supports the feature).

Type of MS (GSM 450 or GSM 480 or P-GSM 900 or EGSM or DCS 1 800).

Foreseen Final State of the MS

"Idle, updated" with TMSI allocated and camped on cell B.

Test Procedure

This procedure is repeated for execution counter $M = 1..2$.

A teleservice is selected that is supported by the MS; if the MS supports speech, the selected teleservice is speech. If necessary, the MS is configured for that teleservice.

The MS is made to initiate a call on Cell A. After the SS has sent the CALL PROCEEDING message the SS sends a HANDOVER COMMAND message, ordering the MS to switch to cell B. The MS shall then begin to send access bursts on the new DCCH to cell B. The SS observes the access bursts and after receiving n (n being arbitrarily chosen between values according to table 26.6-2 of section 26.6.5) access bursts, the SS sends one PHYSICAL INFORMATION message with an arbitrarily chosen Timing Advance. The MS shall activate the channel in sending and receiving mode. The MS shall establish a signalling link. The MS shall be ready to transmit a HANDOVER COMPLETE message before x ms after the end of the PHYSICAL INFORMATION message, but not before a UA frame has been sent by the SS. After the successful handover procedure the SS sends the ALERTING message. The correct alerting indication shall be given to the user (only applicable if the MS supports this feature). The SS sends the CONNECT message indicating that the call has been answered. The appropriate bearer channel shall be through connected in both directions. The MS shall send then the CONNECT ACKNOWLEDGE message as the response on the CONNECT message. Having reached the active state, the call is cleared by the SS.

The term "ready to transmit" is defined in GSM 04.13. The value of " x " depends upon the target channel and is specified in the specific message contents section.

Maximum Duration of Test

2 minutes, including 1 minute for any necessary operator actions.

Expected Sequence

The sequence is performed for execution counter $M = 1..2$ (unless a particular TCH is not supported).

Step	Direction	Message	Comments
1	-----	-----	A MO call is initiated on cell A.
2	MS -> SS	CHANNEL REQUEST	Establishment cause is "originating call and the network does not set the NECI bit to 1".
3	SS -> MS	IMMEDIATE ASSIGNMENT	See specific message contents.
4	MS -> SS	CM SERVICE REQUEST	CM Service Type = Mobile Originating Call Establishment.
5	SS -> MS	AUTHENTICATION REQUEST	
6	MS -> SS	AUTHENTICATION RESPONSE	SRES specifies correct value.
7	SS -> MS	CIPHERING MODE COMMAND	SS starts deciphering after sending the message.
8	MS -> SS	CIPHERING MODE COMPLETE	Shall be sent enciphered. All following messages shall be sent enciphered.
9	SS		SS starts ciphering.
10	MS -> SS	SETUP	
11	SS -> MS	CALL PROCEEDING	
12	SS -> MS	HANDOVER COMMAND	See specific message contents.
13	MS -> SS	HANDOVER ACCESS	Repeated on every burst of the uplink main DCCH until reception of PHYSICAL INFORMATION. Handover Reference as included in the HANDOVER COMMAND.
14	SS -> MS	PHYSICAL INFORMATION	Sent after reception of n HANDOVER ACCESS message. Timing Advance is arbitrarily chosen.
15	MS -> SS	SABM	Sent without information field.
16	SS -> MS	UA	
17	MS -> SS	HANDOVER COMPLETE	This message shall be ready to be transmitted before "x" ms after the completion of step 14.
18	SS -> MS	ALERTING	
19	MS		Depending on the PICS, an alerting indication is given.
20	SS -> MS	CONNECT	
21	MS -> SS	CONNECT ACKNOWLEDGE	
22	MS		The appropriate bearer channel is through connected in both directions.
23	SS -> MS	DISCONNECT	
24	MS -> SS	RELEASE	
25	SS -> MS	RELEASE COMPLETE	
26	SS -> MS	CHANNEL RELEASE	The main signalling link is released.

Specific Message Contents For Mobiles Supporting Speech

M = 1:

For GSM 450:

IMMEDIATE ASSIGNMENT

Information Element	value/remark
As default message contents.	

HANDOVER COMMAND

Information Element	value/remarks
As default message contents, except: Cell Description <ul style="list-style-type: none"> - Network Colour Code - Base Station Colour Code - BCCH Carrier Number Channel Description <ul style="list-style-type: none"> - Channel Type - TDMA offset - Timeslot number - Training Sequence Code - Hopping - MAIO - HSN Synchronization Indication IE is not included Frequency list after time <ul style="list-style-type: none"> - Frequency List Channel Mode IE	3 0 274 TCH/F + ACCHs Chosen arbitrarily. Chosen arbitrarily but not zero. Chosen arbitrarily. RF hopping channel. Chosen arbitrarily from the set (0, 1 to N-1), where N is the number of frequencies encoded in the Frequency List IE. Zero (this gives cyclic hopping). use Range 128 to encode the following 15 frequencies (260, 262, 264, 266, 268, 270, 272, 276, 279, 281, 283, 285, 287, 289, 291). Speech (full rate version 1 or half rate version 1).

Step 17: "x" = 500.

For GSM 480:

IMMEDIATE ASSIGNMENT

Information Element	value/remark
As default message contents.	

HANDOVER COMMAND

Information Element	value/remarks
As default message contents, except: Cell Description <ul style="list-style-type: none"> - Network Colour Code - Base Station Colour Code - BCCH Carrier Number Channel Description <ul style="list-style-type: none"> - Channel Type - TDMA offset - Timeslot number - Training Sequence Code - Hopping - MAIO - HSN Synchronization Indication IE is not included Frequency list after time <ul style="list-style-type: none"> - Frequency List Channel Mode IE	3 0 321 TCH/F + ACCHs Chosen arbitrarily. Chosen arbitrarily but not zero. Chosen arbitrarily. RF hopping channel. Chosen arbitrarily from the set (0, 1 to N-1), where N is the number of frequencies encoded in the Frequency List IE. Zero (this gives cyclic hopping). use Range 128 to encode the following 15 frequencies (307, 309, 311, 313, 315, 317, 319, 323, 326, 328, 330, 332, 334, 336, 338). Speech (full rate version 1 or half rate version 1).

Step 17: "x" = 500.

For GSM 900:

IMMEDIATE ASSIGNMENT

Information Element	value/remark
As default message contents.	

HANDOVER COMMAND

Information Element	value/remarks
As default message contents, except:	
Cell Description	
- Network Colour Code	3
- Base Station Colour Code	0
- BCCH Carrier Number	40
Channel Description	
- Channel Type	TCH/F + ACCHs
- TDMA offset	Chosen arbitrarily.
- Timeslot number	Chosen arbitrarily but not zero.
- Training Sequence Code	Chosen arbitrarily.
- Hopping	RF hopping channel.
- MAIO	Chosen arbitrarily from the set (0, 1 to N-1), where N is the number of frequencies encoded in the Frequency List IE.
- HSN	Zero (this gives cyclic hopping).
Synchronization Indication IE is not included	
Frequency list after time	
- Frequency List	uses bit map 0 to allocate the following 15 frequencies (14, 18, 22, 24, 30, 31, 38, 60, 66, 73, 74, 75, 76, 108, 114).
Channel Mode IE	Speech (full rate version 1 or half rate version 1).

Step 17: "x" = 500.

DCS 1 800:

IMMEDIATE ASSIGNMENT

Information Element	value/remark
As default message contents.	

HANDOVER COMMAND

Information Element	value/remarks
As default message contents, except:	
Cell Description	
- Network Colour Code	3
- Base Station Colour Code	0
- BCCH Carrier Number	764
Channel Description	
- Channel Type	TCH/F + ACCHs
- TDMA offset	Chosen arbitrarily.
- Timeslot number	Chosen arbitrarily but not zero.
- Training Sequence Code	Chosen arbitrarily.
- Hopping	RF hopping channel.
- MAIO	Chosen arbitrarily from the set (0, 1 to N-1), where N is the number of frequencies encoded in the Frequency Short List IE.
- HSN	Zero (this gives cyclic hopping).
Synchronization Indication IE not included.	
Frequency Short List after time	
- Frequency Short List	Use Range 128 to encode the following 2 frequencies (746, 779).
Mode of First Channel	Speech (full rate version 1 or half rate version 1).

Step 17: "x" = 500.

M = 2:

GSM 450:

IMMEDIATE ASSIGNMENT

Information Element	value/remark
As default message contents except: L2 pseudo length	14 octets (11 + contents of the MA).
Channel Description	SDCCH/8
- Channel Type	As default message contents.
- TDMA offset	Arbitrary value, but not zero.
- Timeslot number	Chosen arbitrarily.
- Training Sequence Code	RF hopping channel.
- Hopping	Chosen arbitrarily from the set (0, 1 to N-1), where N is the number of frequencies encoded in the Mobile Allocation.
- MAIO	Zero (this gives cyclic hopping).
- HSN	
Mobile Allocation	3 octets.
- Length	Indicates only three frequencies: (281, 283, 285).
- Contents	

HANDOVER COMMAND

As default message contents, except:	
Cell Description	
- Network Colour Code	3
- Base Station Colour Code	0
- BCCH Carrier Number	274
Channel Description	
- Channel Type	TCH/H + ACCHs
- TDMA offset	Chosen arbitrarily.
- Timeslot number	Chosen arbitrarily but not zero.
- Training Sequence Code	Chosen arbitrarily.
- Hopping	RF hopping channel.
- MAIO	Chosen arbitrarily from the set (0, 1 to N-1), where N is the number of frequencies encoded in the Mobile Allocation.
- HSN	Chosen arbitrarily from the set (1, 2.. 63).
Synchronization Indication	
- Report Observed Time Difference	Shall not be included.
- Synchronization Indication	"Non synchronized".
- Normal Cell Indication	Ignore out of range timing advance.
Cell Channel Description	use Range 128 to encode: (274, 279, 281, 283, 285, 287, 289, 291) only.
Mobile Allocation after time	indicates channel (281, 283, 285) only.
Channel Mode IE	speech (full rate version 1 or half rate version 1).

Step 17: "x" = 750.

GSM 480:

IMMEDIATE ASSIGNMENT

Information Element	value/remark
As default message contents except: L2 pseudo length	14 octets (11 + contents of the MA).
Channel Description	SDCCH/8
- Channel Type	As default message contents.
- TDMA offset	Arbitrary value, but not zero.
- Timeslot number	Chosen arbitrarily.
- Training Sequence Code	RF hopping channel.
- Hopping	Chosen arbitrarily from the set (0, 1 to N-1), where N is the number of frequencies encoded in the Mobile Allocation.
- MAIO	Zero (this gives cyclic hopping).
- HSN	
Mobile Allocation	3 octets.
- Length	Indicates only three frequencies: (328, 330, 332).
- Contents	

HANDOVER COMMAND

As default message contents, except:	
Cell Description	
- Network Colour Code	3
- Base Station Colour Code	0
- BCCH Carrier Number	321
Channel Description	
- Channel Type	TCH/H + ACCHs
- TDMA offset	Chosen arbitrarily.
- Timeslot number	Chosen arbitrarily but not zero.
- Training Sequence Code	Chosen arbitrarily.
- Hopping	RF hopping channel.
- MAIO	Chosen arbitrarily from the set (0, 1 to N-1), where N is the number of frequencies encoded in the Mobile Allocation.
- HSN	Chosen arbitrarily from the set (1, 2.. 63).
Synchronization Indication	
- Report Observed Time Difference	Shall not be included.
- Synchronization Indication	"Non synchronized".
- Normal Cell Indication	Ignore out of range timing advance.
Cell Channel Description	use Range 128 to encode: (321, 326, 328, 330, 332, 334, 336, 338) only.
Mobile Allocation after time	indicates channel (328, 330, 332) only.
Channel Mode IE	speech (full rate version 1 or half rate version 1).

Step 17: "x" = 750.

GSM 900:

IMMEDIATE ASSIGNMENT

Information Element	value/remark
As default message contents except: L2 pseudo length	14 octets (11 + contents of the MA).
Channel Description	SDCCH/8
- Channel Type	As default message contents.
- TDMA offset	Arbitrary value, but not zero.
- Timeslot number	Chosen arbitrarily.
- Training Sequence Code	RF hopping channel.
- Hopping	Chosen arbitrarily from the set (0, 1 to N-1), where N is the number of frequencies encoded in the Mobile Allocation.
- MAIO	Zero (this gives cyclic hopping).
- HSN	
Mobile Allocation	3 octets.
- Length	Indicates only three frequencies: (73, 74, 75).
- Contents	

HANDOVER COMMAND

As default message contents, except:	
Cell Description	
- Network Colour Code	3
- Base Station Colour Code	0
- BCCH Carrier Number	40
Channel Description	
- Channel Type	TCH/H + ACCHs
- TDMA offset	Chosen arbitrarily.
- Timeslot number	Chosen arbitrarily but not zero.
- Training Sequence Code	Chosen arbitrarily.
- Hopping	RF hopping channel.
- MAIO	Chosen arbitrarily from the set (0, 1 to N-1), where N is the number of frequencies encoded in the Mobile Allocation.
- HSN	Chosen arbitrarily from the set (1, 2.. 63).
Synchronization Indication	
- Report Observed Time Difference	Shall not be included.
- Synchronization Indication	"Non synchronized".
- Normal Cell Indication	Ignore out of range timing advance.
Cell Channel Description	uses bit map 0 to encode: (40, 66, 73, 74, 75, 76, 108, 114) only.
Mobile Allocation after time	indicates channel (73, 74, 75) only.
Channel Mode IE	speech (full rate version 1 or half rate version 1).

Step 17: "x" = 750.

DCS 1 800:

IMMEDIATE ASSIGNMENT

Information Element	value/remark
As default message contents except: Channel Description - Channel Type - TDMA offset - Timeslot number - Training Sequence Code - Hopping - MAIO - HSN Mobile Allocation	Channel Description. SDCCH/8 As default message contents. zero. Chosen arbitrarily. RF hopping channel. Chosen arbitrarily from the set (0, 1 to N-1), where N is the number of frequencies encoded in the Mobile Allocation. Zero (this gives cyclic hopping). Indicates all of the CA of cell A except for the following 2 frequencies: (747 and 767).

HANDOVER COMMAND

Information Element	value/remarks
As default message contents, except: Cell Description - Network Colour Code - Base Station Colour Code - BCCH Carrier Number Channel Description - Channel Type - TDMA offset - Timeslot number - Training Sequence Code - Hopping - MAIO - HSN Synchronization Indication - Report Observed Time Difference - Synchronization Indication - Normal Cell Indication Cell Channel Description Mobile Allocation after time Mode of First Channel	3 0 764 TCH/H + ACCHs Chosen arbitrarily. Chosen arbitrarily but not zero. Chosen arbitrarily. RF hopping channel. Chosen arbitrarily from the set (0, 1 to N-1), where N is the number of frequencies encoded in the Mobile Allocation. Chosen arbitrarily from the set (1, 2.. 63). Shall not be included. "Non synchronized". Ignore out of range timing advance. Use Range 512 to encode the following frequencies: (761, 764, 771, 779, 782, 791, 798, 829, 832). Indicates channel (791, 798, 829) only. Speech (full rate version 1 or half rate version 1).

Step 17: "x" = 750.

Specific Message Contents For Mobiles not Supporting Speech

The message contents shall be the same for the declared type of Mobile Station (GSM 450 or GSM 480 or P-GSM 900 or DCS 1 800 supporting speech, except for:

For M = 1 (TCH/F):

HANDOVER COMMAND

Information Element	value/remarks
Mode of first channel	Arbitrary from those supported (12, 6, 3.6 kbps).

For M = 2 (TCH/H):

HANDOVER COMMAND

Information Element	value/remarks
Mode of first channel	Arbitrary from those supported (6, 3.6 kbps).

26.9.8 Directed Retry / Mobile Terminated Call

This test is applicable to all MS which support at least one MT circuit switched basic service.

26.9.8.1 Conformance requirements

The MS shall correctly apply the Directed Retry procedure from SDCCH/8 (with frequency hopping) or SDCCH/4 to TCH/F or TCH/H with or without frequency hopping in the non-synchronized case during call establishment. The call control entity of the Mobile Station in the "call delivered" state shall, if the MS supports immediate connect, continue the call establishment by through-connecting the traffic channel in both directions, or if the MS does not support immediate connect, send an ALERTING message. The MS indicates acceptance of a MT call by sending CONNECT.

For speech calls the mobile station shall attach the user connection at latest when sending the CONNECT message, except if there is no compatible radio resource available at this time. In this case the attachment shall be delayed until such a resource becomes available.

For Data Calls the mobile station shall attach the user connection when receiving the CONNECT ACKNOWLEDGE message from the network.

References

GSM 04.08, sections 3.4.4, 5.2.2.5, 5.2.2.6, 5.2.2.9 and 9.1.15.

GSM 04.13, section 5.2.6.2.

26.9.8.2 Test purpose

To test that when the MS is ordered to perform a non-synchronized handover after the CALL CONFIRM message, it continuously sends access bursts on the main DCCH until it receives a PHYSICAL INFORMATION message from the SS. To test that the MS correctly takes the values of the Timing Advance information element in the PHYSICAL INFORMATION message into account. To test that the MS activates the new channel correctly and transmits the HANDOVER COMPLETE message without undue delay. To test that the call control entity of the Mobile Station in the "call delivered" state, if the MS supports immediate connect, continues the call establishment by through-connecting the traffic channel in both directions, or if the MS does not support immediate connect, sends an ALERTING message. To test that the MS indicates acceptance of a MT call by sending CONNECT.

To test that for speech calls the mobile station attaches the user connection at latest when sending the CONNECT message, except if there is no compatible radio resource available at this time. To test that in this case the attachment is delayed until such a resource becomes available.

To test that for Data Calls the mobile station attaches the user connection when receiving the CONNECT ACKNOWLEDGE message from the network.

26.9.8.3 Method of test

Initial Conditions

System Simulator:

2 cells A and B with same LAI, default parameters, except:

GSM 450:

Cell A has:

BCCH ARFCN = 263.

Cell Allocation = (259, 261, 263, 265, 267, 269, 271, 273, 275, 277, 279, 281, 283, 285, 287, 289, 291).

PLMN colour code, NCC = as defaults.

BS colour code, BCC = as defaults.

PLMN_PERM = 00001010.

Cell B has:

BCCH ARFCN = 274

Cell Allocation = (260, 262, 264, 266, 268, 270, 272, 274, 276, 279, 281, 283, 285, 287, 289, 291).

PLMN colour code, NCC = 3.

BS colour code, BCC = 0.

Both cells send SYSTEM INFORMATION TYPE 1 messages containing the complete Cell Allocation of the cell, using range 128 format.

The timebase of Cells A and B shall be such that the edges of their timeslots are not coincident at the antenna connector.

For execution counter M = 1 a combined CCH/SDCCH is used.

For execution counter M = 2 a non-combined SDCCH is used.

GSM 480:

Cell A has:

BCCH ARFCN = 310.

Cell Allocation = (306, 308, 310, 312, 314, 316, 318, 320, 322, 324, 326, 328, 330, 332, 334, 336, 338).

PLMN colour code, NCC = as defaults.

BS colour code, BCC = as defaults.

PLMN_PERM = 00001010.

Cell B has:

BCCH ARFCN = 321.

Cell Allocation = (307, 309, 311, 313, 315, 317, 319, 321, 323, 326, 328, 330, 332, 334, 336, 338).

PLMN colour code, NCC = 3.

BS colour code, BCC = 0.

Both cells send SYSTEM INFORMATION TYPE 1 messages containing the complete Cell Allocation of the cell, using range 128 format.

The timebase of Cells A and B shall be such that the edges of their timeslots are not coincident at the antenna connector.

For execution counter M = 1 a combined CCH/SDCCH is used.

For execution counter M = 2 a non-combined SDCCH is used.

GSM 900:

Cell A has:

BCCH ARFCN = 20.

Cell Allocation = (10, 17, 20, 26, 34, 42, 45, 46, 52, 59, 66, 73, 74, 75, 76, 108, 114).

PLMN colour code, NCC = as defaults.

BS colour code, BCC = as defaults.

PLMN_PERM = 00001010.

Cell B has:

BCCH ARFCN = 40.

Cell Allocation = (14, 18, 22, 24, 30, 31, 38, 40, 60, 66, 73, 74, 75, 76, 108, 114).

PLMN colour code, NCC = 3.

BS colour code, BCC = 0.

Both cells send SYSTEM INFORMATION TYPE 1 messages containing the complete Cell Allocation of the cell, using bit map 0 format.

The timebase of Cells A and B shall be such that the edges of their timeslots are not coincident at the antenna connector.

For execution counter M = 1 a combined CCH/SDCCH is used.

For execution counter M = 2 a non-combined SDCCH is used.

DCS 1 800:

Cell A has:

BCCH ARFCN = 747.

Cell Allocation = (734, 741, 747, 754, 759, 762, 766, 767, 773, 775, 779, 782, 791, 798, 829, 832, 844).

PLMN colour code, NCC = as defaults.

BS colour code, BCC = as defaults.

PLMN_PERM = 00001010.

Cell B has:

BCCH ARFCN = 764.

Cell Allocation = (739, 743, 746, 749, 756, 758, 761, 764, 771, 779, 782, 791, 798, 829, 832, 844).

PLMN colour code, NCC = 3.

BS colour code, BCC = 0.

Both cells send SYSTEM INFORMATION TYPE 1 messages containing the complete Cell Allocation of the cell, using Range 512 format.

The timebase of Cells A and B shall be such that the edges of their timeslots are not coincident at the antenna connector.

For execution counter M = 1 a combined CCH/SDCCH is used.

For execution counter M = 2 a non combined SDCCH is used.

Mobile Station:

The MS is in the "idle, updated" state, with a TMSI allocated and camped on cell A.

Related PICS/PIXIT Statements

Supported rate(s) of TCH: TCH/F and/or TCH/H

Support for MT calls.

Supported teleservices.

Way to indicate alerting (only applicable if the MS supports the feature).

Way to make the MS accept an incoming call after alerting (possibly dependent on teleservice and configuration).

Immediate connect supported (Y/N).

Type of MS (GSM 450 or GSM 480 or P-GSM 900 or EGSM or DCS 1 800).

Foreseen Final State of the MS

"Idle, updated" with TMSI allocated and camped on cell B.

Test Procedure

This procedure is repeated for execution counter $M = 1..2$.

A teleservice is selected that is supported by the MS; if the MS supports speech, the selected teleservice is speech. If necessary, the MS is configured for that teleservice.

The MS is paged on Cell A. The MS responds to the PAGING REQUEST message and establishes a mobile terminated call on Cell A. If the MS supports immediate connect, it continues the call establishment by through-connecting the traffic channel in both directions, or if the MS does not support immediate connect, it sends an ALERTING message. The MS indicates acceptance of a MT call by sending CONNECT.

After the MS has sent the CALL CONFIRMED message (if the MS supports immediate connect then the MS sends the CONNECT message after the CALL CONFIRMED message on the old channel) the SS sends a HANDOVER COMMAND message, ordering the MS to switch to cell B. The MS shall then begin to send access bursts on the new DCCH to cell B. The SS observes the access bursts and after receiving n (n being arbitrarily chosen between values according to table 26.6-2 of section 26.6.5) access bursts, the SS sends one PHYSICAL INFORMATION message with an arbitrarily chosen Timing Advance. The MS shall activate the channel in sending and receiving mode. The MS shall establish a signalling link. The MS shall be ready to transmit a HANDOVER COMPLETE message before x ms after the end of the PHYSICAL INFORMATION message, but not before a UA frame has been sent by the SS. After the successful handover procedure the MS sends the ALERTING message (if the MS runs the immediate connect procedure then the MS does not send an ALERTING message). The correct alerting indication shall be given to the user (only applicable if the MS supports the feature or if the MS is not using the immediate connect procedure). After the MS sent the CONNECT message the appropriate bearer channel shall be through connected in both directions. The SS sends then the CONNECT ACKNOWLEDGE message as the response on the CONNECT message. Having reached the active state, the call is cleared by the SS.

The term "ready to transmit" is defined in GSM 04.13. The value of " x " depends upon the target channel and is specified in the specific message contents section.

Maximum Duration of Test

2 minutes, including 1 minute for any necessary operator actions.

Expected Sequence

The sequence is performed for execution counter M = 1..2 (unless a particular TCH is not supported).

Step	Direction	Message	Comments
1	SS -> MS	PAGING REQUEST TYPE 1	Sent on the correct paging subchannel on cell A. See specific message contents. Message is contained in SABM. SRES specifies correct value. SS starts deciphering after sending the message. Shall be sent enciphered. All following messages shall be sent enciphered. SS starts ciphering. If the MS supports immediate connect then branch A applies. If the MS does not support immediate connect then branch B applies
2	MS -> SS	CHANNEL REQUEST	
3	SS -> MS	IMMEDIATE ASSIGNMENT	
4	MS -> SS	PAGING RESPONSE	
5	SS -> MS	AUTHENTICATION REQUEST	
6	MS -> SS	AUTHENTICATION RESPONSE	
7	SS -> MS	CIPHERING MODE COMMAND	
8	MS -> SS	CIPHERING MODE COMPLETE	
9	SS		
10	SS -> MS	SETUP	
11	MS -> SS	CALL CONFIRMED	
A12	MS -> SS	CONNECT	sent on the old channel See specific message contents. Repeated on every burst of the uplink main DCCH until reception of PHYSICAL INFORMATION. Handover Reference as included in the HANDOVER COMMAND. If the HANDOVER COMMAND includes a starting time IE then the first HANDOVER ACCESS message shall be transmitted in the indicated frame (unless the indicated frame is not used by that channel, in which case the next frame used by that channel shall be used). Sent after reception of n HANDOVER ACCESS message. Timing Advance is arbitrarily chosen. Sent without information field.
A13	SS -> MS	HANDOVER COMMAND	
A14	MS -> SS	HANDOVER ACCESS	
A15	SS -> MS	PHYSICAL INFORMATION	
A16	MS -> SS	SABM	
A17	SS -> MS	UA	
A18	MS -> SS	HANDOVER COMPLETE	This message shall be ready to be transmitted before "x" ms after the completion of step A15.
B12	SS -> MS	HANDOVER COMMAND	See specific message contents. Repeated on every burst of the uplink main DCCH until reception of PHYSICAL INFORMATION. Handover Reference as included in the HANDOVER COMMAND. If the HANDOVER COMMAND includes a starting time IE then the first HANDOVER ACCESS message shall be transmitted in the indicated frame (unless the indicated frame is not used by that channel, in which case the next frame used by that channel shall be used). Sent after reception of n HANDOVER ACCESS message. Timing Advance is arbitrarily chosen. Sent without information field. This message shall be ready to be transmitted before "x" ms after the completion of step B14. Gives an alerting indication as defined in a PICS/PIXIT statement is given by the MS The MS is made to accept the call in the way described in a PICS/PIXIT statement
B13	MS -> SS	HANDOVER ACCESS	
B14	SS -> MS	PHYSICAL INFORMATION	
B15	MS -> SS	SABM	
B16	SS -> MS	UA	
B17	MS -> SS	HANDOVER COMPLETE	
B18	MS -> SS	ALERTING	
B19	MS		
B20	MS		
B21	MS -> SS	CONNECT	
22	MS		If the call is a speech call, the TCH shall be through connected in both directions.
23	SS -> MS	CONNECT ACKNOWLEDGE	If the call is a data call, the TCH shall be through connected in both directions.
24	MS		
25	SS -> MS	DISCONNECT	
26	MS -> SS	RELEASE	
27	SS -> MS	RELEASE COMPLETE	
28	SS -> MS	CHANNEL RELEASE	

Specific Message Contents For Mobiles Supporting Speech

M = 1:**For GSM 450:**

IMMEDIATE ASSIGNMENT

Information Element	value/remark
As default message contents.	

HANDOVER COMMAND

Information Element	value/remarks
As default message contents, except:	
Cell Description	
- Network Colour Code	3
- Base Station Colour Code	0
- BCCH Carrier Number	274
Channel Description	
- Channel Type	TCH/F + ACCHs
- Timeslot number	Zero.
- Training Sequence Code	Chosen arbitrarily.
- Hopping	Single RF Channel.
- ARFCN	Chosen arbitrarily from the Cell Allocation of Cell B, but not the BCCH carrier of Cell B.
Synchronization Indication IE not included.	
Mode of First Channel	Speech (full rate version 1 or half rate version 1).

Step A18 / B17: "x" = 500.

For GSM 480:

IMMEDIATE ASSIGNMENT

Information Element	value/remark
As default message contents.	

HANDOVER COMMAND

Information Element	value/remarks
As default message contents, except:	
Cell Description	
- Network Colour Code	3
- Base Station Colour Code	0
- BCCH Carrier Number	321
Channel Description	
- Channel Type	TCH/F + ACCHs
- Timeslot number	Zero.
- Training Sequence Code	Chosen arbitrarily.
- Hopping	Single RF Channel.
- ARFCN	Chosen arbitrarily from the Cell Allocation of Cell B, but not the BCCH carrier of Cell B.
Synchronization Indication IE not included.	
Mode of First Channel	Speech (full rate version 1 or half rate version 1).

Step A18 / B17: "x" = 500.

For GSM 900:

IMMEDIATE ASSIGNMENT

Information Element	value/remark
As default message contents.	

HANDOVER COMMAND

Information Element	value/remarks
As default message contents, except:	
Cell Description	
- Network Colour Code	3
- Base Station Colour Code	0
- BCCH Carrier Number	40
Channel Description	
- Channel Type	TCH/F + ACCHs
- Timeslot number	Zero.
- Training Sequence Code	Chosen arbitrarily.
- Hopping	Single RF Channel.
- ARFCN	Chosen arbitrarily from the Cell Allocation of Cell B, but not the BCCH carrier of Cell B.
Synchronization Indication IE not included.	
Mode of First Channel	Speech (full rate version 1 or half rate version 1).

Step A18 / B17: "x" = 500.

DCS 1 800:

IMMEDIATE ASSIGNMENT

Information Element	value/remark
As default message contents.	

HANDOVER COMMAND

Information Element	value/remarks
As default message contents, except:	
Cell Description	
- Network Colour Code	3
- Base Station Colour Code	0
- BCCH Carrier Number	764
Channel Description	
- Channel Type	TCH/F + ACCHs
- Timeslot number	Zero.
- Training Sequence Code	Chosen arbitrarily.
- Hopping	Single RF Channel.
- ARFCN	Chosen arbitrarily from the Cell Allocation of Cell B, but not the BCCH carrier of Cell B.
Synchronization Indication IE not included.	
Mode of First Channel	Speech (full rate version 1 or half rate version 1).

Step A18 / B17: "x" = 500.

M = 2:

GSM 450:

IMMEDIATE ASSIGNMENT

Information Element	value/remark
As default message contents except:	
L2 pseudo length	14 octets (11 + contents of the MA).
Channel Description	
- Channel Type	SDCCH/8
- TDMA offset	As default message contents.
- Timeslot number	Arbitrary value, but not zero.
- Training Sequence Code	Chosen arbitrarily.
- Hopping	RF hopping channel.
- MAIO	Chosen arbitrarily from the set (0, 1 to N-1), where N is the number of frequencies encoded in the Mobile Allocation.
- HSN	Chosen arbitrarily from the set (1,2,..63).
Mobile Allocation	
- Length	3 octets.
- Contents	Indicates only three frequencies: (281, 283, 285).

HANDOVER COMMAND

Information Element	value/remarks
As default message contents, except:	
Cell Description	
- Network Colour Code	3
- Base Station Colour Code	0
- BCCH Carrier Number	274
Channel Description	TCH/H + ACCHs
- Channel Type	Chosen arbitrarily.
- TDMA offset	Chosen arbitrarily, but not Zero.
- Timeslot number	Chosen arbitrarily.
- Training Sequence Code	Chosen arbitrarily.
- Hopping	RF hopping channel.
- MAIO	Chosen arbitrarily from the set (0, 1 to N-1), where N is the number of frequencies encoded in the Frequency List IE.
- HSN	Zero (this gives cyclic hopping).
Frequency List after time	
- Frequency List	use Range 128 to encode the following 12 frequencies: (260, 262, 264, 266, 276, 279, 281, 283, 285, 287, 289, 291).
Synchronization Indication	Shall not be included.
- Report Observed Time Difference	"Non synchronized".
- Synchronization Indication	Ignore out of range timing advance.
- Normal Cell Indication	Speech (full rate version 1 or half rate version 1).
Mode of First Channel	Indicates the frame number of cell B. that will occur approximately 1,1 seconds (238 frames have elapsed) after the HANDOVER COMMAND is sent by cell A.
Starting Time	

Step A18 / B17: "x" = 750.

GSM 480:

IMMEDIATE ASSIGNMENT

Information Element	value/remark
As default message contents except:	
L2 pseudo length	14 octets (11 + contents of the MA).
Channel Description	SDCCH/8
- Channel Type	As default message contents.
- TDMA offset	Arbitrary value, but not zero.
- Timeslot number	Chosen arbitrarily.
- Training Sequence Code	RF hopping channel.
- Hopping	Chosen arbitrarily from the set (0, 1 to N-1), where N is the number of frequencies encoded in the Mobile Allocation.
- MAIO	Chosen arbitrarily from the set (1,2,..63).
- HSN	
Mobile Allocation	3 octets.
- Length	Indicates only three frequencies: (328, 330, 332).
- Contents	

HANDOVER COMMAND

Information Element	value/remarks
As default message contents, except:	
Cell Description	
- Network Colour Code	3
- Base Station Colour Code	0
- BCCH Carrier Number	321
Channel Description	
- Channel Type	TCH/H + ACCHs
- TDMA offset	Chosen arbitrarily.
- Timeslot number	Chosen arbitrarily, but not Zero.
- Training Sequence Code	Chosen arbitrarily.
- Hopping	RF hopping channel.
- MAIO	Chosen arbitrarily from the set (0, 1 to N-1), where N is the number of frequencies encoded in the Frequency List IE.
- HSN	Zero (this gives cyclic hopping).
Frequency List after time	
- Frequency List	use Range 128 to encode the following 12 frequencies: (307, 309, 311, 313, 323, 326, 328, 330, 332, 334, 336, 338).
Synchronization Indication	
- Report Observed Time Difference	Shall not be included.
- Synchronization Indication	"Non synchronized".
- Normal Cell Indication	Ignore out of range timing advance.
Mode of First Channel	Speech (full rate version 1 or half rate version 1).
Starting Time	Indicates the frame number of cell B. that will occur approximately 1,1 seconds (238 frames have elapsed) after the HANDOVER COMMAND is sent by cell A.

Step A18 / B17: "x" = 750.

GSM 900:

IMMEDIATE ASSIGNMENT

Information Element	value/remark
As default message contents except:	
L2 pseudo length	14 octets (11 + contents of the MA).
Channel Description	
- Channel Type	SDCCH/8
- TDMA offset	As default message contents.
- Timeslot number	Arbitrary value, but not zero.
- Training Sequence Code	Chosen arbitrarily.
- Hopping	RF hopping channel.
- MAIO	Chosen arbitrarily from the set (0, 1 to N-1), where N is the number of frequencies encoded in the Mobile Allocation.
- HSN	Chosen arbitrarily from the set (1,2,..63).
Mobile Allocation	
- Length	3 octets.
- Contents	Indicates only three frequencies: (73, 74, 75).

HANDOVER COMMAND

Information Element	value/remarks
As default message contents, except:	
Cell Description	
- Network Colour Code	3
- Base Station Colour Code	0
- BCCH Carrier Number	40
Channel Description	
- Channel Type	TCH/H + ACCHs
- TDMA offset	Chosen arbitrarily.
- Timeslot number	Chosen arbitrarily, but not Zero.
- Training Sequence Code	Chosen arbitrarily.
- Hopping	RF hopping channel.
- MAIO	Chosen arbitrarily from the set (0, 1 to N-1), where N is the number of frequencies encoded in the Frequency List IE.
- HSN	Zero (this gives cyclic hopping).
Frequency List after time	
- Frequency List	use bit map 0 to allocates the following 12 frequencies: (14, 18, 22, 24, 60, 66, 73, 74, 75, 76,108, 114).
Synchronization Indication	
- Report Observed Time Difference	Shall not be included.
- Synchronization Indication	"Non synchronized".
- Normal Cell Indication	Ignore out of range timing advance.
Mode of First Channel	Speech (full rate version 1 or half rate version 1).
Starting Time	Indicates the frame number of cell B. that will occur approximately 1,1 seconds (238 frames have elapsed) after the HANDOVER COMMAND is sent by cell A.

Step A18 / B17: "x" = 750.

DCS 1 800:

IMMEDIATE ASSIGNMENT

Information Element	value/remark
As default message contents except:	
L2 pseudo length	14 octets (11 + contents of the MA).
Channel Description	Channel Description.
- Channel Type	SDCCH/8
- TDMA offset	As default message contents.
- Timeslot number	Arbitrary value but not zero.
- Training Sequence Code	Chosen arbitrarily.
- Hopping	RF hopping channel.
- MAIO	Chosen arbitrarily from the set (0, 1 to N-1), where N is the number of frequencies encoded in the Mobile Allocation.
- HSN	Chosen arbitrarily from the set (1,2,..63).
Mobile Allocation	
- Length	3octets.
- Contents	Indicates only three frequencies: (773, 775, 779).

HANDOVER COMMAND

Information Element	value/remarks
As default message contents, except:	
Cell Description	
- Network Colour Code	3
- Base Station Colour Code	0
- BCCH Carrier Number	764
Channel Description	
- Channel Type	TCH/H + ACCHs
- TDMA offset	Chosen arbitrarily.
- Timeslot number	Chosen arbitrarily but not Zero.
- Training Sequence Code	Chosen arbitrarily.
- Hopping	RF hopping channel.
- MAIO	Chosen arbitrarily from the set (0, 1 to N-1), where N is the number of frequencies encoded in the Frequency List IE.
- HSN	Zero (this gives cyclic hopping).
Frequency List after time	
- Frequency List	Use Range 1024 to allocate the following 12 frequencies: (749, 758, 761, 764, 771, 779, 782, 791, 798, 829, 832, 844).
Synchronization Indication	
- Report Observed Time Difference	Shall not be included.
- Synchronization Indication	"Non synchronized".
- Normal Cell Indication	Ignore out of range timing advance.
Mode of First Channel	Speech (full rate version 1 or half rate version 1).
Starting Time	Indicates the frame number of cell B that will occur approximately 1.1 seconds (238 frames have elapsed) after the HANDOVER COMMAND is sent by cell A..

Step A18 / B17: "x" = 750.

Specific Message Contents For Mobiles not Supporting Speech

The message contents shall be the same for the declared type of Mobile Station (GSM 450 or GSM 480 or P-GSM 900 or DCS 1 800 supporting speech, except for:

For M = 1 (TCH/F):

HANDOVER COMMAND

Information Element	value/remarks
Mode of first channel	Arbitrary from those supported (12, 6, 3.6 kbps).

For M = 2 (TCH/H):

HANDOVER COMMAND

Information Element	value/remarks
Mode of first channel	Arbitrary from those supported (6, 3.6 kbps).

26.9.9 Default contents of messages

ALERTING (mobile station to network direction)

Information element	Value/remark
Facility	Not checked
User-user	Not checked
SS version	Not checked

ALERTING (network to mobile station direction)

Information element	Value/remark
Facility	Omitted
Progress indicator	Omitted
User-user	Omitted

ASSIGNMENT COMMAND

Information element	Value/remark
Description of the first channel	describes non-hopping Bm+ACCHs or Lm+ACCHs as appropriate for the test
Power Command	As in section 26.1.1
Frequency list	Omitted
Cell channel description	Omitted
Mode of the first channel	appropriate for one bearer capability chosen for the test
Description of the second channel	Omitted
Mode of the second channel	Omitted
Mobile allocation	Omitted
Starting time	Omitted
Cipher mode setting	Omitted

ASSIGNMENT COMPLETE

Information element	Value/remark
RR cause	normal event

AUTHENTICATION REQUEST

Information element	Value/remark
Ciphering key sequence number	Arbitrary
Spare half octet	(spare bits)
Authentication parameter RAND	Arbitrary

AUTHENTICATION RESPONSE

Information element	Value/remark
Authentication parameter SRES	Correct for given SRES

CALL CONFIRMED

Information element	Value/remark
Repeat indicator Bearer capability 1	Omitted The <i>bearer capability 1</i> information element shall be included if and only if at least one of the following cases holds: <ul style="list-style-type: none"> - the mobile station wishes another bearer capability than that given by the <i>bearer capability 1</i> information element of the incoming SETUP message; - the <i>bearer capability 1</i> information element received in the SETUP message is accepted and the "radio channel requirement" of the Mobile Station is other than "full rate support only mobile station". - the <i>bearer capability 1</i> information element received in the SETUP message indicates speech and is accepted and the Mobile Station supports other speech versions than GSM full rate version 1/ half rate version 1.
Bearer capability 2	Omitted
Cause	Omitted
CC Capabilities	may be present

CALL PROCEEDING

Information element	Value/remark
Repeat Indicator Bearer Capability 1	Omitted Omitted if the SETUP message did not specify in the bearer capability 1 IE a connection element value "both, transparent preferred" or "both, non-transparent preferred". Otherwise included; in that case the connection element specifies the value that is appropriate for the selected teleservice (either value "transparent" or value "non transparent (RLP)"), all other parameters are same as in the bearer capability 1 IE of the received SETUP message.
Bearer Capability 2	Omitted
Facility	Omitted
Progress indicator	Omitted

CHANNEL RELEASE

Information element	Value/remark
RR cause	Normal event

CHANNEL REQUEST

Information element	Value/remark
Establishment cause	Answer to paging (100)
Random reference	Arbitrary value of 5 bits length

CIPHERING MODE COMMAND

Information element	Value/remark
Cipher mode setting	indicates a supported algorithm
algorithm identifier	
SC	Start ciphering
Cipher response	IMEI must not be included
CR	

CIPHERING MODE COMPLETE

Information element	Value/remark
Mobile equipment identity	Omitted

CM SERVICE ACCEPT

Information element	Value/remark
none but message head	

CM SERVICE REQUEST

Information element	Value/remark
CM service type	Mobile originating call establishment or packet mode connection establishment
Ciphering key sequence number	CKSN of the MS
Mobile station classmark 2	as given by PICS.
Mobile identity	TMSI of MS

CONNECT (network to mobile station direction)

Information element	Value/remark
Facility	Omitted
Progress indicator	Omitted
Connected number	Omitted
Connected subaddress	Omitted
User-user	Omitted

CONNECT (mobile station to network direction)

Information element	Value/remark
Facility	Not checked
Connected subaddress	Not checked
User-user	Not checked
SS version	Not checked

CONNECT ACKNOWLEDGE

Information element	Value/remark
none but message head	

DISCONNECT (network to mobile station direction)

Information element	Value/remark
Cause	
Coding standard	GSM
Location	User
Cause value	Normal clearing
Facility	Omitted
Progress indicator	Omitted
User-user	Omitted

DISCONNECT (mobile station to network direction)

Information element	Value/remark
Cause	
Coding standard	GSM
Location	User
Cause value	Normal clearing
Facility	Not checked
User-user	Not checked
SS version	Not checked

EMERGENCY SETUP

Information element	Value/remark
Bearer Capability	May be present or omitted. If present, it shall indicate speech, the appropriate speech version(s) and have the appropriate value of radio channel requirement field

IMMEDIATE ASSIGNMENT

Information element	Value/remark
Page mode	Normal paging
Channel description	describes a valid SDCCH+SACCH in non-hopping mode
Request reference	
Random access information	As received from MS
N51, N32, N26	Corresponding to frame number of the CHANNEL REQUEST
Timing advance	Arbitrary
Mobile allocation	Empty (L=0)
Starting time	Omitted

PAGING REQUEST TYPE 1

Information element	Value/remark
L2 pseudo length	L2 pseudo length of the message
Page Mode	Normal Paging
Channels needed for Mobiles 1 and 2	
channel (first)	any channel
channel (second)	any channel
Mobile identity 1	TMSI of MS under test
Mobile identity 2	Omitted
P1 rest octets	(spare octets)

PAGING RESPONSE

Information element	Value/remark
Ciphering key sequence number Spare half octet Mobile station classmark 2 Mobile identity	Value assigned to MS in the initial conditions (spare bits) as given by PICS specifies TMSI of MS

RELEASE (network to mobile station direction)

Information element	Value/remark
Cause Second cause Facility User-user	Omitted Omitted Omitted Omitted

RELEASE (mobile station to network direction)

Information element	Value/remark
Cause Second cause Facility User-user SS version	Not checked Not checked Not checked Not checked Not checked

RELEASE COMPLETE (network to mobile station direction)

Information element	Value/remark
Cause Facility User-user	Omitted Omitted Omitted

RELEASE COMPLETE (mobile station to network direction)

Information element	Value/remark
Cause Facility User-user SS version	Not checked Not checked Not checked Not checked

SETUP (MS to SS)

Information element	Value/remark
BC Repeat indicator	Omitted
Bearer capability 1	Appropriate for the teleservice selected for the test
Bearer capability 2	Omitted
Facility	Not checked
Calling party subaddress	Not checked
Called party BCD number	As entered
Called party subaddress	Omitted
LLC repeat indicator	Omitted
Low layer compatibility I	Appropriate for teleservice selected for the test
Low layer compatibility II	Omitted
HLC repeat indicator	Omitted
High layer compatibility i	Appropriate for teleservice selected for the test
High layer compatibility ii	Omitted
User-user	Not checked
SS version	Not checked
CLIR suppression	Not checked
CC Capabilities	may be present

SETUP (SS to MS)

Information element	Value/remark
BC repeat indicator	Omitted
Bearer capability 1	Appropriate for teleservice selected for the test
Bearer capability 2	Omitted
Facility	Omitted
Progress indicator	Omitted
Signal	Omitted
Calling party BCD number	Omitted
Calling party subaddress	Omitted
Called party BCD number	Omitted
Called party subaddress	Omitted
LLC repeat indicator	Omitted
Low layer compatibility I	Appropriate for teleservice selected for the test
Low layer compatibility II	Omitted
HLC repeat indicator	Omitted
High layer compatibility i	Appropriate for the teleservice selected for the test
High layer compatibility ii	Omitted
User-user	Omitted

26.10 E-GSM or R-GSM signalling

26.10.1 E-GSM or R-GSM signalling / general considerations

Section 26.10 only applies to E-GSM and R-GSM mobile stations. E-GSM signalling testing and R-GSM signalling testing in the section are mutually exclusive. An E-GSM MS needs E-GSM signalling tests while an R-GSM MS needs the R-GSM signalling tests. It is not necessary for an R-GSM MS to be tested under E-GSM test parameters. The details of frequencies used in different test cases are listed below.

Table 26.1: Frequencies used for E-GSM or R-GSM signalling tests

Test Case	Frequencies used in the test case	
	E-GSM testing	R-GSM testing
26.10.2.1	neighbour cell and serving cell : 0, 2, 26, 38, 990, 1003, 1005, 1020,	neighbour cell and serving cell : 0, 2, 26, 38, 960, 970, 990, 1020
26.10.2.2	single RF: 1015, hopping RF's: 0, 80, 1005, 1010	single RF: 972, hopping RF's: 0, 80, 958, 1010
26.10.2.3	k=1 hopping RF's c=1 : 1005, 1010, 1015 c=2 : 73, 74, 75, 76, 77 c=3 : 980, 981, 982, 983 c=4 : 30, 40, 1010, 1015 c=5 : 980, 991, 992, 993, 994, 1015 c=6 : 20, 40, 66 k=2 hopping RF's c=1 : 1005, 1010, 1015 c=2 : 73, 74, 75, 76, 77 c=3 : 980, 981, 982, 983 c=4 : 0, 30, 40, 1010, 1015 c=5 : 990, 991, 992, 993, 994 c=6 : 20, 40, 66	k=1 hopping RF's c=1 : 964, 969, 972 c=2 : 73, 76, 80, 85, 90 c=3 : 956, 959, 976, 980 c=4 : 30, 40, 969, 972, 990, 1020 c=5 : 956, 960, 963, 966, 969, 972 c=6 : 20, 40, 66 k=2 hopping RF's c=1 : 964, 969, 972 c=2 : 66, 73, 76, 79, 108 c=3 : 960, 963, 978, 990 c=4 : 0, 30, 40, 969, 972, 990, 1020 c=5 : 962, 965, 968, 972 c=6 : 20, 40, 66
26.10.2.4.1	Target cell BCCH: 40 k=1 hopping RF's c=1 : 1005, 1010, 1015 c=2 : 73, 74, 75, 76, 77 c=3 : 980, 981, 982, 983 c=4 : 30, 40, 1010, 1015 c=5 : 980, 991, 992, 993, 994, 1015 k=2 hopping RF's c=1 : 1005, 1010, 1015 c=2 : 73, 74, 75, 76, 77 c=3 : 980, 981, 982, 983 c=4 : 30, 40, 1010, 1015 c=5 : 980, 991, 992, 993, 994, 1015 c=6 : 20, 40, 66 k=3 hopping RF's c=1 : 1005, 1010, 1015 c=2 : 73, 74, 75, 76, 77 c=3 : 980, 981, 982, 983 c=4 : 30, 40, 1010, 1015 c=5 : 990, 991, 992, 993, 994 c=6 : 20, 40, 66	Target cell BCCH: 965 k=1 hopping RF's c=1 : 964, 969, 972 c=2 : 73, 76, 79, 86, 97 c=3 : 956, 960, 963, 970 c=4 : 30, 40, 969, 972, 990, 1020 c=5 : 956, 960, 964, 967, 970, 973 k=2 hopping RF's c=1 : 964, 969, 972 c=2 : 73, 76, 79, 86, 97 c=3 : 956, 960, 963, 970 c=4 : 30, 40, 969, 972, 990, 1020 c=5 : 956, 960, 964, 967, 970, 973 c=6 : 20, 40, 66 k=3 hopping RF's c=1 : 964, 969, 972 c=2 : 73, 76, 79, 108, 115 c=3 : 960, 964, 969, 972 c=4 : 30, 40, 969, 972, 990, 1020 c=5 : 960, 963, 966, 969, 972 c=6 : 20, 40, 66
26.10.2.4.2	Original cell BCCH: 20 Target cell BCCH: 40 hopping RF's : 1005, 1010, 1015	Original cell BCCH: 990 Target cell BCCH: 965 hopping RF's : 960, 970, 990
26.10.2.5	hopping RF's c=1 : 1005, 1010, 1015 c=2 : 73, 74, 75, 76, 77 c=3 : 980, 981, 982, 983 c=4 : 30, 40, 1010, 1015 c=5 : 990, 991, 992, 993, 994 c=6 : 30, 50, 70	hopping RF's c=1 : 964, 969, 972 c=2 : 73, 76, 79, 108, 114 c=3 : 960, 964, 968, 972 c=4 : 30, 40, 969, 972, 990, 1020 c=5 : 960, 964, 967, 970, 972 c=6 : 30, 50, 70
26.10.3.1	BCCH : 20 Immediate Assignment : 40 Assignment : 990	BCCH : 20 Immediate Assignment : 40 Assignment : 965
26.10.3.2	BCCH : 20 Immediate Assignment : 40 Assignment : 990	BCCH : 20 Immediate Assignment : 40 Assignment : 965

Conformance requirements of section 26 fully apply to any mobile station (P-GSM, E-GSM, R-GSM or DCS) in the whole supported band of the mobile station.

Besides, as an E-GSM or R-GSM mobile station shall support the P-GSM band, it shall pass successfully every test of section 26 under the described GSM 900 conditions.

The purpose of this extra section is to test the different procedures which may be impacted when some channel uses E-GSM or R-GSM frequency(ies).

26.10.2 E-GSM or R-GSM signalling / RR

26.10.2.1 E-GSM or R-GSM signalling / RR / Measurement

This test applies to E-GSM or R-GSM mobile stations.

Conformance requirements of section 26.6.3 fully apply to any mobile station (P-GSM, E-GSM, R-GSM or DCS) in the whole supported band of the mobile station.

Besides, as an E-GSM or R-GSM mobile station shall support the P-GSM band, it shall pass successfully every test of section 26.6.3 under the described GSM 900 conditions.

The purpose of this extra section is to test the reporting of measurements in the case where cells use E-GSM or R-GSM frequency(s). Several coding formats may be used by the network in the SYSTEM INFORMATION message.

26.10.2.1.1 Conformance requirements

The MS shall continuously send MEASUREMENT REPORT messages on every SACCH blocks and the measurement valid indication shall be set to valid (0) within the second block at the latest. After 20 seconds the values in the MEASUREMENT REPORT message shall contain measurement results for the 6 th strongest cells belonging to the set of cells indicated either in SI5 and SI5bis messages or in SI5 and SI5ter messages.

References

GSM 04.08 sections 3.4.1.2 and 9.1.39, GSM 05.08 section 8.4.

26.10.2.1.2 Test purpose

To test that, when the SS gives information about neighbouring cells indicated either in SI5 and SI5bis messages or in SI5 and SI5ter messages, the MS reports appropriate results.

26.10.2.1.3 Method of test

Initial Conditions

System Simulator:

8 cells with the following settings:

E-GSM:

Transmitter	Level	NCC	BCC	ARFCN	Cell Identity
Serving, S1	-60	1	3	002	0001H
Neighbour, N1	-85	1	5	990	0002H
Neighbour, N2	-80	1	7	1005	0003H
Neighbour, N3	-75	1	1	000	0004H
Neighbour, N4	-55	1	3	026	0005H
Neighbour, N5	-50	1	5	1020	0006H
Neighbour, N6	-45	1	7	038	0007H
Neighbour, N7	-40	1	1	1003	0008H

R-GSM:

Transmitter	Level	NCC	BCC	ARFCN	Cell Identity
Serving, S1	-60	1	3	002	0001H
Neighbour, N1	-85	1	5	990	0002H
Neighbour, N2	-80	1	7	970	0003H
Neighbour, N3	-75	1	1	000	0004H
Neighbour, N4	-55	1	3	026	0005H
Neighbour, N5	-50	1	5	1020	0006H
Neighbour, N6	-45	1	7	038	0007H
Neighbour, N7	-40	1	1	960	0008H

With the exception of the Cell Allocation, the rest of the parameters for all eight cells are the same as the default settings and default SYSTEM INFORMATION TYPE 1 to 4 message contents for cell A. The Cell Allocation for the serving cell is the same as the default setting for cell A. The Cell Allocations for the neighbour cells need have only one entry, consisting of the ARFCN of that cell's BCCH.

Mobile Station:

The MS is in the active state of a call (U10).

Related PICS/PIXIT Statements

Support E-GSM or R-GSM.

Support for state U10 of the Call Control protocol.

Foreseen Final State of the MS

Active state of a call (U10).

Test Procedure

The test is performed for execution counter, c=1 to 9

For c=1 to 6, the following procedure applies .

With the MS having a call in progress, the SS sends SYSTEM INFORMATION TYPE 5, 5bis & 6 on the SACCH. The MS shall send MEASUREMENT REPORTs back to the SS, and it shall be indicated in these that measurement results for the 6 strongest present carriers of the supported band have been obtained.

For c=7 to 9, the following procedure applies :

With the MS having a call in progress, the SS sends SYSTEM INFORMATION TYPE 5, 5ter & 6 on the SACCH. The MS shall send MEASUREMENT REPORTs back to the SS, and it shall be indicated in these that measurement results for the 6 strongest present carriers of the supported band have been obtained.

Maximum Duration of Test

8 minutes, including 1 minute for any necessary operator actions.

Expected Sequence

This sequence is performed for execution counter, c= 1 to 9.

Since SYSTEM INFORMATION TYPE 5, SYSTEM INFORMATION TYPE 6 and MEASUREMENT REPORT are sent continuously, a table is not applicable in this test. The interval between 2 successive Layer 2 frames containing MEASUREMENT REPORTs shall not exceed one Layer 2 frame.

Specific Message Contents

E-GSM:

SYSTEM INFORMATION TYPE 5:

Information Element	value/remark
Protocol Discriminator Message Type Neighbour Cells Description - EXT IND - BA-IND	RR management Sys Info 5. - EXT IND= 1, for c= 1 to 6: Information Element carries only a part of the BA. - EXT IND= 0, for c=7 to 9: Information Element carries the complete BA. 0 for c=1, use range 128 to encode the following frequencies: (26, 38) for c=2, use range 256 to encode the following frequencies (990, 1 003, 1 005) for c=3, use range 512 to encode the following frequencies (520, 990, 1 003, 1 005, 1 020) for c=4, use range 1 024 to encode the following frequencies (0, 26, 38, 990, 1 003, 1 005) for c=5, use variable Bitmap to encode the following frequencies (0, 26, 38) for c=6, use Bitmap 0 to encode the following frequencies (26) for c=7, use range 512 to encode the following frequencies : (520, 990, 1020) for c=8, use range 1024 to encode the following frequencies : (0, 26, 38, 990, 1005, 1020) for c=9, use range 256 to encode the following frequencies : (38)

SYSTEM INFORMATION TYPE 5bis:

Information Element	value/remark
Protocol Discriminator Message Type Neighbour Cells Description - EXT IND - BA-IND	RR management Sys Info 5bis. Information Element carries only a part of the BA. 0 for c=1, use range 512 to encode the following frequencies: (520, 990, 1 003, 1 005, 1 020) for c=2, use range 128 to encode the following frequencies (0, 26, 38) for c=3, use range 256 to encode the following frequencies (0, 26, 38) for c=4, use range 1 024 to encode the following frequencies (520, 1 000) for c=5, use range 128 to encode the following frequencies (884, 990, 1 003, 1 005) for c=6, use range 512 to encode the following frequencies (520, 990, 1 003)

SYSTEM INFORMATION TYPE 5ter:

Information Element	value/remark
Protocol Discriminator	RR management
Message Type	Sys Info 5ter.
Neighbour Cells Description	normal reporting of the six strongest cells, irrespective of the band used.
- multiband reporting	0
- BA-IND	for c=7, use range 1024 to encode the following frequencies (0,26,1003, 1005) for c=8, use variable bitmap to encode the following frequencies (1000,1003) for c=9,, use range 256 to encode the following frequencies (26, 1003, 1020)

SYSTEM INFORMATION TYPE 6:

Information Element	value/ remark
Protocol Discriminator	RR Management
Message Type	sys info 6
Cell Identity	default
LAI	default
Cell Options	
- Power Control Indicator	Power Control Indicator is set
- DTX Indicator	MS shall not use DTX
- Radio-Link-Time-out	default
PLMN permitted	only NCC 1 permitted

MEASUREMENT REPORT:

Information Element	value/remark
Protocol Discriminator	RR Management
Transaction Identifier	0000
Message Type	MEASUREMENT REPORT
Measurement Results	
BA-used	0
DTX-used	DTX was not used
RXLEV-FULL-SERVING-CELL	See note 1
RXLEV-SUB-SERVING-CELL	See note 1
MEAS-VALID	See note 3
RXQUAL-FULL-SERVING-CELL	See note 1
RXQUAL-SUB-SERVING-CELL	See note 1
NO-NCELL-M	n (see note 2)
RXLEV-NCELL-1	See note 1
BCCH-FREQ-NCELL-1	See note 2
BSIC-NCELL-1	Corresponds to that of BCCH-FREQ-NCELL-1
RXLEV-NCELL-2	See note 1
BCCH-FREQ-NCELL-2	See note 2
BSIC-NCELL-2	Corresponds to that of BCCH-FREQ-NCELL-2
RXLEV-NCELL-3	See note 1
BCCH-FREQ-NCELL-3	See note 2
BSIC-NCELL-3	Corresponds to that of BCCH-FREQ-NCELL-3
RXLEV-NCELL-4	See note 1
BCCH-FREQ-NCELL-4	See note 2
BSIC-NCELL-4	Corresponds to that of BCCH-FREQ-NCELL-4
RXLEV-NCELL-5	See note 1
BCCH-FREQ-NCELL-5	See note 2
BSIC-NCELL-5	Corresponds to that of BCCH-FREQ-NCELL-5
RXLEV-NCELL-6	See note 1
BCCH-FREQ-NCELL-6	See note 2
BSIC-NCELL-6	Corresponds to that of BCCH-FREQ-NCELL-6

NOTE 1: These actual values are not checked.

NOTE 2: ARFCN 2 is the serving cell carrier.

c=1 report on ARFCNs 26, 38, 990, 1 003, 1 005, 1 020, n=6

c=2 report on ARFCNs 26, 38, 990, 1 003, 1 005, 0, (1 020 stronger than 1 005 but not broadcasted in SYS INFO), n=6

c=3 report on ARFCNs 26, 38, 1 003, 1 005, 1 020, 0 (990 less strong, 520 DCS), n=6

c=4 report on ARFCNs 26, 38, 990, 1 003, 1 005, 0 (1 000 less strong, 520 DCS, 1 020 not broadcasted in SYS INFO), n=6

c=5 report on ARFCNs 26, 38, 990, 1 003, 1 005, 0 (884 DCS), n=6

c=6 report on ARFCNs 26, 990, 1 003, n=3

c=7 report on ARFCNs 26, 990, 1003, 1005, 1020, 0 (520 DCS), n=6

c=8 report on ARFCNs 26, 38, 1003, 1005, 1020, 0 (990 and 1000 less strong), n=6

c=9 report on ARFCNs 26,38, 1003, 1020, n=4.

NOTE 3: The Measurement Valid Indication shall be set to valid within the second SACCH block at the latest.

R-GSM:

SYSTEM INFORMATION TYPE 5:

Information Element	value/remark
Protocol Discriminator Message Type Neighbour Cells Description - EXT IND - BA-IND	RR management Sys Info 5. - EXT IND= 1, for c=1 to 6: Information Element carries only a part of the BA. - EXT IND= 0, for c=7 to 9: Information Element carries the BA. 0 for c=1, use range 128 to encode the following frequencies: (26, 38) for c=2, use range 256 to encode the following frequencies (960, 970, 990) for c=3, use range 512 to encode the following frequencies (520, 960, 970, 990, 1020) for c=4, use range 1 024 to encode the following frequencies (0, 26, 38, 960, 970, 990) for c=5, use variable Bitmap to encode the following frequencies (0, 26, 38) for c=6, use Bitmap 0 to encode the following frequencies (26) for c=7, use range 512 to encode the following frequencies : (520, 990, 1020) for c=8, use range 1024 to encode the following frequencies : (0, 26, 38, 970, 990, 1020) for c=9, use range 256 to encode the following frequencies : (38)

SYSTEM INFORMATION TYPE 5bis:

Information Element	value/remark
Protocol Discriminator Message Type Neighbour Cells Description - EXT IND - BA-IND	RR management Sys Info 5bis. Information Element carries only a part of the BA. 0 for c=1, use range 512 to encode the following frequencies: (520, 960, 970, 990, 1020) for c=2, use range 128 to encode the following frequencies (0, 26, 38) for c=3, use range 256 to encode the following frequencies (0, 26, 38) for c=4, use range 1 024 to encode the following frequencies (520, 1 000) for c=5, use variable Bitmap to encode the following frequencies (884, 960, 970, 990) for c=6, use range 512 to encode the following frequencies (520, 960, 990)

SYSTEM INFORMATION TYPE 5ter:

Information Element	value/remark
Protocol Discriminator Message Type Neighbour Cells Description - multiband reporting - BA-IND	RR management Sys Info 5ter. normal reporting of the six strongest cells, irrespective of the band used. 0 for c=7, use range 1024 to encode the following frequencies (0, 26, 960, 970) for c=8, use variable bitmap to encode the following frequencies (960, 1000) for c=9,, use range 256 to encode the following frequencies (26, 960, 1020)

SYSTEM INFORMATION TYPE 6:

Information Element	value/ remark
Protocol Discriminator Message Type Cell Identity LAI Cell Options - Power Control Indicator - DTX Indicator - Radio-Link-Time-out PLMN permitted	RR Management sys info 6 default default Power Control Indicator is set MS shall not use DTX default only NCC 1 permitted

MEASUREMENT REPORT:

Information Element	value/remark
Protocol Discriminator	RR Management
Transaction Identifier	0000
Message Type	MEASUREMENT REPORT
Measurement Results	
BA-used	1
DTX-used	DTX was not used
RXLEV-FULL-SERVING-CELL	See note 4
RXLEV-SUB-SERVING-CELL	See note 4
MEAS-VALID	See note 6
RXQUAL-FULL-SERVING-CELL	See note 4
RXQUAL-SUB-SERVING-CELL	See note 4
NO-NCELL-M	n (see note 5)
RXLEV-NCELL-1	See note 4
BCCH-FREQ-NCELL-1	See note 5
BSIC-NCELL-1	Corresponds to that of BCCH-FREQ-NCELL-1
RXLEV-NCELL-2	See note 4
BCCH-FREQ-NCELL-2	See note 5
BSIC-NCELL-2	Corresponds to that of BCCH-FREQ-NCELL-2
RXLEV-NCELL-3	See note 4
BCCH-FREQ-NCELL-3	See note 5
BSIC-NCELL-3	Corresponds to that of BCCH-FREQ-NCELL-3
RXLEV-NCELL-4	See note 4
BCCH-FREQ-NCELL-4	See note 5
BSIC-NCELL-4	Corresponds to that of BCCH-FREQ-NCELL-4
RXLEV-NCELL-5	See note 4
BCCH-FREQ-NCELL-5	See note 5
BSIC-NCELL-5	Corresponds to that of BCCH-FREQ-NCELL-5
RXLEV-NCELL-6	See note 4
BCCH-FREQ-NCELL-6	See note 5
BSIC-NCELL-6	Corresponds to that of BCCH-FREQ-NCELL-6

NOTE 4: These actual values are not checked.

NOTE 5: ARFCN 2 is the serving cell carrier.

c=1 report on ARFCNs: 26, 38, 960, 970, 990, 1020. n=6

c=2 report on ARFCNs: 26, 38, 960, 970, 990, 0. (1020 stronger than 970 but not broadcasted in SYS INFO). n=6

c=3 report on ARFCNs: 26, 38, 960, 970, 1020, 0. (990 less strong, 520 DCS). n=6

c=4 report on ARFCNs: 26, 38, 960, 970, 990, 0. (1000 less strong, 520 DCS, 1020 not broadcasted in SYS INFO). n=6

c=5 report on ARFCNs: 26, 38, 960, 970, 990, 0. (884 DCS). n=6

c=6 report on ARFCNs: 26, 960, 990. n=3

c=7 report on ARFCNs: 26, 960, 970, 990, 1020, 0 (520 DCS). n=6

c=8 report on ARFCNs: 26, 38, 960, 970, 1020, 0 (990 and 1000 less strong). n=6

c=9 report on ARFCNs: 26, 38, 960, 1020. n=4.

NOTE 6: The Measurement Valid Indication shall be set to valid within the second SACCH block at the latest.

26.10.2.2 E-GSM or R-GSM signalling / RR / Immediate assignment

This section only applies to E-GSM or R-GSM mobile stations.

Conformance requirements of section 26.6.1 fully apply to any mobile station (P-GSM, E-GSM, R-GSM or DCS) in the whole supported band of the mobile station.

Besides, as an E-GSM or R-GSM mobile station shall support the P-GSM band, it shall pass successfully every test of section 26.6.1 under the described GSM 900 conditions.

The purpose of this extra section is to test the immediate assignment procedure in the case where the target channel is E-GSM or R-GSM frequency.

26.10.2.2.1 Conformance requirement

Following a PAGING REQUEST message, the MS shall correctly set up an RR connection on a supported channel described in the IMMEDIATE ASSIGNMENT message, using some E-GSM or R-GSM frequency.

Reference(s)

GSM 04.08 section 3.3.1.1.2

26.10.2.2.2 Test purpose

To verify that the MS can correctly set up a dedicated control channel when E-GSM or R-GSM frequencies are used.

This tested for a SDCCH/8.

26.10.2.2.3 Method of test

Initial Conditions

System Simulator:

1 cell.

E-GSM:

CCCH-CONF is set to "1 basic physical channel used for CCCH not combined with SDCCHs".

SYSTEM INFORMATION type 1 message contains the following frequencies in the Cell Channel Description IE: 0, 30, 40, 66, 80, 1 005, 1 010, 1 015 (use range 1 024 to encode).

BCCH carrier number 1 015.

R-GSM:

CCCH-CONF is set to "1 basic physical channel used for CCCH not combined with SDCCHs".

SYSTEM INFORMATION type 1 message contains the following frequencies in the Cell Channel Description IE: 0, 30, 40, 66, 80, 958, 1010, 972 (use range 1 024 to encode).

BCCH carrier number 972.

Mobile Station:

The MS is in the "idle, updated" state, with a TMSI allocated.

Related PICS/PIXIT Statement(s)

Support E-GSM or R-GSM.

Foreseen Final State of the MS

"Idle, updated", with TMSI allocated.

Test Procedure

This test procedure is performed twice.

The System Simulator pages the MS and after the MS has responded with a CHANNEL REQUEST message the SS assigns an SDCCH channel using some E-GSM or R-GSM frequencies. The MS shall go to the correct channel and send a PAGING RESPONSE message. Then the SS initiates RR-release by sending a CHANNEL RELEASE message.

Maximum Duration of Test

15 seconds.

Expected Sequence

The sequence is performed for execution counter k=1,2.

Step	Direction	Message	Comments
1	SS -> MS	PAGING REQUEST TYPE 1	
2	MS -> SS	CHANNEL REQUEST	cause "answer to paging"
3	SS -> MS	IMMEDIATE ASSIGNMENT	Channel Type: see below
4	MS -> SS	PAGING RESPONSE	Shall be sent on the correct channel
5	SS -> MS	CHANNEL RELEASE	

Specific Message Contents

E-GSM:

IMMEDIATE ASSIGNMENT

As default except:

Information element	remark/value
Channel description	
- Channel Type	SDCCH/8
- Timeslot number	arbitrary but not zero
- Training sequence code	arbitrary
- Hopping channel	k=1 Single RF
	k=2 RF hopping channel
- Channel Selector	k=1 ARFCN=1 015
	k=2 MAIO = arbitrarily chosen HSN arbitrary chosen from the set (1,..63)
Mobile allocation	k=1 empty
	k=2 indicates the following frequencies (0, 80, 1 005, 1 010)

R-GSM:

IMMEDIATE ASSIGNMENT

As default except:

Information element	remark/value
Channel description	
- Channel Type	SDCCH/8
- Timeslot number	arbitrary but not zero
- Training sequence code	arbitrary
- Hopping channel	k=1 Single RF
	k=2 RF hopping channel
- Channel Selector	k=1 ARFCN=972
	k=2 MAIO = arbitrarily chosen HSN arbitrarily chosen from the set (1,..63)
Mobile allocation	k=1 empty
	k=2 indicates the following frequencies (0, 80, 958, 1010)

26.10.2.3 E-GSM or R-GSM signalling / RR / channel assignment procedure

This test is only applicable to an E-GSM or R-GSM mobile station.

Conformance requirements of section 26.6.4 fully apply to any mobile station (P-GSM, E-GSM, R-GSM or DCS) in the whole supported band of the mobile station.

Besides, as an E-GSM or R-GSM mobile station shall support the P-GSM band, it shall pass successfully every test of section 26.6.4 under the described GSM 900 conditions.

The purpose of this extra section is to test the assignment in the case where the allocated channel uses E-GSM or R-GSM frequency(s): in the case of frequency hopping several coding formats may be used by the network in the ASSIGNMENT COMMAND message.

26.10.2.3.1 Conformance requirements

1. Upon receipt of the ASSIGNMENT COMMAND message, the mobile station initiates a local end release of link layer connections, disconnects the physical channels, commands the switching to the assigned channels and initiates the establishment of lower layer connections (this includes the activation of the channels, their connection and the establishment of the main signalling links).
2. The MS shall apply the hopping frequencies specified in ASSIGNMENT COMMAND message in the mobile allocation or frequency list or frequency short list at the time accessing the new channel.

References

GSM 04.08, subclause 3.4.3.

GSM 04.08, subclause 9.1.2.

26.10.2.3.2 Test purpose

1. To verify that upon receipt of an ASSIGNMENT COMMAND, the MS switches to the channel defined in the ASSIGNMENT COMMAND, establishes the link and sends an ASSIGNMENT COMPLETE message.
2. To verify that an MS, having received an ASSIGNMENT COMMAND, is able in case of frequency hopping to decode the mobile allocation and frequency list correctly and applies the specified frequencies.

26.10.2.3.3 Method of test

Initial Conditions

System Simulator:

1 cell, default parameters.

Mobile Station:

The MS is in the "idle, updated" state with a TMSI allocated.

Related PICS/PIXIT Statements

- Support E-GSM or R-GSM.
- TCH supported (Y/N).
- The supported channel mode(s) need to be declared.

Foreseen Final State of the MS

"Idle, updated", with TMSI allocated.

Test Procedure

The test procedure is performed 2 times.

The SS pages the MS and allocates an SDCCH. Then a channel is assigned with ASSIGNMENT COMMAND. Each time the MS shall switch to the assigned channel, establish the link and send an ASSIGNMENT COMPLETE message.

The SS initiates the channel release procedure.

Maximum Duration of Test

3 min.

Expected Sequence

The test sequence is performed for execution counter k=1 to 2.

Step	Direction	Message	Comments
1	SS -> MS	PAGING REQUEST TYPE 1	
2	MS -> SS	CHANNEL REQUEST	
3	SS -> MS	IMMEDIATE ASSIGNMENT	Timeslot Number = n.
4	MS -> SS	PAGING RESPONSE	
5	SS -> MS	ASSIGNMENT COMMAND	See specific message contents Timeslot Number = (n+1) mod 8
6	MS -> SS	ASSIGNMENT COMPLETE	Sent on the correct channel after establishment of the main signalling link. Steps 5 and 6 are repeated cmax times, where cmax is the number of frequency formats allowed for each value of k. Use repetition counter c: See specific message content.
7	SS -> MS	CHANNEL RELEASE	The main signalling link is released.

Specific Message Contents

E-GSM:

ASSIGNMENT COMMAND:

Information element	value/remark
Protocol Discriminator	RR
Skip indicator	0000
Message type	ASSIGNMENT COMMAND
Channel Description	
- Channel type	TCH/F + ACCHs if supported by the MS or SDCCH/8 if not
- Timeslot number	arbitrary
- Training sequence code	chosen arbitrarily
- Hopping	RF hopping channel
- MAIO	arbitrary
- HSN	arbitrarily chosen from the set (1,2...63)
Power Command	
- Power level	Arbitrarily chosen
For k=1	
Cell Channel Description IE is not included	
Frequency list	for c=1, use range 128 to encode the following frequencies: (1 005, 1 010, 1 015) for c=2, use range 256 to encode the following frequencies (73, 74, 75, 76, 77) for c=3, use range 512 to encode the following frequencies (980, 981, 982, 983) for c=4, use range 1 024 to encode the following frequencies (30, 40, 1 010, 1 015) for c=5, use variable Bitmap to encode the following frequencies (980, 991, 992, 993, 994, 1 015) with an encoding origin set to 980 for c=6, use Bitmap 0 to encode the following frequencies (20, 40, 66)
For k=2	
Cell Channel Description	for c=1, use range 128 to encode the following 13 frequencies: (980, 981, 982, 983, 990, 991, 992, 993, 994, 1 000, 1 005, 1 010, 1 015) for c=2, use range 256 to encode the following 13 frequencies (20, 40, 66, 73, 74, 75, 76, 77, 78, 79, 108, 114, 115) for c=3, use range 512 to encode the following 13 frequencies (980, 981, 982, 983, 990, 991, 992, 993, 994, 1 000, 1 005, 1 010, 1 015) for c=4, use range 1 024 to encode the following 8 frequencies (0, 30, 40, 66, 80, 1 005, 1 010, 1 015) for c=5, use variable Bitmap to encode the following frequencies (980, 981, 982, 983, 990, 991, 992, 993, 994, 1 000, 1 005, 1 010, 1 015) for c=6, use Bitmap 0 to encode the following 12 frequencies (20, 40, 66, 73, 74, 75, 76, 77, 78, 79, 108, 114)
For k = 2	
Mobile Allocation	indicates the following the frequencies: for c=1 (1 005, 1 010, 1 015) for c=2 (73, 74, 75, 76, 77) for c=3 (980, 981, 982, 983) for c=4 (0, 30, 40, 1 010, 1 015) for c=5 (990, 991, 992, 993, 994) for c=6 (20, 40, 66)
Mode of the First channel	speech full rate version 1 for TCH/F except if speech is not supported: arbitrary from those supported
Starting Time	not included

R-GSM:

ASSIGNMENT COMMAND:

Information element	value/remark
Protocol Discriminator Skip indicator Message type Channel Description <ul style="list-style-type: none"> - Channel type - Timeslot number - Training sequence code - Hopping - MAIO - HSN Power Command <ul style="list-style-type: none"> - Power level For k=1 Cell Channel Description IE is not included Frequency list For k=2 Cell Channel Description For k = 2 Mobile Allocation Mode of the First channel Starting Time	RR 0000 ASSIGNMENT COMMAND TCH/F + ACCHs if supported by the MS or SDCCH/8 if not arbitrary chosen arbitrarily RF hopping channel arbitrary arbitrarily chosen from the set (1,2...63) Arbitrarily chosen for c=1, use range 128 to encode the following frequencies: (964, 969, 972) for c=2, use range 256 to encode the following frequencies (73, 76, 80, 85, 90) for c=3, use range 512 to encode the following frequencies (956, 960, 976, 980) for c=4, use range 1 024 to encode the following frequencies (30, 40, 969, 972, 990, 1020) for c=5, use variable Bitmap to encode the following frequencies (956, 960, 963, 966, 969, 972) with an encoding origin set to 956 for c=6, use Bitmap 0 to encode the following frequencies (20, 40, 66) for c=1, use range 128 to encode the following 13 frequencies: (960, 961, 962, 963, 964, 965, 966, 967, 968, 969, 970, 971, 972) for c=2, use range 256 to encode the following 13 frequencies (20, 40, 66, 73, 74, 75, 76, 77, 78, 79, 108, 114, 115) for c=3, use range 512 to encode the following 13 frequencies (960, 961, 962, 963, 964, 965, 966, 967, 968, 969, 970, 978, 990) for c=4, use range 1 024 to encode the following 10 frequencies (0, 30, 40, 66, 80, 964, 969, 972, 990, 1020) for c=5, use variable Bitmap to encode the following 13 frequencies (960, 961, 962, 963, 964, 965, 966, 967, 968, 969, 970, 971, 972) for c=6, use Bitmap 0 to encode the following 12 frequencies (20, 40, 66, 73, 74, 75, 76, 77, 78, 79, 108, 114) indicates the following the frequencies: for c=1 (964, 969, 972) for c=2 (66, 73, 76, 79, 108) for c=3 (960, 964, 978, 990) for c=4 (0, 30, 40, 969, 972, 990, 1020) for c=5 (962, 965, 968, 972) for c=6 (20, 40, 66) speech full rate version 1 for TCH/F except if speech is not supported: arbitrary from those supported not included

26.10.2.4 E-GSM or R-GSM signalling / RR / Handover

This section only applies to E-GSM or R-GSM mobile stations.

Conformance requirements of section 26.6.5 fully apply to any mobile station (P-GSM, E-GSM, R-GSM or DCS) in the whole supported band of the mobile station.

Besides, as an E-GSM or R-GSM mobile station shall support the P-GSM band, it shall pass successfully every test of section 26.6.5 under the described GSM 900 conditions.

The purpose of this extra section is to test the handover in the case where the target channel uses E-GSM or R-GSM frequency(s): in the case of frequency hopping several coding formats may be used by the network in the HANDOVER COMMAND message.

26.10.2.4.1 E-GSM or R-GSM signalling / RR / Handover / Successful handover

26.10.2.4.1.1 Conformance requirements

The MS shall correctly apply the handover procedure from a channel without frequency hopping in the primary band to a channel with frequency hopping using P-GSM and E-GSM or P-GSM and R-GSM frequencies whatever the coding used for the frequency hopping description.

References

GSM 04.08, sections 3.4.4 and 9.1.15.

26.10.2.4.1.2 Test purpose

To check that the MS correctly performs a non-synchronized handover, from a non hopping primary band SDCCH to a hopping TCH or SDCCH using E-GSM or R-GSM frequencies, whatever the coding used for the hopping sequence description and that it activates the new channel correctly.

This is tested in the following case:

E-GSM or R-GSM signalling / Handover / successful / call under establishment / non-synchronized /

- from SDCCH/8 to TCH/F if the MS supports a TCH

- from SDCCH/8 to SDCCH/8 if not

26.10.2.4.1.3 Method of test

Initial Conditions

System Simulator:

E-GSM:

2 cells A and B with same LAI, default parameters;

except for Cell A: the broadcasted Cell Channel Description in SYSTEM INFORMATION type 1 message contains the following frequencies: 20, 40, 66, 73, 74, 75, 76, 77, 78, 79, 108, 114 (encoded using Bit Map 0 format).

The broadcasted BCCH frequency list for Cell A in SYSTEM INFORMATION type 2 and 5 contains the following frequencies: 10, 20, 40, 80, 90, 100, 110 and 120 (encoded in Bit Map 0 format).

R-GSM:

2 cells A and B with same LAI, default parameters;

except for Cell A: the broadcasted Cell Channel Description in SYSTEM INFORMATION type 1 message contains the following frequencies: 20, 40, 66, 73, 74, 75, 76, 77, 78, 79, 108, 114 (encoded using Bit Map 0 format).

Except for Cell B: the BCCH carrier number is 965

Mobile Station:

The MS is in the "idle, updated" state, with a TMSI allocated and camped on cell A.

Related PICS/PIXIT Statements

Support E-GSM or R-GSM.

Support of TCH (Y/N).

Support of speech (Y/N).

Support for state U10 of the Call Control protocol.

Foreseen Final State of the MS

"Idle, updated" with TMSI allocated and camped on cell B.

Test Procedure

The test procedure is performed 18 times.

A Mobile Originating Call is initiated on cell A. After the MS has sent the SETUP message (and before the last L2 frame carrying the SETUP message is acknowledged by the SS) the SS sends a HANDOVER COMMAND message, ordering the MS to switch to cell B.

The MS shall then begin to send access bursts on the new channel, a TCH/F if supported (see PICS/PIXIT) or an SDCCH if not, to cell B.

The SS observes the access bursts. After receiving n access bursts, n being randomly drawn between 10 and 20 for the TCH case, 2 and 5 for the SDCCH (see table 26.6-2 of section 26.6.5), the SS sends one PHYSICAL INFORMATION message with a Timing Advance of 20 (see table 26.6-1 of section 26.6.5).

The MS shall activate the channel in sending and receiving mode. Then the MS shall establish a signalling link using the correct timing advance. The MS shall be ready to transmit a HANDOVER COMPLETE message before x ms after the end of the PHYSICAL INFORMATION message but not before a UA frame has been sent by the SS. The MS shall then again send the SETUP message to the SS, using the same value in the N(SD) field. Finally the SS sends a CHANNEL RELEASE to end the test.

The term "ready to transmit" is specified in GSM 04.13. The value of " x " depends upon the target channel:

case SDCCH/8 $x = 750$.

case TCH/F $x = 500$.

Maximum Duration of Test

10 min.

Expected Sequence

The sequence is performed for execution counter k=1 to 3 and c=1 to 6.

Step	Direction	Message	Comments
1	-----	-----	A MO call is initiated on cell A
2	MS -> SS	CHANNEL REQUEST	Establish. Cause = "Originating call, NECI not set to 1
3	SS -> MS	IMMEDIATE ASSIGNMENT	see specific message contents
4	MS -> SS	CM SERVICE REQUEST	CM Service Type = Mobile Originating Call Establishment.
5	SS -> MS	CIPHERING MODE COMMAND	
6	MS -> SS	CIPHERING MODE COMPLETE	
7	MS -> SS	SETUP	Last L2 frame not acknowledged by the SS.
8	SS -> MS	HANDOVER COMMAND	see specific message contents
9	MS -> SS	HANDOVER ACCESS	Repeated on every burst of the uplink main DCCH until reception of PHYSICAL INFORMATION. Handover Reference as included in the HANDOVER COMMAND
10	SS -> MS	PHYSICAL INFORMATION	Sent after reception of n HANDOVER ACCESS. Timing Advance: 20
11	MS -> SS	SABM	Sent without information field
12	SS -> MS	UA	
13	MS -> SS	HANDOVER COMPLETE	This message shall be ready to be transmitted before "x" ms after the completion of step 10
14	MS -> SS	SETUP	Same N(SD) as in step 7.
15	SS -> MS	CHANNEL RELEASE	

Specific Message Contents

E-GSM:

IMMEDIATE ASSIGNMENT

Information Element	Value/remark
As default message contents, except:	
Cell Description	
- BCCH carrier number	20
Channel Description	
- Channel type	SDCCH/8
- Timeslot number	arbitrary but not zero
- Training sequence code	chosen arbitrarily
- Hopping	Single RF channel
- ARFCN	Chosen arbitrarily from the Cell Allocation of Cell A, but not the BCCH carrier of Cell A.

HANDOVER COMMAND

Information Element	Value/remark
<p>As default message contents, except:</p> <p>Cell Description - BCCH carrier number</p> <p>Channel Description - Channel type</p> <p>- Timeslot number - Training sequence code - Hopping - MAIO - HSN</p> <p>Synchronization Indication IE is not included</p> <p>For k = 1, Cell Channel Description IE is not included Frequency short list</p> <p>For k=2 Cell Channel Description IE is not included Frequency list</p> <p>For k=3 Cell Channel Description</p>	<p>40</p> <p>TCH/F + ACCHs if supported by the MS or SDCCH/8 if not arbitrary but not zero chosen arbitrarily RF hopping channel arbitrary arbitrarily chosen from the set (1,2...63)</p> <p>for c=1, use range 128 to encode the following frequencies: (1 005, 1 010, 1 015) for c=2, use range 256 to encode the following frequencies (73, 74, 75, 76, 77) for c=3, use range 512 to encode the following frequencies (980, 981, 982, 983) for c=4, use range 1 024 to encode the following frequencies (30, 40, 1 010, 1 015) for c=5, use variable Bitmap to encode the following frequencies (980, 991, 992, 993, 994, 1 015)</p> <p>for c=1, use range 128 to encode the following frequencies: (1 005, 1 010, 1 015) for c=2, use range 256 to encode the following frequencies (73, 74, 75, 76, 77) for c=3, use range 512 to encode the following frequencies (980, 981, 982, 983) for c=4, use range 1 024 to encode the following frequencies (30, 40, 1 010, 1 015) for c=5, use variable Bitmap to encode the following frequencies (980, 991, 992, 993, 994, 1 015) for c=6, use Bitmap 0 to encode the following frequencies (20, 40, 66)</p> <p>for c=1, use range 128 to encode the following 13 frequencies: (980, 981, 982, 983, 990, 991, 992, 993, 994, 1 000, 1 005, 1 010, 1 015) for c=2, use range 256 to encode the following 13 frequencies (20, 40, 66, 73, 74, 75, 76, 77, 78, 79, 108, 114, 115) for c=3, use range 512 to encode the following 13 frequencies (980, 981, 982, 983, 990, 991, 992, 993, 994, 1 000, 1 005, 1 010, 1 015) for c=4, use range 1 024 to encode the following 10 frequencies (0, 30, 40, 66, 80, 520, 975, 1 005, 1 010, 1 015) for c=5, use variable Bitmap to encode the following 13 frequencies (980, 981, 982, 983, 990, 991, 992, 993, 994, 1 000, 1 005, 1 010, 1 015) for c=6, use Bitmap 0 to encode the following 12 frequencies (20, 40, 66, 73, 74, 75, 76, 77, 78, 79, 108, 114)</p>

Information Element	Value/remark
For k = 3 Mobile Allocation Mode of the First channel	indicates the following the frequencies: for c=1 (1 005, 1 010, 1 015) for c=2 (73, 74, 75, 76, 77) for c=3 (980, 981, 982, 983) for c=4 (30, 40, 1 010, 1 015) for c=5 (990, 991, 992, 993, 994) for c=6 (20, 40, 66) if SDCCH/8: signalling if TCH/F: speech full rate version 1 if speech is supported, otherwise arbitrary from those supported

R-GSM:

IMMEDIATE ASSIGNMENT

Information Element	Value/remark
As default message contents, except: Cell Description - BCCH carrier number Channel Description - Channel type - Timeslot number - Training sequence code - Hopping - ARFCN	20 SDCCH/8 arbitrary but not zero chosen arbitrarily Single RF channel Chosen arbitrarily from the Cell Allocation of Cell A, but not the BCCH carrier of Cell A.

HANDOVER COMMAND

Information Element	Value/remark
<p>As default message contents, except:</p> <p>Cell Description</p> <ul style="list-style-type: none"> - BCCH carrier number <p>Channel Description</p> <ul style="list-style-type: none"> - Channel type - Timeslot number - Training sequence code - Hopping - MAIO - HSN <p>Synchronization Indication IE is not included</p> <p>For k = 1, Cell Channel Description IE is not included Frequency short list</p> <p>For k=2 Cell Channel Description IE is not included Frequency list</p> <p>For k=3 Cell Channel Description</p> <p>For k = 3 Mobile Allocation</p> <p>Mode of the First channel</p>	<p>965</p> <p>TCH/F + ACCHs if supported by the MS or SDCCH/8 if not arbitrary but not zero chosen arbitrarily RF hopping channel arbitrary arbitrarily chosen from the set (1,2...63)</p> <p>for c=1, use range 128 to encode the following frequencies: (964, 969, 972) for c=2, use range 256 to encode the following frequencies (73, 76, 79, 86, 97) for c=3, use range 512 to encode the following frequencies (956, 960, 964, 970) for c=4, use range 1 024 to encode the following frequencies (30, 40, 969, 972, 990, 1020) for c=5, use variable Bitmap to encode the following frequencies (956, 960, 964, 967, 970, 973)</p> <p>for c=1, use range 128 to encode the following frequencies: (964, 969, 972) for c=2, use range 256 to encode the following frequencies (73, 76, 79, 86, 97) for c=3, use range 512 to encode the following frequencies (956, 960, 963, 970) for c=4, use range 1 024 to encode the following frequencies (30, 40, 969, 972, 990, 1020) for c=5, use variable Bitmap to encode the following frequencies (956, 960, 964, 967, 970, 973) for c=6, use Bitmap 0 to encode the following frequencies (20, 40, 66)</p> <p>for c=1, use range 128 to encode the following 13 frequencies: (960, 961, 962, 963, 964, 965, 966, 967, 968, 969, 970, 971, 972) for c=2, use range 256 to encode the following 13 frequencies (20, 40, 66, 73, 74, 75, 76, 77, 78, 79, 108, 114, 115) for c=3, use range 512 to encode the following 13 frequencies (960, 961, 962, 963, 964, 965, 966, 967, 968, 969, 970, 971, 972) for c=4, use range 1 024 to encode the following 12 frequencies (0, 30, 40, 66, 80, 520, 955, 964, 969, 972, 990, 1020) for c=5, use variable Bitmap to encode the following frequencies (960, 961, 962, 963, 964, 965, 966, 967, 968, 969, 970, 971, 972) for c=6, use Bitmap 0 to encode the following 12 frequencies (20, 40, 66, 73, 74, 75, 76, 77, 78, 79, 108, 114)</p> <p>indicates the following the frequencies: for c=1 (964, 969, 972) for c=2 (73, 76, 79, 108, 115) for c=3 (960, 964, 969, 972) for c=4 (30, 40, 969, 972, 990, 1020) for c=5 (960, 963, 966, 969, 972) for c=6 (20, 40, 66)</p> <p>if SDCCH/8: signalling if TCH/F: speech full rate version 1 if speech is supported, otherwise arbitrary from those supported</p>

26.10.2.4.2 E-GSM or R-GSM signalling / RR / Handover / layer 1 failure

26.10.2.4.2.1 Conformance requirements

During a handover from a channel in the E-GSM or R-GSM band to a channel in the P-GSM band, or the contrary, the MS shall correctly return to the old channel in the case of an handover failure caused by a layer 1 failure on the target cell.

References

GSM 04.08 section 3.4.4.

26.10.2.4.2.2 Test purpose

To check that the MS correctly returns to the old channel in the case of an handover failure caused by a layer 1 failure on the target cell, even if the origin is in the P-GSM band and the target in the E-GSM or R-GSM band.

26.10.2.4.2.3 Method of test

Initial Conditions

System Simulator:

E-GSM:

2 cells with same LAI, default parameters.

R-GSM:

2 cells with same LAI, default parameters, except the BCCH carrier number of Cell A is 990, the BCCH carrier number of Cell B is 965

Mobile Station:

E-GSM:

The MS is in the active state (U10) of a call on a P-GSM channel of cell A. power level = 10.

R-GSM:

The MS is in the active state (U10) of a call on a E-GSM channel of cell A, power level = 10.

Related PICS/PIXIT Statements

Support E-GSM or R-GSM.

Supported rate(s) of TCH: TCH/F.

Supported mode(s).

Support for state U10 of the Call Control protocol.

Foreseen Final State of the MS

The active state (U10) of a mobile call (on cell A), used power level 10.

Test Procedure

The MS is in the active state (U10) of a call on a P-GSM channel (on an E-GSM channel for R-GSM testing) of cell A (used power level 10). The SS sends a HANOVER COMMAND on the main DCCH. The MS shall begin to send access bursts at the commanded power level on the new DCCH to cell B (power level 12). With the exception of normal BCCH signalling, the SS does not transmit anything on cell B (thus causing a time-out of T3124). The MS shall re-establish the old link on cell A and send a HANOVER FAILURE within 3 seconds from the transmission of HANOVER COMMAND, using the old power level.

Maximum Duration of Test

1 min.

Expected Sequence

Step	Direction	Message	Comments
1	SS -> MS	HANOVER COMMAND	to an E-GSM or R-GSM channel see specific message contents
2	MS -> SS	HANOVER ACCESS	Several messages are sent, all with correct Handover References.
3	MS -> SS	HANOVER FAILURE	Sent on old channel, RR cause value = "Abnormal release, unspecified", "Abnormal release, channel unacceptable", "Abnormal release, timer expired", "Abnormal release, no activity on the radio path" or "Protocol error unspecified". Layer 1 header has the same power level as the layer 1 header in step 1. Shall be sent within 3 seconds from the transmission of HANOVER COMMAND.

Specific Message Contents

E-GSM:

HANOVER COMMAND

Information Element	Value/remark
As default message contents, except:	
Cell Description	
- BCCH carrier number	40
Channel Description	
- Channel type	TCH/F + ACCHs if supported by the MS
- Timeslot number	arbitrary but not zero
- Training sequence code	chosen arbitrarily
- Hopping	RF hopping channel
- MAIO	arbitrary
- HSN	chosen randomly from the set (1,2...63)
Synchronization Indication IE is not included	
Cell Channel Description IE is not included	
Frequency short list	use range 128 to encode the following frequencies: (1 005, 1 010, 1 015)
Mode of the first channel	Full rate speech version 1 if supported. If not, arbitrary from those supported except signalling.

R-GSM:

HANDOVER COMMAND

Information Element	Value/remark
As default message contents, except:	
Cell Description	
- BCCH carrier number	965
Channel Description	
- Channel type	TCH/F + ACCHs if supported by the MS
- Timeslot number	arbitrary but not zero
- Training sequence code	chosen arbitrarily
- Hopping	RF hopping channel
- MAIO	arbitrary
- HSN	chosen randomly from the set (1,2...63)
Synchronization Indication IE is not included	
Cell Channel Description IE is not included	
Frequency short list	use range 128 to encode the following frequencies: (960, 970, 990)
Mode of the first channel	Full rate speech version 1 if supported. If not, arbitrary from those supported except signalling.

26.10.2.5 E-GSM or R-GSM signalling / RR / Frequency Redefinition

This section only applies to E-GSM and R-GSM mobile stations.

Conformance requirements of section 26.6.6 fully apply to any mobile station (P-GSM, E-GSM, R-GSM or DCS) in the whole supported band of the mobile station.

Besides, as an E-GSM or R-GSM mobile station shall support the P-GSM band, it shall pass successfully every test of section 26.6.6 under the described GSM 900 conditions.

The purpose of this extra section is to test the frequency redefinition procedure in the case where the target channel uses E-GSM or R-GSM frequency(ies): in the case of frequency hopping several coding formats may be used by the network in the FREQUENCY REDEFINITION message.

26.10.2.5.1 Conformance requirements

- 1) To verify that the MS, after receiving a FREQUENCY REDEFINITION message, correctly starts using the new frequencies, and hopping sequence when some E-GSM or R-GSM frequencies are used.
- 2) The last received Cell Channel Description information element is used to decode the Mobile Allocation IE received on the FREQUENCY REDEFINITION message.

References

GSM 04.08, 3.4.5 and 9.1.13.

26.10.2.5.2 Test purpose

- 1) To verify that the MS, after receiving a FREQUENCY REDEFINITION message, starts using the new frequencies and hopping sequence when some E-GSM or R-GSM frequencies are used.
- 2) To check that the last received Cell Channel Description information element is used to decode the Mobile Allocation IE received in the FREQUENCY REDEFINITION message.

26.10.2.5.3 Method of test

Initial conditions

System Simulator:

1 cell; default parameters.

Mobile Station:

The MS is in "idle, updated" state with TMSI allocated.

Related PICS/PIXIT statement(s)

- Support E-GSM or R-GSM.
- Support of a TCH (Y/N)

Foreseen final state of the MS

"Idle, updated", with TMSI allocated.

Test procedure

The test procedure is performed six times.

The System Simulator pages the MS and after the MS has responded with a CHANNEL REQUEST, the simulator assigns a TCH/F if supported otherwise a SDCCH/8. Then the SS sends to MS a FREQUENCY REDEFINITION. The MS shall then use the new frequencies/hopping sequence.

Maximum duration of test

3 min.

Expected sequence

The sequence is performed for execution counter c=1 to 6.

Step	Direction	Message	Comments
1	SS->MS	PAGING REQUEST TYPE 1	
2	MS->SS	CHANNEL REQUEST	
3	SS->MS	IMMEDIATE ASSIGNMENT	Hopping channel, Channel type = TCH/F if a TCH is supported otherwise, Channel type=SDCCH/8.
4	MS->SS	PAGING RESPONSE	Sent on the correct channel after establishment of the main signalling link
5	SS->MS	FREQUENCY REDEFINITION	See specific message contents.
6	-----	-----	The SS checks that the MS is transmitting on the correct frequencies.
7	SS->MS	CHANNEL RELEASE	The main signalling link is released.

R-GSM:

FREQUENCY REDEFINITION

Information Element	Value/remark
As default message contents, except:	
Cell Description	
- BCCH carrier number	40
Channel Description	
- Channel type	Same as in IMMEDIATE ASSIGNMENT
- Timeslot number	Same as in IMMEDIATE ASSIGNMENT
- Training sequence code	Same as in IMMEDIATE ASSIGNMENT
- Hopping	RF hopping channel
- MAIO	arbitrary
- HSN	Same as in IMMEDIATE ASSIGNMENT
Cell Channel Description	for c=1, use range 128 to encode the following 13 frequencies: (960, 961, 962, 963, 964, 965, 966, 967, 968, 969, 970, 971, 972) for c=2, use range 256 to encode the following 13 frequencies (20, 40, 66, 73, 74, 75, 76, 77, 78, 79, 108, 114, 115) for c=3, use range 512 to encode the following 13 frequencies (960, 961, 962, 963, 964, 965, 966, 967, 968, 969, 970, 971, 972) for c=4, use range 1 024 to encode the following 10 frequencies (0, 30, 40, 66, 80, 964, 969, 972, 990, 1020) for c=5, use variable Bitmap to encode the following 13 frequencies (960, 961, 962, 963, 964, 965, 966, 967, 968, 969, 970, 971, 972) for c=6, not present (the mobile station will use the last Cell Channel Description IE received, i.e. the one broadcast in the SYSTEM INFORMATION TYPE 1 message).
Mobile Allocation	indicates the following frequencies: for c=1 (964, 969, 972) for c=2 (73, 76, 79, 108, 114) for c=3 (960, 964, 968, 972) for c=4 (30, 40, 969, 972, 990, 1020) for c=5 (960, 964, 967, 970, 972) for c=6 (30, 50, 70)
Starting time	indicates (current frame number + 100 frames) mod 42432

26.10.3 E-GSM or R-GSM signalling / Structured procedure

Conformance requirements of section 26.9 fully apply to any mobile station (P-GSM, E-GSM, R-GSM or DCS) in the whole supported band of the mobile station.

Besides, as an E-GSM or R-GSM mobile station shall support the P-GSM band, it shall pass successfully every test of section 26.9 under the described GSM 900 conditions.

The purpose of these tests is to verify that the MS performs certain elementary procedures of the RR, MM, and CC protocol correctly within a structured procedure. This tested here in an E-GSM or R-GSM context to evaluate the global behaviour of an E-GSM or R-GSM mobile station using its specific frequency capability.

One mobile originated call and one emergency call are performed.

In one of the different cases the different following situations occur: early and late assignments, call release initiated by the network and by the MS.

26.10.3.1 E-GSM or R-GSM signalling / Structured procedure / Mobile originated call

26.10.3.1.1 Conformance requirement

- 1) An MS in MM state "idle, updated" and in RR idle mode with a TMSI assigned, when made to initiate a call for a selected teleservice that is supported by the MS, shall start to initiate an immediate assignment procedure by sending the CHANNEL REQUEST message with correct establishment cause.
- 2) Upon receipt of the ASSIGNMENT COMMAND message, the Mobile Station initiates a local end release of link layer connections, disconnects the physical channels, commands the switching to the assigned channels and initiates the establishment of lower layer connections (this includes the activation of the channels, their connection and the establishment of the data links). After the main signalling link is successfully established, the MS returns an ASSIGNMENT COMPLETE message, specifying cause "normal event", to the network on the main DCCH.
- 3,4) The call control entity of the Mobile Station in the "call initiated" state, in the "mobile originating call proceeding" state or in the "call delivered" state, shall, upon receipt of a CONNECT message:
 - attach the user connection to the radio path;
 - return a CONNECT ACKNOWLEDGE message.

References

- Conformance requirement 1: GSM 04.08 section 3.3.1.1
- Conformance requirement 2: GSM 04.08 sections 3.4.3.1 and 3.4.3.2.
- Conformance requirement 3: GSM 04.08 section 3.4.3.
- Conformance requirement 4: GSM 04.08 section 5.2.1.1.6.
- Conformance requirement 5: GSM 02.07.
- Conformance requirement 6: GSM 04.08 sections 5.2.1.1.6 and 5.1.3.

26.10.3.1.2 Test purpose

- 1) To verify that the MS in MM state "idle, updated" and in RR idle mode with a TMSI assigned, when made to initiate a call for a selected teleservice that is supported by the MS as declared in a PICS/PIXIT statement, starts to initiate an immediate assignment procedure by sending the CHANNEL REQUEST message.
- 2) To verify that subsequently after receipt of an IMMEDIATE ASSIGNMENT message allocating an SDCCH, after completion of establishment of the main signalling link, after having sent a CM SERVICE REQUEST message, after having successfully performed authentication and cipher mode setting procedures, after having sent a SETUP message, after having received a CALL PROCEEDING message followed by an ALERTING message and an ASSIGNMENT COMMAND message allocating an appropriate TCH, the MS sends an ASSIGNMENT COMPLETE message.
- 3) To verify that subsequently, after the suite of actions specified in test purposes 1 and 2, the MS after receiving a CONNECT message returns a CONNECT ACKNOWLEDGE message.
- 4) To verify that after the suite of actions specified in test purposes 1 and 2, the MS after receiving a CONNECT message attaches the user connection to the radio path. (This is checked by verifying that there is a point in time after transmission of the first L2 frame containing the (complete) CONNECT message, where the MS is sending appropriate speech or data frames whenever it does not have to transmit or acknowledge an I frame on layer 2 of the FACCH.)

26.10.3.1.3 Method of test

Related PICS/PIXIT statements

- Support E-GSM or R-GSM.
- Interface to the human user (p1 = Y/N).
- Way to display the called number (only applicable if the MS has an interface to the human user).
- Way to indicate alerting (only applicable if the MS supports the feature).
- Way to make the MS accept an incoming call after alerting (possibly dependent on teleservice and configuration).
- Supported teleservices.
- Classmark.

Initial Conditions

System Simulator:

1 cell, default parameters.

Mobile Station:

The MS is in MM-state "idle, updated" with valid TMSI and CKSN.

Foreseen Final State of the MS

The MS is in MM state "idle updated".

Test procedure

The following test is performed for one teleservice supported by the MS:

A teleservice is selected that is supported by the MS; if the MS supports speech, the selected teleservice is speech. If necessary, the MS is configured for that teleservice.

The MS is made to initiate a call. The call is established with late assignment. The release of the call is initiated by the MS.

Maximum Duration of Test

1 minute.

Expected Sequence

Step	Direction	Message	Comments
1	MS		The "called number" is entered
3	MS		
4	MS -> SS	CHANNEL REQUEST	Establishment cause is "originating call and the network does not set the NECI bit to 1".
5	SS -> MS	IMMEDIATE ASSIGNMENT	
6	MS -> SS	CM SERVICE REQUEST	Message is contained in SABM.
7	SS -> MS	AUTHENTICATION REQUEST	
8	MS -> SS	AUTHENTICATION RESPONSE	SRES specifies correct value.
9	SS -> MS	CIPHERING MODE COMMAND	SS starts deciphering after sending the message.
10	MS -> SS	CIPHERING MODE COMPLETE	Shall be sent enciphered. All following messages shall be sent enciphered.
11	SS		SS starts ciphering.
12	MS -> SS	SETUP	
13	SS -> MS	CALL PROCEEDING	
14	SS -> MS	ALERTING	
15	MS		Depending on the PICS, an alerting indication is given.
16	SS -> MS	ASSIGNMENT COMMAND	
17	MS -> SS	ASSIGNMENT COMPLETE	
18	SS -> MS	CONNECT	
19	MS -> SS	CONNECT ACKNOWLEDGE	
20	MS		The appropriate bearer channel is through connected in both directions.
21	MS		If the call is a data call, the TCH shall be through connected in both directions.
22	MS		The MS is made to release the call.
23	MS -> SS	DISCONNECT	
24	SS -> MS	RELEASE	
25	MS -> SS	RELEASE COMPLETE	
26	SS -> MS	CHANNEL RELEASE	The main signalling link is released.

Specific Message Contents:

None.

26.10.3.2 E-GSM or R-GSM signalling / Structured procedures / emergency call

Emergency call establishment can be initiated by an MS whether location updating has been successful or not and whether a SIM is inserted into the MS or not; but only if the MS is equipped for speech.

This section is only applicable to an MS supporting speech.

26.10.3.2.1 Conformance requirement

- 1) The MS in the "idle, updated" state, as after a successful location update, after the number 112 has been entered by user, shall send a CHANNEL REQUEST message with correct establishment cause ("emergency call").
- 2) After assignment of a dedicated channel the first layer message sent by the MS on the assigned dedicated channel shall be a CM SERVICE REQUEST message specifying the correct IMEI and a non-available CKSN, with CM Service Type "emergency call establishment".
- 3) After cipher mode setting acceptance by the network, the MS shall send an EMERGENCY SETUP message.
- 4),5) The emergency call shall be correctly established. The assignment procedure shall be correctly performed.
- 6) After receipt of a CONNECT ACKNOWLEDGE message during correct establishment of the emergency call the TCH shall be through connected in both directions if an appropriate TCH is available.
- 7) The call shall be cleared correctly.

Requirement Reference:

For conformance requirement 1 and 2:

GSM 04.08 section 3.3.1.1, GSM 04.08 section 5.2.1, GSM 04.08 section 4.5.1.5., GSM 02.30 section 4.

For conformance requirement 3:

GSM 04.08, section 5.2.1.2.

For conformance requirements 4 and 5:

GSM 04.08, sections 5.2.1.1 and 3.4.3.

For conformance requirement 6:

GSM 04.08, sections 5.2.1.1.6 and 5.1.3.

For conformance requirement 7:

GSM 04.08, section 5.4.

26.10.3.2.2 Test purpose

- 1) To verify that the MS in the "idle, no IMSI" state (no SIM inserted) when made to call the number 112, sends a CHANNEL REQUEST message with establishment cause "emergency call".
- 2) To verify that after assignment of a dedicated channel the first layer message sent by the MS on the assigned dedicated channel is a CM SERVICE REQUEST message specifying the correct CKSN and TMSI, with CM Service Type "emergency call establishment".
- 3) To verify that after receipt of a CM SERVICE ACCEPT message from the SS, the MS sends an EMERGENCY SETUP message.
- 4) To verify that subsequently, the SS having sent a CALL PROCEEDING message and then an ALERT message and having initiated the assignment procedure, the MS performs correctly that assignment procedure.
- 5) To verify subsequent correct performance of a connect procedure.
- 6) To verify that subsequently the MS has through connected the TCH in both directions.
- 7) To verify that the call is cleared correctly.

This is tested in the following case:

Structured procedures / emergency call / idle, no IMSI / accept case.

26.10.3.2.3 Method of test**Related PICS/PIXIT Statements**

- Support E-GSM or R-GSM.
- Speech supported (Y/N).
- Classmark.

Initial Conditions

System Simulator:

1 cell, default parameters except:

E-GSM:

BCCH ARFCN = 990.

R-GSM:

BCCH ARFCN = 965.

Mobile Station:

The MS is in MM-state "idle, no IMSI", no SIM inserted.

Foreseen Final State of the MS

The MS is in MM-state "idle, no IMSI", no SIM inserted.

Test procedure

The MS is made to initiate an emergency call. The call is established without authentication, without ciphering, with early assignment. Having reached the active state, the call is cleared by the SS.

Maximum Duration of Test

1 minute.

Expected Sequence

Step	Direction	Message	Comments
1	MS		
2	MS -> SS	CHANNEL REQUEST	The "called number" 112 is entered
3	SS -> MS	IMMEDIATE ASSIGNMENT	Establishment cause is "emergency call".
4	MS -> SS	CM SERVICE REQUEST	Message is contained in SABM. The CM service type IE indicates "emergency call establishment". The mobile identity IE specifies the IMEI of the MS. The cipher key sequence number IE indicates "no key is available". The mobile station classmark IE is as specified by the manufacturer in a PICS/PIXIT statement.
5	SS -> MS	CM SERVICE ACCEPT	
6	MS -> SS	EMERGENCY SETUP	
7	SS -> MS	CALL PROCEEDING	
8	SS -> MS	ASSIGNMENT COMMAND	The rate of the channel is one indicated by the EMERGENCY SETUP message.
9	MS -> SS	ASSIGNMENT COMPLETE	
10	SS -> MS	ALERTING	
11	SS -> MS	CONNECT	
12	MS -> SS	CONNECT ACKNOWLEDGE	
13	MS		The TCH is through connected in both directions.
14	SS -> MS	DISCONNECT	
15	MS -> SS	RELEASE	
16	SS -> MS	RELEASE COMPLETE	
17	SS -> MS	CHANNEL RELEASE	The main signalling link is released.

Specific Message Contents:

None.

26.10.3.3 Default contents of messages

Same as in 26.9.7 except for the following:

ASSIGNMENT COMMAND

E-GSM:

Information element	Value/remark
Description of the first channel	describes non-hopping Bm+ACCHs or Lm+ACCHs as appropriate for the test ARFCN = 990
Power Command -	Chosen arbitrarily but within the range supported by the MS.
Frequency list	Omitted
Cell channel description	Omitted
Mode of the first channel	appropriate for one bearer capability chosen for the test
Description of the second channel	Omitted
Mode of the second channel	Omitted
Mobile allocation	Omitted
Starting time	Omitted
Cipher mode setting	Omitted

R-GSM:

Information element	Value/remark
Description of the first channel	describes non-hopping Bm+ACCHs or Lm+ACCHs as appropriate for the test ARFCN = 965
Power Command -	Chosen arbitrarily but within the range supported by the MS.
Frequency list	Omitted
Cell channel description	Omitted
Mode of the first channel	appropriate for one bearer capability chosen for the test
Description of the second channel	Omitted
Mode of the second channel	Omitted
Mobile allocation	Omitted
Starting time	Omitted
Cipher mode setting	Omitted

IMMEDIATE ASSIGNMENT

Information element	Value/remark
Page mode	Normal paging
Channel description	describes a valid SDCCH+SACCH in non-hopping mode ARFCN = 40
Request reference Random access information N51, N32, N26	As received from MS Corresponding to frame number of the CHANNEL REQUEST
Timing advance	Arbitrary
Mobile allocation	Empty (L=0)
Starting time	Omitted

26.10.4 E-GSM or R-GSM signalling / Default message contents

Default SYSTEM INFORMATION:

NOTE: SYSTEM INFORMATION 7, and SYSTEM INFORMATION 8 messages are not used.

SYSTEM INFORMATION type 1 message

Information elements	Value/Remark
Cell Channel Description For Cell A - Format identifier - Cell Allocation ARFCN For Cell B - Format identifier - Cell Allocation ARFCN RACH Control parameters SI1 Rest octets	Bit Map 0 Channel Numbers 20, 30, 50 and 70. Bit Map 0 Channel Numbers 10, 12, 40, 60, 62, 63 see below see below

SYSTEM INFORMATION type 2 message

Information elements	Value/Remark
BCCH frequency list For cell A - Format identifier - BCCH Allocation Sequence - BCCH Allocation ARFCN - EXT-IND For cell B - Format identifier - BCCH Allocation Sequence - BCCH Allocation ARFCN - EXT-IND NCC permitted RACH control parameters	bit map 0 0 Channels numbers 10, 20, 80, 90, 100, 110 and 120 This IE does not carry the complete BA bit map 0 0 Channels numbers 10, 36, 40, 114, 118 This IE does not carry the complete BA see below see below

SYSTEM INFORMATION type 2bis message

E-GSM:

Information elements	Value/Remark
Extended BCCH frequency list For cell A - Format identifier - BCCH Allocation Sequence - BCCH Allocation ARFCN - EXT-IND For cell B - Format identifier - BCCH Allocation Sequence - BCCH Allocation ARFCN - EXT-IND RACH control parameters SI 2bis rest octets	range 256 0 988, 990, 1 003 This IE does not carry the complete BA range 128 0 Channels numbers 1 005, 1 010, 1 015 This IE does not carry the complete BA see below see below

R-GSM:

Information elements	Value/Remark
Extended BCCH frequency list	
For cell A	
- Format identifier	range 256
- BCCH Allocation Sequence	0
- BCCH Allocation ARFCN	962, 965, 968, 980, 990
- EXT-IND	This IE does not carry the complete BA
For cell B	
- Format identifier	range 128
- BCCH Allocation Sequence	0
- BCCH Allocation ARFCN	Channels numbers 969, 970, 972, 1005, 1010
- EXT-IND	This IE does not carry the complete BA
RACH control parameters	see below
SI 2bis rest octets	see below

SYSTEM INFORMATION type 3 message

Information elements	Value/Remark
Cell identity	see below
LAI	see below
Control channel description	see below
Cell options	see below
Cell Selection parameters	see below
RACH control parameter	see below
SI3 Rest octets	see below

SYSTEM INFORMATION type 4 message

Information elements	Value/Remark
LAI	see below
Cell selection parameters	see below
RACH control parameters	see below
CBCH Channel Description	see below
CBCH MA	see below
SI4 Rest octets	see below

SYSTEM INFORMATION type 5 message

Information elements	Value/Remark
BCCH frequency list	
For cell A	
- Format identifier	bit map 0
- BCCH Allocation Sequence	0
- BCCH Allocation ARFCN	Channels numbers 10, 20, 80, 90, 100, 110 and 120
- EXT-IND	This IE does not carry the complete BA
For cell B	
- Format identifier	Bit map 0
- BCCH Allocation Sequence	0
- BCCH Allocation ARFCN	Channels numbers 10, 36, 40, 114, 118
- EXT-IND	This IE does not carry the complete BA

SYSTEM INFORMATION type 5bis message

E-GSM:

Information elements	Value/Remark
Extension of BCCH frequency list description For cell A <ul style="list-style-type: none"> - Format identifier - BCCH Allocation Sequence - BCCH Allocation ARFCN - EXT-IND For cell B <ul style="list-style-type: none"> - Format identifier - BCCH Allocation Sequence - BCCH Allocation ARFCN - EXT-IND 	Range 256 0 Channels numbers 988, 990, 1 003 This IE does not carry the complete BA range 128 0 Channels numbers 1 005, 1 010, 1 015 This IE does not carry the complete BA

R-GSM:

Information elements	Value/Remark
Extension of BCCH frequency list description For cell A <ul style="list-style-type: none"> - Format identifier - BCCH Allocation Sequence - BCCH Allocation ARFCN - EXT-IND For cell B <ul style="list-style-type: none"> - Format identifier - BCCH Allocation Sequence - BCCH Allocation ARFCN - EXT-IND 	Range 256 0 Channels numbers 962, 965, 968, 980, 990 This IE does not carry the complete BA range 128 0 Channels numbers 968, 970, 972, 1005, 1010 This IE does not carry the complete BA

SYSTEM INFORMATION type 6 message

Information elements	Value/Remark
Cell identity LAI Cell options NCC permitted	see below see below see below see below

Common contents of information elements in SYSTEM INFORMATION TYPE 1 to 6 messages

(CBCH) Channel Description	Not present
(CBCH) Mobile Allocation	Not present
Cell Identity	
- Cell Identity Value	0001H for cell A, 0002H for cell B
Cell Options	
- Power Control Indicator	Power Control Indicator is not set
- DTX Indicator	MS shall not use DTX
- Radio-Link-Time-out	8 SACCH blocks
Cell Selection Parameters	
- Cell-Reselect-Hysteresis	12 dB
- MX-TXPWR-MAX-CCH	Minimum level
- ACS	No addition cell parameters are present in SYSTEM INFORMATION messages 7 and 8.
- NECI	New establishment causes not supported
- RXLEV-ACCESS-MIN	Minimum level
Control Channel Description	
- Attach-Detach allowed	No Attach/Detach
- BS-AG-BLKS-RES	0 blocks reserved for access grant
- CCCH-CONF	1 basic physical channel used for CCCH, combined with SDCCHs
- BS-PA-MFRMS	5 multiframe periods for transmission of paging messages
- T3212 Time-out value	Infinite
L2 pseudo length	
- System information 1	21
- System information 2	22
- System information 2bis	21
- System information 3	18
- System information 4	12
Location Area Identification	
- Mobile Country Code	001 decimal
- Mobile Network Code	01 decimal
- Location Area Code	0001H
Message Type	
- System information 1	00011001
- System information 2	00011010
- System information 2bis	00000010
- System information 3	00011011
- System information 4	00011100
- System information 5	00011101
- System information 5bis	00000101
- System information 6	00011110
NCC Permitted	0000 0010
RACH Control Parameters	
- Max Retrans	Max 1 retrans
- Tx-integer	5 slots used
- Cell Barred for Access	Cell is not barred
- Call Reestablishment Allowed	Not allowed
- Access Control Class	Access is not barred
- Emergency Call allowed	Yes
SI 1 rest octets	Not used (all bits are set to spare)
SI 2 rest octets	Not used (all bits are set to spare)
SI 3 rest octets	Not used (all bits are set to spare)
SI 4 rest octets	Not used (all bits are set to spare)

Default settings for cell A:

Downlink input level	63 dBmicroVolt emf
Uplink output power	minimum supported by the MS's power class
Propagation profile	static
BCCH/CCCH carrier number	20

Default settings for cell B:

Downlink input level	53 dBmicroVolt emf
Uplink output power	minimum supported by the MS's power class
Propagation profile	static
BCCH/CCCH carrier number	10

Default message contents for other messages

For sections 26.10.1 to 26.10.2.5	same as in 26.6.14
For section 26.10.3	same as in 26.9.7

26.11 Multiband signalling

26.11.1 General considerations

This section applies only to Multiband mobile stations, as defined in GSM 02.06 section 3.2.1.

Conformance requirements of section 26 fully apply to any Multiband MS in the whole supported band(s) of operation of the mobile station.

A Multiband mobile station has the functionality to perform handover, channel assignment, cell selection and re-selection between all its bands of operation within a PLMN.

A Multiband mobile station shall meet all requirements specified for each individual band. In addition it shall meet the extra functional requirements for multiband mobile stations.

The purpose of this section is to test these extra functional requirements for a multiband mobile station.

26.11.2 Multiband signalling / RR

26.11.2.1 Multiband signalling / RR / Immediate assignment procedure

To inform the multiband network of the MSs additional frequency and power capability, the multiband MS has to send a CLASSMARK CHANGE as soon as possible in a connection establishment.

26.11.2.1.1 Conformance requirement

Following a PAGING REQUEST message, the MS shall correctly set up an RR connection on a supported channel described in the IMMEDIATE ASSIGNMENT message. On the MS side, the procedure is terminated when the establishment of the main signalling link is confirmed. When the ES bit is set to 1 in the Classmark 1 or the Classmark 2 information element and the Early Sending Classmark Control bit is set to 0 in SI3 Rest Octets, then the MS shall send, on the first occasion, the CLASSMARK CHANGE message.

During a contention resolution procedure, if the last timeslot of the block containing a L2 UA frame occurs at time T, then the MS shall be ready to transmit the CLASSMARK CHANGE before T + 40 ms.

Reference(s)

GSM 04.08 sections 3.3.1.1.2 and 3.3.1.1.4.

GSM 04.13 section 5.2.11.

GSM 05.10 section 06.10

26.11.2.1.2 Test purpose

To verify that the MS can correctly set up a dedicated control channel and that a multi band MS is able to perform early sending of CLASSMARK CHANGE.

To verify the performance requirement on early sending of the CLASSMARK CHANGE message.

26.11.2.1.3 Method of test

Initial Conditions

System Simulator:

For 450/900 MS: 1 cell.

CCCH-CONF is set to "1 basic physical channel used for CCCH not combined with SDCCHs".
BCCH carrier number 263.

For 480/900 MS: 1 cell.

CCCH-CONF is set to "1 basic physical channel used for CCCH not combined with SDCCHs".
BCCH carrier number 310.

For 450/1800 MS: 1 cell.

CCCH-CONF is set to "1 basic physical channel used for CCCH not combined with SDCCHs".
BCCH carrier number 263.

For 480/1800 MS: 1 cell.

CCCH-CONF is set to "1 basic physical channel used for CCCH not combined with SDCCHs".
BCCH carrier number 310.

For 900/1800 MS: 1 cell.

CCCH-CONF is set to "1 basic physical channel used for CCCH not combined with SDCCHs".
BCCH carrier number 20.

Mobile Station:

The MS is in the "idle, updated" state, with a TMSI allocated.

Related PICS/PIXIT Statement(s)

Type of MS (Multiband).

Frequency bands supported.

Support rate(s) of TCH: TCH/F and/or TCH/H.

Foreseen Final State of the MS

"Idle, updated", with TMSI allocated.

Test Procedure

The test is performed twice, first time in the lower band (BCCH carrier number 20, 263 or 310) and second time in the upper band (BCCH carrier number 20 or 590).

The System Simulator pages the MS and after the MS has responded with a CHANNEL REQUEST message the SS assigns an SDCCH. The MS shall go to the correct channel and send a PAGING RESPONSE message followed by a CLASSMARK CHANGE message. Then the SS initiates RR-release by sending a CHANNEL RELEASE message.

Before the procedure is repeated, the SS is reconfigured to transmit BCCH carrier in the upper band of operation (ARFCN 20 or 590).

Maximum Duration of Test

6 seconds per value of the execution timer and 1 min for reconfiguring the SS.

Expected Sequence

This sequence is performed for execution counter $k = 1, 2$.

Step	Direction	Message	Comments
1	SS -> MS	PAGING REQUEST TYPE 1	Channel Type: SDCCH/8 Shall be sent on the correct channel Shall be ready to transmit (see GSM 05.10 section 06.10) within 40 ms after the completion of step 4. Shall indicate the MS frequency and power capabilities Note: In this case 'ready to transmit' shall result in the actual transmission of the Classmark Change 51 frames later ($51 * 4.62\text{ms} = 235.62\text{ms}$). Therefore receipt of the Classmark Change within 250ms of step 4 is required.
2	MS -> SS	CHANNEL REQUEST	
3	SS -> MS	IMMEDIATE ASSIGNMENT	
4	MS -> SS	SABM (PAGING RESPONSE)	
5	SS -> MS	UA (PAGING RESPONSE)	
6	MS -> SS	CLASSMARK CHANGE	
7	SS -> MS	CHANNEL RELEASE	

Specific Message Contents

For 450/900 MS:

IMMEDIATE ASSIGNMENT

As default except:

Information element	Value/remark
Channel description <ul style="list-style-type: none"> - Channel Type - Timeslot number - Training sequence code - Hopping channel - Channel selector 	SDCCH/8 Arbitrary but not zero Arbitrary Single RF k=1; ARFCN 263 k=2; ARFCN 20
Mobile Allocation	empty

PAGING RESPONSE

Information element	Value/remark
Protocol Discriminator	RR management
Ciphering Key Sequence number <ul style="list-style-type: none"> - Key Sequence 	Key sequence number previously allocated to MS, or "111" if no key is available
Mobile station Classmark 2 <ul style="list-style-type: none"> - ES IND - RF power capability 	Shall indicate early autonomous sending of CLASSMARK CHANGE corresponding to the frequency band in use k=1; GSM 450 power capability k=2; GSM 900 power capability
Mobile Identity <ul style="list-style-type: none"> - odd/even - Type of identity - Identity digits 	Even TMSI TMSI previously allocated to MS

CLASSMARK CHANGE

Information element	Value/remark
Protocol Discriminator	RR management
Mobile station Classmark 2	
- ES IND	Shall indicate early autonomous sending of CLASSMARK CHANGE
- RF power capability	corresponding to the frequency band in use k=1; GSM 450 power capability k=2; GSM 900 power capability
Additional MS Classmark information	
- Band 1 (P-GSM) supported	According to PICS/PIXIT statement
- Band 2 (E-GSM) supported	According to PICS/PIXIT statement
- R-Band (R-GSM) supported	According to PICS/PIXIT statement
- GSM 400 Band (GSM 450) supported	According to PICS/PIXIT statement
- GSM400 Associated radio capability	Corresponding to GSM 400 band
- Associated radio capability 1	Corresponding to GSM 900 band
- R-Band Associated radio capability	Corresponding to R-GSM 900 band

For 480/900 MS:

IMMEDIATE ASSIGNMENT

As default except:

Information element	Value/remark
Channel description	
- Channel Type	SDCCH/8
- Timeslot number	Arbitrary but not zero
- Training sequence code	Arbitrary
- Hopping channel	Single RF
- Channel selector	k=1; ARFCN 310 k=2; ARFCN 20
Mobile Allocation	empty

PAGING RESPONSE

Information element	Value/remark
Protocol Discriminator	RR management
Ciphering Key Sequence number	
- Key Sequence	Key sequence number previously allocated to MS, or "111" if no key is available
Mobile station Classmark 2	
- ES IND	Shall indicate early autonomous sending of CLASSMARK CHANGE
- RF power capability	corresponding to the frequency band in use k=1; GSM 480 power capability k=2; GSM 900 power capability
Mobile Identity	
- odd/even	Even
- Type of identity	TMSI
- Identity digits	TMSI previously allocated to MS

CLASSMARK CHANGE

Information element	Value/remark
Protocol Discriminator	RR management
Mobile station Classmark 2	
- ES IND	Shall indicate early autonomous sending of CLASSMARK CHANGE
- RF power capability	corresponding to the frequency band in use k=1; GSM 480 power capability k=2; GSM 900 power capability
Additional MS Classmark information	
- Band 1 (P-GSM) supported	According to PICS/PIXIT statement
- Band 2 (E-GSM) supported	According to PICS/PIXIT statement
- R-Band (R-GSM) supported	According to PICS/PIXIT statement
- GSM 400 Band (GSM 480) supported	According to PICS/PIXIT statement
- GSM 400 Associated radio capability	Corresponding to GSM 480 band
- Associated radio capability 1	Corresponding to GSM 900 band
- R-Band Associated radio capability	Corresponding to R-GSM 900 band

For 450/1800 MS:

IMMEDIATE ASSIGNMENT

As default except:

Information element	Value/remark
Channel description	
- Channel Type	SDCCH/8
- Timeslot number	Arbitrary but not zero
- Training sequence code	Arbitrary
- Hopping channel	Single RF
- Channel selector	k=1; ARFCN 263 k=2; ARFCN 590
Mobile Allocation	empty

PAGING RESPONSE

Information element	Value/remark
Protocol Discriminator	RR management
Ciphering Key Sequence number	
- Key Sequence	Key sequence number previously allocated to MS, or "111" if no key is available
Mobile station Classmark 2	
- ES IND	Shall indicate early autonomous sending of CLASSMARK CHANGE
- RF power capability	corresponding to the frequency band in use k=1; GSM 450 power capability k=2; DCS 1 800 power capability
Mobile Identity	
- odd/even	Even
- Type of identity	TMSI
- Identity digits	TMSI previously allocated to MS

CLASSMARK CHANGE

Information element	Value/remark
Protocol Discriminator	RR management
Mobile station Classmark 2	
- ES IND	Shall indicate early autonomous sending of CLASSMARK CHANGE
- RF power capability	corresponding to the frequency band in use k=1; GSM 450 power capability k=2; DCS 1 800 power capability
Additional MS Classmark information	
- Band 3 (DCS 1 800) supported	According to PICS/PIXIT statement
- GSM 400 Band (GSM 450) supported	According to PICS/PIXIT statement
- GSM 400 Associated radio capability	Corresponding to GSM 450 band
- Associated radio capability 2	Corresponding to DCS 1 800 band

For 480/1800 MS:

IMMEDIATE ASSIGNMENT

As default except:

Information element	Value/remark
Channel description	
- Channel Type	SDCCH/8
- Timeslot number	Arbitrary but not zero
- Training sequence code	Arbitrary
- Hopping channel	Single RF
- Channel selector	k=1; ARFCN 310 k=2; ARFCN 590
Mobile Allocation	empty

PAGING RESPONSE

Information element	Value/remark
Protocol Discriminator	RR management
Ciphering Key Sequence number	
- Key Sequence	Key sequence number previously allocated to MS, or "111" if no key is available
Mobile station Classmark 2	
- ES IND	Shall indicate early autonomous sending of CLASSMARK CHANGE
- RF power capability	corresponding to the frequency band in use k=1; GSM 480 power capability k=2; DCS 1 800 power capability
Mobile Identity	
- odd/even	Even
- Type of identity	TMSI
- Identity digits	TMSI previously allocated to MS

CLASSMARK CHANGE

Information element	Value/remark
Protocol Discriminator	RR management
Mobile station Classmark 2	
- ES IND	Shall indicate early autonomous sending of CLASSMARK CHANGE
- RF power capability	corresponding to the frequency band in use k=1; GSM 480 power capability k=2; DCS 1 800 power capability
Additional MS Classmark information	
- Band 3 (DCS 1 800) supported	According to PICS/PIXIT statement
- GSM 400 Band (GSM 480) supported	According to PICS/PIXIT statement
- GSM 400 Associated radio capability	Corresponding to GSM 480 band
- Associated radio capability 2	Corresponding to DCS 1 800 band

For 900/1800 MS:

IMMEDIATE ASSIGNMENT

As default except:

Information element	Value/remark
Channel description	
- Channel Type	SDCCH/8
- Timeslot number	Arbitrary but not zero
- Training sequence code	Arbitrary
- Hopping channel	Single RF
- Channel selector	k=1; ARFCN 20 k=2; ARFCN 590
Mobile Allocation	empty

PAGING RESPONSE

Information element	Value/remark
Protocol Discriminator	RR management
Ciphering Key Sequence number	
- Key Sequence	Key sequence number previously allocated to MS, or "111" if no key is available
Mobile station Classmark 2	
- ES IND	Shall indicate early autonomous sending of CLASSMARK CHANGE
- RF power capability	corresponding to the frequency band in use k=1; GSM 900 power capability k=2; DCS 1 800 power capability
Mobile Identity	
- odd/even	Even
- Type of identity	TMSI
- Identity digits	TMSI previously allocated to MS

CLASSMARK CHANGE

Information element	Value/remark
Protocol Discriminator	RR management
Mobile station Classmark 2	
- ES IND	Shall indicate early autonomous sending of CLASSMARK CHANGE corresponding to the frequency band in use
- RF power capability	k=1; GSM 900 power capability k=2; DCS 1 800 power capability
Additional MS Classmark information	
- Band 1 (P-GSM) supported	According to PICS/PIXIT statement
- Band 2 (E-GSM) supported	According to PICS/PIXIT statement
- Band 3 (DCS 1 800) supported	According to PICS/PIXIT statement
- R-Band (R-GSM) supported	According to PICS/PIXIT statement
- Associated radio capability 1	Corresponding to GSM 900 band
- Associated radio capability 2	Corresponding to DCS 1 800 band
- R-Band Associated radio capability	Corresponding to R-GSM 900 band

26.11.2.2 Multiband signalling / RR / Handover

This section applies to any multiband mobile stations.

The purpose of this extra section is to test the handover where the target cell uses frequencies outside the frequency band of the serving cell.

26.11.2.2.1 Multiband signalling / RR / Handover / successful / active call / non-synchronized

26.11.2.2.1.1 Conformance requirements

The MS shall correctly apply the handover procedure in the non-synchronized case when a call is in progress and when handover is performed from a TCH/F without frequency hopping in one band towards a TCH/F without frequency hopping in another band.

When the MS releases a TCH or SDCCH and returns to idle mode, it shall, as quickly as possible, camp on the BCCH carrier of the cell whose channel has just been released, ie the BCCH carrier indicated in the HANDOVER COMMAND.

A multi band mobile station shall not consider a HANDOVER COMMAND as invalid because it indicates target channel frequencies that are all in a different frequency band to that of the ARFCN in the Cell Description IE.

References

GSM 04.08 sections 3.4.4 and 9.1.15.

GSM 04.13 section 5.2.6.2.

GSM 05.08 section 6.7.1.

26.11.2.2.1.2 Test purpose

To test that when the MS is ordered to make a non-synchronized handover it continuously sends access bursts on the main DCCH until it receives a PHYSICAL INFORMATION message from the SS. To test that the MS correctly handles the Timing Advance IE in the PHYSICAL INFORMATION message. To test that the MS activates the new channel correctly and transmits the HANDOVER COMPLETE message without undue delay. To test that upon release of the TCH, the mobile camps on the BCCH carrier of the cell indicated in the HANDOVER COMMAND.

26.11.2.2.1.3 Method of test

Initial Conditions

For execution counter M =1, 2

System Simulator:

For 450/900 MS: 2 cells, A and B with same LAI, default parameters except:

Cell A has:

BCCH ARFCN = 263

Cell Allocation = (259, 261, 263, 265, 267, 269, 271, 273, 275, 277, 279, 281, 283, 285, 287, 289, 291)

Cell B has:

BCCH ARFCN = 20

Cell Allocation = (10, 17, 20, 26, 34, 42, 45, 46, 52, 59, 66, 73, 74, 75, 76, 108, 114)

The frame numbers of cells A and B shall be different by 100.

The timebase of cells A and B shall be such that the edges of their timeslots are not coincident at the antenna connector.

For 480/900 MS: 2 cells, A and B with same LAI, default parameters except:

Cell A has:

BCCH ARFCN = 310

Cell Allocation = (306, 308, 310, 312, 314, 316, 318, 320, 322, 324, 326, 328, 330, 332, 334, 336, 338)

Cell B has:

BCCH ARFCN = 20

Cell Allocation = (10, 17, 20, 26, 34, 42, 45, 46, 52, 59, 66, 73, 74, 75, 76, 108, 114)

The frame numbers of cells A and B shall be different by 100.

The timebase of cells A and B shall be such that the edges of their timeslots are not coincident at the antenna connector.

For 450/1800 MS: 2 cells, A and B with same LAI, default parameters except:

Cell A has:

BCCH ARFCN = 263

Cell Allocation = (259, 261, 263, 265, 267, 269, 271, 273, 275, 277, 279, 281, 283, 285, 287, 289, 291)

Cell B has:

BCCH ARFCN = 764

Cell Allocation = (739, 743, 746, 749, 756, 758, 761, 764, 771, 779, 782, 791, 798, 829, 832, 844)

The frame numbers of cells A and B shall be different by 100.

The timebase of cells A and B shall be such that the edges of their timeslots are not coincident at the antenna connector.

For 480/1800 MS: 2 cells, A and B with same LAI, default parameters except:

Cell A has:

BCCH ARFCN = 310

Cell Allocation = (306, 308, 310, 312, 314, 316, 318, 320, 322, 324, 326, 328, 330, 332, 334, 336, 338)

Cell B has:

BCCH ARFCN = 764

Cell Allocation = (739, 743, 746, 749, 756, 758, 761, 764, 771, 779, 782, 791, 798, 829, 832, 844)

The frame numbers of cells A and B shall be different by 100.

The timebase of cells A and B shall be such that the edges of their timeslots are not coincident at the antenna connector.

For 900/1800 MS: 2 cells, A and B with same LAI, default parameters except:

Cell A has:

BCCH ARFCN = 20

Cell Allocation = (10, 17, 20, 26, 34, 42, 45, 46, 52, 59, 66, 73, 74, 75, 76, 108, 114)

Cell B has:

BCCH ARFCN = 764

Cell Allocation = (739, 743, 746, 749, 756, 758, 761, 764, 771, 779, 782, 791, 798, 829, 832, 844)

The frame numbers of cells A and B shall be different by 100.

The timebase of cells A and B shall be such that the edges of their timeslots are not coincident at the antenna connector.

Mobile Station:

The MS is in the active state (U10) of a call on cell A. (for execution counter M = 1) and on cell B (for execution counter M=2)

For execution counter M = 3

System Simulator:

For 450/900 MS: 2 cells, A and B with different LAI, default parameters except:

Cell A has :

BCCH ARFCN = 263

Cell Allocation = (259, 261, 263, 265, 267, 269, 271, 273, 275, 277, 279, 281, 283, 285, 287, 289, 291)

Cell B has :

LAI = 0003 H

BCCH ARFCN = 20

Cell Allocation = (10, 17, 20, 26, 34, 42, 45, 46, 52, 59, 66, 73, 74, 75, 76, 108, 114)

The frame numbers of cells A and B shall be the same. The timebase of cells A and B shall be such that the edges of their timeslots are coincident at the antenna connector. ie cells A and B shall be fully synchronised.

For 480/900 MS: 2 cells, A and B with different LAI, default parameters except:

Cell A has :

BCCH ARFCN = 310

Cell Allocation = (306, 308, 310, 312, 314, 316, 318, 320, 322, 324, 326, 328, 330, 332, 334, 336, 338)

Cell B has :

LAI = 0003 H

BCCH ARFCN = 20

Cell Allocation = (10, 17, 20, 26, 34, 42, 45, 46, 52, 59, 66, 73, 74, 75, 76, 108, 114)

The frame numbers of cells A and B shall be the same. The timebase of cells A and B shall be such that the edges of their timeslots are coincident at the antenna connector. ie cells A and B shall be fully synchronised.

For 450/1800 MS: 2 cells, A and B with different LAI, default parameters except:

Cell A has :

BCCH ARFCN = 263

Cell Allocation = (259, 261, 263, 265, 267, 269, 271, 273, 275, 277, 279, 281, 283, 285, 287, 289, 291)

Cell B has :

LAI = 0003 H

BCCH ARFCN = 764

Cell Allocation = (739, 743, 746, 749, 756, 758, 761, 764, 771, 779, 782, 791, 798, 829, 832, 844)

The frame numbers of cells A and B shall be the same. The timebase of cells A and B shall be such that the edges of their timeslots are coincident at the antenna connector. ie cells A and B shall be fully synchronised.

For 480/1800 MS: 2 cells, A and B with different LAI, default parameters except:

Cell A has :

BCCH ARFCN = 310

Cell Allocation = (306, 308, 310, 312, 314, 316, 318, 320, 322, 324, 326, 328, 330, 332, 334, 336, 338)

Cell B has :

LAI = 0003 H

BCCH ARFCN = 764

Cell Allocation = (739, 743, 746, 749, 756, 758, 761, 764, 771, 779, 782, 791, 798, 829, 832, 844)

The frame numbers of cells A and B shall be the same. The timebase of cells A and B shall be such that the edges of their timeslots are coincident at the antenna connector. ie cells A and B shall be fully synchronised.

For 900/1800 MS: 2 cells, A and B with different LAI, default parameters except:

Cell A has :

BCCH ARFCN = 20

Cell Allocation = (10, 17, 20, 26, 34, 42, 45, 46, 52, 59, 66, 73, 74, 75, 76, 108, 114)

Cell B has :

LAI = 0003 H

BCCH ARFCN = 764

Cell Allocation = (739, 743, 746, 749, 756, 758, 761, 764, 771, 779, 782, 791, 798, 829, 832, 844)

The frame numbers of cells A and B shall be the same. The timebase of cells A and B shall be such that the edges of their timeslots are coincident at the antenna connector. ie cells A and B shall be fully synchronised.

Mobile Station:

The MS is successfully registered in the LA of cell A and the MS is in the active state (U10) of a call on cell A.

Related PICS/PIXIT Statements

Supported rate(s) of TCH: TCH/FS and/or TCH/HS.

Support for state U10 of the Call Control protocol.

Support for speech: yes/no

Support of multiband functionality

Foreseen Final State of the MS

For execution counter M = 1

The active state (U10) of a call on cell B.

For execution counter M = 2

The active state (U10) of a call on cell A.

For execution counter M = 3

The MM idle state on cell A.

Test Procedure

The MS is in the active state (U10) of a call on cell A. The SS sends a HANOVER COMMAND on the main DCCH. The MS shall begin to send access bursts on the new DCCH of the target cell. The SS observes the access bursts and after receiving n (n being randomly drawn between values according to table 26.6-2 of section 26.6.5) access bursts, the SS sends one PHYSICAL INFORMATION message with a Timing Advance as specified in table 26.6-1 of section 26.6.5. The MS shall activate the channel in sending and receiving mode. The MS shall establish a signalling link. The MS shall be ready to transmit a HANOVER COMPLETE message, before " x " ms after the end of the PHYSICAL INFORMATION message, but not before a UA frame has been sent by the SS.

The term "ready to transmit" is defined in GSM 04.13. The value of " x " depends upon the target channel and is specified in the specific message contents section.

For execution counter $M = 3$, the call is then released and then the SS sends a CHANNEL RELEASE message. It is then checked for 2 minutes that the MS does not access Cell B.

Maximum Duration of Test

5 minutes, including 1 minute for any necessary operator actions.

Expected Sequence

This sequence is performed for an execution counter $M = 1, 2, 3$ for an MS which supports TCH/F.

Steps after step 7 are only performed for execution counter $M = 3$.

Step	Direction	Message	Comments
0	MS -> SS		The MS and SS are in the active state of a call on the channel described below.
1	SS -> MS	HANOVER COMMAND	See Specific message contents
2	MS -> SS	HANOVER ACCESS	Repeated on every burst of the uplink main DCCH until reception of PHYSICAL INFORMATION. Handover Reference as included in the HANOVER COMMAND.
3	SS -> MS	PHYSICAL INFORMATION	Sent after reception of n HANOVER ACCESS messages. See specific message contents.
4	MS -> SS	SABM	Sent without information field
5	SS -> MS	UA	
6	MS -> SS	HANOVER COMPLETE	The message shall be ready to be transmitted before " x " ms after the completion of step 3.
7	MS -> SS		The MS and SS are in the active state of a call on the channel described below.
8	SS -> MS	RELEASE COMPLETE	steps 8-10 are only performed for execution counter $M = 3$.
9	SS -> MS	CHANNEL RELEASE	
10	SS		The SS checks that for a period of 2 minutes, the MS does not access cell B.

Specific Message Contents **For Mobiles Supporting Speech**

In case of 450/900 MS:

SYSTEM INFORMATION TYPE 5ter

Information Element	Value/remark
Neighbour Cells Description 2 Multiband reporting For Cell A - Format notation - BA_IND - BCCH Allocation ARFCN	0 Bit map 0 0 ARFCN 3, 20, 29, 62, 84, 89, 99 and 119

For M = 1:

Step 0: The MS and SS are using a full rate TCH in non-hopping mode on cell A.

HANDOVER COMMAND

Information Element	value/remarks
As default message contents, except: Cell Description - Network Colour Code - Base Station Colour Code - BCCH Carrier Number Channel description - Channel type - Timeslot number - Training Sequence Code - Hopping - ARFCN Synchronization Indication - Report Observed Time Difference - Synchronization Indication - Normal Cell Indication	 1 5 20 TCH/F + ACCHs Chosen arbitrarily, but not zero Chosen arbitrarily Single RF. Chosen arbitrarily from Cell Allocation for cell B. Shall not be included. "Non synchronized". Ignore out of range timing advance.

PHYSICAL INFORMATION

Information Element	value/remarks
As default message contents.	

Step 6: x = 500.

Step 7: The MS and SS are using a full rate TCH in non hopping mode on cell B.

For M = 2:

Step 0: The MS and SS are using a full rate TCH in non-hopping mode on cell B.

HANDOVER COMMAND

Information Element	value/remarks
As default message contents, except: Cell Description - Network Colour Code - Base Station Colour Code - BCCH Carrier Number Channel Description - Channel Type - Timeslot number - Training Sequence Code - Hopping - MAIO - HSN Synchronization Indication IE is not included. Channel Mode IE is not included. Frequency List after time - Frequency List	1 5 263 TCH/F + ACCHs Chosen arbitrarily, but not Zero Chosen arbitrarily RF hopping channel. Chosen arbitrarily from the set (0, 1 to N-1), where N is the number of frequencies encoded in the Frequency List IE. Chosen arbitrarily from the set (1,2,..63) Allocates the following 12 frequencies (259, 261, 263, 265, 277, 279, 281, 283, 285, 287, 289, 291)

PHYSICAL INFORMATION

Information Element	value/remarks
As default message contents, except: Timing advance	Arbitrarily selected but different to default value.

Step 6: x = 500.

Step 7: The MS and SS are using a full rate TCH in hopping mode on cell A.

For M = 3 :

Step 0 : The MS and SS are using a full rate TCH in hopping mode on cell A.

HANDOVER COMMAND

Information Element	value/remarks
As default message contents, except : Cell Description - Network Colour Code - Base Station Colour Code - BCCH Carrier Number Channel description - Channel type - Timeslot number - Training Sequence Code - Hopping - ARFCN Synchronisation Indication - Report Observed Time Difference - Synchronisation Indication - Normal Cell Indication	1 5 263 TCH/F + ACCHs Chosen arbitrarily, but not zero Chosen arbitrarily Single RF. Chosen arbitrarily from Cell Allocation for cell B. Shall not be included. 'Non synchronised'. Ignore out of range timing advance.

PHYSICAL INFORMATION

Information Element	value/remarks
As default message contents.	

Step 6 : x = 500

Step 7 : The MS and SS are using a full rate TCH in non hopping mode on cell B.

In case of 480/900 MS:

SYSTEM INFORMATION TYPE 5ter

Information Element	Value/remark
Neighbour Cells Description 2 Multiband reporting For Cell A	0
- Format notation	Bit map 0
- BA_IND	0
- BCCH Allocation ARFCN	ARFCN 3, 20, 29, 62, 84, 89, 99 and 119

For M = 1:

Step 0: The MS and SS are using a full rate TCH in non-hopping mode on cell A.

HANDOVER COMMAND

Information Element	value/remarks
As default message contents, except:	
Cell Description	
- Network Colour Code	1
- Base Station Colour Code	5
- BCCH Carrier Number	20
Channel description	
- Channel type	TCH/F + ACCHs
- Timeslot number	Chosen arbitrarily, but not zero
- Training Sequence Code	Chosen arbitrarily
- Hopping	Single RF.
- ARFCN	Chosen arbitrarily from Cell Allocation for cell B.
Synchronization Indication	
- Report Observed Time Difference	Shall not be included.
- Synchronization Indication	"Non synchronized".
- Normal Cell Indication	Ignore out of range timing advance.

PHYSICAL INFORMATION

Information Element	value/remarks
As default message contents.	

Step 6: x = 500.

Step 7: The MS and SS are using a full rate TCH in non hopping mode on cell B.

For M = 2:

Step 0: The MS and SS are using a full rate TCH in non-hopping mode on cell B.

HANDOVER COMMAND

Information Element	value/remarks
As default message contents, except: Cell Description - Network Colour Code - Base Station Colour Code - BCCH Carrier Number Channel Description - Channel Type - Timeslot number - Training Sequence Code - Hopping - MAIO - HSN Synchronization Indication IE is not included. Channel Mode IE is not included. Frequency List after time - Frequency List	1 5 310 TCH/F + ACCHs Chosen arbitrarily, but not Zero Chosen arbitrarily RF hopping channel. Chosen arbitrarily from the set (0, 1 to N-1), where N is the number of frequencies encoded in the Frequency List IE. Chosen arbitrarily from the set (1,2,..63) Allocates the following 12 frequencies (306, 308, 310, 312, 324, 326, 328, 330, 332, 334, 336, 338)

PHYSICAL INFORMATION

Information Element	value/remarks
As default message contents, except: Timing advance	Arbitrarily selected but different to default value.

Step 6: x = 500.

Step 7: The MS and SS are using a full rate TCH in hopping mode on cell A.

For M = 3 :

Step 0 : The MS and SS are using a full rate TCH in hopping mode on cell A.

HANDOVER COMMAND

Information Element	value/remarks
As default message contents, except : Cell Description - Network Colour Code - Base Station Colour Code - BCCH Carrier Number Channel description - Channel type - Timeslot number - Training Sequence Code - Hopping - ARFCN Synchronisation Indication - Report Observed Time Difference - Synchronisation Indication - Normal Cell Indication	1 5 310 TCH/F + ACCHs Chosen arbitrarily, but not zero Chosen arbitrarily Single RF. Chosen arbitrarily from Cell Allocation for cell B. Shall not be included. 'Non synchronised'. Ignore out of range timing advance.

PHYSICAL INFORMATION

Information Element	value/remarks
As default message contents.	

Step 6 : x = 500

Step 7 : The MS and SS are using a full rate TCH in non hopping mode on cell B.

In case of 450/1800 MS:

SYSTEM INFORMATION TYPE 5ter

Information Element	Value/remark
Neighbour Cells Description 2 Multiband reporting For Cell A	0
- Format notation	Range 512
- BA_IND	0
- BCCH Allocation ARFCN	ARFCN 520, 590, 600, 700, 764, 780, 810 and 870

For M = 1:

Step 0: The MS and SS are using a full rate TCH in non-hopping mode on cell A.

HANDOVER COMMAND

Information Element	value/remarks
As default message contents, except:	
Cell Description	
- Network Colour Code	1
- Base Station Colour Code	5
- BCCH Carrier Number	764
Channel description	
- Channel type	TCH/F + ACCHs
- Timeslot number	Chosen arbitrarily, but not zero
- Training Sequence Code	Chosen arbitrarily
- Hopping	Single RF.
- ARFCN	Chosen arbitrarily from Cell Allocation for cell B.
Synchronization Indication	
- Report Observed Time Difference	Shall not be included.
- Synchronization Indication	"Non synchronized".
- Normal Cell Indication	Ignore out of range timing advance.

PHYSICAL INFORMATION

Information Element	value/remarks
As default message contents.	

Step 6: x = 500.

Step 7: The MS and SS are using a full rate TCH in non hopping mode on cell B.

For M = 2:

Step 0: The MS and SS are using a full rate TCH in non-hopping mode on cell B.

HANDOVER COMMAND

Information Element	value/remarks
As default message contents, except: Cell Description - Network Colour Code - Base Station Colour Code - BCCH Carrier Number Channel Description - Channel Type - Timeslot number - Training Sequence Code - Hopping - MAIO - HSN Synchronization Indication IE is not included. Channel Mode IE is not included. Frequency List after time - Frequency List	1 5 263 TCH/F + ACCHs Chosen arbitrarily, but not Zero Chosen arbitrarily RF hopping channel. Chosen arbitrarily from the set (0, 1 to N-1), where N is the number of frequencies encoded in the Frequency List IE. Chosen arbitrarily from the set (1,2,..63) Allocates the following 12 frequencies (259, 261, 263, 265, 277, 279, 281, 283, 285, 287, 289, 291)

PHYSICAL INFORMATION

Information Element	value/remarks
As default message contents, except: Timing advance	Arbitrarily selected but different to default value.

Step 6: x = 500.

Step 7: The MS and SS are using a full rate TCH in hopping mode on cell A.

For M = 3 :

Step 0 : The MS and SS are using a full rate TCH in hopping mode on cell A.

HANDOVER COMMAND

Information Element	value/remarks
As default message contents, except : Cell Description - Network Colour Code - Base Station Colour Code - BCCH Carrier Number Channel description - Channel type - Timeslot number - Training Sequence Code - Hopping - ARFCN Synchronisation Indication - Report Observed Time Difference - Synchronisation Indication - Normal Cell Indication	1 5 263 TCH/F + ACCHs Chosen arbitrarily, but not zero Chosen arbitrarily Single RF. Chosen arbitrarily from Cell Allocation for cell B. Shall not be included. 'Non synchronised'. Ignore out of range timing advance.

PHYSICAL INFORMATION

Information Element	value/remarks
As default message contents.	

Step 6 : x = 500

Step 7 : The MS and SS are using a full rate TCH in non hopping mode on cell B.

In case of 480/1800 MS:

SYSTEM INFORMATION TYPE 5ter

Information Element	Value/remark
Neighbour Cells Description 2 Multiband reporting For Cell A	0
- Format notation	Range 512
- BA_IND	0
- BCCH Allocation ARFCN	ARFCN 520, 590, 600, 700, 764, 780, 810 and 870

For M = 1:

Step 0: The MS and SS are using a full rate TCH in non-hopping mode on cell A.

HANDOVER COMMAND

Information Element	value/remarks
As default message contents, except:	
Cell Description	
- Network Colour Code	1
- Base Station Colour Code	5
- BCCH Carrier Number	764
Channel description	
- Channel type	TCH/F + ACCHs
- Timeslot number	Chosen arbitrarily, but not zero
- Training Sequence Code	Chosen arbitrarily
- Hopping	Single RF.
- ARFCN	Chosen arbitrarily from Cell Allocation for cell B.
Synchronization Indication	
- Report Observed Time Difference	Shall not be included.
- Synchronization Indication	"Non synchronized".
- Normal Cell Indication	Ignore out of range timing advance.

PHYSICAL INFORMATION

Information Element	value/remarks
As default message contents.	

Step 6: x = 500.

Step 7: The MS and SS are using a full rate TCH in non hopping mode on cell B.

For M = 2:

Step 0: The MS and SS are using a full rate TCH in non-hopping mode on cell B.

HANDOVER COMMAND

Information Element	value/remarks
As default message contents, except: Cell Description - Network Colour Code - Base Station Colour Code - BCCH Carrier Number Channel Description - Channel Type - Timeslot number - Training Sequence Code - Hopping - MAIO - HSN Synchronization Indication IE is not included. Channel Mode IE is not included. Frequency List after time - Frequency List	1 5 310 TCH/F + ACCHs Chosen arbitrarily, but not Zero Chosen arbitrarily RF hopping channel. Chosen arbitrarily from the set (0, 1 to N-1), where N is the number of frequencies encoded in the Frequency List IE. Chosen arbitrarily from the set (1,2,..63) Allocates the following 12 frequencies (306, 308, 310, 312, 324, 326, 328, 330, 332, 334, 336, 338)

PHYSICAL INFORMATION

Information Element	value/remarks
As default message contents, except: Timing advance	Arbitrarily selected but different to default value.

Step 6: x = 500.

Step 7: The MS and SS are using a full rate TCH in hopping mode on cell A.

For M = 3 :

Step 0 : The MS and SS are using a full rate TCH in hopping mode on cell A.

HANDOVER COMMAND

Information Element	value/remarks
As default message contents, except : Cell Description - Network Colour Code - Base Station Colour Code - BCCH Carrier Number Channel description - Channel type - Timeslot number - Training Sequence Code - Hopping - ARFCN Synchronisation Indication - Report Observed Time Difference - Synchronisation Indication - Normal Cell Indication	1 5 310 TCH/F + ACCHs Chosen arbitrarily, but not zero Chosen arbitrarily Single RF. Chosen arbitrarily from Cell Allocation for cell B. Shall not be included. 'Non synchronised'. Ignore out of range timing advance.

PHYSICAL INFORMATION

Information Element	value/remarks
As default message contents.	

Step 6 : x = 500

Step 7 : The MS and SS are using a full rate TCH in non hopping mode on cell B.

In case of 900/1800 MS:

SYSTEM INFORMATION TYPE 5ter

Information Element	Value/remark
Neighbour Cells Description 2 Multiband reporting For Cell A	0
- Format notation	Range 512
- BA_IND	0
- BCCH Allocation ARFCN	ARFCN 520, 590, 600, 700, 764, 780, 810 and 870

For M = 1:

Step 0: The MS and SS are using a full rate TCH in non-hopping mode on cell A.

HANDOVER COMMAND

Information Element	value/remarks
As default message contents, except:	
Cell Description	
- Network Colour Code	1
- Base Station Colour Code	5
- BCCH Carrier Number	764
Channel description	
- Channel type	TCH/F + ACCHs
- Timeslot number	Chosen arbitrarily, but not zero
- Training Sequence Code	Chosen arbitrarily
- Hopping	Single RF.
- ARFCN	Chosen arbitrarily from Cell Allocation for cell B.
Synchronization Indication	
- Report Observed Time Difference	Shall not be included.
- Synchronization Indication	"Non synchronized".
- Normal Cell Indication	Ignore out of range timing advance.

PHYSICAL INFORMATION

Information Element	value/remarks
As default message contents.	

Step 6: x = 500.

Step 7: The MS and SS are using a full rate TCH in non hopping mode on cell B.

For M = 2:

Step 0: The MS and SS are using a full rate TCH in non-hopping mode on cell B.

HANDOVER COMMAND

Information Element	value/remarks
As default message contents, except: Cell Description - Network Colour Code - Base Station Colour Code - BCCH Carrier Number Channel Description - Channel Type - Timeslot number - Training Sequence Code - Hopping - MAIO - HSN Synchronization Indication IE is not included. Channel Mode IE is not included. Frequency Channel Sequence after time - Frequency Channel Sequence	1 5 20 TCH/F + ACCHs Chosen arbitrarily, but not Zero Chosen arbitrarily RF hopping channel. Chosen arbitrarily from the set (0, 1 to N-1), where N is the number of frequencies encoded in the Frequency Channel Sequence IE. Chosen arbitrarily from the set (1,2,..63) Allocates the following 12 frequencies (10, 17, 20, 26, 59, 66, 73, 74, 75, 76,108, 114)

PHYSICAL INFORMATION

Information Element	value/remarks
As default message contents, except: Timing advance	Arbitrarily selected but different to default value.

Step 6: x = 500.

Step 7: The MS and SS are using a full rate TCH in hopping mode on cell A.

For M = 3 :

Step 0 : The MS and SS are using a full rate TCH in hopping mode on cell A.

HANDOVER COMMAND

Information Element	value/remarks
As default message contents, except : Cell Description - Network Colour Code - Base Station Colour Code - BCCH Carrier Number Channel description - Channel type - Timeslot number - Training Sequence Code - Hopping - ARFCN Synchronisation Indication - Report Observed Time Difference - Synchronisation Indication - Normal Cell Indication	1 5 20 TCH/F + ACCHs Chosen arbitrarily, but not zero Chosen arbitrarily Single RF. Chosen arbitrarily from Cell Allocation for cell B. Shall not be included. 'Non synchronised'. Ignore out of range timing advance.

PHYSICAL INFORMATION

Information Element	value/remarks
As default message contents.	

Step 6 : $x = 500$

Step 7 : The MS and SS are using a full rate TCH in non hopping mode on cell B.

26.11.2.2.2 Multiband signalling / RR / Handover / layer 1 failure

26.11.2.2.2.1 Conformance requirements

During a handover from a channel in the lower band to a channel in the upper band, or the contrary, the MS shall correctly return to the old channel in the case of an handover failure caused by a layer 1 failure on the target cell.

References

GSM 04.08 section 3.4.4.

26.11.2.2.2.2 Test purpose

To check that the MS correctly returns to the old channel in the case of an handover failure caused by a layer 1 failure on the target cell, if the origin is in the lower band and the target is in the upper band or the contrary.

26.11.2.2.2.3 Method of test

Initial Conditions

System Simulator:

For 450/900 MS: 2 cells, A and B with same LAI, default parameters except:

Cell A has:

BCCH ARFCN = 263.

Cell B has:

BCCH ARFCN = 20.

For 480/900 MS: 2 cells, A and B with same LAI, default parameters except:

Cell A has:

BCCH ARFCN = 310.

Cell B has:

BCCH ARFCN = 20.

For 450/1800 MS: 2 cells, A and B with same LAI, default parameters except:

Cell A has:

BCCH ARFCN = 263.

Cell B has:

BCCH ARFCN = 764.

For 480/1800 MS: 2 cells, A and B with same LAI, default parameters except:

Cell A has:

BCCH ARFCN = 310.

Cell B has:

BCCH ARFCN = 764.

For 900/1800 MS: 2 cells, A and B with same LAI, default parameters except:

Cell A has:

BCCH ARFCN = 20.

Cell B has:

BCCH ARFCN = 764.

Mobile Station:

The MS is in the active state (U10) of a call on cell A. Used power level is the maximum supported by the MS in the band in use.

Related PICS/PIXIT Statements

Supported rate(s) of TCH: TCH/F.
 Support for state U10 of the Call Control protocol.
 Support for multiband functionality.

Foreseen Final State of the MS

The active state (U10) of a mobile call on cell A. Used power level is the maximum supported by the MS in the band in use.

Test Procedure

The MS is in the active state (U10) of a call on cell A. The SS sends a HANOVER COMMAND on the main DCCH. The MS shall begin to send access bursts at the commanded power level on the new DCCH to cell B. With the exception of normal BCCH signalling, the SS does not transmit anything on cell B (thus causing a time-out of T3124). The MS shall re-establish the old link on cell A and send a HANOVER FAILURE within 3 seconds from the transmission of HANOVER COMMAND, using the old power level.

Maximum Duration of Test

5 minutes, including 1 minute for any necessary operator actions.

Expected Sequence

Step	Direction	Message	Comments
0	SS	-	The SS records the power level in the layer 1 header of the last SACCH message sent by the MS before step 1.
1	SS -> MS	HANOVER COMMAND	Channel description: non-hopping, full rate. Synchronisation Indication: non synchronised.
2	MS -> SS	HANOVER ACCESS	Several messages are sent, all with correct Handover References.
3	MS -> SS	HANOVER FAILURE	Sent on old channel, RR cause value ="Abnormal release, unspecified", "Abnormal release, channel unacceptable", "Abnormal release, timer expired", "Abnormal release, no activity on the radio path" or "Protocol error unspecified". Layer 1 header has the same power level as the layer 1 header in step 1. Shall be sent within 3 seconds from the transmission of HANOVER COMMAND.
4	SS	-	The SS checks that the power level reported in the layer 1 header of the SACCH message that is sent in the first SACCH multiframe following the SABM is the same as in step 0.

Specific Message Contents

For 450/900 MS:

SYSTEM INFORMATION TYPE 5ter

Information Element	Value/remark
Neighbour Cells Description 2	0
Multiband reporting	
For Cell A	
- Format notation	Bit map 0
- BA_IND	0
- BCCH Allocation ARFCN	ARFCN 3, 20, 29, 62, 84, 89, 99 and 119

HANDOVER COMMAND

Information Element	value/remarks
As default message contents, except:	
Cell Description	
- Network Colour Code	1
- Base Station Colour Code	5
- BCCH Carrier Number	20
Channel description	
- Channel type	TCH/F + ACCHs
- Timeslot number	Chosen arbitrarily, but not zero
- Training Sequence Code	Chosen arbitrarily
- Hopping	Single RF.
- ARFCN	Chosen arbitrarily from Cell Allocation for cell B.
Synchronization Indication	
- Report Observed Time Difference	Shall not be included.
- Synchronization Indication	"Non synchronized".
- Normal Cell Indication	Ignore out of range timing advance.

For 480/900 MS:

SYSTEM INFORMATION TYPE 5ter

Information Element	Value/remark
Neighbour Cells Description 2	0
Multiband reporting	
For Cell A	
- Format notation	Bit map 0
- BA_IND	0
- BCCH Allocation ARFCN	ARFCN 3, 20, 29, 62, 84, 89, 99 and 119

HANDOVER COMMAND

Information Element	value/remarks
As default message contents, except:	
Cell Description	
- Network Colour Code	1
- Base Station Colour Code	5
- BCCH Carrier Number	20
Channel description	
- Channel type	TCH/F + ACCHs
- Timeslot number	Chosen arbitrarily, but not zero
- Training Sequence Code	Chosen arbitrarily
- Hopping	Single RF.
- ARFCN	Chosen arbitrarily from Cell Allocation for cell B.
Synchronization Indication	
- Report Observed Time Difference	Shall not be included.
- Synchronization Indication	"Non synchronized".
- Normal Cell Indication	Ignore out of range timing advance.

For 450/1800 MS:

SYSTEM INFORMATION TYPE 5ter

Information Element	Value/remark
Neighbour Cells Description 2 Multiband reporting For Cell A	0
- Format notation	Range 512
- BA_IND	0
- BCCH Allocation ARFCN	ARFCN 520, 590, 600, 700, 764, 780, 810 and 870

HANDOVER COMMAND

Information Element	value/remarks
As default message contents, except:	
Cell Description	
- Network Colour Code	1
- Base Station Colour Code	5
- BCCH Carrier Number	764
Channel description	
- Channel type	TCH/F + ACCHs
- Timeslot number	Chosen arbitrarily, but not zero
- Training Sequence Code	Chosen arbitrarily
- Hopping	Single RF.
- ARFCN	Chosen arbitrarily from Cell Allocation for cell B.
Synchronization Indication	
- Report Observed Time Difference	Shall not be included.
- Synchronization Indication	"Non synchronized".
- Normal Cell Indication	Ignore out of range timing advance.

For 480/1800 MS:

SYSTEM INFORMATION TYPE 5ter

Information Element	Value/remark
Neighbour Cells Description 2 Multiband reporting For Cell A	0
- Format notation	Range 512
- BA_IND	0
- BCCH Allocation ARFCN	ARFCN 520, 590, 600, 700, 764, 780, 810 and 870

HANDOVER COMMAND

Information Element	value/remarks
As default message contents, except:	
Cell Description	
- Network Colour Code	1
- Base Station Colour Code	5
- BCCH Carrier Number	764
Channel description	
- Channel type	TCH/F + ACCHs
- Timeslot number	Chosen arbitrarily, but not zero
- Training Sequence Code	Chosen arbitrarily
- Hopping	Single RF.
- ARFCN	Chosen arbitrarily from Cell Allocation for cell B.
Synchronization Indication	
- Report Observed Time Difference	Shall not be included.
- Synchronization Indication	"Non synchronized".
- Normal Cell Indication	Ignore out of range timing advance.

For 900/1800 MS:

SYSTEM INFORMATION TYPE 5ter

Information Element	Value/remark
Neighbour Cells Description 2	0
Multiband reporting	
For Cell A	
- Format notation	Range 512
- BA_IND	0
- BCCH Allocation ARFCN	ARFCN 520, 590, 600, 700, 764, 780, 810 and 870

HANDOVER COMMAND

Information Element	value/remarks
As default message contents, except:	
Cell Description	
- Network Colour Code	1
- Base Station Colour Code	5
- BCCH Carrier Number	764
Channel description	
- Channel type	TCH/F + ACCHs
- Timeslot number	Chosen arbitrarily, but not zero
- Training Sequence Code	Chosen arbitrarily
- Hopping	Single RF.
- ARFCN	Chosen arbitrarily from Cell Allocation for cell B.
Synchronization Indication	
- Report Observed Time Difference	Shall not be included.
- Synchronization Indication	"Non synchronized".
- Normal Cell Indication	Ignore out of range timing advance.

26.11.2.2.3 Multiband signalling / RR / Handover / Multiband BCCH / successful / active call / non synchronized

26.11.2.2.3.1 Conformance requirements

This test relates to cells supporting frequencies in GSM 400, GSM 900 and DCS 1800 bands.

The MS shall correctly apply the handover procedure in the non synchronized case when a call is in progress and when handover is performed from a TCH/F without frequency hopping in one band towards a TCH/F either with frequency hopping or not in another band.

References

GSM 04.08 sections 3.4.4 and 9.1.15.

GSM 04.13 section 5.2.6.2.

GSM 05.08 section 6.7.1.

26.11.2.2.3.2 Test purpose

To test that when the MS is ordered to make a non synchronized handover it sends continuously access bursts on the main DCCH until it receives a PHYSICAL INFORMATION message from the SS. To test that the MS correctly handles the Timing Advance IE in the PHYSICAL INFORMATION. To test that the MS activates the new channel correctly and transmits the HANDOVER COMPLETE message without undue delay.

26.11.2.2.3.3 Method of test

Initial Conditions

For execution counter M =1, 2.

System Simulator:

For 450/900 MS: 2 cells, A and B with same LAI, default parameters except:

Cell A has:

BCCH ARFCN = 263

GSM 450 frequencies: 259, 263, 267, 271, 275, 279, 283, 291.

GSM 900 frequencies: 10, 20, 34, 45, 52, 66, 74, 114.

Cell B has:

BCCH ARFCN = 268

GSM 450 frequencies: 260, 261, 268, 277, 281, 287, 288, 289.

GSM 900 frequencies: 14, 17, 32, 59, 73, 76, 87, 108.

For 480/900 MS: 2 cells, A and B with same LAI, default parameters except:

Cell A has:

BCCH ARFCN = 310

GSM 480 frequencies: 306, 310, 314, 318, 322, 326, 332, 338.

GSM 900 frequencies: 10, 20, 34, 45, 52, 66, 74, 114.

Cell B has:

BCCH ARFCN = 315

GSM 480 frequencies: 307, 308, 315, 324, 328, 334, 335, 336.

GSM 900 frequencies: 14, 17, 32, 59, 73, 76, 87, 108.

For 450/1800 MS: 2 cells, A and B with same LAI, default parameters except:

Cell A has:

BCCH ARFCN = 263

GSM 450 frequencies: 259, 263, 267, 271, 275, 279, 283, 291.

DCS 1800 frequencies: 739, 746, 756, 761, 771, 782, 798, 832.

Cell B has:

BCCH ARFCN = 268

GSM 450 frequencies: 260, 261, 268, 277, 281, 287, 288, 289.

DCS 1800 frequencies: 743, 749, 758, 764, 779, 791, 829, 844.

For 480/1800 MS: 2 cells, A and B with same LAI, default parameters except:

Cell A has:

BCCH ARFCN = 310

GSM 480 frequencies: 306, 310, 314, 318, 322, 326, 332, 338.

DCS 1800 frequencies: 739, 746, 756, 761, 771, 782, 798, 832.

Cell B has:

BCCH ARFCN = 315

GSM 480 frequencies: 307, 308, 315, 324, 328, 334, 335, 336.

DCS 1800 frequencies: 743, 749, 758, 764, 779, 791, 829, 844.

For 900/1800 MS: 2 cells, A and B with same LAI, default parameters except:

Cell A has:

BCCH ARFCN = 20

GSM 900 frequencies: 10, 20, 34, 45, 52, 66, 74, 114.

DCS 1800 frequencies: 739, 746, 756, 761, 771, 782, 798, 832.

Cell B has:

BCCH ARFCN = 32

GSM 900 frequencies: 14, 17, 32, 59, 73, 76, 87, 108.

DCS 1800 frequencies: 743, 749, 758, 764, 779, 791, 829, 844.

Mobile Station:

For execution counter $M = 1$, the MS is in the active state (U10) of a call on cell A, using a TCH in the lower band.

For execution counter $M = 2$, the MS is in the active state (U10) of a call on cell B, using a TCH in the upper band.

Related PICS/PIXIT Statements

Supported rate(s) of TCH: TCH/FS and/or TCH/HS.

Support for state U10 of the Call Control protocol.

Support for speech: yes/no

Support of multiband functionality

Foreseen Final State of the MS

For execution counter $M = 1$

The active state (U10) of a call with a TCH in the upper band on cell B.

For execution counter $M = 2$

The active state (U10) of a call in hopping mode in the upper band on cell A.

Test Procedure

The MS is in the active state (U10) of a call. The SS sends a HANDOVER COMMAND on the main DCCH. The MS shall begin to send access bursts on the new DCCH of the target cell. The SS observes the access bursts and after receiving n (n being randomly drawn between values [10-20]) access bursts, the SS sends one PHYSICAL INFORMATION message with an arbitrary Timing Advance. The MS shall activate the channel in sending and receiving mode. The MS shall establish a signalling link. The MS shall be ready to transmit a HANDOVER

COMPLETE message, before "x" ms after the end of the PHYSICAL INFORMATION message, but not before a UA frame has been sent by the SS.

The term "ready to transmit" is defined in GSM 04.13. The value of "x" depends upon the target channel and is specified in the specific message contents section.

Maximum Duration of Test

5 minutes, including 1 minute for any necessary operator actions.

Expected Sequence

This sequence is performed for an execution counter M = 1 and 2 for an MS which supports TCH/F.

Step	Direction	Message	Comments
0	MS -> SS		M=1, The MS and SS are using a full rate TCH in lower band, in non hopping mode on cell A. M=2, the MS and SS are using a full rate TCH in upper band, in non hopping mode on cell B.
1	SS -> MS	HANDOVER COMMAND	See Specific message contents
2	MS -> SS	HANDOVER ACCESS	Repeated on every burst of the uplink main DCCH until reception of PHYSICAL INFORMATION. Handover Reference as included in the HANDOVER COMMAND.
3	SS -> MS	PHYSICAL INFORMATION	Sent after reception of n HANDOVER ACCESS messages. See specific message contents.
4	MS -> SS	SABM	Sent without information field
5	SS -> MS	UA	
6	MS -> SS	HANDOVER COMPLETE	The message shall be ready to be transmitted before "x" ms after the completion of step 3.
7	MS -> SS		The MS and SS are in the active state of a call.

For 450/900 MS:

For M = 1:

Step 0: The MS and SS are using a full rate TCH in the GSM 450 band, in non-hopping mode on cell A.

HANDOVER COMMAND

Information Element	value/remarks
As default message contents, except:	
Cell Description	
- Network Colour Code	1
- Base Station Colour Code	5
- BCCH Carrier Number	268
Channel description	
- Channel type	TCH/F + ACCHs
- Timeslot number	Chosen arbitrarily
- Training Sequence Code	Chosen arbitrarily
- Hopping	Single RF Channel.
- ARFCN	Chosen arbitrarily from the GSM 900 frequencies allocated to the cell.
Handover Reference	
- Value	Chosen arbitrarily from the range (0, 1..255)
Power command	
- Power Level	Arbitrarily chosen, but different to the one already in use and within the range supported by that type of MS.
Synchronization Indication	
- Report Observed Time Difference	Shall not be included.
- Synchronization Indication	"Non Synchronized".
- Normal Cell Indication	Ignore out of range timing advance.

PHYSICAL INFORMATION

Information Element	value/remarks
As default message contents, except:	

Step 6: x = 650 ms.

Step 7: The MS and SS are using a full rate TCH in the GSM 900 band, in non hopping mode on cell B.

For M = 2:

Step 0: The MS and SS are using a full rate TCH in the GSM 900 band, in non-hopping mode on cell B.

HANDOVER COMMAND

Information Element	value/remarks
As default message contents, except:	
Cell Description	
- Network Colour Code	1
- Base Station Colour Code	5
- BCCH Carrier Number	263
Channel Description	
- Channel Type	TCH/F + ACCHs
- Timeslot number	Chosen arbitrarily
- Training Sequence Code	Chosen arbitrarily
- Hopping	RF hopping channel.
- MAIO	Chosen arbitrarily from the set (0, 1 to N-1), where N is the number of frequencies in the Mobile Allocation IE.
- HSN	Chosen arbitrarily from the set (1,2,..63)
Handover Reference	
- Value	Chosen arbitrarily from the range (0, 1..255)
Power command	
- Power Level	Arbitrarily chosen, but different to the one already in use and within the range supported by that type of MS.
Synchronization Indication.	
- Report Observed Time Difference	Shall not be included
- Synchronization Indication	"Non Synchronized".
- Normal Cell Indication	Ignore out of range timing advance
Cell Channel Description:	GSM 450 frequencies: 259, 263, 267, 271, 275, 279, 283, 291
	GSM 900 frequencies: 10, 20, 34, 45, 52, 66, 74, 114
Channel Mode IE is not included.	
Mobile Allocation	Indicates GSM 900 frequencies (10, 34, 45, 66, 114).

PHYSICAL INFORMATION

Information Element	value/remarks
As default message contents, except:	
Timing Advance	Arbitrarily selected but different to default value.

Step 6: x = 650 ms.

Step 7: The MS and SS are using a full rate TCH in hopping mode in the GSM 900 band on cell A.

For 480/900 MS:

For M = 1:

Step 0: The MS and SS are using a full rate TCH in the GSM 480 band, in non-hopping mode on cell A.

HANDOVER COMMAND

Information Element	value/remarks
As default message contents, except:	
Cell Description	
- Network Colour Code	1
- Base Station Colour Code	5
- BCCH Carrier Number	315
Channel description	
- Channel type	TCH/F + ACCHs
- Timeslot number	Chosen arbitrarily
- Training Sequence Code	Chosen arbitrarily
- Hopping	Single RF Channel.
- ARFCN	Chosen arbitrarily from the GSM 900 frequencies allocated to the cell.
Handover Reference	
- Value	Chosen arbitrarily from the range (0, 1..255)
Power command	
- Power Level	Arbitrarily chosen, but different to the one already in use and within the range supported by that type of MS.
Synchronization Indication	
- Report Observed Time Difference	Shall not be included.
- Synchronization Indication	"Non Synchronized".
- Normal Cell Indication	Ignore out of range timing advance.

PHYSICAL INFORMATION

Information Element	value/remarks
As default message contents, except:	

Step 6: x = 650 ms.

Step 7: The MS and SS are using a full rate TCH in the GSM 900 band, in non hopping mode on cell B.

For M = 2:

Step 0: The MS and SS are using a full rate TCH in the GSM 900 band, in non-hopping mode on cell B.

HANDOVER COMMAND

Information Element	value/remarks
As default message contents, except:	
Cell Description	
- Network Colour Code	1
- Base Station Colour Code	5
- BCCH Carrier Number	310
Channel Description	
- Channel Type	TCH/F + ACCHs
- Timeslot number	Chosen arbitrarily
- Training Sequence Code	Chosen arbitrarily
- Hopping	RF hopping channel.
- MAIO	Chosen arbitrarily from the set (0, 1 to N-1), where N is the number of frequencies in the Mobile Allocation IE.
- HSN	Chosen arbitrarily from the set (1,2,..63)
Handover Reference	
- Value	Chosen arbitrarily from the range (0, 1..255)
Power command	
- Power Level	Arbitrarily chosen, but different to the one already in use and within the range supported by that type of MS.
Synchronization Indication.	
- Report Observed Time Difference	Shall not be included
- Synchronization Indication	"Non Synchronized".
- Normal Cell Indication	Ignore out of range timing advance
Cell Channel Description:	GSM 480 frequencies: 306, 310, 314, 318, 322, 326, 332, 338
	GSM 900 frequencies: 10, 20, 34, 45, 52, 66, 74, 114
Channel Mode IE is not included.	
Mobile Allocation	Indicates GSM 900 frequencies (10, 34, 45, 66, 114).

PHYSICAL INFORMATION

Information Element	value/remarks
As default message contents, except:	
Timing Advance	Arbitrarily selected but different to default value.

Step 6: x = 650 ms.

Step 7: The MS and SS are using a full rate TCH in hopping mode in the GSM 900 band on cell A.

For 450/1800 MS:

For M = 1:

Step 0: The MS and SS are using a full rate TCH in the GSM 450 band, in non-hopping mode on cell A.

HANDOVER COMMAND

Information Element	value/remarks
As default message contents, except:	
Cell Description	
- Network Colour Code	1
- Base Station Colour Code	5
- BCCH Carrier Number	268
Channel description	
- Channel type	TCH/F + ACCHs
- Timeslot number	Chosen arbitrarily
- Training Sequence Code	Chosen arbitrarily
- Hopping	Single RF Channel.
- ARFCN	Chosen arbitrarily from the DCS 1800 frequencies allocated to the cell.
Handover Reference	
- Value	Chosen arbitrarily from the range (0, 1..255)
Power command	
- Power Level	Arbitrarily chosen, but different to the one already in use and within the range supported by that type of MS.
Synchronization Indication	
- Report Observed Time Difference	Shall not be included.
- Synchronization Indication	"Non Synchronized".
- Normal Cell Indication	Ignore out of range timing advance.

PHYSICAL INFORMATION

Information Element	value/remarks
As default message contents, except:	

Step 6: x = 650 ms.

Step 7: The MS and SS are using a full rate TCH in the DCS 1800 band, in non hopping mode on cell B.

For M = 2:

Step 0: The MS and SS are using a full rate TCH in the DCS 1800 band, in non-hopping mode on cell B.

HANDOVER COMMAND

Information Element	value/remarks
As default message contents, except:	
Cell Description	
- Network Colour Code	1
- Base Station Colour Code	5
- BCCH Carrier Number	263
Channel Description	
- Channel Type	TCH/F + ACCHs
- Timeslot number	Chosen arbitrarily
- Training Sequence Code	Chosen arbitrarily
- Hopping	RF hopping channel.
- MAIO	Chosen arbitrarily from the set (0, 1 to N-1), where N is the number of frequencies in the Mobile Allocation IE.
- HSN	Chosen arbitrarily from the set (1,2,..63)
Handover Reference	
- Value	Chosen arbitrarily from the range (0, 1..255)
Power command	
- Power Level	Arbitrarily chosen, but different to the one already in use and within the range supported by that type of MS.
Synchronization Indication.	
- Report Observed Time Difference	Shall not be included
- Synchronization Indication	"Non Synchronized".
- Normal Cell Indication	Ignore out of range timing advance
Cell Channel Description:	GSM 450 frequencies: 259, 263, 267, 271, 275, 279, 283, 291
	GSM 1800 frequencies: 739, 746, 756, 761, 771, 782, 798, 832
Channel Mode IE is not included.	
Mobile Allocation	Indicates DCS 1800 frequencies (739, 756, 761, 782, 832).

PHYSICAL INFORMATION

Information Element	value/remarks
As default message contents, except:	
Timing Advance	Arbitrarily selected but different to default value.

Step 6: x = 650 ms.

Step 7: The MS and SS are using a full rate TCH in hopping mode in the DCS band on cell A.

For 480/1800 MS:

For M = 1:

Step 0: The MS and SS are using a full rate TCH in the GSM 480 band, in non-hopping mode on cell A.

HANDOVER COMMAND

Information Element	value/remarks
As default message contents, except:	
Cell Description	
- Network Colour Code	1
- Base Station Colour Code	5
- BCCH Carrier Number	315
Channel description	
- Channel type	TCH/F + ACCHs
- Timeslot number	Chosen arbitrarily
- Training Sequence Code	Chosen arbitrarily
- Hopping	Single RF Channel.
- ARFCN	Chosen arbitrarily from the DCS 1800 frequencies allocated to the cell.
Handover Reference	
- Value	Chosen arbitrarily from the range (0, 1..255)
Power command	
- Power Level	Arbitrarily chosen, but different to the one already in use and within the range supported by that type of MS.
Synchronization Indication	
- Report Observed Time Difference	Shall not be included.
- Synchronization Indication	"Non Synchronized".
- Normal Cell Indication	Ignore out of range timing advance.

PHYSICAL INFORMATION

Information Element	value/remarks
As default message contents, except:	

Step 6: x = 650 ms.

Step 7: The MS and SS are using a full rate TCH in the DCS 1800 band, in non hopping mode on cell B.

For M = 2:

Step 0: The MS and SS are using a full rate TCH in the DCS 1800 band, in non-hopping mode on cell B.

HANDOVER COMMAND

Information Element	value/remarks
As default message contents, except:	
Cell Description	
- Network Colour Code	1
- Base Station Colour Code	5
- BCCH Carrier Number	310
Channel Description	
- Channel Type	TCH/F + ACCHs
- Timeslot number	Chosen arbitrarily
- Training Sequence Code	Chosen arbitrarily
- Hopping	RF hopping channel.
- MAIO	Chosen arbitrarily from the set (0, 1 to N-1), where N is the number of frequencies in the Mobile Allocation IE.
- HSN	Chosen arbitrarily from the set (1,2,..63)
Handover Reference	
- Value	Chosen arbitrarily from the range (0, 1..255)
Power command	
- Power Level	Arbitrarily chosen, but different to the one already in use and within the range supported by that type of MS.
Synchronization Indication.	
- Report Observed Time Difference	Shall not be included
- Synchronization Indication	"Non Synchronized".
- Normal Cell Indication	Ignore out of range timing advance
Cell Channel Description	
	GSM 480 frequencies: 306, 310, 314, 318, 322, 326, 332, 338
	GSM 1800 frequencies: 739, 746, 756, 761, 771, 782, 798, 832
Channel Mode IE is not included.	
Mobile Allocation	Indicates DCS 1800 frequencies (739, 756, 761, 782, 832).

PHYSICAL INFORMATION

Information Element	value/remarks
As default message contents, except:	
Timing Advance	Arbitrarily selected but different to default value.

Step 6: x = 650 ms.

Step 7: The MS and SS are using a full rate TCH in hopping mode in the DCS band on cell A.

For 900/1800 MS:

For M = 1:

Step 0: The MS and SS are using a full rate TCH in the GSM 900 band, in non-hopping mode on cell A.

HANDOVER COMMAND

Information Element	value/remarks
As default message contents, except:	
Cell Description	
- Network Colour Code	1
- Base Station Colour Code	5
- BCCH Carrier Number	32
Channel description	
- Channel type	TCH/F + ACCHs
- Timeslot number	Chosen arbitrarily
- Training Sequence Code	Chosen arbitrarily
- Hopping	Single RF Channel.
- ARFCN	Chosen arbitrarily from the DCS 1800 frequencies allocated to the cell.
Handover Reference	
- Value	Chosen arbitrarily from the range (0, 1..255)
Power command	
- Power Level	Arbitrarily chosen, but different to the one already in use and within the range supported by that type of MS.
Synchronization Indication	
- Report Observed Time Difference	Shall not be included.
- Synchronization Indication	"Non Synchronized".
- Normal Cell Indication	Ignore out of range timing advance.

PHYSICAL INFORMATION

Information Element	value/remarks
As default message contents, except:	

Step 6: x = 650 ms.

Step 7: The MS and SS are using a full rate TCH in the DCS 1800 band, in non hopping mode on cell B.

For M = 2:

Step 0: The MS and SS are using a full rate TCH in the DCS 1800 band, in non-hopping mode on cell B.

HANDOVER COMMAND

Information Element	value/remarks
As default message contents, except:	
Cell Description	
- Network Colour Code	1
- Base Station Colour Code	5
- BCCH Carrier Number	20
Channel Description	
- Channel Type	TCH/F + ACCHs
- Timeslot number	Chosen arbitrarily
- Training Sequence Code	Chosen arbitrarily
- Hopping	RF hopping channel.
- MAIO	Chosen arbitrarily from the set (0, 1 to N-1), where N is the number of frequencies in the Mobile Allocation IE.
- HSN	Chosen arbitrarily from the set (1,2,..63)
Handover Reference	
- Value	Chosen arbitrarily from the range (0, 1..255)
Power command	
- Power Level	Arbitrarily chosen, but different to the one already in use and within the range supported by that type of MS.
Synchronization Indication.	
- Report Observed Time Difference	Shall not be included
- Synchronization Indication	"Non Synchronized".
- Normal Cell Indication	Ignore out of range timing advance
Cell channel description:	GSM 900 frequencies: 10, 20, 34, 45, 52, 66, 74, 114 GSM 1800 frequencies: 739, 746, 756, 761, 771, 782, 798, 832
Channel Mode IE is not included.	
Mobile Allocation	Indicates DCS 1800 frequencies (739, 756, 761, 782, 832).

PHYSICAL INFORMATION

Information Element	value/remarks
As default message contents, except:	
Timing Advance	Arbitrarily selected but different to default value.

Step 6: x = 650 ms.

Step 7: The MS and SS are using a full rate TCH in hopping mode in the DCS band on cell A.

26.11.2.2.4 Multiband signalling / RR / Handover/ Multiband BCCH / Intracell Handover - Interband Assignment

In case of multi-band networks, an intracell change of channel can be requested by upper layers in order to change the channel type (Directed Retry from a channel belonging to one frequency band to a channel belonging to another frequency band), or it may be initiated by the RR-sublayer for an intra cell and inter-band handover for cells supporting GSM 400, GSM 900 and DCS 1800 frequencies. This change is performed using the channel assignment procedure.

26.11.2.2.4.1 Dedicated assignment / successful case

This test is only applicable to an MS supporting a TCH.

26.11.2.2.4.1.1 Conformance requirements

1. Upon receipt of the ASSIGNMENT COMMAND message, the mobile station initiates a local end release of link layer connections, disconnects the physical channels, commands the switching to the assigned channels and initiates the establishment of lower layer connections (this includes the activation of the channels, their connection and the establishment of the main signalling links).
2. MM-messages and CM-messages using SAPI=0 sent from the mobile station to the network can be duplicated by the data link layer in the following case:
 - a channel change of dedicated channels is required (assignment or handover procedure) and the last layer 2 frame has not been acknowledged by the peer data link layer before the mobile station leaves the old channel.In this case, the mobile station does not know whether the network has received the message correctly. Therefore, the mobile station has to send the message again after the new dedicated channel is established.
3. The MS shall establish the link with the power level specified in the ASSIGNMENT COMMAND message.
 - The MS shall confirm the power control level that it is currently employing in the uplink SACCH L1 header. The indicated value shall be the power control level actually used by the mobile for the last burst of the previous SACCH period.
4. The MS shall apply the hopping frequencies specified in ASSIGNMENT COMMAND message in the Mobile Allocation IE or the Frequency List IE at the time of accessing the new channel using the last received Cell Allocation.
5. After receipt of the ASSIGNMENT COMMAND the MS shall perform the assignment and return an ASSIGNMENT COMPLETE without undue delay.

References

- 1, 3, 5. GSM 04.08, subclause 3.4.3.
2. GSM 04.08, subclause 3.1.4.3.
4. GSM 04.08, subclause 3.4.3; GSM 05.08, subclause 4.2.
6. GSM 04.13, subclause 5.2.4.

26.11.2.2.4.2 Test purpose

1. To verify that upon receipt of an ASSIGNMENT COMMAND, the MS switches to the channel defined in the ASSIGNMENT COMMAND, establishes the link and sends an ASSIGNMENT COMPLETE message. This is tested for an MS supporting TCH in the special cases of a transition.

NOTE: in all cases the old and the new channel assigned belong to different frequency bands.

- 1.1 from non-hopping SDCCH in the lower band to hopping TCH/F in the upper band using a different timeslot;
 - 1.2 from hopping TCH/F in the upper band to non-hopping TCH/F in the lower band using a different timeslot;
 - 1.3 from non-hopping TCH/F in the lower band to hopping TCH/F in the upper band using a different timeslot.
 - 1.4 from hopping TCH/F in the upper band to hopping TCH/H in the lower band using a different timeslot; this test purpose is only applicable if the MS supports TCH/H;
 - 1.5 from hopping TCH/H in the lower band to non-hopping TCH/H in the upper band using a different timeslot; this test purpose is only applicable if the MS supports TCH/H;
 - 1.6 from non-hopping TCH/H in the upper band to hopping TCH/F in the lower band using a different timeslot; this test purpose is only applicable if the MS supports TCH/H.
2. To verify that an MS supporting TCH, having received an ASSIGNMENT COMMAND, is able in the case of frequency hopping to decode the Mobile Allocation and Frequency List IEs correctly and applies the specified frequencies using the correct Cell Allocation.

3. To verify that after receipt of the ASSIGNMENT COMMAND the MS returns an ASSIGNMENT COMPLETE without undue delay.

26.11.2.2.4.3 Method of test

Initial Conditions

System Simulator:

For 450/900 MS: 1 cell with GSM 450 and GSM 900 frequencies, using a BCCH in the GSM 450 band, default parameters except:

BCCH ARFCN =263.

System Information 1 Cell Allocation = 259, 263, 267, 271, 275, 279, 283, 291, 10, 20, 34, 45, 52, 66, 76, 114.

For 480/900 MS: 1 cell with GSM 480 and GSM 900 frequencies, using a BCCH in the GSM 480 band, default parameters except:

BCCH ARFCN =310.

System Information 1 Cell Allocation = 306, 310, 314, 318, 322, 326, 332, 338, 10, 20, 34, 45, 52, 66, 76, 114.

For 450/1800 MS: 1 cell with GSM 450 and DCS 1800 frequencies, using a BCCH in the GSM 450 band, default parameters except:

BCCH ARFCN =263.

System Information 1 Cell Allocation = 259, 263, 267, 271, 275, 279, 283, 291, 739, 746, 756, 761, 771, 782, 798, 832.

For 480/1800 MS: 1 cell with GSM 480 and DCS 1800 frequencies, using a BCCH in the GSM 480 band, default parameters except:

BCCH ARFCN =310.

System Information 1 Cell Allocation = 306, 310, 314, 318, 322, 326, 332, 338, 739, 746, 756, 761, 771, 782, 798, 832.

For 900/1800 MS: 1 cell with GSM and DCS 1800 frequencies, using a BCCH in the GSM band, default parameters except:

BCCH ARFCN =20.

System Information 1 Cell Allocation = 10, 20, 34, 45, 52, 66, 76, 114, 739, 746, 756, 761, 771, 782, 798, 832.

NOTE: Cell Allocation IE broadcasted in SYSTEM INFORMATION 1 shall be coded with a format so that frequencies belonging to both lower and upper frequency band can be included. Format Identifier of Cell Channel Description IE will thus be Range 1024.

Mobile Station:

The MS is in the "idle, updated" state with a TMSI allocated.

Related PICS/PIXIT Statements

- TCH supported (Y/N).
- Supported rate(s) of TCH: TCH/F and/or TCH/H.
- The supported channel mode(s) need to be declared.
- Support of multiband functionality.

Foreseen Final State of the MS

"Idle, updated", with TMSI allocated.

Test Procedure

The SS pages the MS and allocates an SDCCH. Then three channels are assigned with ASSIGNMENT COMMANDs messages. Each time the MS shall switch to the assigned channel, establish the link and send an ASSIGNMENT COMPLETE message.

For an MS not supporting TCH/H, the SS initiates the channel release procedure and the test ends here. For an MS supporting TCH/H, the channel assignment procedure is performed another three times, with half rate channels involved, and again it is checked that the MS correctly completes the procedures, before the SS initiates the channel release procedure.

Maximum Duration of Test

60 s.

Expected Sequence

Step	Direction	Message	Comments
1	SS -> MS	PAGING REQUEST TYPE 1	
2	MS -> SS	CHANNEL REQUEST	
3	SS -> MS	IMMEDIATE ASSIGNMENT	See specific message contents.
4	MS -> SS	PAGING RESPONSE	
5	SS -> MS	ASSIGNMENT COMMAND	See specific message contents.
6	MS -> SS	ASSIGNMENT COMPLETE	Sent on the correct channel after establishment of the main signalling link. This message shall be ready to be transmitted before 600 ms after the completion of step 5.
7	SS -> MS	ASSIGNMENT COMMAND	See specific message contents.
8	MS -> SS	ASSIGNMENT COMPLETE	Sent on the correct channel after establishment of the main signalling link. This message shall be ready to be transmitted before 600 ms after the completion of step 7.
9	SS -> MS	ASSIGNMENT COMMAND	See specific message contents.
10	MS -> SS	ASSIGNMENT COMPLETE	Sent on the correct channel after establishment of the main signalling link. This message shall be ready to be transmitted before 600 ms after the completion of step 9.
A			This test part is performed if the MS doesn't support TCH/H (see PICS/PIXIT)
A 11	SS -> MS	CHANNEL RELEASE	The main signalling link is released.
B			This test part is performed if the MS supports TCH/H (see PICS/PIXIT).
B11	SS -> MS	ASSIGNMENT COMMAND	See specific message contents.
B12	MS -> SS	ASSIGNMENT COMPLETE	Sent on the correct channel after establishment of the main signalling link. This message shall be ready to be transmitted before 600 ms after the completion of step 11.
B13	SS -> MS	ASSIGNMENT COMMAND	See specific message contents.
B14	MS -> SS	ASSIGNMENT COMPLETE	Sent on the correct channel after establishment of the main signalling link. This message shall be ready to be transmitted before 600 ms after the completion of step 13.
B15	SS -> MS	ASSIGNMENT COMMAND	See specific message contents.
B16	MS -> SS	ASSIGNMENT COMPLETE	Sent on the correct channel after establishment of the main signalling link. This message shall be ready to be transmitted before 600 ms after the completion of step 15.
B17	SS -> MS	CHANNEL RELEASE	The main signalling link is released.

Specific Message Contents

For 450/900 MS:

Step 3

IMMEDIATE ASSIGNMENT:

As default message contents except Channel Description - Channel Type TDMA offset - Timeslot Number - Training Sequence Code - Hopping - ARFCN	SDCCH/8 Chosen arbitrarily N, chosen arbitrarily Chosen arbitrarily Single RF Channel chosen arbitrarily from CA of the common BCCH in the GSM 450 part of the list.
---	---

Step 5

ASSIGNMENT COMMAND:

Channel Description - Channel Type and TDMA offset - Timeslot Number - Training Sequence Code - Hopping - MAIO - HSN Power Command - Power level Frequency list IE Channel Mode - Mode Mobile Allocation Starting Time	TCH/F (N+1) mod 8 Chosen arbitrarily RF hopping channel Chosen arbitrarily from the set (0, 1 to N-1) where N is the number of frequencies in the Mobile Allocation IE. Chosen arbitrarily from the set (1 to 63) Chosen arbitrarily but with a changed value. Not included Signalling Indicates only GSM 900 frequencies of the CA (broadcast on the BCCH). (10, 20, 45, 52, 66, 114) Not included
---	--

Step 7

ASSIGNMENT COMMAND:

Channel Description - Channel Type and TDMA offset - Timeslot Number - Training Sequence Code - Hopping - ARFCN Power Command - Power level Channel Mode Frequency list IE Cell Channel Description Mobile Allocation Starting Time	TCH/F (N+2) mod 8 Chosen arbitrarily Single RF Channel chosen arbitrarily from CA of the common BCCH in the GSM 450 part of the list. Chosen arbitrarily but with a changed value. A non-signalling mode arbitrarily selected from the full rate capabilities declared for the MS Not Included Range 1024 format encodes: (271, 275, 279, 283, 291, 10, 20, 34, 45, 52, 66, 76, 114.). Not included Not included
---	--

Step 9

ASSIGNMENT COMMAND:

Channel Description <ul style="list-style-type: none"> - Channel Type and TDMA offset - Timeslot Number - Training Sequence Code - Hopping <ul style="list-style-type: none"> - MAIO - HSN Power Command <ul style="list-style-type: none"> - Power level Channel Mode Frequency list IE Mobile Allocation Starting Time	TCH/F $(N+3) \bmod 8$ Chosen arbitrarily RF Hopping Channel Chosen arbitrarily from the set (0, 1 to N-1) where N is the number of frequencies in the Mobile Allocation IE. Chosen arbitrarily from the set (1 to 63). Chosen arbitrarily but with a changed value. A non-signalling mode arbitrarily selected from the full rate capabilities declared for the MS Not Included Indicates GSM 900 frequencies (10, 45, 114). Not included
--	---

Step 11

ASSIGNMENT COMMAND:

Channel Description - Channel Type and TDMA offset - Timeslot Number - Training Sequence Code - Hopping - MAIO - HSN Power Command - Power level Channel Mode Frequency list IE Cell Channel Description Mobile Allocation Starting Time	TCH/H (N+4) mod 8 Chosen arbitrarily RF hopping channel Chosen arbitrarily from the set (0, 1 to N-1) where N is the number of frequencies in the Mobile Allocation IE. Chosen arbitrarily from the set (1 to 63) Chosen arbitrarily but with a changed value. Not included Not included Range 1024 format encodes: (259, 263, 267, 271, 275, 279, 283, 291, 10, 20, 34, 45, 52, 66, 76, 114). Indicates frequencies (259, 263, 267, 271, 275, 279, 283, 291). Not included
---	--

Step 13

ASSIGNMENT COMMAND:

Channel Description - Channel Type and TDMA offset - Timeslot Number - Training Sequence Code - Hopping - ARFCN Power Command - Power level Channel Mode Frequency list IE Cell Channel Description Mobile Allocation Starting Time	TCH/H (N+5) mod 8 Chosen arbitrarily Single RF Channel chosen arbitrarily from CA of the BCCH in the GSM 900 part of the list. Chosen arbitrarily but with a changed value. signalling Not included Not included Not included Not included not included
---	--

Step 15

ASSIGNMENT COMMAND:

Channel Description	TCH/F
- Channel Type	Chosen arbitrarily
TDMA offset	(N+6) mod 8
- Timeslot Number	Chosen arbitrarily
- Training Sequence Code	RF hopping channel
- Hopping	Chosen arbitrarily from the set (0, 1 to N-1) where N is the number of GSM 450 frequencies in the Frequency List IE.
- MAIO	Chosen arbitrarily from the set (1 to 63)
- HSN	
Power Command	Chosen arbitrarily but with a changed value.
- Power level	
Channel Mode	A non-signalling mode arbitrarily selected from the half rate capabilities declared for the MS
Cell Channel Description	Not included
Frequency list IE	Use Range 128 to encode (259, 263, 267, 271, 275, 279, 283, 291).
Mobile Allocation	Not included
Starting Time	Not included

For 480/900 MS:

Step 3

IMMEDIATE ASSIGNMENT:

As default message contents except	
Channel Description	SDCCH/8
- Channel Type	Chosen arbitrarily
TDMA offset	N, chosen arbitrarily
- Timeslot Number	Chosen arbitrarily
- Training Sequence Code	Single RF Channel
- Hopping	chosen arbitrarily from CA of the common BCCH in the GSM 480 part of the list.
- ARFCN	

Step 5

ASSIGNMENT COMMAND:

Channel Description	TCH/F
- Channel Type and TDMA offset	(N+1) mod 8
- Timeslot Number	Chosen arbitrarily
- Training Sequence Code	RF hopping channel
- Hopping	Chosen arbitrarily from the set (0, 1 to N-1) where N is the number of frequencies in the Mobile Allocation IE.
- MAIO	Chosen arbitrarily from the set (1 to 63)
- HSN	
Power Command	Chosen arbitrarily but with a changed value.
- Power level	
Frequency list IE	Not included
Channel Mode	
- Mode	Signalling
Mobile Allocation	Indicates only GSM 900 frequencies of the CA (broadcast on the BCCH). (10, 20, 45, 52, 66, 114)
Starting Time	Not included

Step 7

ASSIGNMENT COMMAND:

Channel Description - Channel Type and TDMA offset - Timeslot Number - Training Sequence Code - Hopping - ARFCN Power Command - Power level Channel Mode Frequency list IE Cell Channel Description Mobile Allocation Starting Time	TCH/F (N+2) mod 8 Chosen arbitrarily Single RF Channel chosen arbitrarily from CA of the common BCCH in the GSM 480 part of the list. Chosen arbitrarily but with a changed value. A non-signalling mode arbitrarily selected from the full rate capabilities declared for the MS Not Included Range 1024 format encodes: (318, 322, 326, 332, 338, 10, 20, 34, 45, 52, 66, 76, 114.). Not included Not included
---	--

Step 9

ASSIGNMENT COMMAND:

Channel Description - Channel Type and TDMA offset - Timeslot Number - Training Sequence Code - Hopping - MAIO - HSN Power Command - Power level Channel Mode Frequency list IE Mobile Allocation Starting Time	TCH/F (N+3) mod 8 Chosen arbitrarily RF Hopping Channel Chosen arbitrarily from the set (0, 1 to N-1) where N is the number of frequencies in the Mobile Allocation IE. Chosen arbitrarily from the set (1 to 63). Chosen arbitrarily but with a changed value. A non-signalling mode arbitrarily selected from the full rate capabilities declared for the MS Not Included Indicates GSM 900 frequencies (10, 45, 114). Not included
---	---

Step 11

ASSIGNMENT COMMAND:

Channel Description - Channel Type and TDMA offset - Timeslot Number - Training Sequence Code - Hopping - MAIO - HSN Power Command - Power level Channel Mode Frequency list IE Cell Channel Description Mobile Allocation Starting Time	TCH/H (N+4) mod 8 Chosen arbitrarily RF hopping channel Chosen arbitrarily from the set (0, 1 to N-1) where N is the number of frequencies in the Mobile Allocation IE. Chosen arbitrarily from the set (1 to 63) Chosen arbitrarily but with a changed value. Not included Not included Range 1024 format encodes: (306, 310, 314, 318, 322, 326, 332, 338, 10, 20, 34, 45, 52, 66, 76, 114.). Indicates frequencies (306, 310, 314, 318, 322, 326, 332, 338). Not included
---	---

Step 13

ASSIGNMENT COMMAND:

Channel Description - Channel Type and TDMA offset - Timeslot Number - Training Sequence Code - Hopping - ARFCN Power Command - Power level Channel Mode Frequency list IE Cell Channel Description Mobile Allocation Starting Time	TCH/H (N+5) mod 8 Chosen arbitrarily Single RF Channel chosen arbitrarily from CA of the BCCH in the GSM 900 part of the list. Chosen arbitrarily but with a changed value. signalling Not included Not included Not included Not included not included
---	--

Step 15

ASSIGNMENT COMMAND:

Channel Description	TCH/F
- Channel Type	Chosen arbitrarily
TDMA offset	(N+6) mod 8
- Timeslot Number	Chosen arbitrarily
- Training Sequence Code	RF hopping channel
- Hopping	Chosen arbitrarily from the set (0, 1 to N-1) where N is the number of GSM 480 frequencies in the Frequency List IE.
- MAIO	Chosen arbitrarily from the set (1 to 63)
- HSN	
Power Command	Chosen arbitrarily but with a changed value.
- Power level	
Channel Mode	A non-signalling mode arbitrarily selected from the half rate capabilities declared for the MS
Cell Channel Description	Not included
Frequency list IE	Uses Range 128 to encode (306, 310, 314, 318, 322, 326, 332, 338).
Mobile Allocation	Not included
Starting Time	Not included

For 450/1800 MS:

Step 3

IMMEDIATE ASSIGNMENT:

As default message contents except	
Channel Description	SDCCH/8
- Channel Type	Chosen arbitrarily
TDMA offset	N, chosen arbitrarily
- Timeslot Number	Chosen arbitrarily
- Training Sequence Code	Single RF Channel
- Hopping	chosen arbitrarily from CA of the common BCCH in the GSM 450 part of the list.
- ARFCN	

Step 5

ASSIGNMENT COMMAND:

Channel Description	TCH/F
- Channel Type and TDMA offset	(N+1) mod 8
- Timeslot Number	Chosen arbitrarily
- Training Sequence Code	RF hopping channel
- Hopping	Chosen arbitrarily from the set (0, 1 to N-1) where N is the number of frequencies in the Mobile Allocation IE.
- MAIO	Chosen arbitrarily from the set (1 to 63)
- HSN	
Power Command	Chosen arbitrarily but with a changed value.
- Power level	
Frequency list IE	Not included
Channel Mode	Signalling
- Mode	Indicates only DCS 1800 frequencies of the CA (broadcast on the BCCH).
Mobile Allocation	(739, 746, 761, 771, 782, 832)
Starting Time	Not included

Step 7

ASSIGNMENT COMMAND:

Channel Description - Channel Type and TDMA offset - Timeslot Number - Training Sequence Code - Hopping - ARFCN Power Command - Power level Channel Mode Frequency list IE Cell Channel Description Mobile Allocation Starting Time	TCH/F (N+2) mod 8 Chosen arbitrarily Single RF Channel chosen arbitrarily from CA of the common BCCH in the GSM 450 part of the list. Chosen arbitrarily but with a changed value. A non-signalling mode arbitrarily selected from the full rate capabilities declared for the MS Not Included Range 1024 format encodes: (271, 275, 279, 283, 291, 739, 746, 756, 761, 771, 782, 798, 832.). Not included Not included
---	---

Step 9

ASSIGNMENT COMMAND:

Channel Description - Channel Type and TDMA offset - Timeslot Number - Training Sequence Code - Hopping - MAIO - HSN Power Command - Power level Channel Mode Frequency list IE Mobile Allocation Starting Time	TCH/F (N+3) mod 8 Chosen arbitrarily RF Hopping Channel Chosen arbitrarily from the set (0, 1 to N-1) where N is the number of frequencies in the Mobile Allocation IE. Chosen arbitrarily from the set (1 to 63). Chosen arbitrarily but with a changed value. A non-signalling mode arbitrarily selected from the full rate capabilities declared for the MS Not Included Indicates DCS frequencies (739, 761, 832). Not included
---	---

Step 11

ASSIGNMENT COMMAND:

Channel Description - Channel Type and TDMA offset - Timeslot Number - Training Sequence Code - Hopping - MAIO - HSN Power Command - Power level Channel Mode Frequency list IE Cell Channel Description Mobile Allocation Starting Time	TCH/H (N+4) mod 8 Chosen arbitrarily RF hopping channel Chosen arbitrarily from the set (0, 1 to N-1) where N is the number of frequencies in the Mobile Allocation IE. Chosen arbitrarily from the set (1 to 63) Chosen arbitrarily but with a changed value. Not included Not included Range 1024 format encodes: (259, 263, 267, 271, 275, 279, 283, 291, 739, 746, 756, 761, 771, 782, 798, 832.). Indicates frequencies (259, 263, 267, 271, 275, 279, 283, 291). Not included
---	--

Step 13

ASSIGNMENT COMMAND:

Channel Description - Channel Type and TDMA offset - Timeslot Number - Training Sequence Code - Hopping - ARFCN Power Command - Power level Channel Mode Frequency list IE Cell Channel Description Mobile Allocation Starting Time	TCH/H (N+5) mod 8 Chosen arbitrarily Single RF Channel chosen arbitrarily from CA of the BCCH in the DCS 1800 part of the list. Chosen arbitrarily but with a changed value. signalling Not included Not included Not included Not included not included
---	---

Step 15

ASSIGNMENT COMMAND:

Channel Description	TCH/F
- Channel Type	Chosen arbitrarily
TDMA offset	(N+6) mod 8
- Timeslot Number	Chosen arbitrarily
- Training Sequence Code	RF hopping channel
- Hopping	Chosen arbitrarily from the set (0, 1 to N-1) where N is the number of GSM 450 frequencies in the Frequency List IE.
- MAIO	Chosen arbitrarily from the set (1 to 63)
- HSN	
Power Command	Chosen arbitrarily but with a changed value.
- Power level	
Channel Mode	A non-signalling mode arbitrarily selected from the half rate capabilities declared for the MS
Cell Channel Description	Not included
Frequency list IE	Use Range 128 to encode (259, 263, 267, 271, 275, 279, 283, 291).
Mobile Allocation	Not included
Starting Time	Not included

For 480/1800 MS:

Step 3

IMMEDIATE ASSIGNMENT:

As default message contents except	
Channel Description	SDCCH/8
- Channel Type	Chosen arbitrarily
TDMA offset	N, chosen arbitrarily
- Timeslot Number	Chosen arbitrarily
- Training Sequence Code	Single RF Channel
- Hopping	chosen arbitrarily from CA of the common BCCH in the GSM 480 part of the list.
- ARFCN	

Step 5

ASSIGNMENT COMMAND:

Channel Description	TCH/F
- Channel Type and TDMA offset	(N+1) mod 8
- Timeslot Number	Chosen arbitrarily
- Training Sequence Code	RF hopping channel
- Hopping	Chosen arbitrarily from the set (0, 1 to N-1) where N is the number of frequencies in the Mobile Allocation IE.
- MAIO	Chosen arbitrarily from the set (1 to 63)
- HSN	
Power Command	Chosen arbitrarily but with a changed value.
- Power level	
Frequency list IE	Not included
Channel Mode	
- Mode	Signalling
Mobile Allocation	Indicates only DCS 1800 frequencies of the CA (broadcast on the BCCH). (739, 746, 761, 771, 782, 832)
Starting Time	Not included

Step 7

ASSIGNMENT COMMAND:

Channel Description - Channel Type and TDMA offset - Timeslot Number - Training Sequence Code - Hopping - ARFCN	TCH/F (N+2) mod 8 Chosen arbitrarily Single RF Channel chosen arbitrarily from CA of the common BCCH in the GSM 480 part of the list.
Power Command - Power level	Chosen arbitrarily but with a changed value.
Channel Mode	A non-signalling mode arbitrarily selected from the full rate capabilities declared for the MS
Frequency list IE	Not Included
Cell Channel Description	Range 1024 format encodes: (318, 322, 326, 332, 338, 739, 746, 756, 761, 771, 782, 798, 832.).
Mobile Allocation	Not included
Starting Time	Not included

Step 9

ASSIGNMENT COMMAND:

Channel Description - Channel Type and TDMA offset - Timeslot Number - Training Sequence Code - Hopping - MAIO	TCH/F (N+3) mod 8 Chosen arbitrarily RF Hopping Channel Chosen arbitrarily from the set (0, 1 to N-1) where N is the number of frequencies in the Mobile Allocation IE.
- HSN	Chosen arbitrarily from the set (1 to 63).
Power Command - Power level	Chosen arbitrarily but with a changed value.
Channel Mode	A non-signalling mode arbitrarily selected from the full rate capabilities declared for the MS
Frequency list IE	Not Included
Mobile Allocation	Indicates DCS frequencies (739, 761, 832).
Starting Time	Not included

Step 11

ASSIGNMENT COMMAND:

Channel Description - Channel Type and TDMA offset - Timeslot Number - Training Sequence Code - Hopping - MAIO - HSN Power Command - Power level Channel Mode Frequency list IE Cell Channel Description Mobile Allocation Starting Time	TCH/H (N+4) mod 8 Chosen arbitrarily RF hopping channel Chosen arbitrarily from the set (0, 1 to N-1) where N is the number of frequencies in the Mobile Allocation IE. Chosen arbitrarily from the set (1 to 63) Chosen arbitrarily but with a changed value. Not included Not included Range 1024 format encodes: (306, 310, 314, 318, 322, 326, 332, 338, 739, 746, 756, 761, 771, 782, 798, 832.). Indicates frequencies (306, 310, 314, 318, 322, 326, 332, 338). Not included
---	--

Step 13

ASSIGNMENT COMMAND:

Channel Description - Channel Type and TDMA offset - Timeslot Number - Training Sequence Code - Hopping - ARFCN Power Command - Power level Channel Mode Frequency list IE Cell Channel Description Mobile Allocation Starting Time	TCH/H (N+5) mod 8 Chosen arbitrarily Single RF Channel chosen arbitrarily from CA of the BCCH in the DCS 1800 part of the list. Chosen arbitrarily but with a changed value. signalling Not included Not included Not included Not included not included
---	---

Step 15

ASSIGNMENT COMMAND:

Channel Description	TCH/F
- Channel Type	Chosen arbitrarily
TDMA offset	(N+6) mod 8
- Timeslot Number	Chosen arbitrarily
- Training Sequence Code	RF hopping channel
- Hopping	Chosen arbitrarily from the set (0, 1 to N-1) where N is the number of GSM 480 frequencies in the Frequency List IE.
- MAIO	Chosen arbitrarily from the set (1 to 63)
- HSN	
Power Command	Chosen arbitrarily but with a changed value.
- Power level	
Channel Mode	A non-signalling mode arbitrarily selected from the half rate capabilities declared for the MS
Cell Channel Description	Not included
Frequency list IE	Use Range 128 to encode (306, 310, 314, 318, 322, 326, 332, 338).
Mobile Allocation	Not included
Starting Time	Not included

For 900/1800 MS:

Step 3

IMMEDIATE ASSIGNMENT:

As default message contents except	
Channel Description	SDCCH/8
- Channel Type	Chosen arbitrarily
TDMA offset	N, chosen arbitrarily
- Timeslot Number	Chosen arbitrarily
- Training Sequence Code	Single RF Channel
- Hopping	chosen arbitrarily from CA of the common BCCH in the GSM part of the list.
- ARFCN	

Step 5

ASSIGNMENT COMMAND:

Channel Description	TCH/F
- Channel Type and TDMA offset	(N+1) mod 8
- Timeslot Number	Chosen arbitrarily
- Training Sequence Code	RF hopping channel
- Hopping	Chosen arbitrarily from the set (0, 1 to N-1) where N is the number of frequencies in the Mobile Allocation IE.
- MAIO	Chosen arbitrarily from the set (1 to 63)
- HSN	
Power Command	Chosen arbitrarily but with a changed value.
- Power level	
Frequency list IE	Not included
Channel Mode	Signalling
- Mode	Indicates only DCS 1800 frequencies of the CA (broadcast on the BCCH).
Mobile Allocation	(739, 746, 761, 771, 782, 832)
Starting Time	Not included

Step 7

ASSIGNMENT COMMAND:

Channel Description - Channel Type and TDMA offset - Timeslot Number - Training Sequence Code - Hopping - ARFCN Power Command - Power level Channel Mode Frequency list IE Cell Channel Description Mobile Allocation Starting Time	TCH/F (N+2) mod 8 Chosen arbitrarily Single RF Channel chosen arbitrarily from CA of the common BCCH in the GSM part of the list. Chosen arbitrarily but with a changed value. A non-signalling mode arbitrarily selected from the full rate capabilities declared for the MS Not Included Range 1024 format encodes: (45, 52, 66, 76, 114, 739, 746, 756, 761, 771, 782, 798, 832.). Not included Not included
---	---

Step 9

ASSIGNMENT COMMAND:

Channel Description - Channel Type and TDMA offset - Timeslot Number - Training Sequence Code - Hopping - MAIO - HSN Power Command - Power level Channel Mode Frequency list IE Mobile Allocation Starting Time	TCH/F (N+3) mod 8 Chosen arbitrarily RF Hopping Channel Chosen arbitrarily from the set (0, 1 to N-1) where N is the number of frequencies in the Mobile Allocation IE. Chosen arbitrarily from the set (1 to 63). Chosen arbitrarily but with a changed value. A non-signalling mode arbitrarily selected from the full rate capabilities declared for the MS Not Included Indicates DCS frequencies (739, 761, 832). Not included
---	---

Step 11

ASSIGNMENT COMMAND:

Channel Description	TCH/H
- Channel Type and TDMA offset	(N+4) mod 8
- Timeslot Number	Chosen arbitrarily
- Training Sequence Code	RF hopping channel
- Hopping	Chosen arbitrarily from the set (0, 1 to N-1) where N is the number of frequencies in the Mobile Allocation IE.
- MAIO	Chosen arbitrarily from the set (1 to 63)
- HSN	
Power Command	
- Power level	Chosen arbitrarily but with a changed value.
Channel Mode	Not included
Frequency list IE	Not included
Cell Channel Description	Range 1024 format encodes: (10, 20, 34, 45, 52, 66, 76, 114, 739, 746, 756, 761, 771, 782, 798, 832.).
Mobile Allocation	Indicates frequencies (10, 20, 34, 45, 52, 66, 76, 114).
Starting Time	Not included

Step 13

ASSIGNMENT COMMAND:

Channel Description	TCH/H
- Channel Type and TDMA offset	(N+5) mod 8
- Timeslot Number	Chosen arbitrarily
- Training Sequence Code	Single RF Channel
- Hopping	chosen arbitrarily from CA of the BCCH in the DCS 1800 part of the list.
- ARFCN	
Power Command	
- Power level	Chosen arbitrarily but with a changed value.
Channel Mode	signalling
Frequency list IE	Not included
Cell Channel Description	Not included
Mobile Allocation	Not included
Starting Time	not included

Step 15

ASSIGNMENT COMMAND:

Channel Description	
- Channel Type	TCH/F
TDMA offset	Chosen arbitrarily
- Timeslot Number	(N+6) mod 8
- Training Sequence Code	Chosen arbitrarily
- Hopping	RF hopping channel
- MAIO	Chosen arbitrarily from the set (0, 1 to N-1) where N is the number of GSM frequencies in the Frequency List IE.
- HSN	Chosen arbitrarily from the set (1 to 63)
Power Command	
- Power level	Chosen arbitrarily but with a changed value.
Channel Mode	A non-signalling mode arbitrarily selected from the half rate capabilities declared for the MS
Cell Channel Description	Not included
Frequency list IE	Uses Bitmap 0 to indicate (10, 20, 34, 45, 52, 66, 76, 114).
Mobile Allocation	Not included
Starting Time	Not included

26.11.2.3 Multiband signalling / RR / Measurement reporting

This test applies to any multiband MSs supporting simultaneous multiband operation.

26.11.2.3.1 Conformance requirements

The MS shall continuously send MEASUREMENT REPORT messages on every SACCH blocks and the measurement valid indication shall be set to valid (0) within the second block at the latest. After 20 seconds the values in the MEASUREMENT REPORT message shall contain measurement results for up to the 6 strongest BCCH carriers among those with known and allowed NCC part of BSIC on which the mobile is asked to report. For a multi band MS the number of neighbour cells, for each frequency band supported, which shall be included is indicated by the parameter MULTIBAND_REPORTING.

References

GSM 04.08 section 3.4.1.2, GSM 05.08 section 8.4.

26.11.2.3.2 Test purpose

To test that, when the SS gives information about neighbouring cells, the MS reports the appropriate results and correctly orders the BA list made from System Information 5 and System Information 5ter.

26.11.2.3.3 Method of test

Initial Conditions

System Simulator:

For 450/900 MS: 8 cells with the following settings:

Transmitter	Level	NCC	BCC	ARFCN	Cell identity
Serving, S1	-60	1	3	259	0001H
Neighbour, N1	-85	1	5	002	0002H
Neighbour, N2	-79	1	7	261	0003H
Neighbour, N3	-75	1	1	263	0004H
Neighbour, N4	-55	1	3	088	0005H
Neighbour, N5	-50	1	5	274	0006H
Neighbour, N6	-45	1	7	114	0007H
Neighbour, N7	-40	1	1	278	0008H

For 480/900 MS: 8 cells with the following settings:

Transmitter	Level	NCC	BCC	ARFCN	Cell identity
Serving, S1	-60	1	3	306	0001H
Neighbour, N1	-85	1	5	002	0002H
Neighbour, N2	-79	1	7	308	0003H
Neighbour, N3	-75	1	1	310	0004H
Neighbour, N4	-55	1	3	088	0005H
Neighbour, N5	-50	1	5	321	0006H
Neighbour, N6	-45	1	7	114	0007H
Neighbour, N7	-40	1	1	325	0008H

For 450/1800 MS: 8 cells with the following settings:

Transmitter	Level	NCC	BCC	ARFCN	Cell identity
Serving, S1	-60	1	3	259	0001H
Neighbour, N1	-85	1	5	520	0002H
Neighbour, N2	-79	1	7	261	0003H
Neighbour, N3	-75	1	1	263	0004H
Neighbour, N4	-55	1	3	780	0005H
Neighbour, N5	-50	1	5	274	0006H
Neighbour, N6	-45	1	7	880	0007H
Neighbour, N7	-40	1	1	278	0008H

For 480/1800 MS: 8 cells with the following settings:

Transmitter	Level	NCC	BCC	ARFCN	Cell identity
Serving, S1	-60	1	3	306	0001H
Neighbour, N1	-85	1	5	520	0002H
Neighbour, N2	-79	1	7	308	0003H
Neighbour, N3	-75	1	1	310	0004H
Neighbour, N4	-55	1	3	780	0005H
Neighbour, N5	-50	1	5	321	0006H
Neighbour, N6	-45	1	7	880	0007H
Neighbour, N7	-40	1	1	325	0008H

For 900/1800 MS: 8 cells with the following settings:

Transmitter	Level	NCC	BCC	ARFCN	Cell Identity
Serving, S1	-60	1	3	002	0001H
Neighbour, N1	-85	1	5	520	0002H
Neighbour, N2	-79	1	7	014	0003H
Neighbour, N3	-75	1	1	020	0004H
Neighbour, N4	-55	1	3	780	0005H
Neighbour, N5	-50	1	5	032	0006H
Neighbour, N6	-45	1	7	880	0007H
Neighbour, N7	-40	1	1	044	0008H

With the exception of the Cell Allocation, the rest of the parameters for all eight cells are the same as the default settings and default SYSTEM INFORMATION TYPE 1, 2 and 4 message contents for cell A. The Cell Allocation for the serving cell is the same as the default setting for cell A. The Cell Allocations for the neighbour cells need have only one entry, consisting of the ARFCN of that cell's BCCH.

Mobile Station:

The MS is in the active state of a call (U10).

Related PICS/PIXIT Statements

Support for state U10 of the Call Control protocol.

Type of MS (multiband GSM 450/900, GSM 480/900, GSM 450/DCS 1 800, GSM 480/DCS 1 800 or GSM 900/DCS 1 800 MS supporting simultaneous multiband operation).

Foreseen Final State of the MS

Active state of a call (U10).

Test Procedure

This test procedure is performed three times.

With the MS having a call in progress, the SS sends SYSTEM INFORMATION TYPE 5, 5ter & 6 on the SACCH. All 8 of the BCCHs "on air" are indicated in the BA. The MS shall send MEASUREMENT REPORTs back to the SS, and it shall be indicated in these that measurement results for the 6 strongest carriers, on which the mobile is asked to report (indicated by the parameter MULTIBAND_REPORTING), have been obtained.

Maximum Duration of Test

5 minutes, including 1 minute for any necessary operator actions.

Expected Sequence

This sequence is performed for execution counter, $k = 1, 2, 3$.

Since SYSTEM INFORMATION TYPE 5, SYSTEM INFORMATION TYPE 5ter, SYSTEM INFORMATION TYPE 6 and MEASUREMENT REPORT are sent continuously, a table is not applicable in this test. The interval between 2 successive Layer 2 frames containing MEASUREMENT REPORTs shall not exceed one Layer 2 frame.

Specific Message Contents

For 450/900 MS:

SYSTEM INFORMATION TYPE 2ter:

Information Element	value/remark
As defaults except: Neighbour Cells Description 2 Multiband Reporting	k=1, 3: Minimum 3 cells reported from each band supported excluding the frequency band of the serving cell. k=2: Normal reporting of six strongest cells, irrespective of the band used.

SYSTEM INFORMATION TYPE 3:

Information Element	value/remark
as default except: - SI 2ter indicator - Early Classmark Sending Control	SI 3 rest octets System Information 2ter is available Early Sending is explicitly accepted

SYSTEM INFORMATION TYPE 5:

Information Element	value/remark
Protocol Discriminator Message Type Neighbour Cells Description - Format Identifier - BCCH Allocation Sequence - BCCH Allocation ARFCN - EXT IND	RR management Sys Info 5. k=1, 2: Range 128 k=3: Bit map 0 1 k=1, 2: ARFCN 261, 263, 274, 278 k=3: ARFCN 2, 88, 114 Information Element carries the complete BA.

SYSTEM INFORMATION TYPE 5ter:

Information Element	value/remark
Protocol Discriminator Message Type - Neighbour Cells Description 2 - Multiband reporting - Format notation - BA_IND - BCCH Allocation ARFCN	RR management Sys Info 5ter. k=1, 3: Normal reporting of six strongest cells, irrespective of the band used k=2: Minimum 3 cells reported from each band supported excluding the frequency band of the serving cell. Range 512 1 k=1, 2: ARFCN 2, 88, 114 k=3: ARFCN 261, 263, 274, 278

MEASUREMENT REPORT:

Information Element	value/remark
Protocol Discriminator	RR Management
Transaction Identifier	0000
Message Type	MEASUREMENT REPORT
Measurement Results	
BA-used	1
DTX-used	DTX was not used
RXLEV-FULL-SERVING-CELL	See note 1
RXLEV-SUB-SERVING-CELL	See note 1
MEAS-VALID	See note 3
RXQUAL-FULL-SERVING-CELL	See note 1
RXQUAL-SUB-SERVING-CELL	See note 1
NO-NCELL-M	6 neighbour cell measurement results
RXLEV-NCELL-1	See note 1
BCCH-FREQ-NCELL-1	See note 2
BSIC-NCELL-1	Corresponds to that of BCCH-FREQ-NCELL-1
RXLEV-NCELL-2	See note 1
BCCH-FREQ-NCELL-2	See note 2
BSIC-NCELL-2	Corresponds to that of BCCH-FREQ-NCELL-2
RXLEV-NCELL-3	See note 1
BCCH-FREQ-NCELL-3	See note 2
BSIC-NCELL-3	Corresponds to that of BCCH-FREQ-NCELL-3
RXLEV-NCELL-4	See note 1
BCCH-FREQ-NCELL-4	See note 2
BSIC-NCELL-4	Corresponds to that of BCCH-FREQ-NCELL-4
RXLEV-NCELL-5	See note 1
BCCH-FREQ-NCELL-5	See note 2
BSIC-NCELL-5	Corresponds to that of BCCH-FREQ-NCELL-5
RXLEV-NCELL-6	See note 1
BCCH-FREQ-NCELL-6	See note 2
BSIC-NCELL-6	Corresponds to that of BCCH-FREQ-NCELL-6

NOTE 1: These actual values are not checked.

NOTE 2: k=1; report on ARFCNs 261, 263, 274, 278, 88, 114

ie: BSIC-NCELL values of 0, 1, 2, 3, 5 and 6 but not 4

k=2; report on ARFCNs 263, 274, 278, 2, 88, 114
of 1, 2, 3, 4, 5 and 6 but not 0

k=3; report on ARFCNs 88, 114, 261, 263, 274, 278

ie: BSIC-NCELL values of 1, 2, 3, 4, 5 and 6 but not 0

ie: BSIC-NCELL values

NOTE 3: The Measurement Valid Indication shall be set to valid within the second SACCH block at the latest.

For 480/900 MS:

SYSTEM INFORMATION TYPE 2ter:

Information Element	value/remark
As defaults except: Neighbour Cells Description 2 Multiband Reporting	k=1, 3: Minimum 3 cells reported from each band supported excluding the frequency band of the serving cell. k=2: Normal reporting of six strongest cells, irrespective of the band used.

SYSTEM INFORMATION TYPE 3:

Information Element	value/remark
as default except: - SI 2ter indicator - Early Classmark Sending Control	SI 3 rest octets System Information 2ter is available Early Sending is explicitly accepted

SYSTEM INFORMATION TYPE 5:

Information Element	value/remark
Protocol Discriminator	RR management
Message Type	Sys Info 5.
Neighbour Cells Description	
- Format Identifier	k=1, 2: Range 128 k=3: Bit map 0
- BCCH Allocation Sequence	1
- BCCH Allocation ARFCN	k=1, 2: ARFCN 308, 310, 321, 325 k=3: ARFCN 2, 88, 114
- EXT IND	Information Element carries the complete BA.

SYSTEM INFORMATION TYPE 5ter:

Information Element	value/remark
Protocol Discriminator	RR management
Message Type	Sys Info 5ter.
- Neighbour Cells Description 2	
- Multiband reporting	k=1, 3: Normal reporting of six strongest cells, irrespective of the band used k=2: Minimum 3 cells reported from each band supported excluding the frequency band of the serving cell.
- Format notation	Range 512
- BA_IND	1
- BCCH Allocation ARFCN	k=1, 2: ARFCN 2, 88, 114 k=3: ARFCN 308, 310, 321, 325

MEASUREMENT REPORT:

Information Element	value/remark
Protocol Discriminator	RR Management
Transaction Identifier	0000
Message Type	MEASUREMENT REPORT
Measurement Results	
BA-used	1
DTX-used	DTX was not used
RXLEV-FULL-SERVING-CELL	See note 1
RXLEV-SUB-SERVING-CELL	See note 1
MEAS-VALID	See note 3
RXQUAL-FULL-SERVING-CELL	See note 1
RXQUAL-SUB-SERVING-CELL	See note 1
NO-NCELL-M	6 neighbour cell measurement results
RXLEV-NCELL-1	See note 1
BCCH-FREQ-NCELL-1	See note 2
BSIC-NCELL-1	Corresponds to that of BCCH-FREQ-NCELL-1
RXLEV-NCELL-2	See note 1
BCCH-FREQ-NCELL-2	See note 2
BSIC-NCELL-2	Corresponds to that of BCCH-FREQ-NCELL-2
RXLEV-NCELL-3	See note 1
BCCH-FREQ-NCELL-3	See note 2
BSIC-NCELL-3	Corresponds to that of BCCH-FREQ-NCELL-3
RXLEV-NCELL-4	See note 1
BCCH-FREQ-NCELL-4	See note 2
BSIC-NCELL-4	Corresponds to that of BCCH-FREQ-NCELL-4
RXLEV-NCELL-5	See note 1
BCCH-FREQ-NCELL-5	See note 2
BSIC-NCELL-5	Corresponds to that of BCCH-FREQ-NCELL-5
RXLEV-NCELL-6	See note 1
BCCH-FREQ-NCELL-6	See note 2
BSIC-NCELL-6	Corresponds to that of BCCH-FREQ-NCELL-6

NOTE 1: These actual values are not checked.

NOTE 2: k=1; report on ARFCNs 308, 310, 321, 325, 88, 114

ie: BSIC-NCELL values of 0, 1, 2, 3, 5 and 6 but not 4

k=2; report on ARFCNs 310, 321, 325, 2, 88, 114

of 1, 2, 3, 4, 5 and 6 but not 0

k=3; report on ARFCNs 88, 114, 308, 310, 321, 325

ie: BSIC-NCELL values of 1, 2, 3, 4, 5 and 6 but not 0

ie: BSIC-NCELL values

NOTE 3: The Measurement Valid Indication shall be set to valid within the second SACCH block at the latest.

For 450/1800 MS:

SYSTEM INFORMATION TYPE 2ter:

Information Element	value/remark
As defaults except: Neighbour Cells Description 2 Multiband Reporting	k=1, 3: Minimum 3 cells reported from each band supported excluding the frequency band of the serving cell. k=2: Normal reporting of six strongest cells, irrespective of the band used.

SYSTEM INFORMATION TYPE 3:

Information Element	value/remark
as default except: - SI 2ter indicator - Early Classmark Sending Control	SI 3 rest octets System Information 2ter is available Early Sending is explicitly accepted

SYSTEM INFORMATION TYPE 5:

Information Element	value/remark
Protocol Discriminator Message Type Neighbour Cells Description - Format Identifier - BCCH Allocation Sequence - BCCH Allocation ARFCN - EXT IND	RR management Sys Info 5. k=1, 2: Range 128 k=3: Range 512 1 k=1, 2: ARFCN 261, 263, 274, 278 k=3: ARFCN 520, 780, 880 Information Element carries the complete BA.

SYSTEM INFORMATION TYPE 5ter:

Information Element	value/remark
Protocol Discriminator Message Type - Neighbour Cells Description 2 - Multiband reporting - Format notation - BA_IND - BCCH Allocation ARFCN	RR management Sys Info 5ter. k=1, 3: Normal reporting of six strongest cells, irrespective of the band used k=2: Minimum 3 cells reported from each band supported excluding the frequency band of the serving cell. Range 512 1 k=1, 2: ARFCN 520, 780, 880 k=3: ARFCN 261, 263, 274, 278

MEASUREMENT REPORT:

Information Element	value/remark
Protocol Discriminator	RR Management
Transaction Identifier	0000
Message Type	MEASUREMENT REPORT
Measurement Results	
BA-used	1
DTX-used	DTX was not used
RXLEV-FULL-SERVING-CELL	See note 1
RXLEV-SUB-SERVING-CELL	See note 1
MEAS-VALID	See note 3
RXQUAL-FULL-SERVING-CELL	See note 1
RXQUAL-SUB-SERVING-CELL	See note 1
NO-NCELL-M	6 neighbour cell measurement results
RXLEV-NCELL-1	See note 1
BCCH-FREQ-NCELL-1	See note 2
BSIC-NCELL-1	Corresponds to that of BCCH-FREQ-NCELL-1
RXLEV-NCELL-2	See note 1
BCCH-FREQ-NCELL-2	See note 2
BSIC-NCELL-2	Corresponds to that of BCCH-FREQ-NCELL-2
RXLEV-NCELL-3	See note 1
BCCH-FREQ-NCELL-3	See note 2
BSIC-NCELL-3	Corresponds to that of BCCH-FREQ-NCELL-3
RXLEV-NCELL-4	See note 1
BCCH-FREQ-NCELL-4	See note 2
BSIC-NCELL-4	Corresponds to that of BCCH-FREQ-NCELL-4
RXLEV-NCELL-5	See note 1
BCCH-FREQ-NCELL-5	See note 2
BSIC-NCELL-5	Corresponds to that of BCCH-FREQ-NCELL-5
RXLEV-NCELL-6	See note 1
BCCH-FREQ-NCELL-6	See note 2
BSIC-NCELL-6	Corresponds to that of BCCH-FREQ-NCELL-6

NOTE 1: These actual values are not checked.

NOTE 2: k=1; report on ARFCNs 261, 263, 274, 278, 780, 880

ie: BSIC-NCELL values of 0, 1, 2, 3, 5 and 6 but not 4

k=2; report on ARFCNs 263, 274, 278, 520, 780, 880
values of 1, 2, 3, 4, 5 and 6 but not 0

ie: BSIC-NCELL

k=3; report on ARFCNs 780, 880, 261, 263, 274, 278

ie: BSIC-NCELL values of 1, 2, 3, 4, 5 and 6 but not 0

NOTE 3: The Measurement Valid Indication shall be set to valid within the second SACCH block at the latest.

For 480/1800 MS:

SYSTEM INFORMATION TYPE 2ter:

Information Element	value/remark
As defaults except: Neighbour Cells Description 2 Multiband Reporting	k=1, 3: Minimum 3 cells reported from each band supported excluding the frequency band of the serving cell. k=2: Normal reporting of six strongest cells, irrespective of the band used.

SYSTEM INFORMATION TYPE 3:

Information Element	value/remark
as default except: - SI 2ter indicator - Early Classmark Sending Control	SI 3 rest octets System Information 2ter is available Early Sending is explicitly accepted

SYSTEM INFORMATION TYPE 5:

Information Element	value/remark
Protocol Discriminator	RR management
Message Type	Sys Info 5.
Neighbour Cells Description	
- Format Identifier	k=1, 2: Range 128 k=3: Range 512
- BCCH Allocation Sequence	1
- BCCH Allocation ARFCN	k=1, 2: ARFCN 308, 310, 321, 325 k=3: ARFCN 520, 780, 880
- EXT IND	Information Element carries the complete BA.

SYSTEM INFORMATION TYPE 5ter:

Information Element	value/remark
Protocol Discriminator	RR management
Message Type	Sys Info 5ter.
- Neighbour Cells Description 2	
- Multiband reporting	k=1, 3: Normal reporting of six strongest cells, irrespective of the band used k=2: Minimum 3 cells reported from each band supported excluding the frequency band of the serving cell. Range 512
- Format notation	1
- BA_IND	1
- BCCH Allocation ARFCN	k=1, 2: ARFCN 520, 780, 880 k=3: ARFCN 308, 310, 321, 325

MEASUREMENT REPORT:

Information Element	value/remark
Protocol Discriminator	RR Management
Transaction Identifier	0000
Message Type	MEASUREMENT REPORT
Measurement Results	
BA-used	1
DTX-used	DTX was not used
RXLEV-FULL-SERVING-CELL	See note 1
RXLEV-SUB-SERVING-CELL	See note 1
MEAS-VALID	See note 3
RXQUAL-FULL-SERVING-CELL	See note 1
RXQUAL-SUB-SERVING-CELL	See note 1
NO-NCELL-M	6 neighbour cell measurement results
RXLEV-NCELL-1	See note 1
BCCH-FREQ-NCELL-1	See note 2
BSIC-NCELL-1	Corresponds to that of BCCH-FREQ-NCELL-1
RXLEV-NCELL-2	See note 1
BCCH-FREQ-NCELL-2	See note 2
BSIC-NCELL-2	Corresponds to that of BCCH-FREQ-NCELL-2
RXLEV-NCELL-3	See note 1
BCCH-FREQ-NCELL-3	See note 2
BSIC-NCELL-3	Corresponds to that of BCCH-FREQ-NCELL-3
RXLEV-NCELL-4	See note 1
BCCH-FREQ-NCELL-4	See note 2
BSIC-NCELL-4	Corresponds to that of BCCH-FREQ-NCELL-4
RXLEV-NCELL-5	See note 1
BCCH-FREQ-NCELL-5	See note 2
BSIC-NCELL-5	Corresponds to that of BCCH-FREQ-NCELL-5
RXLEV-NCELL-6	See note 1
BCCH-FREQ-NCELL-6	See note 2
BSIC-NCELL-6	Corresponds to that of BCCH-FREQ-NCELL-6

NOTE 1: These actual values are not checked.

NOTE 2: k=1; report on ARFCNs 308, 310, 321, 325, 780, 880

ie: BSIC-NCELL values of 0, 1, 2, 3, 5 and 6 but not 4

k=2; report on ARFCNs 310, 321, 325, 520, 780, 880

ie: BSIC-NCELL

values of 1, 2, 3, 4, 5 and 6 but not 0

k=3; report on ARFCNs 780, 880, 308, 310, 321, 325

ie: BSIC-NCELL values of 1, 2, 3, 4, 5 and 6 but not 0

NOTE 3: The Measurement Valid Indication shall be set to valid within the second SACCH block at the latest.

For 900/1800 MS:

SYSTEM INFORMATION TYPE 2ter:

Information Element	value/remark
As defaults except: Neighbour Cells Description 2 Multiband Reporting	k=1, 3: Minimum 3 cells reported from each band supported excluding the frequency band of the serving cell. k=2: Normal reporting of six strongest cells, irrespective of the band used.

SYSTEM INFORMATION TYPE 3:

Information Element	value/remark
as default except: - SI 2ter indicator - Early Classmark Sending Control	SI 3 rest octets System Information 2ter is available Early Sending is explicitly accepted

SYSTEM INFORMATION TYPE 5:

Information Element	value/remark
Protocol Discriminator Message Type Neighbour Cells Description - Format Identifier - BCCH Allocation Sequence - BCCH Allocation ARFCN - EXT IND	RR management Sys Info 5. k=1, 2: Bit map 0 k=3: Range 512 1 k=1, 2: ARFCN 14, 20, 32, 44 k=3: ARFCN 520, 780, 880 Information Element carries the complete BA.

SYSTEM INFORMATION TYPE 5ter:

Information Element	value/remark
Protocol Discriminator Message Type - Neighbour Cells Description 2 - Multiband reporting - Format notation - BA_IND - BCCH Allocation ARFCN	RR management Sys Info 5ter. k=1, 3: Normal reporting of six strongest cells, irrespective of the band used k=2: Minimum 3 cells reported from each band supported excluding the frequency band of the serving cell. Range 512 1 k=1, 2: ARFCN 520, 780, 880 k=3: ARFCN 14, 20, 32, 44

MEASUREMENT REPORT:

Information Element	value/remark
Protocol Discriminator	RR Management
Transaction Identifier	0000
Message Type	MEASUREMENT REPORT
Measurement Results	
BA-used	1
DTX-used	DTX was not used
RXLEV-FULL-SERVING-CELL	See note 1
RXLEV-SUB-SERVING-CELL	See note 1
MEAS-VALID	See note 3
RXQUAL-FULL-SERVING-CELL	See note 1
RXQUAL-SUB-SERVING-CELL	See note 1
NO-NCELL-M	6 neighbour cell measurement results
RXLEV-NCELL-1	See note 1
BCCH-FREQ-NCELL-1	See note 2
BSIC-NCELL-1	Corresponds to that of BCCH-FREQ-NCELL-1
RXLEV-NCELL-2	See note 1
BCCH-FREQ-NCELL-2	See note 2
BSIC-NCELL-2	Corresponds to that of BCCH-FREQ-NCELL-2
RXLEV-NCELL-3	See note 1
BCCH-FREQ-NCELL-3	See note 2
BSIC-NCELL-3	Corresponds to that of BCCH-FREQ-NCELL-3
RXLEV-NCELL-4	See note 1
BCCH-FREQ-NCELL-4	See note 2
BSIC-NCELL-4	Corresponds to that of BCCH-FREQ-NCELL-4
RXLEV-NCELL-5	See note 1
BCCH-FREQ-NCELL-5	See note 2
BSIC-NCELL-5	Corresponds to that of BCCH-FREQ-NCELL-5
RXLEV-NCELL-6	See note 1
BCCH-FREQ-NCELL-6	See note 2
BSIC-NCELL-6	Corresponds to that of BCCH-FREQ-NCELL-6

NOTE 1: These actual values are not checked.

NOTE 2: k=1; report on ARFCNs 14, 20, 32, 44, 780, 880
 ie: BSIC-NCELL values of 0, 1, 2, 3, 5 and 6 but not 4
 k=2; report on ARFCNs 20, 32, 44, 520, 780, 880
 ie: BSIC-NCELL values of 1, 2, 3, 4, 5 and 6 but not 0
 k=3; report on ARFCNs 780, 880, 14, 20, 32, 44
 ie: BSIC-NCELL values of 1, 2, 3, 4, 5 and 6 but not 0

NOTE 3: The Measurement Valid Indication shall be set to valid within the second SACCH block at the latest.

26.11.3 Multiband signalling / MM

26.11.3.1 Multiband signalling / MM / Location updating

This procedure is used to register the MS in the network. If it is not performed correctly, no call can be established.

26.11.3.1.1 Location updating / accepted

This test is applicable for any Multiband MSs supporting simultaneous multiband operation.

26.11.3.1.1.1 Conformance requirement

If the network accepts a location updating from the Mobile, the Mobile Station shall, after receiving a Location updating Accept message, store the received LAI, stop timer T3210, reset the attempt counter and set the update status in the SIM to updated.

A mobile station that makes use of System information 2ter (to choose correct cell for location updating) , shall not ignore this message if it has a L2 pseudolength different from 18 .

Reference(s)

GSM 04.08 section 4.4.4.6.

26.11.3.1 1.2 Test purpose

To test the behaviour of the MS if the network accepts the location updating of the MS, irrespective of frequency band used.

To test the behaviour of the MS if it receives a System information 2ter with L2pseudolength different from 18 .

26.11.3.1.1.3 Method of test

Initial conditions:

System Simulator:

Two cells, A and B, belonging to different location areas with location area identification a and b of the same PLMN and using frequencies from different frequency bands.

IMSI attach/detach is allowed in both cells.

The T3212 time-out value is 1/10 hour in both cells.

Mobile Station:

The MS has a valid TMSI. It is "idle updated" on cell A.

Related PICS/PIXIT statement(s)

Frequency bands supported (GSM 450, GSM 480, P-GSM, E-GSM, R-GSM or DCS 1 800).

Foreseen final state of the MS

The MS has a valid TMSI. It is "idle, updated" on cell A.

Test Procedure

The MS is made to select cell B. A normal location updating is performed in cell B. The channel is released. The MS is made to select cell A. A normal location updating is performed in cell A.

The LOCATION UPDATING ACCEPT message contains neither IMSI nor TMSI.

Maximum duration of test

3 minutes.

Expected sequence

Step	Direction	Message	Comments
1	SS		The RF level of cell A is lowered but kept suitable , and the RF level of cell B is set higher, in order that the MS can choose cell B as a better cell than cell A , if it correctly read the information broadcasted on the BCCH. The following message are received and sent on cell B . "Establishment cause": Location updating.
2	MS -> SS	CHANNEL REQUEST	"location updating type" = normal, "CKSN" = CKSN1, "location area identification" = a and "mobile identity" = TMSI.
3	SS -> MS	IMMEDIATE ASSIGNMENT	
4	MS -> SS	LOCATION UPDATING REQUEST	
5	SS -> MS	UA(LOCATION UPDATING REQUEST)	
6	MS -> SS	CLASSMARK CHANGE	Indicating the frequency and power capability of the MS "Mobile identity" IE not included. After the sending of this message, the SS waits for the disconnection of the main signalling link.
7	SS -> MS	LOCATION UPDATING ACC	
8	SS -> MS	CHANNEL RELEASE	
9	SS		The RF level of cell B is lowered but kept suitable , and the RF level of cell A is set higher, in order that the MS can choose cell A as a better cell than cell B , if it correctly read the information broadcasted on the BCCH. The following message are received and sent on cell A . "Establishment cause": Location updating
10	MS -> SS	CHANNEL REQUEST	"location updating type" = normal, "CKSN" = CKSN1, "location area identification" = b and "mobile identity" = TMSI.
11	SS -> MS	IMMEDIATE ASSIGNMENT	
12	MS -> SS	LOCATION UPDATING REQUEST	
13	SS -> MS	UA(LOCATION UPDATING REQUEST)	Indicating the frequency and power capability of the MS "Mobile identity" IE not included. After the sending of this message, the SS waits for the disconnection of the main signalling link.
14	MS -> SS	CLASSMARK CHANGE	
15	SS -> MS	LOCATION UPDATING ACC	
16	SS -> MS	CHANNEL RELEASE	

Specific message contents:

SYSTEM INFORMATION 2TER of CELL B

Information element	Value/remark
as default except: L2 pseudolength	= 0

LOCATION UPDATING REQUEST

Information element	Value/remark
as default except: Mobile station Classmark 1 - ES IND - RF power capability	Controlled Early Classmark Sending option is implemented corresponding to frequency band used

CLASSMARK CHANGE

Information element	Value/remark
as default except: Mobile station Classmark 2 -ES IND -RF power capability Additional MS Classmark information -Band 1 (P-GSM) supported -Band 2 (E-GSM) supported - R-Band (R-GSM) supported -Band 3 (DCS) supported -GSM 400 Band supported -Associated radio capability -Associated radio capability -Associated radio capability - R-Band Associated radio capability	Controlled Early Classmark Sending is implemented. corresponding to the frequency band in use According to PICS/PIXIT statement According to PICS/PIXIT statement According to PICS/PIXIT statement According to PICS/PIXIT statement According to PICS/PIXIT statement Corresponding to GSM 400 band Corresponding to GSM 900 band Corresponding to DCS 1 800 band Corresponding to R-GSM 900 band

26.11.3.1.2 Location updating / periodic

This test is applicable for any Multiband MSs supporting simultaneous multiband operation.

26.11.3.1.2.1 Conformance requirement

- 1) If the Mobile Station is in service state NO CELL AVAILABLE, LIMITED SERVICE, PLMN SEARCH or PLMN SEARCH-NORMAL SERVICE when the timer expires the location updating procedure is delayed until this service state is left.
- 2) The T3212 time-out value shall not be changed in the NO CELL AVAILABLE, LIMITED SERVICE, PLMN SEARCH and PLMN SEARCH-NORMAL SERVICE states.
- 3) If the selected cell is in the location area where the mobile station is registered and IMSI ATTACH is not required and timer T3212 has not expired, then the state is NORMAL SERVICE.

References

- 1 GSM 04.08 section 4.4.2.
- 2 GSM 04.08 section 4.4.2.
- 3 GSM 04.08 section 4.2.1.1.

26.11.3.1.2.2 Test purpose

- 1) To check that if the PLU timer expires while the MS is out of coverage, the MS informs the network of its return to coverage, irrespective of frequency band used.
- 2) To check that the PLU timer is not disturbed by cells of forbidden PLMNs.
- 3) To check that if the PLU timer does not expire while out of coverage and if the mobile returns to the LA where it is updated, the mobile does not inform the network of its return to coverage.

26.11.3.1.2.3 Method of test

Initial conditions

System Simulator:

Two cells, A and B, belonging to the same location area but using different frequency bands.

Cell A is switched on and cell B is switched off.

T3212 is set to 12 minutes on cell A and cell B.

IMSI attach is allowed in both cells.

Mobile Station:

The MS has a valid TMSI. It is "idle updated" on cell A.

Related PICS/PIXIT statements

Frequency bands supported (GSM 450, GSM 480, P-GSM, E-GSM, R-GSM or DCS 1 800).

Foreseen final state of the MS

The MS is "idle updated" on cell A.

Test procedure

The MS is deactivated. The MS is then activated and placed in automatic network selection mode. It performs IMSI attach. 1 minute after the end of the IMSI attach procedure, cell A is switched off. 8 minutes after the end of the IMSI attach procedure, cell B is switched on. The MS shall not location update on cell B before 11,75 minutes after the end of the IMSI attach procedure. The MS shall perform a periodic location update on cell B between 11,75 minutes and 12,25 minutes after the end of the IMSI attach procedure.

3 minutes after the end of the periodic location updating procedure, cell B is switched off. 14 minutes after the end of the periodic location updating procedure, cell A is switched on. The MS shall perform a location update on cell A before 17 minutes after the end of the periodic location updating procedure.

Maximum duration of test

35 minutes.

Expected sequence

Step	Direction	Message	Comments
1	MS		The MS is activated in automatic network selection mode
2	MS -> SS	CHANNEL REQUEST	
3	SS -> MS	IMMEDIATE ASSIGNMENT	
4	MS -> SS	LOCATION UPDATING REQUEST	"location updating type": IMSI attach
5	SS -> MS	UA(LOCATION UPDATING REQUEST)	
6	MS -> SS	CLASSMARK CHANGE	Indicating the frequency and power capability of the MS
7	SS -> MS	LOCATION UPDATING ACC	
8	SS -> MS	CHANNEL RELEASE	After the sending of this message, the SS waits for the disconnection of the main signalling link.
9	SS		1 minute after step 6, cell A is switched off
10	SS		8 minutes after step 6, cell B is switched on
11	MS -> SS	CHANNEL REQUEST	This message shall be sent on cell B by the MS between 11 minutes 45s and 12 minutes 15s after step 6.
12	SS -> MS	IMMEDIATE ASSIGNMENT	
13	MS -> SS	LOCATION UPDATING REQUEST	"location updating type": periodic updating
14	SS -> MS	UA(LOCATION UPDATING REQUEST)	
15	MS -> SS	CLASSMARK CHANGE	Indicating the frequency and power capability of the MS
16	SS -> MS	LOCATION UPDATING ACC	
17	SS -> MS	CHANNEL RELEASE	After the sending of this message, the SS waits for the disconnection of the main signalling link.
18	SS		3 minutes after step 13, cell B is switched off
19	SS		14 minutes after step 13, cell A is switched on.
20	MS -> SS	CHANNEL REQUEST	This message shall be sent on cell A by the MS before 17 minutes after step 13.
21	SS -> MS	IMMEDIATE ASSIGNMENT	
22	MS -> SS	LOCATION UPDATING REQUEST	"Location updating type" = periodic
23	SS -> MS	UA(LOCATION UPDATING REQUEST)	
24	MS -> SS	CLASSMARK CHANGE	Indicating the frequency and power capability of the MS
25	SS -> MS	LOCATION UPDATING ACC	
26	SS -> MS	CHANNEL RELEASE	After the sending of this message, the SS waits for the disconnection of the main signalling link.

Specific message contents

LOCATION UPDATING REQUEST

Information element	Value/remark
as default except: Mobile station Classmark 1 - ES IND - RF power capability	Controlled Early Classmark Sending option is implemented corresponding to frequency band used

CLASSMARK CHANGE

Information element	Value/remark
as default except: Mobile station Classmark 2 -ES IND -RF power capability	Controlled Early Classmark Sending is implemented. corresponding to the frequency band in use
Additional MS Classmark information -Band 1 (P-GSM) supported -Band 2 (E-GSM) supported -Band 3 (DCS) supported -GSM 400 Band supported - R-Band (R-GSM) supported -Associated radio capability -Associated radio capability -Associated radio capability - R-Band Associated radio capability	According to PICS/PIXIT statement According to PICS/PIXIT statement According to PICS/PIXIT statement According to PICS/PIXIT statement According to PICS/PIXIT statement Corresponding to GSM 400 band Corresponding to GSM 900 band Corresponding to DCS 1 800 band Corresponding to R-GSM 900 band

26.11.4 Multiband signalling / CC

Reserved for future use.

26.11.5 Multiband signalling / Structured procedures

These tests applies only to multiband mobile stations.

26.11.5.1 Multiband signalling / Structured procedures / MS originated call / early assignment

26.11.5.1.1 Conformance requirements

- 1) An MS in MM state "idle, updated" and in RR idle mode, when made to initiate a call, if it provides a human interface, shall display the dialled number.
- 2) An MS in MM state "idle, updated" and in RR idle mode, when made to initiate a call for a selected teleservice that is supported by the MS, shall start to initiate the immediate assignment procedure by sending a CHANNEL REQUEST message with correct establishment cause.
- 3) After the initial message the multiband MS shall send a CLASSMARK CHANGE message in the uplink block followed direct after the Layer 2 UA message sent from the network. The CLASSMARK CHANGE message shall contain information elements Mobile Station Classmark 2 and Mobile Station Classmark 3.
- 4) Subsequently after establishment of an MM connection, the MS shall send a SETUP message with correct parameters.
- 5) The call control entity of the Mobile Station in the "call initiated" state, in the "mobile originating call proceeding" state or in the "call delivered" state, shall, upon receipt of a CONNECT message:
 - attach the user connection to the radio path;
 - return a CONNECT ACKNOWLEDGE message.
- 6) Subsequently when the network initiates call clearing by sending a DISCONNECT message, the MS shall proceed to release the call by sending a RELEASE message.
- 7) On receipt of a CHANNEL RELEASE message, the MS shall disconnect the main signalling link.

References

- Conformance requirement 1: GSM 02.07.
Conformance requirement 2: GSM 04.08 section 3.3.1.1

Conformance requirement 3: GSM 04.08 section 3.3.1.1.4

Conformance requirement 4: GSM 04.08 section 5.2.1.1.

Conformance requirement 5: GSM 04.08 section 5.2.1.6.

Conformance requirement 6: GSM 04.08 section 5.4.4.

Conformance requirement 7: GSM 04.08, section 3.4.13.1

26.11.5.1.2 Test purpose

- 1) To verify that the MS in MM state "idle, updated" with a TMSI assigned, when made to initiate a call for a selected teleservice that is supported by the MS as declared in a PICS/PIXIT statement, displays the dialled number in the way described in a PICS/PIXIT statement.
- 2) To verify that the MS in MM state "idle, updated" and in RR idle mode, with a TMSI assigned, when made to initiate a call for a selected teleservice that is supported by the MS as declared in a PICS/PIXIT statement, starts to initiate an immediate assignment procedure by sending the CHANNEL REQUEST message with correct establishment cause.
- 3) To verify that a multiband MS is able to send an early CLASSMARK CHANGE on the DCCH uplink.
- 4) To verify that subsequently after receipt of an IMMEDIATE ASSIGNMENT message allocating an SDCCH, after completion of establishment of the main signalling link, after having sent a CM SERVICE REQUEST message, after having successfully performed the authentication and cipher mode setting procedures, the MS sends a SETUP message with correct parameters.
- 5) To verify that subsequently, after receipt of a CALL PROCEEDING message and of an HANDOVER COMMAND message allocating an appropriate TCH in another band, after having completed the traffic channel early assignment procedure by replying with the HANDOVER COMPLETE message, after receipt of an ALERTING message and a CONNECT message, the MS returns a CONNECT ACKNOWLEDGE message.

To verify that subsequently the MS has attached the user connection to the radio path. (This is checked by verifying that there is a point in time after transmission of the first L2 frame containing the (complete) CONNECT message, where the MS is sending appropriate speech or data frames whenever it does not have to transmit or acknowledge an I frame on layer 2 of the FACCH.)

- 6) To verify that subsequently upon the network initiating call clearing by sending a DISCONNECT message, the MS proceed to release the call with RELEASE.
- 7) To verify that subsequently, on receipt of a RELEASE COMPLETE message followed by a CHANNEL RELEASE message, the MS disconnects the main signalling link.

26.11.5.1.3 Method of test

Related PICS/PIXIT Statements

- Interface to the human user (p1 = Y/N).
- Way to display the called number (only applicable if the MS has an interface to the human user).
- Way to indicate alerting (only applicable if the MS supports the feature).
- Way to make the MS accept an incoming call after alerting (possibly dependent on teleservice and configuration).
- Supported teleservices.
- Classmark.
- Frequency bands supported.

Initial Conditions

System Simulator:

For 450/900 MS:

2 cells, A and B, with same LAI.

Cell A is a GSM 450 cell with default parameters.

Cell B is a GSM 900 cell with default parameters.

For 480/900 MS:

2 cells, A and B, with same LAI.

Cell A is a GSM 480 cell with default parameters.

Cell B is a GSM 900 cell with default parameters.

For 450/1800 MS:

2 cells, A and B, with same LAI.

Cell A is a GSM 450 cell with default parameters.

Cell B is a DCS 1 800 cell with default parameters.

For 480/1800 MS:

2 cells, A and B, with same LAI.

Cell A is a GSM 480 cell with default parameters.

Cell B is a DCS 1 800 cell with default parameters.

For 900/1800 MS:

2 cells, A and B, with same LAI.

Cell A is a GSM 900 cell with default parameters.

Cell B is a DCS 1 800 cell with default parameters.

Mobile Station:

The MS is in MM-state idle, updated on cell A with valid TMSI.

Foreseen Final State of the MS

The MS is in MM-state idle, updated on cell B with valid TMSI.

Test procedure

The following test is performed for one teleservice supported by the MS:

A teleservice is selected that is supported by the MS; if the MS supports speech, the selected teleservice is speech. If necessary, the MS is configured for that teleservice.

The MS is made to initiate a call on any frequency band supported by the MS. The call is established with early assignment. Having reached the active state, the call is cleared by the SS.

Maximum Duration of Test

1 minute.

Expected Sequence

Step	Direction	Message	Comments
1	MS		The "called number" is entered
2	MS -> SS	CHANNEL REQUEST	Establishment cause is "originating call and the network does not set the NECI bit to 1".
3	SS -> MS	IMMEDIATE ASSIGNMENT	
4	MS -> SS	CM SERVICE REQUEST	Message is contained in SABM. Indicating early sending of CLASSMARK CHANGE
5	SS -> MS	UA (CM SERVICE REQUEST)	
6	MS -> SS	CLASSMARK CHANGE	Indicating the frequency and power capability of the MS
7	SS -> MS	AUTHENTICATION REQUEST	
8	MS -> SS	AUTHENTICATION RESP	SRES specifies correct value.
9	SS -> MS	CIPHERING MODE COMMAND	SS starts deciphering after sending the message.
10	MS -> SS	CIPHERING MODE COMPLETE	Shall be sent enciphered. All following messages shall be sent enciphered.
11	SS		SS starts ciphering.
12	MS -> SS	SETUP	
13	SS -> MS	CALL PROCEEDING	
14	SS -> MS	HANDOVER COMMAND	See specific message contents below.
15	MS -> SS	HANDOVER ACCESS	May or may not be sent. The sending of the HANDOVER ACCESS is optional as indicated in HANDOVER COMMAND.
	MS -> SS	HANDOVER ACCESS	
	MS -> SS	HANDOVER ACCESS	
	MS -> SS	HANDOVER ACCESS	Handover Reference is included in the HANDOVER COMMAND.
16	MS -> SS	SABM	Sent without information field
17	SS -> MS	UA	
18	MS -> SS	HANDOVER COMPLETE	
19	SS -> MS	ALERTING	
20	MS		Depending on the PICS, an alerting indication is given
21	SS -> MS	CONNECT	
22	MS -> SS	CONNECT ACKNOWLEDGE	
23	MS		The appropriate bearer channel is through connected in both directions.
24	SS -> MS	DISCONNECT	
25	MS -> SS	RELEASE	
26	SS -> MS	RELEASE COMPLETE	
27	SS -> MS	CHANNEL RELEASE	The main signalling link is released.

Specific Message Contents:

For 450/900 MS:

CM SERVICE REQUEST

as default except:

Information element	Value/remark
Mobile station Classmark 2 - ES IND	Shall indicate early autonomous sending of CLASSMARK CHANGE
- RF power capability	corresponding to the frequency band in use

CLASSMARK CHANGE

as default except:

Information element	Value/remark
Protocol Discriminator	RR management
Mobile station Classmark 2	
- ES IND	Shall indicate early autonomous sending of CLASSMARK CHANGE corresponding to the frequency band in use
- RF power capability	
Additional MS Classmark information	
- Band 1 (P-GSM) supported	According to PICS/PIXIT statement
- Band 2 (E-GSM) supported	According to PICS/PIXIT statement
- R-Band (R-GSM) supported	According to PICS/PIXIT statement
- GSM 400 Band supported	According to PICS/PIXIT statement
- GSM 400 Associated radio capability	Corresponding to GSM 450 band
- Associated radio capability 1	Corresponding to GSM 900 band
- R-Band Associated radio capability	Corresponding to R-GSM 900 band

HANDOVER COMMAND

Information element	Value/remark
Protocol Discriminator	RR management
Cell Description	
- NCC	1
- BCC	5
- BCCH Carrier Number	20
Channel description	
- Channel type	TCH/F + ACCH's
- Timeslot number	Arbitrary value
- Training sequence code	Chosen arbitrarily
- Hopping	Single RF channel
- ARFCN	50
Handover Reference	Chosen arbitrarily from the range (0,1...255)
Power Command & Access type	
- Power level	Arbitrarily chosen, but different to the one already in use and within the range supported by the MS.
- Access type control	Sending of HANOVER ACCESS is optional
Synchronization Indication	pre-synchronized; ROT=0; NCI=0.
Timing Advance	same as in IMMEDIATE ASSIGNMENT
Mode of the First Channel	appropriate for the selected bearer service

For 480/900 MS:

CM SERVICE REQUEST

as default except:

Information element	Value/remark
Mobile station Classmark 2	
- ES IND	Shall indicate early autonomous sending of CLASSMARK CHANGE corresponding to the frequency band in use
- RF power capability	

CLASSMARK CHANGE

as default except:

Information element	Value/remark
Protocol Discriminator	RR management
Mobile station Classmark 2	
- ES IND	Shall indicate early autonomous sending of CLASSMARK CHANGE corresponding to the frequency band in use
- RF power capability	
Additional MS Classmark information	
- Band 1 (P-GSM) supported	According to PICS/PIXIT statement
- Band 2 (E-GSM) supported	According to PICS/PIXIT statement
- GSM 400 Band supported	According to PICS/PIXIT statement
- R-Band (R-GSM) supported	According to PICS/PIXIT statement
- GSM 400 Associated radio capability	Corresponding to GSM 400 band
- Associated radio capability 1	Corresponding to GSM 900 band
- R-Band Associated radio capability	Corresponding to R-GSM 900 band

HANDOVER COMMAND

Information element	Value/remark
Protocol Discriminator	RR management
Cell Description	
- NCC	1
- BCC	5
- BCCH Carrier Number	20
Channel description	
- Channel type	TCH/F + ACCH's
- Timeslot number	Arbitrary value
- Training sequence code	Chosen arbitrarily
- Hopping	Single RF channel
- ARFCN	50
Handover Reference	Chosen arbitrarily from the range (0,1...255)
Power Command & Access type	
- Power level	Arbitrarily chosen, but different to the one already in use and within the range supported by the MS.
- Access type control	Sending of HANOVER ACCESS is optional
Synchronization Indication	pre-synchronized; ROT=0; NCI=0.
Timing Advance	same as in IMMEDIATE ASSIGNMENT
Mode of the First Channel	appropriate for the selected bearer service

For 450/1800 MS:

CM SERVICE REQUEST

as default except:

Information element	Value/remark
Mobile station Classmark 2	
- ES IND	Shall indicate early autonomous sending of CLASSMARK CHANGE corresponding to the frequency band in use
- RF power capability	

CLASSMARK CHANGE

as default except:

Information element	Value/remark
Protocol Discriminator	RR management
Mobile station Classmark 2	
- ES IND	Shall indicate early autonomous sending of CLASSMARK CHANGE corresponding to the frequency band in use
- RF power capability	
Additional MS Classmark information	
- Band 3 (DCS 1 800) supported	According to PICS/PIXIT statement
- GSM 400 Band supported	According to PICS/PIXIT statement
- GSM 400 Associated radio capability	Corresponding to GSM 450 band
- Associated radio capability 2	Corresponding to DCS 1 800 band

HANDOVER COMMAND

Information element	Value/remark
Protocol Discriminator	RR management
Cell Description	
- NCC	1
- BCC	5
- BCCH Carrier Number	590
Channel description	
- Channel type	TCH/F + ACCH's
- Timeslot number	Arbitrary value
- Training sequence code	Chosen arbitrarily
- Hopping	Single RF channel
- ARFCN	650
Handover Reference	Chosen arbitrarily from the range (0,1...255)
Power Command & Access type	
- Power level	Arbitrarily chosen, but different to the one already in use and within the range supported by the MS.
- Access type control	Sending of HANDOVER ACCESS is optional
Synchronization Indication	pre-synchronized; ROT=0; NCI=0.
Timing Advance	same as in IMMEDIATE ASSIGNMENT
Mode of the First Channel	appropriate for the selected bearer service

For 480/1800 MS:

CM SERVICE REQUEST

as default except:

Information element	Value/remark
Mobile station Classmark 2	
- ES IND	Shall indicate early autonomous sending of CLASSMARK CHANGE corresponding to the frequency band in use
- RF power capability	

CLASSMARK CHANGE

as default except:

Information element	Value/remark
Protocol Discriminator	RR management
Mobile station Classmark 2	
- ES IND	Shall indicate early autonomous sending of CLASSMARK CHANGE corresponding to the frequency band in use
- RF power capability	
Additional MS Classmark information	
- Band 3 (DCS 1 800) supported	According to PICS/PIXIT statement
- GSM 400 Band supported	According to PICS/PIXIT statement
- GSM 400 Associated radio capability	Corresponding to GSM 480 band
- Associated radio capability 2	Corresponding to DCS 1 800 band

HANDOVER COMMAND

Information element	Value/remark
Protocol Discriminator	RR management
Cell Description	
- NCC	1
- BCC	5
- BCCH Carrier Number	590
Channel description	
- Channel type	TCH/F + ACCH's
- Timeslot number	Arbitrary value
- Training sequence code	Chosen arbitrarily
- Hopping	Single RF channel
- ARFCN	650
Handover Reference	Chosen arbitrarily from the range (0,1...255)
Power Command & Access type	
- Power level	Arbitrarily chosen, but different to the one already in use and within the range supported by the MS.
- Access type control	Sending of HANDOVER ACCESS is optional
Synchronization Indication	pre-synchronized; ROT=0; NCI=0.
Timing Advance	same as in IMMEDIATE ASSIGNMENT
Mode of the First Channel	appropriate for the selected bearer service

For 900/1800 MS:

CM SERVICE REQUEST

as default except:

Information element	Value/remark
Mobile station Classmark 2	
- ES IND	Shall indicate early autonomous sending of CLASSMARK CHANGE corresponding to the frequency band in use
- RF power capability	

CLASSMARK CHANGE

as default except:

Information element	Value/remark
Protocol Discriminator	RR management
Mobile station Classmark 2	
- ES IND	Shall indicate early autonomous sending of CLASSMARK CHANGE corresponding to the frequency band in use
- RF power capability	
Additional MS Classmark information	
- Band 1 (P-GSM) supported	According to PICS/PIXIT statement
- Band 2 (E-GSM) supported	According to PICS/PIXIT statement
- Band 3 (DCS 1 800) supported	According to PICS/PIXIT statement
- R-Band (R-GSM) supported	According to PICS/PIXIT statement
- Associated radio capability 1	Corresponding to GSM 900 band
- Associated radio capability 2	Corresponding to DCS 1 800 band
- R-Band Associated radio capability	Corresponding to R-GSM 900 band

HANDOVER COMMAND

Information element	Value/remark
Protocol Discriminator	RR management
Cell Description	
- NCC	1
- BCC	5
- BCCH Carrier Number	590
Channel description	
- Channel type	TCH/F + ACCH's
- Timeslot number	Arbitrary value
- Training sequence code	Chosen arbitrarily
- Hopping	Single RF channel
- ARFCN	650
Handover Reference	Chosen arbitrarily from the range (0,1...255)
Power Command & Access type	
- Power level	Arbitrarily chosen, but different to the one already in use and within the range supported by the MS.
- Access type control	Sending of HANDOVER ACCESS is optional
Synchronization Indication	pre-synchronized; ROT=0; NCI=0.
Timing Advance	same as in IMMEDIATE ASSIGNMENT
Mode of the First Channel	appropriate for the selected bearer service

26.11.5.2 Structured procedures / MS terminated call / late assignment

26.11.5.2.1 Conformance requirement

- 1) After the initial message the multiband MS shall send a CLASSMARK CHANGE message in the uplink block followed direct after Layer 2 UA message sent from the network.
- 2) The MS shall acknowledge the SETUP message with a CALL CONFIRMED message, if compatibility checking was successful, the MS is not busy, and the user does not refuse the call.
- 3) The MS on acceptance of the call sends a CONNECT, otherwise user alerting is initiated.
- 4) The MS indicates acceptance of a call by sending a CONNECT message.
- 5) HANDOVER COMMAND is answered by HANDOVER COMPLETE.
- 6) For speech calls:

The mobile station shall attach the user connection at latest when sending the connect message, except if there is no compatible radio resource available at this time. In this case the attachment shall be delayed until such a resource becomes available.

For data calls:

The mobile station shall attach the user connection when receiving the CONNECT ACKNOWLEDGE message from the network.

Requirement reference:

Conformance requirement 1: GSM 04.08, section 3.3.1.1.4

Conformance requirements 2, 3, 4: GSM 04.08, sections 5.2.2.3.1, 5.2.2.3.2 and 5.2.2.5.

Conformance requirement 5: GSM 04.08, section 3.4.3.1.

Conformance requirement 6: GSM 04.08, section 5.2.2.9.

26.11.5.2.2 Test purpose

- 1) To verify that a multiband MS is able to send an early CLASSMARK CHANGE message on the DCCH uplink.
- 2) To verify that the MS in "Idle, Updated" state with a TMSI assigned, after being paged by the network on the correct paging subchannel, after initiating the immediate assignment procedure by sending the CHANNEL REQUEST message, after receipt of an IMMEDIATE ASSIGNMENT message allocating an SDCCH, after having established the main signalling link, after having sent a PAGING RESPONSE message, after having performed successful authentication and cipher mode setting procedures, after receipt of a SETUP message containing a signal information element, returns a CALL CONFIRMED message followed by:
 - an ALERTING message;
 - or a CONNECT message.
- 3) To verify that in the situation of test purpose 1, if the MS sends an ALERTING message, the MS generates an alerting indication in the way described in a PICS/PIXIT statement.
- 4) To verify that subsequently the MS, if it had not yet sent a CONNECT message, upon acceptance of the call, sends a CONNECT message.
- 5) To verify that subsequently after receipt of an HANDOVER COMMAND ALLOCATING A tch IN another band, the MS sends an HANDOVER COMPLETE message.
- 6) To verify that subsequently the MS
 - if the call is a speech call: after sending the HANDOVER COMPLETE message has through connected the TCH in both directions (this is checked by verifying that after transmission of the first L2 frame containing the (complete) HANDOVER COMPLETE message, the MS is sending appropriate speech or data frames whenever it does not have to transmit or acknowledge an I frame on layer 2 of the FACCH.)
 - if the call is a data call: after receipt of a subsequent CONNECT ACKNOWLEDGE message through connects the TCH in both directions (this is checked by verifying that there is a point in time after transmission of the first L2 frame containing the (complete) CONNECT ACKNOWLEDGE message, where the MS is sending appropriate speech or data frames whenever it does not have to transmit or acknowledge an I frame on layer 2 of the FACCH.)

26.11.5.2.3 Method of test

Related PICS/PIXIT statements

- Interface to the human user (p1 = Y/N).
- Way to display the called number (only applicable if the MS has an interface to the human user).
- Way to indicate alerting (only applicable if the MS supports the feature).
- Way to make the MS accept an incoming call after alerting (possibly dependent on teleservice and configuration).

- Supported teleservices.
- Classmark.
- Frequency bands supported.
- Immediate connect supported (Y/N).

Initial Conditions

System Simulator:

For 450/900 MS:

2 cells, A and B, with same LAI.

Cell A is a GSM 450 cell with default parameters.

Cell B is a GSM 900 cell with default parameters.

For 480/900 MS:

2 cells, A and B, with same LAI.

Cell A is a GSM 480 cell with default parameters.

Cell B is a GSM 900 cell with default parameters.

For 450/1800 MS:

2 cells, A and B, with same LAI.

Cell A is a GSM 450 cell with default parameters.

Cell B is a DCS 1 800 cell with default parameters.

For 480/1800 MS:

2 cells, A and B, with same LAI.

Cell A is a GSM 480 cell with default parameters.

Cell B is a DCS 1 800 cell with default parameters.

For 900/1800 MS:

2 cells, A and B, with same LAI.

Cell A is a GSM 900 cell with default parameters.

Cell B is a DCS 1 800 cell with default parameters.

Mobile Station:

The MS is in MM-state idle, updated on cell A with valid TMSI.

Foreseen Final State of the MS

The MS is in MM-state idle, updated on cell B with valid TMSI.

Test procedure

A teleservice is selected that is supported by the MS; if the MS supports speech, the selected teleservice is speech. If necessary, the MS is configured for that teleservice.

The MS is paged on any frequency band supported by the MS and a MT call is established with late assignment (after CONNECT). The release of the call is initiated by the MS.

Maximum Duration of Test

40 seconds.

Expected Sequence

Step	Direction	Message	Comments
1	SS -> MS	PAGING REQUEST TYPE 1	Sent on the correct paging subchannel
2	MS -> SS	CHANNEL REQUEST	Establishment cause indicates "answer to paging".
3	SS -> MS	IMMEDIATE ASSIGNMENT	
4	MS -> SS	PAGING RESPONSE	Message is contained in SABM.
5	SS -> MS	UA (PAGING RESPONSE)	
6	MS -> SS	CLASSMARK CHANGE	Indicating the frequency and power capability of the MS
7	SS -> MS	AUTHENTICATION REQUEST	
8	MS -> SS	AUTHENTICATION RESP	SRES specifies correct value.
9	SS -> MS	CIPHERING MODE COMMAND	SS starts deciphering after sending the message.
10	MS -> SS	CIPHERING MODE COMPLETE	Shall be sent enciphered. All following messages shall be sent enciphered.
11	SS		SS starts ciphering.
12	SS -> MS	SETUP	Message contains the signal IE.
13	MS -> SS	CALL CONFIRMED	
A14	MS -> SS	CONNECT	
B14	MS -> SS	ALERTING	An alerting indication as defined in an PICS/PIXIT statement is given by the MS.
B15	MS		The MS is made to accept the call in the way described in a PICS/PIXIT statement.
B16	MS		
B18	MS -> SS	CONNECT	
19	SS -> MS	HANDOVER COMMAND	See specific message contents below.
20	MS -> SS	HANDOVER ACCESS	Handover Reference is included in the HANDOVER COMMAND.
21	MS -> SS	HANDOVER ACCESS	
22	MS -> SS	HANDOVER ACCESS	
23	MS -> SS	HANDOVER ACCESS	
24	MS -> SS	SABM	Sent without information field
25	SS -> MS	UA	
26	MS -> SS	HANDOVER COMPLETE	
27	MS		If the call is a speech call, the TCH shall be through connected in both directions.
28	SS -> MS	CONNECT ACKNOWLEDGE	
29	MS		If the call is a data call, the MS shall through connect the TCH in both directions
30	MS		The MS is made to release the call.
31	MS -> SS	DISCONNECT	
32	SS -> MS	RELEASE	
33	MS -> SS	RELEASE COMPLETE	
34	SS -> MS	CHANNEL RELEASE	The main signalling link is released.

Specific Message Contents:

For 450/900 MS:

PAGING RESPONSE

Information element	Value/remark
Mobile station Classmark 2 - ES IND - RF power capability	Shall indicate early autonomous sending of CLASSMARK CHANGE corresponding to the frequency band in use

CLASSMARK CHANGE

Information element	Value/remark
Protocol Discriminator Mobile station Classmark - ES IND - RF power capability Additional MS Classmark information - Band 1 (P-GSM) supported - Band 2 (E-GSM) supported - GSM 400 Band supported - R-Band (R-GSM) supported - GSM 400 Associated radio capability - Associated radio capability 1 - R-Band Associated radio capability	RR management Shall indicate early autonomous sending of CLASSMARK CHANGE corresponding to the frequency band in use According to PICS/PIXIT statement According to PICS/PIXIT statement According to PICS/PIXIT statement According to PICS/PIXIT statement Corresponding to GSM 450 band Corresponding to GSM 900 band Corresponding to R-GSM 900 band

HANDOVER COMMAND

Information element	Value/remark
Protocol Discriminator Cell Description - NCC - BCC - BCCH Carrier Number Channel description - Channel type - Timeslot number - Training sequence code - Hopping - ARFCN Handover Reference Power Command & Access type - Power level - Access type control Synchronization Indication Timing Advance Mode of the first channel	RR management 1 5 20 TCH/F + ACCH's Arbitrary value Chosen arbitrarily Single RF channel 50 Chosen arbitrarily from the range (0,1...255) Arbitrarily chosen, but different to the one already in use and within the range supported by the MS. Sending of HANDOVER ACCESS is mandatory. pre-synchronized; ROT=0; NCI=0. same as in IMMEDIATE ASSIGNMENT appropriate for the selected bearer service

For 480/900 MS:

PAGING RESPONSE

Information element	Value/remark
Mobile station Classmark 2 - ES IND - RF power capability	Shall indicate early autonomous sending of CLASSMARK CHANGE corresponding to the frequency band in use

CLASSMARK CHANGE

Information element	Value/remark
Protocol Discriminator Mobile station Classmark - ES IND - RF power capability Additional MS Classmark information - Band 1 (P-GSM) supported - Band 2 (E-GSM) supported - GSM 400 Band supported - R-Band (R-GSM) supported - GSM 400 Associated radio capability - Associated radio capability 1 - R-Band Associated radio capability	RR management Shall indicate early autonomous sending of CLASSMARK CHANGE corresponding to the frequency band in use According to PICS/PIXIT statement According to PICS/PIXIT statement According to PICS/PIXIT statement According to PICS/PIXIT statement Corresponding to GSM 480 band Corresponding to GSM 900 band Corresponding to R-GSM 900 band

HANDOVER COMMAND

Information element	Value/remark
Protocol Discriminator Cell Description - NCC - BCC - BCCH Carrier Number Channel description - Channel type - Timeslot number - Training sequence code - Hopping - ARFCN Handover Reference Power Command & Access type - Power level - Access type control Synchronization Indication Timing Advance Mode of the first channel	RR management 1 5 20 TCH/F + ACCH's Arbitrary value Chosen arbitrarily Single RF channel 50 Chosen arbitrarily from the range (0,1...255) Arbitrarily chosen, but different to the one already in use and within the range supported by the MS. Sending of HANOVER ACCESS is mandatory. pre-synchronized; ROT=0; NCI=0. same as in IMMEDIATE ASSIGNMENT appropriate for the selected bearer service

For 450/1800 MS:

PAGING RESPONSE

Information element	Value/remark
Mobile station Classmark 2 - ES IND - RF power capability	Shall indicate early autonomous sending of CLASSMARK CHANGE corresponding to the frequency band in use

CLASSMARK CHANGE

Information element	Value/remark
Protocol Discriminator	RR management
Mobile station Classmark	
- ES IND	Shall indicate early autonomous sending of CLASSMARK CHANGE
- RF power capability	corresponding to the frequency band in use
Additional MS Classmark information	
- Band 3 (DCS 1 800) supported	According to PICS/PIXIT statement
- GSM 400 Band supported	According to PICS/PIXIT statement
- GSM 400 Associated radio capability	Corresponding to GSM 450 band
- Associated radio capability 2	Corresponding to DCS 1 800 band

HANDOVER COMMAND

Information element	Value/remark
Protocol Discriminator	RR management
Cell Description	
- NCC	1
- BCC	5
- BCCH Carrier Number	590
Channel description	
- Channel type	TCH/F + ACCH's
- Timeslot number	Arbitrary value
- Training sequence code	Chosen arbitrarily
- Hopping	Single RF channel
- ARFCN	650
Handover Reference	Chosen arbitrarily from the range (0,1...255)
Power Command & Access type	
- Power level	Arbitrarily chosen, but different to the one already in use and within the range supported by the MS.
- Access type control	Sending of HANDOVER ACCESS is mandatory.
Synchronization Indication	pre-synchronized; ROT=0; NCI=0.
Timing Advance	same as in IMMEDIATE ASSIGNMENT
Mode of the first channel	appropriate for the selected bearer service

For 480/1800 MS:

PAGING RESPONSE

Information element	Value/remark
Mobile station Classmark 2	
- ES IND	Shall indicate early autonomous sending of CLASSMARK CHANGE
- RF power capability	corresponding to the frequency band in use

CLASSMARK CHANGE

Information element	Value/remark
Protocol Discriminator	RR management
Mobile station Classmark	
- ES IND	Shall indicate early autonomous sending of CLASSMARK CHANGE
- RF power capability	corresponding to the frequency band in use
Additional MS Classmark information	
- Band 3 (DCS 1 800) supported	According to PICS/PIXIT statement
- GSM 400 Band supported	According to PICS/PIXIT statement
- GSM 400 Associated radio capability	Corresponding to GSM 480 band
- Associated radio capability 2	Corresponding to DCS 1 800 band

HANDOVER COMMAND

Information element	Value/remark
Protocol Discriminator	RR management
Cell Description	
- NCC	1
- BCC	5
- BCCH Carrier Number	590
Channel description	
- Channel type	TCH/F + ACCH's
- Timeslot number	Arbitrary value
- Training sequence code	Chosen arbitrarily
- Hopping	Single RF channel
- ARFCN	650
Handover Reference	Chosen arbitrarily from the range (0,1...255)
Power Command & Access type	
- Power level	Arbitrarily chosen, but different to the one already in use and within the range supported by the MS.
- Access type control	Sending of HANDOVER ACCESS is mandatory.
Synchronization Indication	pre-synchronized; ROT=0; NCI=0.
Timing Advance	same as in IMMEDIATE ASSIGNMENT
Mode of the first channel	appropriate for the selected bearer service

For 900/1800 MS:

PAGING RESPONSE

Information element	Value/remark
Mobile station Classmark 2	
- ES IND	Shall indicate early autonomous sending of CLASSMARK CHANGE
- RF power capability	corresponding to the frequency band in use

CLASSMARK CHANGE

Information element	Value/remark
Protocol Discriminator	RR management
Mobile station Classmark	
- ES IND	Shall indicate early autonomous sending of CLASSMARK CHANGE
- RF power capability	corresponding to the frequency band in use
Additional MS Classmark information	
- Band 1 (P-GSM) supported	According to PICS/PIXIT statement
- Band 2 (E-GSM) supported	According to PICS/PIXIT statement
- Band 3 (DCS 1 800) supported	According to PICS/PIXIT statement
- R-Band (R-GSM) supported	According to PICS/PIXIT statement
- Associated radio capability 1	Corresponding to GSM 900 band
- Associated radio capability 2	Corresponding to DCS 1 800 band
- R-Band Associated radio capability	Corresponding to R-GSM 900 band

HANDOVER COMMAND

Information element	Value/remark
Protocol Discriminator	RR management
Cell Description	
- NCC	1
- BCC	5
- BCCH Carrier Number	590
Channel description	
- Channel type	TCH/F + ACCH's
- Timeslot number	Arbitrary value
- Training sequence code	Chosen arbitrarily
- Hopping	Single RF channel
- ARFCN	650
Handover Reference	Chosen arbitrarily from the range (0,1...255)
Power Command & Access type	
- Power level	Arbitrarily chosen, but different to the one already in use and within the range supported by the MS.
- Access type control	Sending of HANDOVER ACCESS is mandatory.
Synchronization Indication	pre-synchronized; ROT=0; NCI=0.
Timing Advance	same as in IMMEDIATE ASSIGNMENT
Mode of the first channel	appropriate for the selected bearer service

26.11.6 Multiband signalling / Default messages contents

Default SYSTEM INFORMATION

The following parameters shall be coded into the system information messages. Parameters shall be coded according to GSM 04.08.

SYSTEM INFORMATION TYPE 2bis, SYSTEM INFORMATION TYPE 5bis, SYSTEM INFORMATION TYPE 7 and SYSTEM INFORMATION TYPE 8 messages are not used.

For 450/900 MS:

SYSTEM INFORMATION TYPE 1

Information Element	Value/remark
Cell channel description	
For Cell A	
- Format identifier	Range 128
- Cell Allocation ARFCN	ARFCN 263, 267, 275 and 279
For Cell B	
- Format identifier	Bit map 0
- Cell Allocation ARFCN	ARFCN 20, 30, 50 and 70
RACH control parameters	see below
SI1 rest octets	see below

SYSTEM INFORMATION TYPE 2

Information Element	Value/remark
BCCH Frequency list	
For Cell A	
- Format identifier	Range 128
- BCCH Allocation Sequence	0
- BCCH Allocation ARFCN	ARFCN 261, 263, 282, 284, 287, 290, 293
- EXT-IND	"The information element carries the complete BA"
For Cell B	
- Format identifier	Bit map 0
- BCCH Allocation Sequence	0
- BCCH Allocation ARFCN	ARFCN 10, 20, 80, 90, 100, 110 and 120
- EXT-IND	"This IE carries the complete BA"
NCC permitted	see below
RACH control parameters	see below

SYSTEM INFORMATION TYPE 2ter

Information Element	Value/remark
Neighbour Cells Description 2	0
Multiband reporting	
For Cell A	
- Format notation	Range 1024
- BA_IND	0
- BCCH Allocation ARFCN	ARFCN 10, 20, 80, 90, 100, 110 and 120
For Cell B	
- Format notation	Range 128
- BA_IND	0
- BCCH Allocation ARFCN	ARFCN 261, 263, 282, 284, 287, 290, 293
SI 2ter rest octets	see below

SYSTEM INFORMATION TYPE 3

Information Element	Value/remark
Cell identity	see below
Location Area Identification	see below
Control Channel Description	see below
Cell options	see below
Cell selection parameters	see below
RACH control parameters	see below
SI3 rest octets	
SI 2ter Indicator	System Information 2ter is available
Early Sending Classmark Control	Early Sending is explicitly accepted

SYSTEM INFORMATION TYPE 4

Information Element	Value/remark
Location Area Identification	see below
Cell selection parameters	see below
RACH control parameters	see below
CBCH Channel Description	see below
CBCH Mobile Allocation	see below
SI4 rest octets	see below

SYSTEM INFORMATION TYPE 5

Information Element	Value/remark
BCCH Frequency list For Cell A <ul style="list-style-type: none"> - Format identifier - BCCH Allocation Sequence - BCCH Allocation ARFCN - EXT-IND For Cell B <ul style="list-style-type: none"> - Format identifier - BCCH Allocation Sequence - BCCH Allocation ARFCN - EXT-IND 	Range 128 0 ARFCN 261, 263, 282, 284, 287, 290, 293 "The information element carries the complete BA" Bit map 0 0 ARFCN 10, 20, 80, 90, 100, 110 and 120 This IE carries the complete BA

SYSTEM INFORMATION TYPE 5ter

Information Element	Value/remark
Neighbour Cells Description 2 Multiband reporting For Cell A <ul style="list-style-type: none"> - Format notation - BA_IND - BCCH Allocation ARFCN For Cell B <ul style="list-style-type: none"> - Format notation - BA_IND - BCCH Allocation ARFCN 	0 Range 1024 0 ARFCN 10, 20, 80, 90, 100, 110 and 120 Range 128 0 ARFCN 261, 263, 282, 284, 287, 290, 293

SYSTEM INFORMATION TYPE 6

Information Element	Value/remark
Cell identity Location Area Identification Cell options NCC permitted	see below see below see below see below

Common contents of information elements in SYSTEM INFORMATION TYPE 1 to 6 messages.

CBCH Channel Description	Not present
CBCH Mobile Allocation	Not present
Cell identity	
CI VALUE	0001H for cell A, 0002H for cell B
Cell options	
Power Control Indicator	power control indicator is not set
DTX Indicator	MS shall not use DTX
RADIO LINK TIME-OUT	8 SACCH blocks
Cell selection parameters	
CELL RESELECT HYSTERESIS	12 dB
MS-TXPWR-MAX-CCH	Minimum level
RXLEV-ACCESS-MIN	Minimum level
ACS	There are no additional cell parameters included in SI7 and SI8
NECI	New establishment cause not supported
Control Channel Description	
ATT	No Attach/Detach
BS-AG-BLKS-RES	0 blocks reserved
CCCH-CONF	Combined CCCH/SDCCH
BS-PA-MFRMS	5 multiframe
T3212	Infinite
L2 pseudo length	
SI 1	21
SI 2	22
SI 2ter	18
SI 3	18
SI 4	12
Location Area Identification	
MCC	001 decimal
MNC	01 decimal
LAC	0001H
Message Type	
SI 1	00011001
SI 2	00011010
SI 2ter	00000011
SI 3	00011011
SI 4	00011100
SI 5	00011101
SI 5ter	00000110
SI 6	00011110
NCC permitted	00000010
RACH control parameters	
MAX RETRANS	Max 1 retrans
TX-INTEGERS	5 slots used
CELL BAR ACCESS	Not barred
CALL RE-ESTABLISHMENT	Not Allowed
EMERGENCY CALL	Allowed
ACCESS CONTROL CLASS (0...9, 11...15)	None Barred
SI 1 rest octets	Not used (all bits are set to spare)
SI 2 rest octets	Not used (all bits are set to spare)
SI 2ter rest octets	Not used (all bits are set to spare)
SI 4 rest octets	Not used (all bits are set to spare)

Default settings for cell A

Downlink input level	63 dBmicroVolt emf
Uplink output power	Minimum supported by the MS
Propagation profile	Static
BCCH/CCCH	ARFCN 263

Default settings for cell B

Downlink input level	53 dBmicroVolt emf
Uplink output power	Minimum supported by the MS
Propagation profile	Static
BCCH/CCCH	ARFCN 20

For 480/900 MS:

SYSTEM INFORMATION TYPE 1

Information Element	Value/remark
Cell channel description	
For Cell A	
- Format identifier	Range 128
- Cell Allocation ARFCN	ARFCN 310, 315, 322, 326
For Cell B	
- Format identifier	Bit map 0
- Cell Allocation ARFCN	ARFCN 20, 30, 50 and 70
RACH control parameters	see below
SI1 rest octets	see below

SYSTEM INFORMATION TYPE 2

Information Element	Value/remark
BCCH Frequency list	
For Cell A	
- Format identifier	Range 128
- BCCH Allocation Sequence	0
- BCCH Allocation ARFCN	ARFCN 308, 310, 329, 331, 334, 337, 340
- EXT-IND	"The information element carries the complete BA"
For Cell B	
- Format identifier	Bit map 0
- BCCH Allocation Sequence	0
- BCCH Allocation ARFCN	ARFCN 10, 20, 80, 90, 100, 110 and 120
- EXT-IND	"This IE carries the complete BA"
NCC permitted	see below
RACH control parameters	see below

SYSTEM INFORMATION TYPE 2ter

Information Element	Value/remark
Neighbour Cells Description 2	0
Multiband reporting	
For Cell A	
- Format notation	Bit map 0
- BA_IND	0
- BCCH Allocation ARFCN	ARFCN 10, 20, 80, 90, 100, 110 and 120
For Cell B	
- Format notation	Range 128
- BA_IND	0
- BCCH Allocation ARFCN	ARFCN 308, 310, 329, 331, 334, 337, 340
SI 2ter rest octets	see below

SYSTEM INFORMATION TYPE 3

Information Element	Value/remark
Cell identity	see below
Location Area Identification	see below
Control Channel Description	see below
Cell options	see below
Cell selection parameters	see below
RACH control parameters	see below
SI3 rest octets	
SI 2ter Indicator	System Information 2ter is available
Early Sending Classmark Control	Early Sending is explicitly accepted

SYSTEM INFORMATION TYPE 4

Information Element	Value/remark
Location Area Identification	see below
Cell selection parameters	see below
RACH control parameters	see below
CBCH Channel Description	see below
CBCH Mobile Allocation	see below
SI4 rest octets	see below

SYSTEM INFORMATION TYPE 5

Information Element	Value/remark
BCCH Frequency list	
For Cell A	
- Format identifier	Range 128
- BCCH Allocation Sequence	0
- BCCH Allocation ARFCN	ARFCN 308, 310, 329, 331, 334, 337, 340
- EXT-IND	"The information element carries the complete BA"
For Cell B	
- Format identifier	Bit map 0
- BCCH Allocation Sequence	0
- BCCH Allocation ARFCN	ARFCN 10, 20, 80, 90, 100, 110 and 120
- EXT-IND	This IE carries the complete BA

SYSTEM INFORMATION TYPE 5ter

Information Element	Value/remark
Neighbour Cells Description 2	0
Multiband reporting	
For Cell A	
- Format notation	Range 1024
- BA_IND	0
- BCCH Allocation ARFCN	ARFCN 10, 20, 80, 90, 100, 110 and 120
For Cell B	
- Format notation	Range 128
- BA_IND	0
- BCCH Allocation ARFCN	ARFCN 308, 310, 329, 331, 334, 337, 340

SYSTEM INFORMATION TYPE 6

Information Element	Value/remark
Cell identity	see below
Location Area Identification	see below
Cell options	see below
NCC permitted	see below

Common contents of information elements in SYSTEM INFORMATION TYPE 1 to 6 messages.

CBCH Channel Description	Not present
CBCH Mobile Allocation	Not present
Cell identity	
CI VALUE	0001H for cell A, 0002H for cell B
Cell options	
Power Control Indicator	power control indicator is not set
DTX Indicator	MS shall not use DTX
RADIO LINK TIME-OUT	8 SACCH blocks
Cell selection parameters	
CELL RESELECT HYSTERESIS	12 dB
MS-TXPWR-MAX-CCH	Minimum level
RXLEV-ACCESS-MIN	Minimum level
ACS	There are no additional cell parameters included in SI7 and SI8
NECI	New establishment cause not supported
Control Channel Description	
ATT	No Attach/Detach
BS-AG-BLKS-RES	0 blocks reserved
CCCH-CONF	Combined CCCH/SDCCH
BS-PA-MFRMS	5 multiframe
T3212	Infinite
L2 pseudo length	
SI 1	21
SI 2	22
SI 2ter	18
SI 3	18
SI 4	12
Location Area Identification	
MCC	001 decimal
MNC	01 decimal
LAC	0001H
Message Type	
SI 1	00011001
SI 2	00011010
SI 2ter	00000011
SI 3	00011011
SI 4	00011100
SI 5	00011101
SI 5ter	00000110
SI 6	00011110
NCC permitted	00000010
RACH control parameters	
MAX RETRANS	Max 1 retrans
TX-INTEGERS	5 slots used
CELL BAR ACCESS	Not barred
CALL RE-ESTABLISHMENT	Not Allowed
EMERGENCY CALL	Allowed
ACCESS CONTROL CLASS (0...9, 11...15)	None Barred
SI 1 rest octets	Not used (all bits are set to spare)
SI 2 rest octets	Not used (all bits are set to spare)
SI 2ter rest octets	Not used (all bits are set to spare)
SI 4 rest octets	Not used (all bits are set to spare)

Default settings for cell A

Downlink input level	63 dBmicroVolt emf
Uplink output power	Minimum supported by the MS
Propagation profile	Static
BCCH/CCCH	ARFCN 310

Default settings for cell B

Downlink input level	53 dBmicroVolt emf
Uplink output power	Minimum supported by the MS
Propagation profile	Static
BCCH/CCCH	ARFCN 20

For 450/1800 MS:

SYSTEM INFORMATION TYPE 1

Information Element	Value/remark
Cell channel description	
For Cell A	
- Format identifier	Range 128
- Cell Allocation ARFCN	ARFCN 263, 267, 275 and 279
For Cell B	
- Format identifier	Range 512
- Cell Allocation ARFCN	ARFCN 590, 650, 750 and 850
RACH control parameters	see below
SI1 rest octets	see below

SYSTEM INFORMATION TYPE 2

Information Element	Value/remark
BCCH Frequency list	
For Cell A	
- Format identifier	Range 128
- BCCH Allocation Sequence	0
- BCCH Allocation ARFCN	ARFCN 261, 263, 282, 284, 287, 290, 293
- EXT-IND	"The information element carries the complete BA"
For Cell B	
- Format identifier	Range 512
- BCCH Allocation Sequence	0
- BCCH Allocation ARFCN	ARFCN 520, 590, 600, 700, 780, 810 and 870
- EXT-IND	"This IE carries the complete BA"
NCC permitted	see below
RACH control parameters	see below

SYSTEM INFORMATION TYPE 2ter

Information Element	Value/remark
Neighbour Cells Description 2	0
Multiband reporting	
For Cell A	
- Format notation	Range 512
- BA_IND	0
- BCCH Allocation ARFCN	ARFCN 520, 590, 600, 700, 780, 810 and 870
For Cell B	
- Format notation	Range 128
- BA_IND	0
- BCCH Allocation ARFCN	ARFCN 261, 263, 282, 284, 287, 290, 293
SI 2ter rest octets	see below

SYSTEM INFORMATION TYPE 3

Information Element	Value/remark
Cell identity	see below
Location Area Identification	see below
Control Channel Description	see below
Cell options	see below
Cell selection parameters	see below
RACH control parameters	see below
SI3 rest octets	
SI 2ter Indicator	System Information 2ter is available
Early Sending Classmark Control	Early Sending is explicitly accepted

SYSTEM INFORMATION TYPE 4

Information Element	Value/remark
Location Area Identification	see below
Cell selection parameters	see below
RACH control parameters	see below
CBCH Channel Description	see below
CBCH Mobile Allocation	see below
SI4 rest octets	see below

SYSTEM INFORMATION TYPE 5

Information Element	Value/remark
BCCH Frequency list	
For Cell A	
- Format identifier	Range 128
- BCCH Allocation Sequence	0
- BCCH Allocation ARFCN	ARFCN 261, 263, 282, 284, 287, 290, 293
- EXT-IND	"The information element carries the complete BA"
For Cell B	
- Format identifier	Range 512
- BCCH Allocation Sequence	0
- BCCH Allocation ARFCN	ARFCN 520, 590, 600, 700, 780, 810 and 870
- EXT-IND	This IE carries the complete BA

SYSTEM INFORMATION TYPE 5ter

Information Element	Value/remark
Neighbour Cells Description 2	0
Multiband reporting	
For Cell A	
- Format notation	Range 512
- BA_IND	0
- BCCH Allocation ARFCN	ARFCN 520, 590, 600, 700, 780, 810 and 870
For Cell B	
- Format notation	Range 128
- BA_IND	0
- BCCH Allocation ARFCN	ARFCN 261, 263, 282, 284, 287, 290, 293

SYSTEM INFORMATION TYPE 6

Information Element	Value/remark
Cell identity	see below
Location Area Identification	see below
Cell options	see below
NCC permitted	see below

Common contents of information elements in SYSTEM INFORMATION TYPE 1 to 6 messages.

CBCH Channel Description	Not present
CBCH Mobile Allocation	Not present
Cell identity	
CI VALUE	0001H for cell A, 0002H for cell B
Cell options	
Power Control Indicator	power control indicator is not set
DTX Indicator	MS shall not use DTX
RADIO LINK TIME-OUT	8 SACCH blocks
Cell selection parameters	
CELL RESELECT HYSTERESIS	12 dB
MS-TXPWR-MAX-CCH	Minimum level
RXLEV-ACCESS-MIN	Minimum level
ACS	There are no additional cell parameters included in SI7 and SI8
NECI	New establishment cause not supported
Control Channel Description	
ATT	No Attach/Detach
BS-AG-BLKS-RES	0 blocks reserved
CCCH-CONF	Combined CCCH/SDCCH
BS-PA-MFRMS	5 multiframe
T3212	Infinite
L2 pseudo length	
SI 1	21
SI 2	22
SI 2ter	18
SI 3	18
SI 4	12
Location Area Identification	
MCC	001 decimal
MNC	01 decimal
LAC	0001H
Message Type	
SI 1	00011001
SI 2	00011010
SI 2ter	00000011
SI 3	00011011
SI 4	00011100
SI 5	00011101
SI 5ter	00000110
SI 6	00011110
NCC permitted	00000010
RACH control parameters	
MAX RETRANS	Max 1 retrans
TX-INTEGERS	5 slots used
CELL BAR ACCESS	Not barred
CALL RE-ESTABLISHMENT	Not Allowed
EMERGENCY CALL	Allowed
ACCESS CONTROL CLASS (0...9, 11...15)	None Barred
SI 1 rest octets	Not used (all bits are set to spare)
SI 2 rest octets	Not used (all bits are set to spare)
SI 2ter rest octets	Not used (all bits are set to spare)
SI 4 rest octets	Not used (all bits are set to spare)

Default settings for cell A

Downlink input level	63 dBmicroVolt emf
Uplink output power	Minimum supported by the MS
Propagation profile	Static
BCCH/CCCH	ARFCN 263

Default settings for cell B

Downlink input level	53 dBmicroVolt emf
Uplink output power	Minimum supported by the MS
Propagation profile	Static
BCCH/CCCH	ARFCN 590

For 480/1800 MS:

SYSTEM INFORMATION TYPE 1

Information Element	Value/remark
Cell channel description	
For Cell A	
- Format identifier	Range 128
- Cell Allocation ARFCN	ARFCN 310, 315, 322, 326
For Cell B	
- Format identifier	Range 512
- Cell Allocation ARFCN	ARFCN 590, 650, 750 and 850
RACH control parameters	see below
SI1 rest octets	see below

SYSTEM INFORMATION TYPE 2

Information Element	Value/remark
BCCH Frequency list	
For Cell A	
- Format identifier	Range 128
- BCCH Allocation Sequence	0
- BCCH Allocation ARFCN	ARFCN 308, 310, 329, 331, 334, 337, 340
- EXT-IND	"The information element carries the complete BA"
For Cell B	
- Format identifier	Range 512
- BCCH Allocation Sequence	0
- BCCH Allocation ARFCN	ARFCN 520, 590, 600, 700, 780, 810 and 870
- EXT-IND	"This IE carries the complete BA"
NCC permitted	see below
RACH control parameters	see below

SYSTEM INFORMATION TYPE 2ter

Information Element	Value/remark
Neighbour Cells Description 2	0
Multiband reporting	
For Cell A	
- Format notation	Range 512
- BA_IND	0
- BCCH Allocation ARFCN	ARFCN 520, 590, 600, 700, 780, 810 and 870
For Cell B	
- Format notation	Range 128
- BA_IND	0
- BCCH Allocation ARFCN	ARFCN 308, 310, 329, 331, 334, 337, 340
SI 2ter rest octets	see below

SYSTEM INFORMATION TYPE 3

Information Element	Value/remark
Cell identity	see below
Location Area Identification	see below
Control Channel Description	see below
Cell options	see below
Cell selection parameters	see below
RACH control parameters	see below
SI3 rest octets	
SI 2ter Indicator	System Information 2ter is available
Early Sending Classmark Control	Early Sending is explicitly accepted

SYSTEM INFORMATION TYPE 4

Information Element	Value/remark
Location Area Identification	see below
Cell selection parameters	see below
RACH control parameters	see below
CBCH Channel Description	see below
CBCH Mobile Allocation	see below
SI4 rest octets	see below

SYSTEM INFORMATION TYPE 5

Information Element	Value/remark
BCCH Frequency list	
For Cell A	
- Format identifier	Range 128
- BCCH Allocation Sequence	0
- BCCH Allocation ARFCN	ARFCN 308, 310, 329, 331, 334, 337, 340
- EXT-IND	"The information element carries the complete BA"
For Cell B	
- Format identifier	Range 512
- BCCH Allocation Sequence	0
- BCCH Allocation ARFCN	ARFCN 520, 590, 600, 700, 780, 810 and 870
- EXT-IND	This IE carries the complete BA

SYSTEM INFORMATION TYPE 5ter

Information Element	Value/remark
Neighbour Cells Description 2	0
Multiband reporting	
For Cell A	
- Format notation	Range 512
- BA_IND	0
- BCCH Allocation ARFCN	ARFCN 520, 590, 600, 700, 780, 810 and 870
For Cell B	
- Format notation	Range 128
- BA_IND	0
- BCCH Allocation ARFCN	ARFCN 308, 310, 329, 331, 334, 337, 340

SYSTEM INFORMATION TYPE 6

Information Element	Value/remark
Cell identity	see below
Location Area Identification	see below
Cell options	see below
NCC permitted	see below

Common contents of information elements in SYSTEM INFORMATION TYPE 1 to 6 messages.

CBCH Channel Description	Not present
CBCH Mobile Allocation	Not present
Cell identity	
CI VALUE	0001H for cell A, 0002H for cell B
Cell options	
Power Control Indicator	power control indicator is not set
DTX Indicator	MS shall not use DTX
RADIO LINK TIME-OUT	8 SACCH blocks
Cell selection parameters	
CELL RESELECT HYSTERESIS	12 dB
MS-TXPWR-MAX-CCH	Minimum level
RXLEV-ACCESS-MIN	Minimum level
ACS	There are no additional cell parameters included in SI7 and SI8
NECI	New establishment cause not supported
Control Channel Description	
ATT	No Attach/Detach
BS-AG-BLKS-RES	0 blocks reserved
CCCH-CONF	Combined CCCH/SDCCH
BS-PA-MFRMS	5 multiframe
T3212	Infinite
L2 pseudo length	
SI 1	21
SI 2	22
SI 2ter	18
SI 3	18
SI 4	12
Location Area Identification	
MCC	001 decimal
MNC	01 decimal
LAC	0001H
Message Type	
SI 1	00011001
SI 2	00011010
SI 2ter	00000011
SI 3	00011011
SI 4	00011100
SI 5	00011101
SI 5ter	00000110
SI 6	00011110
NCC permitted	00000010
RACH control parameters	
MAX RETRANS	Max 1 retrans
TX-INTEGERS	5 slots used
CELL BAR ACCESS	Not barred
CALL RE-ESTABLISHMENT	Not Allowed
EMERGENCY CALL	Allowed
ACCESS CONTROL CLASS (0...9, 11...15)	None Barred
SI 1 rest octets	Not used (all bits are set to spare)
SI 2 rest octets	Not used (all bits are set to spare)
SI 2ter rest octets	Not used (all bits are set to spare)
SI 4 rest octets	Not used (all bits are set to spare)

Default settings for cell A

Downlink input level	63 dBmicroVolt emf
Uplink output power	Minimum supported by the MS
Propagation profile	Static
BCCH/CCCH	ARFCN 310

Default settings for cell B

Downlink input level	53 dBmicroVolt emf
Uplink output power	Minimum supported by the MS
Propagation profile	Static
BCCH/CCCH	ARFCN 590

For 900/1800 MS:

SYSTEM INFORMATION TYPE 1

Information Element	Value/remark
Cell channel description	
For Cell A	
- Format identifier	Bit map 0
- Cell Allocation ARFCN	ARFCN 20, 30, 50 and 70
For Cell B	
- Format identifier	Range 512
- Cell Allocation ARFCN	ARFCN 590, 650, 750 and 850
RACH control parameters	see below
SI1 rest octets	see below

SYSTEM INFORMATION TYPE 2

Information Element	Value/remark
BCCH Frequency list	
For Cell A	
- Format identifier	Bit map 0
- BCCH Allocation Sequence	0
- BCCH Allocation ARFCN	ARFCN 10, 20, 80, 90, 100, 110 and 120
- EXT-IND	"The information element carries the complete BA"
For Cell B	
- Format identifier	Range 512
- BCCH Allocation Sequence	0
- BCCH Allocation ARFCN	ARFCN 520, 590, 600, 700, 780, 810 and 870
- EXT-IND	"This IE carries the complete BA"
NCC permitted	see below
RACH control parameters	see below

SYSTEM INFORMATION TYPE 2ter

Information Element	Value/remark
Neighbour Cells Description 2	0
Multiband reporting	
For Cell A	
- Format notation	Range 512
- BA_IND	0
- BCCH Allocation ARFCN	ARFCN 520, 590, 600, 700, 780, 810 and 870
For Cell B	
- Format notation	Range 1024
- BA_IND	0
- BCCH Allocation ARFCN	ARFCN 10, 20, 80, 90, 100, 110 and 120
SI 2ter rest octets	see below

SYSTEM INFORMATION TYPE 3

Information Element	Value/remark
Cell identity	see below
Location Area Identification	see below
Control Channel Description	see below
Cell options	see below
Cell selection parameters	see below
RACH control parameters	see below
SI3 rest octets	
SI 2ter Indicator	System Information 2ter is available
Early Sending Classmark Control	Early Sending is explicitly accepted

SYSTEM INFORMATION TYPE 4

Information Element	Value/remark
Location Area Identification	see below
Cell selection parameters	see below
RACH control parameters	see below
CBCH Channel Description	see below
CBCH Mobile Allocation	see below
SI4 rest octets	see below

SYSTEM INFORMATION TYPE 5

Information Element	Value/remark
BCCH Frequency list	
For Cell A	
- Format identifier	Bit map 0
- BCCH Allocation Sequence	0
- BCCH Allocation ARFCN	ARFCN 10, 20, 80, 90, 100, 110 and 120
- EXT-IND	"The information element carries the complete BA"
For Cell B	
- Format identifier	Range 512
- BCCH Allocation Sequence	0
- BCCH Allocation ARFCN	ARFCN 520, 590, 600, 700, 780, 810 and 870
- EXT-IND	This IE carries the complete BA

SYSTEM INFORMATION TYPE 5ter

Information Element	Value/remark
Neighbour Cells Description 2	0
Multiband reporting	
For Cell A	
- Format notation	Range 512
- BA_IND	0
- BCCH Allocation ARFCN	ARFCN 520, 590, 600, 700, 780, 810 and 870
For Cell B	
- Format notation	Range 1024
- BA_IND	0
- BCCH Allocation ARFCN	ARFCN 10, 20, 80, 90, 100, 110 and 120

SYSTEM INFORMATION TYPE 6

Information Element	Value/remark
Cell identity	see below
Location Area Identification	see below
Cell options	see below
NCC permitted	see below

Common contents of information elements in SYSTEM INFORMATION TYPE 1 to 6 messages.

CBCH Channel Description	Not present
CBCH Mobile Allocation	Not present
Cell identity	
CI VALUE	0001H for cell A, 0002H for cell B
Cell options	
Power Control Indicator	power control indicator is not set
DTX Indicator	MS shall not use DTX
RADIO LINK TIME-OUT	8 SACCH blocks
Cell selection parameters	
CELL RESELECT HYSTERESIS	12 dB
MS-TXPWR-MAX-CCH	Minimum level
RXLEV-ACCESS-MIN	Minimum level
ACS	There are no additional cell parameters included in SI7 and SI8
NECI	New establishment cause not supported
Control Channel Description	
ATT	No Attach/Detach
BS-AG-BLKS-RES	0 blocks reserved
CCCH-CONF	Combined CCCH/SDCCH
BS-PA-MFRMS	5 multiframe
T3212	Infinite
L2 pseudo length	
SI 1	21
SI 2	22
SI 2ter	18
SI 3	18
SI 4	12
Location Area Identification	
MCC	001 decimal
MNC	01 decimal
LAC	0001H
Message Type	
SI 1	00011001
SI 2	00011010
SI 2ter	00000011
SI 3	00011011
SI 4	00011100
SI 5	00011101
SI 5ter	00000110
SI 6	00011110
NCC permitted	00000010
RACH control parameters	
MAX RETRANS	Max 1 retrans
TX-INTEGERS	5 slots used
CELL BAR ACCESS	Not barred
CALL RE-ESTABLISHMENT	Not Allowed
EMERGENCY CALL	Allowed
ACCESS CONTROL CLASS (0...9, 11...15)	None Barred
SI 1 rest octets	Not used (all bits are set to spare)
SI 2 rest octets	Not used (all bits are set to spare)
SI 2ter rest octets	Not used (all bits are set to spare)
SI 4 rest octets	Not used (all bits are set to spare)

Default settings for cell A

Downlink input level	63 dBmicroVolt emf
Uplink output power	Minimum supported by the MS
Propagation profile	Static
BCCH/CCCH	ARFCN 20

Default settings for cell B

Downlink input level	53 dBmicroVolt emf
Uplink output power	Minimum supported by the MS
Propagation profile	Static
BCCH/CCCH	ARFCN 590

Default message contents for other messages

For section 26.11.2 same as in 26.6.14 for GSM 900 messages and 26.6.15 for DCS 1 800 messages and 26.6.16 for GSM 450 messages and 26.6.17 for GSM 480 messages.

For section 26.11.3 same as in 26.7.

For section 26.11.4 no tests yet defined.

For section 26.11.5 same as in 26.9.7.

26.12 Enhanced Full Rate signalling

This section only applies to MS supporting enhanced full rate speech.

As an EFR mobile station necessarily supports the speech full rate version 1 or both speech full rate version 1 and speech half rate version 1, conformance requirements of section 26 fully apply to this mobile.

The purpose of this extra section is to test the different procedures which may be impacted when Enhanced full rate speech codec is used.

26.12.1 EFR signalling/ test of the channel mode modify procedure

NOTE: This test is derived from the tests in sections 26.6.7.1 and 26.6.7.2 respectively entitled "Test of the channel mode modify procedure / full rate" and "Test of the channel mode modify procedure / half rate".

This test is only applicable to an enhanced full rate speech MS.

26.12.1.1 Conformance requirement

The MS with a TCH/F allocated acknowledges a CHANNEL MODE MODIFY message by sending a CHANNEL MODE MODIFY ACKNOWLEDGE message specifying the new mode and by switching to this mode when this one is set to :

- speech full rate or half rate version 1
- speech full rate or half rate version 2
- any other mode declared supported by the mobile

If the mobile station does not support the indicated mode, it shall retain the old mode and return the associated channel mode information in the CHANNEL MODE MODIFY ACKNOWLEDGE message.

References

TS GSM 02.06 , subclauses 3.2.3

TS GSM 04.08, subclauses 3.4.6.1.1 and 3.4.6.1.2

26.12.1.2 Test purpose

To verify that the MS with a TCH/F allocated acknowledges a CHANNEL MODE MODIFY message by sending a CHANNEL MODE MODIFY ACKNOWLEDGE message specifying the new mode and by switching to this mode when this one is set to :

- speech full rate or half rate version 1

- speech full rate or half rate version 2
- any other mode declared supported by the mobile

To verify that the MS, in an RR connected state, acknowledges a CHANNEL MODE MODIFY message by sending a CHANNEL MODE MODIFY ACKNOWLEDGE message specifying the old mode when the new mode is not declared as supported by the mobile

26.12.1.3 Method of test

Initial Conditions

System Simulator: 1 cell, default parameters.

Mobile Station: The MS is "idle updated", with TMSI allocated.

Related PICS/PIXIT Statements

- Type of MS (GSM 400 or P-GSM900 or EGSM or DCS1800 or PCS 1900).
- The MS supports speech full rate version 2
 - Bearer Capabilities supported by the MS
 - Channel modes supported by the MS
 - * MS supports speech full rate version 3 (p1 = Y/N)
 - * MS supports data 12 Kb/s (p2 = Y/N)
 - * MS supports data 6 Kb/s full rate (p3 = Y/N)
 - * MS supports data 3,6 Kb/s full rate (p4 = Y/N)

Foreseen Final State of the MS

"Idle, updated", with TMSI allocated.

Test procedure

A Mobile Terminated call is initiated, however following the CHANNEL REQUEST received from the Mobile Station, the SS sends an IMMEDIATE ASSIGNMENT to the MS commanding it to go to a TCH/F. This sets the Channel Mode automatically to "Signalling Only".

The SS then sends a series of CHANNEL MODE MODIFY messages to the MS. Each time it is checked that the MS responds with a CHANNEL MODE MODIFY ACKNOWLEDGE message specifying

- the channel mode that has been specified in the CHANNEL MODE MODIFY message, if the MS supports that mode (this mode then becomes the "channel mode in use"). If necessary, the MS shall be correctly configured in order to accept this mode.
- the channel mode that was in use when the CHANNEL MODE MODIFY message has been received, if the MS does not support the channel mode specified in the CHANNEL MODE MODIFY message.

Maximum Duration of Test

50 seconds.

Expected Sequence

Step	Direction	Message	Comments
1	SS->MS	PAGING REQUEST TYPE 1	Sent on correct paging subchannel Establishment cause indicates "answer to paging" Assignment to a non hopping TCH/F
2	MS->SS	CHANNEL REQUEST	
3	SS->MS	IMMEDIATE ASSIGNMENT	
4	SS->MS	CHANNEL MODE MODIFY	
5	MS->SS	CHANNEL MODE MODIDY ACKNOWLEDGE	
6	SS->MS	CHANNEL MODE MODIFY	
7	MS->SS	CHANNEL MODE MODIDY ACKNOWLEDGE	
8	SS->MS	CHANNEL MODE MODIFY	
9	MS->SS	CHANNEL MODE MODIDY ACKNOWLEDGE	
10	SS->MS	CHANNEL MODE MODIFY	
11	MS->SS	CHANNEL MODE MODIDY ACKNOWLEDGE	
12	SS->MS	CHANNEL MODE MODIFY	
13	MS->SS	CHANNEL MODE MODIDY ACKNOWLEDGE	
14	SS->MS	CHANNEL MODE MODIFY	
15	MS->SS	CHANNEL MODE MODIDY ACKNOWLEDGE	
16	SS->MS	CHANNEL MODE MODIFY	
17	MS->SS	CHANNEL MODE MODIDY ACKNOWLEDGE	
18	SS->MS	CHANNEL MODE MODIFY	
19	MS->SS	CHANNEL MODE MODIDY ACKNOWLEDGE	
20	SS->MS	CHANNEL MODE MODIFY	
21	MS->SS	CHANNEL MODE MODIDY ACKNOWLEDGE	
22	SS->MS	CHANNEL MODE MODIFY	
23	MS->SS	CHANNEL MODE MODIDY ACKNOWLEDGE	
24	SS->MS	CHANNEL RELEASE	

Specific Message Contents

CHANNEL MODE MODIFY

Information Element	value/remark
Channel description	describes the already assigned dedicated channel
Channel mode	
Mode	in step 4: speech full or half rate version 2 in step 6: data 3,6 Kb/s in step 8: speech full or half rate version 2 in step 10: data 6 Kb/s in step 12: speech full or half rate version 2 in step 14: data 12 Kb/s in step 16: speech full or half rate version 2 in step 18: speech full or half rate version 1 in step 20: speech full or half rate version 2 in step 22: speech full or half rate version 3

CHANNEL MODE MODIFY ACKNOWLEDGE

Channel mode Mode	in steps 5, 9, 13, 17, 21 : speech full rate version 2 in step 7: if p 4= Y: data 3,6 Kb/s if p4 = N: same as in step 5 in step 11 : if p3 = Y: data 6,0 Kb/s full rate if p3 = N: same as in step 9 in step 15: if p2 = Y: data 12 Kb/s full rate if p2 = N: same as in step 13 in step 19: speech full rate version 2 in step 23: if p1 = Y: speech full rate version 3 if p1 = N: same as in step 21
----------------------	--

26.12.2 EFR signalling/ tests of handover

With the Handover procedure, it is possible to completely alter the channels allocated to a MS. This makes it possible in particular to switch a call in progress from one cell to another. The procedure is always initiated by the network and with the MS in a dedicated mode.

Section 26.12.2.1 contains generic test procedures to be used for executing successful Handover tests dealing with EFR mode.

It deals with EFR signalling in the Handover/successful/active call/non synchronised case.

Table 1 contains a summary of the different combinations of parameters which have to be tested, together with a reference to the appropriate generic test procedure. If a test uses a channel rate which the MS under test does not support, the test shall be skipped.

sv1 stands for speech full/half rate version 1.

sv2 stands for speech full/half rate version 2 (enhanced full rate).

Table 1

From	To	Timing Adv.	Start Time	Syn ?	State of call	Section	Exec Counter
TCH/F, sv2, no FH	TCH/F, sv2, no FH	20	none	no	U10	26.12.2.1	1
TCH/F, sv2, no FH	TCH/F, sv2, FH	arbitrary	none	no	U10	26.12.2.1	2
TCH/F, sv2, FH	TCH/F, sv2, no FH	20	1,1s	no	U10	26.12.2.1	3
TCH/F, sv2, no FH	TCH/F, sv1, no FH	20	none	no	U10	26.12.2.1	4
TCH/F, sv1, no FH	TCH/F, sv2, no FH	arbitrary	none	no	U10	26.12.2.1	5
TCH/F, sv2, no FH	TCH/F, sv1, FH	arbitrary	none	no	U10	26.12.2.1	6
TCH/F, sv1, FH	TCH/F, sv2, FH	20	1,1	no	U10	26.12.2.1	7
TCH/F, sv2, FH	TCH/F, sv1, FH	arbitrary	none	no	U10	26.12.2.1	8
TCH/F, sv1, FH	TCH/F, sv2, no FH	arbitrary	none	no	U10	26.12.2.1	9
TCH/F, sv2, no FH	TCH/H, sv1, FH	arbitrary	none	no	U10	26.12.2.1	10
TCH/H, sv1, FH	TCH/F, sv2, FH	20	1,1	no	U10	26.12.2.1	11
TCH/F, sv2, FH	TCH/H, sv1, FH	arbitrary	none	no	U10	26.12.2.1	12
TCH/H, sv1, FH	TCH/F, sv2, noFH	20	none	no	U10	26.12.2.1	13
TCH/F, sv2, noFH	TCH/H, sv1, noFH	20	none	no	U10	26.12.2.1	14
TCH/H, sv1, noFH	TCH/F, sv2, noFH	20	none	no	U10	26.12.2.1	15

Table 2

	TCH/FS	TCH/HS	SDCCH
n	10-20	5-10	2-5

n : number of access bursts.

26.12.2.1 EFR signalling / Handover / active call / successful case

NOTE: This test is derived from the one defined in section 26.6.5.1 "Handover/successful/active call/non-synchronized"

This test only applies for MS supporting full rate speech version 2 (enhanced full rate speech).

26.12.2.1.1 Conformance requirements

The MS shall correctly apply the handover procedure in the non-synchronized case when :

- a call is in progress and,
- handover is performed from a TCH/F with/without frequency hopping towards a TCH/F with/without frequency hopping and,
- the mode of either the current or the target channel is set to full rate speech version 2 (enhanced full rate speech).

The MS also supporting half rate shall correctly apply the handover procedure in the non-synchronized case when:

- a call is in progress and,
- a handover is performed between a TCH/H with/without frequency hopping and a TCH/F with/without frequency hopping and,
- the mode of the TCH/F is set to full rate speech version 2.

References

GSM 04.08 sections 3.4.4 and 9.1.15

GSM 04.13 section 5.2.6.2.

26.12.2.1.2 Test purpose

To test that the MS shall correctly apply the handover procedure in the non-synchronized case when :

- a call is in progress and,
- handover is performed from a TCH/F with/without frequency hopping towards a TCH/F with/without frequency hopping and,
- the mode of either the current or the target channel is set to full rate speech version 2 (enhanced full rate speech).

To test that the MS also supporting half rate shall correctly apply the handover procedure in the non-synchronized case when :

- a call is in progress and,
- a handover is performed between a TCH/H with/without frequency hopping and a TCH/F with/without frequency hopping and,
- the mode of the TCH/F is set to full rate speech version 2.

26.12.2.1.3 Method of test

Initial Conditions

System Simulator:

2 cells, A and B with same LAI, default parameters except:

GSM450 :

Cell A has : BCCH ARFCN = 263
Cell Allocation = (259, 261, 263, 265, 267, 269, 271, 273, 275, 277, 279, 281, 283, 285, 287, 289, 291)

Cell B has : BCCH ARFCN = 274
Cell Allocation = (260, 262, 264, 266, 268, 270, 272, 274, 276, 279, 281, 283, 285, 287, 289, 291)

The frame numbers of cells A and B shall be different by 100.

The timebase of cells A and B shall be such that the edges of their timeslots are not coincident at the antenna connector.

GSM480 :

Cell A has : BCCH ARFCN = 310
Cell Allocation = (306, 308, 310, 312, 314, 316, 318, 320, 322, 324, 326, 328, 330, 332, 334, 336, 338)

Cell B has : BCCH ARFCN = 321
Cell Allocation = (307, 309, 311, 313, 315, 317, 319, 321, 323, 326, 328, 330, 332, 334, 336, 338)

The frame numbers of cells A and B shall be different by 100.

The timebase of cells A and B shall be such that the edges of their timeslots are not coincident at the antenna connector.

GSM900 :

Cell A has : BCCH ARFCN = 20
Cell Allocation = (10, 17, 20, 26, 34, 42, 45, 46, 52, 59, 66, 73, 74, 75, 76, 108, 114)

Cell B has : BCCH ARFCN = 40
Cell Allocation = (14, 18, 22, 24, 30, 31, 38, 40, 60, 66, 73, 74, 75, 76, 108, 114)

The frame numbers of cells A and B shall be different by 100.

The timebase of cells A and B shall be such that the edges of their timeslots are not coincident at the antenna connector.

DCS1800 :

Cell A has : BCCH ARFCN = 747
Cell Allocation = (734, 741, 747, 754, 759, 762, 766, 767, 773, 775, 779, 782, 791, 798, 829, 832, 844)

Cell B has : BCCH ARFCN = 764
Cell Allocation = (739, 743, 746, 749, 756, 758, 761, 764, 771, 779, 782, 791, 798, 829, 832, 844)

The Cell Allocation of both Cell A and Cell B shall be coded using range 256 format.

The frame numbers of cells A and B shall be different by 100.

The timebase of cells A and B shall be such that the edges of their timeslots are not coincident at the antenna connector.

PCS 1900 :

Cell A has : BCCH ARFCN = 647
Cell Allocation = (634, 641, 647, 654, 659, 662, 666, 667, 673, 675, 679, 682, 691, 698, 729, 732, 744)

Cell B has : BCCH ARFCN = 664
Cell Allocation = (639, 643, 646, 649, 656, 658, 661, 664, 671, 679, 682, 691, 698, 729, 732, 744)

The Cell Allocation of both Cell A and Cell B shall be coded using range 256 format.

The frame numbers of cells A and B shall be different by 100.

The timebase of cells A and B shall be such that the edges of their timeslots are not coincident at the antenna connector.

Mobile Station: The MS is in the active state (U10) of a call on cell A.

Related PICS/PIXIT Statements

Supported rate(s) of TCH: TCH/F and/or TCH/H.

Support for state U10 of the Call Control protocol.

Support for full rate speech version 2 (enhanced full rate speech)

supported radio interface rates : 12kbps, 6kbps, 3,6kbps

Type of Mobile Station (GSM 450 or GSM 480 or P-GSM900 or EGSM or DCS1800 or PCS 1900).

Foreseen Final State of the MS

The active state (U10) of a call on cell A.

Test Procedure

This procedure is repeated for execution counter M = 1 to 15.

The MS is in the active state (U10) of a call. The SS sends a HANOVER COMMAND on the main DCCH. The MS shall (at the time defined by the Starting Time information element, if included in the message) begin to send access bursts on the new DCCH of the target cell. The SS observes the access bursts and after receiving n (n being arbitrarily chosen between values according to table 2 of section 26.12.2) access bursts, the SS sends one PHYSICAL INFORMATION message with a Timing Advance as specified in table 1 of section 26.12.2. The MS shall activate the channel in sending and receiving mode. The MS shall establish a signalling link. The MS shall be ready to transmit a HANOVER COMPLETE message, before 'x' MS after the end of the PHYSICAL INFORMATION message, but not before a UA frame has been sent by the SS.

The term 'ready to transmit' is defined in TS GSM 04.13. The value of 'x' depends upon the target channel and is specified in the specific message contents section.

Maximum Duration of Test

10 minutes, including 1 minute for any necessary operator actions.

Expected Sequence

This sequence is performed for an execution counter M = 1, 2.. 9 for an MS which supports enhanced full speech codec and only TCH/F .

This sequence is performed for an execution counter M = 1, 2.. 15 for an MS which supports enhanced full speech codec and TCH/F and H.

Step	Direction	Message	Comments
0	MS -> SS		The MS and SS are in the active state of a call on the channel described below.
1	SS -> MS	HANDOVER COMMAND	See Specific message contents
2	MS -> SS	HANDOVER ACCESS	Repeated on every burst of the uplink main DCCH until reception of PHYSICAL INFORMATION. Handover Reference as included in the HANDOVER COMMAND. If the HANDOVER COMMAND includes a starting time IE then the first HANDOVER ACCESS message shall be transmitted in the indicated frame (unless the indicated frame is not used by that channel, in which case the next frame used by that channel shall be used)
3	SS -> MS	PHYSICAL INFORMATION	Sent after reception of n HANDOVER ACCESS messages. See specific message contents.
4	MS -> SS	SABM	Sent without information field
5	SS -> MS	UA	
6	MS -> SS	HANDOVER COMPLETE	The message shall be ready to be transmitted before 'x' ms after the completion of step 3.
7	MS -> SS		The MS and SS are in the active state of a call on the TCH described below. The SS checks that the TCH is through connected in the correct mode.

Specific Message Contents

For M = 1 :

GSM450

Step 0 : The MS and SS are using a full rate TCH with speech full rate version 2 and in non-hopping mode on cell A.

HANDOVER COMMAND

Information Element	value/remarks
As default message contents, except :	
Cell Description	
- Network Colour Code	1
- Base Station Colour Code	5
- BCCH Carrier Number	274
Synchronisation Indication	
- Report Observed Time Difference	Shall not be included.
- Synchronisation Indication	'Non synchronised'.
- Normal Cell Indication	Ignore out of range timing advance.

PHYSICAL INFORMATION

Information Element	value/remarks
As default message contents.	

Step 6 : x = 500

Step 7 : The MS and SS are using a full rate TCH with speech full rate version 2 and in non hopping mode on cell B.

GSM480

Step 0 : The MS and SS are using a full rate TCH with speech full rate version 2 and in non-hopping mode on cell A.

HANDOVER COMMAND

Information Element	value/remarks
As default message contents, except :	
Cell Description	
- Network Colour Code	1
- Base Station Colour Code	5
- BCCH Carrier Number	321
Synchronisation Indication	
- Report Observed Time Difference	Shall not be included.
- Synchronisation Indication	'Non synchronised'.
- Normal Cell Indication	Ignore out of range timing advance.

PHYSICAL INFORMATION

Information Element	value/remarks
As default message contents.	

Step 6 : $x = 500$

Step 7 : The MS and SS are using a full rate TCH with speech full rate version 2 and in non hopping mode on cell B.

P-GSM900

Step 0 : The MS and SS are using a full rate TCH with speech full rate version 2 and in non-hopping mode on cell A.

HANDOVER COMMAND

Information Element	value/remarks
As default message contents, except :	
Cell Description	
- Network Colour Code	1
- Base Station Colour Code	5
- BCCH Carrier Number	40
Synchronisation Indication	
- Report Observed Time Difference	Shall not be included.
- Synchronisation Indication	'Non synchronised'.
- Normal Cell Indication	Ignore out of range timing advance.

PHYSICAL INFORMATION

Information Element	value/remarks
As default message contents.	

Step 6 : $x = 500$

Step 7 : The MS and SS are using a full rate TCH with speech full rate version 2 and in non hopping mode on cell B.

DCS1800

Step 0 : The MS and SS are using a full rate TCH with speech full rate version 2 and in non-hopping mode on cell A.

HANDOVER COMMAND

Information Element	value/remarks
As default message contents, except :	
Cell Description	
- Network Colour Code	1
- Base Station Colour Code	5
- BCCH Carrier Number	764
Synchronisation Indication	
- Report Observed Time Difference	Shall not be included.
- Synchronisation Indication	'Non synchronised'.
- Normal Cell Indication	Ignore out of range timing advance.

PHYSICAL INFORMATION

Information Element	value/remarks
As default message contents.	

Step 6 : $x = 500$

Step 7 : The MS and SS are using a full rate TCH with speech full rate version 2 and in non hopping mode on cell B.

PCS 1900

Step 0 : The MS and SS are using a full rate TCH with speech full rate version 2 and in non-hopping mode on cell A.

HANDOVER COMMAND

Information Element	value/remarks
As default message contents, except :	
Cell Description	
- Network Colour Code	1
- Base Station Colour Code	5
- BCCH Carrier Number	664
Synchronisation Indication	
- Report Observed Time Difference	Shall not be included.
- Synchronisation Indication	'Non synchronised'.
- Normal Cell Indication	Ignore out of range timing advance.

PHYSICAL INFORMATION

Information Element	value/remarks
As default message contents.	

Step 6 : $x = 500$

Step 7 : The MS and SS are using a full rate TCH with speech full rate version 2 and in non hopping mode on cell B.

For $M = 2$:

GSM450

Step 0 : The MS and SS are using a full rate TCH with speech full rate version 2 and in non-hopping mode on cell B.

HANDOVER COMMAND

Information Element	value/remarks
As default message contents, except :	
Cell Description	
- Network Colour Code	1
- Base Station Colour Code	5
- BCCH Carrier Number	263
Channel Description	
- Channel Type	TCH/F + ACCHs
- Timeslot number	Chosen arbitrarily, but not Zero
- Training Sequence Code	Chosen arbitrarily
- Hopping	RF hopping channel.
- MAIO	Chosen arbitrarily from the set (0, 1 to N-1), where N is the number of frequencies encoded in the Frequency List IE.
- HSN	Chosen arbitrarily from the set (1,2,..63)
Synchronisation Indication IE is not included.	
Channel Mode IE is not included.	
Frequency List after time	
- Frequency List	Allocates the following 12 frequencies (259, 261, 263, 265, 277, 279, 281, 283, 285, 287, 289, 291)

PHYSICAL INFORMATION

Information Element	value/remarks
As default message contents, except :	
Timing advance	Arbitrarily selected but different to default value.

Step 6 : $x = 500$

Step 7 : The MS and SS are using a full rate TCH with speech full rate version 2 and in hopping mode on cell A.

GSM480

Step 0 : The MS and SS are using a full rate TCH with speech full rate version 2 and in non-hopping mode on cell B.

HANDOVER COMMAND

Information Element	value/remarks
As default message contents, except :	
Cell Description	
- Network Colour Code	1
- Base Station Colour Code	5
- BCCH Carrier Number	310
Channel Description	
- Channel Type	TCH/F + ACCHs
- Timeslot number	Chosen arbitrarily, but not Zero
- Training Sequence Code	Chosen arbitrarily
- Hopping	RF hopping channel.
- MAIO	Chosen arbitrarily from the set (0, 1 to N-1), where N is the number of frequencies encoded in the Frequency List IE.
- HSN	Chosen arbitrarily from the set (1,2,..63)
Synchronisation Indication IE is not included.	
Channel Mode IE is not included.	
Frequency List after time	
- Frequency List	Allocates the following 12 frequencies (306, 308, 310, 312, 324, 326, 328, 330, 332, 334, 336, 338)

PHYSICAL INFORMATION

Information Element	value/remarks
As default message contents, except :	
Timing advance	Arbitrarily selected but different to default value.

Step 6 : $x = 500$

Step 7 : The MS and SS are using a full rate TCH with speech full rate version 2 and in hopping mode on cell A.

GSM900

Step 0 : The MS and SS are using a full rate TCH with speech full rate version 2 and in non-hopping mode on cell B.

HANDOVER COMMAND

Information Element	value/remarks
As default message contents, except :	
Cell Description	
- Network Colour Code	1
- Base Station Colour Code	5
- BCCH Carrier Number	20
Channel Description	
- Channel Type	TCH/F + ACCHs
- Timeslot number	Chosen arbitrarily, but not Zero
- Training Sequence Code	Chosen arbitrarily
- Hopping	RF hopping channel.
- MAIO	Chosen arbitrarily from the set (0, 1 to N-1), where N is the number of frequencies encoded in the Frequency Channel Sequence IE.
- HSN	Chosen arbitrarily from the set (1,2,..63)
Synchronisation Indication IE is not included.	
Channel Mode IE is not included.	
Frequency Channel Sequence after time	
- Frequency Channel Sequence	Allocates the following 12 frequencies (10, 17, 20, 26, 59, 66, 73, 74, 75, 76,108, 114)

PHYSICAL INFORMATION

Information Element	value/remarks
As default message contents, except : Timing advance	Arbitrarily selected but different to default value.

Step 6 : $x = 500$

Step 7 : The MS and SS are using a full rate TCH with speech full rate version 2 and in hopping mode on cell A.

DCS1800

Step 0 : The MS and SS are using a full rate TCH with speech full rate version 2 and in non-hopping mode on cell B.

HANDOVER COMMAND

Information Element	value/remarks
As default message contents, except : Cell Description - Network Colour Code - Base Station Colour Code - BCCH Carrier Number Channel Description - Channel Type - Timeslot number - Training Sequence Code - Hopping - MAIO - HSN Synchronisation Indication IE is not included. Channel Mode IE is not included. Frequency Short List after time - Frequency List	1 5 747 TCH/F + ACCHs Chosen arbitrarily, but not Zero Chosen arbitrarily RF hopping channel. Chosen arbitrarily from the set (0, 1 to N-1), where N is the number of frequencies encoded in the Frequency Short List IE. Chosen arbitrarily from the set (1,2,..63) Use Range 256 to encode the following 9 frequencies : (747, 775, 779, 782, 791, 798, 829, 832, 844)

PHYSICAL INFORMATION

Information Element	value/remarks
As default message contents, except : Timing advance	Arbitrarily selected but different to default value.

Step 6 : $x = 500$

Step 7 : The MS and SS are using a full rate TCH with speech full rate version 2 and in hopping mode on cell A.

PCS 1900

Step 0 : The MS and SS are using a full rate TCH with speech full rate version 2 and in non-hopping mode on cell B.

HANDOVER COMMAND

Information Element	value/remarks
As default message contents, except :	
Cell Description	
- Network Colour Code	1
- Base Station Colour Code	5
- BCCH Carrier Number	647
Channel Description	
- Channel Type	TCH/F + ACCHs
- Timeslot number	Chosen arbitrarily, but not Zero
- Training Sequence Code	Chosen arbitrarily
- Hopping	RF hopping channel.
- MAIO	Chosen arbitrarily from the set (0, 1 to N-1), where N is the number of frequencies encoded in the Frequency Short List IE.
- HSN	Chosen arbitrarily from the set (1,2,..63)
Synchronisation Indication IE is not included.	
Channel Mode IE is not included.	
Frequency Short List after time	
- Frequency List	Use Range 256 to encode the following 9 frequencies : (647, 675, 679, 682, 691, 698, 729, 732, 744)

PHYSICAL INFORMATION

Information Element	value/remarks
As default message contents, except :	
Timing advance	Arbitrarily selected but different to default value.

Step 6 : $x = 500$

Step 7 : The MS and SS are using a full rate TCH with speech full rate version 2 and in hopping mode on cell A.

For $M = 3$:

GSM450

Step 0 : The MS and SS are using a full rate TCH with speech full rate version 2 and in hopping mode on cell A.

HANDOVER COMMAND

Information Element	value/remarks
As default message contents, except :	
Cell Description	
- Network Colour Code	1
- Base Station Colour Code	5
- BCCH Carrier Number	274
Synchronisation Indication	
- Report Observed Time Difference	Shall not be included.
- Synchronisation Indication	'Non synchronised'.
- Normal Cell Indication	Out of range timing advance shall trigger a handover failure procedure.
Starting Time	Indicates the frame number of cell B that will occur approximately 1,1 seconds (238 frames have elapsed) after the HANDOVER COMMAND is sent by cell A.

PHYSICAL INFORMATION

Information Element	value/remarks
As default message contents.	

Step 6 : x = 500

Step 7 : The MS and SS are using a full rate TCH with speech full rate version 2 and in non-hopping mode on cell B.

GSM480

Step 0 : The MS and SS are using a full rate TCH with speech full rate version 2 and in hopping mode on cell A.

HANDOVER COMMAND

Information Element	value/remarks
As default message contents, except :	
Cell Description	
- Network Colour Code	1
- Base Station Colour Code	5
- BCCH Carrier Number	321
Synchronisation Indication	
- Report Observed Time Difference	Shall not be included.
- Synchronisation Indication	'Non synchronised'.
- Normal Cell Indication	Out of range timing advance shall trigger a handover failure procedure.
Starting Time	Indicates the frame number of cell B that will occur approximately 1,1 seconds (238 frames have elapsed) after the HANDOVER COMMAND is sent by cell A.

PHYSICAL INFORMATION

Information Element	value/remarks
As default message contents.	

Step 6 : x = 500

Step 7 : The MS and SS are using a full rate TCH with speech full rate version 2 and in non-hopping mode on cell B.

GSM900

Step 0 : The MS and SS are using a full rate TCH with speech full rate version 2 and in hopping mode on cell A.

HANDOVER COMMAND

Information Element	value/remarks
As default message contents, except :	
Cell Description	
- Network Colour Code	1
- Base Station Colour Code	5
- BCCH Carrier Number	40
Synchronisation Indication	
- Report Observed Time Difference	Shall not be included.
- Synchronisation Indication	'Non synchronised'.
- Normal Cell Indication	Out of range timing advance shall trigger a handover failure procedure.
Starting Time	Indicates the frame number of cell B that will occur approximately 1,1 seconds (238 frames have elapsed) after the HANDOVER COMMAND is sent by cell A.

PHYSICAL INFORMATION

Information Element	value/remarks
As default message contents.	

Step 6 : x = 500

Step 7 : The MS and SS are using a full rate TCH with speech full rate version 2 and in non-hopping mode on cell B.

DCS1800

Step 0 : The MS and SS are using a full rate TCH with speech full rate version 2 and in hopping mode on cell A.

HANDOVER COMMAND

Information Element	value/remarks
As default message contents, except :	
Cell Description	
- Network Colour Code	1
- Base Station Colour Code	5
- BCCH Carrier Number	764
Synchronisation Indication	
- Report Observed Time Difference	Shall not be included.
- Synchronisation Indication	'Non synchronised'.
- Normal Cell Indication	Out of range timing advance shall trigger a handover failure procedure.
Starting Time	Indicates the frame number of cell B that will occur approximately 1,1 seconds (238 frames have elapsed) after the HANDOVER COMMAND is sent by cell A.

PHYSICAL INFORMATION

Information Element	value/remarks
As default message contents.	

Step 6 : x = 500

Step 7 : The MS and SS are using a full rate TCH with speech version 2 and in non-hopping mode on cell B.

PCS 1900

Step 0 : The MS and SS are using a full rate TCH with speech full rate version 2 and in hopping mode on cell A.

HANDOVER COMMAND

Information Element	value/remarks
As default message contents, except :	
Cell Description	
- Network Colour Code	1
- Base Station Colour Code	5
- BCCH Carrier Number	664
Synchronisation Indication	
- Report Observed Time Difference	Shall not be included.
- Synchronisation Indication	'Non synchronised'.
- Normal Cell Indication	Out of range timing advance shall trigger a handover failure procedure.
Starting Time	Indicates the frame number of cell B that will occur approximately 1,1 seconds (238 frames have elapsed) after the HANDOVER COMMAND is sent by cell A.

PHYSICAL INFORMATION

Information Element	value/remarks
As default message contents.	

Step 6 : $x = 500$

Step 7 : The MS and SS are using a full rate TCH with speech version 2 and in non-hopping mode on cell B.

For $M = 4$:

GSM450

Step 0 : The MS and SS are using a full rate TCH with full rate speech version 2 and in non-hopping mode on cell B.

HANDOVER COMMAND

Information Element	value/remarks
As default message contents, except :	
Cell Description	
- Network Colour Code	1
- Base Station Colour Code	5
- BCCH Carrier Number	263
Synchronisation Indication	
- Report Observed Time Difference	Shall not be included.
- Synchronisation Indication	'Non synchronised'.
- Normal Cell Indication	Ignore out of range timing advance.
Mode of the first channel	
- Mode	speech full rate or half rate version 1

PHYSICAL INFORMATION

Information Element	value/remarks
As default message contents.	

Step 6 : $x = 500$

Step 7 : The MS and SS are using a full rate TCH with speech full rate version 1 and in non hopping mode on cell A.

GSM480

Step 0 : The MS and SS are using a full rate TCH with full rate speech version 2 and in non-hopping mode on cell B.

HANDOVER COMMAND

Information Element	value/remarks
As default message contents, except :	
Cell Description	
- Network Colour Code	1
- Base Station Colour Code	5
- BCCH Carrier Number	310
Synchronisation Indication	
- Report Observed Time Difference	Shall not be included.
- Synchronisation Indication	'Non synchronised'.
- Normal Cell Indication	Ignore out of range timing advance.
Mode of the first channel	
- Mode	speech full rate or half rate version 1

PHYSICAL INFORMATION

Information Element	value/remarks
As default message contents.	

Step 6 : x = 500

Step 7 : The MS and SS are using a full rate TCH with speech full rate version 1 and in non hopping mode on cell A.

P-GSM900

Step 0 : The MS and SS are using a full rate TCH with full rate speech version 2 and in non-hopping mode on cell B.

HANDOVER COMMAND

Information Element	value/remarks
As default message contents, except :	
Cell Description	
- Network Colour Code	1
- Base Station Colour Code	5
- BCCH Carrier Number	20
Synchronisation Indication	
- Report Observed Time Difference	Shall not be included.
- Synchronisation Indication	'Non synchronised'.
- Normal Cell Indication	Ignore out of range timing advance.
Mode of the first channel	
- Mode	speech full rate or half rate version 1

PHYSICAL INFORMATION

Information Element	value/remarks
As default message contents.	

Step 6 : x = 500

Step 7 : The MS and SS are using a full rate TCH with speech full rate version 1 and in non hopping mode on cell A.

DCS1800

Step 0 : The MS and SS are using a full rate TCH with speech full rate version 2 and in non-hopping mode on cell B.

HANDOVER COMMAND

Information Element	value/remarks
As default message contents, except :	
Cell Description	
- Network Colour Code	1
- Base Station Colour Code	5
- BCCH Carrier Number	747
Synchronisation Indication	
- Report Observed Time Difference	Shall not be included.
- Synchronisation Indication	'Non synchronised'.
- Normal Cell Indication	Ignore out of range timing advance.
Mode of the first channel	
- Mode	speech full rate or half rate version 1

PHYSICAL INFORMATION

Information Element	value/remarks
As default message contents.	

Step 6 : x = 500

Step 7 : The MS and SS are using a full rate TCH with speech full rate version 1 and in non hopping mode on cell A.

PCS 1900

Step 0 : The MS and SS are using a full rate TCH with speech full rate version 2 and in non-hopping mode on cell B.

HANDOVER COMMAND

Information Element	value/remarks
As default message contents, except :	
Cell Description	
- Network Colour Code	1
- Base Station Colour Code	5
- BCCH Carrier Number	647
Synchronisation Indication	
- Report Observed Time Difference	Shall not be included.
- Synchronisation Indication	'Non synchronised'.
- Normal Cell Indication	Ignore out of range timing advance.
Mode of the first channel	
- Mode	speech full rate or half rate version 1

PHYSICAL INFORMATION

Information Element	value/remarks
As default message contents.	

Step 6 : $x = 500$

Step 7 : The MS and SS are using a full rate TCH with speech full rate version 1 and in non hopping mode on cell A.

For $M = 5$:

GSM450

Step 0 : The MS and SS are using a full rate TCH with full rate speech version 1 and in non-hopping mode on cell A.

HANDOVER COMMAND

Information Element	value/remarks
As default message contents, except :	
Cell Description	
- Network Colour Code	1
- Base Station Colour Code	5
- BCCH Carrier Number	274
Synchronisation Indication	
- Report Observed Time Difference	Shall not be included.
- Synchronisation Indication	'Non synchronised'.
- Normal Cell Indication	Ignore out of range timing advance.

PHYSICAL INFORMATION

Information Element	value/remarks
As default message contents, except :	
Timing advance	Arbitrarily selected but different to default value.

Step 6 : $x = 500$

Step 7 : The MS and SS are using a full rate TCH with speech full rate version 2 and in non hopping mode on cell B.

GSM480

Step 0 : The MS and SS are using a full rate TCH with full rate speech version 1 and in non-hopping mode on cell A.

HANDOVER COMMAND

Information Element	value/remarks
As default message contents, except :	
Cell Description	
- Network Colour Code	1
- Base Station Colour Code	5
- BCCH Carrier Number	321
Synchronisation Indication	
- Report Observed Time Difference	Shall not be included.
- Synchronisation Indication	'Non synchronised'.
- Normal Cell Indication	Ignore out of range timing advance.

PHYSICAL INFORMATION

Information Element	value/remarks
As default message contents, except :	
Timing advance	Arbitrarily selected but different to default value.

Step 6 : $x = 500$

Step 7 : The MS and SS are using a full rate TCH with speech full rate version 2 and in non hopping mode on cell B.

GSM900

Step 0 : The MS and SS are using a full rate TCH with full rate speech version 1 and in non-hopping mode on cell A.

HANDOVER COMMAND

Information Element	value/remarks
As default message contents, except :	
Cell Description	
- Network Colour Code	1
- Base Station Colour Code	5
- BCCH Carrier Number	40
Synchronisation Indication	
- Report Observed Time Difference	Shall not be included.
- Synchronisation Indication	'Non synchronised'.
- Normal Cell Indication	Ignore out of range timing advance.

PHYSICAL INFORMATION

Information Element	value/remarks
As default message contents, except :	
Timing advance	Arbitrarily selected but different to default value.

Step 6 : $x = 500$

Step 7 : The MS and SS are using a full rate TCH with speech full rate version 2 and in non hopping mode on cell B.

DCS1800

Step 0 : The MS and SS are using a full rate TCH with speech full rate version 1 and in non-hopping mode on cell A.

HANDOVER COMMAND

Information Element	value/remarks
As default message contents, except :	
Cell Description	
- Network Colour Code	1
- Base Station Colour Code	5
- BCCH Carrier Number	764
Synchronisation Indication	
- Report Observed Time Difference	Shall not be included.
- Synchronisation Indication	'Non synchronised'.
- Normal Cell Indication	Ignore out of range timing advance.

PHYSICAL INFORMATION

Information Element	value/remarks
As default message contents.	

Step 6 : $x = 500$

Step 7 : The MS and SS are using a full rate TCH with speech full rate version 2 mode and non hopping mode on cell B.

PCS 1900

Step 0 : The MS and SS are using a full rate TCH with speech full rate version 1 and in non-hopping mode on cell A.

HANDOVER COMMAND

Information Element	value/remarks
As default message contents, except :	
Cell Description	
- Network Colour Code	1
- Base Station Colour Code	5
- BCCH Carrier Number	664
Synchronisation Indication	
- Report Observed Time Difference	Shall not be included.
- Synchronisation Indication	'Non synchronised'.
- Normal Cell Indication	Ignore out of range timing advance.

PHYSICAL INFORMATION

Information Element	value/remarks
As default message contents.	

Step 6 : $x = 500$

Step 7 : The MS and SS are using a full rate TCH with speech full rate version 2 mode and non hopping mode on cell B.

For $M=6$:

GSM450

Step 0 : The MS and SS are using a full rate TCH with speech full rate version 2 and non-hopping mode on cell B.

HANDOVER COMMAND

Information Element	value/remarks
As default message contents, except :	
Cell Description	
- Network Colour Code	1
- Base Station Colour Code	5
- BCCH Carrier Number	263
Channel Description	
- Channel Type	TCH/F + ACCHs
- Timeslot number	Chosen arbitrarily, but not Zero
- Training Sequence Code	Chosen arbitrarily
- Hopping	RF hopping channel.
- MAIO	Chosen arbitrarily from the set (0, 1 to N-1), where N is the number of frequencies encoded in the Frequency List IE.
- HSN	Chosen arbitrarily from the set (1,2,..63)
Synchronisation Indication IE is not included.	
Mode of the first channel.	
- Mode	speech full rate or half rate version 1
Frequency List after time	
- Frequency List	Allocates the following 12 frequencies (259, 261, 263, 265, 277, 279, 281, 283, 285, 287, 289, 291)

PHYSICAL INFORMATION

Information Element	value/remarks
As default message contents, except :	
Timing advance	Arbitrarily selected but different to default value.

Step 6 : $x = 500$

Step 7 : The MS and SS are using a full rate TCH with speech full rate version 1 and hopping mode on cell A.

GSM480

Step 0 : The MS and SS are using a full rate TCH with speech full rate version 2 and non-hopping mode on cell B.

HANDOVER COMMAND

Information Element	value/remarks
As default message contents, except :	
Cell Description	
- Network Colour Code	1
- Base Station Colour Code	5
- BCCH Carrier Number	310
Channel Description	
- Channel Type	TCH/F + ACCHs
- Timeslot number	Chosen arbitrarily, but not Zero
- Training Sequence Code	Chosen arbitrarily
- Hopping	RF hopping channel.
- MAIO	Chosen arbitrarily from the set (0, 1 to N-1), where N is the number of frequencies encoded in the Frequency List IE.
- HSN	Chosen arbitrarily from the set (1,2,..63)
Synchronisation Indication IE is not included.	
Mode of the first channel.	
- Mode	speech full rate or half rate version 1
Frequency List after time	
- Frequency List	Allocates the following 12 frequencies (306, 308, 310, 312, 324, 326, 328, 330, 332, 334, 336, 338)

PHYSICAL INFORMATION

Information Element	value/remarks
As default message contents, except :	
Timing advance	Arbitrarily selected but different to default value.

Step 6 : $x = 500$

Step 7 : The MS and SS are using a full rate TCH with speech full rate version 1 and hopping mode on cell A.

GSM900

Step 0 : The MS and SS are using a full rate TCH with speech full rate version 2 and non-hopping mode on cell B.

HANDOVER COMMAND

Information Element	value/remarks
As default message contents, except :	
Cell Description	
- Network Colour Code	1
- Base Station Colour Code	5
- BCCH Carrier Number	20
Channel Description	
- Channel Type	TCH/F + ACCHs
- Timeslot number	Chosen arbitrarily, but not Zero
- Training Sequence Code	Chosen arbitrarily
- Hopping	RF hopping channel.
- MAIO	Chosen arbitrarily from the set (0, 1 to N-1), where N is the number of frequencies encoded in the Frequency Channel Sequence IE.
- HSN	Chosen arbitrarily from the set (1,2,..63)
Synchronisation Indication IE is not included.	
Mode of the first channel.	
- Mode	speech full rate or half rate version 1
Frequency Channel Sequence after time	
- Frequency Channel Sequence	Allocates the following 12 frequencies (10, 17, 20, 26, 59, 66, 73, 74, 75, 76,108, 114)

PHYSICAL INFORMATION

Information Element	value/remarks
As default message contents, except : Timing advance	Arbitrarily selected but different to default value.

Step 6 : $x = 500$

Step 7 : The MS and SS are using a full rate TCH with speech full rate version 1 and hopping mode on cell A.

DCS1800

Step 0 : The MS and SS are using a full rate TCH with full rate speech version 2 and in non-hopping mode on cell B.

HANDOVER COMMAND

Information Element	value/remarks
As default message contents, except :	
Cell Description	
- Network Colour Code	1
- Base Station Colour Code	5
- BCCH Carrier Number	747
Channel Description	
- Channel Type	TCH/F + ACCHs
- Timeslot number	Chosen arbitrarily, but not Zero
- Training Sequence Code	Chosen arbitrarily
- Hopping	RF hopping channel.
- MAIO	Chosen arbitrarily from the set (0, 1 to N-1), where N is the number of frequencies encoded in the Frequency Short List IE.
- HSN	Chosen arbitrarily from the set (1,2,..63)
Synchronisation Indication IE is not included.	
Mode of the first channel	
- Mode	speech full rate or half rate version 1
Frequency Short List after time	
- Frequency List	Use Range 256 to encode the following 9 frequencies : (747, 775, 779, 782, 791, 798, 829, 832, 844)

PHYSICAL INFORMATION

Information Element	value/remarks
As default message contents, except : Timing advance	Arbitrarily selected but different to default value.

Step 6 : $x = 500$

Step 7 : The MS and SS are using a full rate TCH with full rate speech version 1 and in hopping mode on cell A.

PCS 1900

Step 0 : The MS and SS are using a full rate TCH with full rate speech version 2 and in non-hopping mode on cell B.

HANDOVER COMMAND

Information Element	value/remarks
As default message contents, except :	
Cell Description	
- Network Colour Code	1
- Base Station Colour Code	5
- BCCH Carrier Number	647
Channel Description	
- Channel Type	TCH/F + ACCHs
- Timeslot number	Chosen arbitrarily, but not Zero
- Training Sequence Code	Chosen arbitrarily
- Hopping	RF hopping channel.
- MAIO	Chosen arbitrarily from the set (0, 1 to N-1), where N is the number of frequencies encoded in the Frequency Short List IE.
- HSN	Chosen arbitrarily from the set (1,2,..63)
Synchronisation Indication IE is not included.	
Mode of the first channel	
- Mode	speech full rate or half rate version 1
Frequency Short List after time	
- Frequency List	Use Range 256 to encode the following 9 frequencies : (647, 675, 679, 682, 691, 698, 629, 632, 644)

PHYSICAL INFORMATION

Information Element	value/remarks
As default message contents, except :	
Timing advance	Arbitrarily selected but different to default value.

Step 6 : $x = 500$

Step 7 : The MS and SS are using a full rate TCH with full rate speech version 1 and in hopping mode on cell A.

For $M=7$:

GSM450

Step 0 : The MS and SS are using a full rate TCH with full rate speech version 1 and in hopping mode on cell A.

HANDOVER COMMAND

Information Element	value/remarks
As default message contents, except :	
Cell Description	
- Network Colour Code	1
- Base Station Colour Code	5
- BCCH Carrier Number	274
Channel Description	
- Channel Type	TCH/F + ACCHs
- TDMA offset	Chosen arbitrarily
- Timeslot number	Chosen arbitrarily, but not Zero
- Training Sequence Code	Chosen arbitrarily
- Hopping	RF hopping channel.
- MAIO	Chosen arbitrarily from the set (0, 1 to N-1), where N is the number of frequencies encoded in the Frequency List IE.
- HSN	Chosen arbitrarily from the set (1,2,..63)
Frequency List after time	
- Frequency List	use Range 128 to encode the following 12 frequencies : (260, 262, 264, 266, 276, 279, 281, 283, 285, 287, 289, 291)
Synchronisation Indication	
- Report Observed Time Difference	Shall not be included.
- Synchronisation Indication	'Non synchronised'.
- Normal Cell Indication	Ignore out of range timing advance.
Starting Time	Indicates the frame number of cell B. that will occur approximately 1,1 seconds (238 frames have elapsed) after the HANDOVER COMMAND is sent by cell A.

PHYSICAL INFORMATION

Information Element	value/remarks
As default message contents.	

Step 6 : $x = 750$

Step 7 : The MS and SS are using a full rate TCH with full rate speech version 2 and in hopping mode on cell B.

GSM480

Step 0 : The MS and SS are using a full rate TCH with full rate speech version 1 and in hopping mode on cell A.

HANDOVER COMMAND

Information Element	value/remarks
As default message contents, except :	
Cell Description	
- Network Colour Code	1
- Base Station Colour Code	5
- BCCH Carrier Number	321
Channel Description	
- Channel Type	TCH/F + ACCHs
- TDMA offset	Chosen arbitrarily
- Timeslot number	Chosen arbitrarily, but not Zero
- Training Sequence Code	Chosen arbitrarily
- Hopping	RF hopping channel.
- MAIO	Chosen arbitrarily from the set (0, 1 to N-1), where N is the number of frequencies encoded in the Frequency List IE.
- HSN	Chosen arbitrarily from the set (1,2,..63)
Frequency List after time	
- Frequency List	use Range 128 to encode the following 12 frequencies : (307, 309, 311, 313, 323, 326, 328, 330, 332, 334, 336, 338)
Synchronisation Indication	
- Report Observed Time Difference	Shall not be included.
- Synchronisation Indication	'Non synchronised'.
- Normal Cell Indication	Ignore out of range timing advance.
Starting Time	Indicates the frame number of cell B. that will occur approximately 1,1 seconds (238 frames have elapsed) after the HANDOVER COMMAND is sent by cell A.

PHYSICAL INFORMATION

Information Element	value/remarks
As default message contents.	

Step 6 : $x = 750$

Step 7 : The MS and SS are using a full rate TCH with full rate speech version 2 and in hopping mode on cell B.

GSM900

Step 0 : The MS and SS are using a full rate TCH with full rate speech version 1 and in hopping mode on cell A.

HANDOVER COMMAND

Information Element	value/remarks
As default message contents, except :	
Cell Description	
- Network Colour Code	1
- Base Station Colour Code	5
- BCCH Carrier Number	40
Channel Description	
- Channel Type	TCH/F + ACCHs
- TDMA offset	Chosen arbitrarily
- Timeslot number	Chosen arbitrarily, but not Zero
- Training Sequence Code	Chosen arbitrarily
- Hopping	RF hopping channel.
- MAIO	Chosen arbitrarily from the set (0, 1 to N-1), where N is the number of frequencies encoded in the Frequency List IE.
- HSN	Chosen arbitrarily from the set (1,2,..63)
Frequency List after time	
- Frequency List	use bit map 0 to allocates the following 12 frequencies : (14, 18, 22, 24, 60, 66, 73, 74, 75, 76,108, 114)
Synchronisation Indication	
- Report Observed Time Difference	Shall not be included.
- Synchronisation Indication	'Non synchronised'.
- Normal Cell Indication	Ignore out of range timing advance.
Starting Time	Indicates the frame number of cell B. that will occur approximately 1,1 seconds (238 frames have elapsed) after the HANDOVER COMMAND is sent by cell A.

PHYSICAL INFORMATION

Information Element	value/remarks
As default message contents.	

Step 6 : $x = 750$

Step 7 : The MS and SS are using a full rate TCH with full rate speech version 2 and in hopping mode on cell B.

DCS1800

Step 0 : The MS and SS are using a full rate TCH with full rate speech version 1 and in hopping mode on cell A.

HANDOVER COMMAND

Information Element	value/remarks
As default message contents, except :	
Cell Description	
- Network Colour Code	1
- Base Station Colour Code	5
- BCCH Carrier Number	764
Channel Description	
- Channel Type	TCH/F + ACCHs
- TDMA offset	Chosen arbitrarily
- Timeslot number	Chosen arbitrarily but not Zero
- Training Sequence Code	Chosen arbitrarily
- Hopping	RF hopping channel.
- MAIO	Chosen arbitrarily from the set (0, 1 to N-1), where N is the number of frequencies encoded in the Frequency List IE.
- HSN	Chosen arbitrarily from the set (1,2,..63)
Frequency List after time	
- Frequency List	Use Range 1024 to allocate the following 12 frequencies : (749, 758, 761, 764, 771, 779, 782, 791, 798, 829, 832, 844)
Synchronisation Indication	
- Report Observed Time Difference	Shall not be included.
- Synchronisation Indication	'Non synchronised'.
- Normal Cell Indication	Ignore out of range timing advance.
Starting Time	Indicates the frame number of cell B that will occur approximately 1,1 seconds (238 frames have elapsed) after the HANDOVER COMMAND is sent by cell A.

PHYSICAL INFORMATION

Information Element	value/remarks
As default message contents.	

Step 6 : $x = 750$

Step 7 : The MS and SS are using a full rate TCH with full rate speech version 2 and in hopping mode on cell B.

PCS 1900

Step 0 : The MS and SS are using a full rate TCH with full rate speech version 1 and in hopping mode on cell A.

HANDOVER COMMAND

Information Element	value/remarks
As default message contents, except :	
Cell Description	
- Network Colour Code	1
- Base Station Colour Code	5
- BCCH Carrier Number	664
Channel Description	
- Channel Type	TCH/F + ACCHs
- TDMA offset	Chosen arbitrarily
- Timeslot number	Chosen arbitrarily but not Zero
- Training Sequence Code	Chosen arbitrarily
- Hopping	RF hopping channel.
- MAIO	Chosen arbitrarily from the set (0, 1 to N-1), where N is the number of frequencies encoded in the Frequency List IE.
- HSN	Chosen arbitrarily from the set (1,2,..63)
Frequency List after time	
- Frequency List	Use Range 1024 to allocate the following 12 frequencies : (649, 658, 661, 664, 671, 679, 682, 791, 798, 729, 732, 744)
Synchronisation Indication	
- Report Observed Time Difference	Shall not be included.
- Synchronisation Indication	'Non synchronised'.
- Normal Cell Indication	Ignore out of range timing advance.
Starting Time	Indicates the frame number of cell B that will occur approximately 1,1 seconds (238 frames have elapsed) after the HANDOVER COMMAND is sent by cell A.

PHYSICAL INFORMATION

Information Element	value/remarks
As default message contents.	

Step 6 : $x = 750$

Step 7 : The MS and SS are using a full rate TCH with full rate speech version 2 and in hopping mode on cell B.

For $M = 8$:

GSM450

Step 0 : The MS and SS are using a full rate TCH with full rate speech version 2 and in hopping mode on cell B.

HANDOVER COMMAND

same as for $M=6$

PHYSICAL INFORMATION

same as for $M=6$

Step 6 : $x = 750$

Step 7 : The MS and SS are using a full rate TCH with speech full rate version 1 and in hopping mode on cell A.

GSM480

Step 0 : The MS and SS are using a full rate TCH with full rate speech version 2 and in hopping mode on cell B.

HANDOVER COMMAND

same as for M=6

PHYSICAL INFORMATION

same as for M=6

Step 6 : $x = 750$

Step 7 : The MS and SS are using a full rate TCH with speech full rate version 1 and in hopping mode on cell A.

GSM900

Step 0 : The MS and SS are using a full rate TCH with full rate speech version 2 and in hopping mode on cell B.

HANDOVER COMMAND

same as for M=6

PHYSICAL INFORMATION

same as for M=6

Step 6 : $x = 750$

Step 7 : The MS and SS are using a full rate TCH with speech full rate version 1 and in hopping mode on cell A.

DCS1800

Step 0 : The MS and SS are using a full rate TCH with full rate speech version 2 and in hopping mode on cell B.

HANDOVER COMMAND

same as for M=6

PHYSICAL INFORMATION

same as for M=6

Step 6 : $x = 750$

Step 7 : The MS and SS are using a full rate TCH with speech full rate version 1 and in hopping mode on cell A.

PCS 1900

Step 0 : The MS and SS are using a full rate TCH with full rate speech version 2 and in hopping mode on cell B.

HANDOVER COMMAND

same as for M=6

PHYSICAL INFORMATION

same as for M=6

Step 6 : $x = 750$

Step 7 : The MS and SS are using a full rate TCH with speech full rate version 1 and in hopping mode on cell A.

For M = 9 :

GSM450

Step 0 : The MS and SS are using a full rate TCH with speech full rate version 1 and in hopping mode on cell A.

HANDOVER COMMAND

same as for M=5.

PHYSICAL INFORMATION

same as For M=5.

Step 6 : $x = 750$

Step 7 : The MS and SS are using a full rate TCH with speech full rate version 2 and in non hopping mode on cell B.

GSM480

Step 0 : The MS and SS are using a full rate TCH with speech full rate version 1 and in hopping mode on cell A.

HANDOVER COMMAND

same as for M=5.

PHYSICAL INFORMATION

same as For M=5.

Step 6 : $x = 750$

Step 7 : The MS and SS are using a full rate TCH with speech full rate version 2 and in non hopping mode on cell B.

GSM900

Step 0 : The MS and SS are using a full rate TCH with speech full rate version 1 and in hopping mode on cell A.

HANDOVER COMMAND

same as for M=5.

PHYSICAL INFORMATION

same as For M=5.

Step 6 : $x = 750$

Step 7 : The MS and SS are using a full rate TCH with speech full rate version 2 and in non hopping mode on cell B.

DCS1800

Step 0 : The MS and SS are using a full rate TCH with speech full rate version 1 and in hopping mode on cell A.

HANDOVER COMMAND

same as for M=5.

PHYSICAL INFORMATION

same as for M=5.

Step 6 : $x = 750$

Step 7 : The MS and SS are using a full rate TCH with speech full rate version 2 and in non hopping mode on cell B.

PCS 1900

Step 0 : The MS and SS are using a full rate TCH with speech full rate version 1 and in hopping mode on cell A.

HANDOVER COMMAND

same as for M=5.

PHYSICAL INFORMATION

same as for M=5.

Step 6 : $x = 750$

Step 7 : The MS and SS are using a full rate TCH with speech full rate version 2 and in non hopping mode on cell B.

For M=10 :

GSM450

Step 0 : The MS and SS are using a full rate TCH with full rate speech version 2 and in non hopping mode on cell B.

HANDOVER COMMAND

same as for M=6 except :

Channel Description

- Channel Type TCH/H + ACCHs

PHYSICAL INFORMATION

same as for M=6

Step 6 : $x = 750$

Step 7 : The MS and SS are using a half rate TCH with speech half rate version 1 and in hopping mode on cell A.

GSM480

Step 0 : The MS and SS are using a full rate TCH with full rate speech version 2 and in non hopping mode on cell B.

HANDOVER COMMAND

same as for M=6 except :

Channel Description

- Channel Type TCH/H + ACCHs

PHYSICAL INFORMATION

same as for M=6

Step 6 : $x = 750$

Step 7 : The MS and SS are using a half rate TCH with speech half rate version 1 and in hopping mode on cell A.

GSM900

Step 0 : The MS and SS are using a full rate TCH with full rate speech version 2 and in non hopping mode on cell B.

HANDOVER COMMAND

same as for M=6 except :

Channel Description

- Channel Type TCH/H + ACCHs

PHYSICAL INFORMATION

same as for M=6

Step 6 : $x = 750$

Step 7 : The MS and SS are using a half rate TCH with speech half rate version 1 and in hopping mode on cell A.

DCS1800

Step 0 : The MS and SS are using a full rate TCH with full rate speech version 2 and in non hopping mode on cell B.

HANDOVER COMMAND

same as for M=6 except :

Channel Description

- Channel Type TCH/H + ACCHs

PHYSICAL INFORMATION

same as for M=6

Step 6 : $x = 750$

Step 7 : The MS and SS are using a half rate TCH with speech half rate version 1 and in hopping mode on cell A.

PCS 1900

Step 0 : The MS and SS are using a full rate TCH with full rate speech version 2 and in non hopping mode on cell B.

HANDOVER COMMAND

same as for M=6 except :

Channel Description

- Channel Type TCH/H + ACCHs

PHYSICAL INFORMATION

same as for M=6

Step 6 : $x = 750$

Step 7 : The MS and SS are using a half rate TCH with speech half rate version 1 and in hopping mode on cell A.

For M = 11 :

GSM450

Step 0 : The MS and SS are using a half rate TCH with speech half rate version 1 and in hopping mode on cell A.

HANDOVER COMMAND

same as for M=7

PHYSICAL INFORMATION

same as For M=7.

Step 6 : $x = 750$

Step 7 : The MS and SS are using a full rate TCH with speech full rate version 2 and in hopping mode on cell B.

GSM480

Step 0 : The MS and SS are using a half rate TCH with speech half rate version 1 and in hopping mode on cell A.

HANDOVER COMMAND

same as for M=7

PHYSICAL INFORMATION

same as For M=7.

Step 6 : $x = 750$

Step 7 : The MS and SS are using a full rate TCH with speech full rate version 2 and in hopping mode on cell B.

GSM900

Step 0 : The MS and SS are using a half rate TCH with speech half rate version 1 and in hopping mode on cell A.

HANDOVER COMMAND

same as for M=7

PHYSICAL INFORMATION

same as For M=7.

Step 6 : $x = 750$

Step 7 : The MS and SS are using a full rate TCH with speech full rate version 2 and in hopping mode on cell B.

DCS1800

Step 0 : The MS and SS are using a half rate TCH with speech half rate version 1 and in hopping mode on cell A.

HANDOVER COMMAND

same as for M=7

PHYSICAL INFORMATION

same as for M=7.

Step 6 : $x = 750$

Step 7 : The MS and SS are using a full rate TCH with speech full rate version 2 and in hopping mode on cell B.

PCS 1900

Step 0 : The MS and SS are using a half rate TCH with speech half rate version 1 and in hopping mode on cell A.

HANDOVER COMMAND

same as for M=7

PHYSICAL INFORMATION

same as for M=7.

Step 6 : $x = 750$

Step 7 : The MS and SS are using a full rate TCH with speech full rate version 2 and in hopping mode on cell B.

For M = 12 :

GSM450

Step 0 : The MS and SS are using a full rate TCH with full rate speech version 2 and in hopping mode on cell B.

HANDOVER COMMAND

same as for M=6 except :

Channel Description - Channel Type	TCH/H + ACCHs
---------------------------------------	---------------

PHYSICAL INFORMATION

same as for M=6

Step 6 : x = 750

Step 7 : The MS and SS are using a half rate TCH with speech half rate version 1 and in hopping mode on cell A.

GSM480

Step 0 : The MS and SS are using a full rate TCH with full rate speech version 2 and in hopping mode on cell B.

HANDOVER COMMAND

same as for M=6 except :

Channel Description - Channel Type	TCH/H + ACCHs
---------------------------------------	---------------

PHYSICAL INFORMATION

same as for M=6

Step 6 : x = 750

Step 7 : The MS and SS are using a half rate TCH with speech half rate version 1 and in hopping mode on cell A.

GSM900

Step 0 : The MS and SS are using a full rate TCH with full rate speech version 2 and in hopping mode on cell B.

HANDOVER COMMAND

same as for M=6 except :

Channel Description - Channel Type	TCH/H + ACCHs
---------------------------------------	---------------

PHYSICAL INFORMATION

same as for M=6

Step 6 : $x = 750$

Step 7 : The MS and SS are using a half rate TCH with speech half rate version 1 and in hopping mode on cell A.

DCS1800

Step 0 : The MS and SS are using a full rate TCH with full rate speech version 2 and in hopping mode on cell B.

HANDOVER COMMAND

same as for M=6 except :

Channel Description - Channel Type	TCH/H + ACCHs
---------------------------------------	---------------

PHYSICAL INFORMATION

same as for M=6

Step 6 : $x = 750$

Step 7 : The MS and SS are using a half rate TCH with speech half rate version 1 and in hopping mode on cell A.

PCS 1900

Step 0 : The MS and SS are using a full rate TCH with full rate speech version 2 and in hopping mode on cell B.

HANDOVER COMMAND

same as for M=6 except :

Channel Description - Channel Type	TCH/H + ACCHs
---------------------------------------	---------------

PHYSICAL INFORMATION

same as for M=6

Step 6 : $x = 750$

Step 7 : The MS and SS are using a half rate TCH with speech half rate version 1 and in hopping mode on cell A.

For M = 13 :

GSM450

Step 0 : The MS and SS are using a half rate TCH with speech half rate version 1 and in hopping mode on cell A.

HANDOVER COMMAND

same as for M=1

PHYSICAL INFORMATION

same as For M=1.

Step 6 : $x = 750$

Step 7 : The MS and SS are using a full rate TCH with speech full rate version 2 and in non hopping mode on cell B.

GSM480

Step 0 : The MS and SS are using a half rate TCH with speech half rate version 1 and in hopping mode on cell A.

HANDOVER COMMAND

same as for M=1

PHYSICAL INFORMATION

same as For M=1.

Step 6 : $x = 750$

Step 7 : The MS and SS are using a full rate TCH with speech full rate version 2 and in non hopping mode on cell B.

GSM900

Step 0 : The MS and SS are using a half rate TCH with speech half rate version 1 and in hopping mode on cell A.

HANDOVER COMMAND

same as for M=1

PHYSICAL INFORMATION

same as For M=1.

Step 6 : $x = 750$

Step 7 : The MS and SS are using a full rate TCH with speech full rate version 2 and in non hopping mode on cell B.

DCS1800

Step 0 : The MS and SS are using a half rate TCH with speech half rate version 1 and in hopping mode on cell A.

HANDOVER COMMAND

same as for M=1

PHYSICAL INFORMATION

same as for M=1.

Step 6 : $x = 750$

Step 7 : The MS and SS are using a full rate TCH with speech full rate version 2 and in non hopping mode on cell B.

PCS 1900

Step 0 : The MS and SS are using a half rate TCH with speech half rate version 1 and in hopping mode on cell A.

HANDOVER COMMAND

same as for M=1

PHYSICAL INFORMATION

same as for M=1.

Step 6 : $x = 750$

Step 7 : The MS and SS are using a full rate TCH with speech full rate version 2 and in non hopping mode on cell B.

For M = 14 :

GSM450

Step 0 : The MS and SS are using a full rate TCH with full rate speech version 2 and in non hopping mode on cell B.

HANDOVER COMMAND

same as for M=4 except :

Channel Description - Channel Type	TCH/H + ACCHs
---------------------------------------	---------------

PHYSICAL INFORMATION

same as for M=4

Step 6 : $x = 750$

Step 7 : The MS and SS are using a half rate TCH with speech half rate version 1 and in non hopping mode on cell A.

GSM480

Step 0 : The MS and SS are using a full rate TCH with full rate speech version 2 and in non hopping mode on cell B.

HANDOVER COMMAND

same as for M=4 except :

Channel Description - Channel Type	TCH/H + ACCHs
---------------------------------------	---------------

PHYSICAL INFORMATION

same as for M=4

Step 6 : x = 750

Step 7 : The MS and SS are using a half rate TCH with speech half rate version 1 and in non hopping mode on cell A.

GSM900

Step 0 : The MS and SS are using a full rate TCH with full rate speech version 2 and in non hopping mode on cell B.

HANDOVER COMMAND

same as for M=4 except :

Channel Description - Channel Type	TCH/H + ACCHs
---------------------------------------	---------------

PHYSICAL INFORMATION

same as for M=4

Step 6 : x = 750

Step 7 : The MS and SS are using a half rate TCH with speech half rate version 1 and in non hopping mode on cell A.

DCS1800

Step 0 : The MS and SS are using a full rate TCH with full rate speech version 2 and in non hopping mode on cell B.

HANDOVER COMMAND

same as for M=4 except :

Channel Description - Channel Type	TCH/H + ACCHs
---------------------------------------	---------------

PHYSICAL INFORMATION

same as for M=4

Step 6 : $x = 750$

Step 7 : The MS and SS are using a half rate TCH with speech half rate version 1 and in non hopping mode on cell A.

PCS 1900

Step 0 : The MS and SS are using a full rate TCH with full rate speech version 2 and in non hopping mode on cell B.

HANDOVER COMMAND

same as for M=4 except :

Channel Description - Channel Type	TCH/H + ACCHs
---------------------------------------	---------------

PHYSICAL INFORMATION

same as for M=4

Step 6 : $x = 750$

Step 7 : The MS and SS are using a half rate TCH with speech half rate version 1 and in non hopping mode on cell A.

For M = 15 :

GSM450

Step 0 : The MS and SS are using a half rate TCH with speech half rate version 1 and in non hopping mode on cell A.

HANDOVER COMMAND

same as for M=1

PHYSICAL INFORMATION

same as For M=1.

Step 6 : $x = 750$

Step 7 : The MS and SS are using a full rate TCH with speech full rate version 2 and in non hopping mode on cell B.

GSM480

Step 0 : The MS and SS are using a half rate TCH with speech half rate version 1 and in non hopping mode on cell A.

HANDOVER COMMAND

same as for M=1

PHYSICAL INFORMATION

same as For M=1.

Step 6 : $x = 750$

Step 7 : The MS and SS are using a full rate TCH with speech full rate version 2 and in non hopping mode on cell B.

GSM900

Step 0 : The MS and SS are using a half rate TCH with speech half rate version 1 and in non hopping mode on cell A.

HANDOVER COMMAND

same as for M=1

PHYSICAL INFORMATION

same as For M=1.

Step 6 : $x = 750$

Step 7 : The MS and SS are using a full rate TCH with speech full rate version 2 and in non hopping mode on cell B.

DCS1800

Step 0 : The MS and SS are using a half rate TCH with speech half rate version 1 and in non hopping mode on cell A.

HANDOVER COMMAND

same as for M=1

PHYSICAL INFORMATION

same as for M=1.

Step 6 : $x = 750$

Step 7 : The MS and SS are using a full rate TCH with speech full rate version 2 and in non hopping mode on cell B.

PCS 1900

Step 0 : The MS and SS are using a half rate TCH with speech half rate version 1 and in non hopping mode on cell A.

HANDOVER COMMAND

same as for M=1

PHYSICAL INFORMATION

same as for M=1.

Step 6 : $x = 750$

Step 7 : The MS and SS are using a full rate TCH with speech full rate version 2 and in non hopping mode on cell B.

26.12.3 EFR Signalling / Structured procedures / MS originated call / late assignment

NOTE: this test is derived from the one defined in section 26.9.3 and entitled "Structured procedures / MS originated call / late assignment"

26.12.3.1 Conformance requirement

- 1) The MS shall indicate and include in the mobile originating SETUP for speech call all the speech versions that it supports.
- 2) Upon receipt of the ASSIGNMENT COMMAND message specifying either speech full rate version 1 or speech full rate version 2 or speech half rate version 1 (for an MS also supporting half rate), the Mobile Station starts a normal channel assignment procedure. It means that the MS initiates a local end release of link layer connections, disconnects the physical channels, commands the switching to the assigned channels and initiates the establishment of lower layer connections (this includes the activation of the channels, their connection and the establishment of the data links). After the main signalling link is successfully established, the MS returns an ASSIGNMENT COMPLETE message, specifying cause 'normal event', to the network on the main DCCH.
- 3,4) The call control entity of the Mobile Station in the "call initiated" state, in the "mobile originating call proceeding" state or in the "call delivered" state, shall, upon receipt of a CONNECT message:
 - attach the user connection to the radio path;
 - return a CONNECT ACKNOWLEDGE message.

References

Conformance requirement 1: TS GSM 04.08 sections 10.5.4.5 and 10.5.4.5.1 and TS GSM 02.06 section 3.2.3
Conformance requirement 2: TS GSM 04.08 section 3.4.3.1, 3.4.3.2
Conformance requirement 3: TS GSM 04.08 section 5.2.1.6.

26.12.3.2 Test purpose

- 1) To verify that the MS indicates and includes in the mobile originating SETUP for speech call all the speech versions that it supports.
- 2) To verify that subsequently after receipt of an IMMEDIATE ASSIGNMENT message allocating an SDCCH, after completion of establishment of the main signalling link, after having sent a CM SERVICE REQUEST message, after having successfully performed authentication and cipher mode setting procedures, after having sent a SETUP message, after having received a CALL PROCEEDING message followed by an ALERTING message and an ASSIGNMENT COMMAND message allocating either speech full rate version 1 TCH or speech full rate version 2 TCH or speech half rate version 1 TCH (for an MS also supporting half rate), the MS sends an ASSIGNMENT COMPLETE message.
- 3) To verify that subsequently, after the suite of actions specified in test purposes 1 and 2, the MS after receiving a CONNECT message returns a CONNECT ACKNOWLEDGE message.
- 4) To verify that after the suite of actions specified in test purposes 1 and 2, the MS after receiving a CONNECT message attaches the user connection to the radio path. (This is checked by verifying that there is a point in time after transmission of the first L2 frame containing the (complete) CONNECT message, where the MS is sending appropriate speech or data frames whenever it doesn't have to transmit or acknowledge an I frame on layer 2 of the FACCH.)

26.12.3.3 Method of test

Related PICS/PIXIT statements

- Enhanced full rate speech MS
- Supported speech versions

- Interface to the human user (p1 = Y/N)
- Way to display the called number (only applicable if the MS has an interface to the human user)
- Way to indicate alerting (only applicable if the MS supports the feature)
- Supported teleservices
- Classmark

Initial Conditions

System Simulator:

1 cell, default parameters.

Mobile Station:

The MS is in MM-state "idle, updated" with valid TMSI and CKSN.

Foreseen Final State of the MS

The MS has a MO call in state U10, "active".

Test procedure

The following test is performed for all rates (full rate/half rate) supported by the MS:

The MS is made to initiate a speech call. The call is established with late assignment.

Maximum Duration of Test

3 minutes.

Expected Sequence

This test is repeated for execution counter M=1, 2 for an MS supporting full rate channels only.

This test is repeated for execution counter M=1, 2, 3 for an MS supporting both half and full rate channels.

Step	Direction	Message	Comments
1	MS		The "called number" is entered
2	MS		
3	MS -> SS	CHANNEL REQUEST	Establishment cause is "originating call and the network does not set the NECI bit to 1".
4	SS -> MS	IMMEDIATE ASSIGNMENT	
5	MS -> SS	CM SERVICE REQUEST	Message is contained in SABM.
6	SS -> MS	AUTHENTICATION REQ	
7	MS -> SS	AUTHENTICATION RESP	SRES specifies correct value.
8	SS -> MS	CIPHER MODE COMMAND	SS starts deciphering after sending the message.
9	MS -> SS	CIPHER MODE COMPLETE	Shall be sent enciphered. All following messages shall be sent enciphered.
10	SS		SS starts ciphering.
11	MS -> SS	SETUP	If the mobile only supports full rate speech , it is checked that it indicates support of full rate speech version 1 and version 2. If the mobile supports both rates, it is checked that it indicates full rate speech version 1, half rate speech version 1 and full rate speech version 2.
12	SS -> MS	CALL PROCEEDING	
13	SS -> MS	ALERTING	
14	MS		Depending on the PICS, an alerting indication is given.
15	SS -> MS	ASSIGNMENT COMMAND	
16	MS -> SS	ASSIGNMENT COMPLETE	
17	SS -> MS	CONNECT	
18	MS -> SS	CONNECT ACKNOWLEDGE	
19	MS		The appropriate bearer channel is through connected in both directions.

Specific Message Contents:

For M = 1 :

ASSIGNMENT COMMAND

see default message contents section 26.12.8.

SETUP

Same contents as 26.12.8 but all the speech versions supported by the MS shall be indicated in octet_3a_etc(s).

For M = 2 :

ASSIGNMENT COMMAND

same as for default message contents except :

Mode of the first channel - Mode	speech full rate or half rate version 1
-------------------------------------	---

SETUP

Same contents as 26.12.8 but all the speech versions supported by the MS shall be indicated in octet_3a_etc(s).

For M = 3 :

ASSIGNMENT COMMAND

same as for default message contents except :

Channel Description - TDMA offset Mode of the first channel - Mode	TCH/H+ACCHs speech full rate or half rate version 1
---	--

SETUP

same contents as 26.12.8 but the supported speech versions and their preferred order indicated in octet_3a_etc(s) shall be as declared by the manufacturer.

26.12.4 Structured procedures / MS terminated call / I early assignment

NOTE: this test is derived from the one described in section 26.9.4 and entitled "Structured procedures / MS terminated call / early assignment"

26.12.4.1 Conformance requirement

- 1) In acceptance to a SETUP message indicating speech, the MS shall indicate and include in the CALL CONFIRMED message all the speech versions that it supports.
- 2) Upon receipt of the ASSIGNMENT COMMAND message specifying either speech full rate version 1 or speech full rate version 2 or speech half rate version 1 (for an MS also supporting half rate), the Mobile Station continues a mobile terminating call establishment with early assignment of traffic channel
 - a) by replying to the ASSIGNMENT command with an ASSIGNMENT COMPLETE message and ,
 - b) by continuing the call establishment by through connecting TCH in both directions if it supports immediate connect or by sending an ALERTING message otherwise,
- 3) for speech calls, the mobile station shall attach the user connection at latest when sending the connect message, except if there is no compatible radio resource available at this time. In this case the attachment shall be delayed until such a resource becomes available.

References

Conformance requirement 1:	TS GSM 04.08 sections 10.5.4.5, and 10.5.4.5.1 TS GSM 02.06 section 3.2.3
Conformance requirement 2:	TS GSM 04.08 section 3.4.3.1, 3.4.3.2
Conformance requirement 3:	TS GSM 04.08 section 5.2.2.9

26.12.4.2 Test purpose

- 1) To verify that, in acceptance to a SETUP message indicating speech, the MS indicates and includes in the CALL CONFIRMED message all the speech versions that it supports.
- 2) To verify that upon receipt of the ASSIGNMENT COMMAND message specifying either speech full rate version 1 or speech full rate version 2 or speech half rate version 1 (for an MS also supporting half rate), the Mobile Station continues a mobile terminating call establishment with early assignment of traffic channel
 - a) by replying to the ASSIGNMENT command with an ASSIGNMENT COMPLETE message and ,
 - b) by continuing the call establishment by through connecting TCH in both directions if it supports immediate connect or by sending an ALERTING message otherwise,
- 3) To verify that for speech calls, the mobile station shall attach the user connection at latest when sending the connect message, except if there is no compatible radio resource available at this time. In this case the attachment shall be delayed until such a resource becomes available.

26.12.4.3 Method of test

Related PICS/PIXIT statements

- Enhanced full rate speech MS
- Supported speech versions
- Interface to the human user (p1 = Y/N)
- Way to indicate alerting (only applicable if the MS supports the feature)
- Way to make the MS accept an incoming call after alerting (possibly dependent on teleservice and configuration)
- Supported teleservices
- Classmark
- Immediate connect supported (Y/N)

Initial Conditions

System Simulator: 1 cell, default parameters.

Mobile Station: The MS is in MM-state "idle, updated" with valid TMSI and CKSN.

Foreseen Final State of the MS

CC state U10-call active.

Test procedure

The following test is performed for all rates (full rate/half rate) supported by the MS:

A teleservice is selected that is supported by the MS; if the MS supports speech, the selected teleservice is speech. If necessary, the MS is configured for that teleservice.

The MS is paged and the resulting call is established. Having reached the active state, the MS is made to clear the call.

Maximum Duration of Test

3 minutes.

Expected Sequence

This test is repeated for execution counter M=1, 2 for an MS supporting full rate channels only.

This test is repeated for execution counter M=1, 2, 3 for an MS supporting both half and full rate channels.

Step	Direction	Message	Comments
1	SS -> MS	PAGING REQUEST TYPE 1	Sent on the correct paging subchannel Message is contained in SABM. SRES specifies correct value. SS starts deciphering after sending the message. Shall be sent enciphered. All following messages shall be sent enciphered. SS starts ciphering. Message does not contain the signal IE. If the mobile only supports full rate speech, it is checked that it indicates support of full rate speech version 1 and version 2. If the mobile supports both rates, it is checked that it indicates full rate speech version 1, half rate speech version 1 and full rate speech version 2.
2	MS -> SS	CHANNEL REQUEST	
3	SS -> MS	IMMEDIATE ASSIGNMENT	
4	MS -> SS	PAGING RESPONSE	
5	SS -> MS	AUTHENTICATION REQUEST	
6	MS -> SS	AUTHENTICATION RESPONSE	
7	SS -> MS	CIPHERING MODE COMMAND	
8	MS -> SS	CIPHERING MODE COMPLETE	
9	SS		
10	SS -> MS	SETUP	
11	MS -> SS	CALL CONFIRMED	
			If the MS supports an Immediate connection then branch A applies. If the MS doesn't support an immediate connection then branch B applies.
A12	MS -> SS	CONNECT	sent on the old channel
A13	SS -> MS	ASSIGNMENT COMMAND	
A14	MS -> SS	ASSIGNMENT COMPLETE	
B12	SS -> MS	ASSIGNMENT COMMAND	Sent on the new channel. An alerting indication as defined in an PICS/PIXIT statement is given by the MS. The MS is made to accept the call in the way described in a PICS/PIXIT statement.
B13	MS -> SS	ASSIGNMENT COMPLETE	
B14	MS -> SS	ALERTING	
B15	MS		
B16	MS		
B17	MS -> SS	CONNECT	
18	MS		
19	SS -> MS	CONNECT ACKNOWLEDGE	the TCH shall be through connected in both directions. in the indicated mode. The MS is made to release the call. The main signalling link is released.
20	MS		
21	MS -> SS	DISCONNECT	
22	SS -> MS	RELEASE	
23	MS -> SS	RELEASE COMPLETE	
24	SS -> MS	CHANNEL RELEASE	

Specific Message Contents:

For M = 1 :

ASSIGNMENT COMMAND

see default message contents section 26.12.8.

CALL CONFIRMED

Same contents as 26.12.8 but all the speech versions supported by the MS shall be indicated in octet_3a_etc(s).

For M = 2 :

ASSIGNMENT COMMAND

same as for default message contents except :

Mode of the first channel - Mode	speech full rate or half rate version 1
-------------------------------------	---

CALL CONFIRMED

Same contents as 26.12.8 but all the speech versions supported by the MS shall be indicated in octet_3a_etc(s).

For M = 3 :

ASSIGNMENT COMMAND

same as for default message contents except :

Channel Description - TDMA offset Mode of the first channel - Mode	TCH/H+ACCHs speech full rate or half rate version 1
---	--

CALL CONFIRMED

same contents as 26.12.8 but all the speech versions supported by the MS shall be indicated in octet_3a_etc(s).

26.12.5 Structured procedures / emergency call

NOTE : This test is derived from the ones described in sections 26.9.6.1.1 and 26.9.6.1.2 and respectively entitled "Structured procedures / emergency call / idle updated, preferred channel rate " and "Structured procedures / emergency call / idle updated, non-preferred channel rate".

This test applies to mobiles supporting Enhanced Full Rate speech.

26.12.5.1 Conformance requirement

- 1) The MS in the "idle, updated" state, as after a successful location update, after the number 112 (for GSM 900 and 1800 MS), or 911 (for PCS 1900 MS in USA and Canada), or 08 (for PCS 1900 MS in Mexico) has been entered by user, shall send a CHANNEL REQUEST message with correct establishment cause ("emergency call").
- 2) After assignment of a dedicated channel the first layer message sent by the MS on the assigned dedicated channel shall be a CM SERVICE REQUEST message specifying the correct CKSN and TMSI , with CM Service Type "emergency call establishment".
- 3) Authentication and cipher mode setting shall be performed successfully.
- 4) After cipher mode setting acceptance by the network, the MS shall send an EMERGENCY SETUP message.
- 5) The EFR mobile station shall accept channel assignment to a TCH full rate speech version 1 or 2 and if it supports half rate, in addition it shall accept channel assignment to a TCH half rate speech version 1.
- 6) After receipt of a CONNECT ACKNOWLEDGE message during correct establishment of the emergency call the TCH shall be through connected in both directions if an appropriate TCH is available.
- 7) The call shall be cleared correctly.

Requirement Reference:

For conformance requirement 1 and 2:	TS GSM 04.08 section 3.3.1.1, TS GSM 04.08 section 5.2.1, TS GSM 04.08 section 4.5.1.5., TS GSM 02.30 section 4.
For conformance requirement 3:	TS GSM 04.08, section 3.4.7, TS GSM 04.08 section 4.3.2.
For conformance requirement 4:	TS GSM 04.08, section 5.2.1.1.
For conformance requirement 5 :	TS GSM 04.08, sections 5.2.1.1 and 3.4.3. TS GSM 02.06 , subclause 3.2.3.
For conformance requirement 6:	TS GSM 04.08, section 5.2.1.6
For conformance requirement 7:	TS GSM 04.08, section 5.4.

26.12.5.2 Test purpose

- 1) To verify that an MS supporting speech in the MM state "idle, updated", when made to call the number 112, (for GSM 900 and 1800 MS), or 911 (for PCS 1900 MS in USA and Canada), or 08 (for PCS 1900 MS in Mexico) sends a CHANNEL REQUEST message with establishment cause "emergency call".
- 2) To verify that after assignment of a dedicated channel the first layer message sent by the MS on the assigned dedicated channel is a CM SERVICE REQUEST message specifying the correct CKSN and TMSI, with CM Service Type "emergency call establishment".
- 3) To verify that authentication and cipher mode setting are performed successfully.
- 4) To verify that after cipher mode setting acceptance by the SS, the MS sends an EMERGENCY SETUP message.
- 5) To verify that the EFR mobile station shall both accept channel assignment to a TCH full rate speech version 1 or 2 and if it supports half rate, in addition it shall accept channel assignment to a TCH half rate speech version 1.
- 6) To verify that subsequently the MS has through connected the TCH in both directions.
- 7) To verify that the call is cleared correctly.

26.12.5.3 Method of test

Related PICS/PIXIT Statements

- Speech supported (Y/N).
- Supported rate for speech: (F/H, F).
- Speech version supported :
- Classmark.
- Inclusion of the bearer capability IE in the emergency setup

Initial Conditions

System Simulator:

1 cell, default parameters.

Mobile Station:

The MS is in MM-state "idle, updated" with valid TMSI and CKSN.

Foreseen Final State of the MS

The MS is in MM-state "idle, updated" with valid TMSI and CKSN.

Test procedure

The MS is made to initiate an emergency call. The call is established with late assignment. Having reached the active state, the call is cleared by the SS. This procedure is repeated so that the assignment is made with all the channel rates and speech versions supported by the mobile station.

Maximum Duration of Test

3 minutes

Expected Sequence

The expected sequence is executed for M=1 and 2, for a full rate only mobile station which includes the bearer capabilityv IE in the emergency setup message .

The expected sequence is executed for M=1, 2 and 3, for a dual rate mobile station which includes the bearer capability IE in the emergency setup message.

The expected sequence is executed for M=1, for a mobile which does not include the bearer capability IE in the emergency setup message.

Step	Direction	Message	Comments
1	MS		The appropriate emergency number is entered
3	MS -> SS	CHANNEL REQUEST	Establishment cause is emergency call establishment.
4	SS -> MS	IMMEDIATE ASSIGNMENT	
5	MS -> SS	CM SERVICE REQUEST	Message is contained in SABM. The CM service type IE indicates "emergency call establishment".
6	SS -> MS	AUTHENTICATION REQUEST	
7	MS -> SS	AUTHENTICATION RESPONSE	SRES specifies correct value.
8	SS -> MS	CIPHERING MODE COMMAND	SS starts deciphering after sending the message.
9	MS -> SS	CIPHERING MODE COMPLETE	Shall be sent enciphered. All following messages shall be sent enciphered.
10	SS		SS starts ciphering.
11	MS -> SS	EMERGENCY SETUP	If the bearer capability IE is including, it shall be checked that all the speech versions supported by the MS are present.
12	SS -> MS	CALL PROCEEDING	
13	SS -> MS	ALERTING	
14	SS -> MS	ASSIGNMENT COMMAND	See specific message contents.
15	MS -> SS	ASSIGNMENT COMPLETE	
16	SS -> MS	CONNECT	
17	MS -> SS	CONNECT ACKNOWLEDGE	
18	MS		The TCH is through connected in both directions in the correct mode.
19	SS -> MS	DISCONNECT	
20	MS -> SS	RELEASE	
21	SS -> MS	RELEASE COMPLETE	
23	SS -> MS	CHANNEL RELEASE	The main signalling link is released.

Specific Message Contents:

For M= 1

ASSIGNMENT COMMAND

same as for default message contents except :

Mode of the first channel - Mode	Speech full rate or half rate version 1
-------------------------------------	---

For M= 2

ASSIGNMENT COMMAND

same as for default message contents

For M= 3

ASSIGNMENT COMMAND

same as for default message contents except :

Channel Description - TDMA offset	TCH/H+ACCHs
Mode of the first channel - Mode	Speech full rate or half rate version 1

26.12.6 EFR Signalling / Directed Retry / Mobile Originated Call

This test is applicable to all MS which support EFR speech.

NOTE: This test is derived from the one defined in section 26.9.7 and entitled „Directed Retry / MS originated call"

26.12.6.1 Conformance requirements

The MS shall correctly apply the Directed Retry procedure from SDCCH/8 (no frequency hopping) to TCH/EFR with frequency hopping in the non-synchronized case during call establishment. The call control entity of the Mobile Station in the "mobile originating call proceeding" state shall, upon receipt of a CONNECT message, attach the EFR speech connection to the radio path and return a CONNECT ACKNOWLEDGE message to the SS.

References

GSM 04.08, sections 3.4.4, 5.2.1.6. and 9.1.15.

GSM 04.13, section 5.2.6.2.

26.12.6.2 Test purpose

To test that, when the MS is ordered to perform a non-synchronized handover after the CALL PROCEED message, it continuously sends access bursts on the main DCCH until it receives a PHYSICAL INFORMATION message from the SS. To test that the MS correctly takes the values of the Timing Advance information element in the PHYSICAL INFORMATION message into account. To test that the MS activates the new channel correctly and transmits the HANDOVER COMPLETE message without undue delay. To test that the call control entity of the Mobile Station in the "mobile originating call proceeding" state, upon receipt of a CONNECT message, attaches the EFR speech connection to the radio path and returns a CONNECT ACKNOWLEDGE message to the SS.

26.12.6.3 Method of test

Initial Conditions

System Simulator:

2 cells A and B with same LAI, default parameters, except:

GSM 450:

Cell A has:

BCCH ARFCN = 263.

Cell Allocation = (259, 261, 263, 265, 267, 269, 271, 273, 275, 277, 279, 281, 283, 285, 287, 289, 291).

PLMN colour code, NCC = as defaults.

BS colour code, BCC = as defaults.

PLMN_PERM = 00001010.

Cell B has:

BCCH ARFCN = 274.

Cell Allocation = (260, 262, 264, 266, 268, 270, 272, 274, 276, 279, 281, 283, 285, 287, 289, 291).

PLMN colour code, NCC = 3.

BS colour code, BCC = 0.

Both cells send SYSTEM INFORMATION TYPE 1 messages containing the complete Cell Allocation of the cell, using Range 128 format.

The timebase of Cells A and B shall be such that the edges of their timeslots are not coincident at the antenna connector.

A non-combined SDCCH is used.

GSM 480:

Cell A has:

BCCH ARFCN = 310.

Cell Allocation = (306, 308, 310, 312, 314, 316, 318, 320, 322, 324, 326, 328, 330, 332, 334, 336, 338).

PLMN colour code, NCC = as defaults.

BS colour code, BCC = as defaults.

PLMN_PERM = 00001010.

Cell B has:

BCCH ARFCN = 321.

Cell Allocation = (307, 309, 311, 313, 315, 317, 319, 321, 323, 326, 328, 330, 332, 334, 336, 338).

PLMN colour code, NCC = 3.

BS colour code, BCC = 0.

Both cells send SYSTEM INFORMATION TYPE 1 messages containing the complete Cell Allocation of the cell, using Range 128 format.

The timebase of Cells A and B shall be such that the edges of their timeslots are not coincident at the antenna connector.

A non-combined SDCCH is used.

GSM 900:

Cell A has:

BCCH ARFCN = 20.

Cell Allocation = (10, 17, 20, 26, 34, 42, 45, 46, 52, 59, 66, 73, 74, 75, 76, 108, 114).

PLMN colour code, NCC = as defaults.

BS colour code, BCC = as defaults.

PLMN_PERM = 00001010.

Cell B has:

BCCH ARFCN = 40.

Cell Allocation = (14, 18, 22, 24, 30, 31, 38, 40, 60, 66, 73, 74, 75, 76, 108, 114).

PLMN colour code, NCC = 3.

BS colour code, BCC = 0.

Both cells send SYSTEM INFORMATION TYPE 1 messages containing the complete Cell Allocation of the cell, using bit map 0 format.

The timebase of Cells A and B shall be such that the edges of their timeslots are not coincident at the antenna connector.

A non-combined SDCCH is used.

DCS 1 800:

Cell A has:

BCCH ARFCN = 747.

Cell Allocation = (734, 741, 747, 754, 759, 762, 766, 767, 773, 775, 779, 782, 791, 798, 829, 832, 844).

PLMN colour code, NCC = as defaults.

BS colour code, BCC = as defaults.

PLMN_PERM = 00001010.

Cell B has:

BCCH ARFCN = 764.

Cell Allocation = (739, 743, 746, 749, 756, 758, 761, 764, 771, 779, 782, 791, 798, 829, 832, 844).

PLMN colour code, NCC = 3.

BS colour code, BCC = 0.

Both cells send SYSTEM INFORMATION TYPE 1 messages containing the complete Cell Allocation of the cell, using Range 512 format.

The timebase of Cells A and B shall be such that the edges of their timeslots are not coincident at the antenna connector.

A non combined SDCCH is used.

PCS 1 900:

Cell A has:

BCCH ARFCN = 647.

Cell Allocation = (634, 641, 647, 654, 659, 662, 666, 667, 673, 675, 679, 682, 691, 698, 729, 732, 744).

PLMN colour code, NCC = as defaults.

BS colour code, BCC = as defaults.

PLMN_PERM = 00001010.

Cell B has:

BCCH ARFCN = 664.

Cell Allocation = (639, 643, 646, 649, 656, 658, 661, 664, 671, 679, 682, 691, 698, 729, 732, 744).

PLMN colour code, NCC = 3.

BS colour code, BCC = 0.

Both cells send SYSTEM INFORMATION TYPE 1 messages containing the complete Cell Allocation of the cell, using Range 512 format.

The timebase of Cells A and B shall be such that the edges of their timeslots are not coincident at the antenna connector.

A non combined SDCCH is used.

Mobile Station:

The MS is in the "idle, updated" state, with a TMSI allocated and camped on cell A.

Related PICS/PIXIT Statements

Supported rate(s) of TCH: TCH/EFR.

Support for MO calls.

Way to indicate alerting (only applicable if the MS supports the feature).

Type of MS (GSM 450 or GSM 480 or P-GSM 900 or EGSM or DCS 1 800 or PCS 1900).

Foreseen Final State of the MS

"Idle, updated" with TMSI allocated and camped on cell B.

Test Procedure

The MS is made to initiate a speech call on Cell A. After the SS has sent the CALL PROCEEDING message the SS sends a HANDOVER COMMAND message, ordering the MS to switch to cell B. The MS shall then begin to send access bursts on the new DCCH to cell B. The SS observes the access bursts and after receiving n (n being arbitrarily chosen between values according to table 26.6-2 of section 26.6.5) access bursts, the SS sends one PHYSICAL INFORMATION message with an arbitrarily chosen Timing Advance. The MS shall activate the channel in sending and receiving mode. The MS shall establish a signalling link. The MS shall be ready to transmit a HANDOVER COMPLETE message before x ms after the end of the PHYSICAL INFORMATION message, but not before a UA frame has been sent by the SS. After the successful handover procedure the SS sends the ALERTING message. The correct alerting indication shall be given to the user (only applicable if the MS supports this feature). The SS sends the CONNECT message indicating that the call has been answered. The EFR speech channel shall be through connected in both directions. The MS shall send then the CONNECT ACKNOWLEDGE message as the response on the CONNECT message. Having reached the active state, the call is cleared by the SS.

The term "ready to transmit" is defined in GSM 04.13. The value of " x " depends upon the target channel and is specified in the specific message contents section.

Maximum Duration of Test

1 minute, including 30 seconds for any necessary operator actions.

Expected Sequence

Step	Direction	Message	Comments
1	-----	-----	A MO call is initiated on cell A.
2	MS -> SS	CHANNEL REQUEST	Establishment cause is "originating call and the network does not set the NECl bit to 1".
3	SS -> MS	IMMEDIATE ASSIGNMENT	See specific message contents.
4	MS -> SS	CM SERVICE REQUEST	CM Service Type = Mobile Originating Call Establishment.
5	SS -> MS	AUTHENTICATION REQUEST	
6	MS -> SS	AUTHENTICATION RESPONSE	SRES specifies correct value.
7	SS -> MS	CIPHERING MODE COMMAND	SS starts deciphering after sending the message.
8	MS -> SS	CIPHERING MODE COMPLETE	Shall be sent enciphered. All following messages shall be sent enciphered.
9	SS		SS starts ciphering.
10	MS -> SS	SETUP	EFR speech
11	SS -> MS	CALL PROCEEDING	
12	SS -> MS	HANDOVER COMMAND	See specific message contents.
13	MS -> SS	HANDOVER ACCESS	Repeated on every burst of the uplink main DCCH until reception of PHYSICAL INFORMATION. Handover Reference as included in the HANDOVER COMMAND.
14	SS -> MS	PHYSICAL INFORMATION	Sent after reception of n HANDOVER ACCESS message. Timing Advance is arbitrarily chosen.
15	MS -> SS	SABM	Sent without information field.
16	SS -> MS	UA	
17	MS -> SS	HANDOVER COMPLETE	This message shall be ready to be transmitted before "x" ms after the completion of step 14.
18	SS -> MS	ALERTING	
19	MS		Depending on the PICS, an alerting indication is given.
20	SS -> MS	CONNECT	
21	MS -> SS	CONNECT ACKNOWLEDGE	
22	MS		The EFR speech channel is through connected in both directions.
23	SS -> MS	DISCONNECT	
24	MS -> SS	RELEASE	
25	SS -> MS	RELEASE COMPLETE	
26	SS -> MS	CHANNEL RELEASE	The main signalling link is released.

Specific Message Contents

For GSM 450:

IMMEDIATE ASSIGNMENT

Information Element	value/remark
As default message contents except: Channel Description	Channel Description.
- Channel Type	SDCCH/8
- TDMA offset	As default message contents.
- Timeslot number	As default message contents.
- Training Sequence Code	Chosen arbitrarily.
- Hopping	Single RF Channel.
- ARFCN	Chosen arbitrarily from the Cell Allocation of Cell A.

HANDOVER COMMAND

Information Element	value/remarks
As default message contents, except: Cell Description <ul style="list-style-type: none"> - Network Colour Code - Base Station Colour Code - BCCH Carrier Number Channel Description <ul style="list-style-type: none"> - Channel Type - TDMA offset - Timeslot number - Training Sequence Code - Hopping - MAIO - HSN Synchronization Indication IE is not included Frequency list after time <ul style="list-style-type: none"> - Frequency List Channel Mode IE	 3 0 274 TCH/F + ACCHs Chosen arbitrarily. Chosen arbitrarily but not zero. Chosen arbitrarily. RF hopping channel. Chosen arbitrarily from the set (0, 1 to N-1), where N is the number of frequencies encoded in the Frequency List IE. Zero (this gives cyclic hopping). uses Range 128 to allocate the following 15 frequencies (260, 262, 264, 266, 268, 270, 272, 276, 279, 281, 283, 285, 287, 289, 291). Speech (full rate version 2 or half rate version 2).

Step 17: "x" = 500.

For GSM 480:

IMMEDIATE ASSIGNMENT

Information Element	value/remark
As default message contents except: Channel Description <ul style="list-style-type: none"> - Channel Type - TDMA offset - Timeslot number - Training Sequence Code - Hopping - ARFCN 	Channel Description. SDCCH/8 As default message contents. As default message contents. Chosen arbitrarily. Single RF Channel. Chosen arbitrarily from the Cell Allocation of Cell A.

HANDOVER COMMAND

Information Element	value/remarks
As default message contents, except: Cell Description <ul style="list-style-type: none"> - Network Colour Code - Base Station Colour Code - BCCH Carrier Number Channel Description <ul style="list-style-type: none"> - Channel Type - TDMA offset - Timeslot number - Training Sequence Code - Hopping - MAIO - HSN Synchronization Indication IE is not included Frequency list after time <ul style="list-style-type: none"> - Frequency List Channel Mode IE	 3 0 321 TCH/F + ACCHs Chosen arbitrarily. Chosen arbitrarily but not zero. Chosen arbitrarily. RF hopping channel. Chosen arbitrarily from the set (0, 1 to N-1), where N is the number of frequencies encoded in the Frequency List IE. Zero (this gives cyclic hopping). uses range 128 to allocate the following 15 frequencies (307, 309, 311, 313, 315, 317, 319, 323, 326, 328, 330, 332, 334, 336, 338). Speech (full rate version 2 or half rate version 2).

Step 17: "x" = 500.

For GSM 900:

IMMEDIATE ASSIGNMENT

Information Element	value/remark
As default message contents except: Channel Description <ul style="list-style-type: none"> - Channel Type - TDMA offset - Timeslot number - Training Sequence Code - Hopping - ARFCN 	Channel Description. SDCCH/8 As default message contents. As default message contents. Chosen arbitrarily. Single RF Channel. Chosen arbitrarily from the Cell Allocation of Cell A.

HANDOVER COMMAND

Information Element	value/remarks
As default message contents, except:	
Cell Description	
- Network Colour Code	3
- Base Station Colour Code	0
- BCCH Carrier Number	40
Channel Description	
- Channel Type	TCH/F + ACCHs
- TDMA offset	Chosen arbitrarily.
- Timeslot number	Chosen arbitrarily but not zero.
- Training Sequence Code	Chosen arbitrarily.
- Hopping	RF hopping channel.
- MAIO	Chosen arbitrarily from the set (0, 1 to N-1), where N is the number of frequencies encoded in the Frequency List IE.
- HSN	Zero (this gives cyclic hopping).
Synchronization Indication IE is not included	
Frequency list after time	
- Frequency List	uses bit map 0 to allocate the following 15 frequencies (14, 18, 22, 24, 30, 31, 38, 60, 66, 73, 74, 75, 76, 108, 114).
Channel Mode IE	Speech (full rate version 2 or half rate version 2).

Step 17: "x" = 500.

DCS 1 800:

IMMEDIATE ASSIGNMENT

Information Element	value/remark
As default message contents except:	
Channel Description	Channel Description.
- Channel Type	SDCCH/8
- TDMA offset	As default message contents.
- Timeslot number	As default message contents.
- Training Sequence Code	Chosen arbitrarily.
- Hopping	Single RF Channel.
- ARFCN	Chosen arbitrarily from the Cell Allocation of Cell A.

HANDOVER COMMAND

Information Element	value/remarks
As default message contents, except:	
Cell Description	
- Network Colour Code	3
- Base Station Colour Code	0
- BCCH Carrier Number	764
Channel Description	
- Channel Type	TCH/F + ACCHs
- TDMA offset	Chosen arbitrarily.
- Timeslot number	Chosen arbitrarily but not zero.
- Training Sequence Code	Chosen arbitrarily.
- Hopping	RF hopping channel.
- MAIO	Chosen arbitrarily from the set (0, 1 to N-1), where N is the number of frequencies encoded in the Frequency Short List IE.
- HSN	Zero (this gives cyclic hopping).
Synchronization Indication IE not included.	
Frequency Short List after time	
- Frequency Short List	Use Range 128 to encode the following 2 frequencies (746, 779).
Mode of First Channel	Speech (full rate version 2 or half rate version 2).

Step 17: "x" = 500.

PCS 1900:

IMMEDIATE ASSIGNMENT

Information Element	value/remark
As default message contents except: Channel Description <ul style="list-style-type: none"> - Channel Type - TDMA offset - Timeslot number - Training Sequence Code - Hopping - ARFCN 	Channel Description. SDCCH/8 As default message contents. As default message contents. Chosen arbitrarily. Single RF Channel. Chosen arbitrarily from the Cell Allocation of Cell A.

HANDOVER COMMAND

Information Element	value/remarks
As default message contents, except: Cell Description <ul style="list-style-type: none"> - Network Colour Code - Base Station Colour Code - BCCH Carrier Number Channel Description <ul style="list-style-type: none"> - Channel Type - TDMA offset - Timeslot number - Training Sequence Code - Hopping - MAIO <ul style="list-style-type: none"> - HSN Synchronization Indication IE not included. Frequency Short List after time <ul style="list-style-type: none"> - Frequency Short List Mode of First Channel	 3 0 664 TCH/F + ACCHs Chosen arbitrarily. Chosen arbitrarily but not zero. Chosen arbitrarily. RF hopping channel. Chosen arbitrarily from the set (0, 1 to N-1), where N is the number of frequencies encoded in the Frequency Short List IE. Zero (this gives cyclic hopping). Use Range 128 to encode the following 2 frequencies (646, 679). Speech (full rate version 2 or half rate version 2).

Step 17: "x" = 500.

26.12.7 EFR Signalling / Directed Retry / Mobile Terminated Call

This test is applicable to all MS which support EFR speech.

NOTE: This test is derived from the one defined in section 26.9.8 and entitled „Directed Retry / MS originated call"

26.12.7.1 Conformance requirements

The MS shall correctly apply the Directed Retry procedure from SDCCH/8 with frequency hopping to TCH/EFR with frequency hopping and starting time in the non-synchronized case during call establishment. The call control entity of the Mobile Station in the "call delivered" state shall, if the MS supports immediate connect, continue the call establishment by through-connecting the EFR traffic channel in both directions, or if the MS does not support immediate connect, send an ALERTING message. The MS indicates acceptance of a MT call by sending CONNECT.

The mobile station shall attach the user connection at latest when sending the CONNECT message, except if there is no compatible radio resource available at this time. In this case the attachment shall be delayed until such a resource becomes available.

References

GSM 04.08, sections 3.4.4, 5.2.2.5, 5.2.2.6, 5.2.2.9 and 9.1.15.

GSM 04.13, section 5.2.6.2.

26.12.7.2 Test purpose

To test that when the MS is ordered to perform a non-synchronized handover after the CALL CONFIRM message, it continuously sends access bursts on the main DCCH until it receives a PHYSICAL INFORMATION message from the SS. To test that the MS correctly takes the values of the Timing Advance information element in the PHYSICAL INFORMATION message into account. To test that the MS activates the new channel correctly and transmits the HANDOVER COMPLETE message without undue delay. To test that the call control entity of the Mobile Station in the "call delivered" state, if the MS supports immediate connect, continues the call establishment by through-connecting the EFR traffic channel in both directions, or if the MS does not support immediate connect, sends an ALERTING message. To test that the MS indicates acceptance of a MT call by sending CONNECT.

To test that the mobile station attaches the user connection at latest when sending the CONNECT message, except if there is no compatible radio resource available at this time. To test that in this case the attachment is delayed until such a resource becomes available.

26.12.7.3 Method of test

Initial Conditions

System Simulator:

2 cells A and B with same LAI, default parameters, except:

GSM 450:

Cell A has:

BCCH ARFCN = 263.

Cell Allocation = (259, 261, 263, 265, 267, 269, 271, 273, 275, 277, 279, 281, 283, 285, 287, 289, 291).

PLMN colour code, NCC = as defaults.

BS colour code, BCC = as defaults.

PLMN_PERM = 00001010.

Cell B has:

BCCH ARFCN = 274.

Cell Allocation = (260, 262, 264, 266, 268, 270, 272, 274, 276, 279, 281, 283, 285, 287, 289, 291).

PLMN colour code, NCC = 3.

BS colour code, BCC = 0.

Both cells send SYSTEM INFORMATION TYPE 1 messages containing the complete Cell Allocation of the cell, using Range 128 format.

The timebase of Cells A and B shall be such that the edges of their timeslots are not coincident at the antenna connector.

A non-combined SDCCH is used.

GSM 480:

Cell A has:

BCCH ARFCN = 310.

Cell Allocation = (306, 308, 310, 312, 314, 316, 318, 320, 322, 324, 326, 328, 330, 332, 334, 336, 338).

PLMN colour code, NCC = as defaults.

BS colour code, BCC = as defaults.

PLMN_PERM = 00001010.

Cell B has:

BCCH ARFCN = 321.

Cell Allocation = (307, 309, 311, 313, 315, 317, 319, 321, 323, 326, 328, 330, 332, 334, 336, 338).

PLMN colour code, NCC = 3.

BS colour code, BCC = 0.

Both cells send SYSTEM INFORMATION TYPE 1 messages containing the complete Cell Allocation of the cell, using Range 128 format.

The timebase of Cells A and B shall be such that the edges of their timeslots are not coincident at the antenna connector.

A non-combined SDCCH is used.

GSM 900:

Cell A has:

BCCH ARFCN = 20.

Cell Allocation = (10, 17, 20, 26, 34, 42, 45, 46, 52, 59, 66, 73, 74, 75, 76, 108, 114).

PLMN colour code, NCC = as defaults.

BS colour code, BCC = as defaults.

PLMN_PERM = 00001010.

Cell B has:

BCCH ARFCN = 40.

Cell Allocation = (14, 18, 22, 24, 30, 31, 38, 40, 60, 66, 73, 74, 75, 76, 108, 114).

PLMN colour code, NCC = 3.

BS colour code, BCC = 0.

Both cells send SYSTEM INFORMATION TYPE 1 messages containing the complete Cell Allocation of the cell, using bit map 0 format.

The timebase of Cells A and B shall be such that the edges of their timeslots are not coincident at the antenna connector.

A non-combined SDCCH is used.

DCS 1 800:

Cell A has:

BCCH ARFCN = 747.

Cell Allocation = (734, 741, 747, 754, 759, 762, 766, 767, 773, 775, 779, 782, 791, 798, 829, 832, 844).

PLMN colour code, NCC = as defaults.

BS colour code, BCC = as defaults.

PLMN_PERM = 00001010.

Cell B has:

BCCH ARFCN = 764.

Cell Allocation = (739, 743, 746, 749, 756, 758, 761, 764, 771, 779, 782, 791, 798, 829, 832, 844).

PLMN colour code, NCC = 3.

BS colour code, BCC = 0.

Both cells send SYSTEM INFORMATION TYPE 1 messages containing the complete Cell Allocation of the cell, using Range 512 format.

The timebase of Cells A and B shall be such that the edges of their timeslots are not coincident at the antenna connector.

A non combined SDCCH is used.

PCS 1900:

Cell A has:

BCCH ARFCN = 647.

Cell Allocation = (634, 641, 647, 654, 659, 662, 666, 667, 673, 675, 679, 682, 691, 698, 729, 732, 744).

PLMN colour code, NCC = as defaults.

BS colour code, BCC = as defaults.

PLMN_PERM = 00001010.

Cell B has:

BCCH ARFCN = 664.

Cell Allocation = (639, 643, 646, 649, 656, 658, 661, 664, 671, 679, 682, 691, 698, 729, 732, 744).

PLMN colour code, NCC = 3.

BS colour code, BCC = 0.

Both cells send SYSTEM INFORMATION TYPE 1 messages containing the complete Cell Allocation of the cell, using Range 512 format.

The timebase of Cells A and B shall be such that the edges of their timeslots are not coincident at the antenna connector.

A non combined SDCCH is used.

Mobile Station:

The MS is in the "idle, updated" state, with a TMSI allocated and camped on cell A.

Related PICS/PIXIT Statements

Supported rate(s) of TCH: TCH/EFR.

Support for MT calls.

Way to indicate alerting (only applicable if the MS supports the feature).

Way to make the MS accept an incoming call after alerting.

Immediate connect supported (Y/N).

Type of MS (GSM 450 or GSM 480 or P-GSM 900 or EGSM or DCS 1 800 or PCS 1900).

Foreseen Final State of the MS

"Idle, updated" with TMSI allocated and camped on cell B.

Test Procedure

The MS is paged on Cell A. The MS responds to the PAGING REQUEST message and establishes a mobile terminated speech call on Cell A. If the MS supports immediate connect, it continues the call establishment by through-connecting the traffic channel in both directions, or if the MS does not support immediate connect, it sends an ALERTING message. The MS indicates acceptance of a MT call by sending CONNECT.

After the MS has sent the CALL CONFIRMED message (if the MS supports immediate connect then the MS sends the CONNECT message after the CALL CONFIRMED message on the old channel) the SS sends a HANDOVER COMMAND message, ordering the MS to switch to cell B. The MS shall then begin to send access bursts on the new DCCH to cell B. The SS observes the access bursts and after receiving n (n being arbitrarily chosen between values according to table 26.6-2 of section 26.6.5) access bursts, the SS sends one PHYSICAL INFORMATION message with an arbitrarily chosen Timing Advance. The MS shall activate the channel in sending and receiving mode. The MS shall establish a signalling link. The MS shall be ready to transmit a HANDOVER COMPLETE message before x ms after the end of the PHYSICAL INFORMATION message, but not before a UA frame has been sent by the SS. After the successful handover procedure the MS sends the ALERTING message (if the MS runs the immediate connect procedure then the MS does not send an ALERTING message). The correct alerting indication shall be given to the user (only applicable if the MS supports the feature or if the MS is not using the immediate connect procedure). After the MS sent the CONNECT message the EFR speech channel shall be through connected in both directions. The SS sends then the CONNECT ACKNOWLEDGE message as the response on the CONNECT message. Having reached the active state, the call is cleared by the SS.

The term "ready to transmit" is defined in GSM 04.13. The value of " x " depends upon the target channel and is specified in the specific message contents section.

Maximum Duration of Test

1 minute, including 30 seconds for any necessary operator actions.

Expected Sequence

Step	Direction	Message	Comments
1	SS -> MS	PAGING REQUEST TYPE 1	Sent on the correct paging subchannel on cell A.
2	MS -> SS	CHANNEL REQUEST	
3	SS -> MS	IMMEDIATE ASSIGNMENT	
4	MS -> SS	PAGING RESPONSE	
5	SS -> MS	AUTHENTICATION REQUEST	
6	MS -> SS	AUTHENTICATION RESPONSE	
7	SS -> MS	CIPHERING MODE COMMAND	
8	MS -> SS	CIPHERING MODE COMPLETE	
9	SS		SS starts deciphering.
10	SS -> MS	SETUP	EFR speech.
11	MS -> SS	CALL CONFIRMED	
			If the MS supports immediate connect then branch A applies. If the MS does not support immediate connect then branch B applies
A12	MS -> SS	CONNECT	sent on the old channel
A13	SS -> MS	HANDOVER COMMAND	See specific message contents.
A14	MS -> SS	HANDOVER ACCESS	Repeated on every burst of the uplink main DCCH until reception of PHYSICAL INFORMATION. Handover Reference as included in the HANDOVER COMMAND. The first HANDOVER ACCESS message shall be transmitted in the indicated frame (unless the indicated frame is not used by that channel, in which case the next frame used by that channel shall be used).
A15	SS -> MS	PHYSICAL INFORMATION	Sent after reception of n HANDOVER ACCESS message. Timing Advance is arbitrarily chosen.
A16	MS -> SS	SABM	Sent without information field.
A17	SS -> MS	UA	
A18	MS -> SS	HANDOVER COMPLETE	This message shall be ready to be transmitted before "x" ms after the completion of step A15.
B12	SS -> MS	HANDOVER COMMAND	See specific message contents.
B13	MS -> SS	HANDOVER ACCESS	Repeated on every burst of the uplink main DCCH until reception of PHYSICAL INFORMATION. Handover Reference as included in the HANDOVER COMMAND. The first HANDOVER ACCESS message shall be transmitted in the indicated frame (unless the indicated frame is not used by that channel, in which case the next frame used by that channel shall be used).
B14	SS -> MS	PHYSICAL INFORMATION	Sent after reception of n HANDOVER ACCESS message. Timing Advance is arbitrarily chosen.
B15	MS -> SS	SABM	Sent without information field.
B16	SS -> MS	UA	
B17	MS -> SS	HANDOVER COMPLETE	This message shall be ready to be transmitted before "x" ms after the completion of step B14.
B18	MS -> SS	ALERTING	
B19	MS		Gives an alerting indication as defined in a PICS/PIXIT statement is given by the MS
B20	MS		The MS is made to accept the call in the way described in a PICS/PIXIT statement
B21	MS -> SS	CONNECT	
22	MS		The TCH/EFR channel shall be through connected in both directions.
23	SS -> MS	CONNECT ACKNOWLEDGE	
24	SS -> MS	DISCONNECT	
25	MS -> SS	RELEASE	
26	SS -> MS	RELEASE COMPLETE	
27	SS -> MS	CHANNEL RELEASE	The main signalling link is released.

Specific Message Contents

For GSM 450:

IMMEDIATE ASSIGNMENT

Information Element	value/remark
As default message contents except: L2 pseudo length	14 octets (11 + contents of the MA).
Channel Description	SDCCH/8
- Channel Type	As default message contents.
- TDMA offset	Arbitrary value, but not zero.
- Timeslot number	Chosen arbitrarily.
- Training Sequence Code	RF hopping channel.
- Hopping	Chosen arbitrarily from the set (0, 1 to N-1), where N is the number of frequencies encoded in the Mobile Allocation.
- MAIO	Chosen arbitrarily from the set (1,2,..63).
- HSN	
Mobile Allocation	3 octets.
- Length	Indicates only three frequencies: (281, 283, 285).
- Contents	

HANDOVER COMMAND

Information Element	value/remarks
As default message contents, except:	
Cell Description	
- Network Colour Code	3
- Base Station Colour Code	0
- BCCH Carrier Number	274
Channel Description	
- Channel Type	TCH/F + ACCHs
- TDMA offset	Chosen arbitrarily.
- Timeslot number	Chosen arbitrarily, but not Zero.
- Training Sequence Code	Chosen arbitrarily.
- Hopping	RF hopping channel.
- MAIO	Chosen arbitrarily from the set (0, 1 to N-1), where N is the number of frequencies encoded in the Frequency List IE.
- HSN	Chosen arbitrarily from the set (1,2,..63).
Frequency List after time	
- Frequency List	use Range 128 to encode the following 12 frequencies: (260, 262, 264, 266, 276, 279, 281, 283, 285, 287, 289, 291).
Synchronization Indication	
- Report Observed Time Difference	Shall not be included.
- Synchronization Indication	"Non synchronized".
- Normal Cell Indication	Ignore out of range timing advance.
Mode of First Channel	Speech (full rate version 2 or half rate version 2).
Starting Time	Indicates the frame number of cell B. that will occur approximately 1,1 seconds (238 frames have elapsed) after the HANDOVER COMMAND is sent by cell A.

Step A18 / B17: "x" = 750.

For GSM 480:

IMMEDIATE ASSIGNMENT

Information Element	value/remark
As default message contents except: L2 pseudo length Channel Description <ul style="list-style-type: none"> - Channel Type - TDMA offset - Timeslot number - Training Sequence Code - Hopping - MAIO 	14 octets (11 + contents of the MA). SDCCH/8 As default message contents. Arbitrary value, but not zero. Chosen arbitrarily. RF hopping channel.
- HSN Mobile Allocation <ul style="list-style-type: none"> - Length - Contents 	Chosen arbitrarily from the set (0, 1 to N-1), where N is the number of frequencies encoded in the Mobile Allocation. Chosen arbitrarily from the set (1,2,..63). 3 octets. Indicates only three frequencies: (328, 330, 332).

HANDOVER COMMAND

Information Element	value/remarks
As default message contents, except: Cell Description <ul style="list-style-type: none"> - Network Colour Code - Base Station Colour Code - BCCH Carrier Number 	3 0 321
Channel Description <ul style="list-style-type: none"> - Channel Type - TDMA offset - Timeslot number - Training Sequence Code - Hopping - MAIO 	TCH/F + ACCHs Chosen arbitrarily. Chosen arbitrarily, but not Zero. Chosen arbitrarily. RF hopping channel.
- HSN Frequency List after time <ul style="list-style-type: none"> - Frequency List 	Chosen arbitrarily from the set (0, 1 to N-1), where N is the number of frequencies encoded in the Frequency List IE. Chosen arbitrarily from the set (1,2,..63). use range 128 to encode the following 12 frequencies: (307, 309, 311, 313, 323, 326, 328, 330, 332, 334, 336, 338).
Synchronization Indication <ul style="list-style-type: none"> - Report Observed Time Difference - Synchronization Indication - Normal Cell Indication 	Shall not be included. "Non synchronized". Ignore out of range timing advance.
Mode of First Channel Starting Time	Speech (full rate version 2 or half rate version 2). Indicates the frame number of cell B. that will occur approximately 1,1 seconds (238 frames have elapsed) after the HANDOVER COMMAND is sent by cell A.

Step A18 / B17: "x" = 750.

For GSM 900:

IMMEDIATE ASSIGNMENT

Information Element	value/remark
As default message contents except: L2 pseudo length	14 octets (11 + contents of the MA).
Channel Description	SDCCH/8
- Channel Type	As default message contents.
- TDMA offset	Arbitrary value, but not zero.
- Timeslot number	Chosen arbitrarily.
- Training Sequence Code	RF hopping channel.
- Hopping	Chosen arbitrarily from the set (0, 1 to N-1), where N is the number of frequencies encoded in the Mobile Allocation.
- MAIO	Chosen arbitrarily from the set (1,2,..63).
- HSN	
Mobile Allocation	3 octets.
- Length	Indicates only three frequencies: (73, 74, 75).
- Contents	

HANDOVER COMMAND

Information Element	value/remarks
As default message contents, except:	
Cell Description	
- Network Colour Code	3
- Base Station Colour Code	0
- BCCH Carrier Number	40
Channel Description	
- Channel Type	TCH/F + ACCHs
- TDMA offset	Chosen arbitrarily.
- Timeslot number	Chosen arbitrarily, but not Zero.
- Training Sequence Code	Chosen arbitrarily.
- Hopping	RF hopping channel.
- MAIO	Chosen arbitrarily from the set (0, 1 to N-1), where N is the number of frequencies encoded in the Frequency List IE.
- HSN	Chosen arbitrarily from the set (1,2,..63).
Frequency List after time	
- Frequency List	use bit map 0 to allocates the following 12 frequencies: (14, 18, 22, 24, 60, 66, 73, 74, 75, 76,108, 114).
Synchronization Indication	
- Report Observed Time Difference	Shall not be included.
- Synchronization Indication	"Non synchronized".
- Normal Cell Indication	Ignore out of range timing advance.
Mode of First Channel	Speech (full rate version 2 or half rate version 2).
Starting Time	Indicates the frame number of cell B. that will occur approximately 1,1 seconds (238 frames have elapsed) after the HANDOVER COMMAND is sent by cell A.

Step A18 / B17: "x" = 750.

DCS 1 800:

Information Element	value/remark
As default message contents except: L2 pseudo length Channel Description <ul style="list-style-type: none"> - Channel Type - TDMA offset - Timeslot number - Training Sequence Code - Hopping - MAIO <ul style="list-style-type: none"> - HSN Mobile Allocation <ul style="list-style-type: none"> - Length - Contents 	14 octets (11 + contents of the MA). Channel Description. SDCCH/8 As default message contents. Arbitrary value but not zero. Chosen arbitrarily. RF hopping channel. Chosen arbitrarily from the set (0, 1 to N-1), where N is the number of frequencies encoded in the Mobile Allocation. Chosen arbitrarily from the set (1,2,..63). 3octets. Indicates only three frequencies: (773, 775, 779).

HANDOVER COMMAND

Information Element	value/remarks
As default message contents, except: Cell Description <ul style="list-style-type: none"> - Network Colour Code - Base Station Colour Code - BCCH Carrier Number Channel Description <ul style="list-style-type: none"> - Channel Type - TDMA offset - Timeslot number - Training Sequence Code - Hopping - MAIO <ul style="list-style-type: none"> - HSN Frequency List after time <ul style="list-style-type: none"> - Frequency List Synchronization Indication <ul style="list-style-type: none"> - Report Observed Time Difference - Synchronization Indication - Normal Cell Indication Mode of First Channel Starting Time	 3 0 764 TCH/F + ACCHs Chosen arbitrarily. Chosen arbitrarily but not Zero. Chosen arbitrarily. RF hopping channel. Chosen arbitrarily from the set (0, 1 to N-1), where N is the number of frequencies encoded in the Frequency List IE. Chosen arbitrarily from the set (1,2,..63). Use Range 1024 to allocate the following 12 frequencies: (749, 758, 761, 764, 771, 779, 782, 791, 798, 829, 832, 844). Shall not be included. "Non synchronized". Ignore out of range timing advance. Speech (full rate version 2 or half rate version 2). Indicates the frame number of cell B that will occur approximately 1.1 seconds (238 frames have elapsed) after the HANDOVER COMMAND is sent by cell A..

Step A18 / B17: "x" = 750.

PCS 1900:

Information Element	value/remark
As default message contents except: L2 pseudo length Channel Description - Channel Type - TDMA offset - Timeslot number - Training Sequence Code - Hopping - MAIO - HSN Mobile Allocation - Length - Contents	14 octets (11 + contents of the MA). Channel Description. SDCCH/8 As default message contents. Arbitrary value but not zero. Chosen arbitrarily. RF hopping channel. Chosen arbitrarily from the set (0, 1 to N-1), where N is the number of frequencies encoded in the Mobile Allocation. Chosen arbitrarily from the set (1,2,..63). 3octets. Indicates only three frequencies: (673, 675, 679).

HANDOVER COMMAND

Information Element	value/remarks
As default message contents, except: Cell Description - Network Colour Code - Base Station Colour Code - BCCH Carrier Number Channel Description - Channel Type - TDMA offset - Timeslot number - Training Sequence Code - Hopping - MAIO - HSN Frequency List after time - Frequency List Synchronization Indication - Report Observed Time Difference - Synchronization Indication - Normal Cell Indication Mode of First Channel Starting Time	3 0 664 TCH/F + ACCHs Chosen arbitrarily. Chosen arbitrarily but not Zero. Chosen arbitrarily. RF hopping channel. Chosen arbitrarily from the set (0, 1 to N-1), where N is the number of frequencies encoded in the Frequency List IE. Chosen arbitrarily from the set (1,2,..63). Use Range 1024 to allocate the following 12 frequencies: (649, 658, 661, 664, 671, 679, 682, 691, 698, 729, 732, 744). Shall not be included. "Non synchronized". Ignore out of range timing advance. Speech (full rate version 2 or half rate version 2). Indicates the frame number of cell B that will occur approximately 1.1 seconds (238 frames have elapsed) after the HANDOVER COMMAND is sent by cell A..

Step A18 / B17: "x" = 750.

26.12.8 Default contents of layer 3 messages for Enhanced Full rate speech tests

same as section 26.6.14 for GSM900 MS, 26.6.15 for DCS1800 MS, 26.6.16 for GSM 450 MS, 26.6.17 for GSM 480 and 26.6.18 for PCS 1900 MS except for :

Contents of ASSIGNMENT COMMAND message in the GSM450 band:

Protocol Discriminator	RR Management
Skip Indicator	0000
Message Type	00101110
Channel Description	TCH/F + ACCHs
- Channel Type and TDMA offset	Chosen arbitrarily by the test house
- Timeslot Number	Chosen arbitrarily by the test house
- Training Sequence Code	Single RF channel
- Hopping	Channel number 267
- ARFCN	
Power Command	Chosen arbitrarily by the test house
- Power level	
Mode of the first channel	speech full rate or half rate version 2
- Mode	
All other information elements	Not present

Contents of ASSIGNMENT COMMAND message in the GSM480 band:

Protocol Discriminator	RR Management
Skip Indicator	0000
Message Type	00101110
Channel Description	TCH/F + ACCHs
- Channel Type and TDMA offset	Chosen arbitrarily by the test house
- Timeslot Number	Chosen arbitrarily by the test house
- Training Sequence Code	Single RF channel
- Hopping	Channel number 315
- ARFCN	
Power Command	Chosen arbitrarily by the test house
- Power level	
Mode of the first channel	speech full rate or half rate version 2
- Mode	
All other information elements	Not present

Contents of ASSIGNMENT COMMAND message in the GSM900 band:

Protocol Discriminator	RR Management
Skip Indicator	0000
Message Type	00101110
Channel Description	TCH/F + ACCHs
- Channel Type and TDMA offset	Chosen arbitrarily by the test house
- Timeslot Number	Chosen arbitrarily by the test house
- Training Sequence Code	Single RF channel
- Hopping	Channel number 30
- ARFCN	
Power Command	Chosen arbitrarily by the test house
- Power level	
Mode of the first channel	speech full rate or half rate version 2
- Mode	
All other information elements	Not present

Contents of ASSIGNMENT COMMAND message in the DCS1800 band :

Protocol Discriminator	RR Management
Skip Indicator	0000
Message Type	00101110
Channel Description	TCH/F + ACCHs
- Channel Type and TDMA offset	Chosen arbitrarily by the test house
- Timeslot Number	Chosen arbitrarily by the test house
- Training Sequence Code	Single RF channel
- Hopping	Channel number 650
- ARFCN	
Power Command	Chosen arbitrarily by the test house
- Power level	
Mode of the first channel	speech full rate or half rate version 2
- Mode	
All other information elements	Not present

Contents of ASSIGNMENT COMMAND message in the PCS 1900 band :

Protocol Discriminator	RR Management
Skip Indicator	0000
Message Type	00101110
Channel Description	TCH/F + ACCHs
- Channel Type and TDMA offset	Chosen arbitrarily by the test house
- Timeslot Number	Chosen arbitrarily by the test house
- Training Sequence Code	Single RF channel
- Hopping	Channel number 650
- ARFCN	
Power Command	Chosen arbitrarily by the test house
- Power level	
Mode of the first channel	speech full rate or half rate version 2
- Mode	
All other information elements	Not present

CALL CONFIRMED

Information element	Value/remark
Repeat indicator	Omitted
Bearer capability 1	coding as described in section 11.8.2.9.2
Bearer capability 2	Omitted
Cause	Omitted

Contents of CHANNEL MODE MODIFY message in the GSM450 band :

Protocol Discriminator	RR Management
Skip Indicator	0000
Message Type	00010000
Channel Description	same as the dedicated channel currently allocated
Channel Mode	speech full rate version 2
- Mode	

Contents of CHANNEL MODE MODIFY ACKNOWLEDGE message in the GSM450 band :

Protocol Discriminator	RR Management
Skip Indicator	0000
Message Type	00010111
Channel Description	same as the dedicated channel currently allocated
Channel Mode	Speech full rate version 2
- Mode	

Contents of CHANNEL MODE MODIFY message in the GSM480 band :

Protocol Discriminator	RR Management
Skip Indicator	0000
Message Type	00010000
Channel Description	same as the dedicated channel currently allocated
Channel Mode	
- Mode	speech full rate version 2

Contents of CHANNEL MODE MODIFY ACKNOWLEDGE message in the GSM480 band :

Protocol Discriminator	RR Management
Skip Indicator	0000
Message Type	00010111
Channel Description	same as the dedicated channel currently allocated
Channel Mode	
- Mode	Speech full rate version 2

Contents of CHANNEL MODE MODIFY message in the GSM900 band :

Protocol Discriminator	RR Management
Skip Indicator	0000
Message Type	00010000
Channel Description	same as the dedicated channel currently allocated
Channel Mode	
- Mode	speech full rate version 2

Contents of CHANNEL MODE MODIFY ACKNOWLEDGE message in the GSM900 band :

Protocol Discriminator	RR Management
Skip Indicator	0000
Message Type	00010111
Channel Description	same as the dedicated channel currently allocated
Channel Mode	
- Mode	Speech full rate version 2

Contents of CHANNEL MODE MODIFY message in the DCS1800 band :

Protocol Discriminator	RR Management
Skip Indicator	0000
Message Type	00010000
Channel Description	same as the dedicated channel currently allocated
Channel Mode	
- Mode	speech full rate version 2

Contents of CHANNEL MODE MODIFY ACKNOWLEDGE message in DCS 1800 band :

Protocol Discriminator	RR Management
Skip Indicator	0000
Message Type	00010111
Channel Description	same as the dedicated channel currently allocated
Channel Mode	
- Mode	Speech full/half rate version 2

Contents of CHANNEL MODE MODIFY message in the PCS 1900 band :

Protocol Discriminator	RR Management
Skip Indicator	0000
Message Type	00010000
Channel Description	same as the dedicated channel currently allocated
Channel Mode	
- Mode	speech full rate version 2

Contents of CHANNEL MODE MODIFY ACKNOWLEDGE message in PCS 1900 band :

Protocol Discriminator	RR Management
Skip Indicator	0000
Message Type	00010111
Channel Description	same as the dedicated channel currently allocated
Channel Mode	
- Mode	Speech full/half rate version 2

Contents of HANDOVER COMMAND message in the GSM450 band :

Protocol Discriminator	RR Management
Skip Indicator	0000
Message Type	00101011
Cell Description	
- Network Colour Code	1
- Base station Colour Code	5
- BCCH Carrier Number	Set to the BCCH carrier number of cell B. (one of 261, 263, 282, 284, 287, 290 or 293)
Channel Description	
- Channel Type and TDMA offset	TCH/F + ACCHs
- Timeslot Number	Chosen arbitrarily by the test house
- Training Sequence Code	Chosen arbitrarily by the test house
- Hopping	Single RF channel
- ARFCN	Chosen arbitrarily by the test house from those supported on the target cell
Handover Reference	
- Handover Reference Value	Chosen arbitrarily by the test house.
Power Command	
- Power level	Chosen arbitrarily by the test house
Mode of the first channel	
- Mode	speech full/half rate version 2
All other information elements	Not present

Contents of HANDOVER COMMAND message in the GSM480 band :

Protocol Discriminator	RR Management
Skip Indicator	0000
Message Type	00101011
Cell Description	
- Network Colour Code	1
- Base station Colour Code	5
- BCCH Carrier Number	Set to the BCCH carrier number of cell B. (one of 308, 310, 329, 331, 334, 337 or 340)
Channel Description	TCH/F + ACCHs
- Channel Type and TDMA offset	Chosen arbitrarily by the test house
- Timeslot Number	Chosen arbitrarily by the test house
- Training Sequence Code	Single RF channel
- Hopping	Chosen arbitrarily by the test house from those supported on the target cell
- ARFCN	
Handover Reference	
- Handover Reference Value	Chosen arbitrarily by the test house.
Power Command	
- Power level	Chosen arbitrarily by the test house
Mode of the first channel	
- Mode	speech full/half rate version 2
All other information elements	Not present

Contents of HANDOVER COMMAND message in the GSM900 band :

Protocol Discriminator	RR Management
Skip Indicator	0000
Message Type	00101011
Cell Description	
- Network Colour Code	1
- Base station Colour Code	5
- BCCH Carrier Number	Set to the BCCH carrier number of cell B. (one of 10, 20, 80, 90, 100, 110 or 120)
Channel Description	TCH/F + ACCHs
- Channel Type and TDMA offset	Chosen arbitrarily by the test house
- Timeslot Number	Chosen arbitrarily by the test house
- Training Sequence Code	Single RF channel
- Hopping	Chosen arbitrarily by the test house from those supported on the target cell
- ARFCN	
Handover Reference	
- Handover Reference Value	Chosen arbitrarily by the test house.
Power Command	
- Power level	Chosen arbitrarily by the test house
Mode of the first channel	
- Mode	speech full/half rate version 2
All other information elements	Not present

Contents of HANDOVER COMMAND message in the DCS 1800 band :

Protocol Discriminator	RR Management
Skip Indicator	0000
Message Type	00101011
Cell Description	
- Network Colour Code	1
- Base station Colour Code	5
- BCCH Carrier Number	Set to the BCCH carrier number of cell B. (one of 520, 590, 600, 700, 780, 810 or 870)
Channel Description	TCH/F + ACCHs
- Channel Type and TDMA offset	Chosen arbitrarily by the test house
- Timeslot Number	Chosen arbitrarily by the test house
- Training Sequence Code	Single RF channel
- Hopping	Chosen arbitrarily by the test house from those supported on the target cell
- ARFCN	
Handover Reference	
- Handover Reference Value	Chosen arbitrarily by the test house.
Power Command	
- Power level	Chosen arbitrarily by the test house
Mode of the first channel	
- Mode	speech full/half rate version 2
All other information elements	Not present

Contents of HANDOVER COMMAND message in the PCS 1900 band :

Protocol Discriminator	RR Management
Skip Indicator	0000
Message Type	00101011
Cell Description	
- Network Colour Code	1
- Base station Colour Code	5
- BCCH Carrier Number	Set to the BCCH carrier number of cell B. (one of 520, 590, 650, 600, 680, 710 or 770)
Channel Description	TCH/F + ACCHs
- Channel Type and TDMA offset	Chosen arbitrarily by the test house
- Timeslot Number	Chosen arbitrarily by the test house
- Training Sequence Code	Single RF channel
- Hopping	Chosen arbitrarily by the test house from those supported on the target cell
- ARFCN	
Handover Reference	
- Handover Reference Value	Chosen arbitrarily by the test house.
Power Command	
- Power level	Chosen arbitrarily by the test house
Mode of the first channel	
- Mode	speech full/half rate version 2
All other information elements	Not present

Contents of SETUP message; (MS to SS);

Protocol Discriminator	Call Control
Transaction Identifier	
TI value	any value from the set {0, ..., 6}
TI flag	0
Message Type	0X000101
Other information elements	Not checked
Protocol Discriminator	Call Control
Transaction Identifier	set {0, ..., 6}
TI flag	0
BC repeat indicator	Not present
Bearer capability 1	codind as described in section 11.8.2.9.2
All other information elements	Not present

Contents of SETUP message; (SS to MS for speech teleservice)

Protocol Discriminator	Call Control
Transaction Identifier	
TI value	any value from the set {0, ..., 6}
TI flag	0
Message Type	0X000101
Other information elements	Not checked
Protocol Discriminator	Call Control
Transaction Identifier	set {0, ..., 6}
TI flag	0
BC repeat indicator	Not present
Bearer capability 1	
octet 2	
length	01 H
octet 3	
extension	1
radio channel requirement	01
coding standard	GSM standardized coding
transfer mode	circuit mode
information transfer capability	speech
All other information elements	Not present

26.13 Multislot signalling

26.13.1 Multislot signalling / RR

26.13.1.1 Multislot signalling / RR / Measurement

26.13.1.1.1 Multislot signalling / RR / Measurement / symmetric

This test is applicable to all MS that supports multislot configuration.

26.13.1.1.1.1 Conformance requirements

The MS shall continuously send MEASUREMENT REPORT messages, on every uplink HSCSD channel used, on every SACCH blocks and the measurement valid indication shall be set to valid (0) within the second block at the latest. After 20 seconds the values in the MEASUREMENT REPORT message shall contain measurement results for the 4 strongest BCCH carriers with known and allowed NCC part of BSIC.

References

GSM 04.08 sections 3.4.1.2 and 9.1.21, GSM 05.08 section 8.4.

26.13.1.1.1.2 Test purpose

- 1) To test that, when a combination of normal neighbours, and non-permitted NCCs is "on air", the MS reports only on normal neighbours and that in symmetric HSCSD configuration the neighbouring cell measurement reports are copied on every uplink HSCSD channel used.

26.13.1.1.1.3 Method of test

Initial Conditions

System Simulator:

For GSM 450 or GSM 480: 8 cells with the following settings:

Transmitter	Level	NCC	BSCC	ARFCN (GSM450)	ARFCN (GSM480)	Cell Identity
Serving, S1	-60	1	3	260	307	0001H
Neighbour, N1	-85	1	5	264	311	0002H
Neighbour, N2	-80	1	7	268	315	0003H
Neighbour, N3	-75	2	1	272	319	0004H
Neighbour, N4	-55	3	3	276	323	0005H
Neighbour, N5	-50	4	5	280	327	0006H
Neighbour, N6	-45	1	7	284	331	0007H
Neighbour, N7	-40	1	1	288	335	0008H

For GSM 900 or DCS 1800: 8 cells with the following settings:

Transmitter	Level	NCC	BSCC	ARFCN (GSM900)	ARFCN (DCS1800)	Cell Identity
Serving, S1	-60	1	3	002	514	0001H
Neighbour, N1	-85	1	5	008	530	0002H
Neighbour, N2	-80	1	7	014	602	0003H
Neighbour, N3	-75	2	1	020	665	0004H
Neighbour, N4	-55	3	3	026	762	0005H
Neighbour, N5	-50	4	5	032	686	0006H
Neighbour, N6	-45	1	7	038	549	0007H
Neighbour, N7	-40	1	1	044	810	0008H

With the exception of the Cell Allocation, the rest of the parameters for all eight cells are the same as the default settings and default SYSTEM INFORMATION TYPE 1 to 4 message contents for cell A. The Cell Allocation for the serving cell is the same as the default setting for cell A. The Cell Allocations for the neighbour cells need have only one entry, consisting of the ARFCN of that cell's BCCH.

Mobile Station:

The MS is in the active state of a service using symmetric multislot connection.

Related PICS/PIXIT Statements

- Type of MS (GSM 450 or GSM 480 or P-GSM 900 or EGSM or DCS 1 800).
- Multislot class
- Supported teleservices/bearer services

Foreseen Final State of the MS

Active state of a service using symmetric multislot connection.

Test Procedure

This test procedure is repeated for all the symmetric multislot configurations MS supports.

With the MS having a multislot connection in progress, the SS sends SYSTEM INFORMATION TYPE 5 & 6 on the SACCH/M. All 7 of the BCCHs "on air" are indicated in the BA (N1 is excluded). The MS shall send MEASUREMENT REPORTs back to the SS on every uplink HSCSD channel, and it shall be indicated in these that measurement results for the 4 strongest carriers have been obtained.

Maximum Duration of Test

5 minutes, including 1 minute for any necessary operator actions.

Expected Sequence

SYSTEM INFORMATION TYPE 5, SYSTEM INFORMATION TYPE 6 and MEASUREMENT REPORT are sent continuously, a table is not applicable in this test. The interval between 2 successive Layer 2 frames containing MEASUREMENT REPORTs shall not exceed one Layer 2 frame.

Specific Message Contents

GSM 450 begin:

SYSTEM INFORMATION TYPE 5

Information Element	value/remark
Neighbour Cells Description	
Format Identifier	Range 128
BCCH Allocation Sequence	1
BCCH Allocation ARFCN	The channel numbers 259, 260, 262, 263, 264, 266, 267, 268, 269, 270, 271, 272, 274, 275, 276, 277, 278, 280, 281, 282, 283, 284, 285, 286, 287, 288, 290, 291, 292 and 293 belong to the BCCH allocation.
- EXT IND	Information Element carries complete BA.

SYSTEM INFORMATION TYPE 6:

Information Element	value/remark
Protocol Discriminator	RR Management
Message Type	sys info 6
Cell Identity	Default
LAI	Default
Cell Options	
- Power Control Indicator	Power Control Indicator is set
- DTX Indicator	MS shall not use DTX
- Radio-Link-Time-out	Default
PLMN permitted	only NCC 1 permitted

MEASUREMENT REPORT

Information Element	value/remark
Protocol Discriminator	RR Management
Transaction Identifier	0000
Message Type	MEASUREMENT REPORT
Measurement Results	
BA_used	1
DTX_used	DTX was not used
RXLEV_FULL_SERVING_CELL	See NOTE 1
RXLEV_SUB_SERVING_CELL	See NOTE 1
MEAS_VALID	See NOTE 2
RXQUAL_FULL_SERVING_CELL	See NOTE 1
RXQUAL_SUB_SERVING_CELL	See NOTE 1
NO_NCELL_M	4 neighbour cell measurement results
RXLEV_NCELL_1	See NOTE 1
BCCH_FREQ_NCELL_1	Corresponds to one of N7, N6, S1 or N2
BSIC_NCELL_1	Corresponds to that of BCCH_FREQ_NCELL_1
RXLEV_NCELL_2	See NOTE 1
BCCH_FREQ_NCELL_2	Corresponds to one of N7, N6, S1 or N2
BSIC_NCELL_2	Corresponds to that of BCCH_FREQ_NCELL_2
RXLEV_NCELL_3	See NOTE 1
BCCH_FREQ_NCELL_3	Corresponds to one of N7, N6, S1 or N2
BSIC_NCELL_3	Corresponds to that of BCCH_FREQ_NCELL_3
RXLEV_NCELL_4	See NOTE 1
BCCH_FREQ_NCELL_4	Corresponds to one of N7, N6, S1 or N2
BSIC_NCELL_4	Corresponds to that of BCCH_FREQ_NCELL_4
RXLEV_NCELL_5	00 0000
BCCH_FREQ_NCELL_5	0 0000
BSIC_NCELL_5	00 0000
RXLEV_NCELL_6	00 0000
BCCH_FREQ_NCELL_6	0 0000
BSIC_NCELL_6	00 0000

This message shall contain one report on each of N7, N6, S1 and N2.

GSM 450 end:

GSM 480 begin:

SYSTEM INFORMATION TYPE 5

Information Element	value/remark
Neighbour Cells Description	
Format Identifier	Range 128
BCCH Allocation Sequence	1
BCCH Allocation ARFCN	The channel numbers 306, 307, 308, 310, 311, 312, 313, 315, 316, 317, 318, 319, 321, 322, 323, 324, 325, 326, 327, 329, 330, 331, 332, 333, 334, 335, 337, 338, 339 and 340 belong to the BCCH allocation.
- EXT IND	Information Element carries complete BA.

SYSTEM INFORMATION TYPE 6:

Information Element	value/ remark
Protocol Discriminator	RR Management
Message Type	sys info 6
Cell Identity	Default
LAI	Default
Cell Options	
- Power Control Indicator	Power Control Indicator is set
- DTX Indicator	MS shall not use DTX
- Radio-Link-Time-out	Default
PLMN permitted	only NCC 1 permitted

MEASUREMENT REPORT

Information Element	value/remark
Protocol Discriminator	RR Management
Transaction Identifier	0000
Message Type	MEASUREMENT REPORT
Measurement Results	
BA_used	1
DTX_used	DTX was not used
RXLEV_FULL_SERVING_CELL	See NOTE 1
RXLEV_SUB_SERVING_CELL	See NOTE 1
MEAS_VALID	See NOTE 2
RXQUAL_FULL_SERVING_CELL	See NOTE 1
RXQUAL_SUB_SERVING_CELL	See NOTE 1
NO_NCELL_M	4 neighbour cell measurement results
RXLEV_NCELL_1	See NOTE 1
BCCH_FREQ_NCELL_1	Corresponds to one of N7, N6, S1 or N2
BSIC_NCELL_1	Corresponds to that of BCCH_FREQ_NCELL_1
RXLEV_NCELL_2	See NOTE 1
BCCH_FREQ_NCELL_2	Corresponds to one of N7, N6, S1 or N2
BSIC_NCELL_2	Corresponds to that of BCCH_FREQ_NCELL_2
RXLEV_NCELL_3	See NOTE 1
BCCH_FREQ_NCELL_3	Corresponds to one of N7, N6, S1 or N2
BSIC_NCELL_3	Corresponds to that of BCCH_FREQ_NCELL_3
RXLEV_NCELL_4	See NOTE 1
BCCH_FREQ_NCELL_4	Corresponds to one of N7, N6, S1 or N2
BSIC_NCELL_4	Corresponds to that of BCCH_FREQ_NCELL_4
RXLEV_NCELL_5	00 0000
BCCH_FREQ_NCELL_5	0 0000
BSIC_NCELL_5	00 0000
RXLEV_NCELL_6	00 0000
BCCH_FREQ_NCELL_6	0 0000
BSIC_NCELL_6	00 0000

This message shall contain one report on each of N7, N6, S1 and N2.

GSM 480 end:

GSM 900 begin:

SYSTEM INFORMATION TYPE 5

Information Element	value/remark
Neighbour Cells Description	
Format Identifier	bit map 0
BCCH Allocation Sequence	1
BCCH Allocation ARFCN	The channel numbers 2, 4, 5, 6, 7, 9, 10, 11, 12, 13, 14, 16, 17, 18, 19, 20, 21, 23, 24, 26, 28, 29, 30, 32, 34, 35, 36, 38, 40 and 44 belong to the BCCH allocation.
- EXT IND	Information Element carries complete BA.

SYSTEM INFORMATION TYPE 6:

Information Element	value/ remark
Protocol Discriminator	RR Management
Message Type	sys info 6
Cell Identity	Default
LAI	Default
Cell Options	
- Power Control Indicator	Power Control Indicator is set
- DTX Indicator	MS shall not use DTX
- Radio-Link-Time-out	Default
PLMN permitted	only NCC 1 permitted

MEASUREMENT REPORT

Information Element	value/remark
Protocol Discriminator	RR Management
Transaction Identifier	0000
Message Type	MEASUREMENT REPORT
Measurement Results	
BA_used	1
DTX_used	DTX was not used
RXLEV_FULL_SERVING_CELL	See NOTE 1
RXLEV_SUB_SERVING_CELL	See NOTE 1
MEAS_VALID	See NOTE 2
RXQUAL_FULL_SERVING_CELL	See NOTE 1
RXQUAL_SUB_SERVING_CELL	See NOTE 1
NO_NCELL_M	4 neighbour cell measurement results
RXLEV_NCELL_1	See NOTE 1
BCCH_FREQ_NCELL_1	Corresponds to one of N7, N6, S1 or N2
BSIC_NCELL_1	Corresponds to that of BCCH_FREQ_NCELL_1
RXLEV_NCELL_2	See NOTE 1
BCCH_FREQ_NCELL_2	Corresponds to one of N7, N6, S1 or N2
BSIC_NCELL_2	Corresponds to that of BCCH_FREQ_NCELL_2
RXLEV_NCELL_3	See NOTE 1
BCCH_FREQ_NCELL_3	Corresponds to one of N7, N6, S1 or N2
BSIC_NCELL_3	Corresponds to that of BCCH_FREQ_NCELL_3
RXLEV_NCELL_4	See NOTE 1
BCCH_FREQ_NCELL_4	Corresponds to one of N7, N6, S1 or N2
BSIC_NCELL_4	Corresponds to that of BCCH_FREQ_NCELL_4
RXLEV_NCELL_5	00 0000
BCCH_FREQ_NCELL_5	0 0000
BSIC_NCELL_5	00 0000
RXLEV_NCELL_6	00 0000
BCCH_FREQ_NCELL_6	0 0000
BSIC_NCELL_6	00 0000

This message shall contain one report on each of N7, N6, S1 and N2.

GSM 900 end:

DCS 1 800 begin:

SYSTEM INFORMATION TYPE 5

Information Element	value/remark
Protocol Discriminator	RR management
Message Type	Sys Info 5.
Neighbour Cells Description	
- Format	1024 range
- EXT IND	Information Element carries complete BA.
- W(i)	Non null for ARFCN 514, 549, 602, 665, 686, 762, 810.

SYSTEM INFORMATION TYPE 6

Information Element	value/ remark
Protocol Discriminator	RR Management
Message Type	sys info 6
Cell Identity	Default
LAI	Default
Cell Options	
- Power Control Indicator	Power Control Indicator is set
- DTX Indicator	MS shall not use DTX
- Radio_Link_Timeout	Default
PLMN permitted	only NCC 1 permitted

MEASUREMENT REPORT

Information Element	value/remark
Protocol Discriminator	RR Management
Transaction Identifier	0000
Message Type	MEASUREMENT REPORT
Measurement Results	
BA_used	1
DTX_used	DTX was not used
RXLEV_FULL_SERVING_CELL	See NOTE 1
RXLEV_SUB_SERVING_CELL	See NOTE 1
MEAS_VALID	See NOTE 2
RXQUAL_FULL_SERVING_CELL	See NOTE 1
RXQUAL_SUB_SERVING_CELL	See NOTE 1
NO_NCELL_M	4 neighbour cell measurement results
RXLEV_NCELL_1	See NOTE 1
BCCH_FREQ_NCELL_1	Corresponds to one of N7, N6, S1 or N2
BSIC_NCELL_1	Corresponds to that of BCCH_FREQ_NCELL_1
RXLEV_NCELL_2	See NOTE 1
BCCH_FREQ_NCELL_2	Corresponds to one of N7, N6, S1 or N2
BSIC_NCELL_2	Corresponds to that of BCCH_FREQ_NCELL_2
RXLEV_NCELL_3	See NOTE 1
BCCH_FREQ_NCELL_3	Corresponds to one of N7, N6, S1 or N2
BSIC_NCELL_3	Corresponds to that of BCCH_FREQ_NCELL_3
RXLEV_NCELL_4	See NOTE 1
BCCH_FREQ_NCELL_4	Corresponds to one of N7, N6, S1 or N2
BSIC_NCELL_4	Corresponds to that of BCCH_FREQ_NCELL_4
RXLEV_NCELL_5	00 0000
BCCH_FREQ_NCELL_5	0 0000
BSIC_NCELL_5	00 0000
RXLEV_NCELL_6	00 0000
BCCH_FREQ_NCELL_6	0 0000
BSIC_NCELL_6	00 0000

This message shall contain one report on each of N7, N6, S1 and N2.

DCS 1 800 end:

NOTE 1: These actual values are not checked.

NOTE 2: The Measurement Valid Indication shall be set to valid within the second SACCH block at the latest.

26.13.1.1.2 Multislot signalling / RR / Measurement / asymmetric

This test is applicable to all MS that supports multislot configuration.

26.13.1.1.2.1 Conformance requirements

The MS shall continuously send MEASUREMENT REPORT messages, on every uplink HSCSD channel used, on every SACCH blocks and the measurement valid indication shall be set to valid (0) within the second block at the latest. After 20 seconds the values in the MEASUREMENT REPORT message shall contain measurement results for the 4 strongest BCCH carriers with known and allowed NCC part of BSIC.

References

GSM 04.08 sections 3.4.1.2 and 9.1.21, GSM 05.08 section 8.4.

26.13.1.1.2.2 Test purpose

- 1) To test that, when a combination of normal neighbours, barred cells and non-permitted NCCs is “on air”, the MS reports only on normal neighbours and that in asymmetric HSCSD configuration the neighbouring cell measurement reports are copied on every uplink HSCSD channel used.

26.13.1.1.2.3 Method of test

Initial Conditions

System Simulator:

For GSM 450 or GSM 480: 8 cells with the following settings:

Transmitter	Level	NCC	BSCC	ARFCN (GSM450)	ARFCN (GSM480)	Cell Identity
Serving, S1	-60	1	3	260	307	0001H
Neighbour, N1	-85	1	5	264	311	0002H
Neighbour, N2	-80	1	7	268	315	0003H
Neighbour, N3	-75	2	1	272	319	0004H
Neighbour, N4	-55	3	3	276	323	0005H
Neighbour, N5	-50	4	5	280	327	0006H
Neighbour, N6	-45	1	7	284	331	0007H
Neighbour, N7	-40	1	1	288	335	0008H

For GSM 900 or DCS 1800: 8 cells with the following settings:

Transmitter	Level	NCC	BSCC	ARFCN (GSM900)	ARFCN (DCS1800)	Cell Identity
Serving, S1	-60	1	3	002	514	0001H
Neighbour, N1	-85	1	5	008	530	0002H
Neighbour, N2	-80	1	7	014	602	0003H
Neighbour, N3	-75	2	1	020	665	0004H
Neighbour, N4	-55	3	3	026	762	0005H
Neighbour, N5	-50	4	5	032	686	0006H
Neighbour, N6	-45	1	7	038	549	0007H
Neighbour, N7	-40	1	1	044	810	0008H

With the exception of the Cell Allocation, the rest of the parameters for all eight cells are the same as the default settings and default SYSTEM INFORMATION TYPE 1 to 4 message contents for cell A. The Cell Allocation

for the serving cell is the same as the default setting for cell A. The Cell Allocations for the neighbour cells need have only one entry, consisting of the ARFCN of that cell's BCCH.

Mobile Station:

The MS is in the active state of a service using asymmetric multislot connection.

Related PICS/PIXIT Statements

- Type of MS (GSM 450 or GSM 480 or P-GSM 900 or EGSM or DCS 1 800).
- Multislot class
- Supported teleservices/bearer services

Foreseen Final State of the MS

Active state of a service using asymmetric multislot connection.

Test Procedure

This test procedure is performed twice.

MS having a multislot connection with maximum number of timeslots in the downlink and one slot in uplink direction in progress, the SS sends SYSTEM INFORMATION TYPE 5 & 6 (on the second iteration of the test two timeslots are used in the downlink and one in uplink direction the SS also sends SYSTEM INFORMATION TYPE 5bis) on the SACCH/M. All 7 of the BCCHs "on air" are indicated in the BA (N1 is excluded). The MS shall send MEASUREMENT REPORTs back to the SS on every uplink HSCSD channel, and it shall be indicated in these that measurement results for the 4 strongest carriers have been obtained.

Maximum Duration of Test

5 minutes, including 1 minute for any necessary operator actions.

Expected Sequence

This sequence is performed for execution counter, k = 1, 2.

Since when k = 1, SYSTEM INFORMATION TYPE 5, SYSTEM INFORMATION TYPE 6 and MEASUREMENT REPORT (and when k = 2 an additional SYSTEM INFORMATION TYPE 5bis is included) are sent continuously, a table is not applicable in this test. The interval between 2 successive Layer 2 frames containing MEASUREMENT REPORTs shall not exceed one Layer 2 frame.

Specific Message Contents

GSM 450 begin:

SYSTEM INFORMATION TYPE 5

Information Element	value/remark
Neighbour Cells Description	
Format Identifier	Range 128
BCCH Allocation Sequence	1
BCCH Allocation ARFCN	The channel numbers 259, 260, 262, 263, 264, 266, 267, 268, 269, 270, 271, 272, 274, 275, 276, 277, 278, 280, 281, 282, 283, 284, 285, 286, 287, 288, 290, 291, 292 and 293 belong to the BCCH allocation.
- EXT IND	k = 1. Information Element carries complete BA. k = 2. Information Element carries only a part of the BA.

SYSTEM INFORMATION TYPE 5bis (Sent only when k = 2)

Information Element	value/remark
Protocol Discriminator	RR management
Message Type	Sys Info 5bis.
Neighbour Cells Description	
- Format	256 range
- EXT IND	k = 2. Information Element carries only a part of the BA.
- W(i)	Channel 0 and 800 belong to the BCCH allocation.

SYSTEM INFORMATION TYPE 6:

Information Element	value/ remark
Protocol Discriminator	RR Management
Message Type	sys info 6
Cell Identity	default
LAI	default
Cell Options	
- Power Control Indicator	Power Control Indicator is set
- DTX Indicator	MS shall not use DTX
- Radio_Link_Timeout	default
PLMN permitted	only NCC 1 permitted

MEASUREMENT REPORT

Information Element	Value/remark
Protocol Discriminator	RR Management
Transaction Identifier	0000
Message Type	MEASUREMENT REPORT
Measurement Results	
BA_used	1
DTX_used	DTX was not used
RXLEV_FULL_SERVING_CELL	See NOTE 1
RXLEV_SUB_SERVING_CELL	See NOTE 1
MEAS_VALID	See NOTE 2
RXQUAL_FULL_SERVING_CELL	See NOTE 1
RXQUAL_SUB_SERVING_CELL	See NOTE 1
NO_NCELL_M	4 neighbour cell measurement results
RXLEV_NCELL_1	See NOTE 1
BCCH_FREQ_NCELL_1	Corresponds to one of N7, N6, S1 or N2
BSIC_NCELL_1	Corresponds to that of BCCH_FREQ_NCELL_1
RXLEV_NCELL_2	See NOTE 1
BCCH_FREQ_NCELL_2	Corresponds to one of N7, N6, S1 or N2
BSIC_NCELL_2	Corresponds to that of BCCH_FREQ_NCELL_2
RXLEV_NCELL_3	See NOTE 1
BCCH_FREQ_NCELL_3	Corresponds to one of N7, N6, S1 or N2
BSIC_NCELL_3	Corresponds to that of BCCH_FREQ_NCELL_3
RXLEV_NCELL_4	See NOTE 1
BCCH_FREQ_NCELL_4	Corresponds to one of N7, N6, S1 or N2
BSIC_NCELL_4	Corresponds to that of BCCH_FREQ_NCELL_4
RXLEV_NCELL_5	00 0000
BCCH_FREQ_NCELL_5	0 0000
BSIC_NCELL_5	00 0000
RXLEV_NCELL_6	00 0000
BCCH_FREQ_NCELL_6	0 0000
BSIC_NCELL_6	00 0000

This message shall contain one report on each of N7, N6, S1 and N2.

GSM 450 end:

GSM 480 begin:

SYSTEM INFORMATION TYPE 5

Information Element	value/remark
Neighbour Cells Description Format Identifier BCCH Allocation Sequence BCCH Allocation ARFCN - EXT IND	Range 128 1 The channel numbers 306, 307, 308, 310, 311, 312, 313, 315, 316, 317, 318, 319, 321, 322, 323, 324, 325, 326, 327, 329, 330, 331, 332, 333, 334, 335, 337, 338, 339 and 340 belong to the BCCH allocation. k = 1. Information Element carries complete BA. k = 2. Information Element carries only a part of the BA.

SYSTEM INFORMATION TYPE 5bis (Sent only when k = 2)

Information Element	value/remark
Protocol Discriminator Message Type Neighbour Cells Description - Format - EXT IND - W(i)	RR management Sys Info 5bis. 256 range k = 2. Information Element carries only a part of the BA. Channel 0 and 800 belong to the BCCH allocation.

SYSTEM INFORMATION TYPE 6:

Information Element	value/ remark
Protocol Discriminator Message Type Cell Identity LAI Cell Options - Power Control Indicator - DTX Indicator - Radio_Link_Timeout PLMN permitted	RR Management sys info 6 default default Power Control Indicator is set MS shall not use DTX default only NCC 1 permitted

MEASUREMENT REPORT

Information Element	Value/remark
Protocol Discriminator	RR Management
Transaction Identifier	0000
Message Type	MEASUREMENT REPORT
Measurement Results	
BA_used	1
DTX_used	DTX was not used
RXLEV_FULL_SERVING_CELL	See NOTE 1
RXLEV_SUB_SERVING_CELL	See NOTE 1
MEAS_VALID	See NOTE 2
RXQUAL_FULL_SERVING_CELL	See NOTE 1
RXQUAL_SUB_SERVING_CELL	See NOTE 1
NO_NCELL_M	4 neighbour cell measurement results
RXLEV_NCELL_1	See NOTE 1
BCCH_FREQ_NCELL_1	Corresponds to one of N7, N6, S1 or N2
BSIC_NCELL_1	Corresponds to that of BCCH_FREQ_NCELL_1
RXLEV_NCELL_2	See NOTE 1
BCCH_FREQ_NCELL_2	Corresponds to one of N7, N6, S1 or N2
BSIC_NCELL_2	Corresponds to that of BCCH_FREQ_NCELL_2
RXLEV_NCELL_3	See NOTE 1
BCCH_FREQ_NCELL_3	Corresponds to one of N7, N6, S1 or N2
BSIC_NCELL_3	Corresponds to that of BCCH_FREQ_NCELL_3
RXLEV_NCELL_4	See NOTE 1
BCCH_FREQ_NCELL_4	Corresponds to one of N7, N6, S1 or N2
BSIC_NCELL_4	Corresponds to that of BCCH_FREQ_NCELL_4
RXLEV_NCELL_5	00 0000
BCCH_FREQ_NCELL_5	0 0000
BSIC_NCELL_5	00 0000
RXLEV_NCELL_6	00 0000
BCCH_FREQ_NCELL_6	0 0000
BSIC_NCELL_6	00 0000

This message shall contain one report on each of N7, N6, S1 and N2.

GSM 480 end:

GSM 900 begin:

SYSTEM INFORMATION TYPE 5

Information Element	value/remark
Neighbour Cells Description	
Format Identifier	bit map 0
BCCH Allocation Sequence	1
BCCH Allocation ARFCN	The channel numbers 2, 4, 5, 6, 7, 9, 10, 11, 12, 13, 14, 16, 17, 18, 19, 20, 21, 23, 24, 26, 28, 29, 30, 32, 34, 35, 36, 38, 40 and 44 belong to the BCCH allocation.
- EXT IND	k = 1. Information Element carries complete BA. k = 2. Information Element carries only a part of the BA.

SYSTEM INFORMATION TYPE 5bis (Sent only when k = 2)

Information Element	value/remark
Protocol Discriminator	RR management
Message Type	Sys Info 5bis.
Neighbour Cells Description	
- Format	256 range
- EXT IND	k = 2. Information Element carries only a part of the BA.
- W(i)	Channel 0 and 800 belong to the BCCH allocation.

SYSTEM INFORMATION TYPE 6:

Information Element	value/ remark
Protocol Discriminator	RR Management
Message Type	sys info 6
Cell Identity	default
LAI	default
Cell Options	
- Power Control Indicator	Power Control Indicator is set
- DTX Indicator	MS shall not use DTX
- Radio_Link_Timeout	default
PLMN permitted	only NCC 1 permitted

MEASUREMENT REPORT

Information Element	Value/remark
Protocol Discriminator	RR Management
Transaction Identifier	0000
Message Type	MEASUREMENT REPORT
Measurement Results	
BA_used	1
DTX_used	DTX was not used
RXLEV_FULL_SERVING_CELL	See NOTE 1
RXLEV_SUB_SERVING_CELL	See NOTE 1
MEAS_VALID	See NOTE 2
RXQUAL_FULL_SERVING_CELL	See NOTE 1
RXQUAL_SUB_SERVING_CELL	See NOTE 1
NO_NCELL_M	4 neighbour cell measurement results
RXLEV_NCELL_1	See NOTE 1
BCCH_FREQ_NCELL_1	Corresponds to one of N7, N6, S1 or N2
BSIC_NCELL_1	Corresponds to that of BCCH_FREQ_NCELL_1
RXLEV_NCELL_2	See NOTE 1
BCCH_FREQ_NCELL_2	Corresponds to one of N7, N6, S1 or N2
BSIC_NCELL_2	Corresponds to that of BCCH_FREQ_NCELL_2
RXLEV_NCELL_3	See NOTE 1
BCCH_FREQ_NCELL_3	Corresponds to one of N7, N6, S1 or N2
BSIC_NCELL_3	Corresponds to that of BCCH_FREQ_NCELL_3
RXLEV_NCELL_4	See NOTE 1
BCCH_FREQ_NCELL_4	Corresponds to one of N7, N6, S1 or N2
BSIC_NCELL_4	Corresponds to that of BCCH_FREQ_NCELL_4
RXLEV_NCELL_5	00 0000
BCCH_FREQ_NCELL_5	0 0000
BSIC_NCELL_5	00 0000
RXLEV_NCELL_6	00 0000
BCCH_FREQ_NCELL_6	0 0000
BSIC_NCELL_6	00 0000

This message shall contain one report on each of N7, N6, S1 and N2.

GSM 900 end:

DCS 1 800 begin:

SYSTEM INFORMATION TYPE 5

Information Element	value/remark
Protocol Discriminator	RR management
Message Type	Sys Info 5.
Neighbour Cells Description	
- Format	1024 range
- EXT IND	k = 1. Information Element carries complete BA. k = 2. Information Element carries only a part of the BA.
- W(i)	k = 1. Non null for ARFCN 514, 549, 602, 665, 686, 762, 810. k = 2. Non null for ARFCN 549, 602, 665, 686, 810.

SYSTEM INFORMATION TYPE 5bis (Sent only when k = 2)

Information Element	value/remark
Protocol Discriminator	RR management
Message Type	Sys Info 5bis.
Neighbour Cells Description	
- Format	1024 range
- EXT IND	k = 2. Information Element carries only a part of the BA.
- W(i)	k = 2. Non null ARFCN 20, 514, 762.

SYSTEM INFORMATION TYPE 6

Information Element	value/ remark
Protocol Discriminator	RR Management
Message Type	sys info 6
Cell Identity	default
LAI	default
Cell Options	
- Power Control Indicator	Power Control Indicator is set
- DTX Indicator	MS shall not use DTX
- Radio_Link_Timeout	default
PLMN permitted	only NCC 1 permitted

MEASUREMENT REPORT

Information Element	Value/remark
Protocol Discriminator	RR Management
Transaction Identifier	0000
Message Type	MEASUREMENT REPORT
Measurement Results	
BA_used	1
DTX_used	DTX was not used
RXLEV_FULL_SERVING_CELL	See NOTE 1
RXLEV_SUB_SERVING_CELL	See NOTE 1
MEAS_VALID	See NOTE 2
RXQUAL_FULL_SERVING_CELL	See NOTE 1
RXQUAL_SUB_SERVING_CELL	See NOTE 1
NO_NCELL_M	4 neighbour cell measurement results
RXLEV_NCELL_1	See NOTE 1
BCCH_FREQ_NCELL_1	Corresponds to one of N7, N6, S1 or N2
BSIC_NCELL_1	Corresponds to that of BCCH_FREQ_NCELL_1
RXLEV_NCELL_2	See NOTE 1
BCCH_FREQ_NCELL_2	Corresponds to one of N7, N6, S1 or N2
BSIC_NCELL_2	Corresponds to that of BCCH_FREQ_NCELL_2
RXLEV_NCELL_3	See NOTE 1
BCCH_FREQ_NCELL_3	Corresponds to one of N7, N6, S1 or N2
BSIC_NCELL_3	Corresponds to that of BCCH_FREQ_NCELL_3
RXLEV_NCELL_4	See NOTE 1
BCCH_FREQ_NCELL_4	Corresponds to one of N7, N6, S1 or N2
BSIC_NCELL_4	Corresponds to that of BCCH_FREQ_NCELL_4
RXLEV_NCELL_5	00 0000
BCCH_FREQ_NCELL_5	0 0000
BSIC_NCELL_5	00 0000
RXLEV_NCELL_6	00 0000
BCCH_FREQ_NCELL_6	0 0000
BSIC_NCELL_6	00 0000

This message shall contain one report on each of N7, N6, S1 and N2.

DCS 1 800 end:

NOTE 1: These actual values are not checked.

NOTE 2: The Measurement Valid Indication shall be set to valid within the second SACCH block at the latest.

26.13.1.1.3 Multislot signaling / RR / Measurement / asymmetric / change of the reported subchannel

This test is applicable to all MS that supports multislot configuration.

26.13.1.1.3.1 Conformance requirements

The MS shall continuously send MEASUREMENT REPORT messages, on the main channel, reporting the worst subchannel. One of the other subchannels is made worse than the one originally reported one and the MEASUREMENT REPORTs sent on the main channel are based on the new worst subchannel.

References

GSM 04.08 sections 3.4.1.2 and 9.1.21, GSM 05.08 section 8.4.

26.13.1.1.3.2 Test purpose

- 1) To test that the MS shall report on the main SACCH: RXLEV_FULL and RXLEV_SUB from the main channel and the worst RXQUAL_FULL values and RXQUAL_SUB values from the main channel and the unidirectional channels.

- 2) To test that, when an another subchannel becomes the worst, MEASUREMENT REPORTs sent on the main channel are based on the new worst subchannel.

26.13.1.1.3.3 Method of test

Initial Conditions

System Simulator:

For GSM 450 or GSM 480: 1 cell with the following settings:

Transmitter	Level	NCC	BCC	ARFCN (GSM450)	ARFCN (GSM480)	Cell Identity
Serving, S1	-60	1	3	260	307	0001H

For GSM 900 or DCS 1800: 1 cell with the following settings:

Transmitter	Level	NCC	BCC	ARFCN (GSM900)	ARFCN (DCS1800)	Cell Identity
Serving, S1	-60	1	3	002	514	0001H

Mobile Station:

The MS is in the active state of a service using asymmetric multislot connection.

Related PICS/PIXIT Statements

- Type of MS (GSM 450 or GSM 480 or P-GSM 900 or EGSM or DCS 1 800).
- Multislot class
- Supported teleservices/bearer services

Foreseen Final State of the MS

Active state of a service using asymmetric multislot connection.

Test Procedure

MS having a multislot connection with maximum number of timeslots in the downlink and one slot in uplink direction in progress, the SS sends SYSTEM INFORMATION TYPE 5 & 6 on the SACCH/M. The MS shall send MEASUREMENT REPORTs back to the SS on the main channel based on the worst subchannel. The SS allows 2 seconds for the MS to get used to the RF conditions and then records the reported RXQUAL_FULL_SERVING_CELL and RXQUAL_SUB_SERVING_CELL values.

Then an arbitrarily chosen uni-directional subchannel is made the worst from the RX quality point of view by switching off the ciphering in the SS on this channel. The MS shall send MEASUREMENT REPORTs back to the SS on the main channel based on the new worst channel. The SS allows 2 seconds for the MS to get used to the new RF conditions and then records the reported RXQUAL_FULL_SERVING_CELL and RXQUAL_SUB_SERVING_CELL values.

The difference between the RXQUAL values recorded before and after the change in RX quality shall be greater than 3.

Maximum Duration of Test

5 minutes, including 1 minute for any necessary operator actions.

Expected Sequence

Since SYSTEM INFORMATION TYPE 5, SYSTEM INFORMATION TYPE 6 and MEASUREMENT REPORT are sent continuously, a table is not applicable in this test. The interval between 2 successive Layer 2 frames containing MEASUREMENT REPORTs shall not exceed one Layer 2 frame.

Specific Message Contents

GSM 450 begin:

SYSTEM INFORMATION TYPE 5:

Information Element	value/remark
Neighbour Cells Description	
Format Identifier	Range 128
BCCH Allocation Sequence	1
BCCH Allocation ARFCN	The channel numbers 259, 260, 261, 262, 263, 264, 266, 267, 268, 269, 270, 271, 272, 273, 274, 275, 276, 277, 278, 280, 281, 282, 283, 284, 285, 286, 287, 288, 290, 291, 292 and 293 belong to the BCCH allocation.
- EXT IND	Information Element carries complete BA.

SYSTEM INFORMATION TYPE 6:

Information Element	value/ remark
Protocol Discriminator	RR Management
Message Type	sys info 6
Cell Identity	default
LAI	default
Cell Options	
- Power Control Indicator	Power Control Indicator is set
- DTX Indicator	MS shall not use DTX
- Radio_Link_Timeout	default
PLMN permitted	NCC 1 permitted

MEASUREMENT REPORT:

Information Element	value/remark
Protocol Discriminator	RR Management
Transaction Identifier	0000
Message Type	MEASUREMENT REPORT
Measurement Results	
BA_used	1
DTX_used	DTX was not used
RXLEV_FULL_SERVING_CELL	See NOTE 1
RXLEV_SUB_SERVING_CELL	See NOTE 1
MEAS_VALID	See NOTE 2
RXQUAL_FULL_SERVING_CELL	The worst subchannel
RXQUAL_SUB_SERVING_CELL	The worst subchannel

GSM 450 end:

GSM 480 begin:

SYSTEM INFORMATION TYPE 5:

Information Element	value/remark
Neighbour Cells Description Format Identifier BCCH Allocation Sequence BCCH Allocation ARFCN - EXT IND	Range 128 1 The channel numbers numbers 306, 307, 308, 309, 310, 311, 312, 313, 315, 316, 317, 318, 319, 320, 321, 322, 323, 324, 325, 326, 327, 329, 330, 331, 332, 333, 334, 335, 337, 338, 339 and 340 belong to the BCCH allocation. Information Element carries complete BA.

SYSTEM INFORMATION TYPE 6:

Information Element	value/ remark
Protocol Discriminator Message Type Cell Identity LAI Cell Options - Power Control Indicator - DTX Indicator - Radio_Link_Timeout PLMN permitted	RR Management sys info 6 default default Power Control Indicator is set MS shall not use DTX default NCC 1 permitted

MEASUREMENT REPORT:

Information Element	value/remark
Protocol Discriminator Transaction Identifier Message Type Measurement Results BA_used DTX_used RXLEV_FULL_SERVING_CELL RXLEV_SUB_SERVING_CELL MEAS_VALID RXQUAL_FULL_SERVING_CELL RXQUAL_SUB_SERVING_CELL	RR Management 0000 MEASUREMENT REPORT 1 DTX was not used See NOTE 1 See NOTE 1 See NOTE 2 The worst subchannel The worst subchannel

GSM 480 end:

GSM 900 begin:

SYSTEM INFORMATION TYPE 5:

Information Element	value/remark
Neighbour Cells Description Format Identifier BCCH Allocation Sequence BCCH Allocation ARFCN - EXT IND	bit map 0 1 The channel numbers 2, 4, 5, 6, 7, 8, 9, 10, 11, 12, 13, 14, 16, 17, 18, 19, 20, 21, 22, 23, 24, 26, 28, 29, 30, 32, 34, 35, 36, 38, 40 and 44 belong to the BCCH allocation. Information Element carries complete BA.

SYSTEM INFORMATION TYPE 6:

Information Element	value/ remark
Protocol Discriminator	RR Management
Message Type	sys info 6
Cell Identity	default
LAI	default
Cell Options	
- Power Control Indicator	Power Control Indicator is set
- DTX Indicator	MS shall not use DTX
- Radio_Link_Timeout	default
PLMN permitted	NCC 1 permitted

MEASUREMENT REPORT:

Information Element	value/remark
Protocol Discriminator	RR Management
Transaction Identifier	0000
Message Type	MEASUREMENT REPORT
Measurement Results	
BA_used	1
DTX_used	DTX was not used
RXLEV_FULL_SERVING_CELL	See NOTE 1
RXLEV_SUB_SERVING_CELL	See NOTE 1
MEAS_VALID	See NOTE 2
RXQUAL_FULL_SERVING_CELL	The worst subchannel
RXQUAL_SUB_SERVING_CELL	The worst subchannel

GSM 900 end:

DCS 1 800 begin:

SYSTEM INFORMATION TYPE 5:

Information Element	value/remark
Protocol Discriminator	RR management
Message Type	Sys Info 5.
Neighbour Cells Description	
- Format	1024 range
- EXT IND	Information Element carries complete BA.
- W(i)	Non null for ARFCN 514, 530, 549, 602, 665, 686, 762, 810.

SYSTEM INFORMATION TYPE 6:

Information Element	value/ remark
Protocol Discriminator	RR Management
Message Type	sys info 6
Cell Identity	default
LAI	default
Cell Options	
- Power Control Indicator	Power Control Indicator is set
- DTX Indicator	MS shall not use DTX
- Radio_Link_Timeout	default
PLMN permitted	only NCC 1 permitted

MEASUREMENT REPORT:

Information Element	value/remark
Protocol Discriminator	RR Management
Transaction Identifier	0000
Message Type	MEASUREMENT REPORT
Measurement Results	
BA_used	1
DTX_used	DTX was not used
RXLEV_FULL_SERVING_CELL	See NOTE 1
RXLEV_SUB_SERVING_CELL	See NOTE 1
MEAS_VALID	See NOTE 2
RXQUAL_FULL_SERVING_CELL	The worst subchannel
RXQUAL_SUB_SERVING_CELL	The worst subchannel

DCS 1 800 end:

NOTE 1: These actual values are not checked.

NOTE 2: The Measurement Valid Indication shall be set to valid within the second SACCH block at the latest.

26.13.1.2 Multislot signalling / RR / Dedicated assignment

26.13.1.2.1 Multislot signalling / RR / Dedicated assignment / successful case

This test is applicable to all MS that supports multislot configuration.

26.13.1.2.1.1 Conformance requirements

- 1) Upon receipt of the ASSIGNMENT COMMAND message, the mobile station initiates a local end release of link layer connections, disconnects the physical channels, commands the switching to the assigned channels and initiates the establishment of lower layer connections (this includes the activation of the channels, their connection and the establishment of the main signalling links).
- 2) MM-messages and CM-messages using SAPI=0 sent from the mobile station to the network can be duplicated by the data link layer in the following case:
 - a channel change of dedicated channels is required (assignment or handover procedure) and the last layer 2 frame has not been acknowledged by the peer data link layer before the mobile station leaves the old channel.

In this case, the mobile station does not know whether the network has received the message correctly. Therefore, the mobile station has to send the message again after the new dedicated channel is established.
- 3) The MS shall establish the link with the power level specified in the ASSIGNMENT COMMAND message.

The MS shall confirm the power control level that it is currently employing in the uplink SACCH L1 header. The indicated value shall be the power control level actually used by the mobile for the last burst of the previous SACCH period.
- 4) The MS shall apply the hopping frequencies specified in ASSIGNMENT COMMAND message in the Mobile Allocation IE or the Frequency List IE at the time of accessing the new channel using the last received Cell Allocation.
- 5) After receipt of the ASSIGNMENT COMMAND the MS shall perform the assignment and return an ASSIGNMENT COMPLETE without undue delay.

References

- Conformance requirements 1),4) GSM 04.08 sections 3.4.3 and 9.1.2.
 Conformance requirements 2) GSM 04.08 section 3.1.4.3.
 Conformance requirements 3) GSM 04.08 sections 3.4.3 and 9.1.2; GSM 05.08, section 4.2.
 Conformance requirements 5) GSM 04.08 sections 3.4.3 and 9.1.3, GSM 04.13 section 5.2.4.

26.13.1.2.1.2 Test purpose

- 1) To verify that upon receipt of an ASSIGNMENT COMMAND, the MS switches to the channel(s) defined in the ASSIGNMENT COMMAND, establishes the link and sends an ASSIGNMENT COMPLETE message. This is tested for an MS supporting TCH and multislot configuration in the special cases of a transition.
 - 1.1) from non-hopping SDCCH to hopping multislot configuration;
 - 1.2) from hopping multislot configuration to non-hopping multislot configuration;
 - 1.3) from non-hopping multislot configuration to hopping multislot configuration;
 - 1.4) from hopping symmetric multislot configuration to hopping asymmetric multislot configuration, resource upgrading used;

NOTE: The step 1.5 is applicable to all MS that supports multislot configuration $T_x > 1$ and $\text{Sum} > 3$.

- 1.5) from hopping asymmetric multislot configuration to hopping symmetric multislot configuration;
 - 1.6) from hopping multislot configuration to non-hopping multislot configuration, resources downgrading to one TCH/F;
 - 1.7) from non-hopping multislot configuration with one TCH/F to non-hopping multislot configuration, resource upgrading used;
 - 1.8) from non-hopping multislot configuration to hopping multislot configuration, relocating all channels in multislot configuration call without changing the number of TCH/Fs allocated;
 - 1.9) from hopping multislot configuration to non-hopping multislot configuration, partially relocating the channels in multislot configuration call without changing the number of TCH/Fs allocated;
 - 1.10) from non-hopping multislot configuration to hopping multislot configuration, resource downgrading to one TCH/F;
- 2) To verify that an MS supporting TCH and multislot configuration, having sent a MM- or CM message that was not acknowledged on L2 before the channel assignment procedure was initiated and before the MS has left the old channel, repeats that message after completion of the assignment procedure without incrementing N(SD). This is tested in the special case of MM message AUTHENTICATION RESPONSE.
- 3) To verify that an MS supporting TCH and multislot configuration, having received an ASSIGNMENT COMMAND, having sent an SABM frame to establish the main signalling link on the assigned main channel of the multislot configuration, reports the power level(s) specified in the ASSIGNMENT COMMAND message, in the uplink SACCH L1 header of the SACCH message sent in the SACCH period following the transmission of the SABM frame.
- 4) To verify that an MS supporting TCH and multislot configuration, having received an ASSIGNMENT COMMAND, is able in the case of frequency hopping to decode the Mobile Allocation and Frequency List IEs correctly and applies the specified frequencies using the correct Cell Allocation.
- 5) To verify that after receipt of the ASSIGNMENT COMMAND the MS returns an ASSIGNMENT COMPLETE without undue delay.

26.13.1.2.1.3 Method of test

Initial Conditions

System Simulator:

- 1 cell, default parameters except:
- Early classmark sending enabled in SI3 rest octets

GSM 450:

- BCCH ARFCN =263.

- Throughout the test, the CA broadcast in System Information 1 is (259, 261, 263, 265, 267, 269, 271, 273, 275, 277).

- Note that the actual CA of the cell contains other frequencies.

GSM 480:

- BCCH ARFCN =310.

- Throughout the test, the CA broadcast in System Information 1 is (306, 308, 310, 312, 314, 316, 318, 320, 322, 324).

- Note that the actual CA of the cell contains other frequencies.

GSM 900:

- BCCH ARFCN =20.

- Throughout the test, the CA broadcast in System Information 1 is (10, 17, 20, 26, 34, 42, 45, 46, 52, 59).

- Note that the actual CA of the cell contains other frequencies.

DCS 1 800:

- BCCH ARFCN =747.

- Throughout the test, the CA broadcast in System Information 1 is (734, 741, 747, 754, 759, 766, 773, 775, 779, 782).

- Note that the actual CA of the cell contains other frequencies.

Mobile Station:

- The MS is in the "idle, updated" state with a TMSI allocated.

Related PICS/PIXIT Statements

- Type of MS (GSM 450 or GSM 480 or P-GSM 900 or EGSM or DCS 1 800).
- Multislot class
- Classmark

Foreseen Final State of the MS

- "Idle, updated", with TMSI allocated.

Test Procedure

The SS pages the MS and allocates an SDCCH. Each time the MS shall switch to the assigned channel, establish the link and send an ASSIGNMENT COMPLETE message.

Then the SS sends an AUTHENTICATION REQUEST message. The MS shall answer with an AUTHENTICATION RESPONSE message, which is not acknowledged on L2 by the SS. Immediately after the AUTHENTICATION RESPONSE message is received, the SS sends an ASSIGNMENT COMMAND. The MS shall switch to the assigned channel, establish the link with the commanded power level and send as ASSIGNMENT COMPLETE message. Then MS shall repeat the AUTHENTICATION RESPONSE message, with the same N(SD) value.

Then the SS sends an ASSIGNMENT COMMAND, which includes a Starting Time IE. The MS shall react as specified above, but this shall be done at the time specified in Starting Time IE.

The SS initiates the channel release procedure and the main signalling link is released.

Maximum Duration of Test

30 s.

Expected Sequence

Step	Direction	Message	Comments
1	SS -> MS	PAGING REQUEST TYPE 1	
2	MS -> SS	CHANNEL REQUEST	
3	SS -> MS	IMMEDIATE ASSIGNMENT	See specific message contents.
4	MS -> SS	PAGING RESPONSE	
5	MS -> SS	CLASSMARK CHANGE	Multislot class
6	SS -> MS	ASSIGNMENT COMMAND	See specific message contents.
7	MS -> SS	ASSIGNMENT COMPLETE	Sent on the correct channel after establishment of the main signalling link. This message shall be ready to be transmitted before 600 ms after the completion of step 6.
8	SS		The SS checks that the MS reports the requested power level in the layer 1 header of the SACCH message that is sent in the first SACCH multiframe following the SABM.
9	SS -> MS	ASSIGNMENT COMMAND	See specific message contents.
10	MS -> SS	ASSIGNMENT COMPLETE	Sent on the correct channel after establishment of the main signalling link. This message shall be ready to be transmitted before 600 ms after the completion of step 9.
11	SS -> MS	ASSIGNMENT COMMAND	See specific message contents.
12	MS -> SS	ASSIGNMENT COMPLETE	Sent on the correct channel after establishment of the main signalling link. This message shall be ready to be transmitted before 600 ms after the completion of step 11.
13	SS -> MS	ASSIGNMENT COMMAND	See specific message contents.
14	MS -> SS	ASSIGNMENT COMPLETE	
15 *	SS -> MS	ASSIGNMENT COMMAND	See specific message contents.
16 *	MS -> SS	ASSIGNMENT COMPLETE	Sent on the correct channel after establishment of the main signalling link. This message shall be ready to be transmitted before 600 ms after the completion of step 15.
17	SS -> MS	ASSIGNMENT COMMAND	See specific message contents.
18	MS -> SS	ASSIGNMENT COMPLETE	Sent on the correct channel after establishment of the main signalling link. This message shall be ready to be transmitted before 600 ms after the completion of step 17.
19	SS -> MS	ASSIGNMENT COMMAND	See specific message contents.
20	MS -> SS	ASSIGNMENT COMPLETE	Sent on the correct channel after establishment of the main signalling link. This message shall be ready to be transmitted before 600 ms after the completion of step 19.
21	SS -> MS	ASSIGNMENT COMMAND	See specific message contents.
22	MS -> SS	ASSIGNMENT COMPLETE	Sent on the correct channel after establishment of the main signalling link. This message shall be ready to be transmitted before 600 ms after the completion of step 21.
23	SS -> MS	AUTHENTICATION REQUEST	
24	MS -> SS	AUTHENTICATION RESPONSE	This message is not L2 acknowledged by the SS.
25	SS -> MS	ASSIGNMENT COMMAND	See specific message contents.
26	MS -> SS	ASSIGNMENT COMPLETE	Sent on the correct channel after establishment of the main signalling link. This message shall be transmitted before 600 ms after the completion of step 25.
27	MS -> SS	AUTHENTICATION RESPONSE	N(SD) shall be the same as in step 24.
28	SS -> MS	ASSIGNMENT COMMAND	See specific message contents.
29	MS -> SS	ASSIGNMENT COMPLETE	Sent on the correct channel after establishment of the main signalling link. This message shall be transmitted at the specified Starting Time in step 28.
30	SS -> MS	CHANNEL RELEASE	The main signalling link is released.

* Note: This step is applicable to all MS that supports multislot configuration Tx>1 and Sum >3. Specific Message Contents

GSM 450 begin:

Step 3

IMMEDIATE ASSIGNMENT:

As default message contents except Channel Description - Channel Type TDMA offset - Timeslot Number - Training Sequence Code - Hopping - ARFCN	SDCCH/8 Chosen arbitrarily N, chosen arbitrarily Chosen arbitrarily Single RF Channel the ARFCN of the BCCH carrier
---	--

Step 6

ASSIGNMENT COMMAND

Channel Description 2 - Channel Type and TDMA offset - Timeslot Number - Training Sequence Code - Hopping - MAIO - HSN Power Command - Power level Frequency list IE Multislot allocation - Downlink assignment - Uplink assignment - Channel set X (1=<X<=8) Channel Mode - Mode Mobile Allocation Starting Time	00000 A suitable value for multislot configuration, chosen arbitrarily Chosen arbitrarily RF hopping channel Chosen arbitrarily from the set (0, 1 to N-1) where N is the number of frequencies in the Mobile Allocation IE. Chosen arbitrarily from the set (1 to 63) Chosen arbitrarily but with a changed value. Not included Maximum number of timeslots supported by the MS Maximum number of timeslots supported by the MS after specifying Downlink timeslots Appropriate for the test Data, 12.0 kbit/s radio interface rate Indicates all of the CA (broadcast on the BCCH) except for the BCCH carrier. Not included
--	---

Step 9

ASSIGNMENT COMMAND

Channel Description 2 - Channel Type and TDMA offset - Timeslot Number - Training Sequence Code - Hopping - ARFCN Power Command - Power level Frequency list IE Cell Channel Description Channel Mode - Mode Mobile Allocation Starting Time	10XXX (Maximum number of possible additional bidirectional TCH/Fs and SACCH/Ms subtracted by one, minimum being one) A suitable value for multislot configuration, chosen arbitrarily Chosen arbitrarily Single RF Channel the ARFCN of the BCCH carrier Chosen arbitrarily but with a changed value. Not Included Use Range 128 to encode (271, 273, 275, 277, 279, 281, 283, 285, 287, 289, 291) Data, 12.0 kbit/s radio interface rate Not included Not included
---	---

Step 11

ASSIGNMENT COMMAND

Channel Description 2 - Channel Type and TDMA offset - Timeslot Number - Training Sequence Code - Hopping - MAIO - HSN Power Command - Power level Frequency list IE Cell Channel Description Multislot allocation - Downlink assignment - Uplink assignment - Channel set X (1= X ≤8) Channel Mode - Mode Mobile Allocation Starting Time	00000 A suitable value for multislot configuration, chosen arbitrarily Chosen arbitrarily RF hopping channel Chosen arbitrarily from the set (0, 1 to N-1) where N is the number of frequencies in the Mobile Allocation IE. Chosen arbitrarily from the set (1 to 63) Chosen arbitrarily but with a changed value. Not included Not included Appropriate for the test. Depending on Multislot class, Shall not have maximum number of timeslots. Appropriate for the test, but as many as in downlink assignment Appropriate for the test Data, 12.0 kbit/s radio interface rate Indicates frequencies (271, 273, 281, 283, 285, 287, 289, 291) Not included
--	---

Step 13

ASSIGNMENT COMMAND

Channel Description 2 - Channel Type and TDMA offset	11XXX (Appropriate number of additional unidirectional TCH/FDs and SACCH/MDs or Additional bidirectional TCH/F and SACCH/M and additional unidirectional TCH/FD and SACCH/MD
- Timeslot Number	Number of downlink timeslots shall be more than in step 11) A suitable value for multislots configuration, chosen arbitrarily
- Training Sequence Code	Chosen arbitrarily
- Hopping	RF hopping channel
- MAIO	Chosen arbitrarily from the set (0, 1 to N-1) where N is the number of frequencies in the Mobile Allocation IE.
- HSN	Chosen arbitrarily from the set (1 to 63)
Power Command	
- Power level	Chosen arbitrarily but with a changed value.
Frequency list IE	Not included
Cell Channel Description	Not included
Channel Mode	
- Mode	Data, 12.0 kbit/s radio interface rate
Mobile Allocation	Indicates frequencies (271, 273, 281, 283, 285, 287, 289, 291)
Starting Time	Not included

Step 15

ASSIGNMENT COMMAND

Channel Description 2 - Channel Type and TDMA offset - Timeslot Number	00000 A suitable value for multislots configuration, chosen arbitrarily
- Training Sequence Code	Chosen arbitrarily
- Hopping	RF hopping channel
- MAIO	Chosen arbitrarily from the set (0, 1 to N-1) where N is the number of frequencies in the Mobile Allocation IE.
- HSN	Chosen arbitrarily from the set (1 to 63)
Power Command	
- Power level	Chosen arbitrarily but with a changed value.
Frequency list IE	Not included
Cell Channel Description	Not included
Multislots allocation	
- Downlink assignment	Appropriate for the test. Must be more than one.
- Uplink assignment	Appropriate for the test, but as many as in downlink direction.
- Channel set X (1= X ≤8)	Appropriate for the test
Channel Mode	
- Mode	Data, 12.0 kbit/s radio interface rate
Mobile Allocation	Indicates frequencies (271, 273, 281, 283, 285, 287, 289, 291)
Starting Time	Not included

Step 17

ASSIGNMENT COMMAND

Channel Description 2 - Channel Type and TDMA offset - Timeslot Number	10000 (no additional timeslots) A suitable value for multislot configuration, chosen arbitrarily
- Training Sequence Code	Chosen arbitrarily
- Hopping	Single RF Channel
- ARFCN	the ARFCN of the BCCH carrier
Power Command - Power level	Chosen arbitrarily but with a changed value.
Frequency list IE	Not Included
Cell Channel Description	Use Range 128 to encode (271, 273, 275, 277, 279, 281, 283, 285, 287, 289, 291)
Channel Mode - Mode	Data, 12.0 kbit/s radio interface rate
Mobile Allocation	Not included
Starting Time	Not included

Step 19

ASSIGNMENT COMMAND

Channel Description 2 - Channel Type and TDMA offset - Timeslot Number	00000 A suitable value for multislot configuration, chosen arbitrarily
- Training Sequence Code	Chosen arbitrarily
- Hopping	Single RF Channel
- ARFCN	the ARFCN of the BCCH carrier
Power Command - Power level	Chosen arbitrarily but with a changed value.
Frequency list IE	Not Included
Cell Channel Description	Use Range 128 to encode 271, 273, 275, 277, 279, 281, 283, 285, 287, 289, 291)
Multislot allocation - Downlink assignment	Appropriate for the test, but more than one timeslot allocated and excluding timeslot 0..
- Uplink assignment	Appropriate for the test according to MS Class described in Annex B 05.02.
- Channel set X (1=<X<=8)	Appropriate for the test
Channel Mode - Mode	Data, 12.0 kbit/s radio interface rate
Mobile Allocation	Not included
Starting Time	Not included

Step 21

ASSIGNMENT COMMAND

Channel Description 2 - Channel Type and TDMA offset - Timeslot Number - Training Sequence Code - Hopping - MAIO - HSN	10XXX (Same number of TCH/Fs and timeslot mapping as in step 19) Same as in step 19 Chosen arbitrarily Frequency hopping Chosen arbitrarily from the set (0, 1 to N-1) where N is the number of frequencies in the Mobile Allocation IE. Chosen arbitrarily from the set (1 to 63)
Power Command - Power level	Chosen arbitrarily but with a changed value.
Frequency list IE	Not Included
Cell Channel Description	Use Range 128 to encode (271, 273, 275, 277, 279, 281, 283, 285, 287, 289, 291)
Channel Mode - Mode	Data, 12.0 kbit/s radio interface rate
Mobile Allocation	Indicate frequencies (273, 281, 283)
Starting Time	Not included

Step 25

ASSIGNMENT COMMAND

Channel Description 2 - Channel Type and TDMA offset - Timeslot Number - Training Sequence Code - Hopping - ARFCN	00000 Same as in step 19 Chosen arbitrarily Single RF Channel the ARFCN of the BCCH carrier
Power Command - Power level	Chosen arbitrarily but with a changed value.
Frequency list IE	Not Included
Cell Channel Description	Use Range 128 to encode (271, 273, 275, 277, 279, 281, 283, 285, 287, 289, 291)
Multislot allocation - Downlink assignment - Uplink assignment - Channel set X (1= \leq X \leq 8)	Indicate same timeslots as step 19. Appropriate for the test according to MS Class described in Annex B 05.02. Appropriate for the test
Channel Mode - Mode	Data, 12.0 kbit/s radio interface rate
Mobile Allocation	Not included
Starting Time	Not included

Step 28

ASSIGNMENT COMMAND

Channel Description 2 - Channel Type and TDMA offset - Timeslot Number - Training Sequence Code - Hopping - MAIO - HSN Power Command - Power level Frequency list IE Cell Channel Description Channel Mode - Mode Mobile Allocation Starting Time	10000 (no additional timeslots) Same as in step 19 Chosen arbitrarily Frequency hopping Chosen arbitrarily from the set (0, 1 to N-1) where N is the number of frequencies in the Mobile Allocation IE. Chosen arbitrarily from the set (1 to 63) Chosen arbitrarily but with a changed value. Not Included Not included Data, 12.0 kbit/s radio interface rate Indicate frequencies (273, 281, 283) Chosen arbitrarily
---	--

GSM 450 end:

GSM 480 begin:

Step 3

IMMEDIATE ASSIGNMENT:

As default message contents except Channel Description - Channel Type TDMA offset - Timeslot Number - Training Sequence Code - Hopping - ARFCN	SDCCH/8 Chosen arbitrarily N, chosen arbitrarily Chosen arbitrarily Single RF Channel the ARFCN of the BCCH carrier
---	--

Step 6

ASSIGNMENT COMMAND

Channel Description 2 - Channel Type and TDMA offset - Timeslot Number - Training Sequence Code - Hopping - MAIO - HSN Power Command - Power level Frequency list IE Multislot allocation - Downlink assignment - Uplink assignment - Channel set X (1=<X<=8) Channel Mode - Mode Mobile Allocation Starting Time	00000 A suitable value for multislot configuration, chosen arbitrarily Chosen arbitrarily RF hopping channel Chosen arbitrarily from the set (0, 1 to N-1) where N is the number of frequencies in the Mobile Allocation IE. Chosen arbitrarily from the set (1 to 63) Chosen arbitrarily but with a changed value. Not included Maximum number of timeslots supported by the MS Maximum number of timeslots supported by the MS after specifying Downlink timeslots Appropriate for the test Data, 12.0 kbit/s radio interface rate Indicates all of the CA (broadcast on the BCCH) except for the BCCH carrier. Not included
--	---

Step 9

ASSIGNMENT COMMAND

Channel Description 2 - Channel Type and TDMA offset - Timeslot Number - Training Sequence Code - Hopping - ARFCN Power Command - Power level Frequency list IE Cell Channel Description Channel Mode - Mode Mobile Allocation Starting Time	10XXX (Maximum number of possible additional bidirectional TCH/Fs and SACCH/Ms subtracted by one, minimum being one) A suitable value for multislot configuration, chosen arbitrarily Chosen arbitrarily Single RF Channel the ARFCN of the BCCH carrier Chosen arbitrarily but with a changed value. Not Included Use Range 128 to encode (318, 320, 322, 324, 326, 328, 330, 332, 334, 336, 338) Data, 12.0 kbit/s radio interface rate Not included Not included
---	---

Step 11

ASSIGNMENT COMMAND

Channel Description 2	00000
- Channel Type and TDMA offset	A suitable value for multislot configuration, chosen arbitrarily
- Timeslot Number	Chosen arbitrarily
- Training Sequence Code	RF hopping channel
- Hopping	Chosen arbitrarily from the set (0, 1 to N-1) where N is the number of frequencies in the Mobile Allocation IE.
- MAIO	Chosen arbitrarily from the set (1 to 63)
- HSN	
Power Command	
- Power level	Chosen arbitrarily but with a changed value.
Frequency list IE	Not included
Cell Channel Description	Not included
Multislot allocation	
- Downlink assignment	Appropriate for the test. Depending on Multislot class, Shall not have maximum number of timeslots.
- Uplink assignment	Appropriate for the test, but as many as in downlink assignment
- Channel set X (1=<X<=8)	Appropriate for the test
Channel Mode	
- Mode	Data, 12.0 kbit/s radio interface rate
Mobile Allocation	Indicates frequencies (318, 320, 328, 330, 332, 334, 336, 338)
Starting Time	Not included

Step 13

ASSIGNMENT COMMAND

Channel Description 2	11XXX
- Channel Type and TDMA offset	(Appropriate number of additional unidirectional TCH/FDs and SACCH/MDs or Additional bidirectional TCH/F and SACCH/M and additional unidirectional TCH/FD and SACCH/MD)
- Timeslot Number	Number of downlink timeslots shall be more than in step 11) A suitable value for multislot configuration, chosen arbitrarily
- Training Sequence Code	Chosen arbitrarily
- Hopping	RF hopping channel
- MAIO	Chosen arbitrarily from the set (0, 1 to N-1) where N is the number of frequencies in the Mobile Allocation IE.
- HSN	Chosen arbitrarily from the set (1 to 63)
Power Command	
- Power level	Chosen arbitrarily but with a changed value.
Frequency list IE	Not included
Cell Channel Description	Not included
Channel Mode	
- Mode	Data, 12.0 kbit/s radio interface rate
Mobile Allocation	Indicates frequencies (318, 320, 328, 330, 332, 334, 336, 338)
Starting Time	Not included

Step 15

ASSIGNMENT COMMAND

Channel Description 2 - Channel Type and TDMA offset - Timeslot Number	00000 A suitable value for multislot configuration, chosen arbitrarily
- Training Sequence Code	Chosen arbitrarily
- Hopping	RF hopping channel
- MAIO	Chosen arbitrarily from the set (0, 1 to N-1) where N is the number of frequencies in the Mobile Allocation IE.
- HSN	Chosen arbitrarily from the set (1 to 63)
Power Command	
- Power level	Chosen arbitrarily but with a changed value.
Frequency list IE	Not included
Cell Channel Description	Not included
Multislot allocation	
- Downlink assignment	Appropriate for the test. Must be more than one.
- Uplink assignment	Appropriate for the test, but as many as in downlink direction.
- Channel set X (1=<X<=8)	Appropriate for the test
Channel Mode	
- Mode	Data, 12.0 kbit/s radio interface rate
Mobile Allocation	Indicates frequencies (318, 320, 328, 330, 332, 334, 336, 338)
Starting Time	Not included

Step 17

ASSIGNMENT COMMAND

Channel Description 2 - Channel Type and TDMA offset - Timeslot Number	10000 (no additional timeslots) A suitable value for multislot configuration, chosen arbitrarily
- Training Sequence Code	Chosen arbitrarily
- Hopping	Single RF Channel
- ARFCN	the ARFCN of the BCCH carrier
Power Command	
- Power level	Chosen arbitrarily but with a changed value.
Frequency list IE	Not Included
Cell Channel Description	Use Range 128 to encode (318, 320, 322, 324, 326, 328, 330, 332, 334, 336, 338)
Channel Mode	
- Mode	Data, 12.0 kbit/s radio interface rate
Mobile Allocation	Not included
Starting Time	Not included

Step 19

ASSIGNMENT COMMAND

Channel Description 2 - Channel Type and TDMA offset - Timeslot Number - Training Sequence Code - Hopping - ARFCN Power Command - Power level Frequency list IE Cell Channel Description Multislot allocation - Downlink assignment - Uplink assignment - Channel set X (1=<X<=8) Channel Mode - Mode Mobile Allocation Starting Time	00000 A suitable value for multislot configuration, chosen arbitrarily Chosen arbitrarily Single RF Channel the ARFCN of the BCCH carrier Chosen arbitrarily but with a changed value. Not Included Use Range 128 to encode (318, 320, 322, 324, 326, 328, 330, 332, 334, 336, 338) Appropriate for the test, but more than one timeslot allocated and excluding timeslot 0.. Appropriate for the test according to MS Class described in Annex B 05.02. Appropriate for the test Data, 12.0 kbit/s radio interface rate Not included Not included
--	---

Step 21

ASSIGNMENT COMMAND

Channel Description 2 - Channel Type and TDMA offset - Timeslot Number - Training Sequence Code - Hopping - MAIO - HSN Power Command - Power level Frequency list IE Cell Channel Description Channel Mode - Mode Mobile Allocation Starting Time	10XXX (Same number of TCH/Fs and timeslot mapping as in step 19) Same as in step 19 Chosen arbitrarily Frequency hopping Chosen arbitrarily from the set (0, 1 to N-1) where N is the number of frequencies in the Mobile Allocation IE. Chosen arbitrarily from the set (1 to 63) Chosen arbitrarily but with a changed value. Not Included Use Range 128 to encode (318, 320, 322, 324, 326, 328, 330, 332, 334, 336, 338) Data, 12.0 kbit/s radio interface rate Indicate frequencies (320, 328, 330) Not included
---	--

Step 25

ASSIGNMENT COMMAND

Channel Description 2	00000
- Channel Type and TDMA offset	Same as in step 19
- Timeslot Number	Chosen arbitrarily
- Training Sequence Code	Single RF Channel
- Hopping	the ARFCN of the BCCH carrier
- ARFCN	
Power Command	
- Power level	Chosen arbitrarily but with a changed value.
Frequency list IE	Not Included
Cell Channel Description	Use Range 128 to encode (318, 320, 322, 324, 326, 328, 330, 332, 334, 336, 338)
Multislot allocation	
- Downlink assignment	Indicate same timeslots as step 19.
- Uplink assignment	Appropriate for the test according to MS Class described in Annex B 05.02.
- Channel set X (1=<X<=8)	Appropriate for the test
Channel Mode	
- Mode	Data, 12.0 kbit/s radio interface rate
Mobile Allocation	Not included
Starting Time	Not included

Step 28

ASSIGNMENT COMMAND

Channel Description 2	10000 (no additional timeslots)
- Channel Type and TDMA offset	Same as in step 19
- Timeslot Number	Chosen arbitrarily
- Training Sequence Code	Frequency hopping
- Hopping	Chosen arbitrarily from the set (0, 1 to N-1) where N is the number of frequencies in the Mobile Allocation IE.
- MAIO	Chosen arbitrarily from the set (1 to 63)
- HSN	
Power Command	
- Power level	Chosen arbitrarily but with a changed value.
Frequency list IE	Not Included
Cell Channel Description	Not included
Channel Mode	
- Mode	Data, 12.0 kbit/s radio interface rate
Mobile Allocation	Indicate frequencies (320, 328, 330)
Starting Time	Chosen arbitrarily

GSM 480 end:

GSM 900 begin:

Step 3

IMMEDIATE ASSIGNMENT:

As default message contents except Channel Description - Channel Type TDMA offset - Timeslot Number - Training Sequence Code - Hopping - ARFCN	SDCCH/8 Chosen arbitrarily N, chosen arbitrarily Chosen arbitrarily Single RF Channel the ARFCN of the BCCH carrier
---	--

Step 6

ASSIGNMENT COMMAND

Channel Description 2 - Channel Type and TDMA offset - Timeslot Number - Training Sequence Code - Hopping - MAIO - HSN Power Command - Power level Frequency list IE Multislot allocation - Downlink assignment - Uplink assignment - Channel set X (1= $X \leq 8$) Channel Mode - Mode Mobile Allocation Starting Time	00000 A suitable value for multislot configuration, chosen arbitrarily Chosen arbitrarily RF hopping channel Chosen arbitrarily from the set (0, 1 to N-1) where N is the number of frequencies in the Mobile Allocation IE. Chosen arbitrarily from the set (1 to 63) Chosen arbitrarily but with a changed value. Not included Maximum number of timeslots supported by the MS Maximum number of timeslots supported by the MS after specifying Downlink timeslots Appropriate for the test Data, 12.0 kbit/s radio interface rate Indicates all of the CA (broadcast on the BCCH) except for the BCCH carrier. Not included
---	---

Step 9

ASSIGNMENT COMMAND

Channel Description 2 - Channel Type and TDMA offset - Timeslot Number - Training Sequence Code - Hopping - ARFCN Power Command - Power level Frequency list IE Cell Channel Description Channel Mode - Mode Mobile Allocation Starting Time	10XXX (Maximum number of possible additional bidirectional TCH/Fs and SACCH/Ms subtracted by one, minimum being one) A suitable value for multislot configuration, chosen arbitrarily Chosen arbitrarily Single RF Channel the ARFCN of the BCCH carrier Chosen arbitrarily but with a changed value. Not Included Bit map zero encodes (45, 46, 52, 59, 66, 73, 74, 75, 76, 108, 114) Data, 12.0 kbit/s radio interface rate Not included Not included
---	---

Step 11

ASSIGNMENT COMMAND

Channel Description 2 - Channel Type and TDMA offset - Timeslot Number - Training Sequence Code - Hopping - MAIO - HSN Power Command - Power level Frequency list IE Cell Channel Description Multislot allocation - Downlink assignment - Uplink assignment - Channel set X (1=<X<=8) Channel Mode - Mode Mobile Allocation Starting Time	00000 A suitable value for multislot configuration, chosen arbitrarily Chosen arbitrarily RF hopping channel Chosen arbitrarily from the set (0, 1 to N-1) where N is the number of frequencies in the Mobile Allocation IE. Chosen arbitrarily from the set (1 to 63) Chosen arbitrarily but with a changed value. Not included Not included Appropriate for the test. Depending on Multislot class, Shall not have maximum number of timeslots. Appropriate for the test, but as many as in downlink assignment Appropriate for the test Data, 12.0 kbit/s radio interface rate Indicates frequencies (45, 46, 73, 74, 75, 76, 108, 114) Not included
--	---

Step 13

ASSIGNMENT COMMAND

Channel Description 2 - Channel Type and TDMA offset - Timeslot Number - Training Sequence Code - Hopping - MAIO - HSN Power Command - Power level Frequency list IE Cell Channel Description Channel Mode - Mode Mobile Allocation Starting Time	11XXX (Appropriate number of additional unidirectional TCH/FDs and SACCH/MDs or Additional bidirectional TCH/F and SACCH/M and additional unidirectional TCH/FD and SACCH/MD Number of downlink timeslots shall be more than in step 11) A suitable value for multislot configuration, chosen arbitrarily Chosen arbitrarily RF hopping channel Chosen arbitrarily from the set (0, 1 to N-1) where N is the number of frequencies in the Mobile Allocation IE. Chosen arbitrarily from the set (1 to 63) Chosen arbitrarily but with a changed value. Not included Not included Data, 12.0 kbit/s radio interface rate Indicates frequencies (45, 46, 73, 74, 75, 76, 108, 114) Not included
---	--

Step 15

ASSIGNMENT COMMAND

Channel Description 2 - Channel Type and TDMA offset - Timeslot Number - Training Sequence Code - Hopping - MAIO - HSN Power Command - Power level Frequency list IE Cell Channel Description Multislot allocation - Downlink assignment - Uplink assignment - Channel set X (1=<X<=8) Channel Mode - Mode Mobile Allocation Starting Time	00000 A suitable value for multislot configuration, chosen arbitrarily Chosen arbitrarily RF hopping channel Chosen arbitrarily from the set (0, 1 to N-1) where N is the number of frequencies in the Mobile Allocation IE. Chosen arbitrarily from the set (1 to 63) Chosen arbitrarily but with a changed value. Not included Not included Appropriate for the test. Must be more than one. Appropriate for the test, but as many as in downlink direction. Appropriate for the test Data, 12.0 kbit/s radio interface rate Indicates frequencies (45, 46, 73, 74, 75, 76, 108, 114) Not included
--	--

Step 17

ASSIGNMENT COMMAND

Channel Description 2 - Channel Type and TDMA offset - Timeslot Number	10000 (no additional timeslots) A suitable value for multislot configuration, chosen arbitrarily
- Training Sequence Code - Hopping - ARFCN	Chosen arbitrarily Single RF Channel the ARFCN of the BCCH carrier
Power Command - Power level	Chosen arbitrarily but with a changed value.
Frequency list IE	Not Included
Cell Channel Description	Bit map zero encodes (45, 46, 52, 59, 66, 73, 74, 75, 76, 108, 114)
Channel Mode - Mode	Data, 12.0 kbit/s radio interface rate
Mobile Allocation	Not included
Starting Time	Not included

Step 19

ASSIGNMENT COMMAND

Channel Description 2 - Channel Type and TDMA offset - Timeslot Number	00000 A suitable value for multislot configuration, chosen arbitrarily
- Training Sequence Code - Hopping - ARFCN	Chosen arbitrarily Single RF Channel the ARFCN of the BCCH carrier
Power Command - Power level	Chosen arbitrarily but with a changed value.
Frequency list IE	Not Included
Cell Channel Description	Bit map zero encodes (45, 46, 52, 59, 66, 73, 74, 75, 76, 108, 114)
Multislot allocation - Downlink assignment	Appropriate for the test, but more than one timeslot allocated and excluding timeslot 0..
- Uplink assignment	Appropriate for the test according to MS Class described in Annex B 05.02.
- Channel set X (1= X ≤8)	Appropriate for the test
Channel Mode - Mode	Data, 12.0 kbit/s radio interface rate
Mobile Allocation	Not included
Starting Time	Not included

Step 21

ASSIGNMENT COMMAND

Channel Description 2 - Channel Type and TDMA offset - Timeslot Number - Training Sequence Code - Hopping - MAIO - HSN Power Command - Power level Frequency list IE Cell Channel Description Channel Mode - Mode Mobile Allocation Starting Time	10XXX (Same number of TCH/Fs and timeslot mapping as in step 19) Same as in step 19 Chosen arbitrarily Frequency hopping Chosen arbitrarily from the set (0, 1 to N-1) where N is the number of frequencies in the Mobile Allocation IE. Chosen arbitrarily from the set (1 to 63) Chosen arbitrarily but with a changed value. Not Included Bit map zero encodes (45, 46, 52, 59, 66, 73, 74, 75, 76, 108, 114) Data, 12.0 kbit/s radio interface rate Indicate frequencies (46, 73 74) Not included
---	--

Step 25

ASSIGNMENT COMMAND

Channel Description 2 - Channel Type and TDMA offset - Timeslot Number - Training Sequence Code - Hopping - ARFCN Power Command - Power level Frequency list IE Cell Channel Description Multislot allocation - Downlink assignment - Uplink assignment - Channel set X (1= X ≤8) Channel Mode - Mode Mobile Allocation Starting Time	00000 Same as in step 19 Chosen arbitrarily Single RF Channel the ARFCN of the BCCH carrier Chosen arbitrarily but with a changed value. Not Included Bit map zero encodes (45, 46, 52, 59, 66, 73, 74, 75, 76, 108, 114) Indicate same timeslots as step 19. Appropriate for the test according to MS Class described in Annex B 05.02. Appropriate for the test Data, 12.0 kbit/s radio interface rate Not included Not included
--	---

Step 28

ASSIGNMENT COMMAND

Channel Description 2 - Channel Type and TDMA offset - Timeslot Number - Training Sequence Code - Hopping - MAIO - HSN Power Command - Power level Frequency list IE Cell Channel Description Channel Mode - Mode Mobile Allocation Starting Time	10000 (no additional timeslots) Same as in step 19 Chosen arbitrarily Frequency hopping Chosen arbitrarily from the set (0, 1 to N-1) where N is the number of frequencies in the Mobile Allocation IE. Chosen arbitrarily from the set (1 to 63) Chosen arbitrarily but with a changed value. Not Included Not included Data, 12.0 kbit/s radio interface rate Indicate frequencies (46, 73 74) Chosen arbitrarily
---	--

GSM 900 end:

GSM 1800 begin:

Step 3

IMMEDIATE ASSIGNMENT:

As default message contents except Channel Description - Channel Type TDMA offset - Timeslot Number - Training Sequence Code - Hopping - ARFCN	SDCCH/8 Chosen arbitrarily N, chosen arbitrarily Chosen arbitrarily Single RF Channel the ARFCN of the BCCH carrier
---	--

Step 6

ASSIGNMENT COMMAND

Channel Description 2 - Channel Type and TDMA offset - Timeslot Number - Training Sequence Code - Hopping - MAIO - HSN Power Command - Power level Frequency list IE Multislot allocation - Downlink assignment - Uplink assignment - Channel set X (1= X ≤8) Channel Mode - Mode Mobile Allocation Starting Time	00000 A suitable value for multislot configuration, chosen arbitrarily Chosen arbitrarily RF hopping channel Chosen arbitrarily from the set (0, 1 to N-1) where N is the number of frequencies in the Mobile Allocation IE. Chosen arbitrarily from the set (1 to 63) Chosen arbitrarily but with a changed value. Not included Maximum number of timeslots supported by the MS Maximum number of timeslots supported by the MS after specifying Downlink timeslots Appropriate for the test Data, 12.0 kbit/s radio interface rate Indicates all of the CA (broadcast on the BCCH) except for the BCCH carrier. Not included
--	---

Step 9

ASSIGNMENT COMMAND

Channel Description 2 - Channel Type and TDMA offset - Timeslot Number - Training Sequence Code - Hopping - ARFCN Power Command - Power level Frequency list IE Cell Channel Description Channel Mode - Mode Mobile Allocation Starting Time	10XXX (Maximum number of possible additional bidirectional TCH/Fs and SACCH/Ms subtracted by one, minimum being one) A suitable value for multislot configuration, chosen arbitrarily Chosen arbitrarily Single RF Channel the ARFCN of the BCCH carrier Chosen arbitrarily but with a changed value. Not Included Use Range 128 to encode (773, 775, 779, 782, 791, 798, 829, 832, 844) Data, 12.0 kbit/s radio interface rate Not included Not included
---	---

Step 11

ASSIGNMENT COMMAND

Channel Description 2 - Channel Type and TDMA offset - Timeslot Number	00000 A suitable value for multislot configuration, chosen arbitrarily
- Training Sequence Code	Chosen arbitrarily
- Hopping	RF hopping channel
- MAIO	Chosen arbitrarily from the set (0, 1 to N-1) where N is the number of frequencies in the Mobile Allocation IE.
- HSN	Chosen arbitrarily from the set (1 to 63)
Power Command	
- Power level	Chosen arbitrarily but with a changed value.
Frequency list IE	Not included
Cell Channel Description	Not included
Multislot allocation	
- Downlink assignment	Appropriate for the test. Depending on Multislot class, Shall not have maximum number of timeslots.
- Uplink assignment	Appropriate for the test, but as many as in downlink assignment
- Channel set X (1=<X<=8)	Appropriate for the test
Channel Mode	
- Mode	Data, 12.0 kbit/s radio interface rate
Mobile Allocation	Indicates frequencies (773, 775, 779, 829, 832, 844)
Starting Time	Not included

Step 13

ASSIGNMENT COMMAND

Channel Description 2 - Channel Type and TDMA offset	11XXX (Appropriate number of additional unidirectional TCH/FDs and SACCH/MDs or Additional bidirectional TCH/F and SACCH/M and additional unidirectional TCH/FD and SACCH/MD
- Timeslot Number	Number of downlink timeslots shall be more than in step 11) A suitable value for multislot configuration, chosen arbitrarily
- Training Sequence Code	Chosen arbitrarily
- Hopping	RF hopping channel
- MAIO	Chosen arbitrarily from the set (0, 1 to N-1) where N is the number of frequencies in the Mobile Allocation IE.
- HSN	Chosen arbitrarily from the set (1 to 63)
Power Command	
- Power level	Chosen arbitrarily but with a changed value.
Frequency list IE	Not included
Cell Channel Description	Not included
Channel Mode	
- Mode	Data, 12.0 kbit/s radio interface rate
Mobile Allocation	Indicates frequencies (773, 775, 779, 829, 832, 844)
Starting Time	Not included

Step 15

ASSIGNMENT COMMAND

Channel Description 2 - Channel Type and TDMA offset - Timeslot Number - Training Sequence Code - Hopping - MAIO - HSN Power Command - Power level Frequency list IE Cell Channel Description Multislot allocation - Downlink assignment - Uplink assignment - Channel set X (1=<X<=8) Channel Mode - Mode Mobile Allocation Starting Time	00000 A suitable value for multislot configuration, chosen arbitrarily Chosen arbitrarily RF hopping channel Chosen arbitrarily from the set (0, 1 to N-1) where N is the number of frequencies in the Mobile Allocation IE. Chosen arbitrarily from the set (1 to 63) Chosen arbitrarily but with a changed value. Not included Not included Appropriate for the test. Must be more than one. Appropriate for the test, but as many as in downlink direction. Appropriate for the test Data, 12.0 kbit/s radio interface rate Indicates frequencies (773, 775, 779, 829, 832, 844) Not included
--	--

Step 17

ASSIGNMENT COMMAND

Channel Description 2 - Channel Type and TDMA offset - Timeslot Number - Training Sequence Code - Hopping - ARFCN Power Command - Power level Frequency list IE Cell Channel Description Channel Mode - Mode Mobile Allocation Starting Time	10000 (no additional timeslots) A suitable value for multislot configuration, chosen arbitrarily Chosen arbitrarily Single RF Channel the ARFCN of the BCCH carrier Chosen arbitrarily but with a changed value. Not Included Use Range 128 to encode (773, 775, 779, 782, 791, 798, 829, 832, 844) Data, 12.0 kbit/s radio interface rate Not included Not included
---	--

Step 19

ASSIGNMENT COMMAND

Channel Description 2 - Channel Type and TDMA offset - Timeslot Number - Training Sequence Code - Hopping - ARFCN Power Command - Power level Frequency list IE Cell Channel Description Multislot allocation - Downlink assignment - Uplink assignment - Channel set X (1=<X<=8) Channel Mode - Mode Mobile Allocation Starting Time	00000 A suitable value for multislot configuration, chosen arbitrarily Chosen arbitrarily Single RF Channel the ARFCN of the BCCH carrier Chosen arbitrarily but with a changed value. Not Included Use Range 128 to encode (773, 775, 779, 782, 791, 798, 829, 832, 844) Appropriate for the test, but more than one timeslot allocated and excluding timeslot 0. Appropriate for the test according to MS Class described in Annex B 05.02. Appropriate for the test Data, 12.0 kbit/s radio interface rate Not included Not included
--	--

Step 21

ASSIGNMENT COMMAND

Channel Description 2 - Channel Type and TDMA offset - Timeslot Number - Training Sequence Code - Hopping - MAIO - HSN Power Command - Power level Frequency list IE Cell Channel Description Channel Mode - Mode Mobile Allocation Starting Time	10XXX (Same number of TCH/Fs and timeslot mapping as in step 19) Same as in step 19 Chosen arbitrarily Frequency hopping Chosen arbitrarily from the set (0, 1 to N-1) where N is the number of frequencies in the Mobile Allocation IE. Chosen arbitrarily from the set (1 to 63) Chosen arbitrarily but with a changed value. Not Included Use Range 128 to encode (773, 775, 779, 782, 791, 798, 829, 832, 844) Data, 12.0 kbit/s radio interface rate Indicate frequencies (782, 791, 798) Not included
---	--

Step 25

ASSIGNMENT COMMAND

Channel Description 2	00000
- Channel Type and TDMA offset	Same as in step 19
- Timeslot Number	Chosen arbitrarily
- Training Sequence Code	Single RF Channel
- Hopping	the ARFCN of the BCCH carrier
- ARFCN	
Power Command	
- Power level	Chosen arbitrarily but with a changed value.
Frequency list IE	Not Included
Cell Channel Description	Use Range 128 to encode (773, 775, 779, 782, 791, 798, 829, 832, 844)
Multislot allocation	
- Downlink assignment	Indicate same timeslots as step 19.
- Uplink assignment	Appropriate for the test according to MS Class described in Annex B 05.02.
- Channel set X (1=<X<=8)	Appropriate for the test
Channel Mode	
- Mode	Data, 12.0 kbit/s radio interface rate
Mobile Allocation	Not included
Starting Time	Not included

Step 28

ASSIGNMENT COMMAND

Channel Description 2	10000 (no additional timeslots)
- Channel Type and TDMA offset	Same as in step 19
- Timeslot Number	Chosen arbitrarily
- Training Sequence Code	Frequency hopping
- Hopping	Chosen arbitrarily from the set (0, 1 to N-1) where N is the number of frequencies in the Mobile Allocation IE.
- MAIO	Chosen arbitrarily from the set (1 to 63)
- HSN	
Power Command	
- Power level	Chosen arbitrarily but with a changed value.
Frequency list IE	Not Included
Cell Channel Description	Not Included
Channel Mode	
- Mode	Data, 12.0 kbit/s radio interface rate
Mobile Allocation	Indicate frequencies (782, 791, 798)
Starting Time	Chosen arbitrarily

GSM 1800 end:

26.13.1.2.2 Multislot signalling / RR / Dedicated assignment / failure / general case

This test is applicable to all MS that supports multislot configuration.

26.13.1.2.2.1 Conformance requirements

On the mobile station side, if a lower layer failure happens on the new channel before the ASSIGNMENT COMPLETE message has been sent, the mobile station deactivates the new channels, reactivates the old channels, reconnects the TCHs if any and triggers the establishment of the main signalling link. It then sends an ASSIGNMENT FAILURE message, cause "protocol error unspecified" on the main DCCH and resumes the normal operation, as if no assignment attempt had occurred. The operational parameters (e.g. ciphering mode) when returning on the old channel are those applied before the procedure.

References

Conformance requirements: GSM 04.08 sections 3.4.3, 9.1.3 and 9.1.4

26.13.1.2.2.2 Test purpose

- 1) To test that, when the MS fails to seize the new channel, the MS reactivates the old channel.
- 2) This is tested in the special cases of transition:
 - 2.1) from non-hopping SDCCH to hopping symmetric multislot configuration
 - 2.2) from hopping asymmetric multislot configuration to non-hopping symmetric
 - 2.3) from non hopping symmetric multislot configuration to non-hopping symmetric multislot configuration, resource upgrading used
 - 2.4) from non-hopping asymmetric multislot configuration to non-hopping asymmetric multislot configuration, resource upgrading used
 - 2.5) from hopping symmetric multislot configuration to hopping asymmetric multislot configuration, resource upgrading used
 - 2.6) from hopping asymmetric multislot configuration to non-hopping multislot configuration, resources downgrading to one TCH/F

26.13.1.2.2.3 Method of test

Initial Conditions

System Simulator:

1 cell, default parameters.

Mobile Station:

The MS is "idle updated".

Related PICS/PIXIT Statements

- Type of MS (GSM 450 or GSM 480 or P-GSM 900 or EGSM or DCS 1 800).
- Multislot class

Foreseen Final State of the MS

The MS is "idle updated".

Test Procedure

A mobile terminated RR connection is established on an SDCCH. The following is repeated six times with different parameters:

The SS sends an ASSIGNMENT COMMAND message allocating a hopping/non-hopping symmetric/asymmetric multislot configuration with or without resource upgrading/downgrading, but does not activate the assigned channels. The MS shall try to activate the new channel (this is not verified) and shall then reactivate the old channel and trigger the establishment of the main signalling link on the old channel. Then the MS shall send an ASSIGNMENT FAILURE.

The SS initiates the channel release procedure and the test ends here.

Maximum Duration of Test

30 s.

Expected Sequence

Step	Direction	Message	Comments
1	SS -> MS	PAGING REQUEST TYPE 1	
2	MS -> SS	CHANNEL REQUEST	
3	SS -> MS	IMMEDIATE ASSIGNMENT	Channel Type: SDCCH/4.
4	MS -> SS	PAGING RESPONSE	
5	SS -> MS	ASSIGNMENT COMMAND	See specific message contents below. The MS attempts (and fails) to establish a signalling link on the new channel.
6			The MS re-establishes the signalling link on the old channel.
7	MS -> SS	ASSIGNMENT FAILURE	RR cause value = "protocol error unspecified".
8	SS		The SS checks that the MS reports the old power level (prior to the Assignment command) in the layer 1 header of the SACCH message that is sent in the first SACCH multiframe following the SABM.
9	SS -> MS	ASSIGNMENT COMMAND	See specific message contents below.
10	MS -> SS	ASSIGNMENT COMPLETE	Assignment command is successfully performed.
11	SS -> MS	ASSIGNMENT COMMAND	Channel Type = TCH/F, non-hopping, symmetric multislot configuration. The MS attempts (and fails) to establish a signalling link on the new channel.
12			The MS re-establishes the signalling link on the old channel.
13	MS -> SS	ASSIGNMENT FAILURE	RR cause value = "protocol error unspecified".
14	SS -> MS	ASSIGNMENT COMMAND	Assignment command to non-hopping, symmetric multislot configuration is successfully performed.
15	MS -> SS	ASSIGNMENT COMPLETE	
16	SS -> MS	ASSIGNMENT COMMAND	Channel Type = TCH/F, non-hopping, symmetric multislot configuration, resource upgrading used. The MS attempts (and fails) to establish a signalling link on the new channel.
17			The MS re-establishes the signalling link on the old channel.
18	MS -> SS	ASSIGNMENT FAILURE	RR cause value = "protocol error unspecified".
19	SS -> MS	ASSIGNMENT COMMAND	Assignment command to non-hopping, asymmetric multislot configuration is successfully performed.
20	MS -> SS	ASSIGNMENT COMPLETE	
21	SS -> MS	ASSIGNMENT COMMAND	Channel Type = TCH/F, non-hopping, asymmetric multislot configuration, resource downgrading used. The MS attempts (and fails) to establish a signalling link on the new channel.
22			The MS re-establishes the signalling link on the old channel.
23	MS -> SS	ASSIGNMENT FAILURE	RR cause value = "protocol error unspecified".
24	SS -> MS	ASSIGNMENT COMMAND	Assignment command to hopping, symmetric multislot configuration is successfully performed.
25	MS -> SS	ASSIGNMENT COMPLETE	
26	SS -> MS	ASSIGNMENT COMMAND	Channel Type = TCH/F, hopping, asymmetric multislot configuration, resource upgrading used. The MS attempts (and fails) to establish a signalling link on the new channel.
27			The MS re-establishes the signalling link on the old channel.
28	MS -> SS	ASSIGNMENT FAILURE	RR cause value = "protocol error unspecified".
29	SS -> MS	ASSIGNMENT COMMAND	Assignment command to hopping, asymmetric multislot configuration is successfully performed.
30	MS -> SS	ASSIGNMENT COMPLETE	
31	SS -> MS	ASSIGNMENT COMMAND	Channel Type = TCH/F, non-hopping, multislot configuration, resources downgrading to one TCH/F. The MS attempts (and fails) to establish a signalling link on the new channel.
32			The MS re-establishes the signalling link on the old channel.
33	MS -> SS	ASSIGNMENT FAILURE	RR cause value = "protocol error unspecified".
34	SS -> MS	CHANNEL RELEASE	The main signalling link is released.

Specific Message Contents

GSM 450 begin:

Step 5:

ASSIGNMENT COMMAND

Channel Description 2 - Channel Type and TDMA offset - Timeslot Number - Training Sequence Code - Hopping - MAIO - HSN Power Command - Power level Frequency list IE Cell Channel Description Multislot allocation - Downlink assignment - Uplink assignment - Channel set X (1=<X<=8) Channel Mode - Mode Mobile Allocation Starting Time	00000 A suitable value for multislot configuration, chosen arbitrarily Chosen arbitrarily RF hopping channel Chosen arbitrarily from the set (0, 1 to N-1) where N is the number of frequencies in the Mobile Allocation IE. Chosen arbitrarily from the set (1 to 63) Chosen arbitrarily but with a changed value. Not Included Use Range 128 to encode (271, 273, 275, 277, 279, 281, 283, 285, 287, 289, 291) Maximum number of symmetrical timeslots assigned. As many timeslots as downlink direction. Appropriate for the test Data, 12.0 kbit/s radio interface rate Arbitrarily chosen from Cell channel description Not included
--	---

Step 9:

ASSIGNMENT COMMAND

Channel Description 2 - Channel Type and TDMA offset - Timeslot Number - Training Sequence Code - Hopping - MAIO - HSN Power Command - Power level Frequency list IE Cell Channel Description Multislot allocation - Downlink assignment - Uplink assignment - Channel set X (1=<X<=8) Channel Mode - Mode Mobile Allocation Starting Time	00000 A suitable value for multislot configuration, chosen arbitrarily Chosen arbitrarily RF hopping channel Chosen arbitrarily from the set (0, 1 to N-1) where N is the number of frequencies in the Mobile Allocation IE. Chosen arbitrarily from the set (1 to 63) Chosen arbitrarily but with a changed value. Not Included Use Range 128 to encode (271, 273, 275, 277, 279, 281, 283, 285, 287, 289, 291) Maximum number of timeslots that MS supports. Less timeslots assigned than downlink direction. Appropriate for the test Data, 12.0 kbit/s radio interface rate Arbitrarily chosen from Cell channel description Not included
--	---

Step 11:

ASSIGNMENT COMMAND

Channel Description 2 - Channel Type and TDMA offset - Timeslot Number	00000 A suitable value for multislot configuration, chosen arbitrarily
- Training Sequence Code	Chosen arbitrarily
- Hopping	Single RF channel
- ARFCN	the ARFCN of the BCCH carrier
Power Command - Power level	Chosen arbitrarily but with a changed value.
Frequency list IE	Not Included
Cell Channel Description	Use Range 128 to encode (271, 273, 275, 277, 279, 281, 283, 285, 287, 289, 291)
Multislot allocation - Downlink assignment	Maximum number of symmetrical timeslots supported by MS assigned.
- Uplink assignment	As many timeslots as in downlink direction.
- Channel set X (1= \leq X \leq 8)	Appropriate for the test
Channel Mode - Mode	Data, 12.0 kbit/s radio interface rate
Mobile Allocation	Not included
Starting Time	Not included

Step 14:

ASSIGNMENT COMMAND

Channel Description 2 - Channel Type and TDMA offset - Timeslot Number	00000 A suitable value for multislot configuration, chosen arbitrarily
- Training Sequence Code	Chosen arbitrarily
- Hopping	Single RF channel
- ARFCN	the ARFCN of the BCCH carrier
Power Command - Power level	Chosen arbitrarily but with a changed value.
Frequency list IE	Not Included
Cell Channel Description	Use Range 128 to encode (271, 273, 275, 277, 279, 281, 283, 285, 287, 289, 291)
Multislot allocation - Downlink assignment	Only one timeslot is assigned in downlink direction.
- Uplink assignment	Only one timeslot is assigned in uplink direction.
- Channel set X (1= \leq X \leq 8)	Appropriate for the test
Channel Mode - Mode	Data, 12.0 kbit/s radio interface rate
Mobile Allocation	Not included
Starting Time	Not included

Step 16:

ASSIGNMENT COMMAND

Channel Description 2 - Channel Type and TDMA offset - Timeslot Number	00000 A suitable value for multislot configuration, chosen arbitrarily
- Training Sequence Code - Hopping - ARFCN	Chosen arbitrarily Single RF channel the ARFCN of the BCCH carrier
Power Command - Power level	Chosen arbitrarily but with a changed value.
Frequency list IE	Not Included
Cell Channel Description	Use range 128 to encode (271, 273, 275, 277, 279, 281, 283, 285, 287, 289, 291)
Multislot allocation - Downlink assignment - Uplink assignment - Channel set X (1=<X<=8)	Maximum number of timeslots that MS supports. Maximum number of timeslots that MS supports. Appropriate for the test
Channel Mode - Mode	Data, 12.0 kbit/s radio interface rate
Mobile Allocation	Not included
Starting Time	Not included

Step 19:

ASSIGNMENT COMMAND

Channel Description 2 - Channel Type and TDMA offset - Timeslot Number	00000 A suitable value for multislot configuration, chosen arbitrarily
- Training Sequence Code - Hopping - ARFCN	Chosen arbitrarily Single RF channel the ARFCN of the BCCH carrier
Power Command - Power level	Chosen arbitrarily but with a changed value.
Frequency list IE	Not Included
Cell Channel Description	Use Range 128 to encode (271, 273, 275, 277, 279, 281, 283, 285, 287, 289, 291)
Multislot allocation - Downlink assignment - Uplink assignment - Channel set X (1=<X<=8)	More than one timeslot but less than maximum number of timeslots is assigned in downlink direction. Only one timeslot is assigned in uplink direction. Appropriate for the test
Channel Mode - Mode	Data, 12.0 kbit/s radio interface rate
Mobile Allocation	Not included
Starting Time	Not included

Step 21:

ASSIGNMENT COMMAND

Channel Description 2 - Channel Type and TDMA offset - Timeslot Number	00000 A suitable value for multislot configuration, chosen arbitrarily
- Training Sequence Code	Chosen arbitrarily
- Hopping	Single RF channel
- ARFCN	the ARFCN of the BCCH carrier
Power Command - Power level	Chosen arbitrarily but with a changed value.
Frequency list IE	Not Included
Cell Channel Description	Use Range 128 to encode (271, 273, 275, 277, 279, 281, 283, 285, 287, 289, 291)
Multislot allocation - Downlink assignment - Uplink assignment - Channel set X (1=<X<=8)	Maximum number of timeslots that MS supports. Less timeslots assigned than downlink direction. Appropriate for the test
Channel Mode - Mode	Data, 12.0 kbit/s radio interface rate
Mobile Allocation	Not included
Starting Time	Not included

Step 24:

ASSIGNMENT COMMAND

Channel Description 2 - Channel Type and TDMA offset - Timeslot Number	00000 A suitable value for multislot configuration, chosen arbitrarily
- Training Sequence Code	Chosen arbitrarily
- Hopping	RF hopping channel
- MAIO	Chosen arbitrarily from the set (0, 1 to N-1) where N is the number of frequencies in the Mobile Allocation IE.
- HSN	Chosen arbitrarily from the set (1 to 63)
Power Command - Power level	Chosen arbitrarily but with a changed value.
Frequency list IE	Not Included
Cell Channel Description	Use Range 128 to encode (271, 273, 275, 277, 279, 281, 283, 285, 287, 289, 291)
Multislot allocation - Downlink assignment - Uplink assignment - Channel set X (1=<X<=8)	Only one timeslot is assigned in downlink direction. Only one timeslot is assigned in uplink direction. Appropriate for the test
Channel Mode - Mode	Data, 12.0 kbit/s radio interface rate
Mobile Allocation	Chosen arbitrarily from the Cell channel description
Starting Time	Not included

Step 26:

ASSIGNMENT COMMAND

Channel Description 2	00000
- Channel Type and TDMA offset	A suitable value for multislots configuration, chosen arbitrarily
- Timeslot Number	Chosen arbitrarily
- Training Sequence Code	RF hopping channel
- Hopping	
- MAIO	Chosen arbitrarily from the set (0, 1 to N-1) where N is the number of frequencies in the Mobile Allocation IE.
- HSN	Chosen arbitrarily from the set (1 to 63)
Power Command	
- Power level	Chosen arbitrarily but with a changed value.
Frequency list IE	Not Included
Cell Channel Description	Use Range 128 to encode (271, 273, 275, 277, 279, 281, 283, 285, 287, 289, 291)
Multislots allocation	
- Downlink assignment	Maximum number of timeslots that MS supports.
- Uplink assignment	Less timeslots assigned than in downlink direction.
- Channel set X (1= X ≤8)	Appropriate for the test
Channel Mode	
- Mode	Data, 12.0 kbit/s radio interface rate
Mobile Allocation	Chosen arbitrarily from the Cell channel description
Starting Time	Not included

Step 29:

ASSIGNMENT COMMAND

Channel Description 2	00000
- Channel Type and TDMA offset	A suitable value for multislots configuration, chosen arbitrarily
- Timeslot Number	Chosen arbitrarily
- Training Sequence Code	RF hopping channel
- Hopping	
- MAIO	Chosen arbitrarily from the set (0, 1 to N-1) where N is the number of frequencies in the Mobile Allocation IE.
- HSN	Chosen arbitrarily from the set (1 to 63)
Power Command	
- Power level	Chosen arbitrarily but with a changed value.
Frequency list IE	Not Included
Cell Channel Description	Use Range 128 to encode (271, 273, 275, 277, 279, 281, 283, 285, 287, 289, 291)
Multislots allocation	
- Downlink assignment	Maximum number of timeslots that MS supports.
- Uplink assignment	Less timeslots assigned than in downlink direction.
- Channel set X (1= X ≤8)	Appropriate for the test
Channel Mode	
- Mode	Data, 12.0 kbit/s radio interface rate
Mobile Allocation	Chosen arbitrarily from the Cell channel description
Starting Time	Not included

Step 31:

ASSIGNMENT COMMAND

Channel Description 2 - Channel Type and TDMA offset - Timeslot Number	00000 A suitable value for multislot configuration, chosen arbitrarily
- Training Sequence Code - Hopping - ARFCN	Chosen arbitrarily Single RF channel the ARFCN of the BCCH carrier
Power Command - Power level	Chosen arbitrarily but with a changed value.
Frequency list IE	Not Included
Cell Channel Description	Use Range 128 to encode (271, 273, 275, 277, 279, 281, 283, 285, 287, 289, 291)
Multislot allocation - Downlink assignment - Uplink assignment - Channel set X (1= $X \leq 8$)	Only one timeslot is assigned in downlink direction. Only one timeslot is assigned in uplink direction. Appropriate for the test
Channel Mode - Mode	Data, 12.0 kbit/s radio interface rate
Mobile Allocation	Not included
Starting Time	Not included

GSM 450 end:

GSM 480 begin:

Step 5:

ASSIGNMENT COMMAND

Channel Description 2 - Channel Type and TDMA offset - Timeslot Number	00000 A suitable value for multislot configuration, chosen arbitrarily
- Training Sequence Code - Hopping	Chosen arbitrarily RF hopping channel
- MAIO	Chosen arbitrarily from the set (0, 1 to N-1) where N is the number of frequencies in the Mobile Allocation IE.
- HSN	Chosen arbitrarily from the set (1 to 63)
Power Command - Power level	Chosen arbitrarily but with a changed value.
Frequency list IE	Not Included
Cell Channel Description	Use Range 128 to encode (318, 320, 322, 324, 326, 328, 330, 332, 334, 336, 338)
Multislot allocation - Downlink assignment - Uplink assignment - Channel set X (1= $X \leq 8$)	Maximum number of symmetrical timeslots assigned. As many timeslots as downlink direction. Appropriate for the test
Channel Mode - Mode	Data, 12.0 kbit/s radio interface rate
Mobile Allocation	Arbitrarily chosen from Cell channel description
Starting Time	Not included

Step 9:

ASSIGNMENT COMMAND

Channel Description 2	00000
- Channel Type and TDMA offset	A suitable value for multislot configuration, chosen arbitrarily
- Timeslot Number	Chosen arbitrarily
- Training Sequence Code	RF hopping channel
- Hopping	
- MAIO	Chosen arbitrarily from the set (0, 1 to N-1) where N is the number of frequencies in the Mobile Allocation IE.
- HSN	Chosen arbitrarily from the set (1 to 63)
Power Command	
- Power level	Chosen arbitrarily but with a changed value.
Frequency list IE	Not Included
Cell Channel Description	Use Range 128 to encode (318, 320, 322, 324, 326, 328, 330, 332, 334, 336, 338)
Multislot allocation	
- Downlink assignment	Maximum number of timeslots that MS supports.
- Uplink assignment	Less timeslots assigned than downlink direction.
- Channel set X (1= $X \leq 8$)	Appropriate for the test
Channel Mode	
- Mode	Data, 12.0 kbit/s radio interface rate
Mobile Allocation	Arbitrarily chosen from Cell channel description
Starting Time	Not included

Step 11:

ASSIGNMENT COMMAND

Channel Description 2	00000
- Channel Type and TDMA offset	A suitable value for multislot configuration, chosen arbitrarily
- Timeslot Number	Chosen arbitrarily
- Training Sequence Code	Chosen arbitrarily
- Hopping	Single RF channel
- ARFCN	the ARFCN of the BCCH carrier
Power Command	
- Power level	Chosen arbitrarily but with a changed value.
Frequency list IE	Not Included
Cell Channel Description	Use Range 128 to encode (318, 320, 322, 324, 326, 328, 330, 332, 334, 336, 338)
Multislot allocation	
- Downlink assignment	Maximum number of symmetrical timeslots supported by MS assigned.
- Uplink assignment	As many timeslots as in downlink direction.
- Channel set X (1= $X \leq 8$)	Appropriate for the test
Channel Mode	
- Mode	Data, 12.0 kbit/s radio interface rate
Mobile Allocation	Not included
Starting Time	Not included

Step 14:

ASSIGNMENT COMMAND

Channel Description 2 - Channel Type and TDMA offset - Timeslot Number - Training Sequence Code - Hopping - ARFCN Power Command - Power level Frequency list IE Cell Channel Description Multislot allocation - Downlink assignment - Uplink assignment - Channel set X (1=<X<=8) Channel Mode - Mode Mobile Allocation Starting Time	00000 A suitable value for multislot configuration, chosen arbitrarily Chosen arbitrarily Single RF channel the ARFCN of the BCCH carrier Chosen arbitrarily but with a changed value. Not Included Use Range 128 to encode (318, 320, 322, 324, 326, 328, 330, 332, 334, 336, 338) Only one timeslot is assigned in downlink direction. Only one timeslot is assigned in uplink direction. Appropriate for the test Data, 12.0 kbit/s radio interface rate Not included Not included
--	--

Step 16:

ASSIGNMENT COMMAND

Channel Description 2 - Channel Type and TDMA offset - Timeslot Number - Training Sequence Code - Hopping - ARFCN Power Command - Power level Frequency list IE Cell Channel Description Multislot allocation - Downlink assignment - Uplink assignment - Channel set X (1=<X<=8) Channel Mode - Mode Mobile Allocation Starting Time	00000 A suitable value for multislot configuration, chosen arbitrarily Chosen arbitrarily Single RF channel the ARFCN of the BCCH carrier Chosen arbitrarily but with a changed value. Not Included Use Range 128 to encode (318, 320, 322, 324, 326, 328, 330, 332, 334, 336, 338) Maximum number of timeslots that MS supports. Maximum number of timeslots that MS supports. Appropriate for the test Data, 12.0 kbit/s radio interface rate Not included Not included
--	--

Step 19:

ASSIGNMENT COMMAND

Channel Description 2 - Channel Type and TDMA offset - Timeslot Number	00000 A suitable value for multislot configuration, chosen arbitrarily
- Training Sequence Code - Hopping - ARFCN	Chosen arbitrarily Single RF channel the ARFCN of the BCCH carrier
Power Command - Power level	Chosen arbitrarily but with a changed value.
Frequency list IE	Not Included
Cell Channel Description	Use Range 128 to encode (318, 320, 322, 324, 326, 328, 330, 332, 334, 336, 338)
Multislot allocation - Downlink assignment	More than one timeslot but less than maximum number of timeslots is assigned in downlink direction.
- Uplink assignment - Channel set X (1= X ≤8)	Only one timeslot is assigned in uplink direction. Appropriate for the test
Channel Mode - Mode	Data, 12.0 kbit/s radio interface rate
Mobile Allocation	Not included
Starting Time	Not included

Step 21:

ASSIGNMENT COMMAND

Channel Description 2 - Channel Type and TDMA offset - Timeslot Number	00000 A suitable value for multislot configuration, chosen arbitrarily
- Training Sequence Code - Hopping - ARFCN	Chosen arbitrarily Single RF channel the ARFCN of the BCCH carrier
Power Command - Power level	Chosen arbitrarily but with a changed value.
Frequency list IE	Not Included
Cell Channel Description	Use Range 128 to encode (318, 320, 322, 324, 326, 328, 330, 332, 334, 336, 338)
Multislot allocation - Downlink assignment - Uplink assignment - Channel set X (1= X ≤8)	Maximum number of timeslots that MS supports. Less timeslots assigned than downlink direction. Appropriate for the test
Channel Mode - Mode	Data, 12.0 kbit/s radio interface rate
Mobile Allocation	Not included
Starting Time	Not included

Step 24:

ASSIGNMENT COMMAND

Channel Description 2 - Channel Type and TDMA offset - Timeslot Number	00000 A suitable value for multislot configuration, chosen arbitrarily
- Training Sequence Code - Hopping	Chosen arbitrarily RF hopping channel
- MAIO	Chosen arbitrarily from the set (0, 1 to N-1) where N is the number of frequencies in the Mobile Allocation IE.
- HSN	Chosen arbitrarily from the set (1 to 63)
Power Command - Power level	Chosen arbitrarily but with a changed value.
Frequency list IE	Not Included
Cell Channel Description	Use Range 128 to encode (318, 320, 322, 324, 326, 328, 330, 332, 334, 336, 338)
Multislot allocation - Downlink assignment - Uplink assignment - Channel set X (1= X ≤8)	Only one timeslot is assigned in downlink direction. Only one timeslot is assigned in uplink direction. Appropriate for the test
Channel Mode - Mode	Data, 12.0 kbit/s radio interface rate
Mobile Allocation	Chosen arbitrarily from the Cell channel description
Starting Time	Not included

Step 26:

ASSIGNMENT COMMAND

Channel Description 2 - Channel Type and TDMA offset - Timeslot Number	00000 A suitable value for multislot configuration, chosen arbitrarily
- Training Sequence Code - Hopping	Chosen arbitrarily RF hopping channel
- MAIO	Chosen arbitrarily from the set (0, 1 to N-1) where N is the number of frequencies in the Mobile Allocation IE.
- HSN	Chosen arbitrarily from the set (1 to 63)
Power Command - Power level	Chosen arbitrarily but with a changed value.
Frequency list IE	Not Included
Cell Channel Description	Use Range 128 to encode (318, 320, 322, 324, 326, 328, 330, 332, 334, 336, 338)
Multislot allocation - Downlink assignment - Uplink assignment - Channel set X (1= X ≤8)	Maximum number of timeslots that MS supports. Less timeslots assigned than in downlink direction. Appropriate for the test
Channel Mode - Mode	Data, 12.0 kbit/s radio interface rate
Mobile Allocation	Chosen arbitrarily from the Cell channel description
Starting Time	Not included

Step 29:

ASSIGNMENT COMMAND

Channel Description 2 - Channel Type and TDMA offset - Timeslot Number - Training Sequence Code - Hopping - MAIO - HSN	00000 A suitable value for multislot configuration, chosen arbitrarily Chosen arbitrarily RF hopping channel Chosen arbitrarily from the set (0, 1 to N-1) where N is the number of frequencies in the Mobile Allocation IE. Chosen arbitrarily from the set (1 to 63)
Power Command - Power level	Chosen arbitrarily but with a changed value.
Frequency list IE	Not Included
Cell Channel Description	Use Range 128 to encode (318, 320, 322, 324, 326, 328, 330, 332, 334, 336, 338)
Multislot allocation - Downlink assignment - Uplink assignment - Channel set X (1= \leq X \leq 8)	Maximum number of timeslots that MS supports. Less timeslots assigned than in downlink direction. Appropriate for the test
Channel Mode - Mode	Data, 12.0 kbit/s radio interface rate
Mobile Allocation	Chosen arbitrarily from the Cell channel description
Starting Time	Not included

Step 31:

ASSIGNMENT COMMAND

Channel Description 2 - Channel Type and TDMA offset - Timeslot Number - Training Sequence Code - Hopping - ARFCN	00000 A suitable value for multislot configuration, chosen arbitrarily Chosen arbitrarily Single RF channel the ARFCN of the BCCH carrier
Power Command - Power level	Chosen arbitrarily but with a changed value.
Frequency list IE	Not Included
Cell Channel Description	Use Range 128 to encode (318, 320, 322, 324, 326, 328, 330, 332, 334, 336, 338)
Multislot allocation - Downlink assignment - Uplink assignment - Channel set X (1= \leq X \leq 8)	Only one timeslot is assigned in downlink direction. Only one timeslot is assigned in uplink direction. Appropriate for the test
Channel Mode - Mode	Data, 12.0 kbit/s radio interface rate
Mobile Allocation	Not included
Starting Time	Not included

GSM 480 end:

GSM 900 begin:

Step 5:

ASSIGNMENT COMMAND

Channel Description 2 - Channel Type and TDMA offset - Timeslot Number	00000 A suitable value for multislot configuration, chosen arbitrarily
- Training Sequence Code - Hopping	Chosen arbitrarily RF hopping channel
- MAIO	Chosen arbitrarily from the set (0, 1 to N-1) where N is the number of frequencies in the Mobile Allocation IE.
- HSN	Chosen arbitrarily from the set (1 to 63)
Power Command - Power level	Chosen arbitrarily but with a changed value.
Frequency list IE	Not Included
Cell Channel Description	Bit map zero encodes (45, 46, 52, 59, 66, 73, 74, 75, 76, 108, 114)
Multislot allocation - Downlink assignment - Uplink assignment - Channel set X (1=<X<=8)	Maximum number of symmetrical timeslots assigned. As many timeslots as downlink direction. Appropriate for the test
Channel Mode - Mode	Data, 12.0 kbit/s radio interface rate
Mobile Allocation	Arbitrarily chosen from Cell channel description
Starting Time	Not included

Step 9:

ASSIGNMENT COMMAND

Channel Description 2 - Channel Type and TDMA offset - Timeslot Number	00000 A suitable value for multislot configuration, chosen arbitrarily
- Training Sequence Code - Hopping	Chosen arbitrarily RF hopping channel
- MAIO	Chosen arbitrarily from the set (0, 1 to N-1) where N is the number of frequencies in the Mobile Allocation IE.
- HSN	Chosen arbitrarily from the set (1 to 63)
Power Command - Power level	Chosen arbitrarily but with a changed value.
Frequency list IE	Not Included
Cell Channel Description	Bit map zero encodes (45, 46, 52, 59, 66, 73, 74, 75, 76, 108, 114)
Multislot allocation - Downlink assignment - Uplink assignment - Channel set X (1=<X<=8)	Maximum number of timeslots that MS supports. Less timeslots assigned than downlink direction. Appropriate for the test
Channel Mode - Mode	Data, 12.0 kbit/s radio interface rate
Mobile Allocation	Arbitrarily chosen from Cell channel description
Starting Time	Not included

Step 11:

ASSIGNMENT COMMAND

Channel Description 2 - Channel Type and TDMA offset - Timeslot Number	00000 A suitable value for multislot configuration, chosen arbitrarily
- Training Sequence Code	Chosen arbitrarily
- Hopping	Single RF channel
- ARFCN	the ARFCN of the BCCH carrier
Power Command - Power level	Chosen arbitrarily but with a changed value.
Frequency list IE	Not Included
Cell Channel Description	Bit map zero encodes (45, 46, 52, 59, 66, 73, 74, 75, 76, 108, 114)
Multislot allocation - Downlink assignment	Maximum number of symmetrical timeslots supported by MS assigned.
- Uplink assignment	As many timeslots as in downlink direction.
- Channel set X (1= \leq X \leq 8)	Appropriate for the test
Channel Mode - Mode	Data, 12.0 kbit/s radio interface rate
Mobile Allocation	Not included
Starting Time	Not included

Step 14:

ASSIGNMENT COMMAND

Channel Description 2 - Channel Type and TDMA offset - Timeslot Number	00000 A suitable value for multislot configuration, chosen arbitrarily
- Training Sequence Code	Chosen arbitrarily
- Hopping	Single RF channel
- ARFCN	the ARFCN of the BCCH carrier
Power Command - Power level	Chosen arbitrarily but with a changed value.
Frequency list IE	Not Included
Cell Channel Description	Bit map zero encodes (45, 46, 52, 59, 66, 73, 74, 75, 76, 108, 114)
Multislot allocation - Downlink assignment	Only one timeslot is assigned in downlink direction.
- Uplink assignment	Only one timeslot is assigned in uplink direction.
- Channel set X (1= \leq X \leq 8)	Appropriate for the test
Channel Mode - Mode	Data, 12.0 kbit/s radio interface rate
Mobile Allocation	Not included
Starting Time	Not included

Step 16:

ASSIGNMENT COMMAND

Channel Description 2 - Channel Type and TDMA offset - Timeslot Number	00000 A suitable value for multislot configuration, chosen arbitrarily
- Training Sequence Code	Chosen arbitrarily
- Hopping	Single RF channel
- ARFCN	the ARFCN of the BCCH carrier
Power Command - Power level	Chosen arbitrarily but with a changed value.
Frequency list IE	Not Included
Cell Channel Description	Bit map zero encodes (45, 46, 52, 59, 66, 73, 74, 75, 76, 108, 114)
Multislot allocation - Downlink assignment	Maximum number of timeslots that MS supports.
- Uplink assignment	Maximum number of timeslots that MS supports.
- Channel set X (1= \leq X \leq 8)	Appropriate for the test
Channel Mode - Mode	Data, 12.0 kbit/s radio interface rate
Mobile Allocation	Not included
Starting Time	Not included

Step 19:

ASSIGNMENT COMMAND

Channel Description 2 - Channel Type and TDMA offset - Timeslot Number	00000 A suitable value for multislot configuration, chosen arbitrarily
- Training Sequence Code	Chosen arbitrarily
- Hopping	Single RF channel
- ARFCN	the ARFCN of the BCCH carrier
Power Command - Power level	Chosen arbitrarily but with a changed value.
Frequency list IE	Not Included
Cell Channel Description	Bit map zero encodes (45, 46, 52, 59, 66, 73, 74, 75, 76, 108, 114)
Multislot allocation - Downlink assignment	More than one timeslot but less than maximum number of timeslots is assigned in downlink direction.
- Uplink assignment	Only one timeslot is assigned in uplink direction.
- Channel set X (1= \leq X \leq 8)	Appropriate for the test
Channel Mode - Mode	Data, 12.0 kbit/s radio interface rate
Mobile Allocation	Not included
Starting Time	Not included

Step 21:

ASSIGNMENT COMMAND

Channel Description 2 - Channel Type and TDMA offset - Timeslot Number	00000 A suitable value for multislot configuration, chosen arbitrarily
- Training Sequence Code	Chosen arbitrarily
- Hopping	Single RF channel
- ARFCN	the ARFCN of the BCCH carrier
Power Command - Power level	Chosen arbitrarily but with a changed value.
Frequency list IE	Not Included
Cell Channel Description	Bit map zero encodes (45, 46, 52, 59, 66, 73, 74, 75, 76, 108, 114)
Multislot allocation - Downlink assignment - Uplink assignment - Channel set X (1=<X<=8)	Maximum number of timeslots that MS supports. Less timeslots assigned than downlink direction. Appropriate for the test
Channel Mode - Mode	Data, 12.0 kbit/s radio interface rate
Mobile Allocation	Not included
Starting Time	Not included

Step 24:

ASSIGNMENT COMMAND

Channel Description 2 - Channel Type and TDMA offset - Timeslot Number	00000 A suitable value for multislot configuration, chosen arbitrarily
- Training Sequence Code	Chosen arbitrarily
- Hopping	RF hopping channel
- MAIO	Chosen arbitrarily from the set (0, 1 to N-1) where N is the number of frequencies in the Mobile Allocation IE.
- HSN	Chosen arbitrarily from the set (1 to 63)
Power Command - Power level	Chosen arbitrarily but with a changed value.
Frequency list IE	Not Included
Cell Channel Description	Bit map zero encodes (45, 46, 52, 59, 66, 73, 74, 75, 76, 108, 114)
Multislot allocation - Downlink assignment - Uplink assignment - Channel set X (1=<X<=8)	Only one timeslot is assigned in downlink direction. Only one timeslot is assigned in uplink direction. Appropriate for the test
Channel Mode - Mode	Data, 12.0 kbit/s radio interface rate
Mobile Allocation	Chosen arbitrarily from the Cell channel description
Starting Time	Not included

Step 26:

ASSIGNMENT COMMAND

Channel Description 2 - Channel Type and TDMA offset - Timeslot Number	00000 A suitable value for multislots configuration, chosen arbitrarily
- Training Sequence Code - Hopping	Chosen arbitrarily RF hopping channel
- MAIO	Chosen arbitrarily from the set (0, 1 to N-1) where N is the number of frequencies in the Mobile Allocation IE.
- HSN	Chosen arbitrarily from the set (1 to 63)
Power Command - Power level	Chosen arbitrarily but with a changed value.
Frequency list IE	Not Included
Cell Channel Description	Bit map zero encodes (45, 46, 52, 59, 66, 73, 74, 75, 76, 108, 114)
Multislots allocation - Downlink assignment - Uplink assignment - Channel set X (1= \leq X \leq 8)	Maximum number of timeslots that MS supports. Less timeslots assigned than in downlink direction. Appropriate for the test
Channel Mode - Mode	Data, 12.0 kbit/s radio interface rate
Mobile Allocation	Chosen arbitrarily from the Cell channel description
Starting Time	Not included

Step 29:

ASSIGNMENT COMMAND

Channel Description 2 - Channel Type and TDMA offset - Timeslot Number	00000 A suitable value for multislots configuration, chosen arbitrarily
- Training Sequence Code - Hopping	Chosen arbitrarily RF hopping channel
- MAIO	Chosen arbitrarily from the set (0, 1 to N-1) where N is the number of frequencies in the Mobile Allocation IE.
- HSN	Chosen arbitrarily from the set (1 to 63)
Power Command - Power level	Chosen arbitrarily but with a changed value.
Frequency list IE	Not Included
Cell Channel Description	Bit map zero encodes (45, 46, 52, 59, 66, 73, 74, 75, 76, 108, 114)
Multislots allocation - Downlink assignment - Uplink assignment - Channel set X (1= \leq X \leq 8)	Maximum number of timeslots that MS supports. Less timeslots assigned than in downlink direction. Appropriate for the test
Channel Mode - Mode	Data, 12.0 kbit/s radio interface rate
Mobile Allocation	Chosen arbitrarily from the Cell channel description
Starting Time	Not included

Step 31:

ASSIGNMENT COMMAND

Channel Description 2 - Channel Type and TDMA offset - Timeslot Number	00000 A suitable value for multislot configuration, chosen arbitrarily
- Training Sequence Code	Chosen arbitrarily
- Hopping	Single RF channel
- ARFCN	the ARFCN of the BCCH carrier
Power Command - Power level	Chosen arbitrarily but with a changed value.
Frequency list IE	Not Included
Cell Channel Description	Bit map zero encodes (45, 46, 52, 59, 66, 73, 74, 75, 76, 108, 114)
Multislot allocation - Downlink assignment - Uplink assignment - Channel set X (1=<X<=8)	Only one timeslot is assigned in downlink direction. Only one timeslot is assigned in uplink direction. Appropriate for the test
Channel Mode - Mode	Data, 12.0 kbit/s radio interface rate
Mobile Allocation	Not included
Starting Time	Not included

GSM 900 end:

GSM 1800 begin:

Step 5:

ASSIGNMENT COMMAND

Channel Description 2 - Channel Type and TDMA offset - Timeslot Number	00000 A suitable value for multislot configuration, chosen arbitrarily
- Training Sequence Code	Chosen arbitrarily
- Hopping	RF hopping channel
- MAIO	Chosen arbitrarily from the set (0, 1 to N-1) where N is the number of frequencies in the Mobile Allocation IE.
- HSN	Chosen arbitrarily from the set (1 to 63)
Power Command - Power level	Chosen arbitrarily but with a changed value.
Frequency list IE	Not Included
Cell Channel Description	Use Range 128 to encode (773, 775, 779, 782, 791, 798, 829, 832, 844)
Multislot allocation - Downlink assignment - Uplink assignment - Channel set X (1=<X<=8)	Maximum number of symmetrical timeslots assigned. As many timeslots as downlink direction. Appropriate for the test
Channel Mode - Mode	Data, 12.0 kbit/s radio interface rate
Mobile Allocation	Arbitrarily chosen from Cell channel description
Starting Time	Not included

Step 9:

ASSIGNMENT COMMAND

Channel Description 2 - Channel Type and TDMA offset - Timeslot Number	00000 A suitable value for multislot configuration, chosen arbitrarily
- Training Sequence Code - Hopping	Chosen arbitrarily RF hopping channel
- MAIO	Chosen arbitrarily from the set (0, 1 to N-1) where N is the number of frequencies in the Mobile Allocation IE.
- HSN	Chosen arbitrarily from the set (1 to 63)
Power Command - Power level	Chosen arbitrarily but with a changed value.
Frequency list IE	Not Included
Cell Channel Description	Use Range 128 to encode (773, 775, 779, 782, 791, 798, 829, 832, 844)
Multislot allocation - Downlink assignment - Uplink assignment - Channel set X (1= X ≤8)	Maximum number of timeslots that MS supports. Less timeslots assigned than downlink direction. Appropriate for the test
Channel Mode - Mode	Data, 12.0 kbit/s radio interface rate
Mobile Allocation	Arbitrarily chosen from Cell channel description
Starting Time	Not included

Step 11:

ASSIGNMENT COMMAND

Channel Description 2 - Channel Type and TDMA offset - Timeslot Number	00000 A suitable value for multislot configuration, chosen arbitrarily
- Training Sequence Code - Hopping - ARFCN	Chosen arbitrarily Single RF channel the ARFCN of the BCCH carrier
Power Command - Power level	Chosen arbitrarily but with a changed value.
Frequency list IE	Not Included
Cell Channel Description	Use Range 128 to encode (773, 775, 779, 782, 791, 798, 829, 832, 844)
Multislot allocation - Downlink assignment	Maximum number symmetrical of timeslots supported by MS assigned.
- Uplink assignment - Channel set X (1= X ≤8)	As many timeslots as in downlink direction. Appropriate for the test
Channel Mode - Mode	Data, 12.0 kbit/s radio interface rate
Mobile Allocation	Not included
Starting Time	Not included

Step 14:

ASSIGNMENT COMMAND

Channel Description 2 - Channel Type and TDMA offset - Timeslot Number - Training Sequence Code - Hopping - ARFCN Power Command - Power level Frequency list IE Cell Channel Description Multislot allocation - Downlink assignment - Uplink assignment - Channel set X (1= \leq X \leq 8) Channel Mode - Mode Mobile Allocation Starting Time	00000 A suitable value for multislot configuration, chosen arbitrarily Chosen arbitrarily Single RF channel the ARFCN of the BCCH carrier Chosen arbitrarily but with a changed value. Not Included Use Range 128 to encode (773, 775, 779, 782, 791, 798, 829, 832, 844) Only one timeslot is assigned in downlink direction. Only one timeslot is assigned in uplink direction. Appropriate for the test Data, 12.0 kbit/s radio interface rate Not included Not included
---	--

Step 16:

ASSIGNMENT COMMAND

Channel Description 2 - Channel Type and TDMA offset - Timeslot Number - Training Sequence Code - Hopping - ARFCN Power Command - Power level Frequency list IE Cell Channel Description Multislot allocation - Downlink assignment - Uplink assignment - Channel set X (1= \leq X \leq 8) Channel Mode - Mode Mobile Allocation Starting Time	00000 A suitable value for multislot configuration, chosen arbitrarily Chosen arbitrarily Single RF channel the ARFCN of the BCCH carrier Chosen arbitrarily but with a changed value. Not Included Use Range 128 to encode (773, 775, 779, 782, 791, 798, 829, 832, 844) Maximum number of timeslots that MS supports. Maximum number of timeslots that MS supports. Appropriate for the test Data, 12.0 kbit/s radio interface rate Not included Not included
---	--

Step 19:

ASSIGNMENT COMMAND

Channel Description 2 - Channel Type and TDMA offset - Timeslot Number	00000 A suitable value for multislot configuration, chosen arbitrarily
- Training Sequence Code	Chosen arbitrarily
- Hopping	Single RF channel
- ARFCN	the ARFCN of the BCCH carrier
Power Command - Power level	Chosen arbitrarily but with a changed value.
Frequency list IE	Not Included
Cell Channel Description	Use Range 128 to encode (773, 775, 779, 782, 791, 798, 829, 832, 844)
Multislot allocation - Downlink assignment	More than one timeslot but less than maximum number of timeslots is assigned in downlink direction.
- Uplink assignment	Only one timeslot is assigned in uplink direction.
- Channel set X (1= X ≤8)	Appropriate for the test
Channel Mode - Mode	Data, 12.0 kbit/s radio interface rate
Mobile Allocation	Not included
Starting Time	Not included

Step 21:

ASSIGNMENT COMMAND

Channel Description 2 - Channel Type and TDMA offset - Timeslot Number	00000 A suitable value for multislot configuration, chosen arbitrarily
- Training Sequence Code	Chosen arbitrarily
- Hopping	Single RF channel
- ARFCN	the ARFCN of the BCCH carrier
Power Command - Power level	Chosen arbitrarily but with a changed value.
Frequency list IE	Not Included
Cell Channel Description	Use Range 128 to encode (773, 775, 779, 782, 791, 798, 829, 832, 844)
Multislot allocation - Downlink assignment	Maximum number of timeslots that MS supports.
- Uplink assignment	Less timeslots assigned than downlink direction.
- Channel set X (1= X ≤8)	Appropriate for the test
Channel Mode - Mode	Data, 12.0 kbit/s radio interface rate
Mobile Allocation	Not included
Starting Time	Not included

Step 24:

ASSIGNMENT COMMAND

Channel Description 2 - Channel Type and TDMA offset - Timeslot Number - Training Sequence Code - Hopping - MAIO - HSN Power Command - Power level Frequency list IE Cell Channel Description Multislot allocation - Downlink assignment - Uplink assignment - Channel set X (1= X ≤8) Channel Mode - Mode Mobile Allocation Starting Time	00000 A suitable value for multislot configuration, chosen arbitrarily Chosen arbitrarily RF hopping channel Chosen arbitrarily from the set (0, 1 to N-1) where N is the number of frequencies in the Mobile Allocation IE. Chosen arbitrarily from the set (1 to 63) Chosen arbitrarily but with a changed value. Not Included Use Range 128 to encode (773, 775, 779, 782, 791, 798, 829, 832, 844) Only one timeslot is assigned in downlink direction. Only one timeslot is assigned in uplink direction. Appropriate for the test Data, 12.0 kbit/s radio interface rate Chosen arbitrarily from the Cell channel description Not included
--	--

Step 26:

ASSIGNMENT COMMAND

Channel Description 2 - Channel Type and TDMA offset - Timeslot Number - Training Sequence Code - Hopping - MAIO - HSN Power Command - Power level Frequency list IE Cell Channel Description Multislot allocation - Downlink assignment - Uplink assignment - Channel set X (1= X ≤8) Channel Mode - Mode Mobile Allocation Starting Time	00000 A suitable value for multislot configuration, chosen arbitrarily Chosen arbitrarily RF hopping channel Chosen arbitrarily from the set (0, 1 to N-1) where N is the number of frequencies in the Mobile Allocation IE. Chosen arbitrarily from the set (1 to 63) Chosen arbitrarily but with a changed value. Not Included Use Range 128 to encode (773, 775, 779, 782, 791, 798, 829, 832, 844) Maximum number of timeslots that MS supports. Less timeslots assigned than in downlink direction. Appropriate for the test Data, 12.0 kbit/s radio interface rate Chosen arbitrarily from the Cell channel description Not included
--	--

Step 29:

ASSIGNMENT COMMAND

Channel Description 2 - Channel Type and TDMA offset - Timeslot Number - Training Sequence Code - Hopping - MAIO - HSN Power Command - Power level Frequency list IE Cell Channel Description Multislot allocation - Downlink assignment - Uplink assignment - Channel set X (1= \leq X \leq 8) Channel Mode - Mode Mobile Allocation Starting Time	00000 A suitable value for multislot configuration, chosen arbitrarily Chosen arbitrarily RF hopping channel Chosen arbitrarily from the set (0, 1 to N-1) where N is the number of frequencies in the Mobile Allocation IE. Chosen arbitrarily from the set (1 to 63) Chosen arbitrarily but with a changed value. Not Included Use Range 128 to encode (773, 775, 779, 782, 791, 798, 829, 832, 844) Maximum number of timeslots that MS supports. Less timeslots assigned than in downlink direction. Appropriate for the test Data, 12.0 kbit/s radio interface rate Chosen arbitrarily from the Cell channel description Not included
---	--

Step 31:

ASSIGNMENT COMMAND

Channel Description 2 - Channel Type and TDMA offset - Timeslot Number - Training Sequence Code - Hopping - ARFCN Power Command - Power level Frequency list IE Cell Channel Description Multislot allocation - Downlink assignment - Uplink assignment - Channel set X (1= \leq X \leq 8) Channel Mode - Mode Mobile Allocation Starting Time	00000 A suitable value for multislot configuration, chosen arbitrarily Chosen arbitrarily Single RF channel the ARFCN of the BCCH carrier Chosen arbitrarily but with a changed value. Not Included Use Range 128 to encode (773, 775, 779, 782, 791, 798, 829, 832, 844) Only one timeslot is assigned in downlink direction. Only one timeslot is assigned in uplink direction. Appropriate for the test Data, 12.0 kbit/s radio interface rate Not included Not included
---	--

GSM 1800 end:

26.13.1.3 Test of handover

With the Handover procedure, it is possible to completely alter the channels allocated to a MS. This makes it possible in particular to switch a call in progress from one cell to another. The procedure is always initiated by the network and with the MS in a dedicated mode.

Sections 26.13.1.3.1 - 26.13.1.3.5 contain test procedures to be used for executing successful Handover tests in multislot configuration. Table 26.13.1.3-1 contains a summary of the different combinations of parameters that have to be tested, together with a reference to the appropriate test procedure.

Table 26.13.1.3-1

From	To	Timing Adv.	Start Time	Syn ?	State of call	Section	Exec Counter
Multislot configuration, MAX number of timeslots, no FH	Multislot configuration, MAX number of timeslots, FH	arbitrarily	none	no	U10	26.13.1.3.1	1
Multislot configuration, MIN number of timeslots, no FH	Multislot configuration, MAX number of timeslots, no FH	arbitrarily	none	no	estab*	26.13.1.3.2	1
Multislot configuration, MAX number of timeslots, FH	Multislot configuration, MIN number of timeslots, no FH	arbitrarily	none	finely	U10	26.13.1.3.3	1
Multislot configuration, FH	Multislot configuration, FH	arbitrarily	none	finely	estab *	26.13.1.3.4	1
Multislot configuration, MIN number of timeslots, FH	Multislot configuration, MAX number of timeslots, no FH	arbitrarily	none	pre	estab *	26.13.1.3.5	1

*) The MS is in the "idle, updated" state, with a TMSI allocated and camped on cell A

26.13.1.3.1 Multislot signalling / RR / Handover / successful / active call / non-synchronized

This test is applicable to all MS that supports multislot configuration.

26.13.1.3.1.1 Conformance requirements

- 1) The MS shall correctly apply the handover procedure in the non-synchronized case when a multislot connection is in progress and when handover is performed from a non-hopping multislot configuration towards a hopping multislot configuration.

References

Conformance requirement 1: GSM 04.08 sections 3.4.4 and 9.1.15. GSM 04.13 section 5.2.6.2.

26.13.1.3.1.2 Test purpose

- 1) To test that when the MS is ordered to make a non-synchronized handover from non-hopping multislot configuration to hopping multislot configuration, it continuously sends access bursts on the main DCCH until it receives a PHYSICAL INFORMATION message from the SS.
- 2) To test that the MS correctly handles the Timing Advance IE in the PHYSICAL INFORMATION message.
- 3) To test that the MS activates the new channels correctly and transmits the HANDOVER COMPLETE message without undue delay.

26.13.1.3.1.3 Method of test

Initial Conditions

System Simulator:

- 2 cells, A and B with same LAI, default parameters except:
- Early classmark sending enabled in SI3 rest octets

GSM 450:

Cell A has:

- BCCH ARFCN = 263

Cell B has:

- BCCH ARFCN = 274
- Cell Allocation = (260, 262, 264, 266, 268, 270, 272, 274, 276, 279, 281, 283, 285, 287, 289, 291)
- The Cell Allocation of Cell B shall be coded using range 256 format.
- The frame numbers of cells A and B shall be different by 100.
- The timebase of cells A and B shall be such that the edges of their timeslots are not coincident at the antenna connector.

GSM 480:

Cell A has:

- BCCH ARFCN = 310

Cell B has:

- BCCH ARFCN = 321
- Cell Allocation = (307, 309, 311, 313, 315, 317, 319, 321, 323, 326, 328, 330, 332, 334, 336, 338)
- The Cell Allocation of Cell B shall be coded using range 256 format.
- The frame numbers of cells A and B shall be different by 100.
- The timebase of cells A and B shall be such that the edges of their timeslots are not coincident at the antenna connector.

GSM 900:

Cell A has:

- BCCH ARFCN = 20

Cell B has:

- BCCH ARFCN = 40
- Cell Allocation = (14, 18, 22, 24, 30, 31, 38, 40, 60, 66, 73, 74, 75, 76, 108, 114)
- The Cell Allocation of Cell B shall be coded using range 256 format.
- The frame numbers of cells A and B shall be different by 100.
- The timebase of cells A and B shall be such that the edges of their timeslots are not coincident at the antenna connector.

DCS 1 800:

Cell A has:

- BCCH ARFCN = 747

Cell B has:

- BCCH ARFCN = 764
- Cell Allocation = (739, 743, 746, 749, 756, 758, 761, 764, 771, 779, 782, 791, 798, 829, 832, 844)
- The Cell Allocation of Cell B shall be coded using range 256 format.
- The frame numbers of cells A and B shall be different by 100.
- The timebase of cells A and B shall be such that the edges of their timeslots are not coincident at the antenna connector.

Mobile Station:

- The MS is in the active state (U10) of a service using a multislot connection on cell A.

Related PICS/PIXIT Statements

- Type of MS (GSM 450 or GSM 480 or P-GSM 900 or EGSM or DCS 1 800).
- Multislot class
- Supported teleservices/bearer services
- Classmark

Foreseen Final State of the MS

The active state (U10) of a multislot connection on cell B.

Test Procedure

The MS is in the active state (U10) of a multislot connection. The SS sends a HANOVER COMMAND on the main DCCH. The MS shall begin to send access bursts on the new DCCH of the target cell. The SS observes the access bursts and after receiving 10-20 access bursts, the SS sends one PHYSICAL INFORMATION message with a Timing Advance arbitrarily selected. The MS shall activate the new channels that belongs to same multislot configuration. The MS shall establish a signalling link. The MS shall be ready to transmit a HANOVER COMPLETE message, before 500 ms after the end of the PHYSICAL INFORMATION message, but not before a UA frame has been sent by the SS.

The term "ready to transmit" is defined in GSM 04.13.

Maximum Duration of Test

5 minutes, including 1 minute for any necessary operator actions.

Expected Sequence

Step	Direction	Message	Comments
0	MS, SS		The MS and SS are using a maximum multislot configuration according to the MS multislot class (highest class that MS supports) in non-hopping mode on cell A. See Specific message contents. Repeated on every burst of the uplink main DCCH until reception of PHYSICAL INFORMATION. Handover Reference as included in the HANDOVER COMMAND. Sent after reception of n HANDOVER ACCESS messages. See specific message contents. Sent without information field. The message shall be ready to be transmitted before 500 ms after the completion of step 3. The MS and SS are using a maximum multislot configuration according to the MS multislot class (highest class that MS supports) in hopping mode on cell B and state U10 is reached.
1	SS -> MS	HANDOVER COMMAND	
2	MS -> SS	HANDOVER ACCESS	
3	SS -> MS	PHYSICAL INFORMATION	
4	MS -> SS	SABM	
5	SS -> MS	UA	
6	MS -> SS	HANDOVER COMPLETE	
7	MS, SS		

Specific Message Contents

GSM 450

HANDOVER COMMAND

Information Element	value/remarks
As default message contents, except:	
Cell Description	
- Network Colour Code	1
- Base Station Colour Code	5
- BCCH Carrier Number	274
Channel Description 2	
- Channel Type	00000
- Timeslot number	A suitable value for multislot configuration, chosen arbitrarily.
- Training Sequence Code	Chosen arbitrarily
- Hopping	RF hopping channel.
- MAIO	Chosen arbitrarily from the set (0, 1 to N-1), where N is the number of frequencies encoded in the Frequency List IE.
- HSN	Chosen arbitrarily from the set (1,2,..63).
Synchronization Indication IE is not included.	
Channel Mode IE is not included.	
Description of a multislot configuration:	
- Downlink assignment	As many timeslots assigned as before HANDOVER COMMAND
- Uplink assignment	As many timeslots assigned as before HANDOVER COMMAND
- Channel set X (1=<x<=8)	Same as before HANDOVER COMMAND
Frequency List after time	
- Frequency List	Use Range 128 to encode the following 15 frequencies (260, 262, 264, 266, 268, 270, 272, 276, 279, 281, 283, 285, 287, 289, 291).

PHYSICAL INFORMATION

Information Element	value/remarks
As default message contents, except:	
Timing advance	Arbitrarily selected but different to default value.

GSM 480

HANDOVER COMMAND

Information Element	value/remarks
As default message contents, except: Cell Description - Network Colour Code - Base Station Colour Code - BCCH Carrier Number Channel Description 2 - Channel Type - Timeslot number - Training Sequence Code - Hopping - MAIO - HSN Synchronization Indication IE is not included. Channel Mode IE is not included. Description of a multislot configuration: - Downlink assignment - Uplink assignment - Channel set X (1= x ≤8) Frequency List after time - Frequency List	 1 5 321 00000 A suitable value for multislot configuration, chosen arbitrarily. Chosen arbitrarily RF hopping channel. Chosen arbitrarily from the set (0, 1 to N-1), where N is the number of frequencies encoded in the Frequency List IE. Chosen arbitrarily from the set (1,2,..63). As many timeslots assigned as before HANDOVER COMMAND As many timeslots assigned as before HANDOVER COMMAND Same as before HANDOVER COMMAND Use Range 128 to encode the following 15 frequencies (307, 309, 311, 313, 315, 317, 319, 323, 326, 328, 330, 332, 334, 336, 338).

PHYSICAL INFORMATION

Information Element	value/remarks
As default message contents, except: Timing advance	Arbitrarily selected but different to default value.

P-GSM 900

HANDOVER COMMAND

Information Element	value/remarks
As default message contents, except:	
Cell Description	
- Network Colour Code	1
- Base Station Colour Code	5
- BCCH Carrier Number	40
Channel Description 2	
- Channel Type	00000
- Timeslot number	A suitable value for multislot configuration, chosen arbitrarily.
- Training Sequence Code	Chosen arbitrarily
- Hopping	RF hopping channel.
- MAIO	Chosen arbitrarily from the set (0, 1 to N-1), where N is the number of frequencies encoded in the Frequency Channel Sequence IE.
- HSN	Chosen arbitrarily from the set (1,2,..63).
Synchronization Indication IE is not included.	
Channel Mode IE is not included.	
Description of a multislot configuration:	
- Downlink assignment	As many timeslots assigned as before HANDOVER COMMAND
- Uplink assignment	As many timeslots assigned as before HANDOVER COMMAND
- Channel set X (1=<x<=8)	Same as before HANDOVER COMMAND
Frequency Channel Sequence after time	
- Frequency Channel Sequence	Allocates the following 15 frequencies (14, 18, 22, 24, 30, 31, 38, 53, 66, 73, 74, 75, 76, 108, 114).

PHYSICAL INFORMATION

Information Element	value/remarks
As default message contents, except:	
Timing advance	Arbitrarily selected but different to default value.

DCS 1 800

HANDOVER COMMAND

Information Element	value/remarks
As default message contents, except: Cell Description - Network Colour Code - Base Station Colour Code - BCCH Carrier Number Channel Description 2 - Channel Type - Timeslot number - Training Sequence Code - Hopping - MAIO - HSN Synchronization Indication IE is not included. Channel Mode IE is not included. Description of a multislot configuration: - Downlink assignment - Uplink assignment - Channel set X (1=<X<=8) Frequency List after time - Frequency List	1 5 764 00000 A suitable value for multislot configuration, chosen arbitrarily. Chosen arbitrarily. RF hopping channel. Chosen arbitrarily from the set (0, 1 to N-1), where N is the number of frequencies encoded in the Frequency Short List IE. Chosen arbitrarily from the set (1,2,..63). As many timeslots assigned as before HANDOVER COMMAND As many timeslots assigned as before HANDOVER COMMAND Same as before HANDOVER COMMAND Use Range 256 to encode the following 15 frequencies: (739, 743, 746, 749, 756, 758, 761, 771, 779, 782, 791, 798, 829, 832, 844).

PHYSICAL INFORMATION

Information Element	value/remarks
As default message contents, except: Timing advance	Arbitrarily selected but different to default value.

26.13.1.3.2 Multislot signalling / RR / Handover / successful / call under establishment / non synchronized / resource upgrading

This test is applicable to all MS that supports multislot configuration.

26.13.1.3.2.1 Conformance requirements

- 1) The MS shall correctly apply the handover procedure from non-hopping multislot configuration to non-hopping multislot configuration in the non-synchronized case during call establishment.
- 2) The MS shall activate the new channels that belongs to same multislot configuration correctly, taking into account upgraded resources.
- 3) If during call establishment a Layer 3 MM or CC message just sent by the MS is not Layer 2 acknowledged before the channel change caused by the HANDOVER COMMAND message, the MS shall send the Layer 3 message to the new cell, using the same value in the N(SD) field, after the handover procedure.

References

Conformance requirements: GSM 04.08 sections 3.4.4 and 9.1.15, GSM 04.13 section 5.2.6.2

26.13.1.3.2.2 Test purpose

- 1) To test that when the MS is ordered to make a non-synchronized handover from non-hopping multislot configuration to a non-hopping multislot configuration, it continuously sends access bursts on the main DCCH until it receives a PHYSICAL INFORMATION message from the SS.
- 2) To test that the MS correctly takes the values of the Timing Advance information element in the PHYSICAL INFORMATION message into account.
- 3) To test that the MS activates the new channels that belongs to same multislot configuration correctly, taking into account upgraded resources and transmits the HANDOVER COMPLETE message without undue delay.
- 4) To test that MS correctly retransmits Layer 3 MM or CC messages, that were not acknowledged by Layer 2 before the Handover, after completion of the Handover.

26.13.1.3.2.3 Method of test

Initial Conditions

System Simulator:

- 2 cells, A and B with same LAI, default parameters except:
- Early classmark sending enabled in SI3 rest octets

GSM 450:

Cell A has:

- BCCH ARFCN = 263
- PLMN colour code, NCC = as defaults.
- BS colour code, BCC = as defaults.
- PLMN_PERM = 00001010.

Cell B has:

- BCCH ARFCN = 274
- PLMN colour code, NCC = 3.
- BS colour code, BCC = 0.
- The timebase of cells A and B shall be such that the edges of their timeslots are not coincident at the antenna connector.

GSM 480:

Cell A has:

- BCCH ARFCN = 310
- PLMN colour code, NCC = as defaults.
- BS colour code, BCC = as defaults.
- PLMN_PERM = 00001010.

Cell B has:

- BCCH ARFCN = 321
- PLMN colour code, NCC = 3.
- BS colour code, BCC = 0.

- The timebase of cells A and B shall be such that the edges of their timeslots are not coincident at the antenna connector.

GSM 900:

Cell A has:

- BCCH ARFCN = 20
- PLMN colour code, NCC = as defaults.
- BS colour code, BCC = as defaults.
- PLMN_PERM = 00001010.

Cell B has:

- BCCH ARFCN = 40
- PLMN colour code, NCC = 3.
- BS colour code, BCC = 0.
- The timebase of cells A and B shall be such that the edges of their timeslots are not coincident at the antenna connector.

DCS 1 800:

Cell A has:

- BCCH ARFCN = 747
- PLMN colour code, NCC = as defaults.
- BS colour code, BCC = as defaults.
- PLMN_PERM = 00001010.

Cell B has:

- BCCH ARFCN = 764
- PLMN colour code, NCC = 3.
- BS colour code, BCC = 0.
- The timebase of cells A and B shall be such that the edges of their timeslots are not coincident at the antenna connector.

Mobile Station:

- The MS is in the "idle, updated" state, with a TMSI allocated and camped on cell A..

Related PICS/PIXIT Statements

- Type of MS (GSM 450 or GSM 480 or P-GSM 900 or EGSM or DCS 1 800).
- Multislot class
- Supported teleservices/bearer services
- Classmark

Foreseen Final State of the MS

- "idle, updated" with a TMSI allocated and camped on cell B.

Test Procedure

A Mobile Originating Call is initiated on Cell A. After the MS has sent the SETUP message (and before the last L2 frame carrying the SETUP message is acknowledged by the SS) the SS sends ASSIGNMENT COMMAND message to MS defining used multislot configuration. Multislot configuration with one TCH/F is allocated. MS responds with ASSIGNMENT COMPLETE message. Then the SS sends a HANDOVER COMMAND message, ordering the MS to switch to cell B. The MS shall then begin to send access bursts on the new DCCH to cell B. The SS observes the access bursts and after receiving 10-20 access bursts, the SS sends one PHYSICAL INFORMATION message with a Timing Advance as specified in table 26.13.1.3-1 of section 26.13.1.3.6. The MS shall activate the channels that belongs to same multislot configuration correctly, taking into account upgraded resources. The MS shall establish a signalling link. The MS shall be ready to transmit a HANDOVER COMPLETE message before 650 ms after the end of the PHYSICAL INFORMATION message, but not before a UA frame has been sent by the SS. The MS shall then again send the SETUP message to the SS, using the same value in the N(SD) field. Finally the SS sends a CHANNEL RELEASE to end the test.

The term "ready to transmit" is defined in GSM 04.13.

Maximum Duration of Test

5 minutes, including 1 minute for any necessary operator actions.

Expected Sequence

Step	Direction	Message	Comments
1	-----	-----	An MO call is initiated on cell A.
2	MS -> SS	CHANNEL REQUEST	Establish. Cause = "Originating call, NECI not set to 1"
3	SS -> MS	IMMEDIATE ASSIGNMENT	
4	MS -> SS	CM SERVICE REQUEST	CM Service Type = Mobile Originating Call Establishment.
5	MS -> SS	CLASSMARK CHANGE	Multislot class
6	SS -> MS	AUTHENTICATION REQUEST	
7	MS -> SS	AUTHENTICATION RESPONSE	
8	SS -> MS	CIPHERING MODE COMMAND	
9	MS -> SS	CIPHERING MODE COMPLETE	
10	MS -> SS	SETUP	Last L2 frame not acknowledged by the SS.
11	SS -> MS	ASSIGNMENT COMMAND	Multislot configuration is sent to MS. Multislot configuration with one TCH/F is allocated. See specific message contents below.
12	MS -> SS	ASSIGNMENT COMPLETE	
13	SS -> MS	HANDOVER COMMAND	See specific message contents. Resource upgrading.
14	MS -> SS	HANDOVER ACCESS	Repeated on every burst of the uplink main DCCH until reception of PHYSICAL INFORMATION. Handover Reference as included in the HANDOVER COMMAND
15	SS -> MS	PHYSICAL INFORMATION	Sent after reception of n HANDOVER ACCESS message. Timing Advance as specified in table 26.13.1.3-1 of section 26.13.1.3.6.
16	MS -> SS	SABM	Sent without information field.
17	SS -> MS	UA	
18	MS -> SS	HANDOVER COMPLETE	This message shall be ready to be transmitted before 650 ms after the completion of step 15.
19	MS -> SS	SETUP	Same N(SD) as in step 10.
20	SS -> MS	CHANNEL RELEASE	The main signalling link is released.

Specific Message Contents

GSM 450

ASSIGNMENT COMMAND

Information element	Value/remark
Channel description 2	describes non-hopping Bm+ACCHs or Lm+ACCHs as appropriate for the test
Power Command	As in section 26.1.1
Frequency list	Omitted
Cell channel description	Omitted
Description of the multislot configuration	
- Downlink assignment	Only one timeslot is allocated in downlink direction.
- Uplink assignment	Only one timeslot is allocated in uplink direction.
- Channel set X (1= $X \leq 8$)	Appropriate for the test.
Mode of the channel set X (1= $X \leq 8$)	Appropriate for on bearer capability chosen for the test.
Description of the second channel	Omitted
Mode of the second channel	Omitted
Mobile allocation	Omitted
Starting time	Omitted
Cipher mode setting	Omitted

HANDOVER COMMAND

Information Element	value/remarks
As default message contents, except:	
Cell Description	
- Network Colour Code	3
- Base Station Colour Code	0
- BCCH Carrier Number	274
Channel Description 2	
- Channel Type	00000
- Timeslot number	Chosen arbitrarily, but not Zero.
- Training Sequence Code	Chosen arbitrarily
- Hopping	0 (= no hopping)
- ARFCN	The ARFCN of the BCCH carrier
Synchronization Indication IE is not included.	
Channel Mode IE is not included.	
Description of a multislot configuration:	
- Downlink assignment	More timeslots are assigned than before HANDOVER COMMAND
- Uplink assignment	As many timeslots assigned as before HANDOVER COMMAND
- Channel set X (1= $x \leq 8$)	Same as before HANDOVER COMMAND

PHYSICAL INFORMATION

Information Element	value/remarks
As default message contents, except:	
Timing advance	Arbitrarily selected but different to default value.

GSM 480

ASSIGNMENT COMMAND

Information element	Value/remark
Channel description 2	describes non-hopping Bm+ACCHs or Lm+ACCHs as appropriate for the test
Power Command	As in section 26.1.1
Frequency list	Omitted
Cell channel description	Omitted
Description of the multislot configuration	
- Downlink assignment	Only one timeslot is allocated in downlink direction.
- Uplink assignment	Only one timeslot is allocated in uplink direction.
- Channel set X (1= $X \leq 8$)	Appropriate for the test.
Mode of the channel set X (1= $X \leq 8$)	Appropriate for on bearer capability chosen for the test.
Description of the second channel	Omitted
Mode of the second channel	Omitted
Mobile allocation	Omitted
Starting time	Omitted
Cipher mode setting	Omitted

HANDOVER COMMAND

Information Element	value/remarks
As default message contents, except:	
Cell Description	
- Network Colour Code	3
- Base Station Colour Code	0
- BCCH Carrier Number	321
Channel Description 2	
- Channel Type	00000
- Timeslot number	Chosen arbitrarily, but not Zero.
- Training Sequence Code	Chosen arbitrarily
- Hopping	0 (= no hopping)
- ARFCN	The ARFCN of the BCCH carrier
Synchronization Indication IE is not included.	
Channel Mode IE is not included.	
Description of a multislot configuration:	
- Downlink assignment	More timeslots are assigned than before HANDOVER COMMAND
- Uplink assignment	As many timeslots assigned as before HANDOVER COMMAND
- Channel set X (1= $x \leq 8$)	Same as before HANDOVER COMMAND

PHYSICAL INFORMATION

Information Element	value/remarks
As default message contents, except:	
Timing advance	Arbitrarily selected but different to default value.

P-GSM 900

ASSIGNMENT COMMAND

Information element	Value/remark
Channel description 2	describes non-hopping Bm+ACCHs or Lm+ACCHs as appropriate for the test
Power Command	As in section 26.1.1
Frequency list	Omitted
Cell channel description	Omitted
Description of the multislot configuration	
- Downlink assignment	Only one timeslot is allocated in downlink direction.
- Uplink assignment	Only one timeslot is allocated in uplink direction.
- Channel set X (1= $X \leq 8$)	Appropriate for the test.
Mode of the channel set X (1= $X \leq 8$)	Appropriate for on bearer capability chosen for the test.
Description of the second channel	Omitted
Mode of the second channel	Omitted
Mobile allocation	Omitted
Starting time	Omitted
Cipher mode setting	Omitted

HANDOVER COMMAND

Information Element	value/remarks
As default message contents, except:	
Cell Description	
- Network Colour Code	3
- Base Station Colour Code	0
- BCCH Carrier Number	40
Channel Description 2	
- Channel Type	00000
- Timeslot number	Chosen arbitrarily, but not Zero.
- Training Sequence Code	Chosen arbitrarily
- Hopping	0 (= no hopping)
- ARFCN	The ARFCN of the BCCH carrier
Synchronization Indication IE is not included.	
Channel Mode IE is not included.	
Description of a multislot configuration:	
- Downlink assignment	More timeslots are assigned than before HANDOVER COMMAND
- Uplink assignment	As many timeslots assigned as before HANDOVER COMMAND
- Channel set X (1= $x \leq 8$)	Same as before HANDOVER COMMAND

PHYSICAL INFORMATION

Information Element	value/remarks
As default message contents, except:	
Timing advance	Arbitrarily selected but different to default value.

DCS 1 800

ASSIGNMENT COMMAND

Information element	Value/remark
Channel description 2	describes non-hopping Bm+ACCHs or Lm+ACCHs as appropriate for the test
Power Command	As in section 26.1.1
Frequency list	Omitted
Cell channel description	Omitted
Description of the multislot configuration	Appropriate for the teleservice selected for the test
- Downlink assignment	Only one timeslot is allocated in downlink direction.
- Uplink assignment	Only one timeslot is allocated in uplink direction.
- Channel set X (1= $X \leq 8$)	Appropriate for the test.
Mode of the channel set X (1= $X \leq 8$)	Appropriate for on bearer capability chosen for the test
Description of the second channel	Omitted
Mode of the second channel	Omitted
Mobile allocation	Omitted
Starting time	Omitted
Cipher mode setting	Omitted

HANDOVER COMMAND

Information Element	value/remarks
As default message contents, except:	
Cell Description	
- Network Colour Code	3
- Base Station Colour Code	0
- BCCH Carrier Number	764
Channel Description 2	
- Channel Type	00000
- Timeslot number	Chosen arbitrarily, but not Zero.
- Training Sequence Code	Chosen arbitrarily
- Hopping	0 (= no hopping)
- ARFCN	the ARFCN of the BCCH carrier
Synchronization Indication IE is not included.	
Channel Mode IE is not included.	
Description of a multislot configuration:	
- Downlink assignment	More timeslot are assigned than before HANDOVER COMMAND
- Uplink assignment	As many timeslots assigned as before HANDOVER COMMAND
- Channel set X (1= $x \leq 8$)	Same as before HANDOVER COMMAND

PHYSICAL INFORMATION

Information Element	value/remarks
As default message contents, except:	
Timing advance	Arbitrarily selected but different to default value.

26.13.1.3.3 Multislot signalling / RR / Handover / successful / active call / finely synchronized / resource downgrading

This test is applicable to all MS that supports multislot configuration.

26.13.1.3.3.1 Conformance requirements

- 1) The MS shall correctly apply the handover procedure from multislot configuration with frequency hopping to multislot configuration without frequency hopping in the finely synchronized case when a call is in progress. Resources are downgraded in handover procedure.

References

Conformance requirement 1: GSM 04.08 sections 3.4.4, 9.1.14, 9.1.15 and 9.1.16.

26.13.1.3.3.2 Test purpose

- 1) To test that when the MS is ordered to make a finely synchronized handover to a synchronized cell from a hopping multislot configuration to a non-hopping multislot configuration, it sends 4 access bursts on the main DCCH and then activates the channels correctly, taking into account power command, downgraded resources and correctly calculating the timing advance to use.
- 2) To test the MS activates the new channels that belongs to same multislot configuration correctly, taking into account downgraded resources and transmits the HANOVER COMPLETE message without undue delay.

26.13.1.3.3.3 Method of test

Initial Conditions

System Simulator:

- 2 cells, A and B, with same LAI, default parameters, except:
- Early classmark sending enabled in SI3 rest octets- The BCCH of cell A is sent k bit periods before the BCCH of cell B. The timing advance in cell A sent to the MS is y bit periods. k and y are selected such that $0 < (2k+y) \bmod 256 < 60$.

GSM 450:

- Cell B has BCCH ARFCN = 274.

GSM 480:

- Cell B has BCCH ARFCN = 321.

P-GSM 900:

- Cell B has BCCH ARFCN = 40.

DCS 1 800:

- Cell B has BCCH ARFCN = 764.

Mobile Station:

- The MS is in the active state (U10) of a service using a multislot connection (on cell A). The MS is using a power level P. Where P is a power level within the supported range of that type of MS.

Related PICS/PIXIT Statements

- Type of MS (GSM 450 or GSM 480 or P-GSM 900 or EGSM or DCS 1 800).
- Multislot class
- Supported teleservices/bearer services

Foreseen Final State of the MS

The active state (U10) of a multislot connection (on cell B).

Test Procedure

The MS is in the active state (U10) of a multislot connection on cell A. Maximum number of channels supported by the MS in a HSCSD configuration, is allocated. The SS sends a HANOVER COMMAND on the main DCCH In the case that the MS supports only 1 timeslot in uplink direction the HANOVER COMMAND'S Uplink assignment shall be

one timeslot. The MS shall send 4 access bursts, in 4 successive slots on the new DCCH to cell B. Then the MS shall establish a signalling link indicating the correct Timing Advance and power level and send a HANOVER COMPLETE message.

The MS shall be "ready to transmit" a HANOVER COMPLETE message before 650 ms after the end of the HANOVER COMMAND message, but not before a UA frame has been sent by the SS.

The term "ready to transmit" is defined in GSM 04.13.

Maximum Duration of Test

5 minutes, including 1 minute for any necessary operator actions.

Expected Sequence

Step	Direction	Message	Comments
0	MS, SS		The MS and SS are using a multislot configuration in hopping mode on cell A. Maximum number of channels supported by the MS in a HSCSD configuration, is allocated
1	SS -> MS	HANOVER COMMAND	See Specific Message Contents.
2	MS -> SS	HANOVER ACCESS	See specific message contents. Four messages.
3	MS -> SS	HANOVER ACCESS	are transmitted to Cell B in 4 successive slots.
4	MS -> SS	HANOVER ACCESS	on the new DCCH.
5	MS -> SS	HANOVER ACCESS	
6	MS -> SS	SABM	Sent without information field.
7	SS -> MS	UA	
8	MS -> SS	HANOVER COMPLETE	This message shall be ready to be transmitted before 650 ms after the completion of step 1.
9	SS		The header of the next uplink SACCH/M is examined and the Timing Advance and Power Level indications are examined. The correct timing advance shall be indicated. The power level indication shall indicate the power level used in the handover command.
10	MS, SS		The MS and SS are using a multislot configuration in non-hopping mode on cell B

Specific Message Contents

GSM 450

HANDOVER COMMAND

Information Element	value/remark
As default message contents, except:	
Cell Description	
- Network Colour Code	1
- Base Station Colour Code	5
- BCCH Carrier Number	274
Channel Description 2	
- Channel type	00000
- Timeslot Number	A suitable value for multislot configuration, chosen arbitrarily.
- Training Sequence Code	Chosen arbitrarily.
- Hopping	Single RF Channel.
- ARFCN	274
Handover Reference	
- Value	Chosen arbitrarily from the range (0, 1..255).
Power command	
- Power Level	Arbitrarily chosen, but different to the one already in use and within the range supported by that type of MS.
Synchronization Indication	
- Report Observed Time Difference	Shall not be included.
- Synchronization Indication	"Synchronized".
- Normal Cell Indication	Ignore out of range timing advance.
Description of the multislot connection	
- Uplink assignment	If possible fewer timeslots are allocated than before HANDOVER COMMAND
- Downlink assignment	Less timeslots are allocated than before HANDOVER COMMAND
- Channel set X (1=<X<=8)	Appropriate for the test

HANDOVER ACCESS

Information Element	value/remark
As default message contents except:	
Handover Reference	
- Value	Same as HANDOVER COMMAND

GSM 480

HANDOVER COMMAND

Information Element	value/remark
As default message contents, except:	
Cell Description	
- Network Colour Code	1
- Base Station Colour Code	5
- BCCH Carrier Number	321
Channel Description 2	
- Channel type	00000
- Timeslot Number	A suitable value for multislot configuration, chosen arbitrarily.
- Training Sequence Code	Chosen arbitrarily.
- Hopping	Single RF Channel.
- ARFCN	321
Handover Reference	
- Value	Chosen arbitrarily from the range (0, 1..255).
Power command	
- Power Level	Arbitrarily chosen, but different to the one already in use and within the range supported by that type of MS.
Synchronization Indication	
- Report Observed Time Difference	Shall not be included.
- Synchronization Indication	"Synchronized".
- Normal Cell Indication	Ignore out of range timing advance.
Description of the multislot connection	
- Uplink assignment	If possible fewer timeslots are allocated than before HANDOVER COMMAND
- Downlink assignment	Less timeslots are allocated than before HANDOVER COMMAND
- Channel set X (1=<X<=8)	Appropriate for the test

HANDOVER ACCESS

Information Element	value/remark
As default message contents except:	
Handover Reference	
- Value	Same as HANDOVER COMMAND

GSM 900

HANDOVER COMMAND

Information Element	value/remark
As default message contents, except:	
Cell Description	
- Network Colour Code	1
- Base Station Colour Code	5
- BCCH Carrier Number	40
Channel Description 2	
- Channel type	00000
- Timeslot Number	A suitable value for multislot configuration, chosen arbitrarily.
- Training Sequence Code	Chosen arbitrarily.
- Hopping	Single RF Channel.
- ARFCN	40
Handover Reference	
- Value	Chosen arbitrarily from the range (0, 1..255).
Power command	
- Power Level	Arbitrarily chosen, but different to the one already in use and within the range supported by that type of MS.
Synchronization Indication	
- Report Observed Time Difference	Shall not be included.
- Synchronization Indication	"Synchronized".
- Normal Cell Indication	Ignore out of range timing advance.
Description of the multislot connection	
- Uplink assignment	If possible fewer timeslots are allocated than before HANDOVER COMMAND
- Downlink assignment	Less timeslots are allocated than before HANDOVER COMMAND
- Channel set X (1= $X \leq 8$)	Appropriate for the test

HANDOVER ACCESS

Information Element	value/remark
As default message contents except:	
Handover Reference	
- Value	Same as HANDOVER COMMAND

DCS 1 800

HANDOVER COMMAND

Information Element	value/remark
As default message contents, except:	
Cell Description	
- Network Colour Code	1
- Base Station Colour Code	5
- BCCH Carrier Number	764
Channel Description 2	
- Channel type	00000
- Timeslot Number	A suitable value for multislot configuration, chosen arbitrarily.
- Training Sequence Code	Chosen arbitrarily.
- Hopping	Single RF Channel.
- ARFCN	764
Handover Reference	
- Value	Chosen arbitrarily from the range (0, 1..255).
Power command	
- Power Level	Arbitrarily chosen, but different to the one already in use and within the range supported by that type of MS.
Synchronization Indication	
- Report Observed Time Difference	Shall not be included.
- Synchronization Indication	"Synchronized".
- Normal Cell Indication	Ignore out of range timing advance.
Description of the multislot connection	
- Uplink assignment	Same as before HANDOVER COMMAND or less timeslots are allocated than before HANDOVER COMMAND
- Downlink assignment	Less timeslots are allocated than before HANDOVER COMMAND
- Channel set X (1=<X<=8)	Appropriate for the test

HANDOVER ACCESS

Information Element	value/remark
As default message contents except:	
Handover Reference	
- Value	Same as HANDOVER COMMAND

26.13.1.3.4 Multislot signalling / RR / Handover / successful / call under establishment / finely synchronized / relocation of channels

This test is applicable to all MS that supports multislot configuration.

26.13.1.3.4.1 Conformance requirements

- 1) The MS shall correctly apply the handover procedure from hopping, multislot configuration, finely synchronized case to hopping, multislot configuration, synchronized case during call establishment.
- 2) The MS shall not change number of channels in multislot configuration but the place of each channel is changed.
- 3) If during call establishment a Layer 3 MM or CC message just sent by the MS is not Layer 2 acknowledged before the channel change caused by the HANDOVER COMMAND message, the MS shall send the Layer 3 message to the new cell, using the same value in the N(SD) field, after the handover procedure.

References

Conformance requirements: GSM 04.08 sections 3.4.4 and 9.1.15, GSM 04.13 section 5.2.6.2

26.13.1.3.4.2 Test purpose

- 1) To test that when the MS is ordered to make a finely synchronized handover to a synchronized cell, it sends 4 access bursts on the main DCCH and then activates the channel correctly, taking into account power command, new order of channels in multislot configuration and correctly calculating the timing advance to use. Handover is done from hopping multislot configuration to hopping multislot configuration, number of channels in multislot configuration is not changed but the place of each channel is changed.
- 2) To test that MS correctly retransmits Layer 3 MM or CC messages, that were not acknowledged by Layer 2 before the Handover, after completion of the Handover.
- 3) To verify the MS transmits the HANDOVER COMPLETE message without undue delay.

26.13.1.3.4.3 Method of test

Initial Conditions

System Simulator:

- 2 cells, A and B, with same LAI, default parameters, except:
- Early classmark sending enabled in SI3 rest octets
- The BCCH of cell A is sent k bit periods before the BCCH of cell B. The timing advance in cell A sent to the MS is y bit periods. k and y are selected such that $0 < (2k + y) \bmod 256 < 60$.
- The frame numbers of cells A and B shall be different by 100.

GSM 450:

- Cell A has:
 - BCCH ARFCN = 263.
 - Cell Allocation = (259, 261, 263, 265, 267, 269, 271, 273, 275, 277, 279, 281, 283, 285, 287, 289, 291).
- Cell B has:
 - BCCH ARFCN = 274.
 - Cell Allocation = (260, 262, 264, 266, 268, 270, 272, 274, 276, 279, 281, 283, 285, 287, 289, 291).

GSM 480:

- Cell A has:
 - BCCH ARFCN = 310.
 - Cell Allocation = (306, 308, 310, 312, 314, 316, 318, 320, 322, 324, 326, 328, 330, 332, 334, 336, 338).
- Cell B has:
 - BCCH ARFCN = 321.
 - Cell Allocation = (307, 309, 311, 313, 315, 317, 319, 321, 323, 326, 328, 330, 332, 334, 336, 338).

GSM 900:

- Cell A has:
 - BCCH ARFCN = 20.
 - Cell Allocation = (10, 17, 20, 26, 34, 42, 45, 46, 52, 59, 66, 73, 74, 75, 76, 108, 114).
- Cell B has:
 - BCCH ARFCN = 40.

- Cell Allocation = (14, 18, 22, 24, 30, 31, 38, 40, 60, 66, 73, 74, 75, 76, 108, 114).

DCS 1 800:

- Cell A has:
 - BCCH ARFCN = 747.
 - Cell Allocation = (734, 741, 747, 754, 759, 762, 766, 767, 773, 775, 779, 782, 791, 798, 829, 832, 844).
- Cell B has:
 - BCCH ARFCN = 764.
 - Cell Allocation = (739, 743, 746, 749, 756, 758, 761, 764, 771, 779, 782, 791, 798, 829, 832, 844).

Mobile Station:

- The MS is in the "idle, updated" state, with a TMSI allocated and camped on cell A.

Related PICS/PIXIT Statements

- Type of MS (GSM 450 or GSM 480 or P-GSM 900 or EGSM or DCS 1 800).
- Multislot class.
- Supported teleservices/bearer services
- Classmark

Foreseen Final State of the MS

"Idle, updated" with TMSI allocated and camped on cell B.

Test Procedure

A Mobile Originating Call is initiated on cell A. After the MS has sent the SETUP message (and before the last L2 frame carrying the SETUP message is acknowledged by the SS) the SS sends ASSIGNMENT COMMAND message to MS defining used multislot configuration. MS responds with ASSIGNMENT COMPLETE message. Then the SS sends a HANOVER COMMAND message, ordering the MS to switch to cell B. After the handover timeslots are relocated. Timeslots are also overlapped (this is described in specific message contents). The MS shall then send 4 access bursts, in successive slots on the new DCCH to cell B. Then the MS shall establish a signalling link indicating the correct timing advance and power level (number of channels in multislot configuration is not changed but the place of each channel is changed) and send a HANOVER COMPLETE message. The MS shall be "ready to transmit" the HANOVER COMPLETE message before 1500 ms after the end of the HANOVER COMMAND message, but not before a UA frame has been sent by the SS. The MS shall then again send the SETUP message to the SS, using the same value in the N(SD) field. Finally the SS sends a CHANNEL RELEASE to end the test.

The term "ready to transmit" is defined in GSM 04.13.

Maximum Duration of Test

5 minutes, including 1 minute for any necessary operator actions.

Expected Sequence

Step	Direction	Message	Comments
1	-----	-----	An MO call is initiated.
2	MS -> SS	CHANNEL REQUEST	Establ. Cause = "Originating call, NECI not set to 1"
3	SS -> MS	IMMEDIATE ASSIGNMENT	See Specific Message contents.
4	MS -> SS	CM SERVICE REQUEST	CM Service Type = Mobile Originating Call Establishment.
5	MS -> SS	CLASSMARK CHANGE	Multislot class
6	SS -> MS	AUTHENTICATION REQUEST	
7	MS -> SS	AUTHENTICATION RESPONSE	
8	SS -> MS	CIPHERING MODE COMMAND	
9	MS -> SS	CIPHERING MODE COMPLETE	
10	MS -> SS	SETUP	Last L2 frame not acknowledged by the SS.
11	SS -> MS	ASSIGNMENT COMMAND	Multislot configuration is sent to MS. See specific message contents below.
12	MS -> SS	ASSIGNMENT COMPLETE	
13	MS -> SS	SETUP	Last L2 frame not acknowledged by the SS. Same N(SD) as in step 8.
14	SS -> MS	HANDOVER COMMAND	See Specific Message Contents below.
15	MS -> SS	HANDOVER ACCESS	
16	MS -> SS	HANDOVER ACCESS	
17	MS -> SS	HANDOVER ACCESS	See Specific message contents.
18	MS -> SS	HANDOVER ACCESS	Four messages are transmitted to cell B in 4 successive slots on the new DCCH.
19	MS -> SS	SABM	Sent without information field.
20	SS -> MS	UA	
21	MS -> SS	HANDOVER COMPLETE	The message shall be ready to be transmitted before 1500 ms after the completion of step 12.
22	SS		The header of the next uplink SACCH/M is examined and the Timing Advance and Power Level indications are examined. The correct timing advance shall be indicated. The power level indication shall indicate the power level used in the handover command.
23	MS -> SS	SETUP	Same N(SD) as in step 8.
24	SS -> MS	CHANNEL RELEASE	The main signalling link is released.

Specific Message Contents

DCS 1 800:

ASSIGNMENT COMMAND

Information element	Value/remark
Channel description 2	describes hopping Bm+ACCHs or Lm+ACCHs as appropriate for the test
Power Command	As in section 26.1.1
Frequency list	Omitted
Cell channel description	Omitted
Description of the multislot configuration	
- Uplink assignment	Appropriate for the test
- Downlink assignment	Appropriate for the test
- Channel set X (1=<X<=8)	Appropriate for the test
Mode of the channel set X (1=<X<=8)	Appropriate for the test
Description of the second channel	Omitted
Mode of the second channel	Omitted
Mobile allocation	Arbitrarily chosen from Cell channel description
Starting time	Omitted
Cipher mode setting	Omitted

HANDOVER ACCESS

Information Element	value/remark
As default message contents except: Handover Reference - Value	Same as HANDOVER COMMAND

GSM 450:

ASSIGNMENT COMMAND

Information element	Value/remark
Channel description 2	describes hopping Bm+ACCHs or Lm+ACCHs as appropriate for the test
Power Command	As in section 26.1.1
Frequency list	Omitted
Cell channel description	Omitted
Description of the multislot configuration	
- Uplink assignment	Appropriate for the test
- Downlink assignment	Appropriate for the test
- Channel set X (1= X ≤8)	Appropriate for the test
Mode of the channel set X (1= X ≤8)	Appropriate for the test
Description of the second channel	Omitted
Mode of the second channel	Omitted
Mobile allocation	Omitted
Starting time	Omitted
Cipher mode setting	Omitted

IMMEDIATE ASSIGNMENT

Information Element	value/remark
As default message contents except:	
Channel Description	Channel Description.
- Channel Type	SDCCH/8
- TDMA offset	As default message contents.
- Timeslot number	Arbitrary value, but not zero.
- Training Sequence Code	Chosen arbitrarily.
- Hopping	RF hopping channel.
- MAIO	Chosen arbitrarily from the set (0, 1 to N-1), where N is the number of frequencies encoded in the Mobile Allocation.
- HSN	Chosen arbitrarily from the set (1,2,..63).
Mobile Allocation	Indicates all of the CA of cell A except for the BCCH frequency.

HANDOVER COMMAND

Information Element	value/remark
As default message contents except:	
Cell Description	
- Network Colour Code	1
- Base Station Colour Code	5
- BCCH Carrier Number	274
Channel Description 2	
- Channel Type	00000
- TDMA offset	Chosen arbitrarily.
- Timeslot number	A suitable value for multislot configuration, chosen arbitrarily.
- Training Sequence Code	Chosen arbitrarily.
- Hopping	RF hopping channel.
- MAIO	Chosen arbitrarily from the set (0, 1 to N-1), where N is the number of frequencies encoded in the Frequency List IE.
- HSN	Zero (this gives cyclic hopping).
Handover Reference	
- Value	Chosen arbitrarily from the range (0, 1..255).
Power command	
- Power Level	Arbitrarily chosen, but different to the one already in use and within the range supported by the MS.
Synchronization Indication	
- Report Observed Time Difference	Shall not be included.
- Synchronization Indication	"Synchronized".
- Normal Cell Indication	Ignore out of range timing advance.
Frequency List after time	
- Frequency List	Use Range 512 to encode the complete CA of Cell B.
Description of the multislot configuration	
- Downlink assignment	For Type 1 MS timeslots are shifted one position to right if timeslot 7 is not used. If timeslot 7 is used then timeslots are shifted one position to left. For type 2 MS timeslots are shifted one position to right taking into account rules of multislot capability described in 05.02 Annex B.
- Uplink assignment	For Type 1 MS timeslots are shifted one position to right if timeslot 7 is not used. If timeslot 7 is used then timeslots are shifted one position to left. For type 2 MS timeslots are shifted one position to right taking into account rules of multislot capability described in 05.02 Annex B.
- Channel set X (1=<X<=8)	Appropriate for the test.

HANDOVER ACCESS

Information Element	value/remark
As default message contents except:	
Handover Reference	
- Value	Same as HANDOVER COMMAND

GSM 480:

ASSIGNMENT COMMAND

Information element	Value/remark
Channel description 2	describes hopping Bm+ACCHs or Lm+ACCHs as appropriate for the test
Power Command	As in section 26.1.1
Frequency list	Omitted
Cell channel description	Omitted
Description of the multislot configuration	
- Uplink assignment	Appropriate for the test
- Downlink assignment	Appropriate for the test
- Channel set X (1= $X \leq 8$)	Appropriate for the test
Mode of the channel set X (1= $X \leq 8$)	Appropriate for the test
Description of the second channel	Omitted
Mode of the second channel	Omitted
Mobile allocation	Omitted
Starting time	Omitted
Cipher mode setting	Omitted

IMMEDIATE ASSIGNMENT

Information Element	value/remark
As default message contents except:	
Channel Description	Channel Description.
- Channel Type	SDCCH/8
- TDMA offset	As default message contents.
- Timeslot number	Arbitrary value, but not zero.
- Training Sequence Code	Chosen arbitrarily.
- Hopping	RF hopping channel.
- MAIO	Chosen arbitrarily from the set (0, 1 to N-1), where N is the number of frequencies encoded in the Mobile Allocation.
- HSN	Chosen arbitrarily from the set (1,2,..63).
Mobile Allocation	Indicates all of the CA of cell A except for the BCCH frequency.

HANDOVER COMMAND

Information Element	value/remark
As default message contents except:	
Cell Description	
- Network Colour Code	1
- Base Station Colour Code	5
- BCCH Carrier Number	321
Channel Description 2	
- Channel Type	00000
- TDMA offset	Chosen arbitrarily.
- Timeslot number	A suitable value for multislot configuration, chosen arbitrarily.
- Training Sequence Code	Chosen arbitrarily.
- Hopping	RF hopping channel.
- MAIO	Chosen arbitrarily from the set (0, 1 to N-1), where N is the number of frequencies encoded in the Frequency List IE.
- HSN	Zero (this gives cyclic hopping).
Handover Reference	
- Value	Chosen arbitrarily from the range (0, 1..255).
Power command	
- Power Level	Arbitrarily chosen, but different to the one already in use and within the range supported by the MS.
Synchronization Indication	
- Report Observed Time Difference	Shall not be included.
- Synchronization Indication	"Synchronized".
- Normal Cell Indication	Ignore out of range timing advance.
Frequency List after time	
- Frequency List	Use Range 512 to encode the complete CA of Cell B.
Description of the multislot configuration	
- Downlink assignment	For Type 1 MS timeslots are shifted one position to right if timeslot 7 is not used. If timeslot 7 is used then timeslots are shifted one position to left. For type 2 MS timeslots are shifted one position to right taking into account rules of multislot capability described in 05.02 Annex B.
- Uplink assignment	For Type 1 MS timeslots are shifted one position to right if timeslot 7 is not used. If timeslot 7 is used then timeslots are shifted one position to left. For type 2 MS timeslots are shifted one position to right taking into account rules of multislot capability described in 05.02 Annex B.
- Channel set X (1= \leq X \leq 8)	Appropriate for the test.

HANDOVER ACCESS

Information Element	value/remark
As default message contents except:	
Handover Reference	
- Value	Same as HANDOVER COMMAND

GSM 900:

ASSIGNMENT COMMAND

Information element	Value/remark
Channel description 2	describes hopping Bm+ACCHs or Lm+ACCHs as appropriate for the test
Power Command	As in section 26.1.1
Frequency list	Omitted
Cell channel description	Omitted
Description of the multislot configuration	
- Uplink assignment	Appropriate for the test
- Downlink assignment	Appropriate for the test
- Channel set X (1= $X \leq 8$)	Appropriate for the test
Mode of the channel set X (1= $X \leq 8$)	Appropriate for the test
Description of the second channel	Omitted
Mode of the second channel	Omitted
Mobile allocation	Arbitrarily chosen from Cell channel description
Starting time	Omitted
Cipher mode setting	Omitted

IMMEDIATE ASSIGNMENT

Information Element	value/remark
As default message contents except:	
Channel Description	Channel Description.
- Channel Type	SDCCH/8
- TDMA offset	As default message contents.
- Timeslot number	Arbitrary value, but not zero.
- Training Sequence Code	Chosen arbitrarily.
- Hopping	RF hopping channel.
- MAIO	Chosen arbitrarily from the set (0, 1 to N-1), where N is the number of frequencies encoded in the Mobile Allocation.
- HSN	Chosen arbitrarily from the set (1,2,..63).
Mobile Allocation	Indicates all of the CA of cell A except for the BCCH frequency.

HANDOVER COMMAND

Information Element	value/remark
As default message contents except:	
Cell Description	
- Network Colour Code	1
- Base Station Colour Code	5
- BCCH Carrier Number	40
Channel Description 2	
- Channel Type	00000
- TDMA offset	Chosen arbitrarily.
- Timeslot number	A suitable value for multislot configuration, chosen arbitrarily.
- Training Sequence Code	Chosen arbitrarily.
- Hopping	RF hopping channel.
- MAIO	Chosen arbitrarily from the set (0, 1 to N-1), where N is the number of frequencies encoded in the Frequency List IE.
- HSN	Zero (this gives cyclic hopping).
Handover Reference	
- Value	Chosen arbitrarily from the range (0, 1..255).
Power command	
- Power Level	Arbitrarily chosen, but different to the one already in use and within the range supported by the MS.
Synchronization Indication	
- Report Observed Time Difference	Shall not be included.
- Synchronization Indication	"Synchronized".
- Normal Cell Indication	Ignore out of range timing advance.
Frequency List after time	
- Frequency List	Use Range 512 to encode the complete CA of Cell B.
Description of the multislot configuration	
- Downlink assignment	For Type 1 MS timeslots are shifted one position to right if timeslot 7 is not used. If timeslot 7 is used then timeslots are shifted one position to left. For type 2 MS timeslots are shifted one position to right taking into account rules of multislot capability described in 05.02 Annex B.
- Uplink assignment	For Type 1 MS timeslots are shifted one position to right if timeslot 7 is not used. If timeslot 7 is used then timeslots are shifted one position to left. For type 2 MS timeslots are shifted one position to right taking into account rules of multislot capability described in 05.02 Annex B.
- Channel set X (1= $X \leq 8$)	Appropriate for the test.

HANDOVER ACCESS

Information Element	value/remark
As default message contents except:	
Handover Reference	
- Value	Same as HANDOVER COMMAND

26.13.1.3.5 Multislot signalling / RR /Handover / successful / call under establishment / pre-synchronized / resource upgrading

If an MS does not implement the pre-synchronized handover procedure correctly then calls may fail.

If an MS does not report the observed time difference between cells correctly then pseudo synchronized handovers might not be possible for any MS.

This test is applicable to all MS that supports multislot configuration.

26.13.1.3.5.1 Conformance requirements

- 1) If during call establishment a Layer 3 MM or CC message just sent by the MS is not Layer 2 acknowledged before the channel change caused by the HANOVER COMMAND message, the MS shall send the Layer 3 message to the new cell, using the same value in the N(SD) field, after the handover procedure.
- 2) When the Timing Advance information element is included in the HANOVER COMMAND, the MS shall access the new cell with the timing advance included in the Timing Advance IE.
- 3) The MS shall be ready to transmit the HANOVER COMPLETE message within 650 ms of the end of the HANOVER COMMAND message.
- 4) When requested to do so in the HANOVER COMMAND message, the MS shall return the Mobile Time Difference IE in the HANOVER COMPLETE message indicating the sum of the observed time difference between the cells and the timing advance used on the old cell.

References

Conformance requirement 1: GSM 04.08, sections 3.1.4.3 and 9.1.5.

Conformance requirement 2: GSM 05.10, section 6.6, GSM 04.08 section 9.1.16.

Conformance requirement 3: GSM 04.13, section 5.2.6.1.

Conformance requirement 4: GSM 04.08, section 10.5.2.39.

26.13.1.3.5.2 Test purpose

- 1) To verify that when the MS is ordered to make a pre-synchronized handover from hopping multislot configuration to non-hopping multislot configuration, it sends 4 access bursts on the main DCCH and then activates the channel correctly and correctly calculates the time to transmit.
- 2) To test that the MS activates the new channels that belong to same multislot configuration correctly, taking into account upgraded resources and transmits the HANOVER COMPLETE message without undue delay.

26.13.1.3.5.3 Method of test

Initial Conditions

System Simulator:

- 2 cells, A and B, with same LAI, default parameters, except:
- Early classmark sending enabled in SI3 rest octets
- The BCCH of cell A is sent k bit periods before the BCCH of cell B.

Mobile Station:

- The MS is in the "idle, updated" state, with a TMSI allocated and camped on cell A.

Related PICS/PIXIT Statements

- Type of MS (GSM 450 or GSM 480 or P-GSM 900 or EGSM or DCS 1 800).
- Multislot class
- Classmark

Foreseen Final State of the MS

"Idle, updated" with TMSI allocated and camped on cell B.

Test Procedure

A Mobile Originating Call is initiated. The SS sends an IMMEDIATE ASSIGNMENT message allocating an SDCCH/4. The MS is commanded to use a timing advance of y bit periods on cell A. After the MS has sent the SETUP message (and before the last L2 frame carrying the SETUP message is acknowledged by the SS) the SS sends ASSIGNMENT COMMAND message to MS specifying used multislot configuration. MS responds by sending ASSIGNMENT COMPLETE message to SS. Then the SS sends a HANOVER COMMAND, ordering the MS to switch to cell B. The MS shall then send 4 access bursts, at the commanded power level, in 4 successive slots of the new DCCH to cell B. Then the MS shall establish a signalling link using the correct timing advance and send a HANOVER COMPLETE message. The MS shall be ready to transmit the HANOVER COMPLETE message before 650 ms after the end of the HANOVER COMMAND message, but not before a UA frame has been sent by the SS.

The term "ready to transmit" is defined in GSM 04.13.

The MS shall then again send the SETUP message to the SS, using the same value in the N(SD) field. Finally the SS sends a CHANNEL RELEASE to end the test.

Maximum Duration of Test

20 seconds.

Expected Sequence

Step	Direction	Message	Comments
1	-----	-----	An MO call is initiated.
2	MS -> SS	CHANNEL REQUEST	
3	SS -> MS	IMMEDIATE ASSIGNMENT	to an SDCCH/4.
4	MS -> SS	CM SERVICE REQUEST	
5	MS -> SS	CLASSMARK CHANGE	Multislot class
6	SS -> MS	AUTHENTICATION REQUEST	
7	MS -> SS	AUTHENTICATION RESPONSE	
8	SS -> MS	CIPHERING MODE COMMAND	
9	MS -> SS	CIPHERING MODE COMPLETE	
10	MS -> SS	SETUP	Last L2 frame not acknowledged by the SS.
11	SS -> MS	ASSIGNMENT COMMAND	Multislot configuration is sent to MS. Multislot configuration shall not have the maximum number of timeslots allocated. See specific message contents below.
12	MS -> SS	ASSIGNMENT COMPLETE	
13	MS -> SS	SETUP	Last L2 frame not acknowledged by the SS. Same N(SD) as in step 10.
14	SS -> MS	HANOVER COMMAND	See specific message contents below.
15	MS -> SS	HANOVER ACCESS	Handover Reference as included in the
16	MS -> SS	HANOVER ACCESS	HANOVER COMMAND
17	MS -> SS	HANOVER ACCESS	
18	MS -> SS	HANOVER ACCESS	
19	MS -> SS	SABM	Sent without information field.
20	SS -> MS	UA	
21	MS -> SS	HANOVER COMPLETE	This message shall be ready to be transmitted before 650 ms after the completion of step 14. Shall include the Mobile Time Difference IE with value $(2k+y) \bmod 2,097,152$ half bit periods. A tolerance of ± 2 half bit periods is allowed.
22	MS -> SS	SETUP	Same N(SD) as in step 10
23	SS	-	The SS checks that the timing advance reported in the layer 1 header of the SACCH/M message that is sent in the first SACCH/M multiframe following the SABM is 9 bit periods.
24	SS -> MS	CHANNEL RELEASE	The main signalling link is released.

Specific Message Contents

GSM 450

ASSIGNMENT COMMAND

Information element	Value/remark
Channel description 2	describes hopping Bm+ACCHs or Lm+ACCHs as appropriate for the test
Power Command	As in section 26.1.1
Frequency list	Omitted
Cell channel description	Omitted
Description of the multislot configuration	
- Uplink assignment	Appropriate for the test, shall not be the maximum number of timeslots.
- Downlink assignment	Appropriate for the test, but shall not be the maximum number of timeslots.
- Channel set X (1=<X<=8)	Appropriate for the test
Mode of the channel set X (1=<X<=8)	Appropriate for the test
Description of the second channel	Omitted
Mode of the second channel	Omitted
Mobile allocation	Arbitrarily chosen from Cell channel description
Starting time	Omitted
Cipher mode setting	Omitted

HANDOVER COMMAND

Information Element	value/remarks
As default message contents, except:	
Cell Description	
- Network Colour Code	1
- Base Station Colour Code	5
- BCCH Carrier Number	274
Channel Description 2	
- Channel Type	00000
- Timeslot number	A suitable value for multislot configuration, chosen arbitrarily.
- Training Sequence Code	Chosen arbitrarily
- Hopping	0 (= no hopping)
- ARFCN	Chosen arbitrarily
Synchronization Indication.	pre-synchronized; ROT=1; NCI=0.
Channel Mode IE is not included.	
Description of a multislot configuration:	
- Downlink assignment	More timeslots are allocated than before HANDOVER COMMAND
- Uplink assignment	Same as before HANDOVER COMMAND
- Channel set X (1=<x<=8)	Same as before HANDOVER COMMAND
Timing Advance	9 bit periods.

GSM 480

ASSIGNMENT COMMAND

Information element	Value/remark
Channel description 2	describes hopping Bm+ACCHs or Lm+ACCHs as appropriate for the test
Power Command	As in section 26.1.1
Frequency list	Omitted
Cell channel description	Omitted
Description of the multislot configuration	
- Uplink assignment	Appropriate for the test, shall not be the maximum number of timeslots.
- Downlink assignment	Appropriate for the test, but shall not be the maximum number of timeslots.
- Channel set X (1=<X<=8)	Appropriate for the test
Mode of the channel set X (1=<X<=8)	Appropriate for the test
Description of the second channel	Omitted
Mode of the second channel	Omitted
Mobile allocation	Arbitrarily chosen from Cell channel description
Starting time	Omitted
Cipher mode setting	Omitted

HANDOVER COMMAND

Information Element	value/remarks
As default message contents, except:	
Cell Description	
- Network Colour Code	1
- Base Station Colour Code	5
- BCCH Carrier Number	321
Channel Description 2	
- Channel Type	00000
- Timeslot number	A suitable value for multislot configuration, chosen arbitrarily.
- Training Sequence Code	Chosen arbitrarily
- Hopping	0 (= no hopping)
- ARFCN	Chosen arbitrarily
Synchronization Indication.	pre-synchronized; ROT=1; NCI=0.
Channel Mode IE is not included.	
Description of a multislot configuration:	
- Downlink assignment	More timeslots are allocated than before HANDOVER COMMAND
- Uplink assignment	Same as before HANDOVER COMMAND
- Channel set X (1=<x<=8)	Same as before HANDOVER COMMAND
Timing Advance	9 bit periods.

P-GSM 900

ASSIGNMENT COMMAND

Information element	Value/remark
Channel description 2	describes hopping Bm+ACCHs or Lm+ACCHs as appropriate for the test
Power Command	As in section 26.1.1
Frequency list	Omitted
Cell channel description	Omitted
Description of the multislot configuration	Appropriate for the test, shall not be the maximum number of timeslots.
- Uplink assignment	Appropriate for the test, but shall not be the maximum number of timeslots.
- Downlink assignment	Appropriate for the test
- Channel set X (1=<X<=8)	Appropriate for the test
Mode of the channel set X (1=<X<=8)	Appropriate for the test
Description of the second channel	Omitted
Mode of the second channel	Omitted
Mobile allocation	Arbitrarily chosen from Cell channel description
Starting time	Omitted
Cipher mode setting	Omitted

HANDOVER COMMAND

Information Element	value/remarks
As default message contents, except:	
Cell Description	
- Network Colour Code	1
- Base Station Colour Code	5
- BCCH Carrier Number	40
Channel Description 2	
- Channel Type	00000
- Timeslot number	A suitable value for multislot configuration, chosen arbitrarily.
- Training Sequence Code	Chosen arbitrarily
- Hopping	0 (= no hopping)
- ARFCN	Chosen arbitrarily
Synchronization Indication.	pre-synchronized; ROT=1; NCI=0.
Channel Mode IE is not included.	
Description of a multislot configuration:	
- Downlink assignment	More timeslots are allocated than before HANDOVER COMMAND
- Uplink assignment	Same as before HANDOVER COMMAND
- Channel set X (1=<x<=8)	Same as before HANDOVER COMMAND
Timing Advance	9 bit periods.

DCS 1 800

ASSIGNMENT COMMAND

Information element	Value/remark
Channel description 2	describes hopping Bm+ACCHs or Lm+ACCHs as appropriate for the test
Power Command	As in section 26.1.1
Frequency list	Omitted
Cell channel description	Omitted
Description of the multislot configuration	
- Uplink assignment	Appropriate for the test, but shall not be the maximum number of timeslots.
- Downlink assignment	Appropriate for the test, but shall not be the maximum number of timeslots.
- Channel set X (1=<X<=8)	Appropriate for the test
Mode of the channel set X (1=<X<=8)	Appropriate for the test
Description of the second channel	Omitted
Mode of the second channel	Omitted
Mobile allocation	Arbitrarily chosen from Cell channel description
Starting time	Omitted
Cipher mode setting	Omitted

HANDOVER COMMAND

Information Element	value/remarks
As default message contents, except:	
Cell Description	
- Network Colour Code	1
- Base Station Colour Code	5
- BCCH Carrier Number	764
Channel Description 2	
- Channel Type	00000
- Timeslot number	A suitable value for multislot configuration, chosen arbitrarily.
- Training Sequence Code	Chosen arbitrarily
- Hopping	0 (= no hopping)
- ARFCN	Chosen arbitrarily
Synchronization Indication.	pre-synchronized; ROT=1; NCI=0.
Channel Mode IE is not included.	
Description of a multislot configuration:	
- Downlink assignment	More timeslots are allocated than before HANDOVER COMMAND
- Uplink assignment	Same as before HANDOVER COMMAND
- Channel set X (1=<x<=8)	Same as before HANDOVER COMMAND
Timing Advance	9 bit periods.

26.13.1.4 Multislot signalling / RR / Test of the channel mode modify procedure

This test is applicable to all MS that supports multislot configuration.

26.13.1.4.1 Conformance requirements

- 1) When the MS has received the CHANNEL MODE MODIFY message, the mobile station changes the mode for the indicated channel and then replies by a CHANNEL MODE MODIFY ACKNOWLEDGE message indicating the new channel mode.
- 2) If the mobile station does not support the indicated mode, it shall retain the old mode and return the associated channel mode information in the CHANNEL MODE MODIFY ACKNOWLEDGE message.

References

Conformance requirement: GSM 04.08, sections 3.4.6 and 9.1.5 and 9.1.6

26.13.1.4.2 Test purpose

- 1) To verify that the MS, in an RR connected state, acknowledges a CHANNEL MODE MODIFY message by sending a CHANNEL MODE MODIFY ACKNOWLEDGEMENT message specifying and switching to the correct mode for the channels in a multislot configuration
 - the new mode if that mode is supported
 - the old mode if the new mode is not supported.
- 2) This shall be verified for all existing channel modes
 - data 9.6 Kb/s
 - data 4.8 Kb/s full rate
 - data 14.4 Kb/s

26.13.1.4.3 Method of test

Initial Conditions

System Simulator:

- 1 cells, default parameters except:
- Early classmark sending enabled in SI3 rest octets

Mobile Station:

- The MS is "idle updated", with TMSI allocated.

Related PICS/PIXIT statement(s)

- Type of MS (GSM 450 or GSM 480 or P-GSM 900 or EGSM or DCS 1 800).
- Supported tesleservices/bearer services
- Channel modes supported by the MS:
 - MS supports data 9,6 Kb/s (p1 = Y/N)
 - MS supports data 4,8 Kb/s full rate (p2 = Y/N)
 - MS supports data 14.4 Kb/s (p3 = Y/N)
- Multislot class
- Classmark

Foreseen final state of the MS

“Idle, updated “ with TMSI allocated.

Test procedure

- 1) A Mobile Terminated multislot connection is initiated, however following the Channel Request received from the Mobile Station, the SS sends an Immediate Assignment to the MS commanding it to go to a TCH/F. This sets the Channel Mode automatically to "Signalling Only".
- 2) The SS then sends a series of CHANNEL MODE MODIFY messages to the MS. Each time it is checked that the MS responds with a CHANNEL MODE MODIFY ACKNOWLEDGE message specifying:
 - 2.1) the channel mode that has been specified in the CHANNEL MODE MODIFY message, if the MS supports that mode (this mode then becomes the "channel mode in use");
 - 2.2) the channel mode that was in use when the CHANNEL MODE MODIFY message has been received, if the MS does not support the channel mode specified in the CHANNEL MODE MODIFY message.

Maximum duration of test

3 minutes.

Expected Sequence

Step	Direction	Message	Comments
1	SS->MS	PAGING REQUEST TYPE 1	Sent on correct paging subchannel.
2	MS->SS	CHANNEL REQUEST	Establishment cause indicates "answer to paging".
3	SS->MS	IMMEDIATE ASSIGNMENT	Assignment to a non hopping TCH/F.
4	MS->SS	PAGING RESPONSE	
5	MS->SS	CLASSMARK CHANGE	Multislot class
6	SS->MS	ASSIGNMENT COMMAND	Multislot configuration, Channel mode = 'signalling only'
7	MS->SS	ASSIGNMENT COMPLETE	
8	SS->MS	CHANNEL MODE MODIFY	See specific message contents
9	MS->SS	CHANNEL MODE MODIFY ACKNOWLEDGE	See specific message contents
10	SS->MS	CHANNEL MODE MODIFY	See specific message contents
11	MS->SS	CHANNEL MODE MODIFY ACKNOWLEDGE	See specific message contents
12	SS->MS	CHANNEL MODE MODIFY	See specific message contents
13	MS->SS	CHANNEL MODE MODIFY ACKNOWLEDGE	See specific message contents
14	SS->MS	CHANNEL RELEASE	The main signalling link is released

Specific Message Contents

CHANNEL MODE MODIFY

Information Element	value/remark
Channel description	describes the already assigned dedicated channel.
Channel mode Mode	in step 8: data 9,6 Kb/s in step 10: data 4,8 Kb/s full rate in step 12: data 14,4 Kb/s

CHANNEL MODE MODIFY ACKNOWLEDGE

Channel mode Mode	in step 9: if p1 = Y: data 9,6 Kb/s if p1 = N: signalling only in step 11: if p2 = Y: data 4,8 Kb/s full rate if p2 = N: same as in step 9 in step 13: if p3 = Y: data 14,4 Kb/s full rate if p2 = N: same as in step 11
----------------------	---

26.13.1.5 Multislot signalling / RR / Early classmark sending

This test is applicable to all MS that supports multislot configuration.

26.13.1.5.1 Conformance requirement

- 1) MS uses Controlled Early Classmark Sending procedure when indicated in SYSTEM INFORMATION TYPE 3 (ES ind bit in SI 3 Rest Octets).
 - 1.1) If Controlled Early Classmark Sending is not allowed by network the MS does not send a CLASSMARK CHANGE message.
 - 1.2) If Controlled Early Classmark Sending is allowed by network the MS shall send its multislot class in Mobile Station Classmark 3 in a CLASSMARK CHANGE message.

Reference

Conformance requirement 1: GSM 04.08 sections 3.3.1.1.4 and 3.4.10

26.13.1.5.2 Test purpose

- 1) To verify that the MS sends its multislot class in Mobile Station Classmark 3 using Controlled Early Classmark Sending procedure if allowed by network
- 2) To verify that the MS does not perform Early Classmark Sending if it is not allowed

26.13.1.5.3 Method of test

Initial conditions

Mobile Station:

- The MS is in MM-state "idle, updated" with valid TMSI and CKSN.

System Simulator:

- 1 cell, default parameters except:
- Early classmark sending enabled in SI3 rest octets

Related PICS/PIXIT statement(s)

- Classmark
- Multislot class

Foreseen final state of the MS

MS is in MM-state "idle, updated" with valid TMSI and CKSN.

Test procedure

The MS is made to initiate a multislot connection. In the first case Controlled Early Classmark Sending procedure is allowed by network, the MS performs Early Classmark sending. In the second case Controlled Early Classmark Sending procedure is not allowed by network, the MS does not send a CLASSMARK CHANGE message.

SS checks Controlled Early Classmark Change procedure from CLASSMARK CHANGE message. If Controlled Early Classmark Sending procedure is allowed by the network ES ind bit in SI 3 Resr Octets is set. If this bit is not set SS sends CHANNEL RELEASE and the main signalling link is released. If ES ind bit was set then the MS's multislot class is sent in Mobile Station Classmark 3 (octet 4) in the CLASSMARK CHANGE message.

Maximum duration of test

2 minutes

Expected sequence

This test is executed with the following sequences in allowed and not allowed cases respectively.

After the first sequence Early classmark sending is disabled from SI3 rest octets.

Step	Direction	Message	Comments
	SS		Controlled Early Classmark Sending procedure is allowed by the network.
1	SS -> MS	PAGING REQUEST TYPE 1	Sent on the correct paging subchannel. Establishment cause is: answer to paging Message is contained in SABM. SS checks that MS sent its multislot class in Mobile Station Classmark 3.
2	MS -> SS	CHANNEL REQUEST	
3	SS -> MS	IMMEDIATE ASSIGNMENT	
4	MS -> SS	PAGING RESPONSE	
5	MS -> SS	CLASSMARK CHANGE	
7	SS -> MS	CHANNEL RELEASE	The main signalling link is released

Step	Direction	Message	Comments
	SS		Controlled Early Classmark Sending procedure is not allowed by the network.
1	SS -> MS	PAGING REQUEST TYPE 1	Sent on the correct paging subchannel. Establishment cause is: answer to paging Message is contained in SABM SS checks for 2 seconds that no CLASSMARK CHANGE message is sent by the MS.
2	MS -> SS	CHANNEL REQUEST	
3	SS -> MS	IMMEDIATE ASSIGNMENT	
4	MS -> SS	PAGING RESPONSE	
5	SS		
6	SS -> MS	CHANNEL RELEASE	The main signalling link is released.

NOTE: Step 5: GSM 04.08 section 3.3.1.1.4.1 states that the MS shall send CLASSMARK CHANGE as early as possible. 2 seconds are chosen as a reasonable value to verify that the MS does not send a CLASSMARK CHANGE message.

26.13.1.6 Default contents of layer 3 messages for RR tests

26.13.1.6.1 Default contents of GSM 900 layer 3 messages for RR tests

This section contains the default values of GSM 900 L3 messages, which unless indicated otherwise in section 26.13 shall be transmitted by the system simulator and which are required to be received from the GSM 900 MS under test.

The necessary L3 messages are listed in alphabetic order, with the exception of the SYSTEM INFORMATION messages, where it is the information elements that are listed in alphabetic order (this is because some information elements occur in several SYSTEM INFORMATION types).

In this section, decimal values are normally used. However, sometimes a hexadecimal value, indicated by an "H", or a binary value, indicated by a "B" is used.

Default SYSTEM INFORMATION:

NOTE 1: SYSTEM INFORMATION 2 bis, SYSTEM INFORMATION 5 bis, SYSTEM INFORMATION 7, and SYSTEM INFORMATION 8 messages are not used.

Cell A

Contents of information elements in SYSTEM INFORMATION TYPE 1 to 6 messages for cell A.

(CBCH) Channel Description	Not present.
(CBCH) Mobile Allocation	Not present.
Cell Channel Description	
- Format identifier	bit map 0.
- Cell Allocation ARFCN	Channels 20, 30, 50 and 70.
Cell Identity	
- Cell Identity Value	0001H
Cell Options	
- Power Control Indicator	Power Control Indicator is not set.
- DTX Indicator	MS shall not use DTX.
- Radio_Link_Timeout	8 SACCH blocks.
Cell Selection Parameters	
- Cell_Reselect_Hysteresis	12 dB.
- MX_TXPWR_MAX_CCH	Minimum level.
- ACS	No addition cell parameters are present in SYSTEM INFORMATION messages 7 and 8.
- NECI	New establishment causes not supported.
- RXLEV_ACCESS_MIN	Minimum level.
Control Channel Description	
- Attach-Detach allowed	No Attach/Detach.
- BS_AG_BLK_RES	0 blocks reserved for access grant.
- CCCH_CONF	1 basic physical channel used for CCCH, combined with SDCCCHs.
- BS_PA_MFRMS	5 multiframe periods for transmission of paging messages.
- T3212 Time-out value	Infinite.
L2 pseudo length	
- System information 1	21
- System information 2	22
- System information 3	18
- System information 4	12
Location Area Identification	
- Mobile Country Code	001 decimal
- Mobile Network Code	01 decimal
- Location Area Code	0001H
Message Type	
- System information 1	00011001
- System information 2	00011010
- System information 3	00011011
- System information 4	00011100
- System information 5	00011101
- System information 6	00011110
Neighbour Cells Description	
- Format identifier	bit map 0.
- BCCH Allocation Sequence	0
- BCCH Allocation ARFCN	Channels 10, 20, 40, 80, 90, 100, 110 and 120.
- EXT-IND	This IE carries the complete BA.
NCC Permitted	0000 0010
RACH Control Parameters	
- Max Retrans	Max 1 retrans.
- Tx-integer	5 slots used.
- Cell Barred for Access	Cell is not barred.
- Call Reestablishment Allowed	Not allowed.
- Access Control Class	Access is not barred.
- Emergency Call allowed	Yes.
SI 1 rest octets	Not used (all bits are set to spare).
SI 2 rest octets	Not used (all bits are set to spare).
SI 3 rest octets	Not used (all bits are set to spare).
SI 4 rest octets	Not used (all bits are set to spare).

Default settings for cell A:

Downlink input level Uplink output power Propagation profile BCCH/CCCH carrier number	63 dBmicroVolt emf. minimum supported by the MS's power class. static. 20
--	--

Cell B

The contents of SYSTEM INFORMATION TYPE 1 to 6 messages for cell B are identical to those of cell A with the following exceptions:

Cell Channel Description - Format Identifier - Cell Allocation ARFCN	Bit map 0. Channel Number 10.
--	----------------------------------

NOTE 2: This IE needs modification when used in handover tests that command the MS to go to a frequency hopping channel in cell B.

Cell Identity

- Cell Identity Value 0002H

Default settings for cell B:

Downlink input level Uplink output power Propagation profile BCCH/CCCH carrier number	53 dBmicroVolt emf. minimum supported by the MS's power class. static. 10
--	--

Contents of ALERTING message (SS to MS):

Protocol Discriminator Transaction Identifier TI value TI flag Message Type All other information elements	Call Control. As used in the SETUP message. 1 (destination side). 00000001 Not present.
---	---

Contents of ASSIGNMENT COMMAND message:

Protocol Discriminator Skip Indicator Message Type Channel Description 2 - Channel Type and TDMA offset - Timeslot Number - Training Sequence Code - Hopping - ARFCN Power Command - Power level Multislot allocation - Downlink assignment - Uplink assignment - Channel set 1=<X<=8 Channel mode	RR Management. 0000 00101110 Bm + ACCHs Chosen arbitrarily by the test house. Chosen arbitrarily by the test house. Single RF channel. Channel number 30. Chosen arbitrarily by the test house. Appropriate for the test Appropriate for the test Appropriate for the test Appropriate for the test
---	---

Contents of ASSIGNMENT COMPLETE message:

Protocol Discriminator	RR Management.
Skip Indicator	0000
Message Type	00101001
RR Cause	
- RR Cause Value	Normal event.

Contents of ASSIGNMENT FAILURE message:

Protocol Discriminator	RR Management.
Skip Indicator	0000
Message Type	00101111
RR Cause	
- RR Cause Value	Depending on test.

Contents of AUTHENTICATION REQUEST message:

Protocol Discriminator	MM message.
Skip Indicator	0000
Message Type	00010010
Ciphering Key Sequence Number	
- Key Sequence	Chosen arbitrarily by the test house from the range 0 to 6.
Authentication Parameter RAND	
- RAND value	Chosen arbitrarily by the test house.

Contents of AUTHENTICATION RESPONSE message:

Protocol Discriminator	MM message.
Skip Indicator	0000
Message Type	0X010100
Other information element(s)	Not checked.

Contents of CALL PROCEEDING message:

Protocol Discriminator	Call Control.
Transaction Identifier	
TI value	As used in the SETUP message.
TI flag	1 (destination side).
Message Type	00000010
All other information elements	Not present.

Contents of CHANNEL MODE MODIFY message:

Protocol Discriminator	RR Management.
Skip Indicator	0000
Message Type	00010000
Channel Description 2	
- Channel Type and TDMA offset	Depending on test.
- Timeslot Number	Chosen arbitrarily by the test house.
- Training Sequence Code	Chosen arbitrarily by the test house.
- Hopping	Single RF channel.
- ARFCN	Channel number 30.
Channel Mode	
- Mode	Depending on test.

Contents of CHANNEL MODE MODIFY ACKNOWLEDGE message:

Protocol Discriminator	RR Management.
Skip Indicator	0000
Message Type	00010111
Channel Description 2	
- Channel Type and TDMA offset	Depending on test.
- Timeslot Number	Same as in the CHANNEL MODE MODIFY message.
- Training Sequence Code	Same as in the CHANNEL MODE MODIFY message.
- Hopping	Single RF channel.
- Frequency Band	Band number 0.
- ARFCN	Channel number 30.
Channel Mode	
- Mode	Same as in the CHANNEL MODE MODIFY message.

Contents of CHANNEL RELEASE message:

Protocol Discriminator	RR Management.
Skip Indicator	0000
Message Type	00001101
RR Cause	
- RR Cause Value	Normal event.

Contents of CHANNEL REQUEST message

Establishment Cause	Not checked.
Random Reference	Not checked.

Contents of CIPHERING MODE COMMAND message:

Protocol Discriminator	RR Management.
Skip Indicator	0000
Message Type	00110101
Cipher Mode Setting	
- algorithm identifier	cipher with A5/1.
- SC	Start ciphering.
Cipher Response	IMEI shall not be included.

Contents of CIPHERING MODE COMPLETE message:

Protocol Discriminator	RR Management.
Skip Indicator	0000
Message Type	00110010
Mobile Identity	Not present.

Contents of the CLASSMARK CHANGE message:

Protocol Discriminator	RR Management.
Skip Indicator	0000
Message Type	000100110
Mobile Station Classmark 2	See PICS/PIXIT.
Mobile Station Classmark 3	For presence and contents see PICS/PIXIT.

Contents of CM SERVICE ACCEPT message:

Protocol Discriminator	Mobility Management.
Skip Indicator	0000
Message Type	00100001

Contents of CM SERVICE REQUEST message

Protocol Discriminator	Mobility Management.
Skip Indicator	0000
Message Type	0X100100
Other information elements	Not checked.

Contents of CONFIGURATION CHANGE COMMAND message (SS to MS)

Protocol Discriminator	Radio Resource
Skip Indicator	0000
Message type	00110000
Multislot allocation	Appropriate for the test
- Downlink assignment	Appropriate for the test
- Uplink assignment	Appropriate for the test
- Channel set $1 \leq X \leq 8$	Appropriate for the test
Channel mode $1 \leq X \leq 8$	Appropriate for the test

Contents of CONFIGURATION CHANGE ACKNOWLEDGE message (MS to SS)

Protocol Discriminator	Radio Resource
Skip Indicator	0000
Message type	00110001

Contents of CONFIGURATION CHANGE REJECT message (MS to SS)

Protocol Discriminator	Radio Resource
Skip Indicator	0000
Message type	00110011
RR Cause	Protocol Error Unspecified

Contents of CONNECT message (SS to MS)

Protocol Discriminator	Call Control.
Transaction Identifier	
TI value	As used in the SETUP message.
TI flag	1
Message Type	00000111
All other information elements	Not present.

Contents of CONNECT ACKNOWLEDGE message (MS to SS)

Protocol Discriminator	Call Control.
Transaction Identifier	
TI value	As used in the SETUP message.
TI flag	0
Message Type	0X001111

Contents of HANDOVER ACCESS message:

Handover Reference	Equal to the value included in the Handover Command message.
--------------------	--

Contents of HANDOVER COMMAND message:

Protocol Discriminator	RR Management.
Skip Indicator	0000
Message Type	00101011
Cell Description	
- Network Colour Code	1
- Base station Colour Code	Corresponding to target cell
- BCCH Carrier Number	Set to the BCCH carrier number of cell B. (one of 10, 20, 80, 90, 100, 110 or 120).
Channel Description 2	
- Channel Type and TDMA offset	Bm + ACCHs.
- Timeslot Number	Chosen arbitrarily by the test house.
- Training Sequence Code	Chosen arbitrarily by the test house.
- Hopping	Single RF channel.
- ARFCN	Chosen arbitrarily by the test house from those supported on the target cell.
Handover Reference	
- Handover Reference Value	Chosen arbitrarily by the test house.
Power Command	
- Power level	Chosen arbitrarily by the test house.
Multislot allocation	
- Downlink assignment	Appropriate for the test
- Uplink assignment	Appropriate for the test
- Channel set 1=<X<=8	Appropriate for the test
Channel mode	Appropriate for the test

Contents of HANDOVER COMPLETE message:

Protocol Discriminator	RR Management.
Skip Indicator	0000
Message Type	00101100
RR cause	Normal event.
Time difference	Not present.

Contents of HANDOVER FAILURE message:

Protocol Discriminator	RR Management.
Skip Indicator	0000
Message Type	00101000
RR cause	Dependent on the test.

Contents of IMMEDIATE ASSIGNMENT message:

L2 pseudo length	This is the sum of the lengths of all the information elements present in the message except for the IA rest octets and L2 pseudo length IEs. For the default message the L2 pseudo length is 11.
Protocol Discriminator	RR Management.
Skip Indicator	0000
Message Type	00111111
Page Mode	
- Page Mode	Normal Paging.
Channel Description	
- Channel Type and TDMA offset	For non-combined CCCH/SDCCH (see initial conditions), SDCCH/8, with subchannel chosen arbitrarily by the test house For combined CCCH/SDCCH (default SS conditions), SDCCH/4, with subchannel chosen arbitrarily by the test house.
- Timeslot Number	For non-combined CCCH/SDCCH (see initial conditions), chosen arbitrarily by the test house; For combined CCCH/SDCCH (default SS conditions), SDCCH/4, timeslot zero.
- Training Sequence Code	For non-combined CCCH/SDCCH (see initial conditions), chosen arbitrarily by the test house; For combined CCCH/SDCCH (default SS conditions), SDCCH/4, TSC=5 (same as the BCC).
- Hopping	Single RF channel.
- ARFCN	For non-combined CCCH/SDCCH (see initial conditions), Channel number 30; For combined CCCH/SDCCH (default SS conditions), SDCCH/4, Channel number 20.
Request Reference	Pertaining to last Channel Request sent by the MS.
Timing Advance	
- Timing advance value	30 bit periods.
Mobile Allocation	
- Length	0
Starting Time	Not present.
IA rest octets	Not used (all bits set to spare).

Contents of IMMEDIATE ASSIGNMENT EXTENDED message:

L2 pseudo length	This is the sum of the lengths of all the information elements present in the message except for the IAX rest octets and L2 pseudo length IEs. For the default message the L2 pseudo length is 18.
Protocol Discriminator	RR Management.
Skip Indicator	0000
Message Type	00111001
Page Mode	
- Page Mode	Normal Paging.
Channel Description 1	
- Channel Type and TDMA offset	For non-combined CCCH/SDCCH (see test conditions), SDCCH/8, with subchannel chosen arbitrarily by the test house; For combined CCCH/SDCCH (default SS conditions), SDCCH/4, with subchannel chosen arbitrarily by the test house.
- Timeslot Number	For non-combined CCCH/SDCCH (see test conditions), chosen arbitrarily by the test house; For combined CCCH/SDCCH (default SS conditions), SDCCH/4, timeslot zero.
- Training Sequence Code	For non-combined CCCH/SDCCH (see initial conditions), chosen arbitrarily by the test house; For combined CCCH/SDCCH (default SS conditions), SDCCH/4, TSC=5 (same as the BCC).
- Hopping	Single RF channel.
- ARFCN	For non-combined CCCH/SDCCH (see initial conditions), Channel number 30; For combined CCCH/SDCCH (default SS conditions), SDCCH/4, Channel number 20.
Request Reference 1	Pertaining to last Channel Request sent by the MS.
Timing Advance 1	
- Timing advance value	Chosen arbitrarily by the test house.
Channel Description 2	
- Channel Type and TDMA offset	Same channel type as in Channel Description 1, but different TDMA offset to that in Channel Description 1.
- Timeslot Number	equal to the value in Channel Description 1.
- Training Sequence Code	equal to the value in Channel Description 1.
- Hopping	Single RF channel.
- ARFCN	equal to the value in Channel Description 1.
Request Reference 2	Not pertaining to any Channel Requests sent by the MS.
Timing Advance 2	
- Timing advance value	Chosen arbitrarily by the test house.
Mobile Allocation	
- Length	0
Starting Time	Not present.
IAX rest octets	Not used (all bits set to spare).

Contents of IMMEDIATE ASSIGNMENT REJECT message:

L2 pseudo length	19
Protocol Discriminator	RR Management.
Skip Indicator	0000
Message Type	00111010
Page Mode	
- Page Mode	Normal Paging.
Request Reference	Pertaining to last Channel Request sent by the MS.
Wait Indication	0 seconds.
Request Reference	Not pertaining to the MS under test.
Wait Indication	0 seconds.
Request Reference	Not pertaining to the MS under test.
Wait Indication	0 seconds.
Request Reference	Not pertaining to the MS under test.
Wait Indication	0 seconds.
IAR rest octets	Not used (all bits set to spare).

Contents of LOCATION UPDATING REQUEST message:

Protocol Discriminator	MM message.
Skip Indicator	0000
Message Type	0X001000
Other information elements	Not checked.

Contents of PAGING REQUEST TYPE 1 message:

L2 pseudo length	This is the sum of the lengths of all the information elements present in the message except for the P1 rest octets and L2 pseudo length IEs. For the default message the L2 pseudo length is 9.
Protocol Discriminator	RR Management.
Skip Indicator	0000
Message Type	00100001
Page Mode	
- Page Mode	Normal Paging.
Channels needed	
- first channel	any channel.
- second channel	any channel.
Mobile Identity 1	
- odd/even indication	Even.
- Type of Identity	TMSI.
- Identity Digits	TMSI previously allocated to MS.
Mobile Identity 2	Not present.
P1 rest octets	Not used (all bits set to spare).

Contents of PAGING REQUEST TYPE 2 message:

L2 pseudo length	This is the sum of the lengths of all the information elements present in the message except for the P2 rest octets and L2 pseudo length IEs. For the default message the L2 pseudo length is 11.
Protocol Discriminator	RR Management..
Skip Indicator	0000
Message Type	00100010
Page Mode	
- Page Mode	Normal Paging.
Channels needed	
- first channel	any channel.
- second channel	any channel.
Mobile Identity 1	
- TMSI value	TMSI previously allocated to MS.
Mobile Identity 2	
- TMSI value	TMSI not allocated to MS.
Mobile Identity	Not present.
P2 rest octets	Not used (all bits set to spare).

Contents of PAGING REQUEST TYPE 3 message:

L2 pseudo length	19
Protocol Discriminator	RR Management.
Skip Indicator	0000
Message Type	00100100
Page Mode	
- Page Mode	Normal Paging.
Channels needed	
- first channel	any channel.
- second channel	any channel.
Mobile identity 1	
- TMSI value	TMSI previously allocated to MS.
Mobile identity 2	
- TMSI value	TMSI not allocated to MS.
Mobile identity 3	
- TMSI value	TMSI not allocated to MS.
Mobile identity 4	
- TMSI value	TMSI not allocated to MS.
P3 rest octets	Not used (all bits set to spare).

Contents of PAGING RESPONSE message:

Protocol Discriminator	RR Management.
Skip Indicator	0000
Message Type	00100111
Ciphering Key Sequence Number	
- Key Sequence	Key sequence number previously allocated to MS, or "111" if no key is available.
Mobile Station Classmark 2	
Mobile Identity	
- odd/even indication	Even
- Type of identity	TMSI
- Identity Digits	TMSI previously allocated to MS.

Contents of PHYSICAL INFORMATION message:

Protocol Discriminator	RR Management.
Skip Indicator	0000
Message Type	00101101
Timing advance	20 bit periods.

Contents of SETUP message; (MS to SS):

Protocol Discriminator	Call Control.
Transaction Identifier	
TI value	any value from the set {0, ..., 6}.
TI flag	0
Message Type	0X000101
Other information elements	Not checked.

26.13.1.6.2 Default contents of DCS 1 800 layer 3 messages for RR tests

This section contains the default values of DCS 1 800 L3 messages, which unless indicated otherwise in section 26.6 shall be transmitted by the system simulator and which are required to be received from the DCS 1 800 MS under test. These values are used in order to be consistent with the phase 2 version of 26.6.

The necessary L3 messages are listed in alphabetic order, with the exception of the SYSTEM INFORMATION messages, where it is the information elements that are listed in alphabetic order (this is because some information elements occur in several SYSTEM INFORMATION types).

In this section, decimal values are normally used. However, sometimes a hexadecimal value, indicated by an "H", or a binary value, indicated by a "B" is used.

Default SYSTEM INFORMATION:

NOTE 1: SYSTEM INFORMATION 2 bis, SYSTEM INFORMATION 7, and SYSTEM INFORMATION 8 messages are not used.

SYSTEM INFORMATION 5 bis is not sent as a default message. For those tests that require SYSTEM INFORMATION 5 bis see the specific message contents for that test.

Cell A

Contents of information elements in SYSTEM INFORMATION TYPE 1 to 6 messages for cell A.

(CBCH) Channel Description	Not present.
(CBCH) Mobile Allocation	Not present.
Cell Channel Description	
- Format identifier	Range 512.
- Cell Allocation ARFCN	Channel Numbers, 590, 650, 750 and 850.
Cell Identity	
- Cell Identity Value	0001H
Cell Options	
- Power Control Indicator	Power Control Indicator is not set, 0
- DTX Indicator	MS shall not use DTX.
- Radio_Link_Timeout	8 SACCH blocks.
Cell Selection Parameters	
- Cell_Reselect_Hysteresis	12 dB
- MX_TXPWR_MAX_CCH	Minimum level.
- ACS	No addition cell parameters are present in SYSTEM INFORMATION messages 7 and 8.
- NECI	New establishment causes not supported.
- RXLEV_ACCESS_MIN	Minimum level.
Control Channel Description	
- Attach-Detach allowed	MS shall not apply.
- BS_AG_BLK_RES	0 blocks reserved for access grant.
- CCCH_CONF	1 basic physical channel used for CCCH, combined with SDCCHs.
- BS_PA_MFRMS	5 multiframe periods for transmission of paging messages.
- T3212 Time-out value	Infinite.
L2 pseudo length	
- System information 1	21
- System information 2	22
- System information 3	18
- System information 4	12
Location Area Identification	
- Mobile Country Code	001 decimal.
- Mobile Network Code	01 decimal.
- Location Area Code	0001H
Message Type	
- System information 1	00011001
- System information 2	00011010
- System information 3	00011011
- System information 4	00011100
- System information 5	00011101
- System information 6	00011110
Neighbour Cells Description	
- Format identifier	Range 512.
- BCCH Allocation Sequence	0
- BCCH Allocation ARFCN	Channels numbers, 520, 590, 600, 700, 764, 780, 810, 870.
- EXT-IND	This IE carries the complete BA. EXT-IND is 0.
NCC Permitted	0000 0010
RACH Control Parameters	
- Max Retrans	Max 1 retrans.
- Tx-integer	5 slots used.
- Cell Barred for Access	Cell is not barred.
- Call Reestablishment Allowed	Not Allowed.
- Access Control Class	Access is not barred.
- Emergency Call allowed	Yes.
SI 1 rest octets	Not used (all bits are set to spare).
SI 2 rest octets	Not used (all bits are set to spare).
SI 3 rest octets	Not used (all bits are set to spare).
SI 4 rest octets	Not used (all bits are set to spare).

Default settings for cell A:

Downlink input level Uplink output power Propagation profile BCCH/CCCH carrier number	63 dBmicroVolt emf(). minimum supported by the MS's power class static. ARFN 590.
--	--

Cell B

The contents of SYSTEM INFORMATION TYPE 1 to 6 messages for cell B are identical to those of cell A with the following exceptions:

Cell Channel Description - Format Identifier - Cell Allocation ARFCN	Range 512. Channel Number 520.
--	-----------------------------------

NOTE 2: This IE needs modification when used in handover tests that command the MS to go to a frequency hopping channel in cell B.

Cell Identity - Cell Identity Value	0002H
--	-------

Default settings for cell B:

Downlink input level Uplink output power Propagation profile BCCH/CCCH carrier number	53 dBmicroVolt emf(). minimum supported by the MS's power class static. 520
--	--

Contents of ALERTING message (SS to MS):

Protocol Discriminator Transaction Identifier TI value TI flag Message Type All other information elements	Call Control. As used in the SETUP message. 1 (destination side). 00000001 Not present.
---	---

Contents of ASSIGNMENT COMMAND message:

Protocol Discriminator Skip Indicator Message Type Channel Description - Channel Type and TDMA offset - Timeslot Number - Training Sequence Code - Hopping - ARFCN Power Command - Power level Multislot allocation - Downlink assignment - Uplink assignment - Channel set 1= $X \leq 8$ Channel mode 1= $X \leq 8$	RR Management. 0000 00101110 Bm + ACCHs. Chosen arbitrarily by the test house. Chosen arbitrarily by the test house. Single RF channel. Channel number 650. Chosen arbitrarily by the test house. Appropriate for the test Appropriate for the test Appropriate for the test Appropriate for the test Appropriate for the test
---	---

Contents of ASSIGNMENT COMPLETE message:

Protocol Discriminator	RR Management.
Skip Indicator	0000
Message Type	00101001
RR Cause	
- RR Cause Value	Normal event.

Contents of ASSIGNMENT FAILURE message:

Protocol Discriminator	RR Management.
Skip Indicator	0000
Message Type	00101111
RR Cause	
- RR Cause Value	Depending on test.

Contents of AUTHENTICATION REQUEST message:

Protocol Discriminator	MM message.
Skip Indicator	0000
Message Type	00010010
Ciphering Key Sequence Number	
- Key Sequence	Chosen arbitrarily by the test house from the range 0 to 6.
Authentication Parameter RAND	
- RAND value	Chosen arbitrarily by the test house.

Contents of AUTHENTICATION RESPONSE message:

Protocol Discriminator	MM message.
Skip Indicator	0000
Message Type	0X010100
Other information element(s)	Not checked.

Contents of CALL PROCEEDING message:

Protocol Discriminator	Call Control.
Transaction Identifier	
TI value	As used in the SETUP message.
TI flag	1 (destination side).
Message Type	00000010
All other information elements	Not present.

Contents of CHANNEL MODE MODIFY message:

Protocol Discriminator	RR Management.
Skip Indicator	0000
Message Type	00010000
Channel Description	
- Channel Type and TDMA offset	Depending on test.
- Timeslot Number	Chosen arbitrarily by the test house.
- Training Sequence Code	Chosen arbitrarily by the test house.
- Hopping	Single RF channel.
- ARFCN	Channel number 650.
Channel Mode	
- Mode	Depending on test.

Contents of CHANNEL MODE MODIFY ACKNOWLEDGE message:

Protocol Discriminator	RR Management.
Skip Indicator	0000
Message Type	00010111
Channel Description	Depending on test.
- Channel Type and TDMA offset	Same as in the CHANNEL MODE MODIFY message.
- Timeslot Number	Same as in the CHANNEL MODE MODIFY message.
- Training Sequence Code	Single RF channel.
- Hopping	Band number 0.
- Frequency Band	Channel number 650.
- ARFCN	
Channel Mode	
- Mode	Same as in the CHANNEL MODE MODIFY message.

Contents of CHANNEL RELEASE message:

Protocol Discriminator	RR Management.
Skip Indicator	0000
Message Type	00001101
RR Cause	
- RR Cause Value	Normal event.

Contents of CHANNEL REQUEST message:

Establishment Cause	Not checked.
Random Reference	Not checked.

Contents of CIPHERING MODE COMMAND message:

Protocol Discriminator	RR Management.
Skip Indicator	0000
Message Type	00110101
Cipher Mode Setting	
- algorithm identifier	cipher with A5/1.
- SC	Start ciphering.
Cipher Response	IMEI shall not be included.

Contents of CIPHERING MODE COMPLETE message:

Protocol Discriminator	RR Management.
Skip Indicator	0000
Message Type	00110010
Mobile Identity	Not present.

Contents of the CLASSMARK CHANGE message:

Protocol Discriminator	RR Management.
Skip Indicator	0000
Message Type	000100110
Mobile Station Classmark 2	
- RF Power Capability	See PICS/PIXIT.
- Frequency Capability	Set to 0.
Mobile Station Classmark 3	For presence and contents see PICS/PIXIT.

Contents of CM SERVICE ACCEPT message:

Protocol Discriminator	Mobility Management.
Skip Indicator	0000
Message Type	00100001

Contents of CM SERVICE REQUEST message:

Protocol Discriminator	Mobility Management.
Skip Indicator	0000
Message Type	0X100100
Other information elements	Not checked.

Contents of CONFIGURATION CHANGE COMMAND message (SS to MS)

Protocol Discriminator	Radio Resource
Skip Indicator	0000
Message type	00110000
Multislot allocation	Appropriate for the test
- Downlink assignment	Appropriate for the test
- Uplink assignment	Appropriate for the test
- Channel set $1 \leq X \leq 8$	Appropriate for the test
Channel mode $1 \leq X \leq 8$	Appropriate for the test

Contents of CONFIGURATION CHANGE ACKNOWLEDGE message (MS to SS)

Protocol Discriminator	Radio Resource
Skip Indicator	0000
Message type	00110001

Contents of CONFIGURATION CHANGE REJECT message (MS to SS)

Protocol Discriminator	Radio Resource
Skip Indicator	0000
Message type	00110011
RR Cause	Protocol Error Unspecified

Contents of CONNECT message (SS to MS):

Protocol Discriminator	Call Control.
Transaction Identifier	
TI value	As used in the SETUP message.
TI flag	1
Message Type	00000111
All other information elements	Not present.

Contents of CONNECT ACKNOWLEDGE message (MS to SS):

Protocol Discriminator	Call Control.
Transaction Identifier	
TI value	As used in the SETUP message.
TI flag	0
Message Type	0X001111

Contents of HANDOVER ACCESS message:

Handover Reference	Equal to the value included in the Handover Command message.
--------------------	--

Contents of HANDOVER COMMAND message:

Protocol Discriminator	RR Management.
Skip Indicator	0000
Message Type	00101011
Cell Description	
- Network Colour Code	1
- Base station Colour Code	Corresponding to target cell
- BCCH Carrier Number	Set to the BCCH carrier number of cell B. (one of 520, 590, 600, 700, 780, 810 or 870).
Channel Description	
- Channel Type and TDMA offset	Bm + ACCHs.
- Timeslot Number	Chosen arbitrarily by the test house.
- Training Sequence Code	Chosen arbitrarily by the test house.
- Hopping	Single RF channel.
- ARFCN	Chosen arbitrarily by the test house from those supported on the target cell.
Handover Reference	
- Handover Reference Value	Chosen arbitrarily by the test house.
Power Command	
- Power level	Chosen arbitrarily by the test house.
All other information elements	Not present.

Contents of HANDOVER COMPLETE message:

Protocol Discriminator	RR Management.
Skip Indicator	0000
Message Type	00101100
RR cause	Normal event.
Time difference	Not present.

Contents of HANDOVER FAILURE message:

Protocol Discriminator	RR Management.
Skip Indicator	0000
Message Type	00101000
RR cause	Dependent on the test.

Contents of IMMEDIATE ASSIGNMENT message:

L2 pseudo length	This is the sum of the lengths of all the information elements present in the message except for the IA rest octets and L2 pseudo length IEs. For the default message the L2 pseudo length is 11.
Protocol Discriminator	RR Management.
Skip Indicator	0000
Message Type	00111111
Page Mode	
- Page Mode	Normal Paging.
Channel Description	
- Channel Type and TDMA offset	For non-combined CCCH/SDCCH (see initial conditions), SDCCH/8, with subchannel chosen arbitrarily by the test house For combined CCCH/SDCCH (default SS conditions), SDCCH/4, with subchannel chosen arbitrarily by the test house.
- Timeslot Number	For non-combined CCCH/SDCCH (see initial conditions), chosen arbitrarily by the test house; For combined CCCH/SDCCH (default SS conditions), SDCCH/4, timeslot zero.
- Training Sequence Code	For non-combined CCCH/SDCCH (see initial conditions), chosen arbitrarily by the test house; For combined CCCH/SDCCH (default SS conditions), SDCCH/4, TSC=5 (same as the BCC).
- Hopping	Single RF channel.
- ARFCN	For non-combined CCCH/SDCCH (see initial conditions), Channel number 650; For combined CCCH/SDCCH (default SS conditions), SDCCH/4, Channel number 590.
Request Reference	Pertaining to last Channel Request sent by the MS.
Timing Advance	
- Timing advance value	30 bit periods.
Mobile Allocation	
- Length	0
Starting Time	Not present.
IA rest octets	Not used (all bits set to spare).

Contents of IMMEDIATE ASSIGNMENT EXTENDED message:

L2 pseudo length	This is the sum of the lengths of all the information elements present in the message except for the IAX rest octets and L2 pseudo length IEs. For the default message the L2 pseudo length is 18.
Protocol Discriminator	RR Management.
Skip Indicator	0000
Message Type	00111001
Page Mode	
- Page Mode	Normal Paging.
Channel Description 1	
- Channel Type and TDMA offset	For non-combined CCCH/SDCCH (see test conditions), SDCCH/8, with subchannel chosen arbitrarily by the test house; For combined CCCH/SDCCH (default SS conditions), SDCCH/4, with subchannel chosen arbitrarily by the test house.
- Timeslot Number	For non-combined CCCH/SDCCH (see test conditions), chosen arbitrarily by the test house; For combined CCCH/SDCCH (default SS conditions), SDCCH/4, timeslot zero.
- Training Sequence Code	For non-combined CCCH/SDCCH (see initial conditions), chosen arbitrarily by the test house; For combined CCCH/SDCCH (default SS conditions), SDCCH/4, TSC=5 (same as the BCC).
- Hopping	Single RF channel.
- ARFCN	For non-combined CCCH/SDCCH (see initial conditions), Channel number 650; For combined CCCH/SDCCH (default SS conditions), SDCCH/4, Channel number 590.
Request Reference 1	Pertaining to last Channel Request sent by the MS.
Timing Advance 1	
- Timing advance value	Chosen arbitrarily by the test house.
Channel Description 2	
- Channel Type and TDMA offset	Same channel type as in Channel Description 1, but different TDMA offset to that in Channel Description 1.
- Timeslot Number	equal to the value in Channel Description 1.
- Training Sequence Code	equal to the value in Channel Description 1.
- Hopping	Single RF channel.
- ARFCN	equal to the value in Channel Description 1.
Request Reference 2	Not pertaining to any Channel Requests sent by the MS.
Timing Advance 2	
- Timing advance value	Chosen arbitrarily by the test house.
Mobile Allocation	
- Length	0
Starting Time	Not present.
IAX rest octets	Not used (all bits set to spare).

Contents of IMMEDIATE ASSIGNMENT REJECT message:

L2 pseudo length	19
Protocol Discriminator	RR Management.
Skip Indicator	0000
Message Type	00111010
Page Mode	
- Page Mode	Normal Paging.
Request Reference	Pertaining to last Channel Request sent by the MS.
Wait Indication	0 seconds.
Request Reference	Not pertaining to the MS under test.
Wait Indication	0 seconds.
Request Reference	Not pertaining to the MS under test.
Wait Indication	0 seconds.
Request Reference	Not pertaining to the MS under test.
Wait Indication	0 seconds.
IAR rest octets	Not used (all bits set to spare).

Contents of LOCATION UPDATING REQUEST message:

Protocol Discriminator	MM message.
Skip Indicator	0000
Message Type	0X001000
Other information elements	Not checked.

Contents of PAGING REQUEST TYPE 1 message:

L2 pseudo length	This is the sum of the lengths of all the information elements present in the message except for the P1 rest octets and L2 pseudo length IEs. For the default message the L2 pseudo length is 9.
Protocol Discriminator	RR Management.
Skip Indicator	0000
Message Type	00100001
Page Mode	
- Page Mode	Normal Paging.
Channels needed	
- first channel	any channel.
- second channel	any channel.
Mobile Identity 1	
- odd/even indication	Even.
- Type of Identity	TMSI.
- Identity Digits	TMSI previously allocated to MS.
Mobile Identity 2	Not present.
P1 rest octets	Not used (all bits set to spare).

Contents of PAGING REQUEST TYPE 2 message:

L2 pseudo length	This is the sum of the lengths of all the information elements present in the message except for the P2 rest octets and L2 pseudo length IEs. For the default message the L2 pseudo length is 11.
Protocol Discriminator	RR Management.
Skip Indicator	0000
Message Type	00100010
Page Mode	
- Page Mode	Normal Paging.
Channels needed	
- first channel	any channel.
- second channel	any channel.
Mobile Identity 1	
- TMSI value	TMSI previously allocated to MS.
Mobile Identity 2	
- TMSI value	TMSI not allocated to MS.
Mobile Identity	Not present.
P2 rest octets	Not used (all bits set to spare).

Contents of PAGING REQUEST TYPE 3 message:

L2 pseudo length	19
Protocol Discriminator	RR Management.
Skip Indicator	0000
Message Type	00100100
Page Mode	
- Page Mode	Normal Paging.
Channels needed	
- first channel	any channel.
- second channel	any channel.
Mobile identity 1	
- TMSI value	TMSI previously allocated to MS.
Mobile identity 2	
- TMSI value	TMSI not allocated to MS.
Mobile identity 3	
- TMSI value	TMSI not allocated to MS.
Mobile identity 4	
- TMSI value	TMSI not allocated to MS.
P3 rest octets	Not used (all bits set to spare).

Contents of PAGING RESPONSE message:

Protocol Discriminator	RR Management.
Skip Indicator	0000
Message Type	00100111
Ciphering Key Sequence Number	
- Key Sequence	Key sequence number previously allocated to MS, or "111" if no key is available.
Mobile Station Classmark 2	
Mobile Identity	
- odd/even indication	Even.
- Type of identity	TMSI
- Identity Digits	TMSI previously allocated to MS.

Contents of PHYSICAL INFORMATION message:

Protocol Discriminator	RR Management.
Skip Indicator	0000
Message Type	00101101
Timing advance	20 bit periods.

Contents of SETUP message; (MS to SS):

Protocol Discriminator	Call Control.
Transaction Identifier	
TI value	any value from the set {0, ..., 6}.
TI flag	0
Message Type	0X000101
Other information elements	Not checked.

26.13.1.6.3 Default contents of GSM 450 layer 3 messages for RR tests

This section contains the default values of GSM 450 L3 messages, which unless indicated otherwise in section 26.13 shall be transmitted by the system simulator and which are required to be received from the GSM 450 MS under test.

The necessary L3 messages are listed in alphabetic order, with the exception of the SYSTEM INFORMATION messages, where it is the information elements that are listed in alphabetic order (this is because some information elements occur in several SYSTEM INFORMATION types).

In this section, decimal values are normally used. However, sometimes a hexadecimal value, indicated by an "H", or a binary value, indicated by a "B" is used.

Default SYSTEM INFORMATION:

NOTE 1: SYSTEM INFORMATION 2 bis, SYSTEM INFORMATION 5 bis, SYSTEM INFORMATION 7, and SYSTEM INFORMATION 8 messages are not used.

Cell A

Contents of information elements in SYSTEM INFORMATION TYPE 1 to 6 messages for cell A.

(CBCH) Channel Description	Not present.
(CBCH) Mobile Allocation	Not present.
Cell Channel Description	
- Format identifier	Range 128.
- Cell Allocation ARFCN	Channels 263, 267, 275 and 279.
Cell Identity	
- Cell Identity Value	0001H
Cell Options	
- Power Control Indicator	Power Control Indicator is not set.
- DTX Indicator	MS shall not use DTX.
- Radio_Link_Timeout	8 SACCH blocks.
Cell Selection Parameters	
- Cell_Reselect_Hysteresis	12 dB.
- MX_TXPWR_MAX_CCH	Minimum level.
- ACS	No addition cell parameters are present in SYSTEM INFORMATION messages 7 and 8.
- NECI	New establishment causes not supported.
- RXLEV_ACCESS_MIN	Minimum level.
Control Channel Description	
- Attach-Detach allowed	No Attach/Detach.
- BS_AG_BLK_RES	0 blocks reserved for access grant.
- CCCH_CONF	1 basic physical channel used for CCCH, combined with SDCCCHs.
- BS_PA_MFRMS	5 multiframe periods for transmission of paging messages.
- T3212 Time-out value	Infinite.
L2 pseudo length	
- System information 1	21
- System information 2	22
- System information 3	18
- System information 4	12
Location Area Identification	
- Mobile Country Code	001 decimal
- Mobile Network Code	01 decimal
- Location Area Code	0001H
Message Type	
- System information 1	00011001
- System information 2	00011010
- System information 3	00011011
- System information 4	00011100
- System information 5	00011101
- System information 6	00011110
Neighbour Cells Description	
- Format identifier	Range 128.
- BCCH Allocation Sequence	0
- BCCH Allocation ARFCN	Channels 262, 263, 274, 282, 284, 287, 290 and 293.
- EXT-IND	This IE carries the complete BA.
NCC Permitted	0000 0010
RACH Control Parameters	
- Max Retrans	Max 1 retrans.
- Tx-integer	5 slots used.
- Cell Barred for Access	Cell is not barred.
- Call Reestablishment Allowed	Not allowed.
- Access Control Class	Access is not barred.
- Emergency Call allowed	Yes.
SI 1 rest octets	Not used (all bits are set to spare).
SI 2 rest octets	Not used (all bits are set to spare).
SI 3 rest octets	Not used (all bits are set to spare).
SI 4 rest octets	Not used (all bits are set to spare).

Default settings for cell A:

Downlink input level Uplink output power Propagation profile BCCH/CCCH carrier number	63 dBmicroVolt emf. minimum supported by the MS's power class. static. 263
--	---

Cell B

The contents of SYSTEM INFORMATION TYPE 1 to 6 messages for cell B are identical to those of cell A with the following exceptions:

Cell Channel Description - Format Identifier - Cell Allocation ARFCN	Range 128. Channel Number 261.
--	-----------------------------------

NOTE 2: This IE needs modification when used in handover tests that command the MS to go to a frequency hopping channel in cell B.

Cell Identity

- Cell Identity Value 0002H

Default settings for cell B:

Downlink input level Uplink output power Propagation profile BCCH/CCCH carrier number	53 dBmicroVolt emf. minimum supported by the MS's power class. static. 261
--	---

Contents of ALERTING message (SS to MS):

Protocol Discriminator Transaction Identifier TI value TI flag Message Type All other information elements	Call Control. As used in the SETUP message. 1 (destination side). 00000001 Not present.
---	---

Contents of ASSIGNMENT COMMAND message:

Protocol Discriminator Skip Indicator Message Type Channel Description 2 - Channel Type and TDMA offset - Timeslot Number - Training Sequence Code - Hopping - ARFCN Power Command - Power level Multislot allocation - Downlink assignment - Uplink assignment - Channel set 1= $X \leq 8$ Channel mode	RR Management. 0000 00101110 Bm + ACCHs Chosen arbitrarily by the test house. Chosen arbitrarily by the test house. Single RF channel. Channel number 267. Chosen arbitrarily by the test house. Appropriate for the test Appropriate for the test Appropriate for the test Appropriate for the test
---	--

Contents of ASSIGNMENT COMPLETE message:

Protocol Discriminator	RR Management.
Skip Indicator	0000
Message Type	00101001
RR Cause	
- RR Cause Value	Normal event.

Contents of ASSIGNMENT FAILURE message:

Protocol Discriminator	RR Management.
Skip Indicator	0000
Message Type	00101111
RR Cause	
- RR Cause Value	Depending on test.

Contents of AUTHENTICATION REQUEST message:

Protocol Discriminator	MM message.
Skip Indicator	0000
Message Type	00010010
Ciphering Key Sequence Number	
- Key Sequence	Chosen arbitrarily by the test house from the range 0 to 6.
Authentication Parameter RAND	
- RAND value	Chosen arbitrarily by the test house.

Contents of AUTHENTICATION RESPONSE message:

Protocol Discriminator	MM message.
Skip Indicator	0000
Message Type	0X010100
Other information element(s)	Not checked.

Contents of CALL PROCEEDING message:

Protocol Discriminator	Call Control.
Transaction Identifier	
TI value	As used in the SETUP message.
TI flag	1 (destination side).
Message Type	00000010
All other information elements	Not present.

Contents of CHANNEL MODE MODIFY message:

Protocol Discriminator	RR Management.
Skip Indicator	0000
Message Type	00010000
Channel Description 2	
- Channel Type and TDMA offset	Depending on test.
- Timeslot Number	Chosen arbitrarily by the test house.
- Training Sequence Code	Chosen arbitrarily by the test house.
- Hopping	Single RF channel.
- ARFCN	Channel number 267.
Channel Mode	
- Mode	Depending on test.

Contents of CHANNEL MODE MODIFY ACKNOWLEDGE message:

Protocol Discriminator	RR Management.
Skip Indicator	0000
Message Type	00010111
Channel Description 2	
- Channel Type and TDMA offset	Depending on test.
- Timeslot Number	Same as in the CHANNEL MODE MODIFY message.
- Training Sequence Code	Same as in the CHANNEL MODE MODIFY message.
- Hopping	Single RF channel.
- Frequency Band	Band number 0.
- ARFCN	Channel number 267.
Channel Mode	
- Mode	Same as in the CHANNEL MODE MODIFY message.

Contents of CHANNEL RELEASE message:

Protocol Discriminator	RR Management.
Skip Indicator	0000
Message Type	00001101
RR Cause	
- RR Cause Value	Normal event.

Contents of CHANNEL REQUEST message

Establishment Cause	Not checked.
Random Reference	Not checked.

Contents of CIPHERING MODE COMMAND message:

Protocol Discriminator	RR Management.
Skip Indicator	0000
Message Type	00110101
Cipher Mode Setting	
- algorithm identifier	cipher with A5/1.
- SC	Start ciphering.
Cipher Response	IMEI shall not be included.

Contents of CIPHERING MODE COMPLETE message:

Protocol Discriminator	RR Management.
Skip Indicator	0000
Message Type	00110010
Mobile Identity	Not present.

Contents of the CLASSMARK CHANGE message:

Protocol Discriminator	RR Management.
Skip Indicator	0000
Message Type	000100110
Mobile Station Classmark 2	See PICS/PIXIT.
Mobile Station Classmark 3	For presence and contents see PICS/PIXIT.

Contents of CM SERVICE ACCEPT message:

Protocol Discriminator	Mobility Management.
Skip Indicator	0000
Message Type	00100001

Contents of CM SERVICE REQUEST message

Protocol Discriminator	Mobility Management.
Skip Indicator	0000
Message Type	0X100100
Other information elements	Not checked.

Contents of CONFIGURATION CHANGE COMMAND message (SS to MS)

Protocol Discriminator	Radio Resource
Skip Indicator	0000
Message type	00110000
Multislot allocation	Appropriate for the test
- Downlink assignment	Appropriate for the test
- Uplink assignment	Appropriate for the test
- Channel set 1=<X<=8	Appropriate for the test
Channel mode 1=<X<=8	Appropriate for the test

Contents of CONFIGURATION CHANGE ACKNOWLEDGE message (MS to SS)

Protocol Discriminator	Radio Resource
Skip Indicator	0000
Message type	00110001

Contents of CONFIGURATION CHANGE REJECT message (MS to SS)

Protocol Discriminator	Radio Resource
Skip Indicator	0000
Message type	00110011
RR Cause	Protocol Error Unspecified

Contents of CONNECT message (SS to MS)

Protocol Discriminator	Call Control.
Transaction Identifier	
TI value	As used in the SETUP message.
TI flag	1
Message Type	00000111
All other information elements	Not present.

Contents of CONNECT ACKNOWLEDGE message (MS to SS)

Protocol Discriminator	Call Control.
Transaction Identifier	
TI value	As used in the SETUP message.
TI flag	0
Message Type	0X001111

Contents of HANDOVER ACCESS message:

Handover Reference	Equal to the value included in the Handover Command message.
--------------------	--

Contents of HANDOVER COMMAND message:

Protocol Discriminator	RR Management.
Skip Indicator	0000
Message Type	00101011
Cell Description	
- Network Colour Code	1
- Base station Colour Code	Corresponding to target cell
- BCCH Carrier Number	Set to the BCCH carrier number of cell B. (one of 261, 263, 282, 284, 287, 290 or 293).
Channel Description 2	
- Channel Type and TDMA offset	Bm + ACCHs.
- Timeslot Number	Chosen arbitrarily by the test house.
- Training Sequence Code	Chosen arbitrarily by the test house.
- Hopping	Single RF channel.
- ARFCN	Chosen arbitrarily by the test house from those supported on the target cell.
Handover Reference	
- Handover Reference Value	Chosen arbitrarily by the test house.
Power Command	
- Power level	Chosen arbitrarily by the test house.
Multislot allocation	
- Downlink assignment	Appropriate for the test
- Uplink assignment	Appropriate for the test
- Channel set 1= $X \leq 8$	Appropriate for the test
Channel mode	Appropriate for the test

Contents of HANDOVER COMPLETE message:

Protocol Discriminator	RR Management.
Skip Indicator	0000
Message Type	00101100
RR cause	Normal event.
Time difference	Not present.

Contents of HANDOVER FAILURE message:

Protocol Discriminator	RR Management.
Skip Indicator	0000
Message Type	00101000
RR cause	Dependent on the test.

Contents of IMMEDIATE ASSIGNMENT message:

L2 pseudo length	This is the sum of the lengths of all the information elements present in the message except for the IA rest octets and L2 pseudo length IEs. For the default message the L2 pseudo length is 11.
Protocol Discriminator	RR Management.
Skip Indicator	0000
Message Type	00111111
Page Mode	
- Page Mode	Normal Paging.
Channel Description	
- Channel Type and TDMA offset	For non-combined CCCH/SDCCH (see initial conditions), SDCCH/8, with subchannel chosen arbitrarily by the test house For combined CCCH/SDCCH (default SS conditions), SDCCH/4, with subchannel chosen arbitrarily by the test house.
- Timeslot Number	For non-combined CCCH/SDCCH (see initial conditions), chosen arbitrarily by the test house; For combined CCCH/SDCCH (default SS conditions), SDCCH/4, timeslot zero.
- Training Sequence Code	For non-combined CCCH/SDCCH (see initial conditions), chosen arbitrarily by the test house; For combined CCCH/SDCCH (default SS conditions), SDCCH/4, TSC=5 (same as the BCC).
- Hopping	Single RF channel.
- ARFCN	For non-combined CCCH/SDCCH (see initial conditions), Channel number 30; For combined CCCH/SDCCH (default SS conditions), SDCCH/4, Channel number 263.
Request Reference	Pertaining to last Channel Request sent by the MS.
Timing Advance	
- Timing advance value	30 bit periods.
Mobile Allocation	
- Length	0
Starting Time	Not present.
IA rest octets	Not used (all bits set to spare).

Contents of IMMEDIATE ASSIGNMENT EXTENDED message:

L2 pseudo length	This is the sum of the lengths of all the information elements present in the message except for the IAX rest octets and L2 pseudo length IEs. For the default message the L2 pseudo length is 18.
Protocol Discriminator	RR Management.
Skip Indicator	0000
Message Type	00111001
Page Mode	
- Page Mode	Normal Paging.
Channel Description 1	
- Channel Type and TDMA offset	For non-combined CCCH/SDCCH (see test conditions), SDCCH/8, with subchannel chosen arbitrarily by the test house; For combined CCCH/SDCCH (default SS conditions), SDCCH/4, with subchannel chosen arbitrarily by the test house.
- Timeslot Number	For non-combined CCCH/SDCCH (see test conditions), chosen arbitrarily by the test house; For combined CCCH/SDCCH (default SS conditions), SDCCH/4, timeslot zero.
- Training Sequence Code	For non-combined CCCH/SDCCH (see initial conditions), chosen arbitrarily by the test house; For combined CCCH/SDCCH (default SS conditions), SDCCH/4, TSC=5 (same as the BCC).
- Hopping	Single RF channel.
- ARFCN	For non-combined CCCH/SDCCH (see initial conditions), Channel number 30; For combined CCCH/SDCCH (default SS conditions), SDCCH/4, Channel number 263.
Request Reference 1	Pertaining to last Channel Request sent by the MS.
Timing Advance 1	
- Timing advance value	Chosen arbitrarily by the test house.
Channel Description 2	
- Channel Type and TDMA offset	Same channel type as in Channel Description 1, but different TDMA offset to that in Channel Description 1.
- Timeslot Number	equal to the value in Channel Description 1.
- Training Sequence Code	equal to the value in Channel Description 1.
- Hopping	Single RF channel.
- ARFCN	equal to the value in Channel Description 1.
Request Reference 2	Not pertaining to any Channel Requests sent by the MS.
Timing Advance 2	
- Timing advance value	Chosen arbitrarily by the test house.
Mobile Allocation	
- Length	0
Starting Time	Not present.
IAX rest octets	Not used (all bits set to spare).

Contents of IMMEDIATE ASSIGNMENT REJECT message:

L2 pseudo length	19
Protocol Discriminator	RR Management.
Skip Indicator	0000
Message Type	00111010
Page Mode	
- Page Mode	Normal Paging.
Request Reference	Pertaining to last Channel Request sent by the MS.
Wait Indication	0 seconds.
Request Reference	Not pertaining to the MS under test.
Wait Indication	0 seconds.
Request Reference	Not pertaining to the MS under test.
Wait Indication	0 seconds.
Request Reference	Not pertaining to the MS under test.
Wait Indication	0 seconds.
IAR rest octets	Not used (all bits set to spare).

Contents of LOCATION UPDATING REQUEST message:

Protocol Discriminator	MM message.
Skip Indicator	0000
Message Type	0X001000
Other information elements	Not checked.

Contents of PAGING REQUEST TYPE 1 message:

L2 pseudo length	This is the sum of the lengths of all the information elements present in the message except for the P1 rest octets and L2 pseudo length IEs. For the default message the L2 pseudo length is 9.
Protocol Discriminator	RR Management.
Skip Indicator	0000
Message Type	00100001
Page Mode	
- Page Mode	Normal Paging.
Channels needed	
- first channel	any channel.
- second channel	any channel.
Mobile Identity 1	
- odd/even indication	Even.
- Type of Identity	TMSI.
- Identity Digits	TMSI previously allocated to MS.
Mobile Identity 2	Not present.
P1 rest octets	Not used (all bits set to spare).

Contents of PAGING REQUEST TYPE 2 message:

L2 pseudo length	This is the sum of the lengths of all the information elements present in the message except for the P2 rest octets and L2 pseudo length IEs. For the default message the L2 pseudo length is 11.
Protocol Discriminator	RR Management..
Skip Indicator	0000
Message Type	00100010
Page Mode	
- Page Mode	Normal Paging.
Channels needed	
- first channel	any channel.
- second channel	any channel.
Mobile Identity 1	
- TMSI value	TMSI previously allocated to MS.
Mobile Identity 2	
- TMSI value	TMSI not allocated to MS.
Mobile Identity	Not present.
P2 rest octets	Not used (all bits set to spare).

Contents of PAGING REQUEST TYPE 3 message:

L2 pseudo length	19
Protocol Discriminator	RR Management.
Skip Indicator	0000
Message Type	00100100
Page Mode	
- Page Mode	Normal Paging.
Channels needed	
- first channel	any channel.
- second channel	any channel.
Mobile identity 1	
- TMSI value	TMSI previously allocated to MS.
Mobile identity 2	
- TMSI value	TMSI not allocated to MS.
Mobile identity 3	
- TMSI value	TMSI not allocated to MS.
Mobile identity 4	
- TMSI value	TMSI not allocated to MS.
P3 rest octets	Not used (all bits set to spare).

Contents of PAGING RESPONSE message:

Protocol Discriminator	RR Management.
Skip Indicator	0000
Message Type	00100111
Ciphering Key Sequence Number	
- Key Sequence	Key sequence number previously allocated to MS, or "111" if no key is available.
Mobile Station Classmark 2	
Mobile Identity	
- odd/even indication	Even
- Type of identity	TMSI
- Identity Digits	TMSI previously allocated to MS.

Contents of PHYSICAL INFORMATION message:

Protocol Discriminator	RR Management.
Skip Indicator	0000
Message Type	00101101
Timing advance	20 bit periods.

Contents of SETUP message; (MS to SS):

Protocol Discriminator	Call Control.
Transaction Identifier	
TI value	any value from the set {0, ..., 6}.
TI flag	0
Message Type	0X000101
Other information elements	Not checked.

26.13.1.6.4 Default contents of GSM 480 layer 3 messages for RR tests

This section contains the default values of GSM 480 L3 messages, which unless indicated otherwise in section 26.13 shall be transmitted by the system simulator and which are required to be received from the GSM 480 MS under test.

The necessary L3 messages are listed in alphabetic order, with the exception of the SYSTEM INFORMATION messages, where it is the information elements that are listed in alphabetic order (this is because some information elements occur in several SYSTEM INFORMATION types).

In this section, decimal values are normally used. However, sometimes a hexadecimal value, indicated by an "H", or a binary value, indicated by a "B" is used.

Default SYSTEM INFORMATION:

NOTE 1: SYSTEM INFORMATION 2 bis, SYSTEM INFORMATION 5 bis, SYSTEM INFORMATION 7, and SYSTEM INFORMATION 8 messages are not used.

Cell A

Contents of information elements in SYSTEM INFORMATION TYPE 1 to 6 messages for cell A.

(CBCH) Channel Description	Not present.
(CBCH) Mobile Allocation	Not present.
Cell Channel Description	
- Format identifier	Range 128
- Cell Allocation ARFCN	Channels 310, 315, 322 and 326.
Cell Identity	
- Cell Identity Value	0001H
Cell Options	
- Power Control Indicator	Power Control Indicator is not set.
- DTX Indicator	MS shall not use DTX.
- Radio_Link_Timeout	8 SACCH blocks.
Cell Selection Parameters	
- Cell_Reselect_Hysteresis	12 dB.
- MX_TXPWR_MAX_CCH	Minimum level.
- ACS	No addition cell parameters are present in SYSTEM INFORMATION messages 7 and 8.
- NECI	New establishment causes not supported.
- RXLEV_ACCESS_MIN	Minimum level.
Control Channel Description	
- Attach-Detach allowed	No Attach/Detach.
- BS_AG_BLK_RES	0 blocks reserved for access grant.
- CCCH_CONF	1 basic physical channel used for CCCH, combined with SDCCCHs.
- BS_PA_MFRMS	5 multiframe periods for transmission of paging messages.
- T3212 Time-out value	Infinite.
L2 pseudo length	
- System information 1	21
- System information 2	22
- System information 3	18
- System information 4	12
Location Area Identification	
- Mobile Country Code	001 decimal
- Mobile Network Code	01 decimal
- Location Area Code	0001H
Message Type	
- System information 1	00011001
- System information 2	00011010
- System information 3	00011011
- System information 4	00011100
- System information 5	00011101
- System information 6	00011110
Neighbour Cells Description	
- Format identifier	Range 128
- BCCH Allocation Sequence	0
- BCCH Allocation ARFCN	Channels 308, 310, 321, 329, 331, 334, 337 and 340.
- EXT-IND	This IE carries the complete BA.
NCC Permitted	0000 0010
RACH Control Parameters	
- Max Retrans	Max 1 retrans.
- Tx-integer	5 slots used.
- Cell Barred for Access	Cell is not barred.
- Call Reestablishment Allowed	Not allowed.
- Access Control Class	Access is not barred.
- Emergency Call allowed	Yes.
SI 1 rest octets	Not used (all bits are set to spare).
SI 2 rest octets	Not used (all bits are set to spare).
SI 3 rest octets	Not used (all bits are set to spare).
SI 4 rest octets	Not used (all bits are set to spare).

Default settings for cell A:

Downlink input level Uplink output power Propagation profile BCCH/CCCH carrier number	63 dBmicroVolt emf. minimum supported by the MS's power class. static. 310
--	---

Cell B

The contents of SYSTEM INFORMATION TYPE 1 to 6 messages for cell B are identical to those of cell A with the following exceptions:

Cell Channel Description - Format Identifier - Cell Allocation ARFCN	Range 128 Channel Number 308.
--	----------------------------------

NOTE 2: This IE needs modification when used in handover tests that command the MS to go to a frequency hopping channel in cell B.

Cell Identity

- Cell Identity Value 0002H

Default settings for cell B:

Downlink input level Uplink output power Propagation profile BCCH/CCCH carrier number	53 dBmicroVolt emf. minimum supported by the MS's power class. static. 308
--	---

Contents of ALERTING message (SS to MS):

Protocol Discriminator Transaction Identifier TI value TI flag Message Type All other information elements	Call Control. As used in the SETUP message. 1 (destination side). 00000001 Not present.
---	---

Contents of ASSIGNMENT COMMAND message:

Protocol Discriminator Skip Indicator Message Type Channel Description 2 - Channel Type and TDMA offset - Timeslot Number - Training Sequence Code - Hopping - ARFCN Power Command - Power level Multislot allocation - Downlink assignment - Uplink assignment - Channel set 1= $X \leq 8$ Channel mode	RR Management. 0000 00101110 Bm + ACCHs Chosen arbitrarily by the test house. Chosen arbitrarily by the test house. Single RF channel. Channel number 315. Chosen arbitrarily by the test house. Appropriate for the test Appropriate for the test Appropriate for the test Appropriate for the test
---	--

Contents of ASSIGNMENT COMPLETE message:

Protocol Discriminator	RR Management.
Skip Indicator	0000
Message Type	00101001
RR Cause	
- RR Cause Value	Normal event.

Contents of ASSIGNMENT FAILURE message:

Protocol Discriminator	RR Management.
Skip Indicator	0000
Message Type	00101111
RR Cause	
- RR Cause Value	Depending on test.

Contents of AUTHENTICATION REQUEST message:

Protocol Discriminator	MM message.
Skip Indicator	0000
Message Type	00010010
Ciphering Key Sequence Number	
- Key Sequence	Chosen arbitrarily by the test house from the range 0 to 6.
Authentication Parameter RAND	
- RAND value	Chosen arbitrarily by the test house.

Contents of AUTHENTICATION RESPONSE message:

Protocol Discriminator	MM message.
Skip Indicator	0000
Message Type	0X010100
Other information element(s)	Not checked.

Contents of CALL PROCEEDING message:

Protocol Discriminator	Call Control.
Transaction Identifier	
TI value	As used in the SETUP message.
TI flag	1 (destination side).
Message Type	00000010
All other information elements	Not present.

Contents of CHANNEL MODE MODIFY message:

Protocol Discriminator	RR Management.
Skip Indicator	0000
Message Type	00010000
Channel Description 2	
- Channel Type and TDMA offset	Depending on test.
- Timeslot Number	Chosen arbitrarily by the test house.
- Training Sequence Code	Chosen arbitrarily by the test house.
- Hopping	Single RF channel.
- ARFCN	Channel number 315.
Channel Mode	
- Mode	Depending on test.

Contents of CHANNEL MODE MODIFY ACKNOWLEDGE message:

Protocol Discriminator	RR Management.
Skip Indicator	0000
Message Type	00010111
Channel Description 2	
- Channel Type and TDMA offset	Depending on test.
- Timeslot Number	Same as in the CHANNEL MODE MODIFY message.
- Training Sequence Code	Same as in the CHANNEL MODE MODIFY message.
- Hopping	Single RF channel.
- Frequency Band	Band number 0.
- ARFCN	Channel number 315.
Channel Mode	
- Mode	Same as in the CHANNEL MODE MODIFY message.

Contents of CHANNEL RELEASE message:

Protocol Discriminator	RR Management.
Skip Indicator	0000
Message Type	00001101
RR Cause	
- RR Cause Value	Normal event.

Contents of CHANNEL REQUEST message

Establishment Cause	Not checked.
Random Reference	Not checked.

Contents of CIPHERING MODE COMMAND message:

Protocol Discriminator	RR Management.
Skip Indicator	0000
Message Type	00110101
Cipher Mode Setting	
- algorithm identifier	cipher with A5/1.
- SC	Start ciphering.
Cipher Response	IMEI shall not be included.

Contents of CIPHERING MODE COMPLETE message:

Protocol Discriminator	RR Management.
Skip Indicator	0000
Message Type	00110010
Mobile Identity	Not present.

Contents of the CLASSMARK CHANGE message:

Protocol Discriminator	RR Management.
Skip Indicator	0000
Message Type	000100110
Mobile Station Classmark 2	See PICS/PIXIT.
Mobile Station Classmark 3	For presence and contents see PICS/PIXIT.

Contents of CM SERVICE ACCEPT message:

Protocol Discriminator	Mobility Management.
Skip Indicator	0000
Message Type	00100001

Contents of CM SERVICE REQUEST message

Protocol Discriminator	Mobility Management.
Skip Indicator	0000
Message Type	0X100100
Other information elements	Not checked.

Contents of CONFIGURATION CHANGE COMMAND message (SS to MS)

Protocol Discriminator	Radio Resource
Skip Indicator	0000
Message type	00110000
Multislot allocation	Appropriate for the test
- Downlink assignment	Appropriate for the test
- Uplink assignment	Appropriate for the test
- Channel set 1=<X<=8	Appropriate for the test
Channel mode 1=<X<=8	Appropriate for the test

Contents of CONFIGURATION CHANGE ACKNOWLEDGE message (MS to SS)

Protocol Discriminator	Radio Resource
Skip Indicator	0000
Message type	00110001

Contents of CONFIGURATION CHANGE REJECT message (MS to SS)

Protocol Discriminator	Radio Resource
Skip Indicator	0000
Message type	00110011
RR Cause	Protocol Error Unspecified

Contents of CONNECT message (SS to MS)

Protocol Discriminator	Call Control.
Transaction Identifier	
TI value	As used in the SETUP message.
TI flag	1
Message Type	00000111
All other information elements	Not present.

Contents of CONNECT ACKNOWLEDGE message (MS to SS)

Protocol Discriminator	Call Control.
Transaction Identifier	
TI value	As used in the SETUP message.
TI flag	0
Message Type	0X001111

Contents of HANDOVER ACCESS message:

Handover Reference	Equal to the value included in the Handover Command message.
--------------------	--

Contents of HANDOVER COMMAND message:

Protocol Discriminator	RR Management.
Skip Indicator	0000
Message Type	00101011
Cell Description	
- Network Colour Code	1
- Base station Colour Code	Corresponding to target cell
- BCCH Carrier Number	Set to the BCCH carrier number of cell B. (one of 308, 310, 329, 331, 334, 337 or 340).
Channel Description 2	
- Channel Type and TDMA offset	Bm + ACCHs.
- Timeslot Number	Chosen arbitrarily by the test house.
- Training Sequence Code	Chosen arbitrarily by the test house.
- Hopping	Single RF channel.
- ARFCN	Chosen arbitrarily by the test house from those supported on the target cell.
Handover Reference	
- Handover Reference Value	Chosen arbitrarily by the test house.
Power Command	
- Power level	Chosen arbitrarily by the test house.
Multislot allocation	
- Downlink assignment	Appropriate for the test
- Uplink assignment	Appropriate for the test
- Channel set 1=<X<=8	Appropriate for the test
Channel mode	Appropriate for the test

Contents of HANDOVER COMPLETE message:

Protocol Discriminator	RR Management.
Skip Indicator	0000
Message Type	00101100
RR cause	Normal event.
Time difference	Not present.

Contents of HANDOVER FAILURE message:

Protocol Discriminator	RR Management.
Skip Indicator	0000
Message Type	00101000
RR cause	Dependent on the test.

Contents of IMMEDIATE ASSIGNMENT message:

L2 pseudo length	This is the sum of the lengths of all the information elements present in the message except for the IA rest octets and L2 pseudo length IEs. For the default message the L2 pseudo length is 11.
Protocol Discriminator	RR Management.
Skip Indicator	0000
Message Type	00111111
Page Mode	
- Page Mode	Normal Paging.
Channel Description	
- Channel Type and TDMA offset	For non-combined CCCH/SDCCH (see initial conditions), SDCCH/8, with subchannel chosen arbitrarily by the test house For combined CCCH/SDCCH (default SS conditions), SDCCH/4, with subchannel chosen arbitrarily by the test house.
- Timeslot Number	For non-combined CCCH/SDCCH (see initial conditions), chosen arbitrarily by the test house; For combined CCCH/SDCCH (default SS conditions), SDCCH/4, timeslot zero.
- Training Sequence Code	For non-combined CCCH/SDCCH (see initial conditions), chosen arbitrarily by the test house; For combined CCCH/SDCCH (default SS conditions), SDCCH/4, TSC=5 (same as the BCC).
- Hopping	Single RF channel.
- ARFCN	For non-combined CCCH/SDCCH (see initial conditions), Channel number 30; For combined CCCH/SDCCH (default SS conditions), SDCCH/4, Channel number 310.
Request Reference	Pertaining to last Channel Request sent by the MS.
Timing Advance	
- Timing advance value	30 bit periods.
Mobile Allocation	
- Length	0
Starting Time	Not present.
IA rest octets	Not used (all bits set to spare).

Contents of IMMEDIATE ASSIGNMENT EXTENDED message:

L2 pseudo length	This is the sum of the lengths of all the information elements present in the message except for the IAX rest octets and L2 pseudo length IEs. For the default message the L2 pseudo length is 18.
Protocol Discriminator	RR Management.
Skip Indicator	0000
Message Type	00111001
Page Mode	
- Page Mode	Normal Paging.
Channel Description 1	
- Channel Type and TDMA offset	For non-combined CCCH/SDCCH (see test conditions), SDCCH/8, with subchannel chosen arbitrarily by the test house; For combined CCCH/SDCCH (default SS conditions), SDCCH/4, with subchannel chosen arbitrarily by the test house.
- Timeslot Number	For non-combined CCCH/SDCCH (see test conditions), chosen arbitrarily by the test house; For combined CCCH/SDCCH (default SS conditions), SDCCH/4, timeslot zero.
- Training Sequence Code	For non-combined CCCH/SDCCH (see initial conditions), chosen arbitrarily by the test house; For combined CCCH/SDCCH (default SS conditions), SDCCH/4, TSC=5 (same as the BCC).
- Hopping	Single RF channel.
- ARFCN	For non-combined CCCH/SDCCH (see initial conditions), Channel number 30; For combined CCCH/SDCCH (default SS conditions), SDCCH/4, Channel number 310.
Request Reference 1	Pertaining to last Channel Request sent by the MS.
Timing Advance 1	
- Timing advance value	Chosen arbitrarily by the test house.
Channel Description 2	
- Channel Type and TDMA offset	Same channel type as in Channel Description 1, but different TDMA offset to that in Channel Description 1.
- Timeslot Number	equal to the value in Channel Description 1.
- Training Sequence Code	equal to the value in Channel Description 1.
- Hopping	Single RF channel.
- ARFCN	equal to the value in Channel Description 1.
Request Reference 2	Not pertaining to any Channel Requests sent by the MS.
Timing Advance 2	
- Timing advance value	Chosen arbitrarily by the test house.
Mobile Allocation	
- Length	0
Starting Time	Not present.
IAX rest octets	Not used (all bits set to spare).

Contents of IMMEDIATE ASSIGNMENT REJECT message:

L2 pseudo length	19
Protocol Discriminator	RR Management.
Skip Indicator	0000
Message Type	00111010
Page Mode	
- Page Mode	Normal Paging.
Request Reference	Pertaining to last Channel Request sent by the MS.
Wait Indication	0 seconds.
Request Reference	Not pertaining to the MS under test.
Wait Indication	0 seconds.
Request Reference	Not pertaining to the MS under test.
Wait Indication	0 seconds.
Request Reference	Not pertaining to the MS under test.
Wait Indication	0 seconds.
IAR rest octets	Not used (all bits set to spare).

Contents of LOCATION UPDATING REQUEST message:

Protocol Discriminator	MM message.
Skip Indicator	0000
Message Type	0X001000
Other information elements	Not checked.

Contents of PAGING REQUEST TYPE 1 message:

L2 pseudo length	This is the sum of the lengths of all the information elements present in the message except for the P1 rest octets and L2 pseudo length IEs. For the default message the L2 pseudo length is 9.
Protocol Discriminator	RR Management.
Skip Indicator	0000
Message Type	00100001
Page Mode	
- Page Mode	Normal Paging.
Channels needed	
- first channel	any channel.
- second channel	any channel.
Mobile Identity 1	
- odd/even indication	Even.
- Type of Identity	TMSI.
- Identity Digits	TMSI previously allocated to MS.
Mobile Identity 2	Not present.
P1 rest octets	Not used (all bits set to spare).

Contents of PAGING REQUEST TYPE 2 message:

L2 pseudo length	This is the sum of the lengths of all the information elements present in the message except for the P2 rest octets and L2 pseudo length IEs. For the default message the L2 pseudo length is 11.
Protocol Discriminator	RR Management..
Skip Indicator	0000
Message Type	00100010
Page Mode	
- Page Mode	Normal Paging.
Channels needed	
- first channel	any channel.
- second channel	any channel.
Mobile Identity 1	
- TMSI value	TMSI previously allocated to MS.
Mobile Identity 2	
- TMSI value	TMSI not allocated to MS.
Mobile Identity	Not present.
P2 rest octets	Not used (all bits set to spare).

Contents of PAGING REQUEST TYPE 3 message:

L2 pseudo length	19
Protocol Discriminator	RR Management.
Skip Indicator	0000
Message Type	00100100
Page Mode	
- Page Mode	Normal Paging.
Channels needed	
- first channel	any channel.
- second channel	any channel.
Mobile identity 1	
- TMSI value	TMSI previously allocated to MS.
Mobile identity 2	
- TMSI value	TMSI not allocated to MS.
Mobile identity 3	
- TMSI value	TMSI not allocated to MS.
Mobile identity 4	
- TMSI value	TMSI not allocated to MS.
P3 rest octets	Not used (all bits set to spare).

Contents of PAGING RESPONSE message:

Protocol Discriminator	RR Management.
Skip Indicator	0000
Message Type	00100111
Ciphering Key Sequence Number	
- Key Sequence	Key sequence number previously allocated to MS, or "111" if no key is available.
Mobile Station Classmark 2	
Mobile Identity	
- odd/even indication	Even
- Type of identity	TMSI
- Identity Digits	TMSI previously allocated to MS.

Contents of PHYSICAL INFORMATION message:

Protocol Discriminator	RR Management.
Skip Indicator	0000
Message Type	00101101
Timing advance	20 bit periods.

Contents of SETUP message; (MS to SS):

Protocol Discriminator	Call Control.
Transaction Identifier	
TI value	any value from the set {0, ..., 6}.
TI flag	0
Message Type	0X000101
Other information elements	Not checked.

26.13.2 Multislot signalling / CC

26.13.2.1 Multislot signalling / CC / In-call functions

26.13.2.1.1 Multislot signalling / CC / In-call functions / User initiated service level upgrade / successful

This test is applicable to all MS that supports multislot configuration.

26.13.2.1.1.1 Definition and applicability

Multislot connection is established. Multislot configuration with one TCH/F is allocated. User initiated service level upgrade is successfully performed.

This test is applicable for any equipment supporting multislot connection.

26.13.2.1.1.2 Conformance requirements

- 1) MS shall send MODIFY message to SS indicating that User initiated service level upgrade is initiated.
- 2) MS enters CC state 'Mobile originating modify (U26)' after sending MODIFY.
- 3) MS enters CC state 'Active (U10)' when MODIFY COMPLETE is received.

References

Conformance requirement 1: GSM 04.08, section 9.3.13
Conformance requirement 2: GSM 04.08, section 5.3.5.1
Conformance requirement 3: GSM 04.08, section 5.3.5.2

26.13.2.1.1.3 Test purpose

- 1) To verify that the procedure is initiated by the MS in the "active" state of a multislot connection. It sends a MODIFY message including the wanted value of the "maximum number of traffic channels" and/or the "wanted air interface" parameters; and enters the "mobile originating modify" state. Other parameters of the bearer capability given in MODIFY message and already negotiated and agreed during the establishment phase of the call, may not be changed.
- 2) To verify that upon receipt of the MODIFY COMPLETE message with bearer capability negotiated at call setup in the MS enters the "active" state.

26.13.2.1.1.4 Method of test

Initial conditions

Mobile station:

- MS in the active state of a service using a multislot connection.

System simulator:

- 1 cell, default parameters except:
- Early classmark sending enabled in SI3 rest octets

Related PICS/PIXIT statement(s)

- Supported teleservices/bearer services
- Classmark
- Multislot class

Foreseen final state of the MS

MS is in the active state of a service using a multislot connection.

Test procedure

MS is in the active state of a multislot connection. Multislot configuration with one TCH/F is allocated. User initiates User initiated service level upgrade by sending MODIFY message including the wanted value of the Maximum number of traffic channels, this being one supported by the MS and channel modes supported by the MS. The MS enters 'mobile originating modify' state. This is verified by a status enquiry procedure.

MS receives MODIFY COMPLETE message from SS and enters the 'active' state. This is verified by a status enquiry procedure.

Maximum duration of test

3 min

Expected sequence

Step	Direction	Message	Comments
1	MS -> SS	MODIFY	User initiated service level upgrade is initiated.
2	MS		MS enters the Mobile originating modify state
3	SS -> MS	STATUS ENQUIRY	
4	MS -> SS	STATUS	Cause shall be 30# (response to enq.) and state U26 Mobile originated modify.
5	SS -> MS	MODIFY COMPLETE	
6	MS		MS enters the active state
7	SS -> MS	STATUS ENQUIRY	
8	MS -> SS	STATUS	Cause shall be 30# (response to enq.) and state U10 Active.

Specific message contents

MODIFY

Information element	Value/remark
Bearer capability	Maximum number of TCH/F's the MS is able to support and channel modes supported by the MS
Low layer comp.	Appropriate for the basic service selected for the test
High layer comp.	Appropriate for the basic service selected for the test
Reverse call setup direction	Presence and value not checked

26.13.2.1.2 Multislot signalling / CC / In-call functions / User initiated service level downgrade / successful

25.13.2.1.2.1 Definition and applicability

Multislot connection is established. Multislot configuration has the maximum number of timeslots supported by the MS. User initiated service level downgrade is successfully performed.

This test is applicable for any equipment supporting multislot configuration.

26.13.2.1.2.2 Conformance requirements

- 1) MS shall send MODIFY message to SS indicating that User initiated service level downgrade is initiated.
- 2) MS enters CC state 'Mobile originating modify (U26)' after sending MODIFY.
- 3) MS enters CC state 'Active (U10)' when MODIFY COMPLETE is received.

References

Conformance requirement 1: GSM 04.08, section 9.3.13

Conformance requirement 2: GSM 04.08, section 5.3.5.1

Conformance requirement 3: GSM 04.08, section 5.3.5.2

26.13.2.1.2.3 Test purpose

- 1) To verify that the procedure is initiated by the MS in the “active” state of a multislot connection. It sends a MODIFY message including the wanted value of the “maximum number of traffic channels” and/or the “wanted air interface” parameters; and enters the “mobile originating modify” state. Other parameters of the bearer capability given in MODIFY message and already negotiated and agreed during the establishment phase of the call, may not be changed.
- 2) To verify that upon receipt of the MODIFY COMPLETE message with bearer capability negotiated at call setup in the MS enters the “active” state.

26.13.2.1.2.4 Method of test

Initial conditions

Mobile station:

- MS in the active state of a service using a multislot connection. Multislot configuration has maximum number of timeslots supported by the MS.

System simulator:

- 1 cell, default parameters except:
- Early classmark sending enabled in SI3 rest octets

Related PICS/PIXIT statement(s)

- Supported teleservices/bearer services
- Classmark
- Multislot class

Foreseen final state of the MS

MS is in the active state of a service using a multislot connection.

Test procedure

MS in the active state of a multislot connection. Multislot configuration has maximum number of timeslots supported by the MS. User initiates User initiated service level downgrade by sending MODIFY message including the wanted value of the Maximum number of traffic channels, this being one supported by the MS and channel modes supported by the MS. The MS enters ‘mobile originating modify’ state. This is verified by a status enquiry procedure. MS receives MODIFY COMPLETE message from SS and enters the active state. This is verified by a status enquiry procedure.

Maximum duration of test

3 min

Expected sequence

Step	Direction	Message	Comments
1	MS -> SS	MODIFY	User initiated service level downgrade is initiated.
2	MS		MS enters the Mobile originating modify state
3	SS -> MS	STATUS ENQUIRY	
4	MS -> SS	STATUS	Cause shall be 30# (response to enq.) and state U26 Mobile originated modify.
5	SS -> MS	MODIFY COMPLETE	
6	MS		MS enters the active state
7	SS -> MS	STATUS ENQUIRY	
8	MS -> SS	STATUS	Cause shall be 30# (response to enq.) and state U10 Active.

Specific message contents

MODIFY

Information element	Value/remark
Bearer capability	One TCH/F is indicated and the channel modes supported by the MS
Low layer comp.	Appropriate for the basic service selected for the test
High layer comp.	Appropriate for the basic service selected for the test
Reverse call setup direction	Presence and value not checked

26.13.2.1.3 Multislot signalling / CC / In-call functions / User initiated service level upgrade / Time-out of timer T323

26.13.2.1.3.1 Definition and applicability

Multislot connection is established. Multislot configuration with one TCH/F is allocated. User initiated service level upgrade is requested. Timer T323 expires. Call is cleared.

This test is applicable for any equipment supporting multislot configuration.

26.13.2.1.3.2 Conformance requirements

- 1) MS shall send MODIFY message to SS indicating that User initiated service level upgrade is initiated.
- 2) After timer T323 has expired MS starts call clearing by sending DISCONNECT message.
- 3) After receipt of RELEASE message the MS sends RELEASE COMPLETE message and goes to idle updated state.

References

Conformance requirement 1: GSM 04.08, section 9.3.13

Conformance requirement 2: GSM 04.08, section 9.3.7

Conformance requirement 3: GSM 04.08, sections 9.3.18 and 9.1.7 and 5.4.4.2.2

26.13.2.1.3.3 Test purpose

- 1) To verify that upon expiration of T323 (accuracy +/- 10%) the MS shall initiate the procedures for call clearing with cause #102 "recovery on timer expiry".

26.13.2.1.3.4 Method of test

Initial conditions

Mobile station:

- MS in the active state of a service using a multislot connection.

System simulator:

- 1 cell, default parameters

Related PICS/PIXIT statement(s)

- Supported teleservices/bearer services
- Classmark
- Multislot class

Foreseen final state of the MS

“Idle, updated”, with TMSI allocated.

Test procedure

MS is in the active state of a multislot connection. Multislot configuration with one TCH/F is allocated. User initiates User initiated service level upgrade by sending MODIFY message including the wanted value of the Maximum number of traffic channels, this being one supported by the MS and channel modes supported by the MS.

Timer T323 expires and MS starts call clearing procedure by sending DISCONNECT message to SS. After MS receives RELEASE message it sends RELEASE COMPLETE message. SS sends CHANNEL RELEASE message to MS and the main signalling link is released.

Maximum duration of test

3 min

Expected sequence

Step	Direction	Message	Comments
1	MS -> SS	MODIFY	User initiated service level upgrade is initiated.
2	MS		Timer T323 expires
3	MS -> SS	DISCONNECT	Cause = #102 “recovery on timer expiry”
4	SS -> MS	RELEASE	
5	MS -> SS	RELEASE COMPLETE	
6	SS -> MS	CHANNEL RELEASE	The main signalling link is released

Specific message contents

MODIFY

Information element	Value/remark
Bearer capability	Maximum number of TCH/F's the MS is able to support and channel modes supported by the MS
Low layer comp.	Appropriate for the basic service selected for the test
High layer comp.	Appropriate for the basic service selected for the test
Reverse call setup direction	Presence and value not checked

26.13.2.1.4 Multislot signalling / CC / In-call functions / User initiated service level upgrade / modify reject

26.13.2.1.4.1 Definition and applicability

Multislot connection is established. Multislot configuration with one TCH/F is allocated. User initiated service level upgrade is requested. SS responds to upgrade request by rejecting it. MS enters the active multislot connection state.

This test is applicable for any equipment supporting multislot configuration.

26.13.2.1.4.2 Conformance requirements

- 1) MS shall send MODIFY message to SS indicating that User initiated service level upgrade is initiated.
- 2) MS enters CC state 'Mobile originating modify (U26)' after sending MODIFY.
- 3) MS enters CC state 'Active (U10)' when MODIFY REJECT is received.

References

Conformance requirement 1: GSM 04.08, section 9.3.13

Conformance requirement 2: GSM 04.08, section 5.3.5.1

Conformance requirement 3: GSM 04.08, section 5.3.5.3

26.13.2.1.4.3 Test purpose

- 1) To verify that upon receipt of the MODIFY REJECT message with the bearer capability negotiated at the call setup, the MS is continuously sending user information according to current call mode.

26.13.2.1.4.4 Method of test

Initial conditions

Mobile station:

- MS in the active state of a service using a multislot connection.

System simulator:

- 1 cell, default parameters

Related PICS/PIXIT statement(s)

- Supported teleservices/bearer services
- Classmark
- Multislot class

Foreseen final state of the MS

MS is in the active state of a service using a multislot connection.

Test procedure

MS is in the active state of a multislot connection. Multislot configuration with one TCH/F is allocated. Then user initiates User initiated service level upgrade by sending MODIFY message including the wanted value of the Maximum number of traffic channels, this being one supported by the MS and channel modes supported by the MS. The MS enters 'mobile originating modify' state. This is verified by a status enquiry procedure. SS responds to MODIFY message by sending MODIFY REJECT message to MS. MS enters the active state. This is verified by a status enquiry procedure. Maximum duration of test

1 min

Expected sequence

Step	Direction	Message	Comments
1	MS -> SS	MODIFY	User initiated service level upgrade is initiated.
2	SS -> MS	STATUS ENQUIRY	Cause shall be 30# (response to enq.) and state U26 Mobile originated modify.
3	MS -> SS	STATUS	
4	SS -> MS	MODIFY REJECT	
5	MS		Cause = #58 "bearer capability not presently available". MS enters in the active state of multislot call
6	SS -> MS	STATUS ENQUIRY	Cause shall be 30# (response to enq.) and state U10 Active.
7	MS -> SS	STATUS	

Specific message contents

MODIFY

Information element	Value/remark
Bearer capability	Maximum number of TCH/F's the MS is able to support and channel modes supported by the MS
Low layer comp.	Appropriate for the basic service selected for the test
High layer comp.	Appropriate for the basic service selected for the test
Reverse call setup direction	Presence and value not checked

26.13.2.1.5 Multislot signalling / CC / In call functions / contents of some of the messages

The following messages are used for testing in-call modification procedures, test cases 26.13.2.1.*, as default messages for those ones defined below. If any other values are defined in the expected sequence of the actual test cases, those values take precedence over the ones defined hereafter.

SETUP (MS to SS)

Information element	Value/remark
BC Repeat indicator	Omitted
Bearer capability 1	Appropriate for the teleservice/Bearer Service selected as an initial call mode
Bearer capability 2	Omitted
Facility	Omitted
Calling party subaddress	Omitted
Called party BCD number	As entered
Called party subaddress	Omitted
LLC repeat indicator	Omitted
Low layer compatibility I	See note 1
Low layer compatibility II	Omitted
HLC repeat indicator	Omitted
High layer compatibility I	See note 1
High layer compatibility ii	Omitted
User-user	Omitted
SS version	Omitted
CLIR suppression	Omitted
CC Capabilities	present, but contents not checked

NOTE 1: HLC/LLC may or may not be present. The contents of HLC/LLC are not verified.

CALL PROCEEDING

Information element	Value/remark
Repeat Indicator	Omitted
Bearer Capability 1	GSM 04.08 section 10.5.4.5
Bearer Capability 2	Omitted
Facility	Omitted
Progress indicator	Omitted

MODIFY

Information element	Value/remark
Bearer capability	Appropriate for the selected test
Low layer comp.	Appropriate for the basic service selected for the test
High layer comp.	Appropriate for the basic service selected for the test
Reverse call setup direction	Presence and value not checked

MODIFY COMPLETE

Information element	Value/remark
Bearer capability	Appropriate for the selected test
Low layer comp.	Appropriate for the basic service selected for the test
High layer comp.	Appropriate for the basic service selected for the test
Reverse call setup direction	Presence and value not checked

MODIFY REJECT

Information element	Value/remark
Bearer capability	Appropriate for the selected test
Cause	#58 "bearer capability not presently available".
Low layer compatibility	Appropriate for the basic service selected for the test
High layer compatibility	Appropriate for the basic service selected for the test

26.13.3 Multislot signalling / Structured procedures

26.13.3.1 Multislot signalling / Structured procedures / MS originated call / early assignment / HSCSD / non-transparent

This test is applicable to all MS that supports multislot configuration.

26.13.3.1.1 Conformance requirements

- 1) An MS in MM state "idle, updated" and in RR idle mode, when made to initiate a call, if it provides a human interface, shall display the dialled number.
- 2) An MS in MM state "idle, updated" and in RR idle mode, when made to initiate a call for a selected teleservice/bearer service for HSCSD that is supported by the MS, starts to initiate the immediate assignment procedure by sending a CHANNEL REQUEST message with correct establishment cause.
- 3) Subsequently after establishment of a MM connection, after MS sends its multislot class in CLASSMARK CHANGE message, the MS shall send a SETUP message with correct parameters.
- 4) The call control entity of the Mobile Station in the "call initiated" state, in the "mobile originating call proceeding" state or in the "call delivered" state, shall, upon receipt of a CONNECT message:
 - 4.1) attach the user connection to the radio path;

- 4.2) return a CONNECT ACKNOWLEDGE message;
- 4.3) establish the RLP link.
- 5) User initiated service level upgrade is initiated by sending MODIFY message. After receipt of MODIFY COMPLETE message MS enters the active state.
- 6) After receipt of a CONFIGURATION CHANGE COMMAND message MS sends CONFIGURATION CHANGE ACKNOWLEDGE message.
- 7) Subsequently when the network initiates call clearing by sending a DISCONNECT message, the MS shall proceed to release the call by sending a RELEASE message.
- 8) On receipt of a CHANNEL RELEASE message, the MS shall disconnect the main signalling link.

Reference

- Conformance requirement 1: GSM 02.07
- Conformance requirement 2: GSM 04.08 sections 3.3.1.1 and 9.1.8 and 9.1.18
- Conformance requirement 3: GSM 04.08 sections 3.4.10 and 9.1.11 and 9.3.23
- Conformance requirement 4: GSM 04.08 sections 9.3.5 and 9.3.6, GSM 07.01 section 8
- Conformance requirement 5: GSM 04.08 sections 9.3.13 and 9.3.14
- Conformance requirement 6: GSM 04.08 sections 9.1.12b and 9.1.12c
- Conformance requirement 7: GSM 04.08 sections 5.4.4.2.2 and 9.3.7 and 9.3.18
- Conformance requirement 8: GSM 04.08 section 9.1.7

26.13.3.1.2 Test purpose

- 1) To verify that the MS in MM state "idle, updated" with a TMSI assigned, when made to initiate a call for a selected teleservice/bearer service for HSCSD that is supported by the MS as declared in a PICS/PIXIT statement, displays the dialled number in the way described in a PICS/PIXIT statement.
- 2) To verify that the MS in MM state "idle, updated" and in RR idle mode, with a TMSI assigned, when made to initiate a call for a selected teleservice/bearer service for HSCSD that is supported by the MS as declared in a PICS/PIXIT statement, starts to initiate an immediate assignment procedure by sending the CHANNEL REQUEST message with correct establishment cause.
- 3) To verify that subsequently after receipt of an IMMEDIATE ASSIGNMENT message allocating an SDCCH, after completion of establishment of the main signalling link, after having sent a CM SERVICE REQUEST message, after MS sends its multislot class in CLASSMARK CHANGE message, after having successfully performed the authentication and cipher mode setting procedures, the MS sends a SETUP message with correct parameters.
- 4) Multislot configuration with one TCH/F is allocated. To verify that subsequently, after receipt of a CALL PROCEEDING message and of an ASSIGNMENT COMMAND message allocating an appropriate TCH, after having completed the early assignment procedure by replying with the ASSIGNMENT COMPLETE message, after receipt of an ALERTING message and a CONNECT message, the MS returns a CONNECT ACKNOWLEDGE message.
- 5) To verify that subsequently the MS has attached the user connection to the radio path. This is verified by checking that the MS establishes the RLP link correctly and sends and receives correct RLP frames in each data block.
- 6) To verify that subsequently upon user requests User initiated service level upgrade, the MS sends MODIFY message and after receipt of MODIFY COMPLETE message the MS enters the active state.
- 7) To verify that subsequently, after receipt of a CONFIGURATION CHANGE COMMAND, after MS sends CONFIGURATION CHANGE ACKNOWLEDGE, MS through connects all bi-directional channel(s) in

multislot configuration in both directions and all uni-directional channels in downlink direction. Multislot configuration is upgraded from the simplest case up to the maximum number of channels supported by MS in the HSCSD configuration. This is verified by checking that the MS sends and receives correct RLP frames in each data block.

- 8) To verify that subsequently upon the network initiating call clearing by sending a DISCONNECT message, the MS proceed to release the call with RELEASE.
- 9) To verify that subsequently, on receipt of a RELEASE COMPLETE message followed by a CHANNEL RELEASE message, the MS disconnects the main signalling link.

26.13.3.1.3 Method of test

Initial conditions

Mobile Station:

- The MS is in MM-state "idle, updated" with valid TMSI and CKSN.

System Simulator:

- 1 cell, default parameters except:
- Early classmark sending enabled in SI3 rest octets

Related PICS/PIXIT statement(s)

- Interface to human user (p1 = Y/N)
- Way to display the called number (only applicable if the MS has an interface to human user)
- Supported teleservices/bearer services
- Classmark
- Multislot class

Foreseen final state of the MS

MS is in MM-state "idle, updated" with valid TMSI and CKSN.

Test procedure

The MS is made to initiate a HSCSD connection. The call is established with early assignment. MS enters the active state. Multislot configuration with one TCH/F is allocated. User initiated service level upgrade is successfully performed. The SS sends CONFIGURATION CHANGE COMMAND message to MS and it reply's with CONFIGURATION CHANGE ACKNOWLEDGE message. This is repeated from simplest case up to the maximum number of channels supported by the MS in the HSCSD configuration (this is performed within highest multislot class that the MS supports).

Maximum duration of test

7 min

Expected Sequence

Step	Direction	Message	Comments
1	MS		The "called number" is entered
2	MS		If p1 = Y, the MS must display the called number in the way defined in PICS/PIXIT.
3	MS -> SS	CHANNEL REQUEST	Establishment cause is "Originating call and TCH/F is needed, or originating call and the network does not set NECI bit to 1"
4	SS -> MS	IMMEDIATE ASSIGNMENT	
5	MS -> SS	CM SERVICE REQUEST	Message is contained in SABM
6	MS -> SS	CLASSMARK CHANGE	Multislot class
7	SS -> MS	AUTHENTICATION REQUEST	
8	MS -> SS	AUTHENTICATION RESPONSE	SRES specifies correct value.
9	SS -> MS	CIPHERING MODE COMMAND	SS starts deciphering after sending the message.
10	MS -> SS	CIPHERING MODE COMPLETE	Shall be sent enciphered. All following messages shall be sent enciphered.
11	SS		SS starts ciphering.
12	MS -> SS	SETUP	Non-transparent connection
13	SS -> MS	CALL PROCEEDING	
14	SS -> MS	ASSIGNMENT COMMAND	In multislot allocation only one timeslot is allocated.
15	MS -> SS	ASSIGNMENT COMPLETE	
16	SS -> MS	ALERTING	
17	MS		
18	SS -> MS	CONNECT	
19	MS -> SS	CONNECT ACKNOWLEDGE	
20	MS		The appropriate bearer channel is through connected in both directions. The RLP link establishment is initiated by the MS.
21	MS -> SS	MODIFY	User initiated service level upgrade is initiated
22	SS -> MS	MODIFY COMPLETE	
23	MS		MS enters the active state
24			Next three steps are performed as many times as used multislot class has different channel combinations. Timeslot allocation starts from simplest case and is upgraded up to the maximum that MS multislot class supports, one step at the time (within highest multislot class that the MS supports).
24A	SS -> MS	CONFIGURATION CHANGE COMMAND	Appropriate number of timeslots is selected.
24B	MS -> SS	CONFIGURATION CHANGE ACKNOWLEDGE	
24C	MS		TCH(s) shall be through connected in both directions
25	SS -> MS	DISCONNECT	
26	MS -> SS	RELEASE	
27	SS -> MS	RELEASE COMPLETE	
28	SS -> MS	CHANNEL RELEASE	The main signalling link is released

26.13.3.2 Multislot signalling / Structured procedures / MS originated call / late assignment / HSCSD / non-transparent

This test is applicable to all MS that supports multislot configuration.

26.13.3.2.1 Conformance requirements

- 1) An MS in MM state "idle, updated" and in RR idle mode with a TMSI assigned, when made to initiate a call for a selected teleservice/bearer service for HSCSD that is supported by the MS, shall start to initiate an immediate assignment procedure by sending the CHANNEL REQUEST message with correct establishment cause.
- 2) Subsequently after establishment of a MM connection, after MS sends its multislot class in CLASSMARK CHANGE message, the MS shall send a SETUP message with correct parameters.

- 3) Upon receipt of the ASSIGNMENT COMMAND message, the Mobile Station initiates a local end release of link layer connections, disconnects the physical channels, commands the switching to the assigned channels and initiates the establishment of lower layer connections (this includes the activation of the channels, their connection and the establishment of the data links). After the main signalling link is successfully established, the MS returns an ASSIGNMENT COMPLETE message, specifying cause "normal event", to the network on the main DCCH.
- 4) The call control entity of the Mobile Station in the "call initiated" state, in the "mobile originating call proceeding" state or in the "call delivered" state, shall, upon receipt of a CONNECT message:
 - 4.1) attach the user connection to the radio path;
 - 4.2) return a CONNECT ACKNOWLEDGE message;
- 4.3) establish the RLP link.
- 5) MS sends User initiated service level upgrade with MODIFY message and after receipt of MODIFY COMPLETE message the MS enters the active state.
- 6) MS receives CONFIGURATION CHANGE COMMAND and answers to it by sending CONFIGURATION CHANGE ACKNOWLEDGE message.
- 7) Subsequently when the network initiates call clearing by sending a DISCONNECT message, the MS shall proceed to release the call by sending a RELEASE message.
- 8) On receipt of a CHANNEL RELEASE message, the MS shall disconnect the main signalling link.

Reference

- Conformance requirement 1: GSM 02.07 and GSM 04.08 sections 3.3.1.1 and 9.1.8
- Conformance requirement 2: GSM 04.08 sections 9.1.11 and 9.3.23
- Conformance requirement 3: GSM 04.08 sections 3.4.3, 9.1.2 and 9.1.3
- Conformance requirement 4: GSM 04.08 sections 9.3.5 and 9.3.6, GSM 07.01 section 8
- Conformance requirement 5: GSM 04.08 sections 9.3.13 and 9.3.14
- Conformance requirement 6: GSM 04.08 sections 9.1.12b and 9.1.12c
- Conformance requirement 7: GSM 04.08 sections 9.3.7 and 9.3.18 and 5.4.4.2.2
- Conformance requirement 8: GSM 04.08 section 9.1.7

26.13.3.2.2 Test purpose

- 1) To verify that the MS in MM state "idle, updated" and in RR idle mode with a TMSI assigned, when made to initiate a call for a selected teleservice/bearer service for HSCSD that is supported by the MS as declared in a PICS/PIXIT statement, starts to initiate an immediate assignment procedure by sending the CHANNEL REQUEST message.
- 2) Multislot configuration with one TCH/F is allocated. To verify that subsequently after receipt of an IMMEDIATE ASSIGNMENT message allocating an SDCCH, after completion of establishment of the main signalling link, after having sent a CM SERVICE REQUEST message, after MS sends its multislot class in CLASSMARK CHANGE message, after having successfully performed the authentication and cipher mode setting procedures, after having sent a SETUP message, after having received of a CALL PROCEEDING message followed by an ALERTING message and an ASSIGNMENT COMMAND message allocating an appropriate TCH, the MS sends an ASSIGNMENT COMPLETE message.
- 3) To verify that subsequently, after the suite of actions specified in test purposes 1 and 2, the MS after receiving a CONNECT message returns a CONNECT ACKNOWLEDGE message.

- 4) To verify that subsequently the MS has attached the user connection to the radio path. This is verified by checking that the MS establishes the RLP link correctly and sends and receives correct RLP frames in each data block.
- 5) To verify that subsequently upon user requests User initiated service level upgrade, the MS sends MODIFY message and after receipt of MODIFY COMPLETE message the MS enters the active state.
- 6) To verify that subsequently, after receipt of a CONFIGURATION CHANGE COMMAND, after MS sends CONFIGURATION CHANGE ACKNOWLEDGE, MS through connects all bi-directional channel(s) in multislot configuration in both directions and all uni-directional channels in downlink direction. Multislot configuration is upgraded from the simplest case up to the maximum number of channels supported by MS in the HSCSD configuration. This is verified by checking that the MS sends and receives correct RLP frames in each data block.
- 7) To verify that subsequently upon the network initiating call clearing by sending a DISCONNECT message, the MS proceed to release the call with RELEASE.
- 8) To verify that subsequently, on receipt of a RELEASE COMPLETE message followed by a CHANNEL RELEASE message, the MS disconnects the main signalling link.

26.13.3.2.3 Method of test

Initial conditions

Mobile Station:

- The MS is in MM-state "idle, updated" with valid TMSI and CKSN.

System Simulator:

- 1 cell, default parameters except:
- Early classmark sending enabled in SI3 rest octets

Related PICS/PIXIT statement(s)

- Interface to human user (p1 = Y/N)
- Way to display the called number (only applicable if the MS has an interface to human user)
- Supported teleservices/bearer services
- Classmark
- Multislot class

Foreseen final state of the MS

MS is in MM-state "idle, updated" with valid TMSI and CKSN.

Test procedure

The MS is made to initiate a HSCSD connection. The call is established with late assignment. MS enters the active state. Multislot configuration with one TCH/F is allocated. User initiated service level upgrade is successfully performed. The SS sends CONFIGURATION CHANGE COMMAND message to MS and it reply's with CONFIGURATION CHANGE ACKNOWLEDGE message. This is done from simplest case up to the maximum number of channels supported by the MS in the HSCSD configuration (this is performed within highest multislot class that MS supports).

Maximum duration of test

7 min

Expected Sequence

Step	Direction	Message	Comments
1	MS		The "called number" is entered
2	MS		If p1 = Y, the MS must display the called number in the way defined in PICS/PIXIT.
3	MS -> SS	CHANNEL REQUEST	Establishment cause is "Originating call and TCH/F is needed, or originating call and the network does not set NECI bit to 1"
4	SS -> MS	IMMEDIATE ASSIGNMENT	
5	MS -> SS	CM SERVICE REQUEST	Message is contained in SABM
6	MS -> SS	CLASSMARK CHANGE	Multislot class
7	SS -> MS	AUTHENTICATION REQUEST	
8	MS -> SS	AUTHENTICATION RESPONSE	SRES specifies correct value.
9	SS -> MS	CIPHERING MODE COMMAND	SS starts deciphering after sending the message.
10	MS -> SS	CIPHERING MODE COMPLETE	Shall be sent enciphered. All following messages shall be sent enciphered.
11	SS		SS starts ciphering.
12	MS -> SS	SETUP	Non-transparent connection
13	SS -> MS	CALL PROCEEDING	
14	SS -> MS	ALERTING	
15	MS		
16	SS -> MS	ASSIGNMENT COMMAND	In multislot allocation only one timeslot is allocated.
17	MS -> SS	ASSIGNMENT COMPLETE	
18	SS -> MS	CONNECT	
19	MS -> SS	CONNECT ACKNOWLEDGE	
20	MS		The appropriate bearer channel is through connected in both directions. The RLP link establishment is initiated by the MS.
21	MS -> SS	MODIFY	User initiated service level upgrade is initiated
22	SS -> MS	MODIFY COMPLETE	
23	MS		MS enter the active state
24			Next three steps are performed as many times as used multislot class has different channel combinations. Timeslot allocation starts from simplest case and is upgraded up to the maximum that MS multislot class supports, one step at the time (within highest multislot class that the MS supports).
24A	SS -> MS	CONFIGURATION CHANGE COMMAND	Appropriate number of timeslots is selected.
24B	MS -> SS	CONFIGURATION CHANGE ACKNOWLEDGE	
24C	MS		TCH(s) shall be through connected in both directions
25	SS -> MS	DISCONNECT	
26	MS -> SS	RELEASE	
27	SS -> MS	RELEASE COMPLETE	
28	SS -> MS	CHANNEL RELEASE	The main signalling link is released

26.13.3.3 Multislot signalling / Structured procedures / MS originated call / early assignment / HSCSD / Transparent

This test is applicable to all MS that supports multislot configuration.

26.13.3.3.1 Conformance requirement

- 1) An MS in MM state "idle, updated" and in RR idle mode, when made to initiate a call, if it provides a human interface, shall display the dialled number.
- 2) An MS in MM state "idle, updated" and in RR idle mode, when made to initiate a call for a selected teleservice/bearer service for HSCSD that is supported by the MS, starts to initiate the immediate assignment procedure by sending a CHANNEL REQUEST message with correct establishment cause.
- 3) Subsequently after establishment of a MM connection, after MS sends its multislot class in CLASSMARK CHANGE message, the MS shall send a SETUP message with correct parameters.

- 4) The call control entity of the Mobile Station in the "call initiated" state, in the "mobile originating call proceeding" state or in the "call delivered" state, shall, upon receipt of a CONNECT message:
 - 4.1) attach the user connection to the radio path;
 - 4.2) return a CONNECT ACKNOWLEDGE message.
 - 4.3) establish the TDS link.
- 5) Subsequently when the network initiates call clearing by sending a DISCONNECT message, the MS shall proceed to release the call by sending a RELEASE message.
- 6) On receipt of a CHANNEL RELEASE message, the MS shall disconnect the main signalling link.

Reference

- Conformance requirement 1: GSM 02.07
- Conformance requirement 2: GSM 02.07 and GSM 04.08 sections 3.3.1.1 and 9.1.8
- Conformance requirement 3: GSM 04.08 sections 9.1.11 and 9.3.23
- Conformance requirement 4: GSM 04.08 sections 9.3.5 and 9.3.6, GSM 07.01 section 8
- Conformance requirement 5: GSM 04.08 sections 9.3.7 and 9.3.18 and 5.4.4.2.2
- Conformance requirement 6: GSM 04.08 section 9.1.7

26.13.3.3.2 Test purpose

- 1) To verify that the MS in MM state "idle, updated" with a TMSI assigned, when made to initiate a call for a selected teleservice/bearer service for HSCSD that is supported by the MS as declared in a PICS/PIXIT statement, displays the dialled number in the way described in a PICS/PIXIT statement.
- 2) To verify that the MS in MM state "idle, updated" and in RR idle mode, with a TMSI assigned, when made to initiate a call for a selected teleservice/bearer service for HSCSD that is supported by the MS as declared in a PICS/PIXIT statement, starts to initiate an immediate assignment procedure by sending the CHANNEL REQUEST message with correct establishment cause.
- 3) To verify that subsequently after receipt of an IMMEDIATE ASSIGNMENT message allocating an SDCCH, after completion of establishment of the main signalling link, after having sent a CM SERVICE REQUEST message, after MS sends its multislot class in CLASSMARK CHANGE message, after having successfully performed the authentication and cipher mode setting procedures, the MS sends a SETUP message with correct parameters.
- 4) Multislot configuration with maximum number of channels supported by MS in a HSCSD configuration, is allocated. To verify that subsequently, after receipt of a CALL PROCEEDING message and of an ASSIGNMENT COMMAND message allocating an appropriate TCHs, after having completed the early assignment procedure for all traffic channel in multislot configuration by replying with the ASSIGNMENT COMPLETE message, after receipt of an ALERTING message and a CONNECT message, the MS returns a CONNECT ACKNOWLEDGE message.
- 5) To verify that subsequently the MS has attached the user connection to the radio path. This is verified by checking that the MS synchronises correctly to the TCHs and sends and receives correct data frames in each data block.
- 6) To verify that subsequently upon the network initiating call clearing by sending a DISCONNECT message, the MS proceed to release the call with RELEASE.
- 7) To verify that subsequently, on receipt of a RELEASE COMPLETE message followed by a CHANNEL RELEASE message, the MS disconnects the main signalling link.

26.13.3.3.3 Method of test

Initial conditions

Mobile Station:

- The MS is in MM-state “idle, updated” with valid TMSI and CKSN.

System Simulator:

- 1 cell, default parameters except:
- Early classmark sending enabled in SI3 rest octets

Related PICS/PIXIT statement(s)

- Interface to human user (p1 = Y/N)
- Way to display the called number (only applicable if the MS has an interface to human user)
- Supported teleservices/bearer services - Classmark
- Multislot class

Foreseen final state of the MS

MS is in MM-state “idle, updated” with valid TMSI and CKSN.

Test procedure

The MS is made to initiate a HSCSD connection. Maximum number of channels supported by the MS in a HSCSD configuration, is allocated. The call is established with early assignment. Having reached the active state, the call is cleared by the SS.

Maximum duration of test

7 min

Expected sequence

Step	Direction	Message	Comments
1	MS		The "called number" is entered
2	MS		If p1 = Y, the MS must display the called number in the way defined in PICS/PIXIT.
3	MS -> SS	CHANNEL REQUEST	Establishment cause is "Originating call and TCH/F is needed, or originating call and the network does not set NECI bit to 1"
4	SS -> MS	IMMEDIATE ASSIGNMENT	
5	MS -> SS	CM SERVICE REQUEST	Message is contained in SABM
6	MS -> SS	CLASSMARK CHANGE	Multislot class
7	SS -> MS	AUTHENTICATION REQUEST	
8	MS -> SS	AUTHENTICATION RESPONSE	SRES specifies correct value.
9	SS -> MS	CIPHERING MODE COMMAND	SS starts deciphering after sending the message.
10	MS -> SS	CIPHERING MODE COMPLETE	Shall be sent enciphered. All following messages shall be sent enciphered.
11	SS		SS starts ciphering.
12	MS -> SS	SETUP	Transparent connection
13	SS -> MS	CALL PROCEEDING	
14	SS -> MS	ASSIGNMENT COMMAND	In multislot allocation maximum number of timeslots, that MS supports, is allocated.
15	MS -> SS	ASSIGNMENT COMPLETE	
16	SS -> MS	ALERTING	
17	MS		
18	SS -> MS	CONNECT	
19	MS -> SS	CONNECT ACKNOWLEDGE	
20	MS		The appropriate bearer channel is through connected in both directions
21	SS -> MS	DISCONNECT	
22	MS -> SS	RELEASE	
23	SS -> MS	RELEASE COMPLETE	
24	SS -> MS	CHANNEL RELEASE	The main signalling link is released

26.13.3.4 Multislot signalling / Structured procedures / MS Terminated call / early assignment / HSCSD / non-transparent

This test is applicable to all MS that supports multislot configuration.

26.13.3.4.1 Conformance requirement

- 1) The MS is in MM state "idle, updated" and in RR idle mode when being paged by the network.
- 2) The MS sends CHANNEL REQUEST message to the network and after that it receives IMMEDIATE ASSIGNMENT message from the network
- 3) The MS sends PAGING RESPONSE message to network and after that MS sends its multislot class in CLASSMARK CHANGE message to the network.
- 4) The MS performs successfully authentication and cipher mode setting procedures.
- 5) The MS shall acknowledge the SETUP message with a CALL CONFIRMED message, if compatibility checking was successful, the MS is not busy, and the user does not refuse the call.
- 6) Upon receipt of the ASSIGNMENT COMMAND message the MS continues a mobile terminating call establishment with early establishment of the traffic channel(s)
 - 6.1) by replying to the ASSIGNMENT COMMAND with an ASSIGNMENT COMPLETE message, and
 - 6.2) if the MS supports immediate connect, by continuing the call establishment by through-connecting the traffic channel(s) in both directions, or if the MS does not support immediate connect, by sending an ALERTING message
- 7) An MS indicates acceptance of a MT call by sending CONNECT.

- 8) After receiving the CONNECT ACKNOWLEDGE message from the network the MS shall establish the RLP link.
- 9) User requests User initiated service level upgrade. MS sends MODIFY message and after receipt of MODIFY COMPLETE message the MS enters the active state.
- 10) MS receives CONFIGURATION CHANGE COMMAND message and reply's to SS by sending CONFIGURATION CHANGE ACKNOWLEDGE message.
- 11) The MS initiates call clearing of an active call by sending a DISCONNECT message.
- 12) The MS in this phase of call release, upon receipt of a RELEASE message, shall return a RELEASE COMPLETE message.
- 13) Subsequently the MS, upon receipt of a CHANNEL RELEASE message, shall disconnect the main signalling link.

Reference

- Conformance requirement 1: GSM 02.07
- Conformance requirement 2: GSM 04.08 sections 3.3.1.1 and 9.1.8
- Conformance requirement 3: GSM 04.08 sections 3.3.2.2, 9.1.25 and 9.1.11
- Conformance requirement 4: GSM 04.08 sections 4.3.2, 9.2.2, 9.2.3, 3.4.7, 9.1.9, 9.1.10
- Conformance requirement 5: GSM 04.08, sections 9.3.23 and 9.3.2
- Conformance requirement 6: GSM 04.08 sections 9.1.2 and 9.1.3 and 5.2.1.5 and 9.3.1
- Conformance requirement 7: GSM 04.08 section 9.3.5
- Conformance requirement 8: GSM 04.08 section 9.3.6, GSM 07.01 section 8
- Conformance requirement 9: GSM 04.08 sections 9.3.13 and 9.3.14
- Conformance requirement 10: GSM 04.08 sections 9.1.12b and 9.1.12c
- Conformance requirement 11: GSM 04.08 section 9.3.7
- Conformance requirement 12: GSM 04.08 sections 9.3.18 and 9.3.19 and 5.4.4.2.2
- Conformance requirement 13: GSM 04.08 section 9.1.7

26.13.3.4.2 Test purpose

- 1) To verify that the MS in MM state "idle, updated" and in RR idle mode with a TMSI assigned, after being paged by the network on the correct paging subchannel, after initiating the immediate assignment procedure by sending the CHANNEL REQUEST message, after receipt of an IMMEDIATE ASSIGNMENT message allocating an SDCCH, after having sent a PAGING RESPONSE message on the allocated SDCCH, after having sent multislot class in CLASSMARK CHANGE message, after having performed successful authentication and cipher mode setting procedures, after receipt of a SETUP message not containing a signal information element, returns a CALL CONFIRMED message.
- 2) Multislot configuration with one TCH/F is allocated. To verify that subsequently, the SS sending an ASSIGNMENT COMMAND message, the MS successfully continues a mobile terminating call establishment with early assignment of traffic channel(s):
 - 2.1) by replying to the ASSIGNMENT COMMAND with an ASSIGNMENT COMPLETE message, and
 - 2.2) by continuing the call establishment by either sending a CONNECT message or sending an ALERTING message depending on PICS/PIXIT statement.
- 3) To verify that the MS generates an alerting indication if an ALERTING message had to be sent.

- 4) To verify that if an ALERTING had been sent, subsequently, when the user accepts the call (possibly internal action as declared in PICS/PIXIT statement), the MS returns a CONNECT message.
- 5) To verify that the MS after receipt of a CONNECT ACKNOWLEDGE message subsequently attaches the user connection to the radio path. This is verified by checking that the MS establishes the RLP link correctly and sends and receives correct RLP frames in each data block.
- 6) To verify that subsequently upon user requests User initiated service level upgrade, the MS send MODIFY message and after receipt of MODIFY COMPLETE message the MS enters the active state.
- 7) To verify that subsequently, after receipt of a CONFIGURATION CHANGE COMMAND, after MS sends CONFIGURATION CHANGE ACKNOWLEDGE, MS through connects all bi-directional channel(s) in multislot configuration in both directions and all uni-directional channels in downlink direction. Multislot configuration is upgraded from simplest case up to the maximum number of channels supported by MS in the HSCSD configuration. This is verified by checking that the MS sends and receives correct RLP frames in each data block.
- 8) To verify that subsequently, the MS can initiate call clearing by sending DISCONNECT message.
- 9) To verify that the MS in this phase of call release, upon receipt of a RELEASE message, returns a RELEASE COMPLETE message.
- 10) To verify that subsequently the MS, upon receipt of a CHANNEL RELEASE message, disconnects the main signalling link.

26.13.3.4.3 Method of test

Initial conditions

Mobile Station:

- The MS is in MM-state "idle, updated" with valid TMSI and CKSN.

System Simulator:

- 1 cell, default parameters except:
- Early classmark sending enabled in SI3 rest octets

Related PICS/PIXIT statement(s)

- Interface to the human user (p1= Y/N)
- Way to indicate alerting (only applicable if the MS supports the feature).
- Way to make the MS accept an incoming call after alerting (possibly dependent on teleservice/bearer service and configuration)
- Supported teleservices/bearer service
- Classmark
- Immediate connect supported (Y/N)
- Multislot class

Foreseen final state of the MS

MS is in MM-state "idle, updated" with valid TMSI and CKSN.

Test procedure

The MS is paged and the resulting HSCSD connection is established. Multislot configuration with one TCH/F is allocated. User service level upgrade is performed. MS enters the active state. Then CONFIGURATION CHANGE COMMAND message is sent to MS and it reply's with CONFIGURATION CHANGE ACKNOWLEDGE message. This is done from simplest case up to the maximum number of channels supported by the MS in the HSCSD configuration (this is performed within highest multislot class that MS supports).

Maximum duration of test

7 min

Expected sequence

Step	Direction	Message	Comments
1	SS -> MS	PAGING REQUEST TYPE 1	Sent on the correct paging subchannel.
2	MS -> SS	CHANNEL REQUEST	Establishment cause indicates "answer to paging".
3	SS -> MS	IMMEDIATE ASSIGNMENT	
4	MS -> SS	PAGING RESPONSE	Message is contained in SABM.
5	MS -> SS	CLASSMARK CHANGE	Multislot class
6	SS -> MS	AUTHENTICATION REQUEST	
7	MS -> SS	AUTHENTICATION RESPONSE	SRES specifies correct value.
8	SS -> MS	CIPHERING MODE COMMAND	SS starts deciphering after sending the message.
9	MS -> SS	CIPHERING MODE COMPLETE	Shall be sent enciphered. All following messages shall be sent enciphered.
10	SS		SS starts ciphering.
11	SS -> MS	SETUP	Message does not contain the signal IE. Setup indicates non-transparent connection.
12	MS -> SS	CALL CONFIRMED	If the MS supports immediate connect then branch A applies. If the MS does not support immediate connect then branch B applies
A13	SS -> MS	ASSIGNMENT COMMAND	In multislot allocation only one timeslot is allocated.
A14	MS -> SS	ASSIGNMENT COMPLETE	
A15	MS -> SS	CONNECT	
B13	SS -> MS	ASSIGNMENT COMMAND	In multislot allocation only one timeslot is allocated.
B14	MS -> SS	ASSIGNMENT COMPLETE	
B15	MS -> SS	ALERTING	
B16	MS		An alerting indication as defined in a PICS/PIXIT statement is given by the MS
B17	MS		The MS is made to accept the call in the way described in a PICS/PIXIT statement
B18	MS -> SS	CONNECT	
19	SS -> MS	CONNECT ACKNOWLEDGE	TCH shall be through connected in both directions. The RLP link establishment is initiated by the MS. User initiated service level upgrade is initiated
20	MS		
21	MS -> SS	MODIFY	
22	SS -> MS	MODIFY COMPLETE	
23	MS		
24	MS		
24A	SS -> MS	CONFIGURATION CHANGE COMMAND	
24B	MS -> SS	CONFIGURATION CHANGE ACKNOWLEDGE	
24C	MS		MS connects all bi-directional channels in both directions and all uni-directional channels in downlink direction.
25	MS		The MS is made to release the call.
26	MS -> SS	DISCONNECT	
27	SS -> MS	RELEASE	
28	MS -> SS	RELEASE COMPLETE	
29	SS -> MS	CHANNEL RELEASE	
			The main signalling link is released.

26.13.3.5 Multislot signalling / Structured procedures / MS Terminated call / early assignment / HSCSD / Transparent

This test is applicable to all MS that supports multislot configuration.

26.13.3.5.1 Conformance requirement

- 1) The MS is in MM state "idle, updated" and in RR idle mode when being paged by the network.

- 2) The MS sends CHANNEL REQUEST message to the network and after that it receives IMMEDIATE ASSIGNMENT message from the network
- 3) The MS sends PAGING RESPONSE message to network and after that MS sends its multislot class in CLASSMARK CHANGE message to the network.
- 4) The MS performs successfully authentication and cipher mode setting procedures.
- 5) The MS shall acknowledge the SETUP message with a CALL CONFIRMED message, if compatibility checking was successful, the MS is not busy, and the user does not refuse the call.
- 6) Upon receipt of the ASSIGNMENT COMMAND message the MS continues a mobile terminating call establishment with early establishment of the traffic channel(s)
 - 6.1) by replying to the ASSIGNMENT COMMAND with an ASSIGNMENT COMPLETE message, and
 - 6.2) if the MS supports immediate connect, by continuing the call establishment by through-connecting the traffic channel(s) in both directions, or if the MS does not support immediate connect, by sending an ALERTING message
- 7) An MS indicates acceptance of a MT call by sending CONNECT.
- 8) The mobile station shall attach the user connection and establish the TDS link when receiving the CONNECT ACKNOWLEDGE message from the network.
- 9) MS correctly uses different ciphering bit streams on the different timeslots in a multislot configuration.
- 10) The MS initiates call clearing of an active call by sending a DISCONNECT message.
- 11) The MS in this phase of call release, upon receipt of a RELEASE message, shall return a RELEASE COMPLETE message.
- 12) Subsequently the MS, upon receipt of a CHANNEL RELEASE message, shall disconnect the main signalling link.

Reference

- Conformance requirement 1: GSM 02.07
- Conformance requirement 2: GSM 04.08 sections 3.3.1.1 and 9.1.8
- Conformance requirement 3: GSM 04.08 sections 3.3.2.2, 9.1.25 and 9.1.11
- Conformance requirement 4: GSM 04.08 sections 4.3.2, 9.2.2, 9.2.3, 3.4.7, 9.1.9, 9.1.10
- Conformance requirement 5: GSM 04.08, sections 9.3.23 and 9.3.2
- Conformance requirement 6: GSM 04.08 sections 9.1.2 and 9.1.3
- Conformance requirement 7: GSM 04.08 section 9.3.5
- Conformance requirement 8: GSM 04.08 section 9.3.6, GSM 07.01 section 8
- Conformance requirement 9: GSM 03.34 section 5.2.5, GSM 04.08 sections 3.4.7 and 9.1.9
- Conformance requirement 10: GSM 04.08 section 9.3.7
- Conformance requirement 11: GSM 04.08 section 9.3.19
- Conformance requirement 12: GSM 04.08 section 9.1.7

26.13.3.5.2 Test purpose

- 1) To verify that the MS in MM state "idle, updated" and in RR idle mode with a TMSI assigned, after being paged by the network on the correct paging subchannel, after initiating the immediate assignment procedure by sending the CHANNEL REQUEST message, after receipt of an IMMEDIATE ASSIGNMENT message allocating an SDCCH, after having sent a PAGING RESPONSE message on the allocated SDCCH, after having sent multislot class in CLASMARK CHANGE message which has been explicitly accepted by the network, as indicated in the last reception in the accessed cell of the SYSTEM INFORMATION TYPE 3 message, after having performed successful authentication and cipher mode setting procedures, after receipt of a SETUP message not containing a signal information element, returns a CALL CONFIRMED message.
- 2) Multislot configuration with maximum number of channels supported by MS in a HSCSD configuration, is allocated. To verify that subsequently, the SS sending an ASSIGNMENT COMMAND message, the MS successfully continues a mobile terminating call establishment with early assignment of traffic channel(s):
 - 2.1) by replying to the ASSIGNMENT COMMAND with an ASSIGNMENT COMPLETE message, and
 - 2.2) by continuing the call establishment by either sending a CONNECT messages or sending an ALERTING message depending on PICS/PIXIT statement.
- 3) To verify that the MS generates an alerting indication if an ALERTING message had to be sent.
- 4) To verify that if an ALERTING had been sent, subsequently, when the user accepts the call (possibly internal action as declared in PICS/PIXIT statement), the MS returns a CONNECT message.
- 5) To verify that the MS after receipt of a CONNECT ACKNOWLEDGE message subsequently attaches the user connection to the radio path. This is verified by checking that the MS synchronises correctly to the TCHs and sends and receives correct data frames in each data block.
- 6) To verify that the MS correctly uses different ciphering bit streams on the different timeslots in a multislot configuration.
- 7) To verify that subsequently, the MS can initiate call clearing by sending a DISCONNECT message.
- 8) To verify that the MS in this phase of call release, upon receipt of a RELEASE message, returns a RELEASE COMPLETE message.
- 9) To verify that subsequently the MS, upon receipt of a CHANNEL RELEASE message, disconnects the main signalling link.

These test purposes are tested for all rates supported by the MS (full rate).

26.13.3.5.3 Method of test

Initial conditions

Mobile Station:

- The MS is in MM-state "idle, updated" with valid TMSI and CKSN.

System Simulator:

- 1 cell, default parameters except:
- Early classmark sending enabled in SI3 rest octets

Related PICS/PIXIT statement(s)

- Interface to the human user (p1= Y/N)
- Way to indicate alerting (only applicable if the MS supports the feature).
- Way to make the MS accept an incoming call after alerting (possibly dependent on teleservice/bearer service and configuration)

- Supported teleservices/bearer service
- Classmark
- Immediate connect supported (Y/N)
- Multislot class

Foreseen final state of the MS

MS is in MM-state "idle, updated" with valid TMSI and CKSN.

Test procedure

The MS is paged and the resulting HSCSD connection is established. Maximum number of channels supported by the MS in a HSCSD configuration, is allocated. Having reached the active state, the MS is made to clear the call.

Maximum duration of test

7 min

Expected sequence

Step	Direction	Message	Comments
1	SS -> MS	PAGING REQUEST TYPE 1	Sent on the correct paging subchannel. Establishment cause indicates "answer to paging". Message is contained in SABM. Early classmark sending Multislot class indicated SRES specifies correct value. SS starts deciphering after sending the message. Shall be sent enciphered. All following messages shall be sent enciphered. SS starts ciphering. Message does not contain the signal IE. If the MS supports immediate connect then branch A applies. If the MS does not support immediate connect then branch B applies
2	MS -> SS	CHANNEL REQUEST	
3	SS -> MS	IMMEDIATE ASSIGNMENT	
4	MS -> SS	PAGING RESPONSE	
5	MS -> SS	CLASSMARK CHANGE	
6	SS -> MS	AUTHENTICATION REQUEST	
7	MS -> SS	AUTHENTICATION RESPONSE	
8	SS -> MS	CIPHERING MODE COMMAND	
9	MS -> SS	CIPHERING MODE COMPLETE	
10	SS		
11	SS -> MS	SETUP	
12	MS -> SS	CALL CONFIRMED	
A13	SS -> MS	ASSIGNMENT COMMAND	In multislot allocation maximum number of timeslots that MS supports, is allocated.
A14	MS -> SS	ASSIGNMENT COMPLETE	
A15	MS -> SS	CONNECT	
B13	SS -> MS	ASSIGNMENT COMMAND	In multislot allocation maximum number of timeslots that MS supports, is allocated. sent on the TCH/Sm channel An alerting indication as defined in a PICS/PIXIT statement is given by the MS The MS is made to accept the call in the way described in a PICS/PIXIT statement
B14	MS -> SS	ASSIGNMENT COMPLETE	
B15	MS -> SS	ALERTING	
B16	MS		
B17	MS		
B18	MS -> SS	CONNECT	
19	SS -> MS	CONNECT ACKNOWLEDGE	The appropriate bearer channel is through connected in both directions and the MS correctly uses different ciphering bit streams on the different timeslots. The MS is made to release the call.
20	MS		
21	MS		
22	MS -> SS	DISCONNECT	
23	SS -> MS	RELEASE	
24	MS -> SS	RELEASE COMPLETE	
25	SS -> MS	CHANNEL RELEASE	

26.13.3.6 Default test conditions during layer 3 tests

During tests in section 26.13 the following default test conditions shall apply if not otherwise stated within the test description. In the table below, decimal values are normally used. Sometimes a hexadecimal value, indicated with a "H", or a binary value, indicated with a "B" is given.

	GSM 450	GSM 480
General signalling conditions for all carriers		
Ciphering	yes	yes
General RF-conditions for all carriers		
Frequency hopping mode	Non-hopping	Non-hopping
Propagation profile	Static	Static
Downlink Input Level	63 dB μ Vemf()	63 dB μ Vemf()
Uplink output power	Minimum according to MS power class	Minimum according to MS power class
Serving cell, BCCH/CCCH carrier		
Channel ARFCN	263	310
Alternative channels	274 or 276	321 or 323
Serving cell, Traffic channel, SDCCH		
Channel ARFCN	267	315
Alternative channels	275 or 279	322 or 326
Power Control Indicator	0	0
Neighbouring cells BCCH/CCCH carriers		
Channel ARFCN	261, 282, 284, 287, 290, 293	308, 329, 331, 334, 337, 340
Alternative channels	262, 283, 285, 288, 291, 292	309, 330, 332, 335, 338, 339
Input level	53 dB μ Vemf()	53 dB μ Vemf()
Network dependent parameters		
Cell identity	0001H	0001H
Mobile country code, MCC	001 (decimal)	001 (decimal)
Mobile network code, MNC	01 (decimal)	01 (decimal)
Location area code, LAC	0001H	0001H
Frequency List	Range 128	Range 128
BCCH allocation sequence number(BA_IND)	0	0
Cell Channel Descriptor	Range 128	Range 128
PLMN colour code, NCC	1	1
BS colour code, BCC	5	5
SMS Cell Broadcast	not active	not active
DTX	MS must not use	MS must not use
IMSI Attach-detach	MS shall not apply	MS shall not apply
CCCH_CONF	1 basic physical channel for CCCH combined with SDCCH	1 basic physical channel for CCCH combined with SDCCH
BS_AG_BLKS_RES	0 blocks reserved	0 blocks reserved
BS_PA_MFRMS	5 paging subgroups	5 paging subgroups
CELL_BAR_ACCESS	(not barred)	(not barred)
Call-re-establishment (RE)	(allowed)	(allowed)
Emergency Call allowed	allowed	same
Access Control Class (AC) (0..9, 11..15)	allowed	same

	GSM 900	DCS 1 800
Network dependent timers		
Radio_Link_Time-out	8	8
T3212 Periodic updating in decihours	Infinite	Infinite
Access control parameters		
Max retrans	1	1
Tx-integer, nr. of slots	5	5
CELL_RESELECT_HYSTERESIS	12 dB	12 dB
MS_TXPWR_MAX_CCH	minimum level	minimum level
RXLEV_ACCESS_MIN	minimum	minimum
NECI	New establishment causes are not supported	same
ACS (ADDITIONAL RESELECTION PARAM IND)	No additional cell parameters are present in SI messages 7 and 8	same
P1 and C2 parameters	C2 parameters not present	same
POI and POWER OFFSET	N/A	N/A

	GSM 900	DCS 1 800
General signalling conditions for all carriers		
Ciphering	yes	yes
General RF-conditions for all carriers		
Frequency hopping mode	Non-hopping	Non-hopping
Propagation profile	Static	Static
Downlink Input Level	63 dB μ Vemf()	63 dB μ Vemf()
Uplink output power	Minimum according to MS power class	Minimum according to MS power class
Serving cell, BCCH/CCCH carrier		
Channel ARFCN	20	590
Alternative channels	40 or 60	690 or 830
Serving cell, Traffic channel, SDCCH		
Channel ARFCN	30	650
Alternative channels	50 or 70	750 or 850
Power Control Indicator	0	0
Neighbouring cells BCCH/CCCH carriers		
Channel ARFCN	10, 80, 90, 100, 110, 120	520, 600, 700, 780, 810, 870
Alternative channels	15, 85, 95, 105, 115, 122	530, 610, 710, 790, 820, 880
Input level	53 dB μ Vemf()	53 dB μ Vemf()
Network dependent parameters		
Cell identity	0001H	0001H
Mobile country code, MCC	001 (decimal)	001 (decimal)
Mobile network code, MNC	01 (decimal)	01 (decimal)
Location area code, LAC	0001H	0001H
Frequency List	Bit Map 0	Range 512
BCCH allocation sequence number(BA_IND)	0	0
Cell Channel Descriptor	Bit Map 0	Range 512
PLMN colour code, NCC	1	1
BS colour code, BCC	5	5
SMS Cell Broadcast	not active	not active
DTX	MS must not use	MS must not use
IMSI Attach-detach	MS shall not apply	MS shall not apply
CCCH_CONF	1 basic physical channel for CCCH combined with SDCCH	1 basic physical channel for CCCH combined with SDCCH
BS_AG_BLKS_RES	0 blocks reserved	0 blocks reserved
BS_PA_MFRMS	5 paging subgroups	5 paging subgroups
CELL_BAR_ACCESS	(not barred)	(not barred)
Call-re-establishment (RE)	(allowed)	(allowed)
Emergency Call allowed	allowed	same
Access Control Class (AC) (0..9, 11..15)	allowed	same

	GSM 900	DCS 1 800
Network dependent timers		
Radio_Link_Time-out	8	8
T3212 Periodic updating in decihours	Infinite	Infinite
Access control parameters		
Max retrans	1	1
Tx-integer, nr. of slots	5	5
CELL_RESELECT_HYSTERESIS	12 dB	12 dB
MS_TXPWR_MAX_CCH	minimum level	minimum level
RXLEV_ACCESS_MIN	minimum	minimum
NECI	New establishment causes are not supported	same
ACS (ADDITIONAL RESELECTION PARAM IND)	No additional cell parameters are present in SI messages 7 and 8	same
P1 and C2 parameters	C2 parameters not present	same
POI and POWER OFFSET	N/A	POWER OFFSET Parameter not present.

These information's are provided by system information 1, 2, 3 and 4 messages.

The system information elements that are broadcast on the SACCH/M during the dedicated mode should be consistent with those sent on the BCCH when the MS was in idle mode prior to the channel request.

In addition, all fill paging messages sent on the paging sub-channels will have by default, their page mode set to NORMAL PAGING.

26.13.3.7 Default contents of messages

ALERTING (mobile station to network direction)

Information element	Value/remark
Facility	Not checked
User-user	Not checked
SS version	Not checked

ALERTING (network to mobile station direction)

Information element	Value/remark
Facility	Omitted
Progress indicator	Omitted
User-user	Omitted

ASSIGNMENT COMMAND

Information element	Value/remark
Description of the first channel	describes non-hopping Bm+ACCHs or Lm+ACCHs as appropriate for the test
Power Command	As in section 26.1.1
Frequency list	Omitted
Cell channel description	Omitted
Description of the multislot configuration	Appropriate for the teleservice selected for the test
Mode of the channel set X (1=<X<=8)	Appropriate for on bearer capability chosen for the test
Description of the second channel	Omitted
Mode of the second channel	Omitted
Mobile allocation	Omitted
Starting time	Omitted
Cipher mode setting	Omitted

ASSIGNMENT COMPLETE

Information element	Value/remark
RR cause	normal event

AUTHENTICATION REQUEST

Information element	Value/remark
Ciphering key sequence number	Arbitrary
Spare half octet	(spare bits)
Authentication parameter RAND	Arbitrary

AUTHENTICATION RESPONSE

Information element	Value/remark
Authentication parameter SRES	Correct for given SRES

CALL CONFIRMED

Information element	Value/remark
Repeat indicator	Omitted
Bearer capability 1	GSM 04.08 section 10.5.4.5
Bearer capability 2	Omitted
Cause	Omitted

CALL PROCEEDING

Information element	Value/remark
Repeat Indicator	Omitted
Bearer Capability 1	GSM 04.08 section 10.5.4.5
Bearer Capability 2	Omitted
Facility	Omitted
Progress indicator	Omitted

CHANNEL RELEASE

Information element	Value/remark
RR cause	Normal event

CHANNEL REQUEST

Information element	Value/remark
Establishment cause	Answer to paging (100)
Random reference	Arbitrary value of 5 bits length

CIPHERING MODE COMMAND

Information element	Value/remark
Cipher mode setting	
algorithm identifier	indicates a supported algorithm
SC	Start ciphering
Cipher response	
CR	IMEI must not be included

CIPHERING MODE COMPLETE

Information element	Value/remark
Mobile equipment identity	Omitted

CLASSMARK CHANGE

Information element	Value/remark
MS classmark	Multislot classmark value appropriate for the test
Additional mobile station classmark information	Omitted

CM SERVICE ACCEPT

Information element	Value/remark
none but message head	

CM SERVICE REQUEST

Information element	Value/remark
CM service type	Mobile originating call establishment or packet mode connection establishment
Ciphering key sequence number	CKSN of the MS
Mobile station classmark 2	as given by PICS.
Mobile identity	TMSI of MS

CONFIGURATION CHANGE COMMAND

Information element	Value/remark
Description of the multislot configuration	Appropriate for the teleservice selected for the test
Mode of channel set X (1= $X \leq 8$)	Appropriate channel mode is selected

CONFIGURATION CHANGE REJECT

Information element	Value/remark
RR Cause	Cause = "Channel mode unacceptable"

CONNECT (network to mobile station direction)

Information element	Value/remark
Facility	Omitted
Progress indicator	Omitted
Connected number	Omitted
Connected subaddress	Omitted
User-user	Omitted

CONNECT (mobile station to network direction)

Information element	Value/remark
Facility	Not checked
Connected subaddress	Not checked
User-user	Not checked
SS version	Not checked

CONNECT ACKNOWLEDGE

Information element	Value/remark
none but message head	

DISCONNECT (network to mobile station direction)

Information element	Value/remark
Cause	
Coding standard	GSM
Location	User
Cause value	Normal clearing
Facility	Omitted
Progress indicator	Omitted
User-user	Omitted

DISCONNECT (mobile station to network direction)

Information element	Value/remark
Cause	
Coding standard	GSM
Location	User
Cause value	Normal clearing
Facility	Not checked
User-user	Not checked
SS version	Not checked

IMMEDIATE ASSIGNMENT

Information element	Value/remark
Page mode	Normal paging
Channel description	describes a valid SDCCH+SACCH in non-hopping mode
Request reference	
Random access information	As received from MS
N51, N32, N26	Corresponding to frame number of the CHANNEL REQUEST
Timing advance	Arbitrary
Mobile allocation	Empty (L=0)
Starting time	Omitted

MODIFY

Information element	Value/remark
Bearer capability	
Connection element (octet 6c)	Transparent for cases: 26.13.3.3, 26.13.3.5 Non-transparent for cases: 26.13.3.1, 26.13.3.2, 26.13.3.4
Low layer comp.	Appropriate for the basic service selected for the test
High layer comp.	Appropriate for the basic service selected for the test
Reverse call setup direction	Presence and value not checked

MODIFY COMPLETE

Information element	Value/remark
Bearer capability Connection element (octet 6c)	Transparent for cases: 26.13.3.3, 26.13.3.5 Non-transparent for cases: 26.13.3.1, 26.13.3.2, 26.13.3.4
Low layer comp.	Appropriate for the basic service selected for the test
High layer comp.	Appropriate for the basic service selected for the test
Reverse call setup direction	Presence and value not checked

MODIFY REJECT

Information element	Value/remark
Bearer capability Connection element (octet 6c)	Transparent for cases: 26.13.3.3, 26.13.3.5 Non-transparent for cases: 26.13.3.1, 26.13.3.2, 26.13.3.4
Cause	Cause = Channel Unacceptable
Low layer comp.	Appropriate for the basic service selected for the test
High layer comp.	Appropriate for the basic service selected for the test

PAGING REQUEST TYPE 1

Information element	Value/remark
L2 pseudo length	L2 pseudo length of the message
Page Mode	Normal Paging
Channels needed for Mobiles 1 and 2 channel (first)	any channel
channel (second)	any channel
Mobile identity 1	TMSI of MS under test
Mobile identity 2	Omitted
P1 rest octets	(spare octets)

PAGING RESPONSE

Information element	Value/remark
Ciphering key sequence number	Value assigned to MS in the initial conditions
Spare half octet	(spare bits)
Mobile station classmark 2	as given by PICS
Mobile identity	specifies TMSI of MS

RELEASE (network to mobile station direction)

Information element	Value/remark
Cause	Omitted
Second cause	Omitted
Facility	Omitted
User-user	Omitted

RELEASE (mobile station to network direction)

Information element	Value/remark
Cause	Not checked
Second cause	Not checked
Facility	Not checked
User-user	Not checked
SS version	Not checked

RELEASE COMPLETE (network to mobile station direction)

Information element	Value/remark
Cause	Omitted
Facility	Omitted
User-user	Omitted

RELEASE COMPLETE (mobile station to network direction)

Information element	Value/remark
Cause	Not checked
Facility	Not checked
User-user	Not checked
SS version	Not checked

SETUP (MS to SS)

Information element	Value/remark
BC Repeat indicator	Omitted
Bearer capability 1	Appropriate for the teleservice selected for the test
Bearer capability 2	Omitted
Facility	Not checked
Calling party subaddress	Not checked
Called party BCD number	As entered
Called party subaddress	Omitted
LLC repeat indicator	Omitted
Low layer compatibility I	Appropriate for teleservice selected for the test
Low layer compatibility II	Omitted
HLC repeat indicator	Omitted
High layer compatibility i	Appropriate for teleservice selected for the test
High layer compatibility ii	Omitted
User-user	Not checked
SS version	Not checked
CLIR suppression	Not checked
CC Capabilities	Not checked

SETUP (SS to MS)

Information element	Value/remark
BC repeat indicator	Omitted
Bearer capability 1	Appropriate for teleservice selected for the test
Bearer capability 2	Omitted
Facility	Omitted
Progress indicator	Omitted
Signal	Omitted
Calling party BCD number	Omitted
Calling party subaddress	Omitted
Called party BCD number	Omitted
Called party subaddress	Omitted
LLC repeat indicator	Omitted
Low layer compatibility I	Appropriate for the teleservice selected for the test
Low layer compatibility II	Omitted
HLC repeat indicator	Omitted
High layer compatibility i	Appropriate for the teleservice selected for the test
High layer compatibility ii	Omitted
User-user	Omitted

26.14 VGCS and VBS Tests

This clause applies to mobile station supporting Voice Group Call Service (TS 91) and/or Voice Broadcast Service (TS 92). The objective of this clause is to test VGCS/VBS concerned procedures. A specific VGCS/VBS SIM card is needed for testing. If a mobile supports both VGCS and VBS, the VGCS is selected for tests except when otherwise stated.

For VGCS and VBS, the following possible mobile station implementations exist:

- support of VBS listening
- support of VBS originating
- support of VGCS listening
- support of VGCS talking. This always includes the implementation for VGCS listening
- support of VGCS originating. This always includes the implementation for VGCS talking

Apart from the explicitly mentioned combinations, all possible combinations are optional.

In this clause some L3 messages are sent in UI format to which no L2 acknowledgement/re-transmission mechanism is applied. It is important for overall tests in this clause to ensure that the radio conditions are ideal.

Table 26.14.1 to 26.14.3 define generic procedures to bring the MS into an initial state. For establishment of group transmit mode Table 26.14.1 is used if the MS supports VGCS talking. If an MS supporting VBS originating rather than VGCS, Table 26.14.2 is used for establishment of a VBS call and to bring the MS into group transmit mode. For establishment of group receive mode Table 26.14.3 is applied.

Unless indicated in individual sub-clauses, the default message contents in clause 26.14.10 are applied.

Table 26.14.1: Establishment of group transmit mode for VGCS

Step	Direction	Message	Comments
0	MS		the MS is in idle mode
1	SS -> MS	NOTIFICATION/NCH	with a description of VGCS channel and a VGCS call reference active in the MS
2	MS		After the indication of the notification, MMI action to join the VGCS call
3	SS -> MS	UPLINK FREE	
4	MS		MMI action to request uplink access
5	MS -> SS	UPLINK ACCESS	
6	MS -> SS	UPLINK ACCESS	
7	SS -> MS	UPLINK BUSY	
8	SS -> MS	VGCS UPLINK GRANT	
9	MS -> SS	TALKER INDICATION	L2: SABM / UA

Table 26.14.2: Establishment of a VBS call

Step	Direction	Message	Comments
0	MS		the MS is in idle mode
1	MS		MMI action to initiate a VBS call with setup procedure.
2	MS -> SS	CHANNEL REQUEST	
3	SS -> MS	IMMEDIATE ASSIGNMENT	TCH/F, single RF channel GSM 450: 275, GSM 480: 322 GSM 900: 50, DCS 1800: 750 PCS 1900: 650
4	MS -> SS	CM SERVICE REQUEST	VBS establishment, L2: SABM / UA
5	SS -> MS	CM SERVICE ACCEPT	
6	MS -> SS	SETUP	
7	SS -> MS	CHANNEL MODE MODIFY	
8	MS -> SS	CHANNEL MODE MODIFY ACKNOWLEDGE	
9	SS -> MS	CONNECT	

Table 26.14.3: Establishment of group receive mode for VGCS or VBS

Step	Direction	Message	Comments
0	MS		the MS is in idle mode
1	SS -> MS	NOTIFICATION/NCH	with a description of VGCS/VBS channel and a VGCS/VBS call reference active in the MS, for VGCS call the SF set to '1', for VBS call the SF set to '0'
2	MS		After the indication of the notification, MMI action to join the VGCS/VBS call

26.14.1 VGCS-VBS / Notification

The notification procedure is mandatory for mobile stations supporting VGCS listening or VBS listening.

26.14.1.1 VGCS-VBS / Notification / notification indication

26.14.1.1.1 Conformance requirement

1. Having received a NOTIFICATION/NCH or NOTIFICATION/FACCH which contains group call reference(s) that are active in the MS, the MS shall correctly indicate the notified group/broadcast call reference(s).
2. On request to respond to the call notification, the MS shall join the VGCS/VBS call on the correct channel if a description for the VGCS/VBS channel is included.
3. On request to respond to the call notification, the MS shall establish an RR connection to respond the notification if no description for the VGCS/VBS channel is included.
4. The MS shall ignore any NOTIFICATION/NCH or NOTIFICATION/FACCH which contains group call reference(s) that are not active in the MS.

Reference(s)

GSM 04.08 clause 3.3.3.1, 3.3.3.2.

GSM 03.68 clause 4.1, 11.3.1.3a, 11.3.1.3b.

GSM 03.69 clause 4.1, 11.3.1.3a, 11.3.1.3b.

26.14.1.1.2 Test purpose

To verify that the MS indicates correctly the notified group/broadcast call reference(s) after receiving a NOTIFICATION/NCH or NOTIFICATION/FACCH message which contains group call reference(s) that are active in the MS.

To verify that the MS, on request to respond to a call notification, joins the VGCS/VBS call on the correct channel if a description for the VGCS/VBS channel is included in the NOTIFICATION message.

To verify that the MS, on request to respond to a call notification, establishes an RR connection to respond to the notification if no description for the VGCS/VBS channel is included in the NOTIFICATION message.

To verify that the MS ignores any NOTIFICATION/NCH or NOTIFICATION/FACCH which contains group call reference(s) that are not active in the MS.

To verify that there is no uplink transmission from the MS on TCH after the MS join the call.

26.14.1.1.3 Method of test

Initial Conditions

System Simulator:

1 cell default parameters for ASCII testing

Mobile Station:

The MS is in MM-state "idle, updated". No automatic answering is configured.

Related PICS/PIXIT Statement(s)

Type of MS (GSM 450, GSM 480, P-, E-, R-GSM 900, DCS 1800 or PCS 1900).

Support VGCS listening.

Support VGCS talking.

Support VBS listening.

Support VBS originating.

Way to configure VGCS or VBS.

Way to indicate a call notification.

Way to accept a VGCS or VBS.

Way to verify the downlink speech path.

Foreseen Final State of the MS

"Idle, updated".

Test Procedure

The MS is in idle mode, the SS sends NOTIFICATION/NCH containing VGCS/VBS channel description and VGCS/VBS call reference not active in the MS. It is checked that the MS ignores the message. The SS sends NOTIFICATION/NCH containing VGCS/VBS channel description and VGCS/VBS call reference active in the MS ("good reference"). It is checked whether the MS indicates correctly the notified group call reference(s) and joins VGCS/VBS call on request of responding to the notification. The group call is terminated. The SS sends NOTIFICATION/NCH which contains the "good reference" but no VGCS/VBS channel description. It is checked that the MS indicates correctly the notified group call reference(s) and establishes a RR connection to respond to the notification on request of responding to the call, then joins the call. The group call is terminated.

The MS is brought to group receive mode or CC state U10 or dedicated mode with signalling connection or group transmit mode (for k=1, 2, 3, 4 respectively), the SS sends NOTIFICATION/FACCH containing the “good reference” but no VGCS/VBS channel description. It is checked that the MS gives correct notified group call reference(s) and on request of responding to the call, establishes a RR connection to respond to the notification and joins the call. The call is terminated.

Finally, the MS is brought to group receive mode or CC state U10 or dedicated mode with signalling connection or group transmit mode (for k=1, 2, 3, 4 respectively), the SS sends NOTIFICATION/FACCH containing the “good reference” and VGCS/VBS channel description. It is checked the MS indicates correctly the notified group call reference(s) and joins VGCS/VBS call on request of responding to the notification. The group call is terminated.

Maximum Duration of Test

10 minutes excluding operator operations.

Expected Sequence

Test steps 20 to 50 are executed for k=1, 2, 3, 4 conditionally. If the MS does not support CC state U10, test steps 20 to 50 are not executed for k=2. If the MS does not support VGCS talking or VBS originating, test steps 20 to 50 are not executed for k=4.

Step	Direction	Message	Comments
0	MS		the MS is in idle mode
1	SS -> MS	NOTIFICATION/NCH	with a description of VGCS/VBS channel and a VGCS/VBS call reference not active in the MS
2	MS		check that the MS ignores the notification and there is no uplink transmission on that channel for 10 s.
3	SS -> MS	NOTIFICATION/NCH	with a description of VGCS/VBS channel and a VGCS/VBS call reference active in the MS
4	MS		check that the MS gives an indication containing the notified group call reference
5	MS		MMI action to join the VGCS/VBS call
6	MS		check that the TCH in downlink is through connected and there is no uplink transmission on that channel for 10 s.
7	SS		stop sending NOTIFICATION/NCH
8	SS -> MS	CHANNEL RELEASE	UI format, return to the idle updated state
9	SS		wait for the MS returning to idle updated mode and listening to NCH again
10	SS -> MS	NOTIFICATION/NCH	with a VGCS/VBS call reference active in the MS but different from step 3 and no VGCS/VBS channel description
11	MS		MMI action to join the VGCS/VBS call
12	MS -> SS	CHANNEL REQUEST	
13	SS -> MS	IMMEDIATE ASSIGNMENT	
14	MS -> SS	NOTIFICATION RESPONSE	L2: SABM / UA
15	SS -> MS	CHANNEL RELEASE	release the dedicated channel with a group channel description. The MS releases L2 multiple frame link L2:DISC/UA.
16	MS		check that the TCH in downlink is through connected and there is no uplink transmission on that channel for 10 s.
17	SS		stop sending NOTIFICATION/NCH
18	SS -> MS	CHANNEL RELEASE	UI format, to return to idle updated state
19			wait 5s.
A20 B20 C20 D20	MS		for k=1, the MS is brought into group receive mode for k=2, the MS is brought into CC state U10 for k=3, the MS is brought into dedicated mode with a signalling connection for k=4, the MS is brought into group transmit mode
21	SS -> MS	NOTIFICATION/FACCH	with a VGCS/VBS call reference not active in the MS, but no VGCS/VBS channel description
22	MS		check that the MS ignores the notification and there is no uplink transmission on that channel for 10 s.

Step	Direction	Message	Comments
23	SS -> MS	NOTIFICATION/FACCH	with a VGCS/VBS call reference active in the MS, but no VGCS/VBS channel description check the MS's indication of the notified VGCS/VBS call reference MMI action to join the VGCS/VBS call
24	MS		
25	MS		
A26			for k=1, no signalling needed
B26	MS -> SS	DISCONNECT	for k=2, release the old call and the channel
B27	SS -> MS	RELEASE	
B28	MS -> SS	RELEASE COMPLETE	The MS releases L2 multiple frame link L2:DISC/UA.
B29	SS -> MS	CHANNEL RELEASE	
C26	MS -> SS	DISC/UA	for k=3, release the original dedicated. The MS releases L2 multiple frame link L2:DISC/UA.
D26	MS -> SS	UPLINK RELEASE	for k=4, release original uplink - for VGCS only UI format, to return to idle updated state - for VGCS only
D27	SS -> MS	CHANNEL RELEASE	
D28	MS -> SS	TERMINATION REQUEST	for VBS call only
D29	SS -> MS	TERMINATION	for VBS call only
D30	SS -> MS	CHANNEL RELEASE	The MS releases L2 multiple frame link L2:DISC/UA -for VBS call only
31	MS -> SS	CHANNEL REQUEST	L2: SABM / UA with group channel description. The MS releases L2 multiple frame link L2:DISC/UA. check that the TCH in downlink is through connected and there is no uplink transmission on that channel for 10 s. if the MS supports VGCS talking stop sending NOTIFICATION/NCH UI format, return to the idle updated state wait for the MS returning to idle updated mode
32	SS -> MS	IMMEDIATE ASSIGNMENT	
33	MS -> SS	NOTIFICATION RESPONSE	
34	SS -> MS	CHANNEL RELEASE	
35	MS		
36	SS		
37	SS -> MS	CHANNEL RELEASE	
38			
A	MS		for k=1, the MS is brought into group receive mode for k=2, the MS is brought into CC state U10 for k=3, the MS is brought into dedicated mode with a signalling connection
B40			
C40			for k=4, the MS is brought into group transmit mode with VGCS/VBS channel description and VGCS/VBS call reference active in the MS
D40	SS -> MS	NOTIFICATION/FACCH	
41	SS -> MS	NOTIFICATION/FACCH	check the indication of the notified VGCS/VBS call reference
42	MS		MMI action to join the VGCS/VBS call
43	MS		
A44			for k=1, no signalling needed
B44	MS -> SS	DISCONNECT	for k=2, release the old call and the channel
B45	SS -> MS	RELEASE	
B46	MS -> SS	RELEASE COMPLETE	The MS releases L2 multiple frame link L2:DISC/UA.
B47	SS -> MS	CHANNEL RELEASE	
C44	MS -> SS	DISC/UA	for k=3, release the original dedicated channel. The MS releases L2 multiple frame link L2:DISC/UA.
D44	MS -> SS	UPLINK RELEASE	for k=4, release original uplink - for VGCS call only UI format, to return to idle updated state - for VGCS only
D45	SS -> MS	CHANNEL RELEASE	
D46	MS -> SS	TERMINATION REQUEST	for VBS call only
D47	SS -> MS	TERMINATION	for VBS call only
D48	SS -> MS	CHANNEL RELEASE	The MS releases L2 multiple frame link L2:DISC/UA -for VBS call only
49	MS		check that the TCH in downlink is through connected and there is no uplink transmission on that channel for 10 s.

Step	Direction	Message	Comments
50	SS		stop sending NOTIFICATION/NCH
51	SS -> MS	CHANNEL RELEASE	UI format, to return to the idle updated state

26.14.1.2 VGCS-VBS / Notification / NCH position

26.14.1.2.1 Conformance requirement

The MS shall recognise correctly different NCH positions and blocks if supporting VGCS or VBS.

In the case the CCCH configuration is not compatible with the NCH position, the MS shall behave as if the NCH position field was not present.

Reference(s)

GSM 05.02, clause 6.5.1, 6.5.5, 7 Table 3

GSM 04.08, clause 10.5.2.32

26.14.1.2.2 Test purpose

To verify that the MS recognises correctly different NCH positions of first block and number of blocks.

To verify that the MS behaves as if the NCH position field was not present when the CCCH configuration is not compatible with the NCH position.

26.14.1.2.3 Method of test

Initial Conditions

System Simulator:

1 cell, BS_AG_BLK_RES = 5, CCCH non-combined.

Mobile Station:

The MS is in MM-state "idle, updated". No automatic answering is configured.

Related PICS/PIXIT Statement(s)

Type of MS (GSM 450, GSM 480, P-, E-, R-GSM 900, DCS 1800 or PCS 1900).

Support VGCS listening.

Support VBS listening.

Way to configure VGCS or VBS.

Way to indicate a call notification.

Foreseen Final State of the MS

"Idle, updated".

Test Procedure

The MS is in idle mode, the SS sends SI 1 containing the 1st NCH block number = 3 (B3) and No. of blocks = 1. After the MS decodes the SI 1, the SS sends on the block B1 NOTIFICATION/NCH containing VGCS/VBS channel description and VGCS/VBS call reference active in the MS. It is checked that the MS ignores the notification. The SS stops sending NOTIFICATION/NCH on block B1, but sends on block B3 containing VGCS/VBS channel description and VGCS/VBS call reference active in the MS. It is checked that the MS indicates correctly the notified group call reference(s).

The SS stops sending NOTIFICATION/NCH on block B3 and changes SI 1 containing The 1st NCH block number = 1 and No. of blocks = 2. After the MS decodes the SI the SS sends NOTIFICATION/NCH on the block B2 containing VGCS/VBS channel description and VGCS/VBS call reference active in the MS. It is checked that the MS indicates correctly the notified group call reference(s).

The SS stops sending NOTIFICATION/NCH on block B2 and changes the CCCH configuration with combined SDCCH, BS_AG_BLK_RES = 1. Wait 30 s. and then sends NOTIFICATION/NCH on the block B2 containing VGCS/VBS channel description and VGCS/VBS call reference active in the MS. It is checked that the MS ignores the notification.

Maximum Duration of Test

5 minutes.

Expected Sequence

Step	Direction	Message	Comments
0	MS		the MS is in idle mode
1	SS -> MS	SYSTEM INFORMATION TYPE1	containing The 1st NCH block number = 3 and No. of blocks = 1
2	SS		wait for 5 s.
3	SS -> MS	NOTIFICATION/NCH	sent on block B1, containing a VGCS/VBS channel description and a VGCS/VBS call reference active in the MS
4	MS		check that the MS ignores the notification
5	SS		stop sending NOTIFICATION/NCH on block 1
6	SS -> MS	NOTIFICATION/NCH	sent on block B3, containing a VGCS/VBS channel description and a VGCS/VBS call reference active in the MS
7	MS		check that the MS indicates the notification to user
8	MS		user action to reject the group/broadcast call
10	SS		stop sending NOTIFICATION/NCH on block 3
11	SS -> MS	SYSTEM INFORMATION TYPE 1	containing The 1st NCH block number = 1 and No. of blocks = 2
12	SS		wait for 30 s.
13	SS -> MS	NOTIFICATION/NCH	sent on block B2, containing a VGCS/VBS channel description and a VGCS/VBS call reference active in the MS
14	MS		check that the MS indicates the notification to user
15	MS		user action to reject the group/broadcast call
20	SS		change CCCH with combined SDCCH, BS_AG_BLK_RES = 1 and stop sending NOTIFICATION/NCH on block B2
21	SS -> MS	SYSTEM INFORMATION TYPE 1	containing The 1st NCH block number = 0 and No. of block = 1
22	SS		wait for 30 s.
23	SS -> MS	NOTIFICATION/NCH	sent on block B2, containing a VGCS/VBS channel description and a VGCS/VBS call reference active in the MS
24	MS		check that the MS ignores the notification

26.14.1.3 VGCS-VBS / Notification / Reduced NCH monitoring

26.14.1.3.1 Conformance requirement

1. When the mobile station in idle mode enters a cell and deduces from the BCCH that an NCH is present, it shall read the NCH until it has received at least two messages on the NCH indicating NLN, with the two last received NLN being identical. Then it may stop reading the NCH until it receives on the PCH an NLN(PCH) different from the last previously received NLN.
2. If the reduced NCH monitoring mechanism is used on the NCH, when the MS in group receive mode or group transmit mode enters a cell, it should read the NCH until it has received at least two messages on the NCH indicating NLN, with the two last received NLN being identical. Then it should stop reading the NCH until it receives on the SACCH an NLN(SACCH) different from the last previously received NLN.
3. A change of the NLN status field indicates a change of information on the NCH which is not related to new calls.

Reference(s)

GSM 04.08 clause 3.3.3.3.

GSM 04.08 clause 3.4.15.1.2.4.1.

26.14.1.3.2 Test purpose

To verify that:

1. when the MS in idle mode on a cell where a reduced monitoring is activated, it reads the NCH until it has received at least two NLN (NCH) being identical. Then it stops reading the NCH until it receives a PAGING REQUEST message of any TYPE containing an NLN (PCH) different from the last previously received NLN.
2. after the MS entered in group receive mode or group transmit mode it continues the reduced monitoring until it receives SI6 containing an NLN (SACCH) different from the last previously received NLN (SACCH).
3. when the MS in group receive mode or group transmit mode enters a new cell, it reads the NCH until it has received at least two messages on the NCH indicating NLN, with the two last received NLN being identical. Then it stops reading the NCH until it receives SI6 on the SACCH an NLN(SACCH) different from the last previously received NLN.
4. the MS understands the change of the NLN status field.

26.14.1.3.3 Method of test

Initial Conditions

System Simulator:

2 cells with default parameters for ASCII testing, same LAI.

The values specified in Table 26.14.1.3 override the values in default contents of SI messages in clause 26.6.14. and 26.6.15.

Table 26.14.1.3: Default values of the system information fields

Parameter	GSM 04.08 reference	Abbr.	Normal Setting
CELL_BAR_QUALIFY	10.5.2.35	CBQ	0
CELL_RESELECT_OFFSET	10.5.2.35	CRO	0
TEMPORARY_OFFSET	10.5.2.35	TO	0
PENALTY_TIME	10.5.2.35	PT	31
Power Offset	10.5.2.35	PO	0

Mobile Station:

The MS is in MM-state "idle, updated" with a TMSI allocated on cell A. No automatic answering configured.

Related PICS/PIXIT Statement(s)

Type of MS (GSM 450, GSM 480, P-, E-, R-GSM 900, DCS 1800 or PCS 1900).

Support reduced NCH monitoring.

Support VGCS listening.

Support VGCS talking.

Support VBS listening.

Support VBS originating.

Support NCH monitoring in group receive mode

Support NCH monitoring in group transmit mode

Support NCH monitoring in dedicated mode

Way to configure VGCS or VBS.

Way to indicate uplink granted/rejected.

Way to accept a VGCS or VBS.

Way to request uplink.

Foreseen Final State of the MS

"Idle, updated" on cell B.

Test Procedure

The MS is in idle mode on cell A. The SS sends NOTIFICATION/NCH with NLN (value is '00'B) but not addressing the MS on cell A. After at least 2 such messages have been received by the MS, the SS sends another NLN value ('01'B) in the NOTIFICATION/NCH message which contains call reference active in the MS and VGCS/VBS channel description. It is checked that the MS does not indicate the notification. The SS sends PAGING REQUEST TYPE1 message on the MS's paging sub-channel on cell A with NLN(PCH) containing value '01'B. It is checked that the MS indicates the notification to the user. The MS rejects the VGCS/VBS call on request from MMI. The same procedure is repeated once except SS sends PAGING REQUEST TYPE2 message instead of PAGING REQUEST TYPE1. The NLN value is set to '10'B.

Change the RF levels of cell A and cell B so that the MS re-selects cell B. The same test procedure as described above is repeated once except the SS sends PAGING REQUEST TYPE 3 message on the MS's paging sub-channel on cell B. The NLN value is set to '11'B. The MS joins the VGCS/VBS call on request from MMI and is in group receive mode on cell B.

On cell A the SS sends NOTIFICATION/NCH containing VGCS/VBS channel description, the same call reference and NLN value as those of cell B. Adjust the RF levels of cell A and cell B so that cell B keeps suitable but the MS re-selects cell A. The MS is still in group receive mode. After the MS has consecutively received at least two identical NLN (NCH) the SS sends NOTIFICATION/NCH containing an NLN valued '01'B, VGCS/VBS channel description and call reference active in the MS. It is checked that the MS does not indicate the notification. The SS changes NLN value to '01'B in SI 6 message. It is checked that the MS indicates the notification to the user. The call is rejected. The SS changes NLN status value to '1'B in SI 6 message. It is checked that the MS does not indicate any new notification to the user.

The MS is brought into group transmit mode and handed over to cell B. After at least two NOTIFICATION/NCH messages received on cell B, the SS sends an another NOTIFICATION/NCH message with NLN value ('00'B) and addressing the MS on cell B. It is checked that the MS does not indicate the notification. The SS changes NLN value to '00'B in SI 6 message. It is checked that the MS indicates the notification to the user.

Maximum Duration of Test

10 minutes

Expected Sequence

Test steps 0 to 8 are executed for k=1, 2, 3. When finished the test then goes to step 9. If the MS does not support VGCS talking, test step 18 to 44 are not executed.

Step	Direction	Message	Comments
A0, B0 C0	MS		for k=1, 2 the MS is in idle mode on cell A. The following messages are received and sent on cell A. for k=3, adjust the power level of cell A to 32 dB μ V emf() so that the MS re-selects cell B. The following messages are sent and received on cell B.
1 2 3	SS -> MS SS SS -> MS	NOTIFICATION/NCH NOTIFICATION/NCH	with an initial NLN, a channel description and a call reference not addressing MS. wait 1 second, ensuring that the MS has consecutively received at least two identical NLN (NCH). with an NLN different to step 1, a call reference active in the MS. For k= 1, 2, 3, each NLN is different.
A5 B5 C5	SS -> MS SS -> MS SS -> MS	PAGING REQUEST TYPE 1 PAGING REQUEST TYPE 2 PAGING REQUEST TYPE 3	for k=1, with the NLN (PCH) same as step 3 for k=2, with the NLN (PCH) same as step 3. for k=3, with the NLN (PCH) same as step 3.
6 7	SS MS		wait 1 s. check that the MS indicates the notification sent in step 5.
A8, B8 C8			MMI action to reject the VGCS/VBS call. The MS remains in idle mode on cell A. MMI action to join the VGCS/VBS call. The MS is in group receive mode on cell B.
9 10	SS -> MS SS	NOTIFICATION/NCH 	sent on cell A with a channel description, the same NLN and the call reference in step C5. adjust the power levels of cell A to 63 dB μ V emf() and cell B to 45 dB μ V emf() so that the MS re-selects cell A. Wait 30 s. The following messages are sent and received on cell A.
12 14 15	SS -> MS SS -> MS MS	NOTIFICATION/NCH SYSTEM INFORMATION TYPE 6	with a different NLN from step C5, a valid channel description, a call reference active in the MS . with the NLN(SACCH) same as step 12. wait 5 s. and check that the MS indicates the notification, MMI action to reject the new call.
18 19 20 21 22 23 24 25 26 27 28 29	SS -> MS MS MS -> SS MS -> SS SS -> MS SS -> MS MS -> SS MS SS -> MS MS SS -> MS MS	UPLINK FREE UPLINK ACCESS UPLINK ACCESS UPLINK BUSY VGCS UPLINK GRANT TALKER INDICATION NOTIFICATION/NCH SYSTEM INFORMATION TYPE 6	MMI action to request uplink access of the call. Reference to step 21. L2: SABM / UA check that the TCH is through connected and the MS gives indication to the user. with a different NLN from step 12, a valid channel description, a call reference active in the MS. check that the MS does not indicate the notification. with the NLN (SACCH) same as step 26. wait 5 s. and check that the MS indicates the notification, MMI action to reject the new call.

Step	Direction	Message	Comments
30	SS -> MS	HANDOVER COMMAND	handover to cell B. The following messages are sent and received on cell B. Sent without information field.
31	MS -> SS	HANDOVER ACCESS	
32	MS -> SS	HANDOVER ACCESS	
33	MS -> SS	HANDOVER ACCESS	
34	MS -> SS	HANDOVER ACCESS	
35	MS -> SS	SABM	
36	SS -> MS	UA	
37	MS -> SS	HANDOVER COMPLETE	
38	MS		
39	SS -> MS	NOTIFICATION/NCH	
41	SS -> MS	SYSTEM INFORMATION TYPE 6	with the NLN(SACCH) same as step 39.
42	MS		check that the MS indicates the notification. MMI action to reject the new call.
43	SS -> MS	UPLINK RELEASE	The MS returns to idle mode. L2:DISC/UA.
44	SS -> MS	CHANNEL RELEASE	

Specific Message Contents

NOTIFICATION/NCH

Information Element	value/remark
NT/N Rest Octets Reduced monitoring indication NLN (NCH)	'1'B, reduced monitoring as specified in the test step

PAGING REQUEST TYPE 1

Information Element	value/remark
Mobile Identity 1 P1 Rest Octets - NLN (PCH) indication - NLN (PCH) - NLN status - Priority 1 indication - Priority 2 indication - Group call information indication - Spare padding	TMSI not allocated to MS H as specified in the test step '0'B L L L logic L

PAGING REQUEST TYPE 2

Information Element	value/remark
Mobile Identity 1	TMSI not allocated to MS
P2 Rest Octets	
- CN3 indication	L
- NLN (PCH) indication	H
- NLN (PCH)	as specified in the test step
- NLN status	'0'B
- Priority 1 indication	L
- Priority 2 indication	L
- Priority 3 indication	L
- Spare padding	logic L

PAGING REQUEST TYPE 3

Information Element	value/remark
Mobile Identity 1	TMSI not allocated to MS
P3 Rest Octets	
- CN3 indication	L
- NLN (PCH) indication	H
- NLN (PCH)	as specified in the test step
- Priority 1 indication	L
- Priority 2 indication	L
- Priority 3 indication	L
- Priority 4 indication	L
- NLN status indication	H
- NLN status	'0'B
- Spare padding	logic L

SYSTEM INFORMATION TYPE 6

Information Element	value/remark
S6 Rest Octets	7 octets length
- PCH/NCH info indication	H
- PCH/NCH info	
- paging channel restructuring	0 (not restructured)
- NLN (SACCH)	as specified in the test step
- Call priority indication	'0'B, priority not included
- NLN status	'0'B
- VGCS/VBS options	
- in-band notifications	H
- in-band paging	H
- Spare padding	logic L

HANDOVER COMMAND

Information Element	Value/remark
As default message contents, except:	
Channel Description	TCH/F + ACCHs
- Channel type	arbitrary but not zero
- Timeslot number	chosen arbitrarily
- Training sequence code	Single RF channel
- Hopping	GSM 900: 60
- ARFCN	DCS 1800: 830
	PCS 1900:730
	GSM 450: 276
	GSM 480: 323
Synchronisation Indication	Synchronised
VGCS target mode indication	Group transmit mode

26.14.1.4 VGCS-VBS / Notification / Limited Service state

26.14.1.4.1 Conformance requirement

In state MM IDLE and service state LIMITED SERVICE:

1. The MS shall indicate notifications to the GCC or BCC sub-layer for which a channel description has been received in the notification by the RR sub-layer.
2. The MS shall reject requests of the GCC or BCC sub-layer to respond to notifications for which no channel description has been received in the notification by the RR sub-layer.
3. The MS shall request the RR sub-layer to receive a voice group or broadcast call if the GCC or BCC sublayer requests the reception of a voice group or broadcast call for which a channel description has been received in the notification by the RR sublayer and then go to the service state RECEIVING GROUP CALL (LIMITED SERVICE).
4. The MS shall reject any request of establishing a group call.

Reference(s)

GSM 04.08 clause 4.2.2.3.

26.14.1.4.2 Test purpose

To verify that while in state MM IDLE and service state LIMITED SERVICE:

1. The MS rejects requests from user to respond to notifications for which no channel description has been received in the notification by the RR sub-layer.
2. The MS indicates notifications for which a channel description has been received in the notification.
3. The MS accepts user requests to respond to notifications for which channel description has been received in the notification and goes to the service state RECEIVING GROUP CALL (LIMITED SERVICE).
4. The MS rejects any request of establishing a group call.

26.14.1.4.3 Method of test

Initial Conditions

System Simulator:

1 cell with default parameters for ASCI testing.

Mobile Station:

The MS, with SIM, is in MM-state "idle, limited service" because LA not allowed.

Related PICS/PIXIT Statement(s)

Type of MS (GSM 450, GSM 480, P-, E-, R-GSM 900, DCS 1800 or PCS 1900).

Support VGCS listening.

Support VBS listening.

Support VGCS originating.

Support VBS originating.

Way to configure VGCS or VBS.

Way to indicate a call notification.

Way to accept VGCS or VBS call.

Way to initiate a normal VGCS/VBS call.

Foreseen Final State of the MS

"limited service" mode.

Test Procedure

The MS, with SIM, is in MM idle limited service state because LA is not allowed. The SS sends NOTIFICATION/NCH message containing call reference active in the MS but no VGCS/VBS channel description. It is checked that the MS indicates the notification and rejects the request of joining the notified call. The SS sends NOTIFICATION/NCH message containing call reference active in the MS and VGCS/VBS channel description. It is checked that the MS indicates the notification, and joins the notified call on request. If the MS supports VGCS/VBS originating, the MS is requested to initiate VGCS/VBS call. It is checked that the MS rejects the request.

Maximum Duration of Test

5 minutes.

Expected Sequence

Step	Direction	Message	Comments
0	MS		the MS is in MM idle mode limited service state
1	SS -> MS	NOTIFICATION/NCH	without VGCS/VBS channel description
2	MS		MMI action to request responding to the notification
3	MS		check that the MS rejects the request and that no RR connection establishment is attempted for 10s.
5	SS -> MS	NOTIFICATION/NCH	with VGCS/VBS channel description
6	MS		check that the MS indicates the notification
7	MS		MMI action to request to join the notification
8	MS		check that the TCH in downlink is through connected and there is no uplink transmission on that channel for 10 s.
9	SS -> MS	CHANNEL RELEASE	UI format
10	MS		If the MS supports VGCS/VBS originating MMI action to initiate a normal VGCS/VBS call
11	SS		check that the MS rejects the request and that no RR connection establishment is attempt.

26.14.2 VGCS-VBS / Paging

26.14.2.1 VGCS-VBS / Paging / Paging indication

26.14.2.1.1 Conformance requirement

1. Paging into on-going voice group calls shall be provided as an implementation option.
2. In group receive mode the MS shall be ready to receive paging information on the FACCH containing the mobile subscriber identity and the priority level if eMLPP applies.
3. In group transmit mode if the MS has received a paging message with the own mobile station identity on the PCH or on the voice group call channel downlink, the RR entity shall provide an indication to the upper layers, together with the related priority, if applicable.
4. In group transmit mode if the MS receives information on the voice group call channel of the existence of a paging message in its paging subgroup of the PCH, the RR entity shall pass this information to the upper layers together with the related priority.

Reference(s)

GSM 04.08 clause 3.4.12, 9.1.21a, 3.4.15.1.2.4, 10.5.2.23, 10.5.2.24, 10.5.2.25.

GSM 03.68 clause 11.3.1.3c.

GSM 03.69 clause 11.3.1.3c.

26.14.2.1.2 Test purpose

It is checked that:

1. When the MS in group receive mode if a NOTIFICATION/FACCH message on the voice group call channel containing in-band paging information is received, the MS provides an indication with the correct priority if applicable.
2. When the MS in group receive mode if a paging message with the own mobile station identity on PCH is received, it provides an indication with the correct priority.
3. When the MS in group transmit mode if a NOTIFICATION/FACCH message on the voice group call channel containing in-band paging information is received, the MS provides an indication with the correct priority.
4. If the MS in group transmit mode if a paging message with the own mobile station identity on PCH is received, it provides an indication with the correct priority.

26.14.2.1.3 Method of test

Initial Conditions

System Simulator:

1 cell with default parameters for ASCII testing.

Mobile Station:

No automatic answering configured.

Related PICS/PIXIT Statement(s)

Type of MS (GSM 450, GSM 480, P-, E-, R-GSM , DCS 1800 or PCS 1900).

Support VGCS talking.

Support VBS originating.

Support eMLPP.

Support monitoring on PCH in group transmit mode.

Way to configure VGCS or VBS.

Way to request uplink.

Foreseen Final State of the MS

"Idle, updated".

Test Procedure

The MS is in group receive mode. The SS sends NOTIFICATION/FACCH message containing Paging Information IE which addresses the MS. It is checked that the MS indicates the paging information.

The SS changes SI 6 indicating no support of in-band paging. After waiting 5s. the SS sends a PAGING REQUEST TYPE 1 message addressing the MS on the paging sub-channel of the MS. It is checked that the MS indicates the paging information, together with the priority level if it supports eMLPP. The test procedure is repeated for sending PAGING REQUEST TYPE 2 and PAGING REQUEST TYPE 3 messages.

The same test procedure is repeated for the MS in group transmit mode if supporting VGCS talking or VBS originating.

Maximum Duration of Test

5 minutes

Expected Sequence

If the MS mode supports VGCS talking or VBS originating the test sequence is repeated once for $k=2$. If the MS supports monitoring PCH in group transmit mode steps 5 - 17 for $k=2$ are executed.

Step	Direction	Message	Comments
0	SS		broadcast the default SIs.
A1	MS		for k=1, the MS is brought in group receive mode.
B1			for k=2, the MS is in brought group transmit mode.
2 3 4	SS -> MS MS MS	NOTIFICATION/FACCH	In-band paging Information addresses the MS. check that the MS indicates correctly the paging information of a new MT call with priority 4 if the MS supports eMLPP. user action to reject the point-to-point MT call.
5 6	SS -> MS SS	SYSTEM INFORMATION TYPE 6	indicating no in-band paging on FACCH wait 5s.
7 8 9 10	SS -> MS MS MS SS	PAGING REQUEST TYPE 1	with priority 2 check that the MS indicates correctly the paging information of a new MT call with the priority if the MS supports eMLPP. user action to reject the incoming call. wait 5 s.
11 12 13 14	SS -> MS MS MS SS	PAGING REQUEST TYPE 2	with priority 3 check that the MS indicates correctly the paging information of a new MT call with the priority if the MS supports eMLPP. user action to reject the incoming call. wait 5s.
15 16 17	SS -> MS MS MS	PAGING REQUEST TYPE 3	no priority check that the MS indicates correctly the paging information of a new MT call which no priority is provided to. user action to reject the incoming call.
A18			for k=1, no signalling
B18	SS -> MS	UPLINK RELEASE	for k=2, return to group receive mode. Only for a VGCS call.
19 20	SS -> MS SS -> MS	CHANNEL RELEASE CHANNEL RELEASE	UI format, the MS returns to idle updated state. For (k=1) and (k=2 in case of VGCS call). For k=2, for a VBS call, the MS returns to idle mode. L2:DISC/UA.

Specific Message Contents

NOTIFICATION/FACCH - in step 2

Information Element	value/remark
Group call / Paging information indication	'1', paging information
Paging Information	
- mobility identity	TMSI previously allocated to MS
- channel first	'10'B, TCH/F
eMLPP priority indication	'1'B
- priority	'001'B, call priority level 4
spare padding	logic L

SYSTEM INFORMATION TYPE 6 - in step 5

Information Element	value/remark
S6 Rest Octets	7 octets length
- PCH/NCH info indication	L
- VGCS/VBS options	
- in-band notifications	H
- in-band paging	L
- Spare padding	logic L

PAGING REQUEST TYPE 1 - in step 7

Information Element	value/remark
P1 Rest Octets	
- NLN (PCH) indication	L
- Priority 1 indication	H
- Priority	'011'B, level 2
- Spare padding	logic L

PAGING REQUEST TYPE 2 - in step 11

Information Element	value/remark
P2 Rest Octets	
- CN3 indication	L
- NLN (PCH) indication	L
- Priority 1 indication	H
- Priority	'010'B, level 3
- Spare padding	logic L

PAGING REQUEST TYPE 3 - in step 15

Information Element	value/remark
Mobile Identity 1	TMSI not allocated to MS
P3 Rest Octets	
- CN3 indication	L
- NLN (PCH) indication	L
- Priority 1 indication	H
- Priority	'000'B, no level applied
- Spare padding	logic L

26.14.2.2 VGCS-VBS / Paging / Notification

26.14.2.2.1 Conformance requirement

A PAGING REQUEST TYPE 1 message may have an additional notification coded in the P1 rest octets information element. It allows to notify the mobile an emergency group or broadcast call even when the MS at the moment does not monitor the NCH channel.

Reference(s)

GSM 04.08 clause 3.3.2.1, 3.3.3.1, 10.5.2.23.

26.14.2.2.2 Test purposes

To verify that

1. the MS in idle mode indicates correctly an incoming broadcast or group call when having received a PAGING REQUEST TYPE 1 message whose P1 rest octets information element contains group call information addressing the MS.

2. the MS in group receive mode indicates correctly an incoming broadcast or group call when having received a PAGING REQUEST TYPE 1 message whose P1 rest octets information element contains group call information addressing the MS.

26.14.2.2.3 Method of test

Initial Conditions

System Simulator:

1 cell with default parameters for ASCII testing.

Mobile Station:

The MS is in MM-state "idle, updated" with a TMSI allocated.

Related PICS/PIXIT Statement(s)

Type of MS (GSM 450, GSM 480, P-, E-, R-GSM 900, DCS 1800 or PCS 1900).

Support VGCS listening.

Support VGCS talking.

Support VBS listening.

Support VBS originating.

Way to configure VGCS or VBS.

Way to indicate a call notification.

Way to accept a VGCS or VBS.

Way to verify the downlink speech path.

Foreseen Final State of the MS

"Idle, updated", with TMSI allocated.

Test Procedure

The MS is in idle mode. The SS sends in the NCH block only access grant messages. The SS sends a PAGING REQUEST TYPE 1 message on the paging sub-channel of the MS. The Mobile Identity in the message does not address the MS. The P1 rest octets in the message contains VGCS/VBS channel description and VGCS/VBS call reference not active in the MS. It is checked that the MS ignores the paging message. Similarly, the SS sends again the PAGING REQUEST TYPE 1 message on the paging sub-channel of the MS, not addressing the MS. The message contains VGCS/VBS channel description and VGCS/VBS call reference active in the MS. It is checked that the MS indicates correctly the notified group call reference(s) and joins VGCS/VBS call on request of responding to the notification. The group call is terminated. The SS sends PAGING REQUEST TYPE 1 message on the paging sub-channel of the MS which contains the "good reference" but no VGCS/VBS channel description. The Mobile Identity in the message does not address the MS. It is checked that the MS indicates correctly the notified group call reference(s) and establishes a RR connection to respond to the notification on request of responding to the call, then joins the call. The group call is terminated.

The initial conditions for SS are set to the same as ASCII default. The MS is brought to group receive mode the test procedure is repeated once.

Maximum Duration of Test

5 minutes.

Expected Sequence

Test steps 0 to 19 are executed for k=1, 2.

Step	Direction	Message	Comments
A0	SS		For k = 1, the initial conditions for SS are same as ASCII default, except the NCH block containing only access grant messages. the MS is in idle mode.
A1	MS		
B0	SS		For k = 2, the initial conditions for SS are same as ASCII default, except the NCH block containing only access grant messages. the MS is brought in group receive mode
B1	MS		
2	SS -> MS	PAGING REQUEST TYPE 1	with a description of VGCS/VBS channel and a VGCS/VBS call reference not active in the MS check that the MS ignores the notification and there is no uplink transmission on that channel for 10 s.
3	MS		
4	SS -> MS		
5	MS	PAGING REQUEST TYPE 1	with a description of VGCS/VBS channel and a VGCS/VBS call reference active in the MS check that the MS gives an indication containing the notified group call reference MMI action to join the VGCS/VBS call check that the TCH in downlink is through connected and there is no uplink transmission on that channel for 10 s.
6	MS		
7	MS		
8	SS -> MS		
9	SS	CHANNEL RELEASE	UI format, return to the idle updated state wait 5s.
10	SS -> MS	PAGING REQUEST TYPE 1	with a VGCS/VBS call reference active in the MS but no VGCS/VBS channel description check that the MS gives an indication containing the notified group call reference
11	MS		
A12	MS	CHANNEL REQUEST IMMEDIATE ASSIGNMENT NOTIFICATION RESPONSE CHANNEL RELEASE	For k = 1, MMI action to join the VGCS/VBS call L2: SABM / UA release the dedicated channel. The MS releases L2 multiple frame link L2:DISC/UA. check that the TCH in downlink is through connected and there is no uplink transmission on that channel for 10 s.
A13	MS -> SS		
A14	SS -> MS		
A15	MS -> SS		
A16	SS -> MS		
A17	MS		
B12	SS		For k = 2, MMI action to reject the new VGCS/VBS call
18	SS -> MS	CHANNEL RELEASE	UI format, to return to idle updated state wait 5s.
19			

Specific Message Contents

PAGING REQUEST TYPE 1 - in steps 2

Information Element	value/remark
Mobile Identity 1	TMSI not allocated to MS
P1 Rest Octets	
- NLN (PCH) indication	L
- Priority 1 indication	L
- Priority 2 indication	L
- NLN status indication	L
- Group call information indication	H
- Group or broadcast call reference	not active in the SIM
- SF	VBS if only VBS supported, otherwise VGCS
- AF	'0'B, acknowledgement not required
- priority	4
- Ciphering information	No ciphering
Group Channel Description indication	'1', group channel description
Channel Description	24 bits
- Channel type and TDMA offset	TCH/FS
- Timeslot number	arbitrarily chosen, but not 0
- TSC	arbitrarily chosen
- Hopping	Single RF, non hopping channel
- ARFCN	GSM 450: 279 GSM 480: 326 GSM 900: 70 DCS 1800: 850 PCS 1900: 750
MA or FSL	'0'B, non hopping
Spare padding	logic L

PAGING REQUEST TYPE 1 - in steps 4

Information Element	value/remark
Mobile Identity 1	TMSI not allocated to MS
P1 Rest Octets	
- NLN (PCH) indication	L
- Priority 1 indication	L
- Priority 2 indication	L
- NLN status indication	L
- Group call information indication	H
- Group or broadcast call reference	PICS/PIXIT (27 bits), active in the SIM
- SF	VBS if only VBS supported, otherwise VGCS
- AF	'0'B, acknowledgement not required
- priority	4
- Ciphering information	No ciphering
Group Channel Description indication	'1', group channel description
Channel Description	24 bits
- Channel type and TDMA offset	TCH/FS
- Timeslot number	arbitrarily chosen, but not 0
- TSC	arbitrarily chosen
- Hopping	Single RF, non hopping channel
- ARFCN	GSM 450: 279 GSM 480: 326 GSM 900: 70 DCS 1800: 850 PCS 1900: 750
MA or FSL	'0'B, non hopping
Spare padding	logic L

PAGING REQUEST TYPE 1 - in steps 10

Information Element	value/remark
Mobile Identity 1	TMSI not allocated to MS
P1 Rest Octets	
- NLN (PCH) indication	L
- Priority 1 indication	L
- Priority 2 indication	L
- NLN status indication	L
- Group call information indication	H
- Group or broadcast call reference	PICS/PIXIT (27 bits), active in the SIM
- SF	VBS if only VBS supported, otherwise VGCS
- AF	'0'B, acknowledgement not required
- priority	4
- Ciphering information	No ciphering
Group Channel Description indication	'0', no group channel description
Spare padding	logic L

26.14.3 VGCS-VBS / RR Procedures

26.14.3.1 VGCS-VBS / RR Procedures / frequency redefinition

26.14.3.1.1 Conformance requirements

The MS, after receiving a FREQUENCY REDEFINITION message in group transmit mode, shall start using the new frequencies and hopping sequence in the correct time slot.

References

GSM 04.08 clauses 3.4.5.

26.14.3.1.2 Test purpose

To verify that after receiving a FREQUENCY REDEFINITION message in group transmit mode, the MS starts using the new frequencies and hopping sequence at the time indicated in the message.

26.14.3.1.3 Method of test

Initial Conditions

System Simulator:

1 cell, CCCH_CONF set to 1 basic physical channel used for CCCH, not combined with SDCCHs. The cell allocation is set to CA₄₅₀(1), CA₄₈₀(1), CA_{PGSM}(1), CA_{DCS}(1) or CA_{PCS}(1), depending on the band of operation of the Mobile Station (See PICS/PIXIT), before each execution of this test.

Mobile Station:

The MS is in group transmit mode.

Related PICS/PIXIT Statements

Type of MS (GSM 450 or GSM 480 or P-GSM 900 or EGSM or DCS 1 800 or PCS 1900).

Support VGCS talking.

Support VBS originating.

Way to configure VGCS or VBS.

Way to accept a VGCS or VBS.

Foreseen Final State of the MS

"Idle, updated", with TMSI allocated.

Test Procedure

Test parameters:

GSM450:

$Ca_{450}(1)$ is set to 32.

An arbitrary subset $CA_{450}(1)$ of the set $\{259, \dots, 293\}$ containing $ca_{450}(1)$ elements is drawn.

An element B of the set $CA_{450}(1)$ is arbitrarily chosen.

An arbitrary value $ca_{450}(2)$ in the range 17, ..., 31 is chosen.

An arbitrary subset $CA_{450}(2)$ of the set $\{259, \dots, 293\}$ with $ca_{450}(2)$ elements and containing B is chosen.

For $j = 1, 2$, values $ma_{450}(j)$ in the range $j, \dots, ca_{450}(j)-1$ and values $MAIO_{450}(j)$ in the range $0, \dots, ma_{450}(j)-1$ are arbitrarily chosen.

Subsets $MA_{450}(j)$ of $CA_{450}(j)$ not containing B and having $ma(j)$ elements are arbitrarily chosen.

GSM480:

$Ca_{480}(1)$ is set to 32.

An arbitrary subset $CA_{480}(1)$ of the set $\{306, \dots, 340\}$ containing $ca_{480}(1)$ elements is drawn.

An element B of the set $CA_{480}(1)$ is arbitrarily chosen.

An arbitrary value $ca_{480}(2)$ in the range 17, ..., 31 is chosen.

An arbitrary subset $CA_{480}(2)$ of the set $\{306, \dots, 340\}$ with $ca_{480}(2)$ elements and containing B is chosen.

For $j = 1, 2$, values $ma_{480}(j)$ in the range $j, \dots, ca_{480}(j)-1$ and values $MAIO_{480}(j)$ in the range $0, \dots, ma_{480}(j)-1$ are arbitrarily chosen.

Subsets $MA_{480}(j)$ of $CA_{480}(j)$ not containing B and having $ma(j)$ elements are arbitrarily chosen.

GSM900:

$ca_{PGSM}(1)$ is set to 64.

An arbitrary subset $CA_{PGSM}(1)$ of the set $\{1, \dots, 124\}$ containing $ca_{PGSM}(1)$ elements is drawn.

An element B of the set $CA_{PGSM}(1)$ is arbitrarily chosen.

An arbitrary value $ca_{PGSM}(2)$ in the range 20, ..., 63 is chosen.

An arbitrary subset $CA_{PGSM}(2)$ of the set $\{1, \dots, 124\}$ with $ca_{PGSM}(2)$ elements and containing B is chosen.

For $j = 1, 2$, values $ma_{PGSM}(j)$ in the range $j, \dots, ca_{PGSM}(j)-1$ and values $MAIO_{PGSM}(j)$ in the range $0, \dots, ma_{PGSM}(j)-1$ are arbitrarily chosen.

Subsets $MA_{PGSM}(j)$ of $CA_{PGSM}(j)$ not containing B and having $ma(j)$ elements are arbitrarily chosen.

DCS1800:

$ca_{DCS}(1)$ is set to 64.

An arbitrary subset $CA_{DCS}(1)$ of the set $\{700, \dots, 812\}$ containing $ca_{DCS}(1)$ elements is chosen.

An element B of the set $CA_{DCS}(1)$ is arbitrarily chosen. $CA_{DCS}(1)$ is then coded using the Variable Bit Map coding scheme.

An arbitrary value $ca_{DCS}(2)$ in the range 17, ..., 63 is chosen.

An arbitrary subset $CA_{DCS}(2)$ of the set $\{700, \dots, 812\}$ with $ca_{DCS}(2)$ elements and containing B is chosen. $CA_{DCS}(2)$ is then coded using the Variable Bit Map coding scheme.

For $j = 1, 2$, values $ma_{DCS}(j)$ in the range $j, \dots, ca_{DCS}(j)-1$ and values $MAIO_{DCS}(j)$ in the range $0, \dots, ma_{DCS}(j)-1$ are arbitrarily chosen.

Subsets $MA_{DCS}(j)$ of $CA_{DCS}(j)$ not containing B and having $ma_{DCS}(j)$ elements are arbitrarily chosen.

PCS 1900:

$ca_{PCS}(1)$ is set to 64.

An arbitrary subset $CA_{PCS}(1)$ of the set $\{700, \dots, 812\}$ containing $ca_{PCS}(1)$ elements is chosen.

An element B of the set $CA_{PCS}(1)$ is arbitrarily chosen. $CA_{PCS}(1)$ is then coded using the Variable Bit Map coding scheme.

An arbitrary value $ca_{PCS}(2)$ in the range 17, ..., 63 is chosen.

An arbitrary subset $CA_{PCS}(2)$ of the set $\{700, \dots, 812\}$ with $ca_{PCS}(2)$ elements and containing B is chosen. $CA_{PCS}(2)$ is then coded using the Variable Bit Map coding scheme.

For $j = 1, 2$, values $ma_{PCS}(j)$ in the range $j, \dots, ca_{PCS}(j)-1$ and values $MAIO_{PCS}(j)$ in the range $0, \dots, ma_{PCS}(j)-1$ are arbitrarily chosen.

Subsets $MA_{PCS}(j)$ of $CA_{PCS}(j)$ not containing B and having $ma_{PCS}(j)$ elements are arbitrarily chosen.

DCS1800, GSM900, GSM 450, GSM 480, PCS 1900

An arbitrary value T in the range 92, ..., 29999 is chosen.

The MS is brought into group transmit mode. The SS sends a FREQUENCY REDEFINITION message. It is checked that the MS uses the new frequencies/hopping sequence at the TDMA frame defined by the contents of the "Starting Time" information element. (The range for T ensures that the MS does not start transmission on the new frequencies until the designated frame.)

The check is performed at the RF burst level. The SS checks the received pattern with the expected pattern, and the SS checks for each burst whether the burst is transmitted at the right frequency.

Maximum Duration of Test

$T + 7$

Expected Sequence

Step	Direction	Message	Comments
1	MS		the MS is in group transmit mode using full rate on an RF hopping channel
9 10	SS -> MS MS	FREQUENCY REDEFINITION	see description 1 below. check that the MS uses the new frequencies in the correct frame.
11 12	SS -> MS MS	FREQUENCY REDEFINITION	see description 2 below. check that the MS uses the new frequencies in the correct frame.
13	SS -> MS	CHANNEL RELEASE	The MS releases L2 multiple frame link L2:DISC/UA.

Specific Message Contents

GSM 450:

FREQUENCY REDEFINITION (Description 1)

Information Element	value/remark
as default except: Channel Description - Channel type and TDMA offset - Timeslot number - TSC - Hopping channel - MAIO - HSN Mobile Allocation Starting Time Cell Channel Description - Information element identifier - contents	TCH/FS not changed not changed RF hopping channel MAIO450(1) 0 corresponds to set MA450(1) The last burst of the first L2 frame containing the beginning of this message is transmitted in frame number X. The starting time is set to frame number (X plus T modulo 42 432). 62H corresponds to set CA450(1) with "Format ID" set to "Range 128".

FREQUENCY REDEFINITION (Description 2)

Information Element	value/remark
as default except: Channel Description - Channel type and TDMA offset - Timeslot number - TSC - Hopping channel - MAIO - HSN Mobile Allocation Starting Time Cell Channel Description - Information element identifier - contents	TCH/FS not changed not changed RF hopping channel MAIO450(2) 0 corresponds to set MA450(2) The last burst of the first L2 frame containing the beginning of this message is transmitted in frame number X. The starting time is set to frame number (X plus T modulo 42 432). 62H corresponds to set CA450(2) with "Format ID" set to "Range 128".

GSM 480:

FREQUENCY REDEFINITION (Description 1)

Information Element	value/remark
as default except: Channel Description <ul style="list-style-type: none"> - Channel type and TDMA offset - Timeslot number - TSC - Hopping channel - MAIO - HSN Mobile Allocation Starting Time Cell Channel Description <ul style="list-style-type: none"> - Information element identifier - contents 	TCH/FS not changed not changed RF hopping channel MAIO480(1) 0 corresponds to set MA480(1) The last burst of the first L2 frame containing the beginning of this message is transmitted in frame number X. The starting time is set to frame number (X plus T modulo 42 432). 62H corresponds to set CA480(1) with "Format ID" set to "Range 128".

FREQUENCY REDEFINITION (Description 2)

Information Element	value/remark
as default except: Channel Description <ul style="list-style-type: none"> - Channel type and TDMA offset - Timeslot number - TSC - Hopping channel - MAIO - HSN Mobile Allocation Starting Time Cell Channel Description <ul style="list-style-type: none"> - Information element identifier - contents 	TCH/FS not changed not changed RF hopping channel MAIO480(2) 0 corresponds to set MA480(2) The last burst of the first L2 frame containing the beginning of this message is transmitted in frame number X. The starting time is set to frame number (X plus T modulo 42 432). 62H corresponds to set CA480(2) with "Format ID" set to "Range 128".

GSM 900:

FREQUENCY REDEFINITION (Description 1)

Information Element	value/remark
as default except: Channel Description <ul style="list-style-type: none"> - Channel type and TDMA offset - Timeslot number - TSC - Hopping channel - MAIO - HSN Mobile Allocation Starting Time Cell Channel Description <ul style="list-style-type: none"> - Information element identifier - contents 	TCH/FS not changed not changed RF hopping channel MAIOPGSM(1) 0 corresponds to set MAPGSM(1) The last burst of the first L2 frame containing the beginning of this message is transmitted in frame number X. The starting time is set to frame number (X plus T modulo 42 432). 62H corresponds to set CAPGSM(1) with "Format ID" set to "bit map 0".

FREQUENCY REDEFINITION (Description 2)

Information Element	value/remark
as default except: Channel Description <ul style="list-style-type: none"> - Channel type and TDMA offset - Timeslot number - TSC - Hopping channel - MAIO - HSN Mobile Allocation Starting Time Cell Channel Description <ul style="list-style-type: none"> - Information element identifier - contents 	TCH/FS not changed not changed RF hopping channel MAIOPGSM(2) 0 corresponds to set MAPGSM(2) The last burst of the first L2 frame containing the beginning of this message is transmitted in frame number X. The starting time is set to frame number (X plus T modulo 42 432). 62H corresponds to set CAPGSM(2) with "Format ID" set to "bit map 0".

DCS 1 800:

FREQUENCY REDEFINITION (Description 1)

Information Element	value/remark
as default except: Channel Description - Channel type and TDMA offset - Timeslot number - TSC - Hopping channel - MAIO - HSN Mobile Allocation Starting Time	TCH/FS not changed not changed RF hopping channel MAIODCS(1) 0 corresponds to set MADCS(1) The last burst of the first L2 frame containing the beginning of this message is transmitted in frame number X. The starting time is set to frame number (X plus T modulo 42 432).
Cell Channel Description - Information element identifier - contents	62H corresponds to set CADCS(1) with "Format ID" set to "Variable Bit Map"

FREQUENCY REDEFINITION (Description 2)

Information Element	value/remark
as default except: Channel Description - Channel type and TDMA offset - Timeslot number - TSC - Hopping channel - MAIO - HSN Mobile Allocation Starting Time	TCH/FS not changed not changed RF hopping channel MAIODCS(2) 0 corresponds to set MADCS(2) The last burst of the first L2 frame containing the beginning of this message is transmitted in frame number X. The starting time is set to frame number (X plus T modulo 42 432).
Cell Channel Description - Information element identifier - contents	62H corresponds to set CADCS(2) with "Format ID" set to "Range 1024"

PCS 1900:

FREQUENCY REDEFINITION (Description 1)

Information Element	value/remark
as default except: Channel Description - Channel type and TDMA offset - Timeslot number - TSC - Hopping channel - MAIO - HSN Mobile Allocation Starting Time	TCH/FS not changed not changed RF hopping channel MAIOPCS(1) 0 corresponds to set MAPCS(1) The last burst of the first L2 frame containing the beginning of this message is transmitted in frame number X. The starting time is set to frame number (X plus T modulo 42 432).
Cell Channel Description - Information element identifier - contents	62H corresponds to set CAPCS(1) with "Format ID" set to "Variable Bit Map"

FREQUENCY REDEFINITION (Description 2)

Information Element	value/remark
as default except: Channel Description - Channel type and TDMA offset - Timeslot number - TSC - Hopping channel - MAIO - HSN Mobile Allocation Starting Time	TCH/FS not changed not changed RF hopping channel MAIOPCS(2) 0 corresponds to set MAPCS(2) The last burst of the first L2 frame containing the beginning of this message is transmitted in frame number X. The starting time is set to frame number (X plus T modulo 42 432).
Cell Channel Description - Information element identifier - contents	62H corresponds to set CAPCS(2) with "Format ID" set to "Range 1024"

26.14.3.2 VGCS-VBS / RR Procedures / assignment

26.14.3.2.1 Conformance requirements

1. Upon receipt of the ASSIGNMENT COMMAND message in group transmit mode, the mobile station shall initiate a local end release of link layer connections, disconnect the physical channels, command the switching to the assigned channels and initiate the establishment of lower layer connections (this includes the activation of the channels, their connection and the establishment of the main signalling links).
2. MM-messages and CM-messages using SAPI=0 sent from the mobile station to the network shall be duplicated by the data link layer in the following case:

a channel change of dedicated channels is required (assignment or handover procedure) and the last layer 2 frame has not been acknowledged by the peer data link layer before the mobile station leaves the old channel.

In this case, the mobile station does not know whether the network has received the message correctly. Therefore, the mobile station shall send the message again after the new dedicated channel is established.

3. An ASSIGNMENT COMMAND message may indicate a frequency change in progress, with a starting time and possibly alternative channel descriptions.

In the case of the reception of an ASSIGNMENT COMMAND message which contains only the description of a channel to be used after the starting time, and if the starting time has not already elapsed, the mobile station shall wait up to the starting time before accessing the channel.

4. The MS shall apply the hopping frequencies specified in ASSIGNMENT COMMAND message in the Mobile Allocation IE or the Frequency List IE at the time of accessing the new channel using the last received Cell Allocation.
5. After receipt of the ASSIGNMENT COMMAND the MS shall perform the assignment and return an ASSIGNMENT COMPLETE without undue delay.
6. On the mobile station side, if a lower layer failure happens on the new channel before the ASSIGNMENT COMPLETE message has been sent, the mobile station deactivates the new channels, reactivates the old channels, reconnects the TCHs if any and triggers the establishment of the main signalling link. It then sends a ASSIGNMENT FAILURE message, cause "protocol error unspecified" on the main DCCH and resumes the normal operation, as if no assignment attempt had occurred. The operational parameters (e.g. ciphering mode) when returning on the old channel are those applied before the procedure.

References

GSM 04.08 clause 3.1.4.3, 3.4.3, 3.4.3.3.

GSM 04.13 clause 5.2.4.

26.14.3.2.2 Test purpose

1. To verify that upon receipt of an ASSIGNMENT COMMAND in group transmit mode, the MS switches to the channel defined in the ASSIGNMENT COMMAND, establishes the link and sends an ASSIGNMENT COMPLETE message.
 - 1.1 from non-hopping TCH/F to hopping TCH/F using a different timeslot;
 - 1.2 from hopping TCH/F to non-hopping TCH/F using a different timeslot;
2. To verify that the MS, supporting TCH, having sent an MM- or CM message which was not acknowledged on L2 before the channel assignment procedure was initiated and before the MS has left the old channel, repeats that message after completion of the assignment procedure without incrementing N(SD). This is tested in the special case of MM message AUTHENTICATION RESPONSE.
3. To verify that, if the MS has received an ASSIGNMENT COMMAND message which contains only the description of a channel to be used after the starting time, and if the starting time has not already elapsed, the mobile station waits up to the starting time before accessing the channel.
4. To verify that the MS having received an ASSIGNMENT COMMAND, correctly decodes the Mobile Allocation and Frequency List IEs for frequency hopping and applies the specified frequencies using the correct Cell Allocation.
5. To verify that after receipt of the ASSIGNMENT COMMAND the MS returns an ASSIGNMENT COMPLETE without undue delay.
6. To test that, when the MS fails to seize the new channel, the MS reactivates the old channel.

26.14.3.2.3 Method of test

Initial Conditions

System Simulator:

1 cell, default parameters except:

GSM 450:

BCCH ARFCN =263.

Throughout the test, the CA broadcast in System Information 1 is (259, 261, 263, 265, 267, 269, 271, 273, 275, 277).

Note that the actual CA of the cell contains other frequencies.

GSM 480:

BCCH ARFCN =310.

Throughout the test, the CA broadcast in System Information 1 is (306, 308, 310, 312, 314, 316, 318, 320, 322, 324).

Note that the actual CA of the cell contains other frequencies.

GSM 900:

BCCH ARFCN =20.

Throughout the test, the CA broadcast in System Information 1 is (10, 17, 20, 26, 34, 42, 45, 46, 52, 59).

Note that the actual CA of the cell contains other frequencies.

DCS 1 800:

BCCH ARFCN =747.

Throughout the test, the CA broadcast in System Information 1 is (734, 741, 747, 754, 759, 766, 773, 775, 779, 782).

Note that the actual CA of the cell contains other frequencies.

PCS 1900:

BCCH ARFCN =647.

Throughout the test, the CA broadcast in System Information 1 is ((634, 641, 647, 654, 659, 666, 673, 675, 679, 682).

Note that the actual CA of the cell contains other frequencies.

Mobile Station:

The MS is in group transmit mode.

Related PICS/PIXIT Statements

Support VGCS talking.

Support VBS originating.

Way to configure VGCS or VBS.

Way to initiate a VBS call.

Foreseen Final State of the MS

"Idle, updated", with TMSI allocated.

Test Procedure

The MS is brought into group transmit mode. A hopping channel is assigned with ASSIGNMENT COMMAND, which includes a Starting Time IE. It is checked that the MS switches to the assigned channel at the time specified in Starting Time IE, establishes the link and sends an ASSIGNMENT COMPLETE message.

Then the SS sends a AUTHENTICATION REQUEST message. The MS shall answer with an AUTHENTICATION RESPONSE message, which is not acknowledged on L2 by the SS. Immediately after the AUTHENTICATION RESPONSE message is received, the SS sends an ASSIGNMENT COMMAND. It is checked that the MS switches to the assigned channel, establishes the link with the commanded power level, sends as ASSIGNMENT COMPLETE message and then MS repeats the AUTHENTICATION RESPONSE message, with the same N(SD) value.

Then the SS sends an ASSIGNMENT COMMAND, but the SS does not activate the specified new channel. It is checked that the MS re-establishes the old channel and sends ASSIGNMENT FALIURE message on the old channel.

Maximum Duration of Test

30 s.

Expected Sequence

Step	Direction	Message	Comments
1	MS		the MS is in group transmit mode.
2	SS -> MS	ASSIGNMENT COMMAND	See specific message contents.
3	MS -> SS	ASSIGNMENT COMPLETE	Sent on the correct channel after establishment of the main signalling link. This message shall be ready to be transmitted before 600 ms after the completion of step 2.
4	SS		The SS checks that the MS reports the requested power level in the layer 1 header of the SACCH message that is sent in the first SACCH multiframe following the SABM.
5	SS -> MS	AUTHENTICATION REQUEST	
6	MS -> SS	AUTHENTICATION RESPONSE	This message is not L2 acknowledged by the SS.
7	SS -> MS	ASSIGNMENT COMMAND	See specific message contents.
8	MS -> SS	ASSIGNMENT COMPLETE	Sent on the correct channel after establishment of the main signalling link. This message shall be ready to be transmitted before 600 ms after the completion of step 7.
9	MS -> SS	AUTHENTICATION RESPONSE	N(SD) shall be the same as in step 6.
10	SS -> MS	ASSIGNMENT COMMAND	See specific message contents, the SS does not activate the new channel. The MS attempts (and fails) to establish a signalling link on the new channel.
11	MS		The MS re-establishes the signalling link on the old channel.
12	MS -> SS	ASSIGNMENT FAILURE	RR cause value = "protocol error unspecified".
13	SS -> MS	UPLINK RELEASE	
14	SS -> MS	CHANNEL RELEASE	UI format, the main signalling link is released.

Specific Message Contents

ASSIGNMENT COMMAND - step 2

<p>Channel Description</p> <ul style="list-style-type: none"> - Channel Type and TDMA offset - Timeslot Number - Training Sequence Code - Hopping - MAIO <p>- HSN</p> <p>Power Command</p> <ul style="list-style-type: none"> - Power level <p>Frequency list IE</p> <p>Channel Mode</p> <ul style="list-style-type: none"> - Mode <p>Mobile Allocation</p> <p>Starting Time</p> <p>VGCS target mode Indication</p> <ul style="list-style-type: none"> - Target mode - Group cipher key number 	<p>TCH/F (N+1) mod 8 Chosen arbitrarily RF hopping channel Chosen arbitrarily from the set (0, 1 to N-1) where N is the number of frequencies in the Mobile Allocation IE. Chosen arbitrarily from the set (1 to 63)</p> <p>Chosen arbitrarily but with a changed value. Not included</p> <p>A speech mode arbitrarily chosen from the full rate capabilities declared for the MS</p> <p>Indicates all of the CA (broadcast on the BCCH) except for the BCCH carrier.</p> <p>indicates (current frame number + 100 frames) mod 42432</p> <p>group transmit mode no ciphering</p>
---	--

ASSIGNMENT COMMAND - step 7

<p>Channel Description</p> <ul style="list-style-type: none"> - Channel Type and TDMA offset - Timeslot Number - Training Sequence Code - Hopping - ARFCN <p>Power Command</p> <ul style="list-style-type: none"> - Power level <p>Channel Mode</p> <p>Frequency list IE</p> <p>Cell Channel Description</p> <p>Mobile Allocation</p> <p>Starting Time</p> <p>VGCS target mode Indication</p>	<p>TCH/F (N+3) mod 8 Chosen arbitrarily Single RF Channel the ARFCN of the BCCH carrier</p> <p>Chosen arbitrarily but with a changed value.</p> <p>A speech mode arbitrarily chosen from the full rate capabilities declared for the MS</p> <p>Not Included</p> <p>GSM 450: range 128 encoding (271, 273, 275, 277, 279, 281, 283, 285, 287, 289, 291)</p> <p>GSM 480: range 128 encoding (318, 320, 322, 324, 326, 328, 330, 332, 334, 336, 338)</p> <p>GSM 900: bit map zero encoding (45, 46, 52, 59, 66, 73, 74, 75, 76, 108, 114)</p> <p>DCS 1800: range 128 encoding (773, 775, 779, 782, 791, 798, 829, 832, 844)</p> <p>PCS 1900: range 128 encoding (673, 675, 679, 682, 691, 698, 729, 732, 744)</p> <p>Not included</p> <p>Not included</p> <p>Not included</p>
---	--

ASSIGNMENT COMMAND - step 10

Channel Description	TCH/F
- Channel Type and TDMA offset	(N+2) mod 8
- Timeslot Number	Chosen arbitrarily
- Training Sequence Code	Single RF Channel
- Hopping	The ARFCN of the BCCH carrier
- ARFCN	
Power Command	
- Power level	Chosen arbitrarily but with a changed value.
Channel Mode	A speech mode arbitrarily chosen from the full rate capabilities declared for the MS
Frequency list IE	Not included
Cell Channel Description	Not included
Mobile Allocation	Not included
Starting Time	Not included
VGCS target mode Indication	
- Target mode	group transmit mode
- Group cipher key number	no ciphering

26.14.3.3 VGCS-VBS / RR Procedures / handover / successful in group transmit mode

This clause deals with signalling tests in non-synchronised handover in successful case.

Table 26.14.3.3.1 contains a summary of the different combinations of parameters which have to be tested. For execution counter=3, the target channel is dedicated mode.

Table 26.14.3.3.1

From	To	Timing Adv.	Start Time	Sync ?	State of call	Exec Counter
TCH/F, no FH	TCH/F, no FH	20	1,1s	no	group trans. mode	1
TCH/F, no FH	TCH/F, FH	arbitrary	none	no	group trans. mode	2
TCH/F, FH	TCH/F, no FH	20	none	no	group trans. mode	3

26.14.3.3.1 Conformance requirements

The MS shall correctly apply the handover procedure in the non-synchronised case when in group call transmit mode and when handover is performed from a traffic channel with/without frequency hopping towards a traffic channel with/without frequency hopping.

References

GSM 04.08 clauses 3.4.4.

26.14.3.3.2 Test purpose

To verify that:

1. When the MS is ordered to make a non-synchronised handover it continuously sends access bursts on the main DCCH until it receives a PHYSICAL INFORMATION message from the SS.
2. The MS correctly handles the values of any Starting Time IE in the HANDOVER COMMAND message in the case when none of the information elements referring to before the starting time are present.
3. The MS correctly handles the Timing Advance IE in the PHYSICAL INFORMATION message.
4. The MS activates the new channel correctly and transmits the HANDOVER COMPLETE message without undue delay.

26.14.3.3.3 Method of test

Initial Conditions

System Simulator:

2 cells, A and B with same LAI, default parameters except:

GSM 450:

Cell A has:

BCCH ARFCN = 263

Cell Allocation = (259, 261, 263, 265, 267, 269, 271, 273, 275, 277, 279, 281, 283, 285, 287, 289, 291)

Cell B has:

BCCH ARFCN = 274

Cell Allocation = (260, 262, 264, 266, 268, 270, 272, 274, 276, 279, 281, 283, 285, 287, 289, 291)

The frame numbers of cells A and B shall be different by 100.

The timebase of cells A and B shall be such that the edges of their timeslots are not coincident at the antenna connector.

GSM 480:

Cell A has:

BCCH ARFCN = 310

Cell Allocation = (306, 308, 310, 312, 314, 316, 318, 320, 322, 324, 326, 328, 330, 332, 334, 336, 338)

Cell B has:

BCCH ARFCN = 321

Cell Allocation = (307, 309, 311, 313, 315, 317, 319, 321, 323, 326, 328, 330, 332, 334, 336, 338)

The frame numbers of cells A and B shall be different by 100.

The timebase of cells A and B shall be such that the edges of their timeslots are not coincident at the antenna connector.

GSM 900:

Cell A has:

BCCH ARFCN = 20

Cell Allocation = (10, 17, 20, 26, 34, 42, 45, 46, 52, 59, 66, 73, 74, 75, 76, 108, 114)

Cell B has:

BCCH ARFCN = 40

Cell Allocation = (14, 18, 22, 24, 30, 31, 38, 40, 60, 66, 73, 74, 75, 76, 108, 114)

The frame numbers of cells A and B shall be different by 100.

The timebase of cells A and B shall be such that the edges of their timeslots are not coincident at the antenna connector.

DCS 1 800:

Cell A has:

BCCH ARFCN = 747

Cell Allocation = (734, 741, 747, 754, 759, 762, 766, 767, 773, 775, 779, 782, 791, 798, 829, 832, 844)

Cell B has:

BCCH ARFCN = 764

Cell Allocation = (739, 743, 746, 749, 756, 758, 761, 764, 771, 779, 782, 791, 798, 829, 832, 844)

The Cell Allocation of both Cell A and Cell B shall be coded using range 256 format.

The frame numbers of cells A and B shall be different by 100.

The timebase of cells A and B shall be such that the edges of their timeslots are not coincident at the antenna connector.

PCS 1900:

Cell A has:

BCCH ARFCN = 647

Cell Allocation = (634, 641, 647, 654, 659, 662, 666, 667, 673, 675, 679, 682, 691, 698, 729, 732, 744)

Cell B has:

BCCH ARFCN = 664

Cell Allocation = (639, 643, 646, 649, 656, 658, 661, 664, 671, 679, 682, 691, 698, 729, 732, 744)

The Cell Allocation of both Cell A and Cell B shall be coded using range 256 format.

The frame numbers of cells A and B shall be different by 100.

The timebase of cells A and B shall be such that the edges of their timeslots are not coincident at the antenna connector.

Mobile Station:

The MS is in group transmit mode on cell A.

Related PICS/PIXIT Statements

Type of Mobile Station (GSM 450 or GSM 480 or P-GSM 900 or EGSM or DCS 1 800 or PCS 1900).

Support VGCS talking.

Support VBS originating.

Way to configure VGCS or VBS.

Way to request uplink.

Way to initiate VBS call.

Foreseen Final State of the MS

idle mode on cell B.

Test Procedure

This procedure is repeated for execution counter M = 1 to 3.

The MS is in group transmit mode. The SS sends a HANDOVER COMMAND. The MS (at the time defined by the Starting Time information element, if included in the message) begins to send access bursts on the new DCCH of the

target cell. The SS observes the access bursts and after receiving n (n being arbitrarily chosen between 10 - 20) access bursts, the SS sends one PHYSICAL INFORMATION message with an arbitrary Timing Advance. It is checked that the MS activates the new channel in sending and receiving mode, and it is checked that the MS is ready to transmit a HANOVER COMPLETE message, before " x " MS after the end of the PHYSICAL INFORMATION message, but not before a UA frame has been sent by the SS.

The term "ready to transmit" is defined in GSM 04.13. The value of " x " depends upon the target channel and is specified in the specific message contents clause.

Maximum Duration of Test

5 minutes, including 1 minute for any necessary operator actions.

Expected Sequence

This sequence is performed for execution counter $M = 1, 2, 3$.

Step	Direction	Message	Comments
0	MS		The MS is in group transmit mode.
1	SS -> MS	HANOVER COMMAND	See Specific message contents.
2	MS -> SS	HANOVER ACCESS	Repeated on every burst of the uplink main DCCH until reception of PHYSICAL INFORMATION. Handover Reference as included in the HANOVER COMMAND. If the HANOVER COMMAND includes a starting time IE then the first HANOVER ACCESS message shall be transmitted in the indicated frame (unless the indicated frame is not used by that channel, in which case the next frame used by that channel shall be used).
3	SS -> MS	PHYSICAL INFORMATION	Sent after reception of n HANOVER ACCESS messages. See specific message contents.
4	MS -> SS	SABM	Sent without information field.
5	SS -> MS	UA	
6	MS -> SS	HANOVER COMPLETE	The message shall be ready to be transmitted before " x " ms after the completion of step 3.
A7	MS		for $M=1, 2$, check that the TCH specified is through connected.
B7			for $M=3$, check that the TCH specified is through connected.
B8	SS -> MS	CHANNEL RELEASE	The MS releases L2 multiple frame link L2:DISC/UA.

Specific Message Contents

For $M = 1$:

GSM450

HANDOVER COMMAND

Information Element	value/remarks
As default message contents, except :	
Cell Description	
- Network Colour Code	1
- Base Station Colour Code	5
- BCCH Carrier Number	274
Synchronisation Indication	
- Report Observed Time Difference	Shall not be included.
- Synchronisation Indication	'Non synchronised'.
- Normal Cell Indication	Ignore out of range timing advance.
Starting Time	Indicates the frame number of cell B that will occur approximately 1,1 s (238 frames have elapsed) after the HANDOVER COMMAND is sent by cell A.
VGCS target mode Indication	
- Target mode	group transmit mode
- Group cipher key number	no ciphering

PHYSICAL INFORMATION

Information Element	value/remarks
As default message contents.	

Step 6 : $x = 500$

Step 7 : The MS and SS are using a full rate TCH in non hopping mode on cell B.

GSM480

HANDOVER COMMAND

Information Element	value/remarks
As default message contents, except :	
Cell Description	
- Network Colour Code	1
- Base Station Colour Code	5
- BCCH Carrier Number	321
Synchronisation Indication	
- Report Observed Time Difference	Shall not be included.
- Synchronisation Indication	'Non synchronised'.
- Normal Cell Indication	Ignore out of range timing advance.
Starting Time	Indicates the frame number of cell B that will occur approximately 1,1 s (238 frames have elapsed) after the HANDOVER COMMAND is sent by cell A.
VGCS target mode Indication	
- Target mode	group transmit mode
- Group cipher key number	no ciphering

PHYSICAL INFORMATION

Information Element	value/remarks
As default message contents.	

Step 6 : $x = 500$

Step 7 : The MS and SS are using a full rate TCH in non hopping mode on cell B.

GSM900

HANDOVER COMMAND

Information Element	value/remarks
As default message contents, except :	
Cell Description	
- Network Colour Code	1
- Base Station Colour Code	5
- BCCH Carrier Number	40
Synchronisation Indication	
- Report Observed Time Difference	Shall not be included.
- Synchronisation Indication	'Non synchronised'.
- Normal Cell Indication	Ignore out of range timing advance.
Starting Time	Indicates the frame number of cell B that will occur approximately 1,1 s (238 frames have elapsed) after the HANDOVER COMMAND is sent by cell A.
VGCS target mode Indication	
- Target mode	group transmit mode
- Group cipher key number	no ciphering

PHYSICAL INFORMATION

Information Element	value/remarks
As default message contents.	

Step 6 : $x = 500$

Step 7 : The MS and SS are using a full rate TCH in non hopping mode on cell B.

DCS1800

HANDOVER COMMAND

Information Element	value/remarks
As default message contents, except :	
Cell Description	
- Network Colour Code	1
- Base Station Colour Code	5
- BCCH Carrier Number	764
Synchronisation Indication	
- Report Observed Time Difference	Shall not be included.
- Synchronisation Indication	'Non synchronised'.
- Normal Cell Indication	Ignore out of range timing advance.
Starting Time	Indicates the frame number of cell B that will occur approximately 1,1 s (238 frames have elapsed) after the HANDOVER COMMAND is sent by cell A.
VGCS target mode Indication	
- Target mode	group transmit mode
- Group cipher key number	no ciphering

PHYSICAL INFORMATION

Information Element	value/remarks
As default message contents.	

Step 6 : $x = 500$

Step 7 : The MS and SS are using a full rate TCH in non hopping mode on cell B.

PCS 1900

HANDOVER COMMAND

Information Element	value/remarks
As default message contents, except : Cell Description - Network Colour Code - Base Station Colour Code - BCCH Carrier Number Synchronisation Indication - Report Observed Time Difference - Synchronisation Indication - Normal Cell Indication Starting Time VGCS target mode Indication - Target mode - Group cipher key number	 1 5 664 Shall not be included. 'Non synchronised'. Ignore out of range timing advance. Indicates the frame number of cell B that will occur approximately 1,1 s (238 frames have elapsed) after the HANDOVER COMMAND is sent by cell A. group transmit mode no ciphering

PHYSICAL INFORMATION

Information Element	value/remarks
As default message contents.	

Step 6 : $x = 500$

Step 7 : The MS and SS are using a full rate TCH in non hopping mode on cell B.

For $M = 2$:

GSM450

Step 0 : The MS and SS are using a full rate TCH in non-hopping mode on cell B.

HANDOVER COMMAND

Information Element	value/remarks
As default message contents, except :	
Cell Description	
- Network Colour Code	1
- Base Station Colour Code	5
- BCCH Carrier Number	263
Channel Description	
- Channel Type	TCH/F + ACCHs
- Timeslot number	Chosen arbitrarily, but not Zero
- Training Sequence Code	Chosen arbitrarily
- Hopping	RF hopping channel.
- MAIO	Chosen arbitrarily from the set (0, 1 to N-1), where N is the number of frequencies encoded in the Frequency List IE.
- HSN	Chosen arbitrarily from the set (1,2,..63)
Synchronisation Indication IE is not included.	
Channel Mode IE is not included.	
Frequency List after time	
- Frequency List	Use Range 128 to encode the following 12 frequencies (259, 261, 263, 265, 277, 279, 281, 283, 285, 287, 289, 291)
VGCS target mode Indication	
- Target mode	group transmit mode
- Group cipher key number	no ciphering

PHYSICAL INFORMATION

Information Element	value/remarks
As default message contents, except :	
Timing advance	Arbitrarily chosen but different to default value.

Step 6 : $x = 500$

Step 7 : The MS and SS are using a full rate TCH in hopping mode on cell A.

GSM480

Step 0 : The MS and SS are using a full rate TCH in non-hopping mode on cell B.

HANDOVER COMMAND

Information Element	value/remarks
As default message contents, except :	
Cell Description	
- Network Colour Code	1
- Base Station Colour Code	5
- BCCH Carrier Number	310
Channel Description	
- Channel Type	TCH/F + ACCHs
- Timeslot number	Chosen arbitrarily, but not Zero
- Training Sequence Code	Chosen arbitrarily
- Hopping	RF hopping channel.
- MAIO	Chosen arbitrarily from the set (0, 1 to N-1), where N is the number of frequencies encoded in the Frequency List IE.
- HSN	Chosen arbitrarily from the set (1,2,..63)
Synchronisation Indication IE is not included.	
Channel Mode IE is not included.	
Frequency List after time	
- Frequency List	Use range 128 to encode the following 12 frequencies (306, 308, 310, 312, 324, 326, 328, 330, 332, 334, 336, 338)
VGCS target mode Indication	
- Target mode	group transmit mode
- Group cipher key number	no ciphering

PHYSICAL INFORMATION

Information Element	value/remarks
As default message contents, except :	
Timing advance	Arbitrarily chosen but different to default value.

Step 6 : $x = 500$

Step 7 : The MS and SS are using a full rate TCH in hopping mode on cell A.

GSM900

Step 0 : The MS and SS are using a full rate TCH in non-hopping mode on cell B.

HANDOVER COMMAND

Information Element	value/remarks
As default message contents, except :	
Cell Description	
- Network Colour Code	1
- Base Station Colour Code	5
- BCCH Carrier Number	20
Channel Description	
- Channel Type	TCH/F + ACCHs
- Timeslot number	Chosen arbitrarily, but not Zero
- Training Sequence Code	Chosen arbitrarily
- Hopping	RF hopping channel.
- MAIO	Chosen arbitrarily from the set (0, 1 to N-1), where N is the number of frequencies encoded in the Frequency Channel Sequence IE.
- HSN	Chosen arbitrarily from the set (1,2,..63)
Synchronisation Indication IE is not included.	
Channel Mode IE is not included.	
Frequency Channel Sequence after time	
- Frequency Channel Sequence	Allocates the following 12 frequencies (10, 17, 20, 26, 59, 66, 73, 74, 75, 76,108, 114)
VGCS target mode Indication	
- Target mode	group transmit mode
- Group cipher key number	no ciphering

PHYSICAL INFORMATION

Information Element	value/remarks
As default message contents, except :	
Timing advance	Arbitrarily chosen but different to default value.

Step 6 : $x = 500$

Step 7 : The MS and SS are using a full rate TCH in hopping mode on cell A.

DCS1800

Step 0 : The MS and SS are using a full rate TCH in non-hopping mode on cell B.

HANDOVER COMMAND

Information Element	value/remarks
As default message contents, except :	
Cell Description	
- Network Colour Code	1
- Base Station Colour Code	5
- BCCH Carrier Number	747
Channel Description	
- Channel Type	TCH/F + ACCHs
- Timeslot number	Chosen arbitrarily, but not Zero
- Training Sequence Code	Chosen arbitrarily
- Hopping	RF hopping channel.
- MAIO	Chosen arbitrarily from the set (0, 1 to N-1), where N is the number of frequencies encoded in the Frequency Short List IE.
- HSN	Chosen arbitrarily from the set (1,2,..63)
Synchronisation Indication IE is not included.	
Channel Mode IE is not included.	
Frequency Short List after time	
- Frequency List	Use Range 256 to encode the following 9 frequencies : (747, 775, 779, 782, 791, 798, 829, 832, 844)
VGCS target mode Indication	
- Target mode	group transmit mode
- Group cipher key number	no ciphering

PHYSICAL INFORMATION

Information Element	value/remarks
As default message contents, except :	
Timing advance	Arbitrarily chosen but different to default value.

Step 6 : $x = 500$

Step 7 : The MS and SS are using a full rate TCH in hopping mode on cell A.

PCS 1900

Step 0 : The MS and SS are using a full rate TCH in non-hopping mode on cell B.

HANDOVER COMMAND

Information Element	value/remarks
As default message contents, except :	
Cell Description	
- Network Colour Code	1
- Base Station Colour Code	5
- BCCH Carrier Number	647
Channel Description	
- Channel Type	TCH/F + ACCHs
- Timeslot number	Chosen arbitrarily, but not Zero
- Training Sequence Code	Chosen arbitrarily
- Hopping	RF hopping channel.
- MAIO	Chosen arbitrarily from the set (0, 1 to N-1), where N is the number of frequencies encoded in the Frequency Short List IE.
- HSN	Chosen arbitrarily from the set (1,2,..63)
Synchronisation Indication IE is not included.	
Channel Mode IE is not included.	
Frequency Short List after time	
- Frequency List	Use Range 256 to encode the following 9 frequencies : (647, 675, 679, 682, 691, 698, 729, 732, 744)
VGCS target mode Indication	
- Target mode	group transmit mode
- Group cipher key number	no ciphering

PHYSICAL INFORMATION

Information Element	value/remarks
As default message contents, except :	
Timing advance	Arbitrarily chosen but different to default value.

Step 6 : $x = 500$

Step 7 : The MS and SS are using a full rate TCH in hopping mode on cell A.

For $M = 3$:

GSM450

Step 0 : The MS and SS are using a full rate TCH in hopping mode on cell A.

HANDOVER COMMAND

Information Element	value/remarks
As default message contents, except :	
Cell Description	
- Network Colour Code	1
- Base Station Colour Code	5
- BCCH Carrier Number	274
Synchronisation Indication	
- Report Observed Time Difference	Shall not be included.
- Synchronisation Indication	'Non synchronised'.
- Normal Cell Indication	Out of range timing advance shall trigger a handover failure procedure.
VGCS target mode Indication	
- Target mode	dedicated mode
- Group cipher key number	no ciphering

PHYSICAL INFORMATION

Information Element	value/remarks
As default message contents.	

Step 6 : x = 500

Step 7 : The MS and SS are using a full rate TCH in non-hopping mode on cell B.

GSM480

Step 0 : The MS and SS are using a full rate TCH in hopping mode on cell A.

HANDOVER COMMAND

Information Element	value/remarks
As default message contents, except :	
Cell Description	
- Network Colour Code	1
- Base Station Colour Code	5
- BCCH Carrier Number	321
Synchronisation Indication	
- Report Observed Time Difference	Shall not be included.
- Synchronisation Indication	'Non synchronised'.
- Normal Cell Indication	Out of range timing advance shall trigger a handover failure procedure.
VGCS target mode Indication	
- Target mode	dedicated mode
- Group cipher key number	no ciphering

PHYSICAL INFORMATION

Information Element	value/remarks
As default message contents.	

Step 6 : x = 500

Step 7 : The MS and SS are using a full rate TCH in non-hopping mode on cell B.

GSM900

Step 0 : The MS and SS are using a full rate TCH in hopping mode on cell A.

HANDOVER COMMAND

Information Element	value/remarks
As default message contents, except :	
Cell Description	
- Network Colour Code	1
- Base Station Colour Code	5
- BCCH Carrier Number	40
Synchronisation Indication	
- Report Observed Time Difference	Shall not be included.
- Synchronisation Indication	'Non synchronised'.
- Normal Cell Indication	Out of range timing advance shall trigger a handover failure procedure.
VGCS target mode Indication	
- Target mode	dedicated mode
- Group cipher key number	no ciphering

PHYSICAL INFORMATION

Information Element	value/remarks
As default message contents.	

Step 6 : $x = 500$

Step 7 : The MS and SS are using a full rate TCH in non-hopping mode on cell B.

DCS1800

Step 0 : The MS and SS are using a full rate TCH in hopping mode on cell A.

HANDOVER COMMAND

Information Element	value/remarks
As default message contents, except :	
Cell Description	
- Network Colour Code	1
- Base Station Colour Code	5
- BCCH Carrier Number	764
Synchronisation Indication	
- Report Observed Time Difference	Shall not be included.
- Synchronisation Indication	'Non synchronised'.
- Normal Cell Indication	Out of range timing advance shall trigger a handover failure procedure.
VGCS target mode Indication	
- Target mode	dedicated mode
- Group cipher key number	no ciphering

PHYSICAL INFORMATION

Information Element	value/remarks
As default message contents.	

Step 6 : $x = 500$

Step 7 : The MS and SS are using a full rate TCH in non-hopping mode on cell B.

PCS 1900

Step 0 : The MS and SS are using a full rate TCH in hopping mode on cell A.

HANDOVER COMMAND

Information Element	value/remarks
As default message contents, except :	
Cell Description	
- Network Colour Code	1
- Base Station Colour Code	5
- BCCH Carrier Number	664
Synchronisation Indication	
- Report Observed Time Difference	Shall not be included.
- Synchronisation Indication	'Non synchronised'.
- Normal Cell Indication	Out of range timing advance shall trigger a handover failure procedure.
VGCS target mode Indication	
- Target mode	dedicated mode
- Group cipher key number	no ciphering

PHYSICAL INFORMATION

Information Element	value/remarks
As default message contents.	

Step 6 : x = 500

Step 7 : The MS and SS are using a full rate TCH in non-hopping mode on cell B.

26.14.3.4 VGCS-VBS / RR Procedures / handover / successful at group call establishment

This clause deals with signalling in the Handover/successful/group call establishment/non synchronised case. This clause is aligned with clause 26.6.5.2 (m=1 and M=8).

Table 26.14.3.4.1 contains a summary of the different combinations of parameters which have to be tested. If a test uses a channel rate which the MS under test does not support, the test shall be skipped.

Table 26.14.3.4.1

From	To	Timing Adv.	Start Time	Sync	State of call	Exec Counter
SDCCH/4, no FH	TCH/F, FH	20	none	no	group or broadcast call establishment	1
SDCCH/8, FH	TCH/F, no FH	20	1,1s	no	group or broadcast call establishment	2

Table 26.14.3.4.2

	TCH/FS	SDCCH
n	10-20	2-5

n : number of access bursts.

26.14.3.4.1 Conformance requirements

In dedicated mode or group transmit mode, an intercell or intracell change of channel(s) can be requested by the network RR sublayer. This changed may be performed through the handover procedure.

The purpose of the handover procedure is to completely modify the channels allocated to the mobile station e.g. when the cell is changed. A change in the channel configuration nature is possible. This procedure is used only while in dedicated mode or group transmit mode.

References

GSM 04.08, clauses 3.4.4 and 9.1.15
GSM 04.13, clause 5.2.6.2

26.14.3.4.2 Test purpose

To verify that:

1. The MS correctly applies the handover procedure from non frequency hopping SDCCH/4 to TCH/F with frequency hopping in the non-synchronized case during group or broadcast call establishment.
2. The mobile correctly applies the handover procedures from SDCCH/8 with frequency hopping to TCH/F without frequency hopping in the non-synchronized case during group or broadcast call establishment.
3. If during call establishment a Layer 3 MM or CC message just sent by the MS is not Layer 2 acknowledged before the channel change caused by the HANDOVER COMMAND message, the MS sends the Layer 3 message to the new cell, using the same value in the N(SD) field, after the handover procedure.

26.14.3.4.3 Method of test

Initial Conditions

System Simulator:

2 cells A and B with same LAI, default parameters, except:

GSM450 :

Cell A has : BCCH ARFCN = 263
Cell Allocation = (259, 261, 263, 265, 267, 269, 271, 273, 275, 277, 279, 281, 283, 285, 287, 289, 291)
PLMN colour code, NCC = as defaults.
BS colour code, BCC = as defaults.

Cell B has : BCCH ARFCN = 274
Cell Allocation = (260, 262, 264, 266, 268, 270, 272, 274, 276, 279, 281, 283, 285, 287, 289, 291)
PLMN colour code, NCC = 3.
BS colour code, BCC = 0.

Both cells send SI 1 messages containing the complete Cell Allocation of the cell, using Range 128 format.

The timebase of Cells A and B shall be such that the edges of their timeslots are not coincident at the antenna connector.

For execution counter M = 1 a combined CCH/SDCCH is used.

For execution counter M = 2 a non combined SDCCH is used.

GSM480 :

Cell A has : BCCH ARFCN = 310
Cell Allocation = (306, 308, 310, 312, 314, 316, 318, 320, 322, 324, 326, 328, 330, 332, 334, 336, 338)
PLMN colour code, NCC = as defaults.
BS colour code, BCC = as defaults.

Cell B has : BCCH ARFCN = 321
Cell Allocation = (307, 309, 311, 313, 315, 317, 319, 321, 323, 326, 328, 330, 332, 334, 336, 338)
PLMN colour code, NCC = 3.

BS colour code, BCC = 0.

Both cells send SI 1 messages containing the complete Cell Allocation of the cell, using Range 128 format.

The timebase of Cells A and B shall be such that the edges of their timeslots are not coincident at the antenna connector.

For execution counter M = 1 a combined CCH/SDCCH is used.

For execution counter M = 2 a non combined SDCCH is used.

GSM900 :

Cell A has : BCCH ARFCN = 20
Cell Allocation = (10, 17, 20, 26, 34, 42, 45, 46, 52, 59, 66, 73, 74, 75, 76, 108, 114)
PLMN colour code, NCC = as defaults.
BS colour code, BCC = as defaults.

Cell B has : BCCH ARFCN = 40
Cell Allocation = (14, 18, 22, 24, 30, 31, 38, 40, 60, 66, 73, 74, 75, 76, 108, 114)
PLMN colour code, NCC = 3.
BS colour code, BCC = 0.

Both cells send SI 1 messages containing the complete Cell Allocation of the cell, using bit map 0 format.

The timebase of Cells A and B shall be such that the edges of their timeslots are not coincident at the antenna connector.

For execution counter M = 1 a combined CCH/SDCCH is used.

For execution counter M = 2 a non combined SDCCH is used.

DCS1800 :

Cell A has : BCCH ARFCN = 747
Cell Allocation = (734, 741, 747, 754, 759, 762, 766, 767, 773, 775, 779, 782, 791, 798, 829, 832, 844)
PLMN colour code, NCC = as defaults.
BS colour code, BCC = as defaults.

Cell B has : BCCH ARFCN = 764
Cell Allocation = (739, 743, 746, 749, 756, 758, 761, 764, 771, 779, 782, 791, 798, 829, 832, 844)
PLMN colour code, NCC = 3.
BS colour code, BCC = 0.

Both cells send SI 1 messages containing the complete Cell Allocation of the cell, using Range 512 format.

The timebase of Cells A and B shall be such that the edges of their timeslots are not coincident at the antenna connector.

For execution counter M = 1 a combined CCH/SDCCH is used.

For execution counter M = 2 a non combined SDCCH is used.

PCS 1900 :

Cell A has : BCCH ARFCN = 647
Cell Allocation = (634, 641, 647, 654, 659, 662, 666, 667, 673, 675, 679, 682, 691, 698, 729, 732, 744)
PLMN colour code, NCC = as defaults.
BS colour code, BCC = as defaults.

Cell B has : BCCH ARFCN = 664
Cell Allocation = (639, 643, 646, 649, 656, 658, 661, 664, 671, 679, 682, 691, 698, 729, 732, 744)
PLMN colour code, NCC = 3.
BS colour code, BCC = 0.

Both cells send SI 1 messages containing the complete Cell Allocation of the cell, using Range 512 format.

The timebase of Cells A and B shall be such that the edges of their timeslots are not coincident at the antenna connector.

For execution counter $M = 1$ a combined CCH/SDCCH is used.

For execution counter $M = 2$ a non combined SDCCH is used.

Mobile Station:

The MS is in MM-state "idle, updated" with a TMSI allocated and camped on cell A.

Related PICS/PIXIT Statements

Type of MS (GSM 450 or GSM 480 or P-GSM900 or EGSM or DCS1800 or PCS 1900).

Support VGCS originating.

Support VBS originating.

Way to initiate VGCS call.

Way to initiate VBS call.

Foreseen Final State of the MS

"Idle, updated" with TMSI allocated and camped on cell B.

Test Procedure

This procedure is repeated for execution counter $M = 1$ and 2 (See Table 26.14.3.4.1)

A VBS call is initiated on cell A by setup procedure if the MS supports VBS only, otherwise a VGCS call is initiated by setup procedure on cell A. After the MS has sent the SETUP message (and before the last L2 frame carrying the SETUP message is acknowledged by the SS) the SS sends a HANDOVER COMMAND message, ordering the MS to switch to cell B. The MS shall then begin to send access bursts on the new DCCH to cell B. The SS observes the access bursts and after receiving n (n being arbitrarily chosen between values according to table 26.14.3.4.2) access bursts, the SS sends one PHYSICAL INFORMATION message with a Timing Advance as specified in table 26.14.3.4.1. It is checked that the MS activates the new channel and the MS is ready to transmit a HANDOVER COMPLETE message before x ms after the end of the PHYSICAL INFORMATION message, but not before a UA frame has been sent by the SS. It is also checked that the MS sends again the SETUP message with the same value in the N(SD) field.

The term 'ready to transmit' is defined in TS GSM 04.13. The value of ' x ' depends upon the target channel and is specified in the specific message contents clause.

Maximum Duration of Test

5 minutes, including 1 minute for any necessary operator actions.

Expected Sequence

The sequence is performed for execution counter $M = 1$ and 2 .

Step	Direction	Message	Comments
1	MS		MMI action, a VBS or a VGCS call is initiated on cell A.
2	MS -> SS	CHANNEL REQUEST	
3	SS -> MS	IMMEDIATE ASSIGNMENT	See specific message contents.
4	MS -> SS	CM SERVICE REQUEST	L2: SABM / UA
5	MS -> SS	SETUP	Last L2 frame not acknowledged by the SS.
6	SS -> MS	HANDOVER COMMAND	See specific message contents.
7	MS -> SS	HANDOVER ACCESS	Repeated on every burst of the uplink main DCCH until reception of PHYSICAL INFORMATION. Handover Reference as included in the HANDOVER COMMAND
8	SS -> MS	PHYSICAL INFO	Sent after reception of n HANDOVER ACCESS message. Timing Advance as specified in table 26.14.3.4.1.
9	MS -> SS	SABM	Sent without information field
10	SS -> MS	UA	
11	MS -> SS	HANDOVER COMPLETE	This message shall be ready to be transmitted before 'x' ms after the completion of step 8.
12	MS -> SS	SETUP	Same N(SD) as in step 5.
13	SS -> MS	CHANNEL RELEASE	The MS releases L2 multiple frame link L2:DISC/UA.

Specific Message Contents

M = 1

DCS1800:

IMMEDIATE ASSIGNMENT

Information Element	value/remark
As default message contents.	

HANDOVER COMMAND

Information Element	value/remarks
As default message contents, except :	
Cell Description	
- Network Colour Code	3
- Base Station Colour Code	0
- BCCH Carrier Number	764
Channel Description	
- Channel Type	TCH/F + ACCHs
- Timeslot number	zero.
- Training Sequence Code	Chosen arbitrarily
- Hopping	RF hopping channel.
- MAIO	Chosen arbitrarily from the set (0, 1 to N-1), where N is the number of frequencies encoded in the Frequency Short List IE.
- HSN	Chosen arbitrarily from the set (1,2,..63).
Synchronization IE is not included.	
Channel Mode IE	speech full rate
Frequency Short List after time	
- Frequency Short List	Use Range 128 to encode the following 11 frequencies: (756, 758, 761, 771, 779, 782, 791, 798, 829, 832, 844).

Step 13 : 'x' = 500

GSM900:

IMMEDIATE ASSIGNMENT

Information Element	value/remark
As default message contents.	

HANDOVER COMMAND

Information Element	value/remarks
As default message contents, except :	
Cell Description	
- Network Colour Code	3
- Base Station Colour Code	0
- BCCH Carrier Number	40
Channel Description	
- Channel Type	TCH/F + ACCHs
- Timeslot number	zero
- Training Sequence Code	Chosen arbitrarily
- Hopping	RF hopping channel
- MAIO	Chosen arbitrarily from the set (0, 1 to N-1), where N is the number of frequencies encoded in the Frequency Channel Sequence IE.
- HSN	Chosen arbitrarily from the set {1, 2,..., 63}.
Synchronisation Indication IE is not included	
Channel Mode IE	speech full rate
Frequency Channel Sequence, after time.	
- Frequency Channel Sequence IE	Allocates the following 15 frequencies: (14, 18, 22, 24, 30, 31, 38, 53, 66, 73, 74, 75, 76, 108, 114).

Step 13 : 'x' = 500

GSM480 :

IMMEDIATE ASSIGNMENT

Information Element	value/remark
As default message contents.	

HANDOVER COMMAND

Information Element	value/remarks
As default message contents, except :	
Cell Description	
- Network Colour Code	3
- Base Station Colour Code	0
- BCCH Carrier Number	321
Channel Description	
- Channel Type	TCH/F + ACCHs
- Timeslot number	zero
- Training Sequence Code	Chosen arbitrarily
- Hopping	RF hopping channel
- MAIO	Chosen arbitrarily from the set (0, 1 to N-1), where N is the number of frequencies encoded in the Frequency List IE.
- HSN	Chosen arbitrarily from the set {1, 2,..., 63}.
Synchronisation Indication IE is not included	
Channel Mode IE	speech full rate
Frequency List, after time.	
- Frequency List IE	Use Range 128 to encode the following 15 frequencies: (307, 309, 311, 313, 315, 317, 319, 320, 326, 328, 330, 332, 334, 336, 338).

Step 13 : 'x' = 500

GSM450 :

IMMEDIATE ASSIGNMENT

Information Element	value/remark
As default message contents.	

HANDOVER COMMAND

Information Element	value/remarks
As default message contents, except :	
Cell Description	
- Network Colour Code	3
- Base Station Colour Code	0
- BCCH Carrier Number	274
Channel Description	
- Channel Type	TCH/F + ACCHs
- Timeslot number	zero
- Training Sequence Code	Chosen arbitrarily
- Hopping	RF hopping channel
- MAIO	Chosen arbitrarily from the set (0, 1 to N-1), where N is the number of frequencies encoded in the Frequency List IE.
- HSN	Chosen arbitrarily from the set {1, 2,..., 63}.
Synchronisation Indication IE is not included	
Channel Mode IE	speech full rate
Frequency List, after time.	
- Frequency List IE	Use range 128 to encode the following 15 frequencies: (260, 262, 264, 266, 268, 270, 272, 273, 279, 281, 283, 285, 287, 289, 291).

Step 13 : 'x' = 500

PCS 1900:

IMMEDIATE ASSIGNMENT

Information Element	value/remark
As default message contents.	

HANDOVER COMMAND

Information Element	value/remarks
As default message contents, except :	
Cell Description	
- Network Colour Code	3
- Base Station Colour Code	0
- BCCH Carrier Number	664
Channel Description	
- Channel Type	TCH/F + ACCHs
- Timeslot number	zero.
- Training Sequence Code	Chosen arbitrarily
- Hopping	RF hopping channel.
- MAIO	Chosen arbitrarily from the set (0, 1 to N-1), where N is the number of frequencies encoded in the Frequency Short List IE.
- HSN	Chosen arbitrarily from the set (1,2,..63).
Synchronization IE is not included.	
Channel Mode IE	speech full rate
Frequency Short List after time	
- Frequency Short List	Use Range 128 to encode the following 11 frequencies: (656, 658, 661, 671, 679, 682, 691, 698, 729, 732, 744).

Step 13 : 'x' = 500

M = 2

DCS1800:

IMMEDIATE ASSIGNMENT

Information Element	value/remark
As default message contents except :	
L2 pseudo length	14 octets (11 + contents of the MA)
Channel Description	
- Channel Type	SDCCH/8
- TDMA offset	As default message contents
- Timeslot number	Arbitrary value but not zero.
- Training Sequence Code	Chosen arbitrarily
- Hopping	RF hopping channel.
- MAIO	Chosen arbitrarily from the set (0, 1 to N-1), where N is the number of frequencies encoded in the Mobile Allocation.
- HSN	Chosen arbitrarily from the set (1,2,..63)
Mobile Allocation	
- Length	3 octets.
- Contents	Indicates only three frequencies : (773, 775, 779).

HANDOVER COMMAND

Information Element	value/remarks
As default message contents, except :	
Cell Description	
- Network Colour Code	3
- Base Station Colour Code	0
- BCCH Carrier Number	764
Channel Description	
- Channel Type	TCH/F + ACCHs
- Timeslot number	Zero
- Training Sequence Code	Chosen arbitrarily
- Hopping	Single RF Channel
- ARFCN	Chosen arbitrarily from the Cell Allocation of Cell B, but not the BCCH carrier of Cell B.
Synchronization Indication IE not included.	

Step 13 : 'x' = 500

GSM900:

IMMEDIATE ASSIGNMENT

Information Element	value/remark
As default message contents except :	
L2 pseudo length	14 octets (11 + contents of the MA)
Channel Description	
- Channel Type	SDCCH/8
- TDMA offset	As default message contents
- Timeslot number	Arbitrary value, but not zero.
- Training Sequence Code	Chosen arbitrarily
- Hopping	RF hopping channel.
- MAIO	Chosen arbitrarily from the set (0, 1 to N-1), where N is the number of frequencies encoded in the Mobile Allocation.
- HSN	Chosen arbitrarily from the set (1,2,..63)
Mobile Allocation	
- Length	3 octets.
- Contents	Indicates only three frequencies : (73, 74, 75).

HANDOVER COMMAND

Information Element	value/remarks
As default message contents, except :	
Cell Description	
- Network Colour Code	3
- Base Station Colour Code	0
- BCCH Carrier Number	40
Channel Description	
- Channel Type	TCH/F + ACCHs
- Timeslot number	Zero
- Training Sequence Code	Chosen arbitrarily
- Hopping	Single RF Channel
- ARFCN	Chosen arbitrarily from the Cell Allocation of Cell B, but not the BCCH carrier of Cell B.
Synchronization Indication IE not included.	

Step 13 : 'x' = 500

GSM480 :

IMMEDIATE ASSIGNMENT

Information Element	value/remark
As default message contents except : L2 pseudo length Channel Description - Channel Type - TDMA offset - Timeslot number - Training Sequence Code - Hopping - MAIO - HSN Mobile Allocation - Length - Contents	14 octets (11 + contents of the MA) SDCCH/8 As default message contents Arbitrary value, but not zero. Chosen arbitrarily RF hopping channel. Chosen arbitrarily from the set (0, 1 to N-1), where N is the number of frequencies encoded in the Mobile Allocation. Chosen arbitrarily from the set (1,2,..63) 3 octets. Indicates only three frequencies : (328, 330, 332).

HANDOVER COMMAND

Information Element	value/remarks
As default message contents, except : Cell Description - Network Colour Code - Base Station Colour Code - BCCH Carrier Number Channel Description - Channel Type - Timeslot number - Training Sequence Code - Hopping - ARFCN Synchronization Indication IE not included.	 3 0 321 TCH/F + ACCHs Zero Chosen arbitrarily Single RF Channel Chosen arbitrarily from the Cell Allocation of Cell B, but not the BCCH carrier of Cell B.

Step 13 : 'x' = 500

GSM450 :

IMMEDIATE ASSIGNMENT

Information Element	value/remark
As default message contents except : L2 pseudo length Channel Description - Channel Type - TDMA offset - Timeslot number - Training Sequence Code - Hopping - MAIO - HSN Mobile Allocation - Length - Contents	14 octets (11 + contents of the MA) SDCCH/8 As default message contents Arbitrary value, but not zero. Chosen arbitrarily RF hopping channel. Chosen arbitrarily from the set (0, 1 to N-1), where N is the number of frequencies encoded in the Mobile Allocation. Chosen arbitrarily from the set (1,2,..63) 3 octets. Indicates only three frequencies : (281, 283, 285).

HANDOVER COMMAND

Information Element	value/remarks
As default message contents, except : Cell Description - Network Colour Code - Base Station Colour Code - BCCH Carrier Number Channel Description - Channel Type - Timeslot number - Training Sequence Code - Hopping - ARFCN Synchronization Indication IE not included.	3 0 274 TCH/F + ACCHs Zero Chosen arbitrarily Single RF Channel Chosen arbitrarily from the Cell Allocation of Cell B, but not the BCCH carrier of Cell B.

Step 13 : 'x' = 500

PCS 1900:**IMMEDIATE ASSIGNMENT**

Information Element	value/remark
As default message contents except : L2 pseudo length Channel Description - Channel Type - TDMA offset - Timeslot number - Training Sequence Code - Hopping - MAIO - HSN Mobile Allocation - Length - Contents	14 octets (11 + contents of the MA) SDCCH/8 As default message contents Arbitrary value but not zero. Chosen arbitrarily RF hopping channel. Chosen arbitrarily from the set (0, 1 to N-1), where N is the number of frequencies encoded in the Mobile Allocation. Chosen arbitrarily from the set (1,2,..63) 3 octets. Indicates only three frequencies : (673, 675, 679).

HANDOVER COMMAND

Information Element	value/remarks
As default message contents, except : Cell Description - Network Colour Code - Base Station Colour Code - BCCH Carrier Number Channel Description - Channel Type - Timeslot number - Training Sequence Code - Hopping - ARFCN Synchronization Indication IE not included.	 3 0 664 TCH/F + ACCHs Zero Chosen arbitrarily Single RF Channel Chosen arbitrarily from the Cell Allocation of Cell B, but not the BCCH carrier of Cell B.

Step 13 : 'x' = 500

26.14.3.5 VGCS-VBS / RR Procedures / handover / failure**26.14.3.5.1 Conformance requirements**

After a HANDOVER COMMAND message and subsequent handover failure in group transmit mode, the MS shall return to the old channel.

References

GSM 04.08 clauses 3.4.4.4.

26.14.3.5.2 Test purpose

To verify that after a HANDOVER COMMAND message and subsequent handover failure in group transmit mode, the MS returns to the old channel.

26.14.3.5.3 Method of test

Initial Conditions

System Simulator:

2 cells with same LAI, default parameters.

Mobile Station:

The MS is in group transmit mode on cell A.

Related PICS/PIXIT Statements

Type of MS (GSM 450 or GSM 480 or P-GSM 900 or EGSM or DCS 1 800 or PCS 1900).

Support VGCS talking.

Support VBS originating.

Way to configure VGCS or VBS.

Way to request uplink.

Way to initiate VBS call.

Foreseen Final State of the MS

"Idle, updated", with TMSI allocated.

Test Procedure

The MS is brought to group transmit mode, then the SS sends a HANOVER COMMAND message with Power Command set to 8. The MS begins to send access bursts at the commanded power level on the new DCCH. The SS activates the SACCH, but does not send PHYSICAL INFORMATION (thus causing a time-out of T3124). It is checked that the MS re-establishes the old link and sends a HANOVER FAILURE within 3 s from the transmission of HANOVER COMMAND, using the old power level.

Maximum Duration of Test

5 minutes, including 1 minute for any necessary operator actions.

Expected Sequence

Step	Direction	Message	Comments
1	MS		the MS is in group transmit mode
2	SS -> MS	HANOVER COMMAND	Channel description: non-hopping, full rate Power Command: 8. Synchronisation Indication: non synchronised. Several messages are sent, all with correct Handover References. Sent on old channel, RR cause value = "Abnormal release, unspecified", "Abnormal release, channel unacceptable", "Abnormal release, timer expired", "Abnormal release, no activity on the radio path" or "Protocol error unspecified". Shall be sent within 3 s from the transmission of HANOVER COMMAND. The MS releases L2 multiple frame link L2:DISC/UA.
3	MS -> SS	HANOVER ACCESS	
4	MS -> SS	HANOVER FAILURE	
5	SS -> MS	CHANNEL RELEASE	

26.14.3.6 VGCS-VBS / RR / Measurement Report

This sub-clause tests measurement report of the MS in group transmit mode,

26.14.3.6.1 Measurement / all neighbours present

26.14.3.6.1.1 Conformance requirements

In group transmit mode the MS shall continuously send MEASUREMENT REPORT messages on every SACCH blocks and the measurement valid indication shall be set to valid (0) within the second block at the latest.

After 20 s the values in the MEASUREMENT REPORT message shall contain measurement results for the 6 strongest BCCH carriers with known and allowed NCC part of BSIC when the SS gives information of more than 6 neighbouring cells .

References

GSM 04.08 clause 3.4.1.2,

GSM 05.08 clause 8.4.

26.14.3.6.1.2 Test purpose

To verify that, when the SS gives information of more than 6 neighbouring cells, the MS in group transmit mode reports measurement results for the 6 strongest BCCH carriers with known and allowed NCC part of BSIC.

26.14.3.6.1.3 Method of test

Initial Conditions

System Simulator:

For GSM 450 or GSM 480: 8 cells with the following settings:

Transmitter	Level	NCC	BSCC	ARFCN (GSM450)	ARFCN (GSM480)	Cell Identity
Serving, S1	-60	1	3	260	307	0001H
Neighbour, N1	-85	1	5	264	311	0002H
Neighbour, N2	-80	1	7	268	315	0003H
Neighbour, N3	-75	1	1	272	319	0004H
Neighbour, N4	-55	1	3	276	323	0005H
Neighbour, N5	-50	1	5	280	327	0006H
Neighbour, N6	-45	1	7	284	331	0007H
Neighbour, N7	-40	1	1	288	335	0008H

For GSM 900 or DCS 1800: 8 cells with the following settings:

Transmitter	Level	NCC	BSCC	ARFCN (GSM900)	ARFCN (DCS1800)	ARFCN (PCS 1900)	Cell Identity
Serving, S1	-60	1	3	002	514	514	0001H
Neighbour, N1	-85	1	5	008	530	530	0002H
Neighbour, N2	-80	1	7	014	602	602	0003H
Neighbour, N3	-75	1	1	020	665	665	0004H
Neighbour, N4	-55	1	3	026	762	762	0005H
Neighbour, N5	-50	1	5	032	686	686	0006H
Neighbour, N6	-45	1	7	038	549	549	0007H
Neighbour, N7	-40	1	1	044	810	810	0008H

With the exception of the Cell Allocation, the rest of the parameters for all eight cells are the same as the default settings and default SI 1 to 4 message contents for cell A. The Cell Allocation for the serving cell is the same as the default setting for cell A. The Cell Allocations for the neighbour cells need have only one entry, consisting of the ARFCN of that cell's BCCH.

Mobile Station:

The MS is in group transmit mode.

Related PICS/PIXIT Statements

Type of MS (GSM 450 or GSM 480 or P-GSM 900 or EGSM or DCS 1 800 or PCS 1900).

Support VGCS talking.

Support VBS originating.

Way to initiate VBS call.

Foreseen Final State of the MS

group transmit mode

Test Procedure

This test procedure is performed twice.

The MS is in group transmit mode. The SS sends SI 5 & 6 (on the second iteration of the test the SS also sends SI 5bis) on the SACCH. All 8 of the BCCHs are indicated in the BA. It is checked that the MS sends MEASUREMENT REPORTs containing measurement results for the 6 strongest carriers.

Maximum Duration of Test

5 minutes, including 1 minute for any necessary operator actions.

Expected Sequence

This sequence is performed for execution counter, $k = 1, 2$.

Since when $k = 1$, SI 5, SI 6 and MEASUREMENT REPORT (and when $k = 2$ an additional SI 5bis is included) are sent continuously, a table is not applicable in this test. The interval between 2 successive Layer 2 frames containing MEASUREMENT REPORTs shall not exceed one Layer 2 frame.

Specific Message Contents

GSM450 begin:

SYSTEM INFORMATION TYPE 5:

Information Element	value/remark
Neighbour Cells Description	
Format Identifier	Range 128
BCCH Allocation Sequence	1
BCCH Allocation ARFCN	The channel numbers 259, 260, 261, 262, 263, 264, 265, 267, 268, 269, 270, 271, 272, 273, 274, 275, 276, 278, 279, 280, 281, 282, 283, 284, 285, 286, 287, 288, 289, 290, 291 and 292 belong to the BCCH allocation.
- EXT IND	$k = 1$. Information Element carries complete BA. $k = 2$. Information Element carries only a part of the BA.

SYSTEM INFORMATION TYPE 5bis (Sent only when k = 2):

Information Element	value/remark
Protocol Discriminator	RR Management
Message Type	Sys Info 5bis.
Neighbour Cells Description	
- Format	1024 range
- EXT IND	k = 2. Information Element carries only a part of the BA.
- W(i)	Channel 0 and 800 belong to the BCCH allocation.

MEASUREMENT REPORT:

Information Element	value/remark
Protocol Discriminator	RR Management
Transaction Identifier	0000
Message Type	MEASUREMENT REPORT
Measurement Results	
BA_used	1
DTX_used	DTX was not used
RXLEV_FULL_SERVING_CELL	See NOTE 1
RXLEV_SUB_SERVING_CELL	See NOTE 1
MEAS_VALID	See NOTE 2
RXQUAL_FULL_SERVING_CELL	See NOTE 1
RXQUAL_SUB_SERVING_CELL	See NOTE 1
NO_NCELL_M	6 neighbour cell measurement results
RXLEV_NCELL_1	See NOTE 1
BCCH_FREQ_NCELL_1	Shall not correspond to N1 or N2
BSIC_NCELL_1	Corresponds to that of BCCH_FREQ_NCELL_1
RXLEV_NCELL_2	See NOTE 1
BCCH_FREQ_NCELL_2	Shall not correspond to N1 or N2
BSIC_NCELL_2	Corresponds to that of BCCH_FREQ_NCELL_2
RXLEV_NCELL_3	See NOTE 1
BCCH_FREQ_NCELL_3	Shall not correspond to N1 or N2
BSIC_NCELL_3	Corresponds to that of BCCH_FREQ_NCELL_3
RXLEV_NCELL_4	See NOTE 1
BCCH_FREQ_NCELL_4	Shall not correspond to N1 or N2
BSIC_NCELL_4	Corresponds to that of BCCH_FREQ_NCELL_4
RXLEV_NCELL_5	See NOTE 1
BCCH_FREQ_NCELL_5	Shall not correspond to N1 or N2
BSIC_NCELL_5	Corresponds to that of BCCH_FREQ_NCELL_5
RXLEV_NCELL_6	See NOTE 1
BCCH_FREQ_NCELL_6	Shall not correspond to N1 or N2
BSIC_NCELL_6	Corresponds to that of BCCH_FREQ_NCELL_6

GSM450 end:

GSM480 begin:

SYSTEM INFORMATION TYPE 5:

Information Element	value/remark
Neighbour Cells Description	
Format Identifier	Range 128
BCCH Allocation Sequence	1
BCCH Allocation ARFCN	The channel numbers 306, 307, 308, 309, 310, 311, 312, 314, 315, 316, 317, 318, 319, 320, 321, 322, 323, 325, 326, 327, 328, 329, 330, 331, 332, 333, 334, 335, 336, 337, 338 and 339 belong to the BCCH allocation.
- EXT IND	k = 1. Information Element carries complete BA. k = 2. Information Element carries only a part of the BA.

SYSTEM INFORMATION TYPE 5bis (Sent only when k = 2):

Information Element	value/remark
Protocol Discriminator	RR Management
Message Type	Sys Info 5bis.
Neighbour Cells Description	
- Format	1024 range
- EXT IND	k = 2. Information Element carries only a part of the BA.
- W(i)	Channel 0 and 800 belong to the BCCH allocation.

MEASUREMENT REPORT:

Information Element	value/remark
Protocol Discriminator	RR Management
Transaction Identifier	0000
Message Type	MEASUREMENT REPORT
Measurement Results	
BA_used	1
DTX_used	DTX was not used
RXLEV_FULL_SERVING_CELL	See NOTE 1
RXLEV_SUB_SERVING_CELL	See NOTE 1
MEAS_VALID	See NOTE 2
RXQUAL_FULL_SERVING_CELL	See NOTE 1
RXQUAL_SUB_SERVING_CELL	See NOTE 1
NO_NCELL_M	6 neighbour cell measurement results
RXLEV_NCELL_1	See NOTE 1
BCCH_FREQ_NCELL_1	Shall not correspond to N1 or N2
BSIC_NCELL_1	Corresponds to that of BCCH_FREQ_NCELL_1
RXLEV_NCELL_2	See NOTE 1
BCCH_FREQ_NCELL_2	Shall not correspond to N1 or N2
BSIC_NCELL_2	Corresponds to that of BCCH_FREQ_NCELL_2
RXLEV_NCELL_3	See NOTE 1
BCCH_FREQ_NCELL_3	Shall not correspond to N1 or N2
BSIC_NCELL_3	Corresponds to that of BCCH_FREQ_NCELL_3
RXLEV_NCELL_4	See NOTE 1
BCCH_FREQ_NCELL_4	Shall not correspond to N1 or N2
BSIC_NCELL_4	Corresponds to that of BCCH_FREQ_NCELL_4
RXLEV_NCELL_5	See NOTE 1
BCCH_FREQ_NCELL_5	Shall not correspond to N1 or N2
BSIC_NCELL_5	Corresponds to that of BCCH_FREQ_NCELL_5
RXLEV_NCELL_6	See NOTE 1
BCCH_FREQ_NCELL_6	Shall not correspond to N1 or N2
BSIC_NCELL_6	Corresponds to that of BCCH_FREQ_NCELL_6

GSM480 end:

GSM900 begin:

SYSTEM INFORMATION TYPE 5:

Information Element	value/remark
Neighbour Cells Description	
Format Identifier	bit map 0
BCCH Allocation Sequence	1
BCCH Allocation ARFCN	The channel numbers 2, 4, 5, 6, 7, 8, 9, 10, 11, 12, 13, 14, 16, 17, 18, 19, 20, 21, 22, 23, 24, 26, 28, 29, 30, 32, 34, 35, 36, 38, 40 and 44 belong to the BCCH allocation.
- EXT IND	k = 1. Information Element carries complete BA. k = 2. Information Element carries only a part of the BA.

SYSTEM INFORMATION TYPE 5bis (Sent only when k = 2):

Information Element	value/remark
Protocol Discriminator	RR Management
Message Type	Sys Info 5bis.
Neighbour Cells Description	
- Format	1024 range
- EXT IND	k = 2. Information Element carries only a part of the BA.
- W(i)	Channel 0 and 800 belong to the BCCH allocation.

MEASUREMENT REPORT:

Information Element	value/remark
Protocol Discriminator	RR Management
Transaction Identifier	0000
Message Type	MEASUREMENT REPORT
Measurement Results	
BA_used	1
DTX_used	DTX was not used
RXLEV_FULL_SERVING_CELL	See NOTE 1
RXLEV_SUB_SERVING_CELL	See NOTE 1
MEAS_VALID	See NOTE 2
RXQUAL_FULL_SERVING_CELL	See NOTE 1
RXQUAL_SUB_SERVING_CELL	See NOTE 1
NO_NCELL_M	6 neighbour cell measurement results
RXLEV_NCELL_1	See NOTE 1
BCCH_FREQ_NCELL_1	Shall not correspond to N1 or N2
BSIC_NCELL_1	Corresponds to that of BCCH_FREQ_NCELL_1
RXLEV_NCELL_2	See NOTE 1
BCCH_FREQ_NCELL_2	Shall not correspond to N1 or N2
BSIC_NCELL_2	Corresponds to that of BCCH_FREQ_NCELL_2
RXLEV_NCELL_3	See NOTE 1
BCCH_FREQ_NCELL_3	Shall not correspond to N1 or N2
BSIC_NCELL_3	Corresponds to that of BCCH_FREQ_NCELL_3
RXLEV_NCELL_4	See NOTE 1
BCCH_FREQ_NCELL_4	Shall not correspond to N1 or N2
BSIC_NCELL_4	Corresponds to that of BCCH_FREQ_NCELL_4
RXLEV_NCELL_5	See NOTE 1
BCCH_FREQ_NCELL_5	Shall not correspond to N1 or N2
BSIC_NCELL_5	Corresponds to that of BCCH_FREQ_NCELL_5
RXLEV_NCELL_6	See NOTE 1
BCCH_FREQ_NCELL_6	Shall not correspond to N1 or N2
BSIC_NCELL_6	Corresponds to that of BCCH_FREQ_NCELL_6

GSM900 end:

DCS1800 and PCS 1900 begin:

SYSTEM INFORMATION TYPE 5:

Information Element	value/remark
Protocol Discriminator	RR management
Message Type	Sys Info 5.
Neighbour Cells Description	
- Format	1024 range
- EXT IND	k = 1. Information Element carries complete BA. k = 2. Information Element carries only a part of the BA.
- W(i)	k = 1. Non null for ARFCN 514, 530, 549, 602, 665, 686, 762, 810. k = 2. Non null for ARFCN 549, 602, 665, 686, 810.

SYSTEM INFORMATION TYPE 5bis (Sent only when k = 2):

Information Element	value/remark
Protocol Discriminator	RR management
Message Type	Sys Info 5bis.
Neighbour Cells Description	
- Format	1024 range
- EXT IND	k = 2. Information Element carries only a part of the BA.
- W(i)	k = 2. Non null ARFCN 20, 514, 530, 549, 762.

SYSTEM INFORMATION TYPE 6:

Information Element	value/ remark
Protocol Discriminator	RR Management
Message Type	sys info 6
Cell Identity	default
LAI	default
Cell Options	
- Power Control Indicator	Power Control Indicator is set
- DTX Indicator	MS shall not use DTX
- Radio_Link_Timeout	default
PLMN permitted	only NCC 1 permitted

MEASUREMENT REPORT:

Information Element	value/remark
Protocol Discriminator	RR Management
Transaction Identifier	0000
Message Type	MEASUREMENT REPORT
Measurement Results	
BA_used	1
DTX_used	DTX was not used
RXLEV_FULL_SERVING_CELL	See NOTE 1
RXLEV_SUB_SERVING_CELL	See NOTE 1
MEAS_VALID	See NOTE 2
RXQUAL_FULL_SERVING_CELL	See NOTE 1
RXQUAL_SUB_SERVING_CELL	See NOTE 1
NO_NCELL_M	6 neighbour cell measurement results
RXLEV_NCELL_1	See NOTE 1
BCCH_FREQ_NCELL_1	Shall not correspond to N1 or N2
BSIC_NCELL_1	Corresponds to that of BCCH_FREQ_NCELL_1
RXLEV_NCELL_2	See NOTE 1
BCCH_FREQ_NCELL_2	Shall not correspond to N1 or N2
BSIC_NCELL_2	Corresponds to that of BCCH_FREQ_NCELL_2
RXLEV_NCELL_3	See NOTE 1
BCCH_FREQ_NCELL_3	Shall not correspond to N1 or N2
BSIC_NCELL_3	Corresponds to that of BCCH_FREQ_NCELL_3
RXLEV_NCELL_4	See NOTE 1
BCCH_FREQ_NCELL_4	Shall not correspond to N1 or N2
BSIC_NCELL_4	Corresponds to that of BCCH_FREQ_NCELL_4
RXLEV_NCELL_5	See NOTE 1
BCCH_FREQ_NCELL_5	Shall not correspond to N1 or N2
BSIC_NCELL_5	Corresponds to that of BCCH_FREQ_NCELL_5
RXLEV_NCELL_6	See NOTE 1
BCCH_FREQ_NCELL_6	Shall not correspond to N1 or N2
BSIC_NCELL_6	Corresponds to that of BCCH_FREQ_NCELL_6

DCS1800 and PCS 1900 end:

NOTE 1: These actual values are not checked.

NOTE 2: The Measurement Valid Indication shall be set to valid within the second SACCH block at the latest.

26.14.4 VGCS-VBS / Uplink Access and Uplink Reply Procedures

This clause is applied to the MS supporting VGCS talking.

26.14.4.1 VGCS-VBS / Uplink Access / uplink investigation

26.14.4.1.1 Conformance requirement

1. On receipt of a request from the upper layer to access the uplink and the uplink is free the MS shall start the uplink access procedure.
2. The uplink is not free when receipt of request from the upper layer to access the uplink, and before the Timer T3128 expiring the uplink is still not free, the MS shall remain in group receive mode and indicate a reject of the uplink request to the upper layer.

Reference(s)

GSM 04.08 clause 3.3.1.2.1.1.

26.14.4.1.2 Test purpose

To verify that:

1. The MS starts the uplink access procedure on receipt of a request from the user to access the uplink and the uplink is free.
2. The MS remains in group receive mode and indicates a reject of the uplink request to the user till Timer T3128 expiring.

26.14.4.1.3 Method of test

Initial Conditions

System Simulator:

1 cell with default parameters for ASCII testing.

Mobile Station:

The MS is in group receive mode.

Related PICS/PIXIT Statement(s)

Type of MS (GSM 450, GSM 480, P-, E-, R-GSM 900 or DCS 1800 or PCS 1900).

Support VGCS talking.

Way to configure VGCS.

Way to indicate uplink granted/rejected.

Way to accept a VGCS.

Way to request uplink.

Foreseen Final State of the MS

"Idle, updated", with TMSI allocated.

Test Procedure

The MS is brought into group receive mode. The SS indicates uplink free to the MS. The MS is requested to access uplink by MMI action. It is checked that the MS initiates the uplink access procedure. The request is not granted (a VGCS UPLINK GRANT to irrelevant request reference and an UPLINK BUSY message). It is checked that the MS remains in group receive mode. The MS is requested to access uplink by MMI action. It is checked that the MS does not send UPLINK ACCESS message and indicates uplink access rejected.

Maximum Duration of Test

5 minutes

Expected Sequence

Step	Direction	Message	Comments
0	MS		the MS is in group receive mode.
1	SS -> MS	UPLINK FREE	Uplink access request set to 'L'. MMI action to request uplink access. request reference different from those in step 3 and 4. check that the MS indicates rejection of uplink request and check that the TCH in downlink is still through connected and there is no uplink transmission on that channel for 10 s.
2	MS		
3	MS -> SS	UPLINK ACCESS	
4	MS -> SS	UPLINK ACCESS	
5	SS -> MS	UPLINK BUSY	
6	SS -> MS	VGCS UPLINK GRANT	
7	MS		
10	MS		MMI action to request uplink access. check that there is no UPLINK ACCESS messages for 2 s. check that the MS indicates the access rejection to the user. UI format
11	SS		
12	MS		
13	SS -> MS	CHANNEL RELEASE	

26.14.4.2 Uplink Access / uplink access procedure

26.14.4.2.1 Conformance requirement

1. The mobile station shall send UPLINK ACCESS messages on the voice group call channel with the appropriate establishment cause. The first UPLINK ACCESS message shall be transmitted by the mobile station with a random delay between 0 and 20ms. The UPLINK ACCESS messages shall be repeated after a further period of 100ms plus a random delay between 0 and 20ms.
2. At expiration of timer T3130, the mobile station shall repeat the uplink access procedure if the uplink is free. A maximum of three attempts is allowed and after that a rejection of the uplink request is indicated to the upper layers.
3. When receiving a UPLINK BUSY or a VGCS UPLINK GRANT message aimed to another mobile station (i.e., not corresponding to one of its UPLINK ACCESS messages), the mobile station shall stop sending UPLINK ACCESS message and remain in group receive mode and shall indicate a rejection of the uplink request to the upper layers.
4. On receipt of an VGCS UPLINK GRANT message corresponding to one of its UPLINK ACCESS messages, the mobile station stops T3130, stops sending UPLINK ACCESS messages, and establishes the main signalling link with an SABM containing the TALKER INDICATION message in the information field. Controlled early classmark sending shall be performed. If a UA is received containing the message sent, the mobile station enters group transmit mode and indicates the successful seizure of the uplink to the upper layer.
5. If an uplink identity code (UIC) of the current cell has been provided by the network in the UPLINK FREE message, the mobile station shall use this UIC IE for the coding of the UPLINK ACCESS messages. If no UIC is provided, the mobile station shall use the BSIC received from the current cell, for instance from the initial synchronisation.

Reference(s)

GSM 04.08 clause 3.3.1.2.1.2

GSM 03.68 clause 11.3.7.

GSM 05.03 clause 4.6.

26.14.4.2.2 Test purpose

To verify that:

1. When a request to talk is made by the user and the uplink has been free the MS in group receive mode sends UPLINK ACCESS messages on the voice group call channel with the appropriate establishment cause.
2. The first UPLINK ACCESS message is transmitted by the MS with a random delay between 0 and 20ms. The UPLINK ACCESS messages is repeated after a further period of 100ms plus a random delay between 0 and 20ms.
3. At expiration of timer T3130, the MS repeats the uplink access procedure if the uplink is free and maximum of attempts is three. After three failed attempts a rejection of the uplink request is indicated.
4. The MS stops sending UPLINK ACCESS message and remains in group receive mode and indicates a rejection of the uplink request when receiving a UPLINK BUSY or a VGCS UPLINK GRANT message aimed to another mobile station (i.e., not corresponding to one of its UPLINK ACCESS messages).
5. On receipt of an VGCS UPLINK GRANT message corresponding to one of its UPLINK ACCESS messages, the MS stops T3130, stops sending UPLINK ACCESS messages, and establishes the main signalling link with an SABM containing the TALKER INDICATION message in the information field. Controlled early classmark sending is performed. If a UA is received containing the message sent, the MS enters group transmit mode and indicates the successful uplink seizure.
6. If an uplink identity code (UIC) of the current cell has been provided by the network in the UPLINK FREE message, the mobile station shall use this UIC IE for the coding of the UPLINK ACCESS messages . If no UIC is provided, the mobile station shall use the BSIC received from the current cell, for instance from the initial synchronisation.

26.14.4.2.3 Method of test

Initial Conditions

System Simulator:

- 1 cell with default parameters for ASCI testing.

Mobile Station:

The MS is in group receive mode.

Related PICS/PIXIT Statement(s)

Type of MS (GSM 450, GSM 480,P-, E-, R-GSM 900 or DCS 1800 or PCS 1900).

Support VGCS talking.

Way to configure VGCS.

Way to indicate uplink granted/rejected.

Way to accept a VGCS.

Way to request uplink.

Foreseen Final State of the MS

"Idle, updated", with TMSI allocated.

Test Procedure

The MS is brought into group receive mode. The SS sends UPLINK FREE without UIC. The MS is made to access uplink. It is checked that the MS initiates uplink access procedure with correct establishment cause and with random delay for transmissions and retransmissions and that the access bursts are coded with BSIC. The SS does not respond to the access request. It is checked that the MS repeats the same procedure three times, after three attempts it indicates access rejection and remains in group receive mode.

The SS sends UPLINK FREE with UIC. The MS is made to access uplink. It is checked that the access bursts are coded with UIC. After the second UPLINK ACCESS message, the SS responds with VGCS UPLINK GRANT aimed to another MS and UPLINK BUSY messages. It is checked that the MS stops sending UPLINK ACCESS, remains in group receive mode and indicates uplink access rejection. The SS sends UPLINK FREE. The MS is made to access uplink. The SS sends a message on the downlink SACCH. It is checked that the MS stops sending UPLINK ACCESS for 10 s, then the SS sends another SACCH message. It is checked that the MS is back to group receive mode and indicates access rejection. The MS is made to access uplink. The SS accepts the request. It is checked that the MS establishes the main signalling link correctly, enters group transmit mode and indicates the successful seizure of uplink.

Maximum Duration of Test

5 minutes

Expected Sequence

Step	Direction	Message	Comments
0	MS		The MS is in group receive mode.
1	SS -> MS	UPLINK FREE	Uplink access request set to 'L'. UIC indication set to 'L'.
2	MS		MMI action to request uplink access.
3	MS -> SS	UPLINK ACCESS	check that establishment cause is "Subsequent talker uplink request" and this access burst is coded with BSIC.
4	MS -> SS	UPLINK ACCESS	check that the interval between this burst and the one in step 3 is 100ms plus a value between 0 and 20ms.
5	MS -> SS	UPLINK ACCESS	check that the interval between this burst and the one in step 3 is 5s plus a value between 0 and 20ms.
6	MS -> SS	UPLINK ACCESS	check that the interval between this burst and the one in step 5 is 100ms plus a value between 0 and 20ms, and the interval is different from the interval in step 4.
7	MS -> SS	UPLINK ACCESS	check that the interval between this burst and the one in step 5 is 5s plus a value between 0 and 20ms, and the interval is different from the interval in step 5.
8	MS -> SS	UPLINK ACCESS	check that the interval between this burst and the one in step 7 is 100ms plus a value between 0 and 20ms, and the interval is different from the intervals in step 4 and step 6.
9	MS		check that there is no more UPLINK ACCESS, and that the TCH in downlink is through connected and there is no uplink transmission on that channel for 10 s. The MS indicates also a rejection of the uplink request.
10	SS -> MS	UPLINK FREE	containing UIC.
11	MS		MMI action to request uplink access.
12	MS -> SS	UPLINK ACCESS	
13	MS -> SS	UPLINK ACCESS	
14	SS -> MS	VGCS UPLINK GRANT	request reference different from step 12 and 13
15	SS		check that within 1 second the MS does not send further UPLINK ACCESS.
16	SS -> MS	UPLINK BUSY	this message sent 0.9 s. after step 14.
17	MS		check that the MS indicates a rejection of the uplink request and that the TCH in downlink is through connected and there is no uplink transmission on that channel for 10 s..
18	SS -> MS	UPLINK FREE	
19	MS		MMI action to request uplink access.
20	MS -> SS	UPLINK ACCESS	
21	MS -> SS	UPLINK ACCESS	
22	SS -> MS	UPLINK BUSY	
23	SS		check that there is no more UPLINK ACCESS, and that the TCH in downlink is through connected and there is no uplink transmission on that channel for 10 s. The MS indicates also a rejection of the uplink request.
24	SS -> MS	UPLINK FREE	
26	MS		MMI action to request uplink access.
27	MS -> SS	UPLINK ACCESS	
28	MS -> SS	UPLINK ACCESS	
29	SS -> MS	UPLINK BUSY	
30	SS -> MS	VGCS UPLINK GRANT	Reference to step 27
31	MS -> SS	TALKER INDICATION	L2: SABM / UA
32	SS -> MS	AUTHENTICATION REQUEST	
33	MS -> SS	AUTHENTICATION RESPONSE	
34	SS -> MS	CIPHERING MODE COMMAND	no ciphering
35	MS -> SS	CIPHERING MODE COMPLETE	
36	MS		Check that the TCH is through connected and the MS gives indication to the user.
37	SS -> MS	CHANNEL RELEASE	The MS may send a DISC (step 38) without performing a layer 2 acknowledgement of the CHANNEL RELEASE message.

Step	Direction	Message	Comments
38	MS -> SS	DISC	The MS shall send at least 2 L2 DISC frames, to which the SS does not respond. After a period of 2 seconds, the SS verifies for 3 seconds that the MS does not produce any further Layer 2 messages.

26.14.4.3 VGCS-VBS / Uplink Reply in VGCS receive mode

This test is applicable to the MS supporting VGCS talking.

26.14.4.3.1 Conformance requirement

1. On receipt of an UPLINK FREE message with an uplink access request indication from the network on the voice group call channel downlink, the mobile station shall send two UPLINK ACCESS messages on the voice group call channel with the appropriate establishment cause and then stop immediately transmitting on the uplink.
2. The first UPLINK ACCESS message shall be transmitted by the mobile station with a random delay between 0 and 20 ms. The second UPLINK ACCESS messages shall be repeated after a further period of 100 ms plus a random delay between 0 and 20 ms.
3. If an uplink identity code (UIC) of the current cell has been provided by the network in the UPLINK FREE message, the mobile station shall use this UIC for the coding of the UPLINK ACCESS messages. If no UIC is provided, the mobile station shall use the BSIC received of the serving cell, for instance as received from the initial synchronisation.

Reference(s)

GSM 04.08 clause 3.4.15.1.3.

26.14.4.3.2 Test purpose

To verify that when the MS is in group receive mode:

1. On receipt of an UPLINK FREE message with an uplink access request indication from the network on the voice group call channel downlink, the MS sends two UPLINK ACCESS messages on the voice group call channel with the appropriate establishment cause and then stops immediately transmitting on the uplink.
2. The first UPLINK ACCESS message is transmitted by the MS with a random delay between 0 and 20 ms. The second UPLINK ACCESS messages is repeated after a further period of 100 ms plus a random delay between 0 and 20 ms.
3. If an uplink identity code (UIC) of the current cell has been provided by the network in the UPLINK FREE message, the MS uses this UIC for the coding of the UPLINK ACCESS messages. If no UIC is provided, the MS uses the BSIC received of the serving cell, for instance as received from the initial synchronisation.

26.14.4.3.3 Method of test

Initial Conditions

System Simulator:

1 cell with default parameters for ASCII testing.

Mobile Station:

The MS is in group receive mode.

Related PICS/PIXIT Statement(s)

Type of MS (GSM 450, GSM 480, P-, E-, R-GSM 900 or DCS 1800 or PCS 1900).

Support VGCS talking.

Way to configure VGCS.

Way to indicate uplink granted/rejected.

Way to accept a VGCS call.

Way to request uplink.

Foreseen Final State of the MS

"Idle, updated", with TMSI allocated.

Test Procedure

The MS is in (VGCS) group receive mode. The SS sends UPLINK FREE message with Uplink Access Request Indication Information Element but without UIC Information Element. It is checked that the MS sends two UPLINK ACCESS messages in correct scheduling and the L1 coding of the messages is with BSIC. The SS sends UPLINK FREE containing Uplink Access Request Indication Information Element and UIC Information Element. It is checked that the MS sends two UPLINK ACCESS messages in correct scheduling and the L1 coding of the messages is with UIC.

Maximum Duration of Test

Expected Sequence

Step	Direction	Message	Comments
0	MS		The MS is in group receive mode.
1	SS -> MS	UPLINK FREE	Uplink access request set to 'H'. UIC indication set to 'L'.
2	MS -> SS	UPLINK ACCESS	check that the establishment cause is "Reply on uplink access request" and the L1 coding is with BSIC
3	MS -> SS	UPLINK ACCESS	check that the burst and the one in step 2 is 100ms plus a value between 0 and 20ms, and check that the L1 coding is with BSIC.
4	SS -> MS	UPLINK FREE	with "uplink access request indication" and UIC.
5	MS -> SS	UPLINK ACCESS	check that the establishment cause is "Reply on uplink access request" and the L1 coding is with UIC
6	MS -> SS	UPLINK ACCESS	check that the burst and the one in step 5 is 100ms plus a value between 0 and 20ms; the interval is different from the intervals in step 2 and step 3, and check that the L1 coding is with UIC.
7	SS -> MS	CHANNEL RELEASE	UI format.

26.14.5 VGCS-VBS / Leaving Group Receive or Group Transmit Mode

26.14.5.1 VGCS-VBS / Leaving group receive mode

26.14.5.1.1 Conformance requirement

In group receive mode:

1. The MS shall return to idle mode and give an indication to the upper layer when it received a CHANNEL RELEASE message of UI format.
2. In sub-state NO CHANNEL for VGCS or RECEIVE MODE ACTIVE for VBS, when $T_{no\ channel}$ expires, the GCC/BCC entity in the MS shall inform higher layers, ask lower sub-layers to abort resources and enter the idle state.
3. If the upper layer requests to abort group receive mode, the mobile station shall return to idle mode.

Reference(s)

GSM 04.08 clause 3.4.15.1.2.6, 3.4.15.1.4.1.

GSM 04.68 clause 6.1.2.1.10, 6.3.1.1.

GSM 04.69 clause 6.1.2.1.10, 6.3.3.

26.14.5.1.2 Test purpose

To verify that in group receive mode:

1. The MS enters idle mode when it received a CHANNEL RELEASE message of UI format.
2. On user's request to abort group receive mode, the MS returns to idle mode.
3. In sub-state NO CHANNEL for VGCS or RECEIVE MODE ACTIVE for VBS, when $T_{no\ channel}$ expires the MS aborts resources and enters the idle mode.

26.14.5.1.3 Method of test

Initial Conditions

System Simulator:

1 cell with default parameters for ASCII testing

Mobile Station:

The MS is in group receive mode.

Related PICS/PIXIT Statement(s)

Type of MS (GSM 450, GSM 480, P-, E-, R-GSM 900 or DCS 1800 or PCS 1900).

Support VGCS listening.

Support VBS listening.

Way to configure VGCS or VBS.

Way to indicate a call notification.

Way to accept a VGCS or VBS.

Way to verify the downlink speech path.

Foreseen Final State of the MS

"Idle, updated", with TMSI allocated.

Test Procedure

The MS is in group receive mode. The SS sends CHANNEL RELEASE. It is checked that the MS returns to idle mode by sending PAGING REQUEST. The MS is brought into group receive mode. The MS is requested to stop VGCS/VBS listening by MMI action. It is checked that the MS returns to idle mode. The MS is brought into group receive mode again. The SS stops downlink transmissions on VGCS/VBS downlink channel. It is checked that the MS returns to idle mode after $T_{no\ channel}$ times out (3 s after the SS stops downlink transmission).

Maximum Duration of Test

5 minutes.

Expected Sequence

Step	Direction	Message	Comments
0	MS		the MS is in group receive mode.
1	SS -> MS	CHANNEL RELEASE	UI format.
2	SS		wait 5s.
3	SS -> MS	PAGING REQUEST TYPE 1	"Mobile Identity" IE contains the TMSI allocated to the MS.
4	MS -> SS	CHANNEL REQUEST	"Establishment Cause" = Answer to paging.
5	SS -> MS	IMMEDIATE ASSIGNMENT REJECT	the first "request reference" corresponds to the CHANNEL REQUEST sent by the MS.
6	SS		wait 5s.
7	SS -> MS	NOTIFICATION/NCH	with group call channel description and the call reference active in the MS. The call reference is different from that used in step 0.
8	MS		MMI action to join the VGCS/VBS call.
9	MS		MMI action to stop the VGCS/VBS listening.
10	SS		wait 5s..
11	SS -> MS	PAGING REQUEST TYPE 1	"Mobile Identity" IE contains the TMSI allocated to the MS.
12	MS -> SS	CHANNEL REQUEST	"Establishment Cause" = Answer to paging.
13	SS -> MS	IMMEDIATE ASSIGNMENT REJECT	the first "request reference" corresponds to the CHANNEL REQUEST sent by the MS.
14	SS		wait 5s.
15	SS -> MS	NOTIFICATION/NCH	with group call channel description and the call reference active in the MS. The call reference is different from that used in step 0 and 3.
16	MS		MMI action to join the VGCS/VBS call.
17	SS		stop the VGCS/VBS downlink transmissions and wait 4 s.
18	SS -> MS	PAGING REQUEST TYPE 1	"Mobile Identity" IE contains the TMSI allocated to the MS.
19	MS -> SS	CHANNEL REQUEST	"Establishment Cause" = Answer to paging.
20	SS -> MS	IMMEDIATE ASSIGNMENT REJECT	the first "request reference" corresponds to the CHANNEL REQUEST sent by the MS.

26.14.5.2 VGCS-VBS / Leaving group transmit mode

This test is applicable to the MS support VGCS talking.

26.14.5.2.1 Conformance requirement

In group transmit mode (VGCS):

1. If the uplink release is requested by the upper layer the mobile station shall send an UPLINK RELEASE message on the voice group call channel uplink, perform a release of the main signalling link and go back to group receive mode.
2. If the UPLINK RELEASE message is received from the network on the voice group call channel downlink, the MS shall perform a release of the main signalling link and go back to group receive mode.
3. The talking subscriber's mobile station which has lost the contact with the network shall return immediately to group receive mode.

Reference(s)

GSM 04.08 clause 3.4.13.4, 3.4.13.5.1

GSM 03.68 clause 4.2.2.2.

26.14.5.2.2 Test purpose

To verify that in group transmit mode (VGCS):

1. When uplink release is requested by the user the mobile station sends an UPLINK RELEASE message on the voice group call channel uplink, performs a release of the main signalling link and goes back to group receive mode.
2. When the UPLINK RELEASE message is received from the network on the voice group call channel downlink, the MS performs a release of the main signalling link and goes back to group receive mode.
3. When a radio link failure is detected by the MS the MS shall return to idle mode and, when possible, to group receive mode.

26.14.5.2.3 Method of test

Initial Conditions

System Simulator:

1 cell with default parameters for ASCI testing.

Mobile Station:

The MS is in group transmit mode.

Related PICS/PIXIT Statement(s)

Type of MS (GSM 450, GSM 480, P-, E-, R-GSM 900 or DCS 1800 or PCS 1900).

Support VGCS talking.

Way to configure VGCS.

Way to initiate VGCS talking.

Way to verify the downlink speech path.

Foreseen Final State of the MS

"Idle, updated", with TMSI allocated.

Test Procedure

The MS is in VGCS group transmit mode. The MS is requested to quit group transmit mode by MMI action. It is checked that the MS sends an UPLINK RELEASE message and goes to group receive mode. The MS is brought into group transmit mode. The SS sends UPLINK RELEASE message. It is checked that the MS returns to group receive mode. The MS is brought into group transmit mode again. The SS stops radio transmitting on SACCH. It is checked that the MS returns to group receive mode.

Maximum Duration of Test

5 minutes.

Expected Sequence

Step	Direction	Message	Comments
0	MS		The MS is in group transmit mode.
1	MS		MMI action to quit the VGCS transmit mode.
2	MS -> SS	UPLINK RELEASE	
3	MS		check that the TCH in downlink is through connected and there is no uplink transmission on that channel for 10 s.
8	SS -> MS	UPLINK FREE	
9	MS		MMI action to request access uplink.
10	MS -> SS	UPLINK ACCESS	
11	MS -> SS	UPLINK ACCESS	
12	SS -> MS	UPLINK BUSY	
13	SS -> MS	VGCS UPLINK GRANT	Reference to step 10
14	MS -> SS	TALKER INDICATION	L2: SABM / UA
15	MS		the MS is in group transmit mode for 5 s.
16	SS -> MS	UPLINK RELEASE	
17	MS		check that the TCH in downlink is through connected and there is no uplink transmission on that channel for 10 s.
20	SS -> MS	UPLINK FREE	
21	MS		MMI action to request access uplink.
22	MS -> SS	UPLINK ACCESS	
23	MS -> SS	UPLINK ACCESS	
24	SS -> MS	UPLINK BUSY	
25	SS -> MS	VGCS UPLINK GRANT	Reference to step 23
26	MS -> SS	TALKER INDICATION	L2: SABM / UA
27	MS		the MS is in group transmit mode for 5 s.
28	SS		deactivate downlink SACCH transmissions, but keep TCH active, wait until there is no more uplink SACCH frames received
29	MS		check that the TCH in downlink is through connected and there is no uplink transmission on that channel for 10 s.
30	SS -> MS	CHANNEL RELEASE	UI format

26.14.6 VGCS-VBS / GCC-BCC Procedures

26.14.6.1 VGCS-VBS / GCC-BCC Procedures / MO call establishment

26.14.6.1.1 Conformance requirement

1. The MS in idle updated mode shall initiate a VGCS/VBS call correctly using IMMEDIATE SETUP procedure if a priority level is requested by the user for which the user has the subscription and the fast call setup is enabled.
2. The MS in idle updated mode shall initiate a VGCS/VBS call correctly using SETUP procedure on request.
3. For VGCS call after establishment, the MS shall indicate to the user that an indication of the desire to speak should be made if he wants to speak. If this is not done within a certain time, the MS shall send an UPLINK RELEASE.

Reference(s)

GSM 04.68 clause 6.2.2.

GSM 04.69 clause 6.2.2.

GSM 03.68 clause 11.3.1.1.3.

26.14.6.1.2 Test purpose

To verify that in idle updated mode:

1. The MS initiates a VGCS/VBS call correctly using IMMEDIATE SETUP procedure if a priority level is requested by the user for which the user has the subscription and the fast call setup is enabled.
2. The MS initiates a VGCS/VBS call correctly using SETUP procedure on request.
3. After establishment of VGCS call, the MS indicates that an user action is required if he wants to speak. If such user action is not made within a certain time, the MS sends an UPLINK RELEASE.

26.14.6.1.3 Method of test

Initial Conditions

System Simulator:

1 cell with default parameters for ASCII testing.

Mobile Station:

The MS is in MM-state "idle, updated" with a TMSI allocated.

Related PICS/PIXIT Statement(s)

Type of MS (GSM 450, GSM 480, P-, E-, R-GSM 900 or DCS 1800 or PCS 1900).

Support VGCS originating.

Support VBS originating.

Way to configure VGCS or VBS.

Way to initiate a VGCS/VBS call.

Way to select the immediate set-up or the normal set-up

Way to verify the downlink speech path.

Way to indicate the desire of speaking.

The allowed duration between an indication of a required user action for speaking and an action performed by user.

Foreseen Final State of the MS

"Idle, updated", with TMSI allocated.

Test Procedure

The MS is in MM-state "idle, updated". The MS is requested to initiate a VGCS or VBS call using immediate setup procedure by selecting the subscribed priority '0' with the appropriate MMI action. The field EF_{eMLPP} associates to the subscribed priority '0' the fast-call setup subscription. It is checked that the MS performs correctly the immediate setup procedure. The call is terminated. The MS is requested to initiate a VGCS or VBS call using setup procedure by selecting the priority '4' with the appropriate MMI action. It is checked that the MS performs correctly the setup procedure. The call is cleared.

Maximum Duration of Test

5 minutes.

Expected Sequence

Steps 0 to 18 are executed if MS supports eMLPP.

Step	Direction	Message	Comments
0	MS		The MS is in idle updated state.
1	MS		MMI action to select a priority level 0 and MMI action to initiate VGCS/VBS call with immediate setup.
2	MS -> SS	CHANNEL REQUEST	
3	SS -> MS	IMMEDIATE ASSIGNMENT	TCH/F, single RF channel GSM 450: 275, GSM 480: 322, GSM 900: 50, DCS 1800: 750 PCS 1900: 650 L2: SABM / UA
4	MS -> SS	IMMEDIATE SETUP	
5	SS -> MS	AUTHENTICATION REQUEST	
6	MS -> SS	AUTHENTICATION RESPONSE	
7	SS -> MS	CIPHERING MODE COMMAND	no ciphering
8	MS -> SS	CIPHERING MODE COMPLETE	
9	SS -> MS	CHANNEL MODE MODIFY	very early assignment
10	MS -> SS	CHANNEL MODE MODIFY ACKNOWLEDGE	
11	SS -> MS	CONNECT	verify that the TCH is through connected
12	SS -> MS	GET STATUS	
13	MS -> SS	STATUS	check that the MS is in state U2sr (for VGCS) or U2 (for VBS).
A14	MS		for VGCS call check that the MS indicates a user action needed for a desire of speaking.
A15	MS		user does not answer the indication.
A16	MS -> SS	UPLINK RELEASE	
A17	SS -> MS	UPLINK FREE	
A18	SS -> MS	CHANNEL RELEASE	UI format
B14	SS -> MS	TERMINATION	for VBS call terminate the call.
B15	SS -> MS	CHANNEL RELEASE	The MS releases L2 multiple frame link L2:DISC/UA.
20	MS		MMI action to initiate VGCS/VBS call with setup by selecting the priority '4'.
21	MS -> SS	CHANNEL REQUEST	
22	SS -> MS	IMMEDIATE ASSIGNMENT	TCH/F, single RF channel GSM 450: 275, GSM 480: 322, GSM 900: 50, DCS 1800: 750 PCS 1900: 650 L2: SABM / UA
23	MS -> SS	CM SERVICE REQUEST	
24	SS -> MS	AUTHENTICATION REQUEST	
25	MS -> SS	AUTHENTICATION RESPONSE	
26	SS -> MS	CIPHERING MODE COMMAND	no ciphering
27	MS -> SS	CIPHERING MODE COMPLETE	
28	MS -> SS	SETUP	
29	SS -> MS	CHANNEL MODE MODIFY	very early assignment
30	MS -> SS	CHANNEL MODE MODIFY ACKNOWLEDGE	
31	SS -> MS	CONNECT	verify that the TCH is through connected
A32	MS		only for VGCS call check that the MS indicates a user action needed for a desire of speaking. An user action for speaking.
35	SS -> MS	GET STATUS	
36	MS -> SS	STATUS	check that the MS is in state U2sr (for VGCS) or U2 (for VBS).
37	SS -> MS	TERMINATION	terminate the call.
38	SS -> MS	CHANNEL RELEASE	The MS releases L2 multiple frame link L2:DISC/UA.

26.14.6.2 VGCS-VBS / GCC-BCC Procedures / Transaction Identifier

26.14.6.2.1 Conformance requirement

The originator of the GCC or BCC transaction shall choose the Transaction Identifier (TI).

When the MS (not originator) goes to group transmit mode, it may only send GCC or BCC messages when it has received a GCC or BCC message from network, it shall use the TI value which has been used in the messages from network.

Reference(s)

GSM 04.07 clause 11.2.3.1.3.

GSM 04.68 clause 5.

GSM 04.69 clause 5.

26.14.6.2.2 Test purpose

To verify that The originator of the GCC or BCC transaction chooses the Transaction Identifier (TI).

1. To verify that when the MS (not originator) goes to group transmit mode, if the MS sends GCC or BCC message to network to respond to messages from network, it uses the TI value which is used in the messages received from network.

26.14.6.2.3 Method of test

Initial Conditions

System Simulator:

1 cell with default parameters for ASCII testing.

Mobile Station:

The MS is in MM-state "idle, updated" with a TMSI allocated.

Related PICS/PIXIT Statement(s)

Type of MS (GSM 450, GSM 480, P-, E-, R-GSM 900 or DCS 1800 or PCS 1900).

Support VGCS talking.

Support VBS originating.

Way to configure VGCS or VBS.

Way to accept a group call.

Way to request uplink access.

Way to select the immediate set-up or the normal set-up

Way to initiate VBS call.

Foreseen Final State of the MS

MM idle updated state.

Test Procedure

If the MS supports only VBS, the MS is requested to initiate a VBS call using setup procedure by MMI action. In the BROADCAST CALL ACTIVE (U2) state, it is checked that the MS uses correct TI in the STATUS message to respond to the GET STATUS message.

If the MS supports VGCS, the MS is brought into group transmit mode. In the SEND and RECEIVE state (U2sr), it is checked that the MS uses correct TI in the STATUS message to respond to the GET STATUS message.

Maximum Duration of Test

5 minutes.

Expected Sequence

Step	Direction	Message	Comments
0	MS		If the MS supports VBS originating, step 0 to step 13 are executed. the MS is in idle mode MMI action to initiate VBS call with setup procedure.
1	MS		
2	MS -> SS	CHANNEL REQUEST	
3	SS -> MS	IMMEDIATE ASSIGNMENT	TCH/F, single RF channel GSM 450: 275, GSM 480: 322, GSM 900: 50, DCS 1800: 750 PCS 1900: 650 L2: SABM / UA
4	MS -> SS	CM SERVICE REQUEST	check that the flag of the TI is set to '0'B, and the value of the TI is within '000'B to '110'B.
5	SS -> MS	CM SERVICE ACCEPT	
6	MS -> SS	SETUP	
7	SS -> MS	AUTHENTICATION REQUEST	
8	MS -> SS	AUTHENTICATION RESPONSE	
9	SS -> MS	CHANNEL MODE MODIFY	
10	MS -> SS	CHANNEL MODE MODIFY ACKNOWLEDGE	TI= the TI in step 6 with the flag='1'B. TI value is the same as that in step 10 with flag='0'B.
11	SS -> MS	CONNECT	
10	SS -> MS	GET STATUS	
11	MS -> SS	STATUS	
12	SS -> MS	TERMINATION	The MS releases L2 multiple frame link L2:DISC/UA.
13	SS -> MS	CHANNEL RELEASE	
15	MS		If the MS supports VGCS talking, the following steps are performed. the MS is in group transmit mode (VGCS), but is not the originator of the call.
16	SS -> MS	GET STATUS	TI="0001". TI is set to "1001".
17	MS -> SS	STATUS	
18	SS -> MS	UPLINK RELEASE	UI format.
19	SS -> MS	CHANNEL RELEASE	

26.14.6.3 VGCS-VBS / GCC-BCC Procedures / Call Termination / originator / group transmit mode

This test case is applicable to the MS supporting VGCS/VBS originating.

26.14.6.3.1 Conformance requirement

When in group transmit mode, on request of upper layer, the MS which is the originator of the VGCS/VBS call shall initiate the termination procedure by sending a TERMINATION REQUEST message to its peer entity in the network

and setting timer T_{term} , entering state U5. The network accepts the termination or on T_{term} expiration, the MS returns to idle state.

Reference(s)

GSM 04.68 clause 6.4.1.

GSM 04.69 clause 6.4.1.

26.14.6.3.2 Test purpose

To verify that when in group transmit mode, on request of the user, the MS which is the originator of the VGCS/VBS call initiates the termination procedure by sending a TERMINATION REQUEST message to its peer entity in the network and setting timer T_{term} , entering state U5. If the termination is accepted or on T_{term} is expired, the MS returns to idle mode.

26.14.6.3.3 Method of test

Initial Conditions

System Simulator:

1 cell with default parameters for ASCII testing.

Mobile Station:

The MS is in MM-state "idle, updated" with a TMSI allocated.

Related PICS/PIXIT Statement(s)

Type of MS (GSM 450, GSM 480, P-, E-, R-GSM 900 or DCS 1800 or PCS 1900).

Support VGCS originating.

Support VBS originating.

Supported rates (full / half rate).

Way to configure VGCS or VBS.

Way to initiate VBS call.

Way to initiate VGCS call.

Way to select the immediate set-up or the normal set-up

Way to terminate VGCS/VBS call.

Foreseen Final State of the MS

MM idle, updated state.

Test Procedure

A VGCS/VBS call is established and the MS, as the originator, is brought into group transmit mode. The MS is requested to terminate the VGCS/VBS call by MMI action. It is checked that the MS sends TERMINATION REQUEST message and enters state U5.

For execution counter $k=1$, before T_{term} times out, the SS accepts the termination request, the call is terminated. For $k=2$, the SS does not respond to the termination request. It is checked that after T_{term} times out, the MS clears the context related to the group call and returns to idle mode.

Maximum Duration of Test

5 minutes.

Expected Sequence

The test sequence is executed for $k = 1, 2$.

Step	Direction	Message	Comments	
0	MS		the MS is in idle updated mode.	
1	MS		MMI action to initiate VGCS/VBS call using setup procedure.	
2	MS -> SS	CHANNEL REQUEST	TCH/F, single RF channel GSM 450: 275, GSM 480: 322, GSM 900: 50, DCS 1800: 750 PCS 1900: 650 L2: SABM / UA	
3	SS -> MS	IMMEDIATE ASSIGNMENT		
4	MS -> SS	CM SERVICE REQUEST		
5	SS -> MS	IDENTITY REQUEST	no ciphering	
6	MS -> SS	IDENTITY RESPONSE		
7	SS -> MS	CIPHERING MODE COMMAND		
8	MS -> SS	CIPHERING MODE COMPLETE		
9	MS -> SS	SETUP		
10	SS -> MS	CHANNEL MODE MODIFY		
11	MS -> SS	CHANNEL MODE MODIFY ACKNOWLEDGE		
12	SS -> MS	CONNECT		verify that the TCH is through connected
13	MS			MMI action to terminate the call.
14	MS -> SS	TERMINATION REQUEST		
A15	SS -> MS	TERMINATION		for $k = 1$ sent 8 s. from step 14, cause = protocol error, unspecified
A16	SS -> MS	CHANNEL RELEASE		The MS releases L2 multiple frame link L2:DISC/UA.
B15	SS		for $k = 2$	
B16	MS -> SS	UPLINK RELEASE	wait for T_{term} timeout (round 10s)	
B17	SS -> MS	CHANNEL RELEASE	received between 9 - 11 s. from step 14 - for VGCS only. UI format	
18	SS -> MS	NOTIFICATION/NCH	with a description of VGCS/VBS channel and a VGCS/VBS call reference active in the MS. check that the MS gives an indication containing the notified group call reference MMI action to join the VGCS/VBS call check that the TCH in downlink is through connected and there is no uplink transmission on that channel for 10 s. UI format	
19	MS			
20	MS			
21	MS			
22	SS -> MS	CHANNEL RELEASE		

26.14.6.4 VGCS-VBS / GCC-BCC Procedures / Call Termination / originator in group receive mode

This test case is applicable to the MS supporting VGCS originating.

26.14.6.4.1 Conformance requirement

When in group receive mode, on request of upper layer, the MS which is the originator of the VGCS call shall enter sub-state U2ws and ask RR to enter group transmit mode. As soon as $COMM = T$, it shall send a TERMINATION REQUEST message to its peer entity in the network, set timer T_{term} , and enter state U5. The network accepts the termination or on T_{term} expiration, the MS returns to idle mode.

Reference(s)

GSM 04.68 clause 6.4.1.

26.14.6.4.2 Test purpose

To verify that when in group receive mode, on request of the user, the MS which is the originator of the VGCS call enters sub-state U2ws and asks RR to enter group transmit mode. As soon as COMM = T, it sends a TERMINATION REQUEST message to its peer entity in the network, set timer T_{term} , and enters state U5. The network accepts the termination or on T_{term} expiration, the MS returns to idle mode.

26.14.6.4.3 Method of test

Initial Conditions

System Simulator:

1 cell with default parameters for ASCII testing.

Mobile Station:

The MS is in MM-state "idle, updated" with a TMSI allocated.

Related PICS/PIXIT Statement(s)

Type of MS (GSM 450, GSM 480, P-, E-, R-GSM 900 or DCS 1800 or PCS 1900).

Support VGCS originating.

Supported rates (full / half rate).

Way to configure VGCS.

Way to initiate a VGCS call.

Way to select the immediate set-up or the normal set-up

Way to terminate a VGCS call.

Foreseen Final State of the MS

MM idle, updated state.

Test Procedure

The MS originates a VGCS call and is brought into group receive mode. The MS is requested to terminate the VGCS call by MMI action. It is checked that the MS firstly enters group transmit mode and then sends TERMINATION REQUEST message, enters state U5.

For $k = 1$, the SS accepts the request, the call is terminated. For $k = 2$, the SS does not respond to the request. It is checked that after T_{term} timeout the MS aborts the call.

Maximum Duration of Test

5 minutes.

Expected Sequence

The test sequence is executed for k = 1, 2.

Step	Direction	Message	Comments
0	MS		the MS is in idle updated mode.
1	MS		MMI action to initiate VGCS call using setup procedure.
2	MS -> SS	CHANNEL REQUEST	
3	SS -> MS	IMMEDIATE ASSIGNMENT	
4	MS -> SS	CM SERVICE REQUEST	VGC establishment, L2: SABM / UA
5	SS -> MS	CIPHERING MODE COMMAND	no ciphering
6	MS -> SS	CIPHERING MODE COMPLETE	
7	MS -> SS	SETUP	
8	SS -> MS	AUTHENTICATION REQUEST	
9	MS -> SS	AUTHENTICATION RESPONSE	
10	SS -> MS	ASSIGNMENT COMMAND	TCH/F, for k = 2 TCH/H if possible
11	MS -> SS	ASSIGNMENT COMPLETE	
12	SS -> MS	CONNECT	verify that the TCH is through connected
13	MS		MMI action to quit the VGCS transmit mode
14	MS -> SS	UPLINK RELEASE	check that the TCH in downlink is through connected and there is no uplink transmission on that channel for 10 s.
15	SS -> MS	UPLINK FREE	
17	MS		MMI action to terminate the call, a pending request
18	MS -> SS	UPLINK ACCESS	RR attempts to enter group transmit mode
19	MS -> SS	UPLINK ACCESS	
20	SS -> MS	UPLINK BUSY	
21	SS -> MS	VGCS UPLINK GRANT	Reference to step 19
22	MS -> SS	TALKER INDICATION	L2: SABM / UA
23	MS -> SS	TERMINATION REQUEST	
A25	SS -> MS	TERMINATION	for k = 1 sent 8 s. from step 23, cause = protocol error, unspecified
A26	SS -> MS	CHANNEL RELEASE	The MS releases L2 multiple frame link L2:DISC/UA.
B25	SS		for k = 2 wait for T _{term} timeout (round 10s)
B26	MS -> SS	UPLINK RELEASE	received 9 - 11 s. from step 23.
B27	SS -> MS	CHANNEL RELEASE	UI format
28	SS -> MS	NOTIFICATION/NCH	with a description of VGCS/VBS channel and a VGCS/VBS call reference active in the MS.
29	MS		check that the MS gives an indication containing the notified group call reference
30	MS		MMI action to join the VGCS/VBS call
31	MS		check that the TCH in downlink is through connected and there is no uplink transmission on that channel for 10 s.
32	SS -> MS	CHANNEL RELEASE	UI format

26.14.6.5 VGCS-VBS / GCC-BCC Procedures / Call Termination / not originator

26.14.6.5.1 Conformance requirement

If the MS is not the originator of the VGCS/VBS call, on request of upper layer, the MS shall not attempt to terminate the call.

Reference(s)

GSM 04.68, clause 6.4.1 (implicitly)

GSM 04.69, clause 6.4.1 (implicitly)

26.14.6.5.2 Test purpose

To verify that when the MS is not the originator of the VGCS/VBS call, on request of the user, the MS does not attempt to terminate the call.

26.14.6.5.3 Method of test

Initial Conditions

System Simulator:

1 cell with default parameters for ASCI testing.

Mobile Station:

The MS is in group receive mode (not originator).

Related PICS/PIXIT Statement(s)

Type of MS (GSM 450, GSM 480, P-, E-, R-GSM 900 or DCS 1800 or PCS 1900).

Support VGCS listening.

Support VBS listening.

Way to configure VGCS or VBS.

Way to join a VGCS/VBS call.

Way to terminate a call.

Foreseen Final State of the MS

MM-state idle, updated.

Test Procedure

The MS is brought into group receive mode (not originator). The MS is requested to terminate the call by MMI action. It is checked that the MS does not attempt the termination.

Maximum Duration of Test

2 minutes.

Expected Sequence

Step	Direction	Message	Comments
0	MS		the MS is in group receive mode (not the originator).
1	MS		MMI action to terminate the call.
2	SS		check that there is no transmission from the MS for 10 s.
3	SS -> MS	CHANNEL RELEASE	UI format

26.14.6.6 VGCS-VBS / GCC-BCC Procedures / GCC states

This test is performed if the MS supports VGCS talking.

26.14.6.6.1 Conformance requirement

1. The GCC entity of the MS performs transitions between (main) states. In main state GROUP CALL ACTIVE (U2) it performs transitions between sub-states. It has certain parameters and attributes, which it sets and

changes based on interaction with higher layer and lower layers and on message exchanges with its peer entity. These states and parameters shall be consistent as defined.

2. The mobile station in group transmit mode shall mute the downlink speech if SET STATUS message is received with DA bit set to 1. The mobile station shall no longer mute the downlink after receipt of a downlink SET STATUS message with a reset DA bit.

Reference(s)

GSM 04.68, clause 6.1.2.1, 6.1.2.1.1 - 6.1.2.1.11, 6.5.1.1, 8.4, 9.5.7.

26.14.6.6.2 Test purpose

1. To verify that the GCC states and parameters of the MS are consistent as defined.
2. To verify that the MS in group transmit mode mutes the downlink speech if downlink SET STATUS message is received setting DA bit. The mobile station no longer mutes the downlink speech after a SET STATUS message is received.

26.14.6.6.3 Method of test

Initial Conditions

System Simulator:

1 cell with default parameters for ASCI testing.

Mobile Station:

The MS is in MM-state "idle, updated" with a TMSI allocated.

Related PICS/PIXIT Statement(s)

Type of MS (GSM 450, GSM 480, P-, E-, R-GSM 900 or DCS 1800 or PCS 1900).

Support VGCS originating.

Support VGCS talking.

Support VGCS listening.

Way to configure VGCS.

Way to check downlink is muted or not.

Way to accept VGCS call.

Way to initiate VGCS call.

Foreseen Final State of the MS

MM-state Idle, updated.

Test Procedure

If the MS supports VGCS originating, it is requested to initiate a VGCS call. It is checked by getting status that the MS goes through different GCC states with correct parameters. If the MS supports VGCS talking but not VGCS originating, it is brought to group receive mode and then group transmit mode.

When MS is in group transmit mode the SS sends SET PARAMETER message The DA bit in state attributes is set to 0. It is checked that the downlink of the MS is muted. The SS sends SET PARAMETER message with DA bit set to 1. It is checked that the downlink of the MS is unmuted.

Similarly, it is checked that the MS goes through different GCC states with correct parameters.

Maximum Duration of Test

5 minutes.

Expected Sequence

If the MS supports VGCS originating, the step 1 to step 40 are performed.

Step	Direction	Message	Comments
0	MS		The MS is in idle mode.
1	MS		MMI action to initiate VGCS call
2	MS -> SS	CHANNEL REQUEST	TCH/F, single RF channel GSM 450: 275, GSM 480: 322, GSM 900: 50, DCS 1800: 750 PCS 1900: 650
3	SS -> MS	IMMEDIATE ASSIGNMENT	
4	MS -> SS	CM SERVICE REQUEST	
5	SS -> MS	CM SERVICE ACCEPT	VGC establishment, L2: SABM / UA
6	MS -> SS	SETUP	state U1, ORIG=T COMM=T D-ATT=F U-ATT=F
7	SS -> MS	GET STATUS	
8	MS -> SS	STATUS	
9	SS -> MS	CONNECT	state U2sl, ORIG=T COMM=T D-ATT=T U-ATT=T
10	SS -> MS	GET STATUS	
11	MS -> SS	STATUS	
12	SS -> MS	CHANNEL MODE MODIFY	state U2sr, ORIG=T COMM=T D-ATT=T U-ATT=T
13	MS -> SS	CHANNEL MODE MODIFY ACKNOWLEDGE	
14	SS -> MS	GET STATUS	
15	MS -> SS	STATUS	state U2sr, ORIG=T COMM=T D-ATT=T U-ATT=T the MS asks to indicate the desire of speaking. MMI action to indicate desire of talking. the MS in group talking mode for 5 s.
16	MS		
17	MS		
18	SS -> MS	SET PARAMETER	DA = '0'B check that the downlink is muted DA = '1'B check that the downlink is not muted
19	MS		
20	SS -> MS	SET PARAMETER	
21	MS		
22	MS		MMI action to quit group talking
23	MS -> SS	UPLINK RELEASE	MMI action to request uplink access
24	SS -> MS	UPLINK FREE	
25	MS		
26	MS -> SS	UPLINK ACCESS	Reference to step 28 L2: SABM / UA
27	MS -> SS	UPLINK ACCESS	
28	SS -> MS	UPLINK BUSY	
29	SS -> MS	VGCS UPLINK GRANT	state U2sr, ORIG=T COMM=T D-ATT=T U-ATT=T
30	MS -> SS	TALKER INDICATION	
31	SS -> MS	GET STATUS	
32	MS -> SS	STATUS	
33	MS		MMI action to terminate the VGCS call
34	MS -> SS	TERMINATION REQUEST	state U5, ORIG=T COMM=T D-ATT=T U-ATT=T
35	SS -> MS	GET STATUS	
36	MS -> SS	STATUS	
37	SS -> MS	TERMINATION	The MS releases L2 multiple frame link L2:DISC/UA.
38	SS -> MS	CHANNEL RELEASE	
			The MS is in idle mode.

Step	Direction	Message	Comments	
39	SS -> MS	NOTIFICATON/NCH	with VGCS call reference active in the MS, but without VGCS channel description MMI action to join the VGCS call	
40	MS			
41	MS -> SS	CHANNEL REQUEST		
42	SS -> MS	IMMEDIATE ASSIGNMENT		
43	MS -> SS	NOTIFICATION RESPONSE		
44	SS -> MS	GET STATUS		
45	MS -> SS	STATUS	state U2wr, ORIG=F COMM=T D-ATT=F U-ATT=F I format, with group channel description. The MS releases L2 multiple frame link L2:DISC/UA.	
46	SS -> MS	CHANNEL RELEASE		
47	SS -> MS	UPLINK FREE	MMI action to request uplink access	
48	MS			
49	MS -> SS	UPLINK ACCESS		
50	MS -> SS	UPLINK ACCESS		
51	SS -> MS	UPLINK BUSY		
52	SS -> MS	VGCS UPLINK GRANT		
53	MS -> SS	TALKER INDICATION		
54	SS -> MS	GET STATUS		
55	MS -> SS	STATUS		
56	SS -> MS	UPLINK RELEASE		
57	SS -> MS	CHANNEL RELEASE		
				UI format, the MS returns to idle updated. The MS releases L2 multiple frame link L2:DISC/UA.

26.14.6.7 VGCS-VBS / GCC-BCC Procedures / BCC states

This test is applicable to the MS supporting VBS originating.

26.14.6.7.1 Conformance requirement

The BCC entity of the MS performs transitions between states. It has certain parameters and attributes, which it sets and changes based on interaction with higher layer and lower layers and on message exchanges with its peer entity. These states and parameters shall be consistent as defined.

Reference(s)

GSM 04.69 clause 6.1.2.1 - 6.1.2.11, 6.5.1.1.

26.14.6.7.2 Test purpose

To verify that the BCC states and parameters of the MS are consistent as defined.

26.14.6.7.3 Method of test

Initial Conditions

System Simulator:

1 cell with default parameters for ASCI testing.

Mobile Station:

The MS is in MM-state "idle, updated" with a TMSI allocated.

Related PICS/PIXIT Statement(s)

Type of MS (GSM 450, GSM 480, P-, E-, R-GSM 900 or DCS 1800 or PCS 1900).

Support VBS originating.

Way to configure VBS.

Way to select the immediate set-up or the normal set-up

Way to initiate VBS call.

Foreseen Final State of the MS

MM-state Idle, updated.

Test Procedure

The MS is requested to initiate VBS call. Then it is checked by getting status procedure that the MS goes through different GCC states with correct parameters.

Maximum Duration of Test

5 minutes.

Expected Sequence

Step	Direction	Message	Comments
0	MS		The MS is in idle mode.
1	MS		MMI action to initiate VBS call
2	MS -> SS	CHANNEL REQUEST	
3	SS -> MS	IMMEDIATE ASSIGNMENT	TCH/F, single RF channel GSM 450: 275, GSM 480: 322, GSM 900: 50, DCS 1800: 750 PCS 1900: 650
4	MS -> SS	CM SERVICE REQUEST	VBC establishment, L2: SABM / UA
5	SS -> MS	GET STATUS	
6	MS -> SS	STATUS	state U0.p, ORIG=T COMM=F D-ATT=F U-ATT=F
7	SS -> MS	CM SERVICE ACCEPT	
8	MS -> SS	SETUP	
9	SS -> MS	GET STATUS	
10	MS -> SS	STATUS	state U1, ORIG=T COMM=T D-ATT=F U-ATT=F
11	SS -> MS	CONNECT	
12	SS -> MS	GET STATUS	
13	MS -> SS	STATUS	state U2, ORIG=T COMM=T D-ATT=T U-ATT=T
14	SS -> MS	CHANNEL MODE MODIFY	
15	MS -> SS	CHANNEL MODE MODIFY ACKNOWLEDGE	
16	MS		MMI action to terminate VBS call
17	MS -> SS	TERMINATION REQUEST	
18	SS -> MS	GET STATUS	
19	MS -> SS	STATUS	state U5, ORIG=T COMM=T D-ATT=T U-ATT=T
20	SS -> MS	TERMINATION	
21	SS -> MS	CHANNEL RELEASE	The MS releases L2 multiple frame link L2:DISC/UA.

26.14.7 VGCS-VBS / Error Handling

26.14.7.1 VGCS-VBS / Error Handling / short message length, unknown message type and TI

This test is applicable to the MS supporting VGCS/VBS originating.

26.14.7.1.1 Conformance requirement

1. Whenever a message is received specifying a transaction identifier which is not recognised as relating to an active transaction, if COMM = T, the MS shall send a STATUS message with cause #81 "invalid transaction identifier value" using the received transaction identifier value and including, if possible, as diagnostics the complete message received (this may not be possible, e.g., due to length restrictions). and remain idle.

2. If COMM = T, the MS shall answer to a message received with TI value "111" by sending a STATUS message with same TI value, cause "invalid transaction identifier value", and including, if possible, as diagnostics the complete message received (this may not be possible, e.g., due to length restrictions).
3. When a message is received that is too short to contain a complete message type information element, that message shall be ignored.
4. If the GCC or BCC in the MS receives a message with message type not defined for the PD or not implemented by the receiver, the MS shall ignore the message except for the fact that, if COMM = T, it shall return a STATUS message with cause "message type non-existent or not implemented" and including as diagnostics the message type of the message received.
5. If the GCC or BCC in the MS receives a message not compatible with the protocol state, the MS shall ignore the message except for the fact that, if COMM = T, it shall return a STATUS message with cause "message type not compatible with protocol state" and including as diagnostic the message type of the message received.
6. When a message with semantically incorrect contents is received, the foreseen reaction of the procedural part are performed. If however no such reactions are specified, the MS shall ignore the message except for the fact that, if COMM = T, it returns a STATUS message with cause value "semantically incorrect message" and including, if possible, as diagnostics the complete message received (this may not be possible).

Reference(s)

GSM 04.68 clause 7.2, 7.3, 7.4, 7.8.

GSM 04.69 clause 7.2, 7.3, 7.4, 7.8.

26.14.7.1.2 Test purpose

To verify that:

1. Whenever a message is received specifying a transaction identifier which is not recognised as relating to an active transaction, if COMM = T, the MS sends a STATUS message with cause #81 "invalid transaction identifier value" using the received transaction identifier value and including, if possible, as diagnostics the complete message received (this may not be possible, e.g., due to length restrictions).
2. If COMM = T, the MS answers to a message received with TI value "111" by sending a STATUS message with same TI value, cause "invalid transaction identifier value", and including, if possible, as diagnostics the complete message received (this may not be possible, e.g., due to length restrictions).
3. When a message is received that is too short to contain a complete message type information element, that message is ignored.
4. If the GCC or BCC in the MS receives a message with message type not defined for the PD or not implemented by the receiver, the MS ignores the message. In addition, if COMM = T, it returns a STATUS message with cause "message type non-existent or not implemented" and including as diagnostics the message type of the message received.
5. If the GCC or BCC in the MS receives a message not compatible with the protocol state, the MS ignores the message. In addition, if COMM = T, it returns a STATUS message with cause "message type not compatible with protocol state" and including as diagnostic the message type of the message received.
6. When a message containing semantically incorrect contents is received and no reactions are specified in the procedural part, the MS ignores the message. In addition, if COMM = T, the MS returns a STATUS message with cause value "semantically incorrect message" and as diagnostics, including the complete message received, if possible (this may not be possible).

26.14.7.1.3 Method of test

Initial Conditions

System Simulator

1 cell with default parameters for ASCII testing.

Mobile Station:

The MS is in MM-state "idle, updated" with a TMSI allocated.

Related PICS/PIXIT Statement(s)

Type of MS (GSM 450, GSM 480, P-, E-, R-GSM 900 or DCS 1800 or PCS 1900).

Support VGCS originating.

Support VGCS talking.

Support VBS originating.

Foreseen Final State of the MS

MM-state "Idle, updated".

Test Procedure

If the MS supports VGCS/VBS originating, the test starts from step 1, otherwise if the MS supports VGCS talking the test starts from step 30. If the MS supports VBS originating but no VGCS originating nor VGCS talking, the test stops on step 24.

The MS is requested to initiate a VGCS/VBS call with setup procedure. After the MS sends SETUP message, the SS sends incorrect CONNECT messages which contains incorrect TI flag or incorrect TI value or TI value set to '111'B. It is checked that the MS ignores these messages and responds with STATUS messages containing cause #81. The SS sends a message which is too short to contain a complete message. It is checked that the MS ignores this short message. Finally the SS sends a undefined message, a message not compatible with current protocol state and a message semantically incorrect. It is checked that the MS ignores these messages and returns STATUS messages containing cause #97, #98, #95 respectively. The following steps is applicable to the MS supporting VGCS talking. The MS is brought into group transmit mode. The SS sends GET STATUS message with TI='1001'B, the MS responds with STATUS message containing state U2sr, then the SS sends GET STATUS messages containing TI= '1111'B or '1010'B. It is checked that the MS ignores these messages and responds with STATUS messages containing cause #81.

Maximum Duration of Test

5 minutes.

Expected Sequence

The step 30 -46 are performed if the MS supports VGCS.

Step	Direction	Message	Comments
0	MS		The MS is in idle mode.
1	MS		MMI action to initiate VGCS/VBS call using setup procedure.
2	MS -> SS	CHANNEL REQUEST	
3	SS -> MS	IMMEDIATE ASSIGNMENT	a TCH/FS
4	MS -> SS	CM SERVICE REQUEST	L2: SABM / UA
5	SS -> MS	CM SERVICE ACCEPT	
6	MS -> SS	SETUP	
7	SS -> MS	CONNECT	flag of TI set to '0'B, value of TI is the same as that of SETUP message in step 6.
8	MS -> SS	STATUS	cause #81, "invalid transaction id value".
9	SS -> MS	CONNECT	flag of TI set to '1'B, value of TI is different from that of SETUP message in step 6.
10	MS -> SS	STATUS	cause #81, value of TI is that of step 9.
11	SS -> MS	CONNECT	value of TI set to '111'B.
12	MS -> SS	STATUS	cause #81, value of TI is '111'B
13	SS -> MS	CONNECT	too short message without Call Reference and Originator Indication.
14	SS -> MS	GET STATUS	
15	MS -> SS	STATUS	state U1 ORIG=T COMM=T D-ATT=F U-ATT=F.
16	SS -> MS	UNDEF MESSAGE TYPE	
17	MS -> SS	STATUS	see specific message contents cause #97, "message type non-existent or not implemented".
18	SS -> MS	TERMINATION REJECT	
19	MS -> SS	STATUS	cause #98, "message type not compatible with the protocol state".
20	SS -> MS	CONNECT	value of Originator Indication set to not originator
21	MS -> SS	STATUS	cause #95, "Semantically incorrect message".
22	SS -> MS	TERMINATION	
23	SS -> MS	CHANNEL RELEASE	The MS releases L2 multiple frame link L2:DISC/UA.
30	SS -> MS	NITIFICATION/NCH	with a description of VGCS channel and a VGCS call reference active in the MS
31	MS		MMI action to join the call
32	SS -> MS	UPLINK FREE	
33	MS		MMI action to request to access uplink
34	MS -> SS	UPLINK ACCESS	
35	MS -> SS	UPLINK ACCESS	
36	SS -> MS	UPLINK BUSY	
37	SS -> MS	VGCS UPLINK GRANT	Reference to step 34
38	MS -> SS	TALKER INDICATION	L2: SABM / UA
39	SS -> MS	GET STATUS	TI = '1001'B, GCC of the MS will take this value as the TI of the group call
40	MS -> SS	STATUS	state U2sr
41	SS -> MS	GET STATUS	TI='1111'B
42	MS -> SS	STATUS	cause #81, value of TI is '111'B
43	SS -> MS	GET STATUS	TI='1010'B
44	MS -> SS	STATUS	cause #81, value of TI is '010'B
45	SS -> MS	UPLINK RELEASE	
46	SS -> MS	CHANNEL RELEASE	UI format

Specific message contents:

UNDEF MESSAGE TYPE

Information Element	value/remark
Protocol Discriminator	'0000'B if the test is for VGCS; '0001'B if the test is for VBS.
Message Type	'0x110111'B
Group call reference	PICS/PIXIT
Originator indication	Originator
Spare half octet	

26.14.7.2 VGCS-VBS / Error Handling / incorrect information elements

The test case is applicable to the MS supporting VGCS/VBS listening.

26.14.7.2.1 Conformance requirement

1. When on receipt of a message containing “imperative message part” error or “missing mandatory IE” error or syntactically incorrect mandatory IE’s or unknown IE’s encoded as “comprehension required” or out of sequence IE’s encoded as “comprehension required”, the MS shall ignore the message except for the fact that, if COMM = T, it shall return a STATUS message with cause “invalid mandatory information” and including, if possible, as diagnostics the complete message received.
2. The GCC or BCC in the MS shall ignore all unknown information elements not encoded as “comprehension required” in the non-imperative part.
3. The GCC or BCC in the MS shall ignore all out of sequence information elements not encoded as “comprehension required” in the non-imperative part.
4. The GCC or BCC in the MS shall ignore all syntactically incorrect optional information elements in the non-imperative part.
5. If an information element with format T, TV, or TLV is repeated in a message in which repetition of the information element is not specified, only the contents of the information element appearing first shall be handled and all subsequent repetitions of the information element shall be ignored. When repetition of information elements is specified, only the contents of specified repeated information elements shall be handled. If the limit on repetition of information elements is exceeded, the contents of information elements appearing first up to the limit of repetitions shall be handled and all subsequent repetitions of the information element shall be ignored.

Reference(s)

GSM 04.68 clause 7.5, 7.6, 7.7.

GSM 04.69 clause 7.5, 7.6, 7.7.

26.14.7.2.2 Test purpose

To verify that:

1. On receipt of a message containing “imperative message part” error or “missing mandatory IE” error or syntactically incorrect mandatory IE’s or unknown IE’s encoded as “comprehension required” or out of sequence IE’s encoded as “comprehension required”, the MS ignores the message. In addition, if COMM = T, the MS returns a STATUS message with cause “invalid mandatory information” and including, if possible, as diagnostics the complete message received.
2. The MS ignores unknown information elements not encoded as “comprehension required” in the non-imperative part.
3. The MS ignores out of sequence information elements not encoded as “comprehension required” in the non-imperative part.

4. The MS ignores syntactically incorrect optional information elements in the non-imperative part.
5. The MS ignores subsequent repetition of the information element for which repetition is not specified, only the contents of the information element appearing first are handled. For specified repeated information element, the MS ignores all subsequent repetitions of the information element beyond the limit on repetition, only the contents of information element appearing first up to the limit of repetitions are handled.

26.14.7.2.3 Method of test

Initial Conditions

System Simulator:

1 cell with default parameters for ASCII testing.

Mobile Station:

The MS is in MM-state "idle, updated" with a TMSI allocated.

Related PICS/PIXIT Statement(s)

Type of MS (GSM 450, GSM 480, P-, E-, R-GSM 900 or DCS 1800 or PCS 1900).

Support VGCS originating.

Support VGCS talking.

Support VGCS listening.

Support VBS originating.

Support VBS listening.

Foreseen Final State of the MS

MM-state "Idle, updated".

Test Procedure

The MS is in idle updated mode. The SS sends NOTIFICATION/NCH messages with incorrect mandatory IE (skip='0001'B) or with comprehension required IE. It is checked that the MS ignores these NOTIFICATION/NCH messages. The SS sends NOTIFICATION/NCH containing unknown IE not encoded as comprehension required in non-imperative part. It is checked that the MS ignores the unknown IE and accepts the NOTIFICATION/NCH message. If the MS supports VGCS/VBS listening only, the test stops here.

If the MS supports VGCS talking the test continues on step 7. The MS joins the call. The SS sends correct UPLINK BUSY message then sends UPLINK FREE message containing incorrect mandatory IE. It is checked that the UPLINK FREE message is ignored by the MS. The SS sends correct UPLINK FREE message and the MS is requested to access the uplink. During the uplink access procedure it is checked that the MS ignores the VGCS UPLINK GRANT message in which mandatory IE is missing. After the MS enters group transmit mode, it is brought back to idle updated mode. The test stops here if the MS supports VGCS talking but not VGCS originating.

If the MS supports VGCS/VBS originating the test proceeds on step 30. The MS is requested to originate a VGCS call. During the call establishment it is checked that the MS ignores the CONNECT messages that missing mandatory IE or containing unknown IE encoded as comprehension required, and that the MS ignores unknown IE which is in non-imperative part and is not encoded as comprehension required, it is also checked that the MS ignores subsequent repetition of the information element for which repetition is not specified.

Maximum Duration of Test

5 minutes.

Expected Sequence

The test steps 7 - 29 are performed if the MS supports VGCS talking. The test steps 30 - 56 are performed if the MS supports VGCS/VBS originating.

Step	Direction	Message	Comments
0	MS		The MS is in Idle updated mode.
1	SS -> MS	NOTIFICATION/NCH	skip = '0001'B, with VGCS/VBS channel description and call reference active in the MS
2	MS		check that the MS ignores the NOTIFICATION/NCH message in step 1. This is checked for 10 s.
3	SS -> MS	NOTIFICATION/NCH	containing comprehension required IE, see specific message contents
4	MS		check that the MS ignores the NOTIFICATION/NCH message in step 3. This is checked for 10 s
5	SS -> MS	NOTIFICATION/NCH	unknown IE not encoded as comprehension required, see specific message contents
6	MS		check that the MS indicates the notified call
7	MS		MMI action to join the notified VGCS call
8	SS -> MS	UPLINK BUSY	
9	SS -> MS	UPLINK FREE	message type = '11010'B, the MS shall ignore this message
10	MS		MMI action to request the uplink access
11	SS		check that there is no UPLINK ACCESS for 6 s.
12	SS -> MS	UPLINK FREE	as default
13	MS		MMI action to request the uplink access
14	MS -> SS	UPLINK ACCESS	
15	MS -> SS	UPLINK ACCESS	
16	SS -> MS	VGCS UPLINK GRANT	missing mandatory IE Timing Advance, request reference refers to step 14. The MS ignores VGCS UPLINK GRANT.
17	MS -> SS	UPLINK ACCESS	
18	MS -> SS	UPLINK ACCESS	
19	SS -> MS	VGCS UPLINK GRANT	request reference does not refer to steps 14, 15, 17, 18.
20	SS -> MS	UPLINK BUSY	
21	SS		check that there is no UPLINK ACCESS for 6 s
22	SS -> MS	UPLINK FREE	
23	MS		MMI action to request uplink access
24	MS -> SS	UPLINK ACCESS	
25	MS -> SS	UPLINK ACCESS	
26	SS -> MS	UPLINK BUSY	
27	SS -> MS	VGCS UPLINK GRANT	refer to the reference in step 25
28	MS -> SS	TALKER INDICATION	L2: SABM / UA
29	SS -> MS	CHANNEL RELEASE	The MS releases L2 multiple frame link L2:DISC/UA.
30	MS		MMI action to originate a VGCS/VBS call with setup
31	MS -> SS	CHANNEL REQUEST	
32	SS -> MS	IMMEDIATE ASSIGNMENT	TCH/F, single RF channel GSM 450: 275, GSM 480: 322, GSM 900: 50, DCS 1800: 750 PCS 1900: 650 L2: SABM / UA
33	MS -> SS	CM SERVICE REQUEST	
34	SS -> MS	CM SERVICE ACCEPT	
36	MS -> SS	SETUP	
37	SS -> MS	CHANNEL MODE MODIFY	
38	MS -> SS	CHANNEL MODE MODIFY ACKNOWLEDGE	
39	SS -> MS	CONNECT	missing mandatory IE: Group call reference
40	MS -> SS	STATUS	cause #96

Step	Direction	Message	Comments
41	SS -> MS	CONNECT	unknown IE encoded as comprehension required, see specific message contents cause #96 unknown IE in non-imperative part, see specific message contents state U1
42	MS -> SS	STATUS	
43	SS -> MS	GET STATUS	
44	MS -> SS	STATUS	
45	SS -> MS	CONNECT	
46	SS -> MS	GET STATUS	
A47	MS -> SS	STATUS	for VGCS test state U2sr check the MS asks to indicate the desire of speaking wait for time-out. duplicated IE, see specific message contents check that the MS does not respond state U2r
A48	MS		
A49	MS		
A50	MS -> SS	UPLINK RELEASE	
A51	SS -> MS	GET STATUS	
A52	SS		
A53	SS -> MS	GET STATUS	
A54	MS -> SS	STATUS	
B47	MS -> SS	STATUS	for VBS test state U2
55	SS -> MS	TERMINATOIN	The MS releases L2 multiple frame link L2:DISC/UA.
56	SS -> MS	CHANNEL RELEASE	

Specific message contents:

NOTIFICATION/NCH - in step 3

Information Element	value/remark
L2 Pseudo Length	'15'B
RR Protocol Discriminator	'0110'B
Skip Indicator	'0000'B
Message Type	'00100000'B
Comprehension required IEI	'00000000'B
- Length	1
- unrecognised IE contents	'xxxxxxx'B (arbitrary octet)
NT/N Rest Octets	As default

NOTIFICATION/NCH - in step 6

Information Element	value/remark
L2 Pseudo Length	'15'B
RR Protocol Discriminator	'0110'B
Skip Indicator	'0000'B
Message Type	'00100000'B
Unknown IEI	'11101001'B
- Length	1
- unrecognised IE contents	'xxxxxxx'B (arbitrary octet)
NT/N Rest Octets	As default

CONNECT - in step 41

Information Element	value/remark
Protocol Discriminator	'0000'B for GCC, '0001'B for BCC
Transaction identifier	depending on the context of the test
Message Type	'0x110011'B
Group call reference	PICS/PIXIT
Comprehension required IEI	'00000000'B
- Length	1
- unrecognised IE contents	'xxxxxxx'B (arbitrary octet)
Originator indication	Originator
Spare half octet	'0000'B

GET STATUS - in step 43

Information Element	value/remark
Protocol Discriminator	'0000'B for GCC, '0001'B for BCC
Transaction identifier	depending on the context of the test
Message Type	'0x111001'B
Mobile identity	PICS/PIXIT
Unknown IEI	'11101001'B
- Length	1
- unrecognised IE contents	'xxxxxxx'B (arbitrary octet)

GET STATUS - in step A51

Information Element	value/remark
GCC Protocol Discriminator	'0000'B
Transaction identifier	depending on the context of the test
Message Type	'0x111001'B
Mobile identity	not address the MS
Mobile identity	PICS/PIXIT

26.14.7.3 VGCS-VBS / Messages not addressing VGCS receive mode**26.14.7.3.1 Conformance requirement**

In group receive mode the MS shall ignore messages which are allowed in group receive mode but not sent in UI format on the VGCS or VBS channel downlink.

Mobile stations in group receive mode shall ignore all messages which are not sent in UI format or which are not related to the following procedures: channel mode modify, notification and paging information, uplink status messages, channel release message, information on channel restructuring.

Reference(s)

GSM 04.08 clause 3.4.15.1.2.

26.14.7.3.2 Test purpose

To verify that the MS in group receive mode ignores:

Messages which are applicable to group receive mode but not sent in UI format.

ASSIGNMENT COMMAND and HANDOVER COMMAND messages in which the target mode information element indicates "dedicated mode".

1. Messages which are not applicable to group receive mode.

26.14.7.3.3 Method of test

Initial Conditions

System Simulator:

1 cell with default parameters for ASCI testing.

Mobile Station:

The MS is in MM-state "idle, updated" with a TMSI allocated.

Related PICS/PIXIT Statement(s)

Type of MS (GSM 450, GSM 480, P-, E-, R-GSM 900 or DCS 1800 or PCS 1900).

Support VGCS listening.

Support VBS listening.

Way to configure VGCS or VBS.

Way to indicate a call notification.

Way to accept a VGCS or VBS.

Way to verify the downlink speech path.

Foreseen Final State of the MS

"Idle, updated", with TMSI allocated.

Test Procedure

The MS is brought into group receive mode. The SS sends, in UI format, the messages which are not applicable to group receive mode. It is checked that the MS ignores these messages. The SS sends, in L2 I format, messages which are applicable to group receive mode. It is checked that the MS ignores these messages.

Maximum Duration of Test

5 minutes.

Expected Sequence

Step	Direction	Message	Comments
0	MS		The MS is in Idle updated mode.
1	SS -> MS	NOTIFICATION/NCH	
2	MS		MMI action to join VGCS/VBS call.
3	SS -> MS	IMMEDIATE ASSIGNMENT	UI format.
4	MS		check that the MS ignores the above message.
5	SS -> MS	IMMEDIATE ASSIGNMENT EXTENDED	UI format.
6	MS		check that the MS ignores the above message.
7	SS -> MS	CIPHERING MODE COMMAND	UI format.
8	MS		check that the MS ignores the above message.
9	SS -> MS	ASSIGNMENT COMMAND	sent in the L2 I format.
10	MS		check that the MS ignores the above message.
11	SS -> MS	HANDOVER COMMAND	sent in the L2 I format.
12	MS		check that the MS ignores the above message.
13	SS -> MS	FREQUENCY REDEFINITION	sent in the L2 I format.
14	MS		check that the MS ignores the above message.
15	SS -> MS	CHANNEL MODE MODIFY	sent in the L2 I format.
16	MS		check that the MS ignores the above message.
17	SS -> MS	CHANNEL RELEASE	I format
18	MS		check that the MS ignores the above message.
19	SS -> MS	CHANNEL RELEASE	UI format.

26.14.8 VGCS-VBS / Structured Procedures

The objective of this test group is to verify that the MS in the ASCI context performs certain elementary procedures of the RR, MM, and GCC/BCC protocol correctly within a structured procedure, especially when some channels use R-GSM frequencies with ARFCNs between 955 - 974.

26.14.8.1 VGCS-VBS / Structured Procedures / Very early and early assignment

This test is applicable to the MS supporting VGCS/VBS originating.

26.14.8.1.1 Conformance requirement

The mobile station initiates immediate assignment, service request, and contention resolution.

After sending the CIPHERING MODE COMPLETE message, the mobile station initiates call establishment by sending the SETUP message to the network.

The network allocates a traffic channel to the mobile station before it initiates call establishment in the fixed network.

The network assigns the traffic channel at the earliest possible moment, i.e. in the immediate assignment procedure. The mode of the traffic channel is changed from signalling only to the mode necessary for the call by means of the channel mode change procedure.

Reference(s)

GSM 04.08 clause 7.3.2.

26.14.8.1.2 Test purposes

1. To verify that the MS initiates immediate assignment, service request using the IMMEDIATE ASSIGNMENT or CM SERVICE REQUEST message, and contention resolution.
2. To verify that the MS after sending the CIPHERING MODE COMPLETE message, initiates call establishment by sending the SETUP message to the network.
3. To check that the MS performs correctly the early assignment procedure.
4. To check that the MS performs correctly the very early assignment procedure.

26.14.8.1.3 Method of test

Initial Conditions

System Simulator:

1 cell with default parameters for ASCII testing.

Mobile Station:

The MS is in MM-state "idle, updated" with a TMSI allocated.

Related PICS/PIXIT Statement(s)

Type of MS (GSM 450, GSM 480, P-, E-, R-GSM 900 or DCS 1800 or PCS 1900).

Support VGCS originating.

Support VBS originating.

Supported speech versions.

Way to configure a necessary radio channel rate.

Way to configure VGCS or VBS.

Way to select the immediate set-up or the normal set-up

Way to verify the downlink speech path.

Foreseen Final State of the MS

"Idle, updated", with TMSI allocated.

Test Procedure

The MS is requested to initiate a VGCS/VBS call using immediate setup procedure. The authentication and ciphering mode setting (to no ciphering) procedures are applied. The call is established by using early assignment procedure. For an R-band MS a carrier with ARFCN in the range of 955 - 974 is assigned for the traffic channel. The MS needs to be configured to use EFR codec for the test, if it supports EFR. The MS is requested to terminate the call

The MS is requested to initiate a VGCS/VBS call using setup procedure. The authentication and ciphering mode setting (to no ciphering) procedures are applied. The call is established by using assignment procedure. For an R-band MS a carrier with ARFCN in the range of 955 - 974 is assigned for the traffic channel. The MS needs to be configured to use half rate codec for the test, if it supports dual rate. The call is terminated.

Maximum Duration of Test

5 minutes.

Expected Sequence

Steps 0 to 20 are executed if MS supports eMLPP.

Step	Direction	Message	Comments
0	MS		The MS is in idle updated mode.
1	MS		MMI action to select a priority level 0 and MMI action to initiate VGCS /VBS call using immediate setup procedure.
2	MS -> SS	CHANNEL REQUEST	L2: SABM / UA
3	SS -> MS	IMMEDIATE ASSIGNMENT	
4	MS -> SS	IMMEDIATE SETUP	no ciphering
5	SS -> MS	AUTHENTICATION REQUEST	
6	MS -> SS	AUTHENTICATION RESPONSE	see specific message contents
7	SS -> MS	CIPHERING MODE COMMAND	
8	MS -> SS	CIPHERING MODE COMPLETE	verify that the TCH is through connected
9	SS -> MS	ASSIGNMENT COMMAND	
10	MS -> SS	ASSIGNMENT COMPLETE	MMI action to terminate the call
11	SS -> MS	CONNECT	
12	MS		cause = protocol error, unspecified
13	MS -> SS	TERMINATION REQUEST	
14	SS -> MS	TERMINATION	The MS releases L2 multiple frame link L2:DISC/UA.
15	SS -> MS	CHANNEL RELEASE	
21	MS		MMI action to initiate VGCS/VBS call with setup procedure.
22	MS -> SS	CHANNEL REQUEST	TCH/F needed
23	SS -> MS	IMMEDIATE ASSIGNMENT	L2: SABM / UA
24	MS -> SS	CM SERVICE REQUEST	
25	SS -> MS	AUTHENTICATION REQUEST	no ciphering
26	MS -> SS	AUTHENTICATION RESPONSE	
27	SS -> MS	CIPHERING MODE COMMAND	verify that the TCH is through connected
28	MS -> SS	CIPHERING MODE COMPLETE	
29	MS -> SS	SETUP	The MS releases L2 multiple frame link L2:DISC/UA.
30	SS -> MS	CHANNEL MODE MODIFY	
31	MS -> SS	CHANNEL MODE MODIFY ACKNOWLEDGE	
32	SS -> MS	CONNECT	
33	SS -> MS	TERMINATION	
34	SS -> MS	CHANNEL RELEASE	

Specific message contents:

Step 9

ASSIGNMENT COMMAND:

Channel Description - Channel Type and TDMA offset - Timeslot Number - Training Sequence Code - Hopping - ARFCN	TCH/F 7 3 Single RF Channel 957 if the MS supports R-GSM, otherwise chosen arbitrarily, but not BCCH
Power Command - Power level	Chosen arbitrarily but with a changed value.
Channel Mode	speech full rate or half rate version 2 if the MS supports EFR otherwise speech full rate or half rate version 1
Other IEs	Not present

Step 23

IMMEDIATE ASSIGNMENT:

Channel Description - Channel Type and TDMA offset - Timeslot Number - Training Sequence Code - Hopping - ARFCN	TCH/H if the MS supports dual rate, otherwise TCH/F 3 3 Single RF Channel 970, if the MS supporting R-band otherwise: GSM 450: 275, GSM 480: 322, GSM 900: 50 DCS 1800: 750 PCS 1900: 650
--	--

26.14.9 VGCS-VBS / Cell change

This sub-clause applies to mobile stations supporting VGCS/VBS listening.

26.14.9.1 VGCS-VBS / Cell Change / Same LA

26.14.9.1.1 Conformance requirement

After cell change within the same LA:

1. if no NCH is present on the new cell the MS shall leave group receive mode and go to idle mode;
2. if NCH is present on the new cell but the MS does not receive any notification message for the current group or broadcast call the MS shall leave group receive mode and go to idle mode;
3. if the MS receives a notification message for the current group or broadcast call with the related channel position and if the channel is found, the MS shall change to it and stay in group receive mode;
4. if the MS receives a notification message for the current group or broadcast call without information on the related channel position, the MS shall leave group receive mode, go to idle mode in order to establish a dedicated connection with the network to become informed on the related channel position.

Reference(s)

GSM 03.22 clause 5.2.3.

26.14.9.1.2 Test purpose

The MS was in group receive mode. After cell change within a same LA it is verified that:

1. if no NCH is present on the new cell the MS leaves group receive mode and enters idle mode;
2. if NCH is present on the new cell but there is no NOTIFICATION / NCH for the current group or broadcast call the MS leaves group receive mode and enters idle mode;
3. if the MS receives NOTIFICATION / NCH for the current group or broadcast call with the related channel position the MS changes onto the group channel and stays in group receive mode;
4. if the MS receives NOTIFICATION / NCH for the current group or broadcast call without information on the related channel position, the MS leaves group receive mode, enters idle mode and establishes a dedicated connection with the network to get the related channel position.

26.14.9.1.3 Method of test

26.14.9.1.3.1 Initial Conditions

Initial Conditions

System Simulator:

2 cells within a same LA: cell A and cell B, with default parameters for this clause except:

for k=1, no NCH on cell B;

for k=2, 3, 4, NCH present on cell B.

Mobile Station:

The MS is in MM-state "idle, updated" with a TMSI allocated. No automatic answering is configured.

Related PICS/PIXIT Statement(s)

Type of MS (GSM 450, GSM 480, P-, E-, R-GSM 900 or DCS 1800 or PCS 1900).

Support VGCS listening.

Support VBS listening.

Way to configure VGCS or VBS.

Way to verify the downlink speech path.

Foreseen Final State of the MS

"Idle, updated".

Test Procedure

The following test procedure is repeated for k=1, 2, 3, 4 and c=1, 2.

For c=1, the MS is brought into group receive mode on cell A. Start cell B without NCH (k=1), or with NCH but NOTIFICATON/NCH containing irrelevant group call references (k=2), or with NCH whilst NOTIFICATON/NCH containing the relevant group call reference and VGCS/VBS channel description (k=3), or with NCH whilst NOTIFICATON/NCH containing the relevant group call reference but no VGCS/VBS channel description (k=4). Lower the transmission levels of cell A so that C1 of cell A becomes less than zero. After the MS re-selects to the cell B it is checked that the MS returns to idle mode on cell B (for k=1, 2), or that the MS remains in group receive mode on cell B (for k=3, 4).

The same test procedure is repeated for c=2. Instead of lowering the power level of cell A, the SACCH transmission of cell A is stopped.

Maximum Duration of Test

10 min.

Expected Sequence

The test sequence is repeated for test counter k= 1, 2, 3, 4 and c=1, 2.

Step	Direction	Message	Comments
0	MS		the MS is brought into group receive mode on cell A.
1	SS		k=1, SI1 on cell B not indicating NCH position; k=2, 3, 4, SI1 on cell B indicating NCH position
A2 B2	SS -> MS	NOTIFICATION/NCH	k=1
C2	SS -> MS	NOTIFICATION/NCH	k=2, sent on cell B, containing an irrelevant group call reference.
D2	SS -> MS	NOTIFICATION/NCH	k=3, sent on cell B, containing the relevant group call reference and VGCS/VBS channel description.
			k=4, sent on cell B, with the relevant group call reference but no VGCS/VBS channel description.
3	SS		for c=1, the RF level of cell A is lowered until the MS re-selects cell B. for c=2, to stop downlink SACCH transmission of cell A. The following messages are sent and received on cell B.
A4, B4 A5, B5 A9, B9	SS -> MS MS -> SS SS -> MS	PAGING REQUEST TYPE 1 CHANNEL REQUEST IMMEDIATE ASSIGNMENT REJECT	k=1 or k=2, Wait 5s. until the MS is in idle mode on cell B. "Mobile Identity" IE contains the TMSI allocated to the MS. "Establishment Cause" = Answer to paging. the first "request reference" corresponds to the CHANNEL REQUEST sent by the MS.
C4	MS		k=3, Wait 5s. to ensure that the MS has enough time entering group receive mode on cell B. Check that the TCH in downlink is through connected and there is no uplink transmission on that channel for 10 s.
C9	SS -> MS	CHANNEL RELEASE	UI format, the MS returns to idle mode.
D4 D5 D6 D7	MS -> SS SS -> MS MS -> SS SS -> MS	CHANNEL REQUEST IMMEDIATE ASSIGNMENT NOTIFICATION REPOSENSE CHANNEL RELEASE	k=4, a TCH Respond to notification. I format, MS leaves the dedicated mode and changes onto VGCS/VBS channel.
D8	MS		Check that the TCH in downlink is through connected and there is no uplink transmission on that channel for 10 s.
D9	SS -> MS	CHANNEL RELEASE	UI format, the MS returns to idle state.
10	SS		For c=1, the RF level of cell A is increased to 63 dB μ V emf(), the RF level of cell B is lowered until the MS re-select cell A. For c=2, downlink SACCH on cell A is recovered. Wait 5s.
11	MS		Check that the TCH in downlink on cell A is through connected and there is no uplink transmission on that channel for 10 s.
12	SS		The RF level of cell B is increased to 53 dB μ V emf().

26.14.9.2 VGCS-VBS / Cell Change / Different LA

26.14.9.2.1 Conformance requirement

1. After a cell change the MS shall leave group receive mode and go to idle mode in order to establish a dedicated connection with the network to perform a location update if the cell belongs to a new LA.
2. If NCH is present on the new cell but the MS does not receive any notification message for the current group or broadcast call the MS shall leave group receive mode and go to idle mode;
3. If the MS receives a notification message for the current group or broadcast call with the related channel position and if the channel is found, the MS shall change to it and stay in group receive mode;
4. If the MS receives a notification message for the current group or broadcast call without information on the related channel position, the MS shall leave group receive mode, go to idle mode and in order to establish a dedicated connection with the network to become informed on the related channel position.
5. If a CHANNEL RELEASE is send to a mobile station which is in dedicated mode and which is involved in a voice group call or voice broadcast call, a group channel description may be included, describing the voice group call channel or voice broadcast channel to which the mobile station shall go after the channel release procedure.

Reference(s)

GSM 03.22 clause 5.2.3.

GSM 04.08 clause 9.1.7.1

26.14.9.2.2 Test purpose

In group receive mode it is verified that:

1. after a cell change to a different LA, the MS leaves group receive mode, enters idle mode and establishes a dedicated connection with the network to perform location updating;
2. after location updating, if NCH is present on the new cell but there is no NOTIFICATION / NCH for the current group or broadcast call the MS stays in idle mode;
3. after location updating, if the MS receives NOTIFICATION / NCH for the current group or broadcast call with the related channel position the MS changes to the group channel and stays in group receive mode;
4. after location updating, if the MS receives NOTIFICATION / NCH for the current group or broadcast call without information on the related channel position, the MS establishes a dedicated connection with the network to get the related channel position and then enters to group receive mode.
5. It is also tested, when a mobile, in dedicated mode and involved in a voice group or broadcast call, receives CHANNEL RELEASE including a group channel description channel the mobile station goes onto the channel after the channel release procedure.

26.14.9.2.3 Method of test

Initial Conditions

System Simulator:

2 cells with different LA within a same PLMN: cell A and cell B, with default parameters.

Mobile Station:

The MS is in MM-state "idle, updated" with a TMSI allocated on cell A. No automatic answering is configured.

Related PICS/PIXIT Statement(s)

Type of MS (GSM 450, GSM 480, P-, E-, R-GSM 900 or DCS 1800 or PCS 1900).

Support VGCS listening.

Support VBS listening.

Way to configure VGCS or VBS.

Way to verify the downlink speech path.

Mobile classmark supported

Foreseen Final State of the MS

"Idle, updated".

Test Procedure

The following test procedure is repeated for $k = 1, 2, 3$.

The MS is brought into group receive mode on cell A. Start cell B with NCH but NOTIFICATON/NCH containing irrelevant group call references ($k=1$), or with NOTIFICATON/NCH containing the relevant group call reference but no VGCS/VBS channel description ($k=2$), or with NOTIFICATON/NCH containing the relevant group call reference and VGCS/VBS channel description ($k=3$). Lower the transmission levels of cell A so that C1 of cell A becomes less than zero. The MS re-selects to the cell B. It is checked that the MS does location update on cell B. If it is succeeded the MS either remains in the idle mode (for $k=1$), or enters to group receive mode on cell B (for $k=2, 3$) without manual intervention.

Increase the power level of cell A to the default value and decrease the power level of cell B so that the MS re-selects the cell A. The MS attempts a location updating. The SS rejects it with cause #17 (network failure) to force the MS re-initiate location updating. The SS checks that the TCH in downlink is not connected before a location updated. The MS initiates again a new attempt for location updating, the SS accepts it, then the MS initiates a new group call and enters the group transmit mode, SS sends an UPLINK RELEASE message to bring MS to group receive mode. Then SS assigns a new group channel for it in the CHANNEL RELEASE message. It is checked that the MS enters group receive mode and the new TCH assigned in downlink is through connected.

Maximum Duration of Test

10 min.

Expected Sequence

Repeat the test sequence for test counter k= 1, 2, 3.

Step	Direction	Message	Comments
0	MS		the MS is brought into group receive mode on cell A.
A1	SS -> MS	NOTIFICATION/NCH	k=1, sent on cell B, containing an irrelevant group call reference.
B1	SS -> MS	NOTIFICATION/NCH	k=2, sent on cell B, containing the relevant group call reference but without VGCS/VBS channel description.
C1	SS -> MS	NOTIFICATION/NCH	k=3, sent on cell B, with the relevant group call reference and the VGCS/VBS channel description.
2	SS		The RF level of cell A is lowered until the MS re-selects cell B. The following messages are sent and received on cell B.
3	MS -> SS	CHANNEL REQUEST	location updating
4	SS -> MS	IMMEDIATE ASSIGNMENT	
5	MS -> SS	LOCATION UPDATING REQUEST	"location updating type" = normal, "CKSN" = CKSN1, "location area identification" = a, "mobile station classmark 1" as given by the PICS and "mobile identity" = TMSI1, L2: SABM / UA.
6	SS -> MS	LOCATION UPDATING ACCEPT	MI omitted, follow-on proceed IE included
A7	MS -> SS	CHANNEL RELEASE	k=1, the MS in idle mode on cell B, wait 5s.
A8	SS -> MS	PAGING REQUEST TYPE 1	"Mobile Identity" IE contains the TMSI allocated to the MS.
A9	MS -> SS	CHANNEL REQUEST	"Establishment Cause" = Answer to paging.
A10	SS -> MS	IMMEDIATE ASSIGNMENT REJECT	the first "request reference" corresponds to the CHANNEL REQUEST sent by the MS.
B7	MS -> SS	NOTIFICATION RESPONSE	k=2, Respond to notification.
B8	SS -> MS	CHANNEL RELEASE	I format, change from the dedicated channel onto VGCS channel.
B9	MS		Check that the TCH in downlink is through connected and there is no uplink transmission on that channel for 10 s.
B10	SS -> MS	CHANNEL RELEASE	UI format, the MS returns to idle mode.
C7	MS -> SS	CHANNEL RELEASE	k=3, MS in group receive mode on cell B
C8	MS		Check that the TCH in downlink is through connected and there is no uplink transmission on that channel for 10 s.
C10	SS -> MS	CHANNEL RELEASE	UI format, the MS returns to idle mode.
11	SS		The RF level of cell A is increased to 63 dB μ V emf(), the RF level of cell B is lowered until the MS re-select cell A. The following messages are sent and received on cell A
12	MS -> SS	CHANNEL REQUEST	location updating.
13	SS -> MS	IMMEDIATE ASSIGNMENT	
14	MS -> SS	LOCATION UPDATING REQUEST	"location updating type" = normal, "CKSN" = CKSN1, "location area identification" = b, "mobile station classmark 1" as given by the PICS and "mobile identity" = TMSI1, L2: SABM / UA.
15	SS -> MS	LOCATION UPDATING REJECT	cause #17
16	SS -> MS	CHANNEL RELEASE	
17	SS		Check that the TCH used in the test step 0 is not through connected for 10 s.
18	MS -> SS	CHANNEL REQUEST	"Establishment cause": Location updating. This message is sent by the MS 15s after step 16 (no check for that).
19	SS -> MS	IMMEDIATE ASSIGNMENT	

20	MS -> SS	LOCATION UPDATING REQUEST	"location updating type" = normal, "CKSN" = CKSN1, "location area identification" = b, "mobile station classmark 1" as given by the PICS and "mobile identity" = TMSI1, L2: SABM / UA.
21	SS -> MS	LOCATION UPDATING ACCEPT	both MI and follow-on proceed IE omitted MMI action, a VGCS call is initiated on cell A
22	MS		
23	MS -> SS	CHANNEL REQUEST	L2: SABM / UA
24	SS -> MS	IMMEDIATE ASSIGNMENT	
25	MS -> SS	CM SERVICE REQUEST	
26	SS -> MS	CM SERVICE ACCEPT	
27	MS -> SS	SETUP	
28	SS -> MS	AUTHENTICATION REQUEST	
29	MS -> SS	AUTHENTICATION RESPONSE	
30	SS -> MS	CHANNEL MODE MODIFY	
31	MS -> SS	CHANNEL MODE MODIFY ACKNOWLEDGE	
32	SS -> MS	CONNECT	
33	MS		
34	SS -> MS	CHANNEL RELEASE	Check the MS is involved in group call Including a new group channel description different from the one in step 0. The MS releases L2 multiple frame link (L2:DISC/UA) and enters group receive mode.
35	MS		Check that the TCH assigned in step 22 is in downlink through connected and there is no uplink transmission on that channel for 10 s.
36	SS -> MS	CHANNEL RELEASE	UI format, the MS returns to idle state.

Specific message contents:

CHANNEL RELEASE

Information Element	value/remark
Group channel description	
- IEI	74
- Length	
- Channel type and TDMA offset	TCH/F
- Timeslot number	arbitrarily chosen, but not 0
- TSC	arbitrarily chosen
- Hopping	Single RF, non hopping channel
- ARFCN	GSM 450: 279 GSM 480: 326 GSM 900: 70 DCS 1800: 850 PCS 1900: 750
Group cipher key number	Not included

26.14.9.3 VGCS-VBS / Cell Change / Different PLMN

26.14.9.3.1 Conformance requirement

1. After a cell change to a different LA, if the selected cell belongs to an another PLMN the MS shall leave group receive mode and go to idle mode.

Reference(s)

GSM 03.22 clause 5.2.3.

26.14.9.3.2 Test purpose

In group receive mode it is verified that after a cell change to a different LA of an another PLMN, the MS leaves group receive mode, enters idle mode.

26.14.9.3.3 Method of test

Initial Conditions

System Simulator:

2 cells with different LA belonging to the different PLMN: cell A /PLMN1 and cell B / PLMN2, with default parameters.

Mobile Station:

The MS is in MM-state "idle, updated" with a TMSI allocated on cell A. No automatic answering is configured.

Related PICS/PIXIT Statement(s)

Type of MS (GSM 450, GSM 480, P-, E-, R-GSM 900 or DCS 1800 or PCS 1900).

Support VGCS listening.

Support VBS listening.

Way to configure VGCS or VBS.

Way to verify the downlink speech path.

Foreseen Final State of the MS

"Idle, updated".

Test Procedure

The following test procedure is repeated for k=1, 2.

The MS is brought into group receive mode on cell A. Start cell B with NOTIFICATON/NCH containing an another group call references (k=1), or with NOTIFICATON/NCH containing the same group call reference (k=2). Lower the transmission levels of cell A so that C1 of cell A becomes less than zero. The MS re-selects the cell B and enters idle mode. It is checked that the MS does location update on cell B. If it is succeeded the MS indicates a group/broadcast call with the reference and joins the VGCS/VBS call on MMI request.

Increase the power level of cell A to the default value and decrease the power level of cell B so that the MS re-selects the cell A. The MS does a new location updating and indicates a group/broadcast call.

Maximum Duration of Test

5 minutes.

Expected Sequence

Repeat the test sequence for test counter k= 1, 2.

Step	Direction	Message	Comments
0	MS		the MS is brought into group receive mode on cell A.
A1	SS -> MS	NOTIFICATION/NCH	k=1, sent on cell B, with an another group call reference but with the same VGCS/VBS channel description as in test step 0.
B1	SS -> MS	NOTIFICATION/NCH	k=2, sent on cell B, with the same group call reference and an another VGCS/VBS channel description as in step 0.
2	SS		The RF level of cell A is lowered until the MS re-selects cell B. The following messages are sent and received on cell B.
3	MS -> SS	CHANNEL REQUEST	location updating
4	SS -> MS	IMMEDIATE ASSIGNMENT	
5	MS -> SS	LOCATION UPDATING REQUEST	"location updating type" = normal, "CKSN" = CKSN1, "location area identification" = a, "mobile station classmark 1" as given by the PICS and "mobile identity" = TMSI1, L2: SABM / UA. New TMSI2
6	SS -> MS	LOCATION UPDATING ACCEPT	
7	MS -> SS	TMSI REALLOCATION COMPLETE	
8	SS -> MS	CHANNEL RELEASE	I format , MS returns to idle mode
9	MS		check that the MS gives an indication containing the notified group call reference
10	MS		MMI action to join the VGCS/VBS call
11	MS		check that the downlink voice is received and there is no uplink transmission on that channel for 5 s.
12	SS -> MS	CHANNEL RELEASE	UI format, the MS returns to idle state.
13	SS		The RF level of cell A is increased to 63 dB μ V emf(), the RF level of cell B is lowered until the MS re-select cell A. The following messages are sent and received on cell A.
14	MS -> SS	CHANNEL REQUEST	location updating
15	SS -> MS	IMMEDIATE ASSIGNMENT	
16	MS -> SS	LOCATION UPDATING REQUEST	"location updating type" = normal, "CKSN" = CKSN2, "location area identification" = b, "mobile station classmark 1" as given by the PICS and "mobile identity" = TMSI2, L2: SABM / UA. TMSI1
17	SS -> MS	LOCATION UPDATING ACCEPT	
18	MS -> SS	TMSI REALLOCATION COMPLETE	
19	SS -> MS	CHANNEL RELEASE	I format
20	MS		check that the MS gives an indication containing the notified group call reference
21	SS->MS	CHANNEL RELEASE	UI format.
22	SS		The RF level of cell B is increased to 53 dB μ V emf().

26.14.10 VGCS-VBS / Default Message Contents

The default message contents listed in clause 26.6.14, 26.6.15, 26.6.16, 26.6.17 and 26.6.18 are applicable to the clause 26.14, except BS_AG_BLK_RES = 1. Additional default message contents are specified below.

SYSTEM INFORMATION TYPE 1

Information Element	value/remark
S1 Rest Octets - NCH position indication - NCH position - Spare padding	2 octets length H The 1st NCH block number = 1, No. of blocks = 1

SYSTEM INFORMATION TYPE 6

Information Element	value/remark
S6 Rest Octets - PCH/NCH info indication - VGCS/VBS options - in-band notifications - in-band paging - Spare padding	7 octets length L H 1 1 logical L

NOTIFICATION/NCH

Information Element	value/remark
L2 Pseudo Length	This is the sum of the lengths of all the information elements present in the message except for the NT/N rest octets and L2 pseudo length IEs. For the default message the L2 pseudo length is '09'B.
RR Protocol Discriminator	'0110'B
Skip Indicator	'0000'B
Message Type	'00100000'B
NT/N Rest Octets	
Reduced monitoring indication	'0'B, no reduced monitoring
List of group call NCH information	
Group call reference 1 indication	'1'B
Group or broadcast call reference	
- Group or broadcast call reference	PICS/PIXIT, active in the SIM (27 bits)
- SF	VBS if only VBS supported, otherwise VGCS
- AF	acknowledgement not required
- Ciphering information	No ciphering
Group Channel Description indication	'1'
Channel Description	
- Channel type and TDMA offset	TCH/F
- Timeslot number	arbitrarily chosen but not 0
- TSC	arbitrarily chosen
- Hopping	Single RF Channel
- ARFCN	GSM 450: 275 GSM 480: 322 GSM 900: 50 DCS 1800: 750 PCS 1900: 650
- MA or FSL	'0'B, non hopping
Another Group call references	'0'B, no
Spare padding	logic L

NOTIFICATION/FACCH

Information Element	value/remark
RR short PD	'0'B
message type	'00001'B
short layer 2 header	'00' for UI frame
Group call / Paging information indication	'0', group call information
Group or broadcast call reference	
- Group or broadcast call reference	PICS/PIXIT (27 bits), active in the SIM
- SF	VBS if only VBS supported, otherwise VGCS
- AF	'0'B, acknowledgement not required
- priority	4
- Ciphering information	No ciphering
Group Channel Description indication	'1', group channel description
Channel Description	24 bits
- Channel type and TDMA offset	TCH/F
- Timeslot number	arbitrarily chosen, but not 0
- TSC	arbitrarily chosen
- Hopping	Single RF, non hopping channel
- ARFCN	GSM 450: 279 GSM 480: 326 GSM 900: 70 DCS 1800: 850 PCS 1900: 750
MA or FSL	'0'B, non hopping
Spare padding	logic L

NOTIFICATION RESPONSE

Information Element	value/remark
RR Protocol Discriminator	'0110'B
Skip Indicator	'0000'B
Message Type	'0x100110'B
Mobile station classmark	PICS/PIXIT
Mobile identity	PICS/PIXIT
Group or broadcast call reference 1	
- Group or broadcast call reference	Not checked
- SF	Not checked
- AF	Not checked
- Ciphering information	No ciphering

UPLINK ACCESS

Information field	value/remark
Establishment Cause	'110'B for subsequent talker uplink access; '00100101'B for reply on uplink access request
Random Reference	Not checked for subsequent talker uplink request

UPLINK BUSY

Information Element	value/remark
RR Protocol Discriminator	'0110'B
Skip Indicator	'0000'B
Message Type	'00101010'B

UPLINK FREE

Information Element	value/remark
RR short PD	'0'B
Message Type	'00010'B
short L2 header	'00'B, type 1
Uplink access request bit	L
UIC indication	H
UIC	PICS/PIXIT, bit(6)
Spare padding	logic L

UPLINK RELEASE

Information Element	value/remark
RR Protocol Discriminator	'0110'B
Skip Indicator	'0000'B
Message Type	'00001110'B
RR Cause	Normal event

VGCS UPLINK GRANT

Information Element	value/remark
RR Protocol Discriminator	'0110'B
Skip Indicator	'0000'B
Message Type	'00001001'B
Request Reference	Same as that in UPLINK ACCESS
Timing Advance	30

TALKER INDICATION

Information Element	value/remark
RR Protocol Discriminator	'0110'B
Skip Indicator	'0000'B
Message Type	'00010001'B
Mobile station classmark	PICS/PIXIT
Mobile identity	PICS/PIXIT

Default Message contents for GCC/BCC

CHANNEL MODE MODIFY:

Channel Description	Same as in IMMEDIATE ASSIGNMENT in test
Channel Mode	
- Mode	speech full rate or half rate version 1
VGCS target mode indication	
- ie1	
- target mode	group transmit mode
- group cipher key number	no ciphering
- spare bit	'11'B

CHANNEL MODE MODIFY ACKNOWLEDGE:

Channel Description	Same as in CHANNEL MODE in test
Channel Mode	Same as in CHANNEL MODE in test

CM SERVICE REQUEST

Information Element	value/remark
CM service type Priority	VGC or VBC establishment, depending on the service any or omit

CONNECT

Information Element	value/remark
GCC/BCC Protocol Discriminator Transaction identifier Message Type Broadcast call reference Originator indication Spare half octet	'0000'B for GCC, '0001'B for BCC depending on the context of the test '0x110011'B PICS/PIXIT Originator '0000'B

GET STATUS

Information Element	value/remark
GCC/BCC Protocol Discriminator Transaction identifier Message Type Mobile identity Parameters	'0000'B for GCC, '0001'B for BCC depending on the context of the test '0x111001'B PICS/PIXIT call state & state attribute requested

IMMEDIATE SETUP

Information Element	value/remark
GCC/BCC Protocol Discriminator Transaction identifier Message Type Spare half octet Ciphering key sequence number Mobile station classmark Mobile identity Group identity	'0000'B for GCC, '0001'B for BCC '0001'B '0x110001'B '0000'B PICS/PIXIT PICS/PIXIT PICS/PIXIT PICS/PIXIT

SET PARAMETER

Information Element	value/remark
GCC/BCC Protocol Discriminator Transaction identifier Message Type All other information elements	'0000'B for GCC, '0001'B for BCC depending on the context of the test '0x111010'B Not present

SETUP

Information Element	value/remark
GCC/BCC Protocol Discriminator Transaction identifier Message Type Broadcast identity	'0000'B for GCC, '0001'B for BCC '0001'B '0x110010'B PICS/PIXIT

STATUS

Information Element	value/remark
GCC/BCC Protocol Discriminator	'0000'B for GCC, '0001'B for BCC
Transaction identifier	depending on the context of the test
Message Type	'0x111000'B
Cause	Not checked
Call state	depending on the context of the test
State attributes	depending on the context of the test

TERMINATION

Information Element	value/remark
GCC/BCC Protocol Discriminator	'0000'B for GCC, '0001'B for BCC
Transaction identifier	depending on the context of the test
Message Type	'0x110100'B
Cause	any

TERMINATION REJECT

Information Element	value/remark
GCC/BCC Protocol Discriminator	'0000'B for GCC, '0001'B for BCC
Transaction identifier	depending on the context of the test
Message Type	'0x110110'B
Reject cause	any

TERMINATION REQUEST

Information Element	value/remark
GCC/BCC Protocol Discriminator	'0000'B for GCC, '0001'B for BCC
Transaction identifier	depending on the context of the test
Message Type	'0x110101'B
Broadcast identity	PICS/PIXIT

26.14.11 VGCS-VBS / User-to-Dispatcher Information

26.14.11.1 VGCS-VBS / User-to-Dispatcher Information / BCC MO call

26.14.11.1.1 Conformance requirement

The request of the calling subscriber to set up a voice group call may specify information to be sent as user-to-dispatcher information to the network; in this case the user-to-dispatcher information is included in the signalling for call setup from the mobile station to the network. It is the responsibility of the input function to ensure that the user-to-dispatcher information has a correct format (in particular, an allowed length).

The initial signalling from the originating service subscriber informs the network that a voice group call is required and details the group ID; it may specify user-to-dispatcher information.

The User-to-dispatcher information element is included in the SETUP message.

References

GSM 03.69 clauses 4.2.1.1, 11.3.1.1.1

GSM 04.69 clause 8.5

26.14.11.1.2 Test purpose

To verify that upon initiation of an outgoing broadcast call with User-to-Dispatcher information by the user, the MS includes a User-to-dispatcher information element in the SETUP message;

To verify correct establishment and clearing of the broadcast call.

26.14.11.1.3 Method of test

Initial Conditions

System Simulator:

1 cell with default parameters for ASCII testing.

Mobile Station:

The MS is in MM-state "idle, updated" with a TMSI allocated.

Related PICS/PIXIT Statement(s)

Type of MS (GSM 450, GSM480, P-, E-, R-GSM 900 or DCS 1800 or PCS 1900).

Support VBS originating.

Support User-to-Dispatcher Information

Way to activate User-to-Dispatcher Information

Way to configure VBS.

Way to initiate VBS calls.

Foreseen Final State of the MS

"Idle, updated", with TMSI allocated.

Test Procedure

By means of appropriate MMI function, the user enters a string, which shall be included in the User-to-Dispatcher Information.

Then MS is made to initiate a broadcast call. In the SETUP message, the User-to-dispatcher information element shall be present and shall include the requested string. Then, SS releases immediately the call with a TERMINATION message.

Then MS is made to initiate a second broadcast call with User-to-Dispatcher Information including a long string. In the SETUP message, the User-to-dispatcher information element shall be present with the requested string. Then it is checked that the call can be successfully established and cleared.

Maximum Duration of Test

2 minutes

Expected Sequence

Step	Direction	Message	Comments
0	MS		The MS is in idle mode.
1	MS		MMI actions to initiate a VBS call with User-to-Dispatcher Information including the string 'abcdef9'
2	MS -> SS	CHANNEL REQUEST	
3	SS -> MS	IMMEDIATE ASSIGNMENT	TCH/FS
4	MS -> SS	CM SERVICE REQUEST	L2: SABM / UA
5	SS -> MS	CM SERVICE ACCEPT	
6	MS -> SS	SETUP	User-to-dispatcher IE included. See specific message contents.
7	SS -> MS	TERMINATION	
8	SS -> MS	CHANNEL RELEASE	The MS releases L2 multiple frame link. L2: DISC/UA.
9	MS		MMI actions to initiate a VBS call with User-to-Dispatcher Information with the string 'abcdefghijklmnopqrstuvwxyz012345'
10	MS -> SS	CHANNEL REQUEST	
11	SS -> MS	IMMEDIATE ASSIGNMENT	TCH/F, single RF channel GSM 900: 50, DCS 1800: 750 PCS 1900: 650 L2: SABM / UA
12	MS -> SS	CM SERVICE REQUEST	
13	SS -> MS	CM SERVICE ACCEPT	
14	MS -> SS	SETUP	User-to-dispatcher IE included. See specific message contents.
15	SS -> MS	CHANNEL MODE MODIFY	
16	MS -> SS	CHANNEL MODE MODIFY ACKNOWLEDGE	
17	SS -> MS	CONNECT	
18	SS -> MS	TERMINATION	
19	SS -> MS	CHANNEL RELEASE	The MS releases L2 multiple frame link L2: DISC/UA.

Specific message contents:

SETUP

As default message contents as defined in section 26.14.10 except:

Information Element	Value/remark
User-to-dispatcher	
- IEI	'7E'0
- length	1+the entered string length
- PD	User specific protocol
- user-user	The string as entered coded in IA5 characters

26.14.11.2 VGCS-VBS / User-to-Dispatcher information / GCC MO call

26.14.11.2.1 Conformance requirement

The request of the calling subscriber to set up a voice group call may specify information to be sent as user-to-dispatcher information to the network; in this case the user-to-dispatcher information is included in the signalling for call setup from the mobile station to the network. It is the responsibility of the input function to ensure that the user-to-dispatcher information has a correct format (in particular, an allowed length).

The initial signalling from the originating service subscriber informs the network that a voice group call is required and details the group ID; it may specify user-to-dispatcher information.

The User-to-dispatcher information element is included in the SETUP message.

References

GSM 03.68 clauses 4.2.1.1, 11.3.1.1.1

GSM 04.68 clause 8.5

26.14.11.2.2 Test purpose

To verify that upon initiation of an outgoing group call with User-to-Dispatcher Information by the user, the MS includes a User-to-dispatcher information element in the SETUP message;

To verify that the group call can be successfully established and cleared.

26.14.11.2.3 Method of test

Initial Conditions

System Simulator:

1 cell with default parameters for ASCII testing.

Mobile Station:

The MS is in MM-state "idle, updated" with a TMSI allocated.

Related PICS/PIXIT Statement(s)

Type of MS (GSM 450, GSM480, P-, E-, R-GSM 900 or DCS 1800 or PCS 1900).

Support VGCS originating.

Support User-to-Dispatcher Information

Way to activate User-to-Dispatcher Information

Way to configure VGCS.

Way to initiate VGCS calls.

Foreseen Final State of the MS

"Idle, updated", with TMSI allocated.

Test Procedure

By means of appropriate MMI function, the user enters a string, which shall be included in the User-to-Dispatcher Information.

Then MS is made to initiate a VGCS call. In the SETUP message, the User-to-dispatcher information element shall be present and shall include the requested string. Then, SS releases immediately the call with a TERMINATION message.

Then MS is made to initiate a second VGCS call with User-to-Dispatcher Information including a long string. In the SETUP message, the User-to-dispatcher information element shall be present with the requested string. Then it is checked that the call can be successfully established and cleared.

Maximum Duration of Test

2 minutes

Expected Sequence

Step	Direction	Message	Comments
0	MS		MMI actions to initiate a VGCS call with User-to-Dispatcher Information with the string 'abcdef9'.
1	MS -> SS	CHANNEL REQUEST	TCH/FS L2: SABM / UA
2	SS -> MS	IMMEDIATE ASSIGNMENT	
3	MS -> SS	CM SERVICE REQUEST	
4	SS -> MS	CM SERVICE ACCEPT	
5	MS -> SS	SETUP	User-to dispatcher IE included. See specific message contents
6	SS -> MS	TERMINATION	The MS releases L2 multiple frame link L2: DISC/UA.
7	SS -> MS	CHANNEL RELEASE	
10	MS		MMI actions to initiate a VGCS call with User-to-Dispatcher Information with the string 'abcdefghijklmnopqrstuvwxy012345'.
11	MS -> SS	CHANNEL REQUEST	TCH/F, single RF channel GSM 900: 50, DCS 1800: 750 PCS 1900: 650 L2: SABM / UA
12	SS -> MS	IMMEDIATE ASSIGNMENT	
13	MS -> SS	CM SERVICE REQUEST	
14	SS -> MS	CM SERVICE ACCEPT	
15	MS -> SS	SETUP	User-to-dispatcher IE included
16	SS -> MS	CHANNEL MODE MODIFY	
17	MS -> SS	CHANNEL MODE MODIFY	
18	SS -> MS	ACKNOWLEDGE CONNECT	
19	SS -> MS	TERMINATION	The MS releases L2 multiple frame link L2: DISC/UA.
20	SS -> MS	CHANNEL RELEASE	

Specific message contents:

SETUP

As default message contents as defined in section 26.14.10 except:

Information Element	Value/remark
User-user	
- IEI	'7E'O
- length	1 + the entered string length
- PD	User specific protocol
- user-user	The string as entered coded in IA5 characters

26.14.11.3 VGCS-VBS / User-to-Dispatcher information / Compressed user information in VBS fast call set-up

26.14.11.3.1 Conformance requirement

The request of the calling subscriber to set up a voice group call may specify information to be sent as user-to-dispatcher information to the network; in this case the user-to-dispatcher information is included in the signalling for call setup from the mobile station to the network. It is the responsibility of the input function to ensure that the user-to-dispatcher information has a correct format (in particular, an allowed length).

User-to-dispatcher information can be compressed or uncompressed.

The message IMMEDIATE SETUP 2 is sent by the MS to the network in order to set-up a group call immediately, i.e. without previous establishment of an MM connection, and to include compressed user-to dispatcher information. The message shall be used if the MS has a valid TMSI.

References

GSM 04.69 clauses 4.2.1.1, 4.2.7, 11.3.1.1.1, 11.3.1.1.3

GSM 04.69 clause 6.2.2, 8

26.14.11.3.2 Test purpose

To verify that upon initiation of an outgoing VBS fast call with User-to-Dispatcher Information by the user, the MS includes a Compressed User-to-Dispatcher Information information element in the IMMEDIATE SETUP 2 message;

To verify that the VBS fast call can be successfully established and cleared.

26.14.11.3.3 Method of test

Initial Conditions

System Simulator:

1 cell with default parameters for ASCII testing.

Mobile Station:

The MS is in MM-state "idle, updated" with a TMSI allocated.

Related PICS/PIXIT Statement(s)

Type of MS (GSM 450, GSM480, P-, E-, R-GSM 900 or DCS 1800 or PCS 1900).

Support VBS originating.

Support Compressed User-to-Dispatcher Information

Way to activate User-to-Dispatcher Information

Way to configure VBS.

Way to initiate VBS fast calls set-up.

Foreseen Final State of the MS

"Idle, updated", with TMSI allocated.

Test Procedure

By means of appropriate MMI function, the user enters a string, which shall be included in the User-to-Dispatcher Information. Then MS is made to initiate a VBS fast call. Check that the MS sends an IMMEDIATE SETUP 2 message, and check that the Compressed User-to-Dispatcher Information element is present. Then, it is checked that the call can be successfully established and released.

Maximum Duration of Test

2 minutes

Expected Sequence

Step	Direction	Message	Comments
0	MS		The MS is in idle mode.
1	MS		MMI actions to initiate a VBS fast call with the User-to-Dispatcher Information "1234567890"
2	MS -> SS	CHANNEL REQUEST	TCH/F, single RF channel GSM900: 50 DCS 1800: 750 PCS 1900: 650
3	SS -> MS	IMMEDIATE ASSIGNMENT	
4	MS -> SS	IMMEDIATE SETUP	
5	SS -> MS	CHANNEL MODE MODIFY	Very early assignment
6	MS -> SS	CHANNEL MODE MODIFY ACK	
7	SS -> MS	CONNECT	
8	SS -> MS	TERMINATION	
9	SS -> MS	CHANNEL RELEASE	

Specific message contents:

IMMEDIATE SETUP 2

Information element	Value/remark
Protocol discriminator	'0001'B for BCC
Transaction identifier	'0001'B
Message type	'0x111011'B
Spare half octet	'0000'B
Ciphering key sequence number	PICS/PIXIT
Mobile station classmark	PICS/PIXIT
TMSI	PICS/PIXIT
Group identity	PICS/PIXIT
Compressed utdi	'00075BCD16'O

26.14.11.4 VGCS-VBS / User-to-Dispatcher information / Compressed User-to-Dispatcher information in VGCS fast call set-up

26.14.11.4.1 Conformance requirement

The request of the calling subscriber to set up a voice group call may specify information to be sent as user-to-dispatcher information to the network; in this case the user-to-dispatcher information is included in the signalling for call setup from the mobile station to the network. It is the responsibility of the input function to ensure that the user-to-dispatcher information has a correct format (in particular, an allowed length).

User-to-dispatcher information can be compressed or uncompressed.

The message IMMEDIATE SETUP 2 is sent by the MS to the network in order to set-up a group call immediately, i.e. without previous establishment of an MM connection, and to include compressed user-to dispatcher information. The message shall be used if the MS has a valid TMSI.

References

GSM 03.68 clause s 4.2.1.1, 4.2.7, 11.3.1.1.1, 11.3.1.1.3

GSM 04.68 clause 6.2.2, 8

26.14.11.4.2 Test purpose

To verify that upon initiation of an outgoing VGCS fast call with Compressed User-to-Dispatcher Information by the user, the MS includes a Compressed User-to-Dispatcher Information information element in the IMMEDIATE SETUP 2 message;

To verify that the VGCS fast call can be successfully established and cleared.

26.14.11.4.3 Method of test

Initial Conditions

System Simulator:

1 cell with default parameters for ASCII testing.

Mobile Station:

The MS is in MM-state "idle, updated" with a TMSI allocated.

Related PICS/PIXIT Statement(s)

Type of MS (GSM 450, GSM480, P-, E-, R-GSM 900 or DCS 1800 or PCS 1900).

Support VGCS originating.

Support Compressed User-to-Dispatcher Information

Way to activate User-to-Dispatcher Information

Way to configure VGCS.

Way to initiate VGCS fast calls set-up.

Foreseen Final State of the MS

"Idle, updated", with TMSI allocated.

Test Procedure

By means of appropriate MMI function, the user enters a string, which shall be included in the User-to-Dispatcher Information. Then MS is made to initiate a VGCS fast call. Check that the MS sends an IMMEDIATE SETUP 2 message, and check that the Compressed User-to-Dispatcher Information information element is present. Then, it is checked that the VGCS fast call can be successfully established and released.

Maximum Duration of Test

2 minutes

Expected Sequence

Step	Direction	Message	Comments
0	MS		The MS is in idle mode.
1	MS		MMI actions to initiate a VGCS fast call with the User-to-Dispatcher Information "1234567890"
2	MS -> SS	CHANNEL REQUEST	
3	SS -> MS	IMMEDIATE ASSIGNMENT	TCH/F, single RF channel GSM900: 50 DCS 1800: 750 PCS 1900: 650
4	MS -> SS	IMMEDIATE SETUP	L2: SABM / UA, GCC message including the Compressed utdi information element shall be present, see Specific message contents
5	SS -> MS	CHANNEL MODE MODIFY	
6	MS -> SS	CHANNEL MODE MODIFY ACK	
7	SS -> MS	CONNECT	Very early assignment
8	SS -> MS	TERMINATION	
9	SS -> MS	CHANNEL RELEASE	

Specific message contents:

IMMEDIATE SETUP 2

Information element	value/remark
Protocol discriminator	'0000'B for GCC
Transaction identifier	'0001'B
Message type	'0x111011'B
Spare half octet	'0000'B
Ciphering key sequence number	PICS/PIXIT
Mobile station classmark	PICS/PIXIT
TMSI	PICS/PIXIT
Group identity	PICS/PIXIT
Compressed utdi	'00075BCD16'O

26.15 SoLSA signalling

26.15.1 General considerations

This section applies only to mobile stations supporting SoLSA, as defined in GSM 02.43 and GSM 03.73.

Conformance requirements of section 26 fully apply to any SoLSA MS.

The purpose of this section is to test these extra functional requirements for a SoLSA mobile station.

Additional to the abbreviations and definitions in G3 TR 21.905 the definitions in 20.24 are used within this section.

26.15.1.1 Default message content

Default contents SYSTEM INFORMATION messages and default settings

For cell A and B For GSM^o900 use 26.6.14.

For DCS^o1800 use 26.6.15, for GSM^o450 use 26.6.16, for GSM^o480 use 26.6.17, and for PCS 1900 user 26.6.18.

The following parameters shall be coded into the system information messages. Parameters shall be coded according to GSM 04.18.

SYSTEM INFORMATION TYPE 2bis, SYSTEM INFORMATION TYPE 5bis messages are not used.

SYSTEM INFORMATION TYPE 3

Default except:

Information Element	Value/remark
SI3 rest octets Early Classmark Sending Control	Early Sending is explicitly accepted

Default message contents for other messages

For section 26.15.2	same as in 26.7.6
For section 26.15.3	same as in 26.7.6
For section 26.15.4	same as in 26.7.6
For section 26.15.5	same as in 26.9.9

26.15.1.2 General initial conditions for SIM card

- Following LSA values shall be defined in the fields of the EF_{SLL} (GSM 11.11, 10.4.1.2) and in the LSA descriptor files (GSM 11.11, 10.4.1.3) on the SIM card used for testing:

	LSA ID	CI	LAC	LAC + CI	PLMN code	LSA Priority	Idle mode support	LSA indication for idle mode
LSA1	54 66.001	-			HPLMN	0	On	Off
LSA3	9.000.000			2 + [250..254]	HPLMN	8	On	On

- List of values, that shall not be found in the SIM card, in order to be sure that the SoLSA MS is not subscribed to the LSA defined by the current carrier:

	LSA ID	CI	LAC	LAC + CI
LSA value	[250..255]	[5000..5005]	5	5 + [5000..5005]

26.15.2 SoLSA signalling / RR

26.15.2.1 SoLSA signalling / RR / classmark interrogation

This procedure allows the network to request the MS to supply all its classmark information to the network.

Networks may systematically use this procedure (e.g. during location updating) and, if it is incorrectly implemented in the MS, the basic connection establishment procedure may systematically fail.

26.15.2.1.1 Conformance requirements

On receipt of a CLASSMARK ENQUIRY message, the MS sends a CLASSMARK CHANGE message to the network containing the Mobile Station Classmark 2 information element and depending upon the contents of this information element, possibly the Mobile Station Classmark 3 information element.

References

GSM 04.18 sections 3.3.1.1.4.1, 3.4.11 and 9.1.11

GSM 04.13 section 5.2.9.

26.6.11.2.2 Test purpose

To verify that if the network requests the SoLSA MS to supply all its classmark information then this information is communicated on the DCCH to the network.

26.6.11.2.3 Method of test

Initial Conditions

System Simulator:

1 cell, default parameters.

Mobile Station:

"Idle, updated", with TMSI allocated.

Related PICS/PIXIT Statements

- Support of SoLSA
- Contents of Mobile Station Classmark 2 information element.
- Existence of Mobile Station Classmark 3 information element: yes/no.
- Contents of Mobile Station Classmark 3 information element.
- Switch off button: yes/no.

Foreseen Final State of the MS

"Idle, updated", with TMSI allocated.

Test Procedure

The MS is switched off (or has its power removed).

The SS then sets the IMSI attach-detach flag in the SYSTEM INFORMATION messages so that the MS shall perform a location update when switched on.

The MS is switched on (or its power is re-applied). The MS then initiates a location update attempt. After the successful completion of the location update procedure (with TMSI reallocation) the SS transmits a CLASSMARK ENQUIRY message. The MS shall be ready to transmit the CLASSMARK CHANGE message before 300 ms after the end of the CLASSMARK ENQUIRY message.

The term "ready to transmit" is defined in GSM 04.13.

Then the channel is released.

Maximum Duration of Test

2 minutes.

Expected Sequence

Step	Direction	Message	Comments
1	MS		The MS is switched off (or has its power removed).
2	SS		IMSI attach-detach flag changed.
3	MS		The MS is switched on (or its power is re-applied).
2	MS -> SS	CHANNEL REQUEST	"Establishment cause": Location updating.
3	SS -> MS	IMMEDIATE ASSIGNMENT	
4	MS -> SS	LOCATION UPDATING REQUEST	"location updating type" = normal, "CKSN" = CKSN1, "location area identification" = a, "mobile station classmark 1" and "mobile station classmark 2" including settings for ES IND and SoLSA and "mobile identity" = TMSI1.
5	SS -> MS	UA(LOCATION UPDATING REQUEST)	
6	MS -> SS	CLASSMARK CHANGE	Shall be ready to transmit (see GSM 05.10 section 06.10) within 40 ms after the completion of step 4. Shall indicate the MS frequency and power capabilities Note: In this case 'ready to transmit' shall result in the actual transmission of the Classmark Change 51 frames later (51 * 4.62ms = 235.62 ms). Therefore receipt of the Classmark Change within 250ms of step 4 is required. "mobile station classmark 2" includes settings for ES IND and SoLSA
7	SS -> MS	LOCATION UPDATING ACCEPT	"Mobile identity" = new TMSI (=TMSI2).
8	MS -> SS	TMSI REALLOCATION COMPLETE	
9	SS -> MS	CLASSMARK ENQUIRY	
10	MS -> SS	CLASSMARK CHANGE	Contents as defined in step 6. This message shall be ready to be transmitted before 300 ms after the completion of step 9.
11	SS -> MS	CHANNEL RELEASE	

Specific message contents:

LOCATION UPDATING REQUEST

Information element	Value/remark
as default except: Mobile station Classmark 1 - ES IND	Controlled Early Classmark Sending option is implemented
Mobile station Classmark 2 - ES IND - SoLSA	Controlled Early Classmark Sending option is implemented SoLSA supported

CLASSMARK CHANGE

Information element	Value/remark
as default except: Mobile station Classmark 2 -ES IND -SoLSA	Controlled Early Classmark Sending is implemented. SoLSA supported

26.15.3 SoLSA signalling / MM

26.15.3.1 SoLSA signalling / MM / location updating

This procedure is used to register the MS in the network. If it is not performed correctly, no call can be established.

26.15.3.1.1 Location updating / accepted

To inform the network of the MSs additional SoLSA capability, the SoLSA MS has to send a CLASSMARK CHANGE as soon as possible during a normal location update procedure.

26.15.3.1.1.1 Conformance requirement

If the network accepts a location updating from the Mobile where the ES IND bit is set to 1 in the Classmark 1 and the Classmark 2 information element, the SoLSA bit is set to 1 in the classmark 2 information element and the Early Classmark Sending Control bit is set to high in SI3 Rest Octets, then the MS shall send, on the first occasion, the CLASSMARK CHANGE message.

During a contention resolution procedure, if the last timeslot of the block containing a L2 UA frame occurs at time T, then the MS shall be ready to transmit the CLASSMARK CHANGE before T + 40 ms.

The Mobile Station shall, after receiving a Location updating Accept message, store the relevant received informations and answer correctly to a paging request from the network.

This test is applicable for any SoLSA MSs with an LSA SIM supporting the SoLSA operations.

Reference(s)

TS 24.008 section 4.4.4.6, 9.2.15, 10.5.1.5 and 10.5.1.6

GSM 04.18 sections 3.3.1.1.4.1, 9.1.11 and 10.5.2.34

26.15.3.1.1.2 Test purpose

To verify that the SoLSA MS supports "early classmark sending procedure", e.g. sending information to the network about SoLSA support during location update procedure.

26.15.3.1.1.3 Method of test

Initial conditions:

System Simulator:

Two cells, A and B, belonging to different location areas with location area identification a and b of the same PLMN.

IMSI attach/detach is allowed in both cells.

The T3212 time-out value is 1/10 hour in both cells.

Mobile Station:

The MS has a valid TMSI (=TMSI1) and CKSN (=CKSN1). It is "idle updated" on cell A.

Related PICS/PIXIT statement(s)

- Support of SoLSA

Foreseen final state of the MS

The MS has no valid TMSI. It has valid CKSN and Kc. It is "idle, updated" on cell B.

Test Procedure

The MS is made to select cell B. A normal location updating with TMSI reallocation is performed in cell B. The channel is released. The SS checks, by paging, that the MS has stored the newly allocated TMSI. The channel is released. The MS is made to select cell A. A normal location updating is performed in cell A. The LOCATION UPDATING ACCEPT message contains neither IMSI nor TMSI. The SS checks, by paging, that the MS has kept the old TMSI. The channel is released. The MS is made to select cell B. A normal location updating is performed in cell B. The LOCATION UPDATING ACCEPT message contains an IMSI. The SS checks, by paging, that the MS has deleted its TMSI and responds to paging with IMSI.

Maximum duration of test

4 minutes.

Expected sequence

Step	Direction	Message	Comments
1	SS		The RF level of cell A is lowered until the MS selects cell B.
2	MS -> SS	CHANNEL REQUEST	"Establishment cause": Location updating.
3	SS -> MS	IMMEDIATE ASSIGNMENT	
4	MS -> SS	LOCATION UPDATING REQUEST	"location updating type" = normal, "CKSN" = CKSN1, "location area identification" = a, "mobile station classmark 1" and "mobile station classmark 2" including settings for ES IND and SoLSA and "mobile identity" = TMSI1.
5	SS -> MS	UA(LOCATION UPDATING REQUEST)	
6	MS -> SS	CLASSMARK CHANGE	Shall be ready to transmit (see GSM 05.10 section 06.10) within 40 ms after the completion of step 4. Shall indicate the MS frequency and power capabilities Note: In this case 'ready to transmit' shall result in the actual transmission of the Classmark Change 51 frames later (51 * 4.62ms = 235.62 ms). Therefore receipt of the Classmark Change within 250ms of step 4 is required. "mobile station classmark 2" includes settings for ES IND and SoLSA
7	SS -> MS	LOCATION UPDATING ACCEPT	"Mobile identity" = new TMSI (=TMSI2), LAI = b.
8	MS -> SS	TMSI REALLOCATION COMPLETE	
9	SS -> MS	CHANNEL RELEASE	After the sending of this message, the SS waits for the disconnection of the main signalling link. The SS waits an amount of time which is enough to guarantee that the MS is in service.
10	SS -> MS	PAGING REQUEST TYPE 1	"Mobile identity" IE contains the new TMSI (= TMSI2).
11	MS -> SS	CHANNEL REQUEST	
12	SS -> MS	IMMEDIATE ASSIGNMENT	
13	MS -> SS	SABM (PAGING RESPONSE)	"Mobile identity" IE contains the new TMSI (= TMSI2). "mobile station classmark 2" including settings for ES IND and SoLSA
14	SS -> MS	UA (PAGING RESPONSE)	
15	MS -> SS	CLASSMARK CHANGE	Shall be ready to transmit (see GSM 05.10 section 06.10) within 40 ms after the completion of step 13. Shall indicate the MS frequency and power capabilities Note: In this case 'ready to transmit' shall result in the actual transmission of the Classmark Change 51 frames later (51 * 4.62ms = 235.62 ms). Therefore receipt of the Classmark Change within 250ms of step 13 is required. "mobile station classmark 2" includes settings for ES IND and SoLSA
16	SS -> MS	CHANNEL RELEASE	After the sending of this message, the SS waits for the disconnection of the main signalling link.
17	SS		The RF level of cell B is lowered until the MS selects cell A.
18	MS -> SS	CHANNEL REQUEST	"Establishment cause": Location updating
19	SS -> MS	IMMEDIATE ASSIGNMENT	

20	MS -> SS	LOCATION UPDATING REQUEST	"location updating type" = normal, "CKSN" = CKSN1, "location area identification" = b, "mobile station classmark 1" and "mobile station classmark 2" including settings for ES IND and SoLSA and "mobile identity" = TMSI2.
21	SS -> MS	UA(LOCATION UPDATING REQUEST)	
22	MS -> SS	CLASSMARK CHANGE	Shall be ready to transmit (see GSM 05.10 section 06.10) within 40 ms after the completion of step 20. Shall indicate the MS frequency and power capabilities Note: In this case 'ready to transmit' shall result in the actual transmission of the Classmark Change 51 frames later (51 * 4.62ms = 235.62 ms). Therefore receipt of the Classmark Change within 250ms of step 20 is required. "mobile station classmark 2" includes settings for ES IND and SoLSA
23	SS -> MS	LOCATION UPDATING ACCEPT	"Mobile identity" IE not included.
24	SS -> MS	CHANNEL RELEASE	After the sending of this message, the SS waits for the disconnection of the main signalling link. The SS waits an amount of time which is enough to guarantee that the MS is in service.
25	SS -> MS	PAGING REQUEST TYPE 1	"Mobile identity" IE contains the TMSI (= TMSI2).
26	MS -> SS	CHANNEL REQUEST	
27	SS -> MS	IMMEDIATE ASSIGNMENT	
28	MS -> SS	SABM (PAGING RESPONSE)	"Mobile identity" IE contains the TMSI (= TMSI2). "mobile station classmark 2" including settings for ES IND and SoLSA
29	SS -> MS	UA (PAGING RESPONSE)	
30	MS -> SS	CLASSMARK CHANGE	Shall be ready to transmit (see GSM 05.10 section 06.10) within 40 ms after the completion of step 28. Shall indicate the MS frequency and power capabilities Note: In this case 'ready to transmit' shall result in the actual transmission of the Classmark Change 51 frames later (51 * 4.62ms = 235.62 ms). Therefore receipt of the Classmark Change within 250ms of step 28 is required. "mobile station classmark 2" includes settings for ES IND and SoLSA
31	SS -> MS	CHANNEL RELEASE	After the sending of this message, the SS waits for the disconnection of the main signalling link.
32	SS		The RF level of cell A is lowered until the MS selects cell B.
33	MS -> SS	CHANNEL REQUEST	"Establishment cause": Location updating.
34	SS -> MS	IMMEDIATE ASSIGNMENT	
35	MS -> SS	LOCATION UPDATING REQUEST	"location updating type" = normal, "CKSN" = CKSN1, "location area identification" = a, "mobile station classmark 1" and "mobile station classmark 2" including settings for ES IND and SoLSA and "mobile identity" = TMSI2.
36	SS -> MS	UA(LOCATION UPDATING REQUEST)	"Mobile identity" IE contains IMSI.
37	MS -> SS	CLASSMARK CHANGE	Shall be ready to transmit (see GSM 05.10 section 06.10) within 40 ms after the completion of step 35. Shall indicate the MS frequency and power capabilities Note: In this case 'ready to transmit' shall result in the actual transmission of the Classmark Change 51 frames later (51 * 4.62ms = 235.62 ms). Therefore receipt of the Classmark Change within 250ms of step 35 is required. "mobile station classmark 2" includes settings for ES IND and SoLSA
38	SS -> MS	LOCATION UPDATING ACCEPT	"Mobile identity" IE contains IMSI.
39	SS -> MS	CHANNEL RELEASE	After the sending of this message, the SS waits for the disconnection of the main signalling link. The SS waits an amount of time which is enough to guarantee that the MS is in service.
40	SS -> MS	PAGING REQUEST TYPE 1	"Mobile identity" IE contains the old TMSI (= TMSI2).
41	MS		The MS shall ignore this message. This is checked during 5 seconds.
42	SS -> MS	PAGING REQUEST TYPE 1	"Mobile identity" IE contains the IMSI.

43	MS -> SS	CHANNEL REQUEST	"Mobile identity" IE contains the IMSI. "mobile station classmark 2" including settings for ES IND and SoLSA
44	SS -> MS	IMMEDIATE ASSIGNMENT	
45	MS -> SS	SABM (PAGING RESPONSE)	
46	SS -> MS	UA (PAGING RESPONSE)	Shall be ready to transmit (see GSM 05.10 section 06.10) within 40 ms after the completion of step 45. Shall indicate the MS frequency and power capabilities Note: In this case 'ready to transmit' shall result in the actual transmission of the Classmark Change 51 frames later (51 * 4.62ms = 235.62 ms). Therefore receipt of the Classmark Change within 250ms of step 45 is required. "mobile station classmark 2" includes settings for ES IND and SoLSA
47	MS -> SS	CLASSMARK CHANGE	
48	SS -> MS	CHANNEL RELEASE	After the sending of this message, the SS waits for the disconnection of the main signalling link.

Specific message contents:

LOCATION UPDATING REQUEST

Information element	Value/remark
as default except: Mobile station Classmark 1 - ES IND	Controlled Early Classmark Sending option is implemented
Mobile station Classmark 2 - ES IND - SoLSA	Controlled Early Classmark Sending option is implemented SoLSA supported

CLASSMARK CHANGE

Information element	Value/remark
as default except: Mobile station Classmark 2 -ES IND -SoLSA	Controlled Early Classmark Sending is implemented. SoLSA supported

PAGING RESPONSE

Information element	Value/remark
Protocol Discriminator	RR management
Ciphering Key Sequence number - Key Sequence	Key sequence number previously allocated to MS, or "111" if no key is available
Mobile station Classmark 2 - ES IND - SoLSA	Shall indicate early autonomous sending of CLASSMARK CHANGE SoLSA supported
Mobile Identity - odd/even - Type of identity - Identity digits	Even TMSI TMSI previously allocated to MS

26.15.3.2 SoLSA signalling / MM / MM information

26.15.3.2.1 General remark

1. The network has total control of the LSA indication in active mode.
2. Whatever the System Informations are, the LSA ID transmitted in the MM Information message has higher priority.
3. The indication of the current LSA in active mode is independent from the setting of the configurations parameters "LSA indication in idle mode" and "idle mode support" stored in the SIM in EF_{SLL} (see GSM11.11, 10.4.1.2).

26.15.3.2.2 Definition and applicability

The SoLSA MS in active mode may inform the user whether or not the serving cell is an LSA cell. The information about a serving cell is indicated in the display of the SoLSA MS.

The change out of an LSA or into an LSA may be indicated by the SoLSA MS, e.g. using a beep.

26.15.3.2.3 Conformance requirement

1. It shall be possible to assign a subscriber defined identifier by the operator to each LSA (alphanumeric text up to 10 characters), which can be provided to the user in idle and active mode. As an MS manufacturer option the user may assign an icon or another form of indication to each LSA.

It shall be possible to indicate a change of localised service area during idle and active mode.

The indication is a network option (activated/deactivated by the network).

2. The network decides when to send a notification to the MS about a change of current LSA. The information will be sent from the MSC to the MS and will contain the LSA ID. This is done by adding the LSA ID of the current cell to the MM INFORMATION message. If no LSA ID is included in the MM Information message the MS shall assume that the current cell does not belong to any of the allowed LSAs for the subscriber.

The indication towards the user is optional and can be heard as e.g. a beep in the receiver or by displaying the stored LSA name that corresponds to the received LSA ID.

3. The MM INFORMATION message support is optional in the network. The MM information procedure may be invoked by the network at any time during an RR connection.

The MM information procedure consists only of the MM INFORMATION message sent from the network to the mobile station. During an RR connection, the network shall send none, one, or more MM INFORMATION messages to the mobile station. If more than one MM INFORMATION message is sent, the messages need not have the same content.

NOTE: The network may be able to select particular instants where it can send the MM INFORMATION message without adding delay to, or interrupting, any CM layer transaction, e.g. immediately after the AUTHENTICATION REQUEST message.

When the mobile station (supporting the MM INFORMATION message) receives an MM INFORMATION message, it shall accept the message and optionally use the contents to update appropriate information stored within the mobile station.

If the mobile station does not support the MM INFORMATION message the mobile station shall ignore the contents of the message and return an MM STATUS message with cause #97.

4. This IE (LSA Identity IE) may be sent by the network. The contents of this IE indicate the LSA identity of the serving cell.
5. The form of display and indication are left to manufacturer's choice.
6. If the Length of the LSA Identifier content is equal to 0, then no LSA ID is included. This is used to indicate that the MS has moved to an area where there is no LSA available for that MS.

References

- Conformance requirement 1: GSM 02.43, section 4.2.1.
- Conformance requirement 2: GSM 03.73, section 11.8.2
- Conformance requirement 3: TS24.008, section 4.3.6
- Conformance requirement 4: TS24.008, section 9.2.15a.5
- Conformance requirement 5: GSM 03.73, section 4.3.2
- Conformance requirement 6: TS24.008, section 10.5.3.11

26.15.3.2.4 Test Purpose

To verify that the SoLSA MS correctly handles the LSA information received in MM INFORMATION and performs indication accordingly.

26.15.3.2.5 Method of test

26.15.3.2.5.1 Initial Conditions

- a) The SoLSA MS is in the active state of a call (U10).
- b) The serving cell is cell 1 (carrier 1).
- c) Parameters: same default values defined in Table 20.24.1, except for the following values:

Parameter/condition	Carrier 1
LSA ID	54, 9.000.000, 250
LAC	5
CI	5000
Matching LSA on SIM	LSA1, LSA3
Escape PLMN	No

Run the following test procedure twice by using two different sets of initial conditions:

- with an LSA only SIM (see Definitions in chapter 20.24)
- with a normal LSA SIM (see Definitions in chapter 20.24)

26.15.3.2.5.2 Test Procedure

- a) A MM INFORMATION message including the LSA Identity IE is sent by the SS. The LSA Identity IE contains the LSA ID = 54 (LSA stored in the SIM).
- b) A MM INFORMATION message including the LSA Identity IE is sent by the SS. The LSA Identity IE contains the LSA ID = 250 (LSA not stored in the SIM).

- c) A MM INFORMATION message including the LSA Identity IE is sent by the SS. The LSA Identity IE contains the LSA ID = 54 (LSA stored in the SIM).
- d) The SS sends an MM INFORMATION message without an LSA Identity IE.
- e) A MM INFORMATION message including the LSA Identity IE is sent by the SS. The LSA Identity IE contains the LSA ID = 54 (LSA stored in the SIM).
- f) The SS sends an MM INFORMATION message which contains an LSA Identity IE. The value of the Length of LSA Identifier (octet 2) is set to zero (i.e. there are no LSA IDs included).
- g) A MM INFORMATION message including the LSA Identity IE is sent by the SS. The LSA Identity IE contains the LSA ID = 54 (LSA stored in the SIM).
- h) A MM INFORMATION message including the LSA Identity IE is sent by the SS. The LSA Identity IE contains the LSA ID = 9.000.000 (LSA stored in the SIM).

26.15.3.2.5.3 Related PICS/PIXIT statement(s)

- Support of SoLSA
- Interface to the human user (p1 = Y/N)
- Way to indicate the identity of the current LSA to the human user (only applicable if the SoLSA MS has an interface to the human user)
- Way to indicate the change of the current LSA to the human user (only applicable if the SoLSA MS has an interface to the human user)

26.15.3.2.5.4 Test Requirements

- 1) After step a) the SoLSA MS indicates a change of LSA (a subscribed LSA is entered).
- 2) After step b) the SoLSA MS indicates a change of LSA (a not subscribed LSA is entered).
- 3) After step c) the SoLSA MS indicates a change of LSA (a subscribed LSA is entered).
- 4) After step d) the SoLSA MS indicates a change of LSA (a not subscribed LSA is entered).
- 5) After step e) the SoLSA MS indicates a change of LSA (a subscribed LSA is entered).
- 6) After step f) the SoLSA MS indicates a change of LSA (a not subscribed LSA is entered).
- 7) After step g) the SoLSA MS indicates a change of LSA (a subscribed LSA is entered).
- 8) After step h) the SoLSA MS indicates a change of LSA (another subscribed LSA is entered).

26.15.4 SoLSA signalling / CC

26.15.4.1 SoLSA signalling / CC / call re-establishment / call present

26.15.4.1.1 Conformance requirement

- 1) If the call is in the "active" state or "mobile originating modify" state, the indication from MM that re-establishment is possible shall cause call control to request re-establishment from the MM-connection, suspend any further message to be sent and await the completion of the re-establishment procedure.
- 2) After the initial message the SoLSA MS shall send a CLASSMARK CHANGE message in the uplink block followed direct after the Layer 2 UA message sent from the network. The CLASSMARK CHANGE message shall contain information elements Mobile Station Classmark 2.

- 3) When the call control entity is notified that the MM-connection is re-established, it shall then resume the transmission of possibly suspended messages and resume user data exchange when an appropriate channel is available.

References

- 1) TS 24.008, subclauses 4.5.1.6 and 5.5.4.2.
- 2) GSM 04.18 section 3.3.1.1.4.1, and 9.1.11
GSM 03.73 section 11.4.1
TS 24.008 sections 9.2.9, 9.2.15, 10.5.1.5 and 10.5.1.6
- 3) TS 24.008, subclauses 4.5.1.6 and 5.5.4.3.

26.15.4.1.2 Test purpose

To verify that the SoLSA MS supports "early classmark sending procedure", e.g. sending information to the network about SoLSA support during the re-establishment of an ongoing call.

26.15.4.1.3 Method of test

Related PICS/PIXIT statements

- Support of SoLSA .
- supported teleservices.

Initial conditions

System Simulator:

The SS simulates cells A and B. The LAC of cell A is different from the LAC of cell B. The PLMN identities of cell A and B are equal.

The call re-establishment parameter concerning cell A is set to an arbitrary value.

Cell B is not barred, the RACH control parameters information element sent in SYSTEM INFORMATION TYPE 1 to 4 messages of cell A and B specifies "call reestablishment allowed in the cell", the NCC of cell B is indicated as permitted in the PLMN permitted information element of SYSTEM INFORMATION TYPE 2 and 6 messages of cell A. Cell B is indicated as a neighbour cell of cell A in SYSTEM INFORMATION TYPE 2 and 5 messages of cell A. Cell reselect hysteresis parameter of cell A is set to zero.

Mobile Station:

The MS is in MM-state "idle, updated" with valid TMSI and CKSN on cell A.

Foreseen final state of the MS

The MS is in MM-state "idle, updated" with valid TMSI and CKSN.

Maximum duration of test

1 minute.

Test procedure

The MS is brought to active state by using procedure 26.9.2, "structured procedures, MS originated call, early assignment". The RF level of cell A is lowered so that cell B is to be selected (when the MS performs re-establishment after radio link failure), while keeping the C1 and C2 of cell A greater than zero. SS waits for at least 5 seconds. Then the SS stops transmission on the TCH/SACCH. The MS shall re-establish the call on cell B using a CM RE-ESTABLISHMENT message. The SS performs ciphering mode setting and assignment procedures. The MS shall through-connect the appropriate bearer channel. Then, the call is cleared by the SS.

Expected sequence

Step	Direction	Message	Comments
1			Steps 1-21 of test case 26.15.3.1 are performed (the appropriate bearer channel is through connected in both directions in TCH)
2	SS		The RF level of cell A is lowered. The SS waits at least 5 seconds. The SS stops transmission on the TCH/SACCH.
3	MS -> SS	CHANNEL REQUEST	this is sent on cell B. Establ. Cause shall be "call re-establishment; TCH/F was in use,..."
4	SS -> MS	IMMEDIATE ASSIGNMENT	
5	MS -> SS	CM REESTABLISHMENT REQUEST	note specific message contents
6	SS -> MS	UA (CM REESTABLISHMENT REQUEST)	
7	MS -> SS	CLASSMARK CHANGE	Shall be ready to transmit (see GSM 05.10 section 06.10) within 40 ms after the completion of step 5. "mobile station classmark 2" includes settings for ES IND and SoLSA Note: In this case 'ready to transmit' shall result in the actual transmission of the Classmark Change 51 frames later (51 * 4.62ms = 235.62 ms). Therefore receipt of the Classmark Change within 250ms of step 5 is required.
7	SS -> MS	CIPHERING MODE COMMAND	SS starts deciphering after sending the message.
8	MS -> SS	CIPHERING MODE COMPLETE	Shall be sent enciphered. All following messages shall be sent enciphered.
9	SS		SS starts ciphering.
10	SS -> MS	ASSIGNMENT COMMAND	
11	MS -> SS	ASSIGNMENT COMPLETE	
12	MS		The appropriate bearer channel is through connected in both directions.
13	SS -> MS	DISCONNECT	with cause value "Normal"
14	MS -> SS	RELEASE	
15	SS -> MS	RELEASE COMPLETE	
16	SS -> MS	CHANNEL RELEASE	The main signalling link is released.

Specific message contents:

CM RE-ESTABLISHMENT REQUEST

Information element	Value/remark
Protocol discriminator	Mobility Management
Skip indicator	Encoded as zeroes
Message type	CM RE-ESTABLISHMENT REQUEST
Ciphering key sequence number	The CKSN which the MS was allocated in step 6 of the procedure of section 26.15.3.1
Spare half octet	zero
Mobile station Classmark 2	
- ES IND	Shall indicate early autonomous sending of CLASSMARK CHANGE
- SoLSA	SoLSA supported
Mobile identity	The TMSI that the MS is having initially
Location area identification	Corresponding the LAI of cell A

CLASSMARK CHANGE

Information element	Value/remark
as default except:	
Mobile station Classmark 2	
-ES IND	Controlled Early Classmark Sending is implemented.
-SoLSA	SoLSA supported

26.15.5 SoLSA signalling / structured procedures

These tests applies only to SoLSA mobile stations.

26.15.5.1 SoLSA signalling / structured procedures / MS originated call / early assignment

26.15.5.1.1 Conformance requirements

- 1) An MS in MM state "idle, updated" and in RR idle mode, when made to initiate a call, if it provides a human interface, shall display the dialled number.
- 2) An MS in MM state "idle, updated" and in RR idle mode, when made to initiate a call for a selected teleservice that is supported by the MS, shall start to initiate the immediate assignment procedure by sending a CHANNEL REQUEST message with correct establishment cause.
- 3) After the initial message the SoLSA MS shall send a CLASSMARK CHANGE message in the uplink block followed direct after the Layer 2 UA message sent from the network. The CLASSMARK CHANGE message shall contain information elements Mobile Station Classmark 2.
- 4) Subsequently after establishment of an MM connection, the MS shall send a SETUP message with correct parameters.
- 5) The call control entity of the Mobile Station in the "call initiated" state, in the "mobile originating call proceeding" state or in the "call delivered" state, shall, upon receipt of a CONNECT message:
 - attach the user connection to the radio path;
 - return a CONNECT ACKNOWLEDGE message.
- 6) Subsequently when the network initiates call clearing by sending a DISCONNECT message, the MS shall proceed to release the call by sending a RELEASE message.
- 7) On receipt of a CHANNEL RELEASE message, the MS shall disconnect the main signalling link.

References

- Conformance requirement 1: GSM 02.07 section B.1.1
- Conformance requirement 2: GSM 04.18 section 3.3.1.1
- Conformance requirement 3: GSM 04.18 section 3.3.1.1.4.1 and 9.1.11
GSM 03.73 section 11.4.1
TS 24.008 sections 9.2.9, 9.2.15, 10.5.1.5 and 10.5.1.6
- Conformance requirement 4: TS 24.008 section 5.2.1
- Conformance requirement 5: TS 24.008 section 5.2.1.6
- Conformance requirement 6: TS 24.008 section 5.4.4
- Conformance requirement 7: GSM 04.18 section 3.4.13.1

26.15.5.1.2 Test purpose

To verify that the SoLSA MS supports "early classmark sending procedure", e.g. sending information to the network about SoLSA support during a mobile originating call (MOC) with early assignment procedure.

26.15.5.1.3 Method of test

Related PICS/PIXIT Statements

- Support of SoLSA
- Supported rates (full rate/half rate)
- Supported speech versions (full rate version 1, full rate version 2, half rate version 1)
- Interface to the human user (p1 = Y/N)
- Way to display the called number (only applicable if the MS has an interface to the human user)
- Way to indicate alerting (only applicable if the MS supports the feature)
- SS version
- Supported teleservices
- Classmark

Initial Conditions

System Simulator:

1 cell, default parameters.

Mobile Station:

The MS is in MM-state "idle, updated" with valid TMSI and CKSN.

Foreseen Final State of the MS

The MS is in MM-state "idle, updated" with valid TMSI and CKSN.

Test procedure

The following test is performed for all rates (full rate/half rate) supported by the MS:

A teleservice is selected that is supported by the MS; if the MS supports speech, the selected teleservice is speech. If necessary, the MS is configured for that teleservice.

The MS is made to initiate a call on any frequency band supported by the MS. The call is established with early assignment. Having reached the active state, the call is cleared by the SS.

Maximum Duration of Test

1 minute.

Expected Sequence

Step	Direction	Message	Comments
1	MS		The "called number" is entered
2	MS		If p1 = Y, the MS must display the called number in the way defined in PICS/PIXIT.
3	MS -> SS	CHANNEL REQUEST	Establishment cause is "originating call and the network does not set the NECI bit to 1".
4	SS -> MS	IMMEDIATE ASSIGNMENT	
5	MS -> SS	CM SERVICE REQUEST	Message is contained in SABM. Indicating early sending of CLASSMARK CHANGE and SoLSA support
6	SS -> MS	UA (CM SERVICE REQUEST)	
7	MS -> SS	CLASSMARK CHANGE	Shall be ready to transmit (see GSM 05.10 section 06.10) within 40 ms after the completion of step 5. "mobile station classmark 2" includes settings for ES IND and SoLSA Note: In this case 'ready to transmit' shall result in the actual transmission of the Classmark Change 51 frames later (51 * 4.62ms = 235.62 ms). Therefore receipt of the Classmark Change within 250ms of step 5 is required.
8	SS -> MS	AUTHENTICATION REQUEST	
9	MS -> SS	AUTHENTICATION RESP	SRES specifies correct value.
10	SS -> MS	CIPHERING MODE COMMAND	SS starts deciphering after sending the message.
11	MS -> SS	CIPHERING MODE COMPLETE	Shall be sent enciphered. All following messages shall be sent enciphered. SS starts ciphering.
12	SS		
13	MS -> SS	SETUP	
14	SS -> MS	CALL PROCEEDING	
15	SS -> MS	ASSIGNMENT COMMAND	
16	MS -> SS	ASSIGNMENT COMPLETE	
17	SS -> MS	ALERTING	
18	MS		Depending on the PICS, an alerting indication is given
19	SS -> MS	CONNECT	
20	MS -> SS	CONNECT ACKNOWLEDGE	
21	MS		The appropriate bearer channel is through connected in both directions.
22	SS -> MS	DISCONNECT	
23	MS -> SS	RELEASE	
24	SS -> MS	RELEASE COMPLETE	
25	SS -> MS	CHANNEL RELEASE	The main signalling link is released.

Specific Message Contents:

CM SERVICE REQUEST

Information element	Value/remark
as default except: Mobile station Classmark 2 - ES IND - SoLSA	Shall indicate early autonomous sending of CLASSMARK CHANGE SoLSA supported

CLASSMARK CHANGE

Information element	Value/remark
as default except: Mobile station Classmark 2 -ES IND -SoLSA	Controlled Early Classmark Sending is implemented. SoLSA supported

26.15.5.2 SoLSA signalling / structured procedures / MS originated call / late assignment

26.15.5.2.1 Conformance requirements

- 1) An MS in MM state "idle, updated" and in RR idle mode, when made to initiate a call, if it provides a human interface, shall display the dialled number.
- 2) An MS in MM state "idle, updated" and in RR idle mode, when made to initiate a call for a selected teleservice that is supported by the MS, shall start to initiate the immediate assignment procedure by sending a CHANNEL REQUEST message with correct establishment cause.
- 3) After the initial message the SoLSA MS shall send a CLASSMARK CHANGE message in the uplink block followed direct after the Layer 2 UA message sent from the network. The CLASSMARK CHANGE message shall contain information element Mobile Station Classmark 2.
- 4) Upon receipt of the ASSIGNMENT COMMAND message, the Mobile Station initiates a local end release of link layer connections, disconnects the physical channels, commands the switching to the assigned channels and initiates the establishment of lower layer connections (this includes the activation of the channels, their connection and the establishment of the data links). After the main signalling link is successfully established, the MS returns an ASSIGNMENT COMPLETE message, specifying cause "normal event", to the network on the main DCCH.
- 5, 6) The call control entity of the Mobile Station in the "call initiated" state, in the "mobile originating call proceeding" state or in the "call delivered" state, shall, upon receipt of a CONNECT message:
 - attach the user connection to the radio path;
 - return a CONNECT ACKNOWLEDGE message.
- 7) Subsequently when the network initiates call clearing by sending a DISCONNECT message, the MS shall proceed to release the call by sending a RELEASE message.
- 8) On receipt of a CHANNEL RELEASE message, the MS shall disconnect the main signalling link.

References

- Conformance requirement 1: GSM 02.07 section B.1.1
- Conformance requirement 2: GSM 04.18 section 3.3.1.1
- Conformance requirement 3: GSM 04.18 section 3.3.1.1.4.1, and 9.1.11
GSM 03.73 section 11.4.1
TS 24.008 sections 9.2.9, 9.2.15, 10.5.1.5 and 10.5.1.6
- Conformance requirement 4: GSM 04.18 sections 3.4.3.1 and 3.4.3.2
- Conformance requirement 5: TS 24.008 sections section 5.2.1.6
- Conformance requirement 6: TS 24.008 sections section 5.2.1.6
- Conformance requirement 7: TS 24.008 sections section 5.4.4
- Conformance requirement 8: GSM04.18 section 3.4.13.1

26.15.5.2.2 Test purpose

To verify that the SoLSA MS supports "early classmark sending procedure", e.g. sending information to the network about SoLSA support during a mobile originating call (MOC) with late assignment procedure.

26.15.5.2.3 Method of test

Related PICS/PIXIT Statements

- Support of SoLSA
- Supported rates (full rate/half rate)
- Supported speech versions (full rate version 1, full rate version 2, half rate version 1)
- Interface to the human user (p1 = Y/N)
- Way to display the called number (only applicable if the MS has an interface to the human user)
- Way to indicate alerting (only applicable if the MS supports the feature)
- SS version
- Supported teleservices
- Classmark

Initial Conditions

System Simulator:

1 cell, default parameters

Mobile Station:

The MS is in MM-state "idle, updated" with valid TMSI and CKSN.

Foreseen Final State of the MS

The MS is in MM-state "idle, updated" with valid TMSI and CKSN.

Test procedure

The following test is performed for all rates (full rate/half rate) supported by the MS:

A teleservice is selected that is supported by the MS; if the MS supports speech, the selected teleservice is speech. If necessary, the MS is configured for that teleservice.

The MS is made to initiate a call on any frequency band supported by the MS. The call is established with late assignment. Having reached the active state, the call is cleared by the SS.

Maximum Duration of Test

1 minute.

Expected Sequence

Step	Direction	Message	Comments
1	MS		The "called number" is entered
2	MS		If p1 = Y, the MS must display the called number in the way defined in PICS/PIXIT.
3	MS -> SS	CHANNEL REQUEST	Establishment cause is "originating call and the network does not set the NECI bit to 1".
4	SS -> MS	IMMEDIATE ASSIGNMENT	
5	MS -> SS	CM SERVICE REQUEST	Message is contained in SABM. Indicating early sending of CLASSMARK CHANGE and SoLSA support
6	SS -> MS	UA (CM SERVICE REQUEST)	
7	MS -> SS	CLASSMARK CHANGE	Shall be ready to transmit (see GSM 05.10 section 06.10) within 40 ms after the completion of step 5. "mobile station classmark 2" includes settings for ES IND and SoLSA Note: In this case 'ready to transmit' shall result in the actual transmission of the Classmark Change 51 frames later (51 * 4.62ms = 235.62 ms). Therefore receipt of the Classmark Change within 250ms of step 5 is required.
8	SS -> MS	AUTHENTICATION REQUEST	
9	MS -> SS	AUTHENTICATION RESP	SRES specifies correct value.
10	SS -> MS	CIPHERING MODE COMMAND	SS starts deciphering after sending the message.
11	MS -> SS	CIPHERING MODE COMPLETE	Shall be sent enciphered. All following messages shall be sent enciphered. SS starts ciphering.
12	SS		
13	MS -> SS	SETUP	
14	SS -> MS	CALL PROCEEDING	
15	SS -> MS	ALERTING	
16	MS		Depending on the PICS, an alerting indication is given
17	SS -> MS	ASSIGNMENT COMMAND	
18	MS -> SS	ASSIGNMENT COMPLETE	
19	SS -> MS	CONNECT	
20	MS -> SS	CONNECT ACKNOWLEDGE	
21	MS		The appropriate bearer channel is through connected in both directions.
22	SS -> MS	DISCONNECT	
23	MS -> SS	RELEASE	
24	SS -> MS	RELEASE COMPLETE	
25	SS -> MS	CHANNEL RELEASE	The main signalling link is released.

Specific Message Contents:

CM SERVICE REQUEST

Information element	Value/remark
as default except: Mobile station Classmark 2 - ES IND - SoLSA	Shall indicate early autonomous sending of CLASSMARK CHANGE SoLSA supported

CLASSMARK CHANGE

Information element	Value/remark
as default except: Mobile station Classmark 2 -ES IND -SoLSA	Controlled Early Classmark Sending is implemented. SoLSA supported

26.15.5.3 SoLSA signalling / structured procedures / MS terminated call / early assignment

26.15.5.3.1 Conformance requirement

- 1) After the initial message the SoLSA MS shall send a CLASSMARK CHANGE message in the uplink block followed direct after Layer 2 UA message sent from the network.
- 2) The MS shall acknowledge the SETUP message with a CALL CONFIRMED message, if compatibility checking was successful, the MS is not busy, and the user does not refuse the call.
- 3, 4) Upon receipt of the ASSIGNMENT COMMAND message the MS continues a mobile terminating call establishment with early establishment of the traffic channel
 - a) by replying to the ASSIGNMENT COMMAND with an ASSIGNMENT COMPLETE message, and
 - b) if the MS supports immediate connect, by continuing the call establishment by through-connecting the traffic channel in both directions, or if the MS does not support immediate connect, by sending an ALERTING message
- 5) An MS indicates acceptance of a MT call by sending CONNECT.
- 6) For speech calls:

The mobile station shall attach the user connection at latest when sending the connect message, except if there is no compatible radio resource available at this time. In this case the attachment shall be delayed until such a resource becomes available.

For data calls:

The mobile station shall attach the user connection when receiving the CONNECT ACKNOWLEDGE message from the network.

- 7) The MS initiates call clearing of an active call by sending a DISCONNECT message.
- 8) The MS in this phase of call release, upon receipt of a RELEASE message, shall return a RELEASE COMPLETE message.
- 9) Subsequently the MS, upon receipt of a CHANNEL RELEASE message, shall disconnect the main signalling link.

Requirement reference:

- | | |
|------------------------------|---|
| Conformance requirement 1: | GSM 04.18 section 3.3.1.1.4.1 and 9.1.11
GSM 03.73 section 11.4.1
TS 24.008 sections 9.2.9, 9.2.15, 10.5.1.5 and 10.5.1.6 |
| Conformance requirements 2: | TS 24.008 sections 5.2.2.3.1 |
| Conformance requirement 3,4: | GSM 04.18 section 3.4.3.1, 3.4.3.2 |
| Conformance requirement 5: | TS 24.008 section 5.2.2.5 |
| Conformance requirement 6: | TS 24.008 section 5.2.2.9 |
| Conformance requirement 7: | TS 24.008 section 5.4.3.1 |
| Conformance requirement 8: | TS 24.008 section 5.4.3.3 |
| Conformance requirement 9: | GSM 04.18 section 3.4.13.1 |

26.15.5.3.2 Test Purpose

To verify that the SoLSA MS supports “early classmark sending procedure”, e.g. sending information to the network about SoLSA support during a mobile terminated call (MTC) with early assignment procedure.

26.15.5.3.3 Method of test

Related PICS/PIXIT statements

- Support of SoLSA
- Supported rates (full rate/half rate)
- Supported speech versions (full rate version 1, full rate version 2, half rate version 1)
- Interface to the human user (p1 = Y/N)
- Way to display the called number (only applicable if the MS has an interface to the human user)
- Way to indicate alerting (only applicable if the MS supports the feature)
- Supported teleservices
- Classmark
- Immediate connect supported (Y/N)

Initial Conditions

System Simulator:

1 cell, default parameters.

Mobile Station:

The MS is in MM-state "idle, updated" with valid TMSI and CKSN.

Test procedure

The following test is performed for all rates (full rate/half rate) supported by the MS:

A teleservice is selected that is supported by the MS; if the MS supports speech, the selected teleservice is speech. If necessary, the MS is configured for that teleservice.

The MS is paged and the resulting call is established. Having reached the active state, the MS is made to clear the call.

Maximum Duration of Test

1 minute.

Expected Sequence

Step	Direction	Message	Comments	
1	SS -> MS	PAGING REQUEST TYPE 1	Sent on the correct paging subchannel Establishment cause indicates "answer to paging". Message is contained in SABM "Mobile identity" IE contains the IMSI. "mobile station classmark 2" including settings for ES IND and SoLSA.	
2	MS -> SS	CHANNEL REQUEST		
3	SS -> MS	IMMEDIATE ASSIGNMENT		
4	MS -> SS	PAGING RESPONSE		
5	SS -> MS	UA (PAGING RESPONSE)	Shall be ready to transmit (see GSM 05.10 section 06.10) within 40 ms after the completion of step 4. "mobile station classmark 2" includes settings for ES IND and SoLSA Note: In this case 'ready to transmit' shall result in the actual transmission of the Classmark Change 51 frames later (51 * 4.62ms = 235.62 ms). Therefore receipt of the Classmark Change within 250ms of step 4 is required. SRES specifies correct value. SS starts deciphering after sending the message. Shall be sent enciphered. All following messages shall be sent enciphered. SS starts ciphering. Message contains the signal IE. If the MS supports immediate connect then branch A applies. If the MS does not support immediate connect then branch B applies	
6	MS -> SS	CLASSMARK CHANGE		
7	SS -> MS	AUTHENTICATION REQUEST		
8	MS -> SS	AUTHENTICATION RESP		
9	SS -> MS	CIPHERING MODE COMMAND		
10	MS -> SS	CIPHERING MODE COMPLETE		
11	SS			
12	SS -> MS	SETUP		
13	MS -> SS	CALL CONFIRMED		
A12	MS -> SS	CONNECT		sent on the old channel
A13	SS -> MS	ASSIGNMENT COMMAND		
A14	MS -> SS	ASSIGNMENT COMPLETE		
B12	SS -> MS	ASSIGNMENT COMMAND		sent on the new channel An alerting indication as defined in a PICS/PIXIT statement is given by the MS The MS is made to accept the call in the way described in a PICS/PIXIT statement
B13	MS -> SS	ASSIGNMENT COMPLETE		
B14	MS -> SS	ALERTING		
B15	MS			
B16	MS			
B17	MS -> SS	CONNECT		
18	MS		If the call is a speech call, the TCH shall be through connected in both directions. If the call is a data call, the TCH shall be through connected in both directions. The MS is made to release the call. The main signalling link is released.	
19	SS -> MS	CONNECT ACKNOWLEDGE		
20	MS			
21	MS			
22	MS -> SS	DISCONNECT		
23	SS -> MS	RELEASE		
24	MS -> SS	RELEASE COMPLETE		
25	SS -> MS	CHANNEL RELEASE		

Specific Message Contents:

CLASSMARK CHANGE

Information element	Value/remark
as default except: Mobile station Classmark 2 -ES IND -SoLSA	Controlled Early Classmark Sending is implemented. SoLSA supported

PAGING RESPONSE

Information element	Value/remark
Protocol Discriminator	RR management
Ciphering Key Sequence number - Key Sequence	Key sequence number previously allocated to MS, or "111" if no key is available
Mobile station Classmark 2 - ES IND	Shall indicate early autonomous sending of CLASSMARK CHANGE
- SoLSA	SoLSA supported
Mobile Identity - odd/even	Even
- Type of identity	TMSI
- Identity digits	TMSI previously allocated to MS

26.15.5.4 SoLSA signalling / structured procedures / MS terminated call / late assignment

26.15.5.4.1 Conformance requirement

- 1) After the initial message the SoLSA MS shall send a CLASSMARK CHANGE message in the uplink block followed direct after Layer 2 UA message sent from the network.
- 2) The MS shall acknowledge the SETUP message with a CALL CONFIRMED message, if compatibility checking was successful, the MS is not busy, and the user does not refuse the call.
- 3) An MS indicates acceptance of a MT call by sending CONNECT. If the MS does not support immediate connect, it sends an ALERTING message
- 4, 5) Upon receipt of the ASSIGNMENT COMMAND message the MS continues a mobile terminating call establishment with late establishment of the traffic channel
 - a) by replying to the ASSIGNMENT COMMAND with an ASSIGNMENT COMPLETE message, and
- 6) For speech calls:

The mobile station shall attach the user connection at latest when sending the connect message, except if there is no compatible radio resource available at this time. In this case the attachment shall be delayed until such a resource becomes available.

For data calls:

The mobile station shall attach the user connection when receiving the CONNECT ACKNOWLEDGE message from the network.
- 7) The MS initiates call clearing of an active call by sending a DISCONNECT message.
- 8) The MS in this phase of call release, upon receipt of a RELEASE message, shall return a RELEASE COMPLETE message.
- 9) Subsequently the MS, upon receipt of a CHANNEL RELEASE message, shall disconnect the main signalling link.

Requirement reference:

Conformance requirement 1: GSM 04.18 section 3.3.1.1.4.1, and 9.1.11
 GSM 03.73 section 11.4.1
 TS 24.008 sections 9.2.9, 9.2.15, 10.5.1.5 and 10.5.1.6

Conformance requirements 2: TS 24.008 sections 5.2.2.3.1

Conformance requirement 3,4:	GSM 04.18 section 3.4.3.1, 3.4.3.2
Conformance requirement 5:	TS 24.008 section 5.2.2.5
Conformance requirement 6:	TS 24.008 section 5.2.2.9
Conformance requirement 7:	TS 24.008 section 5.4.3.1
Conformance requirement 8:	TS 24.008 section 5.4.3.3
Conformance requirement 9:	GSM 04.18 section 3.4.13.1

26.15.5.4.2 Test Purpose

To verify that the SoLSA MS supports “early classmark sending procedure”, e.g. sending information to the network about SoLSA support during a mobile terminated call (MTC) with late assignment procedure.

26.15.5.4.3 Method of test

Related PICS/PIXIT statements

- Support of SoLSA
- Supported rates (full rate/half rate)
- Supported speech versions (full rate version 1, full rate version 2, half rate version 1)
- Interface to the human user (p1 = Y/N)
- Way to display the called number (only applicable if the MS has an interface to the human user)
- Way to indicate alerting (only applicable if the MS supports the feature)
- Supported teleservices
- Classmark
- Immediate connect supported (Y/N)

Initial Conditions

System Simulator:

1 cell, default parameters.

Mobile Station:

The MS is in MM-state "idle, updated" with valid TMSI and CKSN.

Test procedure

The following test is performed for all rates (full rate/half rate) supported by the MS:

A teleservice is selected that is supported by the MS; if the MS supports speech, the selected teleservice is speech. If necessary, the MS is configured for that teleservice.

The MS is paged and a MT call is established with late assignment (after CONNECT). Having reached the active state, the MS is made to clear the call.

Maximum Duration of Test

1 minute.

Expected Sequence

Step	Direction	Message	Comments
1	SS -> MS	PAGING REQUEST TYPE 1	Sent on the correct paging subchannel Establishment cause indicates "answer to paging". Message is contained in SABM "Mobile identity" IE contains the IMSI. "mobile station classmark 2" including settings for ES IND and SoLSA.
2	MS -> SS	CHANNEL REQUEST	
3	SS -> MS	IMMEDIATE ASSIGNMENT	
4	MS -> SS	PAGING RESPONSE	
5	SS -> MS	UA (PAGING RESPONSE)	Shall be ready to transmit (see GSM 05.10 section 06.10) within 40 ms after the completion of step 4. "mobile station classmark 2" includes settings for ES IND and SoLSA Note: In this case 'ready to transmit' shall result in the actual transmission of the Classmark Change 51 frames later ($51 * 4.62\text{ms} = 235.62\text{ms}$). Therefore receipt of the Classmark Change within 250ms of step 4 is required. SRES specifies correct value. SS starts deciphering after sending the message. Shall be sent enciphered. All following messages shall be sent enciphered. SS starts ciphering. Message contains the signal IE.
6	MS -> SS	CLASSMARK CHANGE	
7	SS -> MS	AUTHENTICATION REQUEST	
8	MS -> SS	AUTHENTICATION RESP	
9	SS -> MS	CIPHERING MODE COMMAND	
10	MS -> SS	CIPHERING MODE COMPLETE	
11	SS		Message contains the signal IE.
12	SS -> MS	SETUP	
13	MS -> SS	CALL CONFIRMED	
A14 B14 B15	MS -> SS MS -> SS MS	CONNECT ALERTING	An alerting indication as defined in a PICS/PIXIT statement is given by the MS The MS is made to accept the call in the way described in a PICS/PIXIT statement
B16	MS		
B17	MS -> SS	CONNECT	
18	SS -> MS	ASSIGNMENT COMMAND	
19	MS -> SS	ASSIGNMENT COMPLETE	
20	MS		If the call is a speech call, the TCH shall be through connected in both directions. If the call is a data call, the TCH shall be through connected in both directions. The MS is made to release the call. The main signalling link is released.
21	SS -> MS	CONNECT ACKNOWLEDGE	
22	MS		
23	MS		
24	MS -> SS	DISCONNECT	
25	SS -> MS	RELEASE	
26	MS -> SS	RELEASE COMPLETE	
27	SS -> MS	CHANNEL RELEASE	

Specific Message Contents:

CLASSMARK CHANGE

Information element	Value/remark
as default except: Mobile station Classmark 2 -ES IND -SoLSA	Controlled Early Classmark Sending is implemented. SoLSA supported

PAGING RESPONSE

Information element	Value/remark
Protocol Discriminator	RR management
Ciphering Key Sequence number - Key Sequence	Key sequence number previously allocated to MS, or "111" if no key is available
Mobile station Classmark 2 - ES IND	Shall indicate early autonomous sending of CLASSMARK CHANGE SoLSA supported
- SoLSA	
Mobile Identity - odd/even	Even
- Type of identity	TMSI
- Identity digits	TMSI previously allocated to MS

26.15.5.5 SoLSA signalling / structured procedures / emergency call / idle updated

26.15.5.5.1 Conformance requirements

- 1) The MS in the "idle, updated" state, as after a successful location update, after the number 112 (for GSM 900 and 1800 MS), or 911 (for PCS 1900 MS in USA and Canada), or 08 (for PCS 1900 MS in Mexico) has been entered by user, shall send a CHANNEL REQUEST message with correct establishment cause ("emergency call").
- 2) After assignment of a dedicated channel the first layer message sent by the MS on the assigned dedicated channel shall be a CM SERVICE REQUEST message specifying the correct CKSN and TMSI, with CM Service Type "emergency call establishment" and indicating early sending of classmark change and SoLSA support.
- 3) After the initial message the SoLSA MS shall send a CLASSMARK CHANGE message in the uplink block followed direct after the Layer 2 UA message sent from the network. The CLASSMARK CHANGE message shall contain information elements Mobile Station Classmark 2.
- 4) Authentication and cipher mode setting shall be performed successfully.
- 5) After cipher mode setting acceptance by the network, the MS shall send an EMERGENCY SETUP message.
- 6), 7) The emergency call shall be correctly established. The assignment procedure shall be correctly performed.
- 8) After receipt of a CONNECT ACKNOWLEDGE message during correct establishment of the emergency call the TCH shall be through connected in both directions if an appropriate TCH is available.
- 9) The call shall be cleared correctly.

Requirement Reference:

Conformance requirement 1 and 2:	GSM 04.18 section 3.3.1.1 TS 24.008 section 5.2.1, 4.5.1.5 GSM 02.30 section 4.2.2
Conformance requirement 3:	GSM 04.18 section 3.3.1.1.4.1, and 9.1.11 GSM 03.73 section 11.4.1 TS 24.008 sections 9.2.9, 9.2.15, 10.5.1.5 and 10.5.1.6
Conformance requirement 4:	GSM 04.18, section 3.4.7 TS 24.008 section 4.3.2
Conformance requirement 5:	TS 24.008, section 5.2.1

Conformance requirement 6 and 7: GSM 04.18, section 3.4.3

Conformance requirement 8: TS 24.008, sections 5.2.1.6

Conformance requirement 9: TS 24.008, section 5.4.

26.15.5.5.2 Test purpose

To verify that the SoLSA MS supports “early classmark sending procedure”, e.g. sending information to the network about SoLSA support during an Emergency Call.

26.15.5.5.3 Method of test

Related PICS/PIXIT Statements

- Support of SoLSA .
- Speech supported .
- Supported rate for speech: (p1 = F/H, F).
- Classmark.

Initial Conditions

System Simulator:

1 cell, default parameters.

Mobile Station:

The MS is in MM-state "idle, updated" with valid TMSI and CKSN.

Foreseen Final State of the MS

The MS is in MM-state "idle, updated" with valid TMSI and CKSN.

Test procedure

The MS is made to initiate an emergency call. The call is established with late assignment. Having reached the active state, the call is cleared by the SS.

Maximum Duration of Test

1 minute.

Expected Sequence

Step	Direction	Message	Comments
1	MS		The appropriate emergency call number is entered.
2	MS -> SS	CHANNEL REQUEST	Establishment cause is emergency call establishment.
3	SS -> MS	IMMEDIATE ASSIGNMENT	
4	MS -> SS	CM SERVICE REQUEST	Message is contained in SABM. The CM service type IE indicates "emergency call establishment". The classmark 2 IE indicates early sending of CLASSMARK CHANGE and SoLSA support
5	SS -> MS	UA (CM SERVICE REQUEST)	
6	MS -> SS	CLASSMARK CHANGE	Shall be ready to transmit (see GSM 05.10 section 06.10) within 40 ms after the completion of step 4. "mobile station classmark 2" includes settings for ES IND and SoLSA Note: In this case 'ready to transmit' shall result in the actual transmission of the Classmark Change 51 frames later (51 * 4.62ms = 235.62 ms). Therefore receipt of the Classmark Change within 250ms of step 4 is required.
7	SS -> MS	AUTHENTICATION REQUEST	
8	MS -> SS	AUTHENTICATION RESPONSE	SRES specifies correct value.
9	SS -> MS	CIPHERING MODE COMMAND	SS starts deciphering after sending the message.
10	MS -> SS	CIPHERING MODE COMPLETE	Shall be sent enciphered. All following messages shall be sent enciphered.
11	SS		SS starts ciphering.
12	MS -> SS	EMERGENCY SETUP	If p1 = F/H, the message must contain one bearer capability IE indicating in the radio channel requirement field "dual rate/half rate preferred" or "dual rate/full rate preferred". If p1 = F, the message must either contain no bearer capability IE or contain one bearer capability IE indicating in the radio channel requirement field "full rate channel".
13	SS -> MS	CALL PROCEEDING	
14	SS -> MS	ALERTING	
15	SS -> MS	ASSIGNMENT COMMAND	The rate of the channel is that one indicated by the EMERGENCY SETUP message, if that message did not offer a choice, and the rate is the preferred one else.
16	MS -> SS	ASSIGNMENT COMPLETE	
17	SS -> MS	CONNECT	
18	MS -> SS	CONNECT ACKNOWLEDGE	
19	MS		The TCH is through connected in both directions.
20	SS -> MS	DISCONNECT	
21	MS -> SS	RELEASE	
22	SS -> MS	RELEASE COMPLETE	
23	SS -> MS	CHANNEL RELEASE	The main signalling link is released.

Specific Message Contents:

CM SERVICE REQUEST

Information element	Value/remark
as default except: CM Service type	Emergency call establishment
Mobile station Classmark 2 - ES IND	Shall indicate early autonomous sending of CLASSMARK CHANGE
- SoLSA	SoLSA supported

CLASSMARK CHANGE

Information element	Value/remark
as default except: Mobile station Classmark 2 -ES IND -SoLSA	Controlled Early Classmark Sending is implemented. SoLSA supported

26.15.5.6 SoLSA signalling / structured procedures / emergency call / idle, no IMSI

26.15.5.6.1 Conformance requirements

- 1) The MS in the "idle, updated" state, as after a successful location update, after the number 112 (for GSM 900 and 1800 MS), or 911 (for PCS 1900 MS in USA and Canada), or 08 (for PCS 1900 MS in Mexico) has been entered by user, shall send a CHANNEL REQUEST message with correct establishment cause ("emergency call").
- 2) After assignment of a dedicated channel the first layer message sent by the MS on the assigned dedicated channel shall be a CM SERVICE REQUEST message specifying the correct IMEI and a non-available CKSN, with CM Service Type "emergency call establishment" and indicating early sending of classmark change and SoLSA support.
- 3) After the initial message the SoLSA MS shall send a CLASSMARK CHANGE message in the uplink block followed direct after the Layer 2 UA message sent from the network. The CLASSMARK CHANGE message shall contain information elements Mobile Station Classmark 2.
- 4) After cipher mode setting acceptance by the network, the MS shall send an EMERGENCY SETUP message.
- 5),6) The emergency call shall be correctly established. The assignment procedure shall be correctly performed.
- 7) After receipt of a CONNECT ACKNOWLEDGE message during correct establishment of the emergency call the TCH shall be through connected in both directions if an appropriate TCH is available.
- 8) The call shall be cleared correctly.

Requirement Reference:

- Conformance requirement 1 and 2: GSM 04.18 section 3.3.1.1
TS 24.008 section 5.2.1, 4.5.1.5
GSM 02.30 section 4.2.2
- Conformance requirement 3: GSM 04.18 section 3.3.1.1.4.1, and 9.1.11
GSM 03.73 section 11.4.1
TS 24.008 sections 9.2.9, 9.2.15, 10.5.1.5 and 10.5.1.6
- Conformance requirement 4: TS 24.008, section 5.2.1
- Conformance requirement 5 and 6: GSM 04.18, section 3.4.3
- Conformance requirement 7: TS 24.008, section 5.2.1.6
- Conformance requirement 8: TS 24.008, section 5.4

26.15.5.6.2 Test purpose

To verify that the SoLSA MS in the "idle, no IMSI" state (no SIM inserted), supports "early classmark sending procedure", e.g. sending information to the network about SoLSA support during an Emergency Call.

26.15.5.6.3 Method of test

Related PICS/PIXIT Statements

- Support of SoLSA
- Speech supported
- Supported rate for speech: (p1 = F/H, F).
- Classmark.

Initial Conditions

System Simulator:

1 cell, default parameters.

Mobile Station:

The MS is in MM-state "idle, no IMSI" no SIM inserted.

Foreseen Final State of the MS

The MS is in MM-state "idle, no IMSI" no SIM inserted.

Test procedure

The MS is made to initiate an emergency call. The call is established without authentication, without ciphering, with late assignment. Having reached the active state, the call is cleared by the SS.

Maximum Duration of Test

1 minute.

Expected Sequence

Step	Direction	Message	Comments
1	MS		The appropriate emergency call number is entered.
2	MS -> SS	CHANNEL REQUEST	Establishment cause is emergency call establishment.
3	SS -> MS	IMMEDIATE ASSIGNMENT	
4	MS ->	CM SERVICE REQUEST	Message is contained in SABM. The CM service type IE indicates "emergency call establishment". The mobile identity IE specifies the IMEI of the MS. The cipher key sequence number IE indicates "no key is available". The classmark 2 IE indicates early sending of CLASSMARK CHANGE and SoLSA support
5	SS -> MS	UA (CM SERVICE REQUEST)	
6	MS -> SS	CLASSMARK CHANGE	Shall be ready to transmit (see GSM 05.10 section 06.10) within 40 ms after the completion of step 4. "mobile station classmark 2" includes settings for ES IND and SoLSA Note: In this case 'ready to transmit' shall result in the actual transmission of the Classmark Change 51 frames later (51 * 4.62ms = 235.62 ms). Therefore receipt of the Classmark Change within 250ms of step 4 is required.
7	SS -> MS	CM SERVICE ACCEPT	

8	MS -> SS	EMERGENCY SETUP	<p>If p1 = F/H, the message must contain one bearer capability IE indicating in the radio channel requirement field "dual rate/half rate preferred" or "dual rate/full rate preferred". If p1 = F, the message must either contain no bearer capability IE or contain one bearer capability IE indicating in the radio channel requirement field "full rate channel".</p> <p>The rate of the channel is that one indicated by the EMERGENCY SETUP message, if that message did not offer a choice, and the rate is the preferred one else.</p> <p>The TCH is through connected in both directions.</p> <p>The main signalling link is released.</p>
9	SS -> MS	CALL PROCEEDING	
10	SS -> MS	ALERTING	
11	SS -> MS	ASSIGNMENT COMMAND	
12	MS -> SS	ASSIGNMENT COMPLETE	
13	SS -> MS	CONNECT	
14	MS -> SS	CONNECT ACKNOWLEDGE	
15	MS		
16	SS -> MS	DISCONNECT	
17	MS -> SS	RELEASE	
18	SS -> MS	RELEASE COMPLETE	
19	SS -> MS	CHANNEL RELEASE	

Specific Message Contents:

CM SERVICE REQUEST

Information element	Value/remark
as default except: CM Service type Mobile station Classmark 2 - ES IND - SoLSA	Emergency call establishment Shall indicate early autonomous sending of CLASSMARK CHANGE SoLSA supported

CLASSMARK CHANGE

Information element	Value/remark
as default except: Mobile station Classmark 2 -ES IND -SoLSA	Controlled Early Classmark Sending is implemented. SoLSA supported

26.16 Adaptive Multi Rate Signalling

This section only applies to MS supporting the multi rate speech codec in the GSM 400, GSM 900, DCS 1800 and PCS 1900 band.

As the multi-rate mobile station necessarily supports the speech full rate version 1 or both speech full rate version 1 and speech half rate version 1, conformance requirements of section 26 fully apply to this mobile.

If the handset also supports the EFR speech codec this section does not alter the testing that is completed in section 26.12.

The purpose of this section is to test the different procedures, which may be impacted by the multi rate codec.

26.16.1 Inband Signalling, Downlink Codec Adaptation

26.16.1.1 Conformance Requirement

Ideal frequency hopping without DTX is activated, the MS shall produce Codec Mode Requests with the following accuracy

- When a carrier to interferer ratio 4 dB higher than a defined upper threshold is applied to the antenna connector, the MS shall request a higher mode with a probability exceeding 90%. This shall be measured immediately after a settling-time of 200 ms.
- When a carrier to interferer ratio 4 dB lower than a defined lower threshold is applied to the antenna connector, the MS shall request a lower mode with a probability exceeding 90%. This shall be measured immediately after a settling-time of 200 ms.

This test is not intended to verify these conformance requirements, but to verify the correctness of the involved layer 1 and layer 3 signalling.

References:

TS GSM 05.09 sub-clauses: 3.3, 3.4

26.16.1.2 Test Purpose

This test is concerned with the downlink link adaptation for AMR and the related inband signalling. The test shall verify that the MS can monitor the downlink quality of the dedicated channel and generate Codec Mode Requests according to the thresholds provided by the network at call setup, with an allowance for the statistical significance of the test.

NOTE 1: The test is performed under static conditions, since the power variation under TU50 during the measurement time of 200ms can be neglected.

NOTE 2: The inband signals are L1 signalling transmitted every speech frame, as defined in GSM 05.09: In uplink directions Codec Mode Requests and Codec Mode Indications are transmitted alternately, whereas downlink signalling contains of alternate Codec Mode Commands and Codec Mode Indications.

26.16.1.3 Method of Test

Initial Conditions

The MS is "idle updated", with TMSI allocated.

Related PICS/PIXIT Statements

The MS supports the multi-rate speech codec.

Forseen Final State of MS

"Idle, updated", with TMSI allocated.

Test Procedure

- a) A mobile originated call is initiated, following the CHANNEL REQUEST received from the MS the SS sends an IMMEDIATE ASSIGNMENT to the MS commanding it to go to a SDCCH. The MS indicates to the SS that it supports the multi-rate speech codec. The SS allocates the MS a TCH/AFS and signals the allowed codec subset and adaptation thresholds as part of the ASSIGNMENT COMMAND. DTX shall not be activated. Hopping is activated. The hopping band is centred around an ARFCN in the Mid ARFCN range. The hopping frequencies are chosen from those defined in section 6.

The following active codec mode subset shall apply:

Codec Mode	TCH/AFS in kbit/s
CODEC_MODE_1	4,75
CODEC_MODE_2	5,9
CODEC_MODE_3	7,95
CODEC_MODE_4	12,2

The following decision threshold and hysteresis values in terms of normalized carrier to interference ratio (C/I_{norm}), shall apply for Codec Mode Command / Request (MC', MR'):

MC'/MR'	THR_MC_Dn(MC')/ THR_MR_Dn(MR')	THR_MC_Up(MC')/ THR_MR_Up(MR')
CODEC_MODE_4	16,5 dB	+ ∞
CODEC_MODE_3	11,5 dB	18,5 dB
CODEC_MODE_2	6,5 dB	13,5 dB
CODEC_MODE_1	- ∞	8,5 dB

- b) In addition to the wanted signal, the SS produces an independent, uncorrelated interfering signal, Standard Test Signal I1 (unwanted signal).

The unwanted signal is continuous and has no fixed relationship with the bit transitions of the wanted signal. Its amplitude is 64 dB below that of the wanted signal.

- c), d) The downlink radio environment is altered by changing the carrier to interference ratio. When the radio condition crosses an adaptation threshold the MS changes the Codec Mode Request to reflect the changed signal quality. The SS will change the downlink codec to the requested mode and change the downlink Codec Mode Indication accordingly..This is continued for all thresholds given for the Active Codec Set.
- e) The SS sends a HANOVER_COMMAND allocating the MS a TCH/AHS and signals the allowed codec subset and adaptation thresholds as part of the HANOVER_COMMAND. DTX shall not be activated. Hopping is activated. The hopping band is centred around an ARFCN in the Mid ARFCN range. The hopping frequencies are chosen from those defined in section 6.

The following active codec mode subset shall apply:

Codec Mode	TCH/AHS in kbit/s
CODEC_MODE_1	5.15
CODEC_MODE_2	6.7
CODEC_MODE_3	7.95

The following decision threshold and hysteresis values in terms of normalized carrier to interference ratio (C/I_{norm}), shall apply for Codec Mode Command / Request (MC', MR'):

MC'/MR'	THR_MC_Dn(MC')/ THR_MR_Dn(MR')	THR_MC_Up(MC')/ THR_MR_Up(MR')
CODEC_MODE_3	12,5 dB	+∞
CODEC_MODE_2	11,0 dB	15,0 dB
CODEC_MODE_1	- ∞	13,0 dB

- f) step b) to d) are repeated for the settings given in step e)

Maximum Duration of Test

2 minutes

Expected Sequence in step c)

NOTE: Inband signalling is transmitted every frame, but are mentioned only where changes occur. If no new Codec Mode Indications or Codec Mode Commands are to be sent, previous indication respectively request is being repeated. If Active Codec Set contains less than 4 codecs, the steps corresponding to nonassigned codecs shall be ignored.

Step	Direction	Message	Comments
1	MS->SS	Channel Request	
2	SS->MS	Immediate Assignment	
3	MS->SS	Set Up SDCCH	MS indicates which speech codecs it can support
4	SS->MS	Assignment Command SDCCH	Network allocates TCH/AFS / TCH/AHS and allowed codec subset and adaptation thresholds
5	MS->SS	Assignment Complete	SS simulates good radio conditions ($C/I_{norm} = 64\text{dB}$)
A6	SS->MS		Lower radio conditions to below codec mode 4 threshold
A7	MS->SS	Codec Mode Request changes	
A8	SS->MS	Codec Mode Indication changes to requested mode	The downlink codec is changed so that first frame with requested codec is transmitted with the first changed Codec Mode Indication.
9	SS->MS		Lower radio conditions to below codec mode 3 threshold
10	MS->SS	Codec Mode Request changes	
11	SS->MS	Codec Mode Indication changes to requested mode	The downlink codec is changed so that first frame with requested codec is transmitted with the first changed Codec Mode Indication.
12	SS->MS		Lower radio conditions to below codec mode 2 threshold
13	MS->SS	Codec Mode Request changes	
14	SS->MS	Codec Mode Indication changes to requested mode	The downlink codec is changed so that first frame with requested codec is transmitted with the first changed Codec Mode Indication.
15	SS->MS		Improve radio conditions to above codec mode 1 threshold
16	MS->SS	Codec Mode Request changes	
17	SS->MS	Codec Mode Indication changes to requested mode	The downlink codec is changed so that first frame with requested codec is transmitted with the first changed Codec Mode Indication.
18	SS->MS		Improve radio conditions to above codec mode 2 threshold
19	MS->SS	Codec Mode Request changes	
20	SS->MS	Codec Mode Indication changes to requested mode	The downlink codec is changed so that first frame with requested codec is transmitted with the first changed Codec Mode Indication.
A21	SS->MS		Improve radio conditions to above codec mode 3 threshold
A22	MS->SS	Codec Mode Request changes	
A23	SS->MS	Codec Mode Indication changes to requested mode	The downlink codec is changed so that first frame with requested codec is transmitted with the first changed Codec Mode Indication.
24	SS->MS	CHANNEL RELEASE	

In TCH/AHS the Active Codec Set contains only three of four possible codecs, thus steps prefixing A are not implemented in this case.

Specific Message Contents

ASSIGNMENT COMMAND

Information Element	Value/remark
Assignment Command	In step 4: codec mode 4 selected (codec mode 3 for AHS) (ref: GSM 04.08 section 9.1.2)

Codec Mode Requests, uplink inband signalling

Information Element	Value/remark
Requesting preferred downlink mode	In step 6: Codec Mode 4 requested In step 7: Change to Codec mode 3 latest 4dB below THR_MR_Dn(Codec_Mode_4) In step 10: Change to Codec Mode 2 latest 4dB below THR_MR_Dn(Codec_Mode_3) In step 13: Change to Codec Mode 1 latest 4dB below THR_MR_Dn(Codec_Mode_2) In step 16: Change to Codec Mode 2 latest 4dB above THR_MR_Up(Codec_Mode_1) In step 19: Change to Codec Mode 3 latest 4dB above THR_MR_Up(Codec_Mode_2) In step 22: Change to Codec Mode 4 latest 4dB above THR_MR_Up(Codec_Mode_3)

Codec Mode Indications, downlink inband signalling

Information Element	Value/remark
Indicating mode used at downlink	In step 6-7: Codec Mode 4 is indicated In step 8-10: Codec Mode 3 is indicated In step 11-13: Codec Mode 2 is indicated In step 14-16: Codec Mode 1 is indicated In step 17-19: Codec Mode 2 is indicated In step 20-22: Codec Mode 3 is indicated In step 23: Codec Mode 4 is indicated

26.16.2 Inband Signalling, Uplink Codec Adaptation

26.16.2.1 Conformance Requirement

The MS shall after reception of a Codec Mode Command apply the corresponding codec mode in the uplink direction for the next possible speech frame and no more than three speech frames later. This test is not intended to verify these conformance requirements, but to verify the correctness of the involved layer 1 and layer 3 signalling.

References:

TS GSM 05.09 sub-clauses: 3.3, 3.4

26.16.2.2 Test Purpose

This test is concerned with the link adaptation for AMR uplink and the related inband signalling. The test shall verify that the MS in the uplink direction applies the codec mode indicated by the network transmitted Codec Mode Commands, and that the MS correctly signals the used codec as Codec Mode Indication in the uplink inband signalling.

NOTE: The inband signals are L1 signalling transmitted every speech frame, as defined in GSM 05.09: In uplink directions Codec Mode Requests and Codec mode indications are transmitted alternately, whereas downlink signalling contains of alternately Codec Mode Commands and Codec Mode Indications.

26.16.2.3 Method of Test

Initial Conditions

The MS is “idle updated”, with TMSI allocated.

Related PICS/PIXIT Statements

The MS supports the multi-rate speech codec.

Forseen Final State of MS

“Idle, updated”, with TMSI allocated.

Test Procedure

- a) A mobile originated call is initiated, following the CHANNEL REQUEST received from the MS the SS sends an IMMEDIATE ASSIGNMENT to the MS commanding it to go to a SDCCH. The MS indicates to the SS that it supports the multi-rate speech codec. The SS allocates the MS a TCH/AFS and signals the allowed codec subset and adaptation thresholds as part of the ASSIGNMENT COMMAND. DTX shall not be activated. Hopping is activated. The hopping band is centred around an ARFCN in the Mid ARFCN range. The hopping frequencies are chosen from those defined in section 6.

The following active codec mode subset shall apply:

Codec Mode	TCH/AFS in kbit/s
CODEC_MODE_1	4,75
CODEC_MODE_2	5,9
CODEC_MODE_3	7,95
CODEC_MODE_4	12,2

The following decision threshold and hysteresis values in terms of normalized carrier to interference ratio (C/I_{norm}), shall apply for Codec Mode Command / Request (MC', MR'):

MC'/MR'	THR_MC_Dn(MC')/ THR_MR_Dn(MR')	THR_MC_Up(MC')/ THR_MR_Up(MR')
CODEC_MODE_4	16,5 dB	+ ∞
CODEC_MODE_3	11,5 dB	18,5 dB
CODEC_MODE_2	6,5 dB	13,5 dB
CODEC_MODE_1	- ∞	8.5 dB

- b) In addition to the wanted signal, the SS produces an independent, uncorrelated interfering signal, Standard Test Signal I1 (unwanted signal).

The unwanted signal is continuous and has no fixed relationship with the bit transitions of the wanted signal. Its amplitude is 64 dB below that of the wanted signal.

- c) The SS signals that a new codec is wanted in uplink direction by changing the value of the Codec Mode Command. The MS shall apply the commanded mode in uplink by changing the mode and correspondingly the value of the Codec Mode Indication to match the used codec. This is repeated for all neighbouring mode transitions in the Active Codec Set.
- d) The SS sends a HANDOVER_COMMAND allocating the MS a TCH/AHS and signals the allowed codec subset and adaptation thresholds as part of the HANDOVER_COMMAND. DTX shall not be activated. Hopping is activated. The hopping band is centred around an ARFCN in the Mid ARFCN range. The hopping frequencies are chosen from those defined in section 6.

The following active codec mode subset shall apply:

Codec Mode	TCH/AHS in kbit/s
CODEC_MODE_1	5.15
CODEC_MODE_2	6.7
CODEC_MODE_3	7.95

The following decision threshold and hysteresis values in terms of normalized carrier to interference ratio (C/I_{norm}), shall apply for Codec Mode Command / Request (MC', MR'):

MC'/MR'	THR_MC_Dn(MC')/ THR_MR_Dn(MR')	THR_MC_Up(MC')/ THR_MR_Up(MR')
CODEC_MODE_3	12,5 dB	+ ∞
CODEC_MODE_2	11,0 dB	15,0 dB
CODEC_MODE_1	- ∞	13,0 dB

e) step b) to c) are repeated for the settings given in step d)

Maximum Duration of Test

2 minutes

Expected Sequence in step c)

Step	Direction	Message	Comments
1	MS->SS	Channel Request	
2	SS->MS	Immediate Assignment	
3	MS->SS	Set Up SDCCH	
4	SS->MS	Assignment Command SDCCH	MS indicates which speech codecs it can support Network allocates TCH/AFS / TCH/AHS and allowed codec subset and adaptation thresholds
5	MS->SS	Assignment Complete	SS simulates good radio conditions ($C/I_{norm} = 64\text{dB}$)
A6	SS->MS	Codec Mode Command change	Codec Mode 3 is commanded by inband signalling
A7	MS->SS	Codec Mode Indication change	Codec Mode Indication shows current active mode in uplink, thus changed when mode changes
8	SS->MS	Codec Mode Command change	Codec Mode 2 is commanded by inband signalling
9	MS->SS	Codec Mode Indication change	Codec Mode 2 is indicated in inband signalling with first frame using Codec Mode 2
10	SS->MS	Codec Mode Command change	Codec Mode 1 is commanded by changing inband signal
11	MS->SS	Codec Mode Indication change	Codec Mode 1 is indicated in inband signalling with first frame using Codec Mode 1.
12	SS->MS	Codec Mode Command change	Codec Mode 2 is commanded by changing inband signal
13	MS->SS	Codec Mode Indication change	Codec Mode 2 is indicated in inband signalling with first frame using Codec Mode 2.
14	SS->MS	Codec Mode Command change	Codec Mode 3 is commanded by changing inband signal
15	MS->SS	Codec Mode Indication change	Codec Mode 3 is indicated in inband signalling with first frame using Codec Mode 3.
A16	SS->MS	Codec Mode Command change	Codec Mode 4 is commanded by changing inband signal
A17	MS->SS	Codec Mode Indication change	Codec Mode 4 is indicated in inband signalling with first frame using Codec Mode 4
18	SS->MS	CHANNEL RELEASE	

In TCH/AHS the Active Codec Set contains only three of four possible codecs, thus steps prefixing A are not implemented in this case.

Specific Message Contents

ASSIGNMENT COMMAND

Information Element	Value/remark
Assignment Command	In step 4: codec mode 4 selected (codec mode 3 for TCH/AHS) (ref: GSM 04.08 section 9.1.2)

Codec mode commands, downlink inband signalling

Information Element	Value/remark
Channel Mode to be used for uplink	In step 5: Codec Mode 4 commanded in AFS and Codec Mode 3 in AHS In step 6-7: Codec Mode 3 commanded In step 8-9: Codec Mode 2 commanded In step 10-11: Codec Mode 1 commanded In step 12-13: Codec Mode 2 commanded In step 14-15: Codec Mode 3 commanded In step 16-17: Codec Mode 4 commanded

Codec mode indications, **uplink inband signalling**

Information Element	Value/remark
Indicating Codec Mode currently used uplink	In step 5: Codec Mode 4 indicated in AFS and Codec Mode 3 in AHS In step 6: Codec Mode 4 indicated in AFS (step ignored in AHS) In step 7-8: Codec Mode 3 indicated In step 9-10: Codec Mode 2 indicated In step 11-12: Codec Mode 1 indicated In step 13-14: Codec Mode 2 indicated In step 15-16: Codec Mode 3 indicated In step 17: Codec Mode 4 indicated

26.16.3 Structured procedures / MS terminated call / early assignment / no initial codec mode

This test applies to mobiles supporting the AMR speech codec.

Note: this test is derived from the one described in section 26.12 and entitled: "Structured procedures / MS terminated call / early assignment"

26.16.3.1 Conformance requirement

- 1) In acceptance to a SETUP message indicating speech, the MS shall indicate and include in the CALL CONFIRMED message all the speech versions that it supports.
- 2) Upon receipt of the ASSIGNMENT COMMAND message specifying using CHx-FR or CHx/HR the Mobile Station continues a mobile terminating call establishment with early assignment of traffic channel
 - a) by replying to the ASSIGNMENT command with an ASSIGNMENT COMPLETE message and,
 - b) by continuing the call establishment by through connecting TCH in both directions if it supports immediate connect or by sending an ALERTING message otherwise,
- 3) The ASSIGNMENT command will not specify which of the codec modes the MS should use, but allow the handset to select the default codec mode

- 4) For speech calls, the mobile station shall attach the user connection at latest when sending the connect message, except if there is no compatible radio resource available at this time. In this case the attachment shall be delayed until such a resource becomes available.

CH_x – identifies any of the Channel Codec mode

FR – full rate channel

HR – half rate channel

References:

GSM 04.08 sub-clauses: 9.12, 9.1.5

GSM 05.09 sub-clauses: 3.4

26.16.3.2 Test purpose

- 1) To verify that, in acceptance to a SETUP message indicating speech, the MS indicates and includes in the CALL CONFIRMED message all the speech versions that it supports.
- 2) To verify that upon receipt of the ASSIGNMENT COMMAND message specifying using CH_x-FR or CH_x/HR the Mobile Station continues a mobile terminating call establishment with early assignment of traffic channel
 - a) by replying to the ASSIGNMENT command with an ASSIGNMENT COMPLETE message and ,
 - b) by continuing the call establishment by through connecting TCH in both directions if it supports immediate connect or by sending an ALERTING message otherwise,
- 3) The ASSIGNMENT command will not specify which of the codec modes the MS should use, but allow the handset to select the default codec mode
- 4) To verify that for speech calls, the mobile station shall attach the user connection at latest when sending the connect message, except if there is no compatible radio resource available at this time. In this case the attachment shall be delayed until such a resource becomes available.

26.16.3.3 Method of Test

Initial Conditions

SS 1 cell, default parameters

MS in MM-state “idle, updated” with valid TMSI and CKSN

Related PICS/PIXIT Statements

Way to indicate alerting.

Way to make the MS accept an incoming call after alerting.

Speech supported for MR version 1 and full rate version1.

Foreseen Final State of MS

“Idle, updated”, with TMSI allocated.

Test Procedure

The following test is performed for both channel modes of the multi-rate codec, ie full rate and half rate:

A teleservice is selected that is supported by the MS; if the MS supports speech, the selected teleservice is speech. If necessary, the MS is configured for that teleservice.

The MS is paged and the resulting call is established. Having reached the active state, the MS is made to clear the call.

Maximum Duration of Test

3 minutes

Expected Sequence

This test is repeated for M=1,2,3,4 for an MS supporting different codec modes.

This test is repeated for HR and FR channel assignment.

Step	Direction	Message	Comments
1	SS->MS	PAGING REQUEST TYPE 1	Sent on the correct paging sub-channel Message is contained in the SABM SRES specifies correct value SS starts deciphering after sending the message Shall be sent enciphered. All following messages shall be sent enciphered. SS starts ciphering
2	MS->SS	CHANNEL REQUEST	
3	SS->MS	IMMEDIATE ASSIGNMENT	
4	MS->SS	PAGING RESPONSE	
5	SS->MS	AUTHENTICATION REQUEST	
6	MS->SS	AUTHENTICATION RESPONSE	
7	SS->MS	CIPHERING MODE COMMAND	
8	MS->SS	CIPHERING MODE COMPLETE	
9	SS		
10	SS->MS	SETUP	
11	MS->SS	CALL CONFIRMED	
			If the MS supports an Immediate connection then branch A applies. If the MS doesn't support an immediate connection then branch B applies.
A12	MS->SS	CONNECT	sent on the old channel SS allocates allowed subset codec modes, but does not identify a mode for immediate operation.
A13	SS->MS	ASSIGNMENT COMMAND	
A14	MS->SS	ASSIGNMENT COMPLETE	
B12	SS->MS	ASSIGNMENT COMMAND	Sent on the new channel. SS allocates allowed subset codec modes, but does not identify a mode for immediate operation. An alerting indication as defined in the PICS/PIXIT statement is given by the MS. The MS is made to accept the call.
B13	MS->SS	ASSIGNMENT COMPLETE	
B14	MS->SS	ALERTING	
B15	MS		
B16	MS		
B17	MS->SS	CONNECT	
18	MS		
19	SS->MS	CONNECT ACK	The TCH shall be through connected by both directions in the dedicated mode, using the default codec mode specified. The MS is made to release the call.
20	MS		
21	MS->SS	DISCONNECT	
22	SS->MS	RELEASE	
23	MS->SS	RELEASE COMPLETE	
24	SS->MS	CHANNEL RELEASE	

Specific Message Content

M=1

Assignment Command

Use octet 4 only to define the one and only allowed codec mode

M=2

Assignment Command

Use octets 4,5 and 6 to define the 2 allowed codec modes and the threshold values

M=3

Assignment Command

Use octets 4,5,6 and 7 to define the 3 allowed codec modes and the threshold values

M=4

Assignment Command

Use octets 4,5,6,7 and 8 to define the 4 allowed codec modes and the threshold values

26.16.4 Structured procedures / MS originated call / late assignment / specified initial codec mode

This test applies to mobiles supporting the AMR speech codec.

Note: This test is derived from the one described in section 26.12 and entitled: "Structured procedures / MS terminated call / early assignment"

26.16.4.1 Conformance requirement

- 1) The MS shall indicate and include in the mobile originating SETUP for speech call all the speech versions that it supports.
- 2) Upon receipt of the ASSIGNMENT COMMAND message using full rate version 1,2 or 3 or half rate version1, the Mobile Station starts a normal channel assignment procedure. It means that the MS initiates a local end release of link layer connections, disconnects the physical channels, commands the switching to the assigned channels and initiates the establishment of lower layer connections (this includes the activation of the channels, their connection and the establishment of the data links). After the main signalling link is successfully established, the MS returns an ASSIGNMENT COMPLETE message, specifying cause 'normal event', to the network on the main DCCH.
- 3,4) The call control entity of the Mobile Station in the "call initiated" state, in the "mobile originating call proceeding" state or in the "call delivered" state, shall, upon receipt of a CONNECT message:
 - attach the user connection to the radio path;
 - return a CONNECT ACKNOWLEDGE message.

CHx – identifies any of the Channel Codec mode

FR – full rate channel

HR – half rate channel

References:

GSM 04.08 sub-clauses: 9.12, 9.1.5

GSM 05.09 sub-clauses: 3.4

26.16.4.2 Test purpose

- 1) To verify that the MS indicates and includes in the mobile originating SETUP for speech call all the speech versions that it supports.
- 2) To verify that subsequently after receipt of an IMMEDIATE ASSIGNMENT message allocating an SDCCH, after completion of establishment of the main signalling link, after having sent a CM SERVICE REQUEST

message, after having successfully performed authentication and cipher mode setting procedures, after having sent a SETUP message, after having received a CALL PROCEEDING message followed by an ALERTING message and an ASSIGNMENT COMMAND message allocating using speech full rate version1, 2 or 3 or speech half rate version 1, the MS sends an ASSIGNMENT COMPLETE message. The ASSIGNMENT COMMAND message will also identify which codec mode the MS is allowed to use for the call, the threshold values and the initial codec mode for immediate use.

- 3) To verify that subsequently, after the suite of actions specified in test purposes 1 and 2, the MS after receiving a CONNECT message returns a CONNECT ACKNOWLEDGE message.
- 4) To verify that after the suite of actions specified in test purposes 1 and 2, the MS after receiving a CONNECT message attaches the user connection to the radio path. (This is checked by verifying that there is a point in time after transmission of the first L2 frame containing the (complete) CONNECT message, where the MS is sending appropriate speech or data frames whenever it doesn't have to transmit or acknowledge an I frame on layer 2 of the FACCH.)

26.16.4.3 Method of Test

Initial Conditions

SS 1 cell, default parameters

MS in MM-state "idle, updated" with valid TMSI and CKSN

Related PICS/PIXIT Statements

Way to indicate alerting.

Way to make the MS accept an incoming call after alerting.

Speech supported for MR version 1 and full rate version1.

Foreseen Final State of MS

The MS has a MO call in state U10, "active".

Test Procedure

The following test is performed for both channel modes of the multi-rate codec, ie full rate and half rate.

The MS is made to initiate a speech call. The call is established with a late assignment.

Maximum Duration of Test

3 minutes

Expected Sequence

This test is repeated for M=1,2,3,4 for an MS supporting different codec modes.

This test is repeated for HR and FR channel assignment.

Step	Direction	Message	Comments
1	MS		The "called number" is entered
2	MS->SS	CHANNEL REQUEST	
3	SS->MS	IMMEDIATE ASSIGNMENT	
4	MS->SS	CM SERVICE REQUEST	Message is contained in SABM
5	SS->MS	AUTHENTICATION REQUEST	
6	MS->SS	AUTHENTICATION RESPONSE	SRES specifies correct value
7	SS->MS	CIPHERING MODE COMMAND	SS starts deciphering after sending the message
8	MS->SS	CIPHERING MODE COMPLETE	Shall be sent enciphered. All following messages shall be sent enciphered.
9	SS		SS starts ciphering
10	SS->MS	SETUP	The MS indicates it supports the FR version 3 speech, and FR version 1, 2 speech and HR version 1 speech can be supported.
11	MS->SS	CALL CONFIRMED	
12	SS->MS	CALL PROCEEDING	
13	SS->MS	ALERTING	
14	MS		An alerting indication as defined in the PICS/PIXIT statement is given by the MS.
15	SS->MS	ASSIGNMENT COMMAND	SS allocates allowed subset codec modes, but does identifies a mode for immediate operation.
16	MS->SS	ASSIGNMENT COMPLETE	
17	MS->SS	CONNECT	
18	MS		The TCH shall be through connected by both directions in the dedicated mode, using the codec mode specified.
19	SS->MS	CONNECT ACK	

Specific Message Content

M=1

Assignment Command

Use octet 4 only to define the one and only allowed codec mode

M=2

Assignment Command

Use octets 4,5 and 6 to define the 2 allowed codec modes and the threshold values

M=3

Assignment Command

Use octets 4,5,6 and 7 to define the 3 allowed codec modes and the threshold values

M=4

Assignment Command

Use octets 4,5,6,7 and 8 to define the 4 allowed codec modes and the threshold values

26.16.5 AMR signalling / Handover / active call / successful case

A number of different parameters have been identified that may affect the call handover, these are:

- GSM900 or GSM1800 or PCS 1900

- Frequency hopping on, frequency hopping off
- Channel mode: TCH/F or TCH/H
- DTX on or DTX off
- Codec mode (TCH/F : CH1 – CH8 and TCH/H : CH9 – CH14)

This test applies to mobiles supporting the AMR speech codec.

This test applies only to MS supporting the R-GSM, E-GSM, P-GSM 900, GSM 1800 or the PCS 1900 frequency band.

Note: This test is derived from 26.12.2 – EFR Signalling/Handover/active call/successful case.

References:

TS GSM 04.08 sub-clauses: 3.4.3.1, 3.4.6, 9.1.2, 9.1.5, 9.1.15

26.16.5.1 Conformance requirements

The MS shall correctly apply the handover procedure in the non-synchronised case when :

- a call is in progress and,
- handover is performed from a TCH/F with/without frequency hopping towards a TCH/F with/without frequency hopping
- handover is performed from a cell with DTX on/off to a cell with DTX on/off
- handover is performed from a cell where the dedicated channel is TCH/F or H to a cell where the dedicated channel will be TCH/F or H
- handover is performed where the codec mode is set to any valid mode (dependant on the channel allocation) to a cell where codec mode will become any valid mode (dependant on the channel allocation)

26.16.5.2 Test Purpose

To ensure that the terminal handovers correctly, when the cells have different parameter settings. The call shall be established before the handover is made and verified that it is still active after the handover.

The tests below indicate the cell parameter settings from the cell that has the call established to the new cell parameter settings that will maintain the call.

26.16.5.3 Method of Test

Initial Conditions

MS in call active state U10 on cell A.

SS 2 cells, A and B with same LAI, default parameters except:

GSM900 :

Cell A has : BCCH ARFCN = 20
Cell Allocation = (10, 17, 20, 26, 34, 42, 45, 46, 52, 59, 66, 73, 74, 75, 76, 108, 114)

Cell B has : BCCH ARFCN = 40
Cell Allocation = (14, 18, 22, 24, 30, 31, 38, 40, 60, 66, 73, 74, 75, 76, 108, 114)

The frame numbers of cells A and B shall be different by 100.

The timebase of cells A and B shall be such that the edges of their timeslots are not coincident at the antenna connector.

GSM1800 :

Cell A has : BCCH ARFCN = 747
 Cell Allocation = (734, 741, 747, 754, 759, 762, 766, 767, 773, 775, 779, 782, 791, 798, 829, 832, 844)

Cell B has : BCCH ARFCN = 764
 Cell Allocation = (739, 743, 746, 749, 756, 758, 761, 764, 771, 779, 782, 791, 798, 829, 832, 844)

The Cell Allocation of both Cell A and Cell B shall be coded using range 256 format.

The frame numbers of cells A and B shall be different by 100.

The timebase of cells A and B shall be such that the edges of their timeslots are not coincident at the antenna connector.

PCS 1900 :

Cell A has : BCCH ARFCN = 647
 Cell Allocation = (634, 641, 647, 654, 659, 662, 666, 667, 673, 675, 679, 682, 691, 698, 729, 732, 744)

Cell B has : BCCH ARFCN = 664
 Cell Allocation = (639, 643, 646, 649, 656, 658, 661, 664, 671, 679, 682, 691, 698, 729, 732, 744)

The Cell Allocation of both Cell A and Cell B shall be coded using range 256 format.

The frame numbers of cells A and B shall be different by 100.

The timebase of cells A and B shall be such that the edges of their timeslots are not coincident at the antenna connector.

Related PICS/PIXIT Statements

Speech supported for MR version 1 and full rate version1.

Support for state U10 of the Call Control protocol.

Support for the multi-rate speech version 1.

Type of Mobile Station (P-GSM or E-GSM or R-GSM or GSM1800 or PCS 1900).

Foreseen Final State of MS

The MS has a MO call in state U10, "active".

Maximum Duration of Test

10 minutes

Expected Sequence

The following test sequence shall be used for each of the test cases described below.

Step	Direction	Message	Comments
0	MS -> SS		The MS and SS are in the active state of a call on the channel described below.
1	SS -> MS	HANDOVER COMMAND	See Specific message contents
2	MS -> SS	HANDOVER ACCESS	Repeated on every burst of the uplink main DCCH until reception of PHYSICAL INFORMATION. Handover Reference as included in the HANDOVER COMMAND. If the HANDOVER COMMAND includes a starting time IE then the first HANDOVER ACCESS message shall be transmitted in the indicated frame (unless the indicated frame is not used by that channel, in which case the next frame used by that channel shall be used)
3	SS -> MS	PHYSICAL INFORMATION	Sent after reception of n HANDOVER ACCESS messages. See specific message contents.
4	MS -> SS	SABM	Sent without information field
5	SS -> MS	UA	
6	MS -> SS	HANDOVER COMPLETE	The message shall be ready to be transmitted before 'x' ms after the completion of step 3.
7	MS -> SS		The MS and SS are in the active state of a call on the TCH described below. The SS checks that the TCH is through connected in the correct mode.

Test Cases

Test 26.16.5.3.1

Cell Parameters	Cell A	Cell B
Frequency Hopping	ON	ON
900 or 1800 or 1900	900	900
DTX	OFF	OFF
Traffic Channel	FR	FR
Speech Codec	AMR	AMR

Test 26.16.5.3.2

Cell Parameters	Cell A	Cell B
Frequency Hopping	ON	OFF
900 or 1800 or 1900	900	900
DTX	ON	OFF
Traffic Channel	HR	FR
Speech Codec	AMR	AMR

Test 26.16.5.3.3

Cell Parameters	Cell A	Cell B
Frequency Hopping	ON	ON
900 or 1800 or 1900	900	1800 or 1900
DTX	ON	ON
Traffic Channel	FR	HR
Speech Codec	AMR	AMR

Test 26.16.5.3.4

Cell Parameters	Cell A	Cell B
Frequency Hopping	OFF	ON
900 or 1800 or 1900	900	1800 or 1900
DTX	OFF	ON
Traffic Channel	HR	HR
Speech Codec	AMR	AMR

Test 26.16.5.3.5

Cell Parameters	Cell A	Cell B
Frequency Hopping	OFF	ON
900 or 1800 or 1900	1800 or 1900	1800 or 1900
DTX	ON	ON
Traffic Channel	FR	FR
Speech Codec	AMR	AMR

Test 26.16.5.3.6

Cell Parameters	Cell A	Cell B
Frequency Hopping	ON	ON
900 or 1800 or 1900	1800 or 1900	900
DTX	ON	ON
Traffic Channel	FR	FR
Speech Codec	AMR	EFR

Note:

FR – indicates Full Rate traffic channel assigned for AMR use

HR – indicates Half Rate traffic channel assigned for AMR use

26.16.6 Structured procedures / emergency call

This test applies to mobiles supporting the AMR speech codec.

Note: this test is derived from section 26.15.5 - Structured procedures / emergency call

26.16.6.1 Conformance requirement

- 1) The MS in the "idle, updated" state, after a successful location update, the number 112 (for GSM 900 and 1800 MS), or 911 (for PCS 1900 MS in USA and Canada), or 08 (for PCS 1900 MS in Mexico) has been entered by user, shall send a CHANNEL REQUEST message with correct establishment cause ("emergency call").
- 2) After assignment of a dedicated channel the first layer message sent by the MS on the assigned dedicated channel shall be a CM SERVICE REQUEST message specifying the correct CKSN and TMSI, with CM Service Type "emergency call establishment".
- 3) Authentication and cipher mode setting shall be performed successfully.
- 4) After cipher mode setting acceptance by the network, the MS shall send an EMERGENCY SETUP message.
- 5) The AMR mobile station shall accept channel assignment to a TCH/F or TCH/H depending what the network signals to the mobile and also select the correct codec mode. The call shall be set up using the AMR codec.
- 6) After receipt of a CONNECT ACKNOWLEDGE message during correct establishment of the emergency call the TCH shall be through connected in both directions if an appropriate TCH is available.

7) The call shall be cleared correctly.

References:

TS GSM 04.08 sub-clauses: 3.4.3.1, 3.4.6, 9.1.2, 9.1.5

26.16.6.2 Test purpose

- 1) To verify that an MS supporting speech in the MM state "idle, updated", when made to call the number 112 (for GSM 900 and 1800 MS), or 911 (for PCS 1900 MS in USA and Canada), or 08 (for PCS 1900 MS in Mexico), sends a CHANNEL REQUEST message with establishment cause "emergency call".
- 2) To verify that after assignment of a dedicated channel the first layer message sent by the MS on the assigned dedicated channel is a CM SERVICE REQUEST message specifying the correct CKSN and TMSI, with CM Service Type "emergency call establishment".
- 3) To verify that authentication and cipher mode setting are performed successfully.
- 4) To verify that after cipher mode setting acceptance by the SS, the MS sends an EMERGENCY SETUP message.
- 5) To verify that the AMR mobile station shall both accept channel assignment to a TCH/F or TCH/H depending what the network signals to the mobile and also select the correct codec mode. The call shall be set up using the AMR codec.
- 6) To verify that subsequently the MS has through connected the TCH in both directions.
- 7) To verify the call is cleared correctly.

26.16.6.3 Method of Test

Initial Conditions

SS: 1 cell default parameters

MS: The MS is in the MM-state "idle, updated" with valid TMSI and CKSN.

Foreseen Final State of the MS

The MS is in the MM-state "idle, updated" with valid TMSI and CKSN.

Related PICS/PIXIT Statements

Speech supported for MR version 1 and full rate version1.

Test Procedure

The MS is made to initiate and emergency call. The call is established with late assignment. Having reached the active state, the call is cleared by the SS. This procedure is repeated so that the assignment is made with all the channel rates and speech versions supported by the MS.

Maximum Duration of Test

3 minutes

Expected Sequence

Step	Direction	Message	Comments
1	MS		The appropriate emergency call number is entered
2	SS->MS	CHANNEL REQUEST	Establishment cause is emergency call establishment.
3	SS->MS	IMMEDIATE ASSIGNMENT	
4	MS->SS	CM SERVICE REQUEST	Message is contained in SABM. The CM service type IE indicates "emergency call establishment".
5	SS->MS	AUTHENTICATION REQUEST	
6	MS->SS	AUTHENTICATION RESPONSE	SRES specifies correct value
7	SS->MS	CIPHERING MODE COMMAND	SS starts deciphering after sending the message
8	MS->SS	CIPHERING MODE COMPLETE	Shall be sent enciphered. All following messages shall be sent enciphered.
9	SS		SS starts ciphering
10	MS->SS	EMERGENCY SETUP	The MS indicates it which speech it supports.
11	SS->MS	CALL PROCEEDING	
12	SS->MS	ALERTING	
13	SS->MS	ASSIGNMENT COMMAND	See specific message contents.
14	MS->SS	ASSIGNMENT COMPLETE	
15	MS->SS	CONNECT	
16	SS->MS	CONNECT ACK	
17	MS		The TCH shall be through connected by both directions in the dedicated mode, using the codec mode specified.
18	SS->MS	DISCONNECT	
19	MS->SS	RELEASE	
20	SS->MS	RELEASE COMPLETE	
21	SS->MS	CHANNEL RELEASE	

Specific Message Contents:

ASSIGNMENT COMMAND

Mode of the first channel - Mode	Multi rate version 1
-------------------------------------	----------------------

26.16.7 AMR Signalling / Directed Retry / Mobile Originated Call

This test is applicable to all MS which support AMR speech.

This test applies only to MS supporting the R-GSM, E-GSM, P-GSM 900, GSM 1800 or PCS 1900 frequency band.

NOTE: This test is derived from the one defined in section 26.12.6 and entitled "EFR Signalling / Directed Retry / Mobile Originated Call"

26.16.7.1 Conformance requirements

The MS shall correctly apply the Directed Retry procedure from SDCCH/8 (no frequency hopping) to TCH/AMR with frequency hopping in the non-synchronized case during call establishment. The call control entity of the Mobile Station in the "mobile originating call proceeding" state shall, upon receipt of a CONNECT message, attach the AMR speech connection to the radio path and return a CONNECT ACKNOWLEDGE message to the SS.

References

GSM 04.08, sections 3.4.4, 5.2.1.6. and 9.1.15.

GSM 04.13, section 5.2.6.2.

26.16.7.2 Test purpose

To test that, when the MS is ordered to perform a non-synchronized handover after the CALL PROCEED message, it continuously sends access bursts on the main DCCH until it receives a PHYSICAL INFORMATION message from the SS. To test that the MS correctly takes the values of the Timing Advance information element in the PHYSICAL INFORMATION message into account. To test that the MS activates the new channel correctly and transmits the HANDOVER COMPLETE message without undue delay. To test that the call control entity of the Mobile Station in the "mobile originating call proceeding" state, upon receipt of a CONNECT message, attaches the AMR speech connection to the radio path and returns a CONNECT ACKNOWLEDGE message to the SS.

26.16.7.3 Method of test

Initial Conditions

System Simulator:

2 cells A and B with same LAI, default parameters, except:

GSM 900:

Cell A has:

BCCH ARFCN = 20.

Cell Allocation = (10, 17, 20, 26, 34, 42, 45, 46, 52, 59, 66, 73, 74, 75, 76, 108, 114).

PLMN colour code, NCC = as defaults.

BS colour code, BCC = as defaults.

PLMN_PERM = 00001010.

Cell B has:

BCCH ARFCN = 40.

Cell Allocation = (14, 18, 22, 24, 30, 31, 38, 40, 60, 66, 73, 74, 75, 76, 108, 114).

PLMN colour code, NCC = 3.

BS colour code, BCC = 0.

Both cells send SYSTEM INFORMATION TYPE 1 messages containing the complete Cell Allocation of the cell, using bit map 0 format.

The timebase of Cells A and B shall be such that the edges of their timeslots are not coincident at the antenna connector.

A non-combined SDCCH is used.

GSM 1 800:

Cell A has:

BCCH ARFCN = 747.

Cell Allocation = (734, 741, 747, 754, 759, 762, 766, 767, 773, 775, 779, 782, 791, 798, 829, 832, 844).

PLMN colour code, NCC = as defaults.

BS colour code, BCC = as defaults.

PLMN_PERM = 00001010.

Cell B has:

BCCH ARFCN = 764.

Cell Allocation = (739, 743, 746, 749, 756, 758, 761, 764, 771, 779, 782, 791, 798, 829, 832, 844).

PLMN colour code, NCC = 3.

BS colour code, BCC = 0.

Both cells send SYSTEM INFORMATION TYPE 1 messages containing the complete Cell Allocation of the cell, using Range 512 format.

The timebase of Cells A and B shall be such that the edges of their timeslots are not coincident at the antenna connector.

A non combined SDCCH is used.

PCS 1 900:

Cell A has:

BCCH ARFCN = 647.

Cell Allocation = (634, 641, 647, 654, 659, 662, 666, 667, 673, 675, 679, 682, 691, 698, 729, 732, 744).

PLMN colour code, NCC = as defaults.

BS colour code, BCC = as defaults.

PLMN_PERM = 00001010.

Cell B has:

BCCH ARFCN = 664.

Cell Allocation = (639, 643, 646, 649, 656, 658, 661, 664, 671, 679, 682, 691, 698, 729, 732, 744).

PLMN colour code, NCC = 3.

BS colour code, BCC = 0.

Both cells send SYSTEM INFORMATION TYPE 1 messages containing the complete Cell Allocation of the cell, using Range 512 format.

The timebase of Cells A and B shall be such that the edges of their timeslots are not coincident at the antenna connector.

A non combined SDCCH is used.

Mobile Station:

The MS is in the "idle, updated" state, with a TMSI allocated and camped on cell A.

Related PICS/PIXIT Statements

Speech supported for MR version 1 and full rate version1.

Support for MO calls.

Way to indicate alerting (only applicable if the MS supports the feature).

Type of MS (P-GSM 900 or EGSM or RGSM or GSM 1 800 or PCS 1 900).

Foreseen Final State of the MS

"Idle, updated" with TMSI allocated and camped on cell B.

Test Procedure

The MS is made to initiate a speech call on Cell A. After the SS has sent the CALL PROCEEDING message the SS sends a HANDOVER COMMAND message, ordering the MS to switch to cell B. The MS shall then begin to send access bursts on the new DCCH to cell B. The SS observes the access bursts and after receiving n (n being arbitrarily chosen between values according to table 26.6-2 of section 26.6.5) access bursts, the SS sends one PHYSICAL INFORMATION message with an arbitrarily chosen Timing Advance. The MS shall activate the channel in sending and receiving mode. The MS shall establish a signalling link. The MS shall be ready to transmit a HANDOVER COMPLETE message before x ms after the end of the PHYSICAL INFORMATION message, but not before a UA frame has been sent by the SS. After the successful handover procedure the SS sends the ALERTING message. The correct alerting indication shall be given to the user (only applicable if the MS supports this feature). The SS sends the CONNECT message indicating that the call has been answered. The AMR speech channel shall be through connected in both directions. The MS shall send then the CONNECT ACKNOWLEDGE message as the response on the CONNECT message. Having reached the active state, the call is cleared by the SS.

The term "ready to transmit" is defined in GSM 04.13. The value of "x" depends upon the target channel and is specified in the specific message contents section.

Maximum Duration of Test

1 minute, including 30 seconds for any necessary operator actions.

Expected Sequence

Step	Direction	Message	Comments
1	-----	-----	A MO call is initiated on cell A.
2	MS -> SS	CHANNEL REQUEST	Establishment cause is "originating call and the network does not set the NECI bit to 1".
3	SS -> MS	IMMEDIATE ASSIGNMENT	See specific message contents.
4	MS -> SS	CM SERVICE REQUEST	CM Service Type = Mobile Originating Call Establishment.
5	SS -> MS	AUTHENTICATION REQUEST	
6	MS -> SS	AUTHENTICATION RESPONSE	SRES specifies correct value.
7	SS -> MS	CIPHERING MODE COMMAND	SS starts deciphering after sending the message.
8	MS -> SS	CIPHERING MODE COMPLETE	Shall be sent enciphered. All following messages shall be sent enciphered.
9	SS		SS starts ciphering.
10	MS -> SS	SETUP	AMR speech
11	SS -> MS	CALL PROCEEDING	
12	SS -> MS	HANDOVER COMMAND	See specific message contents.
13	MS -> SS	HANDOVER ACCESS	Repeated on every burst of the uplink main DCCH until reception of PHYSICAL INFORMATION. Handover Reference as included in the HANDOVER COMMAND.
14	SS -> MS	PHYSICAL INFORMATION	Sent after reception of n HANDOVER ACCESS message. Timing Advance is arbitrarily chosen.
15	MS -> SS	SABM	Sent without information field.
16	SS -> MS	UA	
17	MS -> SS	HANDOVER COMPLETE	This message shall be ready to be transmitted before "x" ms after the completion of step 14.
18	SS -> MS	ALERTING	
19	MS		Depending on the PICS, an alerting indication is given.
20	SS -> MS	CONNECT	
21	MS -> SS	CONNECT ACKNOWLEDGE	
22	MS		The AMR speech channel is through connected in both directions.
23	SS -> MS	DISCONNECT	
24	MS -> SS	RELEASE	
25	SS -> MS	RELEASE COMPLETE	
26	SS -> MS	CHANNEL RELEASE	The main signalling link is released.

Specific Message Contents

For GSM 900:

IMMEDIATE ASSIGNMENT

Information Element	value/remark
As default message contents except: Channel Description <ul style="list-style-type: none"> - Channel Type - TDMA offset - Timeslot number - Training Sequence Code - Hopping - ARFCN 	Channel Description. SDCCH/8 As default message contents. As default message contents. Chosen arbitrarily. Single RF Channel. Chosen arbitrarily from the Cell Allocation of Cell A.

HANDOVER COMMAND

Information Element	value/remarks
As default message contents, except: Cell Description <ul style="list-style-type: none"> - Network Colour Code - Base Station Colour Code - BCCH Carrier Number Channel Description <ul style="list-style-type: none"> - Channel Type - TDMA offset - Timeslot number - Training Sequence Code - Hopping - MAIO - HSN Synchronization Indication IE is not included Frequency list after time <ul style="list-style-type: none"> - Frequency List Channel Mode IE	3 0 40 TCH/F + ACCHs Chosen arbitrarily. Chosen arbitrarily but not zero. Chosen arbitrarily. RF hopping channel. Chosen arbitrarily from the set (0, 1 to N-1), where N is the number of frequencies encoded in the Frequency List IE. Zero (this gives cyclic hopping). uses bit map 0 to allocate the following 15 frequencies (14, 18, 22, 24, 30, 31, 38, 60, 66, 73, 74, 75, 76, 108, 114). Speech (multi rate version 1).

Step 17: "x" = 500.

GSM 1 800:

IMMEDIATE ASSIGNMENT

Information Element	value/remark
As default message contents except: Channel Description <ul style="list-style-type: none"> - Channel Type - TDMA offset - Timeslot number - Training Sequence Code - Hopping - ARFCN 	Channel Description. SDCCH/8 As default message contents. As default message contents. Chosen arbitrarily. Single RF Channel. Chosen arbitrarily from the Cell Allocation of Cell A.

HANDOVER COMMAND

Information Element	value/remarks
As default message contents, except:	
Cell Description	
- Network Colour Code	3
- Base Station Colour Code	0
- BCCH Carrier Number	764
Channel Description	
- Channel Type	TCH/F + ACCHs
- TDMA offset	Chosen arbitrarily.
- Timeslot number	Chosen arbitrarily but not zero.
- Training Sequence Code	Chosen arbitrarily.
- Hopping	RF hopping channel.
- MAIO	Chosen arbitrarily from the set (0, 1 to N-1), where N is the number of frequencies encoded in the Frequency Short List IE.
- HSN	Zero (this gives cyclic hopping).
Synchronization Indication IE not included.	
Frequency Short List after time	
- Frequency Short List	Use Range 128 to encode the following 2 frequencies (746, 779).
Mode of First Channel	Speech (multi rate version 1).

Step 17: "x" = 500.

PCS 1900:

IMMEDIATE ASSIGNMENT

Information Element	value/remark
As default message contents except:	
Channel Description	Channel Description.
- Channel Type	SDCCH/8
- TDMA offset	As default message contents.
- Timeslot number	As default message contents.
- Training Sequence Code	Chosen arbitrarily.
- Hopping	Single RF Channel.
- ARFCN	Chosen arbitrarily from the Cell Allocation of Cell A.

HANDOVER COMMAND

Information Element	value/remarks
As default message contents, except:	
Cell Description	
- Network Colour Code	3
- Base Station Colour Code	0
- BCCH Carrier Number	664
Channel Description	
- Channel Type	TCH/F + ACCHs
- TDMA offset	Chosen arbitrarily.
- Timeslot number	Chosen arbitrarily but not zero.
- Training Sequence Code	Chosen arbitrarily.
- Hopping	RF hopping channel.
- MAIO	Chosen arbitrarily from the set (0, 1 to N-1), where N is the number of frequencies encoded in the Frequency Short List IE.
- HSN	Zero (this gives cyclic hopping).
Synchronization Indication IE not included.	
Frequency Short List after time	
- Frequency Short List	Use Range 128 to encode the following 2 frequencies (646, 679).
Mode of First Channel	Speech (multi rate version 1).

Step 17: "x" = 500.

26.16.8 AMR Signalling / Directed Retry / Mobile Terminated Call

This test is applicable to all MS which support AMR speech.

This test applies only to MS supporting the R-GSM, E-GSM, P-GSM 900, GSM 1800 or the PCS 1900 frequency band.

NOTE: This test is derived from the one defined in section 26.12.7 and entitled "EFR Signalling / Directed Retry / Mobile Terminated Call"

26.16.8.1 Conformance requirements

The MS shall correctly apply the Directed Retry procedure from SDCCH/8 with frequency hopping to TCH/AMR with frequency hopping and starting time in the non-synchronized case during call establishment. The call control entity of the Mobile Station in the "call delivered" state shall, if the MS supports immediate connect, continue the call establishment by through-connecting the AMR traffic channel in both directions, or if the MS does not support immediate connect, send an ALERTING message. The MS indicates acceptance of a MT call by sending CONNECT.

The mobile station shall attach the user connection at latest when sending the CONNECT message, except if there is no compatible radio resource available at this time. In this case the attachment shall be delayed until such a resource becomes available.

References

GSM 04.08, sections 3.4.4, 5.2.2.5, 5.2.2.6, 5.2.2.9 and 9.1.15.

GSM 04.13, section 5.2.6.2.

26.16.8.2 Test purpose

To test that when the MS is ordered to perform a non-synchronized handover after the CALL CONFIRM message, it continuously sends access bursts on the main DCCH until it receives a PHYSICAL INFORMATION message from the SS. To test that the MS correctly takes the values of the Timing Advance information element in the PHYSICAL INFORMATION message into account. To test that the MS activates the new channel correctly and transmits the HANDOVER COMPLETE message without undue delay. To test that the call control entity of the Mobile Station in the "call delivered" state, if the MS supports immediate connect, continues the call establishment by through-connecting the AMR traffic channel in both directions, or if the MS does not support immediate connect, sends an ALERTING message. To test that the MS indicates acceptance of a MT call by sending CONNECT.

To test that the mobile station attaches the user connection at latest when sending the CONNECT message, except if there is no compatible radio resource available at this time. To test that in this case the attachment is delayed until such a resource becomes available.

26.16.8.3 Method of test

Initial Conditions

System Simulator:

2 cells A and B with same LAI, default parameters, except:

GSM 900:

Cell A has:

BCCH ARFCN = 20.

Cell Allocation = (10, 17, 20, 26, 34, 42, 45, 46, 52, 59, 66, 73, 74, 75, 76, 108, 114).

PLMN colour code, NCC = as defaults.

BS colour code, BCC = as defaults.

PLMN_PERM = 00001010.

Cell B has:

BCCH ARFCN = 40.

Cell Allocation = (14, 18, 22, 24, 30, 31, 38, 40, 60, 66, 73, 74, 75, 76, 108, 114).

PLMN colour code, NCC = 3.

BS colour code, BCC = 0.

Both cells send SYSTEM INFORMATION TYPE 1 messages containing the complete Cell Allocation of the cell, using bit map 0 format.

The timebase of Cells A and B shall be such that the edges of their timeslots are not coincident at the antenna connector.

A non-combined SDCCH is used.

GSM 1 800:

Cell A has:

BCCH ARFCN = 747.

Cell Allocation = (734, 741, 747, 754, 759, 762, 766, 767, 773, 775, 779, 782, 791, 798, 829, 832, 844).

PLMN colour code, NCC = as defaults.

BS colour code, BCC = as defaults.

PLMN_PERM = 00001010.

Cell B has:

BCCH ARFCN = 764.

Cell Allocation = (739, 743, 746, 749, 756, 758, 761, 764, 771, 779, 782, 791, 798, 829, 832, 844).

PLMN colour code, NCC = 3.

BS colour code, BCC = 0.

Both cells send SYSTEM INFORMATION TYPE 1 messages containing the complete Cell Allocation of the cell, using Range 512 format.

The timebase of Cells A and B shall be such that the edges of their timeslots are not coincident at the antenna connector.

A non combined SDCCH is used. PCS 1900:

Cell A has:

BCCH ARFCN = 647.

Cell Allocation = (634, 641, 647, 654, 659, 662, 666, 667, 673, 675, 679, 682, 691, 698, 729, 732, 744).

PLMN colour code, NCC = as defaults.

BS colour code, BCC = as defaults.

PLMN_PERM = 00001010.

Cell B has:

BCCH ARFCN = 664.

Cell Allocation = (639, 643, 646, 649, 656, 658, 661, 664, 671, 679, 682, 691, 698, 729, 732, 744).

PLMN colour code, NCC = 3.

BS colour code, BCC = 0.

Both cells send SYSTEM INFORMATION TYPE 1 messages containing the complete Cell Allocation of the cell, using Range 512 format.

The timebase of Cells A and B shall be such that the edges of their timeslots are not coincident at the antenna connector.

A non combined SDCCH is used.

Mobile Station:

The MS is in the "idle, updated" state, with a TMSI allocated and camped on cell A.

Related PICS/PIXIT Statements

Speech supported for MR version 1 and full rate version1.

Support for MT calls.

Way to indicate alerting (only applicable if the MS supports the feature).

Way to make the MS accept an incoming call after alerting.

Immediate connect supported (Y/N).

Type of MS (P-GSM 900 or EGSM or RGSM or GSM 1 800 or PCS 1900).

Foreseen Final State of the MS

"Idle, updated" with TMSI allocated and camped on cell B.

Test Procedure

The MS is paged on Cell A. The MS responds to the PAGING REQUEST message and establishes a mobile terminated speech call on Cell A. If the MS supports immediate connect, it continues the call establishment by through-connecting the traffic channel in both directions, or if the MS does not support immediate connect, it sends an ALERTING message. The MS indicates acceptance of a MT call by sending CONNECT.

After the MS has sent the CALL CONFIRMED message (if the MS supports immediate connect then the MS sends the CONNECT message after the CALL CONFIRMED message on the old channel) the SS sends a HANDOVER COMMAND message, ordering the MS to switch to cell B. The MS shall then begin to send access bursts on the new DCCH to cell B. The SS observes the access bursts and after receiving n (n being arbitrarily chosen between values according to table 26.6-2 of section 26.6.5) access bursts, the SS sends one PHYSICAL INFORMATION message with an arbitrarily chosen Timing Advance. The MS shall activate the channel in sending and receiving mode. The MS shall establish a signalling link. The MS shall be ready to transmit a HANDOVER COMPLETE message before x ms after the end of the PHYSICAL INFORMATION message, but not before a UA frame has been sent by the SS. After the successful handover procedure the MS sends the ALERTING message (if the MS runs the immediate connect procedure then the MS does not send an ALERTING message). The correct alerting indication shall be given to the user (only applicable if the MS supports the feature or if the MS is not using the immediate connect procedure). After the MS sent the CONNECT message the AMR speech channel shall be through connected in both directions. The SS sends

then the CONNECT ACKNOWLEDGE message as the response on the CONNECT message. Having reached the active state, the call is cleared by the SS.

The term "ready to transmit" is defined in GSM 04.13. The value of "x" depends upon the target channel and is specified in the specific message contents section.

Maximum Duration of Test

1 minute, including 30 seconds for any necessary operator actions.

Expected Sequence

Step	Direction	Message	Comments
1	SS -> MS	PAGING REQUEST TYPE 1	Sent on the correct paging subchannel on cell A. See specific message contents. Message is contained in SABM. SRES specifies correct value. SS starts deciphering after sending the message. Shall be sent enciphered. All following messages shall be sent enciphered. SS starts ciphering. AMR speech. If the MS supports immediate connect then branch A applies. If the MS does not support immediate connect then branch B applies
2	MS -> SS	CHANNEL REQUEST	
3	SS -> MS	IMMEDIATE ASSIGNMENT	
4	MS -> SS	PAGING RESPONSE	
5	SS -> MS	AUTHENTICATION REQUEST	
6	MS -> SS	AUTHENTICATION RESPONSE	
7	SS -> MS	CIPHERING MODE COMMAND	
8	MS -> SS	CIPHERING MODE COMPLETE	
9	SS		
10	SS -> MS	SETUP	
11	MS -> SS	CALL CONFIRMED	
A12	MS -> SS	CONNECT	sent on the old channel See specific message contents. Repeated on every burst of the uplink main DCCH until reception of PHYSICAL INFORMATION. Handover Reference as included in the HANDOVER COMMAND. The first HANDOVER ACCESS message shall be transmitted in the indicated frame (unless the indicated frame is not used by that channel, in which case the next frame used by that channel shall be used). Sent after reception of n HANDOVER ACCESS message. Timing Advance is arbitrarily chosen. Sent without information field. This message shall be ready to be transmitted before "x" ms after the completion of step A15.
A13	SS -> MS	HANDOVER COMMAND	
A14	MS -> SS	HANDOVER ACCESS	
A15	SS -> MS	PHYSICAL INFORMATION	
A16	MS -> SS	SABM	
A17	SS -> MS	UA	
A18	MS -> SS	HANDOVER COMPLETE	
B12	SS -> MS	HANDOVER COMMAND	
B13	MS -> SS	HANDOVER ACCESS	
B14	SS -> MS	PHYSICAL INFORMATION	
B15	MS -> SS	SABM	
B16	SS -> MS	UA	
B17	MS -> SS	HANDOVER COMPLETE	
B18	MS -> SS	ALERTING	
B19	MS		
B20	MS		
B21	MS -> SS	CONNECT	
22	MS		The TCH/AMR channel shall be through connected in both directions. The main signalling link is released.
23	SS -> MS	CONNECT ACKNOWLEDGE	
24	SS -> MS	DISCONNECT	
25	MS -> SS	RELEASE	
26	SS -> MS	RELEASE COMPLETE	
27	SS -> MS	CHANNEL RELEASE	

Specific Message Contents

For GSM 900:

IMMEDIATE ASSIGNMENT

Information Element	value/remark
As default message contents except: L2 pseudo length	14 octets (11 + contents of the MA).
Channel Description	SDCCH/8
- Channel Type	As default message contents.
- TDMA offset	Arbitrary value, but not zero.
- Timeslot number	Chosen arbitrarily.
- Training Sequence Code	RF hopping channel.
- Hopping	Chosen arbitrarily from the set (0, 1 to N-1), where N is the number of frequencies encoded in the Mobile Allocation.
- MAIO	Chosen arbitrarily from the set (1,2,..63).
- HSN	
Mobile Allocation	3 octets.
- Length	Indicates only three frequencies: (73, 74, 75).
- Contents	

HANDOVER COMMAND

Information Element	value/remarks
As default message contents, except:	
Cell Description	
- Network Colour Code	3
- Base Station Colour Code	0
- BCCH Carrier Number	40
Channel Description	
- Channel Type	TCH/F + ACCHs
- TDMA offset	Chosen arbitrarily.
- Timeslot number	Chosen arbitrarily, but not Zero.
- Training Sequence Code	Chosen arbitrarily.
- Hopping	RF hopping channel.
- MAIO	Chosen arbitrarily from the set (0, 1 to N-1), where N is the number of frequencies encoded in the Frequency List IE.
- HSN	Chosen arbitrarily from the set (1,2,..63).
Frequency List after time	
- Frequency List	use bit map 0 to allocates the following 12 frequencies: (14, 18, 22, 24, 60, 66, 73, 74, 75, 76,108, 114).
Synchronization Indication	
- Report Observed Time Difference	Shall not be included.
- Synchronization Indication	"Non synchronized".
- Normal Cell Indication	Ignore out of range timing advance.
Mode of First Channel	Speech (multi rate version 1).
Starting Time	Indicates the frame number of cell B. that will occur approximately 1,1 seconds (238 frames have elapsed) after the HANDOVER COMMAND is sent by cell A.

Step A18 / B17: "x" = 750.

GSM 1 800:

IMMEDIATE ASSIGNMENT

Information Element	value/remark
As default message contents except: L2 pseudo length	14 octets (11 + contents of the MA).
Channel Description	Channel Description. SDCCH/8
- Channel Type	As default message contents.
- TDMA offset	Arbitrary value but not zero.
- Timeslot number	Chosen arbitrarily.
- Training Sequence Code	RF hopping channel.
- Hopping	Chosen arbitrarily from the set (0, 1 to N-1), where N is the number of frequencies encoded in the Mobile Allocation.
- MAIO	Chosen arbitrarily from the set (1,2,..63).
- HSN	
Mobile Allocation	3octets.
- Length	Indicates only three frequencies: (773, 775, 779).
- Contents	

HANDOVER COMMAND

Information Element	value/remarks
As default message contents, except:	
Cell Description	
- Network Colour Code	3
- Base Station Colour Code	0
- BCCH Carrier Number	764
Channel Description	
- Channel Type	TCH/F + ACCHs
- TDMA offset	Chosen arbitrarily.
- Timeslot number	Chosen arbitrarily but not Zero.
- Training Sequence Code	Chosen arbitrarily.
- Hopping	RF hopping channel.
- MAIO	Chosen arbitrarily from the set (0, 1 to N-1), where N is the number of frequencies encoded in the Frequency List IE.
- HSN	Chosen arbitrarily from the set (1,2,..63).
Frequency List after time	
- Frequency List	Use Range 1024 to allocate the following 12 frequencies: (749, 758, 761, 764, 771, 779, 782, 791, 798, 829, 832, 844).
Synchronization Indication	
- Report Observed Time Difference	Shall not be included.
- Synchronization Indication	"Non synchronized".
- Normal Cell Indication	Ignore out of range timing advance.
Mode of First Channel	Speech (multi rate version 1)
Starting Time	Indicates the frame number of cell B that will occur approximately 1.1 seconds (238 frames have elapsed) after the HANDOVER COMMAND is sent by cell A..

Step A18 / B17: "x" = 750.

PCS 1900:

Information Element	value/remark
As default message contents except: L2 pseudo length	14 octets (11 + contents of the MA).
Channel Description	Channel Description. SDCCH/8
- Channel Type	As default message contents.
- TDMA offset	Arbitrary value but not zero.
- Timeslot number	Chosen arbitrarily.
- Training Sequence Code	RF hopping channel.
- Hopping	Chosen arbitrarily from the set (0, 1 to N-1), where N is the number of frequencies encoded in the Mobile Allocation.
- MAIO	Chosen arbitrarily from the set (1,2,..63).
- HSN	
Mobile Allocation	3octets.
- Length	Indicates only three frequencies: (673, 675, 679).
- Contents	

HANDOVER COMMAND

Information Element	value/remarks
As default message contents, except:	
Cell Description	
- Network Colour Code	3
- Base Station Colour Code	0
- BCCH Carrier Number	664
Channel Description	
- Channel Type	TCH/F + ACCHs
- TDMA offset	Chosen arbitrarily.
- Timeslot number	Chosen arbitrarily but not Zero.
- Training Sequence Code	Chosen arbitrarily.
- Hopping	RF hopping channel.
- MAIO	Chosen arbitrarily from the set (0, 1 to N-1), where N is the number of frequencies encoded in the Frequency List IE.
- HSN	Chosen arbitrarily from the set (1,2,..63).
Frequency List after time	
- Frequency List	Use Range 1024 to allocate the following 12 frequencies: (649, 658, 661, 664, 671, 679, 682, 691, 698, 729, 732, 744).
Synchronization Indication	
- Report Observed Time Difference	Shall not be included.
- Synchronization Indication	"Non synchronized".
- Normal Cell Indication	Ignore out of range timing advance.
Mode of First Channel	Speech (multi rate version 1).
Starting Time	Indicates the frame number of cell B that will occur approximately 1.1 seconds (238 frames have elapsed) after the HANDOVER COMMAND is sent by cell A..

Step A18 / B17: "x" = 750.

26.16.9 Default contents of layer 3 messages for AMR signalling tests

Same as section 26.6.14 for GSM900 MS, 26.6.15 for DCS1800 MS, 26.6.16 for GSM 450 MS, 26.6.17 for GSM 480 and 26.6.18 for PCS 1900.

27 Testing of the SIM/ME interface

The following sequence of tests confirms:

- a) the correct interpretation of data read from the SIM (Subscriber Identification Module) by the ME;
- b) the correct writing of data to the SIM by the ME;
- c) the initiation of appropriate procedures by the ME;
- d) low level protocols;
- e) electrical characteristics;
- f) physical characteristics.

All tests apply to GSM, DCS 1 800 and PCS 1900 MEs using either ID-1 or Plug-in SIM.

A SIM simulator will be required as part of the SS. Alternatively, to perform the logical tests, SIMs programmed with specific data may be used. The SIM data is not defined within the initial conditions of the tests unless it differs from the default values defined below.

Definition of default values for SIM/ME interface testing

A SIM containing the following default values is used for all tests of this section unless otherwise stated.

For each data item, the logical default values and the coding within the elementary files (EF) of the SIM follow.

NOTE 1: Bx represents Byte x of the coding.

NOTE 2: Unless otherwise defined, the coding values are hexadecimal.

EF_{IMSI} (IMSI)

Logically: 246813579

Coding: B1 B2 B3 B4 B5 B6 B7 B8 B9
05 29 64 18 53 97 FF FF FF

GSM and DCS 1 800 begin

EF_{LocI} (Location Information)

Logically: LAI-MCC: 246
LAI-MNC: 81
LAI-LAC: 0001
TMSI: "FF .. FF"

Coding: B1 B2 B3 B4 B5 B6 B7 B8 B9 B10 B11
FF FF FF FF 42 F6 18 00 01 FF 00

GSM and DCS 1 800 end

PCS 1900 begin

EF_{LocI} (Location Information)

Logically: LAI-MCC: 246

LAI-MNC: 813

LAI-LAC: 0001

TMSI: "FF .. FF"

Coding:	B1	B2	B3	B4	B5	B6	B7	B8	B9	B10	B11
	FF	FF	FF	FF	42	36	18	00	01	FF	00

PCS 1900 end

EF_{Kc} (Cipherring Key Kc)

Logically: Key Kc: xx

Sequence No: 1

Coding: B1 B2 B3 B4 B5 B6 B7 B8 B9

xx xx xx xx xx xx xx xx 01

EF_{ACC} (Access Control Class)

Logically: One and only one access class from 0 - 9, e.g. class 7 for which the coding is "00 80".

GSM and DCS 1 800 begin

EF_{FPLMN} (Forbidden PLMNs)

Logically: PLMN1: 234 02 (MCC MNC)

PLMN2: 234 03

PLMN3: 234 04

PLMN4: 234 05

Coding:	B1	B2	B3	B4	B5	B6	B7	B8	B9	B10	B11	B12
	32	F4	20	32	F4	30	32	F4	40	32	F4	50

GSM and DCS 1 800 end

PCS 1900 begin

EF_{FPLMN} (Forbidden PLMNs)

Logically: PLMN1: 234 023 (MCC MNC)

PLMN2: 234 034

PLMN3: 234 045

PLMN4: 234 056

Coding:	B1	B2	B3	B4	B5	B6	B7	B8	B9	B10	B11	B12
	32	34	20	32	44	30	32	54	40	32	64	50

PCS 1900 end

EF_{SST} (SIM Service Table)

Logically: CHV1 disable function allocated and activated.
 Abbreviated dialling numbers allocated and activated.
 PLMN selector allocated and activated.
 Fixed dialling numbers not activated.

Coding: B1 B2 B3 B4
 xx0x1111 0011xxxx xxxxxxxx 0000xxxx (binary)

The coding of EF_{SST} shall conform with the capabilities of the SIM used.

EF_{ADN} (Abbreviated Dialling Number)

Logically:
 At least 10 records.
 Record 1:
 Length of alpha identifier: 32 characters
 Alpha identifier: "ABCDEFGHJKLMNOPQRSTUVWXYZABCDEF"
 Length of BCD number: "03"
 TON and NPI: Telephony and Unknown
 Dialed number: 123
 CCI: None
 ExtI: None

Coding:	B1	B2	B3	...	B32	B33	B34	B35	B36	B37	B38	B39	...	B46
Record 1:	41	42	43	...	46	03	81	21	F3	FF	FF	FF	...	FF

EF_{Phase}

Logically: Phase 2

Coding: "02"

GSM and DCS 1 800 begin

EF_{PLMNsel} (PLMN Selector)

Logically: 1st PLMN: 234 01 (MCC MNC)
 2nd PLMN: 234 02
 3rd PLMN: 234 03
 4th PLMN: 234 04
 5th PLMN: 234 05
 6th PLMN: 234 06
 7th PLMN: 246 81
 8th PLMN: 246 82

Coding:	B1	B2	B3	B4	B5	B6	B7	B8	B0	B10	B11	B12
	32	F4	10	32	F4	20	32	F4	30	32	F4	40
	B13	B14	B15	B16	B17	B18	B19	B20	B21	B22	B23	B24
	32	F4	50	32	F4	60	42	F6	18	42	F6	28

GSM and DCS 1 800 end

PCS 1900 begin

EF_{PLMNsel} (PLMN Selector)

Logically: 1st PLMN: 234 012 (MCC MNC)

2nd PLMN: 234 023

3rd PLMN: 234 034

4th PLMN: 234 045

5th PLMN: 234 056

6th PLMN: 234 067

7th PLMN: 246 813

8th PLMN: 246 824

Coding:	B1	B2	B3	B4	B5	B6	B7	B8	B0	B10	B11	B12
	32	24	10	32	34	20	32	44	30	32	54	40
	B13	B14	B15	B16	B17	B18	B19	B20	B21	B22	B23	B24
	32	64	50	32	74	60	42	36	18	42	46	28

PCS 1900 end

CHV1 (PIN)

Logically: 2468

Coding: B1 B2 B3 B4 B5 B6 B7 B8
32 34 36 38 FF FF FF FF

CHV2 (PIN2)

Logically: 3579

Coding: B1 B2 B3 B4 B5 B6 B7 B8
33 35 37 39 FF FF FF FF

Unblock CHV1 (PUK)

Logically: 13243546

Coding: B1 B2 B3 B4 B5 B6 B7 B8
31 33 32 34 33 35 34 36

Unblock CHV2 (PUK2)

Logically: 08978675

Coding: B1 B2 B3 B4 B5 B6 B7 B8
30 38 39 37 38 36 37 35

Definition of FDN SIM

Some test cases require a different configuration than the one described above. For that purpose a default FDN SIM is defined. In general the values of the FDN SIM are identical to the default SIM, with the following exceptions:

EF_{SST} (SIM Service Table)

Logically: CHV1 disable function allocated and activated.
Abbreviated dialling numbers allocated and activated.

PLMN selector allocated and activated.
 Fixed dialling numbers allocated and activated.
 Advice of Charge allocated and activated.

Coding: B1 B2 B3 B4
 xx111111 0011xx11 xxxxxxxx 0000xxxx (binary)

The coding of EF_{SST} shall conform with the capabilities of the SIM used.

EF_{FDN} (Fixed Dialling Numbers)

Logically:

Record 1:

Length of alpha identifier: 6 characters
 Alpha identifier: "FDN111"
 Length of BCD number: "06"
 TON and NPI: Telephony and International
 Dialed number: +1357924680
 CCI: None
 Ext1: None

Coding for record 1:

B1	B2	B3	B4	B5	B6	B7	B8	B9	B10	B11	B12	B13
46	44	4E	31	31	31	06	91	31	75	29	64	08
B14	B15	B16	B17	B18	B19	B20						
FF	FF	FF	FF	FF	FF	FF						

Record 2:

Length of alpha identifier: 6 characters
 Alpha identifier: "FDN222"
 Length of BCD number: "04"
 TON and NPI: Telephony and Unknown
 Dialed number: +24680
 CCI: None
 Ext1: None

Coding for record 2:

B1	B2	B3	B4	B5	B6	B7	B8	B9	B10	B11	B12	B13
46	44	4E	32	32	32	04	81	42	86	F0	FF	FF
B14	B15	B16	B17	B18	B19	B20						
FF	FF	FF	FF	FF	FF	FF						

Record 3:

Length of alpha identifier: 6 characters
 Alpha identifier: "FDN333"
 Length of BCD number: "0B"
 TON and NPI: Telephony and International
 Dialed number: +12345678901234567890
 CCI: None
 Ext1: None

Coding for record 3:

B1	B2	B3	B4	B5	B6	B7	B8	B9	B10	B11	B12	B13
46	44	4E	33	33	33	0B	91	21	43	65	87	09
B14	B15	B16	B17	B18	B19	B20						
21	43	65	87	09	FF	FF						

27.1 MS identification by short IMSI

27.1.1 MS identification by short IMSI - Normal case

27.1.1.1 Definition and applicability

The IMSI is used for unique identification of the MS by a GSM network. The IMSI is stored in the SIM and read during the SIM/ME initialization procedure.

This test applies to GSM, DCS 1 800 and PCS 1900 MEs using either ID-1 or Plug-in SIM.

27.1.1.2 Conformance requirement

On the receipt of an IMMEDIATE ASSIGNMENT message the MS shall send PAGING RESPONSE containing the IMSI of the SIM.

GSM 11.11, clause 11.2.1 and 11.4.2, GSM 04.08, clause 10.5.1.4.

27.1.1.3 Test purpose

- 1) To verify that the ME uses the IMSI of the SIM.
- 2) To verify that the ME can handle an IMSI of less than the maximum length.

27.1.1.4 Method of test

27.1.1.4.1 Initial conditions

The SS transmits on the BCCH, with the following network parameters:

Attach/detach: disabled
LAI (MCC/MNC/LAC): 246/81/0001 for GSM and DCS 1 800
246/813/0001 for PCS 1900
Access control: unrestricted.

The default SIM is installed into the ME and the MS is powered on.

27.1.1.4.2 Procedure

- a) The SS sends PAGING REQUEST to the MS using the IMSI stored in the SIM.
- b) After receipt of a CHANNEL REQUEST from the MS, the SS sends IMMEDIATE ASSIGNMENT to the MS.
- c) After receipt of a PAGING RESPONSE from the MS, the SS sends CHANNEL RELEASE to the MS.

27.1.1.5 Test requirement

After step b) the MS shall send PAGING RESPONSE to the SS containing the IMSI stored in the SIM.

27.1.2 MS identification by short IMSI, Phase 1 DCS SIM

27.1.2.1 Definition and applicability

Different from Phase 2, the IMSI in a Phase 1 DCS SIM is stored in a directory DF_{DCS1800} with the specific identifier "7F 21". To ensure backwards compatibility, if selection of the phase 2 identifier "7F 20" fails, the MS shall select "7F 21". Otherwise access to the IMSI and other data is impossible with a Phase 1 DCS SIM

This test applies to DCS 1 800 MEs.

27.1.2.2 Conformance requirement

If selection of DFGSM by the identifier "7F 20" fails, the ME shall select DF_{DCS1800} with "7F 21".
GSM 11.11, clause 10.4.

27.1.2.3 Test purpose

To verify that the ME uses the identifier "7F 21" to select DF_{DCS1800} in a Phase 1 DCS SIM.

27.1.2.4 Method of test

27.1.2.4.1 Initial conditions

The SS transmits on the BCCH, with the following network parameters:

Attach/detach: disabled
LAI (MCC/MNC/LAC):246/81/0001
Access control: unrestricted.

A phase 1 DCS SIM (identifier of DF_{DCS1800} is "7F 21", DF_{GSM} not existing) with default values is installed into the ME and the MS is powered on.

27.1.2.4.2 Procedure

- a) The SS sends PAGING REQUEST to the MS using the IMSI stored in the SIM.
- b) After receipt of a CHANNEL REQUEST from the MS, the SS sends IMMEDIATE ASSIGNMENT to the MS.
- c) After receipt of a PAGING RESPONSE from the MS, the SS sends CHANNEL RELEASE to the MS.

27.1.2.5 Test requirement

After step b) the MS shall send PAGING RESPONSE to the SS containing the IMSI stored in the SIM.

27.2 MS identification by short TMSI

27.2.1 Definition and applicability

The TMSI is temporarily used for identification of the MS by a GSM network. It will have been previously assigned by the network. The TMSI is stored in the SIM by the ME and read during the SIM/ME initialization procedure.

This test applies to GSM, DCS 1 800 and PCS 1900 MEs using either ID-1 or Plug-in SIM.

27.2.2 Conformance requirement

On the receipt of an IMMEDIATE ASSIGNMENT message the MS shall send PAGING RESPONSE containing the TMSI stored in the SIM.

GSM 11.11, clause 11.2.1 and 11.4.5, GSM 04.08, clause 10.5.1.4.

27.2.3 Test purpose

- 1) To verify that the ME uses the TMSI stored in the SIM.
- 2) To verify that the ME can handle a TMSI of less than maximum length.

27.2.4 Method of test

27.2.4.1 Initial conditions

The SS transmits on the BCCH, with the following network parameters:

Attach/detach: disabled
 LAI (MCC/MNC/LAC):246/81/0001
 Access control: unrestricted.

The default SIM is used with the following exception:

GSM and DCS 1 800 begin

EF_{LOC1} (Location Information)

Logically: LAI-MCC: 246
 LAI-MNC: 81
 LAI-LAC: 0001
 TMSI: "2143"

Coding:	B1	B2	B3	B4	B5	B6	B7	B8	B9	B10	B11
	00	00	21	43	42	F6	18	00	01	FF	00

GSM and DCS 1 800 end

PCS 1900 begin

EF_{LOC1} (Location Information)

Logically: LAI-MCC: 246
 LAI-MNC: 813
 LAI-LAC: 0001
 TMSI: "2143"

Coding:	B1	B2	B3	B4	B5	B6	B7	B8	B9	B10	B11
	00	00	21	43	42	36	18	00	01	FF	00

PCS 1900 end

The SIM is installed into the ME and the MS is powered on.

27.2.4.2 Procedure

- The SS sends PAGING REQUEST to the MS using the TMSI stored in the SIM.
- After receipt of a CHANNEL REQUEST from the MS, the SS sends IMMEDIATE ASSIGNMENT to the MS.
- After receipt of a PAGING RESPONSE from the MS, the SS sends CHANNEL RELEASE to the MS.

27.2.5 Test requirement

After step b) the MS shall send PAGING RESPONSE to the SS containing the TMSI stored in the SIM.

27.3 MS identification by long TMSI

27.3.1 Definition and applicability

The TMSI is temporarily used for identification of the MS by a GSM network. It will have been previously assigned by the network. The TMSI is stored in the SIM by the ME and read during the SIM/ME initialization procedure.

This test applies to GSM, DCS 1 800 and PCS 1900 MEs using either ID-1 or Plug-in SIM.

27.3.2 Conformance requirement

On the receipt of an IMMEDIATE ASSIGNMENT message the MS shall send PAGING RESPONSE containing the correct TMSI stored in the SIM.

GSM 11.11, clause 11.2.1 and 11.4.5, GSM 04.08, clause 10.5.1.4.

27.3.3 Test purpose

- 1) To verify that the ME uses the TMSI stored in the SIM.
- 2) To verify that the ME can handle a TMSI of maximum length.
- 3) To verify that the ME does not respond to page requests containing a previous TMSI.

27.3.4 Method of test

27.3.4.1 Initial conditions

Prior to this test, the ME shall have been operated with a SIM containing TMSI "2143". This may be achieved by executing the previous test (27.2) prior to this test. Only under this condition will test purpose 3) be verified.

The SS transmits on the BCCH, with the following network parameters:

Attach/detach: disabled
 LAI (MCC/MNC/LAC):246/81/0001 for GSM and DCS 1 800
 246/813/0001 for PCS 1900
 Access control: unrestricted.

The default SIM is used with the following exception:

GSM and DCS 1 800 begin

EF_{LOCI} (Location Information)

Logically: LAI-MCC: 246
 LAI-MNC: 81
 LAI-LAC: 0001
 TMSI: "21430000"

Coding:	B1	B2	B3	B4	B5	B6	B7	B8	B9	B10	B11
	21	43	00	00	42	F6	18	00	01	FF	00

GSM and DCS 1 800 end

PCS 1900 begin

EF_{LOCI} (Location Information)

Logically: LAI-MCC: 246

LAI-MNC: 813

LAI-LAC: 0001

TMSI: "21430000"

Coding:	B1	B2	B3	B4	B5	B6	B7	B8	B9	B10	B11
	21	43	00	00	42	36	18	00	01	FF	00

PCS 1900 end

The SIM is installed into the ME and the MS is powered on.

27.3.4.2 Procedure

- a) The SS sends PAGING REQUEST to the MS using the TMSI "2143".
- b) The SS sends PAGING REQUEST to the MS using the TMSI stored in the SIM.
- c) After receipt of a CHANNEL REQUEST from the MS, the SS sends IMMEDIATE ASSIGNMENT to the MS.
- d) After receipt of a PAGING RESPONSE from the MS, the SS sends CHANNEL RELEASE to the MS.

27.3.5 Test requirement

- 1) After step a) the MS shall not respond to the PAGING REQUEST.
- 2) After step c) the MS shall send PAGING RESPONSE to the SS containing the TMSI stored in the SIM.

27.4 MS identification by long IMSI, TMSI updating and cipher key sequence number assignment

27.4.1 Definition and applicability

The IMSI and TMSI are used for identification of the MS by a GSM network. They are read from the SIM during the SIM/ME initialization procedure. Within the authentication procedure the network sends a cipher key sequence number to the MS. In addition the network may allocate a new TMSI to the MS. Cipher key sequence number and TMSI are stored in the SIM after call termination and/or at GSM session termination.

Test purpose 2) will only be verified if this test sequentially follows the previous test (27.3).

The test applies to GSM, DCS 1 800 and PCS 1900 MEs using either ID-1 or Plug-in SIM.

27.4.2 Conformance requirement

1. On the receipt of an IMMEDIATE ASSIGNMENT message the MS shall send PAGING RESPONSE containing the correct IMSI stored in the SIM.
GSM 11.11, clauses 11.2.1 and 11.4.2, GSM 04.08, clause 10.5.1.4.
2. After call termination the SIM shall contain the cipher key sequence number and TMSI received by the MS during the authentication and TMSI reallocation procedures.

GSM 11.11, clauses 11.2.2, 11.4.5 and 11.4.6, GSM 02.17, clause 6.1.

- d) After receipt of a PAGING RESPONSE from the MS, the SS sends AUTHENTICATION REQUEST to the MS containing cipher key sequence number set to binary 010.
- e) After receipt of AUTHENTICATION RESPONSE from the MS, the SS sends TMSI REALLOCATION to the MS containing TMSI "32547698".
- f) Within 5 seconds after receipt of TMSI REALLOCATION COMPLETE from the MS, the SS sends CHANNEL RELEASE to the MS.
- g) To allow examination of the values in the SIM after call termination the MS shall not be soft powered down. If the test is performed with a SIM simulator, the simulation is stopped. If the test is performed with a SIM, the SIM is removed without soft powering down the MS. If this is not possible, the power supply of the ME is removed and then the SIM removed.

27.4.5 Test requirement

- 1) After step a) the MS shall not respond to the PAGING REQUEST.
- 2) After step c) the MS shall send PAGING RESPONSE to the SS containing the IMSI stored in the SIM.
- 3) After step e) the MS shall send TMSI REALLOCATION COMPLETE to the SS.
- 4) After step g) the SIM shall contain the following values:

GSM and DCS 1 800 begin

EF_{LOCI} (Location Information)

Logically: LAI-MCC: 246
 LAI-MNC: 81
 TMSI: "32547698"

Coding:	B1	B2	B3	B4	B5	B6	B7	B8	B9	B10	B11
	32	54	76	98	42	F6	18	xx	xx	xx	xx

GSM and DCS 1 800 end

PCS 1900 begin

EF_{LOCI} (Location Information)

Logically: LAI-MCC: 246
 LAI-MNC: 813
 TMSI: "32547698"

Coding:	B1	B2	B3	B4	B5	B6	B7	B8	B9	B10	B11
	32	54	76	98	42	36	18	xx	xx	xx	xx

PCS 1900 end

EF_{Kc} (Ciphering Key Kc)

Logically: Key Kc: xx (result of the authentication algorithm)
 Sequence No: 2

Coding: B1 B2 B3 B4 B5 B6 B7 B8 B9
 xx xx xx xx xx xx xx xx 02

27.5 Forbidden PLMNs, location updating and undefined cipher key

27.5.1 Definition and applicability

A list of forbidden PLMNs stored in the SIM and providing storage for up to 4 entries is managed by the MS. In automatic PLMN selection mode the MS controls location updating attempts to appropriate networks with respect to this list of forbidden PLMNs. As a result of a location update reject with the cause "PLMN not allowed" the MS stores the PLMN which rejected the update request in the SIM.

After a location update, which is not followed by an authentication procedure, the cipher key sequence number indicates that the cipher key is undefined.

This test applies to GSM, DCS 1 800 and PCS 1900 MEs using either ID-1 or Plug-in SIM.

27.5.2 Conformance requirement

1. In automatic PLMN selection mode the MS shall only attempt a LOCATION UPDATE if it receives a BCCH containing a LAI that is not indicated in the EF_{FPLMN} in the SIM.

GSM 02.11, clause 2.3, GSM 11.11, clauses 11.2.1 and 11.4.8.

2. After receipt of a LOCATION UPDATE REJECT message with the cause "PLMN not allowed" the ME shall update the EF_{FPLMN} in the SIM.

GSM 02.11, clause 2.3, GSM 11.11, clauses 11.2.1 and 11.4.8.

3. After call termination the SIM shall contain the correct cipher key sequence number.

GSM 11.11, clauses 11.2.2, 11.4.5 and 11.4.6, GSM 02.17, clause 6.1.

4. After call termination the SIM shall contain the correct TMSI and location information received by the MS.

GSM 11.11, clauses 11.2.2, 11.4.5 and 11.4.6, GSM 02.17, clause 6.1.

27.5.3 Test purpose

- 1) To verify that in automatic PLMN selection mode the MS does not attempt to access PLMNs stored in EF_{FPLMN} on the SIM.
- 2) To verify that the EF_{FPLMN} is correctly updated by the ME after receipt of a LOCATION UPDATE REJECT message with cause "PLMN not allowed".
- 3) To verify that the EF_{Kc} has been correctly updated by the ME.
- 4) To verify that the EF_{LOCI} has been correctly updated by the ME.

27.5.4 Method of test

27.5.4.1 Initial conditions

The SS transmits on the BCCH, with the following network parameters:

Attach/detach: disabled
LAI (MCC/MNC/LAC): 234/02/0001 for GSM and DCS 1 800
234/023/0001 for PCS 1900
Access control: unrestricted.

The default SIM is used with the following exception:

GSM and DCS 1 800 begin

EF_{IMSI} (IMSI)

Logically: 246811111111111

Coding: B1 B2 B3 B4 B5 B6 B7 B8 B9
08 29 64 18 11 11 11 11 11

EF_{LOCI} (Location Information)

Logically: LAI-MCC: 234
LAI-MNC: 01
LAI-LAC: 0000
TMSI: "32547698"

Coding:	B1	B2	B3	B4	B5	B6	B7	B8	B9	B10	B11
	32	54	76	98	32	F4	10	00	00	FF	00

GSM and DCS 1 800 end

PCS 1900 begin

EF_{IMSI} (IMSI)

Logically: 246813111111111

Coding: B1 B2 B3 B4 B5 B6 B7 B8 B9
08 29 64 18 13 11 11 11 11

EF_{LOCI} (Location Information)

Logically: LAI-MCC: 234
LAI-MNC: 012
LAI-LAC: 0000
TMSI: "32547698"

Coding:	B1	B2	B3	B4	B5	B6	B7	B8	B9	B10	B11
	32	54	76	98	32	24	10	00	00	FF	00

PCS 1900 end

The SIM is installed into the ME and the MS is set to automatic PLMN selection mode.

EF_{Kc} (Ciphering Key Kc)

Logically: Key Kc: undefined
Sequence No: 2

Coding: B1 B2 B3 B4 B5 B6 B7 B8 B9
xx xx xx xx xx xx xx xx 02

27.5.4.2 Procedure

- a) The MS is powered on.
- b) The SS stops all RF output on the BCCH for a long enough period of time to cause a cell reselection procedure in the MS. The BCCH is changed to contain:

LAI (MCC/MNC): 234/03 for GSM and DCS 1 800
234/034 for PCS 1900

The SS then resumes RF output on the BCCH.

- c) The SS stops all RF output on the BCCH for a long enough period of time to cause a cell reselection procedure in the MS. The BCCH is changed to contain:

LAI (MCC/MNC): 234/04 for GSM and DCS 1 800
234/045 for PCS 1900

The SS then resumes RF output on the BCCH.

- d) The SS stops all RF output on the BCCH for a long enough period of time to cause a cell reselection procedure in the MS. The BCCH is changed to contain:

LAI (MCC/MNC): 234/05 for GSM and DCS 1 800
234/056 for PCS 1900

The SS then resumes RF output on the BCCH.

- e) The SS stops all RF output on the BCCH for a long enough period of time to cause a cell reselection procedure in the MS. The BCCH is changed to contain:

LAI (MCC/MNC): 234/01 for GSM and DCS 1 800
234/012 for PCS 1900

The SS then resumes RF output on the BCCH.

- f) After receipt of a CHANNEL REQUEST from the MS, the SS sends IMMEDIATE ASSIGNMENT to the MS.
g) After receipt of a LOCATION UPDATE REQUEST from the MS, the SS sends LOCATION UPDATE REJECT to the MS with cause "PLMN Not Allowed", followed by CHANNEL RELEASE.

The SS stops all RF output on the BCCH for a long enough period of time to cause a cell reselection procedure in the MS. The BCCH is changed to contain:

LAI (MCC/MNC): 234/06 for GSM and DCS 1 800
234/067 for PCS 1900

The SS then resumes RF output on the BCCH.

- h) After receipt of a CHANNEL REQUEST from the MS, the SS sends IMMEDIATE ASSIGNMENT to the MS.
i) After receipt of a LOCATION UPDATE REQUEST from the MS, the SS sends LOCATION UPDATE ACCEPT with:

LAI (MCC/MNC): 234/06 for GSM and DCS 1 800
234/067 for PCS 1900

TMSI: "43658709"

to the MS.

- j) After receipt of a TMSI REALLOCATION COMPLETE from the MS, the SS sends CHANNEL RELEASE to the MS.

k) The MS is soft powered down.

27.5.5 Test requirement

- 1) After each of the steps a) to d) the MS shall not attempt a LOCATION UPDATE.
- 2) After step f) the MS shall send LOCATION UPDATE REQUEST to the SS.
- 3) After step h) the MS shall send LOCATION UPDATE REQUEST to the SS.
- 4) After step i) the MS shall respond with TMSI REALLOCATION COMPLETE.
- 5) After step k) the SIM shall contain the following values:

GSM and DCS 1 800 begin

EF_{LOCI} (Location Information)

Logically: LAI-MCC: 234
LAI-MNC: 06
TMSI: "43658709"

Coding: B1 B2 B3 B4 B5 B6 B7 B8 B9 B10 B11
43 65 87 09 32 F4 60 xx xx xx 00

GSM and DCS 1 800 end

PCS 1900 begin

EF_{LOCI} (Location Information)

Logically: LAI-MCC: 234
LAI-MNC: 067
TMSI: "43658709"

Coding: B1 B2 B3 B4 B5 B6 B7 B8 B9 B10 B11
43 65 87 09 32 74 60 xx xx xx 00

PCS 1900 end

EF_{Kc} (Cipherring Key Kc)

Logically: Key Kc: xx
Sequence No: 7

Coding: B1 B2 B3 B4 B5 B6 B7 B8 B9
xx xx xx xx xx xx xx xx 07

GSM and DCS 1 800 begin

EF_{FPLMN} (Forbidden PLMNs)

Logically: PLMN1: 234 03 (MCC MNC)

PLMN2: 234 04

PLMN3: 234 05

PLMN4: 234 01

Coding:	B1	B2	B3	B4	B5	B6	B7	B8	B9	B10	B11	B12
	32	F4	30	32	F4	40	32	F4	50	32	F4	10

GSM and DCS 1 800 end

PCS 1900 begin

EF_{FPLMN} (Forbidden PLMNs)

Logically: PLMN1: 234 034 (MCC MNC)

PLMN2: 234 045

PLMN3: 234 056

PLMN4: 234 012

Coding:	B1	B2	B3	B4	B5	B6	B7	B8	B9	B10	B11	B12
	32	44	30	32	54	40	32	64	50	32	24	10

PCS 1900 end

27.6 MS updating forbidden PLMNs

27.6.1 Definition and applicability

A list of forbidden PLMNs stored in the SIM provides storage for up to 4 entries, and is managed by the MS. In automatic PLMN selection mode the MS controls location updating attempts to appropriate networks with respect to this list of forbidden PLMNs. As a result of a location update reject with the cause "PLMN not allowed" the MS stores the PLMN which rejected the update request in the SIM.

This test applies to GSM, DCS 1 800 and PCS 1900 MEs using either ID-1 or Plug-in SIM.

27.6.2 Conformance requirement

After the receipt of a LOCATION UPDATE REJECT message with the cause "PLMN not allowed" the MS shall update the EF_{FPLMN} in the SIM.

GSM 02.11, clause 3.2.2.4.

27.6.3 Test purpose

To verify that the MS correctly updates the EF_{FPLMN}, i.e. fill up existing gaps in the elementary file before overwriting any existing entries.

27.6.4 Method of test

27.6.4.1 Initial conditions

The SS transmits on the BCCH, with the following network parameters:

Attach/detach: disabled

LAI (MCC/MNC/LAC):234/03/0001 for GSM and DCS 1 800

234/034/0001 for PCS 1900

Access control: unrestricted.

The default SIM is used with the following exception:

GSM and DCS 1 800 begin

EF_{FPLMN} (Forbidden PLMNs)

Logically: PLMN1: 234 02 (MCC MNC)

PLMN2: empty

PLMN3: 234 04

PLMN4: 234 05

Coding:	B1	B2	B3	B4	B5	B6	B7	B8	B9	B10	B11	B12
	32	F4	20	FF	FF	FF	32	F4	40	32	F4	50

GSM and DCS 1 800 end

PCS 1900 begin

EF_{FPLMN} (Forbidden PLMNs)

Logically: PLMN1: 234 023 (MCC MNC)

PLMN2: empty

PLMN3: 234 045

PLMN4: 234 056

Coding:	B1	B2	B3	B4	B5	B6	B7	B8	B9	B10	B11	B12
	32	34	20	FF	FF	FF	32	54	40	32	64	50

PCS 1900 end

The SIM is installed into the ME and the MS is set to automatic PLMN selection mode.

27.6.4.2 Procedure

- a) The MS is powered on.
- b) After receipt of a CHANNEL REQUEST from the MS, the SS sends IMMEDIATE ASSIGNMENT to the MS.
- c) After receipt of a LOCATION UPDATE REQUEST from the MS, the SS sends LOCATION UPDATE REJECT to the MS with the cause "PLMN not allowed", followed by CHANNEL RELEASE.
- d) The MS is soft powered down.

27.6.5 Test requirement

- 1) After step b) the MS shall send LOCATION UPDATE REQUEST to the SS.
- 2) After step d) the SIM shall contain:

GSM and DCS 1 800 begin

EF_{FPLMN} (Forbidden PLMNs)

Logically: PLMN1: 234 02 (MCC MNC)

PLMN2: 234 03

PLMN3: 234 04

PLMN4: 234 05

Coding:	B1	B2	B3	B4	B5	B6	B7	B8	B9	B10	B11	B12
	32	F4	20	32	F4	30	32	F4	40	32	F4	50

or

EF_{FPLMN} (Forbidden PLMNs)

Logically: PLMN1: 234 02 (MCC MNC)

PLMN2: 234 04

PLMN3: 234 05

PLMN4: 234 03

Coding:	B1	B2	B3	B4	B5	B6	B7	B8	B9	B10	B11	B12
	32	F4	20	32	F4	40	32	F4	50	32	F4	30

GSM and DCS 1 800 end

PCS 1900 begin

EF_{FPLMN} (Forbidden PLMNs)

Logically: PLMN1: 234 023 (MCC MNC)

PLMN2: 234 034

PLMN3: 234 045

PLMN4: 234 056

Coding:	B1	B2	B3	B4	B5	B6	B7	B8	B9	B10	B11	B12
	32	34	20	32	44	30	32	54	40	32	64	50

or

EF_{FPLMN} (Forbidden PLMNs)

Logically: PLMN1: 234 023 (MCC MNC)

PLMN2: 234 045

PLMN3: 234 056

PLMN4: 234 034

Coding:	B1	B2	B3	B4	B5	B6	B7	B8	B9	B10	B11	B12
	32	34	20	32	54	40	32	64	50	32	44	30

PCS 1900 end

27.7 MS deleting forbidden PLMNs

27.7.1 Definition and applicability

In manual PLMN selection mode the MS allows location update attempts to all available PLMNs, including forbidden PLMNs (as indicated by the forbidden PLMN list on the SIM). As a result of a successful location update procedure onto a PLMN which is in the forbidden PLMN list, the forbidden PLMN list is automatically updated by the MS.

This test applies to GSM, DCS 1 800 and PCS 1900 MEs using either ID-1 or Plug-in SIM.

27.7.2 Conformance requirement

1. In manual PLMN selection mode the MS shall be able to perform a LOCATION UPDATE attempt to a PLMN which is in the forbidden PLMN list.

GSM 02.11, clause 3.2.2.2.

2. After receipt of LOCATION UPDATE ACCEPT the MS shall delete the forbidden PLMN from the forbidden PLMN list.

GSM 02.11, clause 3.2.2.4.

27.7.3 Test purpose

- 1) To verify that in automatic PLMN selection mode the MS does not attempt to access PLMNs stored in EF_{FPLMN} on the SIM.
- 2) To verify that the MS is able to perform a LOCATION UPDATE on a forbidden PLMN in manual PLMN selection mode.
- 3) To verify that the MS after a successful LOCATION UPDATE deletes the PLMN in the EF_{FPLMN} on the SIM.

27.7.4 Method of test

27.7.4.1 Initial conditions

The SS transmits on the BCCH, with the following network parameters:

Attach/detach: disabled
 LAI (MCC/MNC/LAC):234/01/0001 for GSM and DCS 1 800
 234/012/0001 for PCS 1900
 Access control: unrestricted.

The default SIM is used with the following exception:

GSM and DCS 1 800 begin

EF_{FPLMN} (Forbidden PLMNs)

Logically: PLMN1: empty
 PLMN2: empty
 PLMN3: 234 01 (MCC MNC)
 PLMN4: empty

Coding:	B1	B2	B3	B4	B5	B6	B7	B8	B9	B10	B11	B12
	FF	FF	FF	FF	FF	FF	32	F4	10	FF	FF	FF

GSM and DCS 1 800 end

PCS 1900 begin

EF_{FPLMN} (Forbidden PLMNs)

Logically: PLMN1: empty
 PLMN2: empty
 PLMN3: 234 012 (MCC MNC)
 PLMN4: empty

Coding:	B1	B2	B3	B4	B5	B6	B7	B8	B9	B10	B11	B12
	FF	FF	FF	FF	FF	FF	32	24	10	FF	FF	FF

PCS 1900 end

The SIM is installed into the ME and the MS is set to automatic PLMN selection mode.

27.7.4.2 Procedure

- a) The MS is powered on.
- b) PLMN with MCC/MNC of 234/01 (PCS 1900: 234/012) is manually selected.
- c) After receipt of a CHANNEL REQUEST from the MS, the SS sends IMMEDIATE ASSIGNMENT to the MS.

- d) After receipt of a LOCATION UPDATE REQUEST from the MS, the SS sends LOCATION UPDATE ACCEPT with:

LAI (MCC/MNC): 234/01 for GSM and DCS 1 800
 234/012 for PCS 1900
 TMSI: "12345678"

to the MS.

- e) After receipt of TMSI REALLOCATION COMPLETE from the MS, the SS sends CHANNEL RELEASE.
 f) The MS is soft powered down.

27.7.5 Test requirement

- 1) After step a) the MS shall not attempt a LOCATION UPDATE.
- 2) After step c) the MS shall send LOCATION UPDATE REQUEST to the SS.
- 3) After step d) the MS shall respond with TMSI REALLOCATION COMPLETE.
- 4) After step f) the SIM shall contain the following values:

GSM and DCS 1 800 begin

EF_{LOCI} (Location Information)

Logically: LAI-MCC: 234
 LAI-MNC: 01
 TMSI: "12345678"

Coding:	B1	B2	B3	B4	B5	B6	B7	B8	B9	B10	B11
	12	34	56	78	32	F4	10	xx	xx	xx	00

EF_{FPLMN} (Forbidden PLMNs)

Logically: PLMN1: empty
 PLMN2: empty
 PLMN3: empty
 PLMN4: empty

Coding:	B1	B2	B3	B4	B5	B6	B7	B8	B9	B10	B11	B12
	FF	FF	FF	FF	FF	FF	FF	FF	FF	FF	FF	FF

GSM and DCS 1 800 end

PCS 1900 begin

EF_{LOCI} (Location Information)

Logically: LAI-MCC: 234
 LAI-MNC: 012
 TMSI: "12345678"

Coding:	B1	B2	B3	B4	B5	B6	B7	B8	B9	B10	B11
	12	34	56	78	32	24	10	xx	xx	xx	00

EF_{FPLMN} (Forbidden PLMNs)

Logically: PLMN1: empty
 PLMN2: empty
 PLMN3: empty
 PLMN4: empty

Coding:	B1	B2	B3	B4	B5	B6	B7	B8	B9	B10	B11	B12
	FF	FF	FF	FF	FF	FF	FF	FF	FF	FF	FF	FF

PCS 1900 end

27.8 MS updating the PLMN selector list

27.8.1 Definition and applicability

The PLMN selector list gives in priority order the preferred PLMNs on which the MS shall register. The list is stored on the SIM in the EF_{PLMNsel}. Update and deletion of PLMNs may be performed by the subscriber.

This test applies to GSM, DCS 1 800 and PCS 1900 MEs using either ID-1 or Plug-in SIM.

27.8.2 Conformance requirement

The MS shall correctly replace the selected PLMN in the PLMN selector list.

GSM 11.11, clause 11.5.5.

27.8.3 Test purpose

To verify that the MS correctly updates the EF_{PLMNsel}.

27.8.4 Method of test

27.8.4.1 Initial conditions

No SS is required for this test.

The default SIM is used.

The SIM is installed into the ME and the MS is powered on.

27.8.4.2 Procedure

- a) The user shall initiate an MMI dependent procedure to change the second PLMN in the PLMN selector list to MCC/MNC of 567/01 (PCS 1900: 567/018).
- b) The MS is soft powered down.

27.8.5 Test requirement

After step b) the SIM shall contain the following values:

GSM and DCS 1 800 begin

EF_{PLMNsel} (PLMN Selector)

Logically: 1st PLMN: 234 01 (MCC MNC)

2nd PLMN: 567 01

3rd PLMN: 234 03

4th PLMN: 234 04

5th PLMN: 234 05

6th PLMN: 234 06

7th PLMN: 246 81

8th PLMN: 246 82

Coding:	B1	B2	B3	B4	B5	B6	B7	B8	B0	B10	B11	B12
	32	F4	10	65	F7	10	32	F4	30	32	F4	40

B13	B14	B15	B16	B17	B18	B19	B20	B21	B22	B23	B24
32	F4	50	32	F4	60	42	F6	18	42	F6	28

GSM and DCS 1 800 end

PCS 1900 begin

EF_{PLMNsel} (PLMN Selector)

Logically: 1st PLMN: 234 012 (MCC MNC)

2nd PLMN: 567 018

3rd PLMN: 234 034

4th PLMN: 234 045

5th PLMN: 234 056

6th PLMN: 234 067

7th PLMN: 246 813

8th PLMN: 246 824

Coding:	B1	B2	B3	B4	B5	B6	B7	B8	B0	B10	B11	B12
	32	24	10	65	87	10	32	44	30	32	54	40
	B13	B14	B15	B16	B17	B18	B19	B20	B21	B22	B23	B24
	32	64	50	32	74	60	42	36	18	42	46	28

PCS 1900 end

27.9 MS recognizing the priority order of the PLMN selector list

27.9.1 Definition and applicability

The PLMN selector list gives in priority order the preferred PLMNs on which the MS shall register. The list is stored on the SIM in the EF_{PLMNsel}. Update and deletion of PLMNs may be performed by the subscriber by the use of the PIN.

This test applies to GSM, DCS 1 800 and PCS 1900 MEs using either ID-1 or Plug-in SIM.

27.9.2 Conformance requirement

When registering onto a VPLMN the MS shall take into account the priority order of the PLMNs in the preferred list on the SIM.

GSM 02.11, clause 3.2.2.2.

27.9.3 Test purpose

To verify that the PLMN with the higher priority (defined by its position in EF_{PLMNsel}) takes precedence over the PLMN with the lower priority when the MS performs a network selection.

27.9.4 Method of test

27.9.4.1 Initial conditions

The SS transmits on two BCCHs, with the following network parameters:

Attach/detach: disabled

LAI (MCC/MNC/LAC):234/33/0001 for GSM and DCS 1 800

234/334/0001 for PCS 1900

Access control: unrestricted.

Attach/detach: disabled
 LAI (MCC/MNC/LAC):234/34/0001 for GSM and DCS 1 800
 234/345/0001 for PCS 1900
 Access control: unrestricted.

The default SIM is used with the following exception:

GSM and DCS 1 800 begin

EF_{PLMNsel} (PLMN Selector)

Logically: 1st PLMN: 234 01 (MCC MNC)
 2nd PLMN: 234 02

 32nd PLMN: 234 32
 33rd PLMN: 234 34
 34th PLMN: 234 33

Coding: B1 B2 B3 B4 B5 B6
 32 F4 10 32 F4 20

 B94 b95 B96 B97 B98 B99 B100 B101 B102
 32 F4 23 32 F4 43 32 F4 33

GSM and DCS 1 800 end

PCS 1900 begin

EF_{PLMNsel} (PLMN Selector)

Logically: 1st PLMN: 234 012 (MCC MNC)
 2nd PLMN: 234 023

 32nd PLMN: 234 323
 33rd PLMN: 234 345
 34th PLMN: 234 334

Coding: B1 B2 B3 B4 B5 B6
 32 24 10 32 34 20

 B94 b95 B96 B97 B98 B99 B100 B101 B102
 32 34 23 32 54 43 32 44 33

PCS 1900 end

The SIM is installed into the ME and the MS is set to automatic PLMN selection mode.

27.9.4.2 Procedure

- a) The MS is powered on.
- b) After receipt of a CHANNEL REQUEST from the MS, the SS sends IMMEDIATE ASSIGNMENT to the MS.
- c) After receipt of a LOCATION UPDATE REQUEST from the MS, the SS sends LOCATION UPDATE ACCEPT with:

LAI (MCC/MNC): 234/34 for GSM and DCS 1 800

234/345 for PCS 1900
TMSI: "34567890"

to the MS

- d) After receipt of a TMSI REALLOCATION COMPLETE from the MS, the SS sends CHANNEL RELEASE to the MS.
- e) The MS is soft powered down.

27.9.5 Test requirement

- 1) After step b) the MS shall send LOCATION UPDATE REQUEST containing an MCC/MNC of 234/34 (PCS 1900: 234/345) to the SS.
- 2) After step c) the MS shall respond with TMSI REALLOCATION COMPLETE.
- 3) After step e) the SIM shall contain the following values:

GSM and DCS 1 800 begin

EF_{LOCI} (Location Information)

Logically: LAI-MCC: 234
LAI-MNC: 34
TMSI: "34567890"

Coding:	B1	B2	B3	B4	B5	B6	B7	B8	B9	B10	B11
	34	56	78	90	32	F4	43	xx	xx	xx	00

GSM and DCS 1 800 end

PCS 1900 begin

EF_{LOCI} (Location Information)

Logically: LAI-MCC: 234
LAI-MNC: 345
TMSI: "34567890"

Coding:	B1	B2	B3	B4	B5	B6	B7	B8	B9	B10	B11
	34	56	78	90	32	54	43	xx	xx	xx	00

PCS 1900 end

27.10 MS access control management

27.10.1 Definition and applicability

Access Control allows restriction of call access attempts. All mobile stations are assigned to a "low order class", and optionally (for priority uses) also to one or more "high order classes".

A "high order class" is only valid in the HPLMN or HPLMN country. Otherwise, the "low order class" is used.

The classes are programmed on the SIM. The network controls which classes at any time may be barred.

In addition, there is a separate mechanism for control of network access for emergency call attempts.

This test applies to GSM, DCS 1 800 and PCS 1900 MEs using ID-1 or Plug-in SIM.

27.10.2 Conformance requirement

1. The ME shall read the access control value as part of the SIM/ME initialization procedure, and subsequently adopt this value.

GSM 11.11, clause 11.2.1.

2. If the MS is a member of at least one access class which corresponds to the permitted classes as signalled over the air interface, and the access class is applicable in the serving network, the MS may make call attempts. Otherwise call access attempts are not allowed.

If access class 10 is barred, MS of classes 0 - 9 and ME without SIMs shall not make emergency call attempts.

MS of classes 11 - 15 are not allowed to make emergency call attempts if access class 10 and the relevant access class(es) between 11 and 15 are barred. Otherwise, emergency call attempts are allowed irrespective of the conditions of access class 10.

All options are shown in figure 27-1 and are referenced to the tests.

GSM 02.11, clauses 4.3 and 4.4.

3. For PCS 1900: The test requirements 1 and 2 above are also tested for emergency call number 911.

27.10.3 Test purpose

- 1) To verify that the ME reads the access control value as part of the SIM/ME initialization procedure, and subsequently adopts this value.
- 2) To verify that the MS controls its network access in accordance with its access control class and the conditions imposed by the serving network.
- 3) For PCS 1900: To verify the requirements in 1 and 2 above by using the emergency call number 911.

The tests verify ME performance for the following:

Tests (a) and (b) No SIM in ME.

Tests (c) to (e) MS with access class 0 to 9.

Test (f) MS with access class 11 and 15 not in HPLMN, and
MS with access class 12,13 and 14 not in HPLMN country.

Test (g) and (h) MS with access class 11 and 15 in HPLMN, and
MS with access class 12,13 and 14 in HPLMN country.

Each of the above are tested against all relevant combinations of access control and emergency call bits signalled by the network, as shown in table 27-1.

27.10.4 Method of test

27.10.4.1 Initial conditions

The SS transmits on the BCCH, with the following network parameters:

Attach/detach: disabled
LAI (MCC/MNC/LAC): see table 27-1
Access control: see table 27-1
RACH: see table 27-1

A SIM is installed in the ME containing IMSI and access control values as given in table 27-1 and the MS is powered on.

NOTE: Depending on the initial value of the EF_{LOCI} , the MS may perform a location update. This will be accepted by the SS.

Coding details

SIM IMSI: Data Field 6F 07

	Value 246813579	Value 2468135x9
byte 1	05H	05H
byte 2	29H	29H
byte 3	64H	64H
byte 4	18H	18H
byte 5	53H	53H
byte 6	97H	9xH
byte 7	FFH	FFH
byte 8	FFH	FFH
byte 9	FFH	FFH

Access class: Data field 6F 78

See GSM 11.11.

NETWORK (SS)

RACH: As defined in GSM 04.08 section 10.5.2.29.

octet 1 01111000
 octet 2 00001000
 octet 3 }
 octet 4 } as table 27-1

27.10.4.2 Procedure

- Using the MMI or EMMI a normal call set-up is attempted.
- Using the MMI or EMMI an emergency call set-up is attempted.
- The test is repeated for each set of values in table 27-1.

27.10.5 Test requirement

After steps a) and b) the MS shall access the network, or shall make no access attempt, in accordance with table 27-1.

NOTE: For type approval, to limit testing, in tests (c), (d) and (e) it is only necessary that one of the access classes is tested.

GSM and DCS 1 800 begin

Table 27-1

SIM		Network		Test result	
IMSI	Access class	RACH octet 3	BCCH/LAI MCC	Normal calls	Emergency calls
		octet 4	MNC		
TEST (a)					
No SIM in ME		00000100 00000000	234 01	No	No
TEST (b)					
No SIM in ME		00000000 00000000	234 01	No	Yes
TEST (c)					
246813579	0	00000100 00000001	246 81	No	No
"	1	00000100 00000010	"	No	No
"	2	00000100 00000100	"	No	No
"	3	00000100 00001000	"	No	No
"	4	00000100 00010000	"	No	No
"	5	00000100 00100000	"	No	No
"	6	00000100 01000000	"	No	No
"	7	00000100 10000000	"	No	No
"	8	00000101 00000000	"	No	No
"	9	00000110 00000000	"	No	No

Table 27-1 (continued)

SIM		Network		Test result	
IMSI	Access class	RACH octet 3 octet 4	BCCH/LAI MNC MNC	Normal calls	Emergency calls
TEST (d)					
246813579	0	00000000 00000001	246 81	No	Yes
"	1	00000000 00000010	"	No	Yes
"	2	00000000 00000100	"	No	Yes
"	3	00000000 00001000	"	No	Yes
"	4	00000000 00010000	"	No	Yes
"	5	00000000 00100000	"	No	Yes
"	6	00000000 01000000	"	No	Yes
"	7	00000000 10000000	"	No	Yes
"	8	00000001 00000000	"	No	Yes
"	9	00000010 00000000	"	No	Yes

Table 27-1 (continued)

SIM IMSI	Access class	Network		Test result	
		RACH octet 3 octet 4	BCCH/LAI MNC MNC	Normal calls	Emergency calls
TEST (e)					
246813579	0	11111011 11111110	246 81	Yes	Yes
"	1	11111011 11111101	"	Yes	Yes
"	2	11111011 11111011	"	Yes	Yes
"	3	11111011 11110111	"	Yes	Yes
"	4	11111011 11101111	"	Yes	Yes
"	5	11111011 11011111	"	Yes	Yes
"	6	11111011 10111111	"	Yes	Yes
"	7	11111011 01111111	"	Yes	Yes
"	8	11111010 11111111	"	Yes	Yes
"	9	11111001 11111111	"	Yes	Yes

Table 27-1 (continued)

SIM IMSI	Access class	Network		Test result	
		RACH octet 3 octet 4	BCCH/LAI MNC MNC	Normal calls	Emergency calls
TEST (f)					
2468135x9	11 & x	00000111 11111111	246 82	No	No
"	"	00000011 11111111	"	No	Yes
"	"	00000000 00000000		Yes	Yes
Set "x" to an arbitrary value in the range 0 to 9 2468135x9	12 & x	00000111 11111111	234 01	No	No
"	"	00000011 11111111	"	No	Yes
"	"	00000000 00000000		Yes	Yes
Set "x" to an arbitrary value in the range 0 to 9 2468135x9	13 & x	00000111 11111111	234 01	No	No
"	"	00000011 11111111	"	No	Yes
"	"	00000000 00000000		Yes	Yes
Set "x" to an arbitrary value in the range 0 to 9 2468135x9	14 & x	00000111 11111111	234 01	No	No
"	"	00000011 11111111	"	No	Yes
"	"	00000000 00000000		Yes	Yes
Set "x" to an arbitrary value in the range 0 to 9 2468135x9	15 & x	00000111 11111111	246 82	No	No
"	"	00000011 11111111	"	No	Yes
"	"	00000000 00000000		Yes	Yes
Set "x" to an arbitrary value in the range 0 to 9					

Table 27-1 (continued)

SIM IMSI	Access Class	Network		Test Result	
		RACH octet 3 octet 4	BCCH/LAI MNC MNC	Normal Calls	Emergency Calls
TEST (g)					
246813579	11 & x	00001111 11111111	246 81	No	No
"	"	00001011 11111111	"	No	Yes
246813579	12 & x	00010111 11111111	246 82	No	No
"	"	00010011 11111111	"	No	Yes
246813579	13 & x	00100111 11111111	246 82	No	No
"	"	00100011 11111111	"	No	Yes
246813579	14 & x	01000111 11111111	246 82	No	No
"	"	01000011 11111111	"	No	Yes
246813579	15 & x	10000111 11111111	246 81	No	No
"	"	10000011 11111111	"	No	Yes
Set "x" to an arbitrary value in the range 0 to 9					

Table 27-1 (continued)

SIM IMSI	Access Class	Network		Test Result	
		RACH octet 3 octet 4	BCCH/LAI MNC MNC	Normal Calls	Emergency Calls
TEST (h)					
246813579	11 & x	11110011 11111111	246 81	Yes	Yes
246813579	12 & x	11101011 11111111	246 82	Yes	Yes
246813579	13 & x	11011011 11111111	246 82	Yes	Yes
246813579	14 & x	10111011 11111111	246 82	Yes	Yes
246813579	15 & x	01111011 11111111	246 81	Yes	Yes
246813579	11 & x	11110111 11111111	246 81	Yes	Yes
246813579	12 & x	11101111 11111111	246 82	Yes	Yes
246813579	13 & x	11011111 11111111	246 82	Yes	Yes
246813579	14 & x	10111111 11111111	246 82	Yes	Yes
246813579	15 & x	01111111 11111111	246 81	Yes	Yes
Set "x" to an arbitrary value in the range 0 to 9					

GSM and DCS 1 800 end

PCS 1900 begin

Table 27-1

SIM		Network		Test result	
IMSI	Access class	RACH octet 3	BCCH/LAI MCC	Normal calls	Emergency calls
		octet 4	MNC		
TEST (a)					
No SIM in ME		00000100 00000000	234 012	No	No
TEST (b)					
No SIM in ME		00000000 00000000	234 012	No	Yes
TEST (c)					
246813579	0	00000100 00000001	246 813	No	No
"	1	00000100 00000010	"	No	No
"	2	00000100 00000100	"	No	No
"	3	00000100 00001000	"	No	No
"	4	00000100 00010000	"	No	No
"	5	00000100 00100000	"	No	No
"	6	00000100 01000000	"	No	No
"	7	00000100 10000000	"	No	No
"	8	00000101 00000000	"	No	No
"	9	00000110 00000000	"	No	No

Table 27-1 (continued)

SIM		Network		Test result	
IMSI	Access class	RACH octet 3 octet 4	BCCH/LAI MNC MNC	Normal calls	Emergency calls
TEST (d)					
246813579	0	00000000 00000001	246 813	No	Yes
"	1	00000000 00000010	"	No	Yes
"	2	00000000 00000100	"	No	Yes
"	3	00000000 00001000	"	No	Yes
"	4	00000000 00010000	"	No	Yes
"	5	00000000 00100000	"	No	Yes
"	6	00000000 01000000	"	No	Yes
"	7	00000000 10000000	"	No	Yes
"	8	00000001 00000000	"	No	Yes
"	9	00000010 00000000	"	No	Yes

Table 27-1 (continued)

SIM IMSI	Access class	Network		Test result	
		RACH octet 3 octet 4	BCCH/LAI MNC MNC	Normal calls	Emergency calls
TEST (e)					
246813579	0	11111011 11111110	246 813	Yes	Yes
"	1	11111011 11111101	"	Yes	Yes
"	2	11111011 11111011	"	Yes	Yes
"	3	11111011 11110111	"	Yes	Yes
"	4	11111011 11101111	"	Yes	Yes
"	5	11111011 11011111	"	Yes	Yes
"	6	11111011 10111111	"	Yes	Yes
"	7	11111011 01111111	"	Yes	Yes
"	8	11111010 11111111	"	Yes	Yes
"	9	11111001 11111111	"	Yes	Yes

Table 27-1 (continued)

SIM IMSI	Access class	Network		Test result	
		RACH octet 3 octet 4	BCCH/LAI MNC MNC	Normal calls	Emergency calls
TEST (f)					
2468135x9	11 & x	00000111 11111111	246 824	No	No
"	"	00000011 11111111	"	No	Yes
"	"	00000000 00000000		Yes	Yes
Set "x" to an arbitrary value in the range 0 to 9 2468135x9	12 & x	00000111 11111111	234 012	No	No
"	"	00000011 11111111	"	No	Yes
"	"	00000000 00000000		Yes	Yes
Set "x" to an arbitrary value in the range 0 to 9 2468135x9	13 & x	00000111 11111111	234 012	No	No
"	"	00000011 11111111	"	No	Yes
"	"	00000000 00000000		Yes	Yes
Set "x" to an arbitrary value in the range 0 to 9 2468135x9	14 & x	00000111 11111111	234 012	No	No
"	"	00000011 11111111	"	No	Yes
"	"	00000000 00000000		Yes	Yes
Set "x" to an arbitrary value in the range 0 to 9 2468135x9	15 & x	00000111 11111111	246 824	No	No
"	"	00000011 11111111	"	No	Yes
"	"	00000000 00000000		Yes	Yes
Set "x" to an arbitrary value in the range 0 to 9					

Table 27-1 (continued)

SIM IMSI	Access Class	Network		Test Result	
		RACH octet 3 octet 4	BCCH/LAI MNC MNC	Normal Calls	Emergency Calls
TEST (g)					
246813579	11 & x	00001111 11111111	246 813	No	No
"	"	00001011 11111111	"	No	Yes
246813579	12 & x	00010111 11111111	246 824	No	No
"	"	00010011 11111111	"	No	Yes
246813579	13 & x	00100111 11111111	246 824	No	No
"	"	00100011 11111111	"	No	Yes
246813579	14 & x	01000111 11111111	246 824	No	No
"	"	01000011 11111111	"	No	Yes
246813579	15 & x	10000111 11111111	246 813	No	No
"	"	10000011 11111111	"	No	Yes
Set "x" to an arbitrary value in the range 0 to 9					

Table 27-1 (continued)

SIM IMSI	Access Class	Network		Test Result	
		RACH octet 3 octet 4	BCCH/LAI MNC MNC	Normal Calls	Emergency Calls
TEST (h)					
246813579	11 & x	11110011 11111111	246 813	Yes	Yes
246813579	12 & x	11101011 11111111	246 824	Yes	Yes
246813579	13 & x	11011011 11111111	246 824	Yes	Yes
246813579	14 & x	10111011 11111111	246 824	Yes	Yes
246813579	15 & x	01111011 11111111	246 813	Yes	Yes
246813579	11 & x	11110111 11111111	246 813	Yes	Yes
246813579	12 & x	11101111 11111111	246 824	Yes	Yes
246813579	13 & x	11011111 11111111	246 824	Yes	Yes
246813579	14 & x	10111111 11111111	246 824	Yes	Yes
246813579	15 & x	01111111 11111111	246 813	Yes	Yes
Set "x" to an arbitrary value in the range 0 to 9					

PCS 1900 end

ACCESS CONTROL

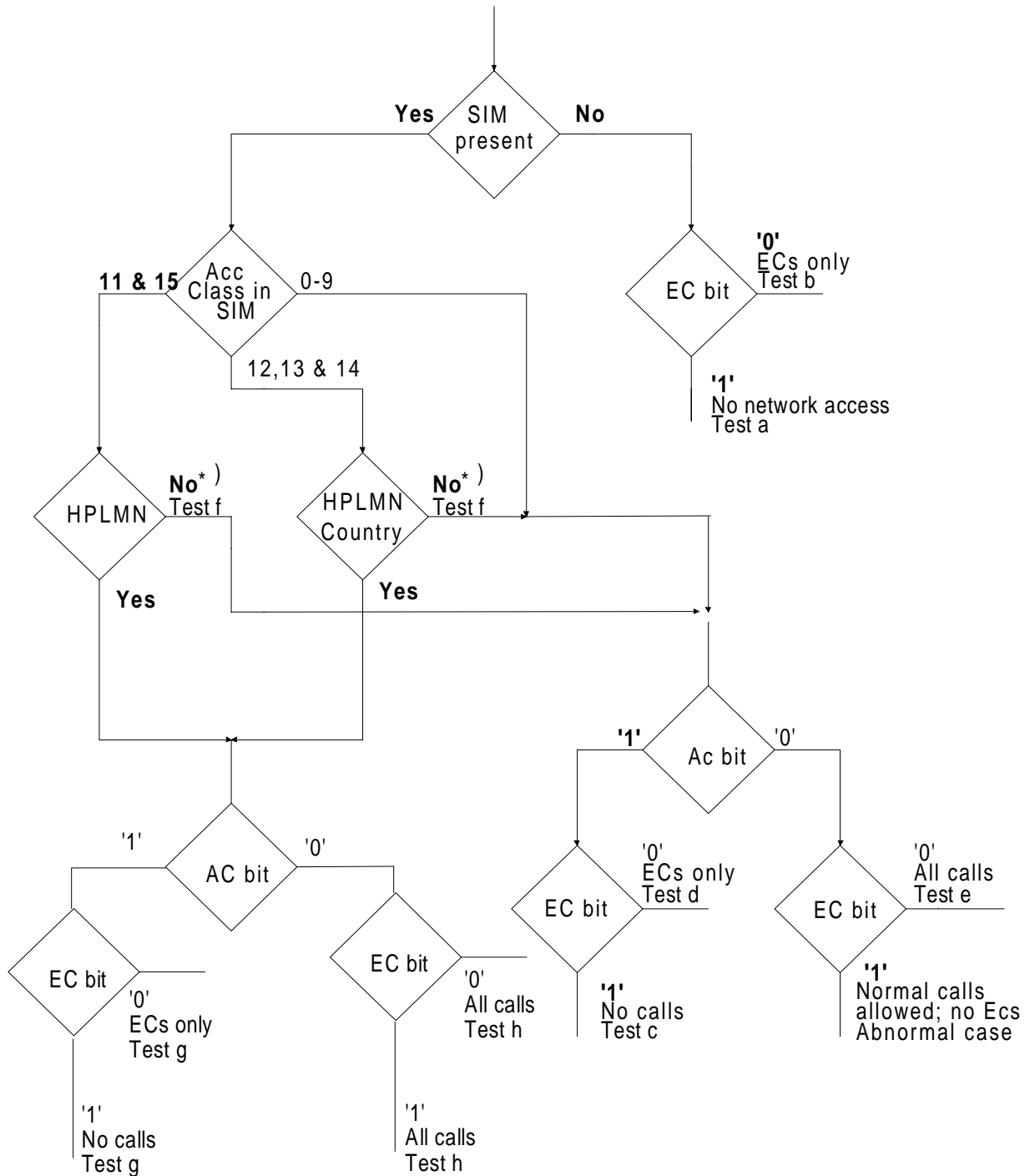

ECs = Emergency Calls

Access Class in SIM - See GSM 11.11 Data Field 6F 78

EC bit = bit3 of octet 3 of RACH Control Parameters - See GSM 04.08 Para 10.5.2.29

AC bit = See bytes 3 & 4 of RACHControl Parameters

*) Mobile adopts Access Class 0-9, based on IMSI. See GSM 02.11

27.11 Exchange protocol tests

27.11.1 Character transmission

27.11.1.1 Bit/character duration during the transmission from the ME to the SIM

27.11.1.1.1 Definition and applicability

Data is transmitted serially across the SIM/ME interface. A character comprises:

- the start bit;
- eight data bits;
- the parity bit.

This test applies to GSM, DCS 1 800 and PCS 1900 MEs using either ID-1 or Plug-in SIM.

27.11.1.1.2 Conformance requirement

The bit/character duration and the delay between two consecutive characters (between start leading edges) sent by the ME shall be in the range specified.

GSM 11.11, section 5.9.

27.11.1.1.3 Test purpose

To verify the timing during the transmission from the ME to the SIM.

27.11.1.1.4 Method of test

27.11.1.1.4.1 Initial conditions

The ME is connected to the SIM simulator, and powered on.

27.11.1.1.4.2 Procedure

A number of characters are transmitted from the ME to the SIM simulator. The SIM simulator shall measure the bit/character duration and the delay between two consecutive characters for all characters transmitted by the ME.

27.11.1.1.5 Test requirement

The timing shall be in the range specified.

27.11.1.2 Bit/character duration during the transmission from the SIM simulator to the ME

27.11.1.2.1 Definition and applicability

Data is transmitted serially across the SIM/ME interface. A character comprises:

- the start bit;
- eight data bits;
- the parity bit.

This test applies to GSM, DCS 1 800 and PCS 1900 MEs using either ID-1 or Plug-in SIM.

27.11.1.2.2 Conformance requirement

Responses with maximum and minimum bit/character duration times shall be accepted by the ME.

GSM 11.11, clause 5.9.

27.11.1.2.3 Test purpose

To verify the acceptance of maximum and minimum bit/character duration during the transmission from the SIM to the ME.

27.11.1.2.4 Method of test

27.11.1.2.4.1 Initial conditions

The ME is connected to the SIM simulator, and powered on.

27.11.1.2.4.2 Procedure

The SIM simulator shall send responses with the maximum and minimum bit/character durations specified in GSM 11.11.

27.11.1.2.5 Test requirement

The ME shall accept the response and act accordingly.

27.11.1.3 Inter-character delay

27.11.1.3.1 Definition and applicability

The inter-character delay is defined as the time between the start edge of a character and the start edge of the previous character. It is given by:

- the length of a character plus an extra guard time of N etu during transmission from the ME to the SIM. N is indicated in ATR character TC1;
- the work waiting time during transmission from the SIM to the ME.

This test applies to GSM, DCS 1 800 and PCS 1900 MEs using either ID-1 or Plug-in SIM.

27.11.1.3.2 Conformance requirement

- 1) If TC1 is 0 or 255 the ME shall work with the SIM.
- 2) If TC1 is not 0 or 255 the ME shall repeat the reset at least 2 times before it rejects the SIM.
- 3) The ME shall accept characters sent by the SIM with the work waiting time within the specified range.

GSM 11.11, clause 5.9.

27.11.1.3.3 Test purpose

- 1) To verify the correct evaluation of the character TC1 indicated in the ATR.
- 2) To verify that the ME accepts the minimum and maximum work waiting time during the transmission from the SIM to the ME.

27.11.1.3.4 Method of test

27.11.1.3.4.1 Initial conditions

The ME is connected to the SIM simulator, and powered on.

27.11.1.3.4.2 Procedure

a) Upon reception of a reset the SIM simulator transmits the ATR as follows:

a.1) $N = 0$;

character name	content	meaning
TS	3B	direct convention
T0	40	TA1, TB1, TD1 not transmitted, TC1 transmitted, no historical characters
TA1	00	$N = 0$

a.2) $N = 255$.

character name	content	meaning
TS	3B	direct convention
T0	40	TA1, TB1, TD1 not transmitted, TC1 transmitted, no historical characters
TA1	FF	$N = 255$

a.3) $N = \text{Value other than 0 and 255}$

character name	content	meaning
TS	3B	direct convention
T0	40	TA1, TB1, TD1 not transmitted, TC1 transmitted, no historical characters
TA1	$00 < XX < FF$	$0 < N < 255$

b) The SIM simulator transmits with a work-waiting-time of 12 etu.

c) The SIM simulator transmits with a work-waiting-time of 9 600 etu.

27.11.1.3.5 Test requirement

In steps a.1) and a.2) the ME shall work with the SIM simulator.

In step a.3) the ME shall repeat the reset at least 2 times and then reject the SIM simulator.

In steps b) and c) the ME shall work with the SIM simulator.

27.11.1.4 Error handling during the transmission from the ME to the SIM

27.11.1.4.1 Definition and applicability

Error checking is done for each character transmitted by making use of the parity bit. If the SIM detects a parity error, an error signal is sent to the ME, and the ME retransmits that character.

This test applies to GSM, DCS 1 800 and PCS 1900 MEs using either ID-1 or Plug-in SIM.

27.11.1.4.2 Conformance requirement

Subsequent to Answer to Reset and the protocol type selection, the error detection and character repetition procedure specified in GSM 11.11 is mandatory for transmission on the basis of $T = 0$. On receipt of an error signal, the ME shall repeat the previously transmitted character.

GSM 11.11, clause 5.10.

27.11.1.4.3 Test purpose

To verify the error handling during the transmission from the ME to the SIM.

27.11.1.4.4 Method of test

27.11.1.4.4.1 Initial conditions

The ME is connected to the SIM simulator, and powered on.

27.11.1.4.4.2 Procedure

The SIM simulator shall transmit an error signal in response to a received character in accordance with ISO 7816-3, section 6.1.3.

27.11.1.4.5 Test requirement

The ME shall repeat the character in accordance with ISO 7816-3, section 6.1.3.

27.11.1.5 Error handling during transmission from the SIM to the ME

27.11.1.5.1 Definition and applicability

Error checking is done for each character transmitted by making use of the parity bit. If the ME detects a parity error, an error signal is sent to the SIM, and the SIM retransmits that character.

This test applies to GSM, DCS 1 800 and PCS 1900 MEs using either ID-1 or Plug-in SIM.

27.11.1.5.2 Conformance requirement

Subsequent to Answer to Reset and the protocol type selection, the error detection and character repetition procedure specified in GSM 11.11 is mandatory for transmission on the basis of $T = 0$. On receipt of a response with a parity error, the ME shall send an error signal and expect the previously transmitted character to be repeated.

GSM 11.11, clause 5.10.

27.11.1.5.3 Test purpose

To verify the error handling during the transmission from the SIM to the ME.

27.11.1.5.4 Method of test

27.11.1.5.4.1 Initial conditions

The ME is connected to the SIM simulator, and powered on.

27.11.1.5.4.2 Procedure

The SIM simulator shall send a response with a parity error and check that the ME performs error handling in accordance with ISO 7816-3, section 6.1.3.

27.11.1.5.5 Test requirement

The ME shall send an error signal in accordance with ISO 7816-3, section 6.1.3, and expect a repetition of the character. The ME shall correctly evaluate the character when repeated by the SIM simulator.

27.11.2 Answer to reset (RST)

27.11.2.1 Acceptance of SIMs with internal RST

27.11.2.1.1 Definition and applicability

Internal RST is one possible implementation of reset, and MEs must be able to accept SIMs with internal reset.

This test applies to GSM, DCS 1 800 and PCS 1900 MEs using either ID-1 or Plug-in SIM.

27.11.2.1.2 Conformance requirement

The ME shall accept a SIM with internal reset by recognizing the ATR within the specified time range.

GSM 11.11, clause 5.

ISO/IEC 7816-3: 1990, section 5.2.

27.11.2.1.3 Test purpose

To verify that the ME accepts a SIM with internal reset.

27.11.2.1.4 Method of test

27.11.2.1.4.1 Initial conditions

The SIM simulator is configured for internal reset. The ME is connected to the SIM simulator and powered on.

27.11.2.1.4.2 Procedure

The SIM simulator starts its ATR between $(400/f_i)$ s and $(40\ 000/f_i)$ s after the clock signal has been detected.

NOTE: f_i is the initial frequency supplied by the ME.

27.11.2.1.5 Test requirement

The ME accepts the SIM simulator with internal reset.

27.11.2.2 Acceptance of SIMs with active low RST

27.11.2.2.1 Definition and applicability

Active low RST is one possible implementation of reset, and MEs must be able to accept SIMs with active low reset.

This test applies to GSM, DCS 1 800 and PCS 1900 MEs using either ID-1 or Plug-in SIM.

27.11.2.2.2 Conformance requirement

The ME shall accept a SIM with active low reset by putting the RST contact to state H. The signal timing shall be in accordance with the specification.

GSM 11.11, clause 5.

ISO/IEC 7816-3: 1990, section 5.2.

27.11.2.2.3 Test purpose

To verify that the ME accepts a SIM with active low reset. The timing of the RST signal shall be in accordance with the specification.

27.11.2.2.4 Method of test

27.11.2.2.4.1 Initial conditions

The SIM simulator is configured for active low reset. The ME is connected to the SIM simulator and powered on.

27.11.2.2.4.2 Procedure

The SIM simulator measures the timing of the RST signal.

27.11.2.2.5 Test requirement

The ME shall accept the SIM simulator with active low reset. The RST signal shall be put to state H after a minimum of (40 000/f_i)s.

27.11.2.3 Characters of the answer to reset

27.11.2.3.1 Definition and applicability

When the SIM is reset, it sends up to 33 characters to the ME, containing information which must be interpreted by the ME to ascertain the transmission protocol to be used.

This test applies to GSM, DCS 1 800 and PCS 1900 MEs using either ID-1 or Plug-in SIM.

27.11.2.3.2 Conformance requirement

1. The ME shall adopt the data encoding convention and initial etu time defined in the initial character TS of the ATR.

GSM 11.11, clause 5.8.

2. The ME shall be able to receive interface characters for other transmission protocols than T = 0, historical characters and a check byte, even if only T = 0 is used by the ME.

GSM 11.11, clause 5.8.1.

27.11.2.3.3 Test purpose

1. To verify that the ME adopts the appropriate data encoding convention and initial elementary time unit (etu) defined in the initial character TS of the Answer to Reset.
2. To verify that the ME accepts interface characters for transmission protocols other than T=0, historical characters and the check byte.

27.11.2.3.4 Method of test

27.11.2.3.4.1 Initial conditions

The ME is connected to the SIM (or SIM simulator).

27.11.2.3.4.2 Procedure

- a) The ME is powered on
- b) The SIM (or SIM simulator) sends an ATR as follows:

character name	content	meaning
TS	3B	direct convention
T0	9F	TB1, TC1 not transmitted, TA1, TD1 transmitted, 15 historical characters
TA1	11	default values F = 372, D = 1
TD1	80	TA2, TB2, TC2 not transmitted, TD2 transmitted, protocol T=0 offered
TD2	01	TA2, TB2, TC2, TD2 not transmitted, protocol T=1 offered
Ti	53 49 4D 20 53 55 42 47 52 4F 55 50 20 39 35	historical characters
TCK	4F	check byte

- c) The ME is made to send further commands to the SIM (or SIM simulator) (e.g. by entering the PIN).
- d) The ME is switched off and on. This time the SIM (or SIM simulator) sends an ATR as follows:

character name	content	meaning
TS	3F	inverse convention
T0	9F	TB1, TC1 not transmitted, TA1, TD1 transmitted, 15 historical characters
TA1	11	default values F = 372, D = 1
TD1	80	TA2, TB2, TC2 not transmitted, TD2 transmitted, protocol T=0 offered
TD2	01	TA2, TB2, TC2, TD2 not transmitted, protocol T=1 offered
Ti	53 49 4D 20 53 55 42 47 52 4F 55 50 20 39 35	historical characters
TCK	4F	check byte

- e) The ME is made to send further commands to the SIM (e.g. by entering the PIN).

27.11.2.3.5 Test requirement

1. After step b), the ME shall work with the SIM (or SIM simulator).
2. After step d), the ME shall work with the SIM (or SIM simulator).

27.11.2.4 PTS procedure

27.11.2.4.1 Definition and applicability

The PTS procedure is required to select the standard transmission protocol if the SIM does not use this as a default.

This test applies to GSM, DCS 1 800 and PCS 1900 MEs using either ID-1 or Plug-in SIM.

27.11.2.4.2 Conformance requirement

If the ME receives an Answer to Reset where TA1 is not equal to "11", it shall initiate the PTS procedure as defined in GSM 11.11.

GSM 11.11, clause 5.8.2.

27.11.2.4.3 Test purpose

To verify that ME uses the PTS procedure as specified in GSM 11.11.

27.11.2.4.4 Method of test

27.11.2.4.4.1 Initial conditions

The ME is connected to the SIM (or SIM simulator).

27.11.2.4.4.2 Procedure

- a) The ME is powered on.
- b) The SIM (or the SIM simulator) sends an ATR as follows:

character name	content	meaning
TS	3B	direct convention
T0	10	TB1, TC1, TD1 not transmitted, TA1 transmitted, no historical characters
TA1	77	invalid values for F and D

27.11.2.4.5 Test requirement

After step b), the ME shall send to the SIM (or the SIM simulator) "FF00FF".

27.11.2.5 Reset repetition

27.11.2.5.1 Definition and applicability

If transmission errors result in the ATR being unintelligible to the ME, the ME performs the reset again. The minimum number of reset attempts is three.

This test applies to GSM, DCS 1 800 and PCS 1900 MEs using either ID-1 or Plug-in SIM.

27.11.2.5.2 Conformance requirement

Following receipt of a wrong ATR, the ME shall perform a reset. The ME shall not reject the SIM until at least three consecutive wrong ATRs are received.

GSM 11.11, clause 5.10.

27.11.2.5.3 Test purpose

To verify that the ME repeats the reset procedure on receipt of a wrong ATR, and does not reject the SIM unless at least three consecutive wrong ATRs are received.

27.11.2.5.4 Method of test

27.11.2.5.4.1 Initial conditions

The ME is connected to the SIM simulator.

27.11.2.5.4.2 Procedure

- a) The ME is powered on.
- b) The SIM simulator sends a non understandable answer to reset to the ME. (e.g. a wrong TS byte), at each reset initiated by the ME.

27.11.2.5.5 Test requirement

After step b), the ME shall repeat the reset at least two times.

27.11.2.6 Speed Enhancement

27.11.2.6.1 Definition and applicability

MEs that support speed enhancement use a specific PTS sequence to indicate the use of different transmission parameters F and D. If this PTS fails, the ME retries with standard parameters.

This test applies to GSM, DCS 1 800 and PCS 1900 MEs supporting speed enhancement.

27.11.2.6.2 Conformance requirement

1. If speed enhancement is implemented in the ME, it is mandatory to support F=512 and D=8 (in addition to the default values F=372 and D=1).

GSM 11.11, clause 5.8.3.

2. If the SIM does not answer the PTS request within the initial waiting time, the ME shall reset the SIM. After two failed PTS attempts using F=512 and D=8 (i.e. no PTS response from the SIM) the ME shall initiate a PTS procedure using default values F=372 and D=1.

GSM 11.11, clause 5.8.3.

27.11.2.6.3 Test purpose

1. To verify that the ME supports the transmission parameters F=512 and D=8
2. To verify that the ME resets the SIM if the SIM does not answer the PTS request within the initial waiting time and initiates a PTS procedure using default values F=372 and D=1 after the second failed PTS attempt.

27.11.2.6.4 Method of test

27.11.2.6.4.1 Initial conditions

The ME is connected to the SIM simulator.

27.11.2.6.4.2 Procedure

- a) The ME is powered on.
- b) The SIM simulator sends an ATR as follows:

character name	content	meaning
TS	3B	direct convention
T0	10	TB1, TC1, TD1 not transmitted, TA1 transmitted, no historical characters
TA1	94	F=512, D=8

- c) After receipt of the PTS Request, the SIM simulator answers with the PTS Response "FF 10 94 7B" using a work waiting time of 9600 etu (initial waiting time).
- d) The SIM simulator transmits with enhanced speed (F=512, D=8).
- e) The ME is switched off and on. The SIM simulator sends an ATR as in step b).
- f) After receipt of the PTS Request, the SIM simulator does not answer.

27.11.2.6.5 Test requirement

After step b) the ME shall send to the SIM simulator the PTS Request "FF 10 94 7B".

After step c) the ME shall work with the SIM simulator.

After step e) the ME shall send to the SIM simulator the PTS Request "FF 10 94 7B" and repeat that once. After that, the ME shall send to the SIM simulator the PTS Request "FF 00 FF".

27.11.3 Command processing, procedure bytes

27.11.3.1 Definition and applicability

The procedure bytes ACK, NULL, and SW1 are sent from the SIM to the ME, and give the ME an acknowledgement for the previous instruction, information concerning transfer of data and the card status at the end of the command.

This test applies to GSM, DCS 1 800 and PCS 1900 MEs using either ID-1 or Plug-in SIM.

27.11.3.2 Conformance requirement

On the basis of protocol T = 0, the ME shall correctly use the different modes of data transmission defined in ISO 7816-3, section 8.2.2.

GSM 11.11, clause 5

ISO/IEC 7816: 1990, section 8.2.2.

27.11.3.3 Test purpose

To verify that the ME uses correctly the different modes of data transmission.

27.11.3.4 Method of test

27.11.3.4.1 Initial conditions

The ME is connected to the SIM simulator and powered on.

27.11.3.4.2 Procedure

- a) The ME is made to initiate a VERIFY CHV command.
- b) The SIM simulator answers the first 3 bytes with ACK=INS complemented.
- c) The SIM simulator answers the next data byte with NULL (NULL="60").
- d) The SIM simulator then sends ACK=INS. This byte is sent when the elapsed time since step b) is greater than the work waiting time.
- e) The SIM simulator answers the transmission of the rest of the data with NULL.
- f) The SIM simulator then sends SW1 and SW2, indicating correct execution of the command ("90" and "00" for SW1 and SW2 respectively). These bytes are sent when the elapsed time since step d) is greater than the work waiting time.

27.11.3.5 Test requirement

The command shall be executed correctly.

27.12 Evaluation of directory characteristics

27.12.1 Operating speed in authentication procedure

27.12.1.1 Definition and applicability

Authentication is performed by a GSM network on the SIM, by sending a random number to the SIM. The SIM then performs a calculation on the random number, and sends the result to the network for verification.

This test applies to GSM, DCS 1 800 and PCS 1900 MEs using either ID-1 or Plug-in SIM.

27.12.1.2 Conformance requirement

If bit b2 of the file characteristics is set to 1, then the ME shall provide a clock frequency of at least 13/4 MHz to enable the SIM to run the authentication process in the required time.

GSM 11.11, clause 5.4.

27.12.1.3 Test purpose

To verify that the authentication procedure is done with a frequency of at least 13/4 MHz if the bit b2 of the file characteristics (byte 1 of the directory characteristics) is set to 1.

27.12.1.4 Method of test

27.12.1.4.1 Initial conditions

System simulator:

1 cell, default parameters.

Mobile Equipment:

Connected to a SIM-simulator with bit b2 of the file characteristics set to 1.

ME is powered on.

27.12.1.4.2 Procedure

An authentication is made in the same way as in test [26.7.2. Authentication]. The MS is paged. After the MS has responded with a PAGING RESPONSE message to the SS, the SS initiates an authentication procedure, sending the MS the value RAND. During authentication, the SIM simulator checks the frequency of the clock supplied by the ME. Following the AUTHENTICATION RESPONSE from the MS, the SS sends CHANNEL RELEASE.

27.12.1.5 Test requirement

The frequency of the clock shall be at least 13/4 MHz during the authentication procedure.

27.12.2 Clock stop

27.12.2.1 Definition and applicability

The ME may switch off the clock signal to the SIM, but only if the SIM indicates that it supports this feature.

This test applies to GSM, DCS 1 800 and PCS 1900 MEs using either ID-1 or Plug-in SIM.

27.12.2.2 Conformance requirement

1. The ME shall not stop the clock, unless the requirements indicated in byte 1 of the file characteristics are met.

GSM 11.11, clauses 5.6 and 9.2.1.

2. The ME shall wait at least 1 860 clock cycles after having received the last character including the minimum guard time (2 etu) of the response before switching off the clock. The ME shall wait at least 744 clock cycles before it sends the first command after having restarted the clock.

GSM 11.11, clause 5.6.

27.12.2.3 Test purpose

1. To verify that the clock is only switched off if requirements are met as indicated in the file characteristics (byte 1 of the directory characteristics).
2. To verify that the timing of the clock switching is as specified.

27.12.2.4 Method of test

27.12.2.4.1 Initial conditions

The ME is connected to a SIM simulator. CHV 1 is enabled.

27.12.2.4.2 Procedure

- a) A SIM simulator is used with bits set as follows:

Bit b1	Bit b3	Bit b4
0	0	0

- b) The ME is powered on. When the ME is in mode PIN check, 10 seconds shall elapse before the PIN is entered.

- c) The ME is powered off, and a SIM simulator is used with bits set as follows:

Bit b1	Bit b3	Bit b4
0	1	0

- d) The ME is powered on. When the ME is in mode PIN check, 10 seconds shall elapse before the PIN is entered.

- e) The ME is powered off, and a SIM simulator is used with bits set as follows:

Bit b1	Bit b3	Bit b4
0	0	1

- f) The ME is powered on. When the ME is in mode PIN check, 10 seconds shall elapse before the PIN is entered.

- g) The ME is powered off, and a SIM simulator is used with bits set as follows:

Bit b1	Bit b3	Bit b4
1	0	0

- h) The ME is powered on. When the ME is in mode PIN check, 10 seconds shall elapse before the PIN is entered.

27.12.2.5 Test requirement

1. During step b), the ME shall not switch off the clock.
2. During step d), the ME shall not switch off the clock, unless at high level.
3. During step f), the ME shall not switch off the clock, unless at low level.
4. During steps d), f) and h), the ME shall not switch off the clock until at least 1 860 clock cycles after having received the last character of the response including the minimum guard time (2 etu).
5. During steps d), f) and h), the ME shall wait at least 744 clock cycles before it sends the first command after having restarted the clock.

27.13 Mechanical tests

27.13.1 Contact pressure

27.13.1.1 Definition and applicability

The contacts of the card reader must exert a force to maintain a good electrical contact, but the force must not be excessive and damage the SIM.

This test applies to GSM, DCS 1 800 and PCS 1900 MEs using either ID-1 or Plug-in SIM.

27.13.1.2 Conformance requirement

A contact force may not be greater than 0,5 N per contact.

GSM 11.11, clause 4.3.4.

27.13.1.3 Test purpose

To verify that the contact pressure of each contacting element is not greater than 0,5 N when each of the following types of card is used:

- i) Unembossed.
- ii) Embossed on the contact side.
- iii) Embossed on the opposite side to the contacts.

NOTE: Only type i) applies to the plug-in SIM.

27.13.1.4 Method of test

27.13.1.4.1 Initial conditions

The ME manufacturers shall provide a separate card reader (mechanical components) to make the measurement possible.

27.13.1.4.2 Procedure

The pressure of each contacting element is measured.

27.13.1.5 Test requirement

The contact pressure of each contacting element shall be not greater than 0,5 N.

27.13.2 Shape of contacts for IC card SIM card reader

27.13.2.1 Definition and applicability

The shape of the contacts is important to maintain a good electrical contact, but must not damage the SIM.

This test applies to GSM, DCS 1 800 and PCS 1900 MEs using either ID-1 or Plug-in SIM.

27.13.2.2 Conformance requirement

The radius of curvature of the contacting elements shall be greater than or equal to 0,8 mm in the contact area of both axes.

GSM 11.11, clause 4.3.4.

27.13.2.3 Test purpose

To verify that the radius of curvature of the contacting elements is greater than or equal to 0,8 mm in the contact area on both axes.

27.13.2.4 Method of test

27.13.2.4.1 Initial conditions

The ME manufacturers shall provide a separate card reader (mechanical components) to make the measurement possible.

27.13.2.4.2 Procedure

The radius of curvature of the contacting elements is measured on both axes.

27.13.2.5 Test requirement

The radius of curvature of the contacting elements shall be greater than or equal to 0,8 mm in the contact area on both axes.

27.14 Secret code usage

27.14.1 Entry of PIN

27.14.1.1 Definition and applicability

The PIN is a number used to authenticate the user to the SIM for security. Entry of the correct PIN allows PIN-protected data to be accessed over the SIM-ME interface.

This test applies to all ME.

27.14.1.2 Conformance requirement

Following insertion of the SIM and switching on the MS, the ME shall check the state of the PIN. If the PIN is enabled, the ME asks the user for PIN verification.

The VERIFY CHV function verifies the PIN presented by the ME to the SIM.

Reference:

GSM 02.30, section 4.6.1; GSM 11.11, sections 8.9, 9.2.9 and 11.3.1.

27.14.1.3 Test purpose

1. To verify that the PIN verification procedure is performed by the ME correctly.
2. To verify that the GSM basic public MMI string is supported.

27.14.1.4 Method of test

27.14.1.4.1 Initial conditions

The ME is connected to a SIM or SIM-simulator with the PIN enabled, and powered off.

The default SIM is used.

27.14.1.4.2 Procedure

- a) The ME is powered on.
- b) When the MS is in mode "PIN check" enter "2468#".

27.14.1.5 Test requirement

- 1) The ME shall send a VERIFY CHV command to the SIM, with CHV number = "01".
- 2) The MS shall give an indication "OK", following a successful execution of the command.

27.14.2 Change of PIN

27.14.2.1 Definition and applicability

The PIN may be changed by the user, by entering the old and new PINs. The length of the PIN is between 4 and 8 digits.

This test applies to all MEs.

27.14.2.2 Conformance requirement

The ME shall support the change of PIN procedure as defined in GSM 02.30 and GSM 11.11.

Reference:

GSM 02.30, section 4.6.2; GSM 11.11, sections 8.10, 9.2.10 and 11.3.2.

27.14.2.3 Test purpose

1. To verify that the PIN substitution procedure is performed correctly by the ME.
2. To verify that the GSM basic public MMI string is supported.

27.14.2.4 Method of test

27.14.2.4.1 Initial conditions

The ME is connected to a SIM or SIM-simulator with the PIN enabled.

The default SIM is used.

The ME is powered-on, with the correct PIN entered.

27.14.2.4.2 Procedure

- a) Enter "***04*2468*01234567*01234567#".
- b) The MS is switched off and on.
- c) When the MS is in mode "PIN-check", the sequence "01234567#" is entered.
- d) The MS is switched off and on.
- e) When the MS is in mode "PIN check" enter "2468#".

27.14.2.5 Test requirement

- 1) After step a), the ME shall send a CHANGE CHV command to the SIM, with CHV number set to "01".
- 2) Following the successful execution of the command, the MS shall give an indication that the new PIN is accepted.
- 3) After step c), the MS shall give an indication "OK".
- 4) After step e), the MS shall give an indication that the entered PIN is not accepted.

27.14.3 Disabling the PIN

27.14.3.1 Definition and applicability

Entry of the PIN may be disabled by the user, depending on the service table of the SIM. It is the responsibility of the ME to check the SIM service table.

This test applies to GSM, DCS 1 800 and PCS 1900 MEs using either ID-1 or Plug-in SIM that support a feature to disable the PIN.

27.14.3.2 Conformance requirement

Disabling PIN is achieved through the DISABLE CHV command. If the PIN disable function in the SIM service table is not allocated or activated, then the ME shall not attempt to disable the PIN.

Reference:

GSM 11.11, sections 8.11, 9.2.11, 10.2.7, 11 and 11.3.3.

27.14.3.3 Test purpose

To verify that the ME does not attempt to disable the PIN.

27.14.3.4 Method of test

27.14.3.4.1 Initial conditions

The ME is connected to the SIM simulator.

Elementary files in the SIM simulator shall be default, with the exception of:

EF_{SST} (SIM Service Table)

Logically: CHV1 disable function not activated.

Abbreviated dialling numbers allocated and activated.

PLMN selector allocated and activated.

Fixed dialling numbers not activated.

Coding: B1 B2 B3 B4
 xx0x110x 0011xxxx xxxxxxxx 0000xxxx (binary)

The coding of EF_{SST} shall conform with the capabilities of the SIM simulator.

The ME is powered on and a correct PIN entered.

27.14.3.4.2 Procedure

Using the ME's MMI procedure, an attempt is made to disable the PIN.

27.14.3.5 Test requirement

The ME shall not send a DISABLE CHV command across the SIM/ME interface.

27.14.4 PUK entry

27.14.4.1 Definition and applicability

After three consecutive wrong entries of the PIN, the PIN becomes blocked. The PUK is used to unblock the PIN. This function may be performed whether or not the PIN is blocked.

This test applies to GSM, DCS 1 800 and PCS 1900 MEs using either ID-1 or Plug-in SIM.

27.14.4.2 Conformance requirement

The ME shall support the procedure to unblock PIN using PUK, as defined in GSM 02.30 and GSM 11.11.

Reference:

GSM 02.30, section 4.6.3; GSM 11.11, sections 8.13, 9.2.13 and 11.3.5.

27.14.4.3 Test purpose

1. To verify that the CHV unblocking procedure is performed correctly.
2. To verify that the GSM basic public MMI string is supported.

27.14.4.4 Method of test

27.14.4.4.1 Initial conditions

The ME is connected to the SIM simulator.

The default SIM is used.

27.14.4.4.2 Procedure

- a) The ME is powered on.
- b) Enter "***05*13243546*1234*1234#"
- c) The ME is powered off and on.
- d) Enter the new PIN: "1234".
- e) The ME is powered off and on.
- f) Enter a wrong PIN three times.
- g) Enter "***05*13243546*2468*2468#"
- h) The ME is powered off and on.
- i) Enter the new PIN: "2468".

27.14.4.5 Test requirements

1. After step b), the ME shall send an UNBLOCK CHV command to the SIM, with CHV number = "00".
2. After step d), the ME shall indicate that the PIN has been accepted.
3. After step f), the ME shall indicate that the PIN has been blocked.
4. After step g), the ME shall send an UNBLOCK CHV command to the SIM, with CHV number = "00".
5. After step j), the ME shall indicate that the PIN has been accepted.

27.14.5 Entry of PIN2

27.14.5.1 Definition and applicability

PIN2 is a number used to authenticate the user to the SIM for security. Entry of the correct PIN2 allows PIN2-protected data to be accessed over the SIM-ME interface.

This test applies to all ME that support a feature requiring entry of PIN2, such as AoC or FDN.

27.14.5.2 Conformance requirement

Where entry of PIN2 is necessary for security access, the ME shall indicate that PIN2 is to be entered.

The VERIFY CHV function verifies the PIN presented by the ME to the SIM.

Reference:

GSM 02.30, section 4.6.1; GSM 11.11, sections 8.9, 9.2.9, and 11.3.1.

27.14.5.3 Test purpose

To verify that entry of PIN2 is processed by the ME correctly.

27.14.5.4 Method of test

27.14.5.4.1 Initial conditions

The ME is connected to a SIM or SIM-simulator and powered on, with the correct PIN entered.

A default FDN SIM is used.

27.14.5.4.2 Procedure

- a) A feature is accessed which requires the entry of PIN2, e.g. resetting ACM for Advice of Charge, or changing a Fixed Dialling Number.
- b) The MMI is used to enter PIN2: "3579".

27.14.5.5 Test requirement

- 1) After step b), the ME shall send a VERIFY CHV command to the SIM, with CHV number = "02".
- 2) Following the successful execution of the command, the MS shall give an indication that PIN2 was accepted.

27.14.6 Change of PIN2

27.14.6.1 Definition and applicability

The PIN2 may be changed by the user, by entering the old and new PIN2s. The length of the PIN is between 4 and 8 digits.

This test applies to all MEs that support PIN2.

27.14.6.2 Conformance requirement

The ME shall support the change of PIN2 procedure as defined in GSM 02.30 and GSM 11.11.

Reference:

GSM 02.30, section 4.6.2; GSM 11.11, sections 8.10, 9.2.10 and 11.3.2.

27.14.6.3 Test purpose

1. To verify that PIN2 substitution procedure is performed correctly by the ME.
2. To verify that the GSM basic public MMI string is supported.

27.14.6.4 Method of test

27.14.6.4.1 Initial conditions

The ME is connected to a SIM or SIM-simulator.

The default FDN SIM is used, with PIN enabled.

The ME is powered on, with the correct PIN entered.

27.14.6.4.2 Procedure

- a) Enter "***042*3579*12345678*12345678#".
- b) The MS is switched off and on, and PIN entered: "2468".
- c) Enter "***042*3579*12345678*12345678#".
- d) Enter "***042*12345678*3579*3579#".

27.14.6.5 Test requirement

- 1) After step a), the ME shall send a CHANGE CHV command to the SIM, with CHV number set to "02".
- 2) Following the successful execution of the command, the MS shall give an indication that the new PIN2 is accepted.

- 3) After step c), the MS shall give an indication that the new PIN2 is not accepted.
- 4) After step d), the MS shall give an indication that the new PIN2 is accepted.

27.14.7 PUK2 entry

27.14.7.1 Definition and applicability

After three consecutive wrong entries of PIN2, it becomes blocked. PUK2 is used to unblock PIN2. This function may be performed whether or not PIN2 is blocked.

This test applies to GSM, DCS 1 800 and PCS 1900 MEs using either ID-1 or Plug-in SIM, that support PIN2.

27.14.7.2 Conformance requirement

The ME shall support the procedure to unblock PIN2 using PUK2, as defined in GSM 02.30 and GSM 11.11.

Reference:

GSM 02.30, section 4.6.3; GSM 11.11, sections 8.13, 9.2.13 and 11.3.5.

27.14.7.3 Test purpose

1. To verify that the PUK2 unblock procedure is performed correctly by the ME.
2. To verify that the GSM basic public MMI string is supported.

27.14.7.4 Method of test

27.14.7.4.1 Initial conditions

The ME is connected to the SIM simulator.

The default FDN SIM is used, with PIN enabled.

27.14.7.4.2 Procedure

- a) The ME is powered on and a correct PIN entered.
- b) Enter "***052*08978675*1234*1234#".
- c) The MS is powered off and on, and PIN entered: "2468".
- d) A feature is selected requiring the entry of PIN2, and the new PIN2 "1234" is entered.
- e) A wrong PIN2 is entered three times.
- f) Enter "***052*08978675*3579*3579#".
- g) A feature is selected requiring the entry of PIN2, and the new PIN2 "3579" is entered.

27.14.7.5 Test requirements

1. After step b), the ME shall send an UNBLOCK CHV command to the SIM, with CHV number = "02"
2. After step d), the ME shall send a VERIFY CHV command, with CHV number = "02". Following the successful execution of the command, the ME shall indicate that the PIN2 has been accepted.
3. After step e), the ME shall indicate that PIN2 has been blocked.
4. After step f), the ME shall send an UNBLOCK CHV command to the SIM, with CHV number = "02"
5. After step g), the ME shall indicate that PIN2 has been accepted.

27.15 Abbreviated Dialling Numbers (ADN)

27.15.1 Definition and applicability

Abbreviated Dialling Numbers contain subscriber number and supplementary service control strings. They may also contain alpha identifiers.

This test applies to both GSM, DCS 1 800 and PCS 1900 MEs using either ID-1 or plug-in SIMs, that support ADN.

27.15.2 Conformance requirement

The ME shall be able to manage the storage and retrieval of ADNs from the SIM, and set up calls to these numbers.

Reference:

GSM 02.07, annex B.3.1; GSM 02.30 section 4.6.4; GSM 11.11, section 11.5.1.

27.15.3 Test purpose

To verify that the ME manages the storage and retrieval of ADNs from the SIM.

27.15.4 Method of Test

27.15.4.1 Initial conditions

Coding of elementary files in the SIM shall be as default, with the addition of:

EF_{ADN} (Abbreviated Dialling Number)

Logically:

At least 101 records.

Record 1:

Length of alpha identifier: 32 characters

Alpha identifier: "ABCDEFGHIJKLMNOPQRSTUVWXYZABCDEF"

Length of BCD number: "03"

TON and NPI: Telephony and Unknown

Dialled number: 123

CCI: None

Ext1: None

Coding for record 1:

B1	B2	B3	...	B32	B33	B34	B35	B36	B37	B38	B39	...	B46
41	42	43	...	46	03	81	21	F3	FF	FF	FF	...	FF

The ME is installed with the default SIM or SIM simulator, and switched on.

27.15.4.2 Procedure

- The code "+123456789012345" is stored (entered) in the MS as abbreviated dialling entry number 7 on the SIM.
- The code "00112233" is stored (entered) in the MS as abbreviated dialling entry number 6 on the SIM.
- The code "***21*44556677#" is stored (entered) in the MS as abbreviated dialling entry number 101 on the SIM.

- d) Retrieve data from SIM entry number 7 using the procedure N(N)(N)#.
- e) Retrieve data from SIM entry number 6 using the procedure N(N)(N)#.
- f) Retrieve data from SIM entry number 101 using the procedure N(N)(N)#.
- g) Retrieve data from SIM entry number 1 using the procedure N(N)(N)#, and display the alpha identifier.

27.15.5 Test requirements

- 1) After step d), the number "+123456789012345" shall be displayed.
- 2) After step e), the number "00112233" shall be displayed.
- 3) After step f), the number "***21*44556677#" (or an equivalent representation) shall be displayed.
- 4) After step g), the ME shall display at least part of the alpha identifier, and shall sustain normal operation.

27.16 MMI reaction to SIM status encoding

27.16.1 Definition and applicability

The SIM gives status information in response to instructions, as two-byte codes. Some of these codes give valuable information to the user, and appropriate indication by the ME is mandatory.

This test applies to GSM, DCS 1 800 and PCS 1900 MEs using either ID-1 or plug-in SIMs.

27.16.2 Conformance requirement

It is mandatory to give the user an appropriate indication when any of the codes given below appear.

Reference:

GSM 02.30, section 4.6.5.

27.16.3 Test purpose

To verify that the ME gives an appropriate indication to the user in response to status information return codes from the SIM.

27.16.4 Method of test

27.16.4.1 Initial conditions

The ME is connected to the SIM simulator. All elementary files are coded as default.

The ME is powered on.

27.16.4.2 Procedure.

The SIM simulator is used to send the following error codes as reaction on an instruction from the ME:

- 9240 Memory Problem
- 9804 Access security policy not fulfilled or secret code rejected
- 9840 Secret code locked
- 6FXX Technical problem with no diagnostic given as reaction on an instruction from the ME.

27.16.5 Test requirement

For each error code, the ME shall give an appropriate MMI indication.

27.17 Electrical tests

General test purpose

Testing of electrical characteristics of the SIM/ME interface.

Whilst non-conformance in this area would be unlikely to cause difficulties to other users or the network (type approval criteria), significant deviations from the specifications (GSM 11.11 and ISO 7816) may damage the SIM. If an attempt is then made to use the SIM in a different ME, then its failure may reflect badly on both that ME and the network.

This section lists the electrical tests to be performed.

They include:

- i) tests during activation and deactivation phases; and
- ii) tests to be performed on each contact in both static and dynamic states: e.g. voltages, currents and signal characteristics.

However, due to the likely difficulty of accessing the terminals of the SIM/ME interface for the purposes of measurements, the ME manufacturer shall provide a test interface in accordance with section 36.5 for the purpose of conformance testing.

These tests apply to GSM, DCS 1 800 and PCS 1900 MEs using either ID-1 or plug-in SIMs with any one of the following types of SIM/ME interface:

- a) 5V SIM interface: The interface only supports the 5V operation mode as specified in GSM 11.11 and ISO 7816-3. The following conformance requirements apply:

27.17.1.1.2

27.17.1.2.2 a)

27.17.1.3.2 a)

27.17.1.4.2 a)

27.17.2.1.1.2 a)

27.17.2.1.2.2 a)

27.17.2.2.2 a)

27.17.2.3.2 a-1,2,3,4)

27.17.2.5.2 a-1,2,3,4)

- b) 3V SIM interface: The interface only supports the 3V operation mode as specified in GSM 11.12. The following conformance requirements apply:

27.17.1.1.2

27.17.1.2.2 b)

27.17.1.4.2 b)

27.17.1.5.1.2

27.17.1.5.2.2

27.17.2.1.1.2 b)

27.17.2.1.2.2 b)

27.17.2.2.2 b)

27.17.2.3.2 b-1,2,3,4)

27.17.2.5.2 b-1,2,3,4)

- c) 5V/3V SIM interface: The interface supports both the 5V operation mode as specified in GSM 11.11 and ISO 7816-3 and the 3V operation mode as specified in GSM 11.12. It recognizes the type of SIM and switches the interface accordingly. The following conformance requirements apply:

27.17.1.1.2

27.17.1.2.2 c-1,2)

27.17.1.3.2 c)

27.17.1.4.2 c-1,2)

27.17.1.5.3.2

27.17.1.5.4.2

27.17.2.1.1.2 c-1,2)

27.17.2.1.2.2 c-1,2)

27.17.2.2.2 c-1,2)

27.17.2.3.2 c-1,2,3,4,5,6,7,8)

27.17.2.5.2 c-1,2,3,4,5,6,7,8)

General measurement conventions

For the 5V interface operation mode, the measurement conventions are specified in ISO/IEC 7816-3 section 4.2.1.

For the 3V interface operation mode these conditions apply in an analogous way.

27.17.1 Test of the power transition phases

27.17.1.1 Phase preceding ME power on

27.17.1.1.1 Definition and applicability

When the mobile equipment is switched off, the contacts of the SIM/ME interface remain in an inactive state in order to prevent any damage to the SIM.

This test applies to GSM, DCS 1 800 and PCS 1900 MEs.

27.17.1.1.2 Conformance requirement

The residual voltage across the contacts of the SIM/ME interface (C1, C2, C3, C6, C7) shall not exceed +/- 0,4 Volts referenced to GND.

Reference:

GSM 11.11, section 4.3.3

27.17.1.1.3 Test purpose

To verify that the residual voltage across the contacts of the SIM/ME interface (C1, C2, C3, C6, C7) is not greater than +/- 0,4 Volts referenced to GND.

27.17.1.1.4 Method of test

27.17.1.1.4.1 Initial condition

The ME is connected to a SIM Simulator.

The contact C1 (Vcc) of the SIM/ME interface is loaded with an impedance of 10 kOhm.

The other contacts (C2, C3, C6, C7) are loaded with an impedance of 50 kOhm.

27.17.1.1.4.2 Procedure

The residual voltage on each contact is measured.

27.17.1.1.5 Test requirement

The residual voltage on each contact shall not exceed +/- 0,4 Volts referenced to GND.

27.17.1.2 Phase during SIM power on

27.17.1.2.1 Definition and applicability

When the mobile station is switched on or when the SIM/ME interface is being activated after 3V/5V switching, the contacts shall be activated in a defined sequence in order to prevent any damage to the SIM.

The timing of this sequence is not defined, a measurement resolution better than or equivalent to 100 ns is assumed.

An ME supporting both 5V and 3V interface operation mode may switch from 3V to 5V after it has read the SIM type identification in the SIM status information by deactivating the SIM and activating it at the new supply voltage.

This test applies to GSM, DCS 1 800 and PCS 1900 MEs with:

- a) 5V SIM interface
- b) 3V SIM interface
- c) 5V/3V SIM interface

27.17.1.2.2 Conformance requirement

- a) When the MS is soft powered on, the contacts of the SIM/ME interface shall be activated in the following order:
 - 1 - RST in state L,
 - 2 - Vcc powered,
 - 3 - I/O (ME) in reception mode,
 - 4 - Clock signal provided with a suitable and stable clock.

When V_{pp} is connected to V_{cc} , as allowed by GSM 11.11 (clause 4.3.2 and 5.3), then V_{pp} is activated together with V_{cc} , at the time of V_{cc} (step 2 in the sequence above).

b) When the MS is soft powered on, the contacts of the SIM/ME interface shall be activated in the following order:

- 1 - RST in state L,
- 2 - V_{cc} powered,
- 3 - I/O (ME) in reception mode,
- 4 - Clock signal provided with a suitable and stable clock.

c-1) When the MS is soft powered on, the contacts of the SIM/ME interface shall be activated to 3V mode in the following order:

- 1 - RST in state L,
- 2 - V_{cc} powered,
- 3 - I/O (ME) in reception mode,
- 4 - Clock signal provided with a suitable and stable clock.

c-2) When the SIM/ME interface is being activated after the 3V/5V switching the contacts shall be activated to 5V mode in the order given in c-1).

Reference:

- a): GSM 11.11, section 4.3.2
b), c-1), c-2) GSM 11.12, section 4.4 and section 4.5

27.17.1.2.3 Test purpose

To verify that the contacts of the SIM/ME interface are activated in the correct order, as described in the conformance requirement.

27.17.1.2.4 Method of test

27.17.1.2.4.1 Initial condition

The ME is connected to a SIM Simulator.

27.17.1.2.4.2 Procedure

To test the requirements a), b) and c-1), the MS is soft powered on.

To test the requirement c-2), the ME is caused to switch the voltage on the SIM/ME interface.

The verification of each activation procedure starts with the first contact leaving the inactive state. The SIM/ME interface is monitored until it is fully activated.

27.17.1.2.5 Test requirement

The contacts of the SIM/ME interface shall be activated in the correct order, as described in the conformance requirement.

27.17.1.3 Phase during ME power off with clock stop forbidden

27.17.1.3.1 Definition and applicability

When the mobile station is soft powered off, the contacts shall be deactivated in a defined sequence in order to prevent any damage to the SIM.

The timing of this sequence is not defined, a measurement resolution better than or equivalent to 100 ns is assumed.

NOTE 1: If during MS operation the SIM is physically removed it is impractical to ensure correct sequencing of deactivation and the possible damage to the SIM cannot be safeguarded by a type approval test. Furthermore, in this situation the integrity of SIM data is not guaranteed (see GSM 02.17).

NOTE 2: Since 3V technology SIMs shall not indicate that clock stop is forbidden, this test applies only to MEs with a 5V interface and MEs with a 5V/3V interface when powered down from 5V mode.

This test applies to GSM, DCS 1 800 and PCS 1900 MEs with:

- a) 5V SIM interface
- b) [not applicable for 3V SIM interface]
- c) 5V/3V SIM interface

27.17.1.3.2 Conformance requirement

- a) When the ME is soft powered down, the contacts of the SIM/ME interface shall be deactivated in the following order:
 - 1 - RST at low state,
 - 2 - Clock stopped at low state,
 - 3 - Vpp inactive (only if Vpp is provided independent of Vcc, see GSM 11.11 clause 5.3),
 - 4 - I/O at state A,
 - 5 - Vcc inactive.

When Vpp is connected to Vcc, as allowed by GSM 11.11 (clause 5.3), then Vpp is deactivated together with Vcc, at the time of Vcc (step 5 in the sequence above).

- c) When the ME is soft powered down from 5V mode, the contacts of the SIM/ME interface shall be deactivated in the following order:
 - 1 - RST at low state,
 - 2 - Clock stopped at low state,
 - 3 - I/O at status A,
 - 4 - Vcc inactive.

Reference:

- a): GSM 11.11, section 4.3.2
- c): GSM 11.12, section 4.5

27.17.1.3.3 Test purpose

To verify that the contacts of the SIM/ME interface become deactivated in the correct order, as given in the conformance requirement.

27.17.1.3.4 Method of test

27.17.1.3.4.1 Initial condition

The ME is connected to a SIM Simulator.

The file characteristics of the directories (byte 14 of STATUS information) shall indicate a 5V SIM with clock stop forbidden.

27.17.1.3.4.2 Procedure

The MS is soft powered off.

The SIM/ME interface is monitored until it is fully deactivated.

27.17.1.3.5 Test requirement

The contacts of the SIM/ME interface shall be deactivated in the correct order, as given in the conformance requirement.

27.17.1.4 Phase during ME power off with clock stop allowed

27.17.1.4.1 Definition and applicability

When the mobile station is soft powered off or when the SIM/ME interface is being deactivated for 3V/5V switching, the contacts shall be deactivated in a defined sequence in order to prevent any damage to the SIM.

The timing of this sequence is not defined, a measurement resolution better than or equivalent to 100 ns is assumed.

NOTE: If during MS operation the SIM is physically removed it is impractical to ensure correct sequencing of deactivation and the possible damage to the SIM cannot be safeguarded by a type approval test. Furthermore, in this situation the integrity of the SIM data is not guaranteed (see GSM 02.17).

This test applies to GSM, DCS 1 800 and PCS 1900 MEs with:

- a) 5V SIM interface
- b) 3V SIM interface
- c) 5V/3V SIM interface

27.17.1.4.2 Conformance requirement

- a) Depending on the state of the clock at the time of deactivation, the contacts of the SIM/ME shall be deactivated in one of two ways.

If the clock is running, the contacts of the SIM/ME interface shall be deactivated in the following order:

- 1 - RST at low level,
- 2 - Clock stopped at low level,
- 3 - Vpp inactive (only if Vpp is provided independent of Vcc, see GSM 11.11 clause 5.3),
- 4 - I/O at status A,
- 5 - Vcc inactive.

When Vpp is connected to Vcc, as allowed by GSM 11.11 (clause 5.3), then Vpp is deactivated together with Vcc, at the time of Vcc (step 5 in the sequence above).

If the clock is stopped and is not restarted, the ME is allowed to deactivate all the contacts in any order, provided that all signals reach low level before Vcc leaves high level.

- b) Depending on the state of the clock at the time of deactivation, the contacts of the SIM/ME shall be deactivated in one of two ways.

If the clock is running, the contacts of the SIM/ME interface shall be deactivated in the following order:

- 1 - RST at low level,
- 2 - Clock stopped at low level,
3. I/O at status A,
- 4.- Vcc inactive.

If the clock is stopped and is not restarted, the ME is allowed to deactivate all the contacts in any order, provided that all signals reach low level before Vcc leaves high level.

- c-1) Depending on the state of the clock at the time of deactivation, the contacts of the SIM/ME interface shall be deactivated in one of two ways.

If the clock is running, the contacts of the SIM/ME interface shall be deactivated in the following order:

- 1 - RST at low level,
- 2 - Clock stopped at low level,
3. I/O at status A,
- 4.- Vcc inactive.

If the clock is stopped and is not restarted, the ME is allowed to deactivate all the contacts in any order, provided that all signals reach low level before Vcc leaves high level.

- c-2) When the SIM/ME interface is deactivated for 3V/5V switching, the contacts shall be deactivated as given in c-1).

Reference:

- a): GSM 11.11, section 4.3.2
b), c-1), c-2): GSM 11.12, section 4.5

27.17.1.4.3 Test purpose

To verify that, depending on the state of the clock (running or stopped), the contacts of the SIM/ME interface become deactivated in the correct order, as given in the conformance requirement.

27.17.1.4.4 Method of test

27.17.1.4.4.1 Initial condition

The ME is connected to a SIM Simulator.

The file characteristics of the directories (byte 14 of STATUS information) shall indicate that clock stop is allowed.

27.17.1.4.4.2 Procedure

To test the requirements a), b) and c-1), the MS is soft powered off.

To test the requirement c-2), the ME is caused to switch the voltage on the SIM/ME interface.

The SIM/ME interface is monitored until it is fully deactivated.

27.17.1.4.5 Test requirement

The contacts of the SIM/ME interface shall be deactivated in the correct order, as given in the conformance requirements.

27.17.1.5 SIM Type Recognition and Voltage Switching

27.17.1.5.1 Reaction of 3V only MEs on SIM type recognition failure

27.17.1.5.1.1 Definition and applicability

When a 3V only ME detects a failure during the SIM type recognition procedure, the ME shall reject the SIM in order to prevent any damage to the SIM.

This test applies to GSM, DCS 1 800 and PCS 1900 MEs with a 3V SIM interface.

27.17.1.5.1.2 Conformance requirement

- 1) The procedure for deriving the identification bit (SIM type recognition procedure) shall be performed by the ME immediately after the ATR and before issuing any other command. The procedure shall consist of the two commands "SELECT GSM" and "STATUS/GET RESPONSE".
- 2) If a 3V only ME cannot complete the SIM type recognition procedure the ME shall deactivate the SIM/ME interface and reject the SIM immediately without issuing any further command.

This procedure shall be finished within 5 seconds after the "STATUS/GET RESPONSE" command.

Reference:

GSM 11.12 section 4.3 and 4.5

27.17.1.5.1.3 Test purpose

- 1) To verify that a 3V only ME correctly performs the SIM type recognition procedure.
- 2) To verify that a 3V only ME deactivates the SIM/ME interface and rejects the SIM in case that the SIM does not respond to the "STATUS/GET RESPONSE" command.

27.17.1.5.1.4 Method of test

27.17.1.5.1.4.1 Initial condition

The ME is connected to a SIM Simulator simulating a 3V technology SIM with nominal test conditions according to table 27.2-2. All elementary files are coded as default.

The ME is powered on.

27.17.1.5.1.4.2 Procedure

After sending the ATR the SIM simulator checks the presence of the commands "SELECT GSM" and "STATUS/GET RESPONSE" as the first and only commands of the GSM card session.

The SIM simulator does not respond to the "STATUS/GET RESPONSE" command.

The SIM/ME interface is monitored for at least 1 minute until the MS is switched off.

27.17.1.5.1.5 Test requirement

- 1) Immediately after the ATR only the two commands "SELECT GSM" and "STATUS/GET RESPONSE" shall be sent by the ME.
- 2) The 3V only ME shall deactivate the SIM/ME interface within 5 seconds and reject the SIM (i.e. not activate the SIM/ME interface within the test procedure).

27.17.1.5.2 Reaction of 3V only MEs on type recognition of 5V only SIMs

27.17.1.5.2.1 Definition and applicability

When a 3V only ME detects a 5V only SIM during the SIM type recognition procedure, the ME shall reject the SIM in order to prevent any damage to the SIM.

This test applies to GSM, DCS 1 800 and PCS 1900 MEs with 3V SIM interface.

27.17.1.5.2.2 Conformance requirement

- 1) The procedure for deriving the identification bit (SIM type recognition procedure) shall be performed by the ME immediately after the ATR and before issuing any other command. The procedure shall consist of the two commands "SELECT GSM" and "STATUS/GET RESPONSE"
- 2) If a 3V only ME identifies a 5V only SIM during the SIM type recognition procedure the ME shall deactivate the SIM/ME interface and reject the SIM immediately without issuing any further command.

Reference:

GSM 11.12 section 4.3 and 4.5.

27.17.1.5.2.3 Test purpose

- 1) To verify that a 3V only ME correctly performs the SIM type recognition procedure.
- 2) To verify that a 3V only ME deactivates the SIM/ME interface and rejects the SIM if a 5V only SIM is applied.

27.17.1.5.2.4 Method of test

27.17.1.5.2.4.1 Initial condition

The ME is connected to a SIM Simulator simulating a 3V technology SIM (to ensure that the ME can perform the SIM type recognition procedure) with nominal test conditions according to table 27.2-2. All elementary files are coded as default. Bit 5 in byte 14 of the status information is set to "0" (i.e. 5V only SIM).

The ME is powered on.

27.17.1.5.2.4.2 Procedure

After sending the ATR the SIM simulator checks the presence of the commands "SELECT GSM" and "STATUS/GET RESPONSE" as the first and only commands of the GSM card session.

The SIM simulator responds to the "STATUS/GET RESPONSE" command with a status information indicating a 5V only SIM.

The SIM/ME interface is monitored for at least 1 minute until the MS is switched off.

27.17.1.5.2.5 Test requirement

- 1) Immediately after the ATR only the two command “SELECT GSM” and “STATUS/GET RESPONSE” shall be sent by the ME.
- 2) The 3V only ME shall deactivate the SIM/ME interface immediately after receipt of the status information from the SIM (but not later than 5 seconds after the “STATUS/GET RESPONSE command) and reject the SIM (i.e. not activate the SIM/ME interface again within the test procedure).

27.17.1.5.3 Reaction of 3V technology MEs on type recognition of 5V only SIMs

27.17.1.5.3.1 Definition and applicability

When a 3V technology ME detects a 5V only SIM during the SIM type recognition procedure, the ME shall switch to 5V operation.

This test applies to GSM, DCS 1 800 and PCS 1900 MEs with the 5V/3V SIM interface.

27.17.1.5.3.2 Conformance requirement

- 1) A 3V technology ME shall initially activate the SIM at 3V (i.e. the first activation of a GSM card session).
- 2) The procedure for deriving the identification bit (SIM type recognition procedure) shall be performed by the ME immediately after the ATR procedure and before issuing any other command. The procedure shall consist of the two commands “SELECT GSM” and “STATUS/GET RESPONSE”.
- 3) If a 3V technology ME identifies a 5V only SIM during the SIM type recognition procedure, the ME shall switch to 5V operation mode. Switching from 3V to 5V shall only be performed by deactivating the SIM and activating it with 5V supply voltage immediately after the SIM type recognition procedure without issuing any further command.

Reference:

GSM 11.12 section 4.3 and 4.4.

27.17.1.5.3.3 Test purpose

- 1) To verify that a 3V technology ME initially activates the SIM with 3V.
- 2) To verify that a 3V technology ME correctly performs the SIM type recognition procedure.
- 3) To verify that a 3V technology ME deactivates the SIM/ME interface immediately after the SIM type recognition procedure (in order to switch the supply voltage) without issuing any further command.

27.17.1.5.3.4 Method of test

27.17.1.5.3.4.1 Initial condition

The ME is connected to a SIM Simulator simulating a 5V only SIM with nominal test conditions according to table 27.2-1. All elementary files are coded as default. Bit 5 in byte 14 of the status information is set to “0” (i.e. 5V only SIM).

The ME is powered on.

27.17.1.5.3.4.2 Procedure

After sending the ATR the SIM simulator checks the presence of the commands “SELECT GSM” and “STATUS/GET RESPONSE” as the first and only commands of the GSM card session.

The SIM simulator responds to the “STATUS/GET RESPONSE” command with a status information indicating a 5V only SIM.

The SIM/ME interface is monitored for at least 1 minute until the MS is switched off.

27.17.1.5.3.5 Test requirement

- 1) The initial activation of the SIM/ME interface shall be performed with 3V supply voltage.
- 2) Immediately after the ATR the two commands "SELECT GSM" and "STATUS/GET RESPONSE" shall be sent by the ME before issuing further commands.
- 3) The 3V technology ME shall deactivate the SIM/ME interface immediately after receipt of the status information from the SIM.

27.17.1.5.4 Reaction of 3V technology MEs on type recognition of 3V technology SIMs

27.17.1.5.4.1 Definition and applicability

When a 3V technology ME detects a 3V technology SIM during the SIM type recognition procedure the ME may either switch to 5V operation or stay in 3V operation.

This test applies to GSM, DCS 1 800 and PCS 1900 MEs with 5V/3V SIM interface.

27.17.1.5.4.2 Conformance requirement

- 1) A 3V technology ME shall initially activate the SIM with a 3V (i.e. the first activation of a GSM card session).
- 2) The procedure for deriving the identification bit (SIM type recognition procedure) shall be performed by the ME immediately after the ATR and before issuing any other command. the procedure shall consist of the two commands "SELECT GSM" and "STATUS/GET RESPONSE".
- 3) If a 3V technology ME identifies a 3V technology SIM during the SIM type recognition the ME may switch to 5V operation. Switching from 3V to 5V shall only be performed by deactivating the SIM and activating it with 5V supply voltage immediately after the SIM type recognition procedure without issuing any further commands.

Reference:

GSM 11.12, section 4.3, 4.4 and 4.7.

27.17.1.5.4.3 Test purpose

- 1) To verify that a 3V technology ME initially activates the SIM with 3V.
- 2) To verify that a 3V technology ME correctly performs the SIM type recognition procedure.
- 3) To verify that a 3V technology ME deactivates the SIM/ME interface immediately after the recognition of a 3V technology SIM (in order to switch the supply voltage) or proceeds with the 3V operation during the whole GSM card session without switching to 5V supply voltage.

27.17.1.5.4.4 Method of test

27.17.1.5.4.4.1 Initial condition

The ME is connected to a SIM Simulator simulating a 3V technology SIM with nominal test conditions according to table 27.2-2. All elementary files are coded as default. Bit 5 in byte 14 of the status information is set to "1" (i.e. 3V technology SIM.)

The ME is powered on.

27.17.1.5.4.4.2 Procedure

After sending the ATR the SIM simulator checks the presence of commands "SELECT GSM" and "STATUS/GET RESPONSE" as the first and only commands of the GSM card session.

The SIM simulator responds to the "STATUS/GET RESPONSE" command with a status information indicating a 3V technology SIM.

The SIM/ME interface is monitored for at least 1 minute until the MS is switched off.

27.27.1.5.4.5 Test requirement

- 1) The initial activation of the SIM/ME interface shall be performed with 3V supply voltage.
- 2) Immediately after the ATR the two commands "SELECT GSM" and "STATUS/GET RESPONSE: shall be sent by the ME.
- 3) The ME shall react in one of the following ways:
 - a) The ME deactivates the SIM/ME interface immediately after the receipt of the status information from the SIM.
 - b) the ME proceeds with the GSM card session without switching to another supply voltage.

27.17.2 Electrical tests on each ME contact

The following tables give the electrical conditions that must be applied by the SIM simulator to all contacts during a test if not stated otherwise.

Table 27.2-1: Nominal test conditions on 5V SIM/ME interface

Contacts	Low level	High level	Max. capacitive load
C1 (Vcc)	---	I = 10 mA	
C2 (RST)	I = -200 μ A	I = +20 μ A	30 pF
C3 (CLK)	I = -200 μ A	I = +20 μ A	30 pF
C5 (GND)	---	---	
C6 ((Vpp)	---	I = 0 mA	
C7 (I/O) ME input ME output	V = 0 V I = -1 mA	I = +20 μ A I = +20 μ A	30 pF

Table 27.2-2: Nominal test conditions on 3V SIM/ME interface

Contacts	Low level	High level	Max. capacitive load
C1 (Vcc)	---	I = 6 mA	
C2 (RST)	I = -200 μ A	I = +200 μ A	30 pF
C3 (CLK)	I = -20 μ A	I = +20 μ A	30 pF
C5 (GND)	---	---	
C6 ((Vpp)	---	---	
C7 (I/O) ME input ME output	V = 0 V I = -1 mA	I = +20 μ A I = +20 μ A	30 pF

NOTE 1: Measurements of contacts voltage levels can be done at any time since the beginning of activation of the SIM and the end of deactivation of the SIM (ISO/IEC 7816-3 section 5.1).

NOTE 2: The reference point of all measurements is the contact C5 (Ground).

NOTE 3: Currents flowing into the SIM are considered positive.

27.17.2.1 Electrical tests on contact C1

C1 = Card power supply (Vcc)

27.17.2.1.1 Test 1

27.17.2.1.1.1 Definition and applicability

When the mobile station is activated, the supply voltage on the SIM/ME interface shall remain in the specified range in order to ensure correct operation and to prevent any damage to the SIM.

This test applies to GSM, DCS 1 800 and PCS 1900 MEs with:

- a) 5V SIM interface
- b) 3V SIM interface
- c) 5V/3V SIM interface

27.17.2.1.1.2 Conformance requirement

- a) The voltage on contact C1 of the SIM/ME interface shall be 5V +/- 10 % for I_{cc} up to 10 mA.
- b) The voltage on contact C1 of the SIM/ME interface shall be 3V +/- 10 % for I_{cc} up to 6 mA.
- c-1) The voltage on contact C1 of the SIM/ME interface shall be 5V +/- 10 % for I_{cc} up to 10 mA when the interface is in 5V operation mode.
- c-2) The voltage on contact C1 of the SIM/ME interface shall be 3V +/- 10 % for I_{cc} up to 6 mA when the interface is in 3V operation mode.

Reference:

- a), c-1): GSM 11.11, section 5.1.
- b):, c-2): GSM 11.12, section 5.

27.17.2.1.1.3 Test purpose

To verify that the ME keeps the voltage on contact C1 of the SIM/ME interface within the ranges specified in the conformance requirements.

27.17.2.1.1.4 Method of test

Initial condition

The ME is connected to a SIM Simulator.

The MS is activated.

The remaining contacts of the SIM/ME interface are in nominal test conditions (See GSM 11.10 section 27.17.2).

Test Procedure

The voltage of contact C1 (V_{cc}) of the SIM/ME interface is measured.

27.17.2.1.1.5 Test requirement

The voltage on contact C1 of the SIM/ME interface shall be within the ranges specified in the conformance requirements.

27.17.2.1.2 Test 2

27.17.2.1.2.1 Definition and applicability

When the mobile station is activated, the supply voltage on the SIM/ME interface shall be able to counteract spikes in the current consumption of the SIM up to the limits given in the conformance requirement, ensuring that the supply voltage stays in the specified range.

This test applies to GSM, DCS 1 800 and PCS 1900 MEs with:

- a) 5V SIM interface
- b) 3V SIM interface
- c) 5V/3V SIM interface

27.17.2.1.2.2 Conformance requirement

- a) The voltage on contact C1 of the SIM/ME interface shall be 5V +/- 10 % for spikes in the current consumption with a maximum charge of 40 nAs with no more than 400 ns duration and an amplitude of at most 200 mA.
- b) The voltage on contact C1 of the SIM/ME interface shall be 3V +/- 10 % for spikes in the current consumption with a maximum charge of 12 nAs with no more than 400 ns duration and an amplitude of at most 60 mA.
- c-1) The voltage on contact C1 of the SIM/ME interface shall be 5V +/- 10 % for spikes in the current consumption with a maximum charge of 40 nAs with no more than 400 ns duration and an amplitude of at most 200 mA when the interface is in 5V operation mode.
- c-2) The voltage on contact C1 of the SIM/ME interface shall be 3V +/- 10 % for spikes in the current consumption with a maximum charge of 12 nAs with no more than 400 ns duration and an amplitude of at most 60 mA when the interface is in 3V operation mode.

Reference:

- a), c-1): GSM 11.11, section 5.2.
- b), c-2): GSM 11.12, section 5

27.17.2.1.2.3 Test purpose

To verify that the ME keeps the voltage on contact C1 of the SIM/ME interface within the specified range for the conditions given in the conformance requirement.

27.17.2.1.2.4 Method of test

Initial condition

The ME is connected to a SIM Simulator.

The MS is activated.

The remaining contacts of the SIM/ME interface are held in nominal test condition (See GSM 11.10 section 27.17.2).

Procedure

To test the requirements a) and c-1), the voltage on contact C1 of the SIM/ME interface is monitored and the following current spikes are applied:

- 1) continuous spikes:
 - current amplitude 20 mA
 - current offset 0 mA

Duration 100 ns

Pause 100 ns

2) continuous spikes:

current 20 mA

current offset 0 mA

Duration 400 ns

Pause 400 ns

3) continuous spikes:

current amplitude 15 mA

current offset 5 mA

(i.e. maximum amplitude = 5 mA + 15 mA = 20 mA)

Duration 150 ns

Pause 300 ns

4) random spikes:

current amplitude 200 mA

current offset 0 mA

Duration 200 ns

Pause between 0,1 ms and 500 ms, randomly varied

5) random spikes:

current amplitude 100 mA

current offset 0 mA

Duration 400 ns

Pause between 0,1 ms and 500 ms, randomly varied

6) random spikes

current amplitude 195 mA

current offset 5mA

(i.e. maximum amplitude = 5 mA + 195 mA = 200 mA)

Duration 200 ns

Pause between 0,1 ms and 500 ms, randomly varied

To test the requirements b) and c-2), the voltage on contact C1 of the SIM/ME interface is monitored and the following current spikes are applied:

1) continuous spikes:

current amplitude 12 mA

current offset 0 mA

Duration 100 ns

Pause 100 ns

2) continuous spikes:

current 12 mA

current offset 0 mA

Duration 400 ns

Pause 400 ns

3) continuous spikes:

current amplitude 9 mA

current offset 3 mA

(i.e. maximum amplitude = 3 mA + 9 mA = 12 mA)

Duration 150 ns

Pause 300 ns

4) random spikes:

current amplitude 60 mA

current offset 0 mA

Duration 200 ns

Pause between 0,1 ms and 500 ms, randomly varied

5) random spikes:

current amplitude 30 mA

current offset 0 mA

Duration 400 ns

Pause between 0,1 ms and 500 ms, randomly varied

6) random spikes

current amplitude 57 mA

current offset 3 mA

(i.e. maximum amplitude = 3 mA + 57 mA = 60 mA)

Duration 200 ns

Pause between 0,1 ms and 500 ms, randomly varied

NOTE: The specified spike durations are measured at 50 % of the spike amplitude.

27.17.2.1.2.5 Test requirement

The voltage on contact C1 of the SIM/ME interface shall be within the ranges specified in the conformance requirements.

27.17.2.2 Electrical tests on contact C2

C2 = Reset (RST)

27.17.2.2.1 Definition and applicability

When the mobile station is activated, the voltage on contact C2 of the SIM/ME interface shall remain in the specified range in order to ensure correct operation and to prevent any damage to the SIM.

This test applies to GSM, DCS 1 800 and PCS 1900 MEs with:

- a) 5V SIM interface
- b) 3V SIM interface
- c) 5V/3V SIM interface

27.17.2.2.2 Conformance requirement

- a) The voltage on contact C2 (RST) of the SIM/ME interface shall be between -0,3V and +0,6V for a current of -200 μ A in low state and between 3,8V and $V_{cc} + 0,3V$ for a current of +20 μ A in high state.
- b) The voltage on contact C2 (RST) of the SIM/ME interface shall be between -0,3V and +0,7V for a current of -200 μ A in low state and between 2,15 V and $V_{cc} + 0,3V$ for a current of +200 μ A in high state.
- c-1) The voltage on contact C2 (RST) of the SIM/ME interface shall be between -0,3V and +0,6V for a current of -200 μ A in low state and between 3,8V and $V_{cc} + 0,3V$ for a current of +20 μ A in high state when the interface is in 5V operation mode.
- c-2) The voltage on contact C2 (RST) of the SIM/ME interface shall be between -0,3V and +0,7V for a current of -200 μ A in low state and between 2,15 V and $V_{cc} + 0,3V$ for a current of +200 μ A in high state when the interface is in 3V operation mode.

Reference:

- a), c-1): GSM 11.11, section 5.
- b), c-2): GSM 11.12, section 5.

27.17.2.2.3 Test purpose

To verify that the ME keeps the voltage on contact C2 (RST) of the SIM/ME interface within the specified range, as given in the conformance requirement.

27.17.2.2.4 Method of test

27.17.2.2.4.1 Initial condition

The ME is connected to a SIM Simulator.

The MS is activated.

The remaining contacts of the SIM/ME interface are held in nominal test conditions (See GSM 11.10 section 27.17.2).

27.17.2.2.4.2 Procedure

The voltage on contact C2 (RST) of the SIM/ME interface is measured.

27.17.2.2.5 Test requirement

The voltage on contact C2 (RST) of the SIM/ME interface shall be within the range specified in the conformance requirement.

27.17.2.3 Electrical tests on contact C3

C3 = Clock (CLK)

27.17.2.3.1 Definition and applicability

When the mobile station is activated, the voltage, the rise/fall time of the signal, the clock cycle ratio and the frequency on contact C3 of the SIM/ME interface shall remain in the specified range in order to ensure correct operation and to prevent any damage to the SIM.

This test applies to GSM, DCS 1 800 and PCS 1900 MEs with:

- a) 5V SIM interface
- b) 3V SIM interface
- c) 5V/3V SIM interface

27.17.2.3.2 Conformance requirement

- a-1) The voltage on contact C3 (CLK) of the SIM/ME interface shall be between -0,3V and +0,5V for a current of -200 μ A in low state and between 3,15V and $V_{cc} + 0,3V$ for a current of +20 μ A in high state.
- a-2) The rise and the fall time of the clock signal shall not exceed 9 % of the clock period .
- a-3) The cycle ratio of the clock signal shall be between 40 % and 60 % of the period, in steady state.
- a-4) The frequency of the clock signal shall be between 1 MHz and 5 MHz.
- b-1) The voltage on contact C3 (CLK) of the SIM/ME interface shall be between -0,3V and +0,7V for a current of -20 μ A in low state and between 1,85V and $V_{cc} + 0,3V$ for a current of +20 μ A in high state.
- b-2) The rise and the fall time of the clock signal shall not exceed 50 ns.
- b-3) The cycle ratio of the clock signal shall be between 40 % and 60 % of the period, in steady state.
- b-4) The frequency of the clock signal shall be between 1 MHz and 4 MHz.
- c-1) The voltage on contact C3 (CLK) of the SIM/ME interface shall be between -0,3V and +0,5V for a current of -200 μ A in low state and between 3,15V and $V_{cc} + 0,3V$ for a current of +20 μ A in high state when the interface is in 5V operation mode.
- c-2) The rise and the fall time of the clock signal shall not exceed 9 % of the clock period when the interface is in 5V operation mode.
- c-3) The cycle ratio of the clock signal shall be between 40 % and 60 % of the period, in steady state when the interface is in 5V operation mode.
- c-4) The frequency of the clock signal shall be between 1 MHz and 5 MHz when the interface is in 5V operation mode.
- c-5) The voltage on contact C3 (CLK) of the SIM/ME interface shall be between -0,3V and +0,7V for a current of -20 μ A in low state and between 1,85V and $V_{cc} + 0,3V$ for a current of +20 μ A in high state when the interface is in 3V operation mode.
- c-6) The rise and the fall time of the clock signal shall not exceed 50 ns when the interface is in 3V operation mode.
- c-7) The cycle ratio of the clock signal shall be between 40 % and 60 % of the period, in steady state when the interface is in 3V operation mode.
- c-8) The frequency of the clock signal shall be between 1 MHz and 4 MHz when the interface is in 3V operation mode.

Reference:

- a), c-1,2,3,4) GSM 11.11, section 5 and section 5.4.
- b), c-3,5,6,7) GSM 11.12, section 4.2 and section 5.

27.17.2.3.3 Test purpose

To verify that the ME keeps the voltage, the rise and fall time, the cycle ratio and the frequency on contact C3 (CLK) of the SIM/ME interface within the ranges specified in the conformance requirements.

27.17.2.3.4 Method of test

27.17.2.3.4.1 Initial condition

The ME is connected to a SIM Simulator.

The MS is activated.

The remaining contacts of the SIM/ME interface are held in nominal test conditions (See GSM 11.10 section 27.17.2).

27.17.2.3.4.2 Procedure

The voltage, the rise/fall time, the clock cycle ratio and the frequency on contact C3 (CLK) of the SIM/ME interface are measured.

27.17.2.3.5 Test requirement

The voltage, the rise and fall time, the cycle ratio and the frequency on contact C3 (CLK) of the SIM/ME interface shall be within the ranges specified in the conformance requirements.

27.17.2.4 [Not used]

27.17.2.5 Electrical tests on contact C7

C7 = Input - output (I/O)

27.17.2.5.1 Definition and applicability

When the mobile station is activated, the ME shall keep the voltage, the current and the rise/fall time of the signal on contact C7 of the SIM/ME interface within the specified range in order to ensure correct operation and to prevent any damage to the SIM.

This test applies to GSM, DCS 1 800 and PCS 1900 MEs with:

- a) 5V SIM interface
- b) 3V SIM interface
- c) 5V/3V SIM interface

27.17.2.5.2 Conformance requirement

- a-1) ME receiving state A (low state):

With an imposed voltage of 0V the current flowing out of the ME shall not exceed 1 mA.

- a-2) ME transmitting state A (low state):

The voltage shall be between -0,3V and 0,4V when a current of 1 mA flowing into the ME is applied.

- a-3) ME transmitting or receiving state Z (high state):

The voltage shall be between +3,8V and $V_{cc} + 0,3V$ when a current of 20 μA flowing out of the ME is applied.

- a-4) The rise time and the fall time of the I/O signal shall not exceed 1 μs .

- b-1) ME receiving state A (low state):

With an imposed voltage of 0V the current flowing out of the ME shall not exceed 1 mA.

b-2) ME transmitting state A (low state):

The voltage shall be between -0,3V and 0,4V when a current of 1 mA flowing into the ME is applied.

b-3) ME transmitting or receiving state Z (high state):

The voltage shall be between $0,7 \cdot V_{cc}$ and $V_{cc} + 0,3V$ when a current of 20 μA flowing out of the ME is applied.

b-4) The rise time and the fall time of the I/O signal shall not exceed 1 μs .

c-1) ME receiving state A (low state):

With an imposed voltage of 0V the current flowing out of the ME shall not exceed 1 mA when the ME is in 5V operation mode.

c-2) ME transmitting state A (low state):

The voltage shall be between -0,3V and 0,4V when a current of 1 mA flowing into the ME is applied when the ME is in 5V operation mode.

c-3) ME transmitting or receiving state Z (high state):

The voltage shall be between +3,8V and $V_{cc} + 0,3V$ when a current of 20 μA flowing out of the ME is applied when the ME is in 5V operation mode.

c-4) The rise time and the fall time of the I/O signal shall not exceed 1 μs when the ME is in 5V operation mode.

c-5) ME receiving state A (low state):

With an imposed voltage of 0V the current flowing out of the ME shall not exceed 1 mA when the ME is in 3V operation mode.

c-6) ME transmitting state A (low state):

The voltage shall be between -0,3V and 0,4V when a current of 1 mA flowing into the ME is applied when the ME is in 3V operation mode.

c-7) ME transmitting or receiving state Z (high state):

The voltage shall be between $0,7 \cdot V_{cc}$ and $V_{cc} + 0,3V$ when a current of 20 μA flowing out of the ME is applied when the ME is in 3V operation mode.

c-8) The rise time and the fall time of the I/O signal shall not exceed 1 μs when the ME is in 3V operation mode.

Reference:

a), c-1,2,3,5) GSM 11.11, section 5.

a), c-1,2,4,5) GSM 11.12, section 5.

27.17.2.5.3 Test purpose

To verify that the ME keeps the voltage, the current and the rise and fall times of the signal on contact C7 (I/O) of the SIM/ME interface within the ranges specified in the conformance requirements.

27.17.2.5.4 Method of test

27.17.2.5.4.1 Initial condition

The ME is connected to a SIM Simulator.

The MS is activated.

The remaining contacts of the SIM/ME interface are held in nominal test conditions (See GSM 11.10 section 27.17.2).

27.17.2.5.4.2 Procedure

The voltage, the current and the rise/fall time on contact C7 (I/O) of the SIM/ME interface are measured.

27.17.2.5.5 Test requirement

The voltage, the current and the rise and fall times of the signal on contact C7 (I/O) of the SIM/ME interface shall be within the ranges specified in the conformance requirements.

27.18 Fixed Number Dialling (FND)

27.18.1 ME and SIM with FND activated

27.18.1.1 EF_{ADN} invalidated and not readable or updatable

27.18.1.1.1 Definition and applicability

Fixed Number Dialling (FND) is a service defined for the SIM. An activated FND service results in call restrictions for the MS. The call restrictions are controlled by the ME. To ascertain the type of SIM and state of FND the MS runs the FND capability request procedure during SIM/ME initialization.

This test applies to GSM, DCS 1 800 and PCS 1900 MEs using either ID-1 or Plug-in SIM and supporting the FND service.

27.18.1.1.2 Conformance requirement

1. Recognizing the state of the SIM (FND enabled) the MS shall perform the SIM initialization procedure as specified.
2. The MS allows call set-up to a directory number as stored in EF_{FND}.
3. The MS allows call set-up to a directory number as stored in EF_{FND} and extended by digits in the end.
4. The MS does not allow call set-up to a directory number stored in EF_{FND} but with missing digits at the end.
5. The MS does not allow call set-up to a directory number having no reference in EF_{FND}.
6. The MS allows call set-up of an emergency call.
7. For PCS 1900: To verify the requirement 6 above by using the emergency call number 911.

Reference:

GSM 11.11, clauses 9.3, 10.2.7, 10.3.2, 11.2.1 and 11.5.1, GSM 02.07, clause 3.2.

27.18.1.1.3 Test purpose

1. To verify that the ME as a result of the state of the SIM rehabilitates EF_{IMSI} and EF_{LOCI} during SIM/ME initialization procedure.
2. To verify that the ME allows call set-up to a FND number.
3. To verify that the ME allows call set-up to a FND number extended by some digits in the end.
4. To verify that the ME rejects call set-up to a FND number not completely corresponding to an entry in EF_{FND}.
5. To verify that the ME rejects call set-up to number having no reference in EF_{FND}.
6. To verify that the ME allows emergency call set-up.

7. For PCS 1900: To verify the requirement 6 above by using the emergency call number 911.

27.18.1.1.4 Method of test

27.18.1.1.4.1 Initial conditions

The SS transmits on the BCCH, with the following network parameters

Attach/detach: disabled

LAI (MCC/MNC/LAC):246/81/0001 for GSM and DCS 1 800

246/813/0001 for PCS 1900

Access control: unrestricted

The default FDN-SIM with FDN service enabled and EF_{ADN} invalidated and neither readable nor updatable is installed into the ME.

27.18.1.1.4.2 Procedure

- a) The MS is powered on and PIN1 is entered.
- b) Using the MMI a call set-up to the fixed dialling number 1 is attempted.
- c) Using the MMI a call set-up to the fixed dialling number 2 extended by "123" in the end is attempted.
- d) Using the MMI a call set-up to a number which is equal to the fixed dialling number 3 without the last digit is attempted, e.g. by recalling the fixed dialling number 3 and deleting the last digit (only in display).
- e) Using the MMI a call set-up to the number "1234567" is attempted.
- f) Using the MMI an emergency call set-up is attempted.

27.18.1.1.5 Test requirement

- 1) After step a) the MS is registered and in idle state.
- 2) After steps b) and c) the MS shall allow call set-up and send the requested number across the air interface.
- 3) After steps d) and e) the MS shall prevent call set-up.
- 4) After step f) the MS shall allow emergency call set-up and send the requested number across the air interface.

27.18.1.2 EF_{ADN} invalidated but readable and updatable

27.18.1.2.1 Definition and applicability

Fixed Number Dialling (FDN) is a service defined for the SIM. An activated FDN service results in call restrictions for the MS. The call restrictions are controlled by the ME.

This test applies to GSM, DCS 1800 and PCS 1900 MEs using either ID-1 or Plug-in SIM, which allow for invalidated EF to be read and updated, and supporting the FDN service.

27.18.1.2.2 Conformance requirement

The MS allows call set-up to a directory number as stored in EF_{FDN} and extended by digits added from an EF_{ADN} .

Reference:

GSM 11.11, clauses 9.3, 10.2.7, 10.3.2, 11.2.1 and 11.5.1, GSM 02.07, clause 3.2.

27.18.1.2.3 Test purpose

To verify that the ME allows call set-up to a FDN number extended by digits from an EF_{ADN}.

27.18.1.2.4 Method of test

27.18.1.2.4.1 Initial conditions

The SS transmits on the BCCH, with the following network parameters

Attach/detach: disabled

LAI (MCC/MNC/LAC): 246/81/0001 for GSM and DCS 1 800
246/813/0001 for PCS 1900

Access control: unrestricted

The default FDN-SIM with FDN service enabled and EF_{ADN} invalidated but readable and updatable is installed into the ME.

27.18.1.2.4.2 Procedure

- a) The MS is powered on and PIN1 is entered.
- b) Using the MMI a call set-up to the fixed dialling number 1 extended by the abbreviated dialling number 1 in the end is attempted.

27.18.1.2.5 Test requirement

- 1) After step a) the MS is registered and in idle state.
- 2) After steps b) the MS shall allow call set-up and send the requested number across the air interface.

27.18.2 ME and SIM with FDN deactivated

27.18.2.1 Definition and applicability

Fixed Number Dialling (FDN) is a service defined for the SIM. An activated FDN service results in call restrictions for the MS. Only directory numbers which are stored in the EF_{FDN} may be dialled by the MS. The call restrictions are controlled by the ME. To ascertain the type of SIM and state of FDN the MS runs the FDN capability request procedure during SIM/ME initialization. Deactivation of the service by the subscriber is possible under the control of PIN2 and switches the SIM into a "normal", non restrictive SIM.

This test apply to GSM, DCS 1 800 and PCS 1900 MEs using either ID-1 or Plug-in SIM and supporting the FDN service.

27.18.2.2 Conformance requirement

1. Recognizing the state of the SIM (FDN disabled) the MS correctly performs the SIM initialization procedure.
2. The MS allows call set-up to a directory number as stored in EF_{FDN}.
3. The MS allows call set-up to a directory number as stored in EF_{ADN}.
4. The MS allows call set-up to a directory number given in manually.

Reference:

GSM 11.11, clauses 10.2.7, 10.3.2, 11.2.1 and 11.5.1, GSM 02.07, clause 3.2.

27.18.2.3 Test purpose

1. To verify that the ME as a result of the state of the SIM correctly performs the SIM/ME initialization procedure.
2. To verify that the ME allows call set-up to a FDN number.
3. To verify that the ME allows call set-up to a ADN number.
4. To verify that the ME allows call set-up to manually given number.

27.18.2.4 Method of test

27.18.2.4.1 Initial conditions

The SS transmits on the BCCH, with the following network parameters

Attach/detach: disabled

LAI (MCC/MNC/LAC): 246/81/0001 for GSM and DCS 1 800
246/813/0001 for PCS 1900

Access control: unrestricted

The default FDN SIM with FDN service disabled is installed into the ME and the MS is powered on.

27.18.2.4.2 Procedure

- a) Using the MMI a call set-up to the fixed dialling number 1 is attempted.
- b) Using the MMI a call set-up to the abbreviated dialling number 1 is attempted.
- c) Using the MMI a call set-up to the number "1234567" is attempted.

27.18.2.5 Test requirement

After steps a), b) and c) the MS shall allow call set-up and send the requested number across the air interface.

27.18.3 Enabling, disabling and updating of FND

27.18.3.1 Definition and applicability

FDN may be enabled and disabled by the subscriber under control of PIN2. Fixed dialling numbers are read with PIN and updated under control of PIN2.

This test apply to GSM, DCS 1 800 and PCS 1900 MEs using either ID-1 or Plug-in SIM and supporting the FDN service.

27.18.3.2 Conformance requirement

1. Recognizing the state of the SIM (FDN enabled) the MS shall perform the SIM initialization procedure as specified.
2. The MS shall allow updating of EF_{FDN} by the use of PIN2.
3. The MS provides means to disable the FDN service by the use of PIN2.
4. The MS shall allow the use of EF_{ADN} after disabling of FDN.

Reference:

GSM 11.11, clauses 10.2.7, 10.3.2, 11.2.1 and 11.5.1, GSM 02.07, clause 3.2.

27.18.3.3 Test purpose

1. To verify that the ME as a result of the state of the SIM rehabilitates EF_{IMSI} and EF_{LOCI} during SIM/ME initialization procedure.
2. To verify that the ME correctly performs the update of a number in EF_{FDN}.
3. To verify that the ME correctly disables FDN service.
4. To verify that the ME recognizes disabling of FDN and allows access to EF_{ADN}.

27.18.3.4 Method of test

27.18.3.4.1 Initial conditions

The SS transmits on the BCCH, with the following network parameters

Attach/detach: disabled

LAI (MCC/MNC/LAC): 246/81/0001 for GSM and DCS 1 800
246/813/0001 for PCS 1900

Access control: unrestricted

The default FDN SIM with FDN service enabled is installed into the ME and the MS is powered on.

27.18.3.4.2 Procedure

- a) The MS is powered on and PIN 1 is entered.
- b) Using the MMI the directory number "+876543210" is stored in EF_{FDN} as fixed dialling number 1 (The alpha identifier is not changed).
- c) Using the MMI the FDN disabling procedure is performed. On request of the MS PIN2 is entered.
- d) Using the MMI a call set-up to the abbreviated dialling number 1 is attempted.
- e) The MS is soft-powered down.

27.18.3.5 Test requirement

- 1) After step a) the MS is registered and in idle state.
- 2) After step c) the MS shall indicate that the FDN disabling procedure has been successful.
- 3) After step d) the MS shall allow call set-up and send the requested number across the air interface.
- 4) After step e) the value of bit 1 of byte 12 in the response data of EF_{ADN} in the SIM shall be "1" and record 1 in EF_{FDN}, shall contain the following values:

B1	B2	B3	B4	B5	B6	B7	B8	B9	B10	B11	B12	B13
46	44	4E	31	31	31	06	91	78	56	34	12	F0
B14	B15	B16	B17	B18	B19	B20						
FF	FF	FF	FF	FF	FF	FF						

27.19 Phase identification

27.19.1 Definition and applicability

The phase of the SIM is indicated in the Elementary File EF_{PHASE}. This allows the ME to identify the phase of the SIM and adapt its functionality accordingly.

This test applies to GSM, DCS 1 800 and PCS 1900 MEs using either ID-1 or plug-in SIMs.

27.19.2 Conformance requirement

The phase of the card shall be determined as part of the initialization procedure.

Reference:

GSM 11.11, sections 10.2.16 and 11.2.1.

27.19.3 Test purpose

To verify that the ME requests the SIM phase as part of the initialization procedure.

27.19.4 Method of test

27.19.4.1 Initial conditions

The ME is connected to the SIM simulator, and powered off.

The default values are used.

27.19.4.2 Procedure

- a) The mobile is powered on.
- b) The SIM simulator monitors the SIM initialization procedure.

27.19.5 Test requirement

The ME shall request the phase of the SIM as part of the initialization procedure.

27.20 SIM presence detection

27.20.1 Definition and applicability

The presence of the SIM is an essential requirement for setting up and maintaining a call. The ME detects the presence of the SIM electronically.

27.20.2 Conformance requirement

To ensure that the SIM has not been removed during a card session, the ME shall send STATUS commands at frequent intervals of no longer than 30 seconds during a call. If the ME detects that the SIM has been removed, a possibly ongoing call shall be terminated by the ME within 5 seconds at the latest after having detected the SIM removal.

Reference:

GSM 11.11, section 11.2.7.

27.20.3 Test purpose

1. To verify that the ME sends STATUS messages at frequent intervals of no longer than 30s during a call.
2. To verify that the ME terminates a call within 5 seconds at the latest after having received a wrong response to the STATUS command.

27.20.4 Method of test

27.20.4.1 Initial conditions

The ME is connected to the SIM-simulator.

All elementary files are coded as default.

27.20.4.2 Procedure

- a) A call is set up using the generic call setup.
- b) The SIM simulator monitors the time interval between STATUS commands sent by the ME.
- c) After 3 minutes, the call is cleared.
- d) A call is set up using the generic call setup.
- e) After one minute after the call was successfully set up, the SIM simulator responds to a STATUS command with the response data of the MF.

27.20.5 Test requirements

1. During step b), the time interval between STATUS commands shall not be longer than 30 seconds.
2. After step e), the ME shall terminate the call within 5 seconds at the latest after having received the wrong response to the STATUS command.

27.21 Advice of Charge (AoC)

27.21.1 AoC not supported by SIM

27.21.1.1 Definition and applicability

If the ME under test supports Advice of Charge Charging, it shall still look at the capability of the SIM, before responding to any AoCC information from the network.

This test is applicable to all MEs supporting AoCC.

27.21.1.2 Conformance requirement

1. An MS not supporting AoCC and in the outgoing call / U4 call delivered state, on receipt of a CONNECT message containing AoCC information shall acknowledge the CONNECT message but ignore and not acknowledge the AoCC information sent within the CONNECT.
2. An MS not supporting AoCC and in the outgoing call / U4 call delivered state, on receipt of a FACILITY message containing AoCC information shall ignore and not acknowledge the AoCC information sent within the FACILITY.
3. An MS not supporting AoCC and in the incoming call / U9 call confirmed state, on receipt of a FACILITY message containing AoCC information shall ignore and not acknowledge the AoCC information sent within the FACILITY.
4. An MS not supporting AoCC and in the U10 call active state, on receipt of a FACILITY message containing AoCC information, shall ignore and not acknowledge the AoCC information sent within the FACILITY.

References:

GSM 03.86, sections 1.2, 1.3, 2.2, 2.3; GSM 04.86, section 2.

27.21.1.3 Test purpose

1. To verify that an MS not supporting AoCC (where the ME does support AoCC but the SIM does not) and in the outgoing call / U4 call delivered state, on receipt of a CONNECT message containing AoCC information shall acknowledge the CONNECT message but ignore and not acknowledge the AoCC information sent within the CONNECT.
2. To verify that an MS not supporting AoCC (where the ME does support AoCC but the SIM does not) and in the outgoing call / U4 call delivered state, on receipt of a FACILITY message containing AoCC information shall ignore and not acknowledge the AoCC information sent within the FACILITY.
3. To verify that an MS not supporting AoCC (where the ME does support AoCC but the SIM does not) and in the incoming call / U9 call confirmed state, on receipt of a FACILITY message containing AoCC information shall ignore and not acknowledge the AoCC information sent within the FACILITY.
4. To verify that an MS not supporting AoCC (where the ME does support AoCC but the SIM does not) and in the U10 call active state, on receipt of a FACILITY message containing AoCC information, shall ignore and not acknowledge the AoCC information sent within the FACILITY.

27.21.1.4 Method of test

27.21.1.4.1 Initial conditions

The ME shall be installed with a SIM or SIM simulator, with all elementary files coded as for the default SIM, with the exception of:

EF_{SST} (SIM Service Table)

Logically: CHV1 disable function allocated and activated.
Abbreviated dialling numbers allocated and activated.
PLMN selector allocated and activated.
Fixed dialling numbers not activated.
AoC not activated.

Coding: B1 B2 B3 B4
xx0x1111 0011xx0x xxxxxxxx 0000xxxx (binary)

The coding of EF_{SST} shall conform with the capabilities of the SIM used.

The generic call set up procedures are followed up to and including the reception, or transmission of the ALERTING message by the MS.

27.21.1.4.2 Procedure

- a) For an MO call in the U4 state the SS transmits CONNECT containing AoCC information.
- b) For an MO call in the U4 state the SS transmits FACILITY containing AoCC information.
- c) For an MTcall in the U9 state the SS transmits FACILITY containing AoCC information.
- d) For an MO call in the U10 state the SS transmits FACILITY containing AoCC information.

27.21.1.5 Test requirement

In all cases, the MS shall ignore the AoCC information sent to it in the Facility information elements as part of the CONNECT/FACILITY messages and not send any AoCC information acknowledgement. It shall be checked for 15 seconds that the MS does not transmit any AoCC information acknowledgement after the receipt of AoCC information.

27.21.2 Maximum frequency of ACM updating

27.21.2.1 Definition and applicability

The ACM shall be updated at the end of every interval, where the interval length is given by parameter e2. The ME shall update the ACM not more frequently than once every 5 seconds, even if the interval is less than 5 seconds. More frequent updating may affect the SIM's read/write cycles.

This test applies to all ME supporting AoC.

27.21.2.2 Conformance requirement

The ACM shall be incremented when the CCM is incremented or once every 5 seconds, whichever is the longer period.

Reference:

GSM 02.24, section 4.3, part h.

27.21.2.3 Test purpose

To verify that the interval between increments is 5 seconds.

27.21.2.4 Method of test

27.21.2.4.1 Initial conditions

The ME shall be connected to the SIM simulator, with all elementary files coded as default with the exception of:

EF_{SST} (SIM Service Table)

Logically: CHV1 disable function allocated and activated.
Abbreviated dialling numbers allocated and activated.
PLMN selector allocated and activated.
Fixed dialling numbers not activated.
AoC allocated and activated.

Coding: B1 B2 B3 B4
xx0x1111 0011xx11 xxxxxxxx 0000xxxx (binary)

The coding of EF_{SST} shall conform with the capabilities of the SIM used.

EF_{ACM} (Accumulated call meter)

Logically: 50 units

EF_{ACMmax} (Accumulated call meter maximum)

Logically: 150 units

System Simulator:

1 cell, default parameters, IMSI attach/detach disabled.

Mobile Station:

The MS is in MM-state "idle, updated".

27.21.2.4.2 Procedure

- a) The MS is made to initiate a call. The call is established with AoCC e-parameters sent in a Facility IE in the CONNECT message, as given below. The MS returns the AoCC acknowledgement within 1 second of the CONNECT message. It is an implementation option whether the AoCC acknowledge is sent by the MS before or after the CONNECT ACKNOWLEDGE.
- b) The call is maintained for 90 seconds, then terminated by the SS. During the call, the SIM-simulator monitors the time intervals between successive INCREMENT commands.

Maximum Duration of Test:

2 minutes.

Expected Sequence:

Step	Direction	Message	Comments
1	MS		The MS is made to initiate a call
2	MS -> SS	CHANNEL REQUEST	
3	SS -> MS	IMMEDIATE ASSIGNMENT	
4	MS -> SS	CM SERVICE REQUEST	
5	SS -> MS	CM SERVICE ACCEPT	
6	MS -> SS	SETUP	
7	SS -> MS	CALL PROCEEDING	
8	SS -> MS	ASSIGNMENT COMMAND	to a supported channel type
9	MS -> SS	ASSIGNMENT COMPLETE	
10	SS -> MS	ALERTING	
11	SS -> MS	CONNECT	As default message except contains Facility IE with contents as indicated in i below
			Either A or B branch is taken
A12	MS -> SS	CONNECT ACKNOWLEDGE	
A13	MS -> SS	FACILITY	As default message except contains Facility IE with contents as indicated in ii below
B12	MS -> SS	FACILITY	As default message except contains Facility IE with contents as indicated in ii below
B13	MS -> SS	CONNECT ACKNOWLEDGE	
14			call duration 90 seconds after CAI information sent by SS,
15	SS -> MS	DISCONNECT	
16	MS -> SS	RELEASE	
17	SS -> MS	RELEASE COMPLETE	
18	SS -> MS	CHANNEL RELEASE	The main signalling link is released.

Specific Message Contents:

i) FACILITY Information Element with Invoke = ForwardChargeInformation component type as defined in GSM 04.80 section 3.6.1 table 3.3.

For ASN.1 description see default message contents in section 31.6.1.3.

The values of the e-parameters within the parameter part of the Facility Information Element shall be set as below:

parameter	e-parameters						
	1	2	3	4	5	6	7
value	1	1	1	0	0	0	0

Values shown in table are in the format and have units as in GSM 02.24 section 3.

ii) FACILITY Information Element with Return Result component type as defined in GSM 04.80 section 3.6.1 table 3.4.

For ASN.1 description see default message contents in section 31.6.1.3.

27.21.2.5 Test requirement

The MS shall send INCREMENT commands to the SIM every 5 seconds.

27.21.3 Call terminated when ACM greater than ACMmax

27.21.3.1 Definition and applicability

ACMmax gives the maximum value of ACM, at which the current calls shall be terminated and no further outgoing calls and charged incoming calls may be made (except emergency calls).

This test applies to all ME supporting AoCC.

27.21.3.2 Conformance requirement

ACM shall be incremented by the value of CCM.

If the ACMmax is valid, and the ACM becomes equal to or exceeds the value of the ACMmax, then all calls in progress, chargeable to the user, shall be terminated by the MS with cause value #68, once the chargeable interval determined by the CAI has elapsed, (except emergency calls).

Reference:

GSM 02.24, section 4.3 part h and section 4.2.2.

GSM 04.86, section 2.3

27.21.3.3 Test purpose

1. To verify that the ME increments the ACM by the correct number of units, even though this may take ACM above ACMmax.
2. To verify that the ME terminates the call with cause value #68.

27.21.3.4 Method of test

27.21.3.4.1 Initial conditions

The ME shall be connected to a SIM or the SIM simulator, with all elementary files coded as default with the exception of:

EF_{SST} (SIM Service Table)

Logically: CHV1 disable function allocated and activated.
Abbreviated dialling numbers allocated and activated.
PLMN selector allocated and activated.
Fixed dialling numbers not activated.
AoC allocated and activated.

Coding: B1 B2 B3 B4
xx0x1111 0011xx11 xxxxxxxx 0000xxxx (binary)

The coding of EF_{SST} shall conform with the capabilities of the SIM used.

EF_{ACM} (Accumulated call meter)

Logically: 80 units

EF_{ACMmax} (Accumulated call meter maximum)

Logically: 94 units

System Simulator:

1 cell, default parameters, IMSI attach/detach disabled.

Mobile Station:

The MS is in MM-state "idle, updated".

27.21.3.4.2 Procedure

- a) The MS is made to initiate a call. The call is established with AoCC e-parameters sent in a Facility IE in the CONNECT message, as given below. The MS returns the AoCC acknowledgement within 1 second of the CONNECT message. It is an implementation option whether the AoCC acknowledge is sent by the MS before or after the CONNECT ACKNOWLEDGE.
- b) The call is maintained until cleared by the MS (after 30 seconds) with cause value #68.
- c) The contents of ACM are checked.

Maximum Duration of Test:

2 minutes.

Expected Sequence:

Step	Direction	Message	Comments
1	MS		The MS is made to initiate a call
2	MS -> SS	CHANNEL REQUEST	
3	SS -> MS	IMMEDIATE ASSIGNMENT	
4	MS -> SS	CM SERVICE REQUEST	
5	SS -> MS	CM SERVICE ACCEPT	
6	MS -> SS	SETUP	
7	SS -> MS	CALL PROCEEDING	
8	SS -> MS	ASSIGNMENT COMMAND to a supported channel type	
9	MS -> SS	ASSIGNMENT COMPLETE	
10	SS -> MS	ALERTING	
11	SS -> MS	CONNECT	As default message except contains Facility IE with contents as indicated in i below
			Either A or B branch is taken
A12	MS -> SS	CONNECT ACKNOWLEDGE	
A13	MS -> SS	FACILITY	As default message except contains Facility IE with contents as indicated in ii below
B12	MS -> SS	FACILITY	As default message except contains Facility IE with contents as indicated in ii below
B13	MS -> SS	CONNECT ACKNOWLEDGE	
14			call duration 30 seconds after CAI information sent by SS
15	MS -> SS	DISCONNECT	
16	SS -> MS	RELEASE	Cause value #68
17	MS -> SS	RELEASE COMPLETE	
18	MS -> SS	CHANNEL RELEASE	The main signalling link is released.

Specific Message Contents:

i) FACILITY Information Element with **Invoke = ForwardChargeInformation** component type as defined in GSM 04.80 section 3.6.1 table 3.3.

For ASN.1 description see default message contents in section 31.6.1.3.

The values of the e-parameters within the parameter part of the Facility Information Element shall be set as below:

parameter value	e-parameters						
	1	2	3	4	5	6	7
	10	10	1	0	0	0	0

Values shown in table are in the format and have units as in GSM 02.24 section 3.

ii) FACILITY Information Element with **Return Result** component type as defined in GSM 04.80 section 3.6.1 table 3.4.

For ASN.1 description see default message contents in section 31.6.1.3.

27.21.3.5 Test requirement

- 1) The MS shall terminate the call correctly 30 seconds after CAI was sent.
- 2) The value of ACM shall be 100 units.

27.21.4 Response codes of increase command

27.21.4.1 Definition and applicability

ACM has a maximum value in terms of coding, and an attempt by the ME to exceed that value by sending an INCREASE command shall result in an error message from the SIM.

This test applies to all MEs supporting AoCC.

27.21.4.2 Conformance requirement

The ME shall perform the increasing procedure, sending the amount to be increased.

The running accumulated charge shall be stored in the ACM of the SIM.

Where this charge cannot be stored in the MS, use of the telecommunications service shall be prevented.

References:

GSM 11.11, section 11.5.3; GSM 02.86, sections 2.2.1 and 2.1.

27.21.4.3 Test purpose

To verify that the ME clears a charged call if the SIM indicates that the ACM cannot be increased.

27.21.4.4 Method of test

27.21.4.4.1 Initial conditions

The ME shall be connected to the SIM simulator, with all elementary files coded as default with the exception of:

EF_{SST} (SIM Service Table)

Logically: CHV1 disable function allocated and activated.
Abbreviated dialling numbers allocated and activated.
PLMN selector allocated and activated.
Fixed dialling numbers not activated.
AoC allocated and activated.

Coding: B1 B2 B3 B4
xx0x1111 0011xx11 xxxxxxxx 0000xxxx (binary)

The coding of EF_{SST} shall conform with the capabilities of the SIM used.

EF_{ACM} (Accumulated call meter)

Logically: (Maximum-10) units

EF_{ACMmax} (Accumulated call meter maximum)

Logically: (Maximum-2) units

System Simulator:

1 cell, default parameters, IMSI attach/detach disabled.

Mobile Station:

The MS is in MM-state "idle, updated".

27.21.4.4.2 Procedure

- a) The MS is made to initiate a call. The call is established with AoCC e-parameters sent in a Facility IE in the CONNECT message, as given below. The MS returns the AoCC acknowledgement within 1 second of the CONNECT message. It is an implementation option whether the AoCC acknowledge is sent by the MS before or after the CONNECT ACKNOWLEDGE.
- b) After an interval has elapsed, the ME increments the ACM. When an INCREASE command is received, the SIM-sim sends back the error "98 50".
- c) Conditions are reset to those described in the initial conditions. Steps a) and b) of the test are repeated, except that the error code sent by the SIM simulator at step b) is now "6F xx".
- d) Conditions are reset to those described in the initial conditions. Steps a) and b) of the test are repeated, except that the error code sent by the SIM simulator at step b) is now "92 40".

Maximum Duration of Test:

3 minutes.

Expected Sequence:

Step	Direction	Message	Comments
1	MS		The MS is made to initiate a call
2	MS -> SS	CHANNEL REQUEST	
3	SS -> MS	IMMEDIATE ASSIGNMENT	
4	MS -> SS	CM SERVICE REQUEST	
5	SS -> MS	CM SERVICE ACCEPT	
6	MS -> SS	SETUP	
7	SS -> MS	CALL PROCEEDING	
8	SS -> MS	ASSIGNMENT COMMAND to a supported channel type	
9	MS -> SS	ASSIGNMENT COMPLETE	
10	SS -> MS	ALERTING	
11	SS -> MS	CONNECT	
			As default message except contains Facility IE with contents as indicated in i below
			Either A or B branch is taken
A12	MS -> SS	CONNECT ACKNOWLEDGE	As default message except contains Facility IE with contents as indicated in ii below
A13	MS -> SS	FACILITY	
B12	MS -> SS	FACILITY	As default message except contains Facility IE with contents as indicated in ii below
B13	MS -> SS	CONNECT ACKNOWLEDGE	
14			call duration approx 10s after CAI information sent by SS
15	MS -> SS	DISCONNECT	
16	SS -> MS	RELEASE	
17	MS -> SS	RELEASE COMPLETE	
18	MS -> SS	CHANNEL RELEASE	
			The main signalling link is released.

Specific Message Contents:

i) **FACILITY Information Element** with **Invoke = ForwardChargeInformation** component type as defined in GSM 04.80 section 3.6.1 table 3.3.

The values of the e-parameters within the parameter part of the Facility Information Element shall be set as below:

parameter	e-parameters						
	1	2	3	4	5	6	7
value	20	10	1	0	0	0	0

Values shown in table are in the format and have units as in GSM 02.24 section 3.

ii) **FACILITY Information Element** with **Return Result** component type as defined in GSM 04.80 section 3.6.1 table 3.4.

27.21.4.5 Test requirement

In each of the three cases, as described in steps b), c) and d) of the procedure, the MS shall terminate the call correctly when it receives an indication from the SIM that the ACM cannot be incremented.

28 Test of autocalling restrictions

28.1 General

It is essential that all autocalling apparatus is prevented from continuously dialling a given number, to avoid machines repeatedly disturbing PSTN subscribers in error, or numerous repeat attempts to unobtainable numbers which cause waste of valuable network resources. Therefore autocalling restrictions are defined by GSM 02.07.

The tests shall be performed using all of the call methods specified by the supplier in the PIXIT statement (annex 3). The supplier shall state any autocalling procedures implemented and how many times they can be repeated to a single number and the minimum re-attempt interval(s), i.e. the complete re-try schedule or algorithm with parameter values. The supplier shall further describe any automatic methods for making repeated calls to a single number. The supplier shall also state in the PIXIT statement (annex 3) the number of B-party numbers that can be stored on the list of blacklisted numbers as described in GSM 02.07, annex A.

For an external R-interface the supplier shall state in the PIXIT statement (annex 3) the procedure for autocalling restrictions for that interface and the possible parameter settings for the number of times the LTE can make a re-attempt and the minimum accepted time between re-attempts accepted by the MS. The conditions for clearing the autocalling constraints shall be stated in the PIXIT statement (annex 3).

For external interfaces the LTE must be programmed so that it clearly attempts to violate the autocalling constraints.

28.2 Constraining the access to a single number (GSM 02.07 category 3)

During this test the SETUP messages shall contain the same B-party number.

No manual intervention shall be performed except to initiate and end the test.

28.2.1 Conformance requirement

A repeat call attempt may be made when a call attempt is unsuccessful for the reasons listed below (as defined in GSM 04.08).

These reasons are classified in three major categories:

1. "Busy destination".
2. "Unobtainable destination - temporary".
3. "Unobtainable destination - permanent/long term".

NOTE: Cause values for each category are defined in GSM 02.07, annex A.

The table below describes a repeat call restriction pattern to any B number. This pattern defines a maximum number (n) of call repeat attempts; when this number n is reached, the associated B number shall be blacklisted by the MT until a manual re-set at the MT is performed in respect of that B number. When a repeat attempt to anyone B number fails, or is blacklisted, this does not prevent calls being made to other B numbers.

For the categories 1 and 2 above, n shall be 10; for category 3, n shall be 1.

Call attempt	Minimum duration between call attempts
Initial call attempt	-
1st repeat attempt	5 sec
2nd repeat attempt	1 min
3rd repeat attempt	1 min
4th repeat attempt	1 min
5th repeat attempt	3 min
.	
.	
nth repeat attempt	3 min

Reference:

GSM 02.07, annex A.

Purpose of the test

28.2.2 Test purpose

To ensure the correct behaviour of the MS to GSM 02.07 Category 3.

28.2.3 Method of test

Initial condition.

There shall be no numbers in the list of blacklisted numbers in the MS. The time set between the first re-attempt and the next re-attempt is set to the minimum value possible. The number of re-attempts is set to the lowest possible number, greater than 1, that is supported by the MS. The autocalling function is invoked for the B-party number to be used during the test.

Related PICS/PIXIT Statement(s)

PICS: Cause number 27 implemented in:

- category 2 (preferred);
- category 3.

PIXIT:Description of auto calling management:

- selection of the auto calling;
- indication that the call failed and a re-try is attempted;
- indication that a call finally failed;
- number of B-party numbers that can be stored in the list of blacklisted numbers.

Non standard keystroke sequences to be used on the EMMI (in line with GSM 11.10, sect. 36):

Foreseen Final State of the MS

The MS has a valid TMSI. It is "idle updated".

Test Procedure

A MS initiated generic call setup is performed upto and including CIPHERING MODE COMPLETE. The SS then releases the establishment with a cause value from Category 3 GSM 02.07 annex A.

The MS will make one further generic call setup attempt invoked by the auto calling function after a channel release is sent out by the SS.

Step	Direction	Message	Comments
1	MS		"called number" entered
2	MS -> SS	CHANNEL REQUEST	Establishment cause indicates "originating call".
3	SS -> MS	IMMEDIATE ASSIGNMENT	
4	MS -> SS	CM SERVICE REQUEST	Message is contained in SABM.
5	SS -> MS	AUTHENTICATION REQUEST	
6	MS -> SS	AUTHENTICATION RESPONSE	
7	SS -> MS	CIPHERING MODE COMMAND	
8	MS -> SS	CIPHERING MODE COMPLETE	SS starts ciphering.
9	SS		
10	MS -> SS	SETUP	
11	SS -> MS	CIPHERING MODE COMMAND	
12	MS -> SS	CIPHERING MODE COMPLETE	SS stops ciphering
13	SS		
14	SS -> MS	RELEASE COMPLETE	Cause value from category 3 of GSM 02.07, annex A. The main signalling link is released
15	SS -> MS	CHANNEL RELEASE	
16			The MS is invoking the auto calling function. The time between step 15 and 17 must be minimum 5 sec.
17	MS -> SS	CHANNEL REQUEST	Establishment cause indicates "originating call".
18	SS -> MS	IMMEDIATE ASSIGNMENT	
19	MS -> SS	CM SERVICE REQUEST	Message is contained in SABM.
20	SS -> MS	AUTHENTICATION REQUEST	
21	MS -> SS	AUTHENTICATION RESPONSE	
22	SS -> MS	CIPHERING MODE COMMAND	
23	MS -> SS	CIPHERING MODE COMPLETE	SS starts ciphering.
24	SS		
25	MS -> SS	SETUP	
26	SS -> MS	CIPHERING MODE COMMAND	
27	MS -> SS	CIPHERING MODE COMPLETE	SS stops ciphering
28	SS		
29	SS -> MS	RELEASE COMPLETE	Cause value from category 3 of GSM 02.07, annex A. The main signalling link is released
30	SS -> MS	CHANNEL RELEASE	
31	MS		Clear the auto calling constraint by manual intervention after a minimum of 2 minutes from step 30.

28.3 Constraining the access to a single number (GSM 02.07 categories 1 and 2)

During this test the SETUP messages shall contain the same B-party number.

No manual intervention shall be performed except to initiate and end the test.

28.3.1 Conformance requirement

The MS must fulfil the requirements for category 1 and 2, see sect. 28.2.1

Reference:

GSM 02.07, annex A.

28.3.2 Test purpose

To ensure the correct behaviour of the MS to GSM 02.07 Categories 1 and 2.

28.3.3 Method of test

Initial condition.

There shall be no numbers in the list of blacklisted numbers in the MS. The re-try scheme is set to give the shortest possible intervals between re-tries. The number of re-attempts is set to the maximum possible number (N), that is supported by the MS. The autocalling function is invoked for the B-party number to be used during the test.

Related PICS/PIXIT Statement(s)

PICS: Cause number 27 implemented in:

- category 2 (preferred);
- category 3.

PIXIT:Description of auto calling management:

- selection of the auto calling;
- indication that the call failed and a re-try is attempted;
- indication that a call finally failed;
- number of B-party numbers that can be stored in the list of blacklisted numbers.

Non standard keystroke sequences to be used on the EMMI (in line with GSM 11.10, sect. 36):

Foreseen Final State of the MS

The MS has a valid TMSI. It is "idle updated".

Test Procedure

A, MS initiated, generic call setup is performed up to and including CIPHERING MODE COMPLETE. The SS then releases the establishment with a cause value from category 1 or 2 (GSM 02.07, annex A).

The MS is continuously making new generic call setup attempts invoked by the auto calling function after each CHANNEL RELEASE from the SS.

Step	Direction	Message	Comments
1	MS		"called number" entered
2	MS -> SS	CHANNEL REQUEST	Establishment cause indicates "originating call".
3	SS -> MS	IMMEDIATE ASSIGNMENT	
4	MS -> SS	CM SERVICE REQUEST	Message is contained in SABM.
5	SS -> MS	AUTHENTICATION REQUEST	
6	MS -> SS	AUTHENTICATION RESPONSE	SS starts deciphering after sending the message.
7	SS -> MS	CIPHERING MODE COMMAND	
8	MS -> SS	CIPHERING MODE COMPLETE	
9	SS		SS starts ciphering.
10	MS -> SS	SETUP	SS stops ciphering Cause value from category 1 or 2 of GSM 02.07, annex A. This shall be chosen randomly, from both categories. Cause no. 27 shall be excluded if the MS has implemented in category 3 of GSM 02.07, as declared in PIXIT statement
11	SS -> MS	CIPHERING MODE COMMAND	
12	MS -> SS	CIPHERING MODE COMPLETE	
13	SS		
14	SS -> MS	RELEASE COMPLETE	The main signalling link is released The MS is invoking the auto calling function. 1: At the first re-attempt the time between step 15 and 17 must be minimum 5 sec. 2: At the 2nd, 3rd and 4th re-attempt the time between step 15 and 17 must be minimum 1 min. 3: At the 5th to 10th re-attempt the time between step 15 and 17 must be minimum 3 min. Establishment cause indicates "originating call".
15	SS -> MS	CHANNEL RELEASE	
16			Message is contained in SABM. SS starts deciphering after sending the message.
17	MS -> SS	CHANNEL REQUEST	
18	SS -> MS	IMMEDIATE ASSIGNMENT	
19	MS -> SS	CM SERVICE REQUEST	
20	SS -> MS	AUTHENTICATION REQUEST	
21	MS -> SS	AUTHENTICATION RESPONSE	
22	SS -> MS	CIPHERING MODE COMMAND	
23	MS -> SS	CIPHERING MODE COMPLETE	
24	SS		SS starts ciphering.
25	MS -> SS	SETUP	SS stops ciphering Cause value from category 1 or 2 of GSM 02.07, annex A. This shall be chosen randomly, from both categories. Cause no. 27 shall be excluded if the MS has implemented in category 3 of GSM 02.07, as declared in PIXIT statement
26	SS -> MS	CIPHERING MODE COMMAND	
27	MS -> SS	CIPHERING MODE COMPLETE	
28	SS		
29	SS -> MS	RELEASE COMPLETE	The main signalling link is released.
30	SS -> MS	CHANNEL RELEASE	
31			The auto calling function shall repeat step 16 to 30 (N-1) times. The MS shall not make more than maximum 10 re-attempts.
32	MS		Clear the auto calling constraint by manual intervention after a minimum of 4 minutes from step 31. Following the final completion of step 31 the MS initiate a call prior to manual intervention.

28.4 Behaviour of the MS when its list of blacklisted numbers is full

The number of B-party numbers that can be stored in the list of blacklisted numbers, as stated in the PIXIT statement (annex 3), is M.

This test shall only apply to MS that are capable of autocalling more than M B-party numbers.

28.4.1 Conformance requirement

The number of B numbers that can be held in the blacklist is at the manufacturers discretion but there shall be at least 8. However, when the blacklist is full the MT shall prohibit further automatic call attempts to any one number until the blacklist is manually cleared at the MT in respect of one or more B numbers.

Reference:

GSM 02.07, annex A.

28.4.2 Test purpose

To ensure the correct behaviour of the MS when its list of blacklisted numbers is full.

28.4.3 Method of test

Initial condition.

The list of blacklisted numbers, in the MS, shall be full. This may be achieved as described in the procedure in 28.2, applied to M B-party numbers.

Related PICS/PIXIT Statement(s)

PICS: Cause number 27 implemented in:

- category 2 (preferred),
- category 3.

PIXIT:Description of auto calling management:

- selection of the auto calling,
- indication that the call failed and a re-try is attempted,
- indication that a call finally failed;
- number of B-party numbers that can be stored in the list of blacklisted numbers.

Non standard keystroke sequences to be used on the EMMI (in line with GSM 11.10, sect. 36):

Foreseen Final State of the MS

The MS has a valid TMSI. It is "idle updated".

Test Procedure

The autocalling function is invoked for a B-party number that is not in the list of blacklisted numbers.

Clear the autocalling constraint by manual intervention after a minimum of 2 minutes.

28.4.4 Test requirements

The MS must not initiate a call.

Step	Direction	Message	Comments	
1	MS		"called number" entered	
2	MS -> SS	CHANNEL REQUEST	Establishment cause indicates "originating call". Message is contained in SABM. SS starts deciphering after sending the message.	
3	SS -> MS	IMMEDIATE ASSIGNMENT		
4	MS -> SS	CM SERVICE REQUEST		
5	SS -> MS	AUTHENTICATION REQUEST		
6	MS -> SS	AUTHENTICATION RESPONSE		
7	SS -> MS	CIPHERING MODE COMMAND		
8	MS -> SS	CIPHERING MODE COMPLETE		
9	SS			SS starts ciphering.
10	MS -> SS	SETUP	SS stops deciphering after sending the message.	
11	SS -> MS	CIPHERING MODE COMMAND		
12	MS -> SS	CIPHERING MODE COMPLETE		
13	SS		SS stops ciphering.	
14	SS -> MS	RELEASE COMPLETE	Cause value from category 3 of GSM 02.07, annex A. This shall be chosen randomly. Cause no. 27 shall be excluded if the MS has implemented in category 2 of GSM 02.07, as declared in PIXIT statement The main signalling link is released The MS is invoking the auto calling function. The time between step 15 and 17 must be minimum 5 sec. Establishment cause indicates "originating call". Message is contained in SABM. SS starts deciphering after sending the message.	
15	SS -> MS	CHANNEL RELEASE		
16				
17	MS -> SS	CHANNEL REQUEST		
18	SS -> MS	IMMEDIATE ASSIGNMENT		
19	MS -> SS	CM SERVICE REQUEST		
20	SS -> MS	AUTHENTICATION REQUEST		
21	MS -> SS	AUTHENTICATION RESPONSE		
22	SS -> MS	CIPHERING MODE COMMAND		
	MS -> SS	CIPHERING MODE COMPLETE		
23	SS			SS starts ciphering.
24	MS -> SS	SETUP		SS stops deciphering after sending the message.
25	SS -> MS	CIPHERING MODE COMMAND		
26	MS -> SS	CIPHERING MODE COMPLETE		
27	SS		SS stops ciphering.	
28	SS -> MS	RELEASE COMPLETE	Cause value from category 3 of GSM 02.07, annex A. This shall be chosen randomly. Cause no. 27 shall be excluded if the MS has implemented in category 2 of GSM 02.07, as declared in PIXIT statement The main signalling link is released.	
29	SS -> MS	CHANNEL RELEASE		
30			The test shall be repeated from steps 1 to 29 using a different B party number each time until the blacklist is full as declared in PIXIT statement. The MS shall not make more than a maximum of 1 re-attempt on each number.	
31			The test shall be repeated from steps 1 to 29 using a non-blacklisted B party number	
32	MS		Clear the auto calling constraint by manual intervention after a minimum of 2 minutes from step 29.	

29 Testing of bearer services

29.1 General

In GSM 07.01, section 2 the reference configurations for access to the data services of a GSM PLMN are described. For testing purposes only the following classifications are used:

- MT2 configuration (Um- and R-interface available for testing)
- Configurations (only Um-interface available for testing) where it is possible to enable the MS to issue or accept a data call and send data over the Um-interface. An MT1 connected to an ISDN TE belongs to this type.

For efficient testing it is essential that such configurations have some means to specifically activate every function towards the Um-interface the MS will perform during operation.

The correctness of the data bits transferred to the Um-interface will not be tested in these configurations. However the correctness of the GSM 04.21 frames sent by the MS will be tested.

Testing the S-interface for the MT1 configuration is for further study.

For some tests it is of no importance whether the call is MO or MT. However, there might be configurations allowing the call to be established only from one side. In this case the appropriate actions shall be taken to establish the call.

In all other cases the data call shall be set up by the SS (i.e. MT) with an appropriate BC-IE which is supported by the MS.

At the beginning of all tests the MS shall be in the idle updated state.

29.2 Testing of transparent data services

During all the tests the GSM 04.21 frames received as output of the channel coder in the SS shall be checked for correctness against GSM 04.21; this means checking that:

- S bits are coded as zeroes unless otherwise specified;
- the E bits have the correct value (for the synchronous services);
- the data bits correctly include the start and stop bits (for the asynchronous services).

29.2.1 Verification of synchronization

29.2.1.1 Definition and applicability

This test applies to Mobile Stations supporting data services in transparent mode.

29.2.1.2 Conformance requirement

A Mobile Stations in MT2 configuration has to comply with all requirements whilst for other configurations some of the requirements are not relevant. These restrictions are explicitly indicated in subclause 29.2.1.5.

29.2.1.3 Test purpose

This test verifies the correct synchronization procedure of user data and status information which are mapped on modified CCITT V.110 frames (as per GSM 04.21).

As V-series interfaces are supported in full duplex mode, it will test the capability to synchronize these frames in the direction from the TAF to the IWF and vice versa.

29.2.1.4 Method of test

The test shall be carried out under ideal radio conditions for all bearer services and user rates in transparent mode that are supported by the MS in case of mobile originated and terminated calls and in-call modification. The setting of Bearer Capability Information Elements in signalling messages sent to the MS by the SS must be supported by the MS for the bearer service(s) to be tested.

NOTE 1: Since "steady state" is implementation dependent, there is no means to define a test "steady state detected". However, the whole testing procedure is limited to 1s. This includes an implicit upper time limit for the MS to detect a steady state. A MS failing this test is highly estimated to never detect a steady state under real radio conditions.

NOTE 2: t_i , as used in the description of the test procedures, are points of time, not timers.

29.2.1.4.1 Procedure for Mobile Originated Calls

- a) The MS is connected to the System Simulator at the Um interface and to the LTE using the appropriate R interface in case of MT2 only.
- b) The MS is configured for data transmission. In the case of MT2 configurations, the LTE shall set the signalling lines of the R interface Ct 105, Ct 108.2 for V-series interface to ON.
- c) A mobile originated call shall be set up.
- d) At the reception of the SETUP message sent by the MS the SS shall send a CONNECT message and starts sending "1/OFF". t_1 is at the completion of the CONNECT message.
- e) The reception of "1/OFF" at the SS side (see table 29-1) defines t_2 . t_2 will be reset at the reception of again "1/OFF" after an interruption of continuous "1/OFF" pattern.
- f) The SS checks bits S1, S3, S6 and S8 of the modified CCITT V.110 frames (as described in GSM 04.21). Let t_3 be the time when all four bits change from OFF to ON (i.e. if $t < t_3$, (S1,S3,S6,S8) $\langle \rangle$ (0,0,0,0) and $t \geq t_3$, (S1,S3,S6,S8) = (0,0,0,0)).

29.2.1.4.2 Procedure for Mobile Terminated Calls

- a) The MS is connected to the System Simulator at the Um interface and to the LTE using the appropriate R interface in case of MT2 only.
- b) The MS is configured for data transmission. In the case of MT2 configurations, The LTE shall set the signalling lines of the R interface Ct. 105, Ct 108.2 for V-series interface to ON.
- c) A mobile terminated call shall be set up.
- d) At the reception of CONNECT the SS sends CONNECT ACKNOWLEDGE. t_1 is at the completion of the CONNECT ACKNOWLEDGE message.
- e) The reception of "1/OFF" at the SS side (see table 29-1) defines t_2 . t_2 will be reset at the reception of again "1/OFF" after an interruption of continuous "1/OFF" pattern.
- f) The SS checks bits S1, S3, S6 and S8 of the modified CCITT V.110 frames (as described in GSM 04.21). Let t_3 be the time when all four bits change from OFF to ON (i.e. if $t < t_3$, (S1,S3,S6,S8) $\langle \rangle$ (0,0,0,0) and $t \geq t_3$, (S1,S3,S6,S8) = (0,0,0,0)).

29.2.1.4.3 Procedure for In Call Modification

- a) The MS is connected to the System Simulator at the Um interface and to the LTE using the appropriate R interface in case of MT2 only.
- b) The MS is configured for data transmission. In the case of MT2 configurations, the LTE shall set the signalling lines of the R interface Ct. 105, Ct 108.2 for V-series interface to ON.
- c) A speech call shall be established with a SETUP message containing two bearer capabilities for speech and the bearer service to be tested.

- d) The MS shall start the ICM procedure with a bearer capability information element supporting the bearer service to be tested.
- e) At the reception of the MODIFY message sent by the MS the SS shall send a CHANNEL MODE MODIFY message.
- f) At the reception of the CHANNEL MODE MODIFY ACKNOWLEDGE message the SS shall send a MODIFY COMPLETE message. t_1 is at the completion of the MODIFY COMPLETE message.
- g) The reception of "1/OFF" (see table 29-1) defines t_2 . t_2 will be reset at the reception of again "1/OFF" after an interruption of continuous "1/OFF" pattern.
- h) The SS checks bits S1, S3, S6 and S8 of the modified CCITT V.110 frames (as described in GSM 04.21). Let t_3 be the time when all four bits change from OFF to ON (i.e. if $t < t_3$, $(S1, S3, S6, S8) \langle (0, 0, 0, 0)$ and $t \geq t_3$, $(S1, S3, S6, S8) = (0, 0, 0, 0)$).

29.2.1.5 Test requirements

29.2.1.5.1 Test requirements for Mobile Originated Calls

- 1) After step b) Cts 106, 107, 109 must be in the "OFF" condition, dataline 104 shall be set to "1".
- 2) At $t_1 + 500$ ms Ct 107 must still be in the "OFF" condition.
- 3) Between $t_1 + 500$ ms and $t_1 + 1000$ ms Ct 107 must switch to the "ON" condition. This indicates successful synchronization of TAF towards IFE.
- 4) Between t_2 and t_3 the SS must receive continuous "1/OFF" frames.
- 5) The time between t_2 and t_3 must be more than 450ms.
- 6) At $t_1 + 1000$ ms the SS must check GSM 04.21 frames sent by the MS with SA and SB bits (i.e. bits S1, S3, S4, S6, S8 and S9) set to "ON". This indicates successful synchronization of IFE towards TAF. At this point of time the whole synchronization procedure has been completed successfully.

NOTE 3: If the MS is not MT2, only requirements 4 to 6 apply.

29.2.1.5.2 Test requirements for Mobile Terminated Calls

- 1) After step b) Cts 106, 107, 109 must be in the "OFF" condition, dataline 104 shall be set to "1".
- 2) At $t_1 + 500$ ms Ct 107 must still be in the "OFF" condition.
- 3) Between $t_1 + 500$ ms and $t_1 + 1000$ ms Ct 107 must switch to the "ON" condition. This indicates successful synchronization of TAF towards IFE.
- 4) Between t_2 and t_3 the SS must receive continuous "1/OFF" frames.
- 5) The time between t_2 and t_3 must be more than 450 ms.
- 6) At $t_1 + 1000$ ms the SS must check GSM 04.21 frames sent by the MS with SA and SB bits (i.e. bits S1, S3, S4, S6, S8 and S9) set to "ON". This indicates successful synchronization of IFE towards TAF. At this point of time the whole synchronization procedure has been completed successfully.

NOTE 4: If the MS is not MT2, only requirements 4 to 6 apply.

29.2.1.5.3 Test requirements for In Call Modification

- 1) After step b) Cts 106, 107, 109 must be in the "OFF" condition, dataline 104 shall be set to "1".
- 2) At $t_1 + 500$ ms Ct 107 must still be in the "OFF" condition.
- 3) Between $t_1 + 500$ ms and $t_1 + 1000$ ms Ct 107 must switch to the "ON" condition. This indicates successful synchronization of TAF towards IFE.

- 4) Between t2 and t3 the SS must receive continuous "1/OFF" frames.
- 5) The time between t2 and t3 must be more than 450 ms.
- 6) At t1 +1 000 ms the SS must check GSM 04.21 frames sent by the MS with SA and SB bits (i.e. bits S1, S3, S4, S6, S8 and S9) set to "ON". This indicates successful synchronization of IFE towards TAF. At this point of time the whole synchronization procedure has been completed successfully.

NOTE 5: If the MS is not MT2, only requirements 4 to 6 apply.

Table 29-1: Definition of synchronization pattern "1/OFF"

Synch-Frame							Data-Frame						
1	1	1	1	1	1	1	D1	D2	D3	D4	D5	D6	S1
1	1	1	1	1	1	1	D7	D8	D9	D10	D11	D12	X
1	1	1	1	1	1	1	D13	D14	D15	D16	D17	D18	S3
1	1	1	1	1	1	1	D19	D20	D21	D22	D23	D24	S4
1	1	1	1	1	1	1	E4	E5	E6	E7	D25	D26	S27
1	1	1	1	1	1	1	D28	D29	D30	S6	D31	D32	S33
1	1	1	1	1	1	1	D34	D35	D36	X	D37	D38	S39
1	1	1	1	1	1	1	D40	D41	D42	S8	D43	D44	S45
1	1	1	1	1	1	1	D46	D47	D48	S9			

GSM 04.21 60 bits frame

Synch-Frame								Data-Frame							
1	1	1	1	1	1	1	1	D1	D2	D3	S1	D4	D5	D6	X
1	1	1	1	1	1	1	1	D7	D8	D9	S3	D10	D11	D12	S4
1	1	1	1	1	1	1	1	E4	E5	E6	E7	D13	D14	D15	S6
1	1	1	1	1	1	1	1	D16	D17	D18	X	D19	D20	D21	S8
1	1	1	1	1	1	1	1	D22	D23	D24	S9				

GSM 04.21 36 bits frame

29.2.2 Filtering of channel control information for transparent BCs

29.2.2.1 Definition and applicability

This test is only applicable to the MT2 configuration.

29.2.2.2 Conformance requirement

An MS supporting data services shall decode and filter channel control information received over the Um-interface.

- 1 GSM 04.21, section 7;
- 2 GSM 07.01, section 8.2.2;
- 3 GSM 07.02, section 3.2.1 (for asynchronous bearer services only);
- 4 GSM 07.03, sections 4.2.1 and 4.2.2 (for synchronous bearer services only).

29.2.2.3 Test purpose

The purpose of this test is to verify the correct decoding and filtering of channel control information from the GSM 04.21 frames to the V.24/X.21 interface circuits. The tests apply after synchronization has been completed.

29.2.2.4 Method of test

The Test shall be carried out for all user data rates supported by the MS (see below) and the circuits CT106 (V.24) (interface circuit bit X) and CT109 (V.24) (interface circuit bit SB) and I (X.21) (S-bits). The test shall be carried out only for those frame formats and circuits which are supported by the MS. The test is to be repeated for all circuits.

Let T(ON-OFF) and T(OFF-ON) be the timers to integrate the ON-OFF and the OFF-ON transition respectively for the circuit to be tested as stated in GSM 07.01, section 8.2.2.

Procedure:

- a) A data call shall be set up between the SS and the MS with a combination of BCIEs (see below) supported by the MS. The interface circuit bit(s) in the GSM 04.21 frame shall be set to OFF. The next step shall be entered 6 s after CT107 has been set to ON by the MS.
- b) The SS shall set the interface circuit bit(s) to continuously ON, wait half of T(OFF-ON) and then set the interface circuit bit(s) again to continuously OFF. The SS shall wait 6 s before entering the next step.
- c) The SS shall set the interface circuit bit(s) to continuously ON, wait twice T(OFF-ON) and then set the interface circuit bit(s) again to continuously OFF. The SS shall wait 6 s before entering the next step.
- d) The SS shall set interface circuit bit(s) to continuously ON and wait 6 s before entering the next step
- e) The SS shall set the interface circuit bit(s) to continuously OFF, wait half of T(ON-OFF) and then set the interface circuit bit(s) again to continuously ON. The SS shall wait 6 s before entering the next step.
- f) The SS shall set the interface circuit bit(s) to continuously OFF, wait twice T(ON-OFF) and then set the interface circuit bit(s) again to continuously ON. The SS shall wait 6 s before entering the next step.

29.2.2.5 Test requirements

- 1) After step a) the interface circuit at the R-interface shall be OFF.
- 2) During step b) the interface circuit at the R-interface shall not change.
- 3) During step c) the interface circuit at the R-interface shall change to ON and then again to OFF.
- 4) After step d) the interface circuit at the R-interface shall be ON.
- 5) During step e) the interface circuit at the R-interface shall not change.
- 6) During step f) the interface circuit at the R-interface shall change to OFF and then again to ON.

29.2.2.6 BCIE

The following combinations shall be considered (ref. GSM 07.01, annex 2):

- a) User Rate = 9,6 kbit/s;
- b) User Rate = 4,8 kbit/s;
- c) User Rate = 2,4 kbit/s;
- d) User Rate = 1,2 kbit/s;
- e) User Rate = 1 200/75 bit/s (only with asynchronous Bearer Services);
- f) User Rate = 300 bit/s (only with asynchronous Bearer Services).

The remaining parameters of the BCIE and the channel type (FR/HR) shall be set to a value supported by the MS.

29.2.3 Correct Terminal Compatibility Decision

29.2.3.1 Negotiation of Radio Channel Requirement (RCR)

29.2.3.1.1 Test purpose

To verify that the MS ignores the RCR field in a mobile terminating setup and negotiates according to its capabilities and to the service requested. A Dual Rate support MS shall accept the channel rate chosen by the network in the ASSIGNMENT COMMAND message.

29.2.3.1.2 Initial conditions

For an MS with an external interface, the interface shall be setup in such a way that the MS is able to successfully receive the call for the service in question. The manufacturer shall state how this is done in a PIXIT statement. The same applies to features which must be activated by MMI before an incoming call can be accepted.

29.2.3.1.3 Test method

- a) The SS transmits a SETUP message containing a BC-IE among those declared as supported by the MS and with the RCR field set to "01".
- b) The SS sends a ASSIGNMENT COMMAND message with a channel type set to "Full Rate" unless the CALL CONFIRM message indicates "dual rate mobile station/full rate preferred". In that case, the channel type is set to "Half Rate".
- c) The call is released and steps a) and b) are repeated with RCR field set to "00".
- d) The call is released and steps a) and b) are repeated with RCR field set to "10".
- e) The call is released and steps a) and b) are repeated with RCR field set to "11".

29.2.3.1.4 Test requirements

- 1) After step a), the MS shall send a CALL CONFIRM message. If present, the BC-IE shall be coded according to GSM 07.01. If any other parameters than those listed below have different values than those of the BC-IE included in the SETUP, then the test shall be failed:
 - Number of stop bits, number of data bits, parity;
 - Connection Element, Structure, Intermediate rate, User Information Layer 2 Protocol, Modem Type, NIRR;
 - Radio Channel Requirement.
- 2) After step b), the MS shall answer to the ASSIGNMENT COMMAND message with an ASSIGNMENT COMPLETE message.

29.2.3.2 Negotiation of Connection Element (CE)

29.2.3.2.1 Test purpose

To verify that the MS accepts a CE equal to "Both, Transparent Preferred" or "Both Non Transparent Preferred" and indicates its choice in the CALL CONFIRM message.

29.2.3.2.2 Initial condition

For an MS with an external interface, the interface shall be setup in such a way that the MS is able to successfully receive the call for the service in question. The manufacturer shall state how this is done in a PIXIT statement. The same applies to features which must be activated by MMI before an incoming call can be accepted.

29.2.3.2.3 Test method

- a) The SS transmits a SETUP message containing a BC-IE among those declared as supported by the MS and with the CE field set to "Both Transparent Preferred". The RCR parameter shall be set to "Full Rate". The UIL2P is not included (i.e. octet 7 is absent). The NIRR is set to "no meaning" (i.e. 0). The IR is set to "16 kbit/s". The modem type is any according to declared capabilities. The user rate is any according to declared capabilities and modem type.
- b) The call is released and step a) is repeated with CE field set to "Both Non Transparent Preferred".

29.2.3.2.4 Test requirements

After step a), the MS shall send a CALL CONFIRM message. The BC-IE shall be present and shall be coded according to GSM 07.01 and shall correspond to a Bearer Service or Teleservice supported by the MS. The CE shall be set to

either "Transparent" or "Non Transparent" If any other parameters than those listed bellow have different values than those of the BC-IE included in the SETUP, then the test shall be failed:

- number of stop bits, number of data bits, parity;
- Connection Element, Structure, Intermediate rate, User Information Layer 2 Protocol, Modem Type, NIRR;
- Radio Channel Requirement.

29.2.3.3 Negotiation of Number of Stop Bits, Number of Data bits, and Parity

29.2.3.3.1 Test purpose

To verify that the MS accepts any value for the parameters Number of Stop Bits, Number of Data bits, and Parity in a mobile terminating Setup and negotiates according to its capabilities and to the service requested.

This test only applies to Mobile Stations supporting asynchronous services.

29.2.3.3.2 Initial condition

For an MS with an external interface, the interface shall be setup in such a way that the MS is able to successfully receive the call for the service in question. The manufacturer shall state how this is done in a PIXIT statement. The same applies to features which must be activated by MMI before an incoming call can be accepted.

29.2.3.3.3 Test method

- a) The SS transmits a SETUP message containing a BC-IE among those declared as supported by the MS and corresponding to an asynchronous Bearer Service, and with the Number of Stop Bits (NSB) field set to "1 bit", the Number of Data Bits (NDB) field set to "8 bits", and the Parity field set to "none".
- b) The call is released and step a) is repeated with the Number of Stop Bits (NSB) field set to "2 bit", the Number of Data Bits (NDB) field set to "7 bits", and the Parity field set to "odd".

29.2.3.3.4 Test requirements

After steps a) and b), the MS shall send a CALL CONFIRMED message. If present, the BC-IE shall be coded according to GSM 07.01 and shall correspond to a Bearer Service supported by the MS. If any other parameters than those listed bellow have different values than those of the BC-IE included in the SETUP, then the test shall be failed:

- Number of stop bits, number of data bits, parity;
- Connection Element, Structure, Intermediate rate, User Information Layer 2 Protocol, Modem Type, NIRR;
- Radio Channel Requirement.

29.2.3.4 Negotiation of Modem Type

29.2.3.4.1 Test purpose

To verify that the MS accepts the value "autobauding type 1" for the parameter Modem Type in a mobile terminating Setup and negotiates according to its capabilities and to the service requested.

This test only applies to Mobile Stations supporting non transparent services.

NOTE 6: It is not clear if the MS should also accept any possible value for the Modem Type field.

29.2.3.4.2 Initial condition

For an MS with an external interface, the interface shall be setup in such a way that the MS is able to successfully receive the call for the service in question. The manufacturer shall state how this is done in a PIXIT statement. The same applies to features which must be activated by MMI before an incoming call can be accepted.

29.2.3.4.3 Test method

- a) The SS transmits a SETUP message containing a BC-IE among those declared as supported by the MS and corresponding to a non transparent Bearer Service (the Connection Element field is coded "Non transparent"), and with the Modem Type field set to "autobauding type 1".
- b) The call is released and step a) is repeated with the same BC in the SETUP message, but with the Connection Element set to "both, non-transparent preferred".

29.2.3.4.4 Test requirements

After steps a) and b), the MS shall send a CALL CONFIRMED message. If present, the BC-IE shall be coded according to GSM 07.01 and shall correspond to a Bearer Service or Teleservice supported by the MS. If any other parameters than those listed bellow have different values than those of the BC-IE included in the SETUP, then the test shall be failed:

- Number of stop bits, number of data bits, parity;
- Connection Element, Structure, Intermediate rate, User Information Layer 2 Protocol, Modem Type, NIRR;
- Radio Channel Requirement.

29.2.3.5 Negotiation of Intermediate Rate

29.2.3.5.1 Test purpose

To verify that the MS responds correctly to a request for a negotiation of the Intermediate Rate parameter in a mobile terminating Setup and negotiates according to its capabilities and to the service requested.

This test only applies to Mobile Stations supporting non transparent services with a full rate channel at a user rate of 4,8 kbit/s or lower.

NOTE 7: The MS may support these services with a 6 Kbit/s or (non exclusive) 12 Kbit/s radio interface rate.

29,2,3.5.2 Initial condition

For an MS with an external interface, the interface shall be setup in such a way that the MS is able to successfully receive the call for the service in question. The manufacturer shall state how this is done in a PIXIT statement. The same applies to features which must be activated by MMI before an incoming call can be accepted.

29.2.3.5.3 Test method

- a) The SS transmits a SETUP message containing a BC-IE among those declared as supported by the MS and corresponding to a non transparent Bearer Service (the Connection Element field is coded "Non transparent") with the user rate lower to or equal 4,8 kbit/s, and with the NIRR field set to "No meaning". The RCR field is set to "full rate", and the Intermediate Rate field is set to "16 kbit/s".
- b) The call is released and step a) is repeated with the same BC in the SETUP message, but with the Connection Element set to "both, non-transparent preferred".
- c) The call is released and steps a) and b) are repeated with the NIRR field of the SETUP message set to "6 kbit/s".

29.2.3.5.4 Test requirements

- 1) After steps a), b) and c), the MS shall send a CALL CONFIRMED message. If present, the BC-IE shall be coded according to GSM 07.01 and shall correspond to a Bearer Service or Teleservice supported by the MS. If any other parameters than those listed bellow have different values than those of the BC-IE included in the SETUP, then the test shall be failed:

- Number of stop bits, number of data bits, parity;
- Connection Element, Structure, Intermediate rate, User Information Layer 2 Protocol, Modem Type, NIRR;

- Radio Channel Requirement.
- 2) If the BC-IE is present in the CALL CONFIRMED message after step c) and if the Connection Element field contains the value "non transparent", the Intermediate Rate field shall indicate:
- 8 kbit/s if the NIRR field is set to "6 kbit/s";
 - 16 kbit/s if the NIRR field is set to "no meaning".

29.2.3.6 Negotiation of User Information Layer 2 Protocol

29.2.3.6.1 Test purpose

To verify that the MS accepts any value (including the absence of) the UIL2P parameter in a mobile terminating Setup and negotiates according to its capabilities and to the service requested.

This test only applies to Mobile Stations supporting asynchronous bearer services in non transparent mode.

29.2.3.6.2 Initial condition

For an MS with an external interface, the interface shall be setup in such a way that the MS is able to successfully receive the call for the service in question. The manufacturer shall state how this is done in a PIXIT statement. The same applies to features which must be activated by MMI before an incoming call can be accepted.

29.2.3.6.3 Test method

- a) The SS transmits a SETUP message containing a BC-IE among those declared as supported by the MS and corresponding to a non transparent Bearer Service (the Connection Element field is coded "Non transparent") and with no UIL2P parameter (i.e. octet 7 of the BC IE is absent).
- b) The call is released and step a) is repeated with the same BC in the SETUP message, but with the value "ISO6429, codeset 0 (DC1/DC3)" in the UIL2P parameter.
- c) The call is released and step b) is repeated with the same BC in the SETUP message, but with the value "COPnoFLCt" in the UIL2P parameter.
- d) The call is released and steps a), b) and c) are repeated with the same BC in the SETUP message, but with the Connection Element set to "both, non-transparent preferred".

29.2.3.6.4 Test requirements

- 1) After steps a), b) and c), the MS shall send a CALL CONFIRMED message. If present, the BC-IE shall be coded according to GSM 07.01 and shall correspond to a Bearer Service or Teleservice supported by the MS. If any other parameters than those listed below have different values than those of the BC-IE included in the SETUP, then the test shall be failed:
 - Number of stop bits, number of data bits, parity;
 - Connection Element, Structure, Intermediate rate, User Information Layer 2 Protocol, Modem Type, NIRR;
 - Radio Channel Requirement.

- 2) If the BC-IE is present in the CALL CONFIRMED message, and if the Connection Element is set to "transparent", octet 7 (containing the UIL2P parameter) shall be absent.

29.2.3.7 Negotiation between TS 61 and TS 62: Mobile Originated call

29.2.3.7.1 Test purpose

To verify that the MS accepts a negotiation from TS 61 to TS 62.

This test only applies to Mobile Stations supporting TS 61.

29.2.3.7.2 Initial condition

For an MS with an external interface, the interface shall be setup in such a way that the MS is able to successfully set up a call for TS 61. The manufacturer shall state how this is done in a PIXIT statement. The same applies to features which must be activated by MMI before an outgoing call can be set up.

29.2.3.7.3 Test method

- a) The MS is made to set up a call for TS 61. If the MS supports it, the first phase of the call is speech.
- b) The SS responds to the SETUP message with a CALL PROCEEDING message containing a BC-IE coded according to GSM 07.01 and corresponding to TS 62.
- c) The SS sends an ALERTING message followed by a CONNECT message.
- d) If the MS supports it, steps a), b) and c) are repeated with a call setup for TS 61 with the first phase of the call being fax.

29.2.3.7.4 Test requirements

- 1) After step b), the MS shall accept the call (i.e. it shall not reject the call with a DISCONNECT message).
- 2) After step c), the MS shall answer with a CONNECT ACKNOWLEDGE message.

29.2.3.8 Negotiation between TS 61 and TS 62: Mobile Terminated call

29.2.3.8.1 Test purpose

To verify that an MS that does not support TS 61 accepts a Mobile Terminated call setup request for TS 61 and negotiates the demand to TS 62.

This test only applies to Mobile Stations supporting TS 62 and not supporting TS 61.

29.2.3.8.2 Initial condition

For an MS with an external interface, the interface shall be setup in such a way that the MS is able to successfully receive the call for the service in question. The manufacturer shall state how this is done in a PIXIT statement. The same applies to features which must be activated by MMI before an incoming call can be accepted.

29.2.3.8.3 Test method

- a) The SS transmits a SETUP message containing two BC-IEs: the first BC shall indicate speech, the second BC shall indicate fax group 3.
- b) The call is released, and the SS transmits a SETUP message containing two BC-IEs: the first BC shall indicate fax group 3, the second BC shall indicate speech.

29.2.3.8.4 Test requirements

After steps a) and b), the MS shall send a CALL CONFIRMED message with one and only one BC-IE. The BC-IE shall be coded according to GSM 07.01 and shall correspond to TS 62.

29.2.4 Data Rate Adaptation for Synchronous Transparent Bearer Capabilities

29.2.4.1 Definition and applicability

This test is applicable to the MT2 configuration and, in a restricted way, to other configurations where the MS is able to send data over the Um-interface.

29.2.4.2 Conformance requirement

An MS supporting synchronous transparent bearer capabilities shall perform data rate adaptation and support the frames at the Um-interface according to the following specifications:

- 1 GSM 04.21, sections 5 and 7.

29.2.4.3 Test purpose

The purpose of these tests is to verify

- that the format and the data bits of the GSM 04.21 frames sent by the MS are consistent with the data input and data rate at the R-interface and
- that the data bits output by the MS at the R-interface are consistent with the received GSM 04.21 frames.

29.2.4.4 Method of test

The Test shall be carried out for all possible user data rates which are supported by the MS (see below). In case of an MT2 configuration, the interface circuits CT105 and CT108 shall be set to the ON condition from the start.

Procedure:

- a) A data call shall be set up between the SS and the MS with a BCIE (see below) supported by the MS. The next step shall be entered immediately after TCH synchronization has been completed at the SS side.
- b) The interface circuit bit(s) in the GSM 04.21 frame shall be set to ON and the SS shall start to transmit pseudo random data bits in the GSM 04.21 frames over the Um-interface to the MS.
- c) MT2 configuration: The SS shall input pseudo random data over the R-interface of the MS.
MT0 configuration: the transmission of data from the MS over the Um-interface shall be stimulated (if it does not start automatically).
- d) Approximately 5 s after the data have been received by the SS over the Um-interface the test shall be stopped.

29.2.4.5 Test requirements

- 1) During the test no GSM 04.21 frame with incorrect format (i.e. format not compliant to GSM 04.21 (see conformance requirement) or not corresponding to the user data rate currently under test) shall have been received by the SS.
- 2) Only MT2 configuration: the user data stream input to the R-interface shall match bit-exactly the user data stream sent to the SS over the Um-interface and the user data stream output from the R-interface shall match bit-exactly the user data stream sent by the SS over the Um-interface.

29.2.4.6 BCIE

The following combinations shall be considered (ref. GSM 07.01, annex 2):

- a) User Rate = 9,6 kbit/s
- b) User Rate = 4,8 kbit/s
- c) User Rate = 2,4 kbit/s
- d) User Rate = 1,2 kbit/s

The remaining parameters of the BCIE and the channel type (FR/HR) shall be set to a value supported by the MS.

29.2.5 Network Independent Clocking

For further study.

29.2.6 Asynchronous Transparent Bearer Capabilities

29.2.6.1 Data Rate Adaptation

29.2.6.1.1 Definition and applicability

This test is applicable to the MT2 configuration and, in a restricted way, to the MT0 configuration where the MS is able to send data over the Um-interface and to use the Bearer Services for asynchronous data.

29.2.6.1.2 Conformance requirement

An MS supporting asynchronous transparent bearer capabilities shall perform data rate adaptation and support the frames at the Um-interface according to the following specifications:

- 1 GSM 04.21, sections 4.1, 4.4, 5 and 7.

29.2.6.1.3 Test purpose

The purpose of these tests is to verify the conversion between an asynchronous data stream at the R-interface and the GSM 04.21 frames at the Um-interface.

29.2.6.1.4 Method of test

The Test shall be carried out for all possible user data rates which are supported by the MS in asynchronous mode (see below).

Procedure:

- a) A data call shall be set up between the SS and the MS with a BCIE (see below) supported by the MS. The next step shall be entered immediately after TCH synchronization has been completed at the SS side.
- b) The interface circuit bit(s) in the GSM 04.21 frame shall be set to ON and the SS shall start to transmit pseudo random characters as described below to the MS.
- c) MT2 configuration: The SS shall input pseudo random characters as described below over the R-interface to the MS.

MT0 configuration: the transmission of data from the MS over the Um-interface shall be stimulated (if it does not start automatically).
- d) Approximately 5 s after the data have been received by the SS over the Um-interface the test shall be stopped.

29.2.6.1.5 Test requirements

- 1) During the test no GSM 04.21 frame with incorrect format (i.e. format not compliant to GSM 04.21 (see conformance requirement) or not corresponding to the user data rate currently under test) shall have been received by the SS.
- 2) MT2 configuration only: the user data stream input to the R-interface shall match character by character the user data stream sent to the SS over the Um-interface and the user data streams output from the R-interface shall match character by character the user data stream sent by the SS over the Um-interface.

29.2.6.1.6 Generation of the asynchronous pseudo random characters

Downlink direction:

The GSM 04.21 frames shall contain a bit stream which consists of repeating:

- a character which is generated pseudo randomly every time;
- n stop bits, where n is drawn pseudo randomly from the interval 1..15 every time.

Uplink direction:

The data stream at the R-interface consists of repeating:

- a character which is generated pseudo randomly every time;
- 1 stop bit;
- 1,13 +/- 1 % bit frames (i.e. 1/nominal data rate) of stop polarity.

29.2.6.1.7 BCIE

Same as 29.2.3.

The Number of Data Bits per character (excl. parity) shall be 8. No parity bit shall be used. The Number of Stop Bits shall be 1. If the MS does not support these values different ones shall be chosen.

The remaining parameters of the BCIE shall and the channel type (FR/HR) be set to a value supported by the MS.

29.2.6.2 Passage of the Break Signal

29.2.6.2.1 Definition and applicability

This test is applicable to the MT2 configuration only.

29.2.6.2.2 Conformance requirement

An MS supporting asynchronous transparent bearer capabilities shall perform passage of the break signal in uplink and downlink direction according to:

- 1 GSM 04.21, sections 4.1, 4.2, 4.4, 5 and 7.

29.2.6.2.3 Test purpose

The purpose of these tests is to verify the ability of the MS to transfer a Break Signal to the R-interface and vice versa.

29.2.6.2.4 Method of test

The Test shall be carried out for all possible user data rates which are supported by the MS in asynchronous mode (see below).

Procedure:

- a) A data call shall be set up between the SS and the MS with a BCIE (see below) supported by the MS. The next step shall be entered immediately after TCH synchronization has been completed at the SS side.
- b) The interface circuit bit(s) in the GSM 04.21 frame shall be set to ON.
- c) The SS shall send pseudo random characters with start and stop bit(s) (as selected by the BCIE) in the GSM 04.21 frames to the MS for approximately 5 s. Then it shall send the following bit sequence in the GSM 04.21 frames:
 - 2M+3 bits of start polarity;
 - 2M bits of stop polarity.
- d) The SS shall send pseudo random characters with start and stop bit(s) (as selected by the BCIE) in the GSM 04.21 frames to the MS for approximately 2 s. Then it shall send the following bit sequence in the GSM 04.21 frames:
 - for 1 s bits of start polarity;
 - 2M bits of stop polarity,

where M is as defined in GSM 04.21, section 4.2, and then again pseudo random characters as above.

- e) The SS shall input pseudo random characters with start and stop bit(s) (as selected by the BCIE) over the R-interface to the MS for approximately 2 s. Then it shall input the following bit sequence to the R-interface:
- M bits of start polarity;
 - 2M bits of stop polarity.
- f) The SS shall input pseudo random characters with start and stop bit(s) (as selected by the BCIE) over the R-interface to the MS for approximately 2 s. Then it shall input the following bit sequence to the R-interface:
- for 1 s bits of start polarity;
 - 2M bits of stop polarity,

where M is as defined in GSM 04.21, section 4.2, and then again pseudo random characters as above.

- g) the test shall be stopped 2 s later.

29.2.6.2.5 Test requirements

- 1) During the test no GSM 04.21 frame with incorrect format (i.e. format not compliant to GSM 04.21 (see conformance requirement) or not corresponding to the user data rate currently under test) shall have been received by the SS.
- 2) The user data stream sent over the Um-interface by the SS shall match character by character the user data stream output at the R-interface.
- 3) The two Break Signals shall be detectable at the R-interface between the same characters as having been sent.
- 4) The user data stream received over the Um-interface by the SS shall match character by character the user data stream input at the R-interface.
- 5) The two Break Signals shall be detectable at the Um-interface between the same characters as having been input.

29.2.6.2.6 BCIE

Same as 29.2.2.6.

29.2.6.3 Overspeed/Underspeed Handling (Local Terminal)

29.2.6.3.1 Definition and applicability

This test is applicable to the MT2 configuration only.

29.2.6.3.2 Conformance requirement

An MS supporting asynchronous transparent bearer capabilities shall handle overspeed and underspeed of the local terminal according to:

- 1 GSM 04.21, sections 4.1, 4.3, 4.4, 5 and 7.

29.2.6.3.3 Test purpose

The purpose of these tests is to verify the ability of the MS to deal with plesiosynchronous bit clocks in the MS and the TE in case of asynchronous Bearer Capabilities.

29.2.6.3.4 Method of test

The Test shall be carried out for all possible user data rates supported by the MS in asynchronous mode (see below).

Procedure:

- a) A data call shall be set up between the SS and the MS with a BCIE (see below) supported by the MS. The next step shall be entered immediately after CT107 has been set to on by the MS.
- b) The interface circuit bit(s) in the GSM 04.21 frame shall be set to ON.
- c) The SS shall input continuously pseudo random characters with a bit clock of:
 - nominal user data rate + 2,5 % bit/s in case of less than 600 bit/s user data rate;
 - nominal user data rate + 1 % in the other cases.(ref. GSM 04.21, section 4.3) to the R-interface of the MS for approximately 5 s.
- d) The SS shall input continuously pseudo random characters with a bit clock of nominal user rate - 2,5 % (ref. CCITT V.14, section 3) to the R-interface of the MS for approximately 5 s.
- e) The test shall be stopped.

29.2.6.3.5 Test requirements

- 1) During the test no GSM 04.21 frame with incorrect format (i.e. format not compliant to GSM 04.21 (see conformance requirement) or not corresponding to the user data rate currently under test) shall have been received by the SS.
- 2) The user data stream input to the R-interface shall match character by character the user data stream sent to the SS over the Um-interface.

29.2.6.3.6 BCIE

Same as 29.2.2.6.

The Number of Data Bits per character (excl. parity) shall be 8. No parity bit shall be used. The Number of Stop Bits shall be 1. If the MS does not support these values different ones shall be chosen.

The remaining parameters of the BCIE and the channel type (FR/HR) shall be set to a value supported by the MS.

29.2.6.4 Overspeed/Underspeed Handling (Remote Terminal)

29.2.6.4.1 Definition and applicability

This test is applicable to the MT2 configuration only.

29.2.6.4.2 Conformance requirement

An MS supporting asynchronous transparent bearer capabilities shall handle overspeed and underspeed of the remote terminal (which shows in the structure of the GSM 04.21 frames received over the Um-interface) according to:

- 1 GSM 04.21, sections 4.1, 4.3, 4.4, 5 and 7.

29.2.6.4.3 Test purpose

The purpose of these tests is to verify the ability of the MS to deal with plesiosynchronous bit clocks in the MS and the remote Terminal in case of asynchronous Bearer Capabilities.

The case of underspeed is covered by 29.6.1. The case of overspeed shall be tested as follows.

29.2.6.4.4 Method of test

The Test shall be carried out for all possible user data rates supported by the MS in asynchronous mode (see below).

Procedure:

- a) A data call shall be set up between the SS and the MS with a BCIE (see below) supported by the MS. The next step shall be entered immediately after CT107 has been set to on by the MS.
- b) The interface circuit bit(s) in the GSM 04.21 frame shall be set to ON.
- c) The SS shall start sending pseudo random characters in the GSM 04.21 frames over the Um-interface with minimal number of stop bits between the characters and where one stop bit is omitted every 8th character.
- e) The test shall be stopped 5 s later.

29.2.6.4.5 Test requirements

- 1) During the test no GSM 04.21 frame with incorrect format (i.e. format not compliant to GSM 04.21 (see conformance requirement) or not corresponding to the user data rate currently under test) shall have been received by the SS.
- 2) The user data stream sent by the SS over the Um-interface shall match character by character the user data stream sent by the MS over the R-interface.

29.2.6.4.6 BCIE

Same as 29.2.6.3.6.

29.2.7 Interchange circuit mapping for transparent bearer capabilities

29.2.7.1 Definition and applicability

This test is applicable to the MT2 configuration only. However, it cannot be applied fully to MSs which support e.g.:

- CT108/2 for releasing the call (e.g. support of CCITT V.25bis) and/or
- similar use of the circuit C for CCITT X.21.

Therefore the test shall be applied only for those interchange circuits which do not influence Layer 3 signalling.

In case of circuit C the X.21-byte timing circuit B shall not be used.

29.2.7.2 Conformance requirement

- 1) An MS supporting transparent bearer capabilities with a V-series R-interface shall map the interchange circuits CT105 and CT108/2 to the GSM 04.21 frames sent over the Um-interface according to:
 - 1.1 GSM 04.21, sections 4.1, 4.4, 5 and 7.
 - 1.2 GSM 07.02, section 3.2.1.
- 2) An MS supporting transparent bearer capabilities with an X-series R-interface shall map the interchange circuit C to the GSM 04.21 frames sent over the Um-interface according to:
 - 2.1 GSM 04.21, sections 4.1, 4.4, 5 and 7.
 - 2.2 GSM 07.03, sections 4.2.1 and 4.2.2.

29.2.7.3 Test purpose

The purpose of these tests is to verify the ability of the MS to correctly convey changes of the interface circuits at the R-interface to the GSM 04.21 frame sent over the Um-interface in case of Transparent Bearer Capabilities.

29.2.7.4 Method of test

The Test shall be carried out for all user data rates supported by the MS (see below) and the circuits CT105 and CT108/2 (CCITT V.24) and C (CCITT X.21). The test shall be carried out only for those frame formats and circuits which are supported by the MS (exceptions see above).

Procedure:

- a) A data call shall be set up between the SS and the MS with a BCIE (see below) supported by the MS. The next step shall be entered immediately after CT107 has been set to ON by the MS.
- b) The interface circuit bit(s) in the GSM 04.21 frame shall be set to ON and the SS shall input continuously pseudo random data to the R-interface during the following steps. The SS shall wait for approximately 1 s before entering the next step.
- c) The SS shall set the interchange circuit at the R-interface to OFF and wait for 2 s.
- d) The SS shall again set the interchange circuit at the R-interface to ON.
- e) After further 2 s the test shall be stopped.

29.2.7.5 Test requirements

- 1) During the test no GSM 04.21 frame with incorrect format (i.e. format not compliant to GSM 04.21 (see conformance requirement) or not corresponding to the user data rate currently under test) shall have been received by the SS.
- 2) The change of the interchange circuit signal level shall be indicated in the GSM 04.21 frames as required by GSM 04.21 and CCITT V.110 (i.e. OFF state shall start and end in the correct GSM 04.21 frame).

29.2.7.6 BCIE

Same as 29.2.2.5.

29.3 Testing of non transparent data services (RLP tests)

SS sends NULL (C/R=0, P/F=0) frames when it has nothing else to send in ADM mode.

SS does not use DTX if not explicitly indicated in the test and sends supervisory RR (C/R=0, P/F=0) frames when it has nothing else to send in ABM mode. N(R) is equal to N(R) of the previous frame. For the first frame N(R)=0.

The information field of the Supervisory frames sent by the SS is fully coded with "1".

The tolerance on timers or delays is +/- 10%.

The SS will check FSI (Frame Start Identifier) alignment in all received RLP frames. The information field of the Supervisory frames sent by the MS is never verified.

The SABM-UA exchange for RLP link establishment is initiated by the MS.

Immediately upon RLP link connection, the MS may send an I+S frame containing updated status bits SA, SB and X and the SS must send it.

29.3.1 Initialization

29.3.1.1 Normal initialization done by the MS

29.3.1.1.1 Test purpose

To test the normal establishment of multiple frame operation between the SS and the MS.

This test is performed twice for testing MO and MT data calls:

29.3.1.1.2 Method of test

Initial Conditions

System Simulator:

The SS is configured to use default RLP parameters.

Mobile Station:

The MS is configured to use default RLP parameters.

MO data call:

The MS is made to establish a MO non transparent data call, so that the initial conditions are that the MS is in call state U10 ("Call Active") after having sent a CONNECT ACKNOWLEDGE message.

MT data call:

The SS establishes a MT non transparent data call, so that the initial conditions are that the MS is in call state U10 ("Call Active") after having received a CONNECT ACKNOWLEDGE message from the SS.

Case a: No negotiation will be initiated by the MS.

Case b: The MS initiates negotiation of RLP default parameters.

NOTE: The MS is allowed to initiate the negotiation of the RLP default parameters, within allowed ranges, defined in GSM 04.22. The MS shall do this in the ADM, after having sent a CONNECT ACKNOWLEDGE message (MO-case) or after having received a CONNECT ACKNOWLEDGE message from the SS (MT-case). The SS shall accept and use the new RLP parameters till the end of the test.

Procedure

The MS shall send a SABM frame.

The SS responds with a correct UA frame (within T1).

The SS waits for 2*T1 after the UA to ensure the SABM frame is not repeated. This confirms that the UA has been received.

The MS shall be in ABM mode. After optional status bits exchange between the MS and the SS, this is verified by sending an I + S frame and waiting for the acknowledgement from the MS.

The MS is returned to the idle state by clearing the call.

Expected sequence

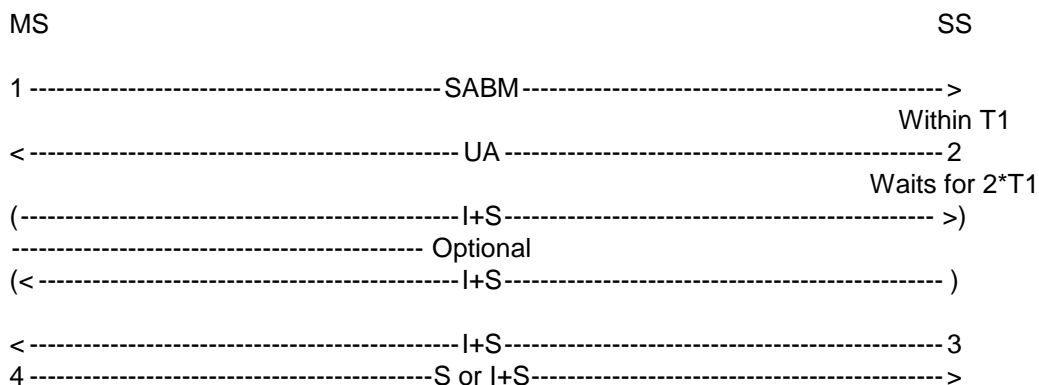

The frames from the SS will be:

2: One UA frame containing:

R=0, F=1.

3: One correct I+S frame in a RR frame with N(S)=0.

29.3.1.1.3 Test requirements

The frames from the MS shall be:

1: One SABM frame containing:

C=1, P=1.

The SABM shall not be repeated.

4: One S or I+S frame with N(R)=1 acknowledging the I+S frame.

29.3.1.2 Initialization failure

29.3.1.2.1 Loss of UA frame

29.3.1.2.1.1 Test purpose

To test the MS response to the loss of an UA frame during initialization.

29.3.1.2.1.2 Method of test

Initial Conditions

System Simulator:

The SS is configured to use default RLP parameters.

Mobile Station:

The MS is configured to use default RLP parameters. The MS is made to establish a MO non transparent data call so that the initial conditions are that the MS is in call state U10 ("Call Active") after having sent a CONNECT ACKNOWLEDGE message.

Case a: No negotiation will be initiated by the MS.

Case b: The MS initiates negotiation of RLP default parameters.

NOTE: The MS is allowed to initiate the negotiation of the RLP default parameters, within allowed ranges, defined in GSM 04.22. The MS shall do this in the ADM, after having sent a CONNECT ACKNOWLEDGE message (MO-case) or after having received a CONNECT ACKNOWLEDGE message from the SS (MT-case). The SS shall accept and use the new RLP parameters till the end of the test.

Procedure

The MS shall send an SABM frame.

The SS ignores the first SABM frame from the MS.

The MS shall wait for time-out of timer T1 and then send a second SABM frame.

The SS responds to the second SABM frame with an UA frame (within T1).

The MS enters in ABM mode. After optional status bits exchange between the MS and the SS, this is verified by sending an I+S frame and waiting for the acknowledgement from the MS.

The MS is returned to the idle state by clearing the call.

Expected sequence

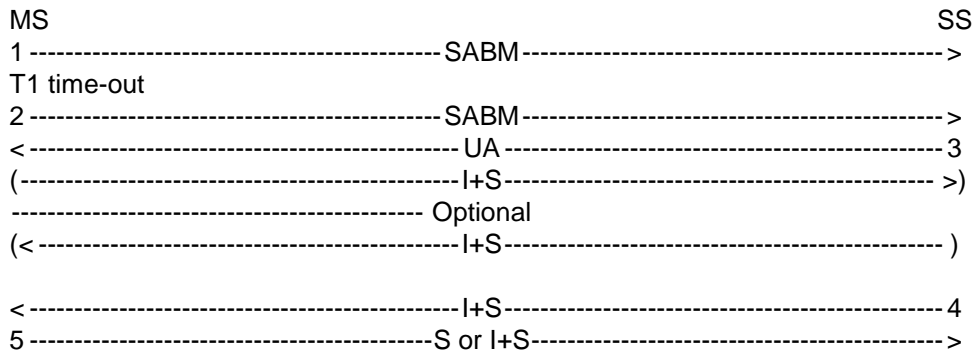

The frames from the SS will be:

3: One UA frame containing:

R=0, F=1.

within T1 after the second SABM.

4: One correct I+S frame in a RR frame with N(S)=0.

29.3.1.2.1.3 Test requirements

The frames from the MS shall be:

1, 2: One SABM frame containing:

C=1, P=1.

The second SABM frame shall follow the first SABM frame after time-out of timer T1.

5: One S or I+S frame with N(R)=1 acknowledging the I+S frame.

29.3.1.2.2 Total loss of UA frame

29.3.1.2.2.1 Test purpose

To test the MS response to a total loss of UA frame during initialization.

29.3.1.2.2.2 Method of test

Initial Conditions

System Simulator:

The SS is configured to use default RLP parameters.

Mobile Station:

The MS is configured to use default RLP parameters.

The MS is made to establish a MO non transparent data call so that the initial conditions are that the MS is in call state U10 ("Call Active") after having sent a CONNECT ACKNOWLEDGE message.

Case a: No negotiation will be initiated by the MS.

Case b: The MS initiates negotiation of RLP default parameters.

NOTE: The MS is allowed to initiate the negotiation of the RLP default parameters, within allowed ranges, defined in GSM 04.22. The MS shall do this in the ADM, after having sent a CONNECT ACKNOWLEDGE message (MO-case) or after having received a CONNECT ACKNOWLEDGE message from the SS (MT-case). The SS shall accept and use the new RLP parameters till the end of the test.

Procedure

The MS shall send an SABM frame.

The SS ignores the SABM frame from the MS.

The MS shall wait for time-out of timer T1 and then send a new SABM frame.

The SS ignores the SABM frame sent by the MS. These 2 last steps are repeated N2 times.

The SS waits for 2 * T1 to ensure the SABM frame is not repeated.

The MS shall not enter in ABM mode. This is verified by sending an I+S frame. The MS shall ignore this frame.

The MS is returned to the idle state by clearing the call.

Expected sequence:

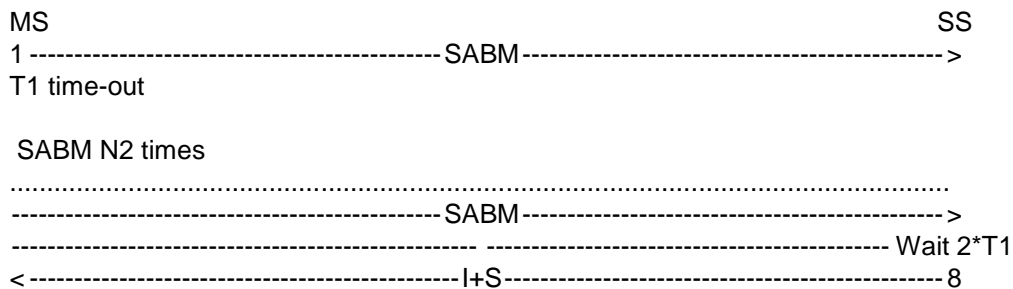

The frames from the SS will be:

8: One correct I+S frame in a RR frame containing with N(S)=0.

29.3.1.2.2.3 Test requirements:

The frames from the MS shall be:

1, N2: One SABM frame containing:

C=1, P=1.

An SABM frame follows the previous one after time-out of timer T1.

29.3.2 Data transfer

29.3.2.1 Default conditions

The initial conditions are that the MS is in call state U10 ("Call Active") and in RLP ABM mode.

During the synchronization of the traffic channel, the MS and the SS have transmitted I+S frames. Unless, other indication in the test, each test of this section will begin in the following conditions:

- the MS has previously sent I+S frames numbered N(S)=0,...,NMS-1 mod(62) and has previously sent a frame containing N(R) = NSS mod (62);
- the SS has previously sent I+S frames numbered N(S)=0,...,NSS-1 mod(62) and has previously sent a frame containing N(R) = NMS mod (62).

The first I+S frame that an MS will send in a test will be numbered $N(S) = NMS$ and the first I+S frame that the SS will send will be numbered NSS .

29.3.2.2 MS sends I+S frames

29.3.2.2.1 N(S) sequence number

29.3.2.2.1.1 Test purpose

To test the correct handling of the N(S) sequence number.

29.3.2.2.1.2 Method of test

Initial Conditions

System Simulator:

The SS is configured to use default RLP parameters.

Mobile Station:

The MS is configured to use RLP default parameters except the window size from MS to IWF (SS), called KMI.

A non transparent data call will be established, so that the MS is in call state U10 ("Call Active").

Since some RLP parameters are different from the default parameters, a negotiation procedure will be initiated by the MS after the CONNECKT ACKNOWLEDGE message. The MS may negotiate the RLP default parameters within allowed ranges, defined in GSM 04.22, except the window size from MS to IWF (SS), called KMI, which has to be a non default value.

The SS shall accept and use the new RLP parameters till the end of the test.

After the negotiation procedure the ABM will be entered. This test is performed twice with 2 different values of KMI, randomly chosen.

Procedure

After optional status bits exchange between the MS and the SS, the MS is made to send continuously I+S frames (more than $2 \cdot 64$ frames). The MS shall send I+S frames with N(S) incremented by $1 \bmod(62)$ in each frame.

The SS acknowledges the I+S frames in RR frame in sequence.

The MS is returned to the idle state by clearing the call.

Expected sequence

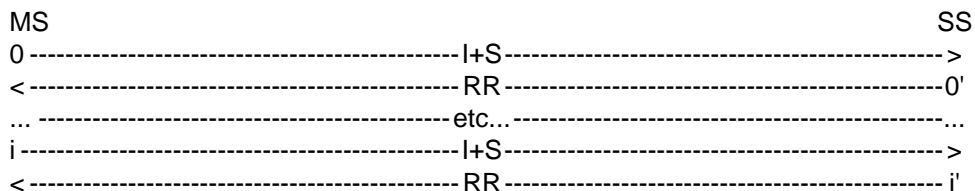

The frames from the SS will be:

0',...,i': One supervisory RR frame containing:

$$N(R) = NMS+1, \dots, NMS+i+1 \bmod(62).$$

29.3.2.2.1.3 Test requirements

The frames from the MS shall be:

0,...,i: One I+S frame containing:

$$N(S) = NMS, \dots, NMS+i \text{ mod}(62)$$

29.3.2.2.2 Transmission window

29.3.2.2.2.1 Test purpose

To test the correct handling of the transmission window.

29.3.2.2.2.2 Method of test

Initial Conditions

System Simulator:

The SS is configured to use default RLP parameters.

Mobile Station:

The MS is configured to use RLP default parameters except the window size from MS to IWF (SS), called KMI.

A non transparent data call will be established, so that the MS is in call state U10 ("Call Active").

Since some RLP parameters are different from the default parameters, a negotiation procedure will be initiated by the MS after the CONNECKT ACKNOWLEDGE message. The MS may negotiate the RLP default parameters within allowed ranges, defined in GSM 04.22, except the window size from MS to IWF (SS), called KMI, which has to be a non default value.

The SS shall accept and use the new RLP parameters till the end of the test.

After the negotiation procedure the ABM will be entered.

This test is performed twice with 2 different values of KMI, randomly chosen.

Procedure

The MS is made to send continuously I+S frames with a delay inferior to T1 between each frame.

The SS does not acknowledge the first KMI frames.

The MS stops sending I+S frames after having sent KMI frames, due to the window size.

The SS waits for $0,5 * T1$ after the last frame of the sequence ($N(S) = NMS + KMI - 1$) to acknowledge the first j frames, with $j < KMI$.

The MS shall transmit j new I+S frames and stop sending I+S frames after having sent them, due to the window size.

The SS waits for $0,5 * T1$ after the last frame of the sequence ($N(S) = NMS + KMI - 1 + j \text{ mod } (62)$) to acknowledge all frames transmitted by the MS.

The MS shall transmit all the following I+S frames.

The SS acknowledges the I+S frames sequentially (i.e. 1 after 1).

The MS is returned to the idle state by clearing the call.

Expected sequence

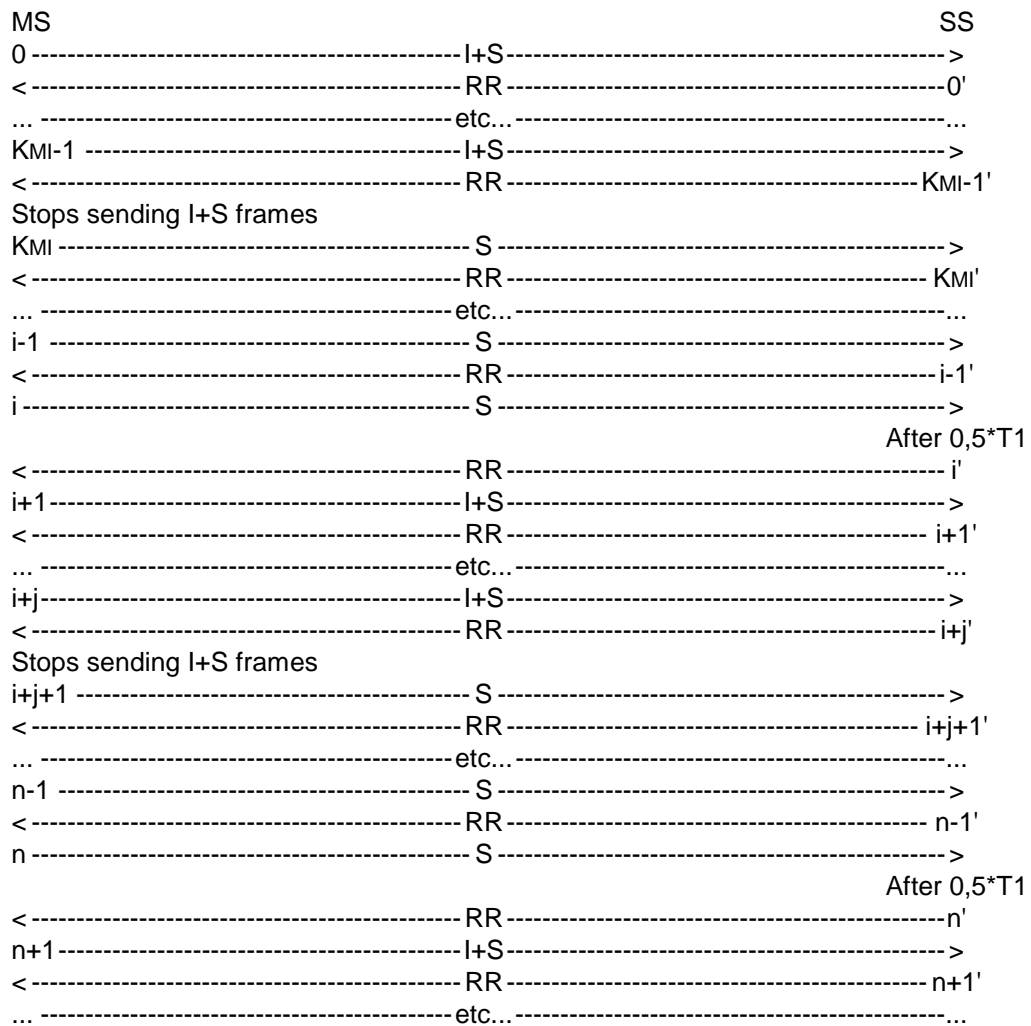

The frames from the SS will be:

0',...,i-1': One RR frame containing:

$$N(R) = NMS \text{ mod}(62).$$

i': One RR frame containing:

$$N(R) = NMS + j \text{ mod}(62) \text{ with } j < KMI,$$

after a delay of $0,5 * T1$ after the last received I+S frame.

i+1',...,n-1': One RR frame containing:

$$N(R) = NMS + j \text{ mod}(62).$$

n': One RR frame containing:

$$N(R) = NMS + KMI + j \text{ mod}(62),$$

after a delay of $0,5 * T1$ after the last received I+S frame.

n+1', n+2',...: One RR frame containing:

$$N(R) = NMS + KMI + j + 1, NMS + KMI + j + 2, \dots \text{ mod}(62).$$

29.3.2.2.2.3 Test requirements

The frames from the MS shall be:

0,...,KMI-1: One I+S frame containing:

$$N(S) = NMS, \dots, NMS + KMI - 1 \text{ mod}(62).$$

MS stops sending I+S frames until reception of an acknowledgement of at least one I+S frame.

KMI,...,i: One S frame.

i+1,...,i+j: One I+S frame containing:

$$N(S) = NMS + KMI, \dots, NMS + KMI + j - 1 \text{ mod}(62).$$

MS stops sending I+S frames until reception of an acknowledgement of at least one I+S frame.

i+j+1,...,n: One S frame.

n+1,n+2,...: One I+S frame containing:

$$N(S) = NMS + KMI + j, NMS + KMI + j + 1, \dots \text{ mod}(62).$$

29.3.2.2.3 Busy condition

29.3.2.2.3.1 Test purpose

To test the correct handling of a RNR frame received.

29.3.2.2.3.2 Method of test

Initial Conditions

System Simulator:

The SS is configured to use default RLP parameters.

Mobile Station:

The MS is configured to use default RLP parameters.

A non transparent data call will be established, so that the MS is in call state U10 ("Call Active").

Case a: No negotiation will be initiated by the MS.

Case b: The MS initiates negotiation of RLP default parameters.

NOTE: The MS is allowed to initiate the negotiation of the RLP default parameters, within allowed ranges, defined in GSM 04.22. The MS shall do this in the ADM, after having sent a CONNECT ACKNOWLEDGE message (MO-case) or after having received a CONNECT ACKNOWLEDGE message from the SS (MT-case). The SS shall accept and use the new RLP parameters till the end of the test.

The ABM will be entered.

Procedure

The MS is made to send continuously I+S frames.

The SS acknowledges the received I+S frames in supervisory RR frames. After 1 second it acknowledged the received I+S frames in supervisory RNR frames.

After the first RNR frame, the MS shall stop sending I+S frames and shall start sending supervisory frames within T2.

After 1 second receiving supervisory frames, the SS sends RR frames instead of RNR.

After the first RR frame, the MS will restart the transmission of I+S frames within T2.

The MS is returned to the idle state by clearing the call.

Expected sequence

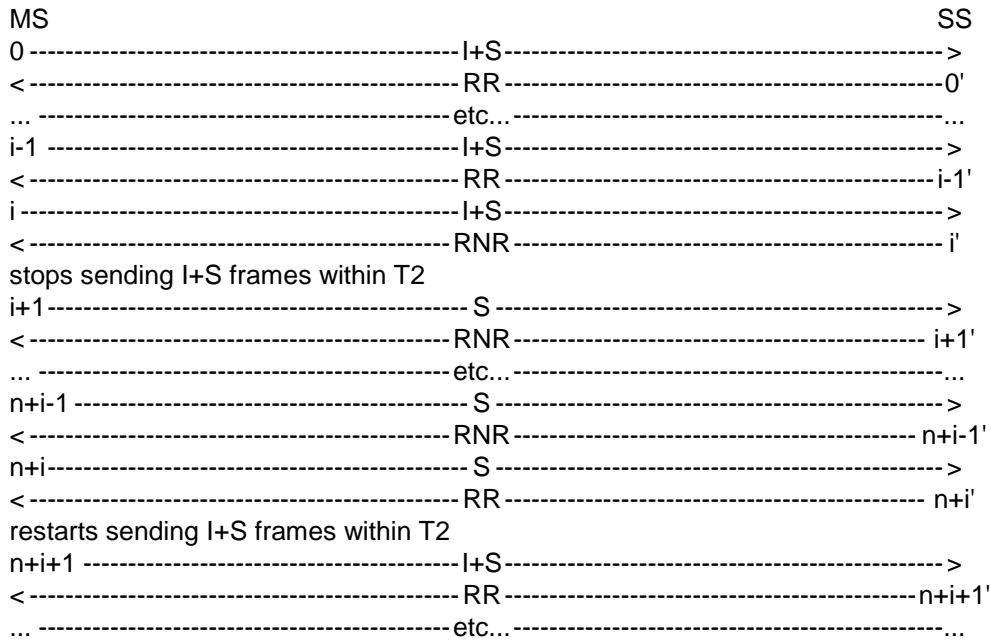

The frames from the SS will be:

0',...,i-1': One RR frame containing:

$$N(R)=NMS+1,\dots,NMS+i \text{ mod}(62).$$

i',...,n+i-1': One RNR frame containing:

$$N(R)=NMS+i+1 \text{ mod}(62).$$

n+i': One RR frame containing:

$$N(R)=NMS+i+1 \text{ mod}(62).$$

n+i+1',n+i+2',...: One RR frame containing:

$$N(R)=NMS+i+2,NMS+i+3,\dots \text{ mod}(62).$$

29.3.2.2.3.3 Test requirements

The frames from the MS shall be:

0',...,i: One I+S frame containing:

$$N(S)=NMS,\dots,NMS+i \text{ mod}(62).$$

MS stops sending I+S frames within T2 after the reception of the first RNR frame from the SS.

i+1',...,n+i: One S frame.

MS restarts sending I+S frames within T2 after the reception of the first RR frame from the SS.

n+i+1,n+i+2',...: One I+S frame containing:

$$N(S)=NMS+i+1,NMS+i+2,\dots \text{ mod}(62).$$

29.3.2.3 SS sends I+S frames

29.3.2.3.1 N(R) sequence number

29.3.2.3.1.1 Test purpose

To test the correct handling of the N(R) sequence number.

29.3.2.3.1.2 Method of test

Initial Conditions

System Simulator:

The SS is configured to use default RLP parameters.

Mobile Station:

The MS is configured to use RLP default parameters except the window size from IWF (SS) to MS, called KIM.

A non transparent data call will be established, so that the MS is in call state U10 ("Call Active").

Since some RLP parameters are different from the default parameters, a negotiation procedure will be initiated by the MS after the CONNECKT ACKNOWLEDGE message. The MS may negotiate the RLP default parameters within allowed ranges, defined in GSM 04.22, except the window size from IWF (SS) to MS, called KIM, which has to be a non default value.

The SS shall accept and use the new RLP parameters till the end of the test.

After the negotiation procedure the ABM will be entered. This test is performed twice with 2 different values of KIM, randomly chosen.

Procedure

The SS is made to send continuously I+S frames (more than 2*64 frames). The delay between two I+S frames shall be superior to T2 and inferior to T1.

The MS is made to send no data i.e. no I+S frame.

NOTE 8: The MS may have previously sent I+S frames.

The SS sends I+S frames in I+S RR frames.

The MS shall acknowledge the I+S frames in RR frame sequentially within T2.

The MS is returned to the idle state by clearing the call.

Expected sequence

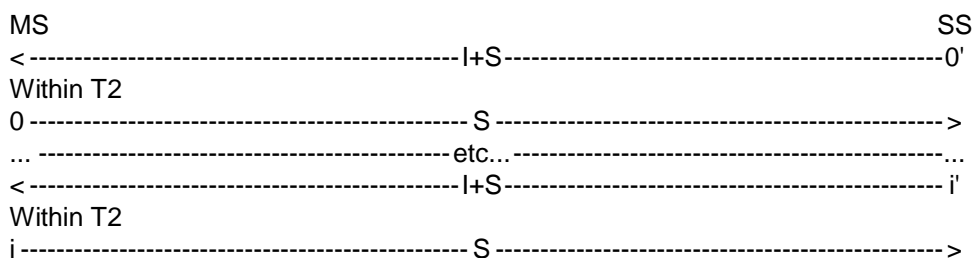

The frames from the SS will be:

0,...,i': One I+S frame containing

$$N(S)=Nss,...,Nss+i \text{ mod}(62).$$

29.3.2.3.1.3 Test requirements

The frames from the MS shall be:

0,...,i: One S frame containing:

$$N(R)=N_{SS}+1,\dots,N_{SS}+i+1 \text{ mod } (62).$$

The MS shall acknowledge the I+S frames sent by the SS within T2.

NOTE 9: If T2 parameter is equal to default T2 (<80 ms), the SS has to checked that the MS acknowledges an I+S frame within 80 ms.

29.3.2.3.2 Busy condition

29.3.2.3.2.1 Test purpose

To test the correct handling of a RNR frame with information received.

29.3.2.3.2.2 Method of test

Initial Conditions

System Simulator:

The SS is configured to use default RLP parameters.

Mobile Station:

The MS is configured to use default RLP parameters.

A non transparent data call will be established, so that the MS is in call state U10 ("Call Active").

Case a: No negotiation will be initiated by the MS.

Case b: The MS initiates negotiation of RLP default parameters.

NOTE: The MS is allowed to initiate the negotiation of the RLP default parameters, within allowed ranges, defined in GSM 04.22. The MS shall do this in the ADM, after having sent a CONNECT ACKNOWLEDGE message (MO-case) or after having received a CONNECT ACKNOWLEDGE message from the SS (MT-case). The SS shall accept and use the new RLP parameters till the end of the test.

The ABM will be entered.

Procedure

The SS is made to send continuously I+S frames. The delay between two consecutive I+S frames shall be inferior to T1.

The MS is made to send continuously I+S frames with a delay inferior to T1 between each frame.

The SS acknowledges the received I+S frames in I+S RR frames. After 1 second, it acknowledged the received I+S frames in supervisory RNR frames. The MS shall acknowledge the I+S frames in I+S RR frame sequentially.

After the first RNR frame, the MS shall stop sending I+S frames and shall acknowledge the I+S received frame in supervisory frames within T2.

After 1 second receiving supervisory frames, the SS sends I+S RR frames instead of RNR.

After the first RR frame, the MS will restart the transmission of I+S frames, it shall acknowledge the I+S received frame in I+S frame within T2.

The MS is returned to the idle state by clearing the call.

Expected sequence

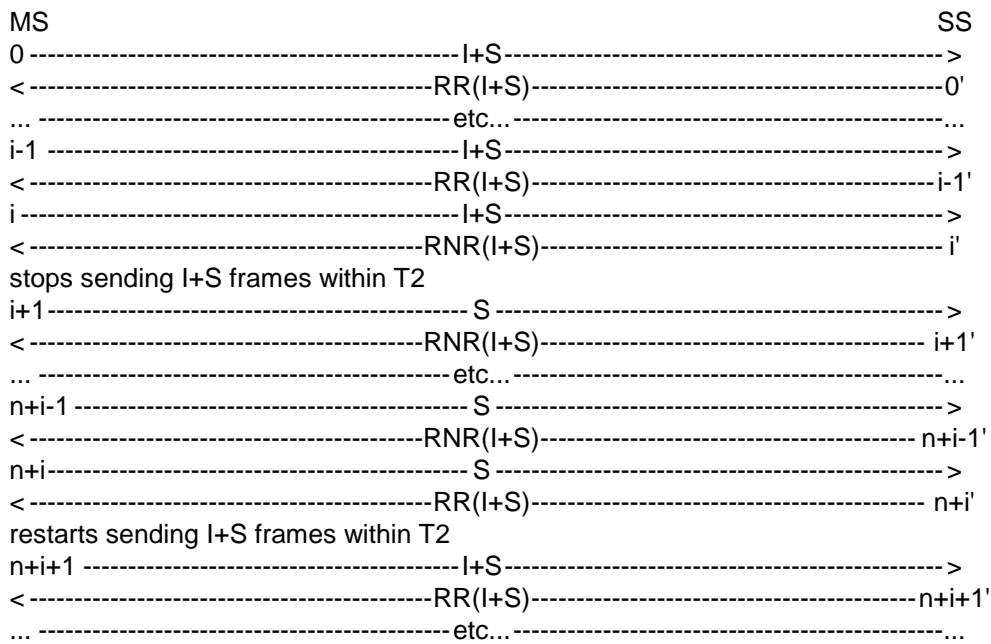

The frames from the SS will be:

0',...,i-1': One I+S RR frame containing:

$$N(S)=N_{SS}, \dots, N_{SS+i-1} \text{ mod}(62),$$

$$N(R)=N_{MS+1}, \dots, N_{MS+i} \text{ mod}(62).$$

i',...,n+i-1': One I+S RNR frame containing:

$$N(S)=N_{SS+i}, \dots, N_{SS+n+i-1} \text{ mod}(62),$$

$$N(R)=N_{MS+i+1} \text{ mod}(62).$$

n+i',n+i+1',...: One I+S RR frame containing:

$$N(S)=N_{SS+n+i}, N_{SS+n+i+1}, \dots \text{ mod}(62),$$

$$N(R)=N_{MS+i+1}, N_{MS+i+2}, \dots \text{ mod}(62).$$

29.3.2.3.2.3 Test requirements

The frames from the MS shall be:

0',...,i: One I+S frame containing:

$$N(S)=N_{MS}, \dots, N_{MS+i} \text{ mod}(62),$$

$$N(R)=N_{SS}, \dots, N_{SS+i} \text{ mod}(62).$$

MS stops sending I+S frames within T2 after the reception of the first RNR frame from the SS.

i+1',...,n+i: One S frame containing:

$$N(R)=N_{SS+i+1}, \dots, N_{SS+n+i} \text{ mod}(62).$$

MS restarts sending I+S frames within T2 after the reception of the first RR frame from the SS.

n+i+1',n+i+2',...: One I+S frame containing:

$$N(S)=N_{MS+i+1}, N_{MS+i+2}, \dots \text{ mod}(62),$$

$$N(R)=N_{SS+n+i+1}, N_{SS+n+i+1} \dots \text{ mod}(62).$$

29.3.2.4 SS rejects I+S frames

29.3.2.4.1 REJ frame

29.3.2.4.1.1 Test purpose

To test the correct handling of a REJ frame received.

29.3.2.4.1.2 Method of test

Initial Conditions

The window size from MS to IWF (SS) is called KMI.

System Simulator:

The SS is configured to use default RLP parameters.

Mobile Station:

The MS is configured to use default RLP parameters.

A non transparent data call will be established, so that the MS is in call state U10 ("Call Active").

Case a: No negotiation will be initiated by the MS.

Case b: The MS initiates negotiation of RLP default parameters.

NOTE: The MS is allowed to initiate the negotiation of the RLP default parameters, within allowed ranges, defined in GSM 04.22. The MS shall do this in the ADM, after having sent a CONNECT ACKNOWLEDGE message (MO-case) or after having received a CONNECT ACKNOWLEDGE message from the SS (MT-case). The SS shall accept and use the new RLP parameters till the end of the test.

The ABM will be entered.

Procedure

The MS is made to send continuously I+S frames with a delay inferior to T1 between each frame.

The SS acknowledges the i first I+S frames in supervisory RR frames.

The SS does not acknowledge the following I+S frames.

The SS rejects the 2 last I+S frames with a REJ and then send UI frames.

The MS shall retransmit the rejected I+S frames and the continue to send I+S frames.

The MS shall stop sending I+S frame when the transmission window is full.

The SS acknowledges all the received I+S frames with a RR frame after a delay of $0,5 * T1$ after the last received I+S frame.

The MS restarts sending I+S frame.

The SS acknowledges the received I+S frames.

The MS is returned to the idle state by clearing of the call.

Expected sequence

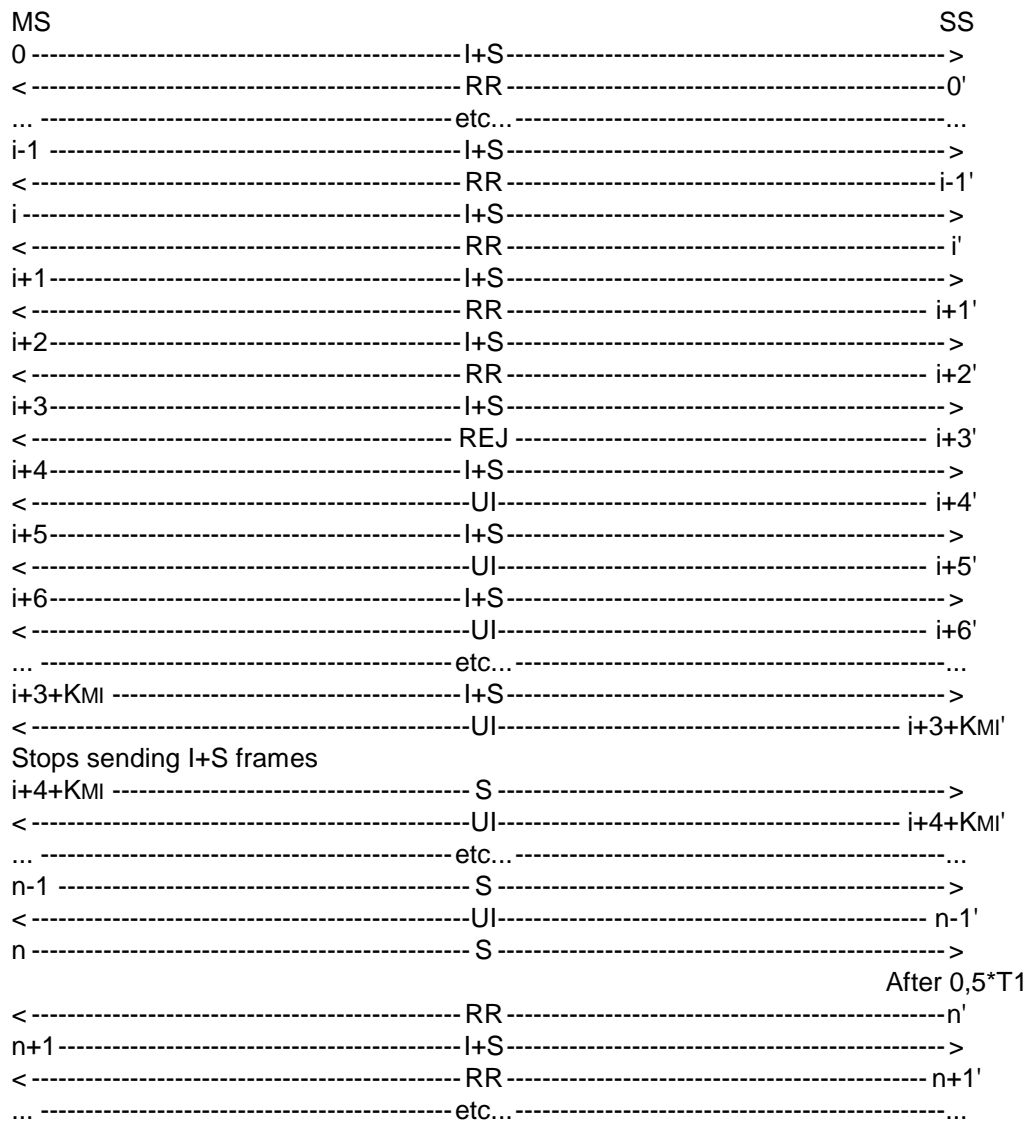

The frames from the SS will be:

0',...,i-1': One RR frame containing:

$$N(R)=NMS+1,\dots,NMS+i \text{ mod}(62).$$

i',...,i+2': One RR frame containing:

$$N(R)=NMS+i \text{ mod}(62).$$

i+3': One REJ frame containing:

$$N(R)=NMS+i+2 \text{ mod}(62).$$

i+4',...,n-1': One UI frame.

n': One RR frame containing:

$$N(R)=NMS+i+2+KMI \text{ mod}(62),$$

after a delay of 0,5*T1 after the last received I+S frame.

n+1',...: One RR frame containing

$$N(R)=NMS+i+3+KMI,\dots \text{ mod}(62).$$

29.3.2.4.1.3 Test requirements

The frames from the MS shall be:

0,...,i+3: One I+S frame containing

$$N(S)=NMS,\dots,NMS+i+3 \bmod(62).$$

i+4,i+5: One I+S frame containing

$$N(S)=NMS+i+2,NMS+i+3 \bmod(62).$$

i+6,...,i+3+KMI: One I+S frame containing:

$$N(S)=NMS+i+4,\dots,NMS+i+KMI+1 \bmod(62).$$

i+4+KMI,...,n: One S frame.

MS stops sending I+S frames until reception of an acknowledging of at least 1 I+S frame of the window (received N(R) from NMS+i+3 to NMS+i+2+KMI mod(62)).

n+1,...: One I+S frame containing:

$$N(S)=NMS+i+KMI,\dots \bmod(62).$$

29.3.2.4.2 SREJ frame

29.3.2.4.2.1 Test purpose

To test the correct handling of a SREJ frame received.

29.3.2.4.2.2 Method of test

Initial Conditions

The window size from MS to IWF (SS) is called KMI.

System Simulator:

The SS is configured to use default RLP parameters.

Mobile Station:

The MS is configured to use default RLP parameters.

A non transparent data call will be established, so that the MS is in call state U10 ("Call Active").

Case a: No negotiation will be initiated by the MS.

Case b: The MS initiates negotiation of RLP default parameters.

NOTE: The MS is allowed to initiate the negotiation of the RLP default parameters, within allowed ranges, defined in GSM 04.22. The MS shall do this in the ADM, after having sent a CONNECT ACKNOWLEDGE message (MO-case) or after having received a CONNECT ACKNOWLEDGE message from the SS (MT-case). The SS shall accept and use the new RLP parameters till the end of the test.

The ABM will be entered.

Procedure

The MS is made to send continuously I+S frames with a delay inferior to $T1$ between each frame.

The SS acknowledges the i first I+S frames in supervisory RR frames.

The SS does not acknowledge the following I+S frames.

The SS rejects one I+S frame with a SREJ and then send UI frames.

The MS shall retransmit the rejected I+S frame and the continue to send I+S frames.

The MS shall stop sending I+S frame when the transmission window is full.

The SS acknowledges all the received I+S frames with a RR frame after a delay of $0,5 * T1$ after the last received I+S frame.

The MS restarts sending I+S frame.

The SS acknowledges the received I+S frames.

The MS is returned to the idle state by clearing of the call.

Expected sequence

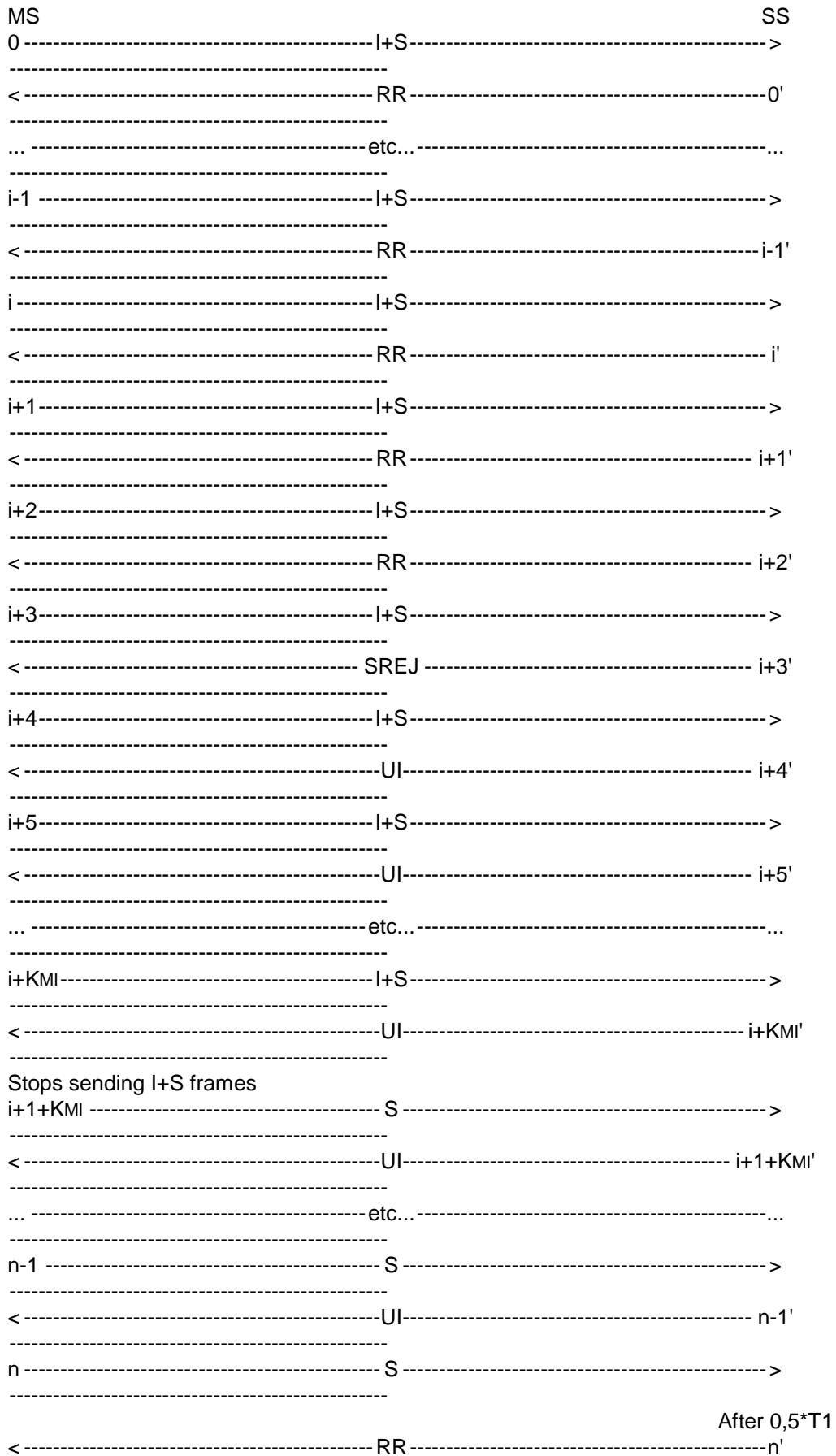

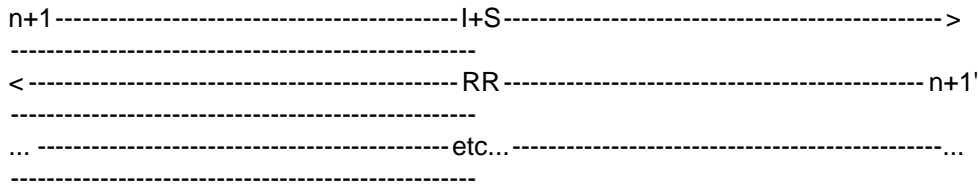

The frames from the SS will be:

0',...,i-1': One RR frame containing:

$$N(R)=NMS+1,\dots,NMS+i \bmod(62).$$

i',...,i+2': One RR frame containing:

$$N(R)=NMS+i \bmod(62).$$

i+3': One SREJ frame containing:

$$N(R)=NMS+i+2 \bmod(62).$$

i+4',...,n-1': One UI frame.

n': One RR frame containing:

$$N(R)=NMS+i+KMI \bmod(62),$$

after a delay of $0,5 \cdot T1$ after the last received I+S frame.

n+1',...: One RR frame containing:

$$N(R)=NMS+i+1+KMI \bmod(62).$$

29.3.2.4.2.3 Test requirements

The frames from the MS shall be:

0',...,i+3: One I+S frame containing:

$$N(S)=NMS,\dots,NMS+i+3 \bmod(62).$$

i+4: One I+S frame containing:

$$N(S)=NMS+i+2 \bmod(62).$$

i+5',...,i+KMI: One I+S frame containing:

$$N(S)=NMS+i+4,\dots,NMS+i+KMI-1 \bmod(62).$$

i+1+KMI',...,n: One S frame.

MS stops sending I+S frames until reception of an acknowledging of at least 1 I+S frame of the window (received $N(R)$ from $NMS+i+1$ to $NMS+i+KMI \bmod(62)$).

n+1',...: One I+S frame containing:

$$N(S)=NMS+i+KMI,\dots \bmod(62).$$

29.3.2.4.3 I+S reject frame

29.3.2.4.3.1 Test purpose

To test the correct handling of a I+S reject frame received.

29.3.2.4.3.2 Method of test

Initial Conditions

The window size from MS to IWF (SS) is called KMI.

System Simulator:

The SS is configured to use default RLP parameters.

Mobile Station:

The MS is configured to use default RLP parameters.

A non transparent data call will be established, so that the MS is in call state U10 ("Call Active").

Case a: No negotiation will be initiated by the MS.

Case b: The MS initiates negotiation of RLP default parameters.

NOTE: The MS is allowed to initiate the negotiation of the RLP default parameters, within allowed ranges, defined in GSM 04.22. The MS shall do this in the ADM, after having sent a CONNECT ACKNOWLEDGE message (MO-case) or after having received a CONNECT ACKNOWLEDGE message from the SS (MT-case). The SS shall accept and use the new RLP parameters till the end of the test.

The ABM will be entered.

Procedure

The MS is made to send continuously I+S frames with a delay inferior to T1 between each frame.

The SS acknowledges the i first I+S frames in supervisory RR frames.

The SS does not acknowledge the following I+S frames.

The SS rejects the 2 last I+S frames with a REJ.

The MS shall retransmit the 2 rejected I+S frames.

The SS acknowledges these 2 frames.

The MS shall continue sending I+S frames.

The SS does not acknowledge these frames.

The SS rejects one I+S frame with a SREJ.

The MS shall retransmit the rejected I+S frame and continue sending I+S frames.

The SS acknowledges the received I+S frames.

The MS is returned to the idle state by clearing of the call.

Expected sequence

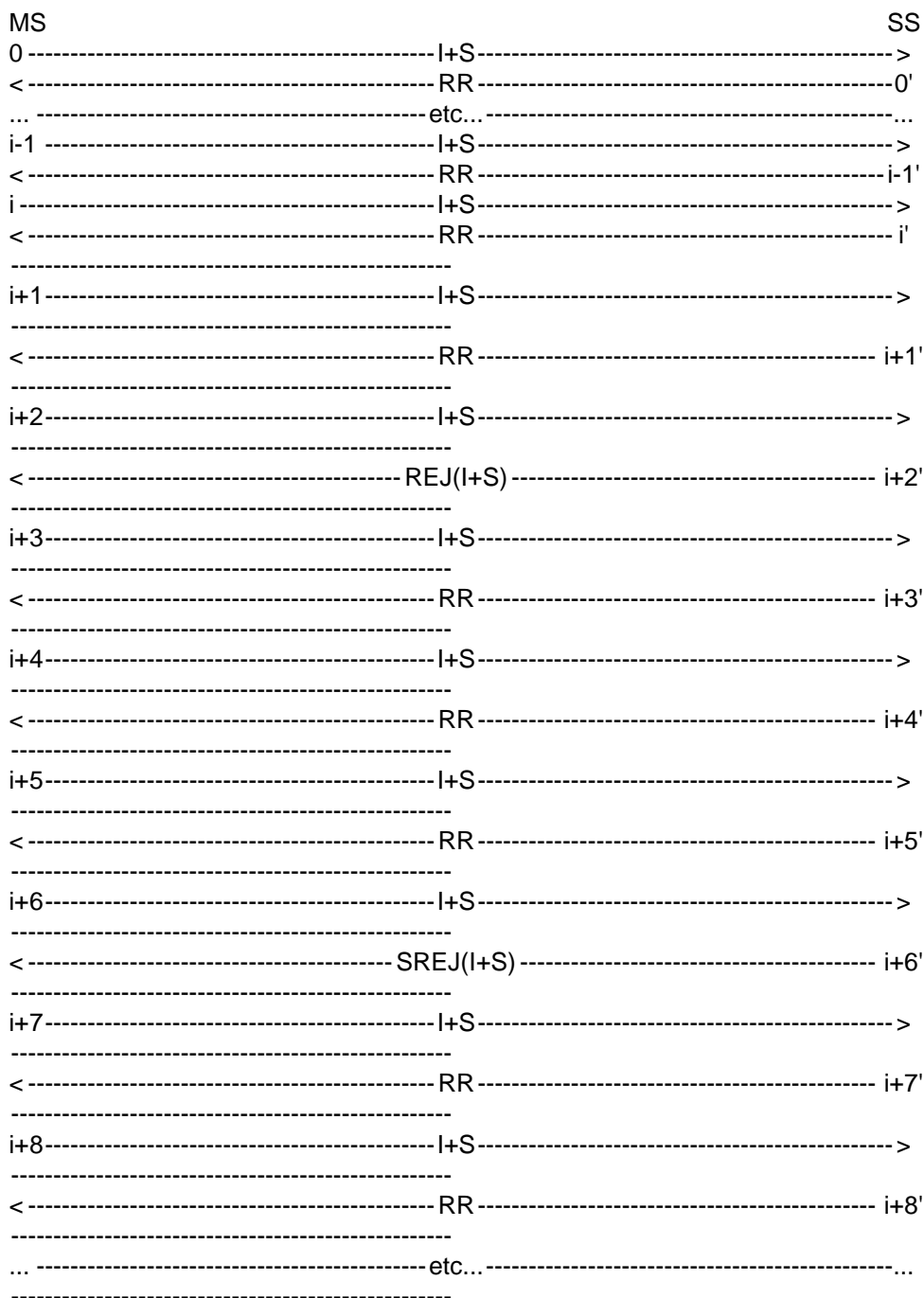

The frames from the SS will be:

0',...,i-1': One RR frame containing:

$$N(R)=NMS+1, \dots, NMS+i \text{ mod}(62).$$

i',i+1': One RR frame containing:

$$N(R)=NMS+i \text{ mod}(62).$$

i+2': One I+S REJ frame containing:

$$N(R)=NMS+i+1 \text{ mod}(62),$$

$$N(S)=Nss \text{ mod}(62).$$

$i+3',i+4'$: One RR frame containing:

$$N(R)=NMS+i+2, NMS+i+3 \text{ mod}(62).$$

$i+5'$: One RR frame containing:

$$N(R)=NMS+i+3 \text{ mod}(62).$$

$i+6'$: One I+S REJ frame containing:

$$N(R)=NMS+i+3 \text{ mod}(62),$$

$$N(S)=NMS+1 \text{ mod}(62).$$

$i+7'$: One RR frame containing:

$$N(R)=NMS+i+3 \text{ mod}(62).$$

$i+8'$: One RR frame containing:

$$N(R)=NMS+i+6, \dots \text{ mod}(62).$$

29.3.2.4.3.3 Test requirements

The frames from the MS shall be:

$0, \dots, i+2$: One I+S frame containing:

$$N(S)=NMS, \dots, NMS+i+2 \text{ mod}(62).$$

$i+3, i+4$: One I+S frame containing:

$$N(S)=NMS+i+1, NMS+i+2 \text{ mod}(62).$$

$i+5, i+6$: One I+S frame containing:

$$N(S)=NMS+i+3, NMS+i+4 \text{ mod}(62).$$

$i+7$: One I+S frame containing:

$$N(S)=NMS+i+3 \text{ mod}(62).$$

$i+8, \dots$: One I+S frame containing:

$$N(S)=NMS+i+5, \dots \text{ mod}(62).$$

The MS shall acknowledge the I+S frames sent by the SS within T2.

29.3.2.5 MS rejects I+S frames

29.3.2.5.1 Rejection with REJ or SREJ supervisory frames

29.3.2.5.1.1 Conformance requirements

The MS shall be able to detect that an I+S frame is out of sequence, and to indicate to the network that some information needs to be retransmitted. This shall be done by using either a REJ or a SREJ RLP frame. The MS has the freedom to choose either one of these frames, but it shall correctly indicate which frames need to be retransmitted.

References

GSM 04.22 sections 5.2.3.4, 5.2.3.6 and 5.3.2.

29.3.2.5.1.2 Test purpose

To test that the MS is able to send correct REJ or SREJ supervisory frames to ask for the transmission of a sequence when an out of sequence information frame has been received.

29.3.2.5.1.3 Test method

Initial Conditions

The window size from IWF (SS) to MS is called K_{IM} .

System Simulator:

The SS is configured to use default RLP parameters.

Mobile Station:

The MS is configured to use default RLP parameters.

A non transparent data call will be established, so that the MS is in call state U10 ("Call Active").

Case a: No negotiation will be initiated by the MS.

Case b: The MS initiates negotiation of RLP default parameters.

NOTE: The MS is allowed to initiate the negotiation of the RLP default parameters, within allowed ranges, defined in GSM 04.22. The MS shall do this in the ADM, after having sent a CONNECT ACKNOWLEDGE message (MO-case) or after having received a CONNECT ACKNOWLEDGE message from the SS (MT-case). The SS shall accept and use the new RLP parameters till the end of the test.

The ABM will be entered.

Related PICS/PIXIT statements

Supported bearer services; characteristics of non-transparent services.

Foreseen final state of the MS

Idle.

Test procedure

The SS is made to send continuously I+S frames. The delay between two consecutive I+S frames shall be inferior to T1.

The MS is made to send no user data. It sends only supervisory frames.

The SS sends a I+S frame numbered Nss. The MS shall acknowledge this frame. Then the SS sends a I+S frame numbered Nss+2.

The MS shall ask for the retransmission of the missing frame numbered Nss+1. The MS may send a SREJ frame (see case a). If it cannot send SREJ, it shall send a REJ frame (see case b).

Case a: If the MS chooses to send a SREJ, it shall send a SREJ frame containing $N(R)=Nss+1$.

The SS sends a I+S frame numbered Nss+4.

The MS shall ask for the retransmission of the missing frame numbered Nss+3. The MS may send a SREJ frame (see case a/a). If it cannot send SREJ, it shall send a REJ frame (see case a/b).

Case a/a: If the MS chooses to send a SREJ, it shall send a SREJ frame containing $N(R)=Nss+3$.

The SS sends a I+S frame numbered Nss+1 and the MS shall acknowledge this frame ($N(R)=Nss+3$).

The SS sends a I+S frame numbered Nss+3 and the MS shall acknowledge this frame ($N(R)=Nss+5$).

Case a/b: If the MS chooses to send a REJ, it shall send a REJ frame containing $N(R)=N_{ss}+1$.

The SS sends I+S frames numbered $N_{ss}+1$, ..., $N_{ss}+4$ and the MS shall acknowledge these frames ($N(R)=N_{ss}+2$, ..., $N_{ss}+5$).

Case b: If the MS chooses to send a REJ, it shall send a REJ frame containing $N(R)=N_{ss}+1$.

The SS sends I+S frames numbered $N_{ss}+1$, $N_{ss}+2$ and the MS shall acknowledge this frame ($N(R)=N_{ss}+2$, $N_{ss}+3$).

The SS sends a I+S frame numbered $N_{ss}+4$.

The MS shall ask for the retransmission of the missing frame numbered $N_{ss}+3$. The MS may send a SREJ frame (see case b/a). If it cannot send SREJ, it shall send a REJ frame (see case b/b).

Case b/a: If the MS chooses to send a SREJ, it shall send a SREJ frame containing $N(R)=N_{ss}+3$.

The SS sends a I+S frame numbered $N_{ss}+3$ and the MS shall acknowledge this frame ($N(R)=N_{ss}+5$).

Case b/b: If the MS chooses to send a REJ, it shall send a REJ frame containing $N(R)=N_{ss}+3$.

The SS sends I+S frames numbered $N_{ss}+3$, $N_{ss}+4$ and the MS shall acknowledge these frames ($N(R)=N_{ss}+4$, $N_{ss}+5$).

The SS sends a I+S frame numbered $N_{ss}+5$. The MS shall acknowledge this frame. Then the SS sends a I+S frame numbered $N_{ss}+5+K_{IM}$.

The MS shall ask for the retransmission of the missing frame numbered $N_{ss}+6$ to $N_{ss}+4+K_{IM}$. The MS may send a SREJ frame (see sequence c with $k=1$). If it cannot send SREJ, it shall send a REJ frame (see sequence d with $k=1$).

Sequence c: If the MS chooses to send a SREJ, it shall send a SREJ frame containing $N(R)=N_{ss}+5+k$.

The SS sends a I+S frame numbered $N_{ss}+5+k$.

When using SREJ frames, the MS shall send RR frames to acknowledge the received I+S frames. The time when these RR frames are sent is not tested.

If $k < K_{IM}-1$, the MS shall ask for the retransmission of the missing frames numbered $N_{ss}+5+k+1$ to $N_{ss}+4+K_{IM}$. The MS may send a SREJ frame (see sequence c with $k=k+1$). If it cannot send SREJ, it shall send a REJ frame (see sequence d with $k=k+1$).

If $k=K_{IM}-1$, the MS has no more frame to reject. It shall acknowledge the frame numbered $N_{ss}+5+K_{IM}$ with a frame containing $N(R)=N_{ss}+6+K_{IM}$. The SS sends I+S frames numbered $N_{ss}+6+K_{IM}$, etc... and the MS shall acknowledge these frames ($N(R)=N_{ss}+7+K_{IM}$, etc).

Sequence d: If the MS chooses to send a REJ, it shall send a REJ frame containing $N(R)=N_{ss}+5+k$.

The SS sends a I+S frame numbered $N_{ss}+5+k$ and the MS shall acknowledge this frame ($N(R)=N_{ss}+5+k+1$).

The SS sends a I+S frame numbered $N_{ss}+5+K_{IM}$.

If $k < K_{IM}-1$, the MS shall ask for the retransmission of the missing frames numbered $N_{ss}+5+k+1$ to $N_{ss}+4+K_{IM}$. The MS may send a SREJ frame (see sequence c with $k=k+1$). If it cannot send SREJ, it shall send a REJ frame (see sequence d with $k=k+1$).

If $k=K_{IM}-1$, the MS has no more frame to reject. It shall acknowledge the frame numbered $N_{ss}+5+K_{IM}$ with a frame containing $N(R)=N_{ss}+6+K_{IM}$. The SS sends I+S frames numbered $N_{ss}+6+K_{IM}$, etc... and the MS shall acknowledge these frames ($N(R)=N_{ss}+7+K_{IM}$, etc).

The MS is returned to the idle state by clearing of the call.

Maximum duration of test

1 minute.

Expected sequence

	MS		SS
		<----- I+S -----	0'
	0	----- RR ----->	
		<----- I+S -----	1'
	1	SREJ(a) or REJ(b) ?	
Case a			
	a - 1	----- SREJ ----->	
		<----- I+S -----	a - 2'
	a - 2	SREJ(a/a) or REJ(a/b) ?	
Case a/a			
	a/a - 1	----- SREJ ----->	
		<----- I+S -----	a/a - 2'
	a/a - 2	----- RR ----->	
		<----- I+S -----	a/a - 3'
	a/a - 3	----- RR ----->	
Case a/b			
	a/b - 1	----- REJ ----->	
		<----- I+S -----	a/b - 2'
	a/b - 2	----- RR ----->	
		<----- I+S -----	a/b - 3'
	a/b - 3	----- RR ----->	
		<----- I+S -----	a/b - 4'
	a/b - 4	----- RR ----->	
		<----- I+S -----	a/b - 5'
	a/b - 5	----- RR ----->	
Case b			
	b - 1	----- REJ ----->	
		<----- I+S -----	b - 2'
	b - 2	----- RR ----->	
		<----- I+S -----	b - 3'
	b - 3	----- RR ----->	
		<----- I+S -----	b - 4'
	b - 4	SREJ(b/a) or REJ(b/b) ?	
Case b/a			
	b/a - 1	----- SREJ ----->	
		<----- I+S -----	b/a - 2'
	b/a - 2	----- RR ----->	
Case b/b			
	b/b - 1	----- REJ ----->	

	<-----	I+S	-----	b/b - 2'
b/b - 2	-----	RR	----->	
	<-----	I+S	-----	b/b - 3'
b/b - 3	-----	RR	----->	
	<-----	I+S	-----	i'
i	-----	RR	----->	
	<-----	I+S	-----	i+1'
i+1		SREJ(c) or REJ(d) ?		
Sequence c (SREJ used)				
c/k - 0	-----	SREJ	----->	
	<-----	I+S	-----	c/k - 0'
c/k - 1		SREJ(c) or REJ(d) ?		
Sequence d (REJ used)				
d/k - 0	-----	REJ	----->	
	<-----	I+S	-----	d/k - 0'
d/k - 1	-----	RR	----->	
	<-----	I+S	-----	d/k - 1'
d/k - 2		SREJ(c) or REJ(d) ?		
j	-----	RR	----->	
	<-----	I+S	-----	j'
...		etc...		...

The frames from the SS will be:

0': One I+S frame containing $N(S)=N_{ss} \bmod(62)$, $N(R)=N_{ms}+1 \bmod(62)$.

1': One I+S frame containing $N(S)=N_{ss}+2 \bmod(62)$, $N(R)=N_{ms}+1 \bmod(62)$.

Case a:

a - 2': One I+S frame containing $N(S)=N_{ss}+4 \bmod(62)$, $N(R)=N_{ms}+1 \bmod(62)$.

Case a/a:

a/a - 2': One I+S frame containing $N(S)=N_{ss}+1 \bmod(62)$, $N(R)=N_{ms}+1 \bmod(62)$.

a/a - 3': One I+S frame containing $N(S)=N_{ss}+3 \bmod(62)$, $N(R)=N_{ms}+1 \bmod(62)$.

Case a/b:

a/b - 2': One I+S frame containing $N(S)=N_{ss}+1 \bmod(62)$, $N(R)=N_{ms}+1 \bmod(62)$.

a/b - 3': One I+S frame containing $N(S)=N_{ss}+2 \bmod(62)$, $N(R)=N_{ms}+1 \bmod(62)$.

a/b - 4': One I+S frame containing $N(S)=N_{ss}+3 \bmod(62)$, $N(R)=N_{ms}+1 \bmod(62)$.

a/b - 5': One I+S frame containing $N(S)=N_{ss}+4 \bmod(62)$, $N(R)=N_{ms}+1 \bmod(62)$.

Case b:

b - 2': One I+S frame containing $N(S)=N_{ss}+1 \bmod(62)$, $N(R)=N_{ms}+1 \bmod(62)$.

b - 3': One I+S frame containing $N(S)=N_{ss}+2 \bmod(62)$, $N(R)=N_{ms}+1 \bmod(62)$.

b - 4': One I+S frame containing $N(S)=N_{ss}+4 \bmod(62)$, $N(R)=N_{ms}+1 \bmod(62)$.

Case b/a:

b/a - 2': One I+S frame containing $N(S)=N_{ss}+3 \bmod(62)$, $N(R)=N_{ms}+1 \bmod(62)$.

Case b/b:

b/b - 2': One I+S frame containing $N(S)=N_{ss}+3 \bmod(62)$, $N(R)=N_{ms}+1 \bmod(62)$.

b/b - 3': One I+S frame containing $N(S)=N_{ss}+4 \bmod(62)$, $N(R)=N_{ms}+1 \bmod(62)$.

i': One I+S frame containing $N(S)=N_{ss}+5 \bmod(62)$, $N(R)=N_{ms}+1 \bmod(62)$.

i+1': One I+S frame containing $N(S)=N_{ss}+5+K_{IM} \bmod(62)$, $N(R)=N_{ms}+1 \bmod(62)$.

Sequence c (with $k=1$ to $K_{IM}-1$):

c/k - 0': One I+S frame containing $N(S)=N_{ss}+5+k \bmod(62)$, $N(R)=N_{ms}+1 \bmod(62)$.

Sequence d (with $k=1$ to $K_{IM}-1$):

d/k - 0': One I+S frame containing $N(S)=N_{ss}+5+k \bmod(62)$, $N(R)=N_{ms}+1 \bmod(62)$.

d/k - 1': One I+S frame containing $N(S)=N_{ss}+5+K_{IM} \bmod(62)$, $N(R)=N_{ms}+1 \bmod(62)$.

j',...: One I+S frame containing $N(S)=N_{ss}+K_{IM}+6, \dots \bmod(62)$, $N(R)=N_{ms}+1 \bmod(62)$.

Specific message content

The frames from the MS shall be:

0: One RR frame containing $N(R)=N_{ss}+1 \bmod(62)$.

1: The MS shall reject the missing I+S frame numbered $N_{ss}+1$. It may send a SREJ frame (see case a). If it cannot send SREJ, it shall send a REJ frame (see case b).

Case a

a - 1: One supervisory SREJ frame containing $N(R)=N_{ss}+1 \bmod(62)$.

a - 2: The MS shall reject the missing I+S frame numbered $N_{ss}+3$. It may send a SREJ frame (see case a). If it cannot send SREJ, it shall send a REJ frame (see case b).

Case a/a

a/a - 1: One supervisory SREJ frame containing $N(R)=N_{ss}+3 \bmod(62)$.

a/a - 2: One RR frame containing $N(R)=N_{ss}+3 \bmod(62)$.

a/a - 3: One RR frame containing $N(R)=N_{ss}+5 \bmod(62)$.

Case a/b

a/b - 1: One supervisory REJ frame containing $N(R)=N_{ss}+1 \bmod(62)$.

a/b - 2: One RR frame containing $N(R)=N_{ss}+2 \bmod(62)$.

a/b - 3: One RR frame containing $N(R)=N_{ss}+3 \bmod(62)$.

a/b - 4: One RR frame containing $N(R)=N_{ss}+4 \bmod(62)$.

a/b - 5: One RR frame containing $N(R)=N_{ss}+5 \bmod(62)$.

Case b

b - 1: One supervisory REJ frame containing $N(R)=N_{ss}+1 \bmod(62)$.

b - 2: One RR frame containing $N(R)=N_{ss}+2 \bmod(62)$.

b - 3: One RR frame containing $N(R)=N_{ss}+3 \bmod(62)$.

b - 4: The MS shall reject the missing I+S frame numbered $N_{ss}+2$. It may send a SREJ frame (see case a). If it cannot send SREJ, it shall send a REJ frame (see case b).

Case b/a

b/a - 1: One supervisory SREJ frame containing $N(R)=N_{ss}+2 \bmod(62)$.

b/a - 2: One RR frame containing $N(R)=N_{ss}+5 \bmod(62)$.

Case b/b

b/b - 1: One supervisory REJ frame containing $N(R)=N_{ss}+2 \bmod(62)$.

b/b - 2: One RR frame containing $N(R)=N_{ss}+4 \bmod(62)$.

b/b - 3: One RR frame containing $N(R)=N_{ss}+5 \bmod(62)$.

i: One RR frame containing $N(R)=N_{ss}+6 \bmod(62)$.

i+1: The MS shall reject all missing I+S frames (i.e. KIM-1 frames). It may send a SREJ frame (see sequence c with $k=1$). If it cannot send SREJ, it shall send a REJ frame (see sequence d with $k=1$).

Sequence c (with $k=1$ to $K_{IM}-1$):

c/k - 0: One SREJ frame containing $N(R)=N_{ss}+5+k \bmod(62)$.

c/k - 1: If $k < K_{IM}-1$, the MS shall reject all missing I+S frames (i.e. KIM-1 frames). It may send a SREJ frame (see sequence c with $k=k+1$). If it cannot send SREJ, it shall send a REJ frame (see sequence d with $k=k+1$). If $k=K_{IM}-1$, the MS has no more frame to reject (see frame numbered j).

Sequence d (with $k=1$ to $K_{IM}-1$):

d/k - 0: One REJ frame containing $N(R)=N_{ss}+5+k \bmod(62)$.

d/k - 1: One RR frame containing $N(R)=N_{ss}+5+k+1 \bmod(62)$.

d/k - 2: If $k < K_{IM}-1$, the MS shall reject all missing I+S frames (i.e. KIM-1 frames). It may send a SREJ frame (see sequence c with $k=k+1$). If it cannot send SREJ, it shall send a REJ frame (see sequence d with $k=k+1$). If $k=K_{IM}-1$, the MS has no more frame to reject (see frame numbered j).

j,...: One RR frame containing $N(R)=N_{ss}+K_{IM}+6,... \bmod(62)$.

29.3.2.5.2 Retransmission of REJ or SREJ frames

29.3.2.5.2.1 Conformance requirements

The MS shall not retransmit a REJ frame upon time-out. It may repeat SREJ frames.

References

GSM 04.22 sections 5.2.3.4 and 5.2.3.6.

29.3.2.5.2.2 Test purpose

To test that the MS is able to retransmit a SREJ supervisory frames, and does not retransmit a REJ frame.

29.3.2.5.2.3 Test method

Initial Conditions

The window size from IWF (SS) to MS is called K_{IM} .

System Simulator:

The SS is configured to use default RLP parameters.

Mobile Station:

The MS is configured to use default RLP parameters.

A non transparent data call will be established, so that the MS is in call state U10 ("Call Active").

Case a: No negotiation will be initiated by the MS.

Case b: The MS initiates negotiation of RLP default parameters.

NOTE: The MS is allowed to initiate the negotiation of the RLP default parameters, within allowed ranges, defined in GSM 04.22. The MS shall do this in the ADM, after having sent a CONNECT ACKNOWLEDGE message (MO-case) or after having received a CONNECT ACKNOWLEDGE message from the SS (MT-case). The SS shall accept and use the new RLP parameters till the end of the test.

The ABM will be entered.

Related PICS/PIXIT statements

Supported bearer services; characteristics of non-transparent services.

Foreseen final state of the MS

Idle.

Test procedure

After optional status bits exchange between the MS and the SS, the SS is made to send continuously I+S frames. The delay between two consecutive I+S frames shall be inferior to T1.

The MS is made to send no user data. It sends only supervisory frames.

The SS sends a I+S frame numbered Nss. The MS shall acknowledge this frame. Then the SS sends a I+S frame numbered Nss+2.

The MS shall ask for the retransmission of the missing frame numbered Nss+1. The MS may send a SREJ frame (see case a). If it cannot send SREJ, it shall send a REJ frame (see case b).

Case a: If the MS chooses to send a SREJ, it shall send a SREJ frame containing $N(R)=Nss+1$.

The SS does not retransmit the rejected frame.

The MS may repeat (see case a1) or not (see case a2) the reject SREJ frame.

Case a1: If the MS chooses to retransmit the SREJ, it shall send a SREJ frame containing $N(R)=Nss+1$, at the expiry of T1.

The SS sends a I+S frame numbered Nss+1 and the MS shall acknowledge this frame ($N(R)=Nss+3$).

The SS sends a I+S frame numbered Nss+4.

The MS shall ask for the retransmission of the missing frame numbered Nss+3. The MS shall send a SREJ frame containing $N(R)=Nss+3$.

At expiry of T1, the MS shall send a new SREJ frame containing $N(R)=Nss+3$. This step is repeated N2 times.

The SS checks for $2*T1$ that the SREJ frame is not repeated by the MS.

Case a2: If the MS chooses not to repeat the SREJ frame, The SS checks for $2 \cdot T1$ that the SREJ frame is not repeated by the MS.

Case b: If the MS chooses to send a REJ, it shall send a REJ frame containing $N(R)=N_{ss}+1$.

The SS does not retransmit the rejected frame.

The MS shall not repeat the reject REJ frame.

The SS checks for $2 \cdot T1$ that the SREJ frame is not repeated by the MS.

The MS is returned to the idle state by clearing of the call.

Maximum duration of test

1 minute.

Expected sequence

	MS			SS
		<-----	I+S	-----> 0'
	0	-----	RR	----->
		<-----	I+S	-----> 1'
	1		SREJ(a) or REJ(b) ?	

Case a

	a - 1	-----	SREJ	----->
	a - 2		SREJ repeated (a1) or not (a2) ?	

Case a1

T1 Time-out	a1 - 1	-----	SREJ	----->
		<-----	I+S	-----> a1 - 1'
	a1 - 2	-----	RR	----->
		<-----	I+S	-----> a1 - 2'
	a1 - 3	-----	SREJ	----->
T1 Time-out	a1 - 4	-----	SREJ	----->
	...		etc...	...
T1 Time-out	a1 - 3+N2	-----	SREJ	----->
T1 Time-out	SREJ not repeated			

Case a2

T1 Time-out SREJ not repeated

Case b

	b - 1	-----	REJ	----->
--	-------	-------	-----	--------

T1 Time-out SREJ not repeated

The frames from the SS will be:

0': One I+S frame containing $N(S)=N_{ss} \bmod(62)$, $N(R)=N_{ms}+1 \bmod(62)$.

1': One I+S frame containing $N(S)=N_{ss}+2 \bmod(62)$, $N(R)=N_{ms}+1 \bmod(62)$.

Case a:

Case a1:

a1 - 1': One I+S frame containing $N(S)=N_{ss}+1 \bmod(62)$, $N(R)=N_{ms}+1 \bmod(62)$.

a1 - 2': One I+S frame containing $N(S)=N_{ss}+4 \bmod(62)$, $N(R)=N_{ms}+1 \bmod(62)$.

Specific message content

The frames from the MS shall be:

0: One RR frame containing $N(R)=N_{ss}+1 \bmod(62)$.

1: The MS shall reject the missing I+S frame numbered $N_{ss}+1$. It may send a SREJ frame (see case a). If it cannot send SREJ, it shall send a REJ frame (see case b).

Case a

a - 1: One supervisory SREJ frame containing $N(R)=N_{ss}+1 \bmod(62)$.

a - 2: SREJ frame may be repeated, (see case a1) or not (see case a2).

Case a1

a1 - 1: On T1 Time-out, one supervisory SREJ frame containing $N(R)=N_{ss}+1 \bmod(62)$.

a1 - 2: One RR frame containing $N(R)=N_{ss}+3 \bmod(62)$.

a1 - 3,...,b2 - 3+N2: On T1 Time-out, one supervisory SREJ frame containing $N(R)=N_{ss}+3 \bmod(62)$.

Case b

b - 1: One supervisory REJ frame containing $N(R)=N_{ss}+1 \bmod(62)$.

29.3.2.5.3 I+S reject frame

29.3.2.5.3.1 Conformance requirements

The MS shall be able to use I+S frames to carry a REJ or SREJ frame when it detects that one or more numbered information frame is received out of sequence.

References

GSM 04.22 sections 5.2.3.4, 5.2.3.6

29.3.2.5.3.2 Test purpose

To test the MS is able to send SREJ or REJ frames in I+S frames when an out of sequence information frame has been received.

29.3.2.5.3.3 Test method

Initial Conditions

The window size from IWF (SS) to MS is called K_{IM} .

System Simulator:

The SS is configured to use default RLP parameters.

Mobile Station:

The MS is configured to use default RLP parameters.

A non transparent data call will be established, so that the MS is in call state U10 ("Call Active").

Case a: No negotiation will be initiated by the MS.

Case b: The MS initiates negotiation of RLP default parameters.

NOTE: The MS is allowed to initiate the negotiation of the RLP default parameters, within allowed ranges, defined in GSM 04.22. The MS shall do this in the ADM, after having sent a CONNECT ACKNOWLEDGE message (MO-case) or after having received a CONNECT ACKNOWLEDGE message from the SS (MT-case). The SS shall accept and use the new RLP parameters till the end of the test.

The ABM will be entered.

Related PICS/PIXIT statements

Supported bearer services; characteristics of non-transparent services.

Foreseen final state of the MS

Idle.

Test procedure

The SS is made to send continuously I+S frames. The delay between two consecutive I+S frames shall be inferior to T1.

The SS acknowledges all the received I+S frames.

The MS is made to send continuously I+S frames.

The SS sends a I+S frame numbered Nss. The MS shall acknowledge this frame. Then the SS sends a I+S frame numbered Nss+2.

The MS shall ask for the retransmission of the missing frame numbered Nss+1. The MS may send a SREJ frame (see case a). If it cannot send SREJ, it shall send a REJ frame (see case b). The MS has user data to transmit, it shall use an I+S frame (instead of supervisory frame) to reject the missing frame.

Case a: If the MS chooses to send a SREJ, it shall send a I+S SREJ frame containing $N(R)=Nss+1$.

The SS sends a I+S frame numbered Nss+1 and the MS acknowledges this frame ($N(R)=Nss+3$).

The SS sends a I+S frame numbered Nss+3, etc... and the MS acknowledges these frames ($N(R)=Nss+4$, etc...).

Case b: If the MS chooses to send a REJ, it shall send a I+S REJ frame containing $N(R)=Nss+1$.

The SS sends I+S frames numbered Nss+1, Nss+2, etc... and the MS shall acknowledge this frame ($N(R)=Nss+2$, Nss+3, etc...).

The MS is returned to the idle state by clearing of the call.

Maximum duration of test

1 minute.

Expected sequence

	MS		SS
		<----- I+S -----	0'
0	-----	I+S ----->	
		<----- I+S -----	1'
1		SREJ(a) or REJ(b) ?	
Case a			
a - 1	-----	SREJ(I+S) ----->	
		<----- I+S -----	a - 2'
a - 2	-----	I+S ----->	
		<----- I+S -----	a - 3'
a - 3	-----	I+S ----->	
Case b			
b - 1	-----	REJ (I+S) ----->	
		<----- I+S -----	b - 2'
b - 2	-----	I+S ----->	
		<----- I+S -----	b - 3'
b - 3	-----	I+S ----->	
...		etc...	...

The frames from the SS will be:

0': One I+S frame containing $N(S)=N_{ss} \bmod(62)$, $N(R)=N_{ms}+1 \bmod(62)$.

1': One I+S frame containing $N(S)=N_{ss}+2 \bmod(62)$, $N(R)=N_{ms}+2 \bmod(62)$.

Case a:

a - 2': One I+S frame containing $N(S)=N_{ss}+1 \bmod(62)$, $N(R)=N_{ms}+3 \bmod(62)$.

a - 3': One I+S frame containing $N(S)=N_{ss}+3 \bmod(62)$, $N(R)=N_{ms}+4 \bmod(62)$.

Case b:

b - 2': One I+S frame containing $N(S)=N_{ss}+1 \bmod(62)$, $N(R)=N_{ms}+3 \bmod(62)$.

b - 3': One I+S frame containing $N(S)=N_{ss}+2 \bmod(62)$, $N(R)=N_{ms}+4 \bmod(62)$.

Specific message content

The frames from the MS shall be:

0: One I+S RR frame containing $N(S)=N_{ms}+1$, $N(R)=N_{ss}+1 \bmod(62)$.

1: The MS shall reject the missing I+S frame numbered $N_{ss}+1$. It may send a I+S SREJ frame (see case a). If it cannot send SREJ, it shall send a I+S REJ frame (see case b).

Case a

a - 1: One I+S SREJ frame containing $N(S)=N_{MS}+2$, $N(R)=N_{SS}+1 \bmod(62)$.

a - 2: One I+S RR frame containing $N(S)=N_{MS}+3$, $N(R)=N_{SS}+3 \bmod(62)$.

a - 3: One I+S RR frame containing $N(S)=N_{MS}+4$, $N(R)=N_{SS}+4 \bmod(62)$.

Case b

b - 1: One I+S REJ frame containing $N(S)=N_{MS}+2$, $N(R)=N_{SS}+1 \bmod(62)$.

b - 2: One I+S RR frame containing $N(S)=N_{MS}+3$, $N(R)=N_{SS}+2 \bmod(62)$.

b - 3: One I+S RR frame containing $N(S)=N_{MS}+4$, $N(R)=N_{SS}+3 \bmod(62)$.

29.3.2.6 Checkpoint recovery

29.3.2.6.1 SS in checkpoint recovery mode

29.3.2.6.1.1 Test purpose

To test the correct handling of received frame with $P=1$.

29.3.2.6.1.2 Method of test

Initial Conditions

System Simulator:

The SS is configured to use default RLP parameters.

Mobile Station:

The MS is configured to use default RLP parameters.

A non transparent data call will be established, so that the MS is in call state U10 ("Call Active").

Case a: No negotiation will be initiated by the MS.

Case b: The MS initiates negotiation of RLP default parameters.

NOTE: The MS is allowed to initiate the negotiation of the RLP default parameters, within allowed ranges, defined in GSM 04.22. The MS shall do this in the ADM, after having sent a CONNECT ACKNOWLEDGE message (MO-case) or after having received a CONNECT ACKNOWLEDGE message from the SS (MT-case). The SS shall accept and use the new RLP parameters till the end of the test.

The ABM will be entered.

Procedure

The MS is made to send continuously I+S frames with a delay inferior to $T1$ between each frame.

The SS is made to send continuously I+S frames with a delay superior to $T2$ and inferior to $T1$ between each frame.

The SS acknowledges the received I+S frames in its sending I+S frames.

The MS shall acknowledge the received I+S frames in its sending I+S frames.

After having sent i I+S frames, the SS sends a I+S frame with P bit set to 1.

The MS shall answer with a supervisory RR or RNR frame with F bit set to 1 and $N(R)$ coded to the next frame waited by the MS.

The SS continue sending I+S frames and acknowledging the I+S frames received from the MS.

The MS shall continue sending I+S frames and acknowledging the I+S frames received from the SS.

The SS rejects 1 I+S frame in a supervisory SREJ frame with P bit set to 1.

The MS shall answer with a supervisory RR or RNR frame with F bit set to 1 and N(R) coded to the next frame waited by the MS.

Then the MS shall retransmit the rejected I+S frame.

The SS continue sending I+S frames and acknowledging the I+S frames received from the MS.

The MS shall continue sending I+S frames and acknowledging the I+S frames received from the SS.

After having sent j I+S frames, the SS sends a supervisory RR frame with P bit set to 1.

The MS shall answer with a supervisory RR or RNR frame with F bit set to 1 and N(R) coded to the next frame waited by the MS.

The SS continue sending I+S frames and acknowledging the I+S frames received from the MS.

The MS shall continue sending I+S frames and acknowledging the I+S frames received from the SS.

The MS is returned to the idle state by clearing of the call.

Expected sequence

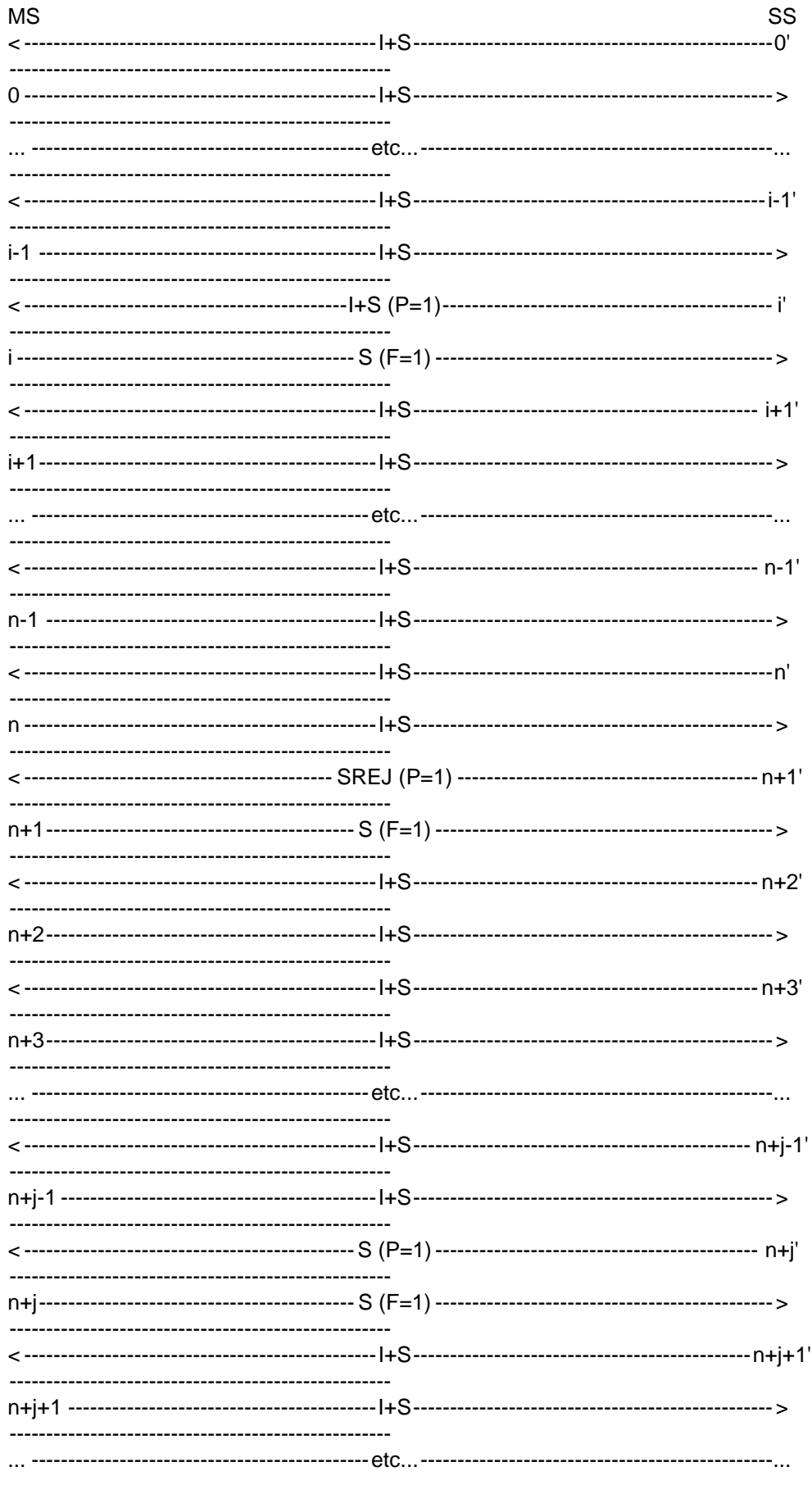

The frames from the SS will be:

0',...,i-1': One I+S RR frame containing:

$$N(S)=N_{SS},\dots,N_{SS+i-1} \bmod(62),$$

$$N(R)=N_{MS},\dots,N_{MS+i-1} \bmod(62).$$

i': One I+S RR frame containing:

$$C/R=1,$$

$$P/F=1,$$

$$N(S)=N_{SS}+i \bmod(62),$$

$$N(R)=N_{MS}+i \bmod(62).$$

i+1',...,n-1': One I+S RR frame containing:

$$N(S)=N_{SS}+i+1,\dots,N_{SS}+n-1 \bmod(62),$$

$$N(R)=N_{MS}+i-1,\dots,N_{MS}+n-3 \bmod(62).$$

n: One I+S RR frame containing:

$$N(S)=N_{SS}+n \bmod(62),$$

$$N(R)=N_{MS}+n-3 \bmod(62).$$

n+1: One supervisory SREJ frame containing:

$$C/R=1,$$

$$P/F=1,$$

$$N(R)=N_{MS}+n-2 \bmod(62).$$

n+2': One I+S RR frame containing:

$$N(S)=N_{SS}+n+1 \bmod(62),$$

$$N(R)=N_{MS}+n-2 \bmod(62).$$

n+3',...,n+j-1': One I+S RR frame containing:

$$N(S)=N_{SS}+n+2,\dots,N_{SS}+n+j \bmod(62),$$

$$N(R)=N_{MS}+n,\dots,N_{MS}+n+j-3 \bmod(62).$$

n+j: One supervisory SREJ frame containing:

$$C/R=1,$$

$$P/F=1,$$

$$N(R)=N_{MS}+n-2 \bmod(62).$$

n+j+1',...: One I+S RR frame containing:

$$N(S)=N_{SS}+n+j+1,\dots \bmod(62),$$

$$N(R)=N_{MS}+n+j-2,\dots \bmod(62).$$

29.3.2.6.1.3 Test requirements

The frames from the MS shall be:

0,...,i-1: One I+S frame containing:

$$N(S)=NMS,\dots,NMS+i-1 \text{ mod}(62),$$

$$N(R)=Nss+1,\dots,Nss+i \text{ mod}(62).$$

i': One supervisory RR frame containing:

$$C/R=0,$$

$$P/F=1,$$

$$N(R)=Nss+i+1 \text{ mod}(62).$$

i+1,...,n: One I+S frame containing:

$$N(S)=NMS+i,\dots,NMS+n-1 \text{ mod}(62),$$

$$N(R)=Nss+i+2,\dots,Nss+n+1 \text{ mod}(62).$$

n+1: One supervisory RR frame containing:

$$C/R=0,$$

$$P/F=1,$$

$$N(R)=Nss+n+1 \text{ mod}(62).$$

n+2: One I+S frame containing:

$$N(S)=NMS+n-2 \text{ mod}(62),$$

$$N(R)=Nss+n+2 \text{ mod}(62).$$

n+3,...,n+j-1: One I+S frame containing:

$$N(S)=NMS+n,\dots,NMS+n+j-3 \text{ mod}(62),$$

$$N(R)=Nss+n+3,\dots,Nss+n+j+1 \text{ mod}(62).$$

n+j: One supervisory RR frame containing:

$$C/R=0,$$

$$P/F=1,$$

$$N(R)=Nss+n+j+1 \text{ mod}(62).$$

n+j+1,...: One I+S frame containing:

$$N(S)=NMS+n+j-2 \text{ mod}(62),$$

$$N(R)=Nss+n+j+2,\dots \text{ mod}(62).$$

29.3.2.6.2 End of the window

29.3.2.6.2.1 Test purpose

To test the correct handling of checkpoint recovery at the end of the window.

29.3.2.6.2.2 Method of test

Initial Conditions

System Simulator:

The SS is configured to use default RLP parameters.

Mobile Station:

The MS is configured to use RLP default parameters except the window size from MS to IWF (SS), called KMI.

A non transparent data call will be established, so that the MS is in call state U10 ("Call Active").

Since some RLP parameters are different from the default parameters, a negotiation procedure will be initiated by the MS after the CONNECKT ACKNOWLEDGE message. The MS may negotiate the RLP default parameters within allowed ranges, defined in GSM 04.22, except the window size from MS to IWF (SS), called KMI, which has to be a non default value.

The SS shall accept and use the new RLP parameters till the end of the test.

After the negotiation procedure the ABM will be entered. This test is repeated twice with 2 different values of KMI, randomly chosen.

Procedure

The MS is made to send continuously I+S frames with a delay inferior to T1 between each frame.

The SS does not acknowledge the received I+S frames in RR frames.

The MS stops sending I+S frames after having sent KMI frames without acknowledgement, due to the window size.

At the expiry of T1 after the last sending I+S frame, the MS shall send a supervisory command RR frame with P bit set to 1.

The SS answer in a RR response frame with F bit set to 1 and acknowledging $j < KMI$ frames (j is randomly chosen).

The MS shall retransmit the $KMI-j$ lost I+S frames and then shall continue to send I+S frames.

The SS acknowledges the received I+S frames in RR frames.

The MS is returned to the idle state by clearing of the call.

Expected sequence

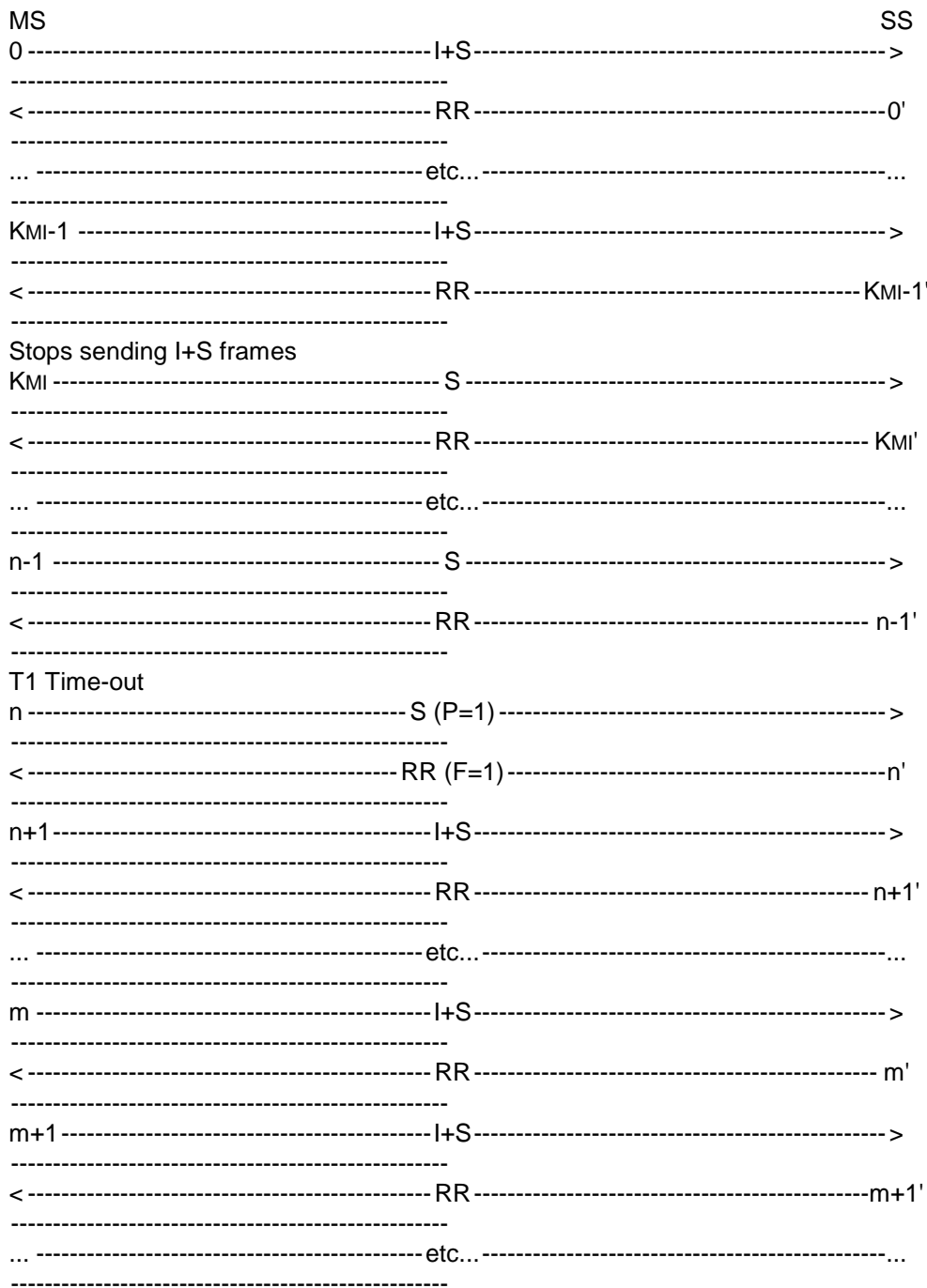

The frames from the SS will be:

0',...,n-1': One RR frame containing:

$$N(R)=NMS \text{ mod}(62).$$

n': One supervisory RR frame containing:

$$C/R=0,$$

$$P/F=1,$$

$$N(R)=NMS+i-1+j \text{ mod}(62).$$

n+1',...: One supervisory RR frame containing:

$$N(R)=NMS+i+j \text{ mod}(62).$$

29.3.2.6.2.3 Test requirements

The frames from the MS shall be:

0,...,KMI-1: One I+S frame containing:

$$N(S)=NMS,\dots,NMS+KMI-1 \text{ mod}(62).$$

KMI,...,n-1: The MS stops sending I+S frames. It sends S frames.

n: On T1 Time-out after the last sent I+S frame, the MS sends a S frame containing C/R=1 and P/F=1.

n+1,...,m: The MS retransmits the lost I+S frames, it send I+S frames containing $N(S)=NMS-1+j,\dots,NMS+KMI-1 \text{ mod}(62)$.

m+1,...: One I+S frames containing:

$$N(S)=NMS+KMI,\dots \text{ mod}(62)$$

29.3.2.6.3 End of a sequence

29.3.2.6.3.1 Test purpose

To test the correct handling of checkpoint recovery at the end of a sequence of frames

29.3.2.6.3.2 Method of test

Initial Conditions

System Simulator:

The SS is configured to use default RLP parameters.

Mobile Station:

The MS is configured to use RLP default parameters except the window size from MS to IWF (SS), called KMI.

A non transparent data call will be established, so that the MS is in call state U10 ("Call Active").

Since some RLP parameters are different from the default parameters, a negotiation procedure will be initiated by the MS after the CONNECKT ACKNOWLEDGE message. The MS may negotiate the RLP default parameters within allowed ranges, defined in GSM 04.22, except the window size from MS to IWF (SS), called KMI, which has to be a non default value.

The SS shall accept and use the new RLP parameters till the end of the test.

After the negotiation procedure the ABM will be entered.

This test is repeated twice with 2 different values of KMI, randomly chosen.

Procedure

The MS is made to send a sequence of i I+S frames ($1 < i < KIM$) with a delay inferior to T1 between each frame.

The SS does not acknowledge the received I+S frames.

The MS sends S frames.

At the expiry of T1 after the last sending I+S frame, the MS shall send a supervisory command RR frame with P bit set to 1.

The SS answer in a RR response frame with F bit set to 1 and acknowledging $j < i$ frames (j is randomly chosen).

The MS shall retransmit the i-j lost I+S frames.

The SS acknowledges the received I+S frames in RR frames.

The MS is returned to the idle state by clearing of the call.

Expected sequence

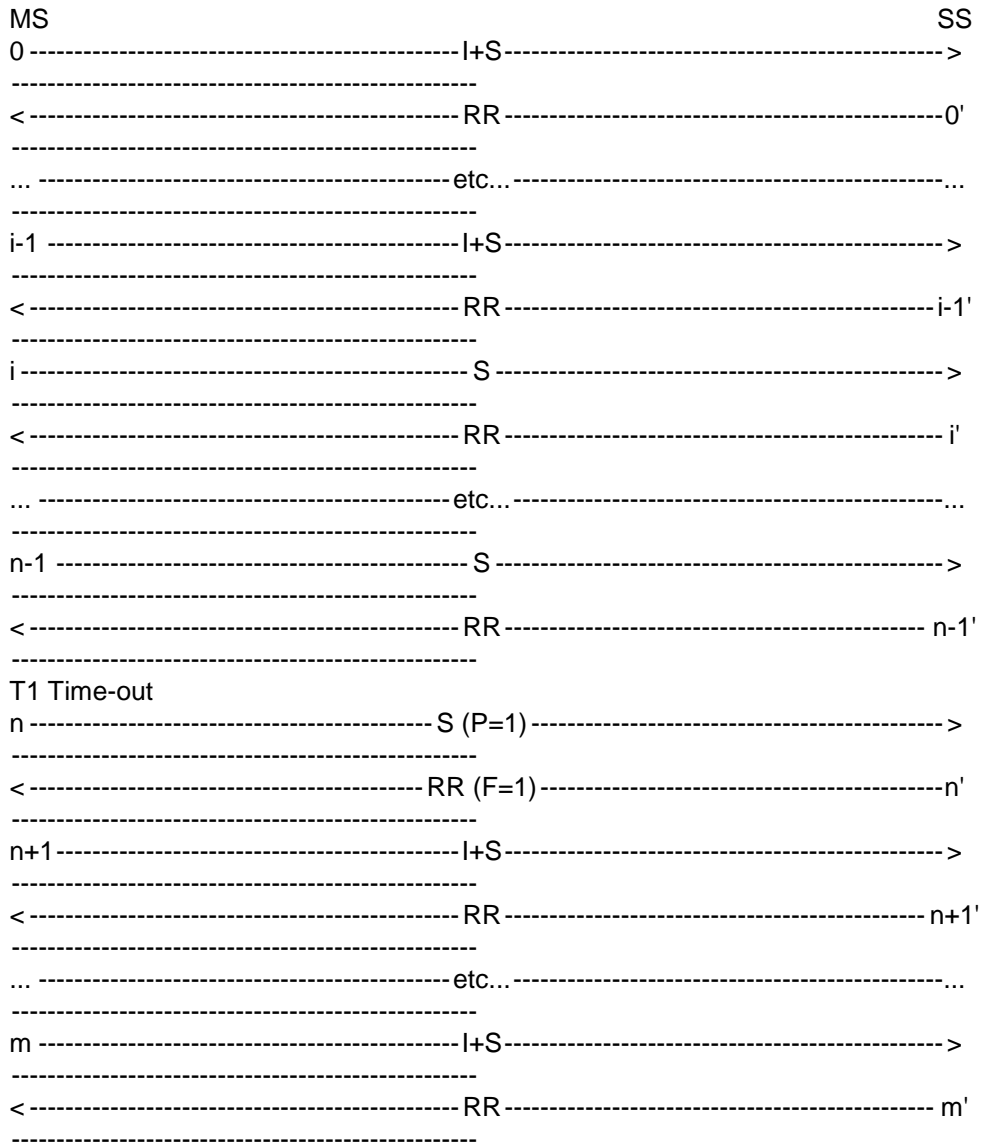

The frames from the SS will be:

0',...,n-1': One RR frame containing:

$$N(R)=NMS \text{ mod}(62).$$

n': One supervisory RR frame containing:

$$C/R=0,$$

$$P/F=1,$$

$$N(R)=NMS+j \text{ mod}(62).$$

n+1',...: One supervisory RR frame containing:

$$N(R)=NMS+j \text{ mod}(62).$$

29.3.2.6.3.3 Test requirements

The frames from the MS shall be:

0,...,i-1: One I+S frame containing:

$$N(S)=NMS,\dots,NMS+i-1 \bmod(62).$$

i-1,...,n-1: The MS sends S frames.

n: On T1 Time-out after the last sent I+S frame, the MS sends a S frame containing C/R=1 and P/F=1.

n+1,...,m: The MS retransmits the lost I+S frames, it send I+S frames containing $N(S)=NMS+j,\dots,NMS+i-1 \bmod(62)$.

29.3.2.6.4 Time-out of one frame

29.3.2.6.4.1 Test purpose

To test the correct handling of checkpoint recovery when a frame is not acknowledge.

29.3.2.6.4.2 Method of test

Initial Conditions

System Simulator:

The SS is configured to use default RLP parameters.

Mobile Station:

The MS is configured to use default RLP parameters.

A non transparent data call will be established, so that the MS is in call state U10 ("Call Active").

Case a: No negotiation will be initiated by the MS.

Case b: The MS initiates negotiation of RLP default parameters.

NOTE: The MS is allowed to initiate the negotiation of the RLP default parameters, within allowed ranges, defined in GSM 04.22. The MS shall do this in the ADM, after having sent a CONNECT ACKNOWLEDGE message (MO-case) or after having received a CONNECT ACKNOWLEDGE message from the SS (MT-case). The SS shall accept and use the new RLP parameters till the end of the test.

The ABM will be entered.

Procedure

The MS is made to send only one I+S frames.

The SS does not acknowledge the received I+S frame.

At the expiry of T1 after the sending of the I+S frame, the MS shall send a supervisory command RR frame with P bit set to 1.

The SS answer in a RR response frame with F bit set to 1 and N(R) corresponding to the I+S frame sent by the MS.

The MS shall retransmit the I+S frame.

The SS acknowledges the received I+S frame in RR frame.

The MS is returned to the idle state by clearing of the call.

Expected sequence

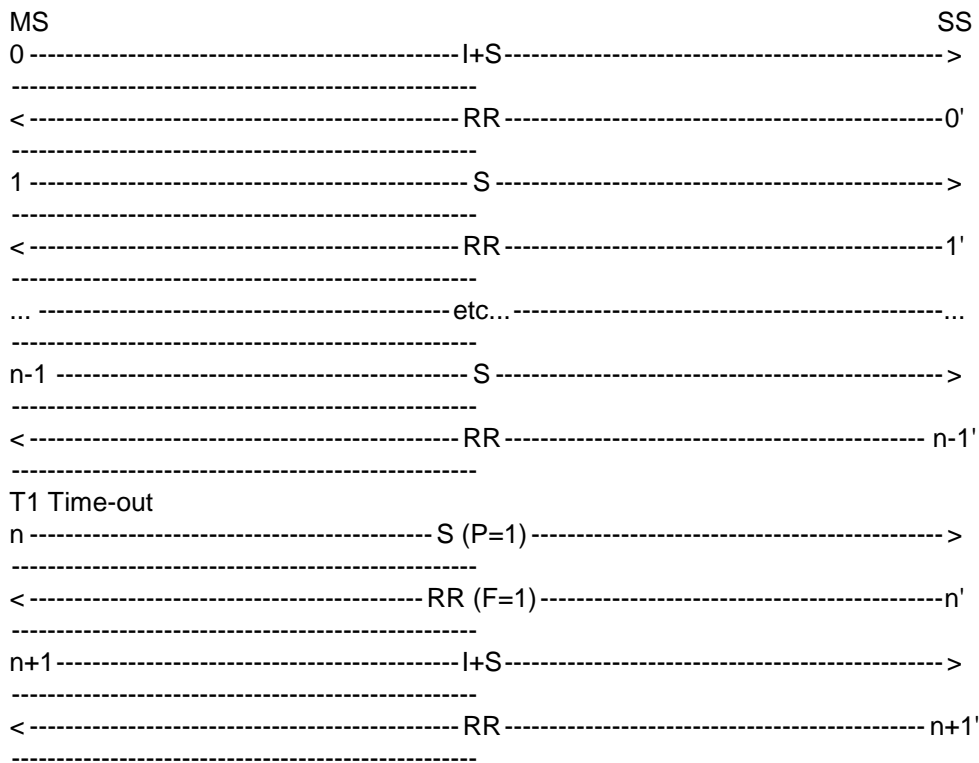

The frames from the SS will be:

0',...,n-1': One RR frame containing:

$$N(R)=NMS \text{ mod}(62).$$

n': One supervisory RR frame containing:

$$C/R=0,$$

$$P/F=1,$$

$$N(R)=NMS \text{ mod}(62).$$

n+1': One supervisory RR frame containing:

$$N(R)=NMS+1 \text{ mod}(62).$$

29.3.2.6.4.3 Test requirements

The frames from the MS shall be:

0,: One I+S frame containing:

$$N(S)=NMS \text{ mod}(62).$$

1,...,n-1: The MS sends S frames.

n: On T1 Time-out after the I+S frame, the MS sends a S frame containing C/R=1 and P/F=1.

n+1: The MS retransmits the I+S frame containing $N(S)=NMS \text{ mod}(62)$.

29.3.2.6.5 No response to checkpointing

29.3.2.6.5.1 Test purpose

To test the correct repetition of a frame with P=1 if SS does not answer to checkpointing.

29.3.2.6.5.2 Method of test

Initial Conditions

System Simulator:

The SS is configured to use default RLP parameters.

Mobile Station:

The MS is configured to use default RLP parameters.

A non transparent data call will be established, so that the MS is in call state U10 ("Call Active").

Case a: No negotiation will be initiated by the MS.

Case b: The MS initiates negotiation of RLP default parameters.

NOTE: The MS is allowed to initiate the negotiation of the RLP default parameters, within allowed ranges, defined in GSM 04.22. The MS shall do this in the ADM, after having sent a CONNECT ACKNOWLEDGE message (MO-case) or after having received a CONNECT ACKNOWLEDGE message from the SS (MT-case). The SS shall accept and use the new RLP parameters till the end of the test.

The ABM will be entered.

Procedure

The MS is made to send only one I+S frames.

The SS does not acknowledge the received I+S frame.

At the expiry of T1 after the sending of the I+S frame, the MS shall send a supervisory command RR frame with P bit set to 1.

The SS answer in a RR response frame with F bit set to 0 and N(R) acknowledging the I+S frame sent by the MS.

At the expiry of T1 after the sending of the frame with P=1, the MS shall send a new supervisory command RR frame with P bit set to 1.

The SS answer in a RR response frame with F bit set to 1 and N(R) corresponding to the I+S frame sent by the MS.

The MS shall retransmit the I+S frame.

The SS acknowledges the received I+S frame in RR frame.

The MS is returned to the idle state by clearing of the call.

Expected sequence

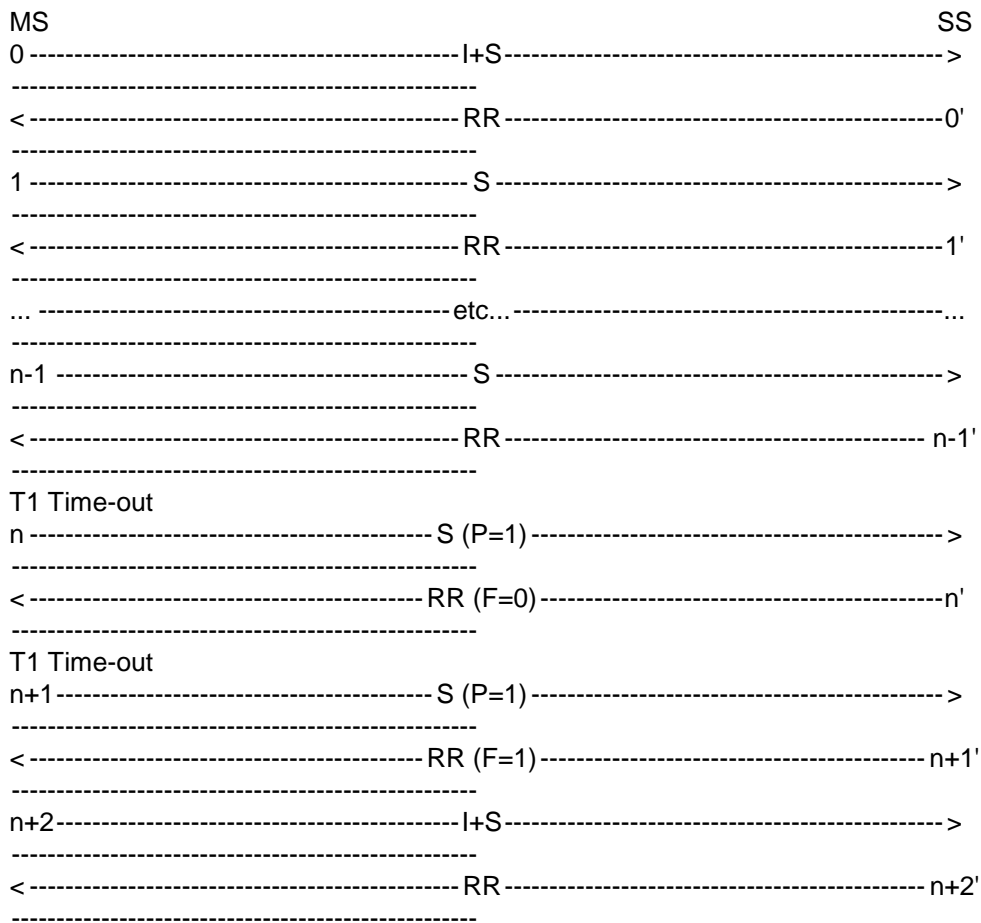

The frames from the SS will be:

0',...,n-1': One RR frame containing:

$$N(R)=NMS \text{ mod}(62).$$

n': One supervisory RR frame containing:

$$C/R=0,$$

$$P/F=0,$$

$$N(R)=NMS+1 \text{ mod}(62).$$

n+1': One supervisory RR frame containing:

$$C/R=0,$$

$$P/F=1,$$

$$N(R)=NMS \text{ mod}(62).$$

n+2': One supervisory RR frame containing:

$$N(R)=NMS+1 \text{ mod}(62).$$

29.3.2.6.5.3 Test requirements

The frames from the MS shall be:

0,: One I+S frame containing:

$N(S) = NMS \bmod(62)$.

1,...,n-1: The MS sends S frames.

n: On T1 Time-out after the I+S frame, the MS sends a S frame containing C/R=1 and P/F=1.

n+1: On T1 Time-out after the sending of the first frame with P=1, the MS sends a S frame containing C/R=1 and P/F=1.

n+2: The MS retransmits the I+S frame containing $N(S) = NMS \bmod(62)$.

29.3.2.6.6 Incorrect response to checkpointing

29.3.2.6.6.1 Test purpose

To test the correct repetition of a frame with P=1 if the answer to checkpointing is incorrect.

29.3.2.6.6.2 Method of test

Initial Conditions

System Simulator:

The SS is configured to use default RLP parameters.

Mobile Station:

The MS is configured to use default RLP parameters.

A non transparent data call will be established, so that the MS is in call state U10 ("Call Active").

Case a: No negotiation will be initiated by the MS.

Case b: The MS initiates negotiation of RLP default parameters.

NOTE: The MS is allowed to initiate the negotiation of the RLP default parameters, within allowed ranges, defined in GSM 04.22. The MS shall do this in the ADM, after having sent a CONNECT ACKNOWLEDGE message (MO-case) or after having received a CONNECT ACKNOWLEDGE message from the SS (MT-case). The SS shall accept and use the new RLP parameters till the end of the test.

The ABM will be entered.

Procedure

The MS is made to send only one I+S frames.

The SS does not acknowledge the received I+S frame.

The MS sends supervisory frame with P set to 0 when it has nothing else to send.

At the expiry of T1 after the sending of the I+S frame, the MS shall send a supervisory command RR frame with P bit set to 1.

The SS answer in a supervisory SREJ response frame with F bit set to 1 and N(R) rejecting the I+S frame sent by the MS.

At the expiry of T1 after the sending of the frame with P=1, the MS shall send a new supervisory command RR frame with P bit set to 1.

The SS answer in a supervisory REJ response frame with F bit set to 1 and N(R) rejecting the I+S frame sent by the MS.

At the expiry of T1 after the sending of the frame with P=1, the MS shall send a new supervisory command RR frame with P bit set to 1.

The SS answer in a RR response frame with F bit set to 1 and N(R) corresponding to the I+S frame sent by the MS.

The MS shall retransmit the I+S frame.

The SS acknowledges the received I+S frame in RR frame.

The MS is returned to the idle state by clearing of the call.

Expected sequence

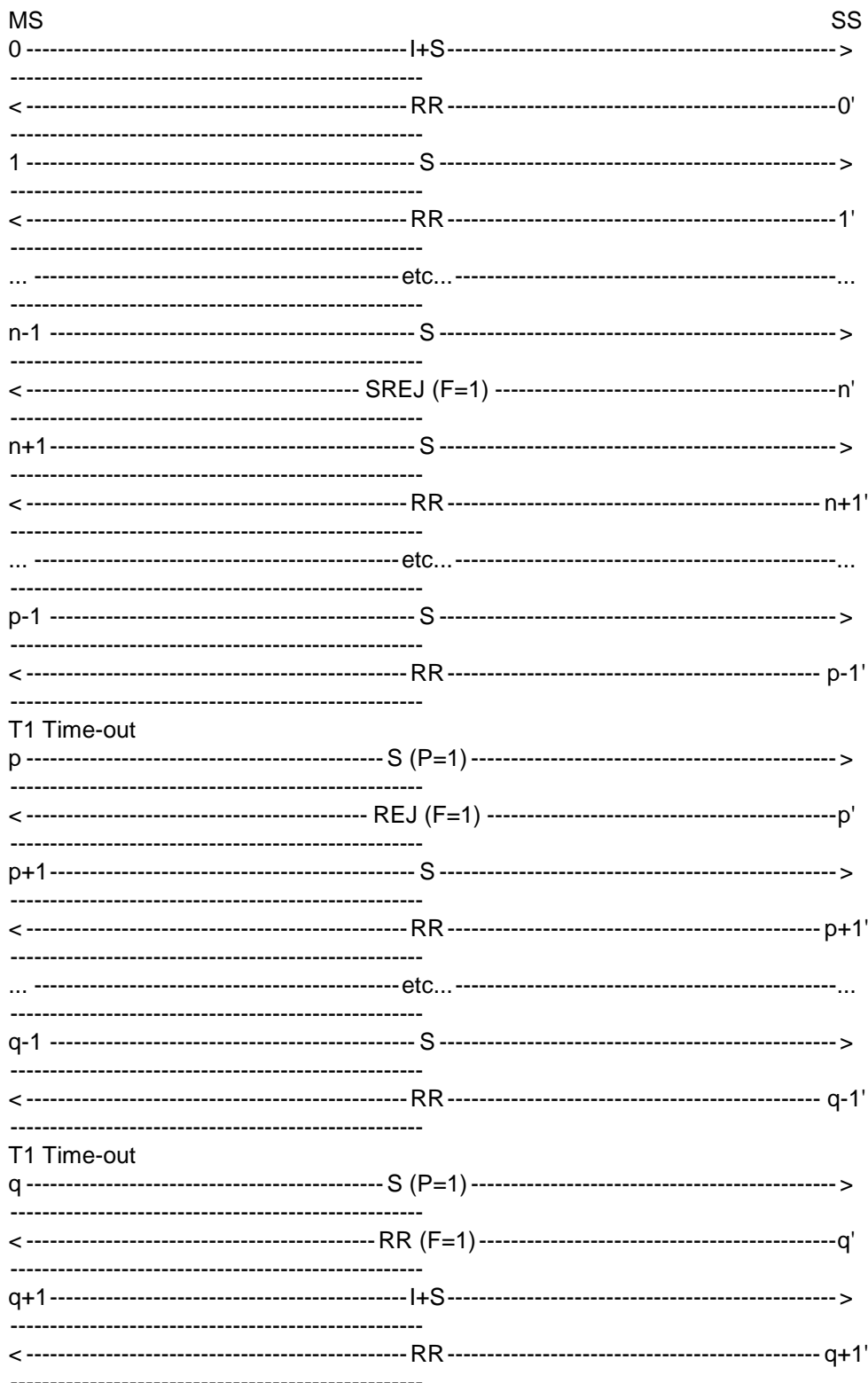

The frames from the SS will be:

0',...,n-1': One RR frame containing:

$$N(R)=NMS \bmod(62).$$

n': One supervisory SREJ frame containing:

$$C/R=0,$$

$$P/F=1,$$

$$N(R)=NMS \bmod(62).$$

m+1',...,p-1': One RR frame containing:

$$N(R)=NMS \bmod(62).$$

p': One supervisory REJ frame containing:

$$C/R=0,$$

$$P/F=1,$$

$$N(R)=NMS \bmod(62).$$

p+1',...,q-1': One RR frame containing:

$$N(R)=NMS \bmod(62).$$

q': One supervisory RR frame containing:

$$C/R=0,$$

$$P/F=1,$$

$$N(R)=NMS \bmod(62).$$

q+1': One RR frame containing:

$$N(R)=NMS+1 \bmod(62).$$

29.3.2.6.6.3 Test requirements

The frames from the MS shall be:

0,: One I+S frame containing:

$$N(S)=NMS \bmod(62).$$

1,...,n-1: The MS sends S frames.

n: On T1 Time-out after the I+S frame, the MS sends a S frame containing:

$$C/R=1,$$

$$P/F=1.$$

n+1,...,p-1: The MS sends S frames.

p: On T1 Time-out after the I+S frame, the MS sends a S frame containing:

$$C/R=1,$$

$$P/F=1.$$

p+1,...,q-1: The MS sends S frames.

q: On T1 Time-out after the I+S frame, the MS sends a S frame containing:

C/R=1,

P/F=1.

q+1: The MS retransmits the I+S frame containing:

$N(S)=NMS \bmod(62)$.

29.3.2.6.7 Total loss of response to checkpointing

29.3.2.6.7.1 Definition and applicability

The last frame of a sequence of numbered information frames is guarded by timer T1. Failure to receive an acknowledgement, or a reject, within a time T1, shall result in the RLP entity starting a checkpoint recovery procedure. If the RLP peer entity fails to respond to a checkpoint command, which is also guarded by timer T1, the checkpoint recovery procedure shall be repeated, up to N2 times.

29.3.2.6.7.2 Conformance requirements

The MS shall start the checkpoint procedure after failure to receive acknowledgement of a numbered information frame within a time T1. GSM 04.22, 5.3.3., 5.3.3.2.

The MS shall repeat the checkpoint procedure, up to N2 times, if the peer RLP entity fails to respond to a checkpoint command within a time T1. GSM 04.22, 5.3.3.2

The MS shall disconnect or reset the RLP link after the checkpoint procedure has been performed N2+1 times, GSM 04.22, 5.3.3.2

References

GSM 04.22 section 5.3.3., 5.3.3.2.

29.3.2.6.7.3 Test purpose

To test the correct handling of a total loss of response to checkpointing.

29.3.2.6.7.4 Method of test

Initial Conditions

System Simulator:

The SS is configured to use default RLP parameters.

Mobile Station:

If possible, the MS is configured to use RLP default parameters except the number of retransmission N2. If a MS cannot be configured to use a non default N2 value, the SS shall use XID negotiation to modify the value of N2 to be used during the test.

A non transparent data call will be established, so that the MS is in call state U10 ("Call Active").

Since some RLP parameters are different from the default parameters, a negotiation procedure will be initiated by the MS after the CONNECKT ACKNOWLEDGE message. The MS may negotiate the RLP default parameters within allowed ranges, defined in GSM 04.22, except the number of retransmission N2, which has to be a non default value.

The SS shall accept and use the new RLP parameters till the end of the test.

After the negotiation procedure the ABM will be entered.

Once in ABM, the SS shall initiate the transmission of an I+S frame, which will transfer L2RCOP status information between peer L2RCOP entities (SS to MS). The MS may respond with an I+S frame containing L2RCOP status information. The SS shall be capable of initiating this sequence, or responding to an I+S L2RCOP status frame from the MS.

This test is repeated twice with 2 different values of N2, randomly chosen.

Test Procedure

The MS is made to send only one I+S frames.

The SS does not acknowledge the received I+S frame.

At the expiry of T1 after the sending of the I+S frame, the MS shall send a supervisory command RR frame with P bit set to 1.

The SS answer in a RR response frame with F bit set to 0 and N(R) acknowledging the I+S frame sent by the MS.

At the expiry of T1 after the sending of the frame with P=1, the MS shall send a new supervisory command RR frame with P bit set to 1.

The SS answer in a RR response frame with F bit set to 0 and N(R) corresponding to the I+S frame sent by the MS.

These 2 last steps are repeated N2 times.

At the expiry of T1 after the sending of the frame with P=1, the MS shall reset (SABM) or disconnect (DISC) the link.

The SS answer with an UA frame.

The MS is returned to the idle state by clearing of the call.

Expected sequence

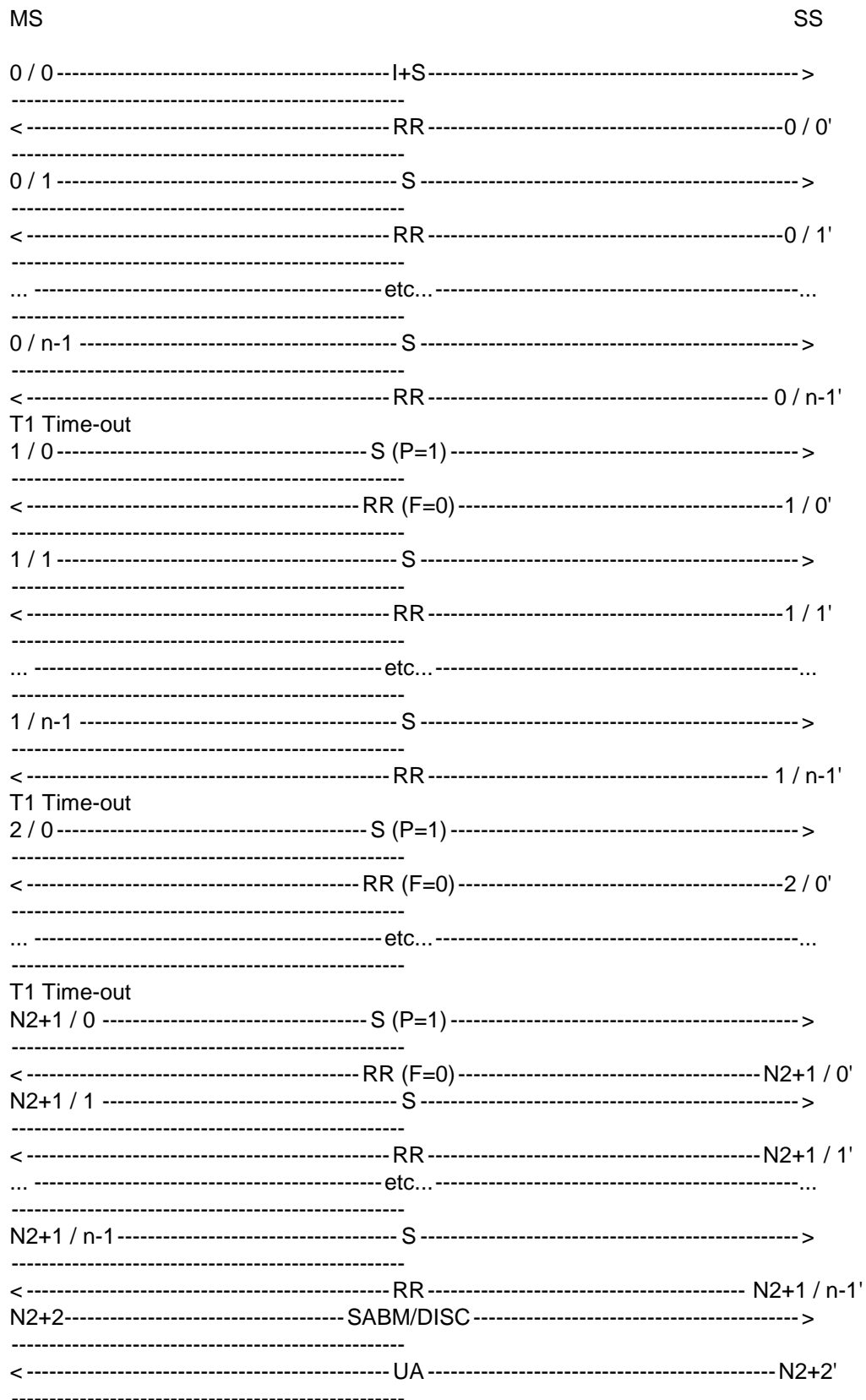

The frames from the SS will be:

0 / i',...,0 / i': One RR frame containing:

P/F=0,

$N(R) = NMS \bmod(62)$.

$i = 0, \dots, n-1$.

$k / i', \dots, k / i'$: One RR frame containing:

$P/F=0$,

$N(R) = NMS \bmod(62)$.

$k = 1, \dots, N2+1, i = 0, \dots, n-1$.

$N2+2'$: One UA frame containing:

$C/R=0$,

$P/F = P/F$ received in the DISC or SABM.

29.3.2.6.7.5 Test requirements

The frames from the MS shall be:

$0 / 0$: One I+S frame containing:

$N(S) = NMS \bmod(62)$.

$0 / 1, \dots, 0 / n-1$: The MS sends S frames.

$k / 0$: On T1 Time-out after the I+S frame, the MS sends a S frame containing:

$C/R=1$,

$P/F=1$.

$k = 1, \dots, N2+1$.

$k / 1, \dots, k / n-1$: The MS sends S frames.

$N2+2$: The MS sends a SABM ($C/R=1, P/F=1$) or a DISC($C/R=1$) frame.

29.3.2.6.8 Retransmission of a sequence

29.3.2.6.8.1 Test purpose

To test the correct repetition of a sequence of frame.

29.3.2.6.8.2 Method of test

Initial Conditions

System Simulator:

The SS is configured to use default RLP parameters.

Mobile Station:

The MS is configured to use RLP default parameters except the number of retransmission $N2$.

A non transparent data call will be established, so that the MS is in call state U10 ("Call Active").

Since some RLP parameters are different from the default parameters, a negotiation procedure will be initiated by the MS after the CONNECKT ACKNOWLEDGE message. The MS may negotiate the RLP default parameters within allowed ranges, defined in GSM 04.22, except the number of retransmission $N2$, which has to be a non default value.

The SS shall accept and use the new RLP parameters till the end of the test.

After the negotiation procedure the ABM will be entered.

This test is repeated twice with 2 different values of N2, randomly chosen. The window size from MS to IWF (SS) is called KMI.

Procedure

The MS is made to send a sequence of i I+S frames ($1 < i < KIM$) with a delay inferior to $T1$ between each frame.

The SS does not acknowledge the received I+S frames.

The MS starts sending supervisory frames after having sent i frames.

At the expiry of $T1$ after the last sending I+S frame, the MS shall send a supervisory command RR frame with P bit set to 1.

The SS answers in a RR response frame with F bit set to 1 and acknowledging no frames.

The MS shall retransmit the all I+S frames. Then the MS shall sends supervisory frames.

At the expiry of $T1$ after the last sending I+S frame, the MS shall send a supervisory command RR frame with P bit set to 1.

The SS answers in a RR response frame with F bit set to 1 and acknowledging $j < i$ frames. (j randomly chosen).

The MS shall retransmit the $i-j$ lost I+S frames.

$0,25 * T1$ after the last I+S frame of the sequence, the SS acknowledges all the received I+S frames in RR frame.

The MS is returned to the idle state by clearing of the call.

Expected sequence

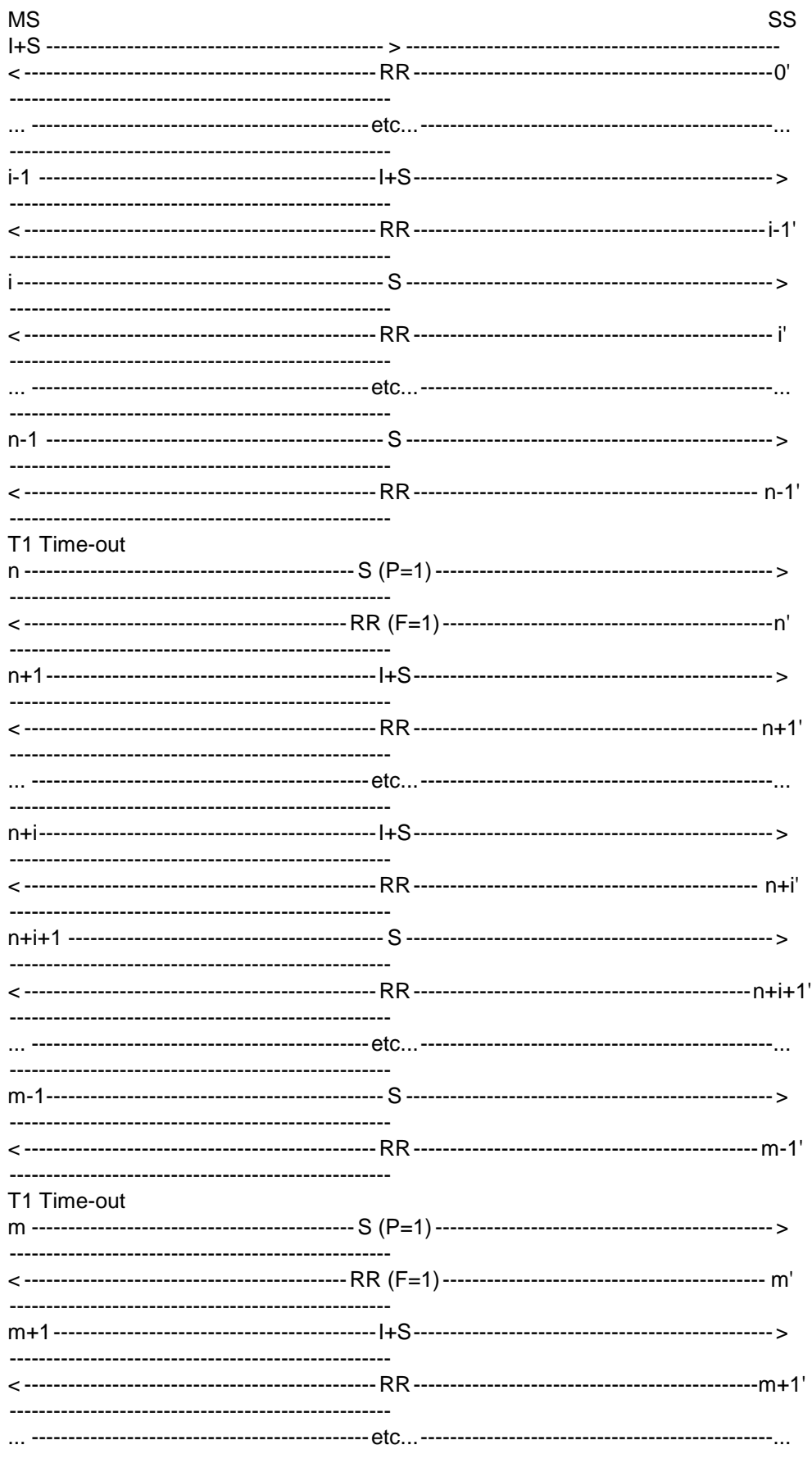

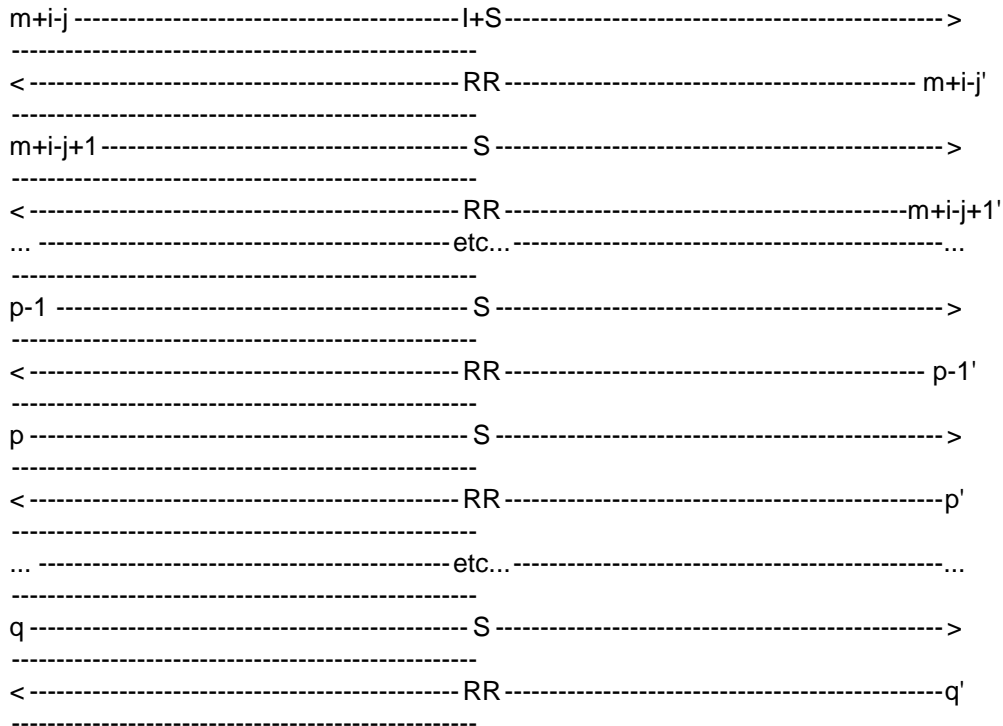

The frames from the SS will be:

0',...,n-1': One RR frame containing:

$$N(R)=NMS \text{ mod}(62).$$

n': One supervisory RR frame containing:

$$C/R=0,$$

$$P/F=1,$$

$$N(R)=NMS \text{ mod}(62).$$

n+1',...,m-1': One supervisory RR frame containing:

$$N(R)=NMS \text{ mod}(62).$$

m': One supervisory RR frame containing:

$$C/R=0,$$

$$P/F=1,$$

$$N(R)=NMS+j \text{ mod}(62).$$

m+1',...,p-2': One supervisory RR frame containing:

$$N(R)=NMS+j \text{ mod}(62).$$

p-1': 0,25*T1 after the last received I+S frame, the SS sends a supervisory RR frame containing:

$$N(R)=NMS+i \text{ mod}(62).$$

p',...,q': during at least T1, the SS sends supervisory frames.

29.3.2.6.8.3 Test requirements

The frames from the MS shall be:

0,...,i-1: One I+S frame containing:

$$N(S)=NMS,\dots,NMS+i-1 \bmod(62).$$

i,...,n-1: The MS sends S frames with P bit set to 0.

n: On T1 Time-out after the I+S frame, the MS sends a S frame containing:

$$C/R=1,$$

$$P/F=1.$$

n+1,...,n+i: The MS retransmits the I+S frames containing:

$$N(S)=NMS,\dots,NMS+i-1 \bmod(62).$$

n+i+1,...,m-1: The MS sends S frames with P bit set to 0.

m: On T1 Time-out after the I+S frame, the MS sends a S frame containing:

$$C/R=1,$$

$$P/F=1.$$

m+1,...,m+i-j: The MS retransmits the I+S frames containing:

$$N(S)=NMS+j,\dots,NMS+i-1 \bmod(62).$$

m+i-j+1,...,q: The MS sends S frames with P bit set to 0.

29.3.2.6.9 N2 retransmission of a sequence

29.3.2.6.9.1 Definition and applicability

The last frame of a sequence of numbered information frames is guarded by timer T1. Failure to receive an acknowledgement, or a reject, within a time T1, shall result in the RLP entity starting a checkpoint recovery procedure. If the peer RLP entity responds with a Supervisory frame with the F-bit set to "1", the MS shall retransmit the numbered frames, if appropriate.

29.3.2.6.9.2 Conformance requirements

The MS shall start the checkpoint procedure after failure to receive acknowledgement of a numbered information frame within a time T1. GSM 04.22, 5.3.3., 5.3.3.2.

The MS shall retransmit the I+S frame sequence starting at N(R), upon reception of a Supervisory frame with the F-bit set to "1" from the peer RLP entity. This shall constitute a retransmission of the original I+S sequence only if N(R) remains constant, GSM 04.22, 5.3.3.

The MS shall disconnect or reset the RLP link after the I+S sequence and checkpoint procedure has been performed N2+1 times, GSM 04.22, 5.3.3.2

References

GSM 04.22 section 5.3.3., 5.3.3.2.

29.3.2.6.9.3 Test purpose

To test the correct repetition of a sequence of frame.

29.3.2.6.9.4 Method of test

Initial Conditions

System Simulator:

The SS is configured to use default RLP parameters.

Mobile Station:

If possible, the MS is configured to use RLP default parameters except the number of retransmission N2. If a MS cannot be configured to use a non default N2 value, the SS shall use XID negotiation to modify the value of N2 to be used during the test.

A non transparent data call will be established, so that the MS is in call state U10 ("Call Active").

Since some RLP parameters are different from the default parameters, a negotiation procedure will be initiated by the MS after the CONNECKT ACKNOWLEDGE message. The MS may negotiate the RLP default parameters within allowed ranges, defined in GSM 04.22, except the number of retransmission N2, which has to be a non default value.

The SS shall accept and use the new RLP parameters till the end of the test.

After the negotiation procedure the ABM will be entered.

Once in ABM, the SS shall initiate the transmission of an I+S frame, which will transfer L2RCOP status information between peer L2RCOP entities (SS to MS). The MS may respond with an I+S frame containing L2RCOP status information. The SS shall be capable of initiating this sequence, or responding to an I+S L2RCOP status frame from the MS.

This test is repeated twice with 2 different values of N2, randomly chosen.

The window size from MS to IWF (SS) is called KMI.

Test Procedure

The MS is made to send a sequence of i I+S frames ($1 < i < KMI$, and $i > N2$) with a delay inferior to T1 between each frame.

The SS does not acknowledge the received I+S frames.

The MS shall send S frames after having sent the i I+S frames.

At the expiry of T1 after the last sending I+S frame, the MS shall send a supervisory command RR frame with P bit set to 1.

The SS answer in a RR response frame with F bit set to 1 and acknowledging 1 frame.

The MS shall retransmit the $i-1$ lost I+S frames.

The SS does not acknowledge the received I+S frames.

The MS shall send S frames after having sent the i I+S frames.

The 5 last steps are repeated N2 times.

At the expiry of T1 after the last sending I+S frame, the MS shall send a supervisory command RR frame with P bit set to 1.

The SS answer in a RR response frame with F bit set to 1 and acknowledging 1 frame.

After the reception of the last RR response the MS shall reset or disconnect the RLP link by sending an SABM (C/R=1, P/F=1) or a DISC (C/R=1) frame.

The SS answer with an UA frame.

The MS is returned to the idle state by clearing of the call.

Expected sequence

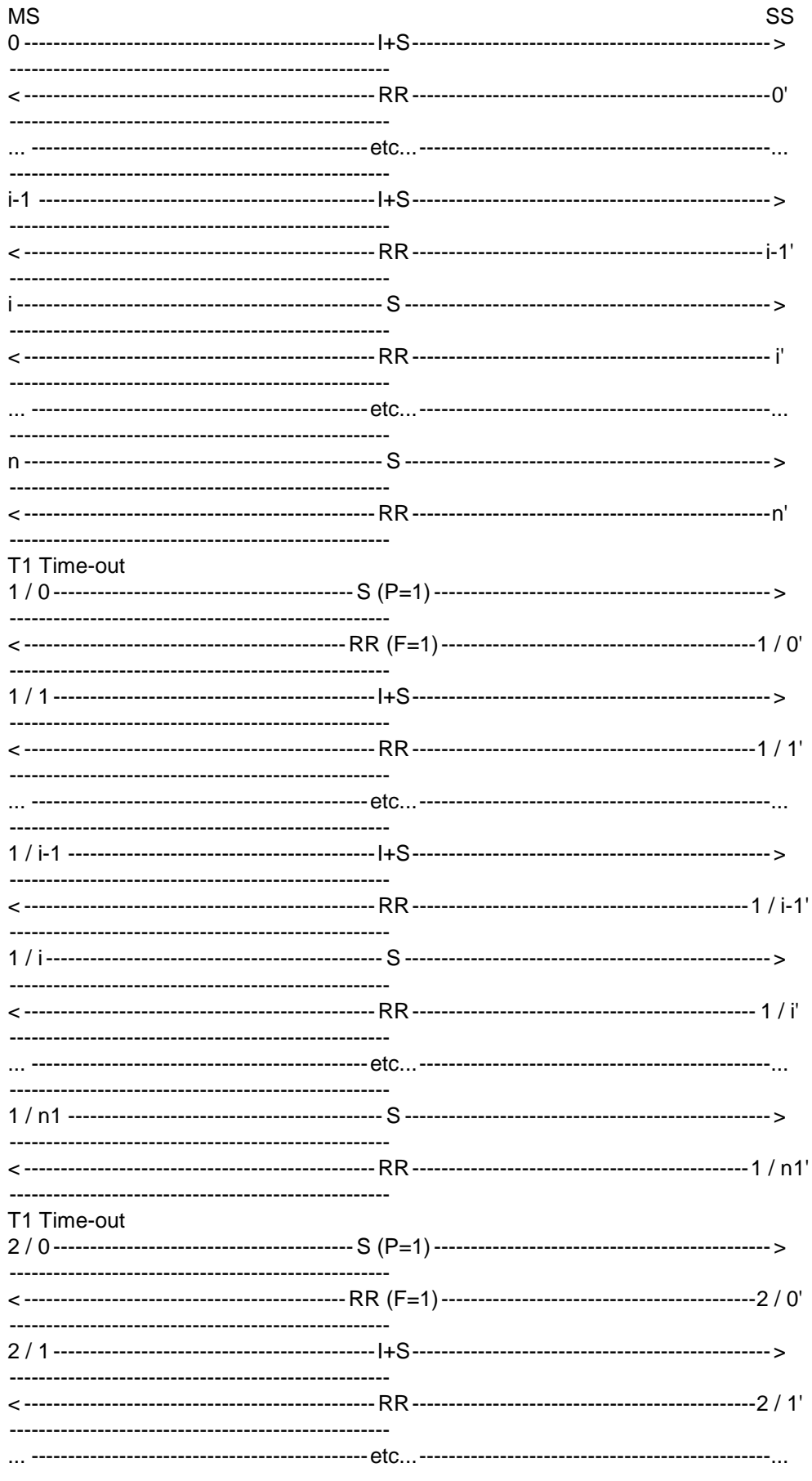

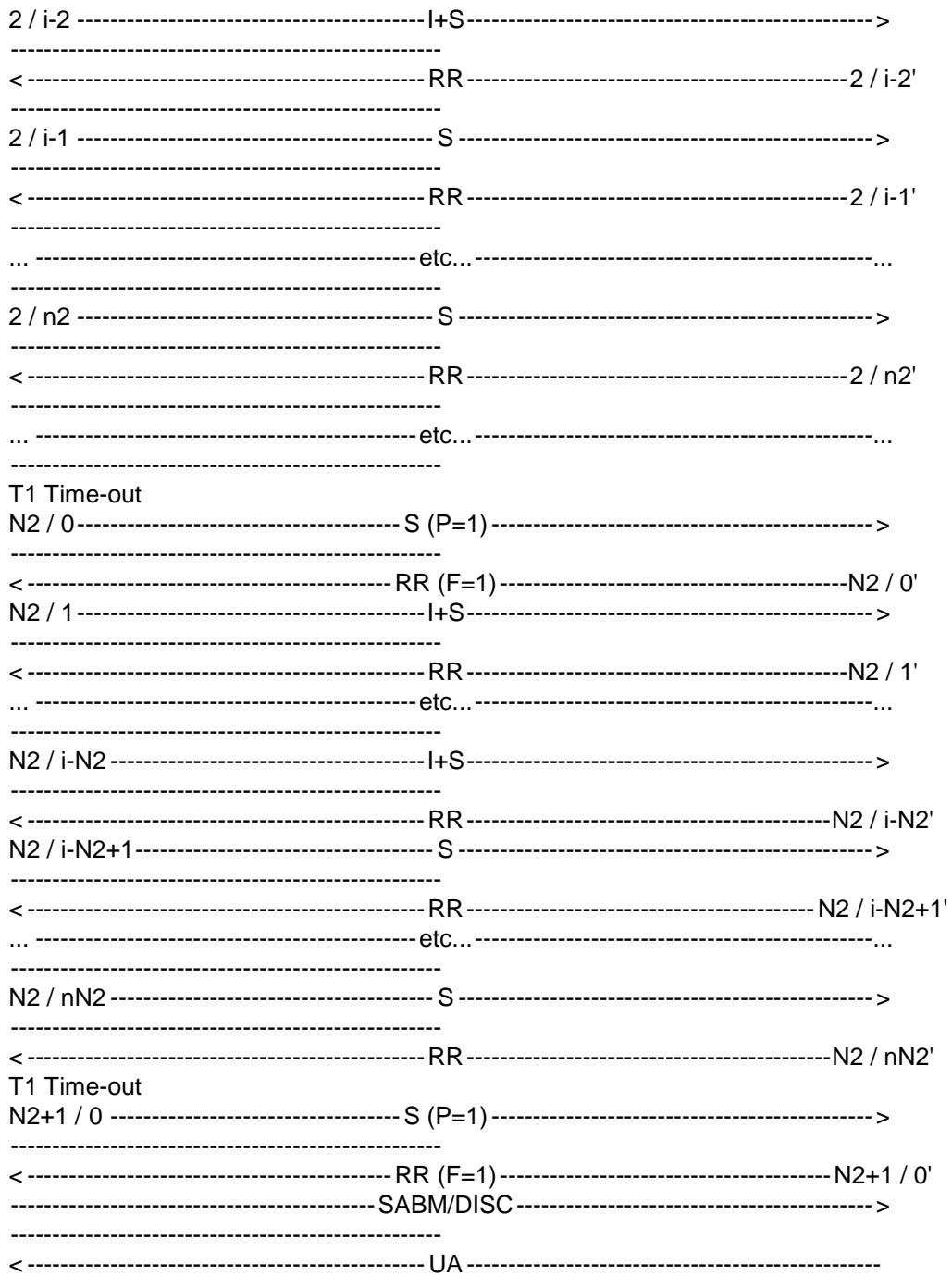

The frames from the SS will be:

0',...,n': One RR frame containing:

$$N(R)=NMS \text{ mod}(62).$$

k / 0': One supervisory RR frame containing:

$$C/R=0,$$

$$P/F=1,$$

$$N(R)=NMS+k \text{ mod}(62).$$

$$k = 1, \dots, N2+1.$$

k / 1',...,k / nk': One RR frame containing:

$$N(R) = NMS + k \text{ mod}(62).$$

$$k = 1, \dots, N2.$$

One UA frame with P/F bit equal to the P/F received.

29.3.2.6.9.5 Test requirements

The frames from the MS shall be:

0,...,i-1: One I+S frame containing:

$$N(S) = NMS, \dots, NMS + i - 1 \text{ mod}(62).$$

i,..., n: The MS sends S frames.

k / 0: The MS stops sending I+S frames. It sends S frames. On T1 Time-out after the last sent I+S frame, the MS sends a S frame containing:

$$C/R = 1,$$

$$P/F = 1.$$

$$k = 1, \dots, N2 + 1.$$

k / 1,..., k / i-k: The MS retransmits the I+S frames containing:

$$N(S) = NMS + k, \dots, NMS + i - 1 \text{ mod}(62).$$

$$k = 1, \dots, N2.$$

k / i-k+1,..., k / nk: The MS sends S frames. k= 1, ..., N2.

The MS shall reset to disconnect the RLP link. It shall send an SABM (C/R=1, P/F=1) or a DISC (C/R=1).

29.3.3 Negotiation of the RLP parameters

29.3.3.1 Negotiation initiated by the SS

29.3.3.1.1 Conformance requirements

The MS shall be able to respond to a negotiation request from the network and to configure its RLP parameters accordingly. It shall do so in ABM mode as well as in ADM mode.

References

GSM 04.22 section 5.2.2.6.

29.3.3.1.2 Test purpose

To test the correct handling of the MS to a received XID frame in ADM or ABM mode.

29.3.3.1.3 Test method

Initial Conditions

System Simulator:

The SS is configured to use default RLP parameters.

Mobile Station:

The MS is configured to use RLP default parameters. The window size from IWF (SS) to MS is called K_{IM} .

The MS is made to establish a MO non transparent data call. In initial conditions MS is in call state U10 ("Call Active") after having sent a CONN_ACK message.

Case a: No negotiation will be initiated by the MS.

Case b: The MS initiates negotiation of RLP default parameters.

NOTE: The MS is allowed to initiate the negotiation of the RLP default parameters, within allowed ranges, defined in GSM 04.22. The MS shall do this in the ADM, after having sent a CONNECT ACKNOWLEDGE message (MO-case) or after having received a CONNECT ACKNOWLEDGE message from the SS (MT-case.)

Related PICS/PIXIT statements

Supported bearer services; characteristics of non-transparent services.

Foreseen final state of the MS

Idle.

Test procedure

Case 1: Testing of the correct handling of the MS to a received XID frame in ADM

Immediately after having received the "CONN_ACK", the SS sends a correct XID frame containing randomly chosen parameters different from the default parameters and supported by the MS.

If the MS initiates a negotiation procedure, before the SS is able to transmit the XID frame (timing conflict), the SS should accept this - XID frame from the MS and start his own negotiation afterwards.

The MS shall respond with a XID frame. If parameters sent in this frame are different from those chosen by the SS, the correct sense of negotiation is checked. The final parameters are noted (T1, T2, N2, K_{IM} (window IWF (SS) -> MS), K_{MI} (window MS -> IWF (SS))).

The MS sends a SABM and the SS answers with an UA. Note: the SABM frame may be sent by the MS before the XID response frame. In such a case, the SS waits for the XID response before sending the UA.

Case 2: Testing of the correct handling of the MS to a received XID frame in ABM

The MS sends a SABM and the SS answer with an UA.

The SS sends a correct XID frame containing parameters different from the default parameters and supported by the MS.

The MS shall respond with a XID frame. If parameters sent in this frame are different from those chosen by the SS, the correct sense of negotiation is checked. The final parameters are noted (T1, T2, N2, K_{IM} (window IWF (SS) -> MS), K_{MI} (window MS -> IWF (SS))).

The SS checks that the MS uses the new parameters determined during the negotiation procedure.

Verification of T2

After optional status bits exchange between the MS and the SS, the SS is configured to send I+S frames with a delay inferior to T1 between each frame. The MS is made to send no user data, it sends only supervisory frame.

The SS sends an I+S frame numbered $N(S)=N_{ss} \bmod(62)$, the MS shall acknowledge this frame within T2.

Verification of K_{IM}

The SS sends an I+S frame numbered $N_{ss}+K_{IM}+1 \bmod(62)$. The MS shall ignore this frame (out of the window), it shall not acknowledge or reject it. This is checked during at least T2.

The SS sends an I+S frame numbered $N(S)=N_{ss}+1 \bmod(62)$, the MS shall acknowledge this frame.

The SS sends an I+S frame numbered $N_{ss}+K_{IM}+1 \bmod(62)$. The MS shall reject all the lost frames numbered $N_{ss}+2 \bmod(62)$ to $N_{ss}+K_{IM} \bmod(62)$. It shall send a REJ or SREJ frame with $N(R)=N_{ss}+2 \bmod(62)$.

If REJ frame is used by the MS, the SS restarts the transmission of I+S frames from frame numbered $N_{ss}+2 \bmod(62)$. The MS shall acknowledge these frames. After having sent at least the frame numbered $N_{ss}+K_{IM}+2 \bmod(62)$, the SS stops sending I+S frames.

If SREJ frame is used by the MS, the SS restarts the transmission of I+S frames from frame numbered $N_{ss}+2 \bmod(62)$. It does send the frame numbered $N_{ss}+K_{IM}+1 \bmod(62)$ a second time. The MS shall acknowledge these frames. After having sent at least the frame numbered $N_{ss}+K_{IM}+2 \bmod(62)$, the SS stops sending I+S frames.

Verification of K_{MI}

The MS is now configured to send continuously I+S frames with a delay inferior to T_1 between each frame.

The MS sends I+S frames, the SS does not acknowledge these frames.

After having sent K_{MI} I+S frames, the MS shall stop sending I+S frames (end of the window).

Verification of T_1

At the expiry of T_1 after the last I+S frame, the MS shall enter in "checkpoint recovery" mode, it shall send a supervisory RR frame with $C=1$ and $P=1$.

The SS does not answer to checkpointing.

Verification of N_2

At the expiry of T_1 after the last RR ($C=1$, $P=1$) frame, the MS shall resend a supervisory RR frame with $C=1$ and $P=1$. The SS does not answer to checkpointing. This is repeated N_2 times.

After N_2 retransmissions of the same RR frame ($C=1$, $P=1$), The MS shall reset or disconnect the RLP link by sending a SABM ($C=1, P=1$) or a DISC ($C=1$) frame. The SS answers with an UA ($R=0$) frame with F bit set to P bit received in SABM or DISC frame.

The MS is returned to the idle state by clearing of the call.

The test is performed for case 1 and 2.

Maximum duration of test

1 minute.

Expected sequence

MS SS

Case 1

optionally:

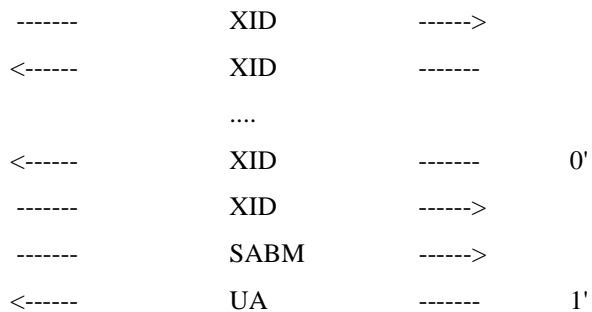

Case 2

optionally:

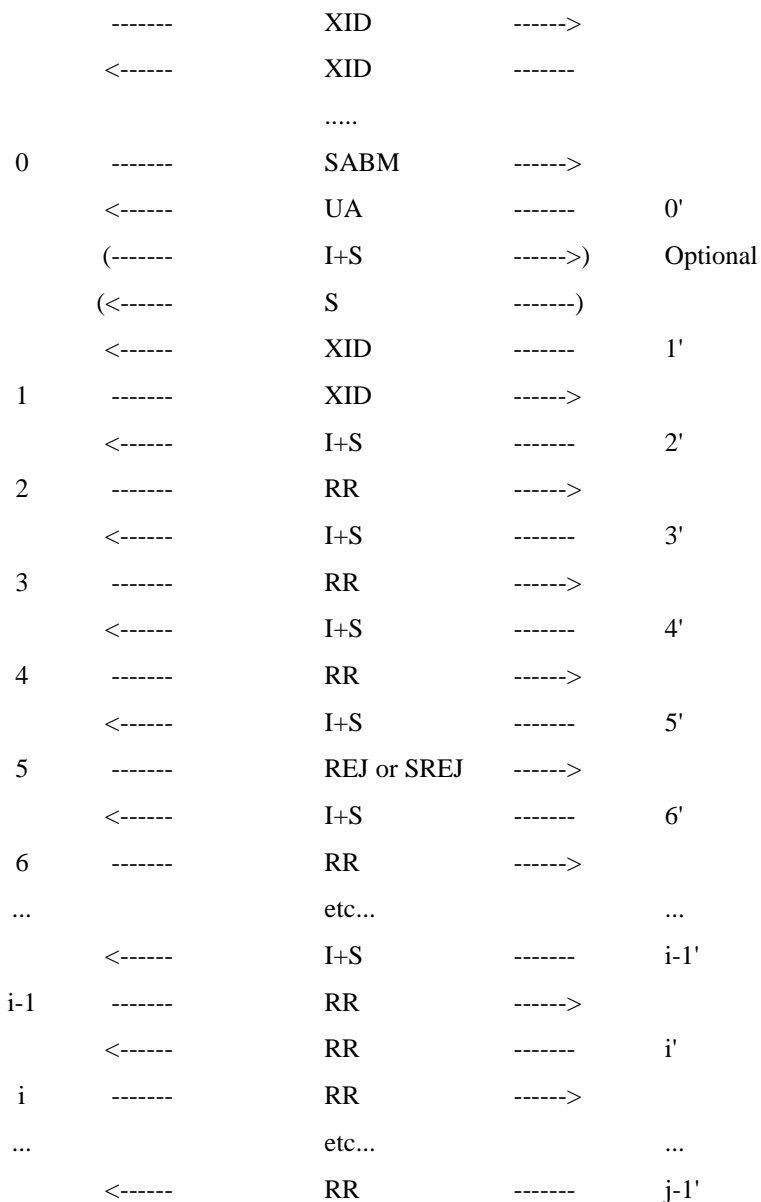

j-1	-----	RR	----->	
j	-----	I+S	----->	
	<-----	RR	-----	j'
...		etc...		...
j+K _{MI} -1	-----	I+S	----->	
	<-----	RR	-----	j+K _{MI} -1'
j+K _{MI}	-----	RR (P=1)	----->	
	<-----	RR	-----	j+K _{MI} '
j+K _{MI} +1	-----	RR (P=1)	----->	
	<-----	RR	-----	j+K _{MI} +1'
...		etc...		...
j+K _{MI} +N ₂	-----	RR (P=1)	----->	
	<-----	RR	-----	j+K _{MI} +N ₂ '
j+K _{MI} +N ₂ +1	-----	SABM / DISC	----->	
	<-----	UA	-----	j+K _{MI} +N ₂ +1'

The frame from the SS will be:

Case 1:

0': One XID frame containing: C=1, P=1.

1': One UA frame containing: R=0, F=1. Note: If SABM is received before the reception of the XID response frame, the SS will wait for the XID before sending the UA frame.

Case 2:

0': One UA frame containing: R=0, F=1.

1': One XID frame containing: C=1, P=1.

2': One I+S frame containing $N(S)=N_{ss} \bmod(62)$, $N(R)=N_{ms} \bmod(62)$.

3': One I+S frame containing $N(S)=N_{ss}+K_{IM}+1 \bmod(62)$, $N(R)=N_{ms} \bmod(62)$.

4': A delay D ($T_2 < D < T_1$) after step 3', one I+S frame containing $N(S)=N_{ss}+1 \bmod(62)$, $N(R)=N_{ms} \bmod(62)$.

5': One I+S frame containing $N(S)=N_{ss}+K_{IM}+1 \bmod(62)$, $N(R)=N_{ms} \bmod(62)$.

If REJ frame is used by the MS:

6',..., $K_{IM}+5'$: One I+S frame containing $N(S)=N_{ss}+2, \dots, N_{ss}+K_{IM}+1 \bmod(62)$, $N(R)=N_{ms} \bmod(62)$.

$K_{IM}+6', \dots, i-1'$: One I+S frame containing $N(S)=N_{ss}+K_{IM}+2, \dots, k-1 \bmod(62)$, $N(R)=N_{ms} \bmod(62)$.

If SREJ frame is used by the MS:

6',..., $K_{IM}+4'$: One I+S frame containing $N(S)=N_{ss}+2, \dots, N_{ss}+K_{IM} \bmod(62)$, $N(R)=N_{ms} \bmod(62)$.

$K_{IM}+5', \dots, i-1'$: One I+S frame containing $N(S)=N_{ss}+K_{IM}+2, \dots, k-1 \bmod(62)$, $N(R)=N_{ms} \bmod(62)$.

The SS stops sending I+S frames.

$i', \dots, j-1'$: One RR frame containing, $N(R)=N_{ms} \bmod(62)$.

$j', \dots, j+K_{MI}-1'$: One RR frame containing $N(R)=N_{ms} \bmod(62)$.

$j+K_{MI}, \dots, j+K_{MI}+N_2$: One RR ($R=0, F=0$) frame containing $N(R)=N_{MS} \bmod (62)$.

$j+K_{MI}+N_2+1$: One UA ($R=0$) frame with F bit set to P bit received in SABM or DISC frame.

Specific message content

The frame from the MS shall be:

Case 1:

0: One XID frame containing: $R=0, F=1$. The MS may changed the RLP parameters. In this case the SS verifies the correct sense of negotiation. The final parameters are noted ($T_1, T_2, N_2, K_{IM}, K_{MI}$).

1: One SABM frame containing: $C=1, P=1$.

NOTE: The MS may send an SABM frame before the XID.

Case 2:

0: One SABM frame containing: $C=1, P=1$.

1: One XID frame containing: $R=0, F=1$. The MS may changed the RLP parameters. In this case the SS verifies the correct sense of negotiation. The final parameters are noted ($T_1, T_2, N_2, K_{IM}, K_{MI}$).

2: One RR frame containing $N(R)=N_{SS}+1 \bmod (62)$ within T_2 .

3: One RR frame containing $N(R)=N_{SS}+1 \bmod (62)$.

4: One RR frame containing $N(R)=N_{SS}+2 \bmod (62)$.

5: One REJ or SREJ frame containing $N(R)=N_{SS}+2 \bmod (62)$.

If REJ frame is used by the MS:

$6, \dots, K_{IM}+5$: One RR frame containing $N(R)=N_{SS}+3, \dots, N_{SS}+K_{IM}+2 \bmod (62)$.

$K_{IM}+6, \dots, i-1$: One RR frame containing $N(R)=N_{SS}+K_{IM}+3, \dots, k \bmod (62)$.

If SREJ frame is used by the MS:

$6, \dots, K_{IM}+3$: One RR frame containing $N(R)=N_{SS}+3, \dots, N_{SS}+K_{IM} \bmod (62)$.

$K_{IM}+4$: One RR frame containing $N(R)=N_{SS}+K_{IM}+2 \bmod (62)$.

$K_{IM}+5, \dots, i-1$: One RR frame containing $N(R)=N_{SS}+K_{IM}+3, \dots, k \bmod (62)$.

$i, \dots, j-1$: One RR frame containing, $N(R)=k \bmod (62)$.

The MS starts sending data.

$j, \dots, j+K_{MI}-1$: One I+S frame containing $N(S)=N_{MS}, \dots, N_{MS}+K_{MI}-1 \bmod (62)$, $N(R)=k \bmod (62)$.

$j+K_{MI}$: T_1 after the last I+S frame sent, one supervisory RR ($C=1, P=1$) frame containing $N(R)=k \bmod (62)$.

$j+K_{MI}+1, \dots, j+K_{MI}+N_2$: At T_1 expiry, one supervisory RR ($C=1, P=1$) frame containing $N(R)=k \bmod (62)$.

$j+K_{MI}+N_2+1$: One SABM ($C=1, P=1$) or DISC ($C=1$) frame.

29.3.3.2 Negotiation initiated by the MS

29.3.3.2.1 Definition and applicability

The XID negotiation procedure allows RLP parameters to be negotiated between peer RLP entities.

This test is only applicable to those MS's which support non-default RLP parameters.

29.3.3.2.2 Conformance requirements

The MS shall be able to initiate a negotiation with the network when its RLP parameters are set to non default values. It shall then configure its RLP parameters accordingly. It shall do so in ABM mode as well as in ADM mode. GSM 04.22, 5.2.2.6.

References

GSM 04.22 section 5.2.2.6.

29.3.3.2.3 Test purpose

To test that the MS initiate the negotiation if RLP parameters are different from default parameters.

29.3.3.2.4 Method of test

Initial Conditions

System Simulator:

The SS is configured to use default RLP parameters.

Mobile Station:

The MS is configured to use RLP arbitrary chosen parameters different from the default parameters.

- 1 - The MS is made to establish a MO non transparent data call. In initial conditions MS is in call state U10 ("Call Active") after having sent a CONN_ACK message.
- 2 - The MS is made to establish a MT non transparent data call. In initial conditions MS is in call state U10 ("Call Active") after having received a CONN_ACK message.

This test is performed for initial conditions 1 and 2.

Once in ABM, the SS shall initiate the transmission of an I+S frame, which will transfer L2RCOP status information between peer L2RCOP entities (SS to MS). The MS may respond with an I+S frame containing L2RCOP status information. The SS shall be capable of initiating this sequence, or responding to an I+S L2RCOP status frame from the MS.

Related PICS/PIXIT statements

Supported bearer services; characteristics of non-transparent services.

Foreseen final state of the MS

Idle.

Test procedure

The MS shall send an XID (C=1, P=1) frame containing a set of RLP parameters different from the default set. The SS answers with XID (R=0, F=1) containing new parameters randomly chosen, the sense of negotiation is correct. Optionally, a renegotiation initiated by the MS should be possible, if the parameters, randomly chosen by the SS are not supported by the MS. In this case, the SS should accept the parameters renegotiated by the MS, if they are within the allowed range defined in GSM 04.22. The final parameters are noted (T1, T2, N2, K_{IM} (window IWF (SS) -> MS), K_M (window MS -> IWF (SS))).

The MS established the ABM mode by sending a SABM (C=1, P=1) frame. The SS answers with a UA (R=0, F=1) frame. The SABM frame may be sent by the MS before the XID. In such a case, the SS answers to the XID after having established the ABM mode (i.e. after having sent the UA).

The SS checks that the MS uses the new parameters determined during the negotiation procedure.

Verification of T2

The SS is configured to send I+S frames with a delay inferior to T1 between each frame. The MS is made to send no user data, it sends only supervisory frame.

The SS sends an I+S frame numbered $N(S)=N_{ss} \bmod(62)$, the MS shall acknowledge this frame within T2.

Verification of K_{IM}

The SS sends an I+S frame numbered $N_{ss}+K_{IM}+1 \bmod(62)$. The MS shall ignore this frame (out of the window), it shall not acknowledge or reject it. This is checked during at least T2.

The SS sends an I+S frame numbered $N(S)=N_{ss}+1 \bmod(62)$, the MS shall acknowledge this frame.

The SS sends an I+S frame numbered $N_{ss}+K_{IM}+1 \bmod(62)$. The MS shall reject all the lost frames numbered $N_{ss}+2 \bmod(62)$ to $N_{ss}+K_{IM} \bmod(62)$. It shall send a REJ or SREJ frame with $N(R)=N_{ss}+2 \bmod(62)$

If REJ frame is used by the MS, the SS restarts the transmission of I+S frames from frame numbered $N_{ss}+2 \bmod(62)$. The MS shall acknowledge these frames. After having sent at least the frame numbered $N_{ss}+K_{IM}+2 \bmod(62)$, the SS stops sending I+S frames.

If SREJ frame is used by the MS, the SS restarts the transmission of I+S frames from frame numbered $N_{ss}+2 \bmod(62)$. It does send the frame numbered $N_{ss}+K_{IM}+1 \bmod(62)$ a second time. The MS shall acknowledge these frames. After having sent at least the frame numbered $N_{ss}+K_{IM}+2 \bmod(62)$, the SS stops sending I+S frames.

Verification of K_{MI}

The MS is now configured to send continuously I+S frames with a delay inferior to T1 between each frame.

The MS sends I+S frames, the SS does not acknowledge these frames.

After having sent K_{MI} I+S frames, the MS shall stop sending I+S frames (end of the window).

Verification of T1

At the expiry of T1 after the last I+S frame, the MS shall enter in "checkpoint recovery" mode, it shall send a supervisory RR frame with C=1 and P=1.

The SS does not answer to checkpointing.

Verification of N2

At the expiry of T1 after the last RR (C=1, P=1) frame, the MS shall resend a supervisory RR frame with C=1 and P=1. The SS does not answer to checkpointing. This is repeated N2 times.

After N2 retransmissions of the same RR frame (C=1, P=1), The MS shall reset or disconnect the RLP link by sending a SABM (C=1,P=1) or a DISC (C=1) frame. The SS answers with an UA (R=0) frame with F bit set to P bit received in SABM or DISC frame.

The MS is returned to the idle state by clearing of the call.

Expected sequence

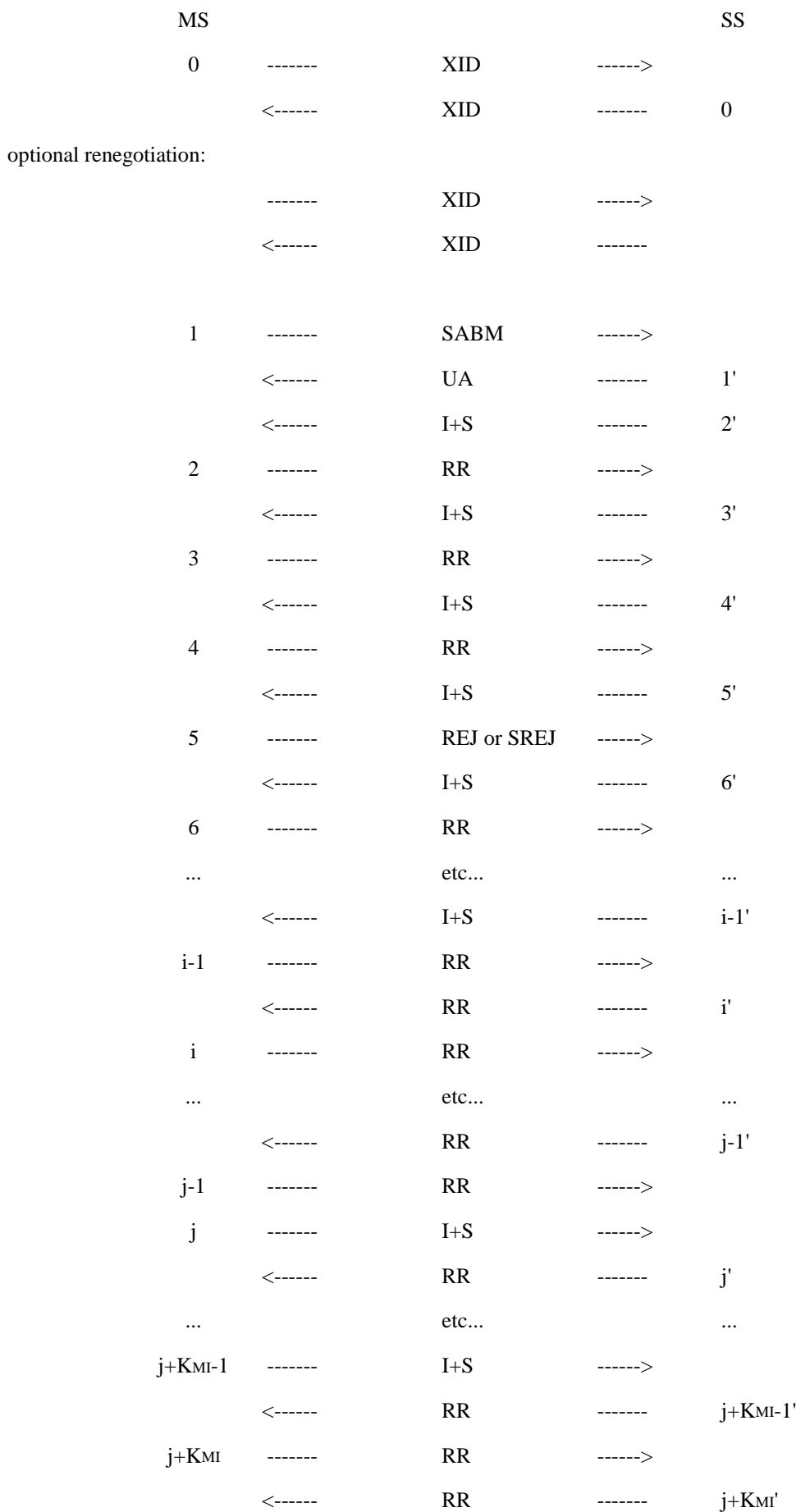

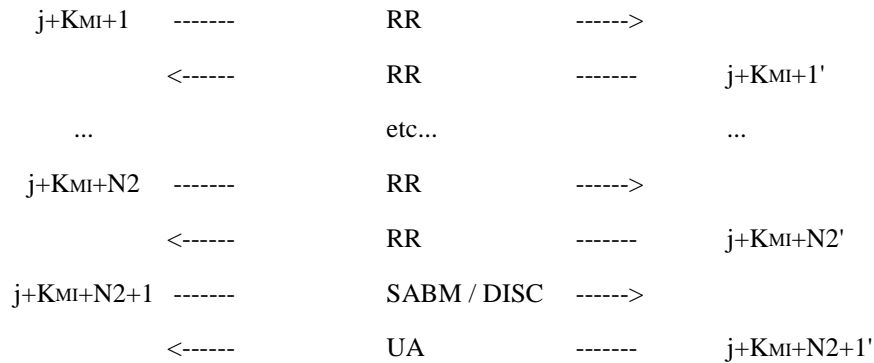

The frame from the SS will be:

0': One XID frame containing: $R=0, F=1$. The RLP parameters are changed by the SS, the sense of negotiation is correct. The final parameters are noted ($T1, T2, N2, K_{IM}, K_{MI}$).

1': One UA frame containing: $R=0, F=1$. Note: If SABM is received before the XID, the SS answers to the XID after having established the ABM mode (i.e. after having sent the UA).

2': One I+S frame containing $N(S)=N_{SS} \bmod(62), N(R)=N_{MS} \bmod(62)$.

3': One I+S frame containing $N(S)=N_{SS}+K_{IM}+1 \bmod(62), N(R)=N_{MS} \bmod(62)$.

4': A delay $D (T2 < D < T1)$ after step 3', one I+S frame containing $N(S)=N_{SS}+1 \bmod(62), N(R)=N_{MS} \bmod(62)$.

5': One I+S frame containing $N(S)=N_{SS}+K_{IM}+1 \bmod(62), N(R)=N_{MS} \bmod(62)$.

If REJ frame is used by the MS:

$6', \dots, K_{IM}+5'$: One I+S frame containing $N(S)=N_{SS}+2, \dots, N_{SS}+K_{IM}+1 \bmod(62), N(R)=N_{MS} \bmod(62)$.

$K_{IM}+6', \dots, i-1'$: One I+S frame containing $N(S)=N_{SS}+K_{IM}+2, \dots, k-1 \bmod(62), N(R)=N_{MS} \bmod(62)$.

If SREJ frame is used by the MS:

$6', \dots, K_{IM}+4'$: One I+S frame containing $N(S)=N_{SS}+2, \dots, N_{SS}+K_{IM} \bmod(62), N(R)=N_{MS} \bmod(62)$.

$K_{IM}+5', \dots, i-1'$: One I+S frame containing $N(S)=N_{SS}+K_{IM}+2, \dots, k-1 \bmod(62), N(R)=N_{MS} \bmod(62)$.

The SS stops sending I+S frames.

$i', \dots, j-1'$: One RR frame containing, $N(R)=N_{MS} \bmod(62)$.

$j', \dots, j+K_{MI}-1'$: One RR frame containing $N(R)=N_{MS} \bmod(62)$.

$j+K_{MI}', \dots, j+K_{MI}+N2'$: One RR ($R=0, F=0$) frame containing $N(R)=N_{MS} \bmod(62)$.

$j+K_{MI}+N2+1'$: One UA ($R=0$) frame with F bit set to P bit received in SABM or DISC frame.

29.3.3.2.5 Test requirements

Specific message content

The frame from the MS shall be:

0: One XID frame containing: $C=1, P=1$.

1: One SABM frame containing: $C=1, P=1$.

NOTE: The MS may send the SABM frame before the XID.

2: One RR frame containing $N(R)=N_{SS}+1 \bmod(62)$ within $T2$.

3: One RR frame containing $N(R)=N_{ss}+1 \bmod (62)$.

4: One RR frame containing $N(R)=N_{ss}+2 \bmod (62)$.

5: One REJ or SREJ frame containing $N(R)=N_{ss}+2 \bmod (62)$.

If REJ frame is used by the MS:

6,..., $K_{IM}+5$: One RR frame containing $N(R)=N_{ss}+3, \dots, N_{ss}+K_{IM}+2 \bmod(62)$.

$K_{IM}+6, \dots, i-1$: One RR frame containing $N(R)=N_{ss}+K_{IM}+3, \dots, k \bmod(62)$.

If SREJ frame is used by the MS:

6,..., $K_{IM}+3$: One RR frame containing $N(R)=N_{ss}+3, \dots, N_{ss}+K_{IM} \bmod(62)$.

$K_{IM}+4$: One RR frame containing $N(R)=N_{ss}+K_{IM}+2 \bmod(62)$.

$K_{IM}+5, \dots, i-1$: One RR frame containing $N(R)=N_{ss}+K_{IM}+3, \dots, k \bmod(62)$.

$i, \dots, j-1$: One RR frame containing, $N(R)=k \bmod (62)$.

The MS starts sending data.

$j, \dots, j+K_{MI}-1$: One I+S frame containing $N(S)=N_{MS}, \dots, N_{MS}+K_{MI}-1 \bmod(62)$, $N(R)=k \bmod (62)$.

$j+K_{MI}$: T1 after the last I+S frame sent, one supervisory RR (C=1, P=1) frame containing $N(R)=k \bmod (62)$.

$j+K_{MI}+1, \dots, j+K_{MI}+N_2$: At T1 expiry, one supervisory RR (C=1, P=1) frame containing $N(R)=k \bmod (62)$.

$j+K_{MI}+N_2+1$: One SABM (C=1, P=1) or DISC (C=1) frame.

29.3.3.3 Collision of XID frames

29.3.3.3.1 Definition and applicability

The XID negotiation procedure allows RLP parameters to be negotiated between peer RLP entities. If a collision of XID frames occurs, the MS shall ignore all XID frames and restart the parameter negotiation on expiry of timer T1.

This test is only applicable to those MS's which support non-default RLP parameters.

29.3.3.3.2 Conformance requirements

The MS shall be able to ignore an XID frame from the network in the case where it has sent a XID frame asking for a negotiation to the network, and to restart the negotiation procedure after expiry of timer T1. GSM 04.22, 5.2.2.6.

References

GSM 04.22 section 5.2.2.6..

29.3.3.3.3 Test purpose

To test that the correct reaction of the MS to a collision of XID frames.

29.3.3.3.4 Method of test

Initial Conditions

System Simulator:

The SS is configured to use default RLP parameters.

Mobile Station:

The MS is configured to use RLP parameters different from the default parameters and arbitrary chosen.

The MS is made to establish a MO non transparent data call. In initial conditions MS is in call state U10 ("Call Active") after having sent a CONN_ACK message.

Once in ABM, the SS shall initiate the transmission of an I+S frame, which will transfer L2RCOP status information between peer L2RCOP entities (SS to MS). The MS may respond with an I+S frame containing L2RCOP status information. The SS shall be capable of initiating this sequence, or responding to an I+S L2RCOP status frame from the MS.

Related PICS/PIXIT statements

Supported bearer services; characteristics of non-transparent services.

Foreseen final state of the MS

Idle.

Test procedure

The MS shall send an XID (C=1, P=1) frame containing a set of RLP parameters different from the default set. The SS sends a XID (C=1, P=1) command frame containing new parameters. After a delay the MS shall resend the same XID that it has previously sent. The SS answers with XID (R=0, F=1) accepting the parameters chosen by the MS. These parameters are noted (T1, T2, N2, K_{IM} (window IWF (SS) -> MS), K_{MI} (window MS -> IWF (SS))).

The MS established the ABM mode by sending a SABM (C=1, P=1) frame. The SS answers with a UA (R=0, F=1) frame. The SABM frame may be sent by the MS at any instant (i.e. just after having received an XID, before having sent the response). In such a case, the SS answers to the XID after having established the ABM mode (i.e. after having sent the UA).

The SS checks that the MS uses the new parameters determined during the negotiation procedure.

Verification of T2

The SS is configured to send I+S frames with a delay inferior to T1 between each frame. The MS is made to send no user data, it sends only supervisory frame.

The SS sends an I+S frame numbered $N(S)=N_{ss} \bmod(62)$, the MS shall acknowledge this frame within T2.

Verification of K_{IM}

The SS sends an I+S frame numbered $N_{ss}+K_{IM}+1 \bmod(62)$. The MS shall ignore this frame (out of the window), it shall not acknowledge or reject it. This is checked during at least T2.

The SS sends an I+S frame numbered $N(S)=N_{ss}+1 \bmod(62)$, the MS shall acknowledge this frame.

The SS sends an I+S frame numbered $N_{ss}+K_{IM}+1 \bmod(62)$. The MS shall reject all the lost frames numbered $N_{ss}+2 \bmod(62)$ to $N_{ss}+K_{IM} \bmod(62)$. It shall send a REJ or SREJ frame with $N(R)=N_{ss}+2 \bmod(62)$.

If REJ frame is used by the MS, the SS restarts the transmission of I+S frames from frame numbered $N_{ss}+2 \bmod(62)$. The MS shall acknowledge these frames. After having sent at least the frame numbered $N_{ss}+K_{IM}+2 \bmod(62)$, the SS stops sending I+S frames.

If SREJ frame is used by the MS, the SS restarts the transmission of I+S frames from frame numbered $N_{ss}+2 \bmod(62)$. It does send the frame numbered $N_{ss}+K_{IM}+1 \bmod(62)$ a second time. The MS shall acknowledge these frames. After having sent at least the frame numbered $N_{ss}+K_{IM}+2 \bmod(62)$, the SS stops sending I+S frames.

Verification of K_{MI}

The MS is now configured to send continuously I+S frames with a delay inferior to T1 between each frame.

The MS sends I+S frames, the SS does not acknowledge these frames.

After having sent K_{MI} I+S frames, the MS shall stop sending I+S frames (end of the window).

Verification of T1

At the expiry of T1 after the last I+S frame, the MS shall enter in "checkpoint recovery" mode, it shall send a supervisory RR frame with C=1 and P=1.

The SS does not answer to checkpointing.

Verification of N2

At the expiry of T1 after the last RR (C=1, P=1) frame, the MS shall resend a supervisory RR frame with C=1 and P=1. The SS does not answer to checkpointing. This is repeated N2 times.

After N2 retransmissions of the same RR frame (C=1, P=1), The MS shall reset or disconnect the RLP link by sending a SABM (C=1,P=1) or a DISC (C=1) frame. The SS answers with an UA (R=0) frame with F bit set to P bit received in SABM or DISC frame.

The MS is returned to the idle state by clearing of the call.

Maximum duration of test

1 minute.

Expected sequence

MS			SS
0	-----	XID ----->	
	<-----	XID	0'
1	-----	XID ----->	
	<-----	XID	1'
2	-----	SABM ----->	
	<-----	UA	2'
	<-----	I+S	3'
3	-----	RR ----->	
	<-----	I+S	4'
4	-----	RR ----->	
	<-----	I+S	5'
5	-----	RR ----->	
	<-----	I+S	6'
6	-----	REJ or SREJ ----->	
	<-----	I+S	7'
7	-----	RR ----->	
...		etc...	...
	<-----	I+S	i-1'
i-1	-----	RR ----->	
	<-----	RR	i'
i	-----	RR ----->	
...		etc...	...
	<-----	RR	j-1'
j-1	-----	RR ----->	
j	-----	I+S ----->	
	<-----	RR	j'
...		etc...	...
j+K _{MI} -1	-----	I+S ----->	
	<-----	RR	j+K _{MI} -1'
j+K _{MI}	-----	RR ----->	
	<-----	RR	j+K _{MI} '
j+K _{MI} +1	-----	RR ----->	
	<-----	RR	j+K _{MI} +1'
...		etc...	...
j+K _{MI} +N2	-----	RR ----->	
	<-----	RR	j+K _{MI} +N2'
j+K _{MI} +N2+1	-----	SABM / DISC ----->	
	<-----	UA	j+K _{MI} +N2+1'

The frame from the SS will be:

- 0': One XID frame containing: C=1, P=1.
- 1': One XID frame containing: R=0, F=1. The RLP parameters are changed by the SS, the sense of negotiation is correct. The final parameters are noted (T1, T2, N2, K_{IM}, K_{MI}).
- 2': One UA frame containing: R=0, F=1. Note: If SABM is received before one of the XID frames, the SS will answer to the XID after having established the ABM mode (i.e. after having sent the UA).
- 3': One I+S frame containing $N(S)=N_{ss} \bmod(62)$, $N(R)=N_{ms} \bmod(62)$.
- 4': One I+S frame containing $N(S)=N_{ss}+K_{IM}+1 \bmod(62)$, $N(R)=N_{ms} \bmod(62)$.
- 5': A delay D ($T_2 < D < T_1$) after step 3', one I+S frame containing $N(S)=N_{ss}+1 \bmod(62)$, $N(R)=N_{ms} \bmod(62)$.
- 6': One I+S frame containing $N(S)=N_{ss}+K_{IM}+1 \bmod(62)$, $N(R)=N_{ms} \bmod(62)$.

If REJ frame is used by the MS:

- 7',..., K_{IM}+6': One I+S frame containing $N(S)=N_{ss}+2, \dots, N_{ss}+K_{IM}+1 \bmod(62)$, $N(R)=N_{ms} \bmod(62)$.
- K_{IM}+7',...,i-1': One I+S frame containing $N(S)=N_{ss}+K_{IM}+2, \dots, k-1 \bmod(62)$, $N(R)=N_{ms} \bmod(62)$.

If SREJ frame is used by the MS:

- 7',..., K_{IM}+5': One I+S frame containing $N(S)=N_{ss}+2, \dots, N_{ss}+K_{IM} \bmod(62)$, $N(R)=N_{ms} \bmod(62)$.
- K_{IM}+6',...,i-1': One I+S frame containing $N(S)=N_{ss}+K_{IM}+2, \dots, k-1 \bmod(62)$, $N(R)=N_{ms} \bmod(62)$.

The SS stops sending I+S frames.

- i',...,j-1': One RR frame containing, $N(R)=N_{ms} \bmod(62)$.
- j',...,j+K_{MI}-1': One RR frame containing $N(R)=N_{ms} \bmod(62)$.
- j+K_{MI}',...,j+K_{MI}+N₂': One RR (R=0, F=0) frame containing $N(R)=N_{ms} \bmod(62)$.
- j+K_{MI}+N₂+1': One UA (R=0) frame with F bit set to P bit received in SABM or DISC frame.

29.3.3.3.5 Test requirements

Specific message content

The frame from the MS shall be:

- 0: One XID frame containing: C=1, P=1.
- 1: After T1(def) expiry, one XID frame containing: C=1, P=1.
- NOTE: The MS may send an SABM frame before the 1st or the 2nd XID frame.
- 2: One SABM frame containing: C=1,P=1.
- 3: One RR frame containing $N(R)=N_{ss}+1 \bmod(62)$ within T2.
- 4: One RR frame containing $N(R)=N_{ss}+1 \bmod(62)$.
- 5: One RR frame containing $N(R)=N_{ss}+2 \bmod(62)$.
- 6: One REJ or SREJ frame containing $N(R)=N_{ss}+2 \bmod(62)$.

If REJ frame is used by the MS:

- 7, ..., K_{IM}+6: One RR frame containing $N(R)=N_{ss}+3, \dots, N_{ss}+K_{IM}+2 \bmod(62)$.

$K_{IM}+7, \dots, i-1$: One RR frame containing $N(R)=N_{SS}+K_{IM}+3, \dots, k \bmod(62)$.

If SREJ frame is used by the MS:

$7, \dots, K_{IM}+4$: One RR frame containing $N(R)=N_{SS}+3, \dots, N_{SS}+K_{IM} \bmod(62)$.

$K_{IM}+5$: One RR frame containing $N(R)=N_{SS}+K_{IM}+2 \bmod(62)$.

$K_{IM}+6, \dots, i-1$: One RR frame containing $N(R)=N_{SS}+K_{IM}+3, \dots, k \bmod(62)$.

$i, \dots, j-1$: One RR frame containing, $N(R)=k \bmod(62)$.

The MS starts sending data.

$j, \dots, j+K_{MI}-1$: One I+S frame containing $N(S)=N_{MS}, \dots, N_{MS}+K_{MI}-1 \bmod(62)$, $N(R)=k \bmod(62)$.

$j+K_{MI}$: T1 after the last I+S frame sent, one supervisory RR (C=1, P=1) frame containing $N(R)=k \bmod(62)$.

$j+K_{MI}+1, \dots, j+K_{MI}+N_2$: At T1 expiry, one supervisory RR (C=1, P=1) frame containing $N(R)=k \bmod(62)$.

$j+K_{MI}+N_2+1$: One SABM (C=1, P=1) or DISC (C=1) frame.

29.3.3.4 Loss of XID frames

29.3.3.4.1 Conformance requirements

The MS shall repeat an XID frame upon expiry of RLP timer T1 if the network has not acknowledged it by a correct XID frame.

References

GSM 04.22 section 5.2.2.6.

29.3.3.4.2 Test purpose

To test that the MS repeats the XID frame if the SS does not answer correctly.

29.3.3.4.3 Test method

Initial Conditions

System Simulator:

The SS is configured to use default RLP parameters.

Mobile Station:

The MS is configured to use RLP parameters different from the default parameters (T1 different from T1(def)).

The MS is made to establish a MO non transparent data call. In initial conditions MS is in call state U10 ("Call Active") after having sent a CONN_ACK message.

Related PICS/PIXIT statements

Supported bearer services; characteristics of non-transparent services.

Foreseen final state of the MS

Idle.

Test procedure

The MS shall send an XID (C=1, P=1) frame containing a set of RLP parameters different from the default set. The SS sends a XID (R=0, F=0) command frame. The MS shall ignore this frame.

After a delay the MS shall resend the same XID that it has previously sent. The SS does not answer.

After a delay the MS shall resend the same XID that it has previously sent. The SS answers with XID (R=0, F=1) accepting the parameters chosen by the MS.

The MS established the ABM mode by sending a SABM (C=1, P=1) frame. The answer with a UA (R=0, F=1) frame. The SABM frame may be sent by the MS at any instant (i.e. just after having received an XID). In such a case, the SS answers to the XID after having established the ABM mode (i.e. after having sent the UA).

The MS is returned to the idle state by clearing of the call.

Maximum duration of test

1 minute.

Expected sequence

MS				SS
0	-----	XID	----->	
	<-----	XID	-----	0'
1	-----	XID	----->	
2	-----	XID	----->	
	<-----	XID	-----	2'
3	-----	SABM	----->	
	<-----	UA	-----	3'

The frame from the SS will be:

0': One XID frame containing: R=0, F=0.

2': One XID frame containing: R=0, F=1. The RLP parameters are accepted by the SS.

3': One UA frame containing: R=0, F=1. Note: If SABM is received before the XID, the SS will answer to the XID after having established the ABM mode (i.e. after having sent the UA).

Specific message content

The frame from the MS shall be:

0: One XID frame containing: C=1, P=1.

1: After T1(def) expiry, one XID frame containing: C=1, P=1.

2: After T1(def) expiry, one XID frame containing: C=1, P=1.

3: One SABM frame containing: C=1,P=1.

NOTE: The MS may send the SABM frame before XID(s), at any moment.

29.3.3.5 Total loss of XID frames

29.3.3.5.1 Definition and applicability

The XID negotiation procedure allows RLP parameters to be negotiated between peer RLP entities. An unsuccessful XID exchange shall be repeated on expiry of T1. After N2 times of unsuccessful repetition, the RLP link shall be disconnected.

This test is only applicable to those MS's which support non-default RLP parameters.

29.3.3.5.2 Conformance requirements

The MS shall not repeat an unacknowledged XID frame more than N2 times. After N2 repetition it shall disconnect the RLP link if it had been connected earlier. GSM04.22, 5.2.2.6.

References

GSM 04.22 section 5.2.2.6.

29.3.3.5.3 Test purpose

To test that the MS repeats the XID frame no more than N2 times, if the SS does not answer correctly.

29.3.3.5.4 Method of test

Initial Conditions

System Simulator:

The SS is configured to use default RLP parameters.

Mobile Station:

The MS is configured to use RLP parameters different from the default parameters.

The MS is made to establish a MO non transparent data call. In initial conditions MS is in call state U10 ("Call Active") after having sent a CONN_ACK message.

Related PICS/PIXIT statements

Supported bearer services; characteristics of non-transparent services.

Foreseen final state of the MS

Idle.

Test procedure

Case a: The MS sends an XID (C=1, P=1) frame in ADM mode

Case b: The MS enters the ABM mode and sends an XID (C=1, P=1) frame after optional status bits exchange between the MS and the SS.

The SS does not answer.

After a delay T1 (def), the MS shall resend the same XID that it has previously sent. The SS does not answer. This step is repeated N2 (def) times.

Case a: After N2 (def) retransmissions the SS waits for $2 * T1$ to ensure that the XID frame is not repeated any more.

Case b: After N2 (def) retransmissions the link shall be disconnected. The MS shall send a DISC (C=1) frame, and the SS answers with a UA (R=0, F equal to the P bit received in the DISC).

The MS is returned to the idle state by clearing of the call.

Maximum duration of test

1 minute.

Expected sequence

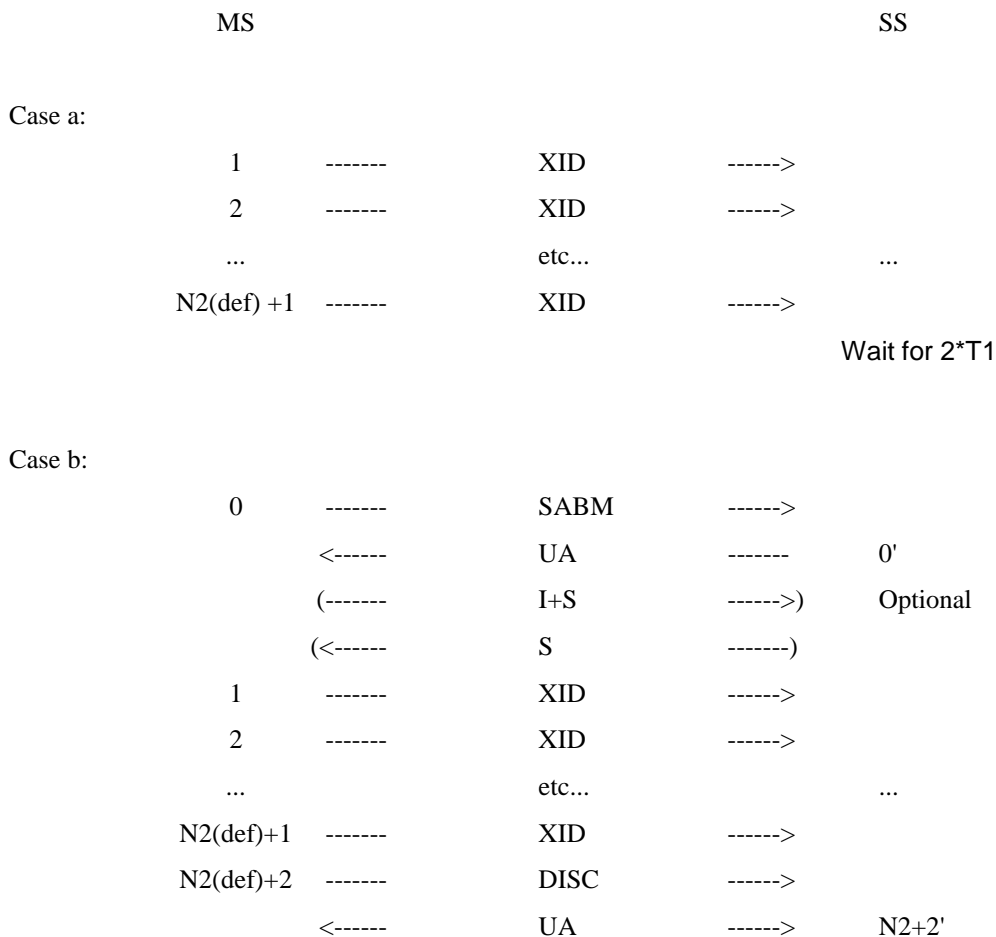

The frame from the SS will be:

0': One UA frame containing: R=0, F=1, if the MS sends a SABM.

N2+2': One UA frame containing: R=0, F equal to P bit received in DISC frame.

29.3.3.5.5 Test requirements

Specific message content

The frame from the MS shall be:

0: The MS may send a SABM frame containing: C=1,P=1. This frame may be sent at any instant. This is not verified.

1: One XID frame containing: C=1, P=1.

2,...,N2(def)+1: After T1 (def) expiry, one XID frame containing: C=1, P=1.

N2(def)+2: If the MS has previously established the ABM mode (SABM/UA exchange), it shall disconnect the link by sending a DISC (C=1) frame.

29.4 Facsimile tests for the transparent network support

29.4.1 General

According to CCITT T.30 a facsimile call can be divided into the following phases:

- Phase A - call establishment procedure;
- Phase B - pre-message procedure (identification and selection of required facilities);
- Phase C - message transmission according to CCITT T.4;
- Phase D - post-message procedure;
- Phase E - call release procedure.

For each phase a single test sequence was drafted, i.e. the verification of the basic procedures of a fax call will at least consist of 5 tests, in order to verify the above described phases.

In the IDLE state the fax adapter, originating or terminating, will send continuously SYNC frames containing the pattern specified in GSM 03.45 (CT105 (see note 2) and 109 (see note 2) are in OFF condition).

For the test of the facsimile data transmission, i.e. the phase C, test chart #2 according to CCITT T.21 should be used.

The T.4/30 messages marked with the '*' sign indicate that for the transmission across the radio interface in case of the BCS phase STATUS frames are used, and in case of the message phase the usage of DATA frames is implied.

Manufacturer-declared fax equipment should be connected to the MS, i.e. where possible a fax adapter and a fax machine Group 3. Measuring devices to monitor the T.4/T.30 protocol, the circuits and the SYNC, STATUS and DATA frames should be provided. Configurations, where no access to the interfaces to monitor the protocol and circuits is possible, might exist.

Abbreviations used:

BC-IE	Bearer Capability Information Element
BCS	Binary Coded Signalling
BCS-REC	BCS Reception State of the FA
BCS-TRA	BCS Transmission State of the FA
CED	Called Station Identification
CFR	Confirmation To Receive
CMM	Channel Mode Modify
CMM ACK	Channel Mode Modify Acknowledge
CNG	Calling Tone
DCD	Data Call Direction
DCS	Digital Command Signal
DIS	Digital Identification Signal
EOM	End Of Message
EOP	End Of Procedure
FA	Fax Adapter
Fax	Facsimile App. or PC-Fax (e.g. fax softw. running on a notebook)
ICM	In-Call Modification

IDLE	Idle State of the FA
MCF	Message Confirmation
MO	Mobile Originating
MPS	Multi Page Signal
MSG-REC	Message Reception State of the FA
MT	Mobile Terminating
RCSD-IE	Reverse Call Setup Direction Information Element
TCF	Training Check Frame
TCH	Traffic Channel
TS 61	Teleservice 61 (alternate speech/fax)
TS 62	Teleservice 62 (automatic fax)

29.4.2 Mobile originated call

29.4.2.1 Call establishment procedure

29.4.2.1.1 Alternate speech / facsimile

29.4.2.1.1.1 Definition and applicability

This test is applicable to an MS supporting TS 61.

29.4.2.1.1.2 Conformance requirement

An MS supporting transparent facsimile group 3 shall perform the ICM and shall support the frames and circuits at the Um-, R- and 2w-interface according to the specifications referred to in the section "Reference".

Reference

GSM 03.45, GSM 07.01, CCITT T.30.

29.4.2.1.1.3 Test purpose

To verify the transition from speech to fax in case of an MS supporting TS 61 and that the circuit and tone handling of the MT and FA is correct.

29.4.2.1.1.4 Method of test

Initial conditions

A TS 61 s/f call is set up. The speech phase is active.

Test procedure

The transition from speech to fax is initiated by manual intervention at both ends of the connection. The data call direction DCD is mobile originated. Upon connection to line the FA turns on CT108.2 (see note 2) as a basic requirement for the transition from speech to fax. Now, within the next 3 seconds the FA has to detect the DCD, which is in this case is mobile originated, i.e. CT105 is set to ON (see note 2) condition. The following ICM procedure via the MODIFY message is carried out by the MT 3 seconds after circuit CT108.2 was set to ON (see note 2) condition. On completion of the ICM procedure the synchronization of the TCH begins and after its completion the MT has to set CT107 to ON (see note 2) condition and the FA has to send the CED tone (see note 2) towards the connected fax. When CT106/109 are set to ON (see note 2) phase A is completed. Then the call is cleared by manual intervention at the MT or the activity progress of the call proceeds to the next phase.

Expected sequence

MS:	SS:
Step	Direction
1	MS-->SS
	Fax: Connect to line (see note 1)
	FA: CT108.2 ON (see note 2)
	Detect DCD
	CT105 ON (see note 2)
	MT: Send MODIFY message -----> Receive MODIFY message
	3 seconds after CT108.2 ON (see note 2)
2	SS-->MS
3	MS<->SS
	TCH Synchronization <-----> Send MODIFY COMPLETE
	MT: CT107 ON (see note 2), when synchronized <-----> TCH Synchronization
	FA: Generate CED (see note 2)
	Fax: Detect CED (see note 2)
4	SS-->MS
	MT: CT106/109 ON (see note 2) <-----> Set X and SB bit in V.110 frame
	FA: Enter BCS-TRA state Enter BCS-REC state

29.4.2.1.1.5 Test requirements

1. The condition of CT108.2 and CT105 is verified (see note 2); CT106, 107, 109 have to be in OFF (see note 2) condition. The MODIFY message has to be sent 3 seconds after circuit CT108.2 has gone to ON condition (see note 2).
2. To be verified that the MT begins the synchronization phase by sending the pattern 1/OFF after the reception of the MODIFY COMPLETE message, that CT107 is turned on (see note 2) by the MT after successful synchronization and that the CED tone (see note 2) is transmitted by the FA after CT107 has gone to ON condition (see note 2).
3. To be verified that CT106 and CT109 are turned on (see note 2), when in the modified V.110 frames received from the SS the X and SB bits are set. The state of the FA shall be verified (-> BCS-TRA).

29.4.2.1.2 Automatic facsimile

29.4.2.1.2.1 Definition and applicability

This test is applicable to an MS supporting TS 62.

29.4.2.1.2.2 Conformance requirement

The MS supporting transparent facsimile group 3 shall perform the call setup procedure and shall support the frames and the circuits at the Um-,R- and 2w-interface according to the specifications referred to in the section "Reference".

Reference

GSM 03.45, GSM 07.01, CCITT T.30.

29.4.2.1.2.3 Test purpose

To verify that the circuit and tone handling of the MT and FA is correct.

29.4.2.1.2.4 Method of test

Initial conditions

The MS, configured for the TS 62 fax call, is updated. Then the call establishment phase A begins.

Test procedure

The FA sets CT108.2 to ON (see note 2) condition and passes the dialling information to the MT. A SETUP message is then sent by the MT towards the SS. When the TCH is available (indicated by the CONNECT message) the synchronization phase begins, i.e. both entities start sending the synchronization pattern 1/OFF. CT106, 107, 109 have to be in OFF condition (see note 2). Upon completion of the synchronization phase the MT sets CT107 to ON condition (see note 2) causing the FA to connect the fax to line. The SS sets CT106 and CT109 to ON at the MT by means of the V.110 X and SB bits. The FA then generates the CED tone (see note 2), which completes phase A. Then the call is cleared by manual intervention at the MT or the activity progress of the call proceeds to the next phase.

Expected sequence

MS:	SS:
Step	Direction
1	MS-->SS
	FA: Fax: Dial
	MT: Pass dialling info, CT108.2 ON (see note 2)
	MT: Send SETUP message
	-----> Receive SETUP message
2	SS-->MS
	<----- Send CONNECT message
3	MS<->SS
	TCH Synchronization
	MT: CT107 ON (see note 2), when synchronized
	<-----> TCH Synchronization
4	SS-->MS
	MT: CT106/109 ON (see note 2)
	FA: Generate CED (see note 2)
	Fax: Detect CED (see note 2)
	<----- Set X and SB bit in V.110 frame
5	FA: Enter BCS-TRA state (see note 3)
	Enter BCS-REC state

29.4.2.1.2.5 Test requirements

1. The condition of CT108.2 (see note 2) is verified and the SETUP message should contain the BC-IE for TS 62.
2. To be verified that at the MT CT106, 107, 109 are in OFF (see note 2) condition, that the MT begins the synchronization phase by sending the pattern 1/OFF and that CT107 (see note 2) is turned on by the MT after successful synchronization.
3. To be verified that CT106 and CT109 are turned on (see note 2), when in the V.110 frames received from the SS the X and SB bits are set and that the FA sends the CED (see note 2) tone towards the fax machine.
4. The state of the FA shall be verified (-> BCS-TRA).

29.4.2.2 Pre-message procedure

29.4.2.2.1 Definition and applicability

This test is applicable to an MS supporting TS 61 and/or TS 62.

29.4.2.2.2 Conformance requirement

The MS supporting transparent facsimile group 3 shall perform the pre-message procedure and shall support the frames and the circuits at the Um-,R- and 2w-interface according to the specifications referred to in the section "Reference".

Reference

GSM 03.45, CCITT T.30.

29.4.2.2.3 Test purpose

To verify the correct handling of the T.30 DIS/DCS/TCF frames.

29.4.2.2.4 Method of test

Initial conditions

The activity progress of the fax call is brought to the beginning of Phase B.

Test procedure

After phase A the FA is in BCS-TRA state and sends SYNC frames. The SS being in BCS-REC state sends the T.30 DIS embedded in STATUS frames indicating its capabilities. The received DIS is checked, if necessary edited by the FA and sent to the fax. Then the FA returns to the idle state. The fax checks whether the indicated capabilities are in line with its own or not, and chooses the capabilities which are supported end-to-end by the connected fax machines by answering with the DCS frame preceded by the preamble. The FA enters the BCS-REC state and the BCS information is transmitted using the STATUS frames. Afterwards the FA returns to the idle state. Upon reception of the training sequence the FA enters the MSG-REC state without waiting for an acknowledge from the SS, i.e. the TCF is conveyed by means of the DATA frames. The FA enters the idle state and sends at least 5 SYNC frames to indicate that the message phase is over. Then the CFR frame is received, i.e. the FA enters the BCS-TRA state and receives the CFR in STATUS frames. Now, phase B is completed and the data transfer phase C begins. Then the call is cleared by manual intervention at the MT or the activity progress of the call proceeds to the next phase.

Expected sequence

MS: Step	Direction		SS:
1	SS-->MS	FA: BCS-TRA Monitor DIS Generate preamble,DIS CT105 OFF (see note 2) IDLE	<----- Send preamble*,DIS*
2	MS-->SS	Fax: Receive preamble,DIS Fax: Send preamble,DCS FA: CT109 ON (see note 2) BCS-REC Monitor DCS Send preamble*,DCS* CT109 OFF (see note 2) IDLE	-----> Receive preamble*,DCS*
3	MS-->SS	Fax: Send training,TCF FA: CT109 ON (see note 2) MSG-REC Send TCF* CT109 OFF (see note 2)	-----> Receive TCF*
4	SS<--MS	FA: CT105 ON (see note 2) BCS-TRA Generate preamble, CFR CT105 OFF (see note 2) IDLE Fax: Receive preamble, CFR	<----- Send preamble*,CFR*

29.4.2.2.5 Test requirements

1. To be verified that SYNC frames are transmitted across the radio interface in BCS-TRA and in the IDLE state and that CT105 is set to OFF (see note 2). The correct generation of the T.30 BCS shall be verified (down-conversion to the BCS speed according to GSM 03.45).
2. The condition of CT109 shall be verified (see note 2); that the DCS is correctly inserted into the STATUS frames and that the IDENT octet contains the BCS-REC identifier. At CT109=OFF (see note 2), the FA returns to the idle state and sends SYNC frames (pattern according to GSM 03.45).
3. To be verified that the FA turns on CT109 (see note 2), enters the MSG-REC state and sends the TCF embedded in DATA frames without waiting for the confirmation that the SS has entered the MSG-TRA state. The ident octet has to be checked (-> MSG-REC). CT109 shall be in OFF condition (see note 2).
4. The condition of CT105 (see note 2) is to be verified. The correct generation of the T.30 BCS shall be checked. In IDLE state SYNC frames have to be sent.

29.4.2.3 Message procedure

29.4.2.3.1 Definition and applicability

This test is applicable to an MS supporting TS 61 and/or TS 62.

29.4.2.3.2 Conformance requirement

The MS supporting transparent facsimile group 3 shall perform the message procedure and shall support the frames and the circuits at the Um-,R- and 2w-interface according the specifications referred to in the section "Reference".

Reference

GSM 03.45, CCITT T.30, CCITT T.4, CCITT T.21.

29.4.2.3.3 Test purpose

To verify the facsimile data transmission phase.

29.4.2.3.4 Method of test

Initial conditions

The activity progress of the fax call is brought to the beginning of Phase C. The ECM shall not be used.

Test procedure

The FA is in IDLE state. The connected fax starts transmitting the fax message. Upon reception of the training sequence the FA enters the MSG-REC state and sends STATUS frames, which contain the ident octet set to MSG-REC, interleaved with SYNC frames to the SS. When the SS has entered the MSG-TRA state, which is indicated to the FA by means of the ident octet set to MSG-TRA, the FA starts sending the fax coded data (received from the connected fax) embedded in DATA frames. When the transmission is finished the FA is again in the idle state for at least 5 SYNC frames to indicate that the message phase is over and Phase D begins. Then the call is cleared by manual intervention at the MT or the activity progress of the call proceeds to the next phase.

29.4.2.4.4 Method of test

Initial conditions

The activity progress of the fax call is brought to the beginning of Phase D. The ECM shall not be used.

Test procedure

The fax sends the preamble followed by the EOP frame. The FA then enters the BCS-REC state after having transmitted at least 5 SYNC frames since the last transition to the idle state and sends the EOP frame embedded in STATUS frames to the SS. The FA enters the idle state again. Upon detection of the BCS-REC identifier octet the BCS-TRA state is entered in order to receive the MCF frame issued by the SS. Then the preamble and the MCF frame are conveyed to the connected fax by the FA. The FA enters the idle state. Phase D of the fax transmission is completed. Then the call is cleared by manual intervention at the MT or the activity progress of the call proceeds to the next phase.

Expected sequence

MS:		SS:	
Step	Direction		

1	MS-->SS	Fax: Send preamble, EOP FA: CT109 ON (see note 2) BCS-REC Send preamble*, EOP* CT109 OFF (see note 2) IDLE	-----> Receive preamble*, EOP*
2	SS-->MS	FA: CT105 ON (see note 2) BCS-TRA Transmit preamble, MCF CT105 OFF (see note 2) IDLE Fax: Receive preamble, MCF	<----- Send preamble*, MCF*

29.4.2.4.5 Test requirements

- To be verified that the FA enters the BCS-REC state and inserts the correct ident octet in the STATUS frames. The up-conversion to the message speed has to be checked.. The condition of CT109 has to be verified (see note 2). The contents of the SYNC frames shall be checked.
- To be verified that the FA enters the BCS-TRA state upon detection of the BCS-REC identifier and that the correct T.30 message is conveyed to the connected fax machine (down-conversion to the BCS speed). The condition of CT105 should be checked (see note 2).

29.4.2.5 Call release procedure

29.4.2.5.1 Definition and applicability

This test is applicable to an MS supporting TS 61 and/or TS 62.

29.4.2.5.2 Conformance requirement

The MS supporting transparent facsimile group 3 shall perform the call release procedure and shall support the frames and the circuits at the Um-,R- and 2w-interface according the specifications referred to in the section "Reference".

Reference

GSM 03.45, CCITT T.30.

29.4.2.5.3 Test purpose

To verify phase E of the facsimile transmission.

29.4.2.5.4 Method of test

Initial conditions

The activity progress of the fax call is brought to the beginning of Phase E.

Test procedure

The fax sends the preamble followed by the DCN frame. The FA then enters the BCS-REC state and sends the DCN frame embedded in STATUS frames to the SS. The FA enters the IDLE state again. CT108.2 will go OFF condition (see note 2) and after 200ms CT109 will go to OFF condition (see note 2) too. The MT then sends the DISC message and the call is cleared.

Expected sequence

MS:		SS:	
Step	Direction		

1	MS-->SS	Fax: Send preamble, DCN	
		FA: CT109 ON (see note 2)	
		BCS-REC	
		CT108.2 OFF (see note 2)	
		Transmit preamble*, DCN*	
		CT109 OFF (see note 2)	-----> Receive preamble*, DCN*
		after 200 ms	
		IDLE	
		MT: Send DISC message	-----> Receive DISC message

29.4.2.5.5 Test requirements

To be verified that CT108.2 is turned off (see note 2) and that CT109 is set to OFF (see note 2) 200ms after the DCN frame has been sent. The contents of the STATUS frames including the ident octet has to be checked (up-conversion to the message speed according to GSM 03.45). The MT shall send the DISC message.

29.4.2.6 CTC processing - 4th PPR for the same block

29.4.2.6.1 Definition and applicability

This test is applicable to an MS supporting TS 61 and/or TS 62. The FA and the facsimile device have to support the error correction mode.

29.4.2.6.2 Conformance requirement

The MS supporting transparent facsimile group 3 shall perform the CTC processing procedure and shall support the frames and the circuits at the Um-,R- and 2w-interface according the specifications referred to in the section "Reference".

Reference

GSM 03.45, CCITT T.30.

29.4.2.6.3 Test purpose

To verify phase D of the facsimile transmission in case of a 4th PPR for the same block.

29.4.2.6.4 Method of test

Initial conditions

The activity progress of the fax call is brought to the beginning of Phase C. The ECM shall be used. The fax transmission shall start a speed of 9,6 kBit/s.

Test procedure

The fax sends the preamble followed by the PPS-NULL(0,0) frame. The FA then enters the BCS-REC state and sends the PPS* frame embedded in STATUS frames to the SS. The SS responds with the PPR* frame requesting corrupted frames to be retransmitted. This test sequence is repeated 4 times causing the fax machine to send the CTC frame which indicates the fallback bit rate of 7 200 kBit/s. The FA sends the CTC* after recognizing the new message speed to the SS. The SS responds with the CTR* frame and the fax machine retransmits the corrupted frames which are inserted into DATA frames by the FA. After every third DATA frame the FA has to insert a SYNC frame. After the retransmission, the fax machine sends the PPS-NULL(0,0) which is answered by the SS with the MCF* frame. Phase D of the fax transmission is completed. Then the call is cleared by manual intervention at the MT or the activity progress of the call proceeds to the next phase.

Expected sequence

MS:	SS:
Step	Direction
1	MS-->SS
	Fax: Send training, fax message
	FA: CT109 ON (see note 2)
	MSG-REC
	Send fax message*
	"
	"
	"
	CT109 OFF (see note 2)
	IDLE
2	MS-->SS
	FA: Send at least
	5 SYNC frames
3	MS-->SS
	Fax: Send preamble, PPS-NULL
	FA: CT109 ON (see note 2)
	BCS-REC
	Send preamble*, PPS-NULL*
	CT109 OFF (see note 2)
	IDLE
4	SS-->MS
	FA: CT105 ON (see note 2)
	BCS-TRA
	Transmit preamble, PPR
	CT105 OFF (see note 2)
	IDLE
	Fax: Receive preamble, PPR
5	Repeat steps 1 to 4 four times
6	MS-->SS
	Fax: Send preamble, CTC
	FA: CT109 ON (see note 2)
	BCS-REC
	Monitor CTC
	Send preamble*, CTC*
	CT109 OFF (see note 2)
	IDLE

7	SS-->MS	FA: CT105 ON (see note 2) BCS-TRA Transmit preamble, CTR CT105 OFF (see note 2) IDLE	<----- Send preamble*, CTR*
8	MS-->SS	Fax: Receive preamble, CTR Fax: Send training, fax message FA: CT109 ON (see note 2) MSG-REC Send fax message* " " " CT109 OFF (see note 2) IDLE	-----> Receive fax message* " " "
9	MS-->SS	FA: Send at least 5 SYNC frames	-----> Receive SYNC frames
10	MS-->SS	Fax: Send preamble, PPS-NULL FA: CT109 ON (see note 2) BCS-REC Send preamble*, PPS-NULL* CT109 OFF (see note 2) IDLE	-----> Receive preamble*, PPS-NULL*
11	SS-->MS	FA: CT105 ON (see note 2) BCS-TRA Transmit preamble, MCF CT105 OFF (see note 2) IDLE Fax: Receive preamble, MCF	<----- Send preamble*, MCF*

29.4.2.6.5 Test requirement

It shall be verified that the FA transmits 1 SYNC frame every 3 DATA frames.

29.4.2.7 Transition from Facsimile to Speech - Procedure interrupt generated by receiving station

29.4.2.7.1 Definition and applicability

This test is applicable to an MS supporting TS 61.

29.4.2.7.2 Conformance requirement

The MS supporting transparent facsimile group 3 shall perform the ICM procedure and shall support the frames and the circuits at the Um-,R- and 2w-interface according the specifications referred to in the section "Reference".

Reference

GSM 03.45, CCITT T.30.

29.4.2.7.3 Test purpose

To verify the transition from fax to speech in case of an MS supporting TS 61.

29.4.2.7.4 Method of test

Initial conditions

The activity progress of the fax call is brought to phase C (message phase). The ECM shall not be used.

Test procedure

During the message phase a procedure interrupt is generated by the SS, which is executed as soon as phase D is entered. The SS then sends the PIP frame causing an alert at the mobile side. When the operator at the mobile side goes on line the PRI-Q frame is generated and results in an alarm at the SS side. The operator at this side going on line completes the PRI handshaking by causing the PIP frame to be sent. Upon completion of the PRI handshaking the MT executes the MODIFY procedure, which leads to the speech phase. Then the call is cleared by manual intervention at the MT or the facsimile phase maybe reselected.

Expected sequence

MS:		SS:	
Step	Direction		
1	Message Procedure (as described above)		Operator intervention requested
2	MS-->SS	Fax: Send preamble, EOP FA: CT109 ON (see note 2) BCS-REC Send preamble*, EOP* CT109 OFF (see note 2) IDLE	-----> Receive preamble*, EOP*
3	SS-->MS	FA: CT105 ON (see note 2) BCS-TRA Transmit preamble, PIP CT105 OFF (see note 2) IDLE Fax: Receive preamble, PIP Alert operator	<----- Send preamble*, PIP*
4	MS-->SS	Operator goes on line Fax: Send preamble, PRI-EOP FA: CT109 ON (see note 2) BCS-REC Send preamble*, PRI-EOP* CT109 OFF (see note 2) IDLE MT: CT106/109 OFF (see note 2)	-----> Receive preamble*, PRI-EOP* Alert operator
5	SS-->MS	FA: CT105 ON (see note 2) BCS-TRA Transmit preamble, PIP CT105 OFF (see note 2) IDLE Fax: Receive preamble, PIP	<----- Operator goes on line Send preamble*, PIP*
6	MS-->SS	FA: CT108.2 OFF (see note 2) MT: Send MODIFY message CT107 OFF (see note 2)	-----> Receive MODIFY m. <----- Send MODIFY COMPLETE

SPEECH PHASE

29.4.2.7.5 Test requirements

1. To be verified that CT106/109 are in OFF (see note 2) condition.
2. To be verified that CT108.2 goes to OFF (see note 2) upon completion of the PRI handshaking, that this transition to OFF triggers the MODIFY message to be sent and that the reception of the MODIFY COMPLETE message causes CT107 to be set to OFF (see note 2) condition by the MT. In addition the availability of the speech channel shall be checked.

29.4.2.8 Transition from Facsimile to Speech - Procedure interrupt generated by transmitting station

29.4.2.8.1 Definition and applicability

This test is applicable to an MS supporting TS 61.

29.4.2.8.2 Conformance requirement

The MS supporting transparent facsimile group 3 shall perform the ICM procedure and shall support the frames and the circuits at the Um-,R- and 2w-interface according the specifications referred to in the section "Reference".

Reference

GSM 03.45, CCITT T.30.

29.4.2.8.3 Test purpose

To verify the transition from fax to speech in case of an MS supporting TS 61.

29.4.2.8.4 Method of test

Initial conditions

The activity progress of the fax call is brought to phase C (message phase). The ECM shall not be used.

Test procedure

During the message phase a procedure interrupt is generated at the MS side, which is executed as soon as phase D is entered. The fax then sends the PRI-EOP frame causing an alert at the SS side. When the operator at the SS side goes on line the PIP frame is generated and results in an alarm at the MS side. The operator at this side going on line completes the PRI handshaking by causing the PRI-EOP frame to be sent. Upon completion of the PRI handshaking the MT executes the MODIFY procedure, which leads to the speech phase. Then the call is cleared by manual intervention at the MT or the facsimile phase maybe reselected.

Expected sequence

MS:	Direction	SS:

1	Message Procedure (as described above) Operator intervention requested	
2	MS-->SS Fax: Send preamble, PRI-EOP FA: CT109 ON (see note 2) BCS-REC Send preamble*, PRI-EOP* CT109 OFF (see note 2) IDLE	-----> Receive preamble*, PRI-EOP*
3	SS-->MS FA: CT105 ON (see note 2) BCS-TRA Transmit preamble, PIP CT105 OFF (see note 2) IDLE Fax: Receive preamble, PIP Alert operator	<----- Send preamble*, PIP*
4	MS-->SS Operator goes on line MT: CT106/109 OFF (see note 2) Fax: Send preamble, PRI-EOP FA: CT109 ON (see note 2) BCS-REC Send preamble*, PRI-EOP* CT109 OFF (see note 2) IDLE	-----> Receive preamble*, PRI-EOP*
5	MS-->SS FA: CT108.2 OFF (see note 2) MT: Send MODIFY message CT107 OFF (see note 2)	-----> Receive MODIFY m. <----- Send MODIFY COMPLETE
SPEECH PHASE		

29.4.2.8.5 Test requirements

1. To be verified that CT106/109 are in OFF (see note 2) condition.
2. To be verified that CT108.2 goes to OFF (see note 2) upon completion of the PRI handshaking, that this transition to OFF triggers the MODIFY message to be sent and that the reception of the MODIFY COMPLETE message causes CT107 to be set to OFF (see note 2) condition by the MT. In addition the availability of the speech channel shall be checked.

29.4.2.9 Quality check

29.4.2.9.1 Definition and applicability

This test is applicable to all configurations supporting transparent facsimile group 3.

29.4.2.9.2 Conformance requirement

The configuration supporting transparent facsimile group 3 shall decode the T.4 coding and shall generate a document.

Reference

GSM 03.45, CCITT T.21, CCITT T.4.

29.4.2.9.3 Test purpose

To verify the quality of the received document.

29.4.2.9.4 Method of test

Initial conditions

The document has been received at the called side.

Test procedure

The quality of the received document at the SS side shall be checked.

29.4.2.9.5 Test requirement

The contents of the transmitted and the received document shall be the same.

29.4.3 Mobile terminated call

29.4.3.1 Call Establishment Procedure

29.4.3.1.1 Alternate Speech/Facsimile

29.4.3.1.1.1 DCD Mobile Terminated

29.4.3.1.1.1.1 Definition and applicability

This test is applicable to an MS supporting TS 61.

29.4.3.1.1.1.2 Conformance requirement

The MS supporting transparent facsimile group 3 shall perform the ICM procedure and shall support the frames and the circuits at the Um-,R- and 2w-interface according the specifications referred to in the section "Reference".

Reference

GSM 03.45, CCITT T.30

29.4.3.1.1.1.3 Test purpose

To verify the transition from speech to fax in case of an MS supporting TS 61 and that the circuit and tone handling of the MT and FA is correct in case of an MT DCD.

29.4.3.1.1.1.4 Method of test

Initial conditions

A TS 61 s/f call is set up. The speech phase is active.

Test procedure

The transition from speech to fax is initiated by manual intervention at both ends of the connection, i.e. the data call direction DCD is mobile terminated. Upon connection to line the FA turns on CT108.2 (see note 2) as a basic requirement for the transition from speech to fax. Now, within the next 3 seconds the FA has to detect the DCD, which is in this case mobile terminated, i.e. CT105 is set to OFF condition (see note 2). The following ICM procedure via the MODIFY message is carried out by the MT 3 seconds after circuit CT108.2 (see note 2) was set to ON condition. On completion of the ICM the synchronization of the TCH begins and after its completion the MT has to set CT107 to ON condition (see note 2). When CT106/109 are set to ON (see note 2) phase A is completed. Then the call is cleared by manual intervention at the MT or the activity progress of the call proceeds to the next phase.

Expected sequence

MS:	SS:		
Step	Direction		
1	MS-->SS	Fax: Connect to line (see note 1)	Connect to line (see note 1)
		FA: CT108.2 ON (see note 2)	
		Detect DCD	
		CT105 OFF (see note 2)	
		MT: Send MODIFY message	-----> Receive MODIFY message
		3 seconds after CT108.2 ON (see note 2)	
2	SS-->MS		<----- Send MODIFY COMPLETE
3	MS<->SS	TCH Synchronization	<----> TCH Synchronization
		MT: CT107 ON (see note 2), when synchronized	
4	SS-->MS		<----- Set X and SB bit in V.110 frame
		MT: CT106/109 ON (see note 2)	
		FA: Enter BCS-REC state	Enter BCS-TRA state

29.4.3.1.1.1.5 Test requirements

1. The condition of CT108.2 and CT105 is verified (see note 2); CT106, 107, 109 have to be in OFF (see note 2) condition. The MODIFY message has to be sent 3 seconds +/- 10% after circuit CT108.2 has gone to ON (see note 2) condition.
2. The RCSD-IE shall not be included in the MODIFY message.
3. To be verified that the MT begins the synchronization phase by sending the pattern 1/OFF after the reception of the MODIFY COMPLETE message, that CT107 is turned on (see note 2) by the MT after successful synchronization.
4. To be verified that CT106 and CT109 are turned on (see note 2), when in the V.110 frames received from the SS the X and SB bits are set. The state of the FA shall be verified (->BCS-REC).

29.4.3.1.1.2 DCD mobile originated

29.4.3.1.1.2.1 Definition and applicability

This test is applicable to an MS supporting TS 61.

29.4.3.1.1.2.2 Conformance requirement

The MS supporting transparent facsimile group 3 shall perform the ICM procedure and shall support the frames and the circuits at the Um-,R- and 2w-interface according the specifications referred to in the section "Reference".

Reference

GSM 03.45, CCITT T.30.

29.4.3.1.1.2.3 Test purpose

To verify the transition from speech to fax in case of an MS supporting TS 61 and that the circuit and tone handling of the MT and FA is correct in case of an MO DCD.

29.4.3.1.1.2.4 Method of test

Initial conditions

A TS 61 s/f call is set up. The speech phase is active.

Test procedure

The transition from speech to fax is initiated by manual intervention at both ends of the connection, i.e. the data call direction DCD is mobile originated. Upon connection to line the FA turns on CT108.2 (see note 2) as a basic requirement for the transition from speech to fax. Now, within the next 3 seconds the FA has to detect the DCD, which is in this case mobile originated, i.e. CT105 is set to ON condition (see note 2), indicating that the MT has to include the RCSD-IE in the MODIFY message. The following ICM procedure via the MODIFY message is carried out by the MT 3 seconds after circuit CT108.2 (see note 2) was set to ON condition. On completion of the ICM the synchronization of the TCH begins and after its completion the MT has to set CT107 to ON condition (see note 2). When CT106/109 are set to ON (see note 2), phase A is completed. Then the call is cleared by manual intervention at the MT or the activity progress of the call proceeds to the next phase.

Expected sequence

MS: Step	Direction		SS:
1	MS-->SS	Fax: Connect to line (see note 1) FA: CT108.2 ON (see note 2) Detect DCD CT105 ON (see note 2) MT: Send MODIFY message with RCSD-IE 3 seconds after CT108.2 ON (see note 2)	Connect to line (see note 1) Receive MODIFY message
2	SS-->MS		Send MODIFY COMPLETE with RCSD-IE
3	MS<->SS	TCH Synchronization MT: CT107 ON (see note 2), when synchronized FA: Generate CED (see note 2) Fax: Detect CED (see note 2)	TCH Synchronization
4	SS-->MS	MT: CT106/109 ON (see note 2) FA: Enter BCS-TRA state	Set X and SB bit in modified V.110 frame Enter BCS-REC state

29.4.3.1.1.2.5 Test requirements

1. The condition of CT108.2 and CT105 is verified (see note 2); CT106, 107, 109 have to be in OFF (see note 2) condition.
2. The MODIFY message containing the RCSD-IE has to be sent 3 seconds +/- 10% after circuit CT108.2 has gone to ON (see note 2) condition.
3. To be verified that the MT begins the synchronization phase by sending the pattern 1/OFF after the reception of the MODIFY COMPLETE message, that CT107 is turned on (see note 2) by the MT after successful synchronization. The CED (see note 2) tone has to be transmitted by the FA.
4. To be verified that CT106 and CT109 are turned on (see note 2), when in the modified V.110 frames received from the SS the X and SB bits are set. The state of the FA shall be verified (-> BCS-TRA).

29.4.3.1.2 Automatic facsimile

29.4.3.1.2.1 Definition and applicability

This test is applicable to an MS supporting TS 62.

29.4.3.1.2.2 Conformance requirement

The MS supporting transparent facsimile group 3 shall perform the call setup procedure and shall support the frames and the circuits at the Um-,R- and 2w-interface according to the specifications referred to in the section "Reference".

Reference

GSM 03.45, GSM 07.01, CCITT T.30.

29.4.3.1.2.3 Test purpose

To verify that the circuit and tone handling of the MT and FA is correct.

29.4.3.1.2.4 Method of test

Initial conditions

The MS, configured for the fax call, is updated. Then the call establishment phase begins.

Test procedure

The SS will send the SETUP message causing CT125 (see note 2) going to ON condition at the MT. The FA then sends ring current (see note 2) to the fax machine, which will connect to line. The FA sets CT108.2 (see note 2) to ON condition which causes the MT to send the CONNECT message towards the SS. When the TCH is available (indicated by the CONNECT ACK message) the synchronization phase begins, i.e. both entities start sending the synchronization pattern 1/OFF. CT106, 107, 109 have to be in OFF (see note 2) condition. Upon completion of the synchronization phase the MT sets CT107 (see note 2) to ON condition causing the FA to send the CNG tone (see note 2) while the SS turns on CT108.2 causing the CED tone to be sent. Then the SS sets CT106 and 109 to ON (see note 2) at the MT by means of the modified V.110 X and SB bits, which completes Phase A. Then the call is cleared by manual intervention at the MT or the activity progress of the call proceeds to the next phase.

Expected sequence

MS: Step	Direction		SS:
1	SS-->MS		<----- Send SETUP message
		MT: CT125 ON (see note 2)	
		FA: Cause ring current to flow (see note 2)	
2	MS-->SS	Fax: Connect to line (see note 1)	
		FA: CT108.2 ON (see note 2)	
		MT: Send CONNECT message	-----> Receive CONNECT message
3	SS-->MS		Send CONN ACK message
4	MS<->SS	TCH Synchronization	<-----> TCH Synchronization
		MT: CT107 ON (see note 2), when completed	
		FA: Generate CNG (see note 2)	
		Fax: Receive CNG (see note 2)	
5	SS-->MS		<----- Set X and SB bit in modified V.110 frame
		MT: CT106/109 ON (see note 2)	
6		FA: Enter BCS-REC state	Enter BCS-TRA state

29.4.3.1.2.5 Test requirements

1. The condition of CT125 (see note 2) shall be verified.
2. CT108.2 to be verified (see note 2) and the CONNECT message has to be sent by the MT.
3. To be verified that at the MT CT106, 107, 109 are in OFF (see note 2) condition, that the MT begins the synchronization phase by sending the pattern 1/OFF, that CT107 is turned on (see note 2) by the MT after successful synchronization and that the CNG tone (see note 2) is sent.
4. It shall be verified that CT106 and CT109 are turned on (see note 2), when in the modified V.110 frames received from the SS the X and SB bits are set.
5. The state of the FA shall be verified (-> BCS-REC).

29.4.3.2 Pre-message procedure

29.4.3.2.1 Definition and applicability

This test is applicable to an MS supporting TS 61 and/or TS 62.

29.4.3.2.2 Conformance requirement

The MS supporting transparent facsimile group 3 shall perform the pre-message procedure and shall support the frames and the circuits at the Um-,R- and 2w-interface according to the specifications referred to in the section "Reference".

Reference

GSM 03.45, CCITT T.30.

29.4.3.2.3 Test purpose

To verify the correct handling of the T.30 DIS/DCS/TCF frames.

29.4.3.2.4 Method of test

Initial conditions

The activity progress of the fax call is brought to the beginning of Phase B. The fax transmission shall start using a speed of 9,6 kBit/s.

Test procedure

After phase A the FA being in BCS-REC state, sends the DIS* frame in order to indicate the capabilities of the connected fax and the FA and returns to the idle state. The SS's answer to the DIS is the DCS*. Upon detection of the BCS-REC identifier the FA enters the BCS-TRA state, receives the DCS* and transmits the DCS to the fax. After being for 75 ± 20 ms in IDLE state the FA autonomously enters the MSG-TRA state and begins transmitting the training sequence towards the fax without being triggered by the remote FA/SS. Meanwhile the SS sends the TCF*, which is buffered by the FA. When the training is done the FA transmits the buffered TCF towards the fax. Then the CFR* frame is transmitted to the SS. Now, phase B is completed and the data transfer phase C begins. Then the call is cleared by manual intervention at the MT or the call activity progress proceeds to the next phase.

Expected sequence

MS: Step	Direction			SS:
1	MS-->SS	Fax: Send preamble,DIS FA: BCS-REC Filter DIS Send preamble*,DIS* CT109 OFF (see note 2) IDLE	----->	Receive preamble*,DIS*
2	SS-->MS	FA: CT105 ON (see note 2) BCS-TRA Monitor DCS Transmit preamble,DCS CT105 OFF (see note 2) IDLE	<-----	Send preamble*,DCS*
3	SS-->MS	Fax: Receive preamble,DCS FA: CT105 ON (see note 2) MSG-TRA Initiate training after 75 ms +-20 ms in IDLE Transmit TCF CT105 OFF (see note 2) IDLE	<-----	Send TCF*
4	MS-->SS	Fax: Receive training,TCF Send preamble, CFR FA: CT109 ON (see note 2) BCS-REC Send preamble*,CFR* CT109 OFF (see note 2) IDLE	----->	Receive preamble*,CFR*

29.4.3.2.5 Test requirements

1. To be verified that the DIS is filtered and that the correct up-conversion to the message speed is applied. CT109 should go to OFF (see note 2).
2. The DCS shall indicate a message speed of 7 200 bit/s and the down-conversion to the BCS speed shall be verified.
3. The FA, after the reception of the DCS, sends SYNC frames for 75 ± 20 ms and changes to the MSG-TRA state without being triggered by the SS. When the training is over the TCF is transmitted to the fax.
4. The condition of CT109 (see note 2), the ident octet of the STATUS frames and the up-conversion to the message speed shall be verified.

29.4.3.3 Message procedure

29.4.3.3.1 Definition and applicability

This test is applicable to an MS supporting TS 61 and/or TS 62.

29.4.3.3.2 Conformance requirement

The MS supporting transparent facsimile group 3 shall perform the message procedure and shall support the frames and the circuits at the Um-,R- and 2w-interface according the specifications referred to in the section "Reference".

Reference

GSM 03.45, CCITT T.30, CCITT T.4, CCITT T.21.

29.4.3.3.3 Test purpose

To verify the facsimile data transmission phase.

29.4.3.3.4 Method of test

Initial conditions

The activity progress of the fax call is brought to the beginning of Phase C. The ECM shall not be used.

Test procedure

The FA is in idle state. Upon reception of the MSG-REC identifier the FA enters the MSG-TRA state, sends the MSG-TRA identifier and initiates the training. While the training is in progress data being received is buffered and conveyed to the connected fax upon end of training. When the transmission is finished the FA is again in the IDLE state and Phase D begins. Then the call is cleared by manual intervention at the MT or the activity progress of the call will proceed to the next phase.

Expected sequence

MS: Step	Direction		SS:

1	SS-->MS		<----- Transmit STATUS interleaved with SYNC frames
2	MS-->SS	FA: CT105 ON (see note 2) MSG-TRA Initiate training Send STATUS interleaved with SYNC frames	----->
3	SS-->MS	FA: Buffer received data during training Receive fax message* " " " CT105 OFF (see note 2) IDLE Fax: Receive training, fax message	<----- Send fax message* " " "

29.4.3.3.5 Test requirements

1. To be verified that the FA enters the MSG-TRA state and inserts the correct ident octet in the STATUS frames. Training has to be initiated (see note 2). STATUS frames have to be sent interleaved with SYNC frames.
2. The condition of CT105 (see note 2) shall be checked.

29.4.3.4 Post-message procedure

29.4.3.4.1 Definition and applicability

This test is applicable to an MS supporting TS 61 and/or TS 62.

29.4.3.4.2 Conformance requirement

The MS supporting transparent facsimile group 3 shall perform the post-message procedure and shall support the frames and the circuits at the Um-,R- and 2w-interface according the specifications referred to in the section "Reference".

Reference

GSM 03.45, CCITT T.30

29.4.3.4.3 Test purpose

To verify phase D of the facsimile transmission.

29.4.3.4.4 Method of test

Initial conditions

The activity progress of the fax call is brought to the beginning of Phase D. The ECM shall not be used.

Test procedure

The SS sends the EOP* frame. The FA then enters the BCS-TRA state and conveys the EOP frame to the fax machine. The fax answers the EOP with the MCF frame. The FA will enter the BCS-REC state, transmit the BCS-REC identifier and will convey the MCF* frame to the SS. Afterwards the FA enters the IDLE state. Phase D of the fax transmission is completed. Then the call is cleared by manual intervention at the MT or the activity progress of the call will proceed to the next phase.

Expected sequence

MS:	Direction	SS:
1	SS-->MS	<----- Send preamble*, EOP*
	FA: CT105 ON (see note 2)	
	BCS-TRA	
	Transmit preamble, EOP	
	CT105 OFF (see note 2)	
	IDLE	
2	MS-->SS	-----> Receive preamble*, MCF*
	Fax: Receive preamble, EOP	
	Fax: Send preamble, MCF	
	FA: CT109 ON (see note 2)	
	BCS-REC	
	Send preamble*, MCF*	
	CT109 OFF (see note 2)	
	IDLE	

29.4.3.4.5 Test requirements

1. To be verified that the FA enters the BCS-TRA state upon detection of the BCS-REC identifier and that the correct T.30 message (down conversion to the message speed) is conveyed to the connected fax.
2. To be verified that the FA enters the BCS-REC state and that the correct STATUS frames are sent (up-conversion to the message speed).

29.4.3.5 Call release procedure

29.4.3.5.1 Definition and applicability

This test is applicable to an MS supporting TS 61 and/or TS 62.

29.4.3.5.2 Conformance requirement

The MS supporting transparent facsimile group 3 shall perform the call release procedure and shall support the frames and the circuits at the Um-,R- and 2w-interface according the specifications referred to in the section "Reference".

Reference

GSM 03.45, CCITT T.30.

29.4.3.5.3 Test purpose

To verify phase E of the facsimile transmission.

29.4.3.5.4 Method of test

Initial conditions

The activity progress of the fax call is brought to the beginning of Phase E.

Test procedure

The SS sends the preamble followed by the DCN frame. The FA then enters the BCS-TRA state and sends the DCN frame to the fax terminal. The FA enters the idle state again. CT108.2 (see note 2) will go OFF condition. The MT then sends the DISC message and the call is cleared.

Expected sequence

MS:	SS:
Step Direction	

1 SS-->MS	<----- Send preamble*, DCN*
FA: CT105 ON (see note 2)	
BCS-TRA	
CT108.2 OFF (see note 2)	
Generate preamble, DCN	
CT105 OFF (see note 2)	
IDLE	
Fax: Receive preamble, DCN	
MT: Send DISC message	-----> Receive DISC message

29.4.3.5.5 Test requirements

To be verified that CT108.2 is turned off (see note 2) and that the correct down-conversion to the BCS speed is applied. The MT shall send the DISC message.

29.4.3.6 Speed conversion factor

29.4.3.6.1 Definition and applicability

This test is applicable to an MS supporting TS 61 and/or TS 62.

29.4.3.6.2 Conformance requirement

The MS supporting transparent facsimile group 3 shall perform the up- and down-conversion procedure and shall support the frames and the circuits at the Um-,R- and 2w-interface according the specifications referred to in the section "Reference".

Reference

GSM 03.45, CCITT T.30.

29.4.3.6.3 Test purpose

To verify the correct speed conversion for the BCS phases.

29.4.3.6.4 Method of test

Initial conditions

The activity progress of the fax call is brought to the beginning of Phase B. The ECM shall not be used.

Test procedure

The following test sequence is repeated 5 times with 5 different DCS frames indicating a message speed of 9,6/7,2/4,8/2,4 and 9,6 kBit/s. This test is done to verify that the FA detects a change of the TCH access rate and due to this updates the speed conversion factor, which is used for the up-conversion of the BCS signalling to the message speed and vice versa. Then the call is cleared by manual intervention at the MT or the activity progress of the call proceeds to the next phase.

Expected sequence

MS: Step	Direction			SS:
1	MS-->SS	Fax: Send preamble,DIS FA: BCS-REC Monitor DIS Send preamble*,DIS* CT109 OFF (see note 2) IDLE	----->	Receive preamble*,DIS*
2	SS-->MS	FA: CT105 ON (see note 2) BCS-TRA Monitor DCS Transmit preamble,DCS CT105 OFF (see note 2) IDLE	<-----	Send preamble*,DCS*
3	SS<->MS	Fax: Receive preamble,DCS Execution of the CMM procedure **): The SS sends the CMM message 150 ms after the DCS has been sent and the MT completes the procedure by sending the CMM ACK message		
4	SS-->MS	FA: CT105 ON (see note 2) MSG-TRA Initiate training after 75 ms +/- 20 ms in idle Generate TCF CT105 OFF (see note 2) IDLE	<-----	Send TCF*
5	MS-->SS	Fax: Receive training,TCF Fax: Send preamble, CFR FA: CT109 ON (see note 2) BCS-REC Send preamble*,CFR* CT109 OFF (see note 2) IDLE	----->	Receive preamble*,CFR*
6	SS-->MS	FA: CT105 ON (see note 2) MSG-TRA Initiate training Buffer received data during training Receive fax message* " " "	<-----	Send fax message* " " "
7	SS-->MS	Fax: Receive training, fax message FA: CT105 ON (see note 2) BCS-TRA Transmit preamble, EOM CT105 OFF (see note 2) IDLE	<-----	Send preamble*, EOM*
8	MS-->SS	Fax: Receive preamble, EOM Fax: Send preamble, MCF FA: CT109 ON (see note 2) BCS-REC Send preamble*, MCF* CT109 OFF (see note 2) IDLE	----->	Receive preamble*, MCF*
9	Repeat steps 2 to 8 four times			

- **)
- only if the requested rate in the DCS differs from the existing radio channel rate (when the radio channel rate equals 9 600 kbit/s and the DCS requests 7 200 kbit/s no CMM will be executed)

29.4.3.6.5 Test requirements

1. The MT shall send the CMM ACK message.
2. For 7,2/9,6 kBit/s:

The correct up- and down-conversion shall be verified (4 STATUS frames for 1 BCS octet)

For 4,8 kBit/s:

The correct up- and down-conversion shall be verified (2 STATUS frames for 1 BCS octet)

For 2,4 kBit/s:

The correct up- and down-conversion shall be verified (1 STATUS frame for 1 BCS octet)

The IDENT octet shall be set to BCS-REC in case of the up-conversion.

29.4.3.7 Quality Check

29.4.3.7.1 Definition and applicability

This test is applicable to all configurations supporting transparent facsimile group 3.

29.4.3.7.2 Conformance requirement

The configuration supporting transparent facsimile group 3 shall decode the T.4 coding and shall generate a document.

Reference

GSM 03.45, CCITT T.21, CCITT T.4.

29.4.3.7.3 Test purpose

To verify the quality of the received document.

29.4.3.7.4 Method of test

Initial conditions

The document has been received at the called side.

Test procedure

The quality of the document at the receiving side shall be checked.

29.4.3.7.5 Test requirements

The contents of the transmitted and the received document shall be the same.

29.4.4 Notes

The following notes apply throughout the clause 29.4.

- NOTE 1: By pressing the START button on the facsimile apparatus or in case of PC fax by selecting the appropriate software menu point or automatically.

NOTE 2: Or equivalent function/means having the same result.

NOTE 3: Tested by monitoring the contents of the STATUS frame ident octet identifier.

NOTE 4: If no access is available to the 2w interface, this requirement cannot always be verified.

30 Speech teleservices

When an artificial ear is required, the ITU-T Recommendation P.57 [107] Type 1 artificial ear shall be used.

If requested by the terminal supplier, the ITU-T Recommendation P.57 [107] Type 3.2 artificial ear shall be used. In this case the following shall apply:

- The low leakage option of Type 3.2 artificial ear shall be adopted;
- The force against the ear shall be as specified in ITU-T Recommendation P.57 [107].
- Sound pressure measurements shall be referred to the ERP as specified in ITU-T Recommendation P.57 [107] or DRP according to the Terminal Supplier's request.
- No leakage correction shall be made in the calculation of RLR (i.e. $L_E=0$).

If requested by the terminal supplier, the ITU-T Recommendation P.57 [107] Type 3.4 artificial ear may be used for Release 96 MS or later. The positioning is defined in ITU-T Recommendation P.64.

The manufacturer declares in the IXIT statement which type of artificial ear will be used for teleservices speech testings.

NOTE 1: An MS may be either a handset MS, a handsfree MS or a combined handset and handsfree MS. The test description for handsfree operation, however, at the moment only covers the stability margin as no test method could be defined for the other parameter.

NOTE 2: Frequency settings in the following tests are taken from ISO 3, R10 series or R40 series or from table 2 of CCITT P.79. A departure from the nominal frequencies of +5 % below 240 Hz and + 2 % at 240 Hz and above is accepted. Any sub-multiple of the sampling frequency of 8 kHz shall be avoided. In the case of 4 kHz the departure is restricted to -2 %.

NOTE 3: The measurement accuracy for signal level is +/- 0,2 dB and for sound pressure +/-0,6 dB.

NOTE 4: The digital test signals shall be generated as 8 bit A-law companded PCM signals, which internally in the SS are expanded according to CCITT Rec. G.721 (Law=1) to 13 bit linear before being applied to the MS via the DAI.

NOTE 5: When measuring signal levels on the DAI, a digital measuring instrument is connected to the 64 kbit/s output of the A-law compression equipment in the SS, which is in turn connected to the DAI in the MS.

NOTE 6: Measurements shall be possible with and without psophometric weighting according to Rec. CCITT G.223, table 4.

30.1 Sending sensitivity/frequency response

30.1.1 Definition and applicability

The sending sensitivity frequency response is, as a function of the input test signal frequency, the ratio expressed in dB between the output level at the Digital Audio Interface (DAI) or at the audio output of the reference speech decoder of the SS and the input sound pressure in the artificial mouth required to obtain this.

The requirements and this test apply to all types of GSM 400, GSM 900, DCS 1 800 and PCS 1900 handset MS supporting speech.

30.1.2 Conformance requirement

The sending sensitivity frequency response shall be within the mask given in GSM 03.50.

GSM 03.50; 3.8.1.1, table 1.

30.1.3 Test purpose

To verify that the sending sensitivity frequency response is within the mask given in GSM 03.50, 3.8.1.1, table 1.

30.1.4 Method of test

30.1.4.1 Initial conditions

When measured at the DAI:

- a) The handset is mounted in the LRGP (see annex A of CCITT Recommendation P.76). The earpiece is sealed to the knife-edge of the artificial ear.
- b) A pure tone with a sound pressure of -4,7 dBPa (in accordance with CCITT Recommendation P.64) is applied at the mouth reference point (MRP) as described in CCITT Recommendation P.64 using an artificial mouth conforming to CCITT Recommendation P.51.
- c) A digital measuring instrument, or high quality digital decoder followed by an analogue level measuring set, is connected to the Digital Audio Interface (DAI). The DAI is set to the operating mode "Test of acoustic devices and A/D & D/A".

When measured at the output of the reference speech decoder of the SS:

- a) The handset is mounted in the LRGP and the earpiece is sealed to the knife-edge of an artificial ear.
- b) A full rate speech call is set up between the MS and the SS.
- c) Artificial speech conforming to ITU-T Recommendation P.50, shall be applied to the MRP, at a wideband sound pressure level of -4,7 dBPa. This implementation could be a real time algorithm producing the artificial speech or a pre-recorded tape of the artificial speech.
- d) The artificial speech shall comprise of a concatenation of three 10 s intervals of "male" and "female" voice. The first 10 s interval is not used for measurement purposes but allows any noise/echo cancelling devices in the MS to adapt. The second and third 10 s intervals consist of separately "male" and "female" artificial voice.

30.1.4.2 Procedure

When measured at the DAI:

The SS measures the output level represented by the PCM bit stream at the DAI (pin 23) at one-twelfth-octave intervals as given by the R40 series of preferred numbers in ISO 3 for frequencies from 100 Hz to 4 000 Hz inclusive.

When measured at the output of the reference speech decoder of the SS:

The 1/3 octave filtered long-term average spectrum of the signal is measured at the analogue or digital output of the reference speech decoder of the SS and an average for the "male" and "female" voices is obtained. The sending sensitivity/frequency response is calculated as the difference between the 1/3 octave input power and the 1/3 octave output power.

30.1.5 Test requirement

The sending sensitivity/frequency response shall be within a mask given in table 30.1. The mask can be drawn with straight lines between the breaking points in the table on a logarithmic (frequency) vs linear (dB sensitivity) scale.

All sensitivity levels are dB on an arbitrary scale.

Table 30.1

Frequency (Hz)	Upper Limit (dB)	Lower Limit (dB)
100	-12	
200	0	
300	0	-12
1000	0	-6
2000	4	-6
3000	4	-6
3400	4	-9
4000	0	

30.2 Sending loudness rating

30.2.1 Definition and applicability

The Sending Loudness Rating (SLR) is a means of expressing the sending frequency response based on objective measurements in a way which relates to how a speech signal would be perceived by a listener.

The requirements and this test apply to all types of GSM 400, GSM 900, DCS 1 800 and PCS 1900 handset MS supporting speech.

30.2.2 Conformance requirement

The Sending Loudness Rating (SLR) shall be 8 +/- 3 dB.

GSM 03.50; 3.1.1.

30.2.3 Test Purpose

To verify that the Sending Loudness Rating (SLR) is 8 +/- 3 dB.

30.2.4 Method of test

30.2.4.1 Initial conditions

When measured at the DAI:

The DAI of the MS is connected to the SS and is set to the operating mode "Test of acoustic devices and A/D & D/A".

When measured at the output of the reference speech decoder of the SS:

A full rate speech call is set up between the MS and the SS.

30.2.4.2 Procedure

When measured at the DAI:

- The sending sensitivity is measured at each of the 14 frequencies given in table 2 of CCITT P.79, bands 4 to 17.
- The sensitivity is expressed in terms of dBV/Pa and the SLR is calculated according to CCITT Recommendation P.79 formula 4.19 b of CCITT P.79, over bands 4 to 17, using the sending weighting factors from CCITT Recommendation P.79 table 2, adjusted according to table 3 of CCITT Recommendation P.79.

When measured at the output of the reference speech decoder of the SS:

- The sending sensitivity from the MRP to the analogue or digital output of the reference speech decoder of the SS is determined according to 30.1.4.1, 30.1.4.2.
- The sensitivity is expressed in terms of dBV/Pa and the SLR shall be calculated according to ITU-T Recommendation P.79 formula 2.1, over bands 4 to 17, and using $m = 0.175$ and the sending weighting factors from ITU-T Recommendation P.79 table 1.

30.2.5 Test requirement

The SLR shall be 8 +/- 3 dB.

30.3 Receiving sensitivity/frequency response

30.3.1 Definition and applicability

The receiving sensitivity frequency response is, as a function of the input test signal frequency, the ratio expressed in dB between the output sound pressure in the artificial ear and the input level, represented by the PCM bit stream at the Digital Audio Interface (DAI) or the level at the SS audio input, required to obtain this.

The requirements and this test apply to all types of GSM 400, GSM 900, DCS 1 800 and PCS 1900 handset MS supporting speech.

30.3.2 Conformance requirement

The receiving sensitivity frequency response shall be within the mask given in GSM 03.50.

GSM 03.50; 3.8.1.2, table 2.

30.3.3 Test purpose

To verify that the receiving sensitivity frequency response is within the mask given in GSM 03.50; 3.8.1.2, table 2.

30.3.4 Method of test

30.3.4.1 Initial conditions

When measured from the DAI:

- a) The handset is mounted in the LRGP and the earpiece is sealed to the knife-edge of the artificial ear.
- b) A digital signal generator is connected at the digital interface delivering a signal equivalent to a pure tone level of -16 dBm₀, see CCITT Recommendation P.64.
- c) The DAI of the MS is connected to the SS and is set to the operating mode "Test of acoustic devices and A/D & D/A".

When measured from the input of the reference speech encoder of the SS:

- a) The handset is mounted in the LRGP and the earpiece is sealed to the knife-edge of the artificial ear.
- b) A full rate speech call is set up between the MS and the SS.
- c) Artificial speech conforming to ITU-T Recommendation P.50, shall be applied to the analogue or digital input of the reference speech encoder of the SS, at a wideband level of -16 dBm₀. This implementation could be a real time algorithm producing the artificial speech or a pre-recorded tape of the artificial speech.
- d) The artificial speech shall comprise of a concatenation of three 10 s intervals of "male" and "female" voice. The first 10 s interval is not used for measurement purposes but allows any echo cancellation devices in the MS to adapt. The second and third 10 s intervals consist of separately "male" and "female" artificial voice.

30.3.4.2 Procedure

When measured from the DAI:

Measurements are made at one twelfth-octave intervals as given in the R.40 series of preferred numbers in ISO 3 for frequencies from 100 Hz to 4 kHz inclusive. At each frequency, the sound pressure in the artificial ear is measured by connecting a suitable measuring set to the artificial ear.

When measured from the input of the reference speech encoder of the SS:

The 1/3 octave filtered long-term average spectrum of the signal is measured and an average for the "male" and "female" voices is obtained. The receiving sensitivity/frequency response is calculated as the difference between the 1/3 octave input power and the 1/3 octave output power.

30.3.5 Test requirement

The receiving sensitivity/frequency response shall be within the mask given by table 30.2. The mask can be drawn with straight lines between the breaking points in the following table on a logarithmic (frequency) vs linear (dB sensitivity) scale.

All sensitivity levels are dB on an arbitrary scale.

Table 30.2

Frequency (Hz)	Upper Limit (dB)	Lower Limit (dB)
100	-12	
200	0	
300	2	-7
500	*	-5
1000	0	-5
3000	2	-5
3400	2	-10
4000	2	

NOTE: * The limit at intermediate frequencies lies on a straight line drawn between the given values on a log (frequency) vs linear (dB) scale.

30.4 Receiving loudness rating

30.4.1 Definition and applicability

The Receiving Loudness Rating (RLR) is a means of expressing the receiving frequency response based on objective measurements in a way which relates to how a speech signal would be perceived by a listener.

The requirements and this test apply to all types of GSM 400, GSM 900, DCS 1 800 and PCS 1900 handset MS supporting speech.

30.4.2 Conformance requirement

- 1) The nominal Receiving Loudness Rating (RLR) shall be 2 +/- 3 dB.

If a user controlled receive volume control is provided the equipment shall meet this nominal value for at least one setting of the control.

GSM 03.50; 3.1.1.

- 2) If a user controlled receive volume control is provided the Receive Loudness Rating (RLR) shall not be less than -13 dB when the control is set to maximum.

GSM 03.50; 3.1.1.

30.4.3 Test purpose

- 1) To verify that the nominal Receiving Loudness Rating (RLR) is 2 +/- 3 dB.
- 2) To verify that if a user controlled receive volume control is provided the Receive Loudness Rating (RLR) is not less than -13 dB when the control is set to maximum.

30.4.4 Method of test

30.4.4.1 Initial conditions

When measured at the DAI:

The DAI of the MS is connected to the SS and is set to the operating mode "Test of acoustic devices and A/D & D/A".

When measured at the output of the reference speech decoder of the SS:

A full rate speech call is set up between the MS and the SS.

30.4.4.2 Procedure

When measured at the DAI:

- a) The receiving sensitivity is measured at each of the 14 frequencies listed in table 2 of CCITT Recommendation P.79, bands 4 to 17.
- b) The sensitivity is expressed in terms of dBPa/V and the RLR is calculated according to CCITT Recommendation P.79 formula 4.19 c, over bands 4 to 17, using the receiving weighting factors from table 2 of CCITT Recommendation P.79, adjusted according to table 3 of CCITT Recommendation P.79.
- c) The artificial ear sensitivity must be corrected according to the real ear correction of table 4 of CCITT Recommendation P.79.

NOTE: The values of real ear correction in CCITT Recommendation P.79 table 4 were derived for one type of handset conforming to the shape defined in CCITT Recommendation P.35.

These values are used in this EN because there is no measurement method agreed for the real ear correction. If a method of measurement is agreed, it is intended to change this EN to use the values appropriate to each handset.

When measured from the input of the reference speech encoder of the SS:

- a) The receiving sensitivity from the analogue or digital input of the reference speech encoder of the SS to the output of the artificial ear is determined according to 30.3.4.1, 30.3.4.2.
- b) The sensitivity is expressed in terms of dBPa/V and the RLR shall be calculated according to ITU-T Recommendation P.79 formula 2.1, over bands 4 to 17, using $m = 0,175$ and the receiving weighting factors from table 1 of ITU-T Recommendation P.79.

30.4.5 Test requirement

If no user controlled receive volume control is provided, the RLR shall be 2 +/- 3 dB.

If a user controlled receive volume control is provided, the RLR shall meet this nominal value for (at least) one setting of the receive volume control.

When the receive volume control is set to maximum the RLR shall not be less than (i.e. louder than) -13 dB.

30.5 Side tones

30.5.1 Side Tone Masking Rating (STMR)

30.5.1.1 Definition and applicability

The sidetone loudness ratings are a means of expressing the path loss from the artificial mouth to the artificial ear based on objective single tone measurements in a way that relates to how a speaker will perceive his own voice when speaking (talker sidetone, expressed by the sidetone masking rating - STMR), or how a listener will perceive the background noise picked up by the microphone (listener sidetone rating - LSTR).

The requirements and this test apply to all types of GSM 400, GSM 900, DCS 1 800 and PCS 1900 handset MS supporting speech.

30.5.1.2 Conformance requirement

The nominal value of the Side Tone Masking Rating (STMR) shall be 13 +/- 5 dB. Where a user controlled receiving volume control is provided the STMR shall meet the requirement at the setting where the RLR is equal to the nominal value.

GSM 03.50; 3.10.1.

30.5.1.3 Test purpose

- 1) To verify that the Side Tone Masking Rating (STMR) is 13 +/- 5 dB.
- 2) To verify that is a user controlled receiving volume control is provided, the STMR is 13 +/- 5 dB at the setting where the RLR is equal to the nominal value.

30.5.1.4 Method of test

30.5.1.4.1 Initial conditions

- a) The DAI of the MS is connected to the SS and is set to the operating mode "Test of acoustic devices and A/D & D/A".
- b) The handset is mounted in the LRGP (see annex 1 of CCITT P.76) and the earpiece is sealed to the knife-edge of the artificial ear conforming to CCITT P.51.

30.5.1.4.2 Procedure

- a) The SS sends a PCM bit stream coded with the value No 1 over the DAI (pin 25). Or alternatively the activation of the A/D and D/A converters is performed via a call setup, in which case the DAI connection between the MS and SS, and the PCM bit stream are optional.

NOTE: The idle channel noise in the receiving direction is the acoustic sound pressure in the artificial ear when the digital input signal at the DAI is the PCM coded value No. 1.

- b) The SS applies a pure tone with a sound pressure of -4,7 dBPa at the mouth reference point as described in CCITT P.64 using an artificial mouth conforming to CCITT P 51.
- c) For each frequency given in table 2 of CCITT P.79, bands 4 to 17, the sound pressure in the artificial ear is measured.
- d) The sidetone path loss (LmeST) is expressed in dB and the STMR (in dB) is calculated from the formula 8.4 of CCITT Recommendation P.79, using the weighting factors of column (3) in table 6 of CCITT Recommendation P.79 (unsealed), and values of LE in accordance with table 4 of CCITT Recommendation P.79.

30.5.1.5 Test requirement

The STMR shall be 13 +/- 5 dB.

Where a user controlled receive volume control is provided, the STMR shall meet the requirement given above at the setting where the RLR is equal to the nominal value.

30.5.2 Listener Side Tone Rating (LSTR)

30.5.2.1 Definition and applicability

The Listener Sidetone Rating (LSTR) is considered a major parameter affecting the user perception of the system.

The requirements and this test is applicable to all types of GSM 400, GSM 900, DCS 1 800 and PCS 1900 handset MS supporting speech.

30.5.2.2 Conformance requirement

The value of the Listener Sidetone Rating (LSTR) shall not be less than 15 dB.

GSM 03.50, 3.10.1.

30.5.2.3 Test purpose

To verify that the value of LSTR is not less than 15dB.

30.5.2.4 Method of test

30.5.2.4.1 Initial conditions

The DAI of the MS is connected to the SS and is set to the operating mode "Test of acoustic devices and A/D & D/A".

The SS sends a PCM bit stream coded with the value No. 1 over the DAI (pin 25) to the MS.

30.5.2.4.2 Procedure

- a) The sound field is calibrated in the absence of any local obstacles. The averaged field shall be uniform to within +4 dB/-2 dB within a radius of 0,15 m of the MRP, when measured in one-third octave bands from 100 Hz to 8 kHz (bands 1 to 20).
- b) A calibrated half-inch microphone is mounted at MRP. The sound field is measured in one-third octave bands. The spectrum shall be "Pink noise" as described in CCITT recommendation P.64 annex B to within +/-1 dB and the level shall be adjusted to 70 dBA (-24 dBPa(A)). The tolerance on this level is +/-1 dB.
- c) The artificial mouth and ear are placed in the correct position relative to MRP, the handset is mounted at LRGP and the earpiece is sealed to the knife-edge of the artificial ear.
- d) Measurements are made in one-third octave bands for the 14 bands centred at 200 Hz to 4 kHz (bands 4 to 17). For each band the sound pressure in the artificial ear shall be measured by connecting a suitable measuring set to the artificial ear.
- e) The listener sidetone path loss is expressed in dB and the LSTR shall be calculated from the CCITT Recommendation P.79 formula 8-4, using the weighting factors in column (3) in table 6 of the Recommendation, and the values of LE; in accordance with table 4 of the Recommendation.

30.5.2.5 Test requirement

The LSTR shall not be less than 15 dB.

30.6 Telephone Acoustic coupling Loss (TAL)

30.6.1 Echo Loss (EL)

30.6.1.1 Definition and applicability

The echo loss is the path loss from the input of the reference speech encoder of the SS to the output of the reference speech decoder of the SS.

The requirements and this test apply to all types of GSM 400, GSM 900, DCS 1 800 and PCS 1900 handset MS supporting speech.

30.6.1.2 Conformance requirement

The echo loss from the input to the output of the reference speech codec in the SS shall be at least 46 dB.

GSM 03.50; 3.4.3.2.

30.6.1.3 Test purpose

To verify that the echo loss from the input to the output of the reference speech codec in the SS is at least 46 dB.

30.6.1.4 Method of test

30.6.1.4.1 Initial conditions

The DAI of the MS is connected to the SS and is set to the operating mode "Normal operation".

The SS sets up a speech call according to the generic call set up procedure.

The handset is mounted in the LRGP (see annex 1 of CCITT P.76) and the earpiece is sealed to the knife-edge of the artificial ear conforming to CCITT P.51.

Where a user controlled volume control is provided it is set to maximum.

30.6.1.4.2 Procedure

An implementation of the CCITT P.50 artificial speech is connected to the analogue or digital input of the reference speech encoder of the SS. This implementation is either a real time algorithm producing the artificial speech or a pre-recorded tape of artificial speech. Both "male" and "female" artificial speech is required.

A ten second segment of the "male" artificial speech is applied to the analogue or digital input of the reference speech encoder of the SS. The third octave power of the input signal is measured. The echo loss signal is not measured at this stage as the first ten second segment is used to allow any acoustic echo cancellation devices within the MS to adapt to the echo path.

Immediately after a second ten second segment of the "male" artificial speech is applied to the analogue or digital input of the reference speech encoder of the SS. The third octave power of the echo signal is measured at the analogue or digital output of the reference speech decoder of the SS.

The difference between the third octave input power and the third octave output power is entered into the CCITT G.122 TCL algorithm and the acoustic echo loss calculated.

The test is repeated with the "female" artificial speech and the results of both "male" and "female" averaged to give the final result.

30.6.1.5 Test requirement

The echo loss from the input to the output of the reference speech codec in the SS shall be at least 46 dB.

30.6.2 Stability margin

30.6.2.1 Definition and applicability

The receive-transmit stability margin is a measure of the gain that would have to be inserted between the go and return paths of the reference speech coder in the SS for oscillation to occur.

The requirements and this test apply to all types of GSM 400, GSM 900, DCS 1 800 and PCS 1900 handset MS supporting speech.

30.6.2.2 Conformance requirement

The stability margin shall be at least 6 dB.

GSM 03.50; 3.2.

30.6.2.3 Test purpose

To verify that the stability margin is at least 6 dB.

30.6.2.4 Method of test

30.6.2.4.1 Initial conditions

For handset operation the handset is placed on a hard plane surface with the transducers facing the surface.

For handsfree operation the test setup is shown in CCITT P.34 (Fig 3/CCITT P.34), but omitting the test table.

Where a user controlled volume control is provided it is set to maximum.

30.6.2.4.2 Procedure

- a) A gain equivalent to the minimum stability margin is inserted in the loop between the go and return paths of the reference speech coder in the SS and any acoustic echo control is enabled.
- b) A test signal according to CCITT O.131 is injected into the loop at the analogue or digital input of the reference speech codec of the SS and the stability is measured. The test signal has a level of -10 dBm0 and a duration of 1 s.

30.6.2.5 Test requirement

The minimum stability margin shall be 6 dB and no audible oscillation shall be detected.

30.7 Distortion

30.7.1 Sending

30.7.1.1 Definition and applicability

The transmit signal to total distortion ratio is a measure of the linearity of the transmitter equipment.

The requirements and this test apply to all types of GSM 400, GSM 900, DCS 1 800 and PCS 1900 handset MS supporting speech.

30.7.1.2 Conformance requirement

The ratio of signal to total distortion power in the sending direction measured with a psophometric filter at the DAI of the MS or at the output of the reference speech decoder of the SS shall be above the limits given in GSM 03.50; 3.9.1, table 3, unless the sound pressure at MRP exceeds +10 dBPa.

GSM 03.50; 3.9.1.

30.7.1.3 Test purpose

To verify that the ratio of signal to total distortion power in the sending direction measured with psophometric filter is above the limits given in GSM 03.50; 3.9.1, table 3.

30.7.1.4 Method of test

30.7.1.4.1 Initial conditions

The handset is mounted in the LRGP (see annex 1 of CCITT P.76) and the earpiece is sealed to the knife-edge of the artificial ear conforming to CCITT P.51.

When measured at the DAI:

The DAI of the MS is connected to the SS and is set to the operating mode "Test of acoustic devices and A/D & D/A".

When measured at the output of the reference speech decoder of the SS:

A full rate speech call is set up between the MS and the SS.

30.7.1.4.2 Procedure

- a) A sine-wave signal with a frequency in the range 1004 Hz to 1025 Hz is applied to the MRP. The level of this signal is adjusted until the level at the DAI output (pin 23) of the MS or at the analogue or digital output of the reference speech decoder of the SS corresponds to -10 dBm₀. The level of the signal at the MRP is then the acoustic reference level (ARL).
- b) The test signal is applied at the following levels: -35, -30, -25, -20, -15, -10, -5, 0, 5, 10 dB relative to the ARL.
- c) The ratio of signal to total distortion power is measured at the DAI of the MS or at the analogue or digital output of the reference speech decoder of the SS with the psophometric noise weighting (see CCITT G.714 and O.132) at each signal level.

NOTE: The measurement is not to be carried out at sound pressures exceeding +10 dBPa.

30.7.1.5 Test requirement

The ratio of signal to total distortion power measured with the psophometric noise weighting (see table 4/CCITT G.223) shall be above the limits given in table 30.3.

Table 30.3

dB relative to ARL	Level ratio
-35 dB	17,5 dB
-30 dB	22,5 dB
-20 dB	30,7 dB
-10 dB	33,3 dB
0 dB	33,7 dB
7 dB	31,7 dB
10 dB	25,5 dB

Limits for the signal to total distortion ratio (sending) when using the sine wave method.

Limits for intermediate levels are found by drawing a straight line between breaking points in a linear (dB signal level) vs linear (dB ratio) scale.

30.7.2 Receiving

30.7.2.1 Definition and applicability

The receive signal to total distortion ratio is a measure of the linearity in the receive equipment (excluding the speech decoder).

The requirements and this test apply to all types of GSM 400, GSM 900, DCS 1 800 and PCS 1900 handset MS supporting speech.

30.7.2.2 Conformance requirement

The ratio of signal to total distortion power in the receiving direction measured at the ERP or DRP according to the Terminal Supplier's request with psophometric filter shall be above the limits given in GSM 03.50; 3.9.2, table 5.

GSM 03.50; 3.9.2.

30.7.2.3 Test purpose

To verify that the ratio of signal to total distortion power in the receiving direction measured at the ERP or DRP according to the Terminal Supplier's request with psophometric filter is above the limits given in GSM 03.50; 3.9.2, table 5.

30.7.2.4 Method of test

30.7.2.4.1 Initial conditions

The handset is mounted in the LRGP (see annex 1 of CCITT P.76) and the earpiece is sealed to the knife-edge of the artificial ear conforming to CCITT P.51.

The DAI of the MS is connected to the SS and is set to the operating mode "Test of acoustic devices and A/D & D/A".

30.7.2.4.2 Procedure

- a) The SS sends, via the DAI (Pin 25), a PCM bit stream simulating a sine-wave signal with a frequency in the range 1 004 Hz to 1 025 Hz corresponding to CCITT O.132 at the following levels: -45, -40, -35, -30, -25, -20, -15, -10, -5, 0 dBm0.
- b) The ratio of signal to total distortion power is measured with the psophometric noise weighting in the artificial ear (see CCITT G.714 and O.132) at each signal level.
- c) The measurement is only carried out at sound pressures between -50 dBPa and +10 dBPa.

30.7.2.5 Test requirement

The ratio of signal to total distortion power measured at the artificial ear with the psophometric noise weighting (see table 4/CCITT G.223) shall be above the limits given in table 30.4.

Table 30.4

Level at the digital audio interface	Level ratio
-45 dBm0	17,5 dB
-40 dBm0	22,5 dB
-30 dBm0	30,5 dB
-20 dBm0	33,0 dB
-10 dBm0	33,5 dB
-3 dBm0	31,2 dB
0 dBm0	25,5 dB

Limits for the signal to total distortion ratio (receiving) when using the sine wave method.

Limits for intermediate levels are found by drawing a straight line between breaking points in a linear (dB signal level) vs linear (dB ratio) scale.

30.8 Sidetone distortion

30.8.1 Definition and applicability

The sidetone distortion expresses the linearity of the sidetone path in the handset.

The requirements and this test apply to all types of GSM 400, GSM 900, DCS 1 800 and PCS 1900 handset MS supporting speech.

30.8.2 Conformance requirement

The third harmonic distortion of the sidetone shall not be greater than 10 %.

GSM 03.50; 3.10.2.

30.8.3 Test purpose

To verify that the third harmonic distortion of the sidetone is not greater than 10 %.

30.8.4 Method of test

30.8.4.1 Initial conditions

The DAI of the MS is connected to the SS and is set to the operating mode "Test of acoustic devices and A/D & D/A".

The handset is mounted in the LRGP (see annex 1 of CCITT P.76) and the earpiece is sealed to the knife-edge of the artificial ear conforming to CCITT P.51.

30.8.4.2 Procedure

- a) The SS sends the PCM bit stream coded with the value No 1 over the DAI (pin 25) to the MS.
- b) An instrument capable of measuring the third harmonic distortion of signals with fundamental frequencies in the range 315 Hz to 1000 Hz is connected to the artificial ear.
- c) A pure-tone signal of -4,7 dBPa is applied at the mouth reference point at frequencies of 315 Hz, 500 Hz, and 1 000 Hz. For each frequency the third harmonic distortion is measured in the artificial ear.

30.8.5 Test requirement

The third harmonic distortion generated shall not be greater than 10 %.

30.9 Out-of-band signals

30.9.1 Sending

30.9.1.1 Definition and applicability

The discrimination against out-of-band input signals in the sending direction is a requirement on the in-band image frequencies created by any out-of-band input signals.

The requirements and this test apply to all types of GSM 400, GSM 900, DCS 1 800 and PCS 1900 handset MS supporting speech.

30.9.1.2 Conformance requirement

With any sine wave signal above 4,6 kHz and up to 8 kHz applied at the MRP at a level of -4,7 dBPa, the level of any image frequency produced at the digital interface shall be below a reference level obtained at 1 kHz (-4,7 dBPa at MRP) by at least the amount (in dB) specified in GSM 03.50; 3.11.1, table 7.

GSM 03.50; 3.11.1.

30.9.1.3 Test purpose

To verify that the conformance requirement is met for input signals with frequencies of 4,65, 5, 6, 6,5, 7 and 7,5 kHz.

30.9.1.4 Method of test

30.9.1.4.1 Initial conditions

The handset is mounted in the LRGP (see annex 1 of CCITT P.76) and the earpiece is sealed to the knife-edge of the artificial ear conforming to CCITT P.51.

The DAI of the MS is connected to the SS and is set to the operating mode "Test of acoustic devices and A/D & D/A".

30.9.1.4.2 Procedure

- a) A pure tone with a sound pressure of -4,7 dBPa is applied at the mouth reference point as described in CCITT P.64 using an artificial mouth conforming to CCITT P 51.

- b) For input signals at frequencies of 4,65, 5, 6, 6,5, 7, and 7,5 kHz, the level represented by the PCM bit stream at the DAI (Pin 23) of any image frequency is measured.

30.9.1.5 Test requirement

The level of any image frequency shall be below a reference obtained at 1 kHz by at least the amount as specified in table 30.5.

Table 30.5

Applied sine-wave frequency	Limit (minimum)
4,6 kHz	30 dB
8 kHz	40 dB

Limits for the image frequency discrimination.

The limit at intermediate frequencies lies on a straight line drawn between the given values on a log(frequency) vs linear(dB) scale.

30.9.2 Receiving

30.9.2.1 Definition and applicability

The discrimination against out-of-band signals in the receiving direction is a requirement on the out-of-band signals generated in the artificial ear from in-band input signals.

The requirements and this test apply to all types of GSM 400, GSM 900, DCS 1 800 and PCS 1900 handset MS supporting speech.

30.9.2.2 Conformance requirement

With a digitally simulated sine wave signal in the frequency range of 300 Hz to 3,4 kHz and at a level of 0 dBm applied at the digital interface, the level of spurious out-of-band image signals in the frequency range of 4,6 to 8 kHz measured selectively in the artificial ear shall be lower than the in-band acoustic level produced by a digital signal at 1 kHz set at the level specified in GSM 03.50; 3.11.2, table 8.

GSM 03.50; 3.11.2.

30.9.2.3 Test purpose

To verify that the conformance requirement is met for input signals at the nominal frequencies 500, 1 000, 2 000, and 3 350 Hz.

30.9.2.4 Method of test

30.9.2.4.1 Initial conditions

The handset is mounted in the LRGP (see annex 1 of CCITT P.76) and the earpiece is sealed to the knife-edge of the artificial ear conforming to CCITT P.51.

The DAI of the MS is connected to the SS and is set to the operating mode "Test of acoustic devices and A/D & D/A".

30.9.2.4.2 Procedure

- a) The SS sends over the DAI (pin 25) a PCM bit stream simulating a sine-wave signal with a level of 0 dBm0.
- b) For input signals at the nominal frequencies 500, 1 000, 2 000, and 3 350 Hz (bearing in mind the restriction on sub-multiples of the sampling frequency) the level of any out-of-band signals at frequencies up to 8 kHz is measured in the artificial ear.

30.9.2.5 Test requirement

The level of out-of-band signals shall be lower than the in-band acoustic level obtained by a digital signal at 1 kHz set at the level specified in table 30.6.

Table 30.6

Image signal frequency	Equivalent input signal level
4,6 kHz	-35 dBm0
8 kHz	-45 dBm0

Limits for the image frequency discrimination.

The limit at intermediate frequencies lies on a straight line drawn between the given values on a log(frequency) vs linear(dB) scale.

30.10 Idle channel noise

30.10.1 Sending

30.10.1.1 Definition and applicability

The idle channel noise in the sending direction is the equivalent noise level produced at the DAI, when the mouth reference point is in a quiet environment.

The requirements and this test apply to all types of GSM 400, GSM 900, DCS 1 800 and PCS 1900 handset MS supporting speech.

30.10.1.2 Conformance requirement

The idle noise in the sending direction shall not exceed -64 dBm0p at the UPCMI under silent conditions.
GSM 03.50; 3.6.1.

30.10.1.3 Test purpose

To verify that the idle noise in the sending direction does not exceed -64 dBm0p at the UPCMI under silent conditions.

30.10.1.4 Method of test

30.10.1.4.1 Initial conditions

The handset is mounted in the LRGP (see annex 1 of CCITT P.76) and the earpiece is sealed to the knife-edge of the artificial ear conforming to CCITT P.51 in a quiet environment (ambient noise less than 30 dBA).

The DAI of the MS is connected to the SS and is set to the operating mode "Test of acoustic devices and A/D & D/A".

30.10.1.4.2 Procedure

The noise level represented by the PCM bit stream output at the DAI (pin 23) is measured with psophometric weighting according to CCITT G.223, table 4.

NOTE: The ambient noise criterion should be met if the ambient noise does not exceed NR20.

30.10.1.5 Test requirement

The noise produced by the MS in the sending direction shall not exceed -64 dBm0p.

30.10.2 Receiving

30.10.2.1 Definition and applicability

The idle channel noise in the receiving direction is the acoustic sound pressure in the artificial ear when the digital input signal at the DAI, is the PCM coded value No 1.

The requirements and this test apply to all types of GSM 400, GSM 900, DCS 1 800 and PCS 1900 handset MS supporting speech.

30.10.2.2 Conformance requirement

1. If no user controlled receiving volume control is provided, or if it is provided, at the setting of the user controlled receiving volume at which the RLR is equal to the nominal value, the noise measured in the artificial ear contributed by the receiving equipment alone shall not exceed -57 dBPa (A) when driven by a PCM signal corresponding to the decoder output value No. 1.

GSM 03.50; 3.6.2.

2. Where a volume control is provided, the measured noise shall not exceed -54 dBPa(A) at the maximum setting of the volume control.

GSM 03.50; 3.6.2.

30.10.2.3 Test purpose

1. To verify that the idle noise in the receiving direction does not exceed -57 dBPa (A). If a user controlled receive volume control is provided it shall be set to the position where RLR is equal to the nominal value.
2. To verify that if a user controlled receive volume control is provided, the idle noise in the receiving direction does not exceed -54 dBPa(A) when the control is set to maximum.

30.10.2.4 Method of test

30.10.2.4.1 Initial conditions

The handset is mounted in the LRGP (see annex 1 of CCITT P.76) and the earpiece is sealed to the knife-edge of the artificial ear conforming to CCITT P.51.

The DAI of the MS is connected to the SS and is set to the operating mode "Test of acoustic devices and A/D & D/A".

30.10.2.4.2 Procedure

- a) The SS sends a PCM bit stream coded with the value No 1 over the DAI (Pin 25) to the MS.
- b) The level of the noise is measured in the artificial ear with any volume control set at the position at which the RLR is equal to the nominal value.
- c) Where a volume control is provided, the level of the noise is measured in the artificial ear with the volume control set to maximum.

30.10.2.5 Test requirement

In step b) the measured noise generated by the MS shall not exceed -57 dBPa (A).

In step c) the measured noise shall not exceed -54 dBPa (A).

30.11 Ambient Noise Rejection

30.11.1 Definition and Applicability

An MS that supports speech will typically be operated within an area of high ambient acoustic noise. A level of noise rejection will therefore be required.

The requirements and this test apply to all types of GSM 400, GSM900, DCS1800 and PCS 1900 handset R96 MS (or later) supporting full rate speech.

30.11.2 Conformance Requirement

Compliance shall be checked by calculating the single figure DELSM (SFDELSM) according to the following formula, the SFDELSM shall be ≥ 0 dB.

$$SFDELSM = -\frac{4}{5} \times \sum_{n=1}^{14} Del_n \times 10^{(-0.0175 \times W_m)}$$

where :-

n = the third octave band centre frequencies from 160Hz to 3150Hz inclusive.

Del_n = is the 1/3 octave band pressure level centered on the n^{th} frequency.

W_m = is the SLR weighting for the n^{th} 1/3 octave band centre frequency.

GSM 03.50; 3.14.1

30.11.3 Test Purpose

To verify that ambient noise calculated as SFDELSM shall be rejected, by verifying that $SFDELSM \geq 0$ dB.

30.11.4 Method of Test

30.11.4.1 Initial Conditions

A 1/2 inch pressure microphone is calibrated using a known sound source and mounted at the MRP, without the LRGP head present. A frequency analyser is calibrated to enable the sound pressure levels at the microphone to be determined in 1/3rd octave bands.

Flood the room in which the measurement is to be made with the selected noise file, and adjust the level such that the noise level at the MRP is 70dBA. A single noise file of real noise, covering the various noise environments that the MS could be subjected to, is used. This file is three minutes long and also commences with a three minute signal. Once this tone has been adjusted to a level of 70dBA, the average level of the noise will be 70dBA. The resulting sound spectrum is Pr_n dBPa, measured in 1/3rd octave bands.

To ensure that the sound field is diffuse enough, the following apply:-

The diffuse sound field is calibrated in the absence of any local obstacles. The averaged field shall be uniform to within ± 3 dB within a radius of 0,15 m of the MRP, when measured in one-third octave bands from 100Hz to 3,15 KHz.

Where more than one loudspeaker is used to produce the desired sound field, the loudspeakers may require to be fed with non-coherent signals to eliminate standing waves and other interference effects.

Position an LRGP in the correct relative position to the MRP and mount the MS under test. Recalibrate the 1/3rd octave frequency analyser using a known voltage source to facilitate the analysis of the Voltage V_{rn} , where V_{rn} is the voltage at the audio output of the System Simulator (SS) due to the noise spectrum input.

30.11.4.2 Procedure

Set up a full rate speech path between the MS and the SS.

The SS determines, as a function of frequency, using the frequency analyser, in 1/3rd octave bands, the electrical output V_{rn} , (expressed as dB rel 1V) at the audio output of the SS for the applied acoustic pressure P_{rn} (expressed as dB rel 1Pa) at the MRP. Since, the MS sending sensitivity is not defined above 3,4kHz and below 300Hz the measurement shall be cut off at 3,4kHz and for the bands below 300Hz. The noise level shall be referenced to the speech level at 300Hz to yield the DELSM.

The room noise sensitivity is defined as :- $S_{mj_m} = V_{rn} \text{ (dBV)} - P_{rn} \text{ (dBPa)}$.

The ambient noise send sensitivity has now been determined.

The MS speech send sensitivity is now required. The required sensitivity is defined as the electrical output from the MS, measured at the audio output of the SS, as a function of the free field sound pressure at the MRP of the artificial mouth.

The measurement is made using an artificial speech source at the MRP of the artificial mouth. The 1/2 inch pressure microphone is calibrated using a known sound source. The frequency analyser is calibrated to measure in 1/3rd octave bands. The artificial mouth output shall be in accordance with the CCITT P.50 male artificial voice. Whilst maintaining the CCITT P.50 'male' spectrum, the total signal level is adjusted to -4,7 dBPa. The resulting sound spectrum is P_0 dBpa, measured in 1/3rd octave bands. The 1/3rd octave frequency analyser shall be re-calibrated, using a known voltage source, to facilitate the analysis of the voltage V_j . Where V_j is the voltage at the audio output of the SS due to the speech spectrum input. A speech path is setup between the MS and the SS. The function of the frequency is determined using the frequency analyser, and in 1/3rd octave bands, the electrical output V_j , (expressed as dB rel. 1V), at the audio output of the SS for the applied acoustic pressure, P_0 , (expressed as dB rel. 1Pa/V), at the MRP.

The sending sensitivity is expressed as :-

$$S_{mjs} \text{ (dB)} = V_j \text{ (dBV)} - P_o \text{ (dBPa)} \text{ dBrel1V / Pa}$$

The D_{SM} for the MS is determined as :-

$$D_{SM} = S_{mj_m} - S_{mjs} \text{ (dB)}.$$

30.11.5 Test Requirement

The MS ambient noise rejection, calculated as a single figure DELSM (SFDELSM) shall be greater than or equal to 0dB.

31 Test of supplementary services

The general aspects of the specification of supplementary services at the layer 3 radio interface are given in GSM 04.10.

The formats and coding are given in GSM 04.80. If the value of a parameter of an uplink message (MS to network) is specified in a test, the implicit meaning is that it has to be checked; if the value is not specified, it is not to be checked unless otherwise stated.

Unless otherwise stated, the MS shall be in the idle updated state at the beginning of each test (including repetition of a test).

In each test, before the MS sends the first REGISTER message, a MM connection is established.

GSM 04.81 to GSM 04.88 give the procedures used at the radio interface for normal operation, registration, erasure, activation, deactivation, invocation and interrogation of supplementary services.

The supplementary services are described in GSM 02.04 and GSM 02.81 to GSM 02.88.

Whenever activation via the standard MMI is mentioned, if the MS does not support it but supports a different procedure, this different procedure is used. In the supplementary services tests, only the applicable (see GSM 02.8x series) MMI service code groups (GSM 02.30 annex 4), of the basic service code in GSM 09.02, which are supported by the MAP, will be used.

31.1 Number identification supplementary services

31.1.1 CLIP

31.1.1.1 Normal operation

Conformance requirement:

GSM 04.81 subclause 1.1

Purpose:

To test that the MS presents to the user the calling number presented to it in an incoming SETUP message

Related PICS/PIXIT statements

- supported MT circuit switched basic services.
- description of display for CLIP
- support of displaying the calling party subaddress

Initial conditions

System Simulator:

1 cell, default parameters.

Mobile Station:

The MS is in MM-state "idle, updated" with valid TMSI and CKSN.

The SIM in the MS under test has CLIP enabled.

Foreseen final state of the MS

State U7

Maximum duration of test

30 s.

Procedure:

Set up an MT call to the MS under test. The SETUP message shall include a calling party BCD number information element and a calling party subaddress information element.

Expected sequence

Step	Direction	Message	Comments
1	SS -> MS	PAGING REQUEST	SS sends paging
2	MS -> SS	CHANNEL REQUEST	
3	SS -> MS	IMMEDIATE ASSIGNMENT	(SDCCH)
4	MS -> SS	PAGING RESPONSE	
5	SS -> MS	AUTHENTICATION REQUEST	
6	MS -> SS	AUTHENTICATION RESPONSE	
7	SS -> MS	CIPHERING MODE COMMAND	
8	MS -> SS	CIPHERING MODE COMPLETE	
9	SS -> MS	SETUP	Shall include a valid calling party BCD number and calling party subaddress
10	MS -> SS	CALL CONFIRMED	
11	MS -> SS	ALERTING	
12	MS		Depending on the PICS, the MS shall display the calling party BCD number and calling party subaddress

31.1.1.2 Interrogation

31.1.1.2.1 Interrogation accepted

Conformance requirement:

GSM 04.81 subclause 1.2

Applicability

MS supporting the CLIP supplementary service.

Test purpose

To test the correct operation of the interrogation procedure, and correct display of the response from the SS in the case of successful interrogation

Initial conditions

System Simulator:

1 cell, default parameters.

Mobile Station:

The MS is "idle updated".

Related PICS/PIXIT statement(s)

Description of the user's commands and of display of the answers from the network for interrogation of CLIP.

Foreseen final state of the MS

The MS is "idle updated".

Test procedure

By means of appropriate MMI functions (using either GSM 02.30 or manufacturer defined MMI), the user requests interrogation of CLIP for all basic service groups.

Upon receipt of the operation (in a REGISTER message), the system simulator answers with a RELEASE COMPLETE message with the Facility information element containing the return result of the InterrogateSS operation.

The SS transaction is released and the dedicated channel is released.

Maximum duration of test

3 min.

Expected sequence

Step	Direction	Message	Comments
1	MS		The MS is made to initiate an interrogation of CLIP (all) with establishment cause "Other procedures which can be completed with an SDCCH" cause: "supplementary service activation"
2	MS -> SS	CHANNEL REQUEST	
3	SS -> MS	IMMEDIATE ASSIGNMENT	
4	MS -> SS	CM SERVICE REQUEST	
5	SS -> MS	CM SERVICE ACCEPT	
6	MS -> SS	REGISTER	
7	SS -> MS	RELEASE COMPLETE	InterrogateSS operation Return_result provide user MMI indication
8	MS		
9	SS -> MS	CHANNEL RELEASE	

Specific message content

step 6 - CLIP

- protocol discriminator: non call related SS message
- message type: REGISTER
- facility

invoke = Interrogation

Supplementary service code = CLIP

Basic service code: no Bearer Service present, no teleservice present.

31.1.1.2.2 Interrogation rejected

Conformance requirement

GSM 04.81 subclause 1.2

Applicability

MS supporting the CLIP supplementary service.

Test purpose

To test the correct operation of the interrogation procedure, and correct display of the response from the SS in the case of an error response and an invoke problem

Initial conditions

System Simulator:

1 cell, default parameters.

Mobile Station:

The MS is in CC state U10.

Related PICS/PIXIT statement(s)

Description of the user's commands and of display of the answers from the network for interrogation of CLIP.

Foreseen final state of the MS

The MS is in CC state U10.

Test procedure

By means of appropriate MMI functions (using either GSM 02.30 or manufacturer defined MMI), the user requests interrogation of CLIP for all basic service groups.

Upon receipt of the operation (in a REGISTER message), the system simulator answers with a RELEASE COMPLETE message with the Facility information element containing a Return_error(error: SS not available) of the InterrogateSS operation.

The system simulator sends STATUS ENQUIRY, the MS responds with STATUS message indicating CC state U10.

Then again, by means of appropriate MMI functions as defined by the basic public MMI described in GSM 02.30, the user requests interrogation of CLIP for all basic service groups.

Upon receipt of the REGISTER message, the system simulator answers with the RELEASE COMPLETE message (same PD and TI that in the REGISTER message) with the Facility information element containing a reject(invoke_problem: resource limitation) of the InterrogateSS operation.

The system simulator sends STATUS ENQUIRY, the MS responds with STATUS message indicating CC state U10.

Maximum duration of test

3 min.

Expected sequence

Step	Direction	Message	Comments
1	MS		
2	MS -> SS	CM SERVICE REQUEST	The MS is made to initiate an interrogation for CLIP (all) cause: "supplementary service activation"
3	SS -> MS	CM SERVICE ACCEPT	
4	MS -> SS	REGISTER	
5	SS -> MS	RELEASE COMPLETE	InterrogateSS operation Return_error
6	SS -> MS	STATUS ENQUIRY	
7	MS -> SS	STATUS	
8	MS		CC state U10 The MS is made to initiate an interrogation of CLIP (all) cause: "supplementary service activation"
9	MS -> SS	CM SERVICE REQUEST	
10	SS -> MS	CM SERVICE ACCEPT	
11	MS -> SS	REGISTER	
12	SS -> MS	RELEASE COMPLETE	InterrogateSS operation Reject provide correct MMI user indication
13	MS		
14	SS -> MS	STATUS ENQUIRY	
15	MS -> SS	STATUS	CC state U10

Specific message content

step 4, 11 - CLIP

- protocol discriminator: non call related SS message
- message type: REGISTER
- facility

invoke = Interrogation

Supplementary service code = CLIP

Basic service code: no Bearer Service present, no teleservice present

step 5 - CLIP

- protocol discriminator: non call related SS message
- transaction identifier: same TI as previous REGISTER message
- message type: RELEASE COMPLETE
- facility:

return error code: SS not available

For the return error the invoke ID must be the same as in the invoke of the InterrogateSS operation.

step 12 -

- protocol discriminator: non call related SS message
- transaction identifier: same TI as previous REGISTER message
- message type: RELEASE COMPLETE
- facility:

reject code: resource limitation

For the reject the invoke ID must be the same as in the invoke of the InterrogateSS operation.

31.1.2 CLIR

31.1.2.1 Normal operation - requesting presentation of CLI

Conformance requirement:

GSM 04.81 subclause 2.2

Test Purpose

To test that when the CLIR presentation mode is temporary (presentation restricted), it is possible for the subscriber to present his CLI on a per call basis

Method of test

Related PICS/PIXIT statements

- supported MO circuit switched basic services.

Initial conditions

System Simulator:

1 cell, default parameters.

Mobile Station:

The SIM in the MS under test has CLIR enabled with CLIR presentation mode "temporary (presentation restricted)".

The MS is in MM-state "idle, updated" with valid TMSI and CKSN.

The MS is brought into the state U0.1 by using table 26.8.1.2/1.

Foreseen final state of the MS

U1, call initiated.

Maximum duration of test

30 s.

Test procedure

An MO circuit switched basic service is selected that is supported by the MS; if the MS supports MO telephony, the selected basic service is telephony. If necessary, the MS is configured for that basic service. Using MMI commands, the MS is made to initiate an outgoing call with CLI presented. When the MS is requesting a MM-connection, the SS will indicate acceptance by sending a CM SERVICE ACCEPT message. The MS shall respond with SETUP. The SETUP message shall contain the CLIR suppression information element.

Expected sequence

Step	Direction	Message	Comments
1	SS -> MS	CM SERVICE ACCEPT	
2	MS -> SS	SETUP	with CLIR suppression information element

31.1.2.2 Normal operation - requesting restriction of CLI presentation

Conformance requirement:

GSM 04.81 subclause 2.3

Test Purpose

To test that when the CLIR presentation mode is temporary (presentation allowed), it is possible for the subscriber to present his CLI on a per call basis

Procedure

Using MMI commands, the MS is made to initiate an outgoing call with CLI restricted.

Requirements:

The SETUP message sent by the MS shall include the CLIR invocation information element.

Method of test

Related PICS/PIXIT statements

- supported MO circuit switched basic services.

Initial conditions

System Simulator:

1 cell, default parameters.

Mobile Station:

The SIM in the MS under test has CLIR enabled with CLIR presentation mode "temporary (presentation allowed)".

The MS is in MM-state "idle, updated" with valid TMSI and CKSN.

The MS is brought into the state U0.1 by using table 26.8.1.2/1.

Foreseen final state of the MS

U1, call initiated.

Maximum duration of test

30 s.

Test procedure

An MO circuit switched basic service is selected that is supported by the MS; if the MS supports MO telephony, the selected basic service is telephony. If necessary, the MS is configured for that basic service. Using MMI commands, the MS is made to initiate an outgoing call with CLI restricted. When the MS is requesting a MM-connection, the SS will indicate acceptance by sending a CM SERVICE ACCEPT message. The MS shall respond with SETUP. The SETUP message sent by the MS shall include the CLIR invocation information element.

Expected sequence

Step	Direction	Message	Comments
1	SS -> MS	CM SERVICE ACCEPT	
2	MS -> SS	SETUP	with CLIR invocation information element

31.1.2.3 Interrogation

31.1.2.3.1 Interrogation accepted

Conformance requirement:

GSM 04.81 subclause 2.4

Applicability

MS supporting the CLIR supplementary service.

Test purpose

To test the correct operation of the interrogation procedure, and correct display of the response from the SS in the case of successful interrogation

Initial conditions

System Simulator:

1 cell, default parameters.

Mobile Station:

The MS is "idle updated".

Related PICS/PIXIT statement(s)

Description of the user's commands and of display of the answers from the network for interrogation of CLIR.

Foreseen final state of the MS

The MS is "idle updated".

Test procedure

By means of appropriate MMI functions (using either GSM 02.30 or manufacturer defined MMI), the user requests interrogation of CLIR for all basic service groups.

Upon receipt of the operation (in a REGISTER message), the system simulator answers with a RELEASE COMPLETE message with the Facility information element containing the return result of the InterrogateSS operation.

The SS transaction is released and the dedicated channel is released.

Maximum duration of test

3 min.

Expected sequence

Step	Direction	Message	Comments
1	MS		
2	MS -> SS	CHANNEL REQUEST	The MS is made to initiate an interrogation of CLIR (all) with establishment cause "Other procedures which can be completed with an SDCCH" cause: "supplementary service activation"
3	SS -> MS	IMMEDIATE ASSIGNMENT	
4	MS -> SS	CM SERVICE REQUEST	
5	SS -> MS	CM SERVICE ACCEPT	
6	MS -> SS	REGISTER	
7	SS -> MS	RELEASE COMPLETE	InterrogateSS operation Return_result provide user MMI indication
8	MS		
9	SS -> MS	CHANNEL RELEASE	

Specific message content

step 6 - CLIR

- protocol discriminator: non call related SS message
- message type: REGISTER
- facility

invoke = Interrogation

Supplementary service code = CLIR

Basic service code: no Bearer Service present, no teleservice present.

31.1.2.3.2 Interrogation rejected

Conformance requirement

GSM 04.81 subclause 2.4

Applicability

MS supporting the CLIR supplementary service.

Test purpose

To test the correct operation of the interrogation procedure, and correct display of the response from the SS in the case of an error response and an invoke problem

Initial conditions

System Simulator:

1 cell, default parameters.

Mobile Station:

The MS is in CC state U10.

Related PICS/PIXIT statement(s)

Description of the user's commands and of display of the answers from the network for interrogation of CLIR.

Foreseen final state of the MS

The MS is in CC state U10.

Test procedure

By means of appropriate MMI functions (using either GSM 02.30 or manufacturer defined MMI), the user requests interrogation of CLIR for all basic service groups.

Upon receipt of the operation (in a REGISTER message), the system simulator answers with a RELEASE COMPLETE message with the Facility information element containing a Return_error(error: SS not available) of the InterrogateSS operation.

The system simulator sends STATUS ENQUIRY, the MS responds with STATUS message indicating CC state U10.

Then again, by means of appropriate MMI functions as defined by the basic public MMI described in GSM 02.30, the user requests interrogation of CLIR for all basic service groups.

Upon receipt of the REGISTER message, the system simulator answers with the RELEASE COMPLETE message (same PD and TI that in the REGISTER message) with the Facility information element containing a reject(involve_problem: resource limitation) of the InterrogateSS operation.

The system simulator sends STATUS ENQUIRY, the MS responds with STATUS message indicating CC state U10.

Maximum duration of test

3 min.

Expected sequence

Step	Direction	Message	Comments
1	MS		
2	MS -> SS	CM SERVICE REQUEST	The MS is made to initiate an interrogation for CLIR (all) cause: "supplementary service activation"
3	SS -> MS	CM SERVICE ACCEPT	
4	MS -> SS	REGISTER	
5	SS -> MS	RELEASE COMPLETE	InterrogateSS operation Return_error
6	SS -> MS	STATUS ENQUIRY	
7	MS -> SS	STATUS	CC state U10 The MS is made to initiate an interrogation of CLIR (all) cause: "supplementary service activation"
8	MS		
9	MS -> SS	CM SERVICE REQUEST	
10	SS -> MS	CM SERVICE ACCEPT	
11	MS -> SS	REGISTER	
12	SS -> MS	RELEASE COMPLETE	InterrogateSS operation Reject provide correct MMI user indication
13	MS		
14	SS -> MS	STATUS ENQUIRY	CC state U10
15	MS -> SS	STATUS	

Specific message content

step 4, 11 - CLIR

- protocol discriminator: non call related SS message
- message type: REGISTER
- facility

invoke = Interrogation

Supplementary service code = CLIR

Basic service code: no Bearer Service present, no teleservice present

step 5 - CLIR

- protocol discriminator: non call related SS message
- transaction identifier: same TI as previous REGISTER message
- message type: RELEASE COMPLETE
- facility:

return error code: SS not available

For the return error the invoke ID must be the same as in the invoke of the InterrogateSS operation.

step 12 -

- protocol discriminator: non call related SS message
- transaction identifier: same TI as previous REGISTER message
- message type: RELEASE COMPLETE
- facility:

reject code: resource limitation

For the reject the invoke ID must be the same as in the invoke of the InterrogateSS operation.

31.1.3 COLP

31.1.3.1 Normal operation

Conformance requirement:

GSM 04.81 subclause 3.1

Applicability

MS supporting the COLP supplementary service.

Purpose:

To test that the MS displays the connected number presented to it in an incoming CONNECT message

Method of test

Related PICS/PIXIT statements

- supported MO circuit switched basic services.
- description of display for COLP

Initial conditions

System Simulator:

1 cell, default parameters.

Mobile Station:

The SIM in the MS under test has COLP enabled.

The MS is in MM-state "idle, updated" with valid TMSI and CKSN.

The MS is brought into the state U1 by using table 26.8.1.2/4.

Foreseen final state of the MS

U10, call active.

Maximum duration of test

30 s.

Test procedure

1. An MO circuit switched basic service is selected that is supported by the MS; if the MS supports MO telephony, the selected basic service is telephony. If necessary, the MS is configured for that basic service. Then, the MS is made to initiate a call. The CC entity of the MS is brought to the state U4. The SS sends a CONNECT message to the MS containing a connected number information element and a connected party subaddress information element. The MS shall respond by sending a CONNECT ACKNOWLEDGE message. The MS shall correctly display the connected line information.

Expected sequence, procedure 1

Step	Direction	Message	Comments
1	SS -> MS	CONNECT	See specific message contents
2	MS -> SS	CONNECT ACKNOWLEDGE	
3	MS		The MS shall correctly display the connected line information

Specific message contents

CONNECT

Connected number information element	
Presentation indicator	Presentation allowed
Screening indicator	User provided, not screened
Connected subaddress	Any valid subaddress

31.1.3.2 Interrogation

31.1.3.2.1 Interrogation accepted

Conformance requirement:

GSM 04.81 subclause 3.2

Applicability

MS supporting the COLP supplementary service.

Test purpose

To test the correct operation of the interrogation procedure, and correct display of the response from the SS in the case of successful interrogation

Initial conditions

System Simulator:

1 cell, default parameters.

Mobile Station:

The MS is "idle updated".

Related PICS/PIXIT statement(s)

Description of the user's commands and of display of the answers from the network for interrogation of COLP.

Foreseen final state of the MS

The MS is "idle updated".

Test procedure

By means of appropriate MMI functions (using either GSM 02.30 or manufacturer defined MMI), the user requests interrogation of COLP for all basic service groups.

Upon receipt of the operation (in a REGISTER message), the system simulator answers with a RELEASE COMPLETE message with the Facility information element containing the return result of the InterrogateSS operation.

The SS transaction is released and the dedicated channel is released.

Maximum duration of test

3 min.

Expected sequence

Step	Direction	Message	Comments
1	MS		
2	MS -> SS	CHANNEL REQUEST	The MS is made to initiate an interrogation of COLP (all) with establishment cause "Other procedures which can be completed with an SDCCH" cause: "supplementary service activation"
3	SS -> MS	IMMEDIATE ASSIGNMENT	
4	MS -> SS	CM SERVICE REQUEST	
5	SS -> MS	CM SERVICE ACCEPT	
6	MS -> SS	REGISTER	
7	SS -> MS	RELEASE COMPLETE	InterrogateSS operation Return_result provide user MMI indication
8	MS		
9	SS -> MS	CHANNEL RELEASE	

Specific message content

step 6 - COLP

- protocol discriminator: non call related SS message
- message type: REGISTER
- facility

invoke = Interrogation

Supplementary service code = COLP

Basic service code: no Bearer Service present, no teleservice present.

31.1.3.2.2 Interrogation rejected

Conformance requirement

GSM 04.81 subclause 3.2

Applicability

MS supporting the COLP supplementary service.

Test purpose

To test the correct operation of the interrogation procedure, and correct display of the response from the SS in the case of an error response and an invoke problem

Initial conditions

System Simulator:

1 cell, default parameters.

Mobile Station:

The MS is in CC state U10.

Related PICS/PIXIT statement(s)

Description of the user's commands and of display of the answers from the network for interrogation of COLP.

Foreseen final state of the MS

The MS is in CC state U10.

Test procedure

By means of appropriate MMI functions (using either GSM 02.30 or manufacturer defined MMI), the user requests interrogation of COLP for all basic service groups.

Upon receipt of the operation (in a REGISTER message), the system simulator answers with a RELEASE COMPLETE message with the Facility information element containing a Return_error(error: SS not available) of the InterrogateSS operation.

The system simulator sends STATUS ENQUIRY, the MS responds with STATUS message indicating CC state U10.

Then again, by means of appropriate MMI functions as defined by the basic public MMI described in GSM 02.30, the user requests interrogation of COLP for all basic service groups.

Upon receipt of the REGISTER message, the system simulator answers with the RELEASE COMPLETE message (same PD and TI that in the REGISTER message) with the Facility information element containing a reject(invoke_problem: resource limitation) of the InterrogateSS operation.

The system simulator sends STATUS ENQUIRY, the MS responds with STATUS message indicating CC state U10.

Maximum duration of test

3 min.

Expected sequence

Step	Direction	Message	Comments
1	MS		
2	MS -> SS	CM SERVICE REQUEST	The MS is made to initiate an interrogation for COLP (all) cause: "supplementary service activation"
3	SS -> MS	CM SERVICE ACCEPT	
4	MS -> SS	REGISTER	
5	SS -> MS	RELEASE COMPLETE	InterrogateSS operation Return_error
6	SS -> MS	STATUS ENQUIRY	
7	MS -> SS	STATUS	CC state U10 The MS is made to initiate an interrogation of COLP (all) cause: "supplementary service activation"
8	MS		
9	MS -> SS	CM SERVICE REQUEST	
10	SS -> MS	CM SERVICE ACCEPT	
11	MS -> SS	REGISTER	
12	SS -> MS	RELEASE COMPLETE	InterrogateSS operation Reject provide correct MMI user indication
13	MS		
14	SS -> MS	STATUS ENQUIRY	CC state U10
15	MS -> SS	STATUS	

Specific message content

step 4, 11 - COLP

- protocol discriminator: non call related SS message
- message type: REGISTER
- facility

invoke = Interrogation

Supplementary service code = COLP

Basic service code: no Bearer Service present, no teleservice present

step 5 - COLP

- protocol discriminator: non call related SS message
- transaction identifier: same TI as previous REGISTER message
- message type: RELEASE COMPLETE
- facility:

return error code: SS not available

For the return error the invoke ID must be the same as in the invoke of the InterrogateSS operation.

step 12 -

- protocol discriminator: non call related SS message
- transaction identifier: same TI as previous REGISTER message
- message type: RELEASE COMPLETE
- facility:

reject code: resource limitation

For the reject the invoke ID must be the same as in the invoke of the InterrogateSS operation.

31.1.4 COLR

31.1.4.1 Interrogation

31.1.4.1.1 Interrogation accepted

Conformance requirement:

GSM 04.81 subclause 4.2

Applicability

MS supporting the COLR supplementary service.

Test purpose

To test the correct operation of the interrogation procedure, and correct display of the response from the SS in the case of successful interrogation

Initial conditions

System Simulator:

1 cell, default parameters.

Mobile Station:

The MS is "idle updated".

Related PICS/PIXIT statement(s)

Description of the user's commands and of display of the answers from the network for interrogation of COLR.

Foreseen final state of the MS

The MS is "idle updated".

Test procedure

By means of appropriate MMI functions (using either GSM 02.30 or manufacturer defined MMI), the user requests interrogation of COLR for all basic service groups.

Upon receipt of the operation (in a REGISTER message), the system simulator answers with a RELEASE COMPLETE message with the Facility information element containing the return result of the InterrogateSS operation.

The SS transaction is released and the dedicated channel is released.

Maximum duration of test

3 min.

Expected sequence

Step	Direction	Message	Comments
1	MS		
2	MS -> SS	CHANNEL REQUEST	The MS is made to initiate an interrogation of COLR (all) with establishment cause "Other procedures which can be completed with an SDCCH" cause: "supplementary service activation"
3	SS -> MS	IMMEDIATE ASSIGNMENT	
4	MS -> SS	CM SERVICE REQUEST	
5	SS -> MS	CM SERVICE ACCEPT	
6	MS -> SS	REGISTER	
7	SS -> MS	RELEASE COMPLETE	InterrogateSS operation Return_result provide user MMI indication
8	MS		
9	SS -> MS	CHANNEL RELEASE	

Specific message content

step 6 - COLR

- protocol discriminator: non call related SS message
- message type: REGISTER
- facility

invoke = Interrogation

Supplementary service code = COLR

Basic service code: no Bearer Service present, no teleservice present.

31.1.4.1.2 Interrogation rejected

Conformance requirement

GSM 04.81 subclause 4.2

Applicability

MS supporting the COLR supplementary service.

Test purpose

To test the correct operation of the interrogation procedure, and correct display of the response from the SS in the case of an error response and an invoke problem

Initial conditions

System Simulator:

1 cell, default parameters.

Mobile Station:

The MS is in CC state U10.

Related PICS/PIXIT statement(s)

Description of the user's commands and of display of the answers from the network for interrogation of COLR.

Foreseen final state of the MS

The MS is in CC state U10.

Test procedure

By means of appropriate MMI functions (using either GSM 02.30 or manufacturer defined MMI), the user requests interrogation of COLR for all basic service groups.

Upon receipt of the operation (in a REGISTER message), the system simulator answers with a RELEASE COMPLETE message with the Facility information element containing a Return_error(error: SS not available) of the InterrogateSS operation.

The system simulator sends STATUS ENQUIRY, the MS responds with STATUS message indicating CC state U10.

Then again, by means of appropriate MMI functions as defined by the basic public MMI described in GSM 02.30, the user requests interrogation of COLR for all basic service groups.

Upon receipt of the REGISTER message, the system simulator answers with the RELEASE COMPLETE message (same PD and TI that in the REGISTER message) with the Facility information element containing a reject(involve_problem: resource limitation) of the InterrogateSS operation.

The system simulator sends STATUS ENQUIRY, the MS responds with STATUS message indicating CC state U10.

Maximum duration of test

3 min.

Expected sequence

Step	Direction	Message	Comments
1	MS		
2	MS -> SS	CM SERVICE REQUEST	The MS is made to initiate an interrogation for COLR (all) cause: "supplementary service activation"
3	SS -> MS	CM SERVICE ACCEPT	
4	MS -> SS	REGISTER	
5	SS -> MS	RELEASE COMPLETE	InterrogateSS operation Return_error
6	SS -> MS	STATUS ENQUIRY	
7	MS -> SS	STATUS	CC state U10
8	MS		The MS is made to initiate a interrogation of COLR (all) cause: "supplementary service activation"
9	MS -> SS	CM SERVICE REQUEST	
10	SS -> MS	CM SERVICE ACCEPT	
11	MS -> SS	REGISTER	
12	SS -> MS	RELEASE COMPLETE	InterrogateSS operation Reject
13	MS		provide correct MMI user indication
14	SS -> MS	STATUS ENQUIRY	
15	MS -> SS	STATUS	CC state U10

Specific message content

step 4, 11 - COLR

- protocol discriminator: non call related SS message
- message type: REGISTER
- facility

invoke = Interrogation

Supplementary service code = COLR

Basic service code: no Bearer Service present, no teleservice present

step 5 - COLR

- protocol discriminator: non call related SS message
- transaction identifier: same TI as previous REGISTER message
- message type: RELEASE COMPLETE
- facility:

return error code: SS not available

For the return error the invoke ID must be the same as in the invoke of the InterrogateSS operation.

step 12 -

- protocol discriminator: non call related SS message
- transaction identifier: same TI as previous REGISTER message
- message type: RELEASE COMPLETE
- facility:

reject code: resource limitation

For the reject the invoke ID must be the same as in the invoke of the InterrogateSS operation.

31.1.4.2 Normal operation

Conformance requirement:

GSM 04.81 subclause 3.1

Applicability

All MS.

Purpose:

To test that the MS is behaving correctly if the number is restricted in an incoming CONNECT message.

Method of test

Related PICS/PIXIT statements

- supported MO circuit switched basic services.

Initial conditions

System Simulator:

1 cell, default parameters.

Mobile Station:

The SIM in the MS under test has COLR enabled.

The MS is in MM-state "idle, updated" with valid TMSI and CKSN.

The MS is brought into the state U1 by using table 26.8.1.2/4.

Foreseen final state of the MS

U10, call active.

Maximum duration of test

30 s.

Test procedure

1. An MO circuit switched basic service is selected that is supported by the MS; if the MS supports MO telephony, the selected basic service is telephony. If necessary, the MS is configured for that basic service. Then, the MS is made to initiate a call. The CC entity of the MS is brought to the state U4. The SS sends a CONNECT message to the MS containing a connected number information element indicating "presentation restricted" with no number digits. The MS shall respond by sending a CONNECT ACKNOWLEDGE message and not display any connected line information.
2. Repeat procedure 1, except that the CONNECT message includes a connected number information element indicating "Number not available due to interworking".

Expected sequence, procedure 1

Step	Direction	Message	Comments
1	SS -> MS	CONNECT	See specific message contents
2	MS -> SS	CONNECT ACKNOWLEDGE	
3	MS		The MS shall display no connected line information

Specific message contents

CONNECT

Connected number information element	
Presentation indicator	Presentation restricted
Screening indicator	User provided, not screened
Number digits 1..n	Not present
Connected subaddress	Not present

Expected sequence, procedure 2

Step	Direction	Message	Comments
1	SS -> MS	CONNECT	See specific message contents
2	MS -> SS	CONNECT ACKNOWLEDGE	
3	MS		The MS shall display no connected line information

Specific message contents

CONNECT

Connected number information element	
Presentation indicator	Number not available due to interworking
Screening indicator	User provided, not screened
Number digits 1..n	Not present
Connected subaddress	Not present

31.2 Call offering supplementary services

The following abbreviations are used:

CFU:	Call Forwarding Unconditional
CFB:	Call Forwarding on mobile subscriber Busy
CFNRy:	Call Forwarding on No Reply
CFNRc:	Call Forwarding on mobile subscriber Not Reachable
CFC:	Call Forwarding Conditional (common name for CFB, CFNRy and CFNRc)
CF:	Call Forwarding (common name for CFU, CFB, CFNRy and CFNRc).

NOTE: These abbreviations are also used to represent the corresponding SS-Code; e.g. CFC is the SS-Code for all conditional forwarding services.

31.2.1 Call forwarding supplementary services

31.2.1.1 Registration

31.2.1.1.1 Registration accepted

31.2.1.1.1.1 Conformance requirements

For registration of any type of call forwarding with any parameters, the MS shall transmit successively

- 1) a CHANNEL REQUEST with establishment cause set to "other services requested by the mobile user";
- 2) a CM SERVICE REQUEST with CM service type indicating "supplementary service activation";
- 3) and then the REGISTER message containing a facility IE that includes an invoke of the RegisterSS operation with parameter values according to the user's request (MMI action);
- 4) Upon receipt of the RELEASE COMPLETE message, the MS shall provide the appropriate user indication (which is to be described by the manufacturer).

References

- 1) GSM 04.08 sections 3.3.1.1.2 and 9.1.9.
- 2) GSM 04.08 sections 4.5.1.1, 9.2.9 and 10.5.33.
- 3) GSM 04.82, GSM 04.80 sections 2.3 and 3.6.
- 4) GSM 02.30 section 4.5.

31.2.1.1.1.2 Test purpose

- 1) To check that the MS correctly requests a supplementary service transaction for registration of call forwarding in CHANNEL REQUEST message.
- 2) To check that the MS correctly requests a supplementary service transaction for registration of call forwarding in the subsequent CM SERVICE REQUEST.
- 3) To check that the MS sends a REGISTER message containing the invoke of the RegisterSS operation with the expected parameter values for registration of call forwarding.
- 4) To check that upon receipt of the result of the operation (in a RELEASE COMPLETE message), the MS provides the appropriate user indication (as described by the manufacturer).

These checks are done for:

- a) CFNRy, for basic service group speech.
- b) CFU, for basic service group all facsimile.

31.2.1.1.1.3 Method of test

Initial conditions

System Simulator:

1 cell, default parameters.

Mobile Station:

The MS is "idle updated".

Related PICS/PIXIT statement(s)

Description of the user's commands and of display of the answers from the network for call forwarding.

Foreseen final state of the MS

The MS is "idle updated".

Test procedure

By means of appropriate MMI functions (using either GSM 02.30 or manufacturer defined MMI), the user requests registration of CFNRy for Speech, to a number arbitrarily selected and with a no reply time value arbitrarily selected.

Upon receipt of the operation (in a REGISTER message), the system simulator answers with a RELEASE COMPLETE message with the Facility information element containing the return result of the RegisterSS operation.

The SS transaction is released and the dedicated channel is released.

Then again, by means of appropriate MMI functions as defined by the basic public MMI described in GSM 02.30, the user requests registration of CFU for all facsimile, to a number arbitrarily selected.

Upon receipt of the REGISTER message, the system simulator answers with the RELEASE COMPLETE message with the Facility information element containing the return result of the RegisterSS operation.

Maximum duration of test

3 min.

Expected sequence

Step	Direction	Message	Comments
1	MS		The MS is made to initiate a registration of call forwarding service for CFNRy (Speech) with establishment cause "Other procedures which can be completed with an SDCCH" cause: "supplementary service activation"
2	MS -> SS	CHANNEL REQUEST	
3	SS -> MS	IMMEDIATE ASSIGNMENT	
4	MS -> SS	CM SERVICE REQUEST	
5	SS -> MS	CM SERVICE ACCEPT	
6	MS -> SS	REGISTER	
7	SS -> MS	RELEASE COMPLETE	CNFRySS operation Return_result provide correct MMI user indication
8	MS		
9	SS -> MS	CHANNEL RELEASE	
10	MS		The MS is made to initiate a registration of call forwarding service for CFU (all facsimile) with establishment cause "Other procedures which can be completed with an SDCCH" cause: "supplementary service activation"
11	MS -> SS	CHANNEL REQUEST	
12	SS -> MS	IMMEDIATE ASSIGNMENT	
13	MS -> SS	CM SERVICE REQUEST	
14	SS -> MS	CM SERVICE ACCEPT	
15	MS -> SS	REGISTER	
16	SS -> MS	RELEASE COMPLETE	RegisterSS operation Return result provide correct MMI user indication
17	MS		
18	SS -> MS	CHANNEL RELEASE	

Specific message content

step 6 - CFNRy

- protocol discriminator: non call related SS message
- message type: REGISTER
- facility

invoke = Registration

Supplementary service code = CFNRy

Forwarded to number: as selected,

No reply condition time: as selected,

Basic service code: TeleService Telephony, no Bearerservice present.

step 7 - CFU

- protocol discriminator: non call related SS message
- transaction identifier: same as at step 6
- message type: RELEASE COMPLETE
- facility

Return Result = Registration

Supplementary service code = CFNRy

Forwarded to number

No Reply condition time

Basic service code: TeleService Telephony, no Bearerservice present.

step 15 - CFU

- protocol discriminator: non call related SS message
- message type: REGISTER
- facility

invoke = Registration

Supplementary service code = CFU

Forwarded to number: as selected,

Basic service code: no bearer service present, teleservice (all facsimile).

step 16 - CFU

- protocol discriminator: non call related SS message
- transaction identifier: same as at step 15
- message type: RELEASE COMPLETE
- facility

Return Result = Registration

Supplementary service code = CFU

Forwarded to number

Basic service code: TeleService (all facsimile), no Bearerservice present.

31.2.1.1.2 Registration rejected

31.2.1.1.2.1 Conformance requirements

- 1) A transaction of any kind being already established, for registration of any type of call forwarding with any parameters, the MS shall establish a parallel MM transaction, sending a CM SERVICE REQUEST with CM service type indicating "supplementary service activation".
- 2) Then the MS shall send a REGISTER message related to the present SS transaction containing a facility IE that includes an invoke of the RegisterSS operation with parameter values according to the user's request (MMI action).
- 3) Upon receipt of the RELEASE COMPLETE message related to the present SS transaction, the SS transaction shall be released but the first transaction shall remain unaffected.
- 4) Upon receipt of the RELEASE COMPLETE message, the MS shall provide the appropriate user indication (which is to be described by the Manufacturer).

References

- 1) GSM 04.08 sections 3.3.1.1.2 and 9.1.9.
- 2) GSM 04.08 sections 4.5.1.1, 9.2.9 and 10.5.33.
- 3) GSM 04.82, GSM 04.80 sections 2.3 and 3.6.
- 4) GSM 02.30 section 4.5.

31.2.1.1.2.2 Test purpose

- 1) To check that the MS correctly requests the establishment of a parallel MM transaction for supplementary service transaction of registration of call forwarding, sending a CM SERVICE REQUEST.

- 2) To check that the MS sends a REGISTER message containing the invoke of the RegisterSS operation with the expected parameter values for registration of call forwarding.
- 3) To check that upon receipt of the RELEASE COMPLETE message related to the present SS transaction, the first transaction remains unaffected.
- 4) To check that upon receipt of the RELEASE COMPLETE message, the MS provides the appropriate user indication (as described by the Manufacturer).

These checks are performed with a call transaction already established for:

- a) CFB, for all asynchronous services, the RELEASE COMPLETE message being sent with a facility IE containing a return_error(error) where error is "Bearer Service not provisioned".
- b) CF, for all facsimile, the RELEASE COMPLETE message being sent with a facility IE containing a reject(invoke_problem) where invoke_problem is "resource limitation".

31.2.1.1.2.3 Method of test

Initial conditions

System Simulator:

1 cell, default parameters.

Mobile Station:

The MS is in CC state U10.

Related PICS/PIXIT statement(s)

Description of the user's commands and of display of the answers from the network for call forwarding.

Foreseen final state of the MS

The MS is in CC state U10.

Test procedure

By means of appropriate MMI functions (using either GSM 02.30 or manufacturer defined MMI), the user requests registration of CFB for all asynchronous services, to a number arbitrarily selected.

Upon receipt of the operation (in a REGISTER message), the system simulator answers with a RELEASE COMPLETE message with the Facility information element containing a Return_error(error: BearerService not provisioned) of the RegisterSS operation.

The system simulator sends STATUS ENQUIRY, the MS responds with STATUS message indicating CC state U10.

Then again, by means of appropriate MMI functions as defined by the basic public MMI described in GSM 02.30, the user requests registration of CF for all facsimile, to a number arbitrarily selected.

Upon receipt of the REGISTER message, the system simulator answers with the RELEASE COMPLETE message with the Facility information element containing a reject(invoke_problem: resource limitation) of the RegisterSS operation.

The system simulator sends STATUS ENQUIRY, the MS responds with STATUS message indicating CC state U10.

Maximum duration of test

3 min.

Expected sequence

Step	Direction	Message	Comments
1	MS		The MS is made to initiate a registration of call forwarding service for CFB (all asynchronous services) cause: "supplementary service activation"
2	MS -> SS	CM SERVICE REQUEST	
3	SS -> MS	CM SERVICE ACCEPT	
4	MS -> SS	REGISTER	
5	SS -> MS	RELEASE COMPLETE	RegisterSS operation Return_error CC state U10
6	SS -> MS	STATUS ENQUIRY	
7	MS -> SS	STATUS	
8	MS		The MS is made to initiate a registration of call forwarding service for CF (all facsimile) cause: "supplementary service activation"
9	MS -> SS	CM SERVICE REQUEST	
10	SS -> MS	CM SERVICE ACCEPT	
11	MS -> SS	REGISTER	
12	SS -> MS	RELEASE COMPLETE	RegisterSS operation Reject provide correct MMI user indication CC state U10
13	MS		
14	SS -> MS	STATUS ENQUIRY	
15	MS -> SS	STATUS	

Specific message content

step 4 - CFB

- protocol discriminator: non call related SS message
- message type: REGISTER
- facility

invoke = Registration

Supplementary service code = CFB

Forwarded to number: as selected,

Basic service code: Bearer Service (all asynchronous services), no teleservice present

step 5 -

- protocol discriminator: non call related SS message
- transaction identifier: same TI as previous REGISTER message
- message type: RELEASE COMPLETE
- facility:

return error code: BearerService not provisioned

For the return error the invoke ID must be the same as in the invoke of the RegisterSS operation.

step 11 - CF

- protocol discriminator: non call related SS message
- message type: REGISTER
- facility

invoke = Registration

Supplementary service code = CF

Forwarded to number: as selected,

Basic service code: no bearer service present, teleservice (all facsimile).

step 12 -

- protocol discriminator: non call related SS message
- transaction identifier: same TI as previous REGISTER message
- message type: RELEASE COMPLETE
- facility:

reject code: resource limitation

For the reject the invoke ID must be the same as in the invoke of the Register SS operation.

31.2.1.2 Erasure by the subscriber

31.2.1.2.1 Erasure accepted

31.2.1.2.1.1 Conformance requirements

For erasure of any type of call forwarding, the MS shall transmit successively

- 1) a CHANNEL REQUEST with establishment cause set to "other services requested by the mobile user";
- 2) a CM SERVICE REQUEST with CM service type indicating "supplementary service activation";
- 3) and then the REGISTER message containing a facility that includes an invoke of the EraseSS operation with the expected parameter values according to the user request (MMI action).
- 4) Upon receipt of the RELEASE COMPLETE message, the MS shall provide the appropriate user indication (which is to be described by the manufacturer).

References

- 1) GSM 04.08 sections 3.3.1.1.2 and 9.1.9.
- 2) GSM 04.08 sections 4.5.1.1, 9.2.9 and 10.5.33.
- 3) GSM 04.82, GSM 04.80 sections 2.3 and 3.6.
- 4) GSM 02.30 section 4.5.

31.2.1.2.1.2 Test purpose

- 1) To check that the MS correctly requests supplementary service transaction for erasure of call forwarding in CHANNEL REQUEST message.
- 2) To check that the MS correctly requests supplementary service transaction for erasure of call forwarding in the subsequent CM SERVICE REQUEST.
- 3) To check that the MS sends a REGISTER message containing the invoke of the EraseSS operation with the expected parameter values for erasure of call forwarding.
- 4) To check that upon receipt of the result of the operation (in a RELEASE COMPLETE message), the MS provides the appropriate user indication (as described by the manufacturer).

These checks are done for:

- a) CFC, for basic service group all facsimile.
- b) CFNRc, for all basic service groups.

31.2.1.2.1.3 Method of test

Initial conditions

System Simulator:

1 cell, default parameters.

Mobile Station:

The MS is "idle updated".

Related PICS/PIXIT statement(s)

Description of the user's commands and of display of the answers from the network for call forwarding.

Foreseen final state of the MS

The MS is "idle updated".

Test procedure

By means of appropriate MMI functions (using either GSM 02.30 or manufacturer defined MMI), the user requests erasure of CFC for all facsimile.

Upon receipt of the operation (in a REGISTER message), the system simulator answers with a RELEASE COMPLETE message with the facility information element containing a return result of the EraseSS operation.

The SS transaction is released and the dedicated channel is released.

Then again, by means of appropriate MMI functions as defined by the basic public MMI described in GSM 02.30, the user requests erasure of CFNRc for all basic service groups.

Upon receipt of the REGISTER message, the system simulator answers with the RELEASE COMPLETE message with the Facility information element containing the return result of the EraseSS operation.

The dedicated channel is released.

Maximum duration of test

3 min.

Expected sequence

Step	Direction	Message	Comments
1	MS		The MS is made to initiate erasure of call forwarding for CFC (all facsimile)
2	MS -> SS	CHANNEL REQUEST	with establishment cause "Other procedures which can be completed with an SDCCH"
3	SS -> MS	IMMEDIATE ASSIGNMENT	
4	MS -> SS	CM SERVICE REQUEST	cause: "supplementary service activation"
5	SS -> MS	CM SERVICE ACCEPT	
6	MS -> SS	REGISTER	
7	SS -> MS	RELEASE COMPLETE	EraseSS operation Return_result
8	MS		provide user MMI indication
9	SS -> MS	CHANNEL RELEASE	
10	MS		The MS is made to initiate a erasure of call forwarding service for CFNRc (all basic services)
11	MS -> SS	CHANNEL REQUEST	with establishment cause "Other procedures which can be completed with an SDCCH"
12	SS -> MS	IMMEDIATE ASSIGNMENT	
13	MS -> SS	CM SERVICE REQUEST	cause: "supplementary service activation"
14	SS -> MS	CM SERVICE ACCEPT	
15	MS -> SS	REGISTER	
16	SS -> MS	RELEASE COMPLETE	EraseSS operation Return result
17	MS		provide correct MMI user indication
18	SS -> MS	CHANNEL RELEASE	

Specific message content

step 6 - CFC

- protocol discriminator: non call related SS message
- message type: REGISTER
- facility

invoke = Erasure

Supplementary service code = CFC

Basic service code: no Bearer Service, teleservice (all facsimile).

step 15 - CFNRc

- protocol discriminator: non call related SS message
- message type: REGISTER
- facility

invoke = Erasure

Supplementary service code = CFNRc

Basic service code: no bearer service present, no teleservice present.

31.2.1.2.2 Erasure rejected

31.2.1.2.2.1 Conformance requirements

- 1) A transaction of any kind being already established, for erasure of any type of call forwarding with any parameters, the MS shall establish a parallel MM transaction, sending a CM SERVICE REQUEST with CM service type indicating "supplementary service activation",
- 2) Then the MS shall send a REGISTER message related to the present SS transaction containing a facility IE that includes an invoke of the EraseSS operation with parameter values according to the user's request (MMI action).
- 3) Upon receipt of the RELEASE COMPLETE message related to the present SS transaction, the SS transaction shall be released but the first transaction shall remain unaffected.
- 4) Upon receipt of the RELEASE COMPLETE message, the MS shall provide the appropriate user indication (which is to be described by the Manufacturer).

References

- 1) GSM 04.08 sections 3.3.1.1.2, 9.1.9
- 2) GSM 04.08 sections 4.5.1.1, 9.2.9, 10.5.33
- 3) GSM 04.82, GSM 04.80 sections 2.3, 3.6
- 4) GSM 02.30 section 4.5

31.2.1.2.2.2 Test purpose

- 1) To check that the MS correctly requests the establishment of a parallel MM transaction for supplementary service transaction of erasure of call forwarding, sending a CM SERVICE REQUEST.
- 2) To check that the MS sends a REGISTER message containing the invoke of the EraseSS operation with the expected parameter values for erasure of call forwarding.
- 3) To check that upon receipt of the RELEASE COMPLETE message related to the present SS transaction, the first transaction remains unaffected.
- 4) To check that upon receipt of the RELEASE COMPLETE message, the MS provides the appropriate user indication (as described by the Manufacturer).

These checks are performed with a call transaction already established for:

- a) CFU, for Speech, the RELEASE COMPLETE message being sent with a facility IE containing a return_error(error) where error is "Teleservice not provisioned".
- b) CFNRy, for all facsimile, the RELEASE COMPLETE message being sent with a facility IE containing a reject(involve_problem) where involve_problem is "resource limitation".

31.2.1.2.2.3 Method of test

Initial conditions

System Simulator:

1 cell, default parameters.

Mobile Station:

The MS is in CC state U10.

Related PICS/PIXIT statement(s)

Description of the user's commands and of display of the answers from the network for call forwarding.

Foreseen final state of the MS

The MS is in CC state U10.

Test procedure

By means of appropriate MMI functions (using either GSM 02.30 or manufacturer defined MMI), the user requests erasure of CFU for Speech.

Upon receipt of the operation (in a REGISTER message), the system simulator answers with a RELEASE COMPLETE message with the Facility information element containing a Return_error(error: TeleService not provisioned) of the EraseSS operation.

The system simulator sends STATUS ENQUIRY, the MS responds with STATUS message indicating CC state U10.

Then again, by means of appropriate MMI functions as defined by the basic public MMI described in GSM 02.30, the user requests erasure of CFNRy for all facsimile.

Upon receipt of the REGISTER message, the system simulator answers with the RELEASE COMPLETE message with the Facility information element containing a reject(involve_problem: resource limitation) of the EraseSS operation.

The system simulator sends STATUS ENQUIRY, the MS responds with STATUS message indicating CC state U10.

Maximum duration of test

3 min.

Expected sequence

Step	Direction	Message	Comments
1	MS		The MS is made to initiate a erasure of call forwarding service for CFU (speech) cause: "supplementary service activation"
2	MS -> SS	CM SERVICE REQUEST	
3	SS -> MS	CM SERVICE ACCEPT	
4	MS -> SS	REGISTER	
5	SS -> MS	RELEASE COMPLETE	EraseSS operation Return_error
6	SS -> MS	STATUS ENQUIRY	CC state U10
7	MS -> SS	STATUS	
8	MS		The MS is made to initiate a erasure of call forwarding service for CFNRy (all facsimile) cause: "supplementary service activation"
9	MS -> SS	CM SERVICE REQUEST	
10	SS -> MS	CM SERVICE ACCEPT	
11	MS -> SS	REGISTER	
12	SS -> MS	RELEASE COMPLETE	EraseSS operation Reject
13	MS		provide correct MMI user indication
14	SS -> MS	STATUS ENQUIRY	CC state U10
15	MS -> SS	STATUS	

Specific message content

step 4 - CFU

- protocol discriminator: non call related SS message
- message type: REGISTER
- facility

invoke = Erasure

Supplementary service code = CFU

Basic service code: Tele Service Telephony, no Bearerservice present

step 5 -

- protocol discriminator: non call related SS message
- transaction identifier: same TI as previous REGISTER message
- message type: RELEASE COMPLETE
- facility:

return error code: TeleService not provisioned

For the return error the invoke ID must be the same as in the invoke of the EraseSS operation.

step 11 - CFNRy

- protocol discriminator: non call related SS message
- message type: REGISTER
- facility

invoke = Erasure

Supplementary service code = CFNRy

Basic service code: no bearer service present, teleservice (all facsimile)).

step 12 -

- protocol discriminator: non call related SS message
- transaction identifier: same TI as previous REGISTER message
- message type: RELEASE COMPLETE
- facility:

reject code: resource limitation

For the reject the invoke ID must be the same as in the invoke of the EraseSS operation.

31.2.1.3 Activation

31.2.1.3.1 Conformance requirements

For activation of any type of call forwarding with any parameters, the MS shall transmit successively

- 1) a CHANNEL REQUEST with establishment cause set to "other services requested by the mobile user";
- 2) a CM SERVICE REQUEST with CM service type indicating "supplementary service activation";
- 3) and then the REGISTER message containing a facility IE that includes an invoke of the ActivateSS operation with parameter values according to the user's request (MMI action).
- 4) Upon receipt of the RELEASE COMPLETE message, the MS shall provide the appropriate user indication (which is to be described by the manufacturer).

References

- 1) GSM 04.08 sections 3.3.1.1.2 and 9.1.9.
- 2) GSM 04.08 sections 4.5.1.1, 9.2.9 and 10.5.33.
- 3) GSM 04.82, GSM 04.80 sections 2.3 and 3.6.
- 4) GSM 02.30 section 4.5.

31.2.1.3.2 Test purpose

- 1) To check that the MS correctly requests a supplementary service transaction for activation of call forwarding in CHANNEL REQUEST message.
- 2) To check that the MS correctly requests a supplementary service transaction for activation of call forwarding in the subsequent CM SERVICE REQUEST.
- 3) To check that the MS sends a REGISTER message containing the invoke of the ActivateSS operation with the expected parameter values for activation of call forwarding.
- 4) To check that upon receipt of the result of the operation (in a RELEASE COMPLETE message), the MS provides the appropriate user indication (as described by the manufacturer).

These checks are done for:

- a) CF, for basic service group "all synchronous services".
- b) CFU, for all basic service groups.

31.2.1.3.3 Method of test

Initial conditions

System Simulator:

1 cell, default parameters.

Mobile Station:

The MS is "idle updated".

Related PICS/PIXIT statement(s)

Description of the user's commands and of display of the answers from the network for call forwarding.

Foreseen final state of the MS

The MS is "idle updated".

Test procedure

By means of appropriate MMI functions (using either GSM 02.30 or manufacturer defined MMI), the user requests activation of CF for all synchronous services.

Upon receipt of the operation (in a REGISTER message), the system simulator answers with the FACILITY message with the Facility information element containing the return result of the ActivateSS operation.

The SS transaction is released and the dedicated channel is released.

Then again, by means of appropriate MMI functions as defined by the basic public MMI described in GSM 02.30, the user requests activation of CFU for all basic service groups.

Upon receipt of the REGISTER message, the system simulator answers with the RELEASE COMPLETE message with the Facility information element containing the return result of the ActivateSS operation.

Maximum duration of test

3 min.

Expected sequence

Step	Direction	Message	Comments
1	MS		The MS is made to initiate a activation of call forwarding service for CF (all synchronous services) with establishment cause "Other procedures which can be completed with an SDCCH" cause: "supplementary service activation"
2	MS -> SS	CHANNEL REQUEST	
3	SS -> MS	IMMEDIATE ASSIGNMENT	
4	MS -> SS	CM SERVICE REQUEST	
5	SS -> MS	CM SERVICE ACCEPT	
6	MS -> SS	REGISTER	
7	SS -> MS	RELEASE COMPLETE	ActivateSS operation Return_result provide user MMI indication
8	MS		
9	SS -> MS	CHANNEL RELEASE	
10	MS		The MS is made to initiate a activation of call forwarding service for CFU (all basic service groups) with establishment cause "Other procedures which can be completed with an SDCCH" cause: "supplementary service activation"
11	MS -> SS	CHANNEL REQUEST	
12	SS -> MS	IMMEDIATE ASSIGNMENT	
13	MS -> SS	CM SERVICE REQUEST	
14	SS -> MS	CM SERVICE ACCEPT	
15	MS -> SS	REGISTER	
16	SS -> MS	RELEASE COMPLETE	ActivateSS operation Return result provide correct MMI user indication
17	MS		
18	SS -> MS	CHANNEL RELEASE	

Specific message contents:

step 6 - CF

- protocol discriminator: non call related SS message
- message type: REGISTER
- facility

invoke = Activation

Supplementary service code = CF

Basic service code: Bearer Service (all synchronous services), no teleservice present.

step 15 - CFU

- protocol discriminator: non call related SS message
- message type: REGISTER
- facility

invoke = Activation

Supplementary service code = CFU

Basic service code: no bearer service present, no teleservice present.

31.2.1.4 Deactivation

31.2.1.4.1 Conformance requirements

For deactivation of any type of call forwarding with any parameters, the MS shall transmit successively.

- 1) a CHANNEL REQUEST with establishment cause set to "other services requested by the mobile user";
- 2) a CM SERVICE REQUEST with CM service type indicating "supplementary service activation";

- 3) and then the REGISTER message containing a facility IE that includes an invoke of the DeactivateSS operation with parameter values according to the user's request (MMI action).
- 4) Upon receipt of the RELEASE COMPLETE message, the MS shall provide the appropriate user indication (which is to be described by the manufacturer).

References

- 1) GSM 04.08 sections 3.3.1.1.2 and 9.1.9.
- 2) GSM 04.08 sections 4.5.1.1, 9.2.9 and 10.5.33.
- 3) GSM 04.82, GSM 04.80 sections 2.3 and 3.6.
- 4) GSM 02.30 section 4.5.

31.2.1.4.2 Test purpose

- 1) To check that the MS correctly requests a supplementary service transaction for deactivation of call forwarding in CHANNEL REQUEST message.
- 2) To check that the MS correctly requests a supplementary service transaction for deactivation of call forwarding in the subsequent CM SERVICE REQUEST.
- 3) To check that the MS sends a REGISTER message containing the invoke of the DeactivateSS operation with the expected parameter values for deactivation of call forwarding.
- 4) To check that upon receipt of the result of the operation (in a RELEASE COMPLETE message), the MS provides the appropriate user indication (as described by the manufacturer).

These checks are done for:

- a) CFC, for basic service group speech.
- b) CFNRc, for basic service group all facsimile.

31.2.1.4.3 Method of test

Initial conditions

System Simulator:

1 cell, default parameters.

Mobile Station:

The MS is "idle updated".

Related PICS/PIXIT statement(s)

Description of the user's commands and of display of the answers from the network for call forwarding.

Foreseen final state of the MS

The MS is "idle updated".

Test procedure

By means of appropriate MMI functions (using either GSM 02.30 or manufacturer defined MMI), the user requests deactivation of CFC for speech.

Upon receipt of the operation (in a REGISTER message), the system simulator answers with a RELEASE COMPLETE message with the Facility information element containing the return result of the DeactivateSS operation.

The SS transaction is released and the dedicated channel is released.

Then again, by means of appropriate MMI functions as defined by the basic public MMI described in GSM 02.30, the user requests deactivation of CFNRc for all facsimile.

Upon receipt of the REGISTER message, the system simulator answers with the RELEASE COMPLETE message with the Facility information element containing the return result of the DeactivateSS operation.

The dedicated channel is released.

Maximum duration of test

3 min.

Expected sequence

Step	Direction	Message	Comments
1	MS		The MS is made to initiate a deactivation of call forwarding service for CFC (speech)
2	MS -> SS	CHANNEL REQUEST	with establishment cause "Other procedures which can be completed with an SDCCH"
3	SS -> MS	IMMEDIATE ASSIGNMENT	
4	MS -> SS	CM SERVICE REQUEST	cause: "supplementary service activation"
5	SS -> MS	CM SERVICE ACCEPT	
6	MS -> SS	REGISTER	
7	SS -> MS	RELEASE COMPLETE	DeactivateSS operation Return_result
8	MS		provide user MMI indication
9	SS -> MS	CHANNEL RELEASE	
10	MS		The MS is made to initiate a deactivation of call forwarding service for CFNRc (all facsimile)
11	MS -> SS	CHANNEL REQUEST	with establishment cause "Other procedures which can be completed with an SDCCH"
12	SS -> MS	IMMEDIATE ASSIGNMENT	
13	MS -> SS	CM SERVICE REQUEST	cause: "supplementary service activation"
14	SS -> MS	CM SERVICE ACCEPT	
15	MS -> SS	REGISTER	
16	SS -> MS	RELEASE COMPLETE	DeactivateSS operation Return result
17	MS		provide correct MMI user indication
18	SS -> MS	CHANNEL RELEASE	

Specific message content

step 6 - CFC

- protocol discriminator: non call related SS message
- message type: REGISTER
- facility

invoke = Deactivation

Supplementary service code = CFC

Basic service code: Bearer Service (speech), no teleservice present.

step 15 - CFNRc

- protocol discriminator: non call related SS message
- message type: REGISTER
- facility

invoke = Deactivation

Supplementary service code = CFNRc

Basic service code: no bearer service present, teleservice (all facsimile).

31.2.1.5 Invocation

Invocation is not applicable to the MS and causes no signalling on the radio path.

31.2.1.6 Interrogation

31.2.1.6.1 Interrogation accepted

31.2.1.6.1.1 Conformance requirements

For interrogation of any specific call forwarding service (not applicable to a group of services) with any parameters, the MS shall transmit successively:

- 1) a CHANNEL REQUEST with establishment cause set to "other services requested by the mobile user";
- 2) a CM SERVICE REQUEST with CM service type indicating "supplementary service activation";
- 3) and then the REGISTER message containing a facility IE that includes an invoke of the InterrogateSS operation with parameter values according to the user's request (MMI action).
- 4) Upon receipt of the RELEASE COMPLETE message, the MS shall provide the appropriate user indication (which is to be described by the manufacturer).

References

- 1) GSM 04.08 sections 3.3.1.1.2 and 9.1.9.
- 2) GSM 04.08 sections 4.5.1.1, 9.2.9 and 10.5.33.
- 3) GSM 04.82, GSM 04.80 sections 2.3 and 3.6.
- 4) GSM 02.30 section 4.5.

31.2.1.6.1.2 Test purpose

- 1) To check that the MS correctly requests a supplementary service transaction for interrogation of a specific call forwarding in CHANNEL REQUEST message.
- 2) To check that the MS correctly requests a supplementary service transaction for interrogation of call forwarding in the subsequent CM SERVICE REQUEST.
- 3) To check that the MS sends a REGISTER message containing the invoke of the InterrogateSS operation with the expected parameter values for interrogation of call forwarding.
- 4) To check that upon receipt of the result of the operation (in a RELEASE COMPLETE message), the MS provides the appropriate user indication (as described by the manufacturer).

These checks are done for:

- a) CFB, for all basic service groups.
- b) CFNRy, for basic service group speech.

31.2.1.6.1.3 Method of test

Initial conditions

System Simulator:

1 cell, default parameters.

Mobile Station:

The MS is "idle updated".

Related PICS/PIXIT statement(s)

Description of the user's commands and of display of the answers from the network for call forwarding.

Foreseen final state of the MS

The MS is "idle updated".

Test procedure

By means of appropriate MMI functions (using either GSM 02.30 or manufacturer defined MMI), the user requests interrogation of CFB for all basic service groups.

Upon receipt of the operation (in a REGISTER message), the system simulator answers with a RELEASE COMPLETE message with the Facility information element containing the return result of the InterrogateSS operation.

The SS transaction is released and the dedicated channel is released.

Then again, by means of appropriate MMI functions as defined by the basic public MMI described in GSM 02.30, the user requests interrogation of CFNRy for speech.

Upon receipt of the REGISTER message, the system simulator answers with the RELEASE COMPLETE message with the Facility information element containing the return result of the InterrogateSS operation.

The dedicated channel is released.

Maximum duration of test

3 min.

Expected sequence

Step	Direction	Message	Comments
1	MS		The MS is made to initiate a registration of call forwarding service for CFB (all) with establishment cause "Other procedures which can be completed with an SDCCH" cause: "supplementary service activation"
2	MS -> SS	CHANNEL REQUEST	
3	SS -> MS	IMMEDIATE ASSIGNMENT	
4	MS -> SS	CM SERVICE REQUEST	
5	SS -> MS	CM SERVICE ACCEPT	
6	MS -> SS	REGISTER	
7	SS -> MS	RELEASE COMPLETE	InterrogateSS operation Return_result provide user MMI indication
8	MS		
9	SS -> MS	CHANNEL RELEASE	
10	MS		The MS is made to initiate a registration of call forwarding service for CFNRy(speech) with establishment cause "Other procedures which can be completed with an SDCCH" cause: "supplementary service activation"
11	MS -> SS	CHANNEL REQUEST	
12	SS -> MS	IMMEDIATE ASSIGNMENT	
13	MS -> SS	CM SERVICE REQUEST	
14	SS -> MS	CM SERVICE ACCEPT	
16	MS -> SS	REGISTER	
17	SS -> MS	RELEASE COMPLETE	InterrogateSS operation Return result provide correct MMI user indication
18	MS		
19	SS -> MS	CHANNEL RELEASE	

Specific message content

step 6 - CFB

- protocol discriminator: non call related SS message
- message type: REGISTER
- facility

invoke = Interrogation

Supplementary service code = CFB

Basic service code: no Bearer Service present, no teleservice present.

step 15 - CFNRy

- protocol discriminator: non call related SS message
- message type: REGISTER
- facility

invoke = Interrogation

Supplementary service code = CFNRy

Basic service code: no bearer service present, teleservice (speech).

31.2.1.6.2 Interrogation rejected

31.2.1.6.2.1 Conformance requirements

- 1) A transaction of any kind being already established, for interrogation of any specific call forwarding service with any parameters, the MS shall establish a parallel MM transaction, sending a CM SERVICE REQUEST with CM service type indicating "supplementary service activation".
- 2) Then the MS shall send a REGISTER message related to the present SS transaction containing a facility IE that includes an invoke of the InterrogateSS operation with parameter values according to the user's request (MMI action).
- 3) Upon receipt of the RELEASE COMPLETE message related to the present SS transaction, the SS transaction shall be released but the first transaction shall remain unaffected.
- 4) Upon receipt of the RELEASE COMPLETE message, the MS shall provide the appropriate user indication (which is to be described by the Manufacturer).

References

- 1) GSM 04.08 sections 3.3.1.1.2 and 9.1.9.
- 2) GSM 04.08 sections 4.5.1.1, 9.2.9 and 10.5.33.
- 3) GSM 04.82, GSM 04.80 sections 2.3 and 3.6.
- 4) GSM 02.30 section 4.5.

31.2.1.6.2.2 Test purpose

- 1) To check that the MS correctly requests the establishment of a parallel MM transaction for supplementary service transaction of interrogation of a specific call forwarding service, sending a CM SERVICE REQUEST.
- 2) To check that the MS sends a REGISTER message containing the invoke of the InterrogateSS operation with the expected parameter values for interrogation of call forwarding.
- 3) To check that upon receipt of the RELEASE COMPLETE message related to the present SS transaction, the first transaction remains unaffected.
- 4) To check that upon receipt of the RELEASE COMPLETE message, the MS provides the appropriate user indication (as described by the Manufacturer).

These checks are performed with a call transaction already established for:

- a) CFNRc, for all basic service group, the RELEASE COMPLETE message being sent with a facility IE containing a return_error(error) where error is "SS not available".
- b) CFB, for all facsimile, the RELEASE COMPLETE message being sent with a facility IE containing a reject(involve_problem) where involve_problem is "resource limitation".

31.2.1.6.2.3 Method of test

Initial conditions

System Simulator:

1 cell, default parameters.

Mobile Station:

The MS is in CC state U10.

Related PICS/PIXIT statement(s)

Description of the user's commands and of display of the answers from the network for call forwarding.

Foreseen final state of the MS

The MS is in CC state U10.

Test procedure

By means of appropriate MMI functions (using either GSM 02.30 or manufacturer defined MMI), the user requests interrogation of CFNRc for all basic service groups.

Upon receipt of the operation (in a REGISTER message), the system simulator answers with a RELEASE COMPLETE message with the Facility information element containing a Return_error(error: SS not available) of the InterrogateSS operation.

The system simulator sends STATUS ENQUIRY, the MS responds with STATUS message indicating CC state U10.

Then again, by means of appropriate MMI functions as defined by the basic public MMI described in GSM 02.30, the user requests interrogation of CFB for all facsimile.

Upon receipt of the REGISTER message, the system simulator answers with the RELEASE COMPLETE message (same PD and TI that in the REGISTER message) with the Facility information element containing a reject(invoke_problem: resource limitation) of the InterrogateSS operation.

The system simulator sends STATUS ENQUIRY, the MS responds with STATUS message indicating CC state U10.

Maximum duration of test

3 min.

Expected sequence

Step	Direction	Message	Comments
1	MS		The MS is made to initiate a registration of call forwarding service for CFNRc (all)
2	MS -> SS	CM SERVICE REQUEST	cause: "supplementary service activation"
3	SS -> MS	CM SERVICE ACCEPT	
4	MS -> SS	REGISTER	
5	SS -> MS	RELEASE COMPLETE	InterrogateSS operation Return_error
6	SS -> MS	STATUS ENQUIRY	
7	MS -> SS	STATUS	CC state U10
8	MS		The MS is made to initiate a interrogation of call forwarding service for CFB (all facsimile)
9	MS -> SS	CM SERVICE REQUEST	cause: "supplementary service activation"
10	SS -> MS	CM SERVICE ACCEPT	
11	MS -> SS	REGISTER	
12	SS -> MS	RELEASE COMPLETE	InterrogateSS operation Reject
13	MS		provide correct MMI user indication
14	SS -> MS	STATUS ENQUIRY	
15	MS -> SS	STATUS	CC state U10

Specific message content

step 4 - CFNRc

- protocol discriminator: non call related SS message
- message type: REGISTER
- facility

invoke = Interrogation

Supplementary service code = CFNRc

Basic service code: no Bearer Service present, no teleservice present

step 5 -

- protocol discriminator: non call related SS message
- transaction identifier: same TI as previous REGISTER message
- message type: RELEASE COMPLETE
- facility:

return error code: SS not available

For the return error the invoke ID must be the same as in the invoke of the InterrogateSS operation.

step 11 - CFB

- protocol discriminator: non call related SS message
- message type: REGISTER
- facility

invoke = Interrogation

Supplementary service code = CFB

Basic service code: no bearer service present, teleservice (all facsimile)).

step 12 -

- protocol discriminator: non call related SS message
- transaction identifier: same TI as previous REGISTER message
- message type: RELEASE COMPLETE
- facility:

reject code: resource limitation

For the reject the invoke ID must be the same as in the invoke of the InterrogateSS operation.

31.2.1.7 Normal operation

31.2.1.7.1 Served mobile subscriber side

31.2.1.7.1.1 Notification during an incoming call

This subscription option is only applicable to CFB and CFNRy.

31.2.1.7.1.1.1 Conformance requirements

- 1) During a call transaction, call establishment or not, upon receipt of a FACILITY message notifying an incoming call, the MS shall provide the appropriate user indication (which is to be described by the manufacturer).
- 2) If a call transaction is being established or is already established when the notification of incoming call is received, the receipt of the notification has no effect on its state.

References

- 1) GSM 02.30 section 4.5.
- 2) GSM 04.82 section 1.

31.2.1.7.1.1.2 Test purpose

- 1) To check that, in state U7 or U10, upon receipt of a FACILITY message notifying an incoming call, the MS shall provide the appropriate user indication (which is to be described by the manufacturer).
- 2) To check that when the notification of incoming call is received while the MS is in CC state U7 and U10 of another incoming call, it has no effect on its state.

These checks are performed in the case of CFB.

31.2.1.7.1.1.3 Method of test

Initial conditions

System Simulator:

1 cell, default parameters.

Mobile Station:

The MS is "idle updated".

Related PICS/PIXIT statement(s)

Description of the user's commands and of display of the answers from the network for call forwarding.

Foreseen final state of the MS

The MS is "idle updated".

Test procedure

The MS is brought to the call state U7 of an incoming call.

The system simulator transmits a FACILITY message with the facility information element containing an invoke of the NotifySS operation for CFB.

The system simulator sends STATUS ENQUIRY, the MS responds with STATUS message indicating CC state U7.

The MS is brought into the call state U10 of an incoming call.

The system simulator transmits a FACILITY message with the facility information element containing an invoke of the NotifySS operation for CFB.

The system simulator sends STATUS ENQUIRY, the MS responds with STATUS message indicating CC state U10.

The transaction and the channel are released by the SS.

Maximum duration of test

1 min.

Expected sequence

Step	Direction	Message	Comments	
1	SS -> MS	PAGING		
2	MS -> SS	CHANNEL REQUEST	with establishment cause "answer to paging"	
3	SS -> MS	IMMEDIATE ASSIGNMENT		
4	MS -> SS	PAGING RESPONSE		
5	SS -> MS	SETUP		
6	MS -> SS	CALL CONFIRMED		
7	SS -> MS	ASSIGNMENT COMMAND		
8	MS -> SS	ASSIGNMENT COMPLETE		
9	MS -> SS	ALERTING		
10	SS -> MS	FACILITY		(invoke NotifySS)
11	SS -> MS	STATUS ENQUIRY		
12	MS -> SS	STATUS		(U7)
13	MS -> SS	CONNECT		MS off hook
14	SS -> MS	CONNECT ACKNOWLEDGE		
15	SS -> MS	FACILITY		(invoke NotifySS)
16	SS -> MS	STATUS ENQUIRY		
17	MS -> SS	STATUS		(U10)
18	SS -> MS	RELEASE COMPLETE		
19	SS -> MS	CHANNEL RELEASE		

Specific message contents

Steps 10 and 15

- protocol discriminator: CC
- transaction identifier: same as for the call transaction already established
- message type: FACILITY
- facility

invoke = notification

Supplementary service code = CFB

SS notification = incoming call is forwarded

(call is forwarded indication to B subscriber).

31.2.1.7.1.2 Notification during an outgoing call

31.2.1.7.1.2.1 Conformance requirements

- 1) As an outgoing call is being established, if the ALERTING message is received with the facility information element containing an SS notification (for CFU or CFC), the MS shall correctly reach CC state U4.
- 2) As an outgoing call is being established, if the ALERTING message is received with the facility information element containing an SS notification (for CFU or CFC), the MS shall provide the appropriate user indication (which is to be described by the manufacturer).
- 3) As an outgoing call is being established, if the CONNECT message is received with the facility information element containing an SS notification (for CFU or CFC), the MS shall normally send a CONNECT ACKNOWLEDGE message and enter CC state U10.

- 4) As an outgoing call is being established, if the CONNECT message is received with the facility information element containing an SS notification (for CFU or CFC), the MS shall provide the appropriate user indication (which is to be described by the manufacturer).

References

- 1) GSM 04.82, GSM 04.80 section 3.6.
- 2) GSM 04.82, TBS. GSM 04.80 section 3.6.

31.2.1.7.1.2.2 Test purpose

- 1) To check that when an outgoing call is being established, if the ALERTING message is received with the facility information element containing an SS notification, the MS correctly reaches CC state U4. This is tested for CFU.
- 2) As an outgoing call is being established, if the ALERTING message is received with the facility information element containing an SS notification, the MS provides the appropriate user indication (which is to be described by the manufacturer). This is tested for CFU.
- 3) As an outgoing call is being established, if the CONNECT message is received with the facility information element containing an SS notification, the MS normally sends a CONNECT ACKNOWLEDGE message and enter CC state U10. This is tested for CFC.
- 4) As an outgoing call is being established, if the CONNECT message is received with the facility information element containing an SS notification (for CFU or CFC), the MS provides the appropriate user indication (which is to be described by the manufacturer). This is tested for CFC.

31.2.1.7.1.2.3 Method of test

Initial conditions

System Simulator:

1 cell, default parameters.

Mobile Station:

The MS is "idle updated".

Related PICS/PIXIT statement(s)

Description of the user's commands and of display of the answers from the network for call forwarding.

Foreseen final state of the MS

The MS is "idle updated".

Test procedure

The MS is made to place an outgoing call.

After having received a SETUP message and sent a CALL PROCEEDING message and after a TCH has been allocated the system simulator transmits an ALERTING message with the facility information element containing a notification.

The system simulator send then a STATUS ENQUIRY message. On receipt of the STATUS ENQUIRY message the MS shall send a STATUS message with CC-state U4.

After that, the system simulator transmits a CONNECT with the facility information element containing a notification.

After reception of a CONNECT ACKNOWLEDGE message the system simulator sends a STATUS ENQUIRY message.

The MS shall respond with a STATUS message indicating CC-state U10.

The transaction and the channel are released by the SS.

Maximum duration of test

1 min.

Expected sequence

Step	Direction	Message	Comments
1	MS -> SS	CHANNEL REQUEST	
2	SS -> MS	IMMEDIATE ASSIGNMENT	
3	MS -> SS	CM SERVICE REQUEST	"mobile originating call establishment"
4	SS -> MS	CM SERVICE ACCEPT	
5	MS -> SS	SETUP	
6	SS -> MS	CALL PROCEEDING	
7	SS -> MS	ASSIGNMENT COMMAND	
8	MS -> SS	ASSIGNMENT COMPLETE	
9	SS -> MS	ALERTING	containing facility IE
10	SS -> MS	STATUS ENQUIRY	
11	MS -> SS	STATUS	(U4)
12	SS -> MS	CONNECT	containing facility IE
13	MS -> SS	CONNECT ACKNOWLEDGE	
14	SS -> MS	STATUS ENQUIRY	
15	MS -> SS	STATUS	(U10)
16	SS -> MS	RELEASE COMPLETE	
17	SS -> MS	CHANNEL RELEASE	

Specific message contents

At step 9 -

Facility invoke = notification

- SS-Code (CFU)
- SS-Status (indicating:
Provisioned, registered and active).

At step 12 -

Facility invoke = notification

- SS-Code (CFC)
- SS-Status (indicating:
Provisioned, registered and active).

31.2.1.7.2 Forwarded-to mobile subscriber side

31.2.1.7.2.1 Conformance requirements

- 1) Upon receipt of the SETUP message containing a notification indication that the call is a forwarded one (with any SS code except CFC), the MS shall correctly continue call establishment and enter CC state U6.
- 2) Upon receipt of the SETUP message containing a notification indication that the call is a forwarded one, or after sending CALL CONFIRMED, or after sending ALERTING, the MS shall provide the appropriate user indication (which is to be described by the manufacturer).

References

- 1) GSM 04.82.

2) GSM O2.30 section 4.5.

31.2.1.7.2.2 Test purpose

- 1) To check that, upon receipt of the SETUP message containing a notification indication that the call is a forwarded one, the MS correctly continues call establishment and enters CC state U6.
- 2) To check that upon receipt of the SETUP message containing a notification indication that the call is a forwarded one, or after sending CALL CONFIRMED, or after sending ALERTING, the MS provides the appropriate user indication (which is to be described by the manufacturer).

31.2.1.7.2.3 Method of test

Initial conditions

System Simulator:

1 cell, default parameters.

Mobile Station:

The MS is "idle updated".

Related PICS/PIXIT statement(s)

Description of the user's commands and of display of the answers from the network for call forwarding.

Foreseen final state of the MS

The MS is "idle updated".

Test procedure

An incoming call is given to the MS with the SETUP message with the facility information element containing an invoke of the NotifySS operation with the indication that the call is forwarded.

After the MS has responded with a CALL CONFIRM message the SS sends a STATUS ENQUIRY message: the MS responds indicating CC state U9 (implying that it has travelled through state U6).

The transaction and the channel are released by the SS.

Maximum duration of test

1 min.

Expected sequence

Step	Direction	Message	Comments
1	SS -> MS	PAGING	with establishment cause "answer to paging"
2	MS -> SS	CHANNEL REQUEST	
3	SS -> MS	IMMEDIATE ASSIGNMENT	containing the notification that the call is a forwarded one
4	MS -> SS	PAGING RESPONSE	
5	SS -> MS	SETUP	
6	MS -> SS	CALL CONFIRMED	Ringing and user indication that the incoming call is forwarded
7	SS -> MS	ASSIGNMENT COMMAND	
8	MS -> SS	ASSIGNMENT COMPLETE	
9	MS -> SS	ALERTING	
10	SS -> MS	STATUS ENQUIRY	(U7)
11	MS -> SS	STATUS	
12	SS -> MS	RELEASE COMPLETE	
13	SS -> MS	CHANNEL RELEASE	

Specific message contents

at step 5 -

- protocol discriminator: CC
 - transaction identifier:
 - message type: SETUP
 - facility
- invoke = notification
- SS-Code (CFU, CFB, CFNRy, CFNRc or CF)
 - SS-Notification (indicating: call is forwarded i.e.
Call is forwarded indication to C-subscriber).

31.2.2 Call transfer and mobile access hunting supplementary services

(Reserved).

31.3 Call completion supplementary services

NOTE: In this section, Subscriber B is the MS under test, and subscribers A, C and D are distant parties to the calls made during the tests.

31.3.1 Call Waiting

31.3.1.1 Waiting call indication and confirmation

Conformance requirement

GSM 04.83 subclause 1.1

Applicability

MS supporting the Call Waiting supplementary service.

Test purpose

With an active call, an MS receiving an MT call shall include Cause #17 "user busy" in the CALL CONFIRMED message sent to the SS, and indicate the waiting call to the subscriber.

Method of test

Related PICS/PIXIT statements

- supported MT circuit switched basic services.
- method of indicating a waiting call to the user

Initial conditions

System Simulator:

1 cell, default parameters.

Mobile Station:

The MS has a call ("Call A-B") of a basic service supported by the MS and applicable to Call Waiting as described in GSM 02.04 Table A.1 in the active state. The SIM in the MS under test has Call Waiting enabled.

Foreseen final state of the MS

Call A-B, state U10. Call C-B, state U7.

Maximum duration of test

30 s.

Procedure

The SS shall initiate Call C-B by sending a SETUP message to the MS. The MS shall respond with a CALL CONFIRMED message including cause #17 "user busy", followed by an ALERTING message.

The MS shall remain in state U10 in respect of the Call A-B, and enter state U7 "Call received" in respect of Call C-B. The MS shall indicate the existence of the waiting call to the user by a method defined by the manufacturer. The call states shall be verified by the SS sending a STATUS ENQUIRY message in respect of the transaction identifier of each call, and receiving a STATUS message indicating the appropriate call state.

Expected sequence

Step	Direction	Message	Comments
1	SS -> MS	SETUP	Transaction identifier different from that of Call A-B cause #17 "user busy".
2	MS -> SS	CALL CONFIRMED	
3	MS -> SS	ALERTING	
4	MS		
5	SS -> MS	STATUS ENQUIRY	A waiting call indication as defined in a PICS/PIXIT statement is given by the MS.
6	MS -> SS	STATUS	Transaction identifier of Call A-B
7	SS -> MS	STATUS ENQUIRY	Transaction identifier of Call A-B, state U10
8	MS -> SS	STATUS	Transaction identifier of Call C-B
			Transaction identifier of Call C-B, state U7

31.3.1.2 Normal operation with successful outcome

31.3.1.2.1 Waiting call accepted; existing call released

Conformance requirement

GSM 04.83 subclause 1.2.1

Applicability

MS supporting the Call Waiting supplementary service.

Test purpose

The MS shall release the active call using the call clearing procedures of GSM 04.08, and then accept the waiting call.

Method of test

Related PICS/PIXIT statements

- supported MT circuit switched basic services.
- method of clearing an active call and answering a waiting call

Initial conditions

System Simulator:

1 cell, default parameters.

Mobile Station:

The MS has Call A-B of a basic service supported by the MS and applicable to Call Waiting as described in GSM 02.04 Table A.1 in the state U10 "Active" and Call C-B in the state U7 "Call Received".

Foreseen final state of the MS

Call A-B, state U0. Call C-B, state U10.

Maximum duration of test

30 s.

Procedure

Using suitable MMI commands, the MS shall clear Call A-B, and then answer Call C-B.

The MS shall send a DISCONNECT message with the transaction identifier Call A-B, and then respond to a RELEASE message from the SS with a RELEASE COMPLETE message, and then enter state U0 "Null" in respect of this call.

The MS shall then send a CONNECT in respect of Call C-B, and enter state U10 "Active" on receipt of a CONNECT ACKNOWLEDGE message. The call states shall be verified by the SS sending a STATUS ENQUIRY message in respect of the transaction identifier of each call, and receiving a RELEASE COMPLETE message with cause #81 "invalid transaction identifier value" for Call A-B and a STATUS message indicating the appropriate call state for Call C-B.

Expected sequence

Step	Direction	Message	Comments
1	MS		Call A-B is cleared using MMI commands
2	MS -> SS	DISCONNECT	Transaction identifier of Call A-B
3	SS -> MS	RELEASE	Transaction identifier of Call A-B
4	MS -> SS	RELEASE COMPLETE	Transaction identifier of Call A-B
5	MS		Call C-B is answered using MMI commands
6	MS -> SS	CONNECT	Transaction identifier of Call C-B
7	SS -> MS	CONNECT ACKNOWLEDGE	Transaction identifier of Call C-B
8	SS -> MS	STATUS ENQUIRY	Transaction identifier of Call A-B
9	MS -> SS	RELEASE COMPLETE	Transaction identifier of Call A-B, with cause #81 "invalid transaction identifier value"
10	SS -> MS	STATUS ENQUIRY	Transaction identifier of Call C-B
11	MS -> SS	STATUS	Transaction identifier of Call C-B, state U10

31.3.1.2.2 Waiting call accepted; existing call on hold

31.3.1.2.2.1 Waiting call accepted; existing call on hold, no additional calls

Conformance requirement

GSM 04.83 subclause 1.2.2

Applicability

MS supporting the Call Waiting supplementary service.

Test purpose

With one active call and one waiting call, the MS shall place the active call on hold, and then accept the waiting call.

Method of test

Related PICS/PIXIT statements

- supported MT circuit switched basic services.
- method of placing an active call on hold and answering a waiting call

Initial conditions

System Simulator:

1 cell, default parameters.

Mobile Station:

The MS has Call A-B of a basic service supported by the MS and applicable to Call Waiting as described in GSM 02.04 Table A.1 in the state U10 "Active" and Call C-B in the state U7 "Call Received".

Foreseen final state of the MS

Call A-B, state U10, auxiliary state "Call held". Call C-B, state U10.

Maximum duration of test

30 s.

Procedure

Using suitable MMI commands, the MS shall place Call A-B on hold, and then answer Call C-B.

The MS shall send a HOLD message to the SS using the transaction identifier of Call A-B and enter state U10 "Active" with auxiliary state "Call held". On receipt of a HOLD ACKNOWLEDGE from the SS the MS shall enter state U10 "Active" with auxiliary state "Call held".

The MS shall then send a CONNECT message to the SS, using the transaction identifier of Call C-B, and on receipt of a CONNECT ACKNOWLEDGE message, shall enter state U10 "Active". The call states shall be verified by the SS sending a STATUS ENQUIRY message in respect of the transaction identifier of each call, and receiving a STATUS message indicating the appropriate call state.

Expected sequence

Step	Direction	Message	Comments
1	MS		Call A-B is placed on hold using MMI commands
2	MS -> SS	HOLD	Transaction identifier of Call A-B
3	SS -> MS	HOLD ACKNOWLEDGE	Transaction identifier of Call A-B
4	MS		Call C-B is answered using MMI commands
5	MS -> SS	CONNECT	Transaction identifier of Call C-B
6	SS -> MS	CONNECT ACKNOWLEDGE	Transaction identifier of Call C-B
7	SS -> MS	STATUS ENQUIRY	Transaction identifier of Call A-B
8	MS -> SS	STATUS	Transaction identifier of Call A-B, state U10, auxiliary state "Call Held"
9	SS -> MS	STATUS ENQUIRY	Transaction identifier of Call C-B
10	MS -> SS	STATUS	Transaction identifier of Call C-B, state U10

31.3.1.2.3 Existing call released by user A; waiting call accepted

Conformance requirement

GSM 04.83 subclause 1.2.3

Applicability

MS supporting the Call Waiting supplementary service.

Test purpose

The MS, on receipt of a DISCONNECT message from the active call, shall complete the clearance of the active call, and accept the waiting call.

Method of test

Related PICS/PIXIT statements

- supported MT circuit switched basic services.
- method of clearing an active call and answering a waiting call

Initial conditions

System Simulator:

1 cell, default parameters.

Mobile Station:

The MS has Call A-B of a basic service supported by the MS and applicable to Call Waiting as described in GSM 02.04 Table A.1 in the state U10 "Active" and Call C-B in the state U7 "Call Received".

Foreseen final state of the MS

Call A-B, state U0. Call C-B, state U10.

Maximum duration of test

30 s.

Procedure

On receipt of a DISCONNECT message using the transaction identifier of Call A-B, the MS shall respond with a RELEASE message. On receipt of a RELEASE COMPLETE message, the MS shall enter state U0 "Null". The call states shall be verified by the SS sending a STATUS ENQUIRY message in respect of the transaction identifier of each call, and receiving a STATUS message indicating the appropriate call state.

If necessary, MMI commands shall be entered to accept call C-B. The MS shall then send a CONNECT message using the transaction identifier of Call C-B, and on receipt of a CONNECT ACKNOWLEDGE message, shall enter state U10 "Active". The call states shall be verified by the SS sending a STATUS ENQUIRY message in respect of the transaction identifier of each call, and receiving a RELEASE COMPLETE message with cause #81 "invalid transaction identifier value" for Call A-B and a STATUS message indicating the appropriate call state for Call C-B.

Expected sequence

Step	Direction	Message	Comments
1	SS -> MS	DISCONNECT	Transaction identifier of Call A-B
2	MS -> SS	RELEASE	Transaction identifier of Call A-B
3	SS -> MS	RELEASE COMPLETE	Transaction identifier of Call A-B
4	MS		If necessary, call C-B is answered using MMI commands
5	MS -> SS	CONNECT	Transaction identifier of Call C-B
6	SS -> MS	CONNECT ACKNOWLEDGE	Transaction identifier of Call C-B
7	SS -> MS	STATUS ENQUIRY	Transaction identifier of Call A-B
8	MS -> SS	RELEASE COMPLETE	Transaction identifier of Call A-B, with cause #81 "invalid transaction identifier value"
9	SS -> MS	STATUS ENQUIRY	Transaction identifier of Call C-B
10	MS -> SS	STATUS	Transaction identifier of Call C-B, state U10

31.3.1.3 Normal operation with unsuccessful outcome

31.3.1.3.1 Waiting call released by subscriber B

Conformance requirement

GSM 04.83 subclause 1.3.1

Applicability

MS supporting the Call Waiting supplementary service.

Test purpose

To test that, using MMI commands, the MS shall clear the waiting call.

Method of test

Related PICS/PIXIT statements

- supported MT circuit switched basic services.
- method of clearing a waiting call

Initial conditions

System Simulator:

1 cell, default parameters.

Mobile Station:

The MS has Call A-B of a basic service supported by the MS and applicable to Call Waiting as described in GSM 02.04 Table A.1 in the state U10 "Active" and Call C-B in the state U7 "Call Received".

Foreseen final state of the MS

Call A-B, state U10. Call C-B, state U0.

Maximum duration of test

30 s.

Procedure

Using appropriate MMI commands, the MS shall clear Call C-B.

The MS shall send a DISCONNECT message with the transaction identifier of Call B, and on receipt of a RELEASE message from the network, shall send a RELEASE COMPLETE and enter state U0 "Null". The call states shall be verified by the SS sending a RELEASE COMPLETE message with cause #81 "invalid transaction identifier value" for Call C-B and STATUS ENQUIRY message in respect of the transaction identifier of each call, and receiving a RELEASE COMPLETE message with cause #81 "invalid transaction identifier value" for Call C-B and a STATUS message indicating the appropriate call state for Call A-B.

Expected sequence

Step	Direction	Message	Comments
1	MS		Call C-B is cleared using MMI commands
2	MS -> SS	DISCONNECT	Transaction identifier of Call C-B
3	SS -> MS	RELEASE	Transaction identifier of Call C-B
4	MS -> SS	RELEASE COMPLETE	Transaction identifier of Call C-B
5	SS -> MS	STATUS ENQUIRY	Transaction identifier of Call A-B
6	MS -> SS	STATUS	Transaction identifier of Call A-B, state U10
7	SS -> MS	STATUS ENQUIRY	Transaction identifier of Call C-B
8	MS -> SS	RELEASE COMPLETE	Transaction identifier of Call C-B, with cause #81 "invalid transaction identifier value"

31.3.1.3.2 Waiting call released by calling user C

Conformance requirement

GSM 04.83 subclause 1.3.2

Applicability

MS supporting the Call Waiting supplementary service.

Test purpose

To test that the MS responds correctly to the receipt of a clearing message from the waiting call.

Method of test

Related PICS/PIXIT statements

- supported MT circuit switched basic services.

Initial conditions

System Simulator:

1 cell, default parameters.

Mobile Station:

The MS has Call A-B of a basic service supported by the MS and applicable to Call Waiting as described in GSM 02.04 Table A.1 in the state U10 "Active" and Call C-B in the state U7 "Call Received".

Foreseen final state of the MS

Call A-B, state U10. Call C-B, state U0.

Maximum duration of test

30 s.

Procedure

On receipt of a DISCONNECT message using the transaction identifier of Call C-B, the MS shall respond with a RELEASE message. On receipt of a RELEASE COMPLETE message, the MS shall enter state U0 "Null". Call A-B shall remain in state U10. The call states shall be verified by the SS sending a STATUS ENQUIRY message in respect of the transaction identifier of each call, and receiving a a RELEASE COMPLETE message with cause #81 "invalid transaction identifier value" for Call C-B and STATUS message indicating the appropriate call state for Call A-B.

Expected sequence

Step	Direction	Message	Comments
1	SS -> MS	DISCONNECT	Transaction identifier of Call C-B
2	MS -> SS	RELEASE	Transaction identifier of Call C-B
3	SS -> MS	RELEASE COMPLETE	Transaction identifier of Call C-B
4	SS -> MS	STATUS ENQUIRY	Transaction identifier of Call A-B
5	MS -> SS	STATUS	Transaction identifier of Call A-B, state U10
6	SS -> MS	STATUS ENQUIRY	Transaction identifier of Call C-B
7	MS -> SS	RELEASE COMPLETE	Transaction identifier of Call C-B, with cause #81 "invalid transaction identifier value"

31.3.1.4 Activation

Conformance requirement

GSM 04.83 subclause 1.4

Applicability

MS supporting the Call Waiting supplementary service.

Test purpose

To test the correct operation of the activation procedure, and correctly display of the response from the SS in the following cases.

- 1) Successful activation
- 2) Error response (reject)
- 3) Activation reject (Invoke problem)

Initial conditions

System Simulator:

1 cell, default parameters.

Mobile Station:

The MS is "idle updated".

Related PICS/PIXIT statement(s)

Description of the user's commands and of display of the answers from the network for activation of Call Waiting.

Foreseen final state of the MS

The MS is "idle updated".

Test procedure

By means of appropriate MMI functions (using either GSM 02.30 or manufacturer defined MMI), the user requests activation of CW for a basic service group supported by the MS.

Upon receipt of the operation (in a REGISTER message), the system simulator answers with the RELEASE COMPLETE message with the Facility information element containing the return result of the ActivateSS operation.

The SS transaction is released and the dedicated channel is released.

Then again, by means of appropriate MMI functions as defined by the basic public MMI described in GSM 02.30, the user requests activation of CW for all basic service groups.

Upon receipt of the REGISTER message, the system simulator answers with the RELEASE COMPLETE message with the Facility information element containing the return result of the ActivateSS operation.

The SS transaction is released and the dedicated channel is released.

By means of appropriate MMI functions (using either GSM 02.30 or manufacturer defined MMI), the user requests activation of CW for a basic service group supported by the MS.

Upon receipt of the operation (in a REGISTER message), the system simulator answers with the RELEASE COMPLETE message with the Facility information element containing a Return Error component with Error code:SS not available.

The SS transaction is released and the dedicated channel is released.

Then again, by means of appropriate MMI functions as defined by the basic public MMI described in GSM 02.30, the user requests activation of CW for all basic service groups.

Upon receipt of the operation (in a REGISTER message), the system simulator answers with the RELEASE COMPLETE message with the Facility information element containing a Return Error component with Error code:SS not available.

The SS transaction is released and the dedicated channel is released.

By means of appropriate MMI functions (using either GSM 02.30 or manufacturer defined MMI), the user requests activation of CW for a basic service group supported by the MS.

Upon receipt of the REGISTER message, the system simulator answers with the RELEASE COMPLETE message with the Facility information element containing a Reject component with Invoke problem (Resource limitation).

The SS transaction is released and the dedicated channel is released.

Then again, by means of appropriate MMI functions as defined by the basic public MMI described in GSM 02.30, the user requests activation of CW for all basic service groups.

Upon receipt of the REGISTER message, the system simulator answers with the RELEASE COMPLETE message with the Facility information element containing A Reject component with Invoke problem (Resource limitation).

Maximum duration of test

9 min.

Expected sequence

Step	Direction	Message	Comments
1	MS		The MS is made to initiate a activation of call forwarding service for CW for the selected basic service group with establishment cause "Other procedures which can be completed with an SDCCH"
2	MS -> SS	CHANNEL REQUEST	
3	SS -> MS	IMMEDIATE ASSIGNMENT	
4	MS -> SS	CM SERVICE REQUEST	cause: "supplementary service activation"
5	SS -> MS	CM SERVICE ACCEPT	
6	MS -> SS	REGISTER	
7	SS -> MS	RELEASE COMPLETE	ActivateSS operation Return_result
8	MS		provide user MMI indication
9	SS -> MS	CHANNEL RELEASE	
10	MS		The MS is made to initiate a activation of CW (all basic service groups)
11	MS -> SS	CHANNEL REQUEST	with establishment cause "Other procedures which can be completed with an SDCCH"
12	SS -> MS	IMMEDIATE ASSIGNMENT	
13	MS -> SS	CM SERVICE REQUEST	cause: "supplementary service activation"
14	SS -> MS	CM SERVICE ACCEPT	
15	MS -> SS	REGISTER	
16	SS -> MS	RELEASE COMPLETE	ActivateSS operation Return result
17	MS		provide correct MMI user indication
18	SS -> MS	CHANNEL RELEASE	
19	MS		The MS is made to initiate a activation of call forwarding service for CW for the selected basic service group with establishment cause "Other procedures which can be completed with an SDCCH"
20	MS -> SS	CHANNEL REQUEST	
21	SS -> MS	IMMEDIATE ASSIGNMENT	
22	MS -> SS	CM SERVICE REQUEST	cause: "supplementary service activation"
23	SS -> MS	CM SERVICE ACCEPT	
24	MS -> SS	REGISTER	
25	SS -> MS	RELEASE COMPLETE	ActivateSS operation Return Error
26	MS		provide user MMI indication
27	SS -> MS	CHANNEL RELEASE	
28	MS		The MS is made to initiate a activation of CW (all basic service groups)
29	MS -> SS	CHANNEL REQUEST	with establishment cause "Other procedures which can be completed with an SDCCH"
30	SS -> MS	IMMEDIATE ASSIGNMENT	
31	MS -> SS	CM SERVICE REQUEST	cause: "supplementary service activation"
32	SS -> MS	CM SERVICE ACCEPT	
33	MS -> SS	REGISTER	
34	SS -> MS	RELEASE COMPLETE	ActivateSS operation Return Error
35	MS		provide correct MMI user indication
36	SS -> MS	CHANNEL RELEASE	
37	MS		The MS is made to initiate a activation of call forwarding service for CW for the selected basic service group with establishment cause "Other procedures which can be completed with an SDCCH"
38	MS -> SS	CHANNEL REQUEST	
39	SS -> MS	IMMEDIATE ASSIGNMENT	
40	MS -> SS	CM SERVICE REQUEST	cause: "supplementary service activation"
41	SS -> MS	CM SERVICE ACCEPT	
42	MS -> SS	REGISTER	
43	SS -> MS	RELEASE COMPLETE	ActivateSS operation Reject
44	MS		provide user MMI indication
45	SS -> MS	CHANNEL RELEASE	
46	MS		The MS is made to initiate a activation of CW (all basic service groups)
47	MS -> SS	CHANNEL REQUEST	with establishment cause "Other procedures which can be completed with an SDCCH"
48	SS -> MS	IMMEDIATE ASSIGNMENT	
49	MS -> SS	CM SERVICE REQUEST	cause: "supplementary service activation"
50	SS -> MS	CM SERVICE ACCEPT	
51	MS -> SS	REGISTER	
52	SS -> MS	RELEASE COMPLETE	ActivateSS operation Reject

53	MS		provide correct MMI user indication
54	SS -> MS	CHANNEL RELEASE	

Specific message contents:

step 6, 24, 42 - CW

- protocol discriminator: non call related SS message
- message type: REGISTER
- facility

invoke = Activation

Supplementary service code = CW

Basic service code: the selected basic service group

step 15, 33, 51 - CW

- protocol discriminator: non call related SS message
- message type: REGISTER
- facility

invoke = Activation

Supplementary service code = CW

Basic service code: no bearer service present, no teleservice present.

31.3.1.5 Deactivation

Conformance requirement

GSM 04.83 subclause 1.5

Applicability

MS supporting the Call Waiting supplementary service.

Test purpose

To test the correct operation of the deactivation procedure, and correct display of the response from the SS in the following cases

- 1) Successful deactivation
- 2) Error response (reject)
- 3) Activation reject (Invoke problem)

Initial conditions

System Simulator:

1 cell, default parameters.

Mobile Station:

The MS is "idle updated".

Related PICS/PIXIT statement(s)

Description of the user's commands and of display of the answers from the network for deactivation of call waiting.

Foreseen final state of the MS

The MS is "idle updated".

Test procedure

By means of appropriate MMI functions (using either GSM 02.30 or manufacturer defined MMI), the user requests deactivation of CW for a basic service group supported by the MS.

Upon receipt of the operation (in a REGISTER message), the system simulator answers with a RELEASE COMPLETE message with the Facility information element containing the return result of the DeactivateSS operation.

The SS transaction is released and the dedicated channel is released.

Then again, by means of appropriate MMI functions as defined by the basic public MMI described in GSM 02.30, the user requests deactivation of CW for all basic service groups.

Upon receipt of the REGISTER message, the system simulator answers with the RELEASE COMPLETE message with the Facility information element containing the return result of the DeactivateSS operation.

The SS transaction is released and the dedicated channel is released.

By means of appropriate MMI functions (using either GSM 02.30 or manufacturer defined MMI), the user requests deactivation of CW for a basic service group supported by the MS.

Upon receipt of the operation (in a REGISTER message), the system simulator answers with the RELEASE COMPLETE message with the Facility information element containing a Return Error component with Error code:SS not available.

The SS transaction is released and the dedicated channel is released.

Then again, by means of appropriate MMI functions as defined by the basic public MMI described in GSM 02.30, the user requests deactivation of CW for all basic service groups.

Upon receipt of the operation (in a REGISTER message), the system simulator answers with the RELEASE COMPLETE message with the Facility information element containing a Return Error component with Error code:SS not available.

The SS transaction is released and the dedicated channel is released.

By means of appropriate MMI functions (using either GSM 02.30 or manufacturer defined MMI), the user requests deactivation of CW for a basic service group supported by the MS.

Upon receipt of the REGISTER message, the system simulator answers with the RELEASE COMPLETE message with the Facility information element containing A Reject component with Invoke problem (Resource limitation).

The SS transaction is released and the dedicated channel is released.

Then again, by means of appropriate MMI functions as defined by the basic public MMI described in GSM 02.30, the user requests deactivation of CW for all basic service groups.

Upon receipt of the REGISTER message, the system simulator answers with the RELEASE COMPLETE message with the Facility information element containing A Reject component with Invoke problem (Resource limitation).

Maximum duration of test

9 min.

Expected sequence

Step	Direction	Message	Comments
1	MS		The MS is made to initiate a deactivation of CW for a basic service group supported by the MS
2	MS -> SS	CHANNEL REQUEST	with establishment cause "Other procedures which can be completed with an SDCCH"
3	SS -> MS	IMMEDIATE ASSIGNMENT	
4	MS -> SS	CM SERVICE REQUEST	cause: "supplementary service activation"
5	SS -> MS	CM SERVICE ACCEPT	
6	MS -> SS	REGISTER	
7	SS -> MS	RELEASE COMPLETE	DeactivateSS operation Return_result
8	MS		provide user MMI indication
9	SS -> MS	CHANNEL RELEASE	
10	MS		The MS is made to initiate a deactivation of CW (all basic services)
11	MS -> SS	CHANNEL REQUEST	with establishment cause "Other procedures which can be completed with an SDCCH"
12	SS -> MS	IMMEDIATE ASSIGNMENT	
13	MS -> SS	CM SERVICE REQUEST	cause: "supplementary service activation"
14	SS -> MS	CM SERVICE ACCEPT	
15	MS -> SS	REGISTER	
16	SS -> MS	RELEASE COMPLETE	DeactivateSS operation Return result
17	MS		provide correct MMI user indication
18	SS -> MS	CHANNEL RELEASE	
19	MS		The MS is made to initiate a deactivation of call forwarding service for CW for the selected basic service group
20	MS -> SS	CHANNEL REQUEST	with establishment cause "Other procedures which can be completed with an SDCCH"
21	SS -> MS	IMMEDIATE ASSIGNMENT	
22	MS -> SS	CM SERVICE REQUEST	cause: "supplementary service activation"
23	SS -> MS	CM SERVICE ACCEPT	
24	MS -> SS	REGISTER	
25	SS -> MS	RELEASE COMPLETE	DeactivateSS operation Return Error
26	MS		provide user MMI indication
27	SS -> MS	CHANNEL RELEASE	
28	MS		The MS is made to initiate a deactivation of CW (all basic service groups)
29	MS -> SS	CHANNEL REQUEST	with establishment cause "Other procedures which can be completed with an SDCCH"
30	SS -> MS	IMMEDIATE ASSIGNMENT	
31	MS -> SS	CM SERVICE REQUEST	cause: "supplementary service activation"
32	SS -> MS	CM SERVICE ACCEPT	
33	MS -> SS	REGISTER	
34	SS -> MS	RELEASE COMPLETE	DeactivateSS operation Return Error
35	MS		provide correct MMI user indication
36	SS -> MS	CHANNEL RELEASE	
37	MS		The MS is made to initiate a deactivation of call forwarding service for CW for the selected basic service group
38	MS -> SS	CHANNEL REQUEST	with establishment cause "Other procedures which can be completed with an SDCCH"
39	SS -> MS	IMMEDIATE ASSIGNMENT	
40	MS -> SS	CM SERVICE REQUEST	cause: "supplementary service activation"
41	SS -> MS	CM SERVICE ACCEPT	
42	MS -> SS	REGISTER	
43	SS -> MS	RELEASE COMPLETE	DeactivateSS operation Reject
44	MS		provide user MMI indication
45	SS -> MS	CHANNEL RELEASE	
46	MS		The MS is made to initiate a deactivation of CW (all basic service groups)
47	MS -> SS	CHANNEL REQUEST	with establishment cause "Other procedures which can be completed with an SDCCH"
48	SS -> MS	IMMEDIATE ASSIGNMENT	
49	MS -> SS	CM SERVICE REQUEST	cause: "supplementary service activation"
50	SS -> MS	CM SERVICE ACCEPT	

51	MS -> SS	REGISTER	
52	SS -> MS	RELEASE COMPLETE	DeactivateSS operation Reject provide correct MMI user indication
53	MS		
54	SS -> MS	CHANNEL RELEASE	

Specific message content

step 6, 24, 42 - CW

- protocol discriminator: non call related SS message
- message type: REGISTER
- facility

invoke = Deactivation

Supplementary service code = CW

Basic service code: the selected basic service group.

step 15, 33, 51 - CW

- protocol discriminator: non call related SS message
- message type: REGISTER
- facility

invoke = Deactivation

Supplementary service code = CW

Basic service code: no bearer service present

31.3.1.6 Interrogation

31.3.1.6.1 Interrogation accepted

Conformance requirement

GSM 04.83 subclause 1.6

Applicability

MS supporting the Call Waiting supplementary service.

Test purpose

To test the correct operation of the interrogation procedure, and correct display of the response from the SS in the case of successful interrogation

Initial conditions

System Simulator:

1 cell, default parameters.

Mobile Station:

The MS is "idle updated".

Related PICS/PIXIT statement(s)

Description of the user's commands and of display of the answers from the network for interrogation of call waiting.

Foreseen final state of the MS

The MS is "idle updated".

Test procedure

By means of appropriate MMI functions (using either GSM 02.30 or manufacturer defined MMI), the user requests interrogation of CW for all basic service groups.

Upon receipt of the operation (in a REGISTER message), the system simulator answers with a RELEASE COMPLETE message with the Facility information element containing the return result of the InterrogateSS (BasicServiceCode(s)) operation.

The SS transaction is released and the dedicated channel is released.

Then again, by means of appropriate MMI functions as defined by the basic public MMI described in GSM 02.30, the user requests interrogation of CW for all basic service groups.

Upon receipt of the REGISTER message, the system simulator answers with the RELEASE COMPLETE message with the Facility information element containing the return result of the InterrogateSS (SS-Status) operation.

The dedicated channel is released.

Maximum duration of test

3 min.

Expected sequence

Step	Direction	Message	Comments
1	MS		
2	MS -> SS	CHANNEL REQUEST	The MS is made to initiate an interrogation of CW (all) with establishment cause "Other procedures which can be completed with an SDCCH"
3	SS -> MS	IMMEDIATE ASSIGNMENT	
4	MS -> SS	CM SERVICE REQUEST	cause: "supplementary service activation"
5	SS -> MS	CM SERVICE ACCEPT	
6	MS -> SS	REGISTER	
7	SS -> MS	RELEASE COMPLETE	InterrogateSS (BasicServiceCode(s)) operation Return_result
8	MS		provide user MMI indication
9	SS -> MS	CHANNEL RELEASE	
10	MS		
11	MS -> SS	CHANNEL REQUEST	The MS is made to initiate an interrogation of CW (all) with establishment cause "Other procedures which can be completed with an SDCCH"
12	SS -> MS	IMMEDIATE ASSIGNMENT	
13	MS -> SS	CM SERVICE REQUEST	cause: "supplementary service activation"
14	SS -> MS	CM SERVICE ACCEPT	
15	MS -> SS	REGISTER	
16	SS -> MS	RELEASE COMPLETE	InterrogateSS (SS-Status) operation Return result
17	MS		provide correct MMI user indication
18	SS -> MS	CHANNEL RELEASE	

Specific message content

step 6, 15 - CW

- protocol discriminator: non call related SS message
- message type: REGISTER
- facility

invoke = Interrogation

Supplementary service code = CW

Basic service code: no Bearer Service present, no teleservice present.

31.3.1.6.2 Interrogation rejected

Conformance requirement

GSM 04.83 subclause 1.6

Applicability

MS supporting the Call Waiting supplementary service.

Test purpose

To test the correct operation of the interrogation procedure, and correct display of the response from the SS in the case of an error response and an invoke problem

Initial conditions

System Simulator:

1 cell, default parameters.

Mobile Station:

The MS is in CC state U10.

Related PICS/PIXIT statement(s)

Description of the user's commands and of display of the answers from the network for call waiting.

Foreseen final state of the MS

The MS is in CC state U10.

Test procedure

By means of appropriate MMI functions (using either GSM 02.30 or manufacturer defined MMI), the user requests interrogation of CW for all basic service groups.

Upon receipt of the operation (in a REGISTER message), the system simulator answers with a RELEASE COMPLETE message with the Facility information element containing a Return_error(error: SS not available) of the InterrogateSS operation.

The system simulator sends STATUS ENQUIRY, the MS responds with STATUS message indicating CC state U10.

Then again, by means of appropriate MMI functions as defined by the basic public MMI described in GSM 02.30, the user requests interrogation of CW for all basic service groups.

Upon receipt of the REGISTER message, the system simulator answers with the RELEASE COMPLETE message (same PD and TI that in the REGISTER message) with the Facility information element containing a reject(invoked_problem: resource limitation) of the InterrogateSS operation.

The system simulator sends STATUS ENQUIRY, the MS responds with STATUS message indicating CC state U10.

Maximum duration of test

3 min.

Expected sequence

Step	Direction	Message	Comments
1	MS		The MS is made to initiate an interrogation of CW (all) cause: "supplementary service activation"
2	MS -> SS	CM SERVICE REQUEST	
3	SS -> MS	CM SERVICE ACCEPT	
4	MS -> SS	REGISTER	
5	SS -> MS	RELEASE COMPLETE	InterrogateSS operation Return_error
6	SS -> MS	STATUS ENQUIRY	
7	MS -> SS	STATUS	CC state U10 The MS is made to initiate an interrogation of CW for (all) cause: "supplementary service activation"
8	MS		
9	MS -> SS	CM SERVICE REQUEST	
10	SS -> MS	CM SERVICE ACCEPT	
11	MS -> SS	REGISTER	
12	SS -> MS	RELEASE COMPLETE	InterrogateSS operation Reject provide correct MMI user indication
13	MS		
14	SS -> MS	STATUS ENQUIRY	CC state U10
15	MS -> SS	STATUS	

Specific message content

step 4, 11 - CW

- protocol discriminator: non call related SS message
- message type: REGISTER
- facility

invoke = Interrogation

Supplementary service code = CW

Basic service code: no Bearer Service present, no teleservice present

step 5 -

- protocol discriminator: non call related SS message
- transaction identifier: same TI as previous REGISTER message
- message type: RELEASE COMPLETE
- facility:

return error code: SS not available

For the return error the invoke ID must be the same as in the invoke of the InterrogateSS operation.

step 12 -

- protocol discriminator: non call related SS message
- transaction identifier: same TI as previous REGISTER message

- message type: RELEASE COMPLETE
- facility:
 - reject code: resource limitation

For the reject the invoke ID must be the same as in the invoke of the InterrogateSS operation.

31.3.2 Call Hold

31.3.2.1 Hold invocation

Conformance requirement

GSM 04.83 subclause 2.1.2

Applicability

MS supporting the Call Hold supplementary service.

Test purpose

To test the correct operation of the Hold procedure, and the MS reaction to the following messages sent in response to the HOLD message

1. HOLD REJECT
2. HOLD ACKNOWLEDGE

Method of test

Related PICS/PIXIT statements

- method of placing a call on hold

Initial conditions

System Simulator:

1 cell, default parameters.

Mobile Station:

The MS shall have a call of a basic service supported by the MS and applicable to Call Hold as described in GSM 02.04 Table A.1 in state U10 "Active"

Foreseen final state of the MS

State U10, Auxiliary state "Call Held"

Maximum duration of test

30 s.

Procedure

Using suitable MMI commands, the MS shall request that the call is placed on hold. The MS shall send a HOLD message and enter auxiliary state "hold request". On receipt of a HOLD REJECT message from the SS shall return to state U10 "Active". The call state shall be verified by the SS sending a STATUS ENQUIRY message in respect of the transaction identifier of the call, and receiving a STATUS message indicating the appropriate call state and auxiliary state.

Using suitable MMI commands, the MS shall again request that the call is placed on hold. The MS shall send a HOLD message and enter auxiliary state "hold request". On receipt of a HOLD ACKNOWLEDGE message from the SS shall enter to state U10 "Active" with auxiliary state "Call held". The call state shall be verified by the SS sending a STATUS ENQUIRY message in respect of the transaction identifier of call, and receiving a STATUS message indicating the appropriate call state and auxiliary state.

Expected sequence

Step	Direction	Message	Comments
1	MS		Using MMI commands, the MS places the call on hold
2	MS -> SS	HOLD	
3	SS -> MS	STATUS ENQUIRY	
4	MS -> SS	STATUS	State U10, auxiliary state "Hold request"
5	SS -> MS	HOLD REJECT	
6	SS -> MS	STATUS ENQUIRY	
7	MS -> SS	STATUS	State U10, no auxiliary state
8	SS		Check that the TCH is through-connected
9	MS		Using MMI commands, the MS places the call on hold
10	MS -> SS	HOLD	
11	SS -> MS	STATUS ENQUIRY	
12	MS -> SS	STATUS	State U10, auxiliary state "Hold request"
13	SS -> MS	HOLD ACKNOWLEDGE	
14	SS -> MS	STATUS ENQUIRY	
15	MS -> SS	STATUS	State U10, auxiliary state "Call held"

31.3.2.2 Retrieve procedure

Conformance requirement

GSM 04.83 subclause 2.1.3

Applicability

MS supporting the Call Hold supplementary service.

Test purpose

To test the correct operation of the retrieve procedure, and the MS reaction to the following messages sent in response to the RETRIEVE message

- 1) RETRIEVE REJECT
- 2) RETRIEVE ACKNOWLEDGE

Initial conditions

The MS shall have a call of a basic service supported by the MS and applicable to Call Hold as described in GSM 02.04 Table A.1 in state U10 "Active" with auxiliary state "Call held".

Method of test

Related PICS/PIXIT statements

- method of retrieving a held call

Initial conditions

System Simulator:

- 1 cell, default parameters.

Mobile Station:

The MS shall have a call of a basic service supported by the MS and applicable to Call Hold as described in GSM 02.04 Table A.1 in state U10 "Active" with auxiliary state "Call held".

Foreseen final state of the MS

State U10, no auxiliary state.

Maximum duration of test

30 s.

Procedure

Using suitable MMI commands, the MS shall request that the call is placed on RETRIEVE. The MS shall send a RETRIEVE message and enter auxiliary state "retrieve request". On receipt of a RETRIEVE REJECT message from the SS, the MS shall return to state U10 "Active" with auxiliary state "Call held". The call state shall be verified by the SS sending a STATUS ENQUIRY message in respect of the transaction identifier of call, and receiving a STATUS message indicating the appropriate call state and auxiliary state.

Using suitable MMI commands, the MS shall again request that the call is placed on RETRIEVE. The MS shall send a RETRIEVE message and enter auxiliary state "retrieve request". On receipt of a RETRIEVE ACKNOWLEDGE message from the SS, the MS shall enter state U10 "Active". The call state shall be verified by the SS sending a STATUS ENQUIRY message in respect of the transaction identifier of call, and receiving a STATUS message indicating the appropriate call state and auxiliary state.

Expected sequence

Step	Direction	Message	Comments
1	MS		Using MMI commands, the MS retrieves the held call
2	MS -> SS	RETRIEVE	
3	SS -> MS	STATUS ENQUIRY	
4	MS -> SS	STATUS	State U10, auxiliary state "Retrieve request"
5	SS -> MS	RETRIEVE REJECT	
6	SS -> MS	STATUS ENQUIRY	
7	MS -> SS	STATUS	State U10, auxiliary state "Call held"
8	MS		Using MMI commands, the MS retrieves the held call
9	MS -> SS	RETRIEVE	
10	SS -> MS	STATUS ENQUIRY	
11	MS -> SS	STATUS	State U10, auxiliary state "Retrieve request"
12	SS -> MS	RETRIEVE ACKNOWLEDGE	
13	SS -> MS	STATUS ENQUIRY	
14	MS -> SS	STATUS	State U10, no auxiliary state
15	SS		Check that the TCH is through-connected

31.3.2.3 Alternate from one call to the other

Conformance requirement

GSM 04.83 subclause 2.1.4

Applicability

MS supporting the Call Hold supplementary service.

Test purpose

To test that the MS correctly alternates between one call and the other, by placing the active call on hold, and retrieving the previously held call.

To test that the MS correctly returns to the original call states in the event of receipt of a HOLD REJECT or RETRIEVE REJECT.

Method of test

Related PICS/PIXIT statements

- method of alternating between an active call and a held call

Initial conditions

System Simulator:

1 cell, default parameters.

Mobile Station:

The MS shall have Call A-B in state U10 "Active", and Call C-B in state U10 "Active" with auxiliary state "Call held". Both calls shall be of a basic service supported by the MS and applicable to Call Hold as described in GSM 02.04 Table A.1.

Foreseen final state of the MS

Call A-B: State U10, Auxiliary State "Call Held"

Call C-B: State U10, No Auxiliary State

Maximum duration of test

30 s.

Procedure

Using suitable MMI commands, the MS shall alternate between Call A-B and Call C-B. The MS shall send a HOLD message with the transaction identifier for Call A-B and enter auxiliary state "hold request", and send a RETRIEVE message with the transaction identifier for Call C-B and enter auxiliary state "retrieve request". On receipt of a HOLD ACKNOWLEDGE and RETRIEVE ACKNOWLEDGE message, the MS shall have Call A-B in state U10 "Active" with auxiliary state "Call held", and Call C-B in state U10 "Active". The call states shall be verified by the SS sending a STATUS ENQUIRY message in respect of the transaction identifier of each call, and receiving a STATUS message indicating the appropriate call state and auxiliary state.

Using suitable MMI commands, the MS shall alternate between Call A-B and Call C-B. The MS shall send a HOLD message with the transaction identifier for Call C-B and enter auxiliary state "hold request", and send a RETRIEVE message with the transaction identifier for Call A-B and enter auxiliary state "retrieve request". On receipt of a HOLD REJECT and RETRIEVE REJECT message, the MS shall have Call A-B remain in state U10 "Active" with auxiliary state "Call held", and Call C-B in state U10 "Active". The call states shall be verified by the SS sending a STATUS ENQUIRY message in respect of the transaction identifier of each call, and receiving a STATUS message indicating the appropriate call state and auxiliary state.

Expected sequence

Step	Direction	Message	Comments
1	MS		Using MMI commands, the MS changes from call A-B to call C-B
2	MS -> SS	HOLD	Transaction identifier for call A-B
3	MS -> SS	RETRIEVE	Transaction identifier for call C-B
4	SS -> MS	STATUS ENQUIRY	Transaction identifier for call A-B
5	MS -> SS	STATUS	Transaction identifier for call A-B, State U10, auxiliary state "Hold request"
6	SS -> MS	STATUS ENQUIRY	Transaction identifier for call C-B
7	MS -> SS	STATUS	Transaction identifier for call C-B, State U10, auxiliary state "Retrieve request"
8	SS -> MS	HOLD ACKNOWLEDGE	Transaction identifier for call A-B
9	SS -> MS	RETRIEVE ACKNOWLEDGE	Transaction identifier for call C-B
10	SS -> MS	STATUS ENQUIRY	Transaction identifier for call A-B
11	MS -> SS	STATUS	Transaction identifier for call A-B, state U10, auxiliary state "Call Held"
12	SS -> MS	STATUS ENQUIRY	Transaction identifier for call C-B
13	MS -> SS	STATUS	Transaction identifier for call C-B, state U10, no auxiliary state
14	SS		Check that the TCH is through-connected
15	MS		Using MMI commands, the MS changes from call C-B to call A-B
16	MS -> SS	HOLD	Transaction identifier for call C-B
17	MS -> SS	RETRIEVE	Transaction identifier for call A-B
18	SS -> MS	STATUS ENQUIRY	Transaction identifier for call C-B
19	MS -> SS	STATUS	Transaction identifier for call C-B, State U10, auxiliary state "Hold request"
20	SS -> MS	STATUS ENQUIRY	Transaction identifier for call A-B
21	MS -> SS	STATUS	Transaction identifier for call A-B, State U10, auxiliary state "Retrieve request"
22	SS -> MS	HOLD REJECT	Transaction identifier for call C-B
23	SS -> MS	RETRIEVE REJECT	Transaction identifier for call A-B
24	SS -> MS	STATUS ENQUIRY	Transaction identifier for call C-B
25	MS -> SS	STATUS	Transaction identifier for call C-B, state U10, no auxiliary state
26	SS -> MS	STATUS ENQUIRY	Transaction identifier for call A-B
27	MS -> SS	STATUS	Transaction identifier for call A-B, state U10, auxiliary state "Call Held"
28	SS		Check that the TCH is through-connected

31.4 Multi-party supplementary services

NOTE: In this section, subscriber A is the MS under test, and subscribers B to G are distant parties in the calls used in the tests.

31.4.1 Beginning the MultiParty service

31.4.1.1 Beginning the MultiParty service, successful case

Conformance requirement

GSM 04.84 subclause 1.1

Applicability

MS supporting the MultiParty supplementary service.

Test purpose

To test that the MS correctly starts the MultiParty service when it has an active call and a held call, and reacts correctly to a response from the SS indicating success.

Method of test

Related PICS/PIXIT statements

Method of joining two calls into a MultiParty call

Initial conditions

System Simulator:

1 cell, default parameters.

Mobile Station:

The MS shall have Call A-B in state U10 "Active" and Call A-C in state U10 "Active" with Auxiliary state "Call held". Both calls shall be of a basic service supported by the MS and relevant to the MultiParty supplementary service as stated in GSM 02.04 Table A.1,

Foreseen final state of the MS

Call A-B, state U10, auxiliary state "Call in MPTY". Call A-C, state U10, auxiliary state "Call in MPTY".

Maximum duration of test

30 s.

Procedure

Using suitable MMI commands, the MS shall join the two calls in a MultiParty call. The MS shall send a FACILITY message containing an invoke component set to BuildMPTY, and with the transaction identifier for either Call A-B or Call A-C. Both calls shall enter auxiliary state "MPTY request". The call states shall be verified by the SS sending a STATUS ENQUIRY message in respect of the transaction identifier of each call, and receiving a STATUS message indicating the appropriate call state.

On receipt of a FACILITY message including a Return Result component, the MS shall enter the state U10 "Active" with auxiliary state "Call in MPTY". The call states shall be verified by the SS sending a STATUS ENQUIRY message in respect of the transaction identifier of each call, and receiving a STATUS message indicating the appropriate call state.

Expected sequence

Step	Direction	Message	Comments
1	MS		Using MMI commands, join the two calls
2	MS -> SS	FACILITY	TI for Call A-B or Call A-C, BuildMPTY Invoke component
3	SS -> MS	STATUS ENQUIRY	Transaction identifier of Call A-B
4	MS -> SS	STATUS	Transaction identifier of Call A-B, state U10, auxiliary state "MPTY request"
5	SS -> MS	STATUS ENQUIRY	Transaction identifier of Call A-C
6	MS -> SS	STATUS	Transaction identifier of Call A-C, state U10, auxiliary state "MPTY request, call held"
7	SS -> MS	FACILITY	Same TI as step 2, Return Result component
8	SS -> MS	STATUS ENQUIRY	Transaction identifier of Call A-B
9	MS -> SS	STATUS	Transaction identifier of Call A-B, state U10, auxiliary state "Call in MPTY"
10	SS -> MS	STATUS ENQUIRY	Transaction identifier of Call A-C
11	MS -> SS	STATUS	Transaction identifier of Call A-C, state U10, auxiliary state "Call in MPTY"
12	SS		Check that the TCH is through-connected

31.4.1.2 Beginning the MultiParty service, unsuccessful case

Conformance requirement

GSM 04.84 subclause 1.1

Applicability

MS supporting the MultiParty supplementary service.

Test purpose

To test that the MS correctly starts the MultiParty service when it has an active call and a held call, and reacts correctly to the following responses from the SS.

- 1) Return error
- 2) Reject

Method of test

Related PICS/PIXIT statements

- method of joining two calls into a MultiParty call

Initial conditions

System Simulator:

1 cell, default parameters.

Mobile Station:

The MS shall have Call A-B in state U10 "Active" and Call A-C in state U10 "Active" with Auxiliary state "Call held". Both calls shall be of a basic service supported by the MS and relevant to the MultiParty supplementary service as stated in GSM 02.04 Table A.1,

Foreseen final state of the MS

Call A-B, state U10, no auxiliary state. Call A-C, state U10, auxiliary state "Call Held".

Maximum duration of test

45 s.

Procedure

Using suitable MMI commands, the MS shall initiate a MultiParty call. The MS shall send a FACILITY message containing an invoke component set to BuildMPTY, and with the transaction identifier for either Call A-B or Call A-C. Both calls shall enter auxiliary state "MPTY request". The call states shall be verified by the SS sending a STATUS ENQUIRY message in respect of the transaction identifier of each call, and receiving a STATUS message indicating the appropriate call state.

On receipt of a FACILITY message including a Return Error component, the MS shall return both calls to their original call states. The call states shall be verified by the SS sending a STATUS ENQUIRY message in respect of the transaction identifier of each call, and receiving a STATUS message indicating the appropriate call state.

Using suitable MMI commands, the MS shall initiate a MultiParty call. The MS shall send a FACILITY message containing an invoke component set to BuildMPTY, and with the transaction identifier for boeither Call A-B or Call A-C. Both calls shall enter auxiliary state "MPTY request". The call states shall be verified by the SS sending a STATUS ENQUIRY message in respect of the transaction identifier of each call, and receiving a STATUS message indicating the appropriate call state.

On receipt of a FACILITY message including a Reject component, the MS shall return both calls to their original call states. The call states shall be verified by the SS sending a STATUS ENQUIRY message in respect of the transaction identifier of each call, and receiving a STATUS message indicating the appropriate call state.

Expected sequence

Step	Direction	Message	Comments
1	MS		Using MMI commands, set up a MultiParty call
2	MS -> SS	FACILITY	TI for Call A-B or Call A-C, BuildMPTY Invoke component
3	SS -> MS	STATUS ENQUIRY	Transaction identifier of Call A-B
4	MS -> SS	STATUS	Transaction identifier of Call A-B, state U10, auxiliary state "MPTY request"
5	SS -> MS	STATUS ENQUIRY	Transaction identifier of Call A-C
6	MS -> SS	STATUS	Transaction identifier of Call A-C, state U10, auxiliary state "MPTY request, call held"
7	SS -> MS	FACILITY	Same TI as step 2, Return Error component
8	SS -> MS	STATUS ENQUIRY	Transaction identifier of Call A-B
9	MS -> SS	STATUS	Transaction identifier of Call A-B, state U10, no auxiliary state
10	SS -> MS	STATUS ENQUIRY	Transaction identifier of Call A-C
11	MS -> SS	STATUS	Transaction identifier of Call A-C, state U10, auxiliary state "Call Held"
12	MS		Using MMI commands, set up a MultiParty call
13	MS -> SS	FACILITY	TI for Call A-B or Call A-C, BuildMPTY Invoke component
14	SS -> MS	STATUS ENQUIRY	Transaction identifier of Call A-B
15	MS -> SS	STATUS	Transaction identifier of Call A-B, state U10, auxiliary state "MPTY request"
16	SS -> MS	STATUS ENQUIRY	Transaction identifier of Call A-C
17	MS -> SS	STATUS	Transaction identifier of Call A-C, state U10, auxiliary state "MPTY request, call held"
18	SS -> MS	FACILITY	Same TI as step 13, Reject component
19	SS -> MS	STATUS ENQUIRY	Transaction identifier of Call A-B
20	MS -> SS	STATUS	Transaction identifier of Call A-B, state U10, no auxiliary state
21	SS -> MS	STATUS ENQUIRY	Transaction identifier of Call A-C
22	MS -> SS	STATUS	Transaction identifier of Call A-C, state U10, auxiliary state "Call Held"

31.4.1.3 Beginning the MultiParty service, expiry of timer T(BuildMPTY)

Conformance requirement

GSM 04.84 subclause 1.1

Applicability

MS supporting the MultiParty supplementary service.

Test purpose

To test that the MS correctly starts the MultiParty service when it has an active call and a held call, and on expiry of timer T(BuildMPTY) returns both calls to their original states.

Method of test

Related PICS/PIXIT statements

- method of joining two calls into a MultiParty call

Initial conditions

System Simulator:

1 cell, default parameters.

Mobile Station:

The MS shall have Call A-B in state U10 "Active" and Call A-C in state U10 "Active" with Auxiliary state "Call held". Both calls shall be of a basic service supported by the MS and relevant to the MultiParty supplementary service as stated in GSM 02.04 Table A.1,

Foreseen final state of the MS

Branch A - Call A-B, state U10, no auxiliary state. Call A-C, state U10, auxiliary state "Call Held".

Branch B - Call A-B, state U10, auxiliary state "MPTY Request". Call A-C, state U10, auxiliary state "MPTY Request".

Maximum duration of test

45 s.

Procedure

Using suitable MMI commands, the MS shall initiate a MultiParty call. The MS shall send a FACILITY message containing an invoke component set to BuildMPTY, and with the transaction identifier for either Call A-B or Call A-C. Both calls shall enter auxiliary state "MPTY request". The call states shall be verified by the SS sending a STATUS ENQUIRY message in respect of the transaction identifier of each call, and receiving a STATUS message indicating the appropriate call state.

Not less than 5s and not more than 30s after sending the FACILITY message, one of the following shall have occurred.

- both calls shall be in their original call states and the MS shall have indicated the failure to the user, or
- the MS shall have sent another FACILITY message with the same contents.

The call states shall be verified by the SS sending a STATUS ENQUIRY message in respect of the transaction identifier of each call, and receiving a STATUS message indicating the appropriate call state.

Expected sequence

Step	Direction	Message	Comments
1	MS		Using MMI commands, set up a MultiParty call
2	MS -> SS	FACILITY	TI for Call A-B or Call A-C, BuildMPTY Invoke component
3	SS -> MS	STATUS ENQUIRY	Transaction identifier of Call A-B
4	MS -> SS	STATUS	Transaction identifier of Call A-B, state U10, auxiliary state "MPTY request"
5	SS -> MS	STATUS ENQUIRY	Transaction identifier of Call A-C
6	MS -> SS	STATUS	Transaction identifier of Call A-C, state U10, auxiliary state "MPTY request, call held"
7	SS		Wait 30 s from receiving FACILITY message
A8	SS -> MS	STATUS ENQUIRY	Take this branch if no message is received within 30 s
A9	MS -> SS	STATUS	Transaction identifier of Call A-B
A10	SS -> MS	STATUS ENQUIRY	Transaction identifier of Call A-B, state U10, no auxiliary state
A11	MS -> SS	STATUS	Transaction identifier of Call A-C
			Transaction identifier of Call A-C, state U10, auxiliary state "Call Held"
B8	MS -> SS	FACILITY	Take this branch if a message is received within 30 s
B9	SS -> MS	STATUS ENQUIRY	Same as Step 2. Message shall not be received less than 5 s after the first FACILITY message
B10	MS -> SS	STATUS	Transaction identifier of Call A-B
			Transaction identifier of Call A-B, state U10, auxiliary state "MPTY request"
B11	SS -> MS	STATUS ENQUIRY	Transaction identifier of Call A-C
B12	MS -> SS	STATUS	Transaction identifier of Call A-C, state U10, auxiliary state "MPTY request, call held"

31.4.2 Managing an active MultiParty call

31.4.2.1 Served mobile subscriber

31.4.2.1.1 Put the MultiParty call on hold

31.4.2.1.1.1 Put the MultiParty call on hold, successful case

Conformance requirement

GSM 04.84 subclause 1.2.1.1

Applicability

MS supporting the MultiParty supplementary service.

Test purpose

To test that the MS correctly places an active MultiParty call on hold, and reacts correctly to a response from the SS indicating success.

Method of test

Related PICS/PIXIT statements

- method of placing a MultiParty call on hold

Initial conditions

System Simulator:

1 cell, default parameters.

Mobile Station:

The MS shall have a MultiParty call to two destinations (Call A-B and Call A-C) active. Both call states shall be U10 "Active" with auxiliary state "Call in MPTY". The call shall be of a basic service supported by the MS and relevant to the MultiParty supplementary service as stated in GSM 02.04 Table A.1,

NOTE: The MultiParty call may be set up using the procedures of section 31.4.1.1.

Foreseen final state of the MS

Call A-B, state U10, auxiliary state "Call in MPTY, call held". Call A-C, state U10, auxiliary state "Call in MPTY, call held".

Maximum duration of test

30 s.

Procedure

Using suitable MMI commands, the MS shall place the MultiParty call on hold. The MS shall send a FACILITY message containing one of the transaction identifiers of the call, and containing an invoke component HoldMPTY. Both calls shall enter the auxiliary state "Call in MPTY, hold request". The call states shall be verified by the SS sending a STATUS ENQUIRY message in respect of the transaction identifier of each call, and receiving a STATUS message indicating the appropriate call state.

On receipt of a FACILITY message with the same transaction identifier and containing a return result component, the MS shall enter the state U10 "Active" with auxiliary state "Call in MPTY, call held" for both transaction identifiers. The call states shall be verified by the SS sending a STATUS ENQUIRY message in respect of the transaction identifier of each call, and receiving a STATUS message indicating the appropriate call state.

Expected sequence

Step	Direction	Message	Comments
1	MS		Using MMI commands, put the MultiParty call on hold
2	MS -> SS	FACILITY	TI for Call A-B or Call A-C, HoldMPTY Invoke component
3	SS -> MS	STATUS ENQUIRY	Transaction identifier of Call A-B
4	MS -> SS	STATUS	Transaction identifier of Call A-B, state U10, auxiliary state "Call in MPTY, hold request"
5	SS -> MS	STATUS ENQUIRY	Transaction identifier of Call A-C
6	MS -> SS	STATUS	Transaction identifier of Call A-C, state U10, auxiliary state "Call in MPTY, hold request"
7	SS -> MS	FACILITY	Same TI as step 2, Return Result component
8	SS -> MS	STATUS ENQUIRY	Transaction identifier of Call A-B
9	MS -> SS	STATUS	Transaction identifier of Call A-B, state U10, auxiliary state "Call in MPTY, call held"
10	SS -> MS	STATUS ENQUIRY	Transaction identifier of Call A-C
11	MS -> SS	STATUS	Transaction identifier of Call A-C, state U10, auxiliary state "Call in MPTY, call held"

31.4.2.1.1.2 Put the MultiParty call on hold, unsuccessful case

Conformance requirement

GSM 04.84 subclause 1.2.1.1

Applicability

MS supporting the MultiParty supplementary service.

Test purpose

To test that the MS correctly places an active MultiParty call on hold, and reacts correctly to a response from the SS indicating an error or a reject condition.

Method of test

Related PICS/PIXIT statements

- method of placing a MultiParty call on hold

Initial conditions

System Simulator:

1 cell, default parameters.

Mobile Station:

The MS shall have a MultiParty call to two destinations (Call A-B and Call A-C) active. Both call states shall be U10 "Active" with auxiliary state "Call in MPTY". The call shall be of a basic service supported by the MS and relevant to the MultiParty supplementary service as stated in GSM 02.04 Table A.1,

NOTE: The MultiParty call may be set up using the procedures of section 31.4.1.1.

Foreseen final state of the MS

Call A-B, state U10, auxiliary state "Call in MPTY". Call A-C, state U10, auxiliary state "Call in MPTY".

Maximum duration of test

45 s.

Procedure

Using suitable MMI commands, the MS shall place the MultiParty call on hold. The MS shall send a FACILITY message containing one of the transaction identifiers of the call, and containing an invoke component HoldMPTY. Both calls shall enter the auxiliary state "Call in MPTY, hold request". The call states shall be verified by the SS sending a STATUS ENQUIRY message in respect of the transaction identifier of each call, and receiving a STATUS message indicating the appropriate call state.

On receipt of a FACILITY message with the same transaction identifier and containing a return error component, the MS shall return to the original states for both transaction identifiers. The call states shall be verified by the SS sending a STATUS ENQUIRY message in respect of the transaction identifier of each call, and receiving a STATUS message indicating the appropriate call state.

Using suitable MMI commands, the MS shall place the MultiParty call on hold. The MS shall send a FACILITY message containing one of the transaction identifiers of the call, and containing an invoke component HoldMPTY. Both calls shall enter the auxiliary state "Call in MPTY, hold request". The call states shall be verified by the SS sending a STATUS ENQUIRY message in respect of the transaction identifier of each call, and receiving a STATUS message indicating the appropriate call state.

On receipt of a FACILITY message with the same transaction identifier and containing a Reject component, the MS shall return to the original states for both transaction identifiers. The call states shall be verified by the SS sending a STATUS ENQUIRY message in respect of the transaction identifier of each call, and receiving a STATUS message indicating the appropriate call state.

Expected sequence

Step	Direction	Message	Comments
1	MS		
2	MS -> SS	FACILITY	Using MMI commands, put the MultiParty call on hold
3	SS -> MS	STATUS ENQUIRY	TI for Call A-B or Call A-C, HoldMPTY Invoke component
4	MS -> SS	STATUS	Transaction identifier of Call A-B
5	SS -> MS	STATUS ENQUIRY	Transaction identifier of Call A-B, state U10, auxiliary
6	MS -> SS	STATUS	state "Call in MPTY, hold request"
7	SS -> MS	FACILITY	Transaction identifier of Call A-C
8	SS -> MS	STATUS ENQUIRY	Transaction identifier of Call A-C, state U10, auxiliary
9	MS -> SS	STATUS	state "Call in MPTY, hold request"
10	SS -> MS	FACILITY	Same TI as step 2, Return Error component
11	MS -> SS	STATUS	Transaction identifier of Call A-B
12	SS -> MS	STATUS ENQUIRY	Transaction identifier of Call A-B, state U10, auxiliary
13	MS -> SS	STATUS	state "Call in MPTY"
14	SS -> MS	STATUS ENQUIRY	Transaction identifier of Call A-C
15	MS -> SS	STATUS	Transaction identifier of Call A-C, state U10, auxiliary
16	SS -> MS	FACILITY	state "Call in MPTY, hold request"
17	MS -> SS	STATUS	Transaction identifier of Call A-C
18	SS -> MS	STATUS ENQUIRY	Transaction identifier of Call A-C, state U10, auxiliary
19	MS -> SS	STATUS	state "Call in MPTY, hold request"
20	SS -> MS	FACILITY	Same TI as step 13, Reject component
21	SS -> MS	STATUS ENQUIRY	Transaction identifier of Call A-B
22	MS -> SS	STATUS	Transaction identifier of Call A-B, state U10, auxiliary
23	SS -> MS	STATUS ENQUIRY	state "Call in MPTY"
24	MS -> SS	STATUS	Transaction identifier of Call A-C
25	SS -> MS	STATUS ENQUIRY	Transaction identifier of Call A-C, state U10, auxiliary
26	MS -> SS	STATUS	state "Call in MPTY"

31.4.2.1.1.3 Put the MultiParty call on hold, expiry of timer T(HoldMPTY)

Conformance requirement

GSM 04.84 subclause 1.2.1.1

Applicability

MS supporting the MultiParty supplementary service.

Test purpose

To test that the MS correctly places an active MultiParty call on hold, and on expiry of T(HoldMPTY) returns the MultiParty call to the auxiliary state "Call in MPTY".

Method of test

Related PICS/PIXIT statements

- method of placing a MultiParty call on hold

Initial conditions

System Simulator:

1 cell, default parameters.

Mobile Station:

The MS shall have a MultiParty call to two destinations (Call A-B and Call A-C) active. Both call states shall be U10 "Active" with auxiliary state "Call in MPTY". The call shall be of a basic service supported by the MS and relevant to the MultiParty supplementary service as stated in GSM 02.04 Table A.1,

NOTE: The MultiParty call may be set up using the procedures of section 31.4.1.1.

Foreseen final state of the MS

Branch A, Call A-B, state U10, auxiliary state "Call in MPTY". Call A-C, state U10, auxiliary state "Call in MPTY".

Branch B, Call A-B, state U10, auxiliary state "Call in MPTY, hold request". Call A-C, state U10, auxiliary state "Call in MPTY, hold request".

Maximum duration of test

45 s.

Procedure

Using suitable MMI commands, the MS shall place the MultiParty call on hold. The MS shall send a FACILITY message containing one of the transaction identifiers of the call, and containing an invoke component HoldMPTY. Both calls shall enter the auxiliary state "Call in MPTY, hold request". The call states shall be verified by the SS sending a STATUS ENQUIRY message in respect of the transaction identifier of each call, and receiving a STATUS message indicating the appropriate call state.

Not less than 5s and not more than 30s after sending the FACILITY message, one of the following shall have occurred

- both calls shall be in their original call states and the MS shall have indicated the failure to the user, or
- the MS shall have sent another FACILITY message with the same contents.

The call states shall be verified by the SS sending a STATUS ENQUIRY message in respect of the transaction identifier of each call, and receiving a STATUS message indicating the appropriate call state.

Expected sequence

Step	Direction	Message	Comments
1	MS		Using MMI commands, put the MultiParty call on hold
2	MS -> SS	FACILITY	TI for Call A-B or Call A-C, HoldMPTY Invoke component
3	SS -> MS	STATUS ENQUIRY	Transaction identifier of Call A-B
4	MS -> SS	STATUS	Transaction identifier of Call A-B, state U10, auxiliary state "Call in MPTY, hold request"
5	SS -> MS	STATUS ENQUIRY	Transaction identifier of Call A-C
6	MS -> SS	STATUS	Transaction identifier of Call A-C, state U10, auxiliary state "Call in MPTY, hold request"
7	SS		Wait 30 s from receiving FACILITY message
A8	SS -> MS	STATUS ENQUIRY	Take this branch if no message is received within 30 s
A9	MS -> SS	STATUS	Transaction identifier of Call A-B
A10	SS -> MS	STATUS ENQUIRY	Transaction identifier of Call A-C
A11	MS -> SS	STATUS	Transaction identifier of Call A-C, state U10, auxiliary state "Call in MPTY"
B8	MS -> SS	FACILITY	Take this branch if a message is received within 30 s
B9	SS -> MS	STATUS ENQUIRY	Same as Step 2. Message shall not be received less than 5 s after the first FACILITY message
B10	MS -> SS	STATUS	Transaction identifier of Call A-B
B11	SS -> MS	STATUS ENQUIRY	Transaction identifier of Call A-C
B12	MS -> SS	STATUS	Transaction identifier of Call A-C, state U10, auxiliary state "Call in MPTY, hold request"

31.4.2.1.2 Create a private communication with one of the remote parties

31.4.2.1.2.1 Create a private communication with one of the remote parties, successful case

Conformance requirement

GSM 04.84 subclause 1.2.1.2

Applicability

MS supporting the MultiParty supplementary service.

Test purpose

To test that the MS correctly splits an active MultiParty call, and reacts correctly to a response from the SS indicating success.

Method of test

Related PICS/PIXIT statements

- method of creating a private communication with one party of a MultiParty call.

Initial conditions

System Simulator:

1 cell, default parameters.

Mobile Station:

The MS shall have a MultiParty call to two destinations (Call A-B and Call A-C) active. Both call states shall be U10 "Active" with auxiliary state "Call in MPTY". The call shall be of a basic service supported by the MS and relevant to the MultiParty supplementary service as stated in GSM 02.04 Table A.1,

NOTE: The MultiParty call may be set up using the procedures of section 31.4.1.1.

Foreseen final state of the MS

Call A-B, state U10, no auxiliary state. Call A-C, state U10, auxiliary state "Call Held".

Maximum duration of test

30 s.

Procedure

Using suitable MMI commands, the MS shall request a private communication with Call A-B. The MS shall send a FACILITY message containing the transaction identifier for Call A-B and an invoke component SplitMPTY. Call A-B shall enter the auxiliary state "split request" and call A-C shall remain in state "Call in MPTY". The call states shall be verified by the SS sending a STATUS ENQUIRY message in respect of the transaction identifier of each call, and receiving a STATUS message indicating the appropriate call state.

On receipt of a FACILITY message containing the same transaction identifier and a return result component, Call A-B shall enter the state U10 "Active", and Call A-C shall enter the state U10 "Active" with auxiliary state "Call held". The call states shall be verified by the SS sending a STATUS ENQUIRY message in respect of the transaction identifier of each call, and receiving a STATUS message indicating the appropriate call state.

Expected sequence

Step	Direction	Message	Comments
1	MS		Using MMI commands, request a private communication with Call A-B
2	MS -> SS	FACILITY	TI for Call A-B, SplitMPTY Invoke component
3	SS -> MS	STATUS ENQUIRY	Transaction identifier of Call A-B
4	MS -> SS	STATUS	Transaction identifier of Call A-B, state U10, auxiliary state "Split request"
5	SS -> MS	STATUS ENQUIRY	Transaction identifier of Call A-C
6	MS -> SS	STATUS	Transaction identifier of Call A-C, state U10, auxiliary state "Call in MPTY"
7	SS -> MS	FACILITY	Return Result component
8	SS -> MS	STATUS ENQUIRY	Transaction identifier of Call A-B
9	MS -> SS	STATUS	Transaction identifier of Call A-B, state U10, no auxiliary state
10	SS -> MS	STATUS ENQUIRY	Transaction identifier of Call A-C
11	MS -> SS	STATUS	Transaction identifier of Call A-C, state U10, auxiliary state "Call held"
12	SS		Check that the TCH is through-connected

31.4.2.1.2.2 Create a private communication with one of the remote parties, unsuccessful case

Conformance requirement

GSM 04.84 subclause 1.2.1.2

Applicability

MS supporting the MultiParty supplementary service.

Test purpose

To test that the MS correctly splits an active MultiParty call, and reacts correctly to a response from the SS indicating an error or reject condition.

Method of test

Related PICS/PIXIT statements

- method of creating a private communication with one party of a MultiParty call.

Initial conditions

System Simulator:

1 cell, default parameters.

Mobile Station:

The MS shall have a MultiParty call to two destinations (Call A-B and Call A-C) active. Both call states shall be U10 "Active" with auxiliary state "Call in MPTY". The call shall be of a basic service supported by the MS and relevant to the MultiParty supplementary service as stated in GSM 02.04 Table A.1,

NOTE: The MultiParty call may be set up using the procedures of section 31.4.1.1.

Foreseen final state of the MS

Call A-B, state U10, auxiliary state "Call in MPTY". Call A-C, state U10, auxiliary state "Call in MPTY".

Maximum duration of test

30 s.

Procedure

Using suitable MMI commands, the MS shall request a private communication with Call A-B. The MS shall send a FACILITY message containing the transaction identifier for Call A-B and an invoke component SplitMPTY. Call A-B shall enter the auxiliary state "Split request" and call A-C shall remain in state "Call in MPTY". The call states shall be verified by the SS sending a STATUS ENQUIRY message in respect of the transaction identifier of each call, and receiving a STATUS message indicating the appropriate call state.

On receipt of a FACILITY message containing the same transaction identifier and a return error component, both calls shall return to their initial states. The call states shall be verified by the SS sending a STATUS ENQUIRY message in respect of the transaction identifier of each call, and receiving a STATUS message indicating the appropriate call state.

Using suitable MMI commands, the MS shall request a private communication with Call A-B. The MS shall send a FACILITY message containing the transaction identifier for Call A-B and an invoke component SplitMPTY. Call A-B shall enter the auxiliary state "Split request" and call A-C shall remain in state "Call in MPTY". The call states shall be verified by the SS sending a STATUS ENQUIRY message in respect of the transaction identifier of each call, and receiving a STATUS message indicating the appropriate call state.

On receipt of a FACILITY message containing the same transaction identifier and a Reject component, both calls shall return to their initial states. The call states shall be verified by the SS sending a STATUS ENQUIRY message in respect of the transaction identifier of each call, and receiving a STATUS message indicating the appropriate call state.

Expected sequence

Step	Direction	Message	Comments
1	MS		Using MMI commands, create a private communication for Call A-B
2	MS -> SS	FACILITY	TI for Call A-B, SplitMPTY Invoke component
3	SS -> MS	STATUS ENQUIRY	Transaction identifier of Call A-B
4	MS -> SS	STATUS	Transaction identifier of Call A-B, state U10, auxiliary state "Split request"
5	SS -> MS	STATUS ENQUIRY	Transaction identifier of Call A-C
6	MS -> SS	STATUS	Transaction identifier of Call A-C, state U10, auxiliary state "Call in MPTY"
7	SS -> MS	FACILITY	Return Error component
8	SS -> MS	STATUS ENQUIRY	Transaction identifier of Call A-B
9	MS -> SS	STATUS	Transaction identifier of Call A-B, state U10, auxiliary state "Call in MPTY"
10	SS -> MS	STATUS ENQUIRY	Transaction identifier of Call A-C
11	MS -> SS	STATUS	Transaction identifier of Call A-C, state U10, auxiliary state "Call in MPTY"
12	MS		Using MMI commands, create a private communication for Call A-B
13	MS -> SS	FACILITY	TI for Call A-B, SplitMPTY Invoke component
14	SS -> MS	STATUS ENQUIRY	Transaction identifier of Call A-B
15	MS -> SS	STATUS	Transaction identifier of Call A-B, state U10, auxiliary state "Split request"
16	SS -> MS	STATUS ENQUIRY	Transaction identifier of Call A-C
17	MS -> SS	STATUS	Transaction identifier of Call A-C, state U10, auxiliary state "Call in MPTY"
18	SS -> MS	FACILITY	Reject component
19	SS -> MS	STATUS ENQUIRY	Transaction identifier of Call A-B
20	MS -> SS	STATUS	Transaction identifier of Call A-B, state U10, auxiliary state "Call in MPTY"
21	SS -> MS	STATUS ENQUIRY	Transaction identifier of Call A-C
22	MS -> SS	STATUS	Transaction identifier of Call A-C, state U10, auxiliary state "Call in MPTY"

31.4.2.1.2.3 Create a private communication with one of the remote parties, expiry of timer T(SplitMPTY)

Conformance requirement

GSM 04.84 subclause 1.2.1.2

Applicability

MS supporting the MultiParty supplementary service.

Test purpose

To test that the MS correctly splits an active MultiParty call, and on expiry of T(SplitMPTY) returns the call to the auxiliary state "Call in MPTY".

Method of test

Related PICS/PIXIT statements

- method of creating a private communication with one party of a MultiParty call.

Initial conditions

System Simulator:

1 cell, default parameters.

Mobile Station:

The MS shall have a MultiParty call to two destinations (Call A-B and Call A-C) active. Both call states shall be U10 "Active" with auxiliary state "Call in MPTY". The call shall be of a basic service supported by the MS and relevant to the MultiParty supplementary service as stated in GSM 02.04 Table A.1,

NOTE: The MultiParty call may be set up using the procedures of section 31.4.1.1.

Foreseen final state of the MS

Branch A, Call A-B, state U10, auxiliary state "Call in MPTY". Call A-C, state U10, auxiliary state "Call in MPTY".

Branch B, Call A-B, state U10, auxiliary state "Call in MPTY". Call A-C, state U10, auxiliary state "Call in MPTY".

Maximum duration of test

30 s.

Procedure

Using suitable MMI commands, the MS shall request a private communication with Call A-B. The MS shall send a FACILITY message containing the transaction identifier for Call A-B and an invoke component SplitMPTY. Call A-B shall enter the auxiliary state "Split request" and call A-C shall remain in state "Call in MPTY". The call states shall be verified by the SS sending a STATUS ENQUIRY message in respect of the transaction identifier of each call, and receiving a STATUS message indicating the appropriate call state.

After not less than 5s and not more than 30s, the MS shall either:

- return both calls to their original states, or
- send another FACILITY message with the same contents

The call states shall be verified by the SS sending a STATUS ENQUIRY message in respect of the transaction identifier of each call, and receiving a STATUS message indicating the appropriate call state.

Expected sequence

Step	Direction	Message	Comments
1	MS		Using MMI commands, request a private communication with Call A-B
2	MS -> SS	FACILITY	TI for Call A-B, SplitMPTY Invoke component
3	SS -> MS	STATUS ENQUIRY	Transaction identifier of Call A-B
4	MS -> SS	STATUS	Transaction identifier of Call A-B, state U10, auxiliary state "Split request"
5	SS -> MS	STATUS ENQUIRY	Transaction identifier of Call A-C
6	MS -> SS	STATUS	Transaction identifier of Call A-C, state U10, auxiliary state "Call in MPTY"
7	SS		Wait 30 s from receiving FACILITY message
A8	SS -> MS	STATUS ENQUIRY	Take this branch if no message is received within 30 s
A9	MS -> SS	STATUS	Transaction identifier of Call A-B
A10	SS -> MS	STATUS ENQUIRY	Transaction identifier of Call A-B, state U10, auxiliary state "Call in MPTY"
A11	MS -> SS	STATUS	Transaction identifier of Call A-C
			Transaction identifier of Call A-C, state U10, auxiliary state "Call in MPTY"
B8	MS -> SS	FACILITY	Take this branch if a message is received within 30 s
B9	SS -> MS	STATUS ENQUIRY	Same as Step 2. Message shall not be received less than 5 s after the first FACILITY message
B10	MS -> SS	STATUS	Transaction identifier of Call A-B
			Transaction identifier of Call A-B, state U10, auxiliary state "Split request"
B11	SS -> MS	STATUS ENQUIRY	Transaction identifier of Call A-C
B12	MS -> SS	STATUS	Transaction identifier of Call A-C, state U10, auxiliary state "Call in MPTY"

31.4.2.1.3 Terminate the entire MultiParty call

Conformance requirement

GSM 04.84 subclause 1.2.1.3

Applicability

MS supporting the MultiParty supplementary service.

Test purpose

To test that the MS correctly terminates an entire MultiParty call by implementing the call clearance procedure for each call in turn.

Method of test

Related PICS/PIXIT statements

- method of terminating a MultiParty call.

Initial conditions

System Simulator:

1 cell, default parameters.

Mobile Station:

The MS shall have a MultiParty call to two destinations (Call A-B and Call A-C) active. Both call states shall be U10 "Active" with auxiliary state "Call in MPTY". The call shall be of a basic service supported by the MS and relevant to the MultiParty supplementary service as stated in GSM 02.04 Table A.1,

NOTE: The MultiParty call may be set up using the procedures of section 31.4.1.1.

Foreseen final state of the MS

Call A-B, state U0. Call A-C, state U0.

Maximum duration of test

30 s.

Procedure

Using suitable MMI commands, the MS shall initiate a clearance of the entire MultiParty call. The MS shall send a DISCONNECT message in respect of each of the transaction identifiers of the call. On receipt of a RELEASE message in respect of each transaction identifier, the MS shall respond with a RELEASE COMPLETE message, and enter state U0 "Null". The call states shall be verified by the SS sending a STATUS ENQUIRY message in respect of the transaction identifier of each call, and receiving a RELEASE COMPLETE message with cause #81 "invalid transaction identifier value".

Expected sequence

Step	Direction	Message	Comments
1	MS		Using MMI commands, terminate the entire MultiParty call
2	MS -> SS	DISCONNECT	Steps 2 and 3 may occur in any order Transaction identifier of Call A-B
3	MS -> SS	DISCONNECT	Transaction identifier of Call A-C
4	SS -> MS	RELEASE	Transaction identifier of Call A-B
5	MS -> SS	RELEASE COMPLETE	Transaction identifier of Call A-B
6	SS -> MS	RELEASE	Transaction identifier of Call A-C
7	MS -> SS	RELEASE COMPLETE	Transaction identifier of Call A-C
8	SS -> MS	STATUS ENQUIRY	Transaction identifier of Call A-B
9	MS -> SS	RELEASE COMPLETE	Transaction identifier of Call A-B, with cause #81 "invalid transaction identifier value"
10	SS -> MS	STATUS ENQUIRY	Transaction identifier of Call A-C
11	MS -> SS	RELEASE COMPLETE	Transaction identifier of Call A-C, with cause #81 "invalid transaction identifier value"

31.4.2.1.4 Explicitly disconnect a remote party

Conformance requirement

GSM 04.84 subclause 1.2.1.4

Applicability

MS supporting the MultiParty supplementary service.

Test purpose

To test that the MS correctly disconnects a single remote party by implementing the call clearance procedure for that party.

Method of test

Related PICS/PIXIT statements

- method of disconnecting one party of a MultiParty call.

Initial conditions

System Simulator:

1 cell, default parameters.

Mobile Station:

The MS shall have a MultiParty call to two destinations (Call A-B and Call A-C) active. Both call states shall be U10 "Active" with auxiliary state "Call in MPTY". The call shall be of a basic service supported by the MS and relevant to the MultiParty supplementary service as stated in GSM 02.04 Table A.1,

NOTE: The MultiParty call may be set up using the procedures of section 31.4.1.1.

Foreseen final state of the MS

Call A-B, state U0. Call A-C, state U10, optionally auxiliary state "Call in MPTY".

Maximum duration of test

30 s.

Procedure

Using suitable MMI commands, the MS shall initiate a clearance of the Call A-B. The MS shall send a DISCONNECT message containing the transaction identifier of Call A-B. On receipt of a RELEASE message the MS shall respond with a RELEASE COMPLETE message, and enter state U0 "Null" for Call A-B. Call A-C shall enter state U10 "Active" with, optionally, auxiliary state "Call in MPTY". The call states shall be verified by the SS sending a STATUS ENQUIRY message in respect of the transaction identifier of each call, and receiving a STATUS message indicating state U10, and optionally "Call in MPTY" for Call A-C, and receiving a RELEASE COMPLETE message with cause #81 "invalid transaction identifier value" for Call A-B.

Expected sequence

Step	Direction	Message	Comments
1	MS		Using MMI commands, clear call A-B
2	MS -> SS	DISCONNECT	Transaction identifier of Call A-B
3	SS -> MS	RELEASE	Transaction identifier of Call A-B
4	MS -> SS	RELEASE COMPLETE	Transaction identifier of Call A-B
5	SS -> MS	STATUS ENQUIRY	Transaction identifier of Call A-B
6	MS -> SS	RELEASE COMPLETE	Transaction identifier of Call A-B, with cause #81 "invalid transaction identifier value"
7	SS -> MS	STATUS ENQUIRY	Transaction identifier of Call A-C
8	MS -> SS	STATUS	Transaction identifier of Call A-C, state U10, and, optionally, auxiliary state "Call in MPTY"

31.4.2.2 Remote parties

31.4.2.2.1 Release from the MultiParty call

Conformance requirement

GSM 04.84 subclause 1.2.1.4

Applicability

MS supporting the MultiParty supplementary service.

Test purpose

To test that the MS responds correctly to a call clearance from one of the remote parties.

Method of test

Related PICS/PIXIT statements

None

Initial conditions

System Simulator:

1 cell, default parameters.

Mobile Station:

The MS shall have a MultiParty call to two destinations (Call A-B and Call A-C) active. Both call states shall be U10 "Active" with auxiliary state "Call in MPTY". The call shall be of a basic service supported by the MS and relevant to the MultiParty supplementary service as stated in GSM 02.04 Table A.1,

NOTE: The MultiParty call may be set up using the procedures of section 31.4.1.1.

Foreseen final state of the MS

Call A-B, state U0. Call A-C, state U10, optionally "Call in MPTY".

Maximum duration of test

30 s.

Procedure

On receipt of a DISCONNECT message containing the transaction identifier of Call A-B, the MS shall send a RELEASE message. On receipt of a RELEASE COMPLETE message the MS shall enter state U0 "Null" for Call A-B. Call A-C shall enter state U10 "Active", and optionally, auxiliary state "Call in MPTY". The call states shall be verified by the SS sending a STATUS ENQUIRY message in respect of the transaction identifier of each call, and receiving a STATUS message indicating state U10, and optionally, auxiliary state "Call in MPTY" for Call A-C, and receiving a RELEASE COMPLETE message with cause #81 "invalid transaction identifier value" for Call A-B.

Expected sequence

Step	Direction	Message	Comments
1	SS -> MS	DISCONNECT	Transaction identifier of Call A-B
2	MS -> SS	RELEASE	Transaction identifier of Call A-B
3	SS -> MS	RELEASE COMPLETE	Transaction identifier of Call A-B
4	SS -> MS	STATUS ENQUIRY	Transaction identifier of Call A-B
5	MS -> SS	RELEASE COMPLETE	Transaction identifier of Call A-B, with cause #81 "invalid transaction identifier value"
6	SS -> MS	STATUS ENQUIRY	Transaction identifier of Call A-C
7	MS -> SS	STATUS	Transaction identifier of Call A-C, state U10, and optionally "Call in MPTY"

31.4.3 Managing a held MultiParty call

31.4.3.1 Retrieve the held MultiParty call

31.4.3.1.1 Retrieve the held MultiParty call, successful case

Conformance requirement

GSM 04.84 subclause 1.3.1.1

Applicability

MS supporting the MultiParty supplementary service.

Test purpose

To test that the MS correctly retrieves a held MultiParty call, and reacts correctly to a response from the SS indicating success.

Method of test

Related PICS/PIXIT statements

- method of retrieveing a held MultiParty call.

Initial conditions

System Simulator:

1 cell, default parameters.

Mobile Station:

The MS shall have a held MultiParty call to two destinations (Call A-B and Call A-C). Both call states shall be U10 "Active" with auxiliary state "Call in MPTY, call held". The call shall be of a basic service supported by the MS and relevant to the MultiParty supplementary service as stated in GSM 02.04 Table A.1,

NOTE: The MultiParty call may be set up using the procedures of section 31.4.2.1.1.1.

Foreseen final state of the MS

Call A-B, state U10, auxiliary state "Call in MPTY". Call A-C, state U10, auxiliary state "Call in MPTY".

Maximum duration of test

30 s.

Procedure

Using suitable MMI commands, the MS shall retrieve the MultiParty call. The MS shall send a FACILITY message containing one of the transaction identifiers of the call, and containing an invoke component RetrieveMPTY. Both calls shall enter the auxiliary state "Call in MPTY, retrieve request". The call states shall be verified by the SS sending a STATUS ENQUIRY message in respect of the transaction identifier of each call, and receiving a STATUS message indicating the appropriate call state.

On receipt of a FACILITY message with the same transaction identifier and containing a return result component, the MS shall enter the state U10 "Active" with auxiliary state "Call in MPTY" for both transaction identifiers. The call states shall be verified by the SS sending a STATUS ENQUIRY message in respect of the transaction identifier of each call, and receiving a STATUS message indicating the appropriate call state.

Expected sequence

Step	Direction	Message	Comments
1	MS		Using MMI commands, retrieve the MultiParty call
2	MS -> SS	FACILITY	TI for Call A-B or Call A-C, RetrieveMPTY Invoke component
3	SS -> MS	STATUS ENQUIRY	Transaction identifier of Call A-B
4	MS -> SS	STATUS	Transaction identifier of Call A-B, state U10, auxiliary state "Call in MPTY, Retrieve request"
5	SS -> MS	STATUS ENQUIRY	Transaction identifier of Call A-C
6	MS -> SS	STATUS	Transaction identifier of Call A-C, state U10, auxiliary state "Call in MPTY, Retrieve request"
7	SS -> MS	FACILITY	Same TI as step 2, Return Result component
8	SS -> MS	STATUS ENQUIRY	Transaction identifier of Call A-B
9	MS -> SS	STATUS	Transaction identifier of Call A-B, state U10, auxiliary state "Call in MPTY"
10	SS -> MS	STATUS ENQUIRY	Transaction identifier of Call A-C
11	MS -> SS	STATUS	Transaction identifier of Call A-C, state U10, auxiliary state "Call in MPTY"
12	SS		Check that the TCH is through-connected

31.4.3.1.2 Retrieve the held MultiParty call, unsuccessful case

Conformance requirement

GSM 04.84 subclause 1.3.1.1

Applicability

MS supporting the MultiParty supplementary service.

Test purpose

To test that the MS correctly retrieves a held MultiParty call, and reacts correctly to a response from the SS indicating an error or a reject condition.

Method of test

Related PICS/PIXIT statements

- method of retrieving a held MultiParty call.

Initial conditions

System Simulator:

1 cell, default parameters.

Mobile Station:

The MS shall have a held MultiParty call to two destinations (Call A-B and Call A-C). Both call states shall be U10 "Active" with auxiliary state "Call in MPTY, call held". The call shall be of a basic service supported by the MS and relevant to the MultiParty supplementary service as stated in GSM 02.04 Table A.1,

NOTE: The MultiParty call may be set up using the procedures of section 31.4.2.1.1.1.

Foreseen final state of the MS

Call A-B, state U10, auxiliary state "Call in MPTY, call held". Call A-C, state U10, auxiliary state "Call in MPTY, call held".

Maximum duration of test

30 s.

Procedure

Using suitable MMI commands, the MS shall retrieve the MultiParty call. The MS shall send a FACILITY message containing one of the transaction identifiers of the call, and containing an invoke component RetrieveMPTY. Both calls shall enter the auxiliary state "Call in MPTY, retrieve request". The call states shall be verified by the SS sending a STATUS ENQUIRY message in respect of the transaction identifier of each call, and receiving a STATUS message indicating the appropriate call state.

On receipt of a FACILITY message with the same transaction identifier and containing a return error component, the MS shall return to the original states for both transaction identifiers. The call states shall be verified by the SS sending a STATUS ENQUIRY message in respect of the transaction identifier of each call, and receiving a STATUS message indicating the appropriate call state.

Using suitable MMI commands, the MS shall retrieve the MultiParty call. The MS shall send a FACILITY message containing one of the transaction identifiers of the call, and containing an invoke component RetrieveMPTY. Both calls shall enter the auxiliary state "Call in MPTY, retrieve request". The call states shall be verified by the SS sending a STATUS ENQUIRY message in respect of the transaction identifier of each call, and receiving a STATUS message indicating the appropriate call state.

On receipt of a FACILITY message with the same transaction identifier and containing a reject component, the MS shall return to the original states for both transaction identifiers. The call states shall be verified by the SS sending a STATUS ENQUIRY message in respect of the transaction identifier of each call, and receiving a STATUS message indicating the appropriate call state.

Expected sequence

Step	Direction	Message	Comments
1	MS		Using MMI commands, retrieve the held MultiParty call
2	MS -> SS	FACILITY	TI for Call A-B or Call A-C, RetrieveMPTY Invoke component
3	SS -> MS	STATUS ENQUIRY	Transaction identifier of Call A-B
4	MS -> SS	STATUS	Transaction identifier of Call A-B, state U10, auxiliary state "Call in MPTY, retrieve request"
5	SS -> MS	STATUS ENQUIRY	Transaction identifier of Call A-C
6	MS -> SS	STATUS	Transaction identifier of Call A-C, state U10, auxiliary state "Call in MPTY, retrieve request"
7	SS -> MS	FACILITY	Same TI as step 2, Return Error component
8	SS -> MS	STATUS ENQUIRY	Transaction identifier of Call A-B
9	MS -> SS	STATUS	Transaction identifier of Call A-B, state U10, auxiliary state "Call in MPTY, call held"
10	SS -> MS	STATUS ENQUIRY	Transaction identifier of Call A-C
11	MS -> SS	STATUS	Transaction identifier of Call A-C, state U10, auxiliary state "Call in MPTY, call held"
12	MS		Using MMI commands, retrieve the held MultiParty call
13	MS -> SS	FACILITY	TI for Call A-B or Call A-C, RetrieveMPTY Invoke component
14	SS -> MS	STATUS ENQUIRY	Transaction identifier of Call A-B
15	MS -> SS	STATUS	Transaction identifier of Call A-B, state U10, auxiliary state "Call in MPTY, retrieve request"
16	SS -> MS	STATUS ENQUIRY	Transaction identifier of Call A-C
17	MS -> SS	STATUS	Transaction identifier of Call A-C, state U10, auxiliary state "Call in MPTY, retrieve request"
18	SS -> MS	FACILITY	Same TI as step 13, Reject component
19	SS -> MS	STATUS ENQUIRY	Transaction identifier of Call A-B
20	MS -> SS	STATUS	Transaction identifier of Call A-B, state U10, auxiliary state "Call in MPTY, call held"
21	SS -> MS	STATUS ENQUIRY	Transaction identifier of Call A-C
22	MS -> SS	STATUS	Transaction identifier of Call A-C, state U10, auxiliary state "Call in MPTY, call held"

31.4.3.1.3 Retrieve the held MultiParty call, expiry of timer T(RetrieveMPTY)

Conformance requirement

GSM 04.84 subclause 1.3.1.1

Applicability

MS supporting the MultiParty supplementary service.

Test purpose

To test that the MS correctly retrieves a MultiParty call on hold, and on expiry of T(RetrieveMPTY) returns the MultiParty call to the auxiliary state "Call in MPTY, call held".

Method of test

Related PICS/PIXIT statements

- method of retrieveing a held MultiParty call.

Initial conditions

System Simulator:

1 cell, default parameters.

Mobile Station:

The MS shall have a held MultiParty call to two destinations (Call A-B and Call A-C). Both call states shall be U10 "Active" with auxiliary state "Call in MPTY, call held". The call shall be of a basic service supported by the MS and relevant to the MultiParty supplementary service as stated in GSM 02.04 Table A.1,

NOTE: The MultiParty call may be set up using the procedures of section 31.4.2.1.1.1.

Foreseen final state of the MS

Branch A, Call A-B, state U10, auxiliary state "Call in MPTY, call held". Call A-C, state U10, auxiliary state "Call in MPTY, call held".

Branch B, Call A-B, state U10, auxiliary state "Call in MPTY, retrieve request". Call A-C, state U10, auxiliary state "Call in MPTY, retrieve request".

Maximum duration of test

45 s.

Procedure

Using suitable MMI commands, the MS shall retrieve the MultiParty call. The MS shall send a FACILITY message containing one of the transaction identifiers of the call, and containing an invoke component RetrieveMPTY. Both calls shall enter the auxiliary state "Call in MPTY, retrieve request". The call states shall be verified by the SS sending a STATUS ENQUIRY message in respect of the transaction identifier of each call, and receiving a STATUS message indicating the appropriate call state.

Not less than 5s and not more than 30s after sending the FACILITY message, one of the following shall have occurred

- both calls shall be in their original call states and the MS shall have indicated the failure to the user, or
- the MS shall have sent another FACILITY message with the same contents.

The call states shall be verified by the SS sending a STATUS ENQUIRY message in respect of the transaction identifier of each call, and receiving a STATUS message indicating the appropriate call state.

Expected sequence

Step	Direction	Message	Comments
1	MS		Using MMI commands, retrieve the held MultiParty call
2	MS -> SS	FACILITY	TI for Call A-B or Call A-C, RetrieveMPTY Invoke component
3	SS -> MS	STATUS ENQUIRY	Transaction identifier of Call A-B
4	MS -> SS	STATUS	Transaction identifier of Call A-B, state U10, auxiliary state "Call in MPTY, retrieve request"
5	SS -> MS	STATUS ENQUIRY	Transaction identifier of Call A-C
6	MS -> SS	STATUS	Transaction identifier of Call A-C, state U10, auxiliary state "Call in MPTY, retrieve request"
7	SS		Wait 30 s from receiving FACILITY message
A8	SS -> MS	STATUS ENQUIRY	Take this branch if no message is received within 30 s
A9	MS -> SS	STATUS	Transaction identifier of Call A-B
A10	SS -> MS	STATUS ENQUIRY	Transaction identifier of Call A-B, state U10, auxiliary state "Call in MPTY, call held"
A11	MS -> SS	STATUS	Transaction identifier of Call A-C
			Transaction identifier of Call A-C, state U10, auxiliary state "Call in MPTY, call held"
B8	MS -> SS	FACILITY	Take this branch if a message is received within 30 s
B9	SS -> MS	STATUS ENQUIRY	Same as Step 2. Message shall not be received less than 5 s after the first FACILITY message
B10	MS -> SS	STATUS	Transaction identifier of Call A-B
B11	SS -> MS	STATUS ENQUIRY	Transaction identifier of Call A-B, state U10, auxiliary state "Call in MPTY, retrieve request"
B12	MS -> SS	STATUS	Transaction identifier of Call A-C
			Transaction identifier of Call A-C, state U10, auxiliary state "Call in MPTY, retrieve request"

31.4.3.2 Initiate a new call

Conformance requirement

GSM 04.84 subclause 1.3.1.2

Applicability

MS supporting the MultiParty supplementary service.

Test purpose

To test that the MS can set up a new outgoing call with a held MultiParty call.

Method of test

Related PICS/PIXIT statements

- method of making a new outgoing call

Initial conditions

System Simulator:

1 cell, default parameters.

Mobile Station:

The MS shall have a held MultiParty call to two destinations (Call A-B and Call A-C). Both call states shall be U10 "Active" with auxiliary state "Call in MPTY, call held". The call shall be of a basic service supported by the MS and relevant to the MultiParty supplementary service as stated in GSM 02.04 Table A.1,

NOTE: The MultiParty call may be set up using the procedures of section 31.4.2.1.1.1.

Foreseen final state of the MS

Call A-B, state U10, auxiliary state "Call in MPTY, call held". Call A-C, state U10, auxiliary state "Call in MPTY, call held". Call A-D State U10.

Maximum duration of test

30 s.

Procedure

Using suitable MMI commands, the MS shall initiate a new outgoing call A-D. The MS shall send a SETUP message with a new transaction identifier and enter state U1 "Call initiated". On receipt of an ALERTING message followed by a CONNECT message, the MS shall send a CONNECT ACKNOWLEDGE message and enter state U10 "Active". The call state of the MultiParty call shall not be affected. The call states shall be verified by the SS sending a STATUS ENQUIRY message in respect of the transaction identifier of each call, and receiving a STATUS message indicating the appropriate call state.

Expected sequence

Step	Direction	Message	Comments
1	MS		Using MMI commands, make a new call
2	MS -> SS	SETUP	TI different from Call A-B or Call A-C (new Call A-D)
3	SS -> MS	ALERTING	Transaction identifier of Call A-D
4	SS -> MS	CONNECT	Transaction identifier of Call A-D
5	MS -> SS	CONNECT ACKNOWLEDGE	Transaction identifier of Call A-D
6	SS -> MS	STATUS ENQUIRY	Transaction identifier of Call A-B
7	MS -> SS	STATUS	Transaction identifier of Call A-B, state U10, auxiliary state "Call in MPTY, call held"
8	SS -> MS	STATUS ENQUIRY	Transaction identifier of Call A-C
9	MS -> SS	STATUS	Transaction identifier of Call A-C, state U10, auxiliary state "Call in MPTY, call held"
10	SS -> MS	STATUS ENQUIRY	Transaction identifier of Call A-D
11	MS -> SS	STATUS	Transaction identifier of Call A-D, state U10, no auxiliary state.

31.4.3.3 Process a call waiting request

Conformance requirement

GSM 04.84 subclause 1.3.1.3

Applicability

MS supporting the MultiParty supplementary service.

Test purpose

To test that the MS can correctly process a Call Waiting request with a held MultiParty call.

Method of test

Related PICS/PIXIT statements

- method of answering a waiting call

Initial conditions

System Simulator:

1 cell, default parameters.

Mobile Station:

The MS shall have a MultiParty call to two destinations (Call A-B and Call A-C) active. Both calls states shall be U10 "Active" with auxiliary state "Call in MPTY". The MS shall also have a Call A-D in state U7 "Call received". The Multiparty call shall be of a basic service supported by the MS and relevant to the MultiParty supplementary service as stated in GSM 02.04 Table A.1,

NOTE: The MultiParty call may be set up using the procedures of section 31.4.1.1.

Foreseen final state of the MS

Call A-B, state U10, auxiliary state "Call in MPTY, call held". Call A-C, state U10, auxiliary state "Call in MPTY, call held". Call A-D State U10.

Maximum duration of test

30 s.

Procedure

Using suitable MMI commands, the MS shall place the MultiParty on hold, and answer Call A-D.

The MS shall send a FACILITY message to the SS using any one of the transaction identifiers of the MultiParty call and containing an invoke component HoldMPTY, and shall enter state U10 "Active", with auxiliary state "call in MPTY, hold request" in respect of each of the transaction identifiers.

On receipt of a FACILITY message using the same transaction identifier and containing a return result component, the MS shall enter state U10 "Active" with auxiliary state "Call in MPTY, call held" for each of the transaction identifiers.

The MS shall then send a CONNECT message to the SS, using the transaction identifier of Call A-D, and on receipt of a CONNECT ACKNOWLEDGE message, shall enter state U10 "Active". The call states shall be verified by the SS sending a STATUS ENQUIRY message in respect of the transaction identifier of each call, and receiving a STATUS message indicating the appropriate call state.

Expected sequence

Step	Direction	Message	Comments
1	MS		Using MMI commands, place the multiparty call on hold and answer the waiting call
2	MS -> SS	FACILITY	Transaction identifier of Call A-B or A-C, HoldMPTY invoke component
3	SS -> MS	FACILITY	Same transaction identifier as step 2
4	MS -> SS	CONNECT	Transaction identifier of Call A-D
5	SS -> MS	CONNECT ACKNOWLEDGE	Transaction identifier of Call A-D
6	SS -> MS	STATUS ENQUIRY	Transaction identifier of Call A-B
7	MS -> SS	STATUS	Transaction identifier of Call A-B, state U10, auxiliary state "Call in MPTY, call held"
8	SS -> MS	STATUS ENQUIRY	Transaction identifier of Call A-C
9	MS -> SS	STATUS	Transaction identifier of Call A-C, state U10, auxiliary state "Call in MPTY, call held"
10	SS -> MS	STATUS ENQUIRY	Transaction identifier of Call A-D
11	MS -> SS	STATUS	Transaction identifier of Call A-D, state U10, no auxiliary state.

31.4.3.4 Terminate the held MultiParty call

Conformance requirement

GSM 04.84 subclause 1.3.1.4

Applicability

MS supporting the MultiParty supplementary service.

Test purpose

To test that the MS correctly terminates a held MultiParty call by initiating call clearance for each party in turn.

Method of test

Related PICS/PIXIT statements

- method of terminating a held MultiParty call

Initial conditions

System Simulator:

1 cell, default parameters.

Mobile Station:

The MS shall have a held MultiParty call to two destinations (Call A-B and Call A-C). Both call states shall be U10 "Active" with auxiliary state "Call in MPTY, call held". The call shall be of a basic service supported by the MS and relevant to the MultiParty supplementary service as stated in GSM 02.04 Table A.1,

NOTE: The MultiParty call may be set up using the procedures of section 31.4.2.1.1.1.

Foreseen final state of the MS

Call A-B, state U0. Call A-C, state U0.

Maximum duration of test

30 s.

Procedure

Using suitable MMI commands, the MS shall initiate a clearance of the entire held MultiParty call. The MS shall send a DISCONNECT message in respect of each of the transaction identifiers of the call. On receipt of a RELEASE message in respect of each transaction identifier, the MS shall respond with a RELEASE COMPLETE message, and enter state U0 "Null". The call states shall be verified by the SS sending a STATUS ENQUIRY message in respect of the transaction identifier of each call and receiving a RELEASE COMPLETE message with cause #81 "invalid transaction identifier value" for each call.

Expected sequence

Step	Direction	Message	Comments
1	MS		Using MMI commands, terminate the entire MultiParty call
2	MS -> SS	DISCONNECT	Steps 2 and 3 may occur in any order Transaction identifier of Call A-B
3	MS -> SS	DISCONNECT	Transaction identifier of Call A-C
4	SS -> MS	RELEASE	Transaction identifier of Call A-B
5	MS -> SS	RELEASE COMPLETE	Transaction identifier of Call A-B
6	SS -> MS	RELEASE	Transaction identifier of Call A-C
7	MS -> SS	RELEASE COMPLETE	Transaction identifier of Call A-C
8	SS -> MS	STATUS ENQUIRY	Transaction identifier of Call A-B
9	MS -> SS	RELEASE COMPLETE	Transaction identifier of Call A-B, with cause #81 "invalid transaction identifier value"
10	SS -> MS	STATUS ENQUIRY	Transaction identifier of Call A-C
11	MS -> SS	RELEASE COMPLETE	Transaction identifier of Call A-C, with cause #81 "invalid transaction identifier value"

31.4.4 Managing a single call and a MultiParty call

31.4.4.1 Served mobile subscriber

31.4.4.1.1 Disconnect the single call

31.4.4.1.1.1 Disconnect active single call

Conformance requirement

GSM 04.84 subclause 1.4.1.1

Applicability

MS supporting the MultiParty supplementary service.

Test purpose

To test that the MS correctly clears the single call when the single call is active and the MultiParty call is held.

Initial conditions

The MS shall have a MultiParty call to two destinations (A-B and A-C) both in state U10 "Active" with auxiliary state "Call in MPTY, call held". The MS shall have in addition a single call (A-D) in state U10 "Active" with no auxiliary state. Both calls shall be of a basic service supported by the MS and relevant to the MultiParty supplementary service as stated in GSM 02.04 Table A.1,

NOTE: The MultiParty call may be set up using the procedures of section 31.4.2.1.1.2.

Method of test

Related PICS/PIXIT statements

- method of clearing the single call.

Initial conditions

System Simulator:

- 1 cell, default parameters.

Mobile Station:

The MS shall have a MultiParty call to two destinations (A-B and A-C) both in state U10 "Active" with auxiliary state "Call in MPTY, call held". The MS shall have in addition a single call (A-D) in state U10 "Active" with no auxiliary state. Both calls shall be of a basic service supported by the MS and relevant to the MultiParty supplementary service as stated in GSM 02.04 Table A.1,

NOTE: The MultiParty call may be set up using the procedures of section 31.4.2.1.1.2.

Foreseen final state of the MS

Call A-B, state U10, auxiliary state "Call in MPTY, call held". Call A-C, state U10, auxiliary state "Call in MPTY, call held". Call A-D State U0.

Maximum duration of test

30 s.

Procedure

Using suitable MMI commands, the MS shall clear Call A-D. The MS shall send a DISCONNECT message with the transaction identifier for Call A-D. On receipt of a RELEASE message the SM shall send a RELEASE COMPLETE message and enter state U0 "Null" for Call A-D.

Within 5 seconds of sending the RELEASE COMPLETE message, the MS may send a FACILITY message to retrieve the Held Call. The SS must reject this request. The call state and auxiliary state for Call A-B and Call A-C shall not change. The call states shall be verified by the SS sending a STATUS ENQUIRY message in respect of the transaction identifier of each call, and receiving a STATUS message indicating the appropriate call state for Calls A-B and A-C, and receiving a RELEASE COMPLETE message with cause #81 "invalid transaction identifier value" for Call A-D.

Expected sequence

Step	Direction	Message	Comments
1	MS		Using MMI commands, clear call A-D
2	MS -> SS	DISCONNECT	Transaction identifier of Call A-D
3	SS -> MS	RELEASE	Transaction identifier of Call A-D
4	MS -> SS	RELEASE COMPLETE	Transaction identifier of Call A-D
5	SS		Wait 5 seconds from receiving a RELEASE COMPLETE
A1	SS -> MS	STATUS ENQUIRY	Take this branch if no message is received within 5s
A2	MS -> SS	STATUS	Transaction identifier of Call A-B
A3	SS -> MS	STATUS ENQUIRY	Transaction identifier of Call A-B, state U10, auxiliary state "Call in MPTY, call held"
A4	MS -> SS	STATUS	Transaction identifier of Call A-C
A5	SS -> MS	STATUS ENQUIRY	Transaction identifier of Call A-C, state U10, auxiliary state "Call in MPTY, call held"
A6	MS -> SS	RELEASE COMPLETE	Transaction identifier of Call A-D
			Transaction identifier of Call A-D, with cause #81 "invalid transaction identifier value"
B1	MS -> SS	FACILITY	Take this branch if a message is received within 5s
B2	SS -> MS	FACILITY	TI for Call A-B, RetrieveMPTY Invoke component
B3	SS -> MS	STATUS ENQUIRY	TI for Call A-B, Reject component
B4	MS -> SS	STATUS	Transaction identifier of Call A-B
			Transaction identifier of Call A-B, state U10, auxiliary state "Call in MPTY, call held"
B5	SS -> MS	STATUS ENQUIRY	Transaction identifier of Call A-C
B6	MS -> SS	STATUS	Transaction identifier of Call A-C, state U10, auxiliary state "Call in MPTY, call held"
B7	SS -> MS	STATUS ENQUIRY	Transaction identifier of Call A-D
B8	MS -> SS	RELEASE COMPLETE	Transaction identifier of Call A-D, with cause #81 "invalid transaction identifier value"

31.4.4.1.1.2 Disconnect held single call

Conformance requirement

GSM 04.84 subclause 1.4.1.1

Applicability

MS supporting the MultiParty supplementary service.

Test purpose

To test that the MS correctly clears the single call when the single call is held and the MultiParty call is active.

Method of test

Related PICS/PIXIT statements

- method of clearing the held single call.

Initial conditions

System Simulator:

1 cell, default parameters.

Mobile Station:

The MS shall have a MultiParty call to two destinations (A-B and A-C) both in state U10 "Active" with auxiliary state "Call in MPTY". The MS shall have in addition a single call (A-D) in state U10 "Active" with auxiliary state "Call held". Both calls shall be of a basic service supported by the MS and relevant to the MultiParty supplementary service as stated in GSM 02.04 Table A.1,

NOTE: The MultiParty call may be set up using the procedures of section 31.4.1.1.

Foreseen final state of the MS

Call A-B, state U10, auxiliary state "Call in MPTY". Call A-C, state U10, auxiliary state "Call in MPTY". Call A-D State U0.

Maximum duration of test

30 s.

Procedure

Using suitable MMI commands, the MS shall clear Call A-D. The MS shall send a DISCONNECT message with the transaction identifier for Call A-D. On receipt of a RELEASE message the MS shall send a RELEASE COMPLETE message and enter state U0 "Null" for Call A-D. The call state and auxiliary state for Call A-B and Call A-C shall not change. The call states shall be verified by the SS sending a STATUS ENQUIRY message in respect of the transaction identifier of each call, and receiving a STATUS message indicating the appropriate call state for Calls A-B and A-C, and receiving a RELEASE COMPLETE message with cause #81 "invalid transaction identifier value" for Call A-D.

Expected sequence

Step	Direction	Message	Comments
1	MS		Using MMI commands, clear call A-D
2	MS -> SS	DISCONNECT	Transaction identifier of Call A-D
3	SS -> MS	RELEASE	Transaction identifier of Call A-D
4	MS -> SS	RELEASE COMPLETE	Transaction identifier of Call A-D
5	SS -> MS	STATUS ENQUIRY	Transaction identifier of Call A-B
6	MS -> SS	STATUS	Transaction identifier of Call A-B, state U10, auxiliary state "Call in MPTY"
7	SS -> MS	STATUS ENQUIRY	Transaction identifier of Call A-C
8	MS -> SS	STATUS	Transaction identifier of Call A-C, state U10, auxiliary state "Call in MPTY"
9	SS -> MS	STATUS ENQUIRY	Transaction identifier of Call A-D
10	MS -> SS	RELEASE COMPLETE	Transaction identifier of Call A-D, with cause #81 "invalid transaction identifier value"

31.4.4.1.2 Disconnect the MultiParty call

31.4.4.1.2.1 Void

31.4.4.1.2.2 Void

31.4.4.1.2.3 Clear all parties of held MultiParty call

Conformance requirement

GSM 04.84 subclause 1.4.1.2

Applicability

MS supporting the MultiParty supplementary service.

Test purpose

To test that the MS correctly clears the MultiParty call by clearing all remote parties to a held MultiParty call.

Initial conditions

The MS shall have a MultiParty call to two destinations (A-B and A-C) both in state U10 "Active" with auxiliary state "Call in MPTY, Call held". The MS shall have in addition a single call (A-D) in state U10 "Active" with no auxiliary state. Both calls shall be of a basic service supported by the MS and relevant to the MultiParty supplementary service as stated in GSM 02.04 Table A.1,

NOTE: The MultiParty call may be set up using the procedures of section 31.4.2.1.1.2.

Method of test

Related PICS/PIXIT statements

- method of clearing a held MultiParty call..

Initial conditions

System Simulator:

1 cell, default parameters.

Mobile Station:

The MS shall have a MultiParty call to two destinations (A-B and A-C) both in state U10 "Active" with auxiliary state "Call in MPTY, Call held". The MS shall have in addition a single call (A-D) in state U10 "Active" with no auxiliary state. Both calls shall be of a basic service supported by the MS and relevant to the MultiParty supplementary service as stated in GSM 02.04 Table A.1,

Foreseen final state of the MS

Call A-B, state U0. Call A-C, state U0. Call A-D State U10, no auxiliary state.

Maximum duration of test

30 s.

Procedure

Using suitable MMI commands, the MS shall clear the MultiParty call. The MS shall send DISCONNECT messages with the transaction identifier for Call A-B and A-C. On receipt of a RELEASE message to each DISCONNECT the MS shall send a RELEASE COMPLETE message and enter state U0 "Null. Call A-B and Call A-C shall enter state U0 "Null". The call state and auxiliary state for Call A-D shall not change. The call states shall be verified by the SS sending a STATUS ENQUIRY message in respect of the transaction identifier of each call, and receiving a STATUS message indicating the appropriate call state for Call A-D, and receiving a RELEASE COMPLETE message with cause #81 "invalid transaction identifier value" for Calls A-B and A-C.

Expected sequence

Step	Direction	Message	Comments
1	MS		Using MMI commands, terminate the entire MultiParty call
2	MS -> SS	DISCONNECT	Steps 2 and and 3 may occur in any order Transaction identifier of Call A-B
3	MS -> SS	DISCONNECT	Transaction identifier of Call A-C
4	SS -> MS	RELEASE	Transaction identifier of Call A-B
5	MS -> SS	RELEASE COMPLETE	Transaction identifier of Call A-B
6	SS -> MS	RELEASE	Transaction identifier of Call A-C
7	MS -> SS	RELEASE COMPLETE	Transaction identifier of Call A-C
8	SS -> MS	STATUS ENQUIRY	Transaction identifier of Call A-B
9	MS -> SS	RELEASE COMPLETE	Transaction identifier of Call A-B, with cause #81 "invalid transaction identifier value"
10	SS -> MS	STATUS ENQUIRY	Transaction identifier of Call A-C
11	MS -> SS	RELEASE COMPLETE	Transaction identifier of Call A-C, with cause #81 "invalid transaction identifier value"
12	SS -> MS	STATUS ENQUIRY	Transaction identifier of Call A-D
13	MS -> SS	STATUS	Transaction identifier of Call A-D, state U10

31.4.4.1.2.4 Clear all parties of active MultiParty call

Conformance requirement

GSM 04.84 subclause 1.4.1.2

Applicability

MS supporting the MultiParty supplementary service.

Test purpose

To test that the MS correctly clears the MultiParty call by clearing all remote parties to an active MultiParty call.

Method of test

Related PICS/PIXIT statements

- method of clearing an active MultiParty call..

Initial conditions

System Simulator:

1 cell, default parameters.

Mobile Station:

The MS shall have a MultiParty call to two destinations (A-B and A-C) both in state U10 "Active" with auxiliary state "Call in MPTY". The MS shall have in addition a single call (A-D) in state U10 "Active" with auxiliary state "Call held". Both calls shall be of a basic service supported by the MS and relevant to the MultiParty supplementary service as stated in GSM 02.04 Table A.1,

Foreseen final state of the MS

Call A-B, state U0. Call A-C, state U0. Call A-D State U10, auxiliary state "Call Held".

Maximum duration of test

30 s.

Procedure

Using suitable MMI commands, the MS shall clear the MultiParty call. The MS shall send DISCONNECT messages with the transaction identifier for Call A-B and A-C. On receipt of a RELEASE message to each DISCONNECT the MS shall send a RELEASE COMPLETE message and enter state U0 "Null". Call A-B and Call A-C shall enter state U0 "Null". Within 5 seconds of sending the RELEASE COMPLETE message, the MS may send a RETRIEVE message to retrieve the Held Call. The SS shall reject this request. The call state and auxiliary state for Call A-D shall not change. The call states shall be verified by the SS sending a STATUS ENQUIRY message in respect of the transaction identifier of each call, and receiving a STATUS message indicating the appropriate call state. for Call A-D, and receiving a RELEASE COMPLETE message with cause #81 "invalid transaction identifier value" for Calls A-B and A-C.

Expected sequence

Step	Direction	Message	Comments
1	MS		Using MMI commands, terminate the entire MultiParty call
2	MS -> SS	DISCONNECT	Steps 2 and 3 may occur in any order
3	MS -> SS	DISCONNECT	Transaction identifier of Call A-B
4	SS -> MS	RELEASE	Transaction identifier of Call A-C
5	MS -> SS	RELEASE COMPLETE	Transaction identifier of Call A-B
6	SS -> MS	RELEASE	Transaction identifier of Call A-C
7	MS -> SS	RELEASE COMPLETE	Transaction identifier of Call A-C
8	SS		Wait 5 seconds from receiving a RELEASE COMPLETE
A9	SS -> MS	STATUS ENQUIRY	Take this branch if no message is received within 5s
A10	MS -> SS	RELEASE COMPLETE	Transaction identifier of Call A-B
A11	SS -> MS	STATUS ENQUIRY	Transaction identifier of Call A-B, with cause #81 "invalid transaction identifier value"
A12	MS -> SS	RELEASE COMPLETE	Transaction identifier of Call A-C
A13	SS -> MS	STATUS ENQUIRY	Transaction identifier of Call A-C, with cause #81 "invalid transaction identifier value"
A14	MS -> SS	STATUS	Transaction identifier of Call A-D
			Transaction identifier of Call A-D, state U10, auxiliary state "Call Held"
B9	MS -> SS	RETRIEVE	Take this branch if a message is received within 5s
B10	SS -> MS	RETRIEVE REJECT	Transaction identifier of Call A-D
B11	SS -> MS	STATUS ENQUIRY	
B12	MS -> SS	RELEASE COMPLETE	Transaction identifier of Call A-B
			Transaction identifier of Call A-B, with cause #81 "invalid transaction identifier value"
B13	SS -> MS	STATUS ENQUIRY	Transaction identifier of Call A-C
B14	MS -> SS	RELEASE COMPLETE	Transaction identifier of Call A-C, with cause #81 "invalid transaction identifier value"
B15	SS -> MS	STATUS ENQUIRY	Transaction identifier of Call A-D
B16	MS -> SS	STATUS	Transaction identifier of Call A-D, state U10, auxiliary state "Call Held"

31.4.4.2 Disconnect all calls

Conformance requirement

GSM 04.84 subclause 1.4.1.3

Applicability

MS supporting the MultiParty supplementary service.

Test purpose

To test the MS correctly clears all active calls, by clearing in turn each connected party.

Method of test

Related PICS/PIXIT statements

- method of clearing all active calls.

Initial conditions

System Simulator:

1 cell, default parameters.

Mobile Station:

The MS shall have a MultiParty call to two destinations (A-B and A-C) both in state U10 "Active" with auxiliary state "Call in MPTY". The MS shall have in addition a single call (A-D) in state U10 "Active" with auxiliary state "Call held". Both calls shall be of a basic service supported by the MS and relevant to the MultiParty supplementary service as stated in GSM 02.04 Table A.1,

Foreseen final state of the MS

Call A-B, state U0. Call A-C, state U0. Call A-D state U0.

Maximum duration of test

30 s.

Procedure

Using suitable MMI commands, the MS shall clear all calls. The MS shall send DISCONNECT messages with the transaction identifier for Call A-B, Call A-C and Call A-D. On receipt of a RELEASE message to each DISCONNECT the MS shall send a RELEASE COMPLETE message and enter state U0 "Null". Call A-B, Call A-C Call A-D shall enter state U0 "Null". The call states shall be verified by the SS sending a STATUS ENQUIRY message in respect of the transaction identifier of each call, and receiving a RELEASE COMPLETE message with cause #81 "invalid transaction identifier value" for each call.

Expected sequence

Step	Direction	Message	Comments	
1	MS		Using MMI commands, terminate the entire MultiParty call	
2	MS -> SS	DISCONNECT	Steps 2, 3 and 4 may occur in any order. Transaction identifier of Call A-B	
3	MS -> SS	DISCONNECT		Transaction identifier of Call A-C
4	MS -> SS	DISCONNECT		Transaction identifier of Call A-D
5	SS -> MS	RELEASE	Transaction identifier of Call A-B	
6	MS -> SS	RELEASE COMPLETE	Transaction identifier of Call A-B	
7	SS -> MS	RELEASE	Transaction identifier of Call A-C	
8	MS -> SS	RELEASE COMPLETE	Transaction identifier of Call A-C	
9	SS -> MS	RELEASE	Transaction identifier of Call A-D	
10	MS -> SS	RELEASE COMPLETE	Transaction identifier of Call A-D	
11	SS -> MS	STATUS ENQUIRY	Transaction identifier of Call A-B	
12	MS -> SS	RELEASE COMPLETE	Transaction identifier of Call A-B, with cause #81 "invalid transaction identifier value"	
13	SS -> MS	STATUS ENQUIRY	Transaction identifier of Call A-C	
14	MS -> SS	RELEASE COMPLETE	Transaction identifier of Call A-C, with cause #81 "invalid transaction identifier value"	
15	SS -> MS	STATUS ENQUIRY	Transaction identifier of Call A-D	
16	MS -> SS	RELEASE COMPLETE	Transaction identifier of Call A-D, with cause #81 "invalid transaction identifier value"	

31.4.4.3 Add the single call to the MPTY

31.4.4.3.1 Add the single call to the MPTY, successful case

Conformance requirement

GSM 04.84 subclause 1.4.1.4

Applicability

MS supporting the MultiParty supplementary service.

Test purpose

To test that the MS correctly adds a single held call to an active MultiParty call, and reacts correctly to a response from the SS indicating success.

Method of test

Related PICS/PIXIT statements

- method of adding the single call to the MultiParty call.

Initial conditions

System Simulator:

1 cell, default parameters.

Mobile Station:

The MS shall have a MultiParty call to two destinations (A-B and A-C) both in state U10 "Active" with auxiliary state "Call in MPTY". The MS shall have in addition a single call (A-D) in state U10 "Active" with auxiliary state "Call held". Both calls shall be of a basic service supported by the MS and relevant to the MultiParty supplementary service as stated in GSM 02.04 Table A.1.

NOTE: The MultiParty call may be set up using the procedures of section 31.4.1.1.

Foreseen final state of the MS

Call A-B, state U10, auxiliary state "Call in MPTY". Call A-C, state U10, auxiliary state "Call in MPTY". Call A-D state U10, auxiliary state "Call in MPTY".

Maximum duration of test

30 s.

Procedure

Using suitable MMI commands, the MS shall add the single call to the MultiParty call. The MS shall send a FACILITY message containing one of the transaction identifiers A-B, A-C or A-D and containing a BuildMPTY invoke component. Calls A-B and A-C shall remain in state U10 "Active" with auxiliary state "Call in MPTY". Call A-D shall enter state U10 "Active" with auxiliary state "MPTY request, call held". The call states shall be verified by the SS sending a STATUS ENQUIRY message in respect of the transaction identifier of each call, and receiving a STATUS message indicating the appropriate call state.

On receipt of a FACILITY message containing a return result component, all calls shall enter state U10 "Active" with auxiliary state "Call in MPTY". The call states shall be verified by the SS sending a STATUS ENQUIRY message in respect of the transaction identifier of each call, and receiving a STATUS message indicating the appropriate call state.

Expected sequence

Step	Direction	Message	Comments
1	MS		Using MMI commands, join the single call to the MultiParty call
2	MS -> SS	FACILITY	TI for Call A-B, Call A-C or call A-D, BuildMPTY Invoke component
3	SS -> MS	STATUS ENQUIRY	Transaction identifier of Call A-B
4	MS -> SS	STATUS	Transaction identifier of Call A-B, state U10, auxiliary state "Call in MPTY"
5	SS -> MS	STATUS ENQUIRY	Transaction identifier of Call A-C
6	MS -> SS	STATUS	Transaction identifier of Call A-C, state U10, auxiliary state "Call in MPTY"
7	SS -> MS	STATUS ENQUIRY	Transaction identifier of Call A-D
8	MS -> SS	STATUS	Transaction identifier of Call A-D, state U10, auxiliary state "MPTY request, Call held"
9	SS -> MS	FACILITY	TI same as step 2, Return Result component
10	SS -> MS	STATUS ENQUIRY	Transaction identifier of Call A-B
11	MS -> SS	STATUS	Transaction identifier of Call A-B, state U10, auxiliary state "Call in MPTY"
12	SS -> MS	STATUS ENQUIRY	Transaction identifier of Call A-C
13	MS -> SS	STATUS	Transaction identifier of Call A-C, state U10, auxiliary state "Call in MPTY"
14	SS -> MS	STATUS ENQUIRY	Transaction identifier of Call A-D
15	MS -> SS	STATUS	Transaction identifier of Call A-D, state U10, auxiliary state "Call in MPTY"
16	SS		Check that the TCH is through-connected

31.4.4.3.2 Add the single call to the MPTY, maximum number of participants exceeded

Conformance requirement

GSM 04.84 subclause 1.4.1.4

Applicability

MS supporting the MultiParty supplementary service.

Test purpose

To test that the MS correctly adds a single held call to an active MultiParty call, and reacts correctly to a response from the SS indicating maximum number of participants exceeded.

Method of test

Related PICS/PIXIT statements

- method of adding the single call to the MultiParty call.

Initial conditions

System Simulator:

1 cell, default parameters.

Mobile Station:

The MS shall have a MultiParty call to five destinations (A-B, A-C and A-D) all in state U10 "Active" with auxiliary state "Call in MPTY". The MS shall have in addition a single call (A-E) in state U10 "Active" with auxiliary state "Call held". Both calls shall be of a basic service supported by the MS and relevant to the MultiParty supplementary service as stated in GSM 02.04 Table A.1,

Foreseen final state of the MS

Call A-B, state U10, auxiliary state "Call in MPTY". Call A-C, state U10, auxiliary state "Call in MPTY". Call A-D state U10, auxiliary state "Call in MPTY", Call A-E state U10, auxiliary state "Call Held".

Maximum duration of test

30 s.

Procedure

Using suitable MMI commands, the MS shall add the single call to the MultiParty call. The MS shall send a FACILITY message containing any one of the transaction identifiers and containing a BuildMPTY invoke component. Calls A-B to A-D shall remain in state U10 "Active" with auxiliary state "Call in MPTY". Call A-E shall enter state U10 "Active" with auxiliary state "MPTY request, call held". The call states shall be verified by the SS sending a STATUS ENQUIRY message in respect of the transaction identifier of each call, and receiving a STATUS message indicating the appropriate call state.

On receipt of a FACILITY message containing a return error component "MaxNumberOfMPTY-ParticipantsExceeded", then all calls shall return to their original states. The call states shall be verified by the SS sending a STATUS ENQUIRY message in respect of the transaction identifier of each call, and receiving a STATUS message indicating the appropriate call state.

Expected sequence

Step	Direction	Message	Comments
1	MS		Using MMI commands, join the single call to the MultiParty call
2	MS -> SS	FACILITY	TI for Call A-B, Call A-C, Call A-D or Call A-E, BuildMPTY Invoke component
3	SS -> MS	STATUS ENQUIRY	Transaction identifier of Call A-B
4	MS -> SS	STATUS	Transaction identifier of Call A-B, state U10, auxiliary state "Call in MPTY"
5	SS -> MS	STATUS ENQUIRY	Transaction identifier of Call A-C
6	MS -> SS	STATUS	Transaction identifier of Call A-C, state U10, auxiliary state " Call in MPTY"
7	SS -> MS	STATUS ENQUIRY	Transaction identifier of Call A-D
8	MS -> SS	STATUS	Transaction identifier of Call A-D, state U10, auxiliary state " Call in MPTY"
9	SS -> MS	STATUS ENQUIRY	Transaction identifier of Call A-E
10	MS -> SS	STATUS	Transaction identifier of Call A-E, state U10, auxiliary state "MPTY request, Call held"
11	SS -> MS	FACILITY	Same TI as step 2, Return error component "MaxNumberOfMPTY-ParticipantsExceeded"
12	SS -> MS	STATUS ENQUIRY	Transaction identifier of Call A-B
13	MS -> SS	STATUS	Transaction identifier of Call A-B, state U10, auxiliary state "Call in MPTY"
14	SS -> MS	STATUS ENQUIRY	Transaction identifier of Call A-C
15	MS -> SS	STATUS	Transaction identifier of Call A-C, state U10, auxiliary state "Call in MPTY"
16	SS -> MS	STATUS ENQUIRY	Transaction identifier of Call A-D
17	MS -> SS	STATUS	Transaction identifier of Call A-D, state U10, auxiliary state "Call in MPTY"
18	SS -> MS	STATUS ENQUIRY	Transaction identifier of Call A-E
19	MS -> SS	STATUS	Transaction identifier of Call A-E, state U10, auxiliary state "Call Held"

31.4.4.4 Alternate between the MPTY call and the single call

Conformance requirement

GSM 04.84 subclause 1.4.1.5

Applicability

MS supporting the MultiParty supplementary service.

Test purpose

To test that the MS correctly alternates between the single call and the MultiParty call, by proper use of the hold and retrieve procedures.

Method of test

Related PICS/PIXIT statements

- method of alternating between the single call to the MultiParty call.

Initial conditions

System Simulator:

1 cell, default parameters.

Mobile Station:

The MS shall have a MultiParty call to two destinations (A-B and A-C) both in state U10 "Active" with auxiliary state "Call in MPTY". The MS shall have in addition a single call (A-D) in state U10 "Active" with auxiliary state "Call held". Both calls shall be of a basic service supported by the MS and relevant to the MultiParty supplementary service as stated in GSM 02.04 Table A.1,

Foreseen final state of the MS

Call A-B, state U10, auxiliary state "Call in MPTY". Call A-C, state U10, auxiliary state "Call in MPTY". Call A-D state U10, auxiliary state "Call Held",

Maximum duration of test

30 s.

Procedure

Using suitable MMI commands, the MS shall alternate between the single call and the MultiParty call. The MS shall send a FACILITY message containing one of the transaction identifiers of the MultiParty call, and containing an invoke component HoldMPTY. The MS shall then send a RETRIEVE message with the transaction identifier for Call A-D. Call A-B and Call A-C shall enter the auxiliary state "Call in MPTY, hold request". Call A-D shall enter auxiliary state "retrieve request". The call states shall be verified by the SS sending a STATUS ENQUIRY message in respect of the transaction identifier of each call, and receiving a STATUS message indicating the appropriate call state.

The SS shall send a FACILITY message with a return result component and then send a RETRIEVE ACKNOWLEDGE message. On receipt of these messages, Calls A-B and A-C shall enter auxiliary state "Call in MPTY, call held", and Call A-D shall enter state U10 "Active" with no auxiliary state. The call states shall be verified by the SS sending a STATUS ENQUIRY message in respect of the transaction identifier of each call, and receiving a STATUS message indicating the appropriate call state.

Using suitable MMI commands, the MS shall again alternate between the single call and the MultiParty call. The MS shall send a FACILITY message containing one of the transaction identifiers of the MultiParty call, and containing an invoke component RetrieveMPTY. The MS shall also send a HOLD message with the transaction identifier for Call A-D. Call A-B and Call A-C shall enter the auxiliary state "Call in MPTY, retrieve request". Call A-D shall enter auxiliary state "hold request". The call states shall be verified by the SS sending a STATUS ENQUIRY message in respect of the transaction identifier of each call, and receiving a STATUS message indicating the appropriate call state.

The SS shall send a FACILITY message with a return result component and shall also send a HOLD ACKNOWLEDGE message. On receipt of these messages, Call A-B and A-C shall enter auxiliary state "Call in MPTY", and Call A-D shall enter state U10 "Active" with auxiliary state "Call held". The call states shall be verified

by the SS sending a STATUS ENQUIRY message in respect of the transaction identifier of each call, and receiving a STATUS message indicating the appropriate call state.

Expected sequence

Step	Direction	Message	Comments
1	MS		Using MMI commands, alternate between the active and held calls
2	MS -> SS	FACILITY	TI for Call A-B or call A-C, HoldMPTY Invoke component
3	MS -> SS	RETRIEVE	Transaction identifier of Call A-D
4	SS -> MS	STATUS ENQUIRY	Transaction identifier of Call A-B
5	MS -> SS	STATUS	Transaction identifier of Call A-B, state U10, auxiliary state "Call in MPTY, Hold request"
6	SS -> MS	STATUS ENQUIRY	Transaction identifier of Call A-C
7	MS -> SS	STATUS	Transaction identifier of Call A-C, state U10, auxiliary state "Call in MPTY, Hold request"
8	SS -> MS	STATUS ENQUIRY	Transaction identifier of Call A-D
9	MS -> SS	STATUS	Transaction identifier of Call A-D, state U10, auxiliary state "Retrieve request"
10	SS -> MS	FACILITY	Same TI as step 2, Return result component
11	SS -> MS	RETRIEVE ACKNOWLEDGE	Transaction identifier of Call A-D
12	SS -> MS	STATUS ENQUIRY	Transaction identifier of Call A-B
13	MS -> SS	STATUS	Transaction identifier of Call A-B, state U10, auxiliary state "Call in MPTY, Call held"
14	SS -> MS	STATUS ENQUIRY	Transaction identifier of Call A-C
15	MS -> SS	STATUS	Transaction identifier of Call A-C, state U10, auxiliary state "Call in MPTY, Call held"
16	SS -> MS	STATUS ENQUIRY	Transaction identifier of Call A-D
17	MS -> SS	STATUS	Transaction identifier of Call A-D, state U10, no auxiliary state
21	SS		Check that the TCH is through-connected
18	MS		Using MMI commands, alternate between the active and held calls
19	MS -> SS	HOLD	Transaction identifier of Call A-D
20	MS -> SS	FACILITY	TI for Call A-B or call A-C, RetrieveMPTY Invoke component
21	SS -> MS	STATUS ENQUIRY	Transaction identifier of Call A-B
22	MS -> SS	STATUS	Transaction identifier of Call A-B, state U10, auxiliary state "Call in MPTY, Retrieve request"
23	SS -> MS	STATUS ENQUIRY	Transaction identifier of Call A-C
24	MS -> SS	STATUS	Transaction identifier of Call A-C, state U10, auxiliary state "Call in MPTY, Retrieve request"
25	SS -> MS	STATUS ENQUIRY	Transaction identifier of Call A-D
26	MS -> SS	STATUS	Transaction identifier of Call A-D, state U10, auxiliary state "Holdrequest"
27	SS -> MS	HOLD ACKNOWLEDGE	Transaction identifier of Call A-D
28	SS -> MS	FACILITY	Same TI as step 20, Return result component
29	SS -> MS	STATUS ENQUIRY	Transaction identifier of Call A-B
30	MS -> SS	STATUS	Transaction identifier of Call A-B, state U10, auxiliary state "Call in MPTY"
31	SS -> MS	STATUS ENQUIRY	Transaction identifier of Call A-C
32	MS -> SS	STATUS	Transaction identifier of Call A-C, state U10, auxiliary state "Call in MPTY"
33	SS -> MS	STATUS ENQUIRY	Transaction identifier of Call A-D
34	MS -> SS	STATUS	Transaction identifier of Call A-D, state U10, auxiliary state "Call Held"
35	SS		Check that the TCH is through-connected

31.4.5 Adding extra remote parties

Conformance requirement

GSM 04.84 subclause 1.5

Applicability

MS supporting the MultiParty supplementary service.

Test purpose

To test that the MS adds extra remote parties to the MultiParty call.

Method of test

Related PICS/PIXIT statements

- method of alternating between the single call to the MultiParty call.

Initial conditions

System Simulator:

1 cell, default parameters.

Mobile Station:

The MS shall have a MultiParty call to two destinations (Call A-B and Call A-C) active. Both call states shall be U10 "Active" with auxiliary state "Call in MPTY". The call shall be of a basic service supported by the MS and relevant to the MultiParty supplementary service as stated in GSM 02.04 Table A.1,

Foreseen final state of the MS

Call A-B, state U10, auxiliary state "Call in MPTY". Call A-C, state U10, auxiliary state "Call in MPTY". Call A-D state U10, auxiliary state "Call in MPTY".

Maximum duration of test

30 s.

Procedure

The procedure of test 34.4.2.1.1.1 "Put the MultiParty call on hold, successful case" shall be performed followed by the procedure of 34.4.3.2 "Initiate a new call", followed by the procedure of 31.4.4.3.1 "Add the single call to the MPTY, successful case".

Expected sequence

Step	Direction	Message	Comments
1	MS		Using MMI commands, put the MultiParty call on Hold
2	MS -> SS	FACILITY	TI for Call A-B or call A-C, HoldMPTY Invoke component
3	SS -> MS	FACILITY	Same TI as step 2, Return Result component
4	MS -> SS	SETUP	TI different from Call A-B or Call A-C (new Call A-D)
5	SS -> MS	ALERTING	Transaction identifier of Call A-D
6	SS -> MS	CONNECT	Transaction identifier of Call A-D
7	MS -> SS	CONNECT ACKNOWLEDGE	Transaction identifier of Call A-D
8	MS -> SS	FACILITY	TI for Call A-B, Call A-C or call A-D, BuildMPTY Invoke component
9	SS -> MS	FACILITY	TI same as step 8, Return Result component
10	SS -> MS	STATUS ENQUIRY	Transaction identifier of Call A-B
11	MS -> SS	STATUS	Transaction identifier of Call A-B, state U10, auxiliary state "Call in MPTY"
12	SS -> MS	STATUS ENQUIRY	Transaction identifier of Call A-C
13	MS -> SS	STATUS	Transaction identifier of Call A-C, state U10, auxiliary state "Call in MPTY"
14	SS -> MS	STATUS ENQUIRY	Transaction identifier of Call A-D
15	MS -> SS	STATUS	Transaction identifier of Call A-D, state U10, auxiliary state "Call in MPTY"
16	SS		Check that the TCH is through-connected

31.5 Community of interest supplementary services

(Reserved).

31.6 Charging supplementary services

The following Advice of Charge abbreviations are used in this section:

AoC	Advice of Charge
AoCC	Advice of Charge Charging
AoCI	Advice of Charge Information
ACM	Accumulated Charge Meter
ACMmax	Accumulated Charge Meter Maximum
CCM	Current Call Meter
CAI	Charge Advice Information
CDUR	Chargeable Duration

The following other abbreviations are used:

IE	Information Element
FIE	Facility Information Element
TCH	Traffic CHannel

General on Advice of Charge.

The purpose of these tests is to verify that the MS under test correctly performs procedures related to the AoC supplementary service.

The reasons for these test purposes are:

- One example of a possible use for AoCC is in applications where the subscriber hires out a GSM ME and SIM to a user and bills the user according to the charge stored on the SIM at the end of the hire period. If a mobile station claims to support AoCC but does so incorrectly or not at all, this may cause the subscriber to mischarge the user of the hire phone. Hence an MS claiming to support AoCC must be shown to be reliable in that context.

- Since AoCC offers the use of telecommunication services according to the charge stored independently in the MS, the AoCC service must not be susceptible to fraud at the MS end.
- To ensure that a mobile station **not** claiming to support AoCC does not respond with a signal to the network indicating that it does. This could cause the network to allow the call to be placed without any charge being inserted on to the SIM.

Mobile originating and terminating speech AoC calls are tested and if supported, Call Hold and Multi-party calls. The type testing of data calls (i.e. those calls with a volume related charging component) will not be specified at the phase 2 stage but will be deferred to phase 2+ since the interaction of AoC with packet services is not yet defined in GSM 09.06 and GSM 09.07.

Tests are made on the ME-SIM interface to ensure that call charges are being correctly stored in the ACM field of the SIM in several situations. The AoC ACMmax function is also tested for incoming and outgoing calls.

Basic service verification tests for the AoCC, Call Hold, and Multi-party supplementary services which have direct relevance to the testing of AoC have been added to GSM 11.10, sections 11.3, 11.4 and 11.5 respectively.

31.6.1 Advice of Charge Charging

31.6.1.1 AoCC time related charging / MS originated call

Purpose:

- 1) To verify that when the MS receives the AoCC parameters in a Facility IE which is contained in the CONNECT message and when a TCH has already been assigned, the MS returns a FACILITY message containing the acknowledgement within 1 second.
- 2) To verify that when the MS receives the AoCC parameters in a Facility IE which is contained in a CONNECT message and when a TCH has already been assigned, the MS stores the correct value in the ACM field of the SIM.
- 3) To verify that when the call has no volume related component the MS ignores non-zero AoCC e5, e6 parameters sent to it.

Conformance Requirement(s):

- 1) When the MS receives the AoCC parameters in a Facility IE which is contained in a CONNECT message and when a TCH has already been assigned, the MS shall return a FACILITY message containing the acknowledgement within 1 second.
- 2) When the MS receives the AoCC parameters in a Facility IE which is contained in a CONNECT or FACILITY message and when a TCH has already been assigned, the MS shall store the correct value in the ACM field of the SIM.
- 3) When the call has no volume related component the MS shall ignore non-zero AoC e5 and e6 parameters sent to it.

Reference(s):

Conformance requirement 1: GSM 03.86, GSM 04.13, GSM 04.86.

Conformance requirement 2: GSM 02.24.

Conformance requirement 3: GSM 02.24.

Related PICS/PIXIT Statement(s):

- Support of AoCC.
- Supported rates (full rate/half rate).
- Method of reading ACM from the SIM via the ME.

- Supported teleservices.
- Support for active state of the call control protocol (U10).

Initial Conditions:**System Simulator:**

1 cell, default parameters, IMSI attach/detach disabled.

Mobile Station:

The MS is in MM-state "idle, updated".

Foreseen Final State of the MS:

The MS is in MM-state "idle, updated".

Method of Test:

The MS is made to initiate a call. The call is established with certain AoCC e-parameters sent in a Facility IE in the CONNECT message. The MS shall return the AoCC acknowledgement within 1 second of the CONNECT message. It is an implementation option whether the AoCC acknowledge is sent by the MS before or after the CONNECT ACKNOWLEDGE.

The SS sends the DISCONNECT y seconds after sending the CONNECT message containing the CAI. The MS shall have stored the correct amount on the SIM according to the e-parameters sent. The test is repeated for several different sets of e-parameters as defined below.

Maximum Duration of Test:

30 minutes.

Expected Sequence:

The sequence step 1-20 is executed for execution counter k = 1,...,5.

Step	Direction	Message	Comments
0			At start of test only, read and note value of ACM on SIM
1	MS		The MS is made to initiate a call
2	MS -> SS	CHANNEL REQUEST	
3	SS -> MS	IMMEDIATE ASSIGNMENT	
4	MS -> SS	CM SERVICE REQUEST	
5	SS -> MS	CM SERVICE ACCEPT	
6	MS -> SS	SETUP	
7	SS -> MS	CALL PROCEEDING	
8	SS -> MS	ASSIGNMENT COMMAND	to a supported channel type
9	MS -> SS	ASSIGNMENT COMPLETE	
10	SS -> MS	ALERTING	
11	SS -> MS	CONNECT	As default message except contains Facility IE with contents as indicated in i below
			Either A or B branch is taken
A12	MS -> SS	CONNECT ACKNOWLEDGE	
A13	MS -> SS	FACILITY	As default message except contains Facility IE with contents as indicated in ii below
B12	MS -> SS	FACILITY	As default message except contains Facility IE with contents as indicated in ii below
B13	MS -> SS	CONNECT ACKNOWLEDGE	
14			call duration y seconds after CAI information sent by SS
15	SS -> MS	DISCONNECT	
16	MS -> SS	RELEASE	
17	SS -> MS	RELEASE COMPLETE	
18	SS -> MS	CHANNEL RELEASE	The main signalling link is released.
19	MS		SIM contents checked (either via MMI or by removing the SIM and using SIM reader). ACM shall have been incremented correctly.

NOTE: The value of y is given below.

The correct value of the ACM is found from the general AoC formula given in GSM 02.24 section 4 with CDUR = y seconds and e parameters as defined below.

Specific Message Contents:

i) FACILITY Information Element with Invoke = ForwardChargeAdvice component type as defined in GSM 04.80 section 3.6.1 table 3.3.

For ASN.1 description see default message contents in section 31.6.4.

y is set to a constant value of 90 seconds.

The values of the e-parameters within the parameter part of the Facility Information Element shall be set as below:

k-value	e-parameter								Step 0 ACM at call end	value increased by
	1	2	3	4	5	6	7	8		
1	6	14	1	25	0	0	60	43	43	
2	0	0	1	100	0	0	0	100	143	
3	250	16	2	500	0	0	60	2000	2143	
4	1	1	1	0	10	10	1	89 or 90	2232 or 2233	
5	12,5	30	1	25	10	10	30	50 or 62,5	2295, 2296, 2282 or 2283	

Values shown in table are in the format and have units as in GSM 02.24 section 3.

The ASN.1 description for each e-parameter allows integers in the range 0 to 8191 to be transmitted but some e-parameters have different actual ranges (e.g. e1 can take any value 0..819,1 with 0,1 resolution). The MS knows how to interpret the received parameter (e.g. received e1 refers to 10 times actual e1, see GSM 04.80 section 4.4.3). Therefore e1=12,5 would be sent to the MS as 125. The MS knows the value sent is 10 times the "real" e1 and hence interprets the value as 12,5.

The non-zero e5 and e6 values for the k=4 and k=5 execution of the test are to check that the MS ignores the volume related parameters when carrying out time only related charging.

ii) FACILITY Information Element with Return Result component type as defined in GSM 04.80 section 3.6.1 table 3.4.

For ASN.1 description see default message contents in section 31.6.4.

31.6.1.2 AoCC time related charging / MS terminated call

Purpose:

- 1) To verify that when the MS receives certain AoCC e-parameters in a Facility IE which is contained in a FACILITY message sent after the CONNECT message and when a TCH has already been assigned, the MS returns a FACILITY message containing the acknowledgement within 1 second.
- 2) To verify that when the MS receives the AoCC parameters in a Facility IE which is contained in a FACILITY message and when a TCH has already been assigned, the MS stores the correct value in the ACM field of the SIM.

Conformance Requirement(s):

- 1) When the MS receives the AoCC parameters in a Facility IE which is contained in a FACILITY message sent after the CONNECT message and when a TCH has already been assigned, the MS shall return a Facility message containing the acknowledgement within 1 second.
- 2) When the MS receives the AoCC parameters in a Facility IE which is contained in a FACILITY message and when a TCH has already been assigned, the MS shall store the correct value in the ACM field of the SIM.

Reference(s):

Conformance requirement 1: GSM 03.86, GSM 04.13, GSM 04.86.

Conformance requirement 2: GSM 02.24.

Related PICS/PIXIT Statement(s):

- Support of AoCC.
- Supported rates (full rate/half rate).
- Method of reading ACM from the SIM via the ME.
- Supported teleservices.
- Support for active state of the call control protocol (U10).

Initial Conditions:

System Simulator:

1 cell, default parameters, IMSI attach/detach disabled.

Mobile Station:

The MS is in MM-state "idle, updated".

Foreseen Final State of the MS:

The MS is in MM-state "idle, updated".

Method of Test:

The SS is made to initiate a call. The call is established and certain AoCC e-parameters are sent to the MS in a Facility IE contained within a FACILITY message. The MS shall return the AoCC acknowledgement within 1 second of the FACILITY message. It is an implementation option whether the AoCC e-parameters and the AoCC acknowledge are sent before or after the CONNECT ACKNOWLEDGE.

The SS sends the DISCONNECT y seconds after sending the FACILITY message. The MS shall have stored the correct amount on the SIM according to the e-parameters sent. The test is repeated for several different sets of e-parameters as defined below.

Maximum Duration of Test:

30 minutes.

Expected Sequence:

The sequence step 1-20 is executed for execution counter $k = 1, \dots, 5$.

Step	Direction	Message	Comments
0			At start of test only, read and note value of ACM on SIM
1	SS		The SS is made to initiate a call
2	SS -> MS	PAGING REQUEST	
3	MS -> SS	CHANNEL REQUEST	
4	SS -> MS	IMMEDIATE ASSIGNMENT	
5	MS -> SS	PAGING RESPONSE	
6	SS -> MS	SETUP	
7	MS -> SS	CALL CONFIRMED	
8	SS -> MS	ASSIGNMENT COMMAND	to a supported channel type
9	MS -> SS	ASSIGNMENT COMPLETE	
10	MS -> SS	ALERTING	
11	MS -> SS	CONNECT	
12	SS -> MS	FACILITY	As default message except contains Facility IE with contents as indicated in i below
			Either A or B branch is taken
A13	SS -> MS	CONNECT ACKNOWLEDGE	
A14	MS -> SS	FACILITY	As default message except contains Facility IE with contents as indicated in ii below
B13	MS -> SS	FACILITY	As default message except contains Facility IE with contents as indicated in ii below
B14	SS -> MS	CONNECT ACKNOWLEDGE	
15			call duration y seconds after CAI information sent by SS
16	SS -> MS	DISCONNECT	
17	MS -> SS	RELEASE	
18	SS -> MS	RELEASE COMPLETE	
19	SS -> MS	CHANNEL RELEASE	The main signalling link is released.
20	MS		SIM contents checked (either via MMI or by removing the SIM and using SIM reader) ACM shall have been incremented correctly.

NOTE: The value of y is given below.

The correct value of the ACM is found from the general AoC formula given in GSM 02.24 section 4 with $CDUR = y$ seconds and e parameters as defined below.

Specific Message Contents:

- i) FACILITY Information Element with Invoke = ForwardChargeAdvice component type as defined in GSM 04.80 section 3.6.1 table 3.3.

For ASN.1 description see default message contents in section 31.6.4.

y is set to a constant value of 90 seconds.

The values of the e-parameters within the parameter part of the Facility Information Element shall be set as below:

k-value	e-parameter							CCM total at call end increased by	Step 0 ACM value
	1	2	3	4	5	6	7		
1	0	0	0	0	0	0	0	0	0
2	0	0	1	100	0	0	0	100	100
3	6	14	1	25	0	0	60	43	143
4	1	1	1	0	0	0	1	89 or 90	233 or 232
5	12,5	30	1	25	0	0	30	50 or 62,5	296, 295, 282 or 283

Values shown in table are in the format and have units as in GSM 02.24 section 3.

- ii) FACILITY Information Element with Return Result component type as defined in GSM 04.80 section 3.6.1 table 3.4.

For ASN.1 description see default message contents in section 31.6.4.

31.6.1.3 AoCC volume related charging / MS originated call

Future addition at GSM Phase 2+ stage.

31.6.1.4 AoCC volume related charging / MS terminated call

Future addition at GSM Phase 2+ stage.

31.6.1.5 Change in charging information during a call

Purpose:

- 1) To verify that when the MS receives new AoCC parameters mid-way through a call in a Facility IE which is contained within a FACILITY message the MS returns a FACILITY message containing the acknowledgement within 1 second.
- 2) To verify that when the MS receives new charging information mid-way through a call in the form of a Facility IE contained within a FACILITY message the MS correctly indicates the total charge considering both sets of charging information.

Conformance Requirement(s):

- 1) When the MS receives new AoCC parameters mid-way through a call in a Facility IE which is contained within a FACILITY message the MS shall return a FACILITY message containing the acknowledgement within 1 second.
- 2) When the MS receives new charging information mid-way through a call in the form of a Facility IE contained within a FACILITY message the MS correctly indicates the total charge considering both sets of charging information.

Reference(s):

Conformance requirement 1: GSM 03.86, GSM 04.13, GSM 04.86.

Conformance requirement 2: GSM 02.24.

Related PICS/PIXIT Statement(s):

- Support of AoCC.
- Supported rates (full rate/half rate).
- Method of reading ACM from the SIM via the ME.
- Supported teleservices.
- Support for active state of the call control protocol (U10).

Initial Conditions:

System Simulator:

1 cell, default parameters, IMSI attach/detach disabled.

Mobile Station:

The MS is in MM-state "idle, updated".

Foreseen Final State of the MS:

The MS is in MM-state "idle, updated".

Method of Test:

The MS is made to initiate a call. The call is established with certain AoCC e-parameters sent in a Facility IE in a FACILITY message sent after the CONNECT message. The MS shall return the AoCC acknowledgement within 1 second of the FACILITY message. x seconds after sending the original CAI, new (and different) e-parameters are sent to the MS in a Facility IE contained within a FACILITY message. The MS shall return the AoCC acknowledgement within 1 second of the FACILITY message.

The SS sends the DISCONNECT y seconds after sending the first CAI in the FACILITY message. The MS shall have stored the correct amount on the SIM according to the two sets of e-parameters sent and the times for the two parts of the call.

Maximum Duration of Test:

10 minutes.

Expected Sequence:

Step	Direction	Message	Comments
0			At start of test only, read and note value of ACM on SIM
1	MS		The MS is made to initiate a call
2	MS -> SS	CHANNEL REQUEST	
3	SS -> MS	IMMEDIATE ASSIGNMENT	
4	MS -> SS	CM SERVICE REQUEST	
5	SS -> MS	CM SERVICE ACCEPT	
6	MS -> SS	SETUP	
7	SS -> MS	CALL PROCEEDING	
8	SS -> MS	ASSIGNMENT COMMAND	to a supported channel type
9	MS -> SS	ASSIGNMENT COMPLETE	
10	SS -> MS	ALERTING	
11	SS -> MS	CONNECT	
			Either A, B or C branch is taken
A12	SS -> MS	FACILITY	As default message except contains Facility IE with contents as indicated in i below
A13	MS -> SS	CONNECT ACKNOWLEDGE	
A14	MS -> SS	FACILITY	As default message except contains Facility IE with contents as indicated in ii below
B12	MS -> SS	CONNECT ACKNOWLEDGE	
B13	SS -> MS	FACILITY	As default message except contains Facility IE with contents as indicated in i below
B14	MS -> SS	FACILITY	As default message except contains Facility IE with contents as indicated in ii below
C12	SS -> MS	FACILITY	As default message except contains Facility IE with contents as indicated in i below
C13	MS -> SS	FACILITY	As default message except contains Facility IE with contents as indicated in ii below
C14	MS-> SS	CONNECT ACKNOWLEDGE	
15	SS -> MS	FACILITY	Second CAI sent x sec after first CAI
16	MS -> SS	FACILITY	As default message except contains Facility IE with contents as indicated in iii below
17			As default message except contains Facility IE with contents as indicated in ii below New CAI held in abeyance until CDUR has timed out present e2 value Call duration y seconds after first CAI information sent by SS
18	SS -> MS	DISCONNECT	
19	MS -> SS	RELEASE	
20	SS -> MS	RELEASE COMPLETE	
21	SS -> MS	CHANNEL RELEASE	The main signalling link is released.
22	MS		SIM contents checked (either via MMI or by removing the SIM and using SIM reader) ACM shall have been incremented correctly

NOTE The values of x and y are given below.

The correct value of the ACM is found from the general AoC formula given in GSM 02.24 section 4 with CDUR = x, y seconds and e parameters as defined below.

Specific Message Contents:

- i) FACILITY Information Element with Invoke = ForwardChargeAdvice component type as defined in GSM 04.80 section 3.6.1 table 3.3.

For ASN.1 description see default message contents in section 31.6.4.

The values of the e-parameters within the parameter part of the Facility Information Element shall be set as defined below:

	e-parameter							CCM total at call end increased by	Step 0 ACM value
	1	2	3	4	5	6	7		
	10	28	1	10	0	0	60	(30)	(30)

Values shown in table are in the format and have units as in GSM 02.24 section 3.

- ii) FACILITY Information Element with Return Result component type as defined in GSM 04.80 section 3.6.1 table 3.4.

For ASN.1 description see default message contents in section 31.6.4.

- iii) FACILITY Information Element with Invoke = ForwardChargeAdvice component type as defined in GSM 04.80 section 3.6.1 table 3.3.

For ASN.1 description see default message contents in section 31.6.4.

x is set to a constant value of 80 seconds.

y is set to a constant value of 180 seconds.

The values of the e-parameters within the parameter part of the Facility Information Element shall be set to:

	e-parameter							CCM total at call end increased by	Step 0 ACM value
	1	2	3	4	5	6	7		
	10	14	1	5	0	0	60	65	65

Values shown in table are in the format and have units as in GSM 02.24 section 3.

31.6.1.6 Different formats of charging information

Purpose:

- 1) To verify that when the MS receives a Facility IE in which certain e-parameters are set to zero the total charge accumulated is the same as that when the same e-parameters are completely omitted from the Facility IE.
- 2) To verify the operation of a shortened channel release procedure where the SS does not send DISCONNECT but only the RELEASE COMPLETE and CHANNEL RELEASE messages or just the CHANNEL RELEASE message.

Conformance Requirement(s):

- 1) When the MS receives a Facility IE in which certain e-parameters are set to zero the total charge accumulated shall be the same as that when the same e-parameters are completely omitted from the Facility IE.
- 2) The channel shall be correctly released when a shortened channel release procedure is used - the SS does not send DISCONNECT but only the RELEASE COMPLETE and CHANNEL RELEASE messages or just the CHANNEL RELEASE message.

Reference(s):

Conformance requirement 1: GSM 02.24.

Conformance requirement 2: GSM 04.08.

Related PICS/PIXIT Statement(s):

- Support of AoCC.
- Supported rates (full rate/half rate).
- Method of reading ACM from the SIM via the ME.
- Supported teleservices.
- Support for active state of the call control protocol (U10).

Initial Conditions:

System Simulator:

1 cell, default parameters, IMSI attach/detach disabled.

Mobile Station:

The MS is in MM-state "idle, updated".

Foreseen Final State of the MS:

The MS is in MM-state "idle, updated".

Method of Test:

Part 1:

The MS is made to initiate a call. The call is established with certain AoCC e-parameters sent in a Facility IE in a FACILITY message sent before the CONNECT message.

The SS sends the DISCONNECT y seconds after sending the FACILITY message containing the e-parameters. The MS shall have stored the correct amount on the SIM according to the e-parameters sent.

Part 2:

Part 1 is repeated twice with the e-parameters that were set to zero above now omitted completely from the Facility IE. The shortened release procedures are used. The MS shall have stored the correct amount on the SIM.

The results of parts 1 and 2 are compared. The value for the charge calculated by the MS shall be identical for parts 1 and 2.

Maximum Duration of Test:

20 minutes.

Expected Sequence:

The sequence step 1-20 is executed for execution counter $k = 1, \dots, 3$.

Step	Direction	Message	Comments
0			At start of test only, read and note value of ACM on SIM
1	MS		The MS is made to initiate a call
2	MS -> SS	CHANNEL REQUEST	
3	SS -> MS	IMMEDIATE ASSIGNMENT	
4	MS -> SS	CM SERVICE REQUEST	
5	SS -> MS	CM SERVICE ACCEPT	
6	MS -> SS	SETUP	
7	SS -> MS	CALL PROCEEDING	
8	SS -> MS	ASSIGNMENT COMMAND	to a supported channel type
9	MS -> SS	ASSIGNMENT COMPLETE	
10	SS -> MS	ALERTING	
11	SS -> MS	FACILITY	As default message except contains Facility IE with contents as indicated in i below
			Either A, B or C branch is taken
A12	SS -> MS	CONNECT	
A13	MS -> SS	CONNECT ACKNOWLEDGE	
A14	MS -> SS	FACILITY	As default message except contains Facility IE with contents as indicated in ii below
B12	SS -> MS	CONNECT	
B13	MS -> SS	FACILITY	As default message except contains Facility IE with contents as indicated in ii below
B14	MS -> SS	CONNECT ACKNOWLEDGE	
C12	MS -> SS	FACILITY	As default message except contains Facility IE with contents as indicated in ii below
C13	SS -> MS	CONNECT	
C14	MS -> SS	CONNECT ACKNOWLEDGE	
15			call duration y seconds after CAI information sent by SS
			Branch D, E and F shall be taken for $k = 1, 2$ and 3 respectively
D16	SS -> MS	DISCONNECT	
D17	MS -> SS	RELEASE	
D18	SS -> MS	RELEASE COMPLETE	
D19	SS -> MS	CHANNEL RELEASE	The main signalling link is released.
E16	SS -> MS	RELEASE COMPLETE	Shortened channel release procedure
E17	SS -> MS	CHANNEL RELEASE	The main signalling link is released.
F16	SS -> MS	CHANNEL RELEASE	
20	MS		SIM contents checked (either via MMI or by removing the SIM and using SIM reader) ACM shall have been incremented correctly.

NOTE The value of y is given below.

The correct value of the ACM is found from the general AoC formula given in GSM 02.24 section 4 with $CDUR = y$ seconds and e parameters as defined below.

Specific Message Contents:

i) FACILITY Information Element with Invoke = ForwardChargeAdvice component type as defined in GSM 04.80 section 3.6.1 table 3.3.

For ASN.1 description see default message contents in section 31.6.4.

y is set to a constant value of 90 seconds.

The values of the e -parameters within the parameter part of the Facility Information Element shall be set to:

k-value	e-parameter							CCM total at call end increased by	Step 0 ACM value
	1	2	3	4	5	6	7		
1	10	40	1	0	0	0	0	20	20
2	10	40	1	-----omitted-----				20	40
3	10	40	1	-----omitted-----				20	60

Values shown in table are in the format and have units as in GSM 02.24 section 3.

ii) FACILITY Information Element with Return Result component type as defined in GSM 04.80 section 3.6.1 table 3.4.

For ASN.1 description see default message contents in section 31.6.4.

31.6.1.7 AoCC on a Call Hold call

Purpose:

- 1) To verify that when the MS invokes a Call Hold call and hence receives Facility IEs containing AoCC e-parameters for each chargeable call the MS returns a FACILITY message containing the AoCC acknowledgement within 1 second of transmission of each set of e-parameters.
- 2) To verify that when the MS invokes a Call Hold call and hence receives Facility IEs containing CAI elements for each chargeable call the CCM records the sum of all the charges for the services currently being used and hence that the ME inserts the correct charge in the ACM field of the SIM.

Conformance Requirement(s):

- 1) When the MS invokes a Call Hold call and hence receives Facility IEs containing AoCC e-parameters for each chargeable call the MS shall return a FACILITY message containing the AoCC acknowledgement within 1 second of receiving each set of e-parameters.
- 2) When the MS invokes a Call Hold call and hence receives Facility IEs containing CAI elements for each chargeable call the CCM shall record the sum of all the charges for the services currently being used and hence the ME shall insert the correct charge in the ACM field of the SIM.

Reference(s):

Conformance requirement 1: GSM 04.13.

Conformance requirement 2: GSM 02.24, GSM 04.83, GSM 04.84, GSM 04.86.

Related PICS/PIXIT Statement(s):

- Support of AoCC.
- Supported rates (full rate/half rate).
- Method of reading ACM from the SIM via the ME.
- Supported teleservices.
- Support for active state of the call control protocol (U10).

Initial Conditions:

System Simulator:

1 cell, default parameters, IMSI attach/detach disabled.

Mobile Station:

The MS is in MM-state "idle, updated".

Foreseen Final State of the MS:

The MS is in MM-state "idle, updated".

Method of Test:

The MS is made to initiate a call. The call is established with certain AoCC e-parameters sent in a Facility IE in the CONNECT message. The MS shall return the AoCC acknowledgement within 1 second of transmission of the CONNECT message.

The call (call B) is then put on hold by sending a HOLD message from the MS to the SS. The SS shall reply with a HOLD ACKNOWLEDGE. The traffic channel is now available to originate another call.

The MS is made to initiate a second call (call C). The call is established with certain AoCC e-parameters sent in a Facility IE in the CONNECT message. The MS shall return the AoCC acknowledgement in a FACILITY message within 1 second of transmission of the CONNECT message.

The SS sends the DISCONNECT to the MS for call B x seconds after sending the call B CAI in the CONNECT/FACILITY message and the DISCONNECT for call C y seconds after sending the call C CAI in the CONNECT/FACILITY message. The MS shall have stored the correct amount on the SIM according to the two sets of e-parameters sent and call times x and y.

Maximum Duration of Test:

10 minutes.

Expected Sequence:

Step	Direction	Message	Comments
0			At start of test only, read and note value of ACM on SIM
1	MS		The MS is made to initiate a call
2	MS -> SS	CHANNEL REQUEST	
3	SS -> MS	IMMEDIATE ASSIGNMENT	
4	MS -> SS	CM SERVICE REQUEST	
5	SS -> MS	CM SERVICE ACCEPT	
6	MS -> SS	SETUP	
7	SS -> MS	CALL PROCEEDING	
8	SS -> MS	ASSIGNMENT COMMAND	to a supported channel type
9	MS -> SS	ASSIGNMENT COMPLETE	
10	SS -> MS	ALERTING	
11	SS -> MS	CONNECT	As default message except contains Facility IE with contents as indicated in i below
			Either D or E branch is taken
D12	MS -> SS	CONNECT ACKNOWLEDGE	
D13	MS -> SS	FACILITY	As default message except contains Facility IE with contents as indicated in ii below
E12	MS -> SS	FACILITY	As default message except contains Facility IE with contents as indicated in ii below
E13	MS -> SS	CONNECT ACKNOWLEDGE	
14	MS		The MS is made to initiate a second call, and the first call is placed on hold. DTMF signalling may occur, when MMI keys are depressed
15	MS -> SS	HOLD	
16	SS -> MS	HOLD ACKNOWLEDGE	
17	MS -> SS	CM SERVICE REQUEST	
18	SS -> MS	CM SERVICE ACCEPT	
19	MS -> SS	SETUP	T1 arbitrary but different from existing T1
20	SS -> MS	CALL PROCEEDING	
21	SS -> MS	ALERTING	
22	SS -> MS	CONNECT	As default message except contains Facility IE with contents as indicated in i below
			Either F or G branch is taken
F23	MS -> SS	CONNECT ACKNOWLEDGE	
F24	MS -> SS	FACILITY	As default message except contains Facility IE with contents as indicated in ii below
G23	MS -> SS	FACILITY	As default message except contains Facility IE with contents as indicated in ii below
G24	MS -> SS	CONNECT ACKNOWLEDGE	
25			Call durations x and y seconds after respective CAI information sent by SS
			Branch H and I branch are taken, the sequence depending on the durations x and y
H26	SS -> MS	DISCONNECT	For call C
H27	MS -> SS	RELEASE	y seconds after call C CAI sent
H28	SS -> MS	RELEASE COMPLETE	
I26	SS -> MS	DISCONNECT	For call B
I27	MS -> SS	RELEASE	x seconds after call B CAI sent
I28	SS -> MS	RELEASE COMPLETE	
29	SS -> MS	CHANNEL RELEASE	The main signalling link is released
30	MS		SIM contents checked (either via MMI or by removing the SIM and using SIM reader) ACM shall have been incremented correctly.

NOTE The value of x and y are given below.

The correct value of the ACM is found from the general AoC formula given in GSM 02.24 section 4 with CDUR = x,y seconds and e parameters as defined below.

Specific Message Contents:

- i) FACILITY Information Element with Invoke = ForwardChargeAdvice component type as defined in GSM 04.80 section 3.6.1 table 3.3.

For ASN.1 description see default message contents in section 31.6.4.

x set to 180 s, y is set to 90 s.

The values of the e-parameters within the parameter part of the Facility Information Element shall be set to:

Call	e-parameter							CCM total at call end increased by	Step 0 ACM value
	1	2	3	4	5	6	7		
B(time x)	7	40	1	0	0	0	0		
C(time y)	13	40	1	0	0	0	0	54	54

Values shown in table are in the format and have units as in GSM 02.24 section 3.

- ii) FACILITY Information Element with Return Result component type as defined in GSM 04.80 section 3.6.1 table 3.4.

For ASN.1 description see default message contents in section 31.6.4.

31.6.1.8 AoCC on a Multi-party call

Purpose:

- 1) To verify that when the MS invokes a Multi-party call and hence receives Facility IEs containing AoCC e-parameters for each chargeable call the MS returns a FACILITY message containing the AoCC acknowledgement within 1 second of transmission of each set of e-parameters.
- 2) To verify that when the MS originates a Multi-party call and hence receives Facility IEs containing CAI elements for each chargeable call the CCM records the sum of all the charges for the services currently being used and hence the ME inserts the correct charge in the ACM field of the SIM.

Conformance Requirement(s):

- 1) When the MS invokes a Multi-party call and hence receives Facility IEs containing AoCC e-parameters for each chargeable call the MS shall return a FACILITY message containing the AoCC acknowledgement within 1 second of receiving each set of e-parameters.
- 2) When the MS originates a Multi-party call and hence receives Facility IEs containing CAI elements for each chargeable call the CCM shall record the sum of all the charges for the services currently being used and hence the ME shall insert the correct charge in the ACM field of the SIM.

Reference(s):

Conformance requirement 1: GSM 04.13.

Conformance requirement 2: GSM 02.24, GSM 04.83, GSM 04.84, GSM 04.86.

Related PICS/PIXIT Statement(s):

- Support of AoCC.
- Supported rates (full rate/half rate).
- Method of reading ACM from the SIM via the ME.

- Supported teleservices.
- Support for active state of the call control protocol (U10).

Initial Conditions:

System Simulator:

1 cell, default parameters, IMSI attach/detach disabled.

Mobile Station:

The MS is in MM-state "idle, updated".

Foreseen Final State of the MS:

The MS is in MM-state "idle, updated".

Method of Test:

The MS is made to initiate a call. The call is established with certain AoCC e-parameters sent in a Facility IE in the CONNECT message. The MS shall return the AoCC acknowledgement within 1 second of transmission of the CONNECT message.

The call (call B) is then put on hold by sending a HOLD message from the MS to the SS. The SS shall reply with a HOLD ACKNOWLEDGE. The traffic channel is now available to originate another call.

The MS is made to initiate a second call (call C). The call is established with certain AoCC e-parameters sent in a Facility IE in the CONNECT message. The MS shall return the AoCC acknowledgement within 1 second of transmission of the CONNECT message.

The MS invokes the multi-party service by sending a FACILITY message to the SS containing the BuildMPTY request.

The SS accepts the request and connects the MS with the other existing connections (active call C and held call B) and confirms with a FACILITY message.

The SS sends the DISCONNECT to the MS for call B x seconds after sending the call B CAI in the CONNECT message and the DISCONNECT for call C y seconds after sending the call C CAI in the CONNECT message. The MS shall have stored the correct amount on the SIM according to the two sets of e-parameters sent and call times x and y.

Maximum Duration of Test:

10 minutes.

Expected Sequence:

Step	Direction	Message	Comments
0			At start of test only, read and note value of ACM on SIM
1	MS		The MS is made to initiate a call
2	MS -> SS	CHANNEL REQUEST	
3	SS -> MS	IMMEDIATE ASSIGNMENT	
4	MS -> SS	CM SERVICE REQUEST	
5	SS -> MS	CM SERVICE ACCEPT	
6	MS -> SS	SETUP	
7	SS -> MS	CALL PROCEEDING	
8	SS -> MS	ASSIGNMENT COMMAND	to a supported channel type
9	MS -> SS	ASSIGNMENT COMPLETE	
10	SS -> MS	ALERTING	
11	SS -> MS	CONNECT	As default message except contains Facility IE with contents as indicated in i below
			Either D or E branch is taken
D12	MS -> SS	CONNECT ACKNOWLEDGE	
D13	MS -> SS	FACILITY	As default message except contains Facility IE with contents as indicated in ii below

Step	Direction	Message	Comments
E12	MS -> SS	FACILITY	As default message except contains Facility IE with contents as indicated in ii below
E13	MS -> SS	CONNECT ACKNOWLEDGE	
14	MS -> SS	HOLD	The MS is made to initiate a second call and the first call (call B) is placed on hold. DTMF signalling may occur, when MMI keys are depressed TI arbitrary but different from existing TI As default message except contains Facility IE with contents as indicated in i below
15	MS->SS	HOLD	
16	SS -> MS	HOLD ACKNOWLEDGE	
17	MS -> SS	CM SERVICE REQUEST	
18	SS -> MS	CM SERVICE ACCEPT	
19	MS -> SS	SETUP	
20	SS -> MS	CALL PROCEEDING	
21	SS -> MS	ALERTING	
22	SS -> MS	CONNECT	As default message except contains Facility IE with contents as indicated in i below
			Either F or G branch is taken
F23	MS -> SS	CONNECT ACKNOWLEDGE	As default message except contains Facility IE with contents as indicated in ii below
F24	MS -> SS	FACILITY	
G23	MS -> SS	FACILITY	As default message except contains Facility IE with contents as indicated in ii below
G24	MS -> SS	CONNECT ACKNOWLEDGE	
25	MS -> SS	FACILITY (TI A-B/A-C)	The MS is made to build a multi-party call. DTMF signalling may occur, when MMI keys are depressed As default message except contains Facility IE with contents as indicated in iii below As default message except contains Facility IE with contents as indicated in iv, below Call durations x and y seconds after respective CAI information sent by SS
26	SS -> MS	FACILITY (TI A-B/A-C)	
27			
			Branch H and branch I are taken, the sequence depending on the durations x and y
H28	SS -> MS	DISCONNECT	For call C y seconds after call C CAI sent
H29	MS -> SS	RELEASE	
H30	SS -> MS	RELEASE COMPLETE	
I28	SS -> MS	DISCONNECT	For call B x seconds after call B CAI sent
I29	MS -> SS	RELEASE	
I30	SS -> MS	RELEASE COMPLETE	
31	SS -> MS	CHANNEL RELEASE	The main signalling link is released. SIM contents checked (either via MMI or by removing the SIM and using SIM reader) ACM shall have been incremented correctly.
32	MS		

NOTE: A-B/A-C indicates a choice. the transaction identifier (TI) used must be that of the active call or the held call (ref. GSM 04.84).

The values of x and y are given below.

The correct value of the ACM is found from the general AoC formula given in GSM 02.24 section 4 with CDUR = x,y seconds and e parameters as defined below.

Specific Message Contents:

- i) FACILITY Information Element with Invoke = ForwardChargeAdvice component type as defined in GSM 04.80 section 3.6.1 table 3.3.

For ASN.1 description see default message contents in section 31.6.4.

x set to 180 s, y set to 90 s.

The values of the e-parameters within the parameter part of the Facility Information Element shall be set to:

Call	e-parameter							CCM total at call end increased by	Step 0 ACM value
	1	2	3	4	5	6	7		
B(time x)	19	40	1	0	0	0	0		
C(time y)	29	40	1	0	0	0	0	134	134

Values shown in table are in the format and have units as in GSM 02.24 section 3.

ii) FACILITY Information Element with Return Result component type as defined in GSM 04.80 section 3.6.1 table 3.4.

For ASN.1 description see default message contents in section 31.6.4.

iii) FACILITY Information Element with Invoke = BuildMPTY component type as defined in GSM 04.80 section 3.6.1 table 3.4.

The following abbreviations are used in the descriptions below:

- U Universal tag class.
- CS Context Specific tag class.
- P Primitive tag form.
- C Constructed tag form.
- FIE Facility Information Element.

Contents	Value/remark	Coding
Facility IE Identifier	As GSM 04.80	00011100
Length of FIE contents	8	00001000
Component type tag	CS/C/tag=1	10100001
Component length	6	00000110
Invoke ID tag	U/P/tag=2	00000010
Invoke ID length	1	00000001
Invoke ID	Arbitrary (1 octet)	(00000000)
Op-Code tag	From GSM 04.80	00000010
Op-Code length	1	00000001
Op-Code	Build Multi-party operation (local value 124)	00000001

ii) FACILITY Information Element with Return Result component type as defined in GSM 04.80 section 3.6.1 table 3.4.

Contents	Value/remark	Coding
Facility IE Identifier	As GSM 04.80	00111100
Length of FIE contents	5	00001001
Component type tag	CS/C/tag=2	10100010
Component length	3	00000011
Invoke ID tag	U/P/Integer	00000010
Invoke ID length	1	00000001
Invoke ID	Same as used as Invoke ID in Invoke FIE	(00000000)

31.6.2 Charge Storage

31.6.2.1 Removal of SIM during an active call

Purpose:

- 1) To verify that when the SIM is removed from the ME during an active AoCC call the ME immediately terminates the call.
- 2) To verify that when the SIM is removed during an active AoCC call the ME has written the total charge up to that point in the call to the ACM field of the SIM.

Conformance Requirement(s):

- 1) When the SIM is removed from the ME during an active AoCC call the ME shall immediately terminate the call.
- 2) When the SIM is removed during an active AoCC call midway through an AoC charging time interval (e7 or e2) the ME shall have written the total charge up to the point in the call where the charging time interval last expired to the ACM field of the SIM.

Reference(s):

Conformance requirement 1: GSM 02.17.

Conformance requirement 1: GSM 02.24.

Related PICS/PIXIT Statement(s):

- Support of AoCC.
- Supported rates (full rate/half rate).
- Removal of the SIM is possible without disconnection of power supply.
- Supported teleservices.
- Support for active state of the call control protocol (U10).

Initial Conditions:

System Simulator:

1 cell, default parameters, IMSI attach/detach disabled.

Mobile Station:

The MS is in MM-state "idle, updated".

Foreseen Final State of the MS:

The MS is in MM-state "idle, updated".

Method of Test:

This test is only performed if it is possible to remove SIM without disconnecting the power supply. If the battery pack must be removed to get at the SIM see 31.6.2.2.

The MS is made to initiate a call. The call is established with certain AoCC e-parameters sent in a Facility IE in the CONNECT message. It is an implementation option whether the AoCC acknowledge is sent before or after the CONNECT ACKNOWLEDGE.

If possible, without removing the power supply, the SIM is removed from the ME y seconds after the SS sends the CAI in the CONNECT/FACILITY message. The call shall be terminated immediately by the MS and the MS shall have stored the correct amount on the SIM according to the e-parameters sent.

Maximum Duration of Test:

5 minutes.

Expected Sequence:

Step	Direction	Message	Comments
0			At start of test only, read and note value of ACM on SIM
1	MS		The MS is made to initiate a call
2	MS -> SS	CHANNEL REQUEST	
3	SS -> MS	IMMEDIATE ASSIGNMENT	
4	MS -> SS	CM SERVICE REQUEST	
5	SS -> MS	CM SERVICE ACCEPT	
6	MS -> SS	SETUP	
7	SS -> MS	CALL PROCEEDING	
8	SS -> MS	ASSIGNMENT COMMAND	to a supported channel type
9	MS -> SS	ASSIGNMENT COMPLETE	
10	SS -> MS	ALERTING	
11	SS -> MS	CONNECT	As default message except contains Facility IE with contents as indicated in i below
			Either A or B branch is taken
A12	MS -> SS	CONNECT ACKNOWLEDGE	
A13	MS -> SS	FACILITY	As default message except contains Facility IE with contents as indicated in ii below
B12	MS -> SS	FACILITY	As default message except contains Facility IE with contents as indicated in ii below
B13	MS -> SS	CONNECT ACKNOWLEDGE	
14			SIM removed y seconds after CAI information sent by SS.
			Either C, D, E or F branch is taken
C15	MS -> SS	DISCONNECT	
C16	SS -> MS	RELEASE	
C17	MS -> SS	RELEASE COMPLETE	
C18	SS -> MS	CHANNEL RELEASE	The main signalling link is released.
D15	MS -> SS	RELEASE COMPLETE	
D16	SS -> MS	CHANNEL RELEASE	The main signalling link is released.
E15	MS -> SS	Layer 2 DISC	
E16	SS -> MS	UA	
F15			No further messages are sent
19			SIM contents checked (by removing the SIM and using SIM reader). ACM shall have been incremented correctly.

NOTE: The value of y is given below.

The correct value of the ACM is found from the general AoC formula given in GSM 02.24 section 4 with $CDUR = y$ seconds and e parameters as defined below.

Specific Message Contents:

i) FACILITY Information Element with Invoke = ForwardChargeAdvice component type as defined in GSM 04.80 section 3.6.1 table 3.3.

For ASN.1 description see default message contents in section 31.6.4.

The SIM is removed after approximately $y=90$ seconds.

The values of the e-parameters within the parameter part of the Facility Information Element shall be set to:

k-value	e-parameter							CCM total at call end increased by	Step 0 ACM value
	1	2	3	4	5	6	7		
	10	55	1	10	0	0	10	30	30

Values shown in table are in the format and have units as in GSM 02.24 section 3.

ii) FACILITY Information Element with Return Result component type as defined in GSM 04.80 section 3.6.1 table 3.4.

For ASN.1 description see default message contents in section 31.6.4.

31.6.2.2 Interruption of power supply during an active call

Purpose:

To verify that when the power supply of the MS is removed during an active AoCC call the ME has written the total charge up to that point in the call to the ACM field of the SIM.

Conformance Requirement(s):

When the power supply of the MS is removed during an active AoCC call midway through an AoC charging time interval (e7 or e2) the ME shall have written the total charge up to the point in the call where the charging time interval last expired to the ACM field of the SIM.

Reference(s):

Conformance requirement 1: GSM 02.24.

Related PICS/PIXIT Statement(s):

- Support of AoCC.
- Supported rates (full rate/half rate).
- Method of removing power supply.
- Supported teleservices.
- Support for active state of the call control protocol (U10).

Initial Conditions:

System Simulator:

1 cell, default parameters, IMSI attach/detach disabled.

Mobile Station:

The MS is in MM-state "idle, updated".

Foreseen Final State of the MS:

The MS is switched off.

Method of Test:

The MS is made to initiate a call. The call is established with certain AoCC e-parameters sent in a Facility IE in the CONNECT message. It is an implementation option whether the AoCC acknowledge is sent before or after the CONNECT ACKNOWLEDGE.

The ME power is switched off by pressing power button on MMI during the active call. The call shall be terminated immediately and the MS shall have stored the correct amount on the SIM according to the e-parameters sent.

The test is repeated for ME power being lost by removal of battery pack. The call shall be terminated immediately and the MS shall have stored the correct amount on the SIM according to the e-parameters sent.

Maximum Duration of Test:

10 minutes.

Expected Sequence:

The sequence step 1-20 is executed for execution counter $k = 1,2$.

Step	Direction	Message	Comments
0			At start of test only, read and note value of ACM on SIM
1	MS		The MS is made to initiate a call
2	MS -> SS	CHANNEL REQUEST	
3	SS -> MS	IMMEDIATE ASSIGNMENT	
4	MS -> SS	CM SERVICE REQUEST	
5	SS -> MS	CM SERVICE ACCEPT	
6	MS -> SS	SETUP	
7	SS -> MS	CALL PROCEEDING	
8	SS -> MS	ASSIGNMENT COMMAND	to a supported channel type
9	MS -> SS	ASSIGNMENT COMPLETE	
10	SS -> MS	ALERTING	
11	SS -> MS	CONNECT	As default message except contains Facility IE with contents as indicated in i below
			Either A or B branch is taken
A12	MS -> SS	CONNECT ACKNOWLEDGE	
A13	MS -> SS	FACILITY	As default message except contains Facility IE with contents as indicated in ii below
B12	MS -> SS	FACILITY	As default message except contains Facility IE with contents as indicated in ii below
B13	MS -> SS	CONNECT ACKNOWLEDGE	
14			ME power interrupted y seconds after CAI information sent by SS by: MMI power switch (for k=1) Removing battery pack (for k=2) Depending on the value of k C or D branch is taken
15			SIM contents checked (by removing the SIM and using SIM reader). ACM shall have been incremented correctly.

NOTE: The value of y is given below.

The correct value of the ACM is found from the general AoC formula given in GSM 02.24 section 4 with CDUR = y seconds and e parameters as defined below.

Specific Message Contents:

- i) FACILITY Information Element with Invoke = ForwardChargeAdvice component type as defined in GSM 04.80 section 3.6.1 table 3.3.

For ASN.1 description see default message contents in section 31.6.4.

The ME power is removed after approximately $\gamma=90$ seconds.

The values of the e-parameters within the parameter part of the Facility Information Element shall be set to:

k-value	e-parameter							CCM total at call end increased by	Step 0 ACM value
	1	2	3	4	5	6	7		
	10	55	1	10	0	0	10	30	30

Values shown in table are in the format and have units as in GSM 02.24 section 3.

- ii) FACILITY Information Element with Return Result component type as defined in GSM 04.80 section 3.6.1 table 3.4.

For ASN.1 description see default message contents in section 31.6.4.

31.6.2.3 MS going out of coverage during an active AoCC call

NOTE: At present the core recommendations for AoCC in the case where the radio link is lost during an active call are vague. Does the mobile go on charging for a fixed period after radio link loss and continue as usual if radio link reestablishment occurs, or does charging stop? Input from people involved in charging for GSM is required.

Hence this test will be enhanced in the future when the requirements become clearer.

Purpose:

To verify that when the MS goes out of radio coverage area and an active call is dropped the ME has written the total charge up to that point in the call to the ACM field of the SIM.

Conformance Requirement(s):

When the MS goes out of radio coverage area during an active AoCC call midway through an AoC charging time interval (e7 or e2) and the call is dropped the ME shall have written the total charge up to the point in the call where the charging time interval last expired to the ACM field of the SIM.

Reference(s):

Conformance requirement 1: GSM 02.24.

Related PICS/PIXIT Statement(s):

- Support of AoCC.
- Supported rates (full rate/half rate).
- Method of reading ACM from the SIM via the ME.
- Supported teleservices.
- Support for active state of the call control protocol (U10).

Initial Conditions:

System Simulator:

1 cell, default parameters, IMSI attach/detach disabled.

Mobile Station:

The MS is in MM-state "idle, updated".

Foreseen Final State of the MS:

The MS is in MM-state "idle, updated".

Method of Test:

The MS is made to initiate a call. The call is established with certain AoCC e-parameters sent in a Facility IE in the CONNECT message. It is an implementation option whether the AoCC acknowledge is sent before or after the CONNECT ACKNOWLEDGE.

The cell simulated by the system simulator is then switched off to model the MS losing radio coverage. The MS shall have stored the correct amount on the SIM according to the e-parameters sent. [What happens on call reestablishment?]

Maximum Duration of Test:

5 minutes.

Expected Sequence:

Step	Direction	Message	Comments
0			At start of test only, read and note value of ACM on SIM
1	MS		The MS is made to initiate a call
2	MS -> SS	CHANNEL REQUEST	
3	SS -> MS	IMMEDIATE ASSIGNMENT	
4	MS -> SS	CM SERVICE REQUEST	
5	SS -> MS	CM SERVICE ACCEPT	
6	MS -> SS	SETUP	
7	SS -> MS	CALL PROCEEDING	
8	SS -> MS	ASSIGNMENT COMMAND	to a supported channel type
9	MS -> SS	ASSIGNMENT COMPLETE	
10	SS -> MS	ALERTING	
11	SS -> MS	CONNECT	As default message except contains Facility IE with contents as indicated in i below
			Either A or B branch is taken
A12	MS -> SS	CONNECT ACKNOWLEDGE	
A13	MS -> SS	FACILITY	As default message except contains Facility IE with contents as indicated in ii below
B12	MS -> SS	FACILITY	As default message except contains Facility IE with contents as indicated in ii below
B13	MS -> SS	CONNECT ACKNOWLEDGE	
14			SS cell switched off y seconds after CAI information sent by SS Failure of radio path, end of call (CEND) occurs and MS stops charging (ref. GSM 02.24 sec 2)
15			SIM contents checked (either via MMI or by removing the SIM and using SIM reader). ACM shall have been incremented correctly.

NOTE: The value of y is given below.

The correct value of the ACM is found from the general AoC formula given in GSM 02.24 section 4 with CDUR = y seconds and e parameters as defined below.

Specific Message Contents:

- i) FACILITY Information Element with Invoke = ForwardChargeAdvice component type as defined in GSM 04.80 section 3.6.1 table 3.3.

For ASN.1 description see default message contents in section 31.6.4.

The cell being simulated by the SS is switched off after approximately $y=90$ seconds.

The values of the e-parameters within the parameter part of the Facility Information Element shall be set to:

k-value	e-parameter							CCM total at call end increased by	Step 0 ACM value
	1	2	3	4	5	6	7		
	10	55	1	10	0	0	10	30	30

Values shown in table are in the format and have units as in GSM 02.24 section 3.

- ii) FACILITY Information Element with Return Result component type as defined in GSM 04.80 section 3.6.1 table 3.4.

For ASN.1 description see default message contents in section 31.6.4.

31.6.2.4 ACMmax operation / Mobile Originating

Purpose:

- 1) To verify that when the value stored in the ACM becomes equal to or exceeds its maximum value, the ACMmax, any outgoing calls in progress for which a non-zero CAI exists are terminated by the ME, with cause value #68 once the chargeable interval determined by the CAI has elapsed, with an appropriate indication given to the user.
- 2) To verify that when the value stored in the ACM becomes equal to or exceeds its maximum limit, the ACMmax, the making of non-emergency calls is inhibited.
- 3) To verify that when the value stored in the ACM becomes equal to or exceeds its maximum limit, the ACMmax, the making of emergency calls is uninhibited.

Conformance Requirement(s):

- 1) When the value stored in the ACM becomes equal to or exceeds its maximum value, the ACMmax, any outgoing calls in progress for which a non-zero CAI exists shall be terminated by the ME with cause value #68, once the chargeable interval determined by the CAI has elapsed, with an appropriate indication given to the user.
- 2) When the value stored in the ACM becomes equal to or exceeds its maximum limit, the ACMmax, the making of further non-emergency calls shall be inhibited.
- 3) When the value stored in the ACM becomes equal to or exceeds its maximum limit, the ACMmax, the making of emergency calls shall be uninhibited.

Reference(s):

Conformance requirement 1: GSM 02:24, GSM 04.86 section 2.3.

Conformance requirement 2: GSM 02.24.

Conformance requirement 3: GSM 02.24.

Related PICS/PIXIT Statement(s):

- Support of AoCC.
- Supported rates (full rate/half rate).

- Method of reading ACM from the SIM via the ME.
- Type of user indication when ACMmax exceeded.
- Supported teleservices.
- Support for active state of the call control protocol (U10).

Initial Conditions:**System Simulator:**

1 cell, default parameters, IMSI attach/detach disabled.

Mobile Station:

The MS is in MM-state "idle, updated".

PIN 2 is entered into the MS allowing modification of both the ACM and ACMmax fields on the SIM. The ACM is reset to zero and the ACMmax is set to 2 units.

Foreseen Final State of the MS:

The MS is in MM-state "idle, updated".

Method of Test:

The MS is made to initiate a call. The call is established with certain AoCC non-zero e-parameters sent in a Facility IE in the CONNECT message. It is an implementation option whether the AoCC acknowledge is sent before or after the CONNECT ACKNOWLEDGE.

After the ACM has been incremented to 2 units (60 s) the call shall be terminated by the MS once an additional chargeable interval of 30s has elapsed, and an indication given to the user. The call duration is recorded and the ACM is checked to ensure it has been incremented to 2 units.

The MS is then made to attempt to originate an ordinary call to the MS for which a non-zero CAI exists for the calling party and shall be unsuccessful. The MS shall not send a CHANNEL REQUEST for that call.

The MS is then made to attempt to originate an emergency call and shall be successful.

Maximum Duration of Test:

10 minutes.

Expected Sequence:

Step	Direction	Message	Comments
0			At start of test only, read and note value of ACM on SIM (it shall be zero)
A1 A2 A3 A4 A5 A6 A7 A8 A9 A10 A11	MS MS -> SS SS -> MS MS -> SS SS -> MS MS -> SS SS -> MS SS -> MS MS -> SS SS -> MS SS -> MS	CHANNEL REQUEST IMMEDIATE ASSIGNMENT CM SERVICE REQUEST CM SERVICE ACCEPT SETUP CALL PROCEEDING ASSIGNMENT COMMAND ASSIGNMENT COMPLETE ALERTING CONNECT	For k= 1 The MS is made to initiate an ordinary call to a supported channel type As default message except contains Facility IE with contents as indicated in l below
B1 B2 B3 B4 B5 B6 B7 B8 B9 B10 B11	MS MS -> SS SS -> MS MS -> SS SS -> MS MS -> SS SS -> MS SS -> MS MS -> SS SS -> MS SS -> MS	CHANNEL REQUEST IMMEDIATE ASSIGNMENT CM SERVICE REQUEST CM SERVICE ACCEPT EMERGENCY SETUP CALL PROCEEDING ASSIGNMENT COMMAND ASSIGNMENT COMPLETE ALERTING CONNECT	For k = 3 The MS is made to initiate an emergency call Establishment cause is emergency call establishment CM service type IE indicates "emergency call establishment" to a supported channel type As default message except contains Facility IE with contents as indicated in i below For k=1 or 3 either branch C or D is taken
C12 C13	MS -> SS MS -> SS	CONNECT ACKNOWLEDGE FACILITY	As default message except contains Facility IE with contents as indicated in ii below
D12 D13	MS -> SS MS -> SS	FACILITY CONNECT ACKNOWLEDGE	As default message except contains Facility IE with contents as indicated in ii below
L14 L15 L16 L17 L18 L19	MS -> SS SS -> MS MS -> SS SS -> MS	DISCONNECT RELEASE RELEASE COMPLETE CHANNEL RELEASE	For k=1 Record call duration, x seconds, after CAI information sent by SS until call is terminated by the ME Cause value #68 The main signalling link is released. ACM checked (shall be 2 units)
M14 M15 M16 M17 M18 M19	MS -> SS SS -> MS MS -> SS SS -> MS	DISCONNECT RELEASE RELEASE COMPLETE CHANNEL RELEASE	For k=3 Call duration y seconds after CAI information sent by SS The main signalling link is released. ACM checked (shall be 2 units)

k=1 - Non zero CAI call attempted by MS and should succeed.

k=2 - Non zero CAI call attempted by MS and should fail.

k=3 - Emergency call attempted by MS and should succeed.

NOTE: The values of x and y are given below.

The correct value of the ACM is found from the general AoC formula given in GSM 02.24 section 4 with CDUR = x,y seconds and e parameters as defined below.

Specific Message Contents:

- i) FACILITY Information Element with Invoke = ForwardChargeAdvice component type as defined in GSM 04.80 section 3.6.1 table 3.3.

For ASN.1 description see default message contents in section 31.6.4.

x shall be 90 ± 2 seconds.

y shall be set to 120 seconds.

The values of the e-parameters within the parameter part of the Facility Information Element shall be set to:

k-value	e-parameter							CCM total at call end increased by	Step 0 ACM value
	1	2	3	4	5	6	7		
1	1	30	1	0	0	0	0	2	2
2	1	30	1	0	0	0	0	0	2
3	0	0	0	0	0	0	0	0	2

Values shown in table are in the format and have units as in GSM 02.24 section 3.

- ii) FACILITY Information Element with Return Result component type as defined in GSM 04.80 section 3.6.1 table 3.4.

For ASN.1 description see default message contents in section 31.6.4.

31.6.2.5 ACMmax operation / Mobile Terminating

Purpose:

- 1) To verify that when the value stored in the ACM becomes equal to or exceeds its maximum value, the ACMmax, any mobile terminating calls in progress for which a non-zero CAI exists are terminated by the ME with cause value #68, once the chargeable interval determined by the CAI has elapsed, with an appropriate indication given to the user.
- 2) To verify that when the value stored in the ACM becomes equal to or exceeds its maximum value, the ACMmax, and an incoming call is received for which subsequently a non-zero CAI is received, then the call is terminated by the ME using cause value #68 with an appropriate indication given to the user.
- 3) To verify that when the value stored in the ACM becomes equal to or exceeds its maximum limit, the ACMmax, the receiving of calls for which the CAI is zero is uninhibited.

Conformance Requirement(s):

- 1) When the value stored in the ACM becomes equal to or exceeds its maximum value, the ACMmax, any mobile terminating calls in progress for which a non-zero CAI exists shall be terminated by the ME with cause value #68, once the chargeable interval determined by the CAI has elapsed, with an appropriate indication given to the user.
- 2) When the value stored in the ACM becomes equal to or exceeds its maximum value, the ACMmax, and an incoming call is received for which subsequently a non-zero CAI is received, the call shall be terminated by the ME using cause value #68 with an appropriate indication given to the user.
- 3) When the value stored in the ACM becomes equal to or exceeds its maximum limit, the ACMmax, the receiving of calls for which the CAI is zero shall be uninhibited.

Reference(s):

Conformance requirement 1: GSM 02:24, GSM 04.86 section 2.3.

Conformance requirement 2: GSM 02.24, GSM 04.86 section 2.3.

Conformance requirement 2: GSM 02.24.

Related PICS/PIXIT Statement(s):

- Support of AoCC.
- Supported rates (full rate/half rate).
- Method of reading ACM from the SIM via the ME.
- Type of user indication when ACMmax exceeded.
- Supported teleservices.
- Support for active state of the call control protocol (U10).

Initial Conditions:

System Simulator:

1 cell, default parameters, IMSI attach/detach disabled.

Mobile Station:

The MS is in MM-state "idle, updated".

PIN 2 is entered into the MS allowing modification of both the ACM and ACMmax fields on the SIM. The ACM is reset to zero and the ACMmax is set to 2 units.

Foreseen Final State of the MS:

The MS is in MM-state "idle, updated".

Method of Test:

The SS is made to initiate a call. The call is established with certain non-zero AoCC e-parameters sent in a Facility IE contained in a FACILITY message sent before the CONNECT message. It is an implementation option whether the AoCC e-parameters and AoCC acknowledge are sent before or after the CONNECT ACKNOWLEDGE.

After the ACM has been incremented to 2 units (60s) the call shall be terminated by the MS once an additional chargeable interval of 30s has elapsed and an indication given to the user. The ACM shall be checked to ensure that it has been incremented to 2 units.

The SS is then made to attempt to make an ordinary call to the MS for which a non-zero CAI exists for the called party and shall be unsuccessful. The MS shall terminate the call with a DISCONNECT message.

The SS is then made to attempt to make an ordinary call to the MS for which a zero CAI exists for the called party and shall be successful.

Maximum Duration of Test:

10 minutes.

Expected Sequence:

The sequence step 1-20 is executed for execution counter $k = 1, \dots, 3..$

Step	Direction	Message	Comments
0			At start of test only, read and note value of ACM on SIM
1	SS		The SS is made to initiate a call
2	SS -> MS	PAGING REQUEST	
3	MS -> SS	CHANNEL REQUEST	
4	SS -> MS	IMMEDIATE ASSIGNMENT	
5	MS -> SS	PAGING RESPONSE	
6	SS -> MS	SETUP	
7	MS -> SS	CALL CONFIRMED	
8	SS -> MS	ASSIGNMENT COMMAND	to a supported channel type
9	MS -> SS	ASSIGNMENT COMPLETE	
10	MS -> SS	ALERTING	
11	MS -> SS	CONNECT	
12	SS -> MS	CONNECT ACKNOWLEDGE	
			For $k=1$ or 3 branch A is taken
A13	SS -> MS	FACILITY	As default message except contains Facility IE with contents as indicated in i below
A14	MS -> SS	FACILITY	As default message except contains Facility IE with contents as indicated in ii below
			For $k=2$ branch B, and then either branch C, D or E is taken
B13	SS -> MS	FACILITY	As default message except contains Facility IE with contents as indicated in i below
C13	MS -> SS	FACILITY	As default message except contains Facility IE with contents as indicated in ii below
C14	MS -> SS	DISCONNECT	MS terminates call with cause value #68
D13	MS -> SS	DISCONNECT	MS terminates call with cause value #68
D14	MS -> SS	FACILITY	As default message except contains Facility IE with contents as indicated in ii below
E13	MS -> SS	DISCONNECT	MS terminates call with cause value #68. DISCONNECT may or may not contain Facility IE with contents as indicated in ii below
			For $k= 1, 2$ and 3, F, G and branch shall be taken respectively
F15			For $k=1$ Record call duration, x seconds, after CAI information sent by SS until call is terminated by the ME MS terminates call with cause value #68
F16	MS -> SS	DISCONNECT	
F17	SS -> MS	RELEASE	
F18	MS -> SS	RELEASE COMPLETE	
F19	SS -> MS	CHANNEL RELEASE	The main signalling link is released.
			For $k=2$
G15	SS -> MS	RELEASE	
G16	MS -> SS	RELEASE COMPLETE	RELEASE COMPLETE may or may not contain Facility IE with contents as indicated in ii below
G17	SS -> MS	CHANNEL RELEASE	The main signalling link is released.
			For $k=3$
H15			Call duration y seconds after CAI information sent by SS
H16	MS -> SS	DISCONNECT	MS terminates call
H17	SS -> MS	RELEASE	
H18	MS -> SS	RELEASE COMPLETE	
H19	SS -> MS	CHANNEL RELEASE	The main signalling link is released.
20			ACM checked (should be 2 units)

$k=1$ - Non zero CAI call attempted to MS and should succeed.

$k=2$ - Non zero CAI call attempted to MS and should fail.

$k=3$ - Zero CAI call attempted to MS and should succeed.

NOTE: The values of x and y are given below.

The correct value of the ACM is found from the general AoC formula given in GSM 02.24 section 4 with $CDUR = x, y$ seconds and e parameters as defined below.

Specific Message Contents:

- i) FACILITY Information Element with Invoke = ForwardChargeAdvice component type as defined in GSM 04.80 section 3.6.1 table 3.3.

For ASN.1 description see default message contents in section 31.6.4.

x shall be 90 ± 2 seconds.

y shall be set to 120 seconds.

The values of the e-parameters within the parameter part of the Facility Information Element shall be set to:

k-value	e-parameter							CCM total at call end increased by	Step 0 ACM value
	1	2	3	4	5	6	7		
1	1	30	1	0	0	0	0	2	2
2	1	30	1	0	0	0	0	0	2
3	0	0	0	0	0	0	0	0	2

Values shown in table are in the format and have units as in GSM 02.24 section 3.

- ii) FACILITY Information Element with Return Result component type as defined in GSM 04.80 section 3.6.1 table 3.4.

For ASN.1 description see default message contents in section 31.6.4.

31.6.3 Advice of Charge Information

31.6.3.1 AoCI time related charging / MS originated call

Purpose:

- 1) To verify that when the MS receives the AoCI parameters in a Facility IE which is contained in the CONNECT message and when a TCH has already been assigned, the MS returns a FACILITY message containing the acknowledgement within 1 second.
- 2) To verify that when the call has no volume related component the MS ignores non-zero AoCI e5, e6 parameters sent to it.

Conformance Requirement(s):

- 1) When the MS receives the AoCI parameters in a Facility IE which is contained in a CONNECT message and when a TCH has already been assigned, the MS shall return a FACILITY message containing the acknowledgement within 1 second.
- 2) When the call has no volume related component the MS shall ignore non-zero AoC e5 and e6 parameters sent to it.

Reference(s):

Conformance requirement 1: GSM 03.86, GSM 04.13, GSM 04.86.

Conformance requirement 2: GSM 02.24.

Related PICS/PIXIT Statement(s):

- Support of AoCI.

- Supported rates (full rate/half rate).
- Supported teleservices.
- Support for active state of the call control protocol (U10).
- MMI method of reading the AoCI information

Initial Conditions:**System Simulator:**

1 cell, default parameters, IMSI attach/detach disabled.

Mobile Station:

The MS is in MM-state "idle, updated".

Foreseen Final State of the MS:

The MS is in MM-state "idle, updated".

Method of Test:

The MS is made to initiate a call. The call is established with certain AoCI e-parameters sent in a Facility IE in the CONNECT message. The MS shall return the AoCI acknowledgement within 1 second of the CONNECT message. It is an implementation option whether the AoCI acknowledge is sent by the MS before or after the CONNECT ACKNOWLEDGE.

The SS sends the DISCONNECT y seconds after sending the CONNECT message containing the CAI. The test is repeated for several different sets of e-parameters as defined below.

Maximum Duration of Test:

30 minutes.

Expected Sequence:

The sequence step 1-20 is executed for execution counter k = 1,...,5.

Step	Direction	Message	Comments
1	MS		The MS is made to initiate a call to a supported channel type As default message except contains Facility IE with contents as indicated in i below Either A or B branch is taken
2	MS -> SS	CHANNEL REQUEST	
3	SS -> MS	IMMEDIATE ASSIGNMENT	
4	MS -> SS	CM SERVICE REQUEST	
5	SS -> MS	CM SERVICE ACCEPT	
6	MS -> SS	SETUP	
7	SS -> MS	CALL PROCEEDING	
8	SS -> MS	ASSIGNMENT COMMAND	
9	MS -> SS	ASSIGNMENT COMPLETE	
10	SS -> MS	ALERTING	
11	SS -> MS	CONNECT	
A12	MS -> SS	CONNECT ACKNOWLEDGE	As default message except contains Facility IE with contents as indicated in ii below
A13	MS -> SS	FACILITY	
B12	MS -> SS	FACILITY	As default message except contains Facility IE with contents as indicated in ii below
B13	MS -> SS	CONNECT ACKNOWLEDGE	
14			call duration y seconds after CAI information sent by SS The main signalling link is released. MS display is checked to determine whether the correct call charge has been indicated
15	SS -> MS	DISCONNECT	
16	MS -> SS	RELEASE	
17	SS -> MS	RELEASE COMPLETE	
18	SS -> MS	CHANNEL RELEASE	
19	MS		

NOTE: The value of y is given below.

The correct value of the ACM is found from the general AoC formula given in GSM 02.24 section 4 with CDUR = y seconds and e parameters as defined below.

Specific Message Contents:

i) FACILITY Information Element with Invoke = ForwardChargeAdvice component type as defined in GSM 04.80 section 3.6.1 table 3.3.

For ASN.1 description see default message contents in section 31.6.4.

y is set to a constant value of 90 seconds.

The values of the e-parameters within the parameter part of the Facility Information Element shall be set as below:

k-value	e-parameter								CCM total	Step 0 ACM at call end	value increased by
	1	2	3	4	5	6	7	8			
1	6	14	1	25	0	0	60		43	43	
2	0	0	1	100	0	0	0		100	143	
3	250	16	2	500	0	0	60		2000	2143	
4	1	1	1	0	10	10	1		89 or 90	2232 or 2233	
5	12,5	30	1	25	10	10	30		50 or 62,5	2295, 2296, 2282 or 2283	

Values shown in table are in the format and have units as in GSM 02.24 section 3.

The ASN.1 description for each e-parameter allows integers in the range 0 to 8191 to be transmitted but some e-parameters have different actual ranges (e.g. e1 can take any value 0..819,1 with 0,1 resolution). The MS knows how to interpret the received parameter (e.g. received e1 refers to 10 times actual e1, see GSM 04.80 section 4.4.3). Therefore e1=12,5 would be sent to the MS as 125. The MS knows the value sent is 10 times the "real" e1 and hence interprets the value as 12,5.

The non-zero e5 and e6 values for the k=4 and k=5 execution of the test are to check that the MS ignores the volume related parameters when carrying out time only related charging.

ii) FACILITY Information Element with Return Result component type as defined in GSM 04.80 section 3.6.1 table 3.4.

For ASN.1 description see default message contents in section 31.6.4.

31.6.3.2 AoCI time related charging / MS terminated call

Purpose:

- 1) To verify that when the MS receives certain AoCI e-parameters in a Facility IE which is contained in a FACILITY message sent after the CONNECT message and when a TCH has already been assigned, the MS returns a FACILITY message containing the acknowledgement within 1 second.

Conformance Requirement(s):

- 1) When the MS receives the AoCI parameters in a Facility IE which is contained in a FACILITY message sent after the CONNECT message and when a TCH has already been assigned, the MS shall return a Facility message containing the acknowledgement within 1 second.

Reference(s):

Conformance requirement 1: GSM 03.86, GSM 04.13, GSM 04.86.

Conformance requirement 2: GSM 02.24.

Related PICS/PIXIT Statement(s):

- Support of AoCI.
- Supported rates (full rate/half rate).
- Supported teleservices.
- Support for active state of the call control protocol (U10).
- MMI method of reading the AoCI information

Initial Conditions:

System Simulator:

1 cell, default parameters, IMSI attach/detach disabled.

Mobile Station:

The MS is in MM-state "idle, updated".

Foreseen Final State of the MS:

The MS is in MM-state "idle, updated".

Method of Test:

The SS is made to initiate a call. The call is established and certain AoCI e-parameters are sent to the MS in a Facility IE contained within a FACILITY message. The MS shall return the AoCI acknowledgement within 1 second of the FACILITY message. It is an implementation option whether the AoCI e-parameters and the AoCI acknowledge are sent before or after the CONNECT ACKNOWLEDGE.

The SS sends the DISCONNECT y seconds after sending the FACILITY message. The test is repeated for several different sets of e-parameters as defined below.

Maximum Duration of Test:

30 minutes.

Expected Sequence:

The sequence step 1-20 is executed for execution counter $k = 1, \dots, 5$.

Step	Direction	Message	Comments
0			At start of test only, read and note value of ACM on SIM
1	SS		The SS is made to initiate a call
2	SS -> MS	PAGING REQUEST	
3	MS -> SS	CHANNEL REQUEST	
4	SS -> MS	IMMEDIATE ASSIGNMENT	
5	MS -> SS	PAGING RESPONSE	
6	SS -> MS	SETUP	
7	MS -> SS	CALL CONFIRMED	
8	SS -> MS	ASSIGNMENT COMMAND	to a supported channel type
9	MS -> SS	ASSIGNMENT COMPLETE	
10	MS -> SS	ALERTING	
11	MS -> SS	CONNECT	
12	SS -> MS	FACILITY	As default message except contains Facility IE with contents as indicated in i below
			Either A or B branch is taken
A13	SS -> MS	CONNECT ACKNOWLEDGE	
A14	MS -> SS	FACILITY	As default message except contains Facility IE with contents as indicated in ii below
B13	MS -> SS	FACILITY	As default message except contains Facility IE with contents as indicated in ii below
B14	SS -> MS	CONNECT ACKNOWLEDGE	
15			call duration y seconds after CAI information sent by SS
16	SS -> MS	DISCONNECT	
17	MS -> SS	RELEASE	
18	SS -> MS	RELEASE COMPLETE	
19	SS -> MS	CHANNEL RELEASE	The main signalling link is released.
20	MS		MS display is checked to determine whether the correct call charge has been indicated

NOTE: The value of y is given below.

The correct value of the ACM is found from the general AoC formula given in GSM 02.24 section 4 with $CDUR = y$ seconds and e parameters as defined below.

Specific Message Contents:

- i) FACILITY Information Element with Invoke = ForwardChargeAdvice component type as defined in GSM 04.80 section 3.6.1 table 3.3.

For ASN.1 description see default message contents in section 31.6.4.

y is set to a constant value of 90 seconds.

The values of the e-parameters within the parameter part of the Facility Information Element shall be set as below:

k-value	e-parameter							CCM total at call end increased by	Step 0 ACM value
	1	2	3	4	5	6	7		
1	0	0	0	0	0	0	0	0	0
2	0	0	1	100	0	0	0	100	100
3	6	14	1	25	0	0	60	43	143
4	1	1	1	0	0	0	1	89 or 90	233 or 232
5	12,5	30	1	25	0	0	30	50 or 62,5	296, 295, 282 or 283

Values shown in table are in the format and have units as in GSM 02.24 section 3.

ii) FACILITY Information Element with Return Result component type as defined in GSM 04.80 section 3.6.1 table 3.4.

For ASN.1 description see default message contents in section 31.6.4.

31.6.3.3 AoCI volume related charging / MS originated call

Future addition at GSM Phase 2+ stage.

31.6.3.4 AoCI volume related charging / MS terminated call

Future addition at GSM Phase 2+ stage.

31.6.3.5 Change in charging information during a call

Purpose:

- 1) To verify that when the MS receives new AoCI parameters mid-way through a call in a Facility IE which is contained within a FACILITY message the MS returns a FACILITY message containing the acknowledgement within 1 second.
- 2) To verify that when the MS receives new charging information mid-way through a call in the form of a Facility IE contained within a FACILITY message the MS correctly indicates the total charge considering both sets of charging information.

Conformance Requirement(s):

- 1) When the MS receives new AoCI parameters mid-way through a call in a Facility IE which is contained within a FACILITY message the MS shall return a FACILITY message containing the acknowledgement within 1 second.
- 2) When the MS receives new charging information mid-way through a call in the form of a Facility IE contained within a FACILITY message the MS correctly indicates the total charge considering both sets of charging information.

Reference(s):

Conformance requirement 1: GSM 03.86, GSM 04.13, GSM 04.86.

Conformance requirement 2: GSM 02.24.

Related PICS/PIXIT Statement(s):

- Support of AoCI.
- Supported rates (full rate/half rate).
- Supported teleservices.

- Support for active state of the call control protocol (U10).
- MMI method of reading the AoCI information

Initial Conditions:**System Simulator:**

1 cell, default parameters, IMSI attach/detach disabled.

Mobile Station:

The MS is in MM-state "idle, updated".

Foreseen Final State of the MS:

The MS is in MM-state "idle, updated".

Method of Test:

The MS is made to initiate a call. The call is established with certain AoCI e-parameters sent in a Facility IE in a FACILITY message sent after the CONNECT message. The MS shall return the AoCI acknowledgement within 1 second of the FACILITY message. x seconds after sending the original CAI, new (and different) e-parameters are sent to the MS in a Facility IE contained within a FACILITY message. The MS shall return the AoCI acknowledge within 1 second of the FACILITY message.

The SS sends the DISCONNECT y seconds after sending the first CAI in the FACILITY message.

Maximum Duration of Test:

10 minutes.

Expected Sequence:

Step	Direction	Message	Comments
0			At start of test only, read and note value of ACM on SIM
1	MS		The MS is made to initiate a call
2	MS -> SS	CHANNEL REQUEST	
3	SS -> MS	IMMEDIATE ASSIGNMENT	
4	MS -> SS	CM SERVICE REQUEST	
5	SS -> MS	CM SERVICE ACCEPT	
6	MS -> SS	SETUP	
7	SS -> MS	CALL PROCEEDING	
8	SS -> MS	ASSIGNMENT COMMAND	to a supported channel type
9	MS -> SS	ASSIGNMENT COMPLETE	
10	SS -> MS	ALERTING	
11	SS -> MS	CONNECT	
			Either A, B or C branch is taken
A12	SS -> MS	FACILITY	As default message except contains Facility IE with contents as indicated in i below
A13	MS -> SS	CONNECT ACKNOWLEDGE	
A14	MS -> SS	FACILITY	As default message except contains Facility IE with contents as indicated in ii below
B12	MS -> SS	CONNECT ACKNOWLEDGE	
B13	SS -> MS	FACILITY	As default message except contains Facility IE with contents as indicated in i below
B14	MS -> SS	FACILITY	As default message except contains Facility IE with contents as indicated in ii below
C12	SS -> MS	FACILITY	As default message except contains Facility IE with contents as indicated in i below
C13	MS -> SS	FACILITY	As default message except contains Facility IE with contents as indicated in ii below
C14	MS-> SS	CONNECT ACKNOWLEDGE	
15	SS -> MS	FACILITY	Second CAI sent x sec after first CAI
16	MS -> SS	FACILITY	As default message except contains Facility IE with contents as indicated in iii below
17			As default message except contains Facility IE with contents as indicated in ii below New CAI held in abeyance until CDUR has timed out present e2 value Call duration y seconds after first CAI information sent by SS
18	SS -> MS	DISCONNECT	
19	MS -> SS	RELEASE	
20	SS -> MS	RELEASE COMPLETE	
21	SS -> MS	CHANNEL RELEASE	The main signalling link is released.
22	MS		MS display is checked to determine whether the correct call charge has been indicated

NOTE The values of x and y are given below.

The correct value of the ACM is found from the general AoC formula given in GSM 02.24 section 4 with CDUR = x, y seconds and e parameters as defined below.

Specific Message Contents:

- i) FACILITY Information Element with Invoke = ForwardChargeAdvice component type as defined in GSM 04.80 section 3.6.1 table 3.3.

For ASN.1 description see default message contents in section 31.6.4.

The values of the e-parameters within the parameter part of the Facility Information Element shall be set as defined below:

	e-parameter							CCM total at call end increased by	Step 0 ACM value
	1	2	3	4	5	6	7		
	10	28	1	10	0	0	60	(30)	(30)

Values shown in table are in the format and have units as in GSM 02.24 section 3.

- ii) FACILITY Information Element with Return Result component type as defined in GSM 04.80 section 3.6.1 table 3.4.

For ASN.1 description see default message contents in section 31.6.4.

- iii) FACILITY Information Element with Invoke = ForwardChargeAdvice component type as defined in GSM 04.80 section 3.6.1 table 3.3.

For ASN.1 description see default message contents in section 31.6.4.

x is set to a constant value of 80 seconds.

y is set to a constant value of 180 seconds.

The values of the e-parameters within the parameter part of the Facility Information Element shall be set to:

	e-parameter							CCM total at call end increased by	Step 0 ACM value
	1	2	3	4	5	6	7		
	10	14	1	5	0	0	60	65	65

Values shown in table are in the format and have units as in GSM 02.24 section 3.

31.6.3.6 Different formats of charging information

Purpose:

- 1) To verify that when the MS receives a Facility IE in which certain e-parameters are set to zero the total charge accumulated is the same as that when the same e-parameters are completely omitted from the Facility IE.
- 2) To verify the operation of a shortened channel release procedure where the SS does not send DISCONNECT but only the RELEASE COMPLETE and CHANNEL RELEASE messages or just the CHANNEL RELEASE message.

Conformance Requirement(s):

- 1) When the MS receives a Facility IE in which certain e-parameters are set to zero the total charge accumulated shall be the same as that when the same e-parameters are completely omitted from the Facility IE.
- 2) The channel shall be correctly released when a shortened channel release procedure is used - the SS does not send DISCONNECT but only the RELEASE COMPLETE and CHANNEL RELEASE messages or just the CHANNEL RELEASE message.

Reference(s):

Conformance requirement 1: GSM 02.24.

Conformance requirement 2: GSM 04.08.

Related PICS/PIXIT Statement(s):

- Support of AoCI.
- Supported rates (full rate/half rate).
- Supported teleservices.
- Support for active state of the call control protocol (U10).
- MMI method of reading the AoCI information

Initial Conditions:

System Simulator:

1 cell, default parameters, IMSI attach/detach disabled.

Mobile Station:

The MS is in MM-state "idle, updated".

Foreseen Final State of the MS:

The MS is in MM-state "idle, updated".

Method of Test:

Part 1:

The MS is made to initiate a call. The call is established with certain AoCI e-parameters sent in a Facility IE in a FACILITY message sent before the CONNECT message.

The SS sends the DISCONNECT y seconds after sending the FACILITY message containing the e-parameters. The MS shall have stored the correct amount on the SIM according to the e-parameters sent.

Part 2:

Part 1 is repeated twice with the e-parameters that were set to zero above now omitted completely from the Facility IE. The shortened release procedures are used. The MS shall have stored the correct amount on the SIM.

The results of parts 1 and 2 are compared. The value for the charge calculated by the MS shall be identical for parts 1 and 2.

Maximum Duration of Test:

20 minutes.

Expected Sequence:

The sequence step 1-20 is executed for execution counter $k = 1, \dots, 3$.

Step	Direction	Message	Comments
0			At start of test only, read and note value of ACM on SIM
1	MS		The MS is made to initiate a call
2	MS -> SS	CHANNEL REQUEST	
3	SS -> MS	IMMEDIATE ASSIGNMENT	
4	MS -> SS	CM SERVICE REQUEST	
5	SS -> MS	CM SERVICE ACCEPT	
6	MS -> SS	SETUP	
7	SS -> MS	CALL PROCEEDING	
8	SS -> MS	ASSIGNMENT COMMAND	to a supported channel type
9	MS -> SS	ASSIGNMENT COMPLETE	
10	SS -> MS	ALERTING	
11	SS -> MS	FACILITY	As default message except contains Facility IE with contents as indicated in i below
			Either A, B or C branch is taken
A12	SS -> MS	CONNECT	
A13	MS -> SS	CONNECT ACKNOWLEDGE	
A14	MS -> SS	FACILITY	As default message except contains Facility IE with contents as indicated in ii below
B12	SS -> MS	CONNECT	
B13	MS -> SS	FACILITY	As default message except contains Facility IE with contents as indicated in ii below
B14	MS -> SS	CONNECT ACKNOWLEDGE	
C12	MS -> SS	FACILITY	As default message except contains Facility IE with contents as indicated in ii below
C13	SS -> MS	CONNECT	
C14	MS -> SS	CONNECT ACKNOWLEDGE	
15			call duration y seconds after CAI information sent by SS
			Branch D, E and F shall be taken for $k = 1, 2$ and 3 respectively
D16	SS -> MS	DISCONNECT	
D17	MS -> SS	RELEASE	
D18	SS -> MS	RELEASE COMPLETE	
D19	SS -> MS	CHANNEL RELEASE	The main signalling link is released.
E16	SS -> MS	RELEASE COMPLETE	Shortened channel release procedure
E17	SS -> MS	CHANNEL RELEASE	The main signalling link is released.
F16	SS -> MS	CHANNEL RELEASE	
20	MS		MS display is checked to determine whether the correct call charge has been indicated

NOTE The value of y is given below.

The correct value of the ACM is found from the general AoC formula given in GSM 02.24 section 4 with $CDUR = y$ seconds and e parameters as defined below.

Specific Message Contents:

i) FACILITY Information Element with Invoke = ForwardChargeAdvice component type as defined in GSM 04.80 section 3.6.1 table 3.3.

For ASN.1 description see default message contents in section 31.6.4.

y is set to a constant value of 90 seconds.

The values of the e -parameters within the parameter part of the Facility Information Element shall be set to:

k-value	e-parameter							CCM total at call end increased by	Step 0 ACM value
	1	2	3	4	5	6	7		
1	10	40	1	0	0	0	0	20	20
2	10	40	1	-----omitted-----				20	40
3	10	40	1	-----omitted-----				20	60

Values shown in table are in the format and have units as in GSM 02.24 section 3.

ii) FACILITY Information Element with Return Result component type as defined in GSM 04.80 section 3.6.1 table 3.4.

For ASN.1 description see default message contents in section 31.6.4.

31.6.3.7 AoCI on a Call Hold call

Purpose:

- 1) To verify that when the MS invokes a Call Hold call and hence receives Facility IEs containing AoCI e-parameters for each chargeable call the MS returns a FACILITY message containing the AoCI acknowledgement within 1 second of transmission of each set of e-parameters.

Conformance Requirement(s):

- 1) When the MS invokes a Call Hold call and hence receives Facility IEs containing AoCI e-parameters for each chargeable call the MS shall return a FACILITY message containing the AoCI acknowledgement within 1 second of receiving each set of e-parameters.

Reference(s):

Conformance requirement 1: GSM 04.13.

Conformance requirement 2: GSM 02.24, GSM 04.83, GSM 04.84, GSM 04.86.

Related PICS/PIXIT Statement(s):

- Support of AoCI.
- Supported rates (full rate/half rate).
- Supported teleservices.
- Support for active state of the call control protocol (U10).
- MMI method of reading the AoCI information

Initial Conditions:

System Simulator:

1 cell, default parameters, IMSI attach/detach disabled.

Mobile Station:

The MS is in MM-state "idle, updated".

Foreseen Final State of the MS:

The MS is in MM-state "idle, updated".

Method of Test:

The MS is made to initiate a call. The call is established with certain AoCI e-parameters sent in a Facility IE in the CONNECT message. The MS shall return the AoCI acknowledgement within 1 second of transmission of the CONNECT message.

The call (call B) is then put on hold by sending a HOLD message from the MS to the SS. The SS shall reply with a HOLD ACKNOWLEDGE. The traffic channel is now available to originate another call.

The MS is made to initiate a second call (call C). The call is established with certain AoCI e-parameters sent in a Facility IE in the CONNECT message. The MS shall return the AoCI acknowledgement in a FACILITY message within 1 second of transmission of the CONNECT message.

The SS sends the DISCONNECT to the MS for call B x seconds after sending the call B CAI in the CONNECT/FACILITY message and the DISCONNECT for call C y seconds after sending the call C CAI in the CONNECT/FACILITY message.

Maximum Duration of Test:

10 minutes.

Expected Sequence:

Step	Direction	Message	Comments
1	MS		The MS is made to initiate a call
2	MS -> SS	CHANNEL REQUEST	
3	SS -> MS	IMMEDIATE ASSIGNMENT	
4	MS -> SS	CM SERVICE REQUEST	
5	SS -> MS	CM SERVICE ACCEPT	
6	MS -> SS	SETUP	
7	SS -> MS	CALL PROCEEDING	
8	SS -> MS	ASSIGNMENT COMMAND	to a supported channel type
9	MS -> SS	ASSIGNMENT COMPLETE	
10	SS -> MS	ALERTING	
11	SS -> MS	CONNECT	As default message except contains Facility IE with contents as indicated in i below
			Either D or E branch is taken
D12	MS -> SS	CONNECT ACKNOWLEDGE	
D13	MS -> SS	FACILITY	As default message except contains Facility IE with contents as indicated in ii below
E12	MS -> SS	FACILITY	As default message except contains Facility IE with contents as indicated in ii below
E13	MS -> SS	CONNECT ACKNOWLEDGE	
14	MS		The MS is made to initiate a second call, and the first call is placed on hold. DTMF signalling may occur, when MMI keys are depressed
15	MS -> SS	HOLD	
16	SS -> MS	HOLD ACKNOWLEDGE	
17	MS -> SS	CM SERVICE REQUEST	
18	SS -> MS	CM SERVICE ACCEPT	
19	MS -> SS	SETUP	TI arbitrary but different from existing TI
20	SS -> MS	CALL PROCEEDING	
21	SS -> MS	ALERTING	
22	SS -> MS	CONNECT	As default message except contains Facility IE with contents as indicated in i below
			Either F or G branch is taken
F23	MS -> SS	CONNECT ACKNOWLEDGE	
F24	MS -> SS	FACILITY	As default message except contains Facility IE with contents as indicated in ii below
G23	MS -> SS	FACILITY	As default message except contains Facility IE with contents as indicated in ii below
G24	MS -> SS	CONNECT ACKNOWLEDGE	
25			Call durations x and y seconds after respective CAI information sent by SS
			Branch H and I branch are taken, the sequence depending on the durations x and y
H26	SS -> MS	DISCONNECT	For call C
H27	MS -> SS	RELEASE	y seconds after call C CAI sent
H28	SS -> MS	RELEASE COMPLETE	
I26	SS -> MS	DISCONNECT	For call B
I27	MS -> SS	RELEASE	x seconds after call B CAI sent
I28	SS -> MS	RELEASE COMPLETE	
29	SS -> MS	CHANNEL RELEASE	The main signalling link is released
30	MS		MS display is checked to determine whether the correct call charge has been indicated

NOTE The value of x and y are given below.

The correct value of the ACM is found from the general AoC formula given in GSM 02.24 section 4 with CDUR = x,y seconds and e parameters as defined below.

Specific Message Contents:

- i) FACILITY Information Element with Invoke = ForwardChargeAdvice component type as defined in GSM 04.80 section 3.6.1 table 3.3.

For ASN.1 description see default message contents in section 31.6.4.

x set to 180 s, y is set to 90 s.

The values of the e-parameters within the parameter part of the Facility Information Element shall be set to:

Call	e-parameter							CCM total at call end increased by	Step 0 ACM value
	1	2	3	4	5	6	7		
B(time x)	7	40	1	0	0	0	0		
C(time y)	13	40	1	0	0	0	0	54	54

Values shown in table are in the format and have units as in GSM 02.24 section 3.

- ii) FACILITY Information Element with Return Result component type as defined in GSM 04.80 section 3.6.1 table 3.4.

For ASN.1 description see default message contents in section 31.6.4.

31.6.3.8 AoCI on a Multi-party call

Purpose:

- 1) To verify that when the MS invokes a Multi-party call and hence receives Facility IEs containing AoCI e-parameters for each chargeable call the MS returns a FACILITY message containing the AoCI acknowledgement within 1 second of transmission of each set of e-parameters.
- 2) To verify that when the MS originates a Multi-party call and hence receives Facility IEs containing CAI elements for each chargeable call the CCM records the sum of all the charges for the services currently being used and hence the ME inserts the correct charge in the ACM field of the SIM.

Conformance Requirement(s):

- 1) When the MS invokes a Multi-party call and hence receives Facility IEs containing AoCI e-parameters for each chargeable call the MS shall return a FACILITY message containing the AoCI acknowledgement within 1 second of receiving each set of e-parameters.
- 2) When the MS originates a Multi-party call and hence receives Facility IEs containing CAI elements for each chargeable call the CCM shall record the sum of all the charges for the services currently being used and hence the ME shall insert the correct charge in the ACM field of the SIM.

Reference(s):

Conformance requirement 1: GSM 04.13.

Conformance requirement 2: GSM 02.24, GSM 04.83, GSM 04.84, GSM 04.86.

Related PICS/PIXIT Statement(s):

- Support of AoCI.
- Supported rates (full rate/half rate).
- MMI method of reading the AoCI information
- Supported teleservices.

- Support for active state of the call control protocol (U10).

Initial Conditions:

System Simulator:

1 cell, default parameters, IMSI attach/detach disabled.

Mobile Station:

The MS is in MM-state "idle, updated".

Foreseen Final State of the MS:

The MS is in MM-state "idle, updated".

Method of Test:

The MS is made to initiate a call. The call is established with certain AoCI e-parameters sent in a Facility IE in the CONNECT message. The MS shall return the AoCI acknowledgement within 1 second of transmission of the CONNECT message.

The call (call B) is then put on hold by sending a HOLD message from the MS to the SS. The SS shall reply with a HOLD ACKNOWLEDGE. The traffic channel is now available to originate another call.

The MS is made to initiate a second call (call C). The call is established with certain AoCI e-parameters sent in a Facility IE in the CONNECT message. The MS shall return the AoCI acknowledgement within 1 second of transmission of the CONNECT message.

The MS invokes the multi-party service by sending a FACILITY message to the SS containing the BuildEMPTY request.

The SS accepts the request and connects the MS with the other existing connections (active call C and held call B) and confirms with a FACILITY message.

The SS sends the DISCONNECT to the MS for call B x seconds after sending the call B CAI in the CONNECT message and the DISCONNECT for call C y seconds after sending the call C CAI in the CONNECT message. The MS shall have stored the correct amount on the SIM according to the two sets of e-parameters sent and call times x and y.

Maximum Duration of Test:

10 minutes.

Expected Sequence:

Step	Direction	Message	Comments
0			At start of test only, read and note value of ACM on SIM
1	MS		The MS is made to initiate a call
2	MS -> SS	CHANNEL REQUEST	
3	SS -> MS	IMMEDIATE ASSIGNMENT	
4	MS -> SS	CM SERVICE REQUEST	
5	SS -> MS	CM SERVICE ACCEPT	
6	MS -> SS	SETUP	
7	SS -> MS	CALL PROCEEDING	
8	SS -> MS	ASSIGNMENT COMMAND	to a supported channel type
9	MS -> SS	ASSIGNMENT COMPLETE	
10	SS -> MS	ALERTING	
11	SS -> MS	CONNECT	As default message except contains Facility IE with contents as indicated in i below
			Either D or E branch is taken
D12	MS -> SS	CONNECT ACKNOWLEDGE	
D13	MS -> SS	FACILITY	As default message except contains Facility IE with contents as indicated in ii below
E12	MS -> SS	FACILITY	As default message except contains Facility IE with contents as indicated in ii below
E13	MS -> SS	CONNECT ACKNOWLEDGE	

Step	Direction	Message	Comments
14	MS -> SS	HOLD	The MS is made to initiate a second call and the first call (call B) is placed on hold. DTMF signalling may occur, when MMI keys are depressed
15	MS->SS	HOLD	
16	SS -> MS	HOLD ACKNOWLEDGE	
17	MS -> SS	CM SERVICE REQUEST	
18	SS -> MS	CM SERVICE ACCEPT	
19	MS -> SS	SETUP	
20	SS -> MS	CALL PROCEEDING	
21	SS -> MS	ALERTING	
22	SS -> MS	CONNECT	As default message except contains Facility IE with contents as indicated in i below
			Either F or G branch is taken
F23	MS -> SS	CONNECT ACKNOWLEDGE	As default message except contains Facility IE with contents as indicated in ii below
F24	MS -> SS	FACILITY	
G23	MS -> SS	FACILITY	As default message except contains Facility IE with contents as indicated in ii below
G24	MS -> SS	CONNECT ACKNOWLEDGE	
25	MS -> SS	FACILITY (TI A-B/A-C)	The MS is made to build a multi-party call. DTMF signalling may occur, when MMI keys are depressed As default message except contains Facility IE with contents as indicated in iii below
26	SS -> MS	FACILITY (TI A-B/A-C)	
27			
			As default message except contains Facility IE with contents as indicated in iv, below Call durations x and y seconds after respective CAI information sent by SS
			Branch H and branch I are taken, the sequence depending on the durations x and y
H28	SS -> MS	DISCONNECT	For call C y seconds after call C CAI sent
H29	MS -> SS	RELEASE	
H30	SS -> MS	RELEASE COMPLETE	
I28	SS -> MS	DISCONNECT	For call B x seconds after call B CAI sent
I29	MS -> SS	RELEASE	
I30	SS -> MS	RELEASE COMPLETE	
31	SS -> MS	CHANNEL RELEASE	The main signalling link is released. MS display is checked to determine whether the correct call charge has been indicated
32	MS		

NOTE: A-B/A-C indicates a choice. the transaction identifier (TI) used must be that of the active call or the held call (ref. GSM 04.84).

The values of x and y are given below.

The correct value of the ACM is found from the general AoC formula given in GSM 02.24 section 4 with CDUR = x,y seconds and e parameters as defined below.

Specific Message Contents:

- i) FACILITY Information Element with Invoke = ForwardChargeAdvice component type as defined in GSM 04.80 section 3.6.1 table 3.3.

For ASN.1 description see default message contents in section 31.6.4.

x set to 180 s, y set to 90 s.

The values of the e-parameters within the parameter part of the Facility Information Element shall be set to:

Call	e-parameter							CCM total at call end increased by	Step 0 ACM value
	1	2	3	4	5	6	7		
B(time x)	19	40	1	0	0	0	0		
C(time y)	29	40	1	0	0	0	0	134	134

Values shown in table are in the format and have units as in GSM 02.24 section 3.

ii) FACILITY Information Element with Return Result component type as defined in GSM 04.80 section 3.6.1 table 3.4.

For ASN.1 description see default message contents in section 31.6.4.

iii) FACILITY Information Element with Invoke = BuildMPTY component type as defined in GSM 04.80 section 3.6.1 table 3.4.

The following abbreviations are used in the descriptions below:

- U Universal tag class.
- CS Context Specific tag class.
- P Primitive tag form.
- C Constructed tag form.
- FIE Facility Information Element.

Contents	Value/remark	Coding
Facility IE Identifier	As GSM 04.80	00011100
Length of FIE contents	8	00001000
Component type tag	CS/C/tag=1	10100001
Component length	6	00000110
Invoke ID tag	U/P/tag=2	00000010
Invoke ID length	1	00000001
Invoke ID	Arbitrary (1 octet)	(00000000)
Op-Code tag	From GSM 04.80	00000010
Op-Code length	1	00000001
Op-Code	Build Multi-party operation (local value 124)	00000001

ii) FACILITY Information Element with Return Result component type as defined in GSM 04.80 section 3.6.1 table 3.4.

Contents	Value/remark	Coding
Facility IE Identifier	As GSM 04.80	00111100
Length of FIE contents	5	00001001
Component type tag	CS/C/tag=2	10100010
Component length	3	00000011
Invoke ID tag	U/P/Integer	00000010
Invoke ID length	1	00000001
Invoke ID	Same as used as Invoke ID in Invoke FIE	(00000000)

31.6.4 Default contents of messages

As default message contents in GSM 11.10 Section 26.8 "Tests related to circuit switched call control". These messages shall not contain SS version IEs.

Where indicated in specific tests CONNECT and FACILITY messages have Facility Information Elements as defined below.

Default contents of ForwardChargeAdvice Facility Information Elements

The following abbreviations are used in the descriptions below:

- U Universal tag class.
- CS Context Specific tag class.
- P Primitive tag form.
- C Constructed tag form.
- FIE Facility Information Element.

i) FACILITY Information Element with Invoke = ForwardChargeAdvice component type as defined in GSM 04.80 section 3.6.1 table 3.3.

Contents	Value/remark	Coding
Facility IE Identifier	As GSM 04.80	00011100
Length of FIE contents	43	00101011
Component type tag	CS/C/tag=1	10100001
Component length	41	00101001
Invoke ID tag	U/P/tag=2	00000010
Invoke ID length	1	00000001
Invoke ID	Arbitrary	(00000000) (1 octet)
Op-Code tag	From GSM 04.80	00000010
Op-Code length	1	00000001
Op-Code	Forward Charge Advice operation	01111101 (local value 125)
Sequence Identifier	U/C/tag=16	00110000 from CCITT X.208
Length Indicator	33	00100001
SS-Code Identifier	CS/P/tag=0	10000000
Length Indicator	1	00000001
SS-Code	AoCC SS-Code (for AoCC tests)	01110010
	AoCI SS-Code (for AoCI tests)	01110001
Charging Info. identifier	CS/C/tag=1	10100001
Length Indicator	28	00011100
e1 Identifier	CS/P/tag=1	10000001
Length Indicator	2	00000010
e1	(2 Octets)	See e-parameter table in relevant test
e2 Identifier	CS/P/tag=2	10000010
Length Indicator	2	00000010
e2	(2 Octets)	See e-parameter table in relevant test
.	.	.
.	.	.
.	.	.
e7 Identifier	CS/P/tag=7	10000111
Length Indicator	2	00000010
e7	(2 Octets)	See e-parameter table in relevant test

- ii) FACILITY Information Element with Return Result component type as defined in GSM 04.80 section 3.6.1 table 3.4.

Contents	Value/remark	Coding
Facility IE Identifier	As GSM 04.80	00111100
Length of FIE contents	5	00001001
Component type tag	CS/C/tag=2	10100010
Component length	3	00000011
Invoke ID tag	U/P/Integer	00000010
Invoke ID length	1	00000001
Invoke ID	Same as used as	(00000000)
Invoke ID in Invoke FIE		

31.7 Additional information transfer supplementary services

(Reserved).

31.8 Call restriction supplementary services

The following abbreviations are used:

BO:	Barring of Outgoing calls.
BAOC:	Barring of All Outgoing Calls.
BOIC:	Barring of Outgoing International Calls.
BOICExHC:	Barring of Outgoing International Call EXcept those directed to the Home PLMN country.
BI:	Barring of Incoming calls.
BAIC:	Barring of All Incoming calls.
BICRoam:	Barring of Incoming when Roaming outside the home PLMN country.
B:	Barring (common name for BAOB, BOIC, BOICExHC, BAIC and BICRoam).

These abbreviations are also used to represent the corresponding SS-Code; e.g. B is the SS-Code for all barring services.

NOTE: The password(s) to be used during tests of this section 31.8 may be randomly chosen - unless otherwise stated - in accordance with GSM 02.04 section 5.2.

31.8.1 Registration of a password

31.8.1.1 Registration accepted

31.8.1.1.1 Conformance requirements

- 1) For registration of a password for all barring services, the MS shall transmit successively
 - 1.1) a CHANNEL REQUEST with establishment cause set to "other services requested by the mobile user",
 - 1.2) a CM SERVICE REQUEST with CM service type indicating "supplementary service activation",
 - 1.3) and then the REGISTER message containing a facility IE that includes an invoke of the RegisterPassword operation with parameter values according to the user's request (MMI action).
- 2) When the mobile subscriber wants to register a new password, the old password, the new password and the repeat of the new password shall be entered into the MS. Then the MS sends to the network an invoke component of the operation "register password".
- 3) The MS shall be able to send a password by sending a FACILITY message in accordance to the user request (MMI actions).
- 4) Upon receipt of the result of the procedure, contained in RELEASE COMPLETE or FACILITY message, the MS shall provide the appropriate user indication (which is to be described by the manufacturer).

References

- 1.1) GSM 04.08 sections 3.3.1.1.2 and 9.1.9.
- 1.2) GSM 04.08 sections 4.5.1.1, 9.2.9 and 10.5.33.
- 1.3) GSM 04.88, GSM 04.80 sections 2.3 and 3.6.
- 2) GSM 04.10 section 4.2.
- 3) GSM 04.80.
- 4) GSM 02.30.

31.8.1.1.2 Test purpose

- 1) To check that the MS correctly requests a supplementary service transaction for registration of a password for all barring services in CHANNEL REQUEST message.
- 2) To check that the MS correctly requests a supplementary service transaction for registration of a password for all barring services in the subsequent CM SERVICE REQUEST.
- 3) To check that the MS sends a REGISTER message containing the invoke of the RegisterPassword operation with the expected parameter values for registration of a password for all barring services.
- 4) To check that when the mobile subscriber wants to register a new password, the old password, the new password and the repeat of the new password shall be entered into the MS before the MS sends to the network a CHANNEL REQUEST.
- 5) To check that the MS is able to send a password by sending a FACILITY message in accordance to the user request (MMI actions).
- 6) To check that upon receipt of the result of the procedure, contained in RELEASE COMPLETE or FACILITY message, the MS provides the appropriate user indication (as described by the manufacturer).

These checks are done for:

all barring services, the result of the operation being sent in a RELEASE COMPLETE message.

31.8.1.1.3 Method of test

Initial conditions

System Simulator:

1 cell, default parameters.

Mobile Station:

The MS is "idle updated".

Related PICS/PIXIT statement(s)

Description of the user's commands and of display of the answers from the network for call barring.

Foreseen final state of the MS

The MS is "idle updated".

Test procedure

By means of appropriate MMI functions (using either GSM 02.30 or manufacturer defined MMI), the user requests registration of a new password for all barring services by entering the old password, new password and a repeat of the old password.

Upon receipt of the operation (in a REGISTER message), the system simulator answers with the FACILITY message with the Facility information element containing an invoke of the GetPassword operation requiring the old password.

Upon receipt of the FACILITY message, the system simulator answers with the FACILITY message with the Facility information element containing an invoke of the GetPassword operation requiring a new password.

Upon receipt of the FACILITY message, the system simulator answers with the FACILITY message with the Facility information element containing an invoke of the GetPassword operation requiring again the new password.

Upon receipt of the FACILITY message, the system simulator answers with the RELEASE COMPLETE message with the Facility information element containing the return result of the RegisterPassword operation.

Maximum duration of test

3 minutes.

Expected sequence

Step	Direction	Message	Comments
1	MS		The MS is made to initiate a registration of a password for all call barring services. The old password, the new password and a repeat of the new password are entered. with establishment cause "Other procedures which can be completed with an SDCCH"
2	MS -> SS	CHANNEL REQUEST	
3	SS -> MS	IMMEDIATE ASSIGNMENT	
4	MS -> SS	CM SERVICE REQUEST	cause: "supplementary service activation"
5	SS -> MS	CM SERVICE ACCEPT	
6	MS -> SS	REGISTER	
7	SS -> MS	FACILITY	Invoke = GetPassword (password)
8	MS -> SS	FACILITY	GetPassword operation ReturnResult
9	SS -> MS	FACILITY	Invoke = GetPassword (new password)
10	MS -> SS	FACILITY	GetPassword operation ReturnResult
11	SS -> MS	FACILITY	Invoke = GetPassword (new password again)
12	MS -> SS	FACILITY	GetPassword operation ReturnResult
13	SS -> MS	RELEASE COMPLETE	RegisterPassword operation ReturnResult
14	SS -> MS	CHANNEL RELEASE	

Specific message content

step 6 -

- protocol discriminator: non call related SS message
 - message type: REGISTER
 - facility
- invoke = RegisterPassword

Supplementary service code = B

steps 7, 9, and 11 -

- protocol discriminator: non call related SS message
 - message type: FACILITY
 - facility
- invoke = GetPassword

Guidance info: Password (step 7), new password (step 9), new password again (step 11)

The linked ID must be the same as the invoke ID in the invoke of the RegisterPassword operation.

31.8.1.2 Registration rejected

31.8.1.2.1 Rejection after invoke of the RegisterPassword operation

31.8.1.2.1.1 Conformance requirements

- 1) A transaction of any kind being already established, for registration of a password for all call restriction services, the MS shall establish a parallel MM transaction, sending a CM SERVICE REQUEST with CM service type indicating "supplementary service activation",
- 2) Then the MS shall send a REGISTER message related to the present SS transaction containing a facility IE that includes an invoke of the RegisterPassword operation with parameter values according to the user's request (MMI action).
- 3) Upon receipt of the RELEASE COMPLETE message related to the present SS transaction, the SS transaction shall be released but the first transaction shall remain unaffected.
- 4) Upon receipt of the RELEASE COMPLETE message, the MS shall provide the appropriate user indication (which is to be described by the Manufacturer).

References

- 1) GSM 04.08 sections 3.3.1.1.2 and 9.1.9.
- 2) GSM 04.08 sections 4.5.1.1, 9.2.9 and 10.5.33.
- 3) GSM 04.88, GSM 04.80 sections 2.3 and 3.6.
- 4) GSM 02.30 section 4.5.

31.8.1.2.1.2 Test purpose

- 1) To check that, when a call transaction is already established, the MS correctly requests the establishment of a parallel MM transaction for supplementary service transaction of registration of a password for all call restriction services, sending a CM SERVICE REQUEST.
- 2) To check that the MS sends a REGISTER message containing the invoke of the RegisterPassword operation with the expected parameter values for registration of a password for all call restriction services.
- 3) To check that upon receipt of the RELEASE COMPLETE message related to the present SS transaction, the first transaction remains unaffected.
- 4) To check that upon receipt of the RELEASE COMPLETE message, the MS provides the appropriate user indication (as described by the Manufacturer).

Those checks are performed with a call transaction already established for:

all call restriction services, the RELEASE COMPLETE message being sent at the beginning of the procedure with a facility IE containing a return_error(error) where error is "SS subscription violation".

31.8.1.2.1.3 Method of test

Initial conditions

System Simulator:

1 cell, default parameters.

Mobile Station:

The MS is in CC state U10.

Related PICS/PIXIT statement(s)

Description of the user's commands and of display of the answers from the network for call barring.

Foreseen final state of the MS

The MS is in CC state U10.

Test procedure

By means of appropriate MMI functions (using either GSM 02.30 or manufacturer defined MMI), the user requests registration of a new password for all call restriction services by entering the old password, the new password and a repeat of the new password.

Upon receipt of the operation (in a REGISTER message), the system simulator answers with the RELEASE COMPLETE (PD and TI of the SS transaction) message with the Facility information element containing a Return_error(error: SS subscription violation) of the RegisterPassword operation.

Upon receipt of the FACILITY message, the system simulator sends STATUS ENQUIRY, the MS responds with STATUS message indicating CC state U10.

Maximum duration of test

2 min.

Expected sequence

Step	Direction	Message	Comments
1	MS		The MS is made to initiate a registration of a new password for all call restriction services. The old password, the new password and a repeat of the new password are entered. cause: "supplementary service activation"
2	MS -> SS	CM SERVICE REQUEST	
3	SS -> MS	CM SERVICE ACCEPT	
4	MS -> SS	REGISTER	
5	SS -> MS	RELEASE COMPLETE	RegisterPassword operation Return_error provide correct MMI user indication
6	MS		
7	SS -> MS	STATUS ENQUIRY	
8	MS -> SS	STATUS	
			CC staTE U10

Specific message content

step 4 -

- protocol discriminator: non call related SS message
- message type: REGISTER
- facility

invoke = RegisterPassword

Supplementary service code = all call restrictions

step 5 -

- protocol discriminator: non call related SS message
- transaction identifier: same TI as previous REGISTER message
- message type: RELEASE COMPLETE
- facility:

return error code: SS subscription violation

For the return error the invoke ID must be the same as in the invoke of the RegisterPassword operation.

31.8.1.2.2 Rejection after password check with negative result

31.8.1.2.2.1 Conformance requirements

- 1) A transaction of any kind being already established, for registration of a password for all call restriction services, the MS shall establish a parallel MM transaction, sending a CM SERVICE REQUEST with CM service type indicating "supplementary service activation",
- 2) Then the MS shall send a REGISTER message related to the present SS transaction containing a facility IE that includes an invoke of the RegisterPassword operation with parameter values according to the user's request (MMI action).
- 3) Upon receipt of the RELEASE COMPLETE message related to the present SS transaction, the SS transaction shall be released but the first transaction shall remain unaffected.
- 4) Upon receipt of the RELEASE COMPLETE message, the MS shall provide the appropriate user indication (which is to be described by the Manufacturer).

References

- 1) GSM 04.08 sections 3.3.1.1.2 and 9.1.9.
- 2) GSM 04.08 sections 4.5.1.1, 9.2.9 and 10.5.33.
- 3) GSM 04.88, GSM 04.80 sections 2.3 and 3.6, GSM 04.10 section 4.2.2, GSM 03.11 section 3.
- 4) GSM 02.30 section 4.5.

31.8.1.2.2.2 Test purpose

- 1) To check that, when a call transaction is already established, the MS correctly requests the establishment of a parallel MM transaction for supplementary service transaction of registration of a password for all call restriction services, sending a CM SERVICE REQUEST.
- 2) To check that the MS sends a REGISTER message containing the invoke of the RegisterPassword operation with the expected parameter values for registration of a password for all call restriction services.
- 3) To check that upon receipt of the RELEASE COMPLETE message related to the present SS transaction, the first transaction remains unaffected.
- 4) To check that upon receipt of the RELEASE COMPLETE message, the MS provides the appropriate user indication (as described by the Manufacturer).

Those checks are performed with a call transaction already established for:

all call restriction services, the RELEASE COMPLETE message being sent at the end of the procedure with a facility IE containing a return_error(error) where error is "NegativePasswordCheck".

31.8.1.2.2.3 Method of test

Initial conditions

System Simulator:

1 cell, default parameters.

WPA > 3

Mobile Station:

The MS is in CC state U10.

Related PICS/PIXIT statements

Description of the user's commands and of display of the answers from the network for call barring.

Foreseen final state of the MS

The MS is in CC state U10.

Test procedure

By means of appropriate MMI functions (using either GSM 02.30 or manufacturer defined MMI), the user requests registration of a new password for all call restriction services. By means of appropriate MMI functions the user enters the old and new passwords.

Upon receipt of the REGISTER message, the system simulator answers with the FACILITY message with the Facility information element containing an invoke of the GetPassword operation requiring the old password.

Upon receipt of the FACILITY message, the system simulator answers with the RELEASE COMPLETE message (PD and TI of the SS transaction) with the Facility information element containing a Return_error(error: NegativePasswordCheck) of the RegisterPassword operation.

The system simulator sends STATUS ENQUIRY, the MS responds with STATUS message indicating CC state U10.

Maximum duration of test

5 min.

Expected sequence

Step	Direction	Message	Comments
1	MS		The MS is made to initiate a registration of a new password for all call restriction services. The old and new passwords are entered.
2	MS -> SS	CM SERVICE REQUEST	cause: "supplementary service activation"
3	SS -> MS	CM SERVICE ACCEPT	
4	MS -> SS	REGISTER	
5	SS -> MS	FACILITY	Invoke = GetPassword (password) Register Password operation ReturnError provide correct MMI user indication
6	SS -> MS	RELEASE COMPLETE	
7	MS		
8	SS -> MS	STATUS ENQUIRY	CC staTE U10
9	MS -> SS	STATUS	

Specific message content

step 4 -

- protocol discriminator: non call related SS message
- message type: REGISTER
- facility

invoke = RegisterPassword

Supplementary service code = B

step 6 -

- protocol discriminator: non call related SS message
- transaction identifier: same TI as previous REGISTER message
- message type: RELEASE COMPLETE
- facility:

error code: NegativePasswordCheck

For the reject the invoke ID must be the same as in the invoke of the Registerpassword operation.

step 5 -

- protocol discriminator: non call related SS message
- transaction identifier: in FACILITY same as previous REGISTER message
- message type: FACILITY
- facility

invoke = GetPassword

Guidance info: Password (step 1)

31.8.1.2.3 Rejection after new password mismatch

31.8.1.2.3.1 Conformance requirements

- 1) A transaction of any kind being already established, for registration of a password for all call restriction services, the MS shall establish a parallel MM transaction, sending a CM SERVICE REQUEST with CM service type indicating "supplementary service activation",
- 2) Then the MS shall send a REGISTER message related to the present SS transaction containing a facility IE that includes an invoke of the RegisterPassword operation with parameter values according to the user's request (MMI action).
- 3) Upon receipt of the RELEASE COMPLETE message related to the present SS transaction, the SS transaction shall be released but the first transaction shall remain unaffected.
- 4) Upon receipt of the RELEASE COMPLETE message, the MS shall provide the appropriate user indication (which is to be described by the Manufacturer).

References

- 1) GSM 04.08 sections 3.3.1.1.2 and 9.1.9.
- 2) GSM 04.08 sections 4.5.1.1, 9.2.9 and 10.5.33.
- 3) GSM 04.88, GSM 04.80 sections 2.3 and 3.6.
- 4) GSM 02.30 section 4.5.
- 5) GSM 04.10 section 4.2.

31.8.1.2.3.2 Test purpose

- 1) To check that, when a call transaction is already established, the MS correctly requests the establishment of a parallel MM transaction for supplementary service transaction of registration of a password for all call restriction services, sending a CM SERVICE REQUEST.
- 2) To check that the MS sends a REGISTER message containing the invoke of the RegisterPassword operation with the expected parameter values for registration of a password for all call restriction services.
- 3) To check that upon receipt of the RELEASE COMPLETE message related to the present SS transaction, the first transaction remains unaffected.
- 4) To check that upon receipt of the RELEASE COMPLETE message, the MS provides the appropriate user indication (as described by the Manufacturer).

Those checks are performed with a call transaction already established for:

all call restriction services, the RELEASE COMPLETE message being sent at the end of the procedure with a facility IE containing a return_error(error) where error is "PasswordRegistrationFailure" with diagnostic "new password mismatch".

31.8.1.2.3.3 Method of test

Initial conditions

System Simulator:

1 cell, default parameters.

Mobile Station:

The MS is in CC state U10.

Related PICS/PIXIT statements

Description of the user's commands and of display of the answers from the network for call barring.

Foreseen final state of the MS

The MS is in CC state U10.

Test procedure

By means of appropriate MMI functions (using either GSM 02.30 or manufacturer defined MMI), the user requests registration of a new password for all call restriction services by entering the old password, the new password and a repeat of the new password.

Upon receipt of the REGISTER message, the system simulator answers with the FACILITY message with the Facility information element containing an invoke of the GetPassword operation requiring the old password.

Upon receipt of the FACILITY message, the system simulator answers with the FACILITY message with the Facility information element containing an invoke of the GetPassword operation requiring the new password.

Upon receipt of the FACILITY message, the system simulator answers with the FACILITY message with the Facility information element containing an invoke of the GetPassword operation requiring again the new password.

Upon receipt of the FACILITY message, the system simulator answers with the RELEASE COMPLETE message (PD and TI of the SS transaction) with the Facility information element containing a Return_error(error: PasswordRegistrationFailure, parameter: NewPasswordMismatch) of the RegisterPassword operation.

The system simulator sends STATUS ENQUIRY, the MS responds with STATUS message indicating CC state U10.

Maximum duration of test

3 min.

Expected sequence

Step	Direction	Message	Comments
1	MS		The MS is made to initiate a registration of a new password for all call restriction services. The old password, new password and a repeat of the new password are entered. cause: "supplementary service activation"
2	MS -> SS	CM SERVICE REQUEST	
3	SS -> MS	CM SERVICE ACCEPT	
4	MS -> SS	REGISTER	
5	SS -> MS	FACILITY	Invoke = GetPassword (password)
6	MS -> SS	FACILITY	GetPassword operation ReturnResult
7	SS -> MS	FACILITY	Invoke = GetPassword (new password)
8	MS -> SS	FACILITY	GetPassword operation ReturnResult
9	SS -> MS	FACILITY	Invoke = GetPassword (new password again)
10	MS -> SS	FACILITY	GetPassword operation ReturnResult
11	SS -> MS	RELEASE COMPLETE	Register Password operation ReturnError
12	MS		provide correct MMI user indication
13	SS -> MS	STATUS ENQUIRY	
14	MS -> SS	STATUS	CC staTE U10

Specific message content

step 4 -

- protocol discriminator: non call related SS message
- message type: REGISTER
- facility

invoke = RegisterPassword

Supplementary service code = B

step 11 -

- protocol discriminator: non call related SS message
- transaction identifier: same TI as previous REGISTER message
- message type: RELEASE COMPLETE
- facility:

error code: PasswordRegistrationFailure

parameter: NewPasswordMismatch

For the reject the invoke ID must be the same as in the invoke of the Registerpassword operation.

steps 5, 7, and 8 -

- protocol discriminator: non call related SS message
- transaction identifier: in FACILITY same as previous REGISTER message
- message type: FACILITY
- facility

invoke = GetPassword

Supplementary service code = B

Guidance info: Password (step 5), new password (step 7), new password again (step 8)

31.8.2 Erasure

Not applicable.

31.8.3 Activation

31.8.3.1 Activation accepted

31.8.3.1.1 Conformance requirements

- 1) For activation of any specific call restriction service with any parameters, the MS shall transmit successively
 - 1.1) a CHANNEL REQUEST with establishment cause set to "other services requested by the mobile user",
 - 1.2) a CM SERVICE REQUEST with CM service type indicating "supplementary service activation",
 - 1.3) and then the REGISTER message containing a facility IE that includes an invoke of the ActivateSS operation with parameter values according to the user's request (MMI action).
- 2) Upon receipt of FACILITY message requiring the password, the MS shall provide the appropriate user indication (which is to be described by the manufacturer).
- 3) The MS shall be able to send a password by sending a FACILITY message in accordance to the user request (MMI actions).
- 4) Upon receipt of the RELEASE COMPLETE message, the MS shall provide the appropriate user indication (which is to be described by the manufacturer).

References

- 1) GSM 04.08 sections 3.3.1.1.2 and 9.1.9.
- 2) GSM 04.08 sections 4.5.1.1, 9.2.9 and 10.5.33.
- 3) GSM 04.88, GSM 04.80 sections 2.3 and 3.6.
- 4) GSM 02.30 section 4.5.

31.8.3.1.2 Test purpose

- 1) To check that the MS correctly requests a supplementary service transaction for activation of a specific call restriction service in CHANNEL REQUEST message.
- 2) To check that the MS correctly requests a supplementary service transaction for activation of call restriction service in the subsequent CM SERVICE REQUEST.
- 3) To check that the MS sends a REGISTER message containing the invoke of the ActivateSS operation with the expected parameter values for activation of a specific call restriction service.

- 4) To check that upon receipt of FACILITY message requiring the password, the MS provides the appropriate user indication (as described by the manufacturer).
- 5) To check that the MS is able to send a password by sending a FACILITY message in accordance to the user request (MMI actions).
- 6) To check that upon receipt of the RELEASE COMPLETE message, the MS provides the appropriate user indication (which is to be described by the manufacturer).

These checks are done for:

- a) BAOC, for basic service group "all synchronous services".
- b) BICRoam, for all basic service groups.

31.8.3.1.3 Method of test

Initial conditions

System Simulator:

1 cell, default parameters.

Mobile Station:

The MS is "idle updated".

Related PICS/PIXIT statements

Description of the user's commands and of display of the answers from the network for call barring.

Foreseen final state of the MS

The MS is "idle updated".

Test procedure

By means of appropriate MMI functions (using either GSM 02.30 or manufacturer defined MMI), the user requests activation of BAOC, for basic service group "all synchronous services".

Upon receipt of the operation (in a REGISTER message), the system simulator answers with the FACILITY message with the Facility information element containing an invoke of the GetPassword operation requiring the current password.

Then, by means of appropriate MMI functions, the user gives a password.

Upon receipt of the FACILITY message, the system simulator answers with a RELEASE COMPLETE message with the Facility information element containing the Return_result of the ActivateSS operation.

The SS transaction and the dedicated channel are released.

Then again, by means of appropriate MMI functions, the user requests activation of BICRoam, for all basic service groups.

Upon receipt of the operation (in a REGISTER message), the system simulator answers with the FACILITY message with the Facility information element containing an invoke of the GetPassword operation requiring the current password.

Then, by means of appropriate MMI functions, the user gives a password.

Upon receipt of the FACILITY message, the system simulator answers with a RELEASE COMPLETE message with the Facility information element containing the Return_result of the ActivateSS operation.

The dedicated channel is released.

Maximum duration of test

3 min.

Expected sequence

Step	Direction	Message	Comments
1	MS		The MS is made to initiate a activation of BAOC(all synchronous services)
2	MS -> SS	CHANNEL REQUEST	with establishment cause "Other procedures which can be completed with an SDCCH"
3	SS -> MS	IMMEDIATE ASSIGNMENT	
4	MS -> SS	CM SERVICE REQUEST	cause: "supplementary service activation"
5	SS -> MS	CM SERVICE ACCEPT	
6	MS -> SS	REGISTER	
7	SS -> MS	FACILITY	GetPassword
8	MS		provide correct MMI user indication A password is entered.
9	MS -> SS	FACILITY	Getpassword operation Return Result
10	SS -> MS	RELEASE COMPLETE	ActivateSS operation Return_result
11	MS		provide user MMI indication
12	SS -> MS	CHANNEL RELEASE	
13	MS		The MS is made to initiate an activation of BICRoam(all basic service groups),
14	MS -> SS	CHANNEL REQUEST	with establishment cause "Other procedures which can be completed with an SDCCH"
15	SS -> MS	IMMEDIATE ASSIGNMENT	
16	MS -> SS	CM SERVICE REQUEST	cause: "supplementary service activation"
17	SS -> MS	CM SERVICE ACCEPT	
18	MS -> SS	REGISTER	
19	SS -> MS	FACILITY	GetPassword
20	MS		provide correct MMI user indication A password is entered.
21	MS -> SS	FACILITY	Getpassword operation Return Result
22	SS -> MS	RELEASE COMPLETE	ActivateSS operation Return result
23	MS		provide correct MMI user indication
24	SS -> MS	CHANNEL RELEASE	

Specific message contents

step 6 - BAOC

- protocol discriminator: non call related SS message
- message type: REGISTER
- facility

invoke = Activation

Supplementary service code = BAOC

Basic service code: Bearer Service (all synchronous services), no teleservice present.

step 18 -

- protocol discriminator: non call related SS message
- message type: REGISTER
- facility

invoke = Activation

Supplementary service code = BICRoam

Basic service code: no bearer service present, no teleservice present.

steps 7, 19 -

- protocol discriminator: non call related SS message
- transaction identifier: in FACILITY same as previous REGISTER message
- message type: FACILITY
- facility

invoke = GetPassword

Guidance info: Password

31.8.3.2 Activation rejected

31.8.3.2.1 Rejection after invoke of ActivateSS operation

31.8.3.2.1.1 Conformance requirements

- 1) A transaction of any kind being already established, for activation of one specific barring services, the MS shall establish a parallel MM transaction, sending a CM SERVICE REQUEST with CM service type indicating "supplementary service activation",
- 2) Then the MS shall send a REGISTER message related to the present SS transaction containing a facility IE that includes an invoke of the ActivateSS operation with parameter values according to the user's request (MMI action).
- 3) Upon receipt of the RELEASE COMPLETE message related to the present SS transaction, the SS transaction shall be released but the first transaction shall remain unaffected.
- 4) Upon receipt of the RELEASE COMPLETE message, the MS shall provide the appropriate user indication (which is to be described by the Manufacturer).

References

- 1) GSM 04.08 sections 3.3.1.1.2 and 9.1.9.
- 2) GSM 04.08 sections 4.5.1.1, 9.2.9 and 10.5.33.
- 3) GSM 04.88, GSM 04.80 sections 2.3 and 3.6.
- 4) GSM 02.30 section 4.5.

31.8.3.2.1.2 Test purpose

- 1) To check that, when a call transaction is already established, the MS correctly requests the establishment of a parallel MM transaction for supplementary service transaction of specific call barring service, sending a CM SERVICE REQUEST.
- 2) To check that the MS sends a REGISTER message containing the invoke of the ActivateSS operation with the expected parameter values for specific call barring service.
- 3) To check that upon receipt of the RELEASE COMPLETE message related to the present SS transaction, the first transaction remains unaffected.
- 4) To check that upon receipt of the RELEASE COMPLETE message, the MS provides the appropriate user indication (as described by the Manufacturer).

Those checks are performed with a call transaction already established for:

BOIC, the RELEASE COMPLETE message being sent at the beginning of the procedure with a facility IE containing a return_error(error) where error is "SS subscription violation".

31.8.3.2.1.3 Method of test

Initial conditions

System Simulator:

1 cell, default parameters.

Mobile Station:

The MS is in CC state U10.

Related PICS/PIXIT statements

Description of the user's commands and of display of the answers from the network for call barring.

Foreseen final state of the MS

The MS is in CC state U10.

Test procedure

By means of appropriate MMI functions (using either GSM 02.30 or manufacturer defined MMI), the user requests activation of BOIC.

Upon receipt of the operation (in a REGISTER message), the system simulator answers with the RELEASE COMPLETE (PD and TI of the SS transaction) message with the Facility information element containing a Return_error(error: SS subscription violation) of the ActivateSS operation.

The system simulator then sends STATUS ENQUIRY, and the MS responds with STATUS message indicating CC state U10.

Maximum duration of test

2 min.

Expected sequence

Step	Direction	Message	Comments
1	MS		The MS is made to initiate a registration of a new password for BOIC cause: "supplementary service activation"
2	MS -> SS	CM SERVICE REQUEST	
3	SS -> MS	CM SERVICE ACCEPT	
4	MS -> SS	REGISTER	
5	SS -> MS	RELEASE COMPLETE	RegisterPassword operation Return_error provide correct MMI user indication
6	MS		
7	SS -> MS	STATUS ENQUIRY	CC state U10
8	MS -> SS	STATUS	

Specific message content

step 4 -

- protocol discriminator: non call related SS message
- message type: REGISTER

- facility

invoke = ActivateSS

Supplementary service code = BOIC

step 5 -

- protocol discriminator: non call related SS message
- transaction identifier: same TI as previous REGISTER message
- message type: RELEASE COMPLETE
- facility:

return error code: SS subscription violation

For the return error the invoke ID must be the same as in the invoke of the ActivateSS operation.

31.8.3.2.2 Rejection after use of password procedure

31.8.3.2.2.1 Conformance requirements

- 1) A transaction of any kind being already established, for activation of any specific call restriction services, the MS shall establish a parallel MM transaction, sending a CM SERVICE REQUEST with CM service type indicating "supplementary service activation",
- 2) Then the MS shall send a REGISTER message related to the present SS transaction containing a facility IE that includes an invoke of the ActivateSS operation with parameter values according to the user's request (MMI action).
- 3) Upon receipt of the RELEASE COMPLETE message related to the present SS transaction, the SS transaction shall be released but the first transaction shall remain unaffected.
- 4) Upon receipt of the RELEASE COMPLETE message, the MS shall provide the appropriate user indication (which is to be described by the Manufacturer).

References

- 1) GSM 04.08 sections 3.3.1.1.2 and 9.1.9.
- 2) GSM 04.08 sections 4.5.1.1, 9.2.9 and 10.5.33.
- 3) GSM 04.88, GSM 04.80 sections 2.3 and 3.6.
- 4) GSM 02.30 section 4.5.

31.8.3.2.2.2 Test purpose

- 1) To check that, when a call transaction is already established, the MS correctly requests the establishment of a parallel MM transaction for supplementary service transaction of activation of one specific call restriction service, sending a CM SERVICE REQUEST.
- 2) To check that the MS sends a REGISTER message containing the invoke of the ActivateSS operation with the expected parameter values for activation of one specific call restriction service.
- 3) To check that upon receipt of the RELEASE COMPLETE message related to the present SS transaction, the first transaction remains unaffected.
- 4) To check that upon receipt of the RELEASE COMPLETE message, the MS provides the appropriate user indication (as described by the Manufacturer).

Those checks are performed with a call transaction already established for:

BAIC, the RELEASE COMPLETE message being sent at the end of the procedure with a facility IE containing a return_error(error) where error is "NegativePasswordCheck".

31.8.3.2.2.3 Method of test

Initial conditions

System Simulator:

1 cell, default parameters.

Mobile Station:

The MS is in CC state U10.

Related PICS/PIXIT statements

Description of the user's commands and of display of the answers from the network for call barring.

Foreseen final state of the MS

The MS is in CC state U10.

Test procedure

By means of appropriate MMI functions (using either GSM 02.30 or manufacturer defined MMI), the user requests registration of a new password for all call restriction services.

Upon receipt of the REGISTER message, the system simulator answers with the FACILITY message with the Facility information element containing an invoke of the GetPassword operation requiring the current password.

Then, by means of appropriate MMI functions, the user gives a password.

Upon receipt of the FACILITY message, the system simulator sends RELEASE COMPLETE message (PD and TI of the SS transaction) with the Facility information element containing a Return_error(error: NegativePasswordCheck) of the GetPassword operation.

The system simulator sends STATUS ENQUIRY, the MS responds with STATUS message indicating CC state U10.

Maximum duration of test

3 min.

Expected sequence

Step	Direction	Message	Comments
1	MS		The MS is made to initiate a registration of BAIC cause: "supplementary service activation"
2	MS -> SS	CM SERVICE REQUEST	
3	SS -> MS	CM SERVICE ACCEPT	
4	MS -> SS	REGISTER	
5	SS -> MS	FACILITY	Invoke = GetPassword (password) provide correct MMI user indication A password is entered.
6	MS		
7	MS -> SS	FACILITY	GetPassword operation Return Result Register Password operation ReturnError provide correct MMI user indication
8	SS -> MS	RELEASE COMPLETE	
9	MS		
10	SS -> MS	STATUS ENQUIRY	CC state U10
11	MS -> SS	STATUS	

Specific message content

step 4 - BAIC

- protocol discriminator: non call related SS message
- message type: REGISTER
- facility

invoke = Activation

Supplementary service code = BAIC

step 5 - All Barring services

- protocol discriminator: non call related SS message
- transaction identifier: in FACILITY same as previous REGISTER message
- message type: FACILITY
- facility

invoke = GetPassword

Guidance info: Password (step 5)

step 8 -

- protocol discriminator: non call related SS message
- transaction identifier: same TI as previous REGISTER message
- message type: RELEASE COMPLETE
- facility:

reject code: NegativePasswordCheck

For the reject the invoke ID must be the same as in the invoke of the GetPassword operation.

31.8.4 Deactivation

31.8.4.1 Deactivation accepted

31.8.4.1.1 Conformance requirements

- 1) For deactivation of any group of call restriction services with any parameters, the MS shall transmit successively
 - 1.1) a CHANNEL REQUEST with establishment cause set to "other services requested by the mobile user",
 - 1.2) a CM SERVICE REQUEST with CM service type indicating "supplementary service activation",
 - 1.3) and then the REGISTER message containing a facility IE that includes an invoke of the DeactivateSS operation with parameter values according to the user's request (MMI action).
- 2) Upon receipt of FACILITY message requiring the password, the MS shall provide the appropriate user indication (which is to be described by the manufacturer).
- 3) The MS shall be able to send a password by sending a FACILITY message in accordance to the user request (MMI actions).
- 3) Upon receipt of the RELEASE COMPLETE message, the MS shall provide the appropriate user indication (which is to be described by the manufacturer).

References

- 1) GSM 04.08 sections 3.3.1.1.2 and 9.1.9.
- 2) GSM 04.08 sections 4.5.1.1, 9.2.9 and 10.5.33.
- 3) GSM 04.88, GSM 04.80 sections 2.3 and 3.6.
- 4) GSM 02.30 section 4.5.

31.8.4.1.2 Test purpose

- 1) To check that the MS correctly requests a supplementary service transaction for deactivation of a group of call barring services in CHANNEL REQUEST message.
- 2) To check that the MS correctly requests a supplementary service transaction for deactivation of a group of call barring services in the subsequent CM SERVICE REQUEST.
- 3) To check that the MS sends a REGISTER message containing the invoke of the DeactivateSS operation with the expected parameter values for deactivation of a group of call restriction services.
- 4) To check that upon receipt of FACILITY message requiring the password, the MS provides the appropriate user indication (as described by the manufacturer).
- 5) To check that the MS is able to send a password by sending a FACILITY message in accordance to the user request (MMI actions).
- 6) To check that upon receipt of the RELEASE COMPLETE message, the MS provides the appropriate user indication (which is to be described by the manufacturer).

These checks are done for:

- a) all restrictions, for basic service group "speech".
- b) barring of outgoing calls, for all facsimile.

31.8.4.1.3 Method of test

Initial conditions

System Simulator:

1 cell, default parameters.

Mobile Station:

The MS is "idle updated".

Related PICS/PIXIT statements

Description of the user's commands and of display of the answers from the network for call barring.

Foreseen final state of the MS

The MS is "idle updated".

Test procedure

By means of appropriate MMI functions (using either GSM 02.30 or manufacturer defined MMI), the user requests deactivation of all restrictions, for speech.

Upon receipt of the operation (in a REGISTER message), the system simulator answers with the FACILITY message with the Facility information element containing an invoke of the GetPassword operation requiring the current password.

Then, by means of appropriate MMI functions, the user gives a password.

Upon receipt of the FACILITY message, the system simulator answers with the FACILITY message with the Facility information element containing the Return_result of the DeactivateSS operation.

The SS transaction and the dedicated channel are released.

Then again, by means of appropriate MMI functions, the user requests activation of barring of outgoing calls, for all facsimile.

Upon receipt of the operation (in a REGISTER message), the system simulator answers with the FACILITY message with the Facility information element containing an invoke of the GetPassword operation requiring the current password.

Then, by means of appropriate MMI functions, the user gives a password.

Upon receipt of the FACILITY message, the system simulator answers with a RELEASE COMPLETE message with the Facility information element containing the Return_result of the DeactivateSS operation.

The dedicated channel is released.

Maximum duration of test

5 min.

Expected sequence

Step	Direction	Message	Comments
1	MS		The MS is made to initiate a deactivation of all call restrictions(speech)
2	MS -> SS	CHANNEL REQUEST	with establishment cause "Other procedures which can be completed with an SDCCH"
3	SS -> MS	IMMEDIATE ASSIGNMENT	
4	MS -> SS	CM SERVICE REQUEST	cause: "supplementary service activation"
5	SS -> MS	CM SERVICE ACCEPT	
6	MS -> SS	REGISTER	
7	SS -> MS	FACILITY	GetPassword
8	MS		provide correct MMI user indication A password is entered.
9	MS -> SS	FACILITY	Getpassword operation Return Result
10	SS -> MS	RELEASE COMPLETE	DeactivateSS operation Return_result
11	SS -> MS	CHANNEL RELEASE	
12	MS		The MS is made to initiate a deactivation of barring of outgoing calls(all facsimile),
13	MS -> SS	CHANNEL REQUEST	with establishment cause "Other procedures which can be completed with an SDCCH"
14	SS -> MS	IMMEDIATE ASSIGNMENT	
15	MS -> SS	CM SERVICE REQUEST	cause: "supplementary service activation"
16	SS -> MS	CM SERVICE ACCEPT	
17	MS -> SS	REGISTER	
18	SS -> MS	FACILITY	GetPassword
19	MS		provide correct MMI user indication A password is entered.
20	MS -> SS	FACILITY	Getpassword operation Return Result
21	SS -> MS	RELEASE COMPLETE	DeactivateSS operation Return result
22	MS		provide correct MMI user indication
23	SS -> MS	CHANNEL RELEASE	

Specific message contents

step 6 - all call restrictions:

- protocol discriminator: non call related SS message
- message type: REGISTER
- facility

invoke = Deactivation

Supplementary service code = B

Basic service code: no Bearer Service present, teleservice: speech.

step 17 - barring of outgoing calls,

- protocol discriminator: non call related SS message
- message type: REGISTER
- facility

invoke = Deactivation

Basic service code: no bearer service present, teleservice: all facsimile.

steps 7, 18 -

- protocol discriminator: non call related SS message
- transaction identifier: in FACILITY same as previous REGISTER message
- message type: FACILITY
- facility

invoke = GetPassword

Guidance info: Password

31.8.4.2 Deactivation rejected

31.8.4.2.1 Rejection after invoke of DeactivateSS operation

31.8.4.2.1.1 Conformance requirements

- 1) A transaction of any kind being already established, for deactivation of a group of call restriction services, the MS shall establish a parallel MM transaction, sending a CM SERVICE REQUEST with CM service type indicating "supplementary service activation",
- 2) Then the MS shall send a REGISTER message related to the present SS transaction containing a facility IE that includes an invoke of the DeactivateSS operation with parameter values according to the user's request (MMI action).
- 3) Upon receipt of the RELEASE COMPLETE message related to the present SS transaction, the SS transaction shall be released but the first transaction shall remain unaffected.
- 4) Upon receipt of the RELEASE COMPLETE message, the MS shall provide the appropriate user indication (which is to be described by the Manufacturer).

References

- 1) GSM 04.08 sections 3.3.1.1.2 and 9.1.9.
- 2) GSM 04.08 sections 4.5.1.1, 9.2.9 and 10.5.33.
- 3) GSM 04.88, GSM 04.80 sections 2.3 and 3.6.
- 4) GSM 02.30 section 4.5.

31.8.4.2.1.2 Test purpose

- 1) To check that, when a call transaction is already established, the MS correctly requests the establishment of a parallel MM transaction for supplementary service transaction of a group of call barring services, sending a CM SERVICE REQUEST.
- 2) To check that the MS sends a REGISTER message containing the invoke of the DeactivateSS operation with the expected parameter values for a group of call barring services.
- 3) To check that upon receipt of the RELEASE COMPLETE message related to the present SS transaction, the first transaction remains unaffected.
- 4) To check that upon receipt of the RELEASE COMPLETE message, the MS provides the appropriate user indication (as described by the Manufacturer).

These checks are performed with a call transaction already established for:

BOIC, the RELEASE COMPLETE message being sent at the beginning of the procedure with a facility IE containing a return_error(error) where error is "SS subscription violation".

31.8.4.2.1.3 Method of test

Initial conditions

System Simulator:

1 cell, default parameters.

Mobile Station:

The MS is in CC state U10.

Related PICS/PIXIT statements

Description of the user's commands and of display of the answers from the network for call barring.

Foreseen final state of the MS

The MS is in CC state U10.

Test procedure

By means of appropriate MMI functions (using either GSM 02.30 or manufacturer defined MMI), the user requests deactivation of incoming calls.

Upon receipt of the operation (in a REGISTER message), the system simulator answers with the RELEASE COMPLETE (PD and TI of the SS transaction) message with the Facility information element containing a Return_error(error: SS subscription violation) of the DeactivateSS operation.

The system simulator then sends STATUS ENQUIRY, and the MS responds with STATUS message indicating CC state U10.

Maximum duration of test

30 s.

Expected sequence

Step	Direction	Message	Comments
1	MS		
2	MS -> SS	CM SERVICE REQUEST	The MS is made to initiate a deactivation for bi cause: "supplementary service activation"
3	SS -> MS	CM SERVICE ACCEPT	
4	MS -> SS	REGISTER	
5	SS -> MS	RELEASE COMPLETE	DeactivateSS operation Return_error provide correct MMI user indication
6	MS		
7	SS -> MS	STATUS ENQUIRY	CC state U10
8	MS -> SS	STATUS	

Specific message content

step 4 -

- protocol discriminator: non call related SS message
- message type: REGISTER
- facility

invoke = DeactivateSS

Supplementary service code = bi

step 5 -

- protocol discriminator: non call related SS message
- transaction identifier: same TI as previous REGISTER message
- message type: RELEASE COMPLETE
- facility:

return error code: SS subscription violation

For the return error the invoke ID must be the same as in the invoke of the DeactivateSS operation.

31.8.4.2.2 Rejection after use of password procedure

31.8.4.2.2.1 Conformance requirements

- 1) A transaction of any kind being already established, for deactivation of a group of call restriction services, the MS shall establish a parallel MM transaction, sending a CM SERVICE REQUEST with CM service type indicating "supplementary service activation",
- 2) Then the MS shall send a REGISTER message related to the present SS transaction containing a facility IE that includes an invoke of the DeactivateSS operation with parameter values according to the user's request (MMI action).
- 3) Upon receipt of the RELEASE COMPLETE message related to the present SS transaction, the SS transaction shall be released but the first transaction shall remain unaffected.
- 4) Upon receipt of the RELEASE COMPLETE message, the MS shall provide the appropriate user indication (which is to be described by the Manufacturer).

References

- 1) GSM 04.08 sections 3.3.1.1.2 and 9.1.9.
- 2) GSM 04.08 sections 4.5.1.1, 9.2.9 and 10.5.33.
- 3) GSM 04.88, GSM 04.80 sections 2.3 and 3.6.
- 4) GSM 02.30 section 4.5.

31.8.4.2.2.2 Test purpose

- 1) To check that, when a call transaction is already established, the MS correctly requests the establishment of a parallel MM transaction for supplementary service transaction of deactivation of a group of call restriction services, sending a CM SERVICE REQUEST.
- 2) To check that the MS sends a REGISTER message containing the invoke of the DeactivateSS operation with the expected parameter values for deactivation of a group of call restriction service.
- 3) To check that upon receipt of the RELEASE COMPLETE message related to the present SS transaction, the first transaction remains unaffected.
- 4) To check that upon receipt of the RELEASE COMPLETE message, the MS provides the appropriate user indication (as described by the Manufacturer).

Those checks are performed with a call transaction already established for:

BOICExHC, the RELEASE COMPLETE message being sent at the end of the procedure with a facility IE containing a return_error(error) where error is "NegativePasswordCheck".

31.8.4.2.2.3 Method of test

Initial conditions

System Simulator:

1 cell, default parameters.

Mobile Station:

The MS is in CC state U10.

Related PICS/PIXIT statements

Description of the user's commands and of display of the answers from the network for call barring.

Foreseen final state of the MS

The MS is in CC state U10.

Test procedure

By means of appropriate MMI functions (using either GSM 02.30 or manufacturer defined MMI), the user requests deactivation of a group of call restriction services.

Upon receipt of the REGISTER message, the system simulator answers with the FACILITY message with the Facility information element containing an invoke of the DeactivateSS operation requiring the current password.

Then, by means of appropriate MMI functions, the user gives a password.

Upon receipt of the FACILITY message, the system simulator sends RELEASE COMPLETE message (PD and TI of the SS transaction) with the Facility information element containing a Return_error(error: NegativePasswordCheck) of the GetPassword operation.

The system simulator sends STATUS ENQUIRY, the MS responds with STATUS message indicating CC state U10.

Maximum duration of test

3 min.

Expected sequence

Step	Direction	Message	Comments
1	MS		
2	MS -> SS	CM SERVICE REQUEST	The MS is made to initiate a deactivation of BoicExHC cause: "supplementary service activation"
3	SS -> MS	CM SERVICE ACCEPT	
4	MS -> SS	REGISTER	
5	SS -> MS	FACILITY	Invoke = GetPassword (password) provide correct MMI user indication A password is entered. Register Password operation ReturnError provide correct MMI user indication
6	MS		
7	SS -> MS	RELEASE COMPLETE	
8	MS		
9	SS -> MS	STATUS ENQUIRY	CC state U10
10	MS -> SS	STATUS	

Specific message content

step 4 -

- protocol discriminator: non call related SS message
- message type: REGISTER
- facility

invoke = DeactivateSS

Supplementary service code = BOICExHC

step 7 -

- protocol discriminator: non call related SS message
- transaction identifier: same TI as previous REGISTER message
- message type: RELEASE COMPLETE
- facility:

reject code: NegativePasswordCheck

For the reject the invoke ID must be the same as in the invoke of the DeactivateSS operation.

step 5 -

- protocol discriminator: non call related SS message
- transaction identifier: in FACILITY same as previous REGISTER message
- message type:FACILITY
- facility

invoke = GetPassword

Guidance info: Password (step 5)

31.8.5 Invocation

Invocation is not applicable.

31.8.6 Interrogation

31.8.6.1 Interrogation accepted

31.8.6.1.1 Conformance requirements

- 1) For interrogation of any specific call restriction service with any parameters, the MS shall transmit successively:
 - 1.1) a CHANNEL REQUEST with establishment cause set to "other services requested by the mobile user",
 - 1.2) a CM SERVICE REQUEST with CM service type indicating "supplementary service activation",
 - 1.3) and then the REGISTER message containing a facility IE that includes an invoke of the InterrogateSS operation with parameter values according to the user's request (MMI action).
- 2) Upon receipt of FACILITY message requiring the password, the MS shall provide the appropriate user indication (which is to be described by the manufacturer).
- 3) The MS shall be able to send a password by sending a FACILITY message in accordance to the user request (MMI actions).
- 4) Upon receipt of the RELEASE COMPLETE message, the MS shall provide the appropriate user indication (which is to be described by the manufacturer).

References

- 1) GSM 04.08 sections 3.3.1.1.2 and 9.1.9.
- 2) GSM 04.08 sections 4.5.1.1, 9.2.9 and 10.5.33.
- 3) GSM 04.88, GSM 04.80 sections 2.3 and 3.6.
- 4) GSM 02.30 section 4.5.

31.8.6.1.2 Test purpose

- 1) To check that the MS correctly requests a supplementary service transaction for interrogation of a specific call barring service in CHANNEL REQUEST message.
- 2) To check that the MS correctly requests a supplementary service transaction for interrogation of a call barring service in the subsequent CM SERVICE REQUEST.
- 3) To check that the MS sends a REGISTER message containing the invoke of the InterrogateSS operation with the expected parameter values for interrogation of one call restriction service.
- 4) To check that upon receipt of FACILITY message requiring the password, the MS provides the appropriate user indication (as described by the manufacturer).
- 5) To check that the MS is able to send a password by sending a FACILITY message in accordance to the user request (MMI actions).
- 6) To check that upon receipt of the RELEASE COMPLETE message, the MS provides the appropriate user indication (which is to be described by the manufacturer).

These checks are done for:

- a) BAIC, the result of the operation being a Basic Service code.
- b) BOICExHC, the result of the operation being a SS-status.

31.8.6.1.3 Method of test

Initial conditions

System Simulator:

1 cell, default parameters.

Mobile Station:

The MS is "idle updated".

Related PICS/PIXIT statements

Description of the user's commands and of display of the answers from the network for call barring.

Foreseen final state of the MS

The MS is "idle updated".

Test procedure

By means of appropriate MMI functions (using either GSM 02.30 or manufacturer defined MMI), the user requests interrogation of BAIC.

Upon receipt of the operation (in a REGISTER message), the system simulator answers with the FACILITY message with the Facility information element containing an invoke of the GetPassword operation requiring the current password.

Then, by means of appropriate MMI functions, the user gives a password.

Upon receipt of the FACILITY message, the system simulator answers with a RELEASE COMPLETE message with the Facility information element containing the Return_result (basic service) of the InterrogateSS operation.

The SS transaction and the dedicated channel are released.

Then again, by means of appropriate MMI functions, the user requests interrogation of BOICExHC.

Upon receipt of the operation (in a REGISTER message), the system simulator answers with the FACILITY message with the Facility information element containing an invoke of the GetPassword operation requiring the current password.

Then, by means of appropriate MMI functions, the user gives a password.

Upon receipt of the FACILITY message, the system simulator answers with a RELEASE COMPLETE message with the Facility information element containing the Return_result(SS-status) of the InterrogateSS operation.

The dedicated channel is released.

Maximum duration of test

3 min.

Expected sequence

Step	Direction	Message	Comments
1	MS		
2	MS -> SS	CHANNEL REQUEST	The MS is made to initiate a interrogation of BAIC with establishment cause "Other procedures which can be completed with an SDCCH"
3	SS -> MS	IMMEDIATE ASSIGNMENT	
4	MS -> SS	CM SERVICE REQUEST	cause: "supplementary service activation"
5	SS -> MS	CM SERVICE ACCEPT	
6	MS -> SS	REGISTER	
7	SS -> MS	FACILITY	GetPassword
8	MS		provide correct MMI user indication A password is entered.
9	MS -> SS	FACILITY	Getpassword operation Return Result
10	SS -> MS	RELEASE COMPLETE	InterrogateSS operation Return_result
11	SS -> MS	CHANNEL RELEASE	
12	MS		
13	MS -> SS	CHANNEL REQUEST	The MS is made to initiate a interrogation of call forwarding service for BOICExHC, with establishment cause "Other procedures which can be completed with an SDCCH"
14	SS -> MS	IMMEDIATE ASSIGNMENT	
15	MS -> SS	CM SERVICE REQUEST	cause: "supplementary service activation"
16	SS -> MS	CM SERVICE ACCEPT	
17	MS -> SS	REGISTER	
18	SS -> MS	FACILITY	GetPassword
19	MS		provide correct MMI user indication A password is entered.
20	MS -> SS	FACILITY	Getpassword operation Return Result
21	SS -> MS	RELEASE COMPLETE	InterrogateSS operation Return result
22	MS		provide correct MMI user indication
23	SS -> MS	CHANNEL RELEASE	

Specific message contents

step 6 - BOIC

- protocol discriminator: non call related SS message
- message type: REGISTER
- facility

invoke = Interrogation

Supplementary service code = BAIC

step 17 - BOICExHC

- protocol discriminator: non call related SS message
- message type: REGISTER
- facility

invoke = Interrogation

Supplementary service code = BOICExHC

steps 7, 18 -

- protocol discriminator: non call related SS message
- transaction identifier: in FACILITY same as previous REGISTER message
- message type: FACILITY
- facility

invoke = GetPassword

Guidance info: Password

31.8.6.2 Interrogation rejected

31.8.6.2.1 Conformance requirements

- 1) A transaction of any kind being already established, for interrogation of any specific call barring with any parameters, the MS shall establish a parallel MM transaction, sending a CM SERVICE REQUEST with CM service type indicating "supplementary service activation",
- 2) Then the MS shall send a REGISTER message related to the present SS transaction containing a facility IE that includes an invoke of the InterrogateSS operation with parameter values according to the user's request (MMI action).
- 3) Upon receipt of the RELEASE COMPLETE message related to the present SS transaction, the SS transaction shall be released but the first transaction shall remain unaffected.
- 4) Upon receipt of the RELEASE COMPLETE message, the MS shall provide the appropriate user indication (which is to be described by the Manufacturer).

References

- 1) GSM 04.08 sections 3.3.1.1.2 and 9.1.9.
- 2) GSM 04.08 sections 4.5.1.1, 9.2.9 and 10.5.33.
- 3) GSM 04.88, GSM 04.80 sections 2.3 and 3.6.
- 4) GSM 02.30 section 4.5.

31.8.6.2.2 Test purpose

- 1) To check that the MS correctly requests the establishment of a parallel MM transaction for supplementary service transaction of interrogation of a specific call barring service message, sending a CM SERVICE REQUEST.

- 2) To check that the MS sends a REGISTER message containing the invoke of the InterrogateSS operation with the expected parameter values for interrogation of call barring.
- 3) To check that upon receipt of the RELEASE COMPLETE message related to the present SS transaction, the first transaction remains unaffected.
- 4) To check that upon receipt of the RELEASE COMPLETE message, the MS provides the appropriate user indication (as described by the Manufacturer).

These checks are performed with a call transaction already established for:

- a) BICRoam, the RELEASE COMPLETE message being sent with a facility IE containing a return_error(error) where error is "SS not available".
- b) BOIC, the RELEASE COMPLETE message being sent with a facility IE containing a reject(invoked_problem) where invoked_problem is "resource limitation".

31.8.6.2.3 Method of test

Initial conditions

System Simulator:

1 cell, default parameters.

Mobile Station:

The MS is in CC state U10.

Related PICS/PIXIT statements

Description of the user's commands and of display of the answers from the network for call barring.

Foreseen final state of the MS

The MS is in CC state U10.

Test procedure

By means of appropriate MMI functions (using either GSM 02.30 or manufacturer defined MMI), the user requests interrogation of BICRoam.

Upon receipt of the operation (in a REGISTER message), the system simulator answers with a RELEASE COMPLETE message with the Facility information element containing a Return_error(error: SS not available) of the InterrogateSS operation.

The system simulator sends STATUS ENQUIRY, the MS responds with STATUS message indicating CC state U10.

Then again, by means of appropriate MMI functions, the user requests interrogation of BOIC.

Upon receipt of the REGISTER message, the system simulator answers with the RELEASE COMPLETE message (same PD and TI that in the REGISTER message) with the Facility information element containing a reject(invoked_problem: resource limitation) of the InterrogateSS operation.

The system simulator sends STATUS ENQUIRY, the MS responds with STATUS message indicating CC state U10.

Maximum duration of test

3 min.

Expected sequence

Step	Direction	Message	Comments
1	MS		The MS is made to initiate a interrogation of call barring service for BICRoam cause: "supplementary service activation"
2	MS -> SS	CM SERVICE REQUEST	
3	SS -> MS	CM SERVICE ACCEPT	
4	MS -> SS	REGISTER	
5	SS -> MS	RELEASE COMPLETE	InterrogateSS operation Return_error CC state U10
6	SS -> MS	STATUS ENQUIRY	
7	MS -> SS	STATUS	
8	MS		The MS is made to initiate a interrogation of call barring service for BOIC cause: "supplementary service activation"
9	MS -> SS	CM SERVICE REQUEST	
10	SS -> MS	CM SERVICE ACCEPT	
11	MS -> SS	REGISTER	
12	SS -> MS	RELEASE COMPLETE	(SS) provide correct MMI user indication CC state U10
13	MS		
14	SS -> MS	STATUS ENQUIRY	
15	MS -> SS	STATUS	

Specific message content

step 4 - BICRoam

- protocol discriminator: non call related SS message
- message type: REGISTER
- facility

invoke = Interrogation

Supplementary service code = BICRoam

step 5 -

- protocol discriminator: non call related SS message
- transaction identifier: same TI as previous REGISTER message
- message type: RELEASE COMPLETE
- facility:

return error code: SS not available

For the return error the invoke ID must be the same as in the invoke of the InterrogateSS operation.

step 11 - BOIC

- protocol discriminator: non call related SS message
- message type: REGISTER
- facility

invoke = Interrogation

Supplementary service code = BOIC

step 12 -

- protocol discriminator: non call related SS message
- transaction identifier: same TI as previous REGISTER message
- message type: RELEASE COMPLETE
- facility:
 - reject code: resource limitation

For the reject the invoke ID must be the same as in the invoke of the InterrogateSS operation.

31.8.7 Normal operation

In case of barring of outgoing call the calling mobile receives information about the activation of supplementary services subscribed.

In case of barring of incoming call the calling mobile receives information about the activation of supplementary services subscribed by the other party (the mobile called).

31.8.7.1 Conformance requirements

Upon receipt of the RELEASE COMPLETE message the MS shall provide the appropriate user indication (which is to be described by the manufacturer).

References

31.8.7.2 Test purpose

To check that upon receipt of the RELEASE COMPLETE message the MS provides the appropriate user indication (as described by the manufacturer).

This is tested in the case of an MS making a call to a mobile with incoming calls barred.

31.8.7.3 Method of test

Initial conditions

System Simulator:

1 cell, default parameters.

Mobile Station:

The MS is "idle updated".

Related PICS/PIXIT statements

Description of the user's commands and of display of the answers from the network for call barring.

Foreseen final state of the MS

The MS is "idle updated".

Test procedure

The MS is made to initiate a call.

Upon receipt of the SETUP message, the system simulator answers with the negative acknowledgement RELEASE COMPLETE (to simulate a case where call barring is activated).

Maximum duration of test

1 min.

Expected sequence

Step	Direction	Message	Comments
1	MS -> SS	CHANNEL REQUEST	
2	SS -> MS	IMMEDIATE ASSIGNMENT	
3	MS -> SS	CM SERVICE REQUEST	
4	SS -> MS	CM SERVICE ACCEPT	
5	MS -> SS	SETUP	
6	SS -> MS	RELEASE COMPLETE	provide correct MMI user indication
7	SS -> MS	CHANNEL RELEASE	

Specific message content

RELEASE COMPLETE

- protocol discriminator
- transaction identifier
- message type
- facility

invoke = notification

SS code = BI

SS status = activation indicator (indicating:

Provisioned, registered and active)

31.9 Handling of undefined (future) GSM supplementary services

31.9.1 Mobile station initiated Unstructured supplementary service data operation

31.9.1.1 ProcessUnstructuredSS-request/accepted

Conformance requirements

- 1) The mobile station shall invoke an USSD request by sending a REGISTER message to the network containing a ProcessUnstructuredSS-Request invoke component. This message will contain the alphabet indicator set to "SMS default alphabet" and the language indicator set to "language unspecified". The ussd-string parameter shall contain the following digits and symbols depending on the operation initiated:

Activation *NN(N)# (no supplementary information included)

*NN(N)*SI# (one field of supplementary infor. included)

*NN(N)*SIA*SIB# (two fields of supplementary infor. included)

Deactivation #NN(N)#

#NN(N)*SI#

#NN(N)*SIA*SIB#

Interrogation *#NN(N)#

 *#NN(N)*SI#

 *#NN(N)*SIA*SIB#

Registration **NN(N)#

 **NN(N)*SI#

 **NN(N)*SIA*SIB#

Erase ##NN(N)#

 ##NN(N)*SI#

 ##NN(N)*SIA*SIB#

Operations not yet see conformance requirement 2)

defined in GSM 02.30

NN(N) features a set of service codes which have not yet been allocated for GSM supplementary services (see GSM 02.30 for service codes already specified).

N is a digit within 1..9 and SI, SIA, SIB strings of characters.

- 2) Concerning operations which are not yet specified in GSM 02.30, the MS shall proceed as follows:

The entry of 1 or 2 characters defined in the GSM 03.38 default alphabet followed by "SEND" shall be interpreted by the MS as an USSD request unless the MS is not engaged in a call and the first of the two character entry followed by "SEND" is a "1".

- 3) For supplementary service procedures independent of any call, the initiating side shall establish a MM-connection between the network and the mobile station according to the rules given in GSM 4.08.
- 4) Within a call, the MS shall transmit a USSD request from the user if any. See GSM 04.07 and GSM 04.08 for the handling of multiple MM connections.
- 5) Upon receipt of the RELEASE COMPLETE message, the MS shall display the information contained to the user in a way described by the manufacturer.

References

Conformance requirement 1: GSM 04.90 subclause 6.1, GSM 02.30 subclause 4.5.2, and GSM 02.90 subclause 4.1.1.

Conformance requirement 2: GSM 02.30 subclause 4.5.3.2.

Conformance requirement 3: GSM 04.10 subclause 3.2.1.

Conformance requirement 4: GSM 04.08 subclause 4.5.1.1.

Conformance requirement 5: GSM 03.90 subclause 6.2.1.

Test Purpose

- 1) To verify that the mobile station invokes an USSD request by sending a REGISTER message to the network containing a ProcessUnstructuredSS-Request invoke component. This message will contain the alphabet indicator set to "SMS default alphabet" and the language indicator set to "language unspecified". The ussd-string parameter shall contain the following digits and symbols depending on the operation initiated:

Activation *NN(N)# (no supplementary information included)

 *NN(N)*SI# (one field of supplementary infor. included)

 *NN(N)*SIA*SIB# (two fields of supplementary infor. included)

Deactivation #NN(N)#
 #NN(N)*SI#
 #NN(N)*SIA*SIB#

Interrogation *#NN(N)#
 *#NN(N)*SI#
 *#NN(N)*SIA*SIB#

Registration **NN(N)#
 **NN(N)*SI#
 **NN(N)*SIA*SIB#

Erasure ##NN(N)#
 ##NN(N)*SI#
 ##NN(N)*SIA*SIB#

Operations not yet see 2)

defined in GSM 02.30

NN(N) features a set of service codes which have not yet been allocated for GSM supplementary services (see GSM 02.30 for service codes already specified).

N is a digit within 1..9 and SI, SIA, SIB strings of characters.

- 2) To check that the entry of 1 or 2 characters defined in the GSM 03.38 default alphabet followed by "SEND" shall be interpreted by the MS as an USSD request unless the MS is not engaged in a call and the first of the two character entry followed by "SEND" is a "1".
- 3) To verify that, for supplementary service procedures independent of any call, the initiating side must establish a MM-connection between the network and the mobile station according to the rules given in GSM 04.07 and GSM 04.08.
- 4) To verify that, within a call the MS shall transmit a USSD request if any. See GSM 04.07 and GSM 04.08 for the handling of multiple MM connections.
- 5) To check that upon receipt of the RELEASE COMPLETE message, the MS shall display the information contained to the user in a way described by the manufacturer.

Related PICS/PIXIT Statements

- support of USSD.
- Description of the user's commands and of display of USSD.
- Full rate supported.
- Supported teleservices.

- Support of active state of the call control protocol (U10).

Initial Conditions

System Simulator:

1 cell, default parameters.

Mobile Station:

The MS is in the MM-state "idle updated".

Foreseen final state of the MS

MM-state "idle updated".

Test Procedure

By means of appropriate MMI functions (using either GSM 02.30 or manufacturer defined MMI) the mobile is made to initiate an Unstructured SS data operation. The mobile first establishes a MM-connection with the SS. Then, a REGISTER message is sent to the SS. Upon receipt of this message, the system simulator answers with the RELEASE COMPLETE message. Then a CHANNEL RELEASE message is sent to the MS to release the main signalling link.

The mobile station is forced to originate a call. After the MS has received a CONNECT ACKNOWLEDGE, MMI keys are depressed on the mobile in order to initiate an Unstructured SS data operation. Then a REGISTER message is sent to the SS. Upon receipt of this message, the system simulator answers with the RELEASE COMPLETE message. Finally, the main signalling link is released by transferring a CHANNEL RELEASE message to the MS.

Expected Sequence

The sequence is executed for execution counters $c=1, \dots, 17$.

Counter c determines the ussd-string selected by the user and sent by the MS (see specific message contents concerning the REGISTER message).

Step	Direction	Message	Comments
1	MS		The user presses appropriate MMI keys to initiate the desired unstructured SS data operation.
2	MS -> SS	CHANNEL REQUEST	with establishment cause set to "Other procedures which can be completed with an SDCCH".
3	SS -> MS	IMMEDIATE ASSIGNMENT	"Supplementary service activation".
4	MS -> SS	CM SERVICE REQUEST	
5	SS -> MS	CM SERVICE ACCEPT	
6	MS -> SS	REGISTER	
7	SS -> MS	RELEASE COMPLETE	The SS checks that the content of this message matches specific message content i).
8	SS -> MS	CHANNEL RELEASE	It terminates the transaction used to initiate the desired unstructured SS data operation. It is checked that the ussd string, if any, is displayed by the MS in a way described by the manufacturer. See ii).
9	MS -> SS	CHANNEL REQUEST	The main signalling link is released.
10	SS -> MS	IMMEDIATE ASSIGNMENT	with establishment cause related to mobile originating call. a TCH/F channel is assigned to the MS. "mobile originating call"
11	MS -> SS	CM SERVICE REQUEST	
12	SS -> MS	CM SERVICE ACCEPT	
13	MS -> SS	SETUP	
14	SS -> MS	CALL PROCEEDING	
15	SS -> MS	ALERTING	
16	SS -> MS	CONNECT	
17	MS -> SS	CONNECT ACKNOWLEDGE	
18			Specific MMI keys are depressed to initiate the desired undefined SS service operation. DTMF signalling may occur.
19	MS -> SS	CM SERVICE REQUEST	"Supplementary service activation".
20	SS -> MS	CM SERVICE ACCEPT	
21	MS -> SS	REGISTER	
223	SS -> MS	RELEASE COMPLETE	The MS starts the transaction on the radio interface. The SS checks that REGISTER matches i).
23	SS -> MS	RELEASE COMPLETE	It terminates the transaction used to activate the desired undefined SS data operation. See specific message contents ii).
24	MS -> SS	CHANNEL RELEASE	See message contents iii). The main signalling link is released.
25	SS -> MS	RELEASE COMPLETE	
26	SS -> MS	RELEASE COMPLETE	
26	SS -> MS	CHANNEL RELEASE	

Specific message contents.i) **REGISTER** message.

Contents	Value/remark
Protocol Discriminator	set to "Supplementary service (call independent)"
Transaction identifier	
Register message type	As GSM 04.80
Facility Information Element	See below
SS version indicator	As specified in GSM 04.80

Facility Information Element with Invoke = ProcessUnstructuredSS-Request component type as defined in GSM 04.80 section 3.6.1 table 3.3.

Contents	Value/remark
Facility IE identifier	As GSM 04.08
Length of FIE contents	
Component type tag	Invoke from GSM 04.80
Component length	depending on the length of ussd-string
InvokeID tag	From GSM 04.80
Invoke ID length	1
Invoke ID	Arbitrary (1 octet)
Operation Code tag	From GSM 04.80
Operation Code length	1
Operation Code	ProcessUnstructuredSS-Request
ussd-dataCodingScheme	1 octet long. Alphabet indicator set to "default alphabet". Language indicator set to "undefined"
ussd-string	c=1, *60# (Activation with no supplementary information included) c=2, *201*35# (Activation with one field of supplementary information included) c=3, *70*635*562# (Activation with two fields of supplementary information included) c=4, #60# (Deactivation with no supplementary information included) c=5, #201*35# (Deactivation with one field of supplementary information included) c=6, #70*635*562# (Deactivation with two fields of supplementary information included) c=7, *#60# (Interrogation with no supplementary information included) c=8, *#201*35# (Interrogation with one field of supplementary information included) c=9, *#70*635*562# (Interrogation with two fields of supplementary information included) c=10, **60# (Registration with no supplementary information included) c=11, **201*35# (Registration with one field of supplementary information included) c=12, **70*635*562# (Registration with two fields of supplementary information included) c=13, ##60# (Erasure with no supplementary information included) c=14, ##201*35# (Erasure with one field of supplementary information included) c=15, ##70*635*562# (Erasure with two fields of supplementary information included) c=16,7 (related to conformance requirement 2) c=17, 36 (related to conformance requirement 2)

ii) RELEASE COMPLETE message.

Contents	Value/remark
Protocol Discriminator	set to "Supplementary service (call independent)"
Transaction identifier	the transaction value is the same as REGISTER transaction value but the transaction flag is different
Release Complete message type	As GSM 04.80
Cause	omitted.
Facility Information Element	See below

Facility information element with Return Result = ProcessUnstructuredSS-Request component type as defined in GSM 04.80 section 3.6.1 table 3.4.

Contents	Value/remark
Facility IE identifier	As GSM 04.08
Length of IE contents	
Component type tag	Return Result from GSM 04.80
Component length	depending on the length of the ussd-string
Invoke ID tag	From GSM 04.80
Invoke ID length	1
Invoke ID	The same as the invoke of the ProcessUnstructuredSS-Request
Sequence Identifier	From GSM 04.80
Operation Code tag	From GSM 04.80
Operation Code length	1
Operation Code	ProcessUnstructuredSS-Request
ussd-dataCodingScheme	1 octet long. Alphabet indicator set to "default alphabet" Language indicator set to "undefined"
ussd-string	chosen at random

iii) RELEASE COMPLETE message.

Contents	Value/remark
Protocol Discriminator	set to "Supplementary service (call control)"
Transaction identifier	same as current call.
Release Complete message type	As GSM 04.08

31.9.1.2 ProcessUnstructuredSS-request/cross phase compatibility and error handling

Conformance requirements

- 1) If a mobile initiated USSD request using protocol version 2 is rejected by the network, and the reason for the rejection is indicated either by the problem code "unrecognized operation" or a cause "facility rejected", the mobile station shall assume that the network only supports protocol version 1 of USSD operations. The mobile station shall re-attempt the request by using the appropriate protocol version 1 USSD operation without a SS version indicator if the unstructured data entered by the user can be coded as an IA5 string.
- 2) Upon receipt of the RELEASE COMPLETE message, the MS shall provide the appropriate user indication (which is to be described by the manufacturer). If ussd-String information is included this shall be given to the user (in a way described by the manufacturer).

References

Conformance requirement1:GSM 04.90 subclause 6.2.1.
Conformance requirement2:GSM 03.90 subclause.

Test Purpose

- 1) To verify that If a mobile initiated USSD request using protocol version 2 is rejected by the network, and the reason for the rejection is indicated either by the problem code "unrecognized operation" or a cause "facility rejected", the mobile station shall assume that the network only supports protocol version 1 of USSD operations. The mobile station shall re-attempt the request by using the appropriate protocol version 1 USSD operation without a SS version indicator if the unstructured data entered by the user can be coded as an IA5 string.
- 2) To check that, upon receipt of the RELEASE COMPLETE message, the MS shall provide the appropriate user indication (which is to be described by the manufacturer). If ussd-String information is included this shall be given to the user (in a way described by the manufacturer).

Related PICS/PIXIT Statements

- support of USSD.
 - Full rate supported.
 - Supported teleservices.
- Support of active state of the call control protocol (U10).

Initial Conditions

System Simulator:

1 cell, default parameters.

Mobile Station:

The MS is in the MM-state "idle updated".

Foreseen final state of the MS

MM-state "idle updated".

Test Procedure

Appropriate MMI keys are depressed on the mobile in order to activate an USSD service. The mobile first establishes a MM-connection with the SS. Then, a REGISTER message is sent to the SS. Upon receipt of this message, the system simulator answers with the RELEASE COMPLETE message with the cause element set to "Facility rejected" or the problem code set to "unrecognized operation". Then the SS checks that the MS re-attempts the request by using a REGISTER message containing an invoke of the ProcessUnstructuredData operation. The SS answers with a normal RELEASE COMPLETE to terminate the transaction. Finally the main signalling link is released by transferring to the MS a CHANNEL RELEASE.

Appropriate MMI keys are depressed on the mobile in order to activate an USSD service. The mobile first establishes a MM-connection with the SS. Then, a REGISTER message is sent to the SS. Upon receipt of this message, the system simulator answers with the RELEASE COMPLETE message with the cause element set to "Facility rejected", the main signalling link is release. Then the SS checks that the MS re-establishes a MM-connection and re-attempts the request by using a REGISTER message containing an invoke of the ProcessUnstructuredData operation. Then the SS answers with a normal RELEASE COMPLETE to terminate the transaction. Finally the main signalling link is released by transferring to the MS a CHANNEL RELEASE.

The mobile station is forced to originate a call. After the SS has sent a CONNECT ACKNOWLEDGE, MMI keys are depressed on the mobile in order to activate an USSD service. A REGISTER message is sent to the SS. Upon receipt of this message, the system simulator answers with the RELEASE COMPLETE message containing a return error with an error or a reject with a problem. Then the radio link is release by transferring to the MS a CHANNEL RELEASE message. This subtest is repeated with different errors and problems in the RELEASE COMPLETE message.

Expected Sequence

Step	Direction	Message	Comments
1	MS		The user presses appropriate MMI keys to initiate the desired undefined supplementary service operation.
2	MS -> SS	CHANNEL REQUEST	with establishment cause set to "Other procedures which can be completed with an SDCCH".
3	SS -> MS	IMMEDIATE ASSIGNMENT	
4	MS -> SS	CM SERVICE REQUEST	"Supplementary service activation".
5	SS -> MS	CM SERVICE ACCEPT	
6	MS -> SS	REGISTER	See specific message contents i). Operation code set to "ProcessUnstructuredSS-Request"
7	SS -> MS	RELEASE COMPLETE	See specific message contents ii).
8	SS -> MS	CHANNEL RELEASE	The main signalling link is released.
9	MS -> SS	CHANNEL REQUEST	with establishment cause set to "Other procedures which can be completed with an SDCCH".
10	SS -> MS	IMMEDIATE ASSIGNMENT	
11	MS -> SS	CM SERVICE REQUEST	"Supplementary service activation".
12	SS -> MS	CM SERVICE ACCEPT	
13	MS -> SS	REGISTER	Operation code is set to "ProcessUnstructuredSS-Data". See specific message content i).
14	MS -> SS	RELEASE COMPLETE	normal release of the transaction. See iii).
15	SS -> MS	CHANNEL RELEASE	The main signalling link is released.
16	MS		The user presses appropriate MMI keys to initiate the desired undefined supplementary service.
17	MS -> SS	CHANNEL REQUEST	with establishment cause set to "Other procedures which can be completed with an SDCCH".
18	SS -> MS	IMMEDIATE ASSIGNMENT	
19	MS -> SS	CM SERVICE REQUEST	"Supplementary service activation".
20	SS -> MS	CM SERVICE ACCEPT	
21	MS -> SS	REGISTER	See specific message contents i). Operation code is set to "ProcessUnstructureSS- Request". See i).
22	MS -> SS	RELEASE COMPLETE	see ii). cause is set to "operation rejected"
23	SS -> MS	CHANNEL RELEASE	The main signalling link is released.
24	MS -> SS	CHANNEL REQUEST	with establishment cause set to "Other procedures which can be completed with an SDCCH".
25	SS -> MS	IMMEDIATE ASSIGNMENT	
26	MS -> SS	CM SERVICE REQUEST	"Supplementary service activation".
27	SS -> MS	CM SERVICE ACCEPT	
28	MS -> SS	REGISTER	Operation code is "ProcessUnstructuredSSdata". See specific message contents i).
29	SS -> MS	RELEASE COMPLETE	normal release of the transaction. See iii).
30	SS -> MS	CHANNEL RELEASE	The main signalling link is released.
			For k=1 to 10, go through steps 31 to 48. Counter k deals with different kinds of general and invoke problems in step 44.
31	MS -> SS	CHANNEL REQUEST	with establishment cause related to mobile originating call.
32	SS -> MS	IMMEDIATE ASSIGNMENT	a TCH/F channel is assigned to the MS.
33	MS -> SS	CM SERVICE REQUEST	"mobile originating call"
34	SS -> MS	CM SERVICE ACCEPT	
35	MS -> SS	SETUP	
36	SS -> MS	CALL PROCEEDING	
37	SS -> MS	ALERTING	
38	SS -> MS	CONNECT	
39	MS -> SS	CONNECT ACKNOWLEDGE	
40			Specific MMI keys are depressed to initiate the desired undefined supplementary service. DTMF signalling may occur.

Step	Direction	Message	Comments
41	MS -> SS	CM SERVICE REQUEST	"supplementary service activation" The MS starts the transaction on the radio interface. See specific message contents i). The operation code is set to "ProcessUnstructuredSS-Request".
42	SS -> MS	CM SERVICE ACCEPT	
43	MS -> SS	REGISTER	
44	SS -> MS	RELEASE COMPLETE	different errors and problems are sent. See specific message contents iiib) and iiic). See message contents iv). The main signalling link is released.
45	SS -> MS	DISCONNECT	
46	MS -> SS	RELEASE	
47	SS -> MS	RELEASE COMPLETE	
48	SS -> MS	CHANNEL RELEASE	

Specific message contents.

i) REGISTER message.

Contents	Value/remark
Protocol Discriminator	set to "Supplementary service (call independent)"
Transaction identifier	
Register message type	As GSM 04.80
Facility Information Element	See below
SS version indicator	As specified in GSM 04.80 for version 2 protocol Always omitted for version 1 protocol

For steps 6, 21 and 43, Facility Information Element with Invoke = ProcessUnstructuredSS-Request (for version 2 protocol) component type as defined in GSM 04.80 section 3.6.1 table 3.3.

For steps 13 and 28, Facility Information Element with Invoke = ProcessUnstructuredSS-Data (for version 1 protocol) as defined in GSM 04.80 section 3.6.1 table 3.3.

Contents	Value/remark
Facility IE identifier	As GSM 04.08
Length of FIE contents	
Component type tag	Invoke from GSM 04.80
Component length	Depending on the length of ussd-string
InvokeID tag	From GSM 04.80
Invoke ID length	1
Invoke ID	Arbitrary (1 octet)
Operation Code tag	From GSM 04.80
Operation Code length	1
Operation Code	ProcessUnstructuredSS-Request (for version 2 protocol) ProcessUnstructuredSS-Data (for version 1 protocol)
ussd-dataCodingScheme	1 octet long. Alphabet indicator set to "default alphabet". Language indicator set to "undefined"
ussd-string	*70*635*562#

ii) RELEASE COMPLETE message.

Contents	Value/remark
Protocol Discriminator	Set to "Supplementary service (call independent)"
Transaction identifier	The transaction value is the same as the REGISTER transaction value but the transaction flag is different
Facility message type	As GSM 04.80
Facility Information Element	See below

Facility Information Element with Reject = ProcessUnstructuredSS-Request component type as defined in GSM 04.80 section 3.6.1 table 3.6.

Contents	Value/remark
Facility IE identifier	As GSM 04.08
Length of FIE contents	
Component type tag	Reject from GSM 04.80
Component length	Depending on the length of ussd-string
InvokeID tag	From GSM 04.80
Invoke ID length	1
Invoke ID	The same as the invoke of the ProcessUnstructuredSS-Request
Problem Code tag	As GSM 04.80
Problem Code length	
General Problem code	Unrecognized operation

iii) **RELEASE COMPLETE** message.

Contents	Value/remark
Protocol Discriminator	Set to "Supplementary service (call independent)"
Transaction identifier	The transaction value is the same as the REGISTER transaction value but the transaction flag is different
Release complete message type	As GSM 04.80
Cause	For step 19, cause is set to "facility rejected" and FIE is omitted. For steps 11, 26, 41 this field is omitted.
Facility Information Element	For step 11 and 26 see iiiia). For step 41 see iiib) and iic). For step 19 this field is omitted.

iiiia) For steps 6, 21 and 43, Facility Information Element with Return Result = ProcessUnstructuredSS-Request component type as defined in GSM 04.80 section 3.6.1 table 3.4.

For steps 13 and 28, Facility Information Element with Return Result = ProcessUnstructuredSS-Data component type as defined in GSM 04.80 section 3.6.1 table 3.4.

Contents	Value/remark
Facility IE identifier	As GSM 04.08
Length of FIE contents	
Component type tag	ReturnResult from GSM 04.80
Component length	Depending on the length of ussd-string
InvokeID tag	From GSM 04.80
Invoke ID length	1
Invoke ID	The same as the invoke of the ProcessUnstructuredSS-Data

iiib) Facility Information Element with Return Error = ProcessUnstructuredSS-Request component type as defined in GSM 04.80 section 3.6.1 table 3.5.

Contents	Value/remark
Facility IE identifier	As GSM 04.08
Length of FIE contents	
Component type tag	Return Error from GSM 04.80
Component length	Depending on the length of ussd-string
InvokeID tag	From GSM 04.80
Invoke ID length	1
Invoke ID	The same as the invoke of the ProcessUnstructuredSS-Request
Error Code tag	As GSM 04.80
Error Code length	
Error Code	k=1, system failure k=2, data missing k=3, unknown alphabet k=4, unexpected data value

iiic) Facility Information Element with Reject = ProcessUnstructuredSS-Request component type as defined in GSM 04.80 section 3.6.1 table 3.6.

Contents	Value/remark
Facility IE identifier	As GSM 04.08
Length of FIE contents	
Component type tag	Reject from GSM 04.80
Component length	Depending on the length of ussd-string
InvokeID tag	From GSM 04.80
Invoke ID length	1
Invoke ID	The same as the invoke of the ProcessUnstructuredSS-Request
Problem Code tag	As GSM 04.80
Problem Code length	
General Problem code	k=5, Unrecognized component k=6, Mistyped component k=7, Badly structured component k=8, Mistyped parameter k=9, Resource limitation k=10, Initiating release
Invoke Problem code	

iv) **RELEASE COMPLETE** message.

Contents	Value/remark
Protocol Discriminator	Set to "Supplementary service (call control)"
Transaction identifier	Same as current call.
Release Complete message type	As GSM 04.08

31.9.2 Network initiated unstructured supplementary service operations

31.9.2.1 UnstructuredSS-Notify/accepted

Conformance requirements

- 1) For a USSD notification, the MS shall display the text provided and await user input. The MS shall acknowledge the operation by sending a FACILITY message containing an empty result component to the network.
- 2) The MS shall include alphabet and language indicators in the response to the network. The alphabet indicator shall indicate "SMS default alphabet". The language indicator shall indicate "language unspecified".
- 3) At any stage while the MS is registered with a network, the network may send an unstructured string to the MS. So, the MS shall be able to process the operation during a call or out of a call.

References

conformance requirement 1: GSM 04.90 subclause 5.2.1.

conformance requirement 2: GSM 02.90 subclause 4.2.2.

conformance requirement 3: GSM 02.90 subclause 4.2.1.

Test Purpose

- 1) To verify that for a USSD notification, the MS shall display the text provided and await user input. If the user enters a response, the MS shall acknowledge the operation by sending a FACILITY message containing an empty result component to the network.
- 2) To verify that the MS shall include alphabet and language indicators in the response to the network. The alphabet indicator shall indicate "SMS default alphabet". The language indicator shall indicate "language unspecified".
- 3) To check that the MS shall be able to process the operation during a call or out of a call.

Related PICS/PIXIT Statements

- support of USSD.
- Full rate supported.
- Supported teleservices.
- Support of active state of the call control protocol (U10).

Initial Conditions

System Simulator:

1 cell, default parameters.

Mobile Station:

The MS is in the MM-state "idle updated".

Foreseen final state of the MS

MM-state "idle updated".

Test Procedure

- The MS is paged and a RR-connection is established. Then, the SS sends a REGISTER message containing a facility information element with operation code set to ProcessUnstructuredSS-Notify. The user checks that the ussd string sent by the SS is correctly displayed by the MS. The MS has to send a FACILITY message with an empty return result component.
- Then the SS originates a call to the MS. When the MS is in the U10 state, the SS releases the transaction identifier concerning USSD transaction by sending a RELEASE COMPLETE. The SS initiates a new ussd transaction by sending a REGISTER message containing a facility information element with operation code set to UnstructuredSS-Notify. The user checks that the ussd string sent by the SS is correctly displayed by the MS. The MS has to send a FACILITY message with an empty return result component. Finally the SS releases both MM connections and the radio link.

Step	Direction	Message	Comments
1	SS -> MS	PAGING REQUEST TYPE 1	<p>a SDCCH is allocated to the MS.</p> <p>initiation of the transaction concerning the USSD notification operation. See i). The MS has to display the USSD string sent from the network. signalling message sent by the MS as the response. The SS checks that it matches ii). incoming call.</p> <p>a TCH is allocated to the MS.</p> <p>this message releases the transaction concerning the USSD operation. See iii). initiation of a USS request operation during a call. See specific message contents i). The MS has to display the USSD string received from the SS. The SS checks that this message matches ii). It releases the transaction identifier concerning the ussd operation. call release initiation. see iv).</p>
2	MS -> SS	CHANNEL REQUEST	
3	SS -> MS	IMMEDIATE ASSIGNMENT	
4	MS -> SS	PAGING RESPONSE	
5	SS -> MS	REGISTER	
6			
7	MS -> SS	FACILITY	
8	SS -> MS	SETUP	
9	MS -> SS	CALL CONFIRMED	
10	MS -> SS	ALERTING	
11	MS -> SS	CONNECT	
12	SS -> MS	ASSIGNMENT COMMAND	
13	MS -> SS	ASSIGNMENT COMPLETE	
14	SS -> MS	CONNECT ACKNOWLEDGE	
15	SS -> MS	RELEASE COMPLETE	
16	SS -> MS	REGISTER	
17			
18	MS -> SS	FACILITY	
19	SS -> MS	RELEASE COMPLETE	
20	SS -> MS	DISCONNECT	
21	MS -> SS	RELEASE	
22	SS -> MS	RELEASE COMPLETE	
23	SS -> MS	CHANNEL RELEASE	

Specific message contents.

i) REGISTER message.

Contents	Value/remark
Protocol Discriminator	set to "Supplementary service (call independent)"
Transaction identifier	
Register message type	As GSM 04.80
Facility Information Element	See below

Facility Information Element with Invoke = UnstructuredSS-Notify component type as defined in GSM 04.90, clause 5.2.1.

Contents	Value/remark
Facility IE identifier	As GSM 04.08
Length of FIE contents	
Component type tag	Invoke from GSM 04.80
Component length	depending on the length of ussd-string
InvokeID tag	From GSM 04.80
Invoke ID length	1
Invoke ID	Arbitrary (1 octet)
Operation Code tag	From GSM 04.80
Operation Code length	1
Operation Code	UnstructuredSS-Notify
ussd-dataCodingScheme	1 octet long. Alphabet indicator set to "default alphabet". Language indicator set to "undefined"
ussd-string	arbitrary chosen by the SS

ii) Facility message.

Contents	Value/remark
Protocol Discriminator Transaction identifier	set to "Supplementary service (call independent)" the transaction value is the same as REGISTER transaction value but the transaction flag is different
Facility message type Facility Information Element	As GSM 04.80 See below

Facility Information Element with Return Result = empty result component according to GSM 04.90, clause 5.2.1, figure 5.3.

Contents	Value/remark
Facility IE identifier	As GSM 04.08
Length of FIE contents	
Component type tag	Return Result from GSM 04.80
Component length	
InvokeID tag	From GSM 04.80
Invoke ID length	1
Invoke ID	The same as the invoke of the UnstructuredSS-Notify

iii) RELEASE COMPLETE message.

Contents	Value/remark
Protocol Discriminator Transaction identifier	set to "Supplementary service (call independent)" the transaction value is the same as REGISTER transaction flag is different
Release Complete message type Facility Information Element	As GSM 04.80 omitted

iv) RELEASE COMPLETE message.

Contents	Value/remark
Protocol Discriminator Transaction identifier Release Complete message type	set to "Supplementary service (call control)" same as current call. As GSM 04.08

31.9.2.2 UnstructuredSS-Notify/rejected on user busy

Conformance requirements

- 1) When the mobile station receives an USSD operation in parallel to any call independent supplementary transaction, it shall respond with a return error component in a RELEASE COMPLETE message, containing the "USSD-Busy" error.

References

conformance requirement 1: GSM 04.90 subclause 5.1.1.

Test Purpose

- 1) To verify that when the mobile station receives an USSD operation in parallel to any call independent supplementary transaction, it responds with a return error component in a RELEASE COMPLETE message, containing the "USSD-Busy" error.

Related PICS/PIXIT Statements

- support of USSD.
 - Full rate supported.
 - Supported teleservices.
- Support of active state of the call control protocol (U10).

Initial Conditions

System Simulator:

1 cell, default parameters.

Mobile Station:

The MS is in the MM-state "idle updated".

Foreseen final state of the MS

MM-state "idle updated".

Test Procedure

- The MS is paged and a RR-connection is established. Then, the SS sends a REGISTER message containing a facility information element with operation code set to UnstructuredSS-Notify. The SS initiates an other USSD transaction by sending a REGISTER message with transaction identifier different from the previous one. The SS checks that the MS answers with a RELEASE COMPLETE message with an error component set to "USSD busy". Then the SS releases the radio link.

Test Procedure

Step	Direction	Message	Comments
1	SS -> MS	PAGING REQUEST TYPE 1	
2	MS -> SS	CHANNEL REQUEST	
3	SS -> MS	IMMEDIATE ASSIGNMENT	a SDCCH is allocated to the MS.
4	MS -> SS	PAGING RESPONSE	
5	SS -> MS	REGISTER	initiation of the transaction concerning the USSD notification operation. See i).
6			The MS has to display the USSD string sent from the SS. See ii).
7	MS -> SS	FACILITY	
8	SS -> MS	REGISTER	initiation of an other USSD notification. The transaction identifier is different from that in step 5. See i).
9	MS -> SS	RELEASE COMPLETE	error set to "USSD busy". Transaction initiated in step 6 by the network is rejected by the MS. See iii).
10	SS -> MS	RELEASE COMPLETE	normal release of transaction initiated in step 5. See iii).
11	SS -> MS	CHANNEL RELEASE	release of the main signalling link.

Specific message contents.

i) REGISTER message.

See paragraph 31.9.2..1.

ii) FACILITY message.

See paragraph 31.9.2..1.

iii) RELEASE COMPLETE message.

Contents	Value/remark
Protocol Discriminator Transaction identifier	set to "Supplementary service (call independent)" for step 10, same as REGISTER transaction identifier for step 9, the transaction value is the same as REGISTER transaction value but the transaction flag is different.
Release complete message type Facility Information Element	As GSM 04.80 for step 9 see iiib). for step 10, see iia).

iiia) Facility Information Element with Return Result = UnstructuredSS-Notify component type as defined in GSM 04.80 section 3.6.1 table 3.4.

Contents	Value/remark
Facility IE identifier Length of FIE contents Component type tag Component length InvokeID tag Invoke ID length Invoke ID	As GSM 04.08 Return Result from GSM 04.80 From GSM 04.80 1 The same as the invoke of the UnstructuredSS-Notify in step 5

iiib) Facility Information Element with Return Error = UnstructuredSS-Notify component type as defined in GSM 04.80 section 3.6.1 table 3.5.

Contents	Value/remark
Facility IE identifier Length of FIE contents Component type tag Component length InvokeID tag Invoke ID length Invoke ID	As GSM 04.08 Return Result from GSM 04.80 From GSM 04.80 1 The same as the invoke of the UnstructuredSS-Notify in step 8
Error Code tag Error Code length Error Code	As GSM 04.80 USSD Busy

31.9.2.3 UnstructuredSS-Request/accepted**Conformance requirements**

- 1) For a USSD request, the MS shall display the text provided and await user input. if the user enters a response, the MS shall return the response to the network, maintaining the transaction.
- 2) The MS shall include alphabet and language indicators in the response to the network. The alphabet indicator shall indicate "SMS default alphabet". The language indicator shall indicate "language unspecified".

- 3) At any stage while the MS is registered with a network, the network may send an unstructured string to the MS. So, the MS shall be able to process the operation during a call or out of a call.

References

conformance requirement 1: GSM 03.90 subclause 5.2.5.

conformance requirement 2: GSM 02.90 subclause 4.2.2.

conformance requirement 3: GSM 02.90 subclause 4.2.1.

Test Purpose

- 1) To test that, for a USSD request, the MS shall display the text provided and await user input. if the user enters a response, the MS shall return the response to the network, maintaining the transaction.
- 2) To verify that the MS shall include alphabet and language indicators in the response to the network. The alphabet indicator shall indicate "SMS default alphabet". The language indicator shall indicate "language unspecified".
- 3) To check that the MS shall be able to process the operation during a call or out of a call.

Related PICS/PIXIT Statements

- support of USSD.
 - Full rate supported.
 - Supported teleservices.
- Support of active state of the call control protocol (U10).

Initial Conditions

System Simulator:

1 cell, default parameters.

Mobile Station:

The MS is in the MM-state "idle updated".

Foreseen final state of the MS

MM-state "idle updated".

Test Procedure

- The MS is paged and a RR-connection is established. Then, the SS sends a REGISTER message containing a facility information element with operation code set to ProcessUnstructuredSS-Request. The user checks that the ussd string sent by the SS is correctly displayed by the MS and answers the request by depressing MMI keys. Then the MS has to send a FACILITY message with ussd string exactly containing the digits and symbols expressed on the mobile equipment keypad.
- Then the SS originates a call to the MS. When the MS is in the U10 state, the SS releases the transaction identifier concerning USSD transaction by sending a RELEASE COMPLETE. The SS initiates a new ussd transaction by sending a REGISTER message containing a facility information element with operation code set to UnstructuredSS-Request. The user checks that the ussd string sent by the SS is correctly displayed by the MS and answers the request by depressing MMI keys. Then the MS has to send a FACILITY message with ussd string exactly containing the digits and symbols expressed on the mobile equipment keypad. Finally the SS releases both MM connections and the radio link.

Step	Direction	Message	Comments
1	SS -> MS	PAGING REQUEST TYPE 1	<p>a SDCCH is allocated to the MS.</p> <p>initiation of the transaction concerning the USSD Request operation. See i).</p> <p>The MS has to display the USSD string sent from the network and waits for the user response. By depressing MMI keys followed by SEND the user answers signalling message sent by the MS as the response. See ii).</p> <p>incoming call.</p> <p>a TCH is allocated to the MS.</p> <p>this message releases the transaction concerning the USSD operation. See iii).</p> <p>initiation of a USS request operation during a call. See specific message contents i).</p> <p>The MS has to display the USSD string received from the SS. By depressing MMI keys followed by SEND, the user answers. DTMF signalling may occur. See ii).</p> <p>It releases the transaction identifier concerning the ussd operation.</p> <p>call release initiation. see iv).</p>
2	MS -> SS	CHANNEL REQUEST	
3	SS -> MS	IMMEDIATE ASSIGNMENT	
4	MS -> SS	PAGING RESPONSE	
5	SS -> MS	REGISTER	
6			
7	MS -> SS	FACILITY	
8	SS -> MS	SETUP	
9	MS -> SS	CALL CONFIRMED	
10	MS -> SS	ALERTING	
11	MS -> SS	CONNECT	
12	SS -> MS	ASSIGNMENT COMMAND	
13	MS -> SS	ASSIGNMENT COMPLETE	
14	SS -> MS	CONNECT ACKNOWLEDGE	
15	SS -> MS	RELEASE COMPLETE	
16	SS -> MS	REGISTER	
17			
18	MS -> SS	FACILITY	
19	SS -> MS	RELEASE COMPLETE	
20	SS -> MS	DISCONNECT	
21	MS -> SS	RELEASE	
22	SS -> MS	RELEASE COMPLETE	
23	SS -> MS	CHANNEL RELEASE	

Specific message contents

i) REGISTER message.

Contents	Value/remark
Protocol Discriminator	set to "Supplementary service (call independent)"
Transaction identifier	
Register message type	As GSM 04.80
Facility Information Element	See below

Facility Information Element with Invoke = UnstructuredSS-Request component type as defined in GSM 04.80 section 3.6.1 table 3.3.

Contents	Value/remark
Facility IE identifier	As GSM 04.08
Length of FIE contents	
Component type tag	Invoke from GSM 04.80
Component length	depending on the length of ussd-string
InvokeID tag	From GSM 04.80
Invoke ID length	1
Invoke ID	Arbitrary (1 octet)
Operation Code tag	From GSM 04.80
Operation Code length	1
Operation Code	UnstructuredSS-Request
ussd-dataCodingScheme	1 octet long. Alphabet indicator set to "default alphabet". Language indicator set to "undefined"
ussd-string	arbitrary chosen by the SS

ii) Facility message.

Contents	Value/remark
Protocol Discriminator Transaction identifier	set to "Supplementary service (call independent)" the transaction identifier value is the same as REGISTER transaction value but the transaction flag is different.
Facility message type	As GSM 04.80
Facility Information Element	See below

Facility Information Element with Return Result = UnstructuredSS-Request component type as defined in GSM 04.80 section 3.6.1 table 3.4.

Contents	Value/remark
Facility IE identifier	As GSM 04.08
Length of FIE contents	
Component type tag	Return Result from GSM 04.80
Component length	depending on the length of ussd-string
InvokeID tag	From GSM 04.80
Invoke ID length	1
Invoke ID	The same as the invoke of the UnstructuredSS-Request
Sequence Identifier	
Sequence length	
Operation Code tag	1
Operation Code length	1
Operation Code	UnstructuredSS-Request
ussd-dataCodingScheme	1 octet long. Alphabet indicator set to "default alphabet". Language indicator set to "undefined"
ussd-string	contains exactly the digits and symbols expressed on the mobile equipment keypad.

iii) RELEASE COMPLETE message.

Contents	Value/remark
Protocol Discriminator Transaction identifier	set to "Supplementary service (call independent)" same as REGISTER transaction identifier
Release Complete message type	As GSM 04.80
Facility Information Element	omitted

iv) RELEASE COMPLETE message.

Contents	Value/remark
Protocol Discriminator Transaction identifier	set to "Supplementary service (call control)" same as current call.
Release Complete message type	As GSM 04.08

31.9.2.4 UnstructuredSS-Request/rejected on user busy

Conformance requirements

- 1) When the mobile station receives an USSD operation in parallel to any call independent supplementary transaction, it shall respond with a return error component in a RELEASE COMPLETE message, containing the "USSD-Busy" error.

References

conformance requirement 1: GSM 04.90 subclause 5.1.1.

Test Purpose

- 1) To verify that when the mobile station receives an USSD operation in parallel to any call independent supplementary transaction, it responds with a return error component in a RELEASE COMPLETE message, containing the "USSD-Busy" error.

Related PICS/PIXIT Statements

- support of USSD.
- Full rate supported.
- Supported teleservices.
- Support of active state of the call control protocol (U10).

Initial Conditions

System Simulator:

1 cell, default parameters.

Mobile Station:

The MS is in the MM-state "idle updated".

Foreseen final state of the MS

MM-state "idle updated".

Test Procedure

- The MS is paged and a RR-connection is established. Then, the SS sends a REGISTER message containing a facility information element with operation code set to UnstructuredSS-Request. The SS initiates an other USSD transaction by sending a REGISTER message with transaction identifier different from the previous one. The SS checks that the MS answers with a RELEASE COMPLETE message with an error component set to "USSD busy". Then the SS releases the radio link.

Test Procedure

Step	Direction	Message	Comments
1	SS -> MS	PAGING REQUEST TYPE 1	
2	MS -> SS	CHANNEL REQUEST	
3	SS -> MS	IMMEDIATE ASSIGNMENT	a SDCCH is allocated to the MS.
4	MS -> SS	PAGING RESPONSE	
5	SS -> MS	REGISTER	initiation of the transaction concerning the USSD Request operation. See i).
6			The MS has to display the USSD string sent from the network and waits for the user response. By depressing MMI keys followed by SEND the user answers.
7	MS -> SS	FACILITY	signalling message sent by the MS as the response to the request. See ii).
8	SS -> MS	REGISTER	initiation of an other USSD request. The transaction identifier is different from that in step 5. See i).
9	MS -> SS	RELEASE COMPLETE	error set to "USSD busy". Transaction initiated in step 6 by the network is rejected by the MS. See iii).
10	SS -> MS	RELEASE COMPLETE	normal release of transaction initiated in step 5. See iii).
11	SS -> MS	CHANNEL RELEASE	release of the main signalling link.

Specific message contents

i) REGISTER **message**.

See paragraph 31.9.2.3.

ii) FACILITY **message**.

See paragraph 31.9.2.3.

iii) RELEASE COMPLETE message.

Contents	Value/remark
Protocol Discriminator Transaction identifier	set to "Supplementary service (call independent)" the transaction identifier value is the same as REGISTER transaction value but the transaction flag is different.
Release complete message type Facility Information Element	As GSM 04.80 for step 9 see iiib). for step10 see iiia).

iiia) Facility Information Element with Return Result = UnstructuredSS-Request component type as defined in GSM 04.80 section 3.6.1 table 3.4.

Contents	Value/remark
Facility IE identifier	As GSM 04.08
Length of FIE contents	
Component type tag	Return Result from GSM 04.80
Component length	depending on the length of ussd-string
InvokeID tag	From GSM 04.80
Invoke ID length	1
Invoke ID	The same as the invoke of the UnstructuredSS-Request

iiib) Facility Information Element with Return Error = UnstructuredSS-Request component type as defined in GSM 04.80 section 3.6.1 table 3.5.

Contents	Value/remark
Facility IE identifier	As GSM 04.08
Length of FIE contents	
Component type tag	Return Error from GSM 04.80
Component length	depending on the length of ussd-string
InvokeID tag	From GSM 04.80
Invoke ID length	1
Invoke ID	The same as the invoke of the UnstructuredSS-Request
Error Code tag	As GSM 04.80
Error Code length	
Error Code	USSD Busy

31.10 MMI input for USSD

31.10.1 Conformance requirements

If the MS cannot interpret the MMI input as a defined GSM Supplementary Services, SIM control procedure or MS manufacturer-defined procedure, and if the MMI input is in the form:

"entry of any characters defined in the GSM 03.38 Default Alphabet (up to the maximum defined in GSM 04.80) followed by #SEND"

or

"entry of 1 or 2 characters defined in the GSM 03.38 Default Alphabet followed by SEND"

then it shall be interpreted by the MS as Unstructured SS Data and sent transparently towards the network, unless the MS is not engaged in a call and the first digit of the 2 character entry, followed by SEND, is a "1". In this case the MS shall transmit this as a call-setup request.

References

GSM 02.30 section 4.5.3.

31.10.2 Test purpose

To check that the entry of 2 digits in the form 1X (X in the set 0,...9) followed by SEND is accepted by the mobile station in idle mode as a normal call establishment for the 1X number. It is checked that the MS sends a CHANNEL REQUEST, sends CM SERVICE REQUEST message for mobile originated call (after having received an IMMEDIATE ASSIGNMENT), and then sends the SETUP message containing the 1X phone number as called number (after having received the CM SERVICE ACCEPT message).

31.10.3 Method of test

Initial conditions

System Simulator:

1 cell, default parameters.

Mobile Station

The MS is "idle updated";

Related PICS/PIXIT statement(s)

Foreseen final state of the MS:

The MS is "idle updated.

Test procedure

The user requests call establishment successively for every 2 digit phone number of the 1X form (X in the set 0,...9) allowing ten seconds between each attempts.

Maximum duration of test

3 min.

Expected Sequence

The following sequence is executed for execution counter k = 1 to 10.

Step	Direction	Message	Comments
1	MS		The MS is made to initiate call establishment for phone number 1X (where X = k-1)
2	MS -> SS	CHANNEL REQUEST	with establishment cause related to mobile originating call
3	SS -> MS	IMMEDIATE ASSIGNMENT	
4	MS -> SS	CM SERVICE REQUEST	"mobile originating call"
5	SS -> MS	CM SERVICE ACCEPT	
6	MS -> SS	SETUP	called BCD number is 1X
7	SS -> MS	RELEASE COMPLETE	
8			Wait for 10 seconds

Specific message contents.

None.

31.11 Specific message contents and ASN.1 codings

Introduction

In this section a mixed form of ASN.1 coding has been used in ASN.1 components within the messages.

Some components use the indefinite form of coding, and some use the short definite form.

An example of a FACILITY message using indefinite form of coding is described below.

The same message using short definite form of coding is described in Test 31.2.1.1.1 Step 7 of this section.

Contents	Value/remark	Coding
Length of FIE contents	43	2B
Component type tag	Return Result	A2
Component length	indefinite	80
Invoke ID tag		02
Invoke ID length	1	01
Invoke ID	As received	--
Sequence tag		30
Sequence length	indefinite	80
Operation Code tag		02
Operation Code length	1	01
Operation Code	RegisterSS	0A
SS-Information		
Forwarding Info tag	Tag=A0	A0
Forwarding Info length	indefinite	80
SS-Code tag	Tag=4	04
SS-Code length	1	01
SS-Code	CFNRy	2A
Forwarding Feature List	Seq.	30
Length Indicator	indefinite	80
Forwarding Feature	Seq.	30
Forwarding Feature length	indefinite	80
Basic Service Code identifier	TeleserviceCode	83
Teleservice length	1	01
Teleservice code	Telephony	11
SS-Status	Tag=84	84
SS-Status length	1	01
SS-Status code	Prov., Registered, Active	07
Forwarded To Number identifier	Tag=85	85
ISDN-AddressString length	5	05
AddressString type	Unknown	81
AddressString	TBCD-String: 00431234	00 34 21 43
NoReplyConditionTime	Tag=87	87
Length Indicator	1	01
NoReplyConditionTime	5	05
End-Of-Content Tag	0	00
Length Indicator	0	00
End-Of-Content Tag	0	00
Length Indicator	0	00
End-Of-Content Tag	0	00
Length Indicator	0	00
End-Of-Content Tag	0	00
Length Indicator	0	00

Test 31.2.1.1.1. Registration accepted

MMI sequence: **61*00431234*11*5#

Step 6: MS -> SS REGISTER

Contents	Value/remark	Coding
Length of FIE contents	26	1A
Component type tag	Invoke	A1 (1)
Component length	24	18
Invoke ID tag		02
Invoke ID length	1	01
Invoke ID	Arbitrary	--
Operation Code tag		02
Operation Code length	1	01
Operation Code	RegisterSS	0A
RegisterSS-Arg	Seq.	30 (1)
RegisterSS-Arg length	16	10
SS-Code tag	Tag=4	04
SS-Code length	1	01
SS-Code	CFNRy	2A
Basic Service Code identifier	TeleserviceCode	83
Teleservice length	1	01
Teleservice code	Telephony	11
Forwarded To Number identifier	Tag=84	84
AddressString length	5	05
AddressString type	Unknown	81
AddressString	TBCD-String: 00431234	00 34 21 43
NoReplyConditionTime tag	Tag=85	85
NoReplyConditionTime length	1	01
NoReplyConditionTime	5	05

NOTE 1: This component may use the indefinite form.

Step 7: SS -> MS RELEASE COMPLETE

Contents	Value/remark	Coding
Length of FIE contents	35	23
Component type tag	Return Result	A2 (1)
Component length	33	21
Invoke ID tag		02
Invoke ID length	1	01
Invoke ID	As received	--
Sequence tag		30 (1)
Sequence length	28	1C
Operation Code tag		02
Operation Code length	1	01
Operation Code	RegisterSS	0A
SS-Information		
Forwarding Info tag	Tag=A0	A0 (1)
Forwarding Info length	23	17
SS-Code tag	Tag=4	04
SS-Code length	1	01
SS-Code	CFNRy	2A
Forwarding Feature List	Seq.	30 (1)
Length Indicator	18	12
Forwarding Feature	Seq.	30 (1)
Forwarding Feature length	16	20
Basic Service Code identifier	TeleserviceCode	83
Teleservice length	1	01
Teleservice code	Telephony	11
SS-Status	Tag=84	84
SS-Status length	1	01
SS-Status code	Prov., Registered, Active	07
Forwarded To Number identifier	Tag=85	85
ISDN-AddressString length	5	05
AddressString type	Unknown	81
AddressString	TBCD-String: 00431234	00 34 21 43
NoReplyConditionTime	Tag=87	87
Length Indicator	1	01
NoReplyConditionTime	5	05

MMI sequence: **21*00431234*13#

Step 15: MS -> SS REGISTER

Contents	Value/remark	Coding
Length of FIE contents	23	17
Component type tag	Invoke	A1 (1)
Component length	21	15
Invoke ID tag		02
Invoke ID length	1	01
Invoke ID	Arbitrary	--
Operation Code tag		02
Operation Code length	1	01
Operation Code	RegisterSS	0A
RegisterSS-Arg	Seq.	30 (1)
RegisterSS-Arg length	13	0D
SS-Code tag	Tag=4	04
SS-Code length	1	01
SS-Code	CFU	21
Basic Service Code identifier	TeleserviceCode	83
Teleservice length	1	01
Teleservice code	All Facsimile Services	60
Forwarded To Number identifier	Tag=84	84
AddressString length	5	05
AddressString type	Unknown	81
AddressString	TBCD-String: 00431234	00 34 21 43

Step 16: SS -> MS RELEASE COMPLETE

Contents	Value/remark	Coding
Length of FIE contents	42	2A
Component type tag	Return Result	A2 (1)
Component length	indefinite	80
Invoke ID tag		02
Invoke ID length	1	01
Invoke ID	As received	--
Sequence tag		30 (1)
Sequence length	indefinite	80
Operation Code tag		02
Operation Code length	1	01
Operation Code	RegisterSS	0A
SS-Information		
Forwarding Info tag	Tag=A0	A0 (1)
Forwarding Info length	indefinite	80
SS-Code tag	Tag=4	04
SS-Code length	1	01
SS-Code	CFU	21
Forwarding Feature List	Seq.	30 (1)
Length indicator	indefinite	80
Forwarding Feature	Seq.	30 (1)
Forwarding Feature length	indefinite	80
Basic Service Code identifier	TeleserviceCode	83
Teleservice length	1	01
Teleservice code	All Facsimile Services	60
SS-Status	Tag=84	84
SS-Status length	1	01
SS-Status code	Prov., Registered, Active	07
Forwarded To Number identifier	Tag=85	85
ISDN-AddressString length	5	05
AddressString type	Unknown	81
AddressString	TBCD-String: 00431234	00 34 21 43
End-Of-Content Tag	0	00
Length Indicator	0	00
End-Of-Content Tag	0	00
Length Indicator	0	00
End-Of-Content Tag	0	00
Length Indicator	0	00
End-Of-Content Tag	0	00
Length Indicator	0	00
End-Of-Content Tag	0	00
Length Indicator	0	00

Test 31.2.1.1.2. Registration rejected

MMI sequence: **67*00431234*21#

Step 4: MS -> SS REGISTER

Contents	Value/remark	Coding
Length of FIE contents	23	17
Component type tag	Invoke	A1 (1)
Component length	21	15
Invoke ID tag		02
Invoke ID length	1	01
Invoke ID	Arbitrary	--
Operation Code tag		02
Operation Code length	1	01
Operation Code	RegisterSS	0A
RegisterSS-Arg	Seq.	30 (1)
RegisterSS-Arg length	13	0D
SS-Code tag	Tag=4	04
SS-Code length	1	01
SS-Code	CFB	29
Basic Service Code identifier	BearerserviceCode	82
Bearerservice length	1	01
Bearerservice code	AllAsynchronousServices	60
Forwarded To Number identifier	Tag=84	84
AddressString length	5	05
AddressString type	Unknown	81
AddressString	TBCD-String: 00431234	00 34 21 43

Step 5: SS -> MS RELEASE COMPLETE

Contents	Value/remark	Coding
Length of FIE contents	8	08
Component type tag	Return Error	A3 (1)
Component length	6	06
Invoke ID tag		02
Invoke ID length	1	01
Invoke ID	As received	--
Error Code tag		02
Error Code length	1	01
Error Code	BearerServiceNot Provisioned	0A

MMI sequence: **002*00431234*13#

Step 11: MS -> SS REGISTER

Contents	Value/remark	Coding
Length of FIE contents	23	1715
Component type tag	Invoke	A1 (1)
Component length	21	15
Invoke ID tag		02
Invoke ID length	1	01
Invoke ID	Arbitrary	--
Operation Code tag		02
Operation Code length	1	01
Operation Code	RegisterSS	0A
RegisterSS-Arg		30 (1)
RegisterSS-Arg length	13	0D
SS-Code tag	Tag=4	04
SS-Code length	1	01
SS-Code	CF	20
Basic Service Code identifier	TeleserviceCode	83
Teleservice length	1	01
Teleservice code	All Facsimile Services	60
Forwarded To Number identifier	Tag=84	84
AddressString length	5	05
AddressString type	Unknown	81
AddressString	TBCD-String: 00431234	00 34 21 43

Step 12: SS -> MS RELEASE COMPLETE

Contents	Value/remark	Coding
Length of FIE contents	8	08
Component type tag	Reject	A4 (1)
Component length	6	06
Invoke ID tag		02
Invoke ID length	1	01
Invoke ID	As received	--
Invoke Problem tag	Tag=81	81
Invoke Problem length	1	01
Invoke Problem code	Resource limitation	03

Test 31.2.1.2.1. Erasure accepted

MMI sequence: ##004**13#

Step 6: MS -> SS REGISTER

Contents	Value/remark	Coding
Length of FIE contents	16	10
Component type tag	Invoke	A1 (1)
Component length	14	0E
Invoke ID tag		02
Invoke ID length	1	01
Invoke ID	Arbitrary	--
Operation Code tag		02
Operation Code length	1	01
Operation Code	EraseSS	0B
SS-ForBS	Seq.	30 (1)
SS-ForBS length	6	06
SS-Code tag	Tag=4	04
SS-Code length	1	01
SS-Code	CFC	28
Basic Service Code identifier	TeleserviceCode	83
Teleservice length	1	01
Teleservice code	All Facsimile Services	60

Step 7: SS -> MS RELEASE COMPLETE

Contents	Value/remark	Coding
Length of FIE contents	31	1F
Component type tag	Return Result	A2 (1)
Component length	29	1D
Invoke ID tag		02
Invoke ID length	1	01
Invoke ID	As received	--
Sequence tag		30 (1)
Sequence length	24	18
Operation Code tag		02
Operation Code length	1	01
Operation Code	EraseSS	0B
SS-Information		
Forwarding Info tag	Tag=A0	A0 (1)
Forwarding Info length	indefinite	80
SS-Code tag	Tag=4	04
SS-Code length	1	01
SS-Code	CFC	28
Forwarding Feature List	Seq.	30 (1)
Length Indicator	indefinite	80
Forwarding Feature	Seq.	30 (1)
Forwarding Feature length	indefinite	80
Basic Service Code identifier	TeleserviceCode	83
Teleservice length	1	01
Teleservice code	All Facsimile Services	60
SS-Status	Tag=84	84
SS-Status length	1	01
SS-Status code	Provisioned	04
End-Of-Content Tag	0	00
Length Indicator	0	00
End-Of-Content Tag	0	00
Length Indicator	0	00
End-Of-Content Tag	0	00
Length Indicator	0	00

MMI sequence: ##62#

Step 15: MS -> SS REGISTER

Contents	Value/remark	Coding
Length of FIE contents	13	0D
Component type tag	Invoke	A1 (1)
Component length	11	0B
Invoke ID tag		02
Invoke ID length	1	01
Invoke ID	Arbitrary	--
Operation Code tag		02
Operation Code length	1	01
Operation Code	EraseSS	0B
SS-ForBS	Seq.	30 (1)
SS-ForBS length	3	03
SS-Code tag	Tag=4	04
SS-Code length	1	01
SS-Code	CFNRc	2B

Step 16: SS -> MS RELEASE COMPLETE

Contents	Value/remark	Coding
Length of FIE contents	22	16
Component type tag	Return Result	A2 (1)
Component length	20	14
Invoke ID tag		02
Invoke ID length	1	01
Invoke ID	As received	--
Sequence tag		30 (1)
Sequence length	15	0F
Operation Code tag		02
Operation Code length	1	01
Operation Code	EraseSS	0B
SS-Information		
Forwarding Info tag	Tag=A0	A0 (1)
Forwarding Info length	10	0A
SS-Code tag	Tag=4	04
SS-Code length	1	01
SS-Code	CFNRc	2B
Forwarding Feature List	Seq.	30 (1)
Length Indicator	5	05
Forwarding Feature	Seq.	30 (1)
Forwarding Feature length	3	03
SS-Status	Tag=84	84
SS-Status length	1	01
SS-Status code	Provisioned	04

Test 31.2.1.2.2. Erasure rejected

MMI sequence: ##21**11#

Step 4: MS -> SS REGISTER

Contents	Value/remark	Coding
Length of FIE contents	16	10
Component type tag	Invoke	A1 (1)
Component length	14	0E
Invoke ID tag		02
Invoke ID length	1	01
Invoke ID	Arbitrary	--
Operation Code tag		02
Operation Code length	1	01
Operation Code	EraseSS	0B
SS-ForBS		30 (1)
SS-ForBS length	6	06
SS-Code tag	Tag=4	04
SS-Code length	1	01
SS-Code	CFU	21
Basic Service Code identifier	TeleserviceCode	83
Teleservice length	1	01
Teleservice code	Telephony	11

Step 5: SS -> MS RELEASE COMPLETE

Contents	Value/remark	Coding
Length of FIE contents	8	08
Component type tag	Return Error	A3 (1)
Component length	6	06
Invoke ID tag		02
Invoke ID length	1	01
Invoke ID	As received	--
Error Code tag	Tag=2	02
Error Code length	1	01
Error Code	TeleserviceNotProvisioned	0B

MMI sequence: ##61**13#

Step 11: MS -> SS REGISTER

Contents	Value/remark	Coding
Length of FIE contents	16	10
Component type tag	Invoke	A1 (1)
Component length	14	0E
Invoke ID tag		02
Invoke ID length	1	01
Invoke ID	Arbitrary	--
Operation Code tag		02
Operation Code length	1	01
Operation Code	EraseSS	0B
SS-ForBS		30 (1)
SS-ForBS length	6	06
SS-Code tag	Tag=4	04
SS-Code length	1	01
SS-Code	CFNRy	2A
Basic Service Code identifier	TeleserviceCode	83
Teleservice length	1	01
Teleservice code	All Facsimile Services	60

Step 12: SS -> MS RELEASE COMPLETE

Contents	Value/remark	Coding
Length of FIE contents	10	0A
Component type tag	Reject	A4 (1)
Component length	indefinite	80
Invoke ID tag		02
Invoke ID length	1	01
Invoke ID	As received	--
Invoke Problem tag		81
Invoke Problem length	1	01
Invoke Problem	Resource limitation	03
End-Of-Content Tag	0	00
Length Indicator	0	00

Test 31.2.1.3. Activation

MMI sequence: *002**22#

Step 6: MS -> SS REGISTER

Contents	Value/remark	Coding
Length of FIE contents	16	10
Component type tag	Invoke	A1 (1)
Component length	14	0E
Invoke ID tag		02
Invoke ID length	1	01
Invoke ID	Arbitrary	--
Operation Code tag		02
Operation Code length	1	01
Operation Code	ActivateSS	0C
SS-ForBS		30 (1)
SS-ForBS length	6	06
SS-Code tag	Tag=4	04
SS-Code length	1	01
SS-Code	CF	20
Basic Service Code identifier	BearerserviceCode	82
Bearerservice length	1	01
Bearerservice code	AllSynchronousServices	68

Step 7:SS -> MS RELEASE COMPLETE

Contents	Value/remark	Coding
Length of FIE contents	29	1D
Component type tag	Return Result	A2 (1)
Component length	indefinite	80
Invoke ID tag		02
Invoke ID length	1	01
Invoke ID	As received	--
Sequence tag		30 (1)
Sequence length	20	14
Operation Code tag		02
Operation Code length	1	01
Operation Code	ActivateSS	0C
SS-Information		
Forwarding Info tag	Tag=A0	A0 (1)
Forwarding Info length	indefinite	80
SS-Code tag	Tag=4	04
SS-Code length	1	01
SS-Code	CF	20
Forwarding Feature List	Seq.	30 (1)
Length Indicator	8	08
Forwarding Feature	Seq.	30 (1)
Forwarding Feature length	6	06
Basic Service Code identifier	BearerserviceCode	82
Bearerservice length	1	01
Bearerservice code	AllSynchronousServices	68
SS-Status	Tag=4	84
SS-Status length	1	01
SS-Status code	Prov., Registered, Active	07
End-Of-Content Tag	0	00
Length Indicator	0	00
End-Of-Content Tag	0	00
Length Indicator	0	00

MMI sequence: *21#

Step 15: MS -> SS REGISTER

Contents	Value/remark	Coding
Length of FIE contents	13	0D
Component type tag	Invoke	A1 (1)
Component length	11	0B
Invoke ID tag		02
Invoke ID length	1	01
Invoke ID	Arbitrary	--
Operation Code tag		02
Operation Code length	1	01
Operation Code	ActivateSS	0C
SS-ForBS	Seq.	30 (1)
SS-ForBS length	3	06
SS-Code tag	Tag=4	04
SS-Code length	1	01
SS-Code	CFU	21

Step 16: SS -> MS RELEASE COMPLETE

Contents	Value/remark	Coding
Length of FIE contents	26	1A
Component type tag	Return Result	A2 (1)
Component length	24	18
Invoke ID tag		02
Invoke ID length	1	01
Invoke ID	As received	--
Sequence tag		30 (1)
Sequence length	indefinite	80
Operation Code tag		02
Operation Code length	1	01
Operation Code	ActivateSS	0C
SS-Information		
Forwarding Info tag	Tag=A0	A0 (1)
Forwarding Info length	indefinite	80
SS-Code tag	Tag=4	04
SS-Code length	1	01
SS-Code	CFU	21
Forwarding Feature List	Seq.	30 (1)
Length Indicator	5	05
Forwarding Feature	Seq.	30 (1)
Forwarding Feature length	3	03
SS-Status	Tag=84	84
SS-Status length	1	01
SS-Status code	Prov. Registered, Active	07
End-Of-Content Tag	0	00
Length Indicator	0	00
End-Of-Content Tag	0	00
Length Indicator	0	00

Test 31.2.1.4. Deactivation

MMI sequence: #004**11#

Step 6: MS -> SS REGISTER

Contents	Value/remark	Coding
Length of FIE contents	16	10
Component type tag	Invoke	A1 (1)
Component length	14	0E
Invoke ID tag		02
Invoke ID length	1	01
Invoke ID	Arbitrary	--
Operation Code tag		02
Operation Code length	1	01
Operation Code	DeactivateSS	0D
SS-ForBS	Seq.	30 (1)
SS-ForBS length	6	06
SS-Code tag	Tag=4	04
SS-Code length	1	01
SS-Code	CFC	28
Basic Service Code identifier	TeleserviceCode	83
Teleservice length	1	01
Teleservice code	Telephony	11

Step 7: SS -> MS RELEASE COMPLETE

Contents	Value/remark	Coding
Length of FIE contents	29	1D
Component type tag	Return Result	A2 (1)
Component length	27	1B
Invoke ID tag		02
Invoke ID length	1	01
Invoke ID	As received	--
Sequence tag		30 (1)
Sequence length	22	16
Operation Code tag		02
Operation Code length	1	01
Operation Code	DeactivateSS	0D
SS-Information		
Forwarding Info tag	Tag=A0	A0 (1)
Forwarding Info length	indefinite	80
SS-Code tag	Tag=4	04
SS-Code length	1	01
SS-Code	CFC	28
Forwarding Feature List	Seq.	30 (1)
Length Indicator	indefinite	80
Forwarding Feature	Seq.	30 (1)
Forwarding Feature length	6	06
Basic Service Code identifier	TeleserviceCode	83
Teleservice length	1	01
Teleservice code	Telephony	11
SS-Status	Tag=84	84
SS-Status length	1	01
SS-Status code	Provisioned, Registered	06
End-Of-Content Tag	0	00
Length Indicator	0	00
End-Of-Content Tag	0	00
Length Indicator	0	00

MMI sequence: #62**13#

Step 15: MS -> SS REGISTER

Contents	Value/remark	Coding
Same header as Step 6		
SS-Code tag	Tag=4	04
SS-Code length	1	01
SS-Code	CFNRc	2B
Basic Service Code identifier	TeleserviceCode	83
Teleservice length	1	01
Teleservice code	All Facsimile Services	60

Step 16: SS -> MS RELEASE COMPLETE

Contents	Value/remark	Coding
Length of FIE contents	27	1B
Component type tag	Return Result	A2 (1)
Component length	25	19
Invoke ID tag		02
Invoke ID length	1	01
Invoke ID	As received	--
Sequence tag		30 (1)
Sequence length	20	14
Operation Code tag		02
Operation Code length	1	01
Operation Code	DeactivateSS	0D
SS-Information		
Forwarding Info tag	Tag=A0	A0 (1)
Forwarding Info length	15	0F
SS-Code tag	Tag=4	04
SS-Code length	1	01
SS-Code	CFNRc	2B
Forwarding Feature List	Seq.	30 (1)
Length Indicator	10	0A
Forwarding Feature	Seq.	30 (1)
Forwarding Feature length	indefinite	80
Basic Service Code identifier	TeleserviceCode	83
Teleservice length	1	01
Teleservice code	All Facsimile Services	60
SS-Status	Tag=4	84
SS-Status length	1	01
SS-Status code	Provisioned, Registered	06
End-Of-Content Tag	0	00
Length Indicator	0	00

Test 31.2.1.6.1. Interrogation accepted

MMI sequence: *#67#

Step 6: MS -> SS REGISTER

Contents	Value/remark	Coding
Length of FIE contents	13	0D
Component type tag	Invoke	A1 (1)
Component length	11	0B
Invoke ID tag		02
Invoke ID length	1	01
Invoke ID	Arbitrary	--
Operation Code tag		02
Operation Code length	1	01
Operation Code	InterrogateSS	0E
SS-ForBS		30 (1)
SS-ForBS length	3	03
SS-Code tag	Tag=4	04
SS-Code length	1	01
SS-Code	CFB	29

Step 7: SS -> MS RELEASE COMPLETE

Contents	Value/Remark	Coding
Length of FIE contents	13	0D
Component type tag	Return Result	A2 (1)
Component length	11	0B
Invoke ID tag	Tag=02	02
Invoke ID length	1	01
Invoke ID	As received	03
Sequence tag		30 (1)
Sequence length	6	06
Operation code tag	Tag=02	02
Operation code length	1	01
Operation code	InterrogateSS	0E
InterrogateSS-Res	Choice	
SS-Status	Tag=80	80
SS-Status length	1	01
SS-Status	Provisioned	04

MMI sequence: *#61**11#

Step 15: MS -> SS REGISTER

Contents	Value/Remark	Coding
Length of FIE contents	16	10
Component type tag	Invoke	A1 (1)
Component length	14	0E
Invoke ID tag		02
Invoke ID length	1	01
Invoke ID	Arbitrary	--
Operation code tag		02
Operation code length	1	01
Operation code	InterrogateSS	0E
SS-ForBS	Seq	30 (1)
SS-ForBS length	6	06
SS code tag	Tag=4	04
SS code length	1	01
SS code	CFNRy	28
Basic Service Code identifier	TeleserviceCode	83
Teleservice length	1	01
Teleservice code	Telephony	11

Step 16: SS -> MS RELEASE COMPLETE

Contents	Value/Remark	Coding
Length of FIE contents	26	1A
Component type tag	Return Result	A2 (1)
Component length	24	18
Invoke ID tag		02
Invoke ID length	1	01
Invoke ID	As received	03
Sequence tag		30 (1)
Sequence length	19	13
Operation code tag		02
Operation code length	1	01
Operation code	InterrogateSS	0E
InterrogateSS-Res	Choice	
Forwarding Feature List	Seq.	A3 (1)
length indicator	14	0E
Forwarding Feature tag	Seq.	30 (1)
Forwarding Feature length	12	0C
Basic Service Code identifier	TeleserviceCode	83
Teleservice length	1	01
Teleservice code	Telephony	11
SS-Status	Tag=84	84
SS-Status length	1	01
SS-Status code	Prov. Registered Active	07
Forwarded To Number Identifier	Tag=85	85
ISDN-AddressString length	4	04
AddressString type	International Number	91
AddressString	TBCD-String: 431234	34 21 43

Test 31.2.1.6.2. Interrogation rejected

MMI sequence: *#62#

Step 4: MS -> SS REGISTER

Contents	Value/remark	Coding
Length of FIE contents	13	0D
Component type tag	Invoke	A1 (1)
Component length	11	0B
Invoke ID tag		02
Invoke ID length	1	01
Invoke ID	Arbitrary	--
Operation Code tag		02
Operation Code length	1	01
Operation Code	InterrogateSS	0E
SS-ForBS		30 (1)
SS-ForBS length	3	03
SS-Code tag	Tag=4	04
SS-Code length	1	01
SS-Code	CFNRc	2B

Step 5: SS -> MS RELEASE COMPLETE

Contents	Value/remark	Coding
Length of FIE contents	8	08
Component type tag	Return Error	A3 (1)
Component length	6	06
Invoke ID tag		02
Invoke ID length	1	01
Invoke ID	As received	--
Error Code tag		02
Error Code length	1	01
Error Code	SS-NotAvailable	12

MMI sequence: *#67**13#

Step 11: MS -> SS REGISTER

Contents	Value/remark	Coding
Length of FIE contents	16	10
Component type tag	Invoke	A1 (1)
Component length	14	0E
Invoke ID tag		02
Invoke ID length	1	01
Invoke ID	Arbitrary	--
Operation code tag		02
Operation code length	1	01
Operation code	InterrogateSS	0E
SS-ForBS	Seq	30 (1)
SS-ForBS length	6	06
SS code tag	Tag=04	04
SS code length	1	01
SS code	CFB: CF on MS Busy	29
Basic Service Code identifier	TeleserviceCode	83
Teleservice length	1	01
Teleservice code	AllFacsimileServices	60

Step 12: SS -> MS RELEASE COMPLETE

Contents	Value/remark	Coding
Length of FIE contents	8	08
Component type tag	Reject	A4 (1)
Component length	indefinite	80
Invoke ID tag		02
Invoke ID length	1	01
Invoke ID	As received	--
Problem code tag	Tag=81	81
Problem code length	1	01
Invoke problem	Resource limitation	03
End-Of-Content Tag	0	00
Length Indicator	0	00

Test 31.2.1.7.1.1. Notification during an incoming call

Step 10 and 15: SS -> MS FACILITY

Contents	Value/remark	Coding
Length of FIE contents	18	12
Component type tag	Invoke	A1 (1)
Component length	16	10
Invoke ID tag		02
Invoke ID length	1	01
Invoke ID	Arbitrary	--
Operation Code tag		02
Operation Code length	1	01
Operation Code	NotifySS	10
SS-ForBS		30 (1)
SS-ForBS length	indefinite	80
SS-Code tag	Tag=81	81
SS-Code length	1	01
SS-Code	CFB	29
SS-Notification tag	Tag=85	85
SS-Notification length	1	01
SS-Notification	Incoming call forwarded	02
End-Of-Content Tag	0	00
Length Indicator	0	00

Test 31.2.1.7.1.2. Notification during an outgoing call

Step 9 : SS -> MS ALERTING

Contents	Value/remark	Coding
Length of FIE contents	18	12
Component type tag	Invoke	A1 (1)
Component length	indefinite	80
Invoke ID tag		02
Invoke ID length	1	01
Invoke ID	Arbitrary	00
Operation code tag		02
Operation code length	1	01
Operation code	NotifySS	10
NotifySS-Arg tag	Seq.	30 (1)
NotifyBS-Arg length	6	06
SS code tag	Tag=81	81
SS code length	1	01
SS code	CFU: Forw Unconditional	21
SS-Status	Tag=84	84
SS-Status length	1	01
SS-Status code	Prov. Registered Active	07
End-Of-Content Tag	0	00
Length Indicator	0	00

Step 10 : SS -> MS CONNECT

Contents	Value/remark	Coding
Length of FIE contents	18	12
Component type tag	Invoke	A1 (1)
Component length	16	10
Invoke ID tag		02
Invoke ID length	1	01
Invoke ID	Arbitrary	01
Operation code tag		02
Operation code length	1	01
Operation code	NotifySS	10
NotifySS-Arg tag	Seq.	30 (1)
NotifyBS-Arg length	indefinite	80
SS code tag	Tag=81	81
SS code length	1	01
SS code	CFC: Conditional Forw.	28
SS-Status	Tag=84	84
SS-Status length	1	01
SS-Status code	Prov. Registered Active	07
End-Of-Content Tag	0	00
Length Indicator	0	00

Test 31.2.1.7.2. Forwarded-to mobile subscriber side

Step 5 : SS -> MS SETUP

Contents	Value/remark	Coding
Length of FIE contents	18	12
Component type tag	Invoke	A1 (1)
Component length	indefinite	80
Invoke ID tag		02
Invoke ID length	1	01
Invoke ID	Arbitrary	00
Operation code tag		02
Operation code length	1	01
Operation code	NotifySS	10
NotifySS-Arg tag	Seq.	30 (1)
NotifyBS-Arg length	6	06
SS code tag	Tag=81	81
SS code length	1	01
SS code	CFNRc MS not reachable	2B
SS-Notification tag	Tag=85	85
SS-Notification length	1	01
SS-Notification	Forwarded call	01
End-Of-Content Tag	0	00
Length Indicator	0	00

Test 31.6.1.1. AOC time related charging/MS originated call

k=1 Step 11: SS -> MS CONNECT

Contents	Value/remark	Coding
Length of FIE contents	41	29
Component type tag	Invoke	A1 (1)
Component length	39	27
Invoke ID tag		02
Invoke ID length	1	01
Invoke ID	Arbitrary	--
Operation code tag		02
Operation code length	1	01
Operation code	ForwardChargeAdvice	7D
ForwardChargeAdviceArg	Seq.	30 (1)
ForwardChargeAdviceArg length	indefinite	80
SS code tag	Tag=80	80
SS code length	1	01
SS code	AoC-Charging	72
Charging Information	Tag=a1	A1 (1)
Charging Information length	24	18
e1 tag	Tag=81	81
e1 length	1	01
e1	Value = 6,0	3C
e2 tag	Tag=82	82
e2 length	2	02
e2	Value = 14,0	00 8C
e3 tag	Tag=83	83
e3 length	1	01
e3	Value = 1,0	64
e4 tag	Tag=84	84
e4 length	2	02
e4	Value = 25,0	00 FA
e5 tag	Tag=85	85
e5 length	1	01
e5	Value = 0,0	00
e6 tag	Tag=86	86
e6 length	1	01
e6	Value = 0,0	00
e7 tag	Tag=87	87
e7 length	2	02
e7	Value = 60,0	02 58
End-Of-Content Tag	0	00
Length Indicator	0	00

Step A13/B12: MS -> SS FACILITY

Contents	Value/remark	Coding
Length of FIE contents	5	05
Component type tag	Return Result	A2 (1)
Component length	3	03
Invoke ID tag		02
Invoke ID length	1	01
Invoke ID	As received	--

k=1...5: e-parameters

k-value	e-parameter values						
	e1	e2	e3	e4	e5	e6	e7
1	6	14	1	25	0	0	60
2	0	0	1	100	0	0	0
3	250	16	2	500	0	0	60
4	1	1	1	0	10	10	1
5	12,5	30	1	25	10	10	30

k-value	e-parameter coding						
	e1	e2	e3	e4	e5	e6	e7
1	3C	00 8C	64	00 FA	00	00	02 58
2	00	00	64	03 E8	00	00	00
3	09 C4	00 A0	00 C8	13 88	00	00	02 58
4	00 0A	00 0A	00 64	00 00	00 64	00 0A	00 0A
5	7D	01 2C	64	00 FA	64	0A	01 2C

Test 31.6.1.2. AOC time related charging/MS terminated call

k=1...5 Step 12: SS -> MS FACILITY e-parameters

k-value	e-parameter values						
	e1	e2	e3	e4	e5	e6	e7
1	0	0	0	0	0	0	0
2	0	0	1	100	0	0	0
3	6	14	1	25	0	0	60
4	1	1	1	0	0	0	1
5	12,5	30	1	25	0	0	30

k-value	e-parameter coding						
	e1	e2	e3	e4	e5	e6	e7
1	00	00	00	00	00	00	00
2	00	00	64	03 E8	00	00	00
3	3C	00 8C	64	00 FA	00	00	02 58
4	0A	0A	64	00	00	00	0A
5	7D	01 2C	00 64	FA	00	00	01 2C

Test 31.6.1.5. Change in charging information during a call

Step A12: SS -> MS FACILITY (initial CAI message)

Contents	Value/remark	Coding
CAI header element		
e1 tag	Tag=81	81
e1 length	1	01
e1	Value = 10,0	64
e2 tag	Tag=82	82
e2 length	2	02
e2	Value = 28,0	01 18
e3 tag	Tag=83	83
e3 length	1	01
e3	Value = 1,0	64
e4 tag	Tag=84	84
e4 length	1	01
e4	Value = 10,0	64
e5 tag	Tag=85	85
e5 length	1	01
e5	Value = 0,0	00
e6 tag	Tag=86	86
e6 length	1	01
e6	Value = 0,0	00
e7 tag	Tag=87	87
e7 length	2	02
e7	Value = 60,0	02 58

Step A12: SS -> MS FACILITY (subsequent CAI message)

Contents	Value/remark	Coding
CAI header element		
e1	Value = 10,0	64
e2	Value = 14,0	00 8C
e3	Value = 1,0	64
e4	Value = 5,0	32
e5	Value = 0,0	00
e6	Value = 0,0	00
e7	Value = 60,0	02 58

Test 31.6.1.6. Different formats of charging information

k=1 SS -> MS FACILITY

Contents	Value/remark	Coding
CAI header element		
e1	Value = 10,0	64
e2	Value = 40,0	01 90
e3	Value = 1,0	64
e4	Value = 0,0	00
e5	Value = 0,0	00
e6	Value = 0,0	00
e7	Value = 0,0	00 00

k=2 SS -> MS FACILITY

Contents	Value/remark	Coding
Length of FIE contents	27	1B
Component type tag	Invoke	A1 (1)
Component length	25	19
Invoke ID tag		02
Invoke ID length	1	01
Invoke ID	Arbitrary	--
Operation code tag		02
Operation code length	1	01
Operation code	forwardChargeAdvice	7D
ForwardChargeAdviceArg	Seq.	30 (1)
ForwardChargeAdviceArg length	17	11
SS code tag	Tag=80	80
SS code length	1	01
SS code	AoC-Charging	72
Charging Information	Tag=a1	A1 (1)
Charging Information length	indefinite	80
e1 tag	Tag=81	81
e1 length	1	01
e1	Value = 10,0	64
e2 tag	Tag=82	82
e2 length	2	02
e2	Value = 40,0	01 90
e3 tag	Tag=83	83
e3 length	1	01
e3	Value = 1,0	64
End-Of-Content Tag	0	00
Length Indicator	0	00

Test 31.6.1.7. AOC on a Call Hold call

Step 11: SS -> MS CONNECT

Contents	Value/remark	Coding
CAI header element		
e1	Value = 7,0	46
e2	Value = 40,0	01 90
e3	Value = 1,0	64
e4	Value = 0,0	00
e5	Value = 0,0	00
e6	Value = 0,0	00
e7	Value = 0,0	00

Step 20: SS -> MS CONNECT

Contents	Value/remark	Coding
CAI header element		
e1	Value = 13,0	00 82
e2	Value = 40,0	01 90
e3	Value = 1,0	64
e4	Value = 0,0	00
e5	Value = 0,0	00
e6	Value = 0,0	00
e7	Value = 0,0	00

Test 31.6.1.8. AOC on a Multi-party call

Step 11 & 20: SS -> MS CONNECT

k-value	e-parameter values						
	e1	e2	e3	e4	e5	e6	e7
1	19	40	1	0	0	0	0
2	29	40	1	0	0	0	0

k-value	e-parameter coding						
	e1	e2	e3	e4	e5	e6	e7
1	00 BE	01 90	64	00	00	00	00
2	01 22	01 90	64	00	00	00	00

Step 23: MS -> SS FACILITY

Contents	Value/remark	Coding
Length of FIE contents	8	08
Component type tag	Invoke	A1 (1)
Component length	6	06
Invoke ID tag		02
Invoke ID length	1	01
Invoke ID	Arbitrary	--
Operation code tag		02
Operation code length	1	01
Operation code	BuildMPTY	7C

Step 24: SS -> MS FACILITY

Contents	Value/remark	Coding
Length of FIE contents	7	07
Component type tag	Return Result	A2 (1)
Component length	indefinite	80
Invoke ID tag		02
Invoke ID length	1	01
Invoke ID	As received	--
End-Of-Content Tag	0	00
Length Indicator	0	00

Test 31.6.2. Charge Storage

31.6.2.1 Removal of SIM during an active call

and 31.6.2.2 Interruption of power supply during an active call

and 31.6.2.3 MS going out of coverage during an active AoCC call

Step A11: SS -> MS CONNECT

Contents	Value/remark	Coding
Length of FIE contents	39	27
Component type tag	Invoke	A1 (1)
Component length	indefinite	80
Invoke ID tag		02
Invoke ID length	1	01
Invoke ID	Arbitrary	--
Operation code tag		02
Operation code length	1	01
Operation code	forwardChargeAdvice	7D
ForwardChargeAdviceArg	Seq.	30 (1)
ForwardChargeAdviceArg length	27	1B
SS code tag	Tag=80	80
SS code length	1	01
SS code	AoC-Charging	72
Charging Information	Tag=a1	A1 (1)
Charging Information length	22	16
e1 tag	Tag=81	81
e1 length	1	01
e1	Value = 10,0	64
e2 tag	Tag=82	82
e2 length	2	02
e2	Value = 55,0	02 26
e3 tag	Tag=83	83
e3 length	1	01
e3	Value = 1,0	64
e4 tag	Tag=84	84
e4 length	1	01
e4	Value = 10,0	64
e5 tag	Tag=85	85
e5 length	1	01
e5	Value = 0,0	00
e6 tag	Tag=86	86
e6 length	1	01
e6	Value = 0,0	00
e7 tag	Tag=87	87
e7 length	1	01
e7	Value = 10,0	64
End-Of-Content Tag	0	00
Length Indicator	0	00

Test 31.6.2.4. ACMmax operation/Mobile Originating

k=1 Step A11: SS -> MS FACILITY

Contents	Value/remark	Coding
Length of FIE contents	41	29
Component type tag	Invoke	A1 (1)
Component length	indefinite	80
Invoke ID tag		02
Invoke ID length	1	01
Invoke ID	Arbitrary	--
Operation code tag		02
Operation code length	1	01
Operation code	ForwardChargeAdvice	7D
ForwardChargeAdviceArg	Seq.	30 (1)
ForwardChargeAdviceArg length	27	1B
SS code tag	Tag=80	80
SS code length	1	01
SS code	AoC-Charging	72
Charging Information	Tag=a1	A1 (1)
Charging Information length	22	16
e1 tag	Tag=81	81
e1 length	1	01
e1	Value = 1,0	0A
e2 tag	Tag=82	82
e2 length	2	02
e2	Value = 30,0	01 2C
e3 tag	Tag=83	83
e3 length	1	01
e3	Value = 1,0	64
e4 tag	Tag=84	84
e4 length	1	01
e4	Value = 0,0	00
e5 tag	Tag=85	85
e5 length	1	01
e5	Value = 0,0	00
e6 tag	Tag=86	86
e6 length	1	01
e6	Value = 0,0	00
e7 tag	Tag=87	87
e7 length	1	01
e7	Value = 0,0	00
End-Of-Content Tag	0	00
Length Indicator	0	00

k=2 Step A11: SS -> MS FACILITY

Contents	Value/remark	Coding
Length of FIE contents	40	28
Component type tag	Invoke	A1 (1)
Component length	indefinite	80
Invoke ID tag		02
Invoke ID length	1	01
Invoke ID	Arbitrary	--
Operation code tag		02
Operation code length	1	01
Operation code	ForwardChargeAdvice	7D
ForwardChargeAdviceArg	Seq.	30 (1)
ForwardChargeAdviceArg length	26	1A
SS code tag	Tag=80	80
SS code length	1	01
SS code	AoC-Charging	72
Charging Information	Tag=a1	A1 (1)
Charging Information length	21	15
e1 tag	Tag=81	81
e1 length	1	01
e1	Value = 0,0	00
e2 tag	Tag=82	82
e2 length	1	01
e2	Value = 0,0	00
e3 tag	Tag=83	83
e3 length	1	01
e3	Value = 0,0	00
e4 tag	Tag=84	84
e4 length	1	01
e4	Value = 0,0	00
e5 tag	Tag=85	85
e5 length	1	01
e5	Value = 0,0	00
e6 tag	Tag=86	86
e6 length	1	01
e6	Value = 0,0	00
e7 tag	Tag=87	87
e7 length	1	01
e7	Value = 0,0	00
End-Of-Content Tag	0	00
Length Indicator	0	00

Test 31.6.2.5 ACMmax operation/Mobile Terminating

k=1 Step A13: SS -> MS FACILITY, k=2 Step B13: SS -> MS FACILITY

Contents	Value/remark	Coding
Length of FIE contents	41	29
Component type tag	Invoke	A1 (1)
Component length	indefinite	80
Invoke ID tag		02
Invoke ID length	1	01
Invoke ID	Arbitrary	--
Operation code tag		02
Operation code length	1	01
Operation code	ForwardChargeAdvice	7D
ForwardChargeAdviceArg	Seq.	30 (1)
ForwardChargeAdviceArg length	27	1B
SS code tag	Tag=80	80
SS code length	1	01
SS code	AoC-Charging	72
Charging Information	Tag=a1	A1 (1)
Charging Information length	28	1C
e1 tag	Tag=81	81
e1 length	1	01
e1	Value = 1,0	00 0A
e2 tag	Tag=82	82
e2 length	2	02
e2	Value = 30,0	01 2C
e3 tag	Tag=83	83
e3 length	1	01
e3	Value = 1,0	64
e4 tag	Tag=84	84
e4 length	1	01
e4	Value = 0,0	00
e5 tag	Tag=85	85
e5 length	1	01
e5	Value = 0,0	00
e6 tag	Tag=86	86
e6 length	1	01
e6	Value = 0,0	00
e7 tag	Tag=87	87
e7 length	1	01
e7	Value = 0,0	00
End-Of-Content Tag	0	00
Length Indicator	0	00

k=3 Step A13: SS -> MS FACILITY

Contents	Value/remark	Coding
Length of FIE contents	40	28
Component type tag	Invoke	A1 (1)
Component length	indefinite	80
Invoke ID tag		02
Invoke ID length	1	01
Invoke ID	Arbitrary	--
Operation code tag		02
Operation code length	1	01
Operation code	ForwardChargeAdvice	7D
ForwardChargeAdviceArg	Seq.	30 (1)
ForwardChargeAdviceArg length	26	1A
SS code tag	Tag=80	80
SS code length	1	01
SS code	AoC-Charging	72
Charging Information	Tag=a1	A1 (1)
Charging Information length	21	15
e1 tag	Tag=81	81
e1 length	1	01
e1	Value = 0,0	00
e2 tag	Tag=82	82
e2 length	1	01
e2	Value = 0,0	00
e3 tag	Tag=83	83
e3 length	1	01
e3	Value = 0,0	00
e4 tag	Tag=84	84
e4 length	1	01
e4	Value = 0,0	00
e5 tag	Tag=85	85
e5 length	1	01
e5	Value = 0,0	00
e6 tag	Tag=86	86
e6 length	1	01
e6	Value = 0,0	00
e7 tag	Tag=87	87
e7 length	1	01
e7	Value = 0,0	00
End-Of-Content Tag	0	00
Length Indicator	0	00

Test 31.8.1.1. Registration of a password accepted

MMI sequence:**03*330*1234*9876*9876#

Step 6: MS -> SS REGISTER

Contents	Value/remark	Coding
Length of FIE contents	11	0B
Component type tag	Invoke	A1 (1)
Component length	9	09
Invoke ID tag		02
Invoke ID length	1	01
Invoke ID	Arbitrary	--
Operation Code tag		02
Operation Code length	1	01
Operation Code	RegisterPasswordSS	11
SS-Code tag	Tag=4	04
SS-Code length	1	01
SS-Code	B: All barring services	90

Step 7: SS -> MS FACILITY

Contents	Value/remark	Coding
Length of FIE contents	14	0E
Component type tag	Invoke	A1 (1)
Component length	12	0C
Invoke ID tag		02
Invoke ID length	1	01
Invoke ID	Arbitrary	--
Linked ID tag		80
Linked ID length	1	01
Linked ID	As received	--
Operation Code tag		02
Operation Code length	1	01
Operation Code	GetPasswordSS	12
Guidance information	Enumerated	0A
Guidance length	1	01
Guidance	enter password	00

Step 9: MS -> SS FACILITY

Contents	Value/remark	Coding
Length of FIE contents	16	10
Component type tag	Return Result	A2 (1)
Component length	14	0E
Invoke ID tag		02
Invoke ID length	1	01
Invoke ID	As received	--

Sequence tag		30 (1)
Sequence length	9	09
Operation Code tag		02
Operation Code length	1	01
Operation Code	GetPasswordSS	12
Password tag	Numeric String	12
Password length	4	04
Password	Password = 1234	31 32 33 34

Step 10 & 12: FACILITY

Contents	Value/remark	Coding
Guidance	Enter New Password	01

Contents	Value/remark	Coding
Password	Password = 9876	39 38 37 36

Step 13 & 15: FACILITY

Contents	Value/remark	Coding
Guidance	EnterNewPasswordAgain	02

Contents	Value/remark	Coding
Password	Password = 9876	39 38 37 36

Step 16: SS -> MS RELEASE COMPLETE

Contents	Value/remark	Coding
Length of FIE contents	20	14
Component type tag	Return Result	A2 (1)
Component length	indefinite	80
Invoke ID tag		02
Invoke ID length	1	01
Invoke ID	As received	--
Sequence tag		30 (1)
Sequence length	indefinite	80
Operation Code tag		02
Operation Code length	1	01
Operation Code	RegisterPasswordSS	11
Password tag	Numeric String	12
Password length	4	04
Password	Password = 1234	31 32 33 34
End-Of-Content Tag	0	00
Length Indicator	0	00
End-Of-Content Tag	0	00
Length Indicator	0	00

Test 31.8.1.2. Registration of a password rejected

MMI sequence:**03*330*1234*9876*987X#

Test 31.8.1.2.1. Rejection after invoke of the RegisterPassword operation

Step 4: MS -> SS REGISTER

Contents	Value/remark	Coding
Length of FIE contents	11	0B
Component type tag	Invoke	A1 (1)
Component length	9	09
Invoke ID tag		02
Invoke ID length	1	01
Invoke ID	Arbitrary	--
Operation Code tag		02
Operation Code length	1	01
Operation Code	RegisterPasswordSS	11
SS-Code tag	Tag=4	04
SS-Code length	1	01
SS-Code	B: All barring services	90

Step 5: SS -> MS RELEASE COMPLETE

Contents	Value/remark	Coding
Length of FIE contents	8	08
Component type tag	Return Error	A3 (1)
Component length	6	06
Invoke ID tag		02
Invoke ID length	1	01
Invoke ID	As received	--
Error Code tag	Tag=2	02
Error Code length	1	01
Error Code	SS subscription violation	13

Test 31.8.1.2.2. Rejection after password check with negative result

Step 6: SS -> MS RELEASE COMPLETE

Contents	Value/remark	Coding
Length of FIE contents	10	0A
Component type tag	Return Error	A3 (1)
Component length	indefinite	80
Invoke ID tag		02
Invoke ID length	1	01
Invoke ID	As received	--
Error Code tag	Tag=2	02
Error Code length	1	01
Error Code	Negative Password Check	26
End-Of-Content Tag	0	00
Length Indicator	0	00

Test 31.8.1.2.3. Rejection after new password mismatch

Step 14: SS -> MS RELEASE COMPLETE

Contents	Value/remark	Coding
Length of FIE contents	11	0B
Component type tag	Return Error	A3 (1)
Component length	9	09
Invoke ID tag		02
Invoke ID length	1	01
Invoke ID	As received	--
Error Code tag	Tag=2	02
Error Code length	1	01
Error Code	PW-Registration Failure	25
pw-Registration Failure cause	Tag=04	04 (2)
pw-Registration Failure length	1	01
pw-Registration Failure	New Password Mismatch	02

NOTE 2: This element is described in Rec. GSM 04.80 4.3.2.12, but there is no ASN.1 description in chapter 4.5. Description given in the informative annex A should be put at the end of chapter 4.5.

Test 31.8.3.1. Activation accepted

MMI sequence: *33**22#

Step 6: MS -> SS REGISTER

Contents	Value/remark	Coding
Length of FIE contents	16	10
Component type tag	Invoke	A1 (1)
Component length	14	0E
Invoke ID tag		02
Invoke ID length	1	01
Invoke ID	Arbitrary (01)	--
Operation code tag		02
Operation code length	1	01
Operation code	ActivateSS	0C
SS-ForBS	Seq.	30 (1)
SS-ForBS length	6	06
SS code tag	Tag=04	04
SS code length	1	01
SS code	BAOC	92
Basic Service Code identifier	BearerServiceCode	82
BearerService length	1	01
BearerService code	AllSynchronousServices	68

Step 7: SS -> MS FACILITY

Contents	Value/remark	Coding
Length of FIE contents	14	0E
Component type tag	Invoke	A1 (1)
Component length	12	0C
Invoke ID tag		02
Invoke ID length	1	01
Invoke ID	Arbitrary (02)	--
Linked ID tag		80
Linked ID length	1	01
Linked ID	As received (01)	--
Operation code tag		02
Operation code length	1	01
Operation code	Getpassword	12
Guidance tag	Enumerated	0a
Guidance length	1	01
Guidance	Enter Password	00

Step 9: MS -> SS FACILITY

Contents	Value/remark	Coding
Length of FIE contents	16	10
Component type tag	Return Result	A2 (1)
Component length	14	0E
Invoke ID tag		02
Invoke ID length	1	01
Invoke ID	As received (02)	--
Sequence tag		30 (1)
Sequence length	9	09
Operation code tag		02
Operation code length	1	01
Operation code	Getpassword	12
Password tag	NumericString	12
Password length	4	04
Password	Password = 1234	31 32 33 34

Step 10: SS -> MS RELEASE COMPLETE

This message is coded to give a complete answer to the MS request. Shorter message can also be used (see last paragraph).

Contents	Value/remark	Coding
Length of FIE contents	29	1D
Component type tag	Return Result	A2 (1)
Component length	27	1B
Invoke ID tag		02
Invoke ID length	1	01
Invoke ID	As received (01)	--
Sequence tag		30 (1)
Sequence length	indefinite	80
Operation code tag		02
Operation code length	1	01
Operation code	ActivateSS	0C
SS information		
CallBarringInfo	Tag=a1	A1 (1)
CallBarringInfo length	indefinite	80
SS code tag	Tag=04	04
SS code length	1	01
SS code	BAOC	92
CallBarringFeature List	Seq.	30 (1)
Length indicator	8	08
CallBarring Feature tag	Seq.	30 (1)
CallBarring Feature length	6	06
Basic Service Code identifier	BearerServiceCode	82
BearerService length	1	01
BearerService code	AllSynchronousServices	68
SS-Status	Tag=84	84
SS-Status length	1	01
SS-Status code	Prov. Registered Active	07
End-Of-Content Tag	0	00
Length Indicator	0	00
End-Of-Content Tag	0	00
Length Indicator	0	00

MMI sequence: *351#

Step 18: MS -> SS REGISTER

Contents	Value/remark	Coding
Length of FIE contents	13	0D
Component type tag	Invoke	A1 (1)
Component length	11	0B
Invoke ID tag		02
Invoke ID length	1	01
Invoke ID	Arbitrary	--
Operation code tag		02
Operation code length	1	01
Operation code	ActivateSS	0C
SS-ForBS	Seq	30 (1)
SS-ForBS length	3	03
SS code tag	Tag=04	04
SS code length	1	01
SS code	BICRoam	9B

Step 22: SS -> MS RELEASE COMPLETE

Contents	Value/remark	Coding
Length of FIE contents	26	1A
Component type tag	Return Result	A2 (1)
Component length	24	18
Invoke ID tag		02
Invoke ID length	1	01
Invoke ID	As received	--
Sequence identifier		30 (1)
Sequence length	19	13
Operation code tag		02
Operation code length	1	01
Operation code	ActivateSS	0C
SS-Information		
CallBarringInfo	Tag=a1	A1 (1)
CallBarringInfo length	14	0E
SS code tag	Tag=04	04
SS code length	1	01
SS code	BICRoam	9B
CallBarringFeature List	Seq.	30 (1)
Length indicator	indefinite	80
CallBarring Feature tag	Seq.	30 (1)
CallBarring Feature length	indefinite	80
SS-Status	Tag=84	84
SS-Status length	1	01
SS-Status code	Prov. Registered Active	07
End-Of-Content Tag	0	00
Length Indicator	0	00
End-Of-Content Tag	0	00
Length Indicator	0	00

Step 10 & 22: short messages

Step 11 and 24 messages can be coded using this shorter form:

Message containing only the "Return result"

Contents	Value/remark	Coding
Length of FIE contents	5	05
Component type tag	Return Result	A2 (1)
Component length	3	03
Invoke ID tag		02
Invoke ID length	1	01
Invoke ID	As received	--

Message containing the "Return result" and the "Operation Code"

Contents	Value/remark	Coding
Length of FIE contents	12	0C
Component type tag	Return Result	A2 (1)
Component length	indefinite	80
Invoke ID tag		02
Invoke ID length	1	01
Invoke ID	As received	--
Sequence identifier		30 (1)
Sequence length	3	03
Operation code tag		02
Operation code length	1	01
Operation code	ActivateSS	0C
End-Of-Content Tag	0	00
Length Indicator	0	00

Test 31.8.3.2.1. Rejection after invoke of ActivateSS operation

MMI sequence: *331#

Step 4: MS -> SS REGISTER

Contents	Value/remark	Coding
Length of FIE contents	13	0D
Component type tag	Invoke	A1 (1)
Component length	11	0B
Invoke ID tag		02
Invoke ID length	1	01
Invoke ID	Arbitrary	--
Operation code tag		02
Operation code length	1	01
Operation code	ActivateSS	0C
SS-ForBS	Seq	30 (1)
SS-ForBS length	3	03
SS code tag	Tag=04	04
SS code length	1	01
SS code	BOIC	93

Step 5: SS -> MS RELEASE COMPLETE

Contents	Value/remark	Coding
Length of FIE contents	8	08
Component type tag	Return Error	A3 (1)
Component length	6	06
Invoke ID tag		02
Invoke ID length	1	01
Invoke ID	As received	--
Error code tag		02
Error code length	1	01
Error code	SS Subscription Violation	13

Test 31.8.3.2.2. Rejection after use of password procedure

MMI sequence: *35#

Step 4: MS -> SS REGISTER

Contents	Value/remark	Coding
Length of FIE contents	13	0D
Component type tag	Invoke	A1 (1)
Component length	11	0B
Invoke ID tag		02
Invoke ID length	1	01
Invoke ID	Arbitrary	--
Operation code tag		02
Operation code length	1	01
Operation code	ActivateSS	0C
SS-ForBS	Seq	30 (1)
SS-ForBS length	3	03
SS code tag	Tag=04	04
SS code length	1	01
SS code	BAIC	9A

Step 8: SS -> MS RELEASE COMPLETE

Contents	Value/remark	Coding
Length of FIE contents	10	0A
Component type tag	Return Error	A3 (1)
Component length	indefinite	80
Invoke ID tag		02
Invoke ID length	1	01
Invoke ID	As received	--
Error code tag		02
Error code length	1	01
Error code	NegativePasswordCheck	26
End-Of-Content Tag	0	00
Length Indicator	0	00

Test 31.8.4.1. Deactivation accepted

MMI sequence: *330**11#

Step 6: MS -> SS REGISTER

Contents	Value/remark	Coding
Length of FIE contents	16	10
Component type tag	Invoke	A1 (1)
Component length	14	0D
Invoke ID tag		02
Invoke ID length	1	01
Invoke ID	Arbitrary	--
Operation code tag		02
Operation code length	1	01
Operation code	DeactivateSS	0D
SS-ForBS	Seq	30 (1)
SS-ForBS length	3	03
SS code tag	Tag=04	04
SS code length	1	01
SS code	B: All barring services	90
Basic Service Code identifier	TeleserviceCode	83
Teleservice length	1	01
Teleservice code	AllSpeechTransmission	10

Step 10: SS -> MS RELEASE COMPLETE

Contents	Value/remark	Coding
Length of FIE contents	21	15
Component type tag	Return Result	A2 (1)
Component length	indefinite	80
Invoke ID tag		02
Invoke ID length	1	01
Invoke ID	As received	--
Sequence identifier		30 (1)
Sequence length	12	0C
Operation code tag		02
Operation code length	1	01
Operation code	DeactivateSS	0D
SS-Information		
CallBarringInfo	Tag=a1	A1 (1)
CallBarringInfo length	7	07
CallBarringFeature List	Seq.	30 (1)
Length indicator	5	05
CallBarring Feature tag	Seq.	30 (1)
CallBarring Feature length	3	03
Basic Service Code Identifier	TeleserviceCode	83
Teleservice Length	1	01
Teleservice code	AllSpeechTransmission	10
End-Of-Content Tag	0	00
Length Indicator	0	00

MMI sequence: #333**13#

Step 17: MS -> SS REGISTER

Contents	Value/remark	Coding
Length of FIE contents	16	10
Component type tag	Invoke	A1 (1)
Component length	14	0E
Invoke ID tag		02
Invoke ID length	1	01
Invoke ID	Arbitrary	--
Operation code tag		02
Operation code length	1	01
Operation code	DeactivateSS	0D
SS-ForBS	Seq	30 (1)
SS-ForBS length	6	06
SS code tag	Tag=04	04
SS code length	1	01
SS code	BO	91
Basic Service Code identifier	TeleserviceCode	83
Teleservice length	1	01
Teleservice code	AllFacsimileServices	60

Step 21: MS -> SS RELEASE COMPLETE

Contents	Value/remark	Coding
Length of FIE contents	21	15
Component type tag	Return Result	A2 (1)
Component length	indefinite	80
Invoke ID tag		02
Invoke ID length	1	01
Invoke ID	As received	--
Sequence identifier		30 (1)
Sequence length	12	0C
Operation code tag		02
Operation code length	1	01
Operation code	DeactivateSS	0D
SS-Information		
CallBarringInfo	Tag=a1	A1 (1)
CallBarringInfo length	7	07
CallBarringFeature List	Seq.	30 (1)
Length indicator	5	05
CallBarring Feature tag	Seq.	30 (1)
CallBarring Feature length	3	03
Basic Service Code Identifier	TeleserviceCode	83
Teleservice Length	1	01
Teleservice code	AllFacsimileServices	60
End-Of-Content Tag	0	00
Length Indicator	0	00

Test 31.8.4.2.1. Deactivation rejected after invoke operation

MMI sequence: *#353#

Step 4: MS -> SS REGISTER

Contents	Value/remark	Coding
Length of FIE contents	13	0D
Component type tag	Invoke	A1 (1)
Component length	11	0B
Invoke ID tag		02
Invoke ID length	1	01
Invoke ID	Arbitrary	--
Operation code tag		02
Operation code length	1	01
Operation code	DeactivateSS	0D
SS-ForBS	Seq	30 (1)
SS-ForBS length	3	03
SS code tag	Tag=04	04
SS code length	1	01
SS code	BI	99

Step 5: SS -> MS RELEASE COMPLETE

Contents	Value/remark	Coding
Length of FIE contents	10	0A
Component type tag	Return Error	A3 (1)
Component length	indefinite	80
Invoke ID tag		02
Invoke ID length	1	01
Invoke ID	As received	--
Error code tag		02
Error code length	1	01
Error code	SS Subscription Violation	13
End-Of-Content Tag	0	00
Length Indicator	0	00

Test 31.8.4.2.2. Deactivation rejection after password operation

MMI sequence: *#332#

Step 4: MS -> SS REGISTER

Contents	Value/remark	Coding
Length of FIE contents	13	0D
Component type tag	Invoke	A1 (1)
Component length	11	0B
Invoke ID tag		02
Invoke ID length	1	01
Invoke ID	Arbitrary	--
Operation code tag		02
Operation code length	1	01
Operation code	DeactivateSS	0D
SS-ForBS	Seq	30 (1)
SS-ForBS length	3	03
SS code tag	Tag=04	04
SS code length	1	01
SS code	BOICExHome	94

Step 7: SS -> MS RELEASE COMPLETE

Contents	Value/remark	Coding
Length of FIE contents	8	08
Component type tag	Return Error	A3 (1)
Component length	6	06
Invoke ID tag		02
Invoke ID length	1	01
Invoke ID	As received	--
Error code tag		02
Error code length	1	01
Error code	NegativePasswordCheck	26

Test 31.8.6.1. Interrogation accepted

MMI sequence: *#35#

Step 6: MS -> SS REGISTER

Contents	Value/remark	Coding
Length of FIE contents	13	0D
Component type tag	Invoke	A1 (1)
Component length	11	0B
Invoke ID tag		02
Invoke ID length	1	01
Invoke ID	Arbitrary	--
Operation code tag		02
Operation code length	1	01
Operation code	InterrogateSS	0E
SS-ForBS	Seq	30 (1)
SS-ForBS length	3	03
SS code tag	Tag=04	04
SS code length	1	01
SS code	BAIC	9A

Step 10: SS -> MS RELEASE COMPLETE

Contents	Value/remark	Coding
Length of FIE Contents	15	0F
Component type tag	Return Result	A2
Component length	13	0D
Invoke ID tag		02
Invoke ID length	1	01
Invoke ID	As received	--
Sequence tag		30
Sequence length	8	08
Operation Code tag		02
Operation Code length	1	01
Operation Code	InterrogateSS	0E
InterrogateSS-Res	Choice	
BasicServiceGroupList tag	Seq.	A2
BasicServiceGroupList length	3	03
BasicService Code identifier	TeleserviceCode	83
Teleservice length	1	01
Teleservice code	Telephony	11

MMI sequence: *#332#

Step 17: MS -> SS REGISTER

Contents	Value/remark	Coding
Length of FIE Contents	13	0D
Component type tag	Invoke	A1
Component length	11	0B
Invoke ID tag		02
Invoke ID length	1	01
Invoke ID	Arbitrary	--
Operation Code tag		02
Operation Code length	1	01
Operation Code	InterrogateSS	0E
SS-ForBS	Seq	30
SS-ForBS length	3	03
SS-Code tag	Tag=4	04
SS-Code length	1	01
SS-Code	BOICExHome	94

Step 21: SS -> MS RELEASE COMPLETE

Contents	Value/remark	Coding
Length of FIE Contents	13	0D
Component type tag	Return Result	A2
Component length	11	0B
Invoke ID tag		02
Invoke ID length	1	01
Invoke ID	As received	--
Sequence tag		30
Sequence length	6	06
Operation Code tag		02
Operation Code length	1	01
Operation Code	InterrogateSS	0E
InterrogateSS-Res	Choice	
SS-Status	Tag=80	80
SS-Status length	1	01
SS-Status	Prov., Registered, Deactive	06

Test 31.8.6.2. Interrogation rejected

MMI sequence: *#351#

Step 4: MS -> SS REGISTER

Contents	Value/remark	Coding
Length of FIE Contents	13	0D
Component type tag	Invoke	A1
Component length	11	0B
Invoke ID tag		02
Invoke ID length	1	01
Invoke ID	Arbitrary	--
Operation Code tag		02
Operation Code length	1	01
Operation Code	InterrogateSS	0E
SS-ForBS	Seq	30
SS-ForBS length	3	03
SS-Code tag	Tag=4	04
SS-Code length	1	01
SS-Code	BICRoam	9B

Step 5: SS -> MS RELEASE COMPLETE

Contents	Value/remark	Coding
Length of FIE Contents	10	0A
Component type tag	Return Error	A3
Component length	indefinite	80
Invoke ID tag		02
Invoke ID length	1	01
Invoke ID	As received	--
Error code tag		02
Error code length	1	01
Error code	SS_NotAvailable	12
End-Of-Content Tag	0	00
Length Indicator	0	00

MMI sequence: *#331#

Step 11: MS -> SS REGISTER

Contents	Value/remark	Coding
Length of FIE Contents	13	0D
Component type tag	Invoke	A1
Component length	11	0B
Invoke ID tag		02
Invoke ID length	1	01
Invoke ID	Arbitrary	--
Operation Code tag		02
Operation Code length	1	01
Operation Code	InterrogateSS	0E
SS-ForBS	Seq	30
SS-ForBS length	3	03
SS-Code tag	Tag=4	04
SS-Code length	1	01
SS-Code	BOIC	93

Step 12: SS -> MS RELEASE COMPLETE

Contents	Value/remark	Coding
Length of FIE Contents	8	08
Component type tag	Reject	A4
Component length	6	06
Invoke ID tag		02
Invoke ID length	1	01
Invoke ID	As received	--
Problem code tag	Tag=81	81
Problem code length	1	01
Invoke problem code	Resource limitation	03

Test 31.8.7. Normal operation

Incoming call

Step 6: MS -> SS RELEASE COMPLETE

Contents	Value/remark	Coding
Length of FIE contents	16	10
Component type tag	Invoke	A1 (1)
Component length	14	0E
Invoke ID tag		02
Invoke ID length	1	01
Invoke ID	Arbitrary	--
Operation code tag		02
Operation code length	1	01
Operation code	NotifySS	10
NotifySS-Arg tag	Seq.	30 (1)
NotifySS-Arg length	6	06
SS code tag	Tag=81	81
SS code length	1	01
SS code	BI	99
SS-Status	Tag=84	84
SS-Status length	1	01
SS-Status code	Prov. Registered Active	07

Test 31.9. Registration accepted of a USSD

MMI sequence: **00#

Contents	Value/remark	Coding
Length of FIE contents	15	0F
Component type tag	Invoke	A1 (1)
Component length	13	0D
Invoke ID tag		02
Invoke ID length	1	01
Invoke ID	Arbitrary	--
Operation Code tag		02
Operation Code length	1	01
Operation Code	ProcessUSSDSS	0A
IA5 String tag	Tag=16	16
IA5 String length	5	05
Content	**00#	2A 2A 30 30 23

31.12 eMLPP Service

This section is applicable to the mobile stations supporting eMLPP service. The eMLPP is applicable to teleservices 1x, 6x, 9x and bearer services 2x, 3x, 4x, 5x.

For an MS supporting speech the test procedures in 31.12.1 and 31.12.2 are performed for full rate speech (teleservice 11, telephony). For an MS not supporting speech but supporting at least one of telecommunication services (TS6x, BS2x, BS3x, BS4x, BS5x), for each of the test procedures 31.12.1 and 31.12.2 a full rate service supported by the MS (see PICS/PIXIT statement) is chosen, and the test is performed corresponding to that service.

31.12.1 eMLPP Service / priority level of MO call

31.12.1.1 Conformance requirement

For the MS supporting MO calls:

1. Mobile stations indicate the priority of their call in the signalling that takes place during the call establishment process.
2. The MS shall verify the selected priority level against the priority levels stored in the SIM. If the selected priority is not allowed, then the priority of the call shall be modified to that of the nearest allowed priority level below the requested level.
3. In case of no priority selection or use of a non-compatible Mobile Station the Mobile Station shall send a standard service request message.
4. Signalling information required for the prioritisation at mobile originating call establishment. (see figure 1 of GSM 04.67 subclause 4.1.1) and Signalling information between the network and the calling mobile station required for the prioritisation in case of a VGCS or VBS call (figure 4 of GSM 04.67 subclause 4.1.4).
5. The user or the network may wish to omit or postpone authentication and ciphering in order to provide for a faster call set-up.

Reference(s)

GSM 03.67 section 11.3.1.1, 11.3.1.2, 11.6, 11.3.1.3

GSM 02.67 section 4.

GSM 04.67 section 4.1.1, 4.1.4

31.12.1.2 Test purpose

For the MS supporting MO, to verify that:

1. When user selects priority level for normal MO call, the priority level is indicated in the signalling message.
2. The MS verifies the selected priority level against the priority levels stored in the SIM. If the selected priority is not allowed, then the priority of the call shall be modified to that of the nearest allowed priority level below the requested level.
3. If the user does not select a priority level, the priority level is not indicated in the signalling message.
4. If a priority selection is performed by the user the MS provides the priority level information element in L3-MM CM SERVICE REQUEST message when a group call is initiated.
5. The mobile is able to establish a normal MO call with a priority level or a group call with a priority level according to the procedure specified in GSM 04.67 subclause 4.1.1 and the procedure in GSM 04.67 subclause 4.1.4.
6. The mobile is able to initiate a fast call set-up without authentication and ciphering.

31.12.1.3 Method of test

Initial Conditions

System Simulator:

1 cell with default parameters.

Mobile Station:

The MS is in idle mode with SIM in which the available priority levels are level 2, level 3, and level 4

Related PICS/PIXIT Statement(s)

Type of MS (GSM 450, GSM 480, P-, E-, R-GSM 900, DCS 1800 or PCS 1900).

Support mobile originating call.

Support mobile emergency call (TS12).

Support VGCS originating.

Support VBS originating.

Support eMLPP.

Way to select a priority level.

Foreseen Final State of the MS

"Idle, updated".

Test Procedure

The test steps 1 to 26 are repeated for k=1, 2, 3. After the repetition is finished the steps 27 to 71 are performed.

The test steps 1 to 7 are performed if the mobile station supports normal MO call. The steps 8 to 13 are executed if the MS supports TS12. The test steps 20 to step 26 are executed for k= 1, 2, 3, if the mobile station supports VGCS/VBS originating.

An allowed priority level (level 3) or a priority level (level 1) higher than allowed level or no priority level is selected by MMI action (for k=1, 2, 3 respectively). An MO call is attempted. It is checked that the MS indicates the selected priority level (for k=1) or the nearest allowed priority level below the selected level (for k=2) or no priority level (for k=3) in the signalling message.

A normal MO call is attempted with an allowed priority level (level 3). It is checked that the MS establishes completely this call.

If the mobile station supports VGCS/VBS originating a VGCS/VBS call is initiated via the MMI by using the SETUP procedure.

A MO VGCS/VBS call is attempted with the allowed priority level 0. It is checked that the MS establishes completely this call using the immediate setup procedure without authentication and ciphering.

Maximum Duration of Test

5 minutes

Expected Sequence

Step	Direction	Message	Comments
1	MS		for k=1, MMI action to select a priority level 3 for k=2, MMI action to select a priority level 0 for k=3, no MMI action to select priority level to initiate a normal MO call
2	MS		
3	MS -> SS	CHANNEL REQUEST	
4	SS -> MS	IMMEDIATE ASSIGNMENT	
5	MS -> SS	CM SERVICE REQUEST	
6	SS -> MS	CM SERVICE REJECT	for k=1, containing priority IE with the selected priority for k=2, containing priority IE with a priority level nearest allowed priority level below the requested one (level 2) for k=3, containing no priority IE
7	SS -> MS	CHANNEL RELEASE	
8	MS		to initiate a normal MO emergency call
9	MS -> SS	CHANNEL REQUEST	for k=1, containing priority IE with the selected priority for k=2, containing priority IE with a priority level nearest allowed priority level below the requested one (level 2) for k=3, containing no priority IE
10	SS -> MS	IMMEDIATE ASSIGNMENT	
11	MS -> SS	CM SERVICE REQUEST	
12	SS -> MS	CM SERVICE REJECT	
13	SS -> MS	CHANNEL RELEASE	
20	MS		for k=1, MMI action to select a priority level 3 for k=2, MMI action to select a priority level 0 for k=3, no MMI action to select priority level to initiate a VGCS call by setup procedure, if supporting VGCS originating. to initiate a VBS call by setup procedure, if supporting only VBS originating. for k=1, containing priority IE with the selected priority for k=2, containing priority IE with a priority level nearest allowed priority level below the requested one (level 2) for k=3, containing no priority IE MMI action to select a priority level 3
21	MS		
22	MS -> SS	CHANNEL REQUEST	
23	SS -> MS	IMMEDIATE ASSIGNMENT	
24	MS -> SS	CM SERVICE REQUEST	
25	SS -> MS	CM SERVICE REJECT	
26	SS -> MS	CHANNEL RELEASE	
27	MS		
28	MS		initiate a normal MO call
29	MS -> SS	CHANNEL REQUEST	
30	SS -> MS	IMMEDIATE ASSIGNMENT	
31	MS -> SS	CM SERVICE REQUEST	containing priority IE with a priority level nearest allowed priority level below the requested one (level 3)
32	SS -> MS	AUTHENTICATION REQUEST	
33	MS -> SS	AUTHENTICATION RESPONSE	
34	SS -> MS	CIPHERING MODE COMMAND	no ciphering
35	MS -> SS	CIPHERING MODE COMPLETE	
36	MS -> SS	SETUP	
37	SS -> MS	CALL PROCEEDING	
38	SS -> MS	ASSIGNMENT COMMAND	
39	MS -> SS	ASSIGNMENT COMPLETE	
40	SS -> MS	ALERTING	
41	SS -> MS	CONNECT	
42	MS -> MS	CONNECT ACKNOWLEDGE	
43	SS -> MS	DISCONNECT	
44	MS -> SS	RELEASE	
45	SS -> MS	RELEASE COMPLETE	
46	SS -> MS	CHANNEL RELEASE	

			Steps 47 – 71 are performed if the MS supports VGCS/VBS originating
47	MS		MMI action to select a priority level 3 and initiate a VGCS/VBS call by setup procedure
49	MS -> SS	CHANNEL REQUEST	
50	SS -> MS	IMMEDIATE ASSIGNMENT	
51	MS -> SS	CM SERVICE REQUEST	containing priority IE with a priority level nearest allowed priority level below the requested one (level 3)
52	SS -> MS	AUTHENTICATION REQUEST	
53	MS -> SS	AUTHENTICATION RESPONSE	
54	SS -> MS	CIPHERING MODE COMMAND	no ciphering
55	MS -> SS	CIPHERING MODE COMPLETE	
56	MS -> SS	SETUP	
57	SS -> MS	CHANNEL MODE MODIFY	
58	MS -> SS	CHANNEL MODE MODIFY ACKNOWLEDGE	
59	SS -> MS	CONNECT	
60	SS		Verify that TCH is through connected
61	SS -> MS	TERMINATION	
62	SS -> MS	CHANNEL RELEASE	
63	MS		MMI action to select a priority level 0, MMI action to initiate VGCS/VBS call.
64	MS -> SS	CHANNEL REQUEST	
65	SS -> MS	IMMEDIATE ASSIGNMENT	TCH/F, single RF channel GSM 450: 275, GSM 480: 322, GSM 900: 50, DCS 1800: 750 PCS 1900: 650
66	MS -> SS	IMMEDIATE SETUP	L2: SABM / UA
67	SS -> MS	CHANNEL MODE MODIFY	very early assignment
68	MS -> SS	CHANNEL MODE MODIFY ACKNOWLEDGE	
69	SS -> MS	CONNECT	verify that the TCH is through connected
70	SS		Verify that TCH is through connected
70	SS -> MS	TERMINATION	
71	SS -> MS	CHANNEL RELEASE	

Special Message Contents

CM SERVICE REQUEST in step 5 and step 24

for k=1, 2

Information Element	value/remark
as default except:	
CM Service Type	not checked
Ciphering key sequence number	not checked
Mobile station classmark	not checked
Priority	
Information element identifier	0001
Spare	0
Call priority	010 for k=1 011 for k=2

for k=3

Information Element	value/remark
as default except: CM Service Type Ciphering key sequence number Mobile station classmark Priority	not checked not checked not checked not present

CM SERVICE REQUEST in step 11

for k=1, 2

Information Element	value/remark
as default except: CM Service Type Ciphering key sequence number Mobile station classmark Priority Information element identifier Spare Call priority	"emergency call establishment" not checked not checked 0001 0 010 for k=1 011 for k=2

for k=3

Information Element	value/remark
as default except: CM Service Type Ciphering key sequence number Mobile station classmark Priority	"emergency call establishment" not checked not checked not present

31.12.2 eMLPP Service / automatic answering point-to-point MT call

31.12.2.1 Conformance requirement

For the MS supporting MT call:

- Automatic answering or, if necessary, called-party pre-emption has to be performed by the Mobile Station as defined in the following:
 - point-to-point calls:

If the user is in idle mode, the Mobile Station shall automatically connect to an incoming call of a sufficient priority level. If the user is in dedicated mode and has a subscription to Call Waiting, a Call Waiting indication including the priority level of the call shall be given to the Mobile Station which automatically accepts the waiting call.
- In dedicated mode, in the case where the called subscriber has a subscription for eMLPP and for Call Waiting and is using a compatible Mobile Station, the Mobile Station shall be informed of the priority of the new call together with the call waiting indication. The Mobile Station will then consult the internal service configuration list stored on the SIM to establish whether it should automatically accept the waiting call without consulting the user, or whether the call waiting facility will be used as normal.

3. In the case where the called subscriber has a subscription for eMLPP and for CW, the mobile station shall be informed of the priority of the new call together with the CW indication. On reception of the set-up message the compatible mobile station decides on called party pre-emption. If called party pre-emption applies, the mobile station shall automatically accept the waiting call and send a hold message to the network. If a hold acknowledge is received, the waiting call is accepted. If a hold reject is received for any reason, e.g. there is no subscription for hold, the other call shall be released and the waiting call accepted. If the ongoing call is not a TS11 call, the mobile station should not send a hold message to the network but release the call and accept the waiting call.

Reference(s)

GSM 02.67 section 4, 5.9.

GSM 03.67 section 4, 11.3.2.4, 11.3.2.5, 11.6

GSM 04.67 section 4.1.3.

GSM 04.83 section 1.1, 1.2.

31.12.2.2 Test purpose

For the MS supporting MT call, to verify that:

1. In idle mode the MS automatically accepts an incoming point-to-point call of priority level for which automatic answering is enabled.
2. In idle mode the MS alerts an incoming point-to-point call of a priority level for which automatic answering is disabled.
3. In dedicated mode and supporting Call Waiting, when a Call Waiting indication includes a level for which automatic answering is enabled and the priority level is higher than the ongoing point-to-point call, the MS automatically confirms the waiting call and sends a hold message to the network. If a hold reject is received the other call is released and the waiting call is accepted.
4. In dedicated mode and supporting Call Waiting, when a Call Waiting indication includes a priority level for which automatic answering is enabled and the priority level is equal or lower than the priority level of the ongoing call, the MS indicates the waiting call.
5. In group receive mode the MS automatically responds to the paging message containing a priority level for which automatic answering is enabled and the priority level is higher than the priority level of the ongoing call.
6. In group receive mode the MS indicates an incoming point-to-point call of a priority level for which automatic answering is enabled and the priority level is equal or lower than the priority level of the ongoing call.

31.12.2.3 Method of test

Initial Conditions

System Simulator:

1 cell with default parameters.

Mobile Station:

the MS is in idle mode;

The auto answering priority level is set to higher than priority level 2.

Related PICS/PIXIT Statement(s)

Type of MS (GSM 450, GSM 480, P-, E-, R-GSM 900, DCS 1800 or PCS 1900).

Support VGCS listening.

Support VBS listening.

Support call waiting

Support hold

Support eMLPP.

Way to configure automatic answering.

Way to indicate a call has been automatically answered.

Foreseen Final State of the MS

"Idle, updated".

Test Procedure

The call waiting is activated. The MS is in idle mode and automatic answering for priority level 2 is disabled. A PAGING REQUEST message containing priority level 2 is sent. It is checked that the MS indicates the incoming call to the user. The automatic answering for level 1 is enabled. A PAGING REQUEST message with priority level 2 is sent. It is checked that the MS automatically accepts the incoming normal call. The call is released. A PAGING REQUEST message without priority level is sent, and during the call set-up the SETUP message contains priority level 1. It is checked that the MS automatically accepts the incoming normal call.

The MS is in dedicated mode (If the MS supports TS11, TS11 service shall be selected for the dedicated mode testing). a SETUP message with priority level higher enough for auto answering is sent by the SS. It is checked that the MS automatically accepts the incoming normal call. A SETUP message containing low priority level without auto answering is sent. It is checked that the MS indicates the incoming call to the user.

The MS is in group receive mode, a NOTIFICATION/FACCH message containing paging information and a PAGING REQUEST message with priority level 0 are sent. It is checked that the MS automatically accepts the incoming normal call. The MS is brought into group receive mode. A NOTIFICATION/FACCH message containing paging information and a PAGING REQUEST message containing low priority level are sent. It is checked that the MS indicates the incoming call to the user.

Maximum Duration of Test

5 minutes

Expected Sequence

Step	Direction	Message	Comments
0	MS		the MS is in idle mode and auto answering for priority level 2 is disabled
1	SS -> MS	PAGING REQUEST TYPE 1	with priority level 2
2	MS -> SS	CHANNEL REQUEST	
3	SS -> MS	IMMEDIATE ASSIGNMENT	SDCCH
4	MS -> SS	PAGING RESPONSE	
5	SS -> MS	SETUP	containing priority level 2, but no signal IE
6	MS -> SS	CALL CONFIRMED	
7	SS -> MS	ASSIGNMENT COMMAND	TCH
8	MS -> SS	ASSIGNMENT COMPLETE	
9	MS -> SS	ALERTING	
10	MS		An alerting indication as defined in a PICS/PIXIT statement is given by the MS
11	MS		The MS is made to accept the call in the way described in a PICS/PIXIT statement
12	MS -> SS	CONNECT	
13	SS -> MS	CONNECT ACKNOWLEDGE	
14	SS -> MS	DISCONNECT	
15	MS -> SS	RELEASE	
16	SS -> MS	RELEASE COMPLETE	
17	SS -> MS	CHANNEL RELEASE	return to idle mode
21	SS -> MS	PAGING REQUEST TYPE 1	containing priority level 1
22	MS -> SS	CHANNEL REQUEST	

Step	Direction	Message	Comments
23	SS -> MS	IMMEDIATE ASSIGNMENT	SDCCH
24	MS -> SS	PAGING RESPONSE	
25	SS -> MS	SETUP	containing priority level 1, but no signal IE
26	MS -> SS	CALL CONFIRMED	
27	MS -> SS	CONNECT	automatic connection
28	SS -> MS	ASSIGNMENT COMMAND	TCH
29	MS -> SS	ASSIGNMENT COMPLETE	
30	SS -> MS	CONNECT ACKNOWLEDGE	
31	MS		to check that the MS gives an indication as defined in a PICS/PIXIT statement for call automatically answered
32	SS -> MS	DISCONNECT	
33	MS -> SS	RELEASE	
34	SS -> MS	RELEASE COMPLETE	
35	SS -> MS	CHANNEL RELEASE	return to idle mode
36	SS -> MS	PAGING REQUEST TYPE 1	containing no priority level
37	MS -> SS	CHANNEL REQUEST	
38	SS -> MS	IMMEDIATE ASSIGNMENT	SDCCH
39	MS -> SS	PAGING RESPONSE	
40	SS -> MS	SETUP	containing priority level 3, but no signal IE
41	MS -> SS	CALL CONFIRMED	
42	MS -> SS	CONNECT	automatic connection
43	SS -> MS	ASSIGNMENT COMMAND	TCH
44	MS -> SS	ASSIGNMENT COMPLETE	
45	SS -> MS	CONNECT ACKNOWLEDGE	
51	SS -> MS	SETUP	new transaction, containing priority level 1 and Signal Information Element with value #7
52	MS -> SS	CALL CONFIRMED	on new transaction with cause #17
53a	MS -> SS	HOLD	on old transaction for service TS11
53b			no signalling for services other than TS11
54a	SS -> MS	HOLD REJECT	on old transaction for service TS11 with cause #69
54b			no signalling for services other than TS11
55	MS -> SS	DISCONNECT	on old transaction, cause = 'Normal call clearing'
56	SS -> MS	RELEASE	on old transaction
57	MS -> SS	RELEASE COMPLETE	on old transaction
58	MS -> SS	CONNECT	on new transaction
59	SS -> MS	CONNECT ACKNOWLEDGE	on new transaction
60	SS -> MS	SETUP	another new transaction different from step 51, containing priority level 1 and Signal Information Element with value #7
61	MS -> SS	CALL CONFIRMED	on the same transaction as step 60, with cause #17
62	MS -> SS	ALERTING	on the same transaction as step 60
63	MS		to check that the MS gives incoming call indication
64	SS -> MS	DISCONNECT	on the same transaction as step 51
65	MS -> SS	RELEASE	on the same transaction as step 51
66	SS -> MS	RELEASE COMPLETE	on the same transaction as step 51
67	SS -> MS	CHANNEL RELEASE	
70	MS		the MS is in group receive mode, the priority level of current call is level 3
72	SS -> MS	PAGING REQUEST TYPE 1	containing priority level 0
73	MS -> SS	CHANNEL REQUEST	
74	SS -> MS	IMMEDIATE ASSIGNMENT	SDCCH
75	MS -> SS	PAGING RESPONSE	
76	SS -> MS	SETUP	without priority level and signal IE
77	MS -> SS	CALL CONFIRMED	
78	MS -> SS	CONNECT	automatic connection
79	SS -> MS	ASSIGNMENT COMMAND	TCH
80	MS -> SS	ASSIGNMENT COMPLETE	
81	SS -> MS	CONNECT ACKNOWLEDGE	
82	SS -> MS	DISCONNECT	
83	MS -> SS	RELEASE	
84	SS -> MS	RELEASE COMPLETE	
85	SS -> MS	CHANNEL RELEASE	

Step	Direction	Message	Comments
86	MS		the MS is brought into group receive mode with the priority level 3
88	SS -> MS	PAGING REQUEST TYPE 1	containing priority level 3
89	MS		to check that the MS gives incoming call indication
90	SS -> MS	CHANNEL RELEASE	UI format

31.12.3 eMLPP Service / automatic answering MT VGCS or VBS call

31.12.3.1 Conformance requirement

For the MS supporting VGCS/VBS listening:

1. Automatic answering or, if necessary, called-party pre-emption has to be performed by the Mobile Station as defined in the following:
 - voice group calls and voice broadcast calls:

Notifications for other voice group calls, voice broadcast calls or information on paging for point-to-point calls shall be given to the Mobile Stations involved in on-going voice group calls or voice broadcast calls as defined in GSM 03.68 and GSM 03.69, respectively. The notifications include the related priority level of the call. In case of a notified call with higher priority where called-party pre-emption applies, the Mobile Station shall automatically leave the on-going voice group call or voice broadcast call and react according to the type of the notified call type.
2. In dedicated mode, in the case where the called subscriber has a subscription for eMLPP and for Call Waiting and is using a compatible Mobile Station, the Mobile Station shall be informed of the priority of the new call together with the call waiting indication. The Mobile Station will then consult the internal service configuration list stored on the SIM to establish whether it should automatically accept the waiting call without consulting the user, or whether the call waiting facility will be used as normal.
3. In the case where the called subscriber has a subscription for eMLPP and for CW, the mobile station shall be informed of the priority of the new call together with the CW indication. On reception of the notification message the compatible mobile station decides on called party pre-emption. If called party pre-emption applies, the mobile station shall automatically release the call and join the new call.

Reference(s)

GSM 02.67 section 4.

GSM 03.68 section 4, 11.3.1.3, 11.3.1.4.

GSM 03.67 section 4.

GSM 04.67 section 4.1.5

31.12.3.2 Test purpose

For the MS supporting VGCS/VBS listening, to verify that:

1. In idle mode the MS automatically accepts an incoming VGCS or VBS call of sufficient priority level.
2. In idle mode the MS indicates an incoming VGCS or VBS call of priority level not high enough for automatic answering.
3. In dedicated mode, the MS automatically accepts an incoming VGCS or VBS call of sufficient priority level.
4. In dedicated mode, the MS indicates an incoming VGCS or VBS call of priority level not high enough for automatic answering.
5. In group receive mode the MS automatically accepts an incoming VGCS or VBS call of sufficient priority level.
6. In group receive mode the MS indicates an incoming VGCS or VBS call of priority level not high enough for automatic answering.

31.12.3.3 Method of test

Initial Conditions

System Simulator:

1 cell with default parameters.

Mobile Station:

the MS is in idle mode;

The auto answering priority level is set to higher than priority level 2.

Related PICS/PIXIT Statement(s)

Type of MS (GSM 450, GSM 480, P-, E-, R-GSM 900, DCS 1800 or PCS 1900).

Support eMLPP.

Way to configure automatic answering.

Way to indicate that a VGCS/VBS call has been automatically accepted.

Foreseen Final State of the MS

"Idle, updated".

Test Procedure

The MS is in idle mode. a NOTIFICATION/NCH message with priority level higher enough for auto answering is sent. It is checked that the MS automatically accepts the incoming VGCS/VBS call. The call is released. A NOTIFICATION/NCH message containing low priority level without auto answering is sent. It is checked that the MS indicates the incoming VGCS/VBS call to the user.

The MS is in dedicated mode. a NOTIFICATION/FACCH message with priority level higher enough for auto answering is sent. It is checked that the MS automatically accepts the incoming VGCS/VBS call. A NOTIFICATION/FACCH message containing low priority level without auto answering is sent. It is checked that the MS indicates the incoming VGCS/VBS call to the user.

The MS is in group receive mode. a NOTIFICATION/FACCH message with priority level higher enough for auto answering and containing VGCS/VBS channel description is sent. It is checked that the MS automatically accepts the incoming VGCS/VBS call. A NOTIFICATION/FACCH message containing priority level not higher enough for auto answering and containing VGCS/VBS channel description is sent. It is checked that the MS indicates the incoming VGCS/VBS call to the user.

Maximum Duration of Test

5 minutes

Expected Sequence

Step	Direction	Message	Comments
1	MS		the MS is in idle mode
2	SS -> MS	NOTIFICATION/NCH	containing priority level 1
3	MS		to check that the MS automatically accepts the VGCS/VBS call
4	SS		stop sending NOTIFICATION/NCH
5	SS -> MS	CHANNEL RELEASE	UI format, release VGCS/VBS channel
6	SS -> MS	NOTIFICATION/NCH	containing priority level 3
7	MS		to check that the MS indicates the VGCS/VBS call to the user
8	SS		stop sending NOTIFICATION/NCH
15	MS		the MS is in dedicated mode, the priority level of current call is level 3
16	SS -> MS	NOTIFICATION/FACCH	containing priority level 2
17	MS -> SS	DISCONNECT	
18	SS -> MS	RELEASE	
19	MS -> SS	RELEASE COMPLETE	
20	SS -> MS	CHANNEL RELEASE	
21	MS		to check that the MS automatically accepts the VGCS/VBS call
22	SS -> MS	CHANNEL RELEASE	UI format, release VGCS/VBS channel
23	MS		the MS is brought into dedicated mode, the priority level of current call is level 3
24	SS -> MS	NOTIFICATION/FACCH	containing priority level 4
25	MS		to check that the MS indicates the VGCS/VBS call to the user
26	SS		stop sending NOTIFICATION/FACCH
27	SS -> MS	DISCONNECT	
28	MS -> SS	RELEASE	
29	SS -> MS	RELEASE COMPLETE	
30	SS -> MS	CHANNEL RELEASE	I format, release dedicated channel
31	MS		the MS is in group receive mode, the priority level of current call is level 3
32	SS -> MS	NOTIFICATION/FACCH	containing priority level 1 and with VGCS/VBS channel description
33	MS		to check the MS automatically accepts the incoming VGCS/VBS call
34	SS -> MS	NOTIFICATION/FACCH	containing priority level 4 and with VGCS/VBS channel description
35	MS		to check the MS indicates the incoming VGCS/VBS call to the user
36	SS -> MS	CHANNEL RELEASE	UI format, release VGCS/VBS channel

31.12.4 eMLPP Service / registration

31.12.4.1 Conformance requirement

For registration of eMLPP default priority level, the MS shall transmit successively:

1. A CHANNEL REQUEST with establishment cause set to "other services requested by the mobile user";
2. A CM SERVICE REQUEST with CM service type indicating "supplementary service activation";
3. An eMLPP registration request from a mobile user shall include the SS-Code of the eMLPP service and the default priority level.

Reference(s)

GSM 04.67 section 4.2 (figure 6),

GSM 04.08 sections 3.3.1.2, 4.5.1.1, 9.1.8, 9.2.9.

31.12.4.2 Test purpose

To check that the MS:

1. Correctly requests a supplementary service transaction for registration of eMLPP in CHANNEL REQUEST message.
2. Correctly requests a supplementary service transaction for registration of eMLPP in the subsequent CM SERVICE REQUEST.
3. Then sends a REGISTER message containing the invoke of the RegisterSS operation with the expected parameter values for registration of eMLPP default priority level.
4. Provides the appropriate user indication (as described by the manufacturer) upon receipt of the result of the operation (in a RELEASE COMPLETE message).

31.12.4.3 Method of test

Initial Conditions

System Simulator:

1 cell with default parameters.

Mobile Station:

the MS is in idle mode

Related PICS/PIXIT Statement(s)

Type of MS (GSM 450, GSM 480, P-, E-, R-GSM 900, DCS 1800 or PCS 1900).

Support eMLPP.

Way to select a priority level.

Way to initiate eMLPP registration.

Way to indicate the result of the eMLPP registration.

Foreseen Final State of the MS

"Idle, updated".

Test Procedure

By means of appropriate MMI functions (using either GSM 02.30 or manufacturer defined MMI), the user requests registration of eMLPP for a default priority level DefaultPriorityLevel arbitrarily selected.

Upon receipt of the operation (in a REGISTER message), the system simulator answers with a RELEASE COMPLETE message with the Facility information element containing the return result of the RegisterSS operation.

The SS transaction is released and the dedicated channel is released.

Then check the MS provides a correct user indication.

Maximum Duration of Test

3 min

Expected Sequence

Step	Direction	Message	Comments
1	MS		The MS is made to initiate a registration of eMLPP default priority level
2	MS -> SS	CHANNEL REQUEST	with establishment cause "Other procedures which can be completed with an SDCCH"
3	SS -> MS	IMMEDIATE ASSIGNMENT	
4	MS -> SS	CM SERVICE REQUEST	cause: "supplementary service activation"
5	SS -> MS	CM SERVICE ACCEPT	
6	MS -> SS	REGISTER	RegisterSS(eMLPP, DefaultPriorityLevel)
7	SS -> MS	RELEASE COMPLETE	RegisterSS operation Return_result
8	MS		provide correct MMI user indication
9	SS -> MS	CHANNEL RELEASE	

Special Message Contents

REGISTER:

Information Element	value/remark
as default except: Facility invoke Supplementary service code Default Priority	RegisterSS eMLPP arbitrary

31.12.5 eMLPP Service / interrogation

31.12.5.1 Conformance requirement

For interrogation of eMLPP default priority level, the MS shall transmit successively:

1. A CHANNEL REQUEST with establishment cause set to "other services requested by the mobile user";
2. A CM SERVICE REQUEST with CM service type indicating "supplementary service activation";
3. And then the REGISTER message containing a facility IE that includes an invoke of the InterrogateSS operation with parameter values eMLPP (MMI action) (See Figure 7 of GSM 04.67 subclause 4.5).

Reference(s)

GSM 04.67 section 4.5 (figure 7),

GSM 04.08 sections 3.3.1.2, 4.5.1.1, 9.1.9, 9.2.9.

31.12.5.2 Test purpose

To check that the MS:

1. Correctly requests a supplementary service transaction for interrogation of eMLPP in CHANNEL REQUEST message.
2. Correctly requests a supplementary service transaction for interrogation of eMLPP in the subsequent CM SERVICE REQUEST.
3. Then sends a REGISTER message containing the invoke of the InterrogateSS operation with the expected parameter values for interrogation of eMLPP default priority level.

4. Provides the appropriate user indication (as described by PIXIT) upon receipt of the result of the operation (in a RELEASE COMPLETE message).

31.12.5.3 Method of test

Initial Conditions

System Simulator:

1 cell with default parameters.

Mobile Station:

the MS is in idle mode

Related PICS/PIXIT Statement(s)

Type of MS (GSM 450, GSM 480, P-, E-, R-GSM 900, DCS 1800 or PCS 1900).

Support eMLPP.

Way to select a priority level.

Way to initiate eMLPP interrogation.

Way to indicate the result of the eMLPP interrogation.

Foreseen Final State of the MS

"Idle, updated".

Test Procedure

By means of appropriate MMI functions (using either GSM 02.30 or manufacturer defined MMI), the user requests interrogation of eMLPP.

Upon receipt of the operation (in a REGISTER message), the system simulator answers with a RELEASE COMPLETE message with the Facility information element containing the return result of the InterrogateSS operation.

The SS transaction is released and the dedicated channel is released.

Then check the MS provides a correct user indication.

Maximum Duration of Test

3 min

Expected Sequence

Step	Direction	Message	Comments
1	MS		The MS is made to initiate a interrogation of eMLPP default priority level with establishment cause "Other procedures which can be completed with an SDCCH" cause: "supplementary service activation" InterrogateSS(eMLPP) InterrogateSS operation Return_result containing SS-Status, MaximumPriorityLevel, DefaultPriorityLevel provide correct MMI user indication
2	MS -> SS	CHANNEL REQUEST	
3	SS -> MS	IMMEDIATE ASSIGNMENT	
4	MS -> SS	CM SERVICE REQUEST	
5	SS -> MS	CM SERVICE ACCEPT	
6	MS -> SS	REGISTER	
7	SS -> MS	RELEASE COMPLETE	
8	MS		
9	SS -> MS	CHANNEL RELEASE	

Special Message Contents

REGISTER:

Information Element	value/remark
as default except: Facility invoke Supplementary service code	InterrogateSS eMLPP

31.13 Explicit Call Transfer (ECT)

NOTE: In this section, Subscriber A is the MS under test, and subscribers B and C are distant parties to the calls made during the tests.

31.13.1 Explicit Call Transfer invocation

31.13.1.1 Explicit Call Transfer invocation, successful case, both calls active, clearing using DISCONNECT

Conformance requirement

GSM 04.91 subclause 4.1, 4.2

Applicability

MS supporting the Explicit Call Transfer supplementary service.

Test purpose

To test that the MS invokes explicit call transfer between two active calls by sending a FACILITY message with the correct invoke component, and reacts correctly on receipt of a DISCONNECT response from the network.

Method of test

Related PICS/PIXIT statements

Method of performing Explicit Call transfer on two active calls

Initial conditions

System Simulator:

1 cell, default parameters.

Mobile Station:

The MS shall have Call A-B in state U10 "Active" with auxiliary state "Call held" and Call A-C in state U10 "Active" with no auxiliary state. Both calls shall be of a basic service supported by the MS and applicable to the ECT supplementary service as described in GSM 02.04 Table A.1.

Foreseen final state of the MS

Call A-B, state U0. Call A-C, state U0.

Maximum duration of test

30 s.

Procedure

Using suitable MMI commands, the MS shall invoke an explicit call transfer between the two calls. The MS shall send a FACILITY message with a transaction identifier for either call A-B or call A-C and containing an ExplicitCT invoke component. The call state of both calls shall be unchanged. The call states shall be verified by the SS sending a STATUS ENQUIRY message in respect of the transaction identifier of each call, and receiving a STATUS message indicating the appropriate call state.

On receipt of a DISCONNECT message with respect to one of the calls containing a return result component, followed by a DISCONNECT message for the other call, the MS shall respond with a RELEASE message for each call. On receipt of a RELEASE COMPLETE message for each call, the MS shall enter state U0 "Null". The call states shall be verified by the SS sending a STATUS ENQUIRY message in respect of the transaction identifier of each call, and receiving a RELEASE COMPLETE message with cause #81 "invalid transaction identifier value".

Expected sequence

Step	Direction	Message	Comments
1	MS		Using MMI commands, perform and explicit call transfer
2	MS -> SS	FACILITY	TI for Call A-B or Call A-C, ExplicitCT Invoke component
3	SS -> MS	STATUS ENQUIRY	Transaction identifier of Call A-B
4	MS -> SS	STATUS	Transaction identifier of Call A-B, state U10, auxiliary state "Call held"
5	SS -> MS	STATUS ENQUIRY	Transaction identifier of Call A-C
6	MS -> SS	STATUS	Transaction identifier of Call A-C, state U10, no auxiliary state
7	SS -> MS	DISCONNECT	Transaction identifier of Call A-B
8	MS -> SS	RELEASE	Transaction identifier of Call A-B
9	SS -> MS	DISCONNECT	Transaction identifier of Call A-C
10	MS -> SS	RELEASE	Transaction identifier of Call A-C
11	SS -> MS	RELEASE COMPLETE	Transaction identifier of Call A-B
12	SS -> MS	RELEASE COMPLETE	Transaction identifier of Call A-C
13	SS -> MS	STATUS ENQUIRY	Transaction identifier of Call A-B
14	MS -> SS	RELEASE COMPLETE	Transaction identifier of Call A-B, with cause #81 "invalid transaction identifier value"
15	SS -> MS	STATUS ENQUIRY	Transaction identifier of Call A-C
16	MS -> SS	RELEASE COMPLETE	Transaction identifier of Call A-C, with cause #81 "invalid transaction identifier value"

31.13.1.2 Explicit Call Transfer invocation, successful case, both calls active, clearing using RELEASE

Conformance requirement

GSM 04.91 subclause 4.1, 4.2

Applicability

MS supporting the Explicit Call Transfer supplementary service.

Test purpose

To test that the MS invokes explicit call transfer between two active calls by sending a FACILITY message with the correct invoke component, and reacts correctly on receipt of a RELEASE response from the network.

Method of test

Related PICS/PIXIT statements

Method of performing Explicit Call transfer on two active calls

Initial conditions

System Simulator:

1 cell, default parameters.

Mobile Station:

The MS shall have Call A-B in state U10 "Active" with auxiliary state "Call held" and Call A-C in state U10 "Active" with no auxiliary state. Both calls shall be of a basic service supported by the MS and applicable to the ECT supplementary service as described in GSM 02.04 Table A.1.

Foreseen final state of the MS

Call A-B, state U0. Call A-C, state U0.

Maximum duration of test

30 s.

Procedure

Using suitable MMI commands, the MS shall invoke an explicit call transfer between the two calls. The MS shall send a FACILITY message with a transaction identifier for either call A-B or call A-C and containing an ExplicitCT invoke component. The call state of both calls shall be unchanged. The call states shall be verified by the SS sending a STATUS ENQUIRY message in respect of the transaction identifier of each call, and receiving a STATUS message indicating the appropriate call state.

On receipt of a RELEASE message with respect to one of the calls containing a return result component, followed by a RELEASE message for the other call, the MS shall respond with a RELEASE COMPLETE message for each call and shall enter state U0 "Null". The call states shall be verified by the SS sending a STATUS ENQUIRY message in respect of the transaction identifier of each call, and receiving a RELEASE COMPLETE message with cause #81 "invalid transaction identifier value".

Expected sequence

Step	Direction	Message	Comments
1	MS		Using MMI commands, perform and explicit call transfer
2	MS -> SS	FACILITY	TI for Call A-B or Call A-C, ExplicitCT Invoke component
3	SS -> MS	STATUS ENQUIRY	Transaction identifier of Call A-B
4	MS -> SS	STATUS	Transaction identifier of Call A-B, state U10, auxiliary state "Call held"
5	SS -> MS	STATUS ENQUIRY	Transaction identifier of Call A-C
6	MS -> SS	STATUS	Transaction identifier of Call A-C, state U10, no auxiliary state
7	SS -> MS	RELEASE	Transaction identifier of Call A-B
8	MS -> SS	RELEASE COMPLETE	Transaction identifier of Call A-B
9	SS -> MS	RELEASE	Transaction identifier of Call A-C
10	MS -> SS	RELEASE COMPLETE	Transaction identifier of Call A-C
11	SS -> MS	STATUS ENQUIRY	Transaction identifier of Call A-B
12	MS -> SS	RELEASE COMPLETE	Transaction identifier of Call A-B, with cause #81 "invalid transaction identifier value"
13	SS -> MS	STATUS ENQUIRY	Transaction identifier of Call A-C
14	MS -> SS	RELEASE COMPLETE	Transaction identifier of Call A-C, with cause #81 "invalid transaction identifier value"

31.13.1.3 Explicit Call Transfer invocation, successful case, both calls active, clearing using RELEASE COMPLETE

Conformance requirement

GSM 04.91 subclause 4.1, 4.2

Applicability

MS supporting the Explicit Call Transfer supplementary service.

Test purpose

To test that the MS invokes explicit call transfer between two active calls by sending a FACILITY message with the correct invoke component, and reacts correctly on receipt of a RELEASE COMPLETE response from the network.

Method of test

Related PICS/PIXIT statements

Method of performing Explicit Call transfer on two active calls

Initial conditions

System Simulator:

1 cell, default parameters.

Mobile Station:

The MS shall have Call A-B in state U10 "Active" with auxiliary state "Call held" and Call A-C in state U10 "Active" with no auxiliary state. Both calls shall be of a basic service supported by the MS and applicable to the ECT supplementary service as described in GSM 02.04 Table A.1.

Foreseen final state of the MS

Call A-B, state U0. Call A-C, state U0.

Maximum duration of test

30 s.

Procedure

Using suitable MMI commands, the MS shall invoke an explicit call transfer between the two calls. The MS shall send a FACILITY message with a transaction identifier for either call A-B or call A-C and containing an ExplicitCT invoke component. The call state of both calls shall be unchanged. The call states shall be verified by the SS sending a STATUS ENQUIRY message in respect of the transaction identifier of each call, and receiving a STATUS message indicating the appropriate call state.

On receipt of a RELEASE COMPLETE message with respect to one of the calls containing a return result component, followed by a RELEASE COMPLETE message for the other call, the MS shall enter state U0 "Null". The call states shall be verified by the SS sending a STATUS ENQUIRY message in respect of the transaction identifier of each call, and receiving a RELEASE COMPLETE message with cause #81 "invalid transaction identifier value".

Expected sequence

Step	Direction	Message	Comments
1	MS		Using MMI commands, perform an explicit call transfer
2	MS -> SS	FACILITY	TI for Call A-B or Call A-C, ExplicitCT Invoke component
3	SS -> MS	STATUS ENQUIRY	Transaction identifier of Call A-B
4	MS -> SS	STATUS	Transaction identifier of Call A-B, state U10, auxiliary state "Call held"
5	SS -> MS	STATUS ENQUIRY	Transaction identifier of Call A-C
6	MS -> SS	STATUS	Transaction identifier of Call A-C, state U10, no auxiliary state
7	SS -> MS	RELEASE COMPLETE	Transaction identifier of Call A-B
8	SS -> MS	RELEASE COMPLETE	Transaction identifier of Call A-C
9	SS -> MS	STATUS ENQUIRY	Transaction identifier of Call A-B
10	MS -> SS	RELEASE COMPLETE	Transaction identifier of Call A-B, with cause #81 "invalid transaction identifier value"
11	SS -> MS	STATUS ENQUIRY	Transaction identifier of Call A-C
12	MS -> SS	RELEASE COMPLETE	Transaction identifier of Call A-C, with cause #81 "invalid transaction identifier value"

31.13.1.4 Explicit Call Transfer invocation, successful case, second call alerting

Conformance requirement

GSM 04.91 subclause 4.1, 4.2

Applicability

MS supporting the Explicit Call Transfer supplementary service.

Test purpose

To test that the MS invokes explicit call transfer between an active held call and an alerting call by sending a FACILITY message with the correct invoke component, and reacts correctly on receipt of clearing messages from the network.

Method of test

Related PICS/PIXIT statements

Method of performing Explicit Call transfer on an active call and an alerting call.

Initial conditions

System Simulator:

1 cell, default parameters.

Mobile Station:

The MS shall have Call A-B in state U10 "Active" with auxiliary state "Call held" and Call A-C in state U4 "Call Delivered" with no auxiliary state. Both calls shall be of a basic service supported by the MS and applicable to the ECT supplementary service as described in GSM 02.04 Table A.1.

Foreseen final state of the MS

Call A-B, state U0. Call A-C, state U0.

Maximum duration of test

30 s.

Procedure

Using suitable MMI commands, the MS shall invoke an explicit call transfer between the two calls. The MS shall send a FACILITY message with a transaction identifier for either call A-B or call A-C and containing an ExplicitCT invoke component. The call state of both calls shall be unchanged. The call states shall be verified by the SS sending a STATUS ENQUIRY message in respect of the transaction identifier of each call, and receiving a STATUS message indicating the appropriate call state.

On receipt of a DISCONNECT message with respect to one of the calls containing a return result component, followed by a DISCONNECT message for the other call, the MS shall respond with a RELEASE message for each call. On receipt of a RELEASE COMPLETE message for each call, the MS shall enter state U0 "Null". The call states shall be verified by the SS sending a STATUS ENQUIRY message in respect of the transaction identifier of each call, and receiving a RELEASE COMPLETE message with cause #81 "invalid transaction identifier value".

Expected sequence

Step	Direction	Message	Comments
1	MS		
2	MS -> SS	FACILITY	Using MMI commands, perform and explicit call transfer
3	SS -> MS	STATUS ENQUIRY	TI for Call A-B or Call A-C, ExplicitCT Invoke component
4	MS -> SS	STATUS	Transaction identifier of Call A-B
5	SS -> MS	STATUS ENQUIRY	Transaction identifier of Call A-B, state U10, auxiliary state "Call held"
6	MS -> SS	STATUS	Transaction identifier of Call A-C
7	SS -> MS	DISCONNECT	Transaction identifier of Call A-C, state U4
8	MS -> SS	RELEASE	Transaction identifier of Call A-B
9	SS -> MS	DISCONNECT	Transaction identifier of Call A-B
10	MS -> SS	RELEASE	Transaction identifier of Call A-C
11	SS -> MS	RELEASE COMPLETE	Transaction identifier of Call A-C
12	SS -> MS	RELEASE COMPLETE	Transaction identifier of Call A-B
13	SS -> MS	STATUS ENQUIRY	Transaction identifier of Call A-C
14	MS -> SS	RELEASE COMPLETE	Transaction identifier of Call A-B, with cause #81 "invalid transaction identifier value"
15	SS -> MS	STATUS ENQUIRY	Transaction identifier of Call A-C
16	MS -> SS	RELEASE COMPLETE	Transaction identifier of Call A-B, with cause #81 "invalid transaction identifier value"

31.13.1.5 Explicit Call Transfer invocation, unsuccessful case

Conformance requirement

GSM 04.91 subclause 4.1, 4.2

Applicability

MS supporting the Explicit Call Transfer supplementary service.

Test purpose

To test that the MS invokes explicit call transfer between an active held call and an alerting call by sending a FACILITY message with the correct invoke component, and returns both calls to their original states on receipt of an error or reject response.

Initial conditions

The MS shall have Call A-B in state U10 "Active" with auxiliary state "Call held" and Call A-C in state U10 "Active" with no auxiliary state. Both calls shall be of a basic service supported by the MS and applicable to the ECT supplementary service as described in GSM 02.04 Table A.1.

Method of test

Related PICS/PIXIT statements

Method of performing Explicit Call transfer on two active calls

Initial conditions

System Simulator:

1 cell, default parameters.

Mobile Station:

The MS shall have Call A-B in state U10 "Active" with auxiliary state "Call held" and Call A-C in state U10 "Active" with no auxiliary state. Both calls shall be of a basic service supported by the MS and applicable to the ECT supplementary service as described in GSM 02.04 Table A.1.

Foreseen final state of the MS

Call A-B, state U10, auxiliary state "Call held". Call A-C, Call A-C, state U10, no auxiliary state.

Maximum duration of test

30 s.

Procedure

Using suitable MMI commands, the MS shall invoke an explicit call transfer between the two calls. The MS shall send a FACILITY message with a transaction identifier for either call A-B or call A-C and containing an ExplicitCT invoke component. The call state of both calls shall be unchanged. The call states shall be verified by the SS sending a STATUS ENQUIRY message in respect of the transaction identifier of each call, and receiving a STATUS message indicating the appropriate call state.

On receipt of a FACILITY message using the same transaction identifier and including a return error component, the MS shall not send any further messages in respect of the transfer attempt, and shall remain in the same call state for both calls. The call states shall be verified by the SS sending a STATUS ENQUIRY message in respect of the transaction identifier of each call, and receiving a STATUS message indicating the appropriate call state.

Using suitable MMI commands, the MS shall again invoke an explicit call transfer between the two calls. The MS shall send a FACILITY message with a transaction identifier for either call A-B or call A-C and containing an ExplicitCT invoke component. The call state of both calls shall be unchanged. The call states shall be verified by the SS sending a STATUS ENQUIRY message in respect of the transaction identifier of each call, and receiving a STATUS message indicating the appropriate call state.

On receipt of a FACILITY message using the same transaction identifier and including a reject component, the MS shall not send any further messages in respect of the transfer attempt, and shall remain in the same call state for both calls. The call states shall be verified by the SS sending a STATUS ENQUIRY message in respect of the transaction identifier of each call, and receiving a STATUS message indicating the appropriate call state.

Expected sequence

Step	Direction	Message	Comments
1	MS		
2	MS -> SS	FACILITY	Using MMI commands, perform an explicit call transfer
3	SS -> MS	STATUS ENQUIRY	TI for Call A-B or Call A-C, ExplicitCT Invoke component
4	MS -> SS	STATUS	Transaction identifier of Call A-B
			Transaction identifier of Call A-B, state U10, auxiliary state "Call held"
5	SS -> MS	STATUS ENQUIRY	Transaction identifier of Call A-C
6	MS -> SS	STATUS	Transaction identifier of Call A-C, state U10, no auxiliary state
7	SS -> MS	FACILITY	TI same as step 2, Return Error component
8	SS -> MS	STATUS ENQUIRY	Transaction identifier of Call A-B
9	MS -> SS	STATUS	Transaction identifier of Call A-B, state U10, auxiliary state "Call held"
10	SS -> MS	STATUS ENQUIRY	Transaction identifier of Call A-C
11	MS -> SS	STATUS	Transaction identifier of Call A-C, state U10, no auxiliary state
12	MS		
13	MS -> SS	FACILITY	Using MMI commands, perform an explicit call transfer
14	SS -> MS	STATUS ENQUIRY	TI for Call A-B or Call A-C, ExplicitCT Invoke component
15	MS -> SS	STATUS	Transaction identifier of Call A-B
			Transaction identifier of Call A-B, state U10, auxiliary state "Call held"
16	SS -> MS	STATUS ENQUIRY	Transaction identifier of Call A-C
17	MS -> SS	STATUS	Transaction identifier of Call A-C, state U10, no auxiliary state
18	SS -> MS	FACILITY	TI same as step 2, Reject component
19	SS -> MS	STATUS ENQUIRY	Transaction identifier of Call A-B
20	MS -> SS	STATUS	Transaction identifier of Call A-B, state U10, auxiliary state "Call held"
21	SS -> MS	STATUS ENQUIRY	Transaction identifier of Call A-C
22	MS -> SS	STATUS	Transaction identifier of Call A-C, state U10, no auxiliary state

31.13.1.6 Explicit Call Transfer invocation, expiry of T(ECT)

Conformance requirement

GSM 04.91 subclause 4.1, 4.2, GSM 04.80 subclause 4.2

Applicability

MS supporting the Explicit Call Transfer supplementary service.

Test purpose

To test that the MS invokes explicit call transfer between an active held call and an alerting call by sending a FACILITY message with the correct invoke component, and returns both calls to their original states on expiry of T(ECT).

Method of test

Related PICS/PIXIT statements

Method of performing Explicit Call transfer on two active calls

Initial conditions

System Simulator:

1 cell, default parameters.

Mobile Station:

The MS shall have Call A-B in state U10 "Active" with auxiliary state "Call held" and Call A-C in state U10 "Active" with no auxiliary state. Both calls shall be of a basic service supported by the MS and applicable to the ECT supplementary service as described in GSM 02.04 Table A.1.

Foreseen final state of the MS

Call A-B, state U10, auxiliary state "Call held". Call A-C, Call A-C, state U10, no auxiliary state.

Maximum duration of test

45 s.

Procedure

Using suitable MMI commands, the MS shall invoke an explicit call transfer between the two calls. The MS shall send a FACILITY message with a transaction identifier for either call A-B or call A-C and containing an ExplicitCT invoke component. The call state of both calls shall be unchanged. The call states shall be verified by the SS sending a STATUS ENQUIRY message in respect of the transaction identifier of each call, and receiving a STATUS message indicating the appropriate call state.

Between 5s and 15s after sending the FACILITY message, the MS shall either:-

- remain in the same call states and indicate failure to the user, or
- send another FACILITY message with the same contents.

The call states shall be verified by the SS sending a STATUS ENQUIRY message in respect of the transaction identifier of each call, and receiving a STATUS message indicating the appropriate call state.

Expected sequence

Step	Direction	Message	Comments
1	MS		Using MMI commands, perform an explicit call transfer
2	MS -> SS	FACILITY	TI for Call A-B or Call A-C, ExplicitCT Invoke component
3	SS -> MS	STATUS ENQUIRY	Transaction identifier of Call A-B
4	MS -> SS	STATUS	Transaction identifier of Call A-B, state U10, auxiliary state "Call held"
5	SS -> MS	STATUS ENQUIRY	Transaction identifier of Call A-C
6	MS -> SS	STATUS	Transaction identifier of Call A-C, state U10, no auxiliary state
7	SS		Wait 15 s from receiving FACILITY message
A8	SS -> MS	STATUS ENQUIRY	Take this branch if no message is received within 15 s
A9	MS -> SS	STATUS	Transaction identifier of Call A-B
A10	SS -> MS	STATUS ENQUIRY	Transaction identifier of Call A-B, state U10, auxiliary state "Call held"
A11	MS -> SS	STATUS	Transaction identifier of Call A-C
			Transaction identifier of Call A-C, state U10, no auxiliary state
B8	MS -> SS	FACILITY	Take this branch if a message is received within 15 s
B9	SS -> MS	STATUS ENQUIRY	Same as Step 2. Message shall not be received less than 5 s after the first FACILITY message
B10	MS -> SS	STATUS	Transaction identifier of Call A-B
			Transaction identifier of Call A-B, state U10, auxiliary state "Call held"
B11	SS -> MS	STATUS ENQUIRY	Transaction identifier of Call A-C
B12	MS -> SS	STATUS	Transaction identifier of Call A-C, state U10, no auxiliary state

31.14 User-to-User Signalling (UUS)

This clause applies to mobile station supporting User-to-User Signalling (UUS). The objective of this clause is to test UUS concerned procedures.

Unless indicated in individual sub-clauses, the default message contents in clause 26.8.4 are applied for CC calls and default message contents in clause 26.14.10 are applied for VGCS/VBS calls.

31.14.1 UUS / Implicit UUS1

31.14.1.1 UUS / Implicit UUS1 / CC MO call

31.14.1.1.1 Conformance requirement

The UUI service is activated implicitly by the presence of UUI in the set-up request from the mobile station;

To activate UUS1 implicitly, the MS shall include a User-user information element in the SETUP message as part of a normal call request;

The MS shall accept the presence of User-user information element in the ALERTING, CONNECT, DISCONNECT, RELEASE or RELEASE COMPLETE messages (as indicated in 3G TS 24.087, Figure 1 in clause 4.1.1).

References

3G TS 23.087 clauses 4.1.1, 5.2.1.2.1

3G TS 24.087 clause 4.1.1

31.14.1.1.2 Test purpose

To verify that upon initiation of an outgoing basic call with implicit UUS1 by the user, the MS includes a User-user information element in the SETUP message;

To verify that inclusion of the User-user information element with different data length in either of the downlink messages ALERTING, CONNECT, DISCONNECT or RELEASE COMPLETE, causes no adverse effects on the operation of the MS.

31.14.1.1.3 Method of test

Initial conditions

System Simulator:

1 cell, default parameters.

Mobile Station:

The MS is in MM-state "idle, updated" with valid TMSI and CKSN.

Related PICS/PIXIT Statement(s)

Type of MS (GSM 450, GSM480, P-, E-, R-GSM900, DCS 1800 or PCS 1900)

Support MO telephony

Support UUS

Support implicit UUS1

Way to activate implicit UUS1

Description of display of the User-user data received from the network.

Foreseen final state of the MS

The MS is in MM-state "idle, updated" with valid TMSI.

Test procedure

By means of appropriate MMI function, the user requests implicit UUS1 and enters a string, which shall be included in the UUS1. Then MS is made to initiate a call. In the SETUP message, the User-user information element shall be present and shall include the requested string. Then, SS releases the call.

The MS is made to initiate a second call with implicit UUS1. In the SETUP message, the User-user information element shall be present with the requested string. SS releases the call, by sending a RELEASE COMPLETE message including a User-user information element with a long data value. It is checked that the MS is not disturbed by the optional User-user information element.

The MS is made to initiate a third call with implicit UUS1. In the SETUP message, the User-user information element shall be present with the requested string. Then SS shall include User-user information element in the ALERTING and in the CONNECT message with respectively short and long data value, it is checked that MS does not respond adversely to the inclusion of the optional User-user information element. After 10 seconds, SS initiates call clearing. SS sends DISCONNECT and RELEASE COMPLETE messages with User-user information element respectively without data and with a short data value, again the MS shall not respond adversely to the inclusion of the User-user information element, but shall continue to clear down the call normally.

Maximum Duration of Test

2 minutes

Expected Sequence

Step	Direction	Message	Comments/actions/next state
0	MS		The MS is in idle mode. MMI actions to initiate a CC call with implicit UUS1 including the string 'abc0123456'.
1	MS -> SS	CHANNEL REQUEST	SDCCH4
2	SS -> MS	IMMEDIATE ASSIGNMENT	
3	MS -> SS	CM SERVICE REQUEST	
4	MS -> SS	SETUP	Check User-user IE is included. See specific message contents
5	SS -> MS	RELEASE COMPLETE	The main signalling link shall be released by the MS (L2: DISC/UA).
6	SS -> MS	CHANNEL RELEASE	
10	MS		MMI actions to initiate a CC call with implicit UUS1 including the string 'abc'
11	MS -> SS	CHANNEL REQUEST	SDCCH4
12	SS -> MS	IMMEDIATE ASSIGNMENT	
13	MS -> SS	CM SERVICE REQUEST	
14	MS -> SS	SETUP	Check User-user IE is included. See specific message contents
15	SS -> MS	RELEASE COMPLETE	Message contains the User-user IE with a long data value, see Specific message contents
16	MS		It is checked that the MS, in a way described by the manufacturer, displays user-user data.
17	SS -> MS	CHANNEL RELEASE	The main signalling link shall be released by the MS (L2: DISC/UA).
20	MS		MMI actions to initiate a CC call with implicit UUS1 including the string '123497'.
21	MS -> SS	CHANNEL REQUEST	SDCCH4
22	SS -> MS	IMMEDIATE ASSIGNMENT	
23	MS -> SS	CM SERVICE REQUEST	
24	MS -> SS	SETUP	Check User-user IE is included. See specific message contents
25	SS -> MS	AUTHENTICATION REQUEST	TCH
26	MS -> SS	AUTHENTICATION RESPONSE	
27	SS -> MS	CALL PROCEEDING	Message contains the User-user IE with a short data value, see Specific message contents
28	SS -> MS	ASSIGNMENT COMMAND	
29	MS -> SS	ASSIGNMENT COMPLETE	
30	SS -> MS	ALERTING	It is checked that the MS, in a way described by the manufacturer, displays user-user data.
31	MS		
32	SS -> MS	CONNECT	Message contains the User-user IE with a long data value, see Specific message contents
33	MS		It is checked that the MS, in a way described by the manufacturer, displays user-user data.
34	MS -> SS	CONNECT ACKNOWLEDGE	Without Progress Indication IE Including the User-user IE without data, see Specific message contents
35	SS -> MS	DISCONNECT	
36	MS		It is checked that the MS, in a way described by the manufacturer, displays no user-user data.
37	MS -> SS	RELEASE	Message contains the User-user IE with a short data value, see Specific message contents
38	SS -> MS	RELEASE COMPLETE	
39	SS		It is checked that the MS, in a way described by the manufacturer, displays user-user data.

40	SS -> MS	CHANNEL RELEASE	The main signalling link shall be released by the MS (L2: DISC/UA).
----	----------	-----------------	---

Specific message contents:

SETUP

As default message contents as defined in section 26.8.4 (mobile station to network direction), except:

Information Element	value/remark
User-user	'7E'O
- IEI	1 + the entered string length
- length	User specific protocol
- PD	The string as entered coded in IA5 characters
- user-user	

ALERTING

As default message contents as defined in section 26.8.4 (network to mobile station direction), except:

Information Element	value/remark
User-user	'7E'O
- IEI	2
- length	User specific protocol
- PD	The following string coded in IA5 characters: "A"
- user-user	

CONNECT

As default message contents as defined in section 26.8.4 (network to mobile station direction), except:

Information Element	value/remark
User-user	'7E'O
- IEI	101
- length	User specific protocol
- PD	The following string with a length of 100 octets coded in IA5 characters:
- user-user	"abcdefghijklmnopqrstuvwxyz0123456789abc....."

DISCONNECT

As default message contents as defined in section 26.8.4 (network to mobile station direction), except:

Information Element	value/remark
User-user	'7E'O
- IEI	1
- length	User specific protocol
- PD	
- user-user	-

RELEASE COMPLETE – step 15

As default message contents as defined in section 26.8.4 (network to mobile station direction), except:

Information Element	value/remark
User-user	'7E'O
- IEI	37
- length	User specific protocol
- PD	The following string coded in IA5 characters:
- user-user	"0123456789abcdefghijklmnopqrstuvwxyz"

RELEASE COMPLETE – step 38

As default message contents as defined in section 26.8.4 (network to mobile station direction), except:

Information Element	value/remark
User-user	
- IEI	'7E'O
- length	17
- PD	User specific protocol
- user-user	The following string coded in IA5 characters: "RELEASE COMPLETE"

31.14.1.2 UUS / Implicit UUS1 / CC MT call**31.14.1.2.1 Conformance requirement**

The MS shall accept the presence of User-user information element in the SETUP and DISCONNECT messages (as indicated in 3G TS 23.087, Figure 5.2.1.2.1.1).

The MS may include User-user information element in the ALERTING or CONNECT messages (as indicated in 3G TS 23.087, Figure 5.2.1.2.1.1).

References

3G TS 23.087 clause 5.2.1.2.1

3G TS 24.087 clause

31.14.1.2.2 Test purpose

To verify that, the receipt of SETUP message including user-user information element with a short or large data value causes no adverse effects on the call establishment operation of the MS.

To verify that MS could include User-user information element in either of the uplink messages ALERTING or CONNECT.

To verify that inclusion of the User-user information element with different data length in either of the downlink message DISCONNECT or RELEASE COMPLETE, causes no adverse effects on the operation of the MS.

31.14.1.2.3 Method of test**Initial conditions****System Simulator:**

1 cell, default parameters.

Mobile Station:

The MS is in MM-state "idle, updated" with valid TMSI and CKSN.

Related PICS/PIXIT Statement(s)

Type of MS (GSM 450, GSM480, P-, E-, R-GSM900, DCS 1800 or PCS 1900)

Support MT telephony

Support UUS

Support implicit UUS1

Support the sending of UUS1 information element in ALERTING message

Support the sending of UUS1 information element in CONNECT message

Way to activate implicit UUS1

Description of display of the User-user data received from the network.

Foreseen final state of the MS

The MS is in MM-state "idle, updated" with valid TMSI.

Test procedure

SS initiates a call. In the SETUP message, the User-user information element shall be present. It is checked that the MS, in a way described by the manufacturer, displays the user-user data. Then, SS releases the call immediately after the MS call confirmation.

The SS initiates a second call and in the SETUP message, the User-user information element shall contain a larger data value. It is checked that the MS, in a way described by the manufacturer, displays the user-user data. Then the SS releases the call immediately after the MS call confirmation. In the RELEASE COMPLETE message, the User-user information element shall also contain a large data value. It is checked that the MS is not disturbed by the User-user optional information element.

By means of appropriate MMI function and if MS supports User-user information element in ALERTING or CONNECT messages, the user enters a string, which shall be included in the UUS1. The SS initiates a third call and in the SETUP message, the User-user information element shall be included without data. After the MS call confirmation and depending on the MS capability, it is checked that the MS sends in the User-user information element of the ALERTING message the string as requested. When the TCH is allocated and depending on the MS capability, it is checked that the MS sends in the User-user information element of the CONNECT message the string as requested. When the call is established, the SS releases the call and shall include in the DISCONNECT message the optional User-user information element. It is checked that the MS is not disturbed by the User-user information element. The SS shall also include in the RELEASE COMPLETE message the optional User-user information element. It is checked that the MS is not disturbed by the User-user information element.

Maximum Duration of Test

2 minutes

Expected Sequence

Step	Direction	Message	Comments/actions/next state
0	MS		The MS is in idle mode.
1	SS -> MS	PAGING REQUEST	
2	MS -> SS	CHANNEL REQUEST	
3	SS -> MS	IMMEDIATE ASSIGNMENT	U0, SDCCH4
4	MS -> SS	PAGING RESPONSE	
7	SS -> MS	SETUP	User-user IE included with a short data value, see Specific message contents
8	MS		Check that the MS, in a way described by the manufacturer, displays the User-user data value.
9	MS -> SS	CALL CONFIRMED	
10	SS -> MS	RELEASE COMPLETE	
11	SS -> MS	CHANNEL RELEASE	The main signalling link shall be released by the MS (L2: DISC/UA).
15	SS -> MS	PAGING REQUEST	
16	MS -> SS	CHANNEL REQUEST	
17	SS -> MS	IMMEDIATE ASSIGNMENT	U0, SDCCH4
18	MS -> SS	PAGING RESPONSE	
21	SS -> MS	SETUP	User-user IE included with a large data value, see Specific message contents
22	MS		Check that the MS, in a way described by the manufacturer, displays the User-user data value.
23	MS -> SS	CALL CONFIRMED	
24	SS -> MS	RELEASE COMPLETE	Message contains the User-user IE with a long data value, see Specific message contents.
25	MS		Check that the MS, in a way described by the manufacturer, displays the User-user data value.
26	SS -> MS	CHANNEL RELEASE	The main signalling link shall be released by the MS (L2: DISC/UA).
30	SS -> MS	PAGING REQUEST	If supported, MMI actions to initiate implicit UUS1 with the string '12346aA'
31	MS -> SS	CHANNEL REQUEST	
32	SS -> MS	IMMEDIATE ASSIGNMENT	U0, SDCCH4
33	MS -> SS	PAGING RESPONSE	
34	SS -> MS	AUTHENTICATION REQUEST	
35	MS -> SS	AUTHENTICATION RESPONSE	
36	SS -> MS	SETUP	User-user IE included without data. See Specific message contents.
37	MS		Check that the MS, in a way described by the manufacturer, displays no User-user data value.
38	MS -> SS	CALL CONFIRMED	
39	MS -> SS	ALERTING	If MS support User-user IE in ALERTING message, then check the presence of this IE. See specific message contents.
40	MS -> SS	CONNECT	If MS support User-user IE in CONNECT message, then check the presence of this IE. See specific message contents.
41	SS -> MS	ASSIGNMENT COMMAND	TCH
42	MS -> SS	ASSIGNMENT COMPLETE	
43	SS -> MS	CONNECT ACKNOWLEDGE	
44	SS -> MS	DISCONNECT	With the User-user IE with a long data value, see Specific message contents
45	MS		Check that the MS, in a way described by the manufacturer, displays the User-user data value.

46	MS -> SS	RELEASE	Message contains the User-user IE with a short data value, see Specific message contents. Check that the MS, in a way described by the manufacturer, displays the User-user data value. The main signalling link shall be released by the MS (L2: DISC/UA).
47	SS-> MS	RELEASE COMPLETE	
48	MS		
49	SS -> MS	CHANNEL RELEASE	

Specific message contents:

SETUP – step 7

As default message contents as defined in section 26.8.4 (network to mobile station direction), except:

Information Element	value/remark
User-user - IEI - length - PD - user-user	'7E'O 4 User specific protocol The following string coded in IA5 characters : "012"

SETUP – step 21

As default message contents as defined in section 26.8.4 (network to mobile station direction), except:

Information Element	value/remark
User-user - IEI - length - PD - user-user	'7E'O 33 User specific protocol The following string coded in IA5 characters : "abcdefghijklmnopqrstuvwxy012345"

SETUP – step 36

As default message contents as defined in section 26.8.4 (network to mobile station direction), except:

Information Element	value/remark
User-user - IEI - length - PD - user-user	'7E'O 1 User specific protocol -

RELEASE COMPLETE – step 24

As default message contents as defined in section 26.8.4 (network to mobile station direction), except:

Information Element	value/remark
User-user - IEI - length - PD - user-user	'7E'O 37 User specific protocol The following string coded in IA5 characters : "abcdefghijklmnopqrstuvwxy0123456789"

RELEASE COMPLETE – step 47

As default message contents as defined in section 26.8.4 (network to mobile station direction), except:

Information Element	value/remark
User-user - IEI - length - PD - user-user	'7E'O 2 User specific protocol The following string coded in IA5 characters: "A"

ALERTING

As default message contents as defined in section 26.8.4 (mobile station to network direction), except:

Information Element	value/remark
User-user - IEI - length - PD - user-user	'7E'O 8 User specific protocol The string '12346aA' coded in IA5 characters

CONNECT

As default message contents as defined in section 26.8.4 (mobile station to network direction), except:

Information Element	Value/remark
User-user - IEI - length - PD - user-user	'7E'O 8 User specific protocol The string '12346aA ' coded in IA5 characters

DISCONNECT

As default message contents as defined in section 26.8.4 (network to mobile station direction), except:

Information Element	Value/remark
User-user - IEI - length - PD - user-user	'7E'O 37 User specific protocol The following string coded in IA5 characters : "abcdefghijklmnopqrstuvwxyz0123456789"

31.14.1.3 UUS / Implicit UUS1 / Interactions with Call Waiting and call HOLD supplementary services

31.14.1.3.1 Conformance requirement

There are no interactions between UUS and the Call hold (HOLD) and Call waiting (CW) supplementary services;

To activate UUS1 implicitly, the MS shall include a User-user information element in the SETUP message as part of a normal call request;

The MS shall accept the presence of User-user information element in the SETUP and DISCONNECT messages (as indicated in 3G TS 23.087, Figure 5.2.1.2.1.1).

References

3G TS 23.087 clauses 4.1.1, 5.2.1.2.1.1, 5.2.1.2.1

3G TS 24.087 clause 4.1.1, 6.4, 6.5

31.14.1.3.2 Test purpose

To verify that when in active Call State and supporting Call Hold, to initiate a second call with implicit UUS1, the MS places the first call on hold and sends a SETUP message with the User-user information element. Verify that the second call is successfully established;

In call active state and supporting Call Waiting, when a Call Waiting indication includes a User-user information element, the MS accepts the waiting call and places the first call on hold and successfully establishes the second call.

31.14.1.3.3 Method of test

Initial conditions

System Simulator:

1 cell, default parameters.

Mobile Station:

The MS has a call ("Call A-B") in the active state. The SIM in the MS under test has Call Waiting enabled.

Related PICS/PIXIT Statement(s)

Type of MS (GSM 450, GSM480, P-, E-, R-GSM900, DCS 1800 or PCS 1900)

Support MO telephony

Support MT telephony

Support UUS

Support implicit UUS1

Support hold

Way to activate implicit UUS1

Description of display of the User-user data received from the network

Foreseen final state of the MS

The MS is in MM-state "idle, updated" with valid TMSI.

Test procedure

A call is established between the MS and SS. This call is the active call named Call A-B.

Using suitable MMI commands, the MS shall request that the call A-B be placed on hold. The MS shall send a HOLD message and enter auxiliary state "hold request". On receipt of a HOLD ACKNOWLEDGE message from the SS, the MS is made to initiate a second call with implicit UUS1. It is checked that the MS includes the User-user information element in the SETUP message. Then the SS sends an ALERTING message including the optional User-user information. It is checked that the MS, in a way described by the manufacturer, displays the User-user data value. Then the SS sends a CONNECT message including the optional User-user information element. It is checked that the MS, in a way described by the manufacturer, displays the User-user data value. On receipt of a CONNECT ACKNOWLEDGE message, MS shall enter state U10 "Active". The SS releases the second call A-C and shall include in the DISCONNECT message the optional User-user information element. It is checked that the MS is not disturbed by the User-user information element. The SS shall also include in the RELEASE COMPLETE message the optional User-user information element. It is checked that the MS is not disturbed by the User-user information element.

The Call A-B is still alive. By means of appropriate MMI function, the user enters a string, which shall be included in the UUS1 sent by the MS. The SS sends a SETUP message including a User-user information element and indicating

the request of a new call, named Call C-A. It is checked with the appropriate MMI function, that the MS displays the contents of the User-user information element. Then the MS shall place Call A-B on hold, and answer Call C-A. The MS shall send a HOLD message to the SS using the transaction identifier of Call A-B. On receipt of a HOLD ACKNOWLEDGE from the SS, the MS shall send a CALL CONFIRMED message and an ALERTING message to the SS, using the transaction identifier of Call C-A, and depending on the MS capability including the optional User-user information element as requested by the user. Then the MS shall send a CONNECT message to the SS, using the transaction identifier of Call C-A, and depending on the MS capability including the optional User-user information element as entered by the user. On receipt of a CONNECT ACKNOWLEDGE message, MS shall enter state U10 "Active". The SS releases the call C-A and shall include in the DISCONNECT message the optional User-user information element. It is checked that the MS is not disturbed by the User-user information element. The SS shall also include in the RELEASE COMPLETE message the optional User-user information element. It is checked that the MS is not disturbed by the User-user information element.

Then SS releases the first call A-B.

Maximum Duration of Test

2 minutes

Expected Sequence

Step	Direction	Message	Comments/actions/next state
0	MS		Active call state with call A-B.
1	MS		If supported, MMI actions to initiate implicit UUS1 with the string '12345'.
2	MS		Call A-C is requested using MMI commands and Call A-B is placed on hold using MMI commands
3	MS -> SS	CM SERVICE REQUEST	Transaction identifier of Call A-C
4	SS -> MS	CM SERVICE ACCEPT	Transaction identifier of Call A-C
5	MS -> SS	SETUP	Check User-user IE is included, transaction identifier of Call A-C, see Specific message contents.
6	SS -> MS	ALERTING	Message contains the User-user IE with a short data value, transaction identifier of Call A-C, see Specific message contents
7	MS		Check that the MS, in a way described by the manufacturer, displays the User-user data value.
8	MS -> SS	HOLD	Transaction identifier of Call A-B
9	SS -> MS	HOLD ACKNOWLEDGE	Transaction identifier of Call A-B
10	SS -> MS	CONNECT	Message contains the User-user IE with a long data value, transaction identifier of Call A-C, see Specific message contents
11	MS		Check that the MS, in a way described by the manufacturer, displays the User-user data value.
12	MS -> SS	CONNECT ACKNOWLEDGE	Transaction identifier of Call A-C
13	SS -> MS	DISCONNECT	Without Progress Indication IE, transaction identifier of Call A-C. With the User-user IE without data, see Specific message contents
14	MS		Check that the MS, in a way described by the manufacturer, displays the User-user data value.
15	MS -> SS	RELEASE	
16	SS-> MS	RELEASE COMPLETE	Message contains the User-user IE with a short data value, transaction identifier of Call A-C, see Specific message contents
17	MS		Check that the MS, in a way described by the manufacturer, displays the User-user data value.
18	SS		Call A-B is released
19	SS -> MS	CHANNEL RELEASE	The main signalling link shall be released by the MS (L2: DISC/UA).
20			Active call state with call A-B.
21	MS		MMI actions to initiate implicit UUS1 with the string '201'.
22	SS -> MS	PAGING REQUEST	
23	MS -> SS	PAGING RESPONSE	
31	SS->MS	SETUP	User-user IE is included, see Specific message contents. Transaction identifier of Call C-A
32	MS		Check that the MS, in a way described by the manufacturer, displays the User-user data value. Call A-B is placed on hold using MMI commands.
34	MS -> SS	HOLD	Transaction identifier of Call A-B
35	SS -> MS	HOLD ACKNOWLEDGE	Transaction identifier of Call A-B
36	MS		Call C-A is answered using MMI commands
37	MS -> SS	CALL CONFIRMED	Transaction identifier of Call C-A
38	MS -> SS	ALERTING	If MS support User-user IE in ALERTING message, then check the presence of this IE. Transaction identifier of Call C-A
39	MS -> SS	CONNECT	If MS supports User-user IE in CONNECT message, then check the presence of this IE. Transaction identifier of Call C-A
40	SS -> MS	CONNECT ACKNOWLEDGE	Transaction identifier of Call C-A

41	SS -> MS	DISCONNECT	With the User-user IE without data, transaction identifier of Call C-A, see Specific message contents. Check that the MS, in a way described by the manufacturer, displays the User-user data value.
42	MS		
43	MS -> SS	RELEASE	Message contains the User-user IE with a short data value, see Specific message contents. Transaction identifier of Call C-A. Check that the MS, in a way described by the manufacturer, displays the User-user data value.
44	SS-> MS	RELEASE COMPLETE	
45	MS		

Specific message contents:

SETUP – step 5

As default message contents as defined in section 26.8.4 (mobile station to network direction), except:

Information Element	value/remark
User-user - IEI - length - PD - user-user	'7E'O 1 + the entered string length User specific protocol The string as entered, coded in IA5 characters

SETUP – step 31

As default message contents as defined in section 26.8.4 (network direction to mobile station), except:

Information Element	value/remark
User-user - IEI - length - PD - user-user	'7E'O 4 User specific protocol The following string coded in IA5 characters : "012"

ALERTING– step 6

As default message contents as defined in section 26.8.4 (network to mobile station direction), except:

Information Element	value/remark
User-user - IEI - length - PD - user-user	'7E'O 4 User specific protocol The following string coded in IA5 characters : "012"

ALERTING– step 38

As default message contents as defined in section 26.8.4 (mobile station to network direction), except:

Information Element	value/remark
User-user - IEI - length - PD - user-user	'7E'O 1 + the entered string length User specific protocol The string as entered, coded in IA5 characters

CONNECT– step 10

As default message contents as defined in section 26.8.4 (network to mobile station direction), except:

Information Element	value/remark
User-user - IEI - length - PD - user-user	'7E'O 37 User specific protocol The following string coded in IA5 characters : "abcdefghijklmnopqrstuvwxyz0123456789"

CONNECT– step 39

As default message contents as defined in section 26.8.4 (mobile station to network direction), except:

Information Element	value/remark
User-user - IEI - length - PD - user-user	'7E'O 1 + the entered string length User specific protocol The string as entered in IA5 characters

DISCONNECT

As default message contents as defined in section 26.8.4 (network to mobile station direction), except:

Information Element	value/remark
User-user - IEI - length - PD - user-user	'7E'O 1 User specific protocol -

RELEASE COMPLETE

As default message contents as defined in section 26.8.4 (network to mobile station direction), except:

Information Element	value/remark
User-user - IEI - length - PD - user-user	'7E'O 2 User specific protocol The following string coded in IA5 characters: "A"

31.15 Follow Me (FM)

This clause applies to mobile station supporting Follow Me (FM). The objective of this clause is to test FM concerned procedures.

Unless indicated in individual sub-clauses, the default message contents in clause 31.11 are applied.

31.15.1 Follow Me (FM) / Registration**31.15.1.1 Conformance requirement**

The initiating subscriber registers the Follow Me feature with respect to a particular remote party. The initiating subscriber shall provide the following information to the network: the number of the remote party. The initiating subscriber shall receive an indication if the FM registration request was accepted or rejected by the network;

MS shall behave as indicated in the Information flow as indicated in 3G TS 23.094, Figure 4.1;

As an operator's option additional information (such as passwords) for registration may be required from the initiating subscriber. This information shall be coded as a USSD string with a length not exceeding 30 characters;

All the messages between MS and the mobile network and internal to the mobile network, which are used for control of Follow Me, are USSD Phase 2 messages;

If a mobile initiated USSD request using protocol version 2 is rejected by the network, and the reason for the rejection is indicated either by the problem code "unrecognized operation" or a cause "Facility rejected", the MS shall assume that the network only supports protocol version 1 of USSD operations. The MS shall re-attempt the request by using the appropriate protocol version 1 USSD operation without an SS version indicator if the unstructured data entered by the user can be coded as an IA5 string.

References

3G TS 22.094 clause 6.3

3G TS 23.094 clauses 4.1, 4.2, 4.4

3G TS 24.090 clause 6.1

31.15.1.2 Test purpose

To check that the MS correctly requests a supplementary service transaction for registration of FM in CHANNEL REQUEST message and in the subsequent CM SERVICE REQUEST;

To check that the MS sends a REGISTER message using USSD phase 2 and containing the FM-request control message for registration;

To check that upon receipt of the result or the error of the operation (in a RELEASE COMPLETE message), the MS provides the appropriate user indication (as described by the manufacturer);

To check that upon receipt of a rejection from the network with the problem code "unrecognized operation" or a cause "Facility rejected", the MS re-attempt the request by using USSD version 1.

31.15.1.3 Method of test

Initial conditions

System Simulator:

1 cell, default parameters.

Mobile Station:

The MS is in MM-state "idle, updated" with valid TMSI and CKSN.

Related PICS/PIXIT Statement(s)

Type of MS (GSM 450, GSM480, P-, E-, R-GSM900, DCS 1800 or PCS 1900)

Support FM

Way to activate the registration of FM

Description of display of the FM answers from the network.

Foreseen final state of the MS

The MS is in MM-state "idle, updated" with valid TMSI.

Test procedure

By means of appropriate MMI functions, the user requests registration of FM for a remote number. Upon receipt of the REGISTER message, SS answers with the RELEASE COMPLETE message with an unsuccessful FM-result information. Check that the MS provides the appropriate user indication (as described by the manufacturer). Then SS transaction is released. This procedure is executed for all possible error values.

The user requests registration of FM for another remote subscriber. Upon receipt of the operation (in a REGISTER message), SS answers with a RELEASE COMPLETE message with a successful FM-response information. Check that the MS provides the appropriate user indication (as described by the manufacturer). The SS transaction is released.

Then user request again two registrations, upon receipt of the REGISTER message, SS answers with a RELEASE COMPLETE message including a rejection with respectively the problem code "unrecognized operation" or a cause "facility rejected". Check that MS re-attempt the request by using USSD version 1: without the SS version indicator information element included in the REGISTER message.

Maximum Duration of Test

2 minutes

Expected Sequence

Test steps 1 to 10 are executed for k=1 to 13 with respectively the following error values:

1. Illegal interaction with incoming barring
2. Unauthorised request
3. Unknown remote party
4. FM not subscribed
5. Remote party already registered
6. Unauthorised changes to remote party
7. Illegal interaction with call forwarding
8. Illegal interaction with call barring
9. Request to own MSISDN not possible
10. Forwarded-to number is invalid directory number
11. Insufficient information
12. Forwarded-to number is a special code
13. Conflicting situation with other supplementary services

Step	Direction	Message	Comments
0	MS		The MS is in idle mode.
1	MS		The MS is made to initiate a registration of FM
2	MS -> SS	CHANNEL REQUEST	With establishment cause "Other procedures which can be completed with an SDCCH"
3	SS -> MS	IMMEDIATE ASSIGNMENT	
4	MS -> SS	CM SERVICE REQUEST	Cause: "supplementary service activation"
5	SS -> MS	CM SERVICE ACCEPT	
6	MS -> SS	REGISTER	Check that the content of this message matches specific message contents.
7	SS -> MS	RELEASE COMPLETE	With an unsuccessful FM-result info with the following error value: k=1: Illegal interaction with incoming barring (code 21) k=2: Unauthorised request (code 22) k=3: Unknown remote party (code 41) k=4: FM not subscribed (code 42) k=5: Remote party already registered (code 61) k=6: Unauthorised changes to remote party (code 64) k=7: Illegal interaction with call forwarding (code 65) k=8: Illegal interaction with call barring (code 66) k=9: Request to own MSISDN not possible (code 67) k=10: Forwarded-to number is invalid directory number (code 80) k=11: Insufficient information (code 81) k=12: Forwarded-to number is a special code (code 82) k=13: Conflicting situation with other supplementary services (code 83) See specific message contents.
8	MS		It is checked that the MS, in a way described by the manufacturer, displays the error.
10	SS -> MS	CHANNEL RELEASE	
15	MS		The MS is made to initiate a registration of FM
16	MS -> SS	CHANNEL REQUEST	With establishment cause "Other procedures which can be completed with an SDCCH"
17	SS -> MS	IMMEDIATE ASSIGNMENT	
18	MS -> SS	CM SERVICE REQUEST	Cause: "supplementary service activation"
19	SS -> MS	CM SERVICE ACCEPT	
20	MS -> SS	REGISTER	Check that the content of this message matches specific message contents.
21	SS -> MS	RELEASE COMPLETE	With a successful FM-result. See specific message contents.
22	MS		It is checked that the MS, in a way described by the manufacturer, displays the positive result.
23	SS -> MS	CHANNEL RELEASE	
30	MS		The MS is made to initiate a registration of FM
31	MS -> SS	CHANNEL REQUEST	With establishment cause "Other procedures which can be completed with an SDCCH"
32	SS -> MS	IMMEDIATE ASSIGNMENT	
33	MS -> SS	CM SERVICE REQUEST	Cause: "supplementary service activation"
34	SS -> MS	CM SERVICE ACCEPT	
35	MS -> SS	REGISTER	Check that the content of this message matches specific message contents.
36	SS -> MS	RELEASE COMPLETE	Including a rejection with the problem code "unrecognized operation"
37	SS -> MS	CHANNEL RELEASE	
38	MS -> SS	CHANNEL REQUEST	With establishment cause "Other procedures which can be completed with an SDCCH"
39	SS -> MS	IMMEDIATE ASSIGNMENT	

40	MS -> SS	CM SERVICE REQUEST	Cause: "supplementary service activation" Check that SS version indicator IE is not included. See specific message contents.
41	SS -> MS	CM SERVICE ACCEPT	
42	MS -> SS	REGISTER	
43	SS -> MS	RELEASE COMPLETE	With a successful FM-result. See specific message contents. It is checked that the MS, in a way described by the manufacturer, displays the positive result.
44	MS		
45	SS -> MS	CHANNEL RELEASE	
50	MS		The MS is made to initiate a registration of FM With establishment cause "Other procedures which can be completed with an SDCCH"
51	MS -> SS	CHANNEL REQUEST	
52	SS -> MS	IMMEDIATE ASSIGNMENT	Cause: "supplementary service activation" The SS checks that the content of this message matches specific message contents.
53	MS -> SS	CM SERVICE REQUEST	
54	SS -> MS	CM SERVICE ACCEPT	
55	MS -> SS	REGISTER	
56	SS -> MS	RELEASE COMPLETE	Including a rejection with the cause value Facility rejected. See specific message contents.
57	SS -> MS	CHANNEL RELEASE	
58	MS -> SS	CHANNEL REQUEST	With establishment cause "Other procedures which can be completed with an SDCCH"
59	SS -> MS	IMMEDIATE ASSIGNMENT	
60	MS -> SS	CM SERVICE REQUEST	Cause: "supplementary service activation" Check that SS version indicator IE is not included. See specific message contents.
61	SS -> MS	CM SERVICE ACCEPT	
62	MS -> SS	REGISTER	
63	SS -> MS	RELEASE COMPLETE	With a successful FM-result. See specific message contents. It is checked that the MS, in a way described by the manufacturer, displays the positive result.
64	MS		
65	SS -> MS	CHANNEL RELEASE	

Specific message contents:

REGISTER

Information Element	value/remark
Supplementary service protocol discriminator	Supplementary service (call independent)
Transaction identifier	'1011'B
Message type	As 3G TS 24.080
Facility 1C	See below
SS version indicator	As specified in 3G TS 24.080 For steps 42 and 62 omitted

For steps 6,20,35 and 55, Facility Information Element with Invoke = ProcessUnstructuredSS-Request component type as defined in 3G TS 24.080 section 3.6.1 table 3.3.

Contents	Value/remark
Facility IE identifier	As 3G TS 24.080
Length of FIE contents	depending on the length of ussd-string
Component type tag	Invoke CS/C/tag=1
Component length	depending on the length of ussd-string
InvokeID tag	From 3G TS 24.080
Invoke ID length	1
Invoke ID	Arbitrary (1 octet)
Operation Code tag	From 3G TS 24.080
Operation Code length	1
Operation Code	UnstructuredSS-Request
Ussd-dataCodingScheme	1 octet long. Alphabet indicator set to "default alphabet". Language indicator set to "undefined"
Ussd-string	For step 6 **214*04965878***# For step 20 **214*04969***# For steps 35 and 55 **214*31245688***#

RELEASE COMPLETE

Information Element	value/remark
Supplementary service protocol discriminator Transaction identifier	Supplementary service (call independent) the transaction value is the same as the REGISTER transaction value but the transaction flag is different
Message type	As 3G TS 24.080
Cause	For step 56, cause is set to "facility rejected" and FIE is omitted. For steps 7,21,43,63,36 this field is omitted.
Facility Information Element SS version indicator	See below (omitted for step 56) As specified in 3G TS 24.080

For steps 7, 21,43 and 63, Facility Information Element with Return result = ProcessUnstructuredSS-Request return result component type as defined in 3G TS 24.080 section 3.6.1 table 3.6.

Contents	Value/remark
Facility IE identifier	As 3G TS 24.080
Length of FIE contents	depending on the length of ussd-string
Component type tag	Return result
Component length	depending on the length of ussd-string
InvokeID tag	From 3G TS 24.080
Invoke ID length	1
Invoke ID	The same as the invoke of the ProcessUnstructuredSS-Request
Ussd-dataCodingScheme	1 octet long. Alphabet indicator set to "default alphabet". Language indicator set to "undefined"
Ussd-string	For step 7: value of the error code For steps 21 43 and 63: 01

For step 36, Facility Information Element with Reject = ProcessUnstructuredSS-Request return result component type as defined in 3G TS 24.080 section 3.6.1 table 3.6.

Contents	Value/remark
Facility IE identifier	As 3G TS 24.080
Length of FIE contents	depending on the length of ussd-string
Component type tag	Reject
Component length	depending on the length of ussd-string
InvokeID tag	From 3G TS 24.080
Invoke ID length	1
Invoke ID	The same as the invoke of the ProcessUnstructuredSS-Request
Problem Code tag	As 3G TS 24.080
Problem Code length	1
General Problem code	Unrecognized operation

31.15.2 Follow Me (FM) / Interrogation

31.15.2.1 Conformance requirement

An initiating subscriber (also the FM service supervisor) shall be able to interrogate the Follow Me data of any remote party, for which she is authorised to become initiating subscriber.

In case the remote party corresponds to a subscriber the remote party shall be able to interrogate her own Follow Me data stored in the network.

As an operator's option additional information (such as passwords) for interrogation may be required from the subscriber. The registration procedure shall transport this information from the subscriber to the network of the remote party. This information shall be coded as a USSD string with a length not exceeding 30 characters.

All the messages between MS and the mobile network and internal to the mobile network, which are used for control of Follow Me, are USSD Phase 2 messages.

MS shall behave as indicated in the Information flow as indicated in 3G TS 23.094, Figure 4.1.

References

3G TS 22.094 clauses 6.8, 7.3

3G TS 23.094 clauses 4.1, 4.2, 4.4

3G TS 24.090 clause 6.1

31.15.2.2 Test purpose

To check that the MS (as initiating subscriber or remote party) correctly requests a supplementary service transaction for interrogation of FM in CHANNEL REQUEST message and in the subsequent CM SERVICE REQUEST;

To check that the MS sends a REGISTER message using USSD version 2 and containing the FM-request control message for interrogation;

To check that upon receipt of the result or the error of the operation (in a RELEASE COMPLETE message), the MS provides the appropriate user indication (as described by the manufacturer).

31.15.2.3 Method of test

Initial conditions

System Simulator:

1 cell, default parameters.

Mobile Station:

The MS is in MM-state "idle, updated" with valid TMSI and CKSN. The MS is registered to FM with respect to a remote party B.

Related PICS/PIXIT Statement(s)

Type of MS (GSM 450, GSM480, P-, E-, R-GSM900, DCS 1800 or PCS 1900)

Support FM

Way to activate the interrogation of FM

Description of display of the FM answers from the network.

Foreseen final state of the MS

The MS is in MM-state "idle, updated" with valid TMSI.

Test procedure

MS is registered to FM.

By means of appropriate MMI functions, the user requests interrogation of FM for a remote number. Upon receipt of the REGISTER message, SS answers with the RELEASE COMPLETE message with an unsuccessful FM-result in a facility information element. Check that the MS provides the appropriate user indication (was described by the manufacturer). Then SS transaction is released. This procedure is executed for all possible error values.

The user requests interrogation of FM for another remote subscriber. Upon receipt of the operation (in a REGISTER message), SS answers with a RELEASE COMPLETE message with a successful FM-response information. Check that the MS provides the appropriate user indication (as described by the manufacturer). The SS transaction is released.

Maximum Duration of Test

2 minutes

Expected Sequence

Test steps 1 to 10 are executed for k=1 to 6 with respectively the following error values:

1. Illegal interaction with incoming barring
2. Unauthorised request
3. Unknown remote party
4. FM not subscribed
5. FM not registered to remote party
6. Conflicting situation with other supplementary services

Step	Direction	Message	Comments
0	MS		The MS is in idle mode. MS is registered to FM with respect to a remote party B.
1	MS		The MS is made to initiate an interrogation of FM of remote subscriber other than B.
2	MS -> SS	CHANNEL REQUEST	with establishment cause "Other procedures which can be completed with an SDCCH"
3	SS -> MS	IMMEDIATE ASSIGNMENT	
4	MS -> SS	CM SERVICE REQUEST	cause: "supplementary service activation"
5	SS -> MS	CM SERVICE ACCEPT	
6	MS -> SS	REGISTER	Check that the content of this message matches specific message contents.
7	SS -> MS	RELEASE COMPLETE	With an unsuccessful FM-result info with the following error value: k=1: Illegal interaction with incoming barring (code 21) k=2: Unauthorised request (code 22) k=3: Unknown remote party (code 41) k=4: FM not subscribed (code 42) k=5: FM not registered to remote party (code 62) k=6: Conflicting situation with other supplementary services (code 83) See specific message contents.
8	MS		Check that the MS, in a way described by the manufacturer, displays the error.
10	SS -> MS	CHANNEL RELEASE	
15	MS		The MS is made to initiate an interrogation of FM of remote party B.
16	MS -> SS	CHANNEL REQUEST	With establishment cause "Other procedures which can be completed with an SDCCH"
17	SS -> MS	IMMEDIATE ASSIGNMENT	
18	MS -> SS	CM SERVICE REQUEST	Cause: "supplementary service activation"
19	SS -> MS	CM SERVICE ACCEPT	
20	MS -> SS	REGISTER	Check that the content of this message matches specific message contents.
21	SS -> MS	RELEASE COMPLETE	With a successful FM-result. See specific message contents.
22	MS		Check that the MS, in a way described by the manufacturer, displays the positive result.
23	SS -> MS	CHANNEL RELEASE	

Specific message contents:

REGISTER

Information Element	value/remark
Supplementary service protocol discriminator	Supplementary service (call independent)
Transaction identifier	'1011'B
Message type	As 3G TS 24.080
Facility 1C	See below
SS version 7F	As 3G TS 24.080

For steps 6 and 20, Facility Information Element with Invoke = ProcessUnstructuredSS-Request component type as defined in 3G TS 24.080 section 3.6.1 table 3.3.

Contents	Value/remark
Facility IE identifier	As 3G TS 24.080
Length of FIE contents	depending on the length of ussd-string
Component type tag	CS/C/tag=1
Component length	depending on the length of ussd-string
InvokeID tag	From 3G TS 24.080
Invoke ID length	1
Invoke ID	Arbitrary (1 octet)
Operation Code tag	From 3G TS 24.080
Operation Code length	1
Operation Code	ProcessUnstructuredSS-Request
Ussd-dataCodingScheme	1 octet long. Alphabet indicator set to "default alphabet". Language indicator set to "undefined"
Ussd-string	For step 6: #21445896**# For step 20: #21431245688**#

RELEASE COMPLETE

Information Element	value/remark
Supplementary service protocol discriminator	Supplementary service (call independent)
Transaction identifier	the transaction value is the same as the REGISTER transaction value but the transaction flag is different
Message type	As 3G TS 24.080
Cause	Omitted.
Facility Information Element	See below
SS version indicator	As specified in 3G TS 24.080

For steps 7 and 21, Facility Information Element with Return result = ProcessUnstructuredSS-Request return result component type as defined in 3G TS 24.080 section 3.6.1 table 3.6.

Contents	Value/remark
Facility IE identifier	As 3G TS 24.080
Length of FIE contents	depending on the length of ussd-string
Component type tag	Return result
Component length	depending on the length of ussd-string
InvokeID tag	From 3G TS 24.080
Invoke ID length	1
Invoke ID	The same as the invoke of the ProcessUnstructuredSS-Request
Ussd-dataCodingScheme	1 octet long. Alphabet indicator set to "default alphabet". Language indicator set to "undefined"
Ussd-string	For step 7: value of the error code For steps 21: 03 31245688

31.15.3 Follow Me (FM) / Erasure

31.15.3.1 Conformance requirement

A previous FM registration can be erased in either of the following ways:

- The initiating subscriber can specifically erase her previous registration with an appropriate control procedure.
- In case the remote party corresponds to a subscriber the remote party can erase any previous registration with an appropriate control procedure.
- The FM service supervisor can erase any previous registration to any remote party with an appropriate control procedure (forced erasure).

The subscriber who initiates the FM erase request shall be informed of the outcome of the request by the network.

As an operator's option additional information (such as passwords) for erasure may be required from the subscriber. The registration procedure shall transport this information from the subscriber to the network of the remote party. This information shall be coded as a USSD string with a length not exceeding 30 characters.

MS shall behave as indicated in the Information flow as indicated in 3G TS 23.094, Figure 4.1.

All the messages between MS and the mobile network and internal to the mobile network, which are used for control of Follow Me, are USSD Phase 2 messages.

References

3G TS 22.094 clause 6.4

3G TS 23.094 clauses 4.1, 4.2, 4.4

3G TS 24.090 clause 6.1

31.15.3.2 Test purpose

To check that the MS, acting as an initiating subscriber or as a remote party, correctly requests a supplementary service transaction for erasure of FM in CHANNEL REQUEST message and in the subsequent CM SERVICE REQUEST;

To check that the MS as initiating subscriber or remote party sends a REGISTER message containing the FM-request control message for erasure;

To check that the MS, acting as a supervisor, correctly requests a supplementary service transaction for erasure of FM in CHANNEL REQUEST message and in the subsequent CM SERVICE REQUEST;

To check that the MS as supervisor sends a REGISTER message containing the FM-request control message for forced-erasure;

To check that upon receipt of the result or the error of the operation (in a RELEASE COMPLETE message), the MS provides the appropriate user indication (as described by the manufacturer).

31.15.3.3 Method of test

Initial conditions

System Simulator:

1 cell, default parameters.

Mobile Station:

The MS is in MM-state "idle, updated" with valid TMSI and CKSN. The MS is registered to FM with respect to a remote party B.

Related PICS/PIXIT Statement(s)

Type of MS (GSM 450, GSM480, P-, E-, R-GSM900, DCS 1800 or PCS 1900)

Support FM

Way to activate the erasure of FM

Description of display of the FM answers from the network.

Foreseen final state of the MS

The MS is in MM-state "idle, updated" with valid TMSI.

Test procedure

MS is registered to FM.

By means of appropriate MMI functions, the user requests erasure of FM for a remote number. Upon receipt of the REGISTER message, SS answers with the RELEASE COMPLETE message with an unsuccessful FM-result information. Check that the MS provides the appropriate user indication (as described by the manufacturer). Then SS transaction is released. This procedure is executed for all possible error values.

The user requests erasure of FM for another remote subscriber. Upon receipt of the operation (in a REGISTER message), SS answers with a RELEASE COMPLETE message with a successful FM-response information. Check that the MS provides the appropriate user indication (as described by the manufacturer). The SS transaction is released.

By means of appropriate MMI functions, the user requests forced-erasure of FM for a remote number. Upon receipt of the REGISTER message, SS answers with the RELEASE COMPLETE message with an unsuccessful FM-result information. Check that the MS provides the appropriate user indication (which is to be described by the manufacturer). Then SS transaction is released. This procedure is executed for all possible error values.

The user requests forced-erasure of FM for another remote subscriber. Upon receipt of the operation (in a REGISTER message), SS answers with a RELEASE COMPLETE message with a successful FM-response information. Check that the MS provides the appropriate user indication (as described by the manufacturer). The SS transaction is released.

Maximum Duration of Test

2 minutes

Expected Sequence

Test steps 1 to 10 and 25 to 34 are executed for k=1 to 10 with respectively the following error values:

1. Illegal interaction with incoming barring
2. Unauthorised request
3. Unknown remote party
4. FM not subscribed
5. FM not registered to remote party
6. Remote party not registered to this MSISDN
7. Unauthorised changes to remote party
8. Illegal interaction with call barring
9. Insufficient information
10. Inconsistent with registration

Step	Direction	Message	Comments
0	MS		The MS is in idle mode. MS is registered to FM with respect to a remote party B.
1	MS		The MS is made to initiate erasure of FM for a remote subscriber other than B.
2	MS -> SS	CHANNEL REQUEST	With establishment cause "Other procedures which can be completed with an SDCCH"
3	SS -> MS	IMMEDIATE ASSIGNMENT	
4	MS -> SS	CM SERVICE REQUEST	Cause: "supplementary service activation"
5	SS -> MS	CM SERVICE ACCEPT	
6	MS -> SS	REGISTER	Check that the content of this message matches specific message contents.
7	SS -> MS	RELEASE COMPLETE	With an unsuccessful FM-result info with the following error value: k=1: Illegal interaction with incoming barring (code 21) k=2: Unauthorised request (code 22) k=3: Unknown remote party (code 41) k=4: FM not subscribed (code 42) k=5: FM not registered to remote party (code 62) k=6: Remote party not registered to this MSISDN (code 63) k=7: Unauthorised changes to remote party (code 64) k=8: Illegal interaction with call barring (code 66) k=9: Insufficient information (code 81) k=10: Inconsistent with registration (code 84) See specific message contents.
8	MS		Check that the MS, in a way described by the manufacturer, displays the error.
10	SS -> MS	CHANNEL RELEASE	
15	MS		The MS is made to initiate erasure of FM for remote subscriber B
16	MS -> SS	CHANNEL REQUEST	With establishment cause "Other procedures which can be completed with an SDCCH"
17	SS -> MS	IMMEDIATE ASSIGNMENT	
18	MS -> SS	CM SERVICE REQUEST	Cause: "supplementary service activation"
19	SS -> MS	CM SERVICE ACCEPT	
20	MS -> SS	REGISTER	Check that the content of this message matches specific message contents.
21	SS -> MS	RELEASE COMPLETE	With a successful FM-result. See specific message contents.
22	MS		Check that the MS, in a way described by the manufacturer, displays the positive result.
23	SS -> MS	CHANNEL RELEASE	
25	MS		The MS is made to initiate forced erasure
26	MS -> SS	CHANNEL REQUEST	With establishment cause "Other procedures which can be completed with an SDCCH"
27	SS -> MS	IMMEDIATE ASSIGNMENT	
28	MS -> SS	CM SERVICE REQUEST	Cause: "supplementary service activation"
29	SS -> MS	CM SERVICE ACCEPT	
30	MS -> SS	REGISTER	Check that the content of this message matches specific message contents.

31	SS -> MS	RELEASE COMPLETE	With an unsuccessful FM-result info with the following error value: k=1: Illegal interaction with incoming barring (code 21) k=2: Unauthorised request (code 22) k=3: Unknown remote party (code 41) k=4: FM not subscribed (code 42) k=5: FM not registered to remote party (code 62) k=6: Remote party not registered to this MSISDN (code 63) k=7: Unauthorised changes to remote party (code 64) k=8: Illegal interaction with call barring (code 66) k=9: Insufficient information (code 81) k=10: Inconsistent with registration (code 84) See specific message contents.
32	MS		Check that the MS, in a way described by the manufacturer, displays the negative result.
34	SS -> MS	CHANNEL RELEASE	
40	MS		The MS is made to initiate forced erasure
41	MS -> SS	CHANNEL REQUEST	With establishment cause "Other procedures which can be completed with an SDCCH"
42	SS -> MS	IMMEDIATE ASSIGNMENT	
43	MS -> SS	CM SERVICE REQUEST	Cause: "supplementary service activation"
44	SS -> MS	CM SERVICE ACCEPT	
45	MS -> SS	REGISTER	Check that the content of this message matches specific message contents.
46	SS -> MS	RELEASE COMPLETE	With a successful FM-result. See specific message contents.
47	MS		Check that the MS, in a way described by the manufacturer, displays the positive result.
49	SS -> MS	CHANNEL RELEASE	

Specific message contents:

REGISTER

Information Element	value/remark
Supplementary service protocol discriminator	Supplementary service (call independent)
Transaction identifier	'1011'B
Message type	As 3G TS 24.080
Facility 1C	See below
SS version 7F	As 3G TS 24.080

For steps 6, 20, 30 and 45, Facility Information Element with Invoke = ProcessUnstructuredSS-Request component type as defined in 3G TS 24.080 section 3.6.1 table 3.3.

Contents	Value/remark
Facility IE identifier	As 3G TS 24.080
Length of FIE contents	depending on the length of ussd-string
Component type tag	CS/C/tag=1
Component length	depending on the length of ussd-string
InvokeID tag	From 3G TS 24.080
Invoke ID length	1
Invoke ID	Arbitrary (1 octet)
Operation Code tag	From 3G TS 24.080
Operation Code length	1
Operation Code	ProcessUnstructuredSS-Request
Ussd-dataCodingScheme	1 octet long. Alphabet indicator set to "default alphabet". Language indicator set to "undefined"
Ussd-string	For step 6: ##214*45896***# For step 20: ##214*31245688***# For steps 30 and 45: ##214*45896*88*0436987*#

RELEASE COMPLETE

Information Element	value/remark
Supplementary service protocol discriminator	Supplementary service (call independent)
Transaction identifier	the transaction value is the same as the REGISTER transaction value but the transaction flag is different
Message type	As 3G TS 24.080
Cause	Omitted.
Facility Information Element	See below
SS version indicator	As specified in 3G TS 24.080

For steps 7, 21, 31 and 46, Facility Information Element with Return result = ProcessUnstructuredSS-Request return result component type as defined in 3G TS 24.080 section 3.6.1 table 3.6.

Contents	Value/remark
Facility IE identifier	As 3G TS 24.080
Length of FIE contents	depending on the length of ussd-string
Component type tag	Return result
Component length	depending on the length of ussd-string
InvokeID tag	From 3G TS 24.080
Invoke ID length	1
Invoke ID	The same as the invoke of the ProcessUnstructuredSS-Request
Ussd-dataCodingScheme	1 octet long. Alphabet indicator set to "default alphabet". Language indicator set to "undefined"
Ussd-string	For steps 7 and 31: value of the error code For steps 21 and 46: 02

32 Testing of speech transcoding functions

The test sequences for speech transcoding and DTX tests, both for input and required output, are defined in GSM 06.10, section 5, and GSM 06.32, section 4 for the full rate speech codec. For the half rate speech codec the test sequences are defined in GSM 06.20, section 5 and GSM 06.42 section 7. They are available on floppy disks in IBM/AT MS-DOS format from ETSI publications department.

The Digital Audio Interface (DAI) is described in 36.4.

NOTE: For a definition of the term "traffic frame" used in this chapter, refer to GSM 06.32 and GSM 06.42.

32.1 Full Rate Downlink speech transcoding

32.1.1 Definition and applicability

Downlink speech transcoding transforms the 13 kbit/s net bit stream obtained by channel decoding the incoming bit stream from the air interface to 13 bit linear PCM.

The requirements and this test apply to all MS supporting TCH/FS.

32.1.2 Conformance requirement

The output bit stream from the speech transcoder shall be continuous and bit by bit exactly the same as the predefined output sequence (SEQ01.OUT, SEQ03.OUT, SEQ04.OUT and SEQ05.OUT).

GSM 06.01, 2; GSM 06.10, 5.2/5.2.2.

32.1.3 Test purpose

To verify that the speech transcoding of the MS can transform all predefined sequences (SEQ01.OUT, SEQ03.OUT, SEQ04.OUT and SEQ05.OUT) at 13 kbits/s level to 104 kbit/s (13 bit linear PCM at 8 kHz) level correctly.

32.1.4 Method of test

32.1.4.1 Initial conditions

DTX is off.

The DAI of the MS is connected to the SS and is set to the operating mode "Test of speech decoder/DTX functions (downlink)".

32.1.4.2 Procedure

- a) The SS resets the speech decoder of the MS via the DAI.
- b) The SS sends test sequence SEQ01.COD at 13 kbit/s to the MS via the air interface after passing it through the SS channel encoder.

NOTE: These test sequence files contain 16 bit words for all speech encoded parameters and are justified as described in GSM 06.10 table 5.1. 76 words are used as input in a period of 20 ms.

- c) The SS records the 104 kbit/s output bit stream from the MS on the digital audio interface.
- d) The test is repeated using the test sequences SEQ03.COD, SEQ04.COD and SEQ05.COD.

32.1.5 Test requirements

The bit stream output shall be continuous and bit by bit exactly the same as the sequence given in the files SEQ01.OUT, SEQ03.OUT, SEQ04.OUT and SEQ05.OUT.

NOTE: These files contain 16 bit words of 13 bit linear PCM left justified.

32.2 Full Rate Downlink receiver DTX functions

32.2.1 Definition and applicability

The DTX receiver functions consist of a SID frame detector, comfort noise generator functions and lost frame substitution and muting functions.

The requirements and this test apply to all MS supporting TCH/FS.

32.2.2 Conformance requirement

- 1) The output level of the decoder has to be constant for an input signal consisting of identical speech frames.

GSM 06.10.

- 2/3) When, after the first lost speech frame subsequent speech frames are lost, a muting technique shall be used that will gradually decrease the output level, resulting in the silencing of the output after a maximum of 320 ms. Speech frames with the FACCH flag set provoke a Bad Frame Indication (BFI = 1) and are hence regarded as lost speech frames.

GSM 06.01, 6; GSM 06.11, 2.1/2.2/3 for requirement 2 (first part).

GSM 06.01, 6; GSM 06.11, 2.1/2.2/3; GSM 06.31, 1.2.2/3.1.1 for requirement 3 (second part).

- 4/5) A valid SID-frame followed by a sequence of lost speech frames shall result in comfort noise generation with constant block amplitude parameters. Speech frames with the FACCH flag set provoke a Bad Frame Indication (BFI = 1) and are hence regarded as lost speech frames.

GSM 06.01, 3/5; GSM 06.12, 3/3.1;

GSM 06.31, 1.2.2/3.1/3.1.1/3.1.2 for requirement 4 (first part).

GSM 06.01, 3/5/6; GSM 06.11, 2.1/2.2; GSM 06.12, 3/3.1;

GSM 06.31, 1.2.2/3.1/3.1.1/3.1.2 for requirement 5 (second part).

- 6/7) An invalid SID-frame followed by a sequence of lost speech frames shall result in comfort noise generation, using the set of parameters from the last valid SID-frame. Speech frames with the FACCH flag set provoke a Bad Frame Indication (BFI = 1) and are hence regarded as lost speech frames.

GSM 06.01, 3/5; GSM 06.12, 3/3.1;

GSM 06.31, 1.2.2/3.1/3.1.1/3.1.2 for requirement 6 (first part).

GSM 06.01, 3/5/6; GSM 06.11, 2.1/2.2; GSM 06.12, 3/3.1;

GSM 06.31, 1.2.2/3.1/3.1.1/3.1.2 for requirement 7 (second part).

- 8) The energy of the output signal is controlled by the block amplitude parameter, x_{maxc} .

GSM 06.10, 3.1.20/3.1.21/3.2.1;

- 9/10) The first SID-frame that is expected and not received shall be substituted by the last valid SID-frame and the procedure for valid SID-frames shall be applied. For the second lost SID-frame, a muting technique shall be used that will gradually decrease the output level, resulting in silencing the output after a maximum of 320 ms. Speech frames with the FACCH flag set provoke a Bad Frame Indication (BFI = 1) and are hence regarded as lost speech frames.

GSM 05.08, 8.3; GSM 06.01, 6; GSM 06.11, 2.3/2.4;

GSM 06.31, 1.2.2/3.1/3.1.2.

32.2.3 Test purpose

- 1) To verify that the signal energy at the output of the decoder is constant with a tolerance of +/- 3 dB if a sequence of identical speech frames is applied at the receiver input.
- 2) To verify that the muting function of the receiver is within the required limits if a sequence of lost speech frames is applied at the receiver input.
- 3) To verify that the muting function of the receiver is within the required limits if a sequence of speech frames with the FACCH flag set is applied at the receiver input.
- 4) To verify the function of comfort noise generation when a valid SID-frame is received followed by a sequence of lost speech frames. The signal energy at the output of the decoder shall be constant with a tolerance of +/- 3 dB.
- 5) To verify the function of comfort noise generation when a valid SID-frame is received followed by a sequence of speech frames with the FACCH flag set. The signal energy at the output of the decoder shall be constant with a tolerance of +/- 3 dB.
- 6) To verify the function of comfort noise generation when an invalid SID-frame is received followed by a sequence of lost speech frames. The signal energy at the output of the decoder shall be constant with a tolerance of +/- 3 dB.
- 7) To verify the function of comfort noise generation when an invalid SID-frame is received followed by a sequence of speech frames with the FACCH flag set. The signal energy at the output of the decoder shall be constant with a tolerance of +/- 3 dB.
- 8) To verify that the signal energy at the output of the decoder depends on the block amplitude x_{maxc} of the input frames if a sequence of speech frames is applied to the decoder. The signal energy at the output of the decoder shall be constant with a tolerance of +/- 3 dB.
- 9) To verify the SID-frame substitution and muting functions on the comfort noise, if two consecutive expected SID-frames are lost with the other frames being lost speech frames.
- 10) To verify the SID-frame substitution and muting functions on the comfort noise, if two consecutive expected SID-frames are lost with the other frames being speech frames with the FACCH flag set.

32.2.4 Method of test

32.2.4.1 Initial conditions

Uplink DTX is off.

The DAI of the MS is connected to the SS and is set to the operating mode "Test of speech decoder/DTX functions (downlink)".

32.2.4.2 Procedure

- a) The SS transmits coded "speech" traffic frames on the air interface after passing them through the SS channel encoder. They contain a special test signal at 13 kbit/s as defined below. All traffic frames are identical with the exception of some frames which are SID frames as defined in GSM 06.32.
- b) The energy of the PCM signal is evaluated (as a mean square average) at the digital audio interface of the MS at 104 kbit/s level (13 bit, 8 kHz linear PCM) and recorded for each block of 20 ms synchronized to the 20 ms speech frame structure.
- c) The SS transmission of the TDMA frames of the TCH/FS on the air interface is ramped "on" and "off" on a traffic frame by traffic frame basis, taking into account the block diagonal interleaving scheme defined in GSM 05.03. The first traffic frame in step 1 occurs one frame after the window of the SACCH multiframe (TDMA frame 60 modulo 104), allocated for the SID frame (see GSM 05.02 and GSM 05.08). The SACCH will also be transmitted.

NOTE 1: 8 timeslots in 8 consecutive TCH/FS TDMA frames are seen as one traffic frame, and the next traffic frame starts in the middle of the previous one (i.e. after 4 TDMA frames of the previous one) due to the block diagonal interleaving scheme defined in GSM 05.03.

- d) The special test frame is an encoded "speech" traffic frame of 260 bits obtained from white Gaussian noise band limited to 300 - 3 400 Hz. When repeated, the special test frame results in a humming sound with a fairly constant level when decoded, and is defined in table 32-1.

Table 32-1: Table of special test traffic frame for receiver DTX tests

Encoded parameter:	Value:			
LARc(1)	38			
LARc(2)	42			
LARc(3)	24			
LARc(4)	20			
LARc(5)	10			
LARc(6)	9			
LARc(7)	5			
LARc(8)	3			
	Sub-block no:			
	0	1	2	3
Grid position (Mc)	1	3	2	0
Block amplitude (xmaxc)	40	40	40	40
LTP gain (Bc)	0	0	0	0
LTP lag (Nc)	40	120	40	120
RPE pulses (xmc)				
- pulse no 1	4	6	6	6
- pulse no 2	4	5	4	3
- pulse no 3	2	1	3	4
- pulse no 4	6	2	1	3
- pulse no 5	3	6	4	1
- pulse no 6	5	1	6	3
- pulse no 7	5	2	5	5
- pulse no 8	5	6	2	1
- pulse no 9	1	3	4	4
- pulse no 10	3	2	4	3
- pulse no 11	5	5	4	5
- pulse no 12	6	1	2	2
- pulse no 13	1	3	4	3

NOTE 2: The signal energy of the decoded special test frame is controlled with the block amplitude parameter (xmaxc). Reducing xmaxc from 40 to 32 reduces the signal energy by 6 dB, and reducing xmaxc from 40 to 24 reduces the signal energy by 12 dB.

e) The sequence of traffic frames on the air interface is as follows:

- e.1) 23 test frames "on".
- e.2) 20 frames "off".
- e.3) 20 test frames "on".
- e.4) 1 SID frame followed by 6 frames "off", another identical SID frame and 23 frames "off". Except for the SID codeword, the SID frames are identical to the test frame.
- e.5) 1 different SID frame, however with 2 to 15 errors inserted in the SID codeword, followed by 23 frames "off".
- e.6) 20 test frames "on", but with the block amplitude parameter xmaxc = 24.
- e.7) 1 SID frame followed by 50 frames "off". Except for the SID codeword, the SID frames are identical to the test frame.
- e.8) The whole test is repeated, but the frames "off" are replaced by frames "on" with the FACCH flag set.

32.2.5 Test requirements

- 1) In step e.1), the signal energy shall be fairly constant within +/- 3 dB.
- 2) In step e.2), the signal energy shall decrease to less than -60 dBm within 17 frames.

- 3) In step e.4), comfort noise shall be generated. The same requirements as in step e.1) apply.
- 4) In step e.5), the same requirements as in step e.4) apply.
- 5) In step e.6), the same requirements as in step e.1) apply. However, the signal energy shall be 12 dB lower.
- 6) In step e.7), the signal energy shall be fairly constant within +/- 3 dB for 28 frames. Then the signal energy shall decrease to less than -60 dBm within 16 frames.
- 7) In step e.8), the same requirements as in all previous steps apply.

32.3 Full Rate Uplink speech transcoding

32.3.1 Definition and applicability

Uplink speech transcoding transforms 13 bit linear PCM to the 13 kbit/s net bit stream. This net bit stream is to be channel encoded for transmission on the air interface.

The requirements and this test apply to all MS supporting TCH/FS.

32.3.2 Conformance requirement

The output bit stream from the speech transcoder shall be bit by bit exactly the same as the predefined output sequence (SEQ01.OUT, SEQ02.OUT, SEQ03.OUT and SEQ04.OUT).

GSM 06.01, 2; GSM 06.10, 5.2/5.2.1.

32.3.3 Test purpose

To verify that the speech transcoder on the MS can transform all predefined sequences (SEQ01.INP, SEQ02.INP, SEQ03.INP and SEQ04.INP) at 104 kbit/s (13 bit linear PCM at 8 kHz) level to 13 kbit/s level correctly.

32.3.4 Method of test

32.3.4.1 Initial conditions

Uplink DTX is off.

The DAI of the MS is connected to the SS and is set to the operating mode "Test of speech encoder/DTX functions (uplink)".

32.3.4.2 Procedure

- a) The SS resets the speech decoder on the MS (see 36.4).
- b) The SS sends a test sequence SEQ01.INP to the MS at 104 kbit/s level via the digital audio interface.
NOTE: These files contain 16 bit words for 13 bit linear PCM left justified. See also GSM 06.10 table 5.1.
- c) The SS records the 13 kbit/s output bit stream obtained by channel decoding the incoming bit stream from the air interface.
- d) The test is repeated using the test sequences SEQ02.INP, SEQ03.INP and SEQ04.INP.

32.3.5 Test requirements

The bit stream output shall be bit by bit exactly the same as the sequence given in the files SEQ01.COD, SEQ02.COD, SEQ03.COD and SEQ04.COD.

NOTE: These files contain 16 bit words of all the 76 parameters in a speech frame justified as in GSM 06.10 table 5.1. 76 codewords shall occur in a frame of 20 ms.

32.4 Full Rate Uplink transmitter DTX functions

32.4.1 Definition and applicability

The VAD/DTX transmitter functions consist of a Voice Activity Detector (VAD) and a surrounding Discontinuous Transmission (DTX) system introducing additional "speech" traffic frames on the air interface compared to those the VAD itself would classify as speech frames containing real speech. The additional traffic frames on the air are introduced due to:

- 1) A "hangover" period at the end of speech bursts in order to be certain that the traffic frames contain only noise and to evaluate the background acoustic noise characteristics when no real speech is present.
- 2) Special traffic frames (SID frames) added on the air at regular intervals containing only the evaluated background acoustic noise characteristics. These frames are used for generation of comfort noise in speaker silence periods on the receiving side.

The requirements and this test apply to all MS supporting TCH/FS.

32.4.2 Conformance requirement

The MS VAD and DTX function allows only those frames to be transmitted that are either marked with SP = 1 or that are properly positioned SID-frames.

GSM 05.08, 8.3; GSM 06.01, 3/4; GSM 06.31, 2.1/2.1.1/2.1.2; GSM 06.32, 1/2/2.1/2.2.8.

32.4.3 Test purpose

To verify that the combination of VAD and DTX operates correctly.

32.4.4 Method of test

32.4.4.1 Initial conditions

A call is set up on a TCH/FS according to the generic call set-up procedure.

Uplink DTX is on.

The DAI of the MS is connected to the SS and is set to the operating mode "Test of speech encoder/DTX functions (uplink)".

32.4.4.2 Procedure.

- a) The SS sends a test sequence SPEC_A1.INP of PCM samples, which are grouped into frames of 20 ms synchronized to the TDMA and traffic frame structure on the air interface, on the digital audio interface in the MS at 104 kbits/s (13 bit, 8 kHz linear PCM).

The start of the test sequences is synchronized with the radio transmission on the air interface so that the first traffic frame on the air occurs just after the traffic frame allocated for the SID frame (TDMA frame 56 modulo 104, see GSM 05.02 and GSM 05.08).

- NOTE: 8 timeslots in 8 consecutive TCH/FS TDMA frames are seen as one traffic frame and the next traffic frame starts in the middle of the previous one (i.e. after 4 TDMA frames of the previous one) due to the block diagonal interleaving scheme defined in GSM 05.03.
- b) The SS detects whether or not there is any power transmitted over the radio path on a timeslot basis excluding SACCH frames. The speech frame by speech frame on/off transmission (on = 1) is recorded.
 - c) The test is repeated for all test sequences *.INP described in GSM 06.32 section 4.

32.4.5 Test requirements

- 1) In step b), the traffic frame on/off sequence recorded shall be bit exact like the sequence of SP flags stored as bit 15 of LAR(2) on the respective reference files *.COD described in GSM 06.32, with the following exceptions:
 - 1.1) The occurrence of a SID frame in its allowed window within the SACCH multiframe as defined in GSM 05.08.
 - 1.2) The occurrence of a SID frame after 1 or more real speech frames consecutively transmitted on the air.

32.5 Full Rate Speech channel transmission delay

32.5.1 Definition and applicability

The total transmission delay within the various elements of a GSM system are specified as round trip delays. For the MS this would be equivalent to applying an RF equivalent of a speech signal to the MS receiver, closing an acoustic path from the ERP to the MRP, detecting the corresponding RF signal at the MS transmitter output and measuring the time interval between the signal originally fed to the MS receiver and that transmitted by the MS transmitter.

This simple approach cannot be demonstrated to be accurate due to the inherent non linear characteristic of the speech transcoder. The overall delay therefore is split into four identifiable and measurable delays. The delays are respectively:

- the downlink delay from RF input to DAI output,
- DAI output to ERP,
- MRP to DAI output, and
- DAI to uplink RF output.

Each delay is defined and its method of test described in the following sections.

The requirements and this test apply to all MS supporting TCH/FS.

32.5.2 Conformance requirement

The overall speech channel transmission delay shall be less than 143,9 ms.

GSM 03.50, section 3.3.6.1.

32.5.3 Test purpose

To verify that the round trip delay, of a speech channel for a MS, which consists of the sum of:

- the downlink delay from RF input to DAI output,
- DAI output to ERP,
- MRP to DAI output, and
- DAI to uplink RF output

meets the requirements when using the predefined test sequences SEQ01.COD, SEQ03.COD, SEQ04.COD and SEQ05.COD.

32.5.4 Downlink processing delay

32.5.4.1 Definition and applicability

The downlink processing delay is the delay from the first bit of a speech block transmitted from the RF output of the SS up to the last bit of the corresponding speech block received at the DAI on the output of the speech transcoder.

The requirements and this test apply to all MS supporting TCH/FS.

32.5.4.2 Method of test

32.5.4.2.1 Initial conditions

DTX is off.

The DAI of the MS is connected to the SS and is set to the operating mode "Test of speech decoder/DTX functions (downlink)".

32.5.4.2.2 Procedure

- a) The test set up is that described in 32.1 for downlink speech transcoding.
- b) The SS transmits one of the test patterns SEQ01.COD, SEQ03.COD, SEQ04.COD or SEQ05.COD to the MS.
- c) The SS measures for each speech block it transmits the time between the first bit at the air interface and the last bit of that speech block on the DAI. This difference is the delay measured.
- d) Step c) is repeated 20 times and the maximum delay measured in ms is the downlink processing delay TDP.

NOTE: This is to account for the fact that the processing time may not be constant.

32.5.5 Downlink coding delay

32.5.5.1 Definition and applicability

The downlink coding delay is defined as the delay between the digital representation of an acoustic signal on the DAI and the corresponding acoustic signal at the ERP.

The requirements and this test apply to all MS supporting TCH/FS.

32.5.5.2 Method of test

32.5.5.2.1 Initial conditions

The DAI of the MS is connected to the SS and is set to the operating mode "Test of acoustic devices and A/D & D/A".

The handset is mounted in the LRGP (see annex 1 of CCITT recommendation P.76) and the earpiece is sealed to the knife edge of the artificial ear conforming to CCITT recommendation P.51.

32.5.5.2.2 Procedure

- a) The SS generates on the DAI a digital representation of a sine wave with a frequency of 1 000 Hz.
- b) The SS measures the "phase shift" \varnothing_1 , in the range of 0 to 360 degrees, between the equivalent sine wave generated at the DAI and the sine wave at the input to the artificial ear.
- c) The frequency is increased to 1100 Hz and the resulting phase shift \varnothing_2 noted.
- d) The downlink coding delay TDC is calculated from either:

$$\text{TDC} = (\varnothing_2 - \varnothing_1)/36 \text{ ms for } \varnothing_2 > \varnothing_1$$

or

$$\text{TDC} = (\varnothing_2 + 360 - \varnothing_1)/36 \text{ ms for } \varnothing_2 < \varnothing_1$$

32.5.6 Uplink processing delay

32.5.6.1 Definition and applicability

The uplink processing delay is the delay from the first bit of a speech block on the DAI to the last bit of that speech block being transmitted on the air interface of the MS.

The requirements and this test apply to all MS supporting TCH/FS.

32.5.6.2 Method of test

32.5.6.2.1 Initial conditions

The DAI of the MS is connected to the SS and is set to the operating mode "Test of speech encoder/DTX functions (uplink)".

32.5.6.2.2 Procedure

- a) The test set up is that described in 32.3 for uplink speech transcoding.
- b) The SS sends one of the test patterns SEQ01.INP, SEQ03.INP, SEQ04.INP or SEQ05.INP to the DAI of the MS.
- c) The SS measures the time between the first bit on the DAI, and the last transmitted bit of the block at the air interface for each speech block the SS sends on the DAI. This time difference is the delay measured.
- d) Step c) is repeated 20 times. The maximum delay measured in ms is the uplink coding delay TUP.

NOTE: This is to account for the fact that the processing time may not be constant.

32.5.7 Uplink coding delay

32.5.7.1 Definition and applicability

The uplink coding delay is defined as the delay between an acoustic signal at the MRP and the digital representation of that signal on the DAI.

The requirements and this test apply to all MS supporting TCH/FS.

32.5.7.2 Method of test

32.5.7.2.1 Initial conditions

The DAI of the MS is connected to the SS and is set to the operating mode "Test of acoustic devices and A/D & D/A".

The handset is mounted in the LRGP (see annex 1 of CCITT recommendation P.76) and the earpiece is sealed to the knife edge of the artificial ear conforming to CCITT recommendation P.51.

32.5.7.2.2 Procedure

- a) The SS generates an acoustic signal at the artificial mouth of the LRGP, being a pure sine wave with a frequency of 1 000 Hz.
- b) The SS measures the "phase shift" \varnothing_1 , in the range of 0 to 360 degrees, between the signal at the MRP and its digital representation on the DAI.
- c) The SS set the generated frequency to 1 100 Hz and measures the resulting phase shift \varnothing_2 .
- d) The uplink coding delay TUC is calculated from either:

$$TUC = (\varnothing_2 - \varnothing_1)/36 \text{ ms for } \varnothing_2 > \varnothing_1$$

or

$$TUC = (\varnothing_2 + 360 - \varnothing_1)/36 \text{ ms for } \varnothing_2 < \varnothing_1$$

32.5.8 Test requirement

The sum of the delays {TDP + TDC + TUP + TUC} shall be less than 144,9 ms.

NOTE 1: This limit includes an allowance of 4*0,25 ms delay from the DAI to the MS transmission path.

NOTE 2: No allowances have been made for any delays within the measurement system. These must either be calibrated out or subtracted from the individual delays before performing the sum above.

32.6 Half Rate Downlink speech transcoding

32.6.1 Definition and applicability

Downlink speech transcoding transforms the 5,6 kbit/s net bit stream obtained by channel decoding the incoming bit stream from the air interface to 104 kbit/s (13 bit linear PCM at 8 kHz) level.

The requirements and this test apply to all MS supporting TCH/HS.

32.6.2 Conformance requirement:

The output bit stream from the speech transcoder shall be continuous and bit by bit exactly the same as the predefined output sequences contained in SEQ01.OUT, SEQ02.OUT, SEQ03.OUT and SEQ04.OUT.

GSM 06.02, 5; GSM 06.20.

32.6.3 Test purpose:

To verify that the speech transcoder of the MS can transform all the predefined sequences (SEQ01.DEC, SEQ02.DEC, SEQ03.DEC and SEQ04.DEC) at 5,6 kbit/s level to 104 kbit/s (13 bit linear PCM at 8 kHz) level correctly.

32.6.4 Method of test

32.6.4.1 Initial conditions

Uplink DTX is off.

The DAI of the MS is connected to the SS and is set to the operating mode "Test of speech decoder/DTX functions (downlink)".

Frequency hopping is on, where the BCCH carrier is part of the hopping sequence. Frequency hopping shall be performed over four carriers using random frequency hopping. Downlink power control shall be activated and a difference of 30 dB between the level of the BCCH carrier and the other carriers adjusted.

NOTE: Frequency hopping is used to ensure that the MS can cope with the reception of bursts (on the BCCH carrier) that have a power level that is different from the rest of the bursts.

32.6.4.2 Procedure

- a) The SS sends a reset pulse to the MS on the digital audio interface. This reset pulse will start the clock output of the MS at 104 kHz (pin 24 of the DAI).
- b) The SS sends test sequence SEQ01.DEC at 5,6 kbit/s to the MS via the air interface after passing it through the SS channel encoder. The speech decoder of the MS is reset by the special reset sequence which is at the beginning of the test sequence.
- c) The SS records the 104 kbit/s output bit stream from the MS on the digital audio interface. The recording shall be triggered by the reception of the encoder homing frame. The encoder homing frame itself shall not be recorded.

- d) The test is repeated using test sequences SEQ02.DEC, SEQ03.DEC and SEQ04.DEC.

32.6.5 Test requirement

The bit stream output shall be continuous and bit by bit exactly the same as the sequence describing the speech data contained in the files SEQ01.OUT, SEQ02.OUT, SEQ03.OUT and SEQ04.OUT. The two encoder homing frames at the beginning of each test sequence *.OUT shall be disregarded for this comparison.

32.7 Half Rate Downlink receiver DTX functions

32.7.1 Definition and applicability

The DTX receiver functions consist of a SID frame detector, comfort noise generator functions and lost frame substitution and muting functions.

The requirements and this test apply to all MS supporting TCH/HS.

32.7.2 Conformance requirement

The output bit stream from the speech transcoder shall be continuous and bit by bit exactly the same as the predefined output sequences contained in DTX*.OUT described in GSM 06.07 subclause 7.

GSM 06.02, 6/8; GSM 06.22; GSM 06.41.

32.7.3 Test purpose

To verify that the MS generates comfort noise correctly.

32.7.4 Method of test

32.7.4.1 Initial conditions

The DAI of the MS is connected to the SS and is set to the operating mode "Test of speech decoder/DTX functions (downlink)".

Frequency Hopping is on, where the BCCH carrier is part of the hopping sequence. Frequency Hopping shall be done over four carriers using random Frequency Hopping.

NOTE: Frequency Hopping is used to ensure that the MS can cope with the reception of dummy bursts (on the BCCH frequency) during DTX.

32.7.4.2 Procedure

- a) The SS sends a reset pulse to the MS on the digital audio interface. This reset pulse will start the clock output of the MS at 104 kHz (pin 24 of the DAI).
- b) The SS sends test sequence DTX01.DEC at 5,6 kbit/s to the MS via the air interface after passing it through the SS channel encoder. The speech decoder of the MS will be reset by the special reset sequence which is at the beginning of the test sequence.
- c) The SS transmission of the TDMA frames of the TCH/HS on the air interface is ramped "on" and "off" on a traffic frame by traffic frame basis, taking into account the block diagonal interleaving scheme defined in GSM 05.03. The first traffic frame in step b occurs one frame after the window of the SACCH multiframe (TDMA frame 0 or 52 modulo 104 for subchannel 0 and TDMA frame 1 or 53 modulo 104 for subchannel 1), allocated for the SID frame (see GSM 05.02 and GSM 05.08). The SACCH will also be transmitted.
- d) The information whether to ramp the transmitter of the SS "on" or "off" is derived from the sequence of SP-flags contained in the file DTX01.COD (see file format description in GSM 06.07 subclause 5 for the position of the SP-flag).

- e) The SS records the 104 kbit/s output bit stream from the MS on the digital audio interface. The recording shall be triggered by the reception of the encoder homing frame. The encoder homing frame itself is not recorded.
- f) The test is repeated using test sequences *.DEC described in GSM 06.07 subclause 7.

32.7.5 Test requirement

The bit stream output shall be continuous and bit by bit exactly the same as the sequence describing the speech data contained in the files DTX*.OUT described in GSM 06.07 subclause 7. The two encoder homing frames at the beginning of each test sequence *.OUT shall be disregarded for this comparison.

32.8 Half Rate Uplink speech transcoding

32.8.1 Definition and applicability

Uplink speech transcoding transforms 104 kbit/s (13 bit linear PCM at 8 kHz) level to the 5,6 kbit/s net bit stream. This net bit stream is to be channel encoded for transmission on the air interface.

The requirements and this test applies to all MS supporting TCH/HS.

32.8.2 Conformance requirement

The output bit stream from the speech transcoder shall be bit by bit exactly the same as the predefined sequences contained in SEQ01.COD, SEQ02.COD and SEQ03.COD described in GSM 06.07 subclause 6.

GSM 06.02, 5; GSM 06.20.

32.8.3 Test purpose

To verify that the speech transcoder of the MS can transform all the predefined sequences SEQ01.INP, SEQ02.INP and SEQ03.INP at 104 kbit/s (13 bit linear PCM at 8 kHz) level to 5,6 kbit/s level correctly.

32.8.4 Method of test

32.8.4.1 Initial conditions

Uplink DTX is off.

The DAI of the MS is connected to the SS and is set to the operating mode "Test of speech encoder/DTX functions (uplink)".

Frequency hopping is on.

32.8.4.2 Procedure

- a) The SS sends a reset pulse to the MS on the digital audio interface. This reset pulse will start the clock output of the MS at 104 kHz (pin 24 of the DAI).
- b) The SS synchronizes the input of the test sequences via the digital audio interface to the framing of the MS in the uplink. This can be done in two steps as follows:
 - b.1) The SS sends to the MS at 104 kbit/s level via the digital audio interface 13 triplets of input frames, each triplet consisting of 480 samples. The 480 samples of one triplet shall all be identical. The 13 bits of one sample shall all be set to "zero" except for one which is set to "one". The position of the bit within the 13 bits of a sample that is set to "one" shall vary in such a way, that all possible 13 positions are exercised within the 13 triplets of input frames. An example for such a sequence is given in test sequence BITSYNC.INP described in GSM 06.07 subclause 8. The SS records the 5,6 kbit/s output bit stream obtained by channel decoding the incoming bit stream from the air interface. As soon as the decoder homing frame is detected at the output, the framing of the MS with respect to the 13 bit long input words is known by looking at the corresponding input frame that has caused the decoder homing frame at the output.

NOTE: The encoder homing frame consists of 160 identical samples, each 13 bit long left justified, with the least significant bit set to "one" and all other bits set to "zero" (0008 hex). The speech encoder will go to its predefined home state at the end of the first received encoder homing frame. Consecutive encoder homing frames will produce the decoder homing frame at the output of the speech encoder.

- b.2) Synchronized to the 13 bit framing of the MS, the SS now sends test sequence SEQSYNC.INP described in GSM 06.07 subclause 8 to the MS at 104 kbit/s level via the digital audio interface. The SS records the 5,6 kbit/s output bit stream obtained by channel decoding the incoming bit stream from the air interface. The recording shall be triggered by the reception of the decoder homing frame. By comparing the first recorded frame that is not a decoder homing frame with the 160 possible output frames contained in sequences SYNC*.COD, the offset of the input to the 20 ms framing of the MS is known.
- c) Synchronized to the 20 ms framing of the MS, the SS sends a test sequence SEQ01.INP to the MS at 104 kbit/s level via the digital audio interface. The speech encoder of the MS is reset by the special homing sequence which is at the beginning of the test sequence.
- d) The SS records the 5,6 kbit/s output bit stream obtained by channel decoding the incoming bit stream from the air interface. The recording shall be triggered by the reception of the decoder homing frame. The decoder homing frame itself is not recorded.
- e) The test is repeated using test sequences SEQ02.INP and SEQ03.INP.

32.8.5 Test requirements

The bit stream output shall be bit by bit exactly the same as the sequences describing the speech parameters contained in the files SEQ01.COD, SEQ02.COD and SEQ03.COD. The two decoder homing frames at the beginning of each test sequence *.COD shall be disregarded for this comparison.

32.9 Half Rate Uplink transmitter DTX functions

32.9.1 Definition and applicability

The VAD/DTX transmitter functions consist of a Voice Activity Detector (VAD) that inhibits the transmitter during speech pauses, and a surrounding Discontinuous Transmission (DTX) system introducing Silence Descriptor (SID) frames on the air interface.

The requirements and this test apply to all MS supporting TCH/HS.

32.9.2 Conformance requirement

The MS VAD and DTX function allow only those frames to be transmitted that are either properly positioned SID-frames, SACCH-frames or frames marked with SP-flag = 1.

For the transmitted frames, the output bit stream from the speech transcoder shall be bit by bit exactly the same as the predefined sequences contained in DTX*.COD described in GSM 06.07 subclause 6.

GSM 05.08, 8.3; GSM 06.02, 6/7; GSM 06.41; GSM 06.42.

32.9.3 Test purpose

To verify that the combination of VAD and DTX operates correctly.

32.9.4 Method of test

32.9.4.1 Initial conditions

Uplink DTX is on.

The DAI of the MS is connected to the SS and is set to the operating mode "Test of speech encoder/DTX functions (uplink)".

Frequency Hopping is on.

32.9.4.2 Procedure

- a) The SS sends a reset pulse to the MS on the digital audio interface. This reset pulse will start the clock output of the MS at 104 kHz (pin 24 of the DAI).
- b) The SS synchronizes the input of the test sequences via the digital audio interface to the framing of the MS in the uplink. This can be done in two steps as follows:
 - b.1) The SS sends to the MS at 104 kbit/s level via the digital audio interface 13 triplets of input frames, each triplet consisting of 480 samples. The 480 samples of one triplet shall all be identical. The 13 bits of one sample shall all be set to "zero" except for one which is set to "one". The position of the bit within the 13 bits of a sample that is set to "one" shall vary in such a way, that all possible 13 positions are exercised within the 13 triplets of input frames. An example for such a sequence is given in test sequence BITSYNC.INP described in GSM 06.07 subclause 8. The SS records the 5,6 kbit/s output bit stream obtained by channel decoding the incoming bit stream from the air interface. As soon as the decoder homing frame is detected at the output, the framing of the MS with respect to the 13 bit long input words is known by looking at the corresponding input frame that has caused the decoder homing frame at the output.

NOTE: The encoder homing frame consists of 160 identical samples, each 13 bit long left justified, with the least significant bit set to "one" and all other bits set to "zero" (0008 hex). The speech encoder will go to its predefined home state at the end of the first received encoder homing frame. Consecutive encoder homing frames will produce the decoder homing frame at the output of the speech encoder.

- b.2) Synchronized to the 13 bit framing of the MS, the SS now sends test sequence SEQSYNC.INP described in GSM 06.07 subclause 8 to the MS at 104 kbit/s level via the digital audio interface. The SS records the 5,6 kbit/s output bit stream obtained by channel decoding the incoming bit stream from the air interface. The recording shall be triggered by the reception of the decoder homing frame. By comparing the first recorded frame that is not a decoder homing frame with the 160 possible output frames contained in sequences SYNC*.COD, the offset of the input to the 20 ms framing of the MS is known.
- c) The SS sends test sequence DTX01.INP of PCM samples described in GSM 06.07 subclause 7 on the digital audio interface in the MS at 104 kbit/s (13 bit linear PCM at 8 kHz). The speech encoder of the MS will be reset by the special homing sequence which is at the beginning of the test sequence.
- d) The start of the test sequence is synchronized with the radio transmission on the air interface so that the first traffic frame on the air caused by the first encoder homing frame in the test sequence occurs just after the traffic frame allocated for the SID frame (TDMA frame 0 or 52 modulo 104 for subchannel 0 and TDMA frame 1 or 53 modulo 104 for subchannel 1), allocated for the SID frame (see GSM 05.02 and GSM 05.08).
- e) The SS detects whether or not there is any power transmitted over the radio path on a time slot basis excluding SACCH frames. The speech frame by speech frame on/off transmission (on = 1) is calculated and recorded. The recording shall be triggered by the reception of the decoder homing frame. The flag marking the decoder homing frame itself is not recorded.
- f) The SS records the 5,6 kbit/s output bit stream obtained by channel decoding the incoming bit stream from the air interface. The recording shall be triggered by the reception of the decoder homing frame. The decoder homing frame itself is not recorded.
- g) The test is repeated for all test sequences DTX*.INP described in GSM 06.07 subclause 7.

32.9.5 Test requirements

- 1) The bit stream recorded in step e) shall be continuous and bit by bit exactly the same as the sequence of SP-flags contained in the files DTX*.COD (see file format description in GSM 06.07 subclause 5 for the position of the SP-flag), except for the bits marking those frames that are SID frames scheduled for transmission according to GSM 06.41. The first two frames in the reference files *.COD shall be disregarded for this comparison.
- 2) The bit stream recorded in step f) shall be continuous and bit by bit exactly the same as the sequence describing the speech parameters contained in the files *.COD described in GSM 06.07 subclause 7, except for the bits of the speech frames marked with SP-flag=0. The two decoder homing frames at the beginning of each test sequence *.COD shall be disregarded for this comparison.

32.10 Half Rate Speech channel transmission delay

32.10.1 Definition and applicability

The total transmission delay within the various elements of a GSM system are specified as round trip delays. For the MS this would be equivalent to applying an RF equivalent of a speech signal to the MS receiver, closing an acoustic path from the ERP to the MRP, detecting the corresponding RF signal at the MS transmitter output and measuring the time interval between the signal originally fed to the MS receiver and that transmitted by the MS transmitter.

This simple approach cannot be demonstrated to be accurate due to the inherent non linear characteristic of the speech transcoder. The overall delay therefore is split into four identifiable and measurable delays. The delays are respectively:

- the downlink delay from RF input to DAI output,
- DAI output to ERP,
- MRP to DAI output, and
- DAI to uplink RF output.

Each delay is defined and its method of test described in the following sections.

The requirements and this test applies to all MS supporting TCH/HS.

32.10.2 Conformance requirement

The overall speech channel transmission delay shall be less than 143,9 ms.

GSM 03.50 section 3.3.6.2.

32.10.3 Test purpose

To verify that the round trip delay of a speech channel for a MS which consists of the sum of:

- the downlink delay from RF input to DAI output,
- DAI output to ERP,
- MRP to DAI output, and
- DAI to uplink RF output

meets the requirements when using the predefined test sequences SEQ01.INP and SEQ01.DEC.

32.10.4 Downlink processing delay

32.10.4.1 Definition and applicability

The downlink processing delay is the delay from the first bit of a speech block transmitted from the RF output of the SS up to the last bit of the corresponding speech block received at the DAI on the output of the speech transcoder.

The requirements and this test apply to all MS supporting TCH/HS.

32.10.4.2 Method of test

32.10.4.2.1 Initial conditions

The DAI of the MS is connected to the SS and is set to the operating mode "Test of speech decoder/DTX functions (downlink)".

32.10.4.2.2 Procedure

- a) The test set up is that described in section 32.6.4.2 for downlink speech transcoding.
- b) The SS transmits the test pattern SEQ01.DEC described in GSM 06.07 subclause 6 to the MS.
- c) The SS measures for each speech block it transmits the time between the first bit at the air interface and the last bit of that speech block on the DAI. This time difference is the delay measured.
- d) Step c) is repeated 20 times and the maximum delay measured in ms is the downlink processing delay TDP.

NOTE: This is to account for the fact that the processing time may not be constant.

32.10.5 Downlink coding delay

32.10.5.1 Definition and applicability

The downlink coding delay is defined as the delay between the digital representation of an acoustic signal on the DAI and the corresponding acoustic signal at the ERP.

The requirements and this test applies to all MS supporting TCH/HS.

32.10.5.2 Method of test

32.10.5.2.1 Initial conditions

The DAI of the MS is connected to the SS and is set to the operating mode "Test of acoustic devices and A/D & D/A".

The handset is mounted in the LRGP (see annex 1 of CCITT recommendation P.76) and the earpiece is sealed to the knife edge of the artificial ear conforming to CCITT recommendation P.51.

32.10.5.2.2 Procedure

- a) The SS generates on the DAI a digital representation of a sine wave with a frequency of 1 000 Hz.
- b) The SS measures the "phase shift" \varnothing_1 , in the range of 0 to 360 degrees, between the equivalent sine wave generated at the DAI and the sine wave at the input to the artificial ear.
- c) The frequency is increased to 1 100 Hz and the resulting phase shift \varnothing_2 noted.
- d) The downlink coding delay TDC is calculated from either:

$$\text{TDC} = (\varnothing_2 - \varnothing_1) \text{ ms}/36 \quad \text{for } \varnothing_2 > \varnothing_1$$

or

$$\text{TDC} = (\varnothing_2 + 360 - \varnothing_1) \text{ ms}/36 \quad \text{for } \varnothing_2 < \varnothing_1$$

32.10.6 Uplink processing delay

32.10.6.1 Definition and applicability

The uplink processing delay is the delay from the first bit of a speech block on the DAI to the last bit of that speech block being transmitted on the air interface of the MS.

The requirements and this test apply to all MS supporting TCH/HS.

32.10.6.2 Method of test

32.10.6.2.1 Initial conditions

The DAI of the MS is connected to the SS and is set to the operating mode "Test of speech encoder/DTX functions (uplink)".

32.10.6.2.2 Procedure

- a) The test set up is that described in section 32.8.4.2 for uplink speech transcoding.
- b) The SS sends one of the test patterns SEQ01.INP described in GSM 06.07 subclause 6 to the DAI of the MS.
- c) The SS measures the time between the first bit on the DAI, and the last transmitted bit of the block at the air interface for each speech block the SS sends on the DAI. This time difference is the delay measured.
- d) Step c) is repeated 20 times. The maximum delay measured in ms is the uplink coding delay TUP.

NOTE: This is to account for the fact that the processing time may not be constant.

32.10.7 Uplink coding delay

32.10.7.1 Definition and applicability

The uplink coding delay is defined as the delay between an acoustic signal at the MRP and the digital representation of that signal on the DAI.

The requirements and this test applies to all MS supporting TCH/HS.

32.10.7.2 Method of test

32.10.7.2.1 Initial conditions

The handset is mounted in the LRGP (see annex 1 of CCITT recommendation P.76) and the earpiece is sealed to the knife edge of the artificial ear conforming to CCITT recommendation P.51.

32.10.7.2.2 Procedure

- a) The SS generates an acoustic signal at the artificial mouth of the LRGP, being a pure sine wave with a frequency of 1 000 Hz.
- b) The SS measures the "phase shift" \varnothing_1 , in the range of 0 to 360 degrees, between the signal at the MRP and its digital representation on the DAI.
- c) The SS sets the generated frequency to 1 100 Hz, and measures the resulting phase shift \varnothing_2 .
- d) The uplink coding delay TUC is calculated from either:

$$TDC = (\varnothing_2 - \varnothing_1) \text{ ms}/36 \quad \text{for } \varnothing_2 > \varnothing_1$$

or

$$TDC = (\varnothing_2 + 360 - \varnothing_1) \text{ ms}/36 \quad \text{for } \varnothing_2 < \varnothing_1$$

32.10.8 Test requirement

The sum of the delays TDP, TDC, TUP, and TUC shall be less than 144,9 ms.

NOTE: This limit includes an allowance of 4*0,25 ms delay from the DAI to the MS transmission path.

32.11 Intra cell channel change from a TCH/HS to a TCH/FS

32.11.1 Definition and applicability

Dual rate MSs support an intra cell channel change from a TCH/HS to a TCH/FS by switching the Speech and channel codec used from HR to FR.

The requirements and this test apply to all MS supporting TCH/HS.

32.11.2 Conformance requirement:

- 1) When commanded to perform an intra cell channel change from a TCH/HS to a TCH/FS, the MS shall switch channels from HR to FR. The maximum time allowed for the MS to perform this switch in rates is 20 ms.

GSM 05.10, section 6.8.

- 2) For an intra cell channel change, the time between the end of the last complete speech or data frame or message block sent on the old channel and the time the MS is ready to transmit on the new channel shall be less than 20 ms.

GSM 05.10, section 6.8.

32.11.3 Test purpose:

- 1) To verify that the MS encodes speech correctly after performing an intra cell channel change from a TCH/HS to a TCH/FS.
- 2) To verify that the MS, when commanded to perform an intracell channel change to a new ARFCN and/or timeslot number within the same cell, if the starting time is not used in the ASSIGNMENT COMMAND, is ready to transmit on the new channel within 20 ms of the last complete speech frame or message block sent on the old channel.

32.11.4 Method of test

32.11.4.1 Initial conditions

Uplink DTX is off.

The SS sets up a call according to the generic call set up procedure on a HR channel in the low ARFCN range on timeslot 1.

32.11.4.2 Procedure

- a) The SS records the sequence of BFI flags obtained by channel decoding the incoming bit stream from the uplink air interface using the HR channel decoder on the old channel and at the same time records the sequence of BFI flags obtained by channel decoding the incoming bit stream from the uplink air interface using the FR channel decoder on the channel to which the channel change will take place.
- b) The SS sends an ASSIGNMENT COMMAND to the MS allocating a FR channel in the high ARFCN range on timeslot 2, and with a power command of 7. These old and new carriers have a relative frequency tolerance of 0, and a relative timing tolerance of 1/4 bit.
- c) The time at which the sequence of BFI flags at the output of the HR channel decoder performs the first transition from 0 to 1 is registered (t_1). In case of occurrence of speech frames after an RR frame, the next transition of the BFI flag from 0 to 1 after the reception of the RR frame is defined as t_1 .
- d) The time values at which the sequence of BFI flags at the output of the FR channel decoder performs transitions from 1 to 0 are registered. The time t_2 is defined as the time where the BFI flag at the output of the FR channel decoder toggles from 1 to 0 due to a correctly received speech traffic frame received at the channel decoder. Transitions due to the occurrence of an ASSIGNMENT COMPLETE frame or an SABM frame after the reception of good speech frames shall not be considered. If the first frame sent on the new traffic channel was an

SABM frame, t_2 is defined as the time the BFI flag toggles from 1 to 0 due to a correctly received speech traffic frame after the reception of the SABM frame.

NOTE: There shall be an allowance of at maximum two transitions for this BFI flag from 0 to 1 and back to zero again after t_2 . These transitions are caused by the SABM frame if it was not the first frame to be sent on the new TCH, or the ASSIGNMENT COMPLETE frame, or both. Since both frames are FACCH frames, each would cause exactly one BFI=1 indications.

e) The time difference $Dt = t_2 - t_1$ shall be calculated.

32.11.5 Test requirement

- 1) The last transition of the BFI flag at the output of the FR channel decoder from 1 to 0 shall be followed by a sequence of at least 50 zeroes, interrupted by at maximum two transitions to 1, each interruption containing exactly one BFI=1 flag, caused by the SABM or the ASSIGNMENT COMPLETE frames.
- 2) The calculated time difference Dt shall not exceed 13 TDMA frames. If the first frame sent on the new channel was an SABM frame, an additional time difference of 4 frames is allowed. If the last frame sent on the old channel was an RR frame, an additional time difference of 9 frames is allowed.

NOTE: The BFI of the old channel will toggle from 0 to 1 only four frames after the reception of the last bit of the speech frame sent on the old channel. The time between the last bit of the last complete speech or data frame or message block sent on the old channel and the time the MS is ready to transmit on the new channel shall be less than 20 ms (5.10, section 6.8). This time will expire 4 frames and 3 timeslots after the sending of the last bit of the last complete speech frame on the old channel, i.e. the MS may not be able to transmit in the corresponding timeslot in the current frame, but must wait approx. 4 frames until the next allowed frame ($FN \bmod 13 = 0, 4 \text{ or } 8$) is reached. The next frame could be an idle frame, so the MS must wait for another frame. This equates to 5 frames, after which the MS is able to start transmission on the new channel. Additionally, 8 frames will be needed due to interleaving until the last bit of the first speech frame on the new channel is received and the BFI flag toggles from 1 to 0. This makes a total of 13 frames or 60 ms between the frame number when the BFI toggles from 0 to 1 on the old channel and the frame number when the BFI toggles from 1 to 0 on the new channel. See diagram below. If SABM is the first frame received on the new channel, 4 more frames are allowed. If RR is the last frame sent on the old channel, additionally 9 more frames are allowed (RR frames plus an idle frame).

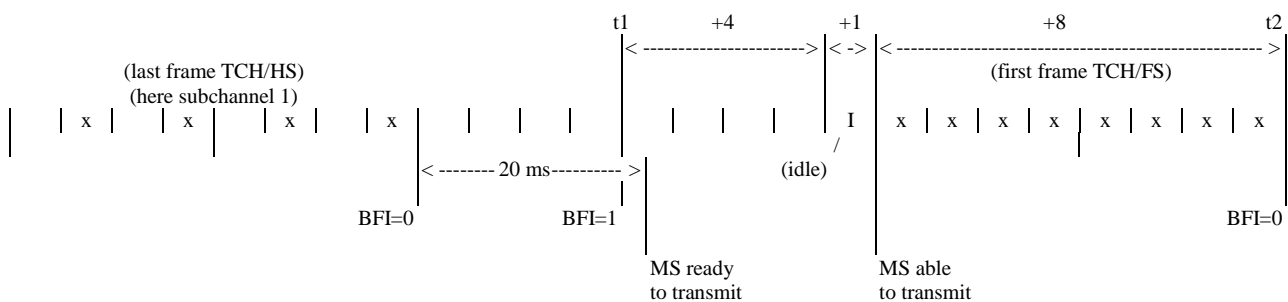

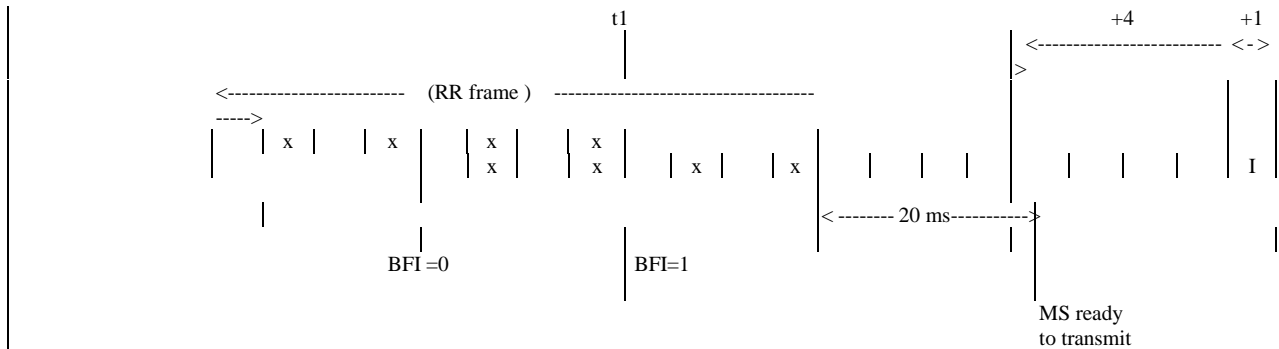

32.12 Intra cell channel change from a TCH/FS to a TCH/HS

32.12.1 Definition and applicability

Dual rate MSs support an intra cell channel change from a TCH/FS to a TCH/HS by switching the Speech and channel codec used from FR to HR.

The requirements and this test apply to all MS supporting TCH/HS.

32.12.2 Conformance requirement:

- 1) When commanded to perform an intra cell channel change from a TCH/FS to a TCH/HS, the MS shall switch channels from FR to HR.
GSM 05.10 section 6.8.
- 2) For an intra cell channel change, the time between the end of the last complete speech or data frame or message block sent on the old channel and the time the MS is ready to transmit on the new channel shall be less than 20 ms.

GSM 05.10, section 6.8.

32.12.3 Test purpose:

- 1) To verify that the MS encodes speech correctly after performing an intra cell channel change from a TCH/FS to a TCH/HS.
- 2) To verify that the MS, when commanded to perform an intra cell channel change to a new ARFCN and/or new timeslot number within the same cell, if the starting time is not used in the ASSIGNMENT COMMAND, is ready to transmit on the new channel within 20 ms of the last complete speech frame or message block sent on an old channel.

32.12.4 Method of test

32.12.4.1 Initial conditions

Uplink DTX is off.

The SS sets up a call according to the generic call set up procedure on a FR channel in the low ARFCN range on timeslot 1.

32.12.4.2 Procedure

- a) The SS records the sequence of BFI flags obtained by channel decoding the incoming bit stream from the uplink air interface using the FR channel decoder on the old channel and at the same time the sequence of BFI flags obtained by channel decoding the incoming bit stream from the uplink air interface using the HR channel decoder on the channel to which the channel change will take place.

- b) The SS sends an ASSIGNMENT COMMAND to the MS allocating a HR channel in the high ARFCN range on timeslot 2, and with a power command of 7. These old and new carriers have a relative frequency tolerance of 0, and a relative timing tolerance of 1/4 bit.
- c) The time at which the sequence of BFI flags at the output of the FR channel decoder performs the first transition from 0 to 1 is registered (t_1). In case of occurrence of speech frames after an RR frame, the next transition of the BFI flag from 0 to 1 after the reception of the RR frame is defined as t_1 .
- d) The time values at which the sequence of BFI flags at the output of the HR channel decoder performs transitions from 1 to 0 are registered. The time t_2 is defined as the time where the BFI flag at the output of the FR channel decoder toggles from 1 to 0 due to a correctly encoded speech traffic frame received at the channel decoder. Transitions due to the occurrence of an ASSIGNMENT COMPLETE frame or and SABM frame after the reception of good speech frames shall not be considered. If the first frame sent on the new traffic channel was an SABM frame, t_2 is defined as the time the BFI flag toggles from 1 to 0 due to a correctly received speech traffic frame after the reception of the SABM frame.

NOTE: There shall be an allowance of at maximum two transitions for this BFI flag from 0 to 1 and back to zero again after t_2 . These transitions are caused by the SABM frame if it was not the first frame to be sent on the new TCH, or the ASSIGNMENT COMPLETE frame, or both. Since both frames are FACCH frames, each would cause exactly two BFI=1 indications.

- e) The time difference $Dt = t_2 - t_1$ shall be calculated.

32.12.5 Test requirement

- 1) The last transition of the BFI flag at the output of the HR channel decoder from 1 to 0 shall be followed by a sequence of at least 50 zeroes, interrupted by at maximum two transitions to 1, each interruption containing exactly two BFI=1 flags, caused by the SABM or the ASSIGNMENT COMPLETE frames.
- 2) The calculated time difference Dt shall not exceed 12 TDMA frames. if the first frame sent on the new channel was an SABM frame, an additional time difference of 9 frames is allowed. If the last frame sent on the old channel was an RR frame, an additional time difference of 5 frames is allowed.

NOTE: The BFI of the old channel will toggle from 0 to 1 only 4 frames after the reception of the last bit of the last speech frame sent on the old channel. The BFI on the old channel will toggle from 0 to 1 only four frames after the reception of the last bit of the last complete speech or data frame or message block sent on the old channel.

The time between the last bit of the last complete speech frame sent on the old channel and the time the MS is ready to transmit on the new channel shall be less than 20 ms (5.10, section 6.8). This time will expire 4 frames and 3 timeslots after the sending of the last bit of the last complete speech frame on the old channel, i.e. the MS may not be able to transmit in the corresponding new timeslot in its current frame, but must wait approx. 4 frames until the next allowed frame ($FN \bmod 13 = 0, 4 \text{ or } 8$) is reached.

The next frame could be an idle frame, so the MS must wait for another frame. This equates to 5 frames, after which the MS is able to start transmission on the new channel.

Additionally, 7 frames will be needed due to interleaving until the last bit of the first speech frame on the new channel is received and the BFI flag toggles from 1 to 0.

This makes a total of 12 frames or 55,4 ms between the frame number when the BFI toggles from 0 to 1 on the old channel and the frame number when the BFI toggles from 1 to 0 on the new channel. See diagram below.

If SABM is the first frame received on the new channel, 9 more frames are allowed.

If RR is the last frame sent on the old channel, 5 more frames are allowed.

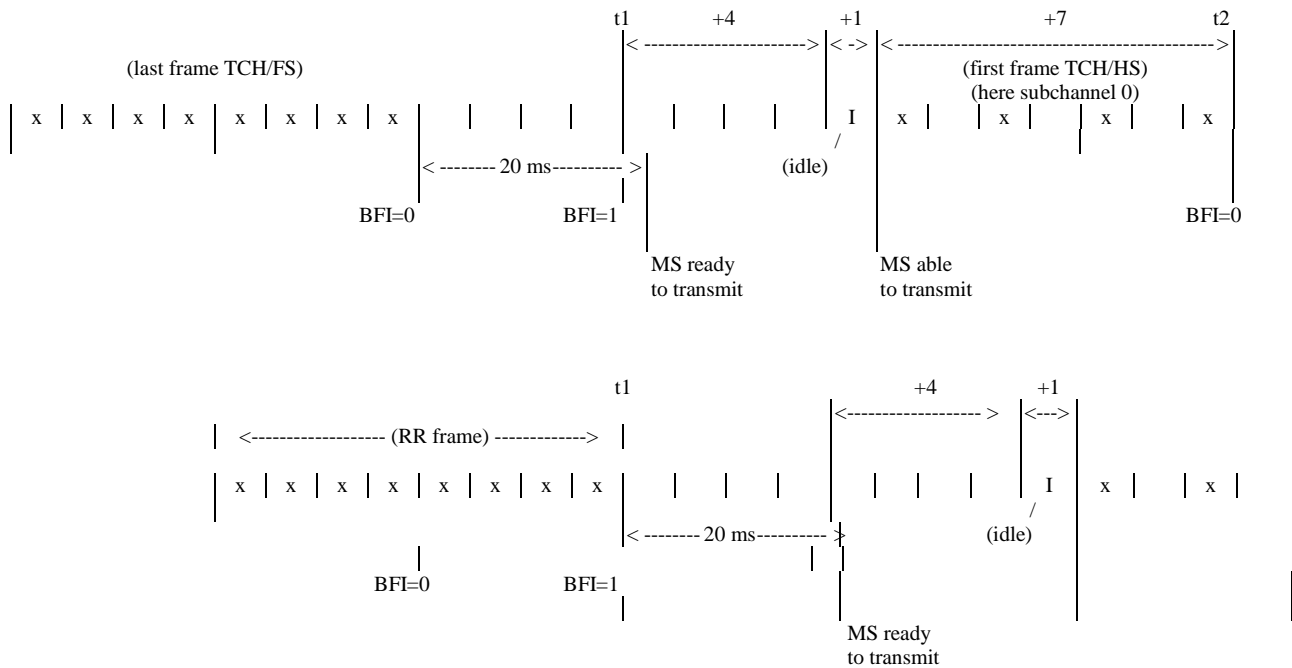

33 Mobile station features

GSM 02.07 defines mandatory and optional MS features. Their presence and appropriate functioning are verified by the following tests.

33.1 Entry and display of called number

33.1.1 Definition and applicability

The entry and display of a called number is the ability of a MS to correctly display and signal to the network the user required number.

The requirements and this test apply to all MS.

33.1.2 Conformance requirement

- 1) The number of the called subscriber is included in the Called party BCD number Information element of the SETUP message for an outgoing call.

The "Display of Called number" shall be implemented in an MS where a human interface is provided.

- 2) The "Numbering plan identification" is included in the Called party BCD number Information element of the SETUP message for an outgoing call.

An MS with MMI shall as default use the Numbering Plan Identification CCITT E164, unless otherwise indicated by the user.

- 3) The "Type of number" is included in the Called party BCD number Information element of the SETUP message for an outgoing call.

An MS with MMI shall, if the "+" is not entered, and a number is entered, set the Type of Number to "unknown".

- 4) The "Type of number" is included in the Called party BCD number Information element of the SETUP message for an outgoing call.

An MS with MMI shall, if the "+" is entered, and a number is entered, set the Type of Number to "International".

33.1.3 Test purpose

- 1) To verify that an MS with human interface, in a SETUP message sent to originate a call, includes the same "Number digits" in the "Called party BCD number" of the SETUP message as displayed.
- 2) To verify that an MS with MMI, when made to establish a call sends a SETUP message, which includes the "Numbering plan identification" in the "Called party BCD number" of the SETUP message for an outgoing call with the value "ISDN/telephony numbering plan (E.164/E.163)".
- 3) To verify that an MS with MMI, when made to establish a call without use of the "+-key" function, sends a SETUP message, which includes the "Type of number" in the "Called party BCD number" of the SETUP message for an outgoing call with the value "unknown".
- 4) To verify that an MS with MMI, implementing the "+-key" function, when made to establish a call with use of the "+-key" function, sends a SETUP message, which includes the "Type of number" in the "Called party BCD number" of the SETUP message for an outgoing call with the value "international number".

33.1.4 Method of test

33.1.4.1 Initial conditions

The MS is registered in a cell of the SS.

33.1.4.2 Procedure

- a) A number (not including "+ function") is entered and then a call is set up.
- b) After the SS has accepted the call the number displayed on the MS and the number received in the SS are compared.
- c) The NPI and TON are examined in the SS.
- d) Steps a) to c) are repeated, but in a), the number entered starts with the "+ function".

NOTE 1: This test may also be performed automatically using the EMMI.

33.1.5 Test requirements

- 1) In step b), both numbers shall be identical.
- 2) In step c), the NPI shall be "E164" and the TON shall be "unknown".
- 3) In step d), the NPI shall be "E164" and the TON shall be "international".

33.2 Indication of call progress signals

33.2.1 Definition and applicability

33.2.2 Conformance requirement

33.2.3 Test purpose

33.2.4 Ringing tone

33.2.4.1 Method of test

- a) According to section "Structured procedures, Mobile originating call, early assignment, Method of test", paragraphs a) to j).

33.2.4.2 Requirements

- 1) According to section "Structured procedures, Mobile originating call, early assignment, Requirements", paragraphs 1) to 7).
- 2) The ringing tone characteristics shall be as follows:

Tone	Frequency	Tolerance	Type
Ringing tone	425 Hz	15 Hz	Periodic tone on 1 s, silence 4 s

33.2.5 Busy tone

33.2.5.1 Method of test

- a) According to section "Structured procedures, Mobile originating call, early assignment, Method of test", paragraphs a) to h).
- b) The SS then sends message DISCONNECT with cause number 17.

Message: DISCONNECT	(GSM 04.08, 9.3.7) to the MS:
<u>Information element</u>	<u>Comment</u>
Protocol discriminator	CM
Transaction identifier	MS orig.
Message type	
Cause	
- Coding standard	GSM
- Location	User
- Cause value	#17 "user busy"

33.2.5.2 Requirements

- 1) According to section "Structured procedures, Mobile originating call, early assignment, Requirements", paragraphs 1) to 5).
- 2) After the reception of DISCONNECT a busy tone shall be generated. The busy tone characteristics shall be as follows:

Tone	Frequency	Tolerance	Type
Busy tone	425 Hz	15 Hz	Periodic tone on 500 ms, silence 500 ms

33.2.6 Congestion tone

33.2.6.1 Method of test

- a) According to section "Structured procedures, Mobile originating call, early assignment, Method of test", paragraphs a) to h).
- b) The SS then sends message DISCONNECT with cause number 42.

DISCONNECT message: As in 33.2.3.1 with cause value #42 "Switching equipment congestion" (0101010).

33.2.6.2 Requirements

- 1) According to section "Structured procedures, Mobile originating call, early assignment, Requirements", paragraphs 1) to 5).

- 2) After the reception of DISCONNECT a congestion tone shall be generated.
- 3) The congestion tone characteristics shall be as follows:

Tone	Frequency	Tolerance	Type
Congestion tone	425 Hz	15 Hz	Periodic tone on 200 ms, silence 200 ms

33.2.7 Authentication failure tone

33.2.7.1 Method of test

- a) According to section "Structured procedures, Mobile originating call, early assignment, Method of test", paragraphs a) to e).
- b) After reception of message AUTHENTICATION RESPONSE the SS sends message AUTHENTICATION REJECT.

Message: AUTHENTICATION REJECT	(GSM 04.08, 9.2.1) to the MS:
<u>Information element</u>	<u>Comment</u>
Protocol discriminator	MM
Transaction identifier	not relevant
Message type	

33.2.7.2 Requirements

- 1) According to section "Structured procedures, Mobile originating call, early assignment, Requirements", paragraphs 1) to 4).
- 2) After reception of AUTHENTICATION REJECT a tone shall be generated indicating authentication failure.
- 3) The authentication failure tone is the error/special information tone with characteristics as follows:

Tone	Frequency	Tolerance	Type
Error/Special Information tone	950 Hz	50 Hz	Triple tone
	1400 Hz	50 Hz	tones on 330 ms
	1800 Hz	50 Hz	silence 1,0 s

33.2.8 Number unobtainable tone

33.2.8.1 Method of test

- a) According to section "Structured procedures, Mobile originating call, early assignment, Method of test", paragraphs a) to h).
- b) The SS then sends message DISCONNECT with cause number 1.

DISCONNECT message: As in 33.2.3.1 with cause value #1 "Unassigned (unallocated) number" (0000001).

33.2.8.2 Requirements

- 1) According to section "Structured procedures, Mobile originating call, early assignment, Requirements", paragraphs 1) to 5).
- 2) After reception of DISCONNECT a tone shall be generated indicating that the called number is unobtainable.

The number unobtainable tone is the error/special information tone with characteristics as in 33.2.7.2.

33.2.9 Call dropped tone

33.2.9.1 Method of test

- a) According to section "Structured procedures, Mobile originating call, early assignment, Method of test", paragraphs a) to l). However, it shall be indicated in the system information messages that call re-establishment shall not be attempted (RACH control parameters).
- b) When the call has been established the SS stops transmitting on the TCH/SACCH.

33.2.9.2 Requirements

- 1) According to section "Structured procedures, Mobile originating call, early assignment, Requirements", paragraphs 1) to 8).
- 2) After the radio link time-out period has expired a tone shall be generated indicating that the call has been dropped.

The call dropped tone characteristics shall be as follows:

Tone	Frequency	Tolerance	Type
Call dropped tone	425 Hz	15 Hz	Tone on 200 ms, silence 200 ms 3 bursts of on/off

33.3 Network selection / indication

33.3.1 Definition and applicability

Network selection and indication is the ability of the MS to correctly select a network and display to the user in accordance with GSM 02.11 and GSM 03.22.

The requirements and this test apply to all MS.

Tests concerning the MS behaviour after having received a location updating reject message with specific causes are included in section 26.7.4.2.

Tests concerning the MS handling of the forbidden PLMN list are also included in section 26.7.4.

33.3.2 Conformance requirement

- 1) Upon switching on, when an IMSI is available and there is no registered PLMN on the SIM, the MS shall select its Home PLMN and perform the cell selection procedure.
- 2) If the MS loses radio coverage for its registered PLMN, and the MS is in automatic PLMN selection mode, it shall attempt to select its Home PLMN.
- 3) If the Registered PLMN is unavailable due to the loss of radio coverage and the MS is in automatic PLMN selection mode and the HPLMN is also unavailable, it shall attempt to select a suitable cell and access the PLMNs in turn, in the order of priority as stored in the SIM,.
- 4) If there is no registered PLMN in the SIM or the registered PLMN is unavailable and If the Home PLMN is unavailable and the MS is in automatic PLMN selection mode, it shall attempt to select a suitable cell and accesses the PLMNs in turn, in the order of priority as stored in the SIM, upon switching on and when the IMSI is available.
- 5) An MS, roaming in a VPLMN whose MCC is the same as the MCC of the IMSI, shall periodically attempt to obtain service on its Home PLMN in automatic mode. For this purpose, a value T minutes, which is the HPLMN search period, may be stored in the SIM; T is either in the range 6 minutes to 8 hours in 6 minutes step or it indicates that no periodic attempt shall be made. If no HPLMN search value is available on the SIM the mobile equipment shall use a default value of 30 minutes.

- 6) At switch on, the MS selects and attempts to perform a Location Update on the Registered PLMN if it exists. If the registered PLMN is a VPLMN of the SIM's home country, the MS shall wait at least 2 minutes before attempting to obtain service on its home PLMN.

33.3.3 Test purpose

- 1) To verify that the MS with SIM containing in the PLMN selector field at least one PLMN different from the Home PLMN and containing no registered PLMN, when in automatic PLMN selection mode, selects its Home PLMN, if available, upon switching on and when the IMSI is available. (This is verified by observation of the location updating procedure).(Steps 1.1 through 1.5).
- 2) To verify that if the MS loses radio coverage for its registered PLMN, and the MS is in automatic PLMN selection mode, it shall attempt to select its Home PLMN. (Steps 1.14C through 1.16C).
- 3) To verify that the MS, when it loses radio coverage for its selected PLMN (i.e. Registered PLMN) and in automatic PLMN selection mode, selects the PLMN with the highest priority among the PLMNs stored on the SIM, if the Home PLMN is unavailable. (Steps 1.10 through 1.12).
- 4) If there is no registered PLMN in the SIM or the registered PLMN is unavailable and If the Home PLMN is unavailable and the MS is in automatic PLMN selection mode, it shall attempt to select a suitable cell and accesses the PLMNs in turn, in the order of priority as stored in the SIM, upon switching on and when the IMSI is available. (Steps 1.22 through 1.25).
- 5) To verify that an MS, roaming in a VPLMN whose MCC is the same as the MCC of the IMSI, shall attempt to obtain service on its Home PLMN in automatic mode with a period of T. To verify that the MS shall not attempt to obtain service on its home PLMN in automatic mode when T is set to "no periodic attempts shall be made". To verify that a default value of 30 min is used when no HPLMN search timer value is available on the SIM. (Steps 1.13 A through 1.15A, 1.13B through 1.15B and 1.13C.)
- 6) To verify that, at switch on, the MS selects and attempts to perform a Location Update on the registered PLMN if it exists. If the registered PLMN is a VPLMN of the SIM's home country, the MS shall wait at least 2 minutes before attempting to obtain service on its home PLMN. (Steps 1.25 through 1.28).

Reference

Requirements 1, 2, 3: see GSM 03.22 section 4.4.3.1.
Requirements 4: see GSM 03.22 section 3.1.
Requirement 5, 6: see GSM 03.22 section 4.4.3.3.

33.3.4 Method of Test

Procedure 1: This procedure applies to both automatic and manual mode for PLMN selection. This procedure is run for each of the following cases:

case A) Timer T is set to 6 min in the SIM.

case B) No HPLMN search timer value is available on the SIM.

case C) Timer T is set to "no periodic attempt to obtain service on the HPLMN shall be made" in the SIM.

Procedure 2: This procedure applies to the manual mode for PLMN selection.

33.3.4.1 Procedure 1

- 1.1) The MS is set up with a SIM which contains, in the "PLMN selector" data field, a list of 3 PLMN in the priority order PLMN2 (highest priority), PLMN3, PLMN4 (lowest priority). PLMN1 is the Home PLMN of the MS as defined in the IMSI. The "Forbidden PLMN" data field shall contain NULL values. "registered PLMN" data field shall contain Null values.

case A) Timer T is set to 6 min in the SIM.

case B) No HPLMN search timer value is available on the SIM.

case C) Timer T is set to "no periodic attempt to obtain service on the HPLMN shall be made" in the SIM.

1.2) The SS transmits 4 BCCH carriers with the following parameters:

	<u>PLMN</u>	<u>Level dBμVemf()</u>
Carrier 1	PLMN1 any value for MCC	28
Carrier 2	PLMN2 any value for MCC	33
Carrier 3	PLMN3 with the same MCC as PLMN1	38
Carrier 4	PLMN4 any value for MCC	43

Each carrier has the "IMSI attach" (ATT) flag set in the BCCH data. (The purpose of this is to force the MS to do location updating whenever it is switched on, so that the SS can determine which PLMN has been selected).

The other system information parameters are as in table 33-1.

- 1.3) The MS is brought into the "on" condition with automatic selection mode active.
- 1.4) The SS checks that the MS sends a "location updating request" on carrier 1.
- 1.5) The SS sends a "location updating accept" message to the MS on carrier 1. After 5 s, the MS "selected PLMN indicator" is checked.
- 1.6) The SS switches off carriers 1.
- 1.7) The SS checks that the MS sends a "location updating request" on carrier2.
- 1.8) The SS sends a "location updating accept" message to the MS on carrier 2. After 5 s, the MS "selected PLMN indicator" is checked.
- 1.9) Carrier 2 is turned off.
- 1.10) The SS checks that the MS sends a "location updating request" on carrier 3.
- 1.11) The SS sends a "location updating accept" message on carrier 3. After 5 s, the MS "selected PLMN indicator" is checked.
- 1.12) Carriers 1 and 2 are turned on with the same parameters as in step 1.2) above.

In case A for which T is set to 6 min, take branch A.

In case B for which default value for T is applied take branch B.

In case C for which T is set to "no periodic attempt shall be made", take branch C.

Branch A

- 1.13A)The SS checks that the MS does not send a "location updating request" on either carrier 1 or 2 during 6 minutes after step 1.11 is completed.
- 1.14A)The SS checks that the MS sends a "location updating request" on channel 1 between 6 and 12 min after step 1.11 is completed.
- 1.15A)The SS sends a "location updating accept" message on carrier 1. After 5 s, the MS "selected PLMN indicator" is checked.

Branch B

- 1.13B)The SS checks that the MS does not send a "location updating request" on either carrier 1 or 2 during 30 minutes after step 1.11 is completed.
- 1.14B)The SS checks that the MS sends a "location updating request" on channel 1 between 30 and 60 min after step 1.11 is completed.
- 1.15B)The SS sends a "location updating accept" message on carrier 1. After 5 s, the MS "selected PLMN indicator" is checked.

Branch C

- 1.13C) The SS checks that the MS does not send a "location updating request" on either carrier 1 or 2 during 40 min.
- 1.14C) The SS switches off carrier 3.
- 1.15C) The SS checks that the MS sends a "location updating request" on channel 1.
- 1.16C) The SS sends a "location updating accept" message on carrier 1. After 5 s, the MS "selected PLMN indicator" is checked.
- 1.17) The SS switches off carrier 1 and switches on carrier 3.
- 1.18) The SS checks that the MS sends a "location updating request" on carrier 2.
- 1.19) The SS sends a "location updating accept" message on carrier 2. After 5 s, the MS "selected PLMN indicator" is checked.
- 1.20) The mobile station is switched off.
- 1.21) The SS switches off carrier 2.
- 1.22) The mobile station is switched on.
- 1.23) The SS checks that the MS sends a "location updating request" on carrier 3.
- 1.24) The SS sends a "location updating accept" message on carrier 3. After 5 s, the MS "selected PLMN indicator" is checked.
- 1.25) The MS is switched off.
- 1.26) The SS switches on carrier 1.
- 1.27) The mobile station is switched on.
- 1.28) The SS checks that the MS does not send a "location updating request" on carrier 1. After 2 min, the MS "selected PLMN indicator" is checked.

33.3.4.2 Requirements 1

Requirement 1.1) is mandatory for all MS. Requirements 1.2) and 1.3) only apply to MS with a human interface.

- 1.1) The MS shall make a response as indicated in steps 1.4, 1.7, 1.10, 1.13A, 1.13B, 1.14A, 1.14B, 1.15C, 1.18, 1.23 above. In cases 1.4, 1.7, 1.10, 1.15C, 1.18 and 1.23, the MS shall respond within 30 s.
- 1.2) The selected PLMN shall be indicated:

End of Step	1.5	1.8	1.11	1.15A/B	1.16C
PLMN indicated:	PLMN1	PLMN2	PLMN3	PLMN1	PLMN1
End of Step	1.19	1.24	1.28		
PLMN indicated:	PLMN2	PLMN3	PLMN3		

33.3.4.3 Procedure 2

- 2a) The MS is set up with a SIM which contains NULL values in the "PLMN selector" data field. PLMN1 is the Home PLMN of the MS as defined in the IMSI. The "forbidden PLMN" data field shall contain PLMN3. the "registered PLMN" field is set to PLMN2.
- 2b) The SS transmits 4 BCCH carriers with the following parameters:

	<u>PLMN</u>	<u>Level dBμVemf()</u>
Carrier 1	PLMN1	28
Carrier 2	PLMN2	33
Carrier 3	PLMN3	38
Carrier 4	PLMN4	43

Each carrier has the "IMSI attach" (ATT) flag set in the BCCH data. (The purpose of this is to force the MS to do location updating whenever it is switched on, so that the SS can determine which PLMN has been selected.)

The other system information parameters are as in table 33-1.

2c) The MS is brought into the "on" condition with manual selection mode active.

2d) The SS checks that the MS sends a "location updating request" on carrier 2.

33.3.4.4 Requirements 2

2.1) The MS shall make a response as indicated in step 2d). The MS shall respond within 30 s.

Table 33-1: Normal system information fields

Parameter	Reference in GSM 04.08	Abbreviation	Normal setting
Cell Channel Description	10.5.2.1	-	Any values
Max retrans	10.5.2.17	-	1
Tx-integer	10.5.2.17	-	Any value
CELL_BAR_ACCESS	10.5.2.17	CBA	0 (i.e. no barred)
AC CN	10.5.2.17	AC	All 0
RE	10.5.2.17	RE	0 (i.e. re-establishment allowed)
BA ARFCN	10.5.2.13	BA	One entry equal to the ARFCN of the carrier
NCC	10.5.2.15	NCC	Any value
Cell Identity	10.5.1.1	-	Any value
MCC, MNC	10.5.1.3	PLMN	Ref. 33.3.2, 1b) and 33.3.2, 2b)
LAC	10.5.1.3	LAC	1111 (Hex)
ATT, B_AG_BLK_RES,T3212,	10.5.2.8	-	ATT = "1"
CCCH_CONF			Other parameters any values.
BS_PA_MFRMS	10.5.2.8	BPM	5 frames
Cell Options	10.5.2.3	-	Any values
CELL_RESELECT_HYSTERESIS	10.5.2.4	CRH	10 dB
MS_TXPWR_MAX_CCH	10.5.2.4	MTMC	Maximum RF output power of MS.
RXLEV_ACCESS_MIN	10.5.2.4	RAM	-95 dBm

33.4 Invalid and blocked PIN indicators

33.4.1 Definition and applicability

The requirements and this test apply to all MS.

33.4.2 Conformance requirement

33.4.3 Test purpose

33.4.4 Method of test

33.4.4.1 Initial conditions

The MS contains a SIM with the PIN enabled, and the SIM unblocking counter set to zero by previous presentation of the personal unblocking key.

33.4.4.2 Procedure

- a) The MS is switched on.
- b) Three wrong PIN are entered.

Activation may be either manual or via the EMMI.

33.4.5 Test requirements

For the first and second incorrect PIN the MS shall indicate that the PIN code has been rejected

For the third incorrect PIN the MS shall indicate that the PIN is blocked.

33.5 Service indicator

33.5.1 Definition and applicability

The requirements and this test apply to all MS.

33.5.2 Conformance requirement

33.5.3 Test purpose

33.5.4 Method of test

33.5.4.1 Initial conditions

- a) The MS is in idle mode, unregistered.
- b) The SS shall emulate perfect radio conditions so that the MS is able to register and to set up or receive a call.

33.5.4.2 Procedure

- a) The MS is brought in an active state by either switching it on or by inserting a SIM.

33.5.5 Test requirements

- 1) The successful registration and the good condition shall be indicated by the MS indicator and by the SS.

33.6 Subscription identity management

33.6.1 Definition and applicability

Subscription identity management is the ability of the MS to prevent the establishment of MO (except MO emergency calls) and MT calls without a valid subscription.

The requirements and this test apply to all MS.

33.6.2 Conformance requirement

An MS can only be operated, if a valid IMSI is present.

33.6.3 Test purpose

1) To verify that during an established call:

either

1.1) on removal of the SIM from an MS, the MS will perform an IMSI detach;

or

1.2) after removing the power source from the MS, removing the SIM, and restoring the power source to the MS, the MS may perform an IMSI detach.

2) To verify that an MS without SIM card will not establish a MO call which is not an emergency call.

3) To verify that an MS without SIM card will not accept an incoming call.

33.6.4 Method of test

33.6.4.1 Initial conditions

33.6.4.2 Procedure

a) A call is set up.

b) (Reserved).

c) Either

(i) the SIM is removed;

or

(ii) where this is not possible, the power source is removed from the MS, the SIM is removed and the power source is restored to the MS.

The SS observes whether or not the MS performs IMSI detach.

d) An attempt to establish a MO call is made (not an emergency call).

e) An attempt to establish a MT call is made.

33.6.5 Test requirements

1) Either

in step c(i), the MS shall perform an IMSI detach;

or

in step c(ii), the MS may perform an IMSI detach.

2) In step d) the MS shall not attempt to set up a new call via the Um interface.

- 3) In step e), the MS shall not respond to the attempt to set up a new call via the Um interface.

33.7 Barring of outgoing calls

33.7.1 Definition and applicability

The barring of outgoing calls is an optional feature. It is the ability of the MS to prevent all MO calls except emergency calls.

The requirements and this test apply to all MS supporting this feature.

33.7.2 Conformance requirement

An MS may have an optional facility to bar outgoing calls. Such barring facility shall not prevent the transmission on emergency calls.

33.7.3 Test purpose

To verify that an MS for which a local facility to bar outgoing calls has been declared as being implemented, is able to establish an emergency call if this facility is activated.

33.7.4 Method of test

33.7.4.1 Initial conditions

33.7.4.2 Procedure

- a) The local facility to bar outgoing calls is activated.
- b) Via MMI, the MS is actioned to establish an emergency call.

33.7.5 Test requirements

- 1) The MS shall establish an emergency call.

33.8 Prevention of unauthorized calls

33.8.1 Definition and applicability

The prevention of unauthorized calls is an optional feature in the MS. It is the ability of the MS to prevent unauthorized use by using a key or keyword protection facility. When activated the MS does not prevent the establishment of except emergency calls.

The requirements and this test apply to all MS supporting this feature.

33.8.2 Conformance requirement

An MS may have an optional facility to prevent unauthorized use. Such facility shall not prevent the transmission on emergency calls.

33.8.3 Test purpose

To verify that an MS for which a local facility to prevent unauthorized use has been declared to be implemented, is able to establish an emergency call, if this facility is activated.

33.8.4 Method of test

33.8.4.1 Initial conditions

33.8.4.2 Procedure

- a) The local facility to restrict operation such that the MS can only be operated by using a key or a keyword is activated. The most restrictive situation is created.
- b) Via MMI, the MS is actioned to establish an emergency call.

33.8.5 Test requirements

- 1) The MS shall establish an emergency call.

34 Short message service (SMS)

Ref.: GSM 03.40, GSM 04.11 (point to point)
GSM 03.41, GSM 04.12 (cell broadcast)

34.1 General

The purpose of these tests is to verify that the MS can handle GSM functions when submitting or receiving Short Messages (SM) between MS and a short message service centre as described in GSM 03.40.

The procedures are based upon services provided by the Mobility Management (MM) sublayer which is not tested in this case.

The SMS comprises three basic services. The SMS point to point services shall work in an active MS at any time independent of whether or not there is a speech or data call in progress. The SMS cell broadcast service only works when the MS is in idle mode.

Since the timer TC1M currently is not standardized, the value of TC1M shall be declared by the manufacturer (to be used in 34.2.1 and 34.2.2).

The manufacturer shall declare whether SMS messages are stored in the SIM and/or the ME. This shall be referred to as the SMS message store in the following tests.

Unless otherwise stated default message contents from section 26.6.14 applies for GSM 900 and default message contents from section 26.6.15 applies for DCS 1 800 and default message contents from section 26.6.16 applies for GSM 450 and default message contents from section 26.6.17 applies for GSM 480 and default message contents from section 26.6.18 applies for PCS 1900.

34.2 Short message service point to point

34.2.1 SMS mobile terminated

34.2.1.1 Conformance requirements

An active MS shall be able to receive short message TPDU (SMS-DELIVER) at any time, independently of whether or not there is a speech or data call in progress. A report will always be returned to the SC, confirming that the MS has received the short message.

Reference

GSM 03.40; 3.1.

34.2.1.2 Test purpose

To verify the ability of a MS to receive and decode the SMS where provided for the point to point service.

34.2.1.3 Method of test

Initial Conditions

System simulator:

1 cell, default parameters.

Mobile Station:

The MS shall be in "Idle, updated" state.

The SMS message storage shall be empty.

Related PICS/PIXIT Statements

Support for Short message MT/PP.

Description of the basic procedures to display a mobile terminated short message.

The value of timer TC1M.

Whether SMS messages are stored in the SIM and/or the ME.

Support for call control state U10.

Foreseen Final State of MS

Idle, updated.

Test Procedure

- a) The SS initiates the transmission of a short message using a paging request. Upon response of the MS to the paging the SS assigns an SDCCH, authenticates the MS and activates ciphering. Then the SS establishes SAPI 3 by sending a SABM frame with SAPI 3 on the SDCCH.

When a UA frame (SAPI 3) is received in response, the SS sends a CP-DATA message. The information element of the CP-DATA message will be RP-DATA RPDU (SMS DELIVER TPDU).

- b) The SS waits a maximum of 25 seconds for the CP-ACK message and then a maximum of 60 seconds for the CP-DATA message containing the RP-ACK RPDU.
- c) The SS sends a CP-ACK to the MS within TC1M with no further CP-DATA messages and the SS initiates channel release.
- d) Steps a), b) and c) are repeated but the first CP-DATA message from the MS is not acknowledged. The second CP-DATA message from the MS is acknowledged by a CP-ACK within a time TC1M.
- e) Steps a) and b) are repeated. The SS is configured not to send CP-ACK. Then maximum 3 CP-DATA retransmissions may occur. After a duration of TC1M + 5 seconds after the last CP-DATA retransmission the SS then initiates the channel release. The 5 seconds is the appropriate time to wait to verify that the MS does not send more than the maximum allowed (3) CP-DATA retransmissions.
- f) The SMS message store shall be cleared manually by the operator.
- g) A data or speech call is established on a TCH with the SS and the state U10 of call control is entered. The SS sends a SABM frame with SAPI-3 on the SACCH associated to the TCH.

When a UA frame (SAPI-3) is received in response, the SS sends a CP-DATA message. The information element of the CP-DATA message will be RP-DATA RPDU (SMS DELIVER TPDU). The SS waits a

maximum of 25 seconds for the CP-ACK message and then a maximum of 60 seconds for the CP-DATA message containing the RP-ACK RPDU.

- h) The SS sends a CP-ACK to the MS within TC1M with no further CP-DATA messages and the SS initiates channel release. The SMS message store shall be cleared manually by the operator.
- i) Steps g) and h) are repeated but the first CP-DATA message from the MS is not acknowledged. The second CP-DATA message from the MS is acknowledged by a CP-ACK within a time TC1M.
- j) Step g) is repeated. The SS is configured not to send CP-ACK. Then maximum 3 CP-DATA retransmissions may occur. After a duration of TC1M + 15 seconds after the last CP-DATA retransmission the SS initiates the channel release. The 15 seconds is the appropriate time to wait to verify that the MS does not send more than the maximum allowed (3) CP-DATA retransmissions (during a call in progress).
- k) A data or speech call is established on a TCH with the SS and the state U10 of call control shall be entered. The SS sends a SABM frame with SAPI-3 on the SACCH associated to the TCH. After the UA response on SAPI-3, the speech call is cleared by the SS with a disconnect message. (The call clearing is continued on the FACCH in parallel to the following exchange of messages related to SMS).

The SS sends a CP-DATA RPDU (SMS DELIVER TPDU) message. The information element of the CP-DATA message is RP-DATA.

The SS waits a maximum of 25 seconds for the CP-ACK message and then a maximum of 60 seconds for the CP-DATA message containing the RP-ACK RPDU.

The SS sends a CP-ACK to the MS within TC1M with no further CP-DATA messages and the SS initiates channel release.

The SMS message store shall be cleared manually by the operator.

- l) A data or speech call is established on a TCH with the SS and the state U10 of call control is entered. The SS sends a SABM frame with SAPI-3 on the SACCH associated to the TCH. After the UA response on SAPI-3, the speech call shall be cleared from the MS. (The call clearing is continued on the FACCH in parallel to the following exchange of messages related to SMS).

The SS sends a CP-DATA message. The information element of the CP-DATA message is RP-DATA RPDU (SMS DELIVER TPDU).

The SS waits a maximum of 25 seconds for the CP-ACK message and then a maximum of 60 seconds for the CP-DATA message containing the RP-ACK RPDU.

The SS sends a CP-ACK to the MS within TC1M with no further CP-DATA messages and the SS initiates channel release.

The SMS message store shall be cleared manually by the operator.

Maximum Duration of Test

20 minutes

Expected Sequence

Step	Direction	Message	Comments
1	SS -> MS	PAGING REQUEST	
2	MS -> SS	CHANNEL REQUEST	Establishment cause is "Answer to paging"
3	SS -> MS	IMMEDIATE ASSIGNMENT	SS assigns an SDCCH
4	MS -> SS	PAGING RESPONSE	Message is contained in SABM.
5	SS -> MS	AUTHENTICATION REQUEST	
6	MS -> SS	AUTHENTICATION RESPONSE	SRES specifies correct value.
7	SS -> MS	CIPHERING MODE COMMAND	SS starts deciphering after sending the message.
8	MS -> SS	CIPHERING MODE COMPLETE	Shall be sent enciphered. All following messages shall be sent enciphered.
9	SS		SS starts ciphering.
10	SS -> MS	SABM (SAPI=3)	SS establishes SAPI 3
11	MS -> SS	UA (SAPI=3)	MS shall respond to SABM in step 10
12	SS -> MS	CP-DATA	Contains RP-DATA RPDU (SMS DELIVER TPDU)
13	SS		Waits max 25 seconds for CP-ACK
14	MS -> SS	CP-ACK	
15	SS		Waits max 60 seconds for RP-ACK RPDU
16	MS -> SS	CP-DATA	Contains RP-ACK RPDU
17	SS -> MS	CP-ACK	
18	MS		There should be no further CP-DATA messages until the MS aborts the RR connection (disconnection of layer 2).
19	MS		The MS shall indicate that an SM has arrived. If the MS provides the functionality to display MT messages, it is checked that the correct message is displayed
20	SS -> MS	PAGING REQUEST	
21	MS -> SS	CHANNEL REQUEST	Establishment cause is "Answer to paging"
22	SS -> MS	IMMEDIATE ASSIGNMENT	SS assigns an SDCCH
23	MS -> SS	PAGING RESPONSE	Message is contained in SABM.
24	SS -> MS	AUTHENTICATION REQUEST	
25	MS -> SS	AUTHENTICATION RESPONSE	SRES specifies correct value.
26	SS -> MS	CIPHERING MODE COMMAND	SS starts deciphering after sending the message.
27	MS -> SS	CIPHERING MODE COMPLETE	Shall be sent enciphered. All following messages shall be sent enciphered.
28	SS		SS starts ciphering.
29	SS -> MS	SABM (SAPI=3)	SS establishes SAPI 3
30	MS -> SS	UA (SAPI=3)	The MS shall respond to the SABM
31	SS -> MS	CP-DATA	Contains RP-DATA RPDU (SMS DELIVER TPDU)
32	SS		Waits max 25 seconds for CP-ACK
33	MS -> SS	CP-ACK	
34	SS		Waits max 60 seconds for RP-ACK RPDU
35	MS -> SS	CP-DATA	First CP-DATA from MS, contains RP-ACK RPDU
36	SS		First CP-DATA message not acknowledged by SS
37	MS -> SS	CP-DATA	Retransmitted CP-DATA from MS within twice TC1M, after step 35, contains RP-ACK RPDU
38	SS -> MS	CP-ACK	Second CP_DATA message is acknowledged
39	MS		There should be no further CP-DATA messages until the MS aborts the RR connection (disconnection of layer 2).
40	MS		The MS shall indicate that an SM has arrived. If the MS provides the functionality to display MT messages, it is checked that the correct message is displayed
41	SS -> MS	PAGING REQUEST	
42	MS -> SS	CHANNEL REQUEST	Establishment cause is "Answer to paging"
43	SS -> MS	IMMEDIATE ASSIGNMENT	SS assigns an SDCCH
44	MS -> SS	PAGING RESPONSE	Message is contained in SABM.
45	SS -> MS	AUTHENTICATION REQUEST	
46	MS -> SS	AUTHENTICATION RESPONSE	SRES specifies correct value.
47	SS -> MS	CIPHERING MODE COMMAND	SS starts deciphering after sending the message.
48	MS -> SS	CIPHERING MODE COMPLETE	Shall be sent enciphered. All following messages shall be sent enciphered.
49	SS		SS starts ciphering.
50	SS -> MS	SABM (SAPI=3)	SS establishes SAPI 3
51	MS -> SS	UA (SAPI=3)	The MS shall respond to the SABM
52	SS -> MS	CP-DATA	Contains RP-DATA RPDU (SMS DELIVER TPDU)
53	SS		Waits max 25 seconds for CP-ACK
54	MS -> SS	CP-ACK	
55	SS		Waits max 60 seconds for RP-ACK RPDU

Step	Direction	Message	Comments
56	MS -> SS	CP-DATA	Contains RP-ACK RPDU
57	SS		First CP-DATA message not acknowledged by SS
58	MS -> SS	CP-DATA	Retransmitted CP-DATA from MS within twice TC1M after step 56, contains RP-ACK RPDU
59	SS		Retransmitted CP-DATA message not acknowledged by SS
60	MS		Depending upon the maximum number of CP-DATA retransmissions implemented, step 58 and 59 may be repeated.
61	SS -> MS	CHANNEL RELEASE	The main signalling link is released after a duration of TC1M + 5 seconds after the last CP-DATA retransmission..
62	MS		The MS shall indicate that an SM has arrived. If the MS provides the functionality to display MT messages, it is checked that the correct message is displayed
63	SS		A data or speech call is established on a TCH and the state U10 of call control is entered.
64	SS -> MS	SABM (SAPI=3)	Sent on SACCH associated with the TCH
65	MS -> SS	UA (SAPI=3)	The MS shall respond to the SABM
66	SS -> MS	CP-DATA	Contains RP-DATA RPDU (SMS DELIVER TPDU)
67	SS		Waits max 25 seconds for CP-ACK
68	MS -> SS	CP-ACK	
69	SS		Waits max 60 seconds for RP-ACK RPDU
70	MS -> SS	CP-DATA	Contains RP-ACK RPDU
71	SS -> MS	CP-ACK	
72-1	SS -> MS	DISCONNECT	Disconnect the active call
72-2	MS -> SS	RELEASE	
72-3	SS -> MS	RELEASE COMPLETE	
72-4	MS		There should be no further CP-DATA messages until the MS aborts the RR connection (disconnection of layer 2)
73	MS		The MS shall indicate that an SM has arrived. If the MS provides the functionality to display MT messages, it is checked that the correct message is displayed
74	MS		Clear the SMS message store
75	SS		A data or speech call is established on a TCH and the state U10 of call control is entered.
76	SS -> MS	SABM (SAPI=3)	Sent on SACCH associated with the TCH
77	MS -> SS	UA (SAPI=3)	The MS shall respond to the SABM
78	SS -> MS	CP-DATA	Contains RP-DATA RPDU (SMS DELIVER TPDU)
79	SS		Waits max 25 seconds for CP-ACK
80	MS -> SS	CP-ACK	
81	SS		Waits max 60 seconds for RP-ACK RPDU
82	MS -> SS	CP-DATA	First CP-DATA from MS, contains RP-ACK RPDU
83	SS		First CP-DATA message not acknowledged by SS
84	MS -> SS	CP-DATA	Retransmitted CP-DATA message within twice TC1M after step 82, contains RP-ACK RPDU
85	SS -> MS	CP-ACK	Second CP-DATA message is acknowledged
86-1	SS -> MS	DISCONNECT	Disconnect the active call
86-2	MS -> SS	RELEASE	
86-3	SS -> MS	RELEASE COMPLETE	
86-4	MS		There should be no further CP-DATA messages until the MS aborts the RR connection (disconnection of layer 2)
87	MS		The MS shall indicate that an SM has arrived. If the MS provides the functionality to display MT messages, it is checked that the correct message is displayed
88	MS		Clear the SMS message store
89	SS		A data or speech call is established on a TCH and the state U10 of call control is entered.
90	SS -> MS	SABM (SAPI=3)	Sent on SACCH associated with the TCH
91	MS -> SS	UA (SAPI=3)	The MS shall respond to the SABM
92	SS -> MS	CP-DATA	Contains RP-DATA RPDU (SMS DELIVER TPDU)
93	SS		Waits max 25 seconds for CP-ACK
94	MS -> SS	CP-ACK	
95	SS		Waits max 60 seconds for RP-ACK RPDU
96	MS -> SS	CP-DATA	First CP-DATA from MS, contains RP-ACK RPDU

Step	Direction	Message	Comments
97	SS		First CP-DATA message not acknowledged by SS
98	MS -> SS	CP-DATA	Transmitted CP-DATA message within twice TC1M after step 96, contains RP-ACK RPDU
99	SS		Retransmitted CP-DATA message not acknowledged by SS
100	MS		Depending on the maximum number of CP-DATA retransmissions implemented, step 98-99 may be repeated. The maximum number of retransmissions may however not exceed three.
101	SS -> MS	CHANNEL RELEASE	The main signalling link is released after a duration of TC1M + 15 seconds after the last CP-DATA retransmission.
102	MS		The MS shall indicate that an SM has arrived. If the MS provides the functionality to display MT messages, it is checked that the correct message is displayed
103	MS		Clear the SMS message store
104	SS		A data or speech call is established on a TCH and the state U10 of call control is entered.
105	SS -> MS	SABM (SAPI=3)	Sent on SACCH associated with the TCH
106	MS -> SS	UA (SAPI=3)	The MS shall respond to the SABM
107	SS -> MS	DISCONNECT	The speech call is cleared by the SS. The call clearing is continued on the FACCH in parallel to the following exchange of messages related to SMS.
108	SS -> MS	CP-DATA	Contains RP-DATA RPDU (SMS DELIVER TPDU)
109	SS		Waits max 25 seconds for CP-ACK
110	MS -> SS	CP-ACK	
111	SS		Waits max 60 seconds for RP-ACK RPDU
112	MS -> SS	CP-DATA	Contains RP-ACK RPDU
113	SS -> MS	CP-ACK	
114	MS		There should be no further CP-DATA messages until the MS aborts the RR connection (disconnection of layer 2).
115	MS		The MS shall indicate that an SM has arrived. If the MS provides the functionality to display MT messages, it is checked that the correct message is displayed
116	MS		Clear the SMS message store
117	SS		A data or speech call is established on a TCH and the state U10 of call control is entered.
118	SS -> MS	SABM (SAPI=3)	Sent on SACCH associated with the TCH
119	MS -> SS	UA (SAPI=3)	The MS shall respond to the SABM
120	MS -> SS	DISCONNECT	The speech call is cleared from the MS.
121	SS -> MS	CP-DATA	Contains RP-DATA RPDU (SMS DELIVER TPDU)
122	SS -> MS	RELEASE	This message is likely to be sent on the FACCH before all of the CP-DATA message has been sent on the SACCH.
123	MS -> SS	RELEASE COMPLETE	
124	MS -> SS	CP-ACK	shall be sent before 25 seconds after the start of step 121
125	SS		Waits max 60 seconds for RP-ACK RPDU
126	MS -> SS	CP-DATA	Contains RP-ACK RPDU
127	SS -> MS	CP-ACK	
128	MS		There should be no further CP-DATA messages until the MS aborts the RR connection (disconnection of layer 2).
129	MS		The MS shall indicate that an SM has arrived. If the MS provides the functionality to display MT messages, it is checked that the correct message is displayed
130	MS		Clear the SMS message store

NOTE: Time values for SS wait time are chosen sufficiently high to be sure that the MS has enough time to respond to the different messages.

Specific Message Contents:

SMS DELIVER TPDU

Information element	Comment Value
TP-MTI	SMS DELIVER "00"B
TP-MMS	more messages are waiting in SC "0"B
TP-RP	no reply path "0"B
TP-UDHI	TP-UD contains only the SM"0"B
TP-SRI	no status report returned"0"B
TP-OA	an international number coded E.164
TP-PID	default "00000000"B
TP-DCS	default alphabet "00000000"B
TP-SCTS	any legal value (cf. GSM 03.40)
TP-UDL	160
TP-UD (140 octets)	text of message (160 characters)

NOTE: The 160 characters shall include at least one occurrence of each character in the default alphabet (see GSM 03.40 annex 2).

34.2.2 SMS mobile originated

34.2.2.1 Conformance requirements

An active MS shall be able to submit short message TPDU (SMS-SUBMIT) at any time, independently of whether or not there is a speech or data call in progress.

Reference

GSM 03.40; 3.1.

34.2.2.2 Test purpose

To verify that the MS is able to correctly send a short message where the SMS is provided for the point to point service. The test also verifies that the MS is capable of simultaneously receive a network originated SM whilst sending a mobile originated SM.

34.2.2.3 Method of test

Initial Conditions

System simulator:

1 cell, default parameters.

Mobile Station:

The MS shall be in "Idle, updated" state.
The SMS message storage shall be empty.

Related PICS/PIXIT Statements

Support for Short message MO/PP.

Description of the basic procedures to display a mobile originated short message.

Support for state U10 of call control.

The value of timer TC1M.

Whether SMS messages are stored in the SIM and/or the ME.

Maximum length (characters) of a mobile originated short message.

Foreseen Final State of MS

Idle, updated.

Test Procedure

- a) The MS shall be set up to send a SM to the SS. The SS responds to the channel request message by allocating an SDCCH. The SS answers correctly to the SABM on SAPI 0 and then performs the authentication and ciphering procedures.
- b) The SS responds with a UA frame SAPI-3 to the MS.
- c) The SS responds to the CP-DATA containing RP-DATA RPDU (SMS SUBMIT TPDU) from the MS with a CP-ACK message within TC1M followed by a CP-DATA message containing the correct RP-ACK RPDU. The SS waits a maximum of 25 seconds for the CP-ACK message.
- d) The SS sends a channel release message to the MS.
- e) Steps a) and b) are repeated. The SS is configured not to send the CP-ACK message. Then maximum 3 CP-DATA retransmissions may occur. After a duration of TC1M + 5 seconds after the last CP-DATA retransmission the SS initiates channel release. The 5 seconds is the appropriate time to wait to verify that the MS does not send more than the maximum CP-DATA retransmissions.
- f) Steps a) and b) are repeated. On receipt of the CP-DATA from the MS the SS sends a CP-ERROR message within TC1M containing a "Network Failure" cause. Then the SS initiates channel release.
- g) A data or speech call is established on a TCH with the SS and the state U10 of call control is entered. The MS is setup to send an SM to the SS. After the reception of the CM SERVICE REQUEST, the SS sends a CM SERVICE ACCEPT message. The SS responds with a UA frame SAPI-3 to the SABM with SAPI-3 received from the MS.
- h) The SS responds to the CP-DATA containing RP-DATA RPDU (SMS SUBMIT TPDU) from the MS with a CP-ACK message within TC1M followed by a CP-DATA message containing the correct RP-ACK RPDU. The SS waits a maximum of 25 seconds for the CP-ACK message. Then the SS sends a channel release message to the MS.
- i) Step g) is repeated. The SS is configured not to send the CP-ACK message. Then maximum 3 CP-DATA retransmissions may occur. After a duration of TC1M + 15 seconds after the last CP-DATA retransmission the SS initiates channel release. The 15 seconds is the appropriate time to wait to verify that the MS does not send more than the maximum CP-DATA retransmissions (during a call in progress).
- j) The SS is configured to receive a mobile originated SM. Steps a) and b) are repeated and, using the end of the CP-DATA message from the MS as a trigger, the SS sends a SM to the MS. In this case a new transaction identifier shall be used in the CP messages of SMS mobile terminated.
- k) The MS is set up to send an SM to the SS. On receipt of the CM SERVICE REQUEST the SS sends a CM SERVICE REJECT message with the reject cause set to "Service Option not supported" or "Service Option temporarily out of order". After 5 seconds the SS initiates channel release.

Maximum Duration of Test

20 minutes

Expected Sequence

Step	Direction	Message	Comments
1	MS -> SS	CHANNEL REQUEST	Establishment cause is "Other procedures which can be completed with an SDDCH" NECI = 0
2	SS -> MS	IMMEDIATE ASSIGNMENT	SS assigns an SDCCH
3	MS -> SS	CM SERVICE REQUEST	Message is contained in SABM on SAPI 0. CM service type set to "Short message transfer"
4	SS -> MS	AUTHENTICATION REQUEST	
5	MS -> SS	AUTHENTICATION RESPONSE	SRES specifies correct value.
6	SS -> MS	CIPHERING MODE COMMAND	SS starts deciphering after sending the message.
7	MS -> SS	CIPHERING MODE COMPLETE	Shall be sent enciphered. All following messages shall be sent enciphered.
8	SS		SS starts ciphering.
9	MS -> SS	SABM (SAPI=3)	MS establishes SAPI 3
10	SS -> MS	UA (SAPI=3)	
11	MS -> SS	CP-DATA	Contains RP-DATA RPDU (SMS SUBMIT TPDU)
12	SS -> MS	CP-ACK	Sent within TC1M after step 11
13	SS -> MS	CP-DATA	Contains RP-ACK RPDU
14	SS		Waits max 25 seconds for CP-ACK
15	MS -> SS	CP-ACK	
16	SS -> MS	CHANNEL RELEASE	The main signalling link is released.
17	MS -> SS	DISC (SAPI=0)	MS shall respond to channel release with a layer 2 DISC frame with SAPI 0
18	MS -> SS	CHANNEL REQUEST	Establishment cause is "Other procedures which can be completed with an SDDCH" (NECI=0)
19	SS -> MS	IMMEDIATE ASSIGNMENT	SS assigns an SDCCH
20	MS -> SS	CM SERVICE REQUEST	Message is contained in SABM on SAPI 0.
21	SS -> MS	AUTHENTICATION REQUEST	
22	MS -> SS	AUTHENTICATION RESPONSE	SRES specifies correct value.
23	SS -> MS	CIPHERING MODE COMMAND	SS starts deciphering after sending the message.
24	MS -> SS	CIPHERING MODE COMPLETE	Shall be sent enciphered. All following messages shall be sent enciphered.
25	SS		SS starts ciphering.
26	MS -> SS	SABM (SAPI=3)	MS establishes SAPI 3
27	SS -> MS	UA (SAPI=3)	
28	MS -> SS	CP-DATA	Contains RP-DATA RPDU (SMS SUBMIT TPDU)
29	SS		SS configured not to send CP-ACK
30	MS -> SS	CP-DATA	Retransmitted CP-DATA message within twice TC1M after step 28
31	MS		Depending on the maximum number of CP-DATA retransmissions implemented, step 30 may be repeated. The maximum number of retransmissions may however not exceed three.
32	SS -> MS	CHANNEL RELEASE	The main signalling link is released after a duration of TC1M + 5 seconds after the last CP-DATA retransmission.
32a	MS -> SS	DISC (SAPI = 0)	MS shall respond to channel release with a layer 2 DISC frame with SAPI 0.
33	MS -> SS	CHANNEL REQUEST	Establishment cause is "Other procedures which can be completed with an SDDCH" (NECI=0)
34	SS -> MS	IMMEDIATE ASSIGNMENT	SS assigns an SDCCH
35	MS -> SS	CM SERVICE REQUEST	Message is contained in SABM. CM service type set to "short message transfer"
36	SS -> MS	AUTHENTICATION REQUEST	
37	MS -> SS	AUTHENTICATION RESPONSE	SRES specifies correct value.
38	SS -> MS	CIPHERING MODE COMMAND	SS starts deciphering after sending the message.
39	MS -> SS	CIPHERING MODE COMPLETE	Shall be sent enciphered. All following messages shall be sent enciphered.
40	SS		SS starts ciphering.
41	MS -> SS	SABM (SAPI=3)	MS establishes SAPI 3
42	SS -> MS	UA (SAPI=3)	
43	MS -> SS	CP-DATA	Contains RP-DATA RPDU (SMS SUBMIT TPDU)
44	SS -> MS	CP-ERROR	Sent within TC1M containing "Network Failure" cause.
45	SS -> MS	CHANNEL RELEASE	The main signalling link is released.
45a	MS -> SS	DISC (SAPI = 0)	MS shall respond to channel release with a layer 2 DISC frame with SAPI 0.

Step	Direction	Message	Comments
46	SS		A data or speech call is established on a TCH and the state U10 of call control is entered.
47	MS		The MS is set up to send an SM
48	MS -> SS	CM SERVICE REQUEST	Sent in a layer 2 frame on the FACCH. CM service type set to "short message transfer"
49	SS -> MS	CM SERVICE ACCEPT	
50	MS -> SS	SABM (SAPI=3)	Sent on SACCH associated with the TCH
51	SS -> MS	UA (SAPI=3)	
52	MS -> SS	CP-DATA	Contains RP-DATA RPDU (SMS SUBMIT TPDU)
53	SS -> MS	CP-ACK	Sent within TC1M after step 52
54	SS -> MS	CP-DATA	Contains RP-ACK RPDU
55	SS		Waits max 25 seconds for CP-ACK
56	MS -> SS	CP-ACK	
57	SS -> MS	CHANNEL RELEASE	The main signalling link is released.
58	MS -> SS	DISC (SAPI =0)	The MS shall respond to channel release with a layer 2 DISC frame with SAPI 0.
59	SS		A data or speech call is established on a TCH and the state U10 of call control is entered.
60	MS -> SS	CM SERVICE REQUEST	Sent in a layer 2 frame on the FACCH. CM service type set to "short message transfer"
61	SS -> MS	CM SERVICE ACCEPT	
62	MS -> SS	SABM (SAPI=3)	Sent on SACCH associated with the TCH
63	SS -> MS	UA (SAPI=3)	
64	MS -> SS	CP-DATA	Contains RP-DATA RPDU (SMS SUBMIT TPDU)
65	SS		SS configured not to send CP-ACK
66	MS -> SS	CP-DATA	Transmitted CP-DATA message within twice TC1M after step 64
67	MS		Depending on the maximum number of CP-DATA retransmissions implemented, step 66 may be repeated. The maximum number of retransmissions may however not exceed three.
68	SS -> MS	CHANNEL RELEASE	The main signalling link is released after a duration of TC1m + 15 seconds after the last CP-DATA retransmission.
69	MS -> SS	DISC (SAPI =0)	The MS shall respond to channel release
70	MS -> SS	CHANNEL REQUEST	Establishment cause is "Other procedures which can be completed with an SDDCH" (NECI=0)
71	SS -> MS	IMMEDIATE ASSIGNMENT	SS assigns an SDCCH
72	MS -> SS	CM SERVICE REQUEST	Message is contained in SABM. CM service type set to "short message transfer"
73	SS -> MS	AUTHENTICATION REQUEST	
74	MS -> SS	AUTHENTICATION RESPONSE	SRES specifies correct value.
75	SS -> MS	CIPHERING MODE COMMAND	SS starts deciphering after sending the message.
76	MS -> SS	CIPHERING MODE COMPLETE	Shall be sent enciphered. All following messages shall be sent enciphered.
77	SS		SS starts ciphering.
78	MS -> SS	SABM (SAPI=3)	MS establishes SAPI 3
79	SS -> MS	UA (SAPI=3)	
80	MS -> SS	CP-DATA	Contains RP-DATA RPDU (SMS SUBMIT TPDU)
81	SS		The SS sends an SM to the MS triggered by the end of the CP-DATA message from the MS
82	SS -> MS	CP-DATA	Contains RP-DATA RPDU (SMS DELIVER TPDU)
83	MS		The MS shall correctly receive the SM and indicate that a message has arrived. If the MS provides the functionality to display MT messages, it is checked that the correct message is displayed. In the MO case the MS shall send the CP-ACK message with transaction identifier assigned to this transfer. In the MT case the MS shall send a CP-ACK message and a CP-DATA message containing the RP-ACK RPDU. The transaction identifier shall be the same as chosen by the SS for the MT transfer.
84	MS -> SS	CHANNEL REQUEST	Establishment cause is "Other procedures which can be completed with an SDDCH" (NECI=0)
85	SS -> MS	IMMEDIATE ASSIGNMENT	SS assigns an SDCCH
86	MS -> SS	CM SERVICE REQUEST	Message is contained in SABM. CM service type set to "short message transfer"

Step	Direction	Message	Comments
87	SS -> MS	CM SERVICE REJ	Reject cause set to "Service Option not supported" or "Service Option temporarily out of order"
88	MS		
89	SS -> MS	CHANNEL RELEASE	Sent 5 seconds after CM SERVICE REJ

NOTE: Time values for SS wait times are chosen sufficiently high to be sure that the MS has enough time to respond to the different messages.

Specific Message Contents:

SMS SUBMIT TPDU

Information element	Comment Value
TP-MTI	SMS SUBMIT"01"B
TP-VPF	not checked
TP-RP	no reply path "0"B
TP-UDHI	not checked
TP-SRR	not checked
TP-MR	not checked
TP-RD	not checked
TP-DA	not checked (an E164 number)
TP-PID	default "00000000"B
TP-DCS	default alphabet "00000000"B
TP-VP	not checked
TP-UDL	as applicable
TP-UD (140 octets max)	maximum number of characters (text of message) as defined by the manufacturer (see PICS/PIXIT)

34.2.3 Test of memory full condition and memory available notification:

The Memory Available Notification provides a means for the MS to notify the network that it has memory available to receive one or more short messages. The SMS status field in the SIM contains status information on the "memory available" notification flag.

34.2.3.1 Conformance requirement

1. When a mobile terminated message is Class 2, the MS shall ensure that the message has been transferred to the SMS data field in the SIM before sending an acknowledgement to the SC. The MS shall return a protocol error message if the short message cannot be stored in the SIM and there is other short message storage available in the MS. If all the short message storage in the MS is already in use, the MS shall return "memory capability exceeded".
2. When the MS rejects a short message due to lack of available memory capability the need to transfer notification shall be stored in the SIM.
3. If the memory capability becomes available because memory is cleared, the value of the memory capability exceeded notification flag in the SIM is read. If the flag is set, the MS notifies the network that memory capability is now available. After a positive acknowledgement from the network, the ME unsets the memory capability exceeded notification flag in the SIM.

References

GSM 03.40, 9.2.3.10, GSM 03.38, 4.

GSM 03.40, 10.3 (operation 14).

GSM 03.40, 10.3 (operation 14).

34.2.3.2 Test purpose

1. To verify that the MS sends the correct acknowledgement when its memory in the SIM becomes full.

2. To verify that the MS sends the correct acknowledgement when its memory in the ME and the SIM becomes full, and sets the "memory exceeded" notification flag in the SIM.
3. To verify that the MS performs the "memory available" procedure when its message store becomes available for receiving short messages, and only at this moment.

34.2.3.3 Method of test

Initial conditions

System Simulator:

1 cell, default parameters

Mobile Station:

The MS shall be in the idle updated state.

The SMS message storage shall be empty.

The MS shall be connected to the SIM simulator. The following shall be present in the SIM simulator:

- EF_{SMS} with at least one record;
- EF_{SMSstatus}, with SMS "Memory Cap. Exceed" notification flag set to "memory available";
- Service no. 4 (SMS) in EF_{SST} set to allocated and activated.

For storing of Class 1 Short Messages the MS shall be set up to store Short Messages in the ME memory (by way of MMI, as described in PICS/PIXIT statement).

Related PICS/PIXIT Statements

Support for Short message MT/PP.

Description of the basic procedures to display a mobile terminated short message.

Whether SMS messages are stored in the SIM and/or the ME.

The value of timer TC1M.

Foreseen Final State of MS

Idle, updated.

Test Procedure

- a) step a) of 34.2.5.3 (test of Class 2 Short Messages) is repeated until the MS sends a negative acknowledgement (RP-ERROR). The SIM simulator shall indicate if the "memory capability exceeded" notification flag has been set on the SIM.
- b) a Class 1 Short Message is sent to the MS.
- c) step b) is repeated until the MS sends a negative acknowledgement (RP-ERROR). The SIM simulator shall indicate if the "memory capability exceeded" notification flag has been set on the SIM.
- d) a Short Message is sent to the MS with the DCS field of the SMS-DELIVER TPDU set to 0.
- e) the SS prompts the operator to read a short message and to remove it from the message store of the MS.
- f) the SS waits for a CHANNEL REQUEST from the MS, and sends an IMMEDIATE ASSIGNMENT allocating an SDCCH.
- g) the SS answers correctly to the SABM on SAPI 0.

- h) the SS answers correctly to the SABM on SAPI 3.
- i) the SS answers to the RP-SMMA from the MS with a CP-DATA containing a RP-ACK RPDU.
- j) after the MS has acknowledged the CP-DATA with a CP-ACK, the SS releases the channel with a CHANNEL RELEASE message. The SIM simulator shall indicate if the "memory capability exceeded" notification flag has been unset on the SIM.
- k) step e) is repeated.

Maximum Duration of Test

-

Expected Sequence

Step	Direction	Message	Comments
1	SS -> MS	PAGING REQUEST	
2	MS -> SS	CHANNEL REQUEST	Establishment cause is "Answer to paging"
3	SS -> MS	IMMEDIATE ASSIGNMENT	SS assigns an SDCCH
4	MS -> SS	PAGING RESPONSE	Message is contained in SABM.
5	SS -> MS	AUTHENTICATION REQUEST	
6	MS -> SS	AUTHENTICATION RESPONSE	SRES specifies correct value.
7	SS -> MS	CIPHERING MODE COMMAND	SS starts deciphering after sending the message.
8	MS -> SS	CIPHERING MODE COMPLETE	Shall be sent enciphered. All following messages shall be sent enciphered.
9	SS		SS starts ciphering.
10	SS -> MS	SABM (SAPI=3)	SS establishes SAPI 3
11	MS -> SS	UA (SAPI=3)	
12	SS -> MS	CP-DATA	Contains RP-DATA RPDU (SMS DELIVER TPDU), Class 2 Short Message
13	SS		Waits max 25 seconds for CP-ACK
14	MS -> SS	CP-ACK	
15	SS		Waits max 60 seconds for RP-ACK RPDU
16	MS -> SS	CP-DATA	Contains RP-ACK RPDU
17	SS -> MS	CP-ACK	Within TC1M after step 16
18	SS -> MS	CHANNEL RELEASE	The main signalling link is released. Step 1-18 is repeated until MS sends a negative acknowledgement (RP-ERROR) in step 16. The RP-ERROR RPDU cause field shall be "Protocol error, unspecified" if there is message capability in the ME, or "Memory capability exceeded" if there is no message capability in the ME. If the total memory store of the MS is full, the ME shall set the "memory capability exceeded" notification flag on the SIM.
19	SS -> MS	PAGING REQUEST	
20	MS -> SS	CHANNEL REQUEST	Establishment cause is "Answer to paging"
21	SS -> MS	IMMEDIATE ASSIGNMENT	SS assigns an SDCCH
22	MS -> SS	PAGING RESPONSE	Message is contained in SABM.
23	SS -> MS	AUTHENTICATION REQUEST	
24	MS -> SS	AUTHENTICATION RESPONSE	SRES specifies correct value.
25	SS -> MS	CIPHERING MODE COMMAND	SS starts deciphering after sending the message.
26	MS -> SS	CIPHERING MODE COMPLETE	Shall be sent enciphered. All following messages shall be sent enciphered.
27	SS		SS starts ciphering.
28	SS -> MS	SABM (SAPI=3)	SS establishes SAPI 3
29	MS -> SS	UA (SAPI=3)	
30	SS -> MS	CP-DATA	Contains RP-DATA RPDU (SMS DELIVER TPDU), Class 1 Short Message
31	SS		Waits max 25 seconds for CP-ACK
32	MS -> SS	CP-ACK	
33	SS		Waits max 60 seconds for RP-ACK RPDU

Step	Direction	Message	Comments
34	MS -> SS	CP-DATA	Shall contain RP-ACK RPDU if there is memory capability in the ME. If not it shall contain RP-ERROR RPDU which cause field shall be "memory capability exceeded". If the total memory store of the MS now becomes full at this step, the ME shall set the "memory cap. exceed" notification flag on the SIM.
35	SS -> MS	CP-ACK	Within TC1M after step 34
36	SS -> MS	CHANNEL RELEASE	The main signalling link is released. Step 19-36 is repeated until the MS sends an RP-ERROR. The SIM simulator shall indicate if the "memory capability exceeded" notification flag has been set on the SIM.
37	SS -> MS	PAGING REQUEST	
38	MS -> SS	CHANNEL REQUEST	Establishment cause is "Answer to paging"
39	SS -> MS	IMMEDIATE ASSIGNMENT	SS assigns an SDCCH
40	MS -> SS	PAGING RESPONSE	Message is contained in SABM.
41	SS -> MS	AUTHENTICATION REQUEST	
42	MS -> SS	AUTHENTICATION RESPONSE	SRES specifies correct value.
43	SS -> MS	CIPHERING MODE COMMAND	SS starts deciphering after sending the message.
44	MS -> SS	CIPHERING MODE COMPLETE	Shall be sent enciphered. All following messages shall be sent enciphered.
45	SS		SS starts ciphering.
46	SS -> MS	SABM (SAPI=3)	SS establishes SAPI 3
47	MS -> SS	UA (SAPI=3)	
48	SS -> MS	CP-DATA	Contains RP-DATA RPDU (SMS DELIVER TPDU) with TP-DCS set to 0
49	SS		Waits max 25 seconds for CP-ACK
50	MS -> SS	CP-ACK	
51	SS		Waits max 60 seconds for RP-ACK RPDU
52	MS -> SS	CP-DATA	Shall contain RP-ERROR RPDU with error cause "memory capability exceeded".
53	SS -> MS	CP-ACK	Within TC1M after step 52
54	SS -> MS	CHANNEL RELEASE	The main signalling link is released.
55	SS		Prompts the operator to remove one of the short messages from the message store of the MS.
57	MS -> SS	CHANNEL REQUEST	Establishment cause "Other services which can be completed with an SDCCH" (NECI=0).
58	SS -> MS	IMMEDIATE ASSIGNMENT	SS allocates an SDCCH
59	MS -> SS	CM SERVICE REQUEST	Message is contained in SABM. CM service type information element is set to "Short message transfer".
60	SS -> MS	CM SERVICE ACCEPT (UA)	SAPI 0
61	MS -> SS	SABM (SAPI=3)	MS shall establish SAPI 3
62	SS -> MS	UA (SAPI=3)	
63	MS -> SS	CP-DATA	Contains RP-SMMA RPDU
64	SS -> MS	CP-ACK	
65	SS -> MS	CP-DATA	Contains RP-ACK RPDU
66	MS -> SS	CP-ACK	Acknowledge of CP-DATA containing the RP-ACK RPDU. The ME shall unset the "memory capability exceeded" notification flag on the SIM.
67	SS -> MS	CHANNEL RELEASE	The main signalling link is released. The SIM simulator shall indicate if the "memory capability exceeded" notification flag has been unset on the SIM.
68	SS		Prompts the operator to remove one of the short messages from the message store of the MS.
69	MS		Shall not attempt to send a RP-SMMA RPDU. This is verified by checking that the MS does not send a CHANNEL REQUEST message with the establishment cause "Other services which can be completed with an SDCCH"

NOTE: Time values for SS wait time are chosen sufficiently high to be sure that the MS has enough time to respond to the different messages.

Specific Message Contents:

SMS-DELIVER TPDU in step 12

Information element	Comment Value
TP-MTI	SMS DELIVER "00"B
TP-MMS	more messages are waiting in SC "0"B
TP-RP	no reply path "0"B
TP-UDHI	TP-UD contains only the SM"0"B
TP-SRI	no status report returned"0"B
TP-OA	an international number coded E.164
TP-PID	default "00000000"B
TP-DCS	default alphabet, class 2 "11110010"B
TP-SCTS	any legal value (cf. GSM 03.40)
TP-UDL	160
TP-UD (140 octets)	text of message (160 characters)

SMS-DELIVER TPDU in step 30

same as in step 12 except:

TP-DCS	default alphabet, class 1 "11110001"B
--------	---------------------------------------

SMS-DELIVER TPDU in step 48

same as in step 12 except:

TP-DCS	default alphabet "00000000"B
--------	------------------------------

34.2.4 Test of the status report capabilities and of SMS-COMMAND:

This test applies to MSs which support the status report capabilities.

34.2.4.1 Conformance requirement

The SMS offers the SC the capabilities of informing the MS of the status of a previously sent mobile originated short message. This is achieved by the SC returning a status report TPDU (SMS-STATUS-REPORT) to the originating MS.

SMS-COMMAND enables an MS to invoke an operation at the SC.

The MS shall increment TP-MR by 1 for each SMS-SUBMIT or SMS-COMMAND being submitted.

References

GSM 03.40; 3.2.9.

GSM 03.40; 9.2.3.6.

34.2.4.2 Test purpose

- 1) To verify that the MS is able to accept a SMS-STATUS-REPORT TPDU.
- 2) To verify that the MS is able to use the SMS-COMMAND functionality correctly and sends an SMS-COMMAND TPDU with the correct TP-Message-Reference.

34.2.4.3 Method of test

Initial conditions

System Simulator:

1 cell, default parameters.

Mobile Station:

The MS shall be in the idle updated state.

Related PICS/PIXIT Statements

Support of SMS MO/PP and MT/PP.

Foreseen Final State of MS

Idle, updated.

Test Procedure

- a) The MS is made to send a Mobile Originated short message as in steps a) to d) of test 34.2.2 (SMS Mobile originated).
- b) The SS establishes a data link on SAPI-3 with the MS, then sends a CP-DATA message containing a RP-DATA RPDU itself containing an SMS-STATUS-REPORT TPDU.
- c) The SS sends a CHANNEL RELEASE message.
- d) The MS is made to send an SMS-COMMAND message enquiring about the previously submitted short message.
- e) The SS responds to the MS so as to enable it to establish a data link on SAPI-3 on an SDCCH.
- f) The SS acknowledges the CP-DATA message from the MS with a CP-ACK followed by a CP-DATA message containing an RP-ACK RPDU
- g) After receiving the CP-ACK from the MS, the SS releases the channel by using a CHANNEL RELEASE message.
- h) The MS is made to send an SMS-COMMAND message requiring to delete the previously submitted short message.
- i) steps e) to g) are repeated.

Maximum Duration of Test

-

Expected Sequence

Step	Direction	Message	Comments
1	MS -> SS	CHANNEL REQUEST	Establishment cause is "Other procedures which can be completed with an SDCCH " (NECI=0)
2	SS -> MS	IMMEDIATE ASSIGNMENT	SS assigns an SDCCH
3	MS -> SS	CM SERVICE REQUEST	Message is contained in SABM.
4	SS -> MS	AUTHENTICATION REQUEST	
5	MS -> SS	AUTHENTICATION RESPONSE	SRES specifies correct value.
6	SS -> MS	CIPHERING MODE COMMAND	SS starts deciphering after sending the message.
7	MS -> SS	CIPHERING MODE COMPLETE	Shall be sent enciphered. All following messages shall be sent enciphered.
8	SS		SS starts ciphering.
9	MS -> SS	SABM (SAPI=3)	MS establishes SAPI 3
10	SS -> MS	UA (SAPI=3)	
11	MS -> SS	CP-DATA	Contains RP-DATA RPDU (SMS SUBMIT TPDU)
12	SS -> MS	CP-ACK	Sent within TC1M after step 11
13	SS -> MS	CP-DATA	Contains RP-ACK RPDU
14	SS		Waits max 25 seconds for CP-ACK
15	MS -> SS	CP-ACK	
16	SS -> MS	CHANNEL RELEASE	The main signalling link is released.
17	SS -> MS	PAGING REQUEST	
18	MS -> SS	CHANNEL REQUEST	Establishment cause is "Answer to paging"
19	SS -> MS	IMMEDIATE ASSIGNMENT	SS assigns an SDCCH
20	MS -> SS	PAGING RESPONSE	Message is contained in SABM.
22	SS -> MS	AUTHENTICATION REQUEST	
23	MS -> SS	AUTHENTICATION RESPONSE	SRES specifies correct value.
24	SS -> MS	CIPHERING MODE COMMAND	SS starts deciphering after sending the message.
25	MS -> SS	CIPHERING MODE COMPLETE	Shall be sent enciphered. All following messages shall be sent enciphered.
26	SS		SS starts ciphering.
27	SS -> MS	SABM (SAPI=3)	SS establishes SAPI 3
28	MS -> SS	UA (SAPI=3)	
29	SS -> MS	CP-DATA	Contains RP-DATA RPDU (SMS-STATUS-REPORT TPDU)
30	MS -> SS	CP-ACK	
31	MS -> SS	CP-DATA	Contains RP-ACK RPDU
32	SS -> MS	CP-ACK	
33	SS -> MS	CHANNEL RELEASE	
34	MS		The MS is made to send an SMS-COMMAND message enquiring about the previously submitted SM
35	MS -> SS	CHANNEL REQUEST	Establishment cause "Other services which can be completed with an SDCCH".
36	SS -> MS	IMMEDIATE ASSIGNMENT	SS assigns an SDCCH
37	MS -> SS	CM SERVICE REQUEST	Message is contained in SABM.
38	SS -> MS	AUTHENTICATION REQUEST	
39	MS -> SS	AUTHENTICATION RESPONSE	SRES specifies correct value.
40	SS -> MS	CIPHERING MODE COMMAND	SS starts deciphering after sending the message.
41	MS -> SS	CIPHERING MODE COMPLETE	Shall be sent enciphered. All following messages shall be sent enciphered.
42	SS		SS starts ciphering.
43	MS -> SS	SABM (SAPI=3)	MS establishes SAPI 3
44	SS -> MS	UA (SAPI=3)	
45	MS -> SS	CP-DATA	Contains RP-DATA RPDU (SMS-COMMAND TPDU) which shall contain the correct TP-MR
46	SS -> MS	CP-ACK	
47	SS -> MS	CP-DATA	Contains RP-ACK RPDU
48	MS -> SS	CP-ACK	
49	SS -> MS	CHANNEL RELEASE	
50	MS	The MS is made to send an SMS-COMMAND	message requiring to delete the previously submitted SM.
51	MS -> SS	CHANNEL REQUEST	Establishment cause "Other services which can be completed with an SDCCH".
52	SS -> MS	IMMEDIATE ASSIGNMENT	SS assigns an SDCCH
53	MS -> SS	CM SERVICE REQUEST	Message is contained in SABM.
54	SS -> MS	AUTHENTICATION REQUEST	
55	MS -> SS	AUTHENTICATION RESPONSE	SRES specifies correct value.
56	SS -> MS	CIPHERING MODE COMMAND	SS starts deciphering after sending the message.

Step	Direction	Message	Comments
57	MS -> SS	CIPHERING MODE COMPLETE	Shall be sent enciphered. All following messages shall be sent enciphered. SS starts ciphering.
58	SS		
59	MS -> SS	SABM (SAPI=3)	MS establishes SAPI 3
60	SS -> MS	UA (SAPI=3)	
61	MS -> SS	CP-DATA	Contains RP-DATA RPDU (SMS-COMMAND TPDU) which shall contain the correct TP-MR
62	SS -> MS	CP-ACK	
63	SS -> MS	CP-DATA	Contains RP-ACK RPDU
64	MS -> SS	CP-ACK	
65	SS -> MS	CHANNEL RELEASE	

Specific Message Contents:

SMS SUBMIT TPDU

Information element	Comment Value
TP-MTI	SMS SUBMIT"01"B
TP-VPF	not checked
TP-RP	no reply path "0"B
TP-UDHI	not checked
TP-SRR	status report is requested "1"B
TP-MR	not checked
TP-RD	not checked
TP-DA	not checked (an E164 number)
TP-PID	default "00000000"B
TP-DCS	default alphabet "00000000"B
TP-VP	not checked
TP-UDL	as applicable
TP-UD (140 octets max)	maximum number of characters

SMS-STATUS-REPORT TPDU (SS to MS in step 29):

Information element	Comment Value
TP-MTI	SMS-STATUS-REPORT"10"B
TP-MR	same as previous SMS-SUBMIT
TP-MMS	no more messages "1"B
TP-SRQ	result of SMS-SUBMIT "0"B
TP-RA	same as the Destination address of the SMS-SUBMIT
TP-SCTS	any legal value (cf. GSM 03.40)
TP-DT	any legal value (cf. GSM 03.40)
TP-ST	SM received "00000000"B

first SMS-COMMAND TPDU (MS to SS in step 44)

Information element	Comment Value
TP-MTI	SMS-COMMAND "10"B
TP-MR	TP-MR in previous SMS-SUBMIT plus "1"
TP-SRR	status report requested (GSM 03.40 9.2.3.19)"1"B
TP-PID	default "00000000"B
TP-CT	Enquiry relating to previously submitted short message "00000000"B
TP-MN	not checked (TP-MR in previous SMS-SUBMIT)
TP-DA	not checked (an E164 number)
TP-CDL	not checked
TP-CD	not checked

second SMS-COMMAND TPDU (MS to SS in step 60)

Information element	Comment Value
TP-MTI	SMS-COMMAND "10"B
TP-MR	TP-MR in previous SMS-COMMAND plus "1"
TP-SRR	status report not requested "0"B
TP-PID	default "00000000"B
TP-CT	Delete previously submitted short message "00000010"B
TP-MN	not checked (TP-MR in previous SMS-SUBMIT)
TP-DA	not checked (an E164 number)
TP-CDL	not checked
TP-CD	not checked

34.2.5 Test of message class 0 to 3

The tests under this section only apply to a MS capable of displaying short messages (see PICS/PIXIT).

34.2.5.1 Short message class 0

34.2.5.1.1 Conformance requirement

When a mobile terminated message is class 0 and the MS has the capability of displaying short messages, the MS shall display the message immediately and send an acknowledgement to the SC when the message has successfully reached the MS irrespective of whether there is memory available in the SIM or ME. The message shall not be automatically stored in the SIM or ME.

References

GSM 03.38, 4.

34.2.5.1.2 Test purpose

To verify that the MS will accept and display but not store a class 0 message, and that it will accept and display a class 0 message if its message store is full.

NOTE: failure of this test in a mobile could cause it to reject a class 0 message when its SMS memory becomes full. This could lead to unwanted repetitions between the MS and the service centre.

34.2.5.1.3 Method of test

Initial conditions

System Simulator:

1 cell, default parameters.

Mobile Station:

The MS shall be in the idle updated state.

The MS message store shall be empty.

Related PICS/PIXIT Statements

Support for Short message MT/PP.

Description of the basic procedures to display a mobile terminated short message.

The value of timer TC1M.

Whether SMS messages are stored in the SIM and/or the ME.

Foreseen Final State of MS

Idle, updated.

Test Procedure

- a) The SS sends a class 0 message by using the method described in step a) of section 34.2.1 but with the TPDU described in this section.
- b) The MS message store shall be filled (for example by using the method of 34.2.3 test of the memory available notification) with the same SMS-DELIVER TPDU except that TP-DCS is set to class 1.
- c) The SS sends a class 0 message as in step a).

Maximum Duration of Test

-

Expected Sequence

Step	Direction	Message	Comments
1	SS -> MS	PAGING REQUEST	
2	MS -> SS	CHANNEL REQUEST	Establishment cause is "Answer to paging"
3	SS -> MS	IMMEDIATE ASSIGNMENT	SS assigns an SDCCH
4	MS -> SS	PAGING RESPONSE	Message is contained in SABM.
5	SS -> MS	AUTHENTICATION REQUEST	
6	MS -> SS	AUTHENTICATION RESPONSE	SRES specifies correct value.
7	SS -> MS	CIPHERING MODE COMMAND	SS starts deciphering after sending the message.
8	MS -> SS	CIPHERING MODE COMPLETE	Shall be sent enciphered. All following messages shall be sent enciphered.
9	SS		SS starts ciphering.
10	SS -> MS	SABM (SAPI=3)	SS establishes SAPI 3
11	MS -> SS	UA (SAPI=3)	
12	SS -> MS	CP-DATA	Contains RP-DATA RPDU (SMS DELIVER TPDU), Class 0 Short Message
13	MS -> SS	CP-ACK	
14	MS -> SS	CP-DATA	Contains RP-ACK RPDU.
15	SS -> MS	CP-ACK	
16	SS -> MS	CHANNEL RELEASE	
17	MS		The content of the short message shall be displayed by the ME. The MS shall not store the message. This can be checked by verifying that it is impossible to retrieve any short messages from the MS message store.
18	SS		The MS message store shall be filled (for example by using the method of 34.2.3) with Class 1 SMS-DELIVER TPDU.
19	SS -> MS	PAGING REQUEST	
20	MS -> SS	CHANNEL REQUEST	Establishment cause is "Answer to paging"
21	SS -> MS	IMMEDIATE ASSIGNMENT	SS assigns an SDCCH
22	MS -> SS	PAGING RESPONSE	Message is contained in SABM.
23	SS -> MS	AUTHENTICATION REQUEST	
24	MS -> SS	AUTHENTICATION RESPONSE	SRES specifies correct value.
25	SS -> MS	CIPHERING MODE COMMAND	SS starts deciphering after sending the message.
26	MS -> SS	CIPHERING MODE COMPLETE	Shall be sent enciphered. All following messages shall be sent enciphered.
27	SS		SS starts ciphering.
28	SS -> MS	SABM (SAPI=3)	SS establishes SAPI 3
29	MS -> SS	UA (SAPI=3)	
30	SS -> MS	CP-DATA	Contains RP-DATA RPDU (SMS DELIVER TPDU), Class 0 Short Message
31	MS -> SS	CP-ACK	
32	MS -> SS	CP-DATA	Contains RP-ACK RPDU.
33	SS -> MS	CP-ACK	
34	SS -> MS	CHANNEL RELEASE	
35	MS		The content of the short message shall be displayed by the ME.

Specific Message Contents:

SMS-DELIVER TPDU (containing a class 0 message) (SS to MS):

Information element	Comment Value
TP-MTI	SMS-DELIVER "00"B
TP-MMS	more messages are waiting in SC "0"B
TP-RP	no reply path "0"B
TP-UDHI	TP-UD contains only the SM"0"B
TP-SRI	no status report returned0
TP-OA	an international number coded E.164
TP-PID	default "00000000"B
TP-DCS	default alphabet, class 0 "1111 0000"B
TP-SCTS	any legal value (cf. GSM 03.40)
TP-UDL	160
TP-UD (140 octets)	text of message (160 characters)

SMS-DELIVER TPDU (containing a class 1 message to fill the MS message store) (SS to MS):

Information element	Comment Value
TP-MTI	SMS-DELIVER "00"B
TP-MMS	more messages are waiting in SC "0"B
TP-RP	no reply path "0"B
TP-UDHI	TP-UD contains only the SM"0"B
TP-SRI	no status report returned0
TP-OA	an international number coded E.164
TP-PID	default "00000000"B
TP-DCS	default alphabet, class 1 "1111 0001"B
TP-SCTS	any legal value (cf. GSM 03.40)
TP-UDL	160
TP-UD (140 octets)	text of message (160 characters)

34.2.5.2 Test of class 1 short messages

This test shall apply to MSs which support:

- storing of received Class 1 Short Messages and
- displaying of stored Short Messages.

34.2.5.2.1 Conformance requirement

When a mobile terminated message is class 1, the MS shall send an acknowledgement to the SC when the message has successfully reached the MS and can be stored, either in the ME or in the SIM.

References

GSM 03.38, 4.

34.2.5.2.2 Test purpose

This procedure verifies that the MS acts correctly on receiving a class 1 message, i.e. that it stores the message in the ME or SIM and sends an acknowledgement (at RP and CP-Layer).

34.2.5.2.3 Method of test

Initial conditions

System Simulator:

1 cell, default parameters.

Mobile Station:

The MS shall be in the idle updated state.

The MS message store shall be empty.

For storing of class 1 Short Messages, the MS shall be set up to store Short Messages in the ME memory (by way of MMI, as described in PICS/PIXIT statement).

Related PICS/PIXIT Statements

Support for Short message MT/PP.

Description of the basic procedures to display a mobile terminated short message.

The value of timer TC1M.

Whether SMS messages are stored in the SIM and/or the ME.

Foreseen Final State of MS

Idle, updated.

Test Procedure

- a) the SS delivers a Short Message of class 1 to the MS as specified in section 34.2.1, step a).
- b) the Short Message is recalled (e.g. by means of the MMI).

Maximum Duration of Test

-

Expected Sequence

Step	Direction	Message	Comments
1	SS -> MS	PAGING REQUEST	
2	MS -> SS	CHANNEL REQUEST	Establishment cause is "Answer to paging"
3	SS -> MS	IMMEDIATE ASSIGNMENT	SS assigns an SDCCH
4	MS -> SS	PAGING RESPONSE	Message is contained in SABM.
5	SS -> MS	AUTHENTICATION REQUEST	
6	MS -> SS	AUTHENTICATION RESPONSE	SRES specifies correct value.
7	SS -> MS	CIPHERING MODE COMMAND	SS starts deciphering after sending the message.
8	MS -> SS	CIPHERING MODE COMPLETE	Shall be sent enciphered. All following messages shall be sent enciphered.
9	SS		SS starts ciphering.
10	SS -> MS	SABM (SAPI=3)	SS establishes SAPI 3
11	MS -> SS	UA (SAPI=3)	
12	SS -> MS	CP-DATA	Contains RP-DATA RPDU (SMS DELIVER TPDU), Class 1 Short Message
13	MS -> SS	CP-ACK	
14	MS -> SS	CP-DATA	Contains RP-ACK RPDU.
15	SS -> MS	CP-ACK	
16	SS -> MS	CHANNEL RELEASE	
17	MS		The short message shall be recalled and displayed at the MS.

Specific Message Contents:

SMS-DELIVER TPDU (containing a class 1 message) (SS to MS):

Information element	Comment Value
TP-MTI	SMS-DELIVER "00"B
TP-MMS	more messages are waiting in SC "0"B
TP-RP	no reply path "0"B
TP-UDHI	TP-UD contains only the SM"0"B
TP-SRI	no status report returned0
TP-OA	an international number coded E.164
TP-PID	default "00000000"B
TP-DCS	default alphabet, class 1 "1111 0001"B
TP-SCTS	any legal value (cf. GSM 03.40)
TP-UDL	160
TP-UD (140 octets)	text of message (160 characters)

34.2.5.3 Test of class 2 short messages

34.2.5.3.1 Definition and applicability

Class 2 Short Messages are defined as SIM specific, and the MS shall ensure that a message of this class is stored on the SIM.

This test shall apply to MSs which support:

- storing of received Class 2 Short Messages in the SIM.

34.2.5.3.2 Conformance requirement

When a mobile terminated message is Class 2, the MS shall ensure that the message has been correctly transferred to the SMS data field in the SIM before sending an acknowledgement to the SC. The MS shall return a "protocol error, unspecified" error message if the short message cannot be stored in the SIM and there is other short message storage available at the MS. If all the short message storage at the MS is already in use, the MS shall return "memory capacity exceeded".

Reference(s)

GSM 03.40, 9.2.3.10; GSM 03.38, 4. GSM 11.11, 10.3.3.

34.2.5.3.3 Test purpose

This procedure verifies that the MS acts correctly on receiving a class 2 message, i.e. that it stores the message correctly in the SIM, and if this is not possible, returns a protocol error message, with the correct error cause, to the network.

There are 2 cases:

- 1) If the MS supports storing of short messages in the SIM and in the ME, and storage in the ME is not full, and the short message cannot be stored in the SIM, the error cause shall be "protocol error, unspecified".
- 2) If the MS supports storing of short messages in the SIM and not in the ME, and storage in the ME is not full, and the short message cannot be stored in the SIM, the error cause shall be "memory capacity exceeded".

NOTE: If the MS supports storing of short messages in the SIM and the ME, and storage in the ME is full, and the short message cannot be stored in the SIM, the error cause shall be "memory capacity exceeded". This case is not tested in this test.

34.2.5.3.4 Test method

Initial conditions

System Simulator:

1 cell, default parameters.

Mobile Station:

The MS shall be in the idle updated state.

The ME message store shall be empty.

The ME shall be connected to the SIM simulator. The following shall be present in the SIM simulator:

- EF_{SMS} with at least two free records and one full record;
- EF_{SMSstatus}, with SMS "Memory Cap. Exceed" notification flag set to "memory available";
- Service no. 4 (SMS) in EF_{SST} set to allocated and activated;

For storing of Class 1 Short Messages the MS shall be set up to store Short Messages in the ME memory (by way of MMI, as described in PICS/PIXIT statement).

Related PICS/PIXIT Statements

Support for Short message MT/PP.

The value of timer TC1M.

Whether SMS messages are stored in the SIM and/or the ME.

Foreseen Final State of MS

Idle, updated.

Test Procedure

- a) the SS delivers a Short Message of class 2 to the MS as specified in section 34.2.1, step b).
- b) following an attempt by the ME to store the short message in a free record of EF_{SMS} in the SIM, the SIM simulator returns the status response "OK" ("90 00").
- c) step a) is repeated.
- d) following an attempt by the ME to store the short message in a free record of EF_{SMS} in the SIM, the SIM simulator returns the status response "memory problem" ("92 40").
- e) the SIM simulator indicates if an attempt was made in steps a) and c) to store the messages and if the messages are stored according to the requirement.

Maximum Duration of Test

-

Expected Sequence

Step	Direction	Message	Comments
1	SS -> MS	PAGING REQUEST	
2	MS -> SS	CHANNEL REQUEST	Establishment cause is "Answer to paging"
3	SS -> MS	IMMEDIATE ASSIGNMENT	SS assigns an SDCCH
4	MS -> SS	PAGING RESPONSE	Message is contained in SABM.
5	SS -> MS	AUTHENTICATION REQUEST	
6	MS -> SS	AUTHENTICATION RESPONSE	SRES specifies correct value.
7	SS -> MS	CIPHERING MODE COMMAND	SS starts deciphering after sending the message.
8	MS -> SS	CIPHERING MODE COMPLETE	Shall be sent enciphered. All following messages shall be sent enciphered.
9	SS		SS starts ciphering.
10	SS -> MS	SABM (SAPI=3)	SS establishes SAPI 3
11	MS -> SS	UA (SAPI=3)	
12	SS -> MS	CP-DATA	Contains RP-DATA RPDU (SMS DELIVER TPDU), Class 2 Short Message
13	MS -> SS	CP-ACK	
14	ME		The ME shall correctly store the short message in a free record of EFSMS in the SIM, i.e. - the ME shall use a free record - the first byte of the record shall indicate "message received by MS from network" <ul style="list-style-type: none"> - the TS-Service-Centre-Address shall be correctly stored - the TPDU shall be identical to that sent by the SS - bytes following the TPDU shall be set to "FF"
15	SIM		The SIM simulator returns the status response "OK" ("90 00"). The SIM simulator shall indicate if an attempt was made by the ME to store the short message in the SIM.
16	MS -> SS	CP-DATA	Contains RP-ACK RPDU.
16A	SS -> MS	CP-ACK	
17	SS -> MS	CHANNEL RELEASE	
18	SS -> MS	PAGING REQUEST	
19	MS -> SS	CHANNEL REQUEST	Establishment cause is "Answer to paging"
20	SS -> MS	IMMEDIATE ASSIGNMENT	SS assigns an SDCCH
21	MS -> SS	PAGING RESPONSE	Message is contained in SABM.
22	SS -> MS	AUTHENTICATION REQUEST	
23	MS -> SS	AUTHENTICATION RESPONSE	SRES specifies correct value.
24	SS -> MS	CIPHERING MODE COMMAND	SS starts deciphering after sending the message.
25	MS -> SS	CIPHERING MODE COMPLETE	Shall be sent enciphered. All following messages shall be sent enciphered.
26	SS		SS starts ciphering.
27	SS -> MS	SABM (SAPI=3)	SS establishes SAPI 3
28	MS -> SS	UA (SAPI=3)	
29	SS -> MS	CP-DATA	Contains RP-DATA RPDU (SMS DELIVER TPDU), Class 2 Short Message
30	MS -> SS	CP-ACK	
31	ME		The ME shall attempt to store the short message in a free record of EFSMS in the SIM.
32	SIM		The SIM simulator returns the status response "memory problem" ("92 40"). The SIM simulator shall indicate if an attempt was made by the ME to store the short message in the SIM.
33	MS -> SS	CP-DATA	Contains RP-ERROR RPDU with error cause "protocol error, unspecified" if the MS supports storing of short messages in the ME, or error cause "memory capacity exceeded" if not.
33A	SS -> MS	CP-ACK	
34	SS -> MS	CHANNEL RELEASE	

Specific Message Contents:

SMS-DELIVER TPDU (containing a class 2 message) (SS to MS):

Information element	Comment Value
TP-MTI	SMS-DELIVER "00"B
TP-MMS	more messages are waiting in SC "0"B
TP-RP	no reply path "0"B
TP-UDHI	TP-UD contains only the SM"0"B
TP-SRI	no status report returned0
TP-OA	an international number coded E.164
TP-PID	default "00000000"B
TP-DCS	default alphabet, class 2 "1111 0010"B
TP-SCTS	any legal value (cf. GSM 03.40)
TP-UDL	160
TP-UD (140 octets)	text of message (160 characters)

34.2.5.4 Test of class 3 short messages

For further study.

34.2.6 Test of short message type 0

For further study.

34.2.7 Test of the replace mechanism for SM type 1-7

34.2.7.1 Definition and applicability

This test shall apply to MSs which support:

- Replace Short Messages and
- display of received Short Messages.

34.2.7.2 Conformance requirement

On receipt of a short message, the MS shall check to see if the associated Protocol Identifier contains a Replace Short Message Type code. If such a code is present, then the MS will check the associated SC address (RP-OA) and originating address (TP-OA) and replace any existing stored message having the same Protocol Identifier code, SC address and originating address with the new short message.

Reference(s)

GSM 03.40; 9.2.3.9.

34.2.7.3 Test purpose

This procedure verifies the correct implementation of the replace mechanism for Replace Short Messages.

34.2.7.4 Test method

Initial conditions

System Simulator:

1 cell, default parameters.

Mobile Station:

The MS shall be in the idle updated state.

The MS message store shall be empty.

Related PICS/PIXIT Statements

Support for Short message MT/PP.

Description of the basic procedures to display a mobile terminated short message.

The value of timer TC1M.

Foreseen Final State of MS

Idle, updated.

Test Procedure

- a) two different numbers n and m are drawn randomly between 1 and 7. Two different addresses for TP-Originating-Address (TPOA1 and TPOA2) are drawn. Two different addresses for RP-Originating-Address (RPOA1 and RPOA2) are drawn.
- b) the SS delivers a short message to the MS as specified in section 34.2.1 step a). In the SMS-DELIVER TPDU, the TP-Protocol-Identifier parameter is "Replace Short Message Type n ", the TP-Originating-Address is TPOA1, and the RP-Originating-Address is RPOA1.
- c) step b) is repeated but with a different TP-Originating-Address (TPOA2), and different contents of TP-User-Data in the SMS-DELIVER TPDU. The other parameters are the same as in step b).
- d) step c) is repeated but with RPOA2 in the RP-Originating-Address, and contents of TP-User-Data different from the former two messages. The other parameters are the same as in step c).
- e) step d) is repeated but with the TP-Protocol-Identifier equal to "Replace Short Message Type m ", and contents of TP-User-Data different from the former three messages. The other parameters are the same as in step d).
- f) step e) is repeated but the contents of TP-User-Data are different from that used in step e).
- g) the SS prompts the operator to display the Short Messages stored in the MS.

Maximum Duration of Test

-

Expected Sequence

Step	Direction	Message	Comments
1	SS -> MS	PAGING REQUEST	
2	MS -> SS	CHANNEL REQUEST	Establishment cause is "Answer to paging"
3	SS -> MS	IMMEDIATE ASSIGNMENT	SS assigns an SDCCH
4	MS -> SS	PAGING RESPONSE	Message is contained in SABM.
5	SS -> MS	AUTHENTICATION REQUEST	
6	MS -> SS	AUTHENTICATION RESPONSE	SRES specifies correct value.
7	SS -> MS	CIPHERING MODE COMMAND	SS starts deciphering after sending the message.
8	MS -> SS	CIPHERING MODE COMPLETE	Shall be sent enciphered. All following messages shall be sent enciphered.
9	SS		SS starts ciphering.
10	SS -> MS	SABM (SAPI=3)	SS establishes SAPI 3
11	MS -> SS	UA (SAPI=3)	
12	SS -> MS	CP-DATA	Contains RP-DATA RPDU (SMS DELIVER TPDU) TP-PID is "Replace Short Message Type n", TP-OA is TPOA1 and RP-OA is RPOA1
13	MS -> SS	CP-ACK	
14	MS -> SS	CP-DATA	Contains RP-ACK RPDU.
14A	SS -> MS	CP-ACK	
15	SS -> MS	CHANNEL RELEASE	
16	SS -> MS	PAGING REQUEST	
17	MS -> SS	CHANNEL REQUEST	Establishment cause is "Answer to paging"
18	SS -> MS	IMMEDIATE ASSIGNMENT	SS assigns an SDCCH
19	MS -> SS	PAGING RESPONSE	Message is contained in SABM.
20	SS -> MS	AUTHENTICATION REQUEST	
21	MS -> SS	AUTHENTICATION RESPONSE	SRES specifies correct value.
22	SS -> MS	CIPHERING MODE COMMAND	SS starts deciphering after sending the message.
23	MS -> SS	CIPHERING MODE COMPLETE	Shall be sent enciphered. All following messages shall be sent enciphered.
24	SS		SS starts ciphering.
25	SS -> MS	SABM (SAPI=3)	SS establishes SAPI 3
26	MS -> SS	UA (SAPI=3)	
27	SS -> MS	CP-DATA	Contains RP-DATA RPDU (SMS DELIVER TPDU) TP-PID is "Replace Short Message Type n", TP-OA is TPOA2 and RP-OA is RPOA1, TP-UD different from step 12
28	MS -> SS	CP-ACK	
29	MS -> SS	CP-DATA	Contains RP-ACK RPDU.
29A	SS -> MS	CP-ACK	
30	SS -> MS	CHANNEL RELEASE	
31	SS -> MS	PAGING REQUEST	
32	MS -> SS	CHANNEL REQUEST	Establishment cause is "Answer to paging"
33	SS -> MS	IMMEDIATE ASSIGNMENT	SS assigns an SDCCH
34	MS -> SS	PAGING RESPONSE	Message is contained in SABM.
35	SS -> MS	AUTHENTICATION REQUEST	
36	MS -> SS	AUTHENTICATION RESPONSE	SRES specifies correct value.
37	SS -> MS	CIPHERING MODE COMMAND	SS starts deciphering after sending the message.
38	MS -> SS	CIPHERING MODE COMPLETE	Shall be sent enciphered. All following messages shall be sent enciphered.
39	SS		SS starts ciphering.
40	SS -> MS	SABM (SAPI=3)	SS establishes SAPI 3
41	MS -> SS	UA (SAPI=3)	
42	SS -> MS	CP-DATA	Contains RP-DATA RPDU (SMS DELIVER TPDU) TP-PID is "Replace Short Message Type n", TP-OA is TPOA2 and RP-OA is RPOA2, TP-UD different from step 12 and 27
43	MS -> SS	CP-ACK	
44	MS -> SS	CP-DATA	Contains RP-ACK RPDU.
44A	SS -> MS	CP-ACK	
45	SS -> MS	CHANNEL RELEASE	
46	SS -> MS	PAGING REQUEST	
47	MS -> SS	CHANNEL REQUEST	Establishment cause is "Answer to paging"
48	SS -> MS	IMMEDIATE ASSIGNMENT	SS assigns an SDCCH
49	MS -> SS	PAGING RESPONSE	Message is contained in SABM.
50	SS -> MS	AUTHENTICATION REQUEST	
51	MS -> SS	AUTHENTICATION RESPONSE	SRES specifies correct value.

Step	Direction	Message	Comments
52	SS -> MS	CIPHERING MODE COMMAND	SS starts deciphering after sending the message.
53	MS -> SS	CIPHERING MODE COMPLETE	Shall be sent enciphered. All following messages shall be sent enciphered.
54	SS		SS starts ciphering.
55	SS -> MS	SABM (SAPI=3)	SS establishes SAPI 3
56	MS -> SS	UA (SAPI=3)	
57	SS -> MS	CP-DATA	Contains RP-DATA RPDU (SMS DELIVER TPDU) TP-PID is "Replace Short Message Type m", TP-OA is TPOA2 and RP-OA is RPOA2, TP-UD different from step 12, 27 and 42
58	MS -> SS	CP-ACK	
59	MS -> SS	CP-DATA	Contains RP-ACK RPDU.
59A	SS -> MS	CP-ACK	
60	SS -> MS	CHANNEL RELEASE	
61	SS -> MS	PAGING REQUEST	
62	MS -> SS	CHANNEL REQUEST	Establishment cause is "Answer to paging"
63	SS -> MS	IMMEDIATE ASSIGNMENT	SS assigns an SDCCH
64	MS -> SS	PAGING RESPONSE	Message is contained in SABM.
65	SS -> MS	AUTHENTICATION REQUEST	
66	MS -> SS	AUTHENTICATION RESPONSE	SRES specifies correct value.
67	SS -> MS	CIPHERING MODE COMMAND	SS starts deciphering after sending the message.
68	MS -> SS	CIPHERING MODE COMPLETE	Shall be sent enciphered. All following messages shall be sent enciphered.
69	SS		SS starts ciphering.
70	SS -> MS	SABM (SAPI=3)	SS establishes SAPI 3
71	MS -> SS	UA (SAPI=3)	
72	SS -> MS	CP-DATA	Contains RP-DATA RPDU (SMS DELIVER TPDU) TP-PID is "Replace Short Message Type m", TP-OA is TPOA2 and RP-OA is RPOA2, TP-UD different from step 57
73	MS -> SS	CP-ACK	
74	MS -> SS	CP-DATA	Contains RP-ACK RPDU.
74A	SS -> MS	CP-ACK	
75	SS -> MS	CHANNEL RELEASE	
76	SS		Prompts the operator to display the Short Messages stored in the MS. Only the Short Messages delivered in step 12, 27, 42 and 72 shall be retrievable and displayed

Specific Message Contents:

SMS-DELIVER TPDU

Information element	Comment Value
TP-MTI	SMS-DELIVER "00"B
TP-MMS	no more messages are waiting in SC "1"B
TP-RP	no Reply Path"0"B
TP-UDHI	TP-UD contains only the SM"0"B
TP-SRI	no Status Report returned "0"B
TP-OA	an international number coded E.164 (see test method description)
TP-PID	binary 01000xxx, xxx represents n resp. m (see test method description)
TP-DCS	default alphabet "00000000"B
TP-SCTS	the time when the message was submitted according to GSM 03.40
TP-UDL	160
TP-UD (140 octets)	text of message (160 characters) (see test method description)

34.2.8 Test of the reply path scheme

34.2.8.1 Definition and applicability

This test applies to MSs which support

- reply procedures (the class of MSs for which this is mandatory is described in GSM 03.40, annex 4)
- displaying of received Short Messages and
- submitting Short Messages.

Steps b) and d) are only executed for MSs which support storing of Short messages.

34.2.8.2 Conformance requirement

When a replying MS receives an original mobile terminated short message it has:

originating SME = TP-Originating Address in the SMS-DELIVER TPDU;

original SC = RP-Originating Address in the RP-MT-DATA.

When submitting the reply mobile originated short message, the replying MS should use parameters as follows:

TP-Destination Address in SMS-SUBMIT TPDU = originating SME;

RP-Destination Address in RP-MO-DATA = original SC.

Reference(s)

GSM 03.40 annex 4, sect. 5, 6.

34.2.8.3 Test purpose

This procedure verifies that the MS is able to send a Reply Short Message back to the correct originating SME even if in the meantime it receives another Short Message.

34.2.8.4 Test method

Initial conditions

System Simulator:

1 cell, default parameters.

Mobile Station:

The MS shall be in the idle updated state.

The MS message store shall be empty.

Related PICS/PIXIT Statements

Support for Short message MT/PP.

Support for Short message MO/PP.

Description of the basic procedures to display a mobile terminated short message.

Description of the basic procedures to send a mobile originated short message.

The value of timer TC1M.

Foreseen Final State of MS

Idle, updated.

Test Procedure

- a) the SS delivers a Short Message as specified in section 34.2.1, step b) with TP-Reply-Path set to 1.
- b) step a) is repeated but with:
 - different TP-Originating-Address for the originating SME;
 - different RP-Originating-Address for the original SC and
 - different message contents TP-User-Data.
- c) one of the two Short Messages is displayed (e.g. by means of the MMI) and the Reply Short Message is submitted (e.g. by means of the MMI).
- d) step c) is repeated for the other Short Message.

Maximum Duration of Test

-

Expected Sequence

Step	Direction	Message	Comments
1	SS -> MS	PAGING REQUEST	
2	MS -> SS	CHANNEL REQUEST	Establishment cause is "Answer to paging"
3	SS -> MS	IMMEDIATE ASSIGNMENT	SS assigns an SDCCH
4	MS -> SS	PAGING RESPONSE	Message is contained in SABM.
5	SS -> MS	AUTHENTICATION REQUEST	
6	MS -> SS	AUTHENTICATION RESPONSE	SRES specifies correct value.
7	SS -> MS	CIPHERING MODE COMMAND	SS starts deciphering after sending the message.
8	MS -> SS	CIPHERING MODE COMPLETE	Shall be sent enciphered. All following messages shall be sent enciphered.
9	SS		SS starts ciphering.
10	SS -> MS	SABM (SAPI=3)	SS establishes SAPI 3
11	MS -> SS	UA (SAPI=3)	
12	SS -> MS	CP-DATA	Contains RP-DATA RPDU (SMS DELIVER TPDU) TP-RP set to 1
13	MS -> SS	CP-ACK	Sent within TC1M after step 12
14	MS -> SS	CP-DATA	Contains RP-ACK RPDU.
14A	SS -> MS	CP-ACK	
15	SS -> MS	CHANNEL RELEASE	
16	SS -> MS	PAGING REQUEST	
17	MS -> SS	CHANNEL REQUEST	Establishment cause is "Answer to paging"
18	SS -> MS	IMMEDIATE ASSIGNMENT	SS assigns an SDCCH
19	MS -> SS	PAGING RESPONSE	Message is contained in SABM.
20	SS -> MS	AUTHENTICATION REQUEST	
21	MS -> SS	AUTHENTICATION RESPONSE	SRES specifies correct value.
22	SS -> MS	CIPHERING MODE COMMAND	SS starts deciphering after sending the message.
23	MS -> SS	CIPHERING MODE COMPLETE	Shall be sent enciphered. All following messages shall be sent enciphered.
24	SS		SS starts ciphering.
25	SS -> MS	SABM (SAPI=3)	SS establishes SAPI 3
26	MS -> SS	UA (SAPI=3)	
27	SS -> MS	CP-DATA	Contains RP-DATA RPDU (SMS DELIVER TPDU) TP-OA, RP-OA and TP-UD different from step 12
28	MS -> SS	CP-ACK	Sent within TC1M after step 12
29	MS -> SS	CP-DATA	Contains RP-ACK RPDU.
29A	SS -> MS	CP-ACK	
30	SS -> MS	CHANNEL RELEASE	
31	MS		One of the two Short Messages is displayed and the Reply Short Message is submitted.
32	MS -> SS	CHANNEL REQUEST	

Step	Direction	Message	Comments
33	SS -> MS	IMMEDIATE ASSIGNMENT	SS assigns an SDCCH
34	MS -> SS	CM SERVICE REQUEST	Message is contained in SABM.
35	SS -> MS	AUTHENTICATION REQUEST	
36	MS -> SS	AUTHENTICATION RESPONSE	SRES specifies correct value.
37	SS -> MS	CIPHERING MODE COMMAND	SS starts deciphering after sending the message.
38	MS -> SS	CIPHERING MODE COMPLETE	Shall be sent enciphered. All following messages shall be sent enciphered.
39	SS		SS starts ciphering.
40	MS -> SS	SABM (SAPI=3)	MS establishes SAPI 3
41	SS -> MS	UA (SAPI=3)	
42	MS -> SS	CP-DATA	Contains RP-DATA RPDU (SMS SUBMIT TPDU) RP-DA = RP-OA corresponding to the message displayed TP-DA = TP-OA corresponding to the message displayed
43	SS -> MS	CP-ACK	Sent within TC1M after step 42
44	SS -> MS	CP-DATA	Contains RP-ACK RPDU
45	SS		Waits max 25 seconds for CP-ACK
46	MS -> SS	CP-ACK	
47	SS -> MS	CHANNEL RELEASE	The main signalling link is released.
48	MS		The other Short Message is displayed and the Reply Short Message is submitted.
49	MS -> SS	CHANNEL REQUEST	
50	SS -> MS	IMMEDIATE ASSIGNMENT	SS assigns an SDCCH
51	MS -> SS	CM SERVICE REQUEST	Message is contained in SABM.
52	SS -> MS	AUTHENTICATION REQUEST	
53	MS -> SS	AUTHENTICATION RESPONSE	SRES specifies correct value.
54	SS -> MS	CIPHERING MODE COMMAND	SS starts deciphering after sending the message.
55	MS -> SS	CIPHERING MODE COMPLETE	Shall be sent enciphered. All following messages shall be sent enciphered.
56	SS		SS starts ciphering.
57	MS -> SS	SABM (SAPI=3)	MS establishes SAPI 3
58	SS -> MS	UA (SAPI=3)	
59	MS -> SS	CP-DATA	Contains RP-DATA RPDU (SMS SUBMIT TPDU) RP-DA = RP-OA corresponding to the Message displayed TP-DA = TP-OA corresponding to the message displayed
60	SS -> MS	CP-ACK	Sent within TC1M after step 59
61	SS -> MS	CP-DATA	Contains RP-ACK RPDU
62	SS		Waits max 25 seconds for CP-ACK
63	MS -> SS	CP-ACK	
64	SS -> MS	CHANNEL RELEASE	The main signalling link is released.

Specific Message Contents:

SMS-DELIVER TPDU

Information element	Comment Value
TP-MTI	SMS-DELIVER "00"B
TP-MMS	no more messages are waiting in SC "1"B
TP-RP	Reply Path exists "1"B
TP-UDHI	TP-UD contains only the SM"0"B
TP-SRI	no Status Report returned "0"B
TP-OA	an international number coded E.164 (see test method description)
TP-PID	default "00000000"B
TP-DCS	default alphabet "00000000"B
TP-SCTS	the time when the message was submitted according to GSM 03.40
TP-UDL	160
TP-UD (140 octets)	text of message (160 characters) (see test method description)

34.2.9 Multiple SMS mobile originated

34.2.9.1 MS in idle mode

This test applies to MS supporting the ability of sending multiple short messages on the same RR connection when there is no call in progress.

34.2.9.1.1 Conformance requirements

When the MS chooses to use the same RR connection to send another short message or a memory available notification, then:

- the MS shall transmit a CM SERVICE REQUEST for the new CM connection before the final CP-ACK (e.g. the one that acknowledges the CP-DATA that carried the RP-ACK) for the old MM connection is transmitted;
- before transmission of the first CP-DATA on the new MM connection, the MS shall transmit the CP-ACK for the old MM connection;
- the Transaction Identifier used on the new MM connection shall be different to that used on the old MM connection; and
- the MS shall not initiate establishment of the new MM connection before the final CP-DATA (e.g. the one carrying the RP-ACK) has been received.

Reference

GSM 03.40; 3.1

GSM 04.11; 5.4

GSM 04.13; 5.6

34.2.9.1.2 Test purpose

To verify that the MS is able to correctly send multiple short messages on the same RR connection when using an SDCCH.

34.2.9.1.3 Method of test

Initial conditions

System simulator:

1 cell, default parameters.

Mobile Station:

The MS shall be in "Idle, updated" state.

The SMS message storage shall be empty.

Related PICS/PIXIT statements

Support for multiple short message MO/PP on the same RR connection

Description of how to enter multiple SMS

Description of the basic procedures to display a mobile originated short message

Whether SMS messages are stored in the SIM and/or the ME.

Foreseen final state of MS

Idle, updated

Test procedure

- a) The MS shall be set up to send 3 short messages as multiple SM to the SS. The SS responds to the channel request message by allocating an SDCCH. The SS answers correctly to the SABM on SAPI 0 and then performs the authentication and ciphering procedures.
- b) The SS responds with a UA frame SAPI-3 to the MS.
- c) The SS responds to the CP-DATA containing RP-DATA RPDU (SMS SUBMIT TPDU) from the MS with a CP-ACK message followed by a CP-DATA message containing the correct RP-ACK RPDU. The Transaction Identifier used on this MM connection is 'x'.
- d) the MS shall transmit a CM SERVICE REQUEST for the new CM connection (for the second short message) before the final CP-ACK (the one that acknowledges the CP-DATA that carried the RP-ACK before) for the old MM connection is transmitted. The MS shall not initiate establishment of the new MM connection before the final CP-DATA (i.e. the one carrying the RP-ACK for the first short message) has been received. Before transmission of the first CP-DATA on the new MM connection, the MS shall transmit the CP-ACK for the old MM connection. The Transaction Identifier used on the new MM connection shall be y, where $y < x$ (see procedure c)).
- e) The SS waits a maximum of 5 seconds after receiving the CM SERVICE REQUEST for the CP-ACK message from the MS.
- f) The SS responds to the CP-DATA containing RP-DATA RPDU (SMS SUBMIT TPDU) from the MS with a CP-ACK message followed by a CP-DATA message containing the correct RP-ACK RPDU.
- g) the MS shall transmit a CM SERVICE REQUEST for the new CM connection (for the third short message) before the final CP-ACK (the one that acknowledges the CP-DATA that carried the RP-ACK before) for the old MM connection is transmitted. Before transmission of the first CP-DATA on the new MM connection, the MS shall transmit the CP-ACK for the old MM connection. The Transaction Identifier used on the new MM connection shall be z, where $z < y$ (see procedure d)). The MS shall not initiate establishment of the new MM connection before the final CP-DATA (i.e. the one carrying the RP-ACK for the second short message) has been received.
- h) The SS waits a maximum of 5 seconds after receiving the CM SERVICE REQUEST for the CP-ACK message from the MS.
- i) The SS responds to the CP-DATA containing RP-DATA RPDU (SMS SUBMIT TPDU) from the MS with a CP-ACK message followed by a CP-DATA message containing the correct RP-ACK RPDU.
- j) The SS waits a maximum of 5 seconds after sending CP-DATA for the CP-ACK message from the MS.
- k) The SS sends a Channel Release message to the MS.

Maximum duration of test

5 min.

Expected sequence

Step	Direction	Message	Comments
1	MS -> SS	CHANNEL REQUEST	Establishment cause is "Other procedures which can be completed with an SDCCH" NECI = 0
2	SS -> MS	IMMEDIATE ASSIGNMENT	SS assigns an SDCCH
3	MS -> SS	CM SERVICE REQUEST	Message is contained in SABM on SAPI 0. CM service type set to "Short message transfer"
4	SS -> MS	AUTHENTICATION REQUEST	
5	MS -> SS	AUTHENTICATION RESPONSE	SRES specifies correct value.
6	SS -> MS	CIPHERING MODE COMMAND	SS starts deciphering after sending the message.
7	MS -> SS	CIPHERING MODE COMPLETE	Shall be sent enciphered. All following messages shall be sent enciphered.
8	SS		SS starts ciphering.
9	MS -> SS	SABM (SAPI=3)	MS establishes SAPI 3 on DCCH
10	SS -> MS	UA (SAPI=3)	
11	MS -> SS	CP-DATA	Contains RP-DATA RPDU (SMS SUBMIT TPDU). The Transaction Identifier used in steps 11, 12, 13 and 15 shall be x.
12	SS -> MS	CP-ACK	
13	SS -> MS	CP-DATA	Contains RP-ACK RPDU
14	MS -> SS	CM SERVICE REQUEST	CM service type set to "Short message transfer".
15	MS -> SS	CP-ACK	Shall be sent within 5 seconds of step 14
16	SS -> MS	CM SERVICE ACCEPT	
17	MS -> SS	CP-DATA	Contains RP-DATA RPDU (SMS SUBMIT TPDU). The Transaction Identifier used in steps 17, 18, 19 and 21 shall be y where y <> x (see step 11).
18	SS -> MS	CP-ACK	
19	SS -> MS	CP-DATA	Contains RP-ACK RPDU
20	MS -> SS	CM SERVICE REQUEST	CM service type set to "Short message transfer".
21	MS -> SS	CP-ACK	Shall be sent within 5 seconds of step 20
22	SS -> MS	CM SERVICE ACCEPT	
23	MS -> SS	CP-DATA	Contains RP-DATA RPDU (SMS SUBMIT TPDU). The Transaction Identifier used in steps 23, 24, 25 and 26 shall be z, where z <> y (see step 17).
24	SS -> MS	CP-ACK	
25	SS -> MS	CP-DATA	Contains RP-ACK RPDU
26	MS -> SS	CP-ACK	Shall be sent within 5 seconds of step 25
27	SS -> MS	CHANNEL RELEASE	The main signalling link is released.
28	MS -> SS	DISC (SAPI=0)	MS shall respond to channel release with a layer 2 DISC frame with SAPI 0

Specific message contents:

SMS SUBMIT TPDU

Information element	Comment Value
TP-MTI	SMS SUBMIT'01'B
TP-VPF	not checked
TP-RP	no reply path '0'B
TP-UDHI	not checked
TP-SRR	not checked
TP-MR	not checked
TP-RD	not checked
TP-DA	not checked (an E164 number)
TP-PID	default '00000000'B
TP-DCS	default alphabet '00000000'B
TP-VP	not checked
TP-UDL	as applicable
TP-UD (140 octets max.)	maximum number of characters (text of message) as defined by the manufacturer (see PICS/PIXIT)

34.2.9.2 MS in active mode

This test applies to MS supporting the ability of sending multiple short messages when there is a call in progress.

34.2.9.2.1 Conformance requirements

When the MS chooses to use the same RR connection to send another short message or a memory available notification, then:

- the MS shall transmit a CM SERVICE REQUEST for the new CM connection before the final CP-ACK (e.g. the one that acknowledges the CP-DATA that carried the RP-ACK) for the old MM connection is transmitted;
- before transmission of the first CP-DATA on the new MM connection, the MS shall transmit the CP-ACK for the old MM connection;
- the Transaction Identifier used on the new MM connection shall be different to that used on the old MM connection; and
- the MS shall not initiate establishment of the new MM connection before the final CP-DATA (e.g. the one carrying the RP-ACK) has been received.

Reference

GSM 03.40; 3.1

GSM 04.11; 5.4

GSM 04.13; 5.6

34.2.9.2.2 Test purpose

To verify that the MS is able to correctly send multiple short messages on the same RR connection when sent parallel to a call.

34.2.9.2.3 Method of test

Initial conditions

System simulator:

1 cell, default parameters.

Mobile Station:

The MS shall be in "Idle, updated" state.

The SMS message storage shall be empty.

Related PICS/PIXIT statements

Support for multiple short message MO/PP on the same RR connection

Description of how to enter multiple SMS

Description of the basic procedures to display a mobile originated short message

Support for state U10 of call control

Whether SMS messages are stored in the SIM and/or the ME.

Foreseen final state of MS

Idle, updated

Test procedure

- a) A data or speech call is established on a TCH with the SS and the state U10 of call control is entered. The MS is set up to send 3 short messages as multiple SM to the SS. After the reception of the CM SERVICE REQUEST, the SS sends a CM SERVICE ACCEPT message. The SS responds with a UA frame SAPI-3 to the SABM with SAPI-3 received from the MS.
- b) Steps c) to k) of the test procedure in section 34.2.9.1.3 are repeated.

Maximum duration of test

5 min.

Expected Sequence

Step	Direction	Message	Comments
1	SS		A data or speech call is established on a TCH and the state U10 of call control is entered.
2	MS		The MS is set up to send 3 short messages as multiple SM
3	MS -> SS	CM SERVICE REQUEST	Sent in a layer 2 frame on the FACCH. CM service type set to "short message transfer"
4	SS -> MS	CM SERVICE ACCEPT	
5	MS -> SS	SABM (SAPI=3)	Sent on SACCH associated with the TCH
6	SS -> MS	UA (SAPI=3)	
7	MS -> SS	CP-DATA	Contains RP-DATA RPDU (SMS SUBMIT TPDU). The Transaction Identifier used in steps 7, 8, 9 and 11 shall be x.
8	SS -> MS	CP-ACK	
9	SS -> MS	CP-DATA	Contains RP-ACK RPDU
10	MS -> SS	CM SERVICE REQUEST	Sent in a layer 2 frame on the FACCH. CM service type set to "short message transfer"
11	MS -> SS	CP-ACK	Shall be sent within 5 seconds of step 10
12	SS -> MS	CM SERVICE ACCEPT	
13	MS -> SS	CP-DATA	Contains RP-DATA RPDU (SMS SUBMIT TPDU). The Transaction Identifier used in steps 13, 14, 15 and 17 shall be y where y <> x (see step 7).
14	SS -> MS	CP-ACK	
15	SS -> MS	CP-DATA	Contains RP-ACK RPDU
16	MS -> SS	CM SERVICE REQUEST	Sent in a layer 2 frame on the FACCH. CM service type set to "short message transfer"
17	MS -> SS	CP-ACK	Shall be sent within 5 seconds of step 16
18	SS -> MS	CM SERVICE ACCEPT	
19	MS -> SS	CP-DATA	Contains RP-DATA RPDU (SMS SUBMIT TPDU). The Transaction Identifier used in steps 19, 20, 21 and 22 shall be z, where z <> y (see step 13).
20	SS -> MS	CP-ACK	
21	SS -> MS	CP-DATA	Contains RP-ACK RPDU
22	MS -> SS	CP-ACK	Shall be sent within 5 seconds of step 21
23	SS -> MS	CHANNEL RELEASE	The main signalling link is released.
24	MS -> SS	DISC (SAPI = 0)	MS shall respond to channel release with a layer 2 DISC frame with SAPI 0.

Specific Message Contents:

SMS SUBMIT TPDU

Information element	Comment Value
TP-MTI	SMS SUBMIT'01'B
TP-VPF	not checked
TP-RP	no reply path '0'B
TP-UDHI	not checked
TP-SRR	not checked
TP-MR	not checked
TP-RD	not checked
TP-DA	not checked (an E164 number)
TP-PID	default '00000000'B
TP-DCS	default alphabet '00000000'B
TP-VP	not checked
TP-UDL	as applicable
TP-UD (140 octets max.)	maximum number of characters (text of message) as defined by the manufacturer (see PICS/PIXIT)

34.3 Short message service cell broadcast

This test applies to all MSs.

34.3.1 Conformance requirements

If the MS supports SMS-CB, it is responsible for recombination of the four blocks received via the radio path into a single block which constitutes the cell broadcast short message.

In idle mode, the MS listens to the BCCH and to the paging sub-channel for the paging group it belongs to. The MS is required to receive and analyse the paging messages and immediate assignment messages sent on the paging subchannel corresponding to its paging subgroup.

Reference

GSM 03.41; 8.

GSM 04.08; 3.2.1, 3.3.2.1.

34.3.2 Test purpose

This test verifies that an MS supporting SMS-CB is able to receive SMS-CB messages.

This test verifies that an MS is able to respond to a paging requested during the transmission of a cell broadcast short message.

34.3.3 Test method

Initial conditions

System Simulator:

1 cell, default parameters, except BS_PA_MFRMS = 2.

The SS provides a BCCH/CCCH to support the MS in idle mode.

Periodic location updating is disabled.

Mobile Station:

The MS shall be in the idle updated state.

Related PICS/PIXIT Statements

Support for short message transmission cell broadcast.

Description of the basic procedures to display a cell broadcasted short message.

Foreseen Final State of MS

Idle, updated.

Test Procedure

- a) Three Cell Broadcast (CB) messages are sent by the SS on the CBCH with serial numbers 0,1,1.
- b) Step a) is repeated, but the SS pages the MS during the transmission of the second CB message. This shall be achieved by paging the MS immediately after the first block of the CB message has been sent. The SS shall ensure that the page is transmitted on the radio interface prior to the transmission of the 4th block of the CB message.

NOTE: The use of BS_PA_MFRMS = 2 ensures that this can be achieved irrespective of the IMSI.

The MS shall respond to the page.

Maximum Duration of Test

-

Expected Sequence

Since the SMS-CB messages are sent continuously, a table is not applicable in this test.

Specific Message Contents:

Cell broadcast test message content

Information element	Comment Value
Serial Number	"00"B
- Geographical scope	see test procedure
- Message code	"0000000000"B or "0000000001"B
- Update number	as applicable
Message identifier	"0"B
Data Coding Scheme	Default alphabet, English "00000001"B
Page parameter	"0001 0001"B
Contents of message	93 user characters using 93 different characters of default 7 bit coded alphabet

SYSTEM INFORMATION TYPE 4

As default except:

Information element	Value/remark
CBCH Channel Description	SDDCH/4 + SACCH/C4 or CBCH (SDDCH/4)
- Channel type and TDMA offset	time slot zero
- Timeslot number	5 (same as BCC)
- Training sequence code	Single RF channel
- Hopping channel	Channel number 263 (for GSM 450 MS) Channel number 310 (for GSM 480 MS) Channel number 20 (for GSM 900 MS) Channel number 590 (for DCS 1 800 and PCS 1900 MS)
-Channel selector	
CBCH Mobile Allocation	Not included

34.4 Default message contents:

CP-DATA (including RP-DATA SS->MS)

Protocol Discriminator	SMS messages ("1001"B)
Transaction Identifier	
TI value	any value from the set {0, ..., 6}
TI flag	0
Message type	00000001
CP-User data	
length indicator	
RP-DATA	max 248 octets
RP-Message Type	001 (RP-DATA SS->MS)
RP-Message Reference	see GSM 04.11 8.2.3
RP-Originator Address	see GSM 04.11 8.2.5.1
RP-Destination Address	length indicator set to 0
RP-User Data	
length indicator	
TP-DATA	max 233 octets

CP-DATA (including RP-DATA MS->SS)

Protocol Discriminator	SMS messages ("1001"B)
Transaction Identifier	
TI value	any value from the set {0, ..., 6}
TI flag	0
Message type	00000001
CP-User data	
length indicator	
RP-DATA	max 248 octets
RP-Message Type	000 (RP-DATA MS->SS)
RP-Message Reference	see GSM 04.11 8.2.3
RP-Originator Address	length indicator set to 0
RP-Destination Address	see GSM 04.11 8.2.5.2
RP-User Data	
length indicator	
TP-DATA	max 233 octets

CP-DATA (including RP-ACK MS->SS)

Protocol Discriminator	SMS messages ("1001"B)
Transaction Identifier	
TI value	
TI flag	
Message type	00000001
CP-User data	
length indicator	
RP-ACK	
RP-Message Type	010 (RP-ACK MS->SS)
RP-Message Reference	see GSM 04.11 8.2.3

CP-DATA (including RP-ACK SS->MS)

Protocol Discriminator	SMS messages ("1001"B)
Transaction Identifier	
TI value	
TI flag	
Message type	00000001
CP-User data	
length indicator	
RP-ACK	
RP-Message Type	011 (RP-ACK SS->MS)
RP-Message Reference	see GSM 04.11 8.2.3

CP-DATA (including RP-ERROR MS->SS)

Protocol Discriminator	SMS messages ("1001"B)
Transaction Identifier	
TI value	
TI flag	
Message type	00000001
CP-User data	
length indicator	
RP-ERROR	
RP-Message Type	100 (RP-ERROR MS->SS)
RP-Message Reference	see GSM 04.11 8.2.3
RP-Cause	see GSM 04.11 8.2.5.4
RP_User Data	see GSM 04.11 8.2.5.3 : optional, may be present or not
Length indicator	
TP-Data	max 233 octets

CP-DATA (including RP-ERROR SS->MS)

Protocol Discriminator	SMS messages ("1001"B)
Transaction Identifier	
TI value	
TI flag	
Message type	00000001
CP-User data	
length indicator	
RP-ERROR	
RP-Message Type	101 (RP-ERROR SS->MS)
RP-Message Reference	see GSM 04.11 8.2.3
RP-Cause	see GSM 04.11 8.2.5.4
RP_User Data	see GSM 04.11 8.2.5.3 : optional, may be present or not
Length indicator	
TP-Data	max 233 octets

CP-DATA (including RP-SMMA MS->SS)

Protocol Discriminator	SMS messages ("1001"B)
Transaction Identifier	
TI value	
TI flag	
Message type	00000001
CP-User data	
length indicator	
RP-SMMA	
RP-Message Type	110 (RP-SMMA MS->SS)
RP-Message Reference	see GSM 04.11 8.2.3

CP-ACK

Protocol Discriminator	SMS messages ("1001"B)
Transaction Identifier	
TI value	
TI flag	
Message type	00000100

CP-ERROR

Protocol Discriminator	SMS messages ("1001"B)
Transaction Identifier	
TI value	
TI flag	
Message type	00010000
CP-Cause	see GSM 04.11 8.1.4.2
Cause value	

35 Low battery voltage detection

35.1 Definition and applicability

Low battery or shutdown voltage detection is used to trigger inhibition of all RF transmission before the MS supply voltage reaches a level where effective use of the radio frequency spectrum is no longer guaranteed.

The requirements and this test apply to all types of GSM 450, GSM 480, GSM 900, DCS 1 800 and PCS 1900 MS.

35.2 Conformance requirement

1. The MS shall not make ineffective use of the radio frequency spectrum. In no case shall the MS exceed the transmitted levels as defined in GSM 05.05 for extreme operation.

GSM 05.05, annex D.2.2.

2. The MS shall inhibit all RF transmission when the power supply voltage is below the manufacturer declared approximate shutdown voltage.

GSM 05.05, annex D.2.2.

35.3 Test purpose

1. To verify that the MS does not make ineffective use of the RF spectrum.
2. To verify that the MS inhibits all RF transmission when the battery voltage falls below the manufacturer declared shutdown level.

35.4 Method of test

35.4.1 Initial conditions

The SS transmits a BCCH with a location updating time set to 0,1 hours.

The SS sends a paging request message to the MS.

The MS responds with a channel request message.

The SS sends an immediate assignment message establishing an SDCCH.

35.4.2 Procedure

- a) The SS gradually reduces the power supply voltage until the MS ceases the production of RF output.

The RF output spectrum shall be monitored for any anomalies while the supply voltage is being reduced.

NOTE 1: The declared approximate shutdown voltage gives an indication of the voltage where the MS will cease RF output.

NOTE 2: If any anomalies occur, then additional testing using the transmitter tests at the voltage where the anomaly occurred is performed to determine in an objective manner, whether or not the conformance requirement is met.

- c) After 7 minutes, the SS sends a paging message to the MS.
- d) The SS observes whether or not the MS produces any RF output.

This measurement is performed over the relevant transmit band.

The spectrum analyser is set to:

Bandwidth: 3 MHz

Peak Hold

- e) The SS modifies the location area of the BCCH.
- f) For 7 minutes, the SS observes whether or not the MS produces any RF output.

NOTE 3: It is anticipated that the MS might attempt location updating.

- g) The MS is switched off and on.
- h) The SS pages the MS.
- i) The SS observes whether or not the MS produces any RF output.

35.5 Test requirement

1. In step a) no anomalies shall occur.
2. In step a), the MS shall cease the production of RF output.
3. In steps d), f) and i), the MS shall not produce any RF output above -30 dBm.

36 Individual equipment type requirements and interworking - special conformance testing functions

Refer to GSM 04.14 for complete specification

37 Void

38 Void

39 Additional CTS-MS testcases

39.1 General paragraph

39.2 Tests for CTS-MS/PLMN interface

39.2.1 CTS not allowed by GSM Network

The normal location updating procedure is used to update the registration of the actual Location Area of a Mobile Station in the network.

39.2.1.1 Conformance requirements

The network may grant authorisation for the mobile station to use GSM-Cordless Telephony System (CTS) in the Location Area and its immediate neighbourhood. The mobile should memorise this permission in non-volatile memory. If the "CTS permission" IE is not present in the message, the mobile is not authorised to use GSM-CTS, and shall accordingly delete any memorised permission.

39.2.1.2 Test purpose

To check that the CTS-MS is able to delete any memorised CTS permission when CTS permission is not allowed by a GSM network.

References

GSM 04.08 section 4.4.4.6

39.2.1.3 Method of test

Related PICS/PIXIT statements

Initial conditions

CTS-MS:

CTS-MS is OFF and under coverage of a GSM network.

CTS-MS is enrolled on at least one CTS-FP

Foreseen Final State of the CTS-MS

CTS-MS is "idle, updated"

Test procedure

The CTS-MS is switched ON. The CTS-MS shall perform a Location Registration procedure. The SS answers with a LOCATION UPDATE ACCEPT without including "CTS permission" IE. The CTS-MS shall accordingly delete any memorised CTS permission. The SS establish a BCH channel. The CTS-MS had one entry in the DF_CTS of the SIM corresponding to the FPBI broadcasted by the SS, before the location updating procedure. The CTS-MS shall not perform an Attachment procedure.

Maximum Duration of Test

[TBD]

Expected Sequence

Step	Direction	Message	Comments
1	CTS-MS -> SS	ACCESS REQUEST	
2	SS -> CTS-MS	IMMEDIATE ASSIGNMENT	
3	CTS-MS -> SS	LOCATION UPDATE REQUEST	
4	SS -> CTS-MS	IDENTITY REQUEST	
5	CTS-MS -> SS	IDENTITY RESPONSE	
6	SS -> CTS-MS	AUTHENTICATION REQUEST	
7	CTS-MS -> SS	AUTHENTICATION RESPONSE	
8	SS -> CTS-MS	CIPHERING COMMAND	
9	CTS-MS -> SS	CIPHERING COMPLETE	
10	SS -> CTS-MS	LOCATION UPDATE ACCEPT	"CTS permission" IE is not present
11	SS -> CTS-MS	CHANNEL RELEASE	
12			The SS establish a BCH channel. The CTS-MS had one entry in the DF_CTS of the SIM corresponding to the FPBI broadcasted by the SS, before the location updating procedure.
13			Check that the CTS-MS does not send CTS ACCESS REQUEST for 2 minutes.

Specific Message Contents

None

39.3 RF tests for CTS-MS/FP interface

39.3.1 Transmit power control timing and confirmation

39.3.1.1 Definition and applicability

The RF power level to be employed by the CTS-MS is indicated by means of the 5 bit TXPWR field sent in the layer 1 header of each downlink SACCH message block and may be sent in a dedicated signalling block.

When a power change is signalled the CTS-MS must change its power control level to the new level at a certain rate of change.

The CTS-MS shall confirm the power level that it is currently employing by setting the CTS-MS_TXPWR_CONF field in the uplink SACCH L1 header.

The requirements and this test apply to all types of GSM 900 and DCS 1 800 CTS-MS.

39.3.1.2 Conformance requirement

1. The RF power control level to be employed by the CTS-MS is indicated by means of the power control information sent in the layer 1 header of each downlink SACCH message block and may be sent in a dedicated signalling block; GSM 05.08, 11.3.2.
2. The CTS-MS shall confirm the power level that it is currently employing in the uplink SACCH L1 header. The indicated value shall be the power control level actually used by the CTS-MS for the last burst of the previous SACCH period; GSM 05.08, 11.3.2.
3. Upon receipt of a command on the SACCH to change its RF power level, the CTS-MS shall change to the new level at a rate of one nominal 2 dB power control step every 60 ms; GSM 05.08, 11.3.7.
4. The change (in conformance requirement 3) shall commence at the first TDMA frame belonging to the next reporting period; GSM 05.08, 11.3.7.
5. In case of channel change the commanded power level shall be applied on the new channel immediately; GSM 05.08, 11.3.7.

39.3.1.3 Test purpose

1. To verify that the CTS-MS will set its transmitter output power in accordance with conformance requirement 1.
2. To verify that the CTS-MS will confirm the power level it is currently employing according to conformance requirement 2.
3. To verify that the CTS-MS, upon receipt of a command from the SACCH to change its RF power level, will change according to conformance requirement 3.
4. To verify that the CTS-MS will commence the change of power level at least by the sixth TDMA frame belonging to the next reporting period.
5. To verify that in case of new channel assignment the commanded power level is applied on the new channel according to conformance requirement 5.

39.3.1.4 Method of test

NOTE: The method of measuring the CTS-MS transmitter output power is given in section 13.3. For CTS-MS transmission, the nominal maximum output power is:

- 11 dBm (0.015 W) in GSM 900 i.e. power control level 16
- 12 dBm (0.016 W) in DCS 1800 i.e. power control level 19. (see GSM 05.05, 4.1.1)

Initial conditions

A call is set up by the SS according to the generic call set up procedure on a channel with ARFCN in the Mid ARFCN range (ref. table 3.3), power control level set to maximum power.

Procedure

- a) The SS signals minimum power control level to the CTS-MS in the SACCH.
- b) The SS measures the CTS-MS transmitter output power on TDMA frames 6, 19, 32 and every subsequent 13th TDMA frame to TDMA frame 214. The SS also monitors the CTS-MS_TXPWR_CONF field in the uplink SACCH L1 header for the four SACCH multiframes after the SS signals the power change.
- c) The SS now sets TXPWR in the SACCH to the maximum peak power appropriate to the CTS-MS.
- d) The SS measures the CTS-MS transmitter output power on TDMA frames 6, 19, 32 and every subsequent 13th TDMA frame to TDMA frame 214. The SS also monitors the CTS-MS_TXPWR_CONF field in the uplink SACCH L1 header for the four SACCH multiframes after the SS signals the power change.
- e) The SS now sets the SACCH TXPWR to 17 in GSM 900 or 11 in DCS 1800.
- f) After 3 s the SS sets the SACCH TXPWR to 18 in GSM 900 or 12 in DCS 1800.
- g) The SS measures the CTS-MS transmitter output power on TDMA frame 6.
- h) The SS sets the SACCH TXPWR to 17 in GSM 900 or 11 in DCS 1800
- i) The SS measures the CTS-MS transmitter output power on TDMA frame 6.
- j) The channel assignment is changed and the demanded power within the channel assignment is set to the minimum power control level of the CTS-MS.
- k) When the CTS-MS has changed channel its output power is measured on the first burst on the new channel.

Test requirements

NOTE: Refer to tables 13-2 and 13-4 for relationship between the power control level, transmitter output power and the relevant tolerances.

- a) In steps b) and d), the transmitter output power shall change by one power step towards the new level signalled for each measured burst until the CTS-MS is operating at the closest supported power control level and from then on, all transmissions shall be at that level.

- b) In steps b) and d), the value of the CTS-MS_TXPWR_CONF field in the uplink SACCH L1 header shall correspond to the actual power control level used for the last transmitted burst of the previous SACCH multiframe. The first one shall indicate the initial transmitted power control level, the subsequent ones shall change by 17 in GSM 900 or 11 in DCS 1800 each time until the final power control level has been reached in which case that value shall be indicated.
- c) In steps g) and i) the transmitter output power of TDMA frame 6 shall correspond to the new commanded power control level.
- d) In step k) the CTS-MS output power, measured on the new channel shall correspond to the power control level in the channel assignment.

39.3.2 CTS Fixed Part selection

39.3.2.1 Definition and applicability

CTS-FP selection is a process in which a CTS-MS attempts to find a suitable CTS-FP. Two methods of searching for a suitable CTS-FP are possible, automatic mode and manual mode. The process ensures that the CTS-MS is attached to a CTS-FP from which it can reliably decode downlink data and with which it has a high probability of communications on the uplink. Once the CTS-MS is attached to a CTS-FP, access to the network is allowed.

In CTS mode only or in automatic mode with CTS preferred, the CTS-MS normally operates on CTS fixed part on which the mobile station is already enrolled. If the CTS-MS loses coverage in these modes, it shall attempt periodically to select again a CTS fixed part.

There are two modes for CTS-FP selection:

- i) automatic mode : This mode uses a list of CTS-FP in priority order. The highest priority CTS-FP available is selected.
- ii) Manual mode : The user selects one of the CTS-FP on which the MS is enrolled. The MS shall attempt only to attach to the selected CTS-FP.

To select a CTS fixed part, the CTS-MS shall listen to the CTSBCH frequencies of all the fixed parts on which the MS is currently enrolled.

This test is applicable for all types of GSM 900 and DCS 1 800 MSs.

39.3.2.2 Conformance requirement

1. In CTS mode only, the CTS-MS shall be able to synchronise to the CTSBCH carrier and to transmit on CTSARCH within 30 seconds.
2. There are various requirements that a CTS fixed part must satisfy before an CTS-MS can perform normal camping on it:
 - 2.1 (i) It should be a CTS fixed part on which the CTS-MS is enrolled with.
 - 2.2 (ii) The radio path loss between CTS-MS and CTS fixed part must be below a threshold set by the CTS operator. This is estimated as shown in section GSM 05.08, 11.1.2.
3. The MS shall be able to calculate correctly the path loss criterion parameter C1, used for CTS fixed part cell selection; GSM 05.08, 11.1.2.

39.3.2.3 Test purpose

1. To verify that the MS meets conformance requirement 1.
2. To verify that the CTS-MS does not select a CTS fixed part on which it is not enrolled.
3. To verify that the MS does not select a cell with $C1 < 0$.

39.3.2.4 Method of test

Initial conditions

Parameter	Carrier 1	Carrier 2
RF Signal Level (dB μ V emf() / dBm)	48 / -65	38 / -75
CBA	1	0
RXLEV_ACCESS_MIN (dBm)	-90	-67
C1	25	-8

The CTS-MS is enrolled with the SS.

Procedure

- a) The SS activates the carriers and monitors carriers 1 and 2 for Access requests from the CTS-MS.
- b) The CTS-MS which is in CTS mode only, is switched on.

Test requirements

After step b), the CTS-MS shall be able to send a CTSARCH on carrier 1 within 30 seconds. There shall be no Access requests from the CTS-MS on carrier 2.

39.3.3 Monitoring of CTSBCH

39.3.3.1 Definition and applicability

Whilst in CTS idle mode, the CTS-MS shall measure the received signal level of the CTSBCH and shall calculate the received level average of the CTSBCH carrier. This ensure that the CTS-MS is attached on a CTS-FP from which it can reliably decode downlink data and with which it has a high probability of communications on the uplink.

This test is applicable for all types of GSM 900 and DCS 1 800 CTS-MSs.

39.3.3.2 Conformance requirement

1. The CTS-MS shall measure the received signal level of the CTSBCH and shall calculate the received level average of the CTSBCH carrier on at least five collected measurement samples ; GSM 05.08, 11.1.3.1.
2. There are various requirements that a cell must satisfy before an CTS-MS can perform normal camping on it:
 - 2.1 (i) It should be a CTS fixed part on which the CTS-MS is enrolled with.
 - 2.2 (ii) The radio path loss between CTS-MS and CTS fixed part must be below a threshold set by the CTS operator. This is estimated as shown in section GSM 05.08, 11.1.2.

NOTE : Criterion (ii) refers to the C1 parameter.

3. The CTS-MS shall be able to calculate correctly the path loss criterion parameter C2 used for the monitoring of received signal level everytime that it decodes the CTSBCH in its CTS paging group; GSM 05.08, 11.1.3.1.

39.3.3.3 Test purpose

1. To verify that the CTS-MS meets conformance requirement 1
2. To verify that:
 - 2.1 The CTS-MS does not “reselect” a fixed part on which it is not enrolled with.
 - 2.2 The CTS-MS does not “reselect” a CTS cell which has a C1<0.
3. To verify that the CTS-MS calculates the C2 parameter correctly.

39.3.3.4 Method of test

Initial conditions

The CTS-MS is enrolled with the SS.

The CTS-MS is in CTS preferred mode.

Parameter	Carrier 1	Carrier 2
RF Signal Level (dB μ V emf() / dBm)	63 / -50	33 / -80
RXLEV_ACCESS_MIN (dB μ V emf() / dBm)	43 / -70	23 / -90
CTS_CELL_RESELECT_OFFSET	5	0
C1	20	10
C2	35	10

Procedure

- a) The SS activates the carriers. The CTS-MS is not paged on carrier 1. The SS monitors CTSBCH on carrier 1 and BCCH on carrier 2 for Access requests from the CTS-MS.
- b) The CTS-MS which is in CTS preferred mode is switched on.
- c) The SS reduces signal level on carrier 1 to -80 dBm / 33 dB μ V emf() for 4 s. Then, the SS raises the level back to -50 dBm / 63 dB μ V emf(). (C1 becomes -10 dB and C2, -5 dB during this period).
- d) The SS reduces signal level on carrier 1 to -80 dBm / 33 dB μ V emf().

39.3.3.5 Test requirements

- 1) After step b), the CTS-MS shall be able to transmit a CTSARCH on carrier 1 within 30 seconds and there shall be no access request from the CTS-MS on carrier 2.
- 2) After step c), the CTS-MS is still "attached to carrier 1" and there shall be no access on carrier 2.
- 3) After step d), the CTS-MS shall consider itself as de-attached to carrier 1 and perform a GSM cell selection by sending a RACH on carrier 2 within 30 seconds.

39.3.4 AFA measurement and reporting

39.3.4.1 Definition and applicability

A precise frequency planning can not be applied to the CTS-FP/MS pair, as the CTS is intended to be developed by the end-user. Therefore, a list of frequencies (GFL) on which it is allowed to operate is given to the CTS. With the AFA, interference measurements will be performed on the frequencies in the GFL to provide a ranking in the AFA table, in order to exclude unacceptably interfered frequencies from the usage in CTS. A set of frequencies shall be selected from the AFA table by the CTS-FP for effective use by the CTS-FP and CTS-MS performing frequency hopping. This subset of frequencies is called the TFH carrier list.

The requirements and this test apply to all types of GSM 900 and DCS 1800 CTS-MS.

39.3.4.2 Conformance requirement

1. For each carrier of the AMFL (AFA monitoring frequency list) the CTS-MS shall perform NAMC (Number of AFA monitoring cycles) basic measurements, where a basic measurement shall be the average received signal level on the 8 timeslots of the TDMA frame, over the full range of -110 dBm to -48 dBm ; GSM 05.08, 11.1.4.1.
2. The RMS received signal level at the receiver input for each frequency specified in the AMFL shall be measured with an absolute accuracy of +/-6 dB over the full range of -110 dBm to -48 dBm under normal conditions; GSM 05.08, 8.1.2.

3. When ordered by the CTS-FP, the CTS-MS shall report in the next AFA monitoring report message a table of received interference level of the AMFL, AMFL_INTERF_LEV (1,...,n) with the tolerances given in conformance requirements 2. Above, together with the minimum of the numbers of performed AFA monitoring cycles, NAMC_REAL ; GSM 05.08, 11.1.4.1.

39.3.4.3 Test purpose

To check that the CTS-MS is able to perform AFA monitoring procedure.

1. To check that the CTS-MS is able to perform AFA monitoring reporting when order by the CTS-FP.

39.3.4.4 Method of test

Initial conditions

The CTS-MS is in the “Attached, idle, updated” mode, with a CTS-MSI allocated.

AFML:

Parameter	Carrier 1	Carrier 2	Carrier 3	Carrier 4	Carrier 5	Carrier 6	Carrier 7
RF signal level (dB μ V emf ()/dBm)	53 / -60	48 / -65	43 / -70	38 / -75	33 / -80	33 / -80	38 / -75

NAMC= 50

Procedure

- a) The SS activates carriers 1 to 7. The CTS-MS is not paged on any of the carriers.
- b) The attached CTS-MS shall respond to a pending CTS_PAGING_REQUEST message.
- c) The CTS-MS shall send CTS_ACCESS_REQUEST messages until the SS answered.
- d) The SS sends a CTS_AFA_MONITORING_COMMAND to ask the CTS_MS to performed 50 basic average received signal measurement on each of the seven carriers representing the AMFL. The received interference level of the carrier shall be the maximum of the NAMC basic measurement.
- e) The SS shall wait (NAMC*5 + 20) seconds ie. Approximately five minutes before starting the AFA reporting procedure to let the CTS-MS enough time to perform the monitoring procedure during NAMC cycles.
- f) When ordered by the SS, the CTS_MS shall report in the CTS_AFA_MONITORING_REPORT message a table of received interference level for all frequencies of the AFA list.

Test requirements

1. After step d), the CTS-MS shall perform 50 basic measurements on each of the frequencies contained in the AMFL.
2. After step f), the CTS-MS shall report to the SS an ordered table of received interference level of the carriers of AMFL containing the seven carriers with the average received signal level at the receiver input for each frequency measured with an absolute accuracy of +/-6 dB as specified in the section 39.3.4.4.1.

39.4 L2 tests for CTS-MS/FP interface

39.5 L3 tests for CTS-MS/FP interface

39.5.3.1 Elementary Procedures

39.5.3.1.1 System Access

39.5.3.1.1.1 Not corresponding FPBI

The purpose of the immediate assignment procedure is to establish an RR connection between the mobile station and the CTS-FP.

39.5.3.1.1.1.1 Conformance requirements

The MS when attached to GSM, but not registered to the CTS-FP, and with a user selection for parallel mode or automatic mode with CTS preferred, shall register with the CTS-FP within 2 minutes after coming in range of the CTS-FP.

The FPBI field indicates the identity of the CTS-FP, in such a way that invalid attachment attempts by CTS-MS which are not enrolled (see GSM 03.56) with this CTS-FP are minimised.

39.5.3.1.1.1.2 Test purpose

To verify that the CTS-MS does not access to a CTS-FP if the FPBI does not match.

References

GSM 2.56 section 5.6

GSM 3.56 section 10.1.4

39.5.3.1.1.1.3 Method of test

Related PICS/PIXIT statements

Initial conditions

SS:

Radio_Link_Timeout set to [TBC]

CTS-MS:

The CTS-MS is OFF.

The CTS-MS does not have the FPBI nor IFPEI of the SS in the DF-CTS field of the SIM.

The CTS-MS is enrolled on a CTS-FP with a different FPBI but with the same CTSBCH ARFCN.

Foreseen Final State of the CTS-MS

Scanning for an available Network.

Test procedure

The CTS-MS is switched ON. The CTS-MS is looking for a suitable Network. It shall not select nor send a CTS ACCESS REQUEST message to start attachment to the SS as long as its FPBI is not known.

Maximum Duration of Test

[TBD]

Expected Sequence

Step	Direction	Message	Comments
1			The CTS-MS is looking for a suitable Network.
2			Check that the CTS-MS does not send CTS ACCESS REQUEST for 2 minutes.

Specific Message Contents

None

39.5.3.1.1.2 Retransmission of CTS Access Request

39.5.3.1.1.2.1 Conformance requirements

After sending the first CTS ACCESS REQUEST, the CTS-MS shall start listening continuously to the CTSAGCH. After having sent MCTS + 1 CTS ACCESS REQUEST messages, the CTS-RR entity of the CTS-MS shall start timer TC3150. At expiry of this timer, the immediate assignment procedure is aborted. If the immediate assignment procedure was triggered by a request from the CTS-MM sublayer, a access failure is indicated to the CTS-MM sublayer.

39.5.3.1.1.2.2 Test purpose

To check that the CTS-MS well manages MCTS and TC3150.

References

GSM 4.56 section 4.3.1.1.2

39.5.3.1.1.2.3 Method of test

Related PICS/PIXIT statements

Initial conditions

SS:

Radio_Link_Timeout set to [TBC]

CTS-MS:

The CTS-MS is OFF.

Foreseen Final State of the CTS-MS

Scanning for available Network.

Test procedure

The attached CTS-MS is switched ON. The CTS-MS sends a CTS ACCESS REQUEST. As long as the SS does not send a CTS IMMEDIATE ASSIGNMENT, the CTS-MS shall send MCTS CTS ACCESS REQUEST. Then the

CTS-MS shall start timer TC3150. When TC3150 expires the CTS-MS shall report the Immediate Assignment failure to upper layers.

The attached CTS-MS is switched OFF then ON. The CTS-MS sends a CTS ACCESS REQUEST. As long as the SS does not send a CTS IMMEDIATE ASSIGNMENT, the CTS-MS shall send MCTS CTS ACCESS REQUEST. Then the CTS-MS shall start timer TC3150. Before expiry of TC3150, the SS sends the CTS IMMEDIATE ASSIGNMENT. The CTS-MS should complete the attachment procedure.

Maximum Duration of Test

[TBD]

Expected Sequence

Step	Direction	Message	Comments
1	CTS-MS -> SS	CTS ACCESS REQUEST	
2	CTS-MS -> SS	CTS ACCESS REQUEST	
3	CTS-MS -> SS	CTS ACCESS REQUEST	
4	CTS-MS -> SS	CTS ACCESS REQUEST	
5	CTS-MS -> SS	CTS ACCESS REQUEST	
6	CTS-MS -> SS	CTS ACCESS REQUEST	
7	CTS-MS -> SS	CTS ACCESS REQUEST	
8	CTS-MS -> SS	CTS ACCESS REQUEST	
9			T _{C3150} expiry
10	SS -> CTS-MS	CTS IMMEDIATE ASSIGNMENT	
11			Check that the CTS-MS doesn't send CTS ATTCHMENT REQUEST for 30 seconds
12			Switch the CTS-MS OFF then ON
13	CTS-MS -> SS	CTS ACCESS REQUEST	
14	CTS-MS -> SS	CTS ACCESS REQUEST	
15	CTS-MS -> SS	CTS ACCESS REQUEST	
16	CTS-MS -> SS	CTS ACCESS REQUEST	
17	CTS-MS -> SS	CTS ACCESS REQUEST	
18	CTS-MS -> SS	CTS ACCESS REQUEST	
19	CTS-MS -> SS	CTS ACCESS REQUEST	
20	CTS-MS -> SS	CTS ACCESS REQUEST	
21			Wait T _{C3150} expiry minus n multiframe
21	SS -> CTS-MS	CTS IMMEDIATE ASSIGNMENT	
22	CTS-MS -> SS	CTS ATTACHMENT REQUEST	
23	SS -> CTS-MS	CTS MS AUTHENTICATION REQUEST	
24	CTS-MS -> SS	CTS MS AUTHENTICATION RESPONSE	
25	SS -> CTS-MS	CTS FP AUTHENTICATION RESPONSE	
26	SS -> CTS-MS	CTS CIPHERING MODE COMMAND	Cipher Mode Setting = "Start Ciphering; cipher with algorithm A5/2". The SS starts deciphering
27	CTS-MS -> SS	CTS CIPHERING MODE COMPLETE	Sent in ciphered mode using the cipher key determined between steps 23&25
28	SS -> CTS-MS	IDENTITY REQUEST	
29	CTS-MS -> SS	IDENTITY RESPONSE	
30	SS -> CTS-MS	CTS CTS-MSI UPDATE COMMAND	New CTS-MSI sent to CTS-MS in ciphered mode
31	CTS-MS -> SS	CTS CTS-MSI UPDATE COMPLETE	New CTS-MSI stored in CTS-MS SIM, however old CTS-MSI is not cancelled [TBC]
32	SS -> CTS-MS	CTS ATTACHMENT ACCEPT	
33	SS -> CTS-MS	CTS CHANNEL RELEASE	

Specific Message Contents

None

39.5.3.1.1.3 No access request when FP is in busy state

In cases where the CTS-FP has no resources to handle accesses from a CTS-MS, the CTSBCH shall indicate that no CTS-MS shall attempt to access the CTS-FP.

39.5.3.1.1.3.1 Conformance requirements

Access to the CTS-FP is allowed to any enrolled CTS-MS when the CTSBCH status field indicates idle. CTS-MS shall not try to access the CTS-FP when the status field indicates busy.

39.5.3.1.1.3.2 Test purpose

To check that the CTS-MS is able to manage dynamically the CTSBCH status field.

References

GSM 3.52 section 10.1

GSM 4.56 section 4.3.1.1.1

39.5.3.1.1.3.3 Method of test

Related PICS/PIXIT statements

Initial conditions

SS:

Status Bit in CTSBCH-SB set to Busy

Radio_Link_Timeout set to [TBC]

CTS-MS:

The CTS-MS is OFF.

The CTS-MS was previously attached on that CTS-FP

Foreseen Final State of the CTS-MS

“Attached, idle, update”, with CTS-MSI allocated.

Test procedure

The attached CTS-MS is switched ON. As long as the CTSBCH-SB Status Bit is set to Busy, the CTS-MS shall not send CTS ACCESS RESQUEST. The CTS-MS shall go back to reselection mode.

The CTSBCH-SB Status Bit is set to Idle. The CTS-MS shall periodically scan the CTSBCH-SB Status Bit and send a CTS ACCESS REQUEST message to start the attachment procedure.

The CTSBCH-SB Status Bit is set to Busy. The CTS-MS is made to start an outgoing call. As long as the CTSBCH-SB Status Bit is set to Busy, the CTS-MS shall not send CTS ACCESS RESQUEST.

Maximum Duration of Test

[TBD]

Expected Sequence

Step	Direction	Message	Comments
1			SS CTSBCH-SB Status Bit set to Busy
2			CTS-MS switched ON. Then check for no CTS ACCESS REQUEST during 2 minutes.
3			SS CTSBCH-SB Status Bit set to Idle
4	CTS-MS -> SS	CTS ACCESS REQUEST	
5	SS -> CTS-MS	CTS IMMEDIATE ASSIGNMENT	
6	CTS-MS -> SS	CTS ATTACHMENT REQUEST	
7	SS -> CTS-MS	CTS MS AUTHENTICATION REQUEST	
8	CTS-MS -> SS	CTS MS AUTHENTICATION RESPONSE	
9	SS -> CTS-MS	CTS FP AUTHENTICATION RESPONSE	
10	SS -> CTS-MS	CTS CIPHERING MODE COMMAND	Cipher Mode Setting = "Start Ciphering; cipher with algorithm A5/2". The SS starts deciphering
11	CTS-MS -> SS	CTS CIPHERING MODE COMPLETE	Sent in ciphered mode using the cipher key determined between steps 7&9
12	SS -> CTS-MS	IDENTITY REQUEST	
13	CTS-MS -> SS	IDENTITY RESPONSE	
14	SS -> CTS-MS	CTS CTS-MSI UPDATE COMMAND	New CTS-MSI sent to CTS-MS in ciphered mode
15	CTS-MS -> SS	CTS CTS-MSI UPDATE COMPLETE	New CTS-MSI stored in CTS-MS SIM, however old CTS-MSI is not cancelled [TBC]
16	SS -> CTS-MS	CTS ATTACHMENT ACCEPT	
17	SS -> CTS-MS	CTS CHANNEL RELEASE	
18			Wait 30 seconds
19			CTSBCH-SB Status Bit set to Busy
20			Start an CTS Outgoing Call. Then check for no CTS ACCESS REQUEST during 30 seconds

Specific Message Contents

None

39.5.3.1.2 Immediate Assignment

39.5.3.1.2.1 Immediate assignment success

The immediate assignment procedure is used by the CTS-FP to establish a dedicated control channel for the attached CTS-MS and CTS-FP to communicate the detail of the service requested.

39.5.3.1.2.1.1 Conformance requirements

Following a CTS PAGING REQUEST message, the attached CTS-MS shall correctly set up an RR connection on the dedicated channel TCH/F described in the CTS IMMEDIATE ASSIGNMENT message

39.5.3.1.2.1.2 Test purpose

To check that the attached CTS-MS is able to accept a CTS IMMEDIATE ASSIGNMENT message and to switch to the indicated channel by sending a CTS PAGING RESPONSE message.

References:

GSM 04.56 section 4.3.1

39.5.3.1.2.1.3 Method of test

Related PICS/PIXIT statements:

Initial conditions:

CTS-MS

"Idle, updated", with CTS-MSI allocated.

Foreseen Final State of the CTS-MS

"Idle, updated", with CTS-MSI allocated.

Test procedure

The SS pages the attached CTS-MS and after the CTS-MS has responded with a CTS ACCESS REQUEST message the SS assigns a dedicated channel. The CTS-MS shall go to the correct channel and send a CTS PAGING RESPONSE message. Then the SS initiates RR-release by sending a CTS CHANNEL RELEASE message.

Maximum Duration of Test

6 seconds

Expected Sequence

Step	Direction	Message	Comments
1	SS -> CTS-MS	CTS PAGING REQUEST	
2	CTS-MS -> SS	CTS ACCESS REQUEST	
3	SS -> CTS-MS	CTS IMMEDIATE ASSIGNMENT	Channel Type: TCH/F
4	CTS-MS -> SS	CTS PAGING RESPONSE	Shall be sent on the correct channel
5	SS -> CTS-MS	CTS CHANNEL RELEASE	

Specific Message Contents

None

39.5.3.1.2.2 Immediate Assignment after Immediate assignment rejection

39.5.3.1.2.2.1 Conformance requirements

If no channel is available for assignment, the CTS-FP may send to the CTS-MS a CTS IMMEDIATE ASSIGNMENT REJECT in unacknowledged mode in the CTSAGCH channel. This message contains an access request reference and a wait indication.

39.5.3.1.2.2.2 Test purpose

To verify that the MS correctly responds to an CTS IMMEDIATE ASSIGNMENT message sent after an CTS IMMEDIATE ASSIGNMENT REJECT message before expiration of Wait indication.

References

GSM 4.56 section 4.3.1.1.3.2

39.5.3.1.2.2.3 Method of test

Related PICS/PIXIT statements

Initial conditions

SS:

Radio_Link_Timeout set to [TBC]

CTS-MS:

The CTS-MS is in the "Attached, idle, updated" mode, with a CTS-MSI allocated

Foreseen Final State of the CTS-MS

Scanning for available Network.

Test procedure

The SS pages the CTS-MS, which shall react by sending a CTS CHANNEL REQUEST. Immediately after reception of the CTS CHANNEL REQUEST the SS sends a CTS IMMEDIATE ASSIGNMENT REJECT message which has the Wait Indication IE set to 6 seconds.

Between 0,75 seconds and 1,25 seconds after sending the CTS IMMEDIATE ASSIGNMENT REJECT message the SS sends a CTS IMMEDIATE ASSIGNMENT message. The MS shall go to the correct channel and send a CTS PAGING RESPONSE message. Then the SS initiates RR-release by sending a CTS CHANNEL RELEASE message.

Maximum Duration of Test

[TBD]

Expected Sequence

Step	Direction	Message	Comments
1	SS -> CTS-MS	CTS PAGING REQUEST	
2	CTS-MS -> SS	CTS ACCESS REQUEST	
3	SS -> CTS-MS	CTS IMMEDIATE ASSIGNMENT REJECT	Wait Indication IE set to 6 seconds.
4	SS -> CTS-MS	CTS IMMEDIATE ASSIGNMENT	references the request from the SS sent between 0,75 s and 1,25 s after the completion of step 3.
5	CTS-MS -> SS	CTS PAGING RESPONSE	
6	SS -> CTS-MS	CTS CHANNEL RELEASE	

Specific Message Contents

None

39.5.3.1.2.3 Immediate assignment / ignore assignment

The purpose of the immediate assignment procedure is to establish an RR connection between the mobile station and the CTS-FP.

39.5.3.1.2.3.1 Conformance requirements

A CTS-MS waiting for a response from the CTS-FP, following the sending of a CTS ACCESS REQUEST, shall ignore a CTS IMMEDIATE ASSIGNMENT message with an Access Request Reference containing another CTS-MSI.

39.5.3.1.2.3.2 Test purpose

To verify that the CTS-MS ignores an assignment for another CTS-MS while waiting for an assignment of its own.

References

GSM 4.56 section 4.3.1.1.3

39.5.3.1.2.3.3 Method of test

Related PICS/PIXIT statements

Initial conditions

SS:

Radio_Link_Timeout set to [TBC]

CTS-MS:

The CTS-MS is in the “Attached, idle, updated” mode, with a CTS-MSI allocated

Foreseen Final State of the CTS-MS

Scanning for available Network.

Test procedure

The SS pages the CTS-MS, which shall react by sending CTS ACCESS REQUEST. Immediately after reception of the third CTS ACCESS REQUEST the SS sends a CTS IMMEDIATE ASSIGNMENT message which has another CTS-MSI in the access request reference field. The CTS-MS shall ignore the assignment and send another CTS ACCESS REQUEST message.

Maximum Duration of Test

[TBD]

Expected Sequence

Step	Direction	Message	Comments
1	SS -> CTS-MS	CTS PAGING REQUEST	
2	CTS-MS -> SS	CTS ACCESS REQUEST	
3	SS -> CTS-MS	CTS IMMEDIATE ASSIGNMENT	CTS-MSI in the access request reference field is not the one allocated to the CTS-MS.
4	CTS-MS -> SS	CTS ACCESS REQUEST	
5	SS -> CTS-MS	CTS IMMEDIATE ASSIGNMENT	CTS-MSI in the access request reference field is the one allocated to the CTS-MS.
6	CTS-MS -> SS	CTS PAGING RESPONSE	
7	SS -> CTS-MS	CTS CHANNEL RELEASE	

Specific Message Contents

None

39.5.3.1.2 Paging

39.5.3.1.3.1 Paging with current CTS-MSI

The Paging procedure is used by the CTS-FP to cause the CTS Mobile Station to establish a radio connection. Normally the CTS Mobile Station listens to its paging subchannel but the correct implementation of the paging procedure in the CTS Mobile Station is essential for the basic establishment of a connection.

39.5.3.1.3.1.1 Conformance requirements:

The attached CTS-MS shall respond correctly to various CTS PAGING REQUEST messages. The MS shall send CTS ACCESS REQUEST messages, with an Establishment Cause set to "Answer to Paging", until the CTS-FP answers. The number of CTS ACCESS REQUEST messages shall be limited by the parameter Max-retrans. After the assignment procedure, the CTS-MS shall send a CTS PAGING RESPONSE message on the channel assigned by the CTS-FP.

39.5.3.1.3.1.2 Test purpose:

To test that the attached CTS-MS is able to determine its paging subgroup correctly and that the CTS-MS responds correctly to various CTS PAGING REQUEST messages. All valid ways of addressing the CTS-MS are tested. It is tested that the CTS-MS responds with the same last issued CTS-MS Identity that is used in the CTS PAGING REQUEST message.

References:

GSM 04.56 section 4.3.2

39.5.3.1.3.1.3 Method of test

Related PICS/PIXIT statements:

Initial conditions:

SS:

Max-Retrans = 2

CTS-MS:

The CTS-MS is in the "Attached, idle, updated", with a CTS-MSI allocated.

Foreseen Final State of the CTS-MS

"Attached, idle, updated", with CTS-MSI allocated.

Test procedure

The SS pages the attached CTS-MS 5 times with different CTS PAGING REQUEST messages on the paging subchannel which corresponds to the CTS-MS's IMSI (CTS-IMSI).

In all the cases the attached CTS-MS shall answer to the paging by sending CTS ACCESS REQUESTs. The SS responds to the second CTS ACCESS REQUEST by assigning a channel, and the CTS-MS shall then send a correct CTS PAGING RESPONSE.

Maximun Duration of Test

5 minutes

Expected Sequence

Step	Direction	Message	Comments
1	SS -> CTS-MS	CTS PAGING REQUEST	PROCEDURE 1. 1st CTS-MSI addresses CTS-MS; 2nd, 3rd and 4th CTS-MSIs address other CTS-MSs.
2	CTS-MS -> SS	CTS ACCESS REQUEST	Establ. Cause = "Answer to paging".
3	CTS-MS -> SS	CTS ACCESS REQUEST	Establ. Cause = "Answer to paging".
4	SS -> CTS-MS	CTS IMMEDIATE ASSIGNMENT	Access Request Reference = pertaining to the message received in step 3.
5	CTS-MS -> SS	CTS PAGING RESPONSE	Mobile Ident: CTS-MSI.
6	SS -> CTS-MS	CTS CHANNEL RELEASE	
	-----	-----	PROCEDURE 2.
7	SS -> CTS-MS	CTS PAGING REQUEST	2nd CTS-MSI addresses CTS-MS; 1st, 3rd and 4th CTS-MSIs address other CTS-MSs.
8	CTS-MS -> SS	CTS ACCESS REQUEST	Establ. Cause = "Answer to paging".
9	CTS-MS -> SS	CTS ACCESS REQUEST	Establ. Cause = "Answer to paging".
10	SS -> CTS-MS	CTS IMMEDIATE ASSIGNMENT	Access Request Reference = pertaining to the message received in step 9.
11	CTS-MS -> SS	CTS PAGING RESPONSE	Mobile Ident: CTS-MSI.
12	SS -> CTS-MS	CTS CHANNEL RELEASE	
	-----	-----	PROCEDURE 3.
13	SS -> CTS-MS	CTS PAGING REQUEST	3rd CTS-MSI addresses CTS-MS; 1st, 2nd and 4th CTS-MSIs address other CTS-MSs.
14	CTS-MS -> SS	CTS ACCESS REQUEST	Establ. Cause = "Answer to paging".
15	CTS-MS -> SS	CTS ACCESS REQUEST	Establ. Cause = "Answer to paging".
16	SS -> CTS-MS	CTS IMMEDIATE ASSIGNMENT	Access Request Reference = pertaining to the message received in step 15.
17	CTS-MS -> SS	CTS PAGING RESPONSE	Mobile Ident: CTS-MSI.
18	SS -> CTS-MS	CTS CHANNEL RELEASE	
	-----	-----	PROCEDURE 4
19	SS -> CTS-MS	CTS PAGING REQUEST	4th CTS-MSI addresses CTS-MS; 1st, 2nd and 3rd CTS-MSIs address other CTS-MSs.
20	CTS-MS -> SS	CTS ACCESS REQUEST	Establ. Cause = "Answer to paging".
21	CTS-MS -> SS	CTS ACCESS REQUEST	Establ. Cause = "Answer to paging".
22	SS -> CTS-MS	CTS IMMEDIATE ASSIGNMENT	Access Request Reference = pertaining to the message received in step 21.
23	CTS-MS -> SS	CTS PAGING RESPONSE	Mobile Ident: CTS-MSI.
24	SS -> CTS-MS	CTS CHANNEL RELEASE	

Specific Message Contents

None

39.5.3.1.3.2 Paging with invalid CTS-MSI

39.5.3.1.3.2.1 Conformance requirements

The attached CTS-MS shall not respond to CTS PAGING REQUEST messages with invalid CTS-MSIs

39.5.3.1.3.2.2 Test purpose

To test that the attached CTS-MS is able to determine its paging subgroup correctly and that the CTS-MS does not respond to a CTS PAGING REQUEST message containing invalid CTS Mobile identities CTS-MSIs.

References:

GSM 04.56 section 4.3.2

39.5.3.1.3.2.3 Method of test

Related PICS/PIXIT statements:

None

Initial conditions:

The CTS-MS is in the "Attached, idle, updated", with a CTS-MSI allocated.

Foreseen Final State of the CTS-MS

"Attached, idle, updated", with CTS-MSI allocated.

Test procedure

The SS pages the attached CTS-MS with a CTS PAGING REQUEST message containing invalid CTS-MSIs on the paging subchannel which corresponds to the CTS-MS's IMSI (CTS-IMSI). The SS does not respond nor produce any Layer 3 message. The SS then stop the paging upon timer expiration.

Maximun Duration of Test

2 seconds

Expected Sequence

Step	Direction	Message	Comments
1	SS -> CTS-MS	CTS PAGING REQUEST	None of the 4 CTS-MSIs addresses correctly CTS-MS.
2	-----	-----	During 1 second, the SS checks that the CTS-MS does not produce any Layer 3 messages.

Specific Message Contents

None

39.5.3.1.4 Reserved

39.5.3.1.5 Reserved

39.5.3.1.6 Reserved

39.5.3.1.7 Reserved

39.5.3.1.8 Reserved

39.5.3.1.9 Channel Release

39.5.3.1.9.1 Channel Release/ TCH-F - L2 ACK

39.5.3.1.9.1.1 Conformance requirements[TBC]

After the acknowledgement of the Layer 2 disconnection by the CTS-FP, the CTS-MS shall not produce any further RF-transmission.

39.5.3.1.9.1.2 Test purpose

To verify that the CTS-MS is able to correctly release a full-rate TCH after having received a CTS CHANNEL RELEASE message.

References:

GSM 04.56 section 4.4.13.1

39.5.3.1.9.1.3 Method of test

Related PICS/PIXIT statements:

Initial conditions:

CTS-MS:

The CTS-MS is in the "Attached, idle, updated", with a CTS-MSI allocated.

Foreseen Final State of the CTS-MS

"Attached, idle, updated", with CTS-MSI allocated.

Test procedure

The CTS-MS is paged and allocated a dedicated channel and the Layer 2 signalling link is established. The SS then sends a CTS CHANNEL RELEASE message, after which the CTS-MS shall initiate a Layer 2 disconnection process on the main signalling link. After the acknowledgement of the Layer 2 disconnection by the SS, the CTS-MS shall stop transmission of Layer 2 messages. This is verified for 3 seconds. The CTS-MS shall return to the idle state, which is verified through the paging procedure to which the CTS-MS shall respond

Maximun Duration of Test

[TBD]

Expected Sequence

Step	Direction	Message	Comments
1	SS->CTS-MS	CTS PAGING REQUEST	
2	CTS-MS->SS	CTS ACCESS REQUEST	Establishment cause indicates "answer to paging".
3	SS->CTS-MS	CTS IMMEDIATE ASSIGNMENT	Channel Type = "Bm + ACCHs"
4	CTS-MS->SS	CTS PAGING RESPONSE	
5	SS->CTS-MS	CTS CHANNEL RELEASE	With a valid RR cause value
6	CTS-MS->SS	DISC L2 frame	The CTS-MS may send the DISC message without performing a layer 2 acknowledgement of the CTS CHANNEL RELEASE message
7	SS->CTS-MS	UA L2 frame	
8			The SS verifies for 3 seconds that the CTS-MS does not produce any Layer 2 messages.
9	SS->CTS-MS	CTS PAGING REQUEST	
10	CTS-MS->SS	CTS ACCESS REQUEST	Establ. Cause = "Answer to paging".
11	SS->CTS-MS	CTS IMMEDIATE ASSIGNMENT	
12	CTS-MS->SS	CTS PAGING RESPONSE	
13	SS->CTS-MS	CTS CHANNEL RELEASE	

Specific Message Contents

[TBD]

39.5.3.1.9.2 Channel Release/ TCH-F – no L2 ACK

39.5.3.1.9.2.1 Conformance requirements [TBC]

After the expiry of timer TC3151 the CTS-MS shall not produce any further RF-transmission.

39.5.3.1.9.2.2 Test purpose

To verify that the CTS-MS is able to correctly release a TCH/F after having received a CTS CHANNEL RELEASE message, even if the CTS-FP does not L2 acknowledge the L2 DISC frame.

References:

GSM 04.56 section 4.4.13.1

39.5.3.1.9.2.3 Method of test

Related PICS/PIXIT statements:

Initial conditions:

CTS-MS:

The CTS-MS is in the "Attached, idle, updated", with a CTS-MSI allocated.

Foreseen Final State of the CTS-MS

"Attached, idle, updated", with CTS-MSI allocated.

Test procedure

The CTS-MS is paged and allocated a dedicated channel and the Layer 2 signalling link is established. The SS then sends a CTS CHANNEL RELEASE after which the MS shall send at least 2 L2 DISC frames. The SS does not acknowledge any of the L2 DISC frames. After 2 seconds, the SS verifies for 3 seconds that the CTS-MS has stopped transmission of Layer 2 messages. The CTS-MS shall return to the idle state, which is verified through the paging procedure to which the CTS-MS shall respond.

Maximum Duration of Test

[TBD]

Expected Sequence

Step	Direction	Message	Comments
1	SS->CTS-MS	CTS PAGING REQUEST	
2	CTS-MS->SS	CTS ACCESS REQUEST	Establishment cause indicates "answer to paging".
3	SS->CTS-MS	CTS IMMEDIATE ASSIGNMENT	Channel Type = "Bm + ACCHs"
4	CTS-MS->SS	CTS PAGING RESPONSE	
5	SS->CTS-MS	CTS CHANNEL RELEASE	With a valid RR cause value
6	CTS-MS->SS	DISC	The CTS-MS may send the DISC message without performing a layer 2 acknowledgement of the CTS CHANNEL RELEASE message. The CTS-MS shall send at least 2 L2 DISC frames, to which the SS does not respond. After a period of 2 seconds, the SS verifies for 3 seconds that the CTS-MS does not produce any further Layer 2 messages.
7			The SS waits 12 seconds to allow the CTS-MS to perform cell reselection.
8	SS->CTS-MS	CTS PAGING REQUEST	
9	CTS-MS->SS	CTS ACCESS REQUEST	Establ. Cause = "Answer to paging".
10	SS->CTS-MS	CTS IMMEDIATE ASSIGNMENT	
11	CTS-MS->SS	CTS PAGING RESPONSE	
12	SS->CTS-MS	CTS CHANNEL RELEASE	

Specific Message Contents

[TBD]

39.5.3.1.10 Authentication

39.5.3.1.10.1 Local Mutual Authentication failure

According to GSM 03.20 Annex E, section 3.2.1.1, an authentication failure occurs if:

- the CTS-MS and the CTS-FP have different Ka or/and
- the algorithms B3 and/or B4 are not implemented as specified (i.e. non type approved equipment)

39.5.3.1.10.1.1 Conformance requirements:

After reception of a CTS Authentication Response message from the CTS-FP and SRES2 does not match with the local XSRES2, the CTS Mobile Station shall disconnect the main signalling link by sending a DISC L2 frame to the CTS-FP.

39.5.3.1.10.1.2 Test purpose:

To check that the CTS-MS is able to process B3 and B4 algorithms.

To check that the CTS-MS abort the RR connection if the authentication of the fixed part fails.

References:

GSM 3.20 section 3.2.1

GSM 4.56 section

39.5.3.1.10.1.3 Method of test

Related PICS/PIXIT statements:

Initial conditions:

SS:

The SS has valid Ka, Kc.

CTS-MS:

The CTS-MS is in the "Attached, idle, updated", with valid CTS-MSI1, Ka', Kc'.

Ka # Ka'

Foreseen Final State of the CTS-MS

"Attached, idle, updated", with CTS-MSI2, Ka', Kc' allocated.

Test procedure

The attached CTS-MS is paged. After the CTS-MS has sent a CTS PAGING RESPONSE message to the SS, the SS initiates a CTS authentication procedure by sending a CTS MS AUTHENTICATION REQUEST with an unpredictable number CH1. The CTS-MS shall send in turn a CTS FP AUTHENTICATION REQUEST with an unpredictable number CH2 and checks the value SRES2 sent by the SS in the CTS FP AUTHENTICATION RESPONSE message. Ka and Ka' are different so the checked SRES2 value is not valid, then CTS-MS shall disconnect the main signalling link by sending a DISC L2 frame to the SS.

Maximun Duration of Test

[TBD]

Expected Sequence

Step	Direction	Message	Comments
1	SS -> CTS-MS	CTS PAGING REQUEST	
2	CTS-MS -> SS	CTS ACCESS REQUEST	Establ. Cause = "Answer to paging"
3	SS -> CTS-MS	CTS IMMEDIATE ASSIGNMENT	
4	CTS-MS -> SS	CTS PAGING RESPONSE	
5	SS -> CTS-MS	CTS MS AUTHENTICATION REQUEST	CH1 is sent by SS
6	CTS-MS -> SS	CTS FP AUTHENTICATION REQUEST	CH2 is sent by CTS-MS
7	SS -> CTS-MS	CTS FP AUTHENTICATION RESPONSE	"Auth. parameter SRES2" IE is not equal to the value XSRES2 produced by the authentication algorithm
8	CTS-MS -> SS	DISC	
9	SS -> CTS-MS	UA	

Specific Message Contents

None

39.5.3.1.11 Reserved

39.5.3.1.12 Reserved

39.5.3.1.13 Radio Link Management

39.5.3.1.13.1 AFA Measurement and Reporting

The CTS radio interface has been designed to meet a requirement of low generated interference, either from the CTS to existing overlaying PLMNS, either from a CTS to another CTS. This requirement is achieved by the combined usage of the three concepts : beacon concept, AFA concept and TFH concept.

39.5.3.1.13.1.1 Conformance requirements

A precise radio frequency planning can not be applied to the CTS-FP/MS pair, as the CTS is intended to be deployed by the end-user. Therefore, a list of frequencies (the GFL) on which it is allowed to operate is given to the CTS. With the AFA, interference measurements will be performed on the frequencies in the GFL to provide a ranking in the AFA table, in order to exclude unacceptably interfered frequencies from the usage in CTS.

39.5.3.1.13.1.2 Test purpose

To check that the CTS-MS is able to perform AFA monitoring procedure.

To check that the CTS-MS is able to perform AFA monitoring reporting when order by the CTS-FP.

References

GSM 3.52 section 12.2.2.1

GSM 3.52 section 12.3.3.2.1

GSM 5.08 section 11.1.4.1

39.5.3.1.13.1.3 Method of test

Related PICS/PIXIT statements

Initial conditions

CTS-MS:

The CTS-MS is in the "Attached, idle, updated" mode, with a CTS-MSI allocated.

Foreseen Final State of the CTS-MS

The CTS-MS is in the "Attached, idle, updated" mode, with a CTS-MSI allocated.

Test procedure

The attached CTS-MS shall respond to a pending CTS PAGING REQUEST message. The CTS-MS shall send CTS ACCESS REQUEST messages, with an Establishment Cause set to "Answer to Paging", until the SS answers. The general access procedure is then performed. The SS sends a CTS AFA MONITORING COMMAND. Finally the SS sends a CTS CHANNEL RELEASE. For each carrier of the AFA List, the CTS-MS shall perform NAMC basic measurements, where a basic measurement shall be the average received signal level on the 8 timeslots of the TDMA frame. The delay between two consecutive basic measurements shall be at least 5 seconds. The received interference level of the carrier shall be the maximum of the NAMC basic measurements. The maximum processing time for this procedure shall be NAMC x 10 seconds.

The SS shall wait (NAMC x 10 + 20) seconds before starting the AFA reporting procedure to let the CTS-MS enough time to perform the monitoring procedure during NAMC cycle. When ordered by the SS with the CTS AFA MONITORING ENQUIRY, the CTS-MS shall report in the CTS AFA MONITORING REPORT message a table of received interference level for all frequencies of the AFA List, together with the AFA monitoring cycles equal to NAMC. Finally the SS sends a CTS CHANNEL RELEASE.

Maximum Duration of Test

[TBD]

Expected Sequence

Step	Direction	Message	Comments
1	SS -> CTS-MS	CTS PAGING REQUEST	CTS-MSI
2	CTS-MS -> SS	CTS ACCESS REQUEST	
3	SS -> CTS-MS	CTS IMMEDIATE ASSIGNMENT	
4	CTS-MS -> SS	CTS PAGING RESPONSE	
5	SS -> CTS-MS	CTS MS AUTHENTICATION REQUEST	
6	CTS-MS -> SS	CTS MS AUTHENTICATION RESPONSE	
7	SS -> CTS-MS	CTS FP AUTHENTICATION RESPONSE	
8	SS -> CTS-MS	CTS CIPHERING MODE COMMAND	
9	CTS-MS -> SS	CTS CIPHERING MODE COMPLETE	
10	SS -> CTS-MS	CTS AFA MONITORING COMMAND	AFA List NAMC = 6
11	SS -> CTS-MS	CTS CHANNEL RELEASE	
12			The CTS-MS is performing AFA measurement. The SS shall wait 80 seconds before starting the AFA reporting procedure to let the CTS-MS enough time to perform the monitoring procedure during NAMC cycle
13	SS -> CTS-MS	CTS PAGING REQUEST	CTS-MSI
14	CTS-MS -> SS	CTS ACCESS REQUEST	
15	SS -> CTS-MS	CTS IMMEDIATE ASSIGNMENT	
16	CTS-MS -> SS	CTS PAGING RESPONSE	
17	SS -> CTS-MS	CTS MS AUTHENTICATION REQUEST	
18	CTS-MS -> SS	CTS MS AUTHENTICATION RESPONSE	
19	SS -> CTS-MS	CTS FP AUTHENTICATION RESPONSE	
20	SS -> CTS-MS	CTS CIPHERING MODE COMMAND	
21	CTS-MS -> SS	CTS CIPHERING MODE COMPLETE	
22	SS -> CTS-MS	CTS AFA MONITORING ENQUIRY	
23	CTS-MS -> SS	CTS AFA MONITORING REPORT	The SS checks the AFA List The SS checks that NAMC = 6
24	SS -> CTS-MS	CTS CHANNEL RELEASE	

Specific Message Contents

None

39.5.3.1.13.2 Total Frequency Hopping List update

The CTS radio interface has been designed to meet a requirement of low generated interference, either from the CTS to existing overlaying PLMNS, either from a CTS to another CTS. This requirement is achieved by the combined usage of the three concepts : beacon concept, AFA concept and TFH concept.

39.5.3.1.13.2.1 Conformance requirements

A precise radio frequency planning can not be applied to the CTS-FP/MS pair, as the CTS is intended to be deployed by the end-user. Therefore, a list of frequencies (the GFL) on which it is allowed to operate is given to the CTS. With the AFA, interference measurements will be performed on the frequencies in the GFL to provide a ranking in the AFA table, in order to exclude unacceptably interfered frequencies from the usage in CTS.

The remaining frequencies are used by the Total Frequency Hopping algorithm in order to reduce the interference of the CTS with the overlaying PLMN and other CTS-FP/MS pairs. With TFH the interference caused by the CTS link is spread across multiple GSM links (interference averaging) and the co-channel interference is due to different users at different locations (interference diversity).

39.5.3.1.13.2.2 Test purpose

To check that the CTS-MS is able to store the new TFH list broadcast by the CTS-FP on a dedicated channel. To check that the CTS-MS is able to establish a TCH/F channel in total frequency hopping mode using the new TFH list.

References

GSM 3.52 section 12.2.2.1

GSM 3.52 section 12.3.3.2.1

39.5.3.1.13.2.3 Method of test

Related PICS/PIXIT statements

Initial conditions

CTS-FP:

Radio_Link_Timeout set to [TBC]

CTS-MS:

The CTS-MS is in the "Attached, idle, updated" mode, with a CTS-MSI allocated.

Foreseen Final State of the CTS-MS

The CTS-MS is in the "Attached, idle, updated" mode, with a CTS-MSI allocated.

Test procedure

The attached CTS-MS shall respond to a pending CTS PAGING REQUEST message. The CTS-MS shall send CTS ACCESS REQUEST messages, with an Establishment Cause set to "Answer to Paging", until the SS answers. The general access procedure is then performed. The SS sends a CTS FREQUENCY HOPPING REDEFINITION. The CTS-MS should store the new TFH list without erasing the old one as long as the frame number broadcast in the Starting Time field as not occurred.

Finally the SS sends a CTS CHANNEL RELEASE.

The SS wait until the new TFH list is applicable.

The SS send a CTS PAGING REQUEST with the last known CTS-MS's CTS-MSI. The CTS-MS should establish a TCH/F channel in total frequency hopping mode using the new TFH list.

Maximum Duration of Test

[TBD]

Expected Sequence

Step	Direction	Message	Comments
1	SS -> CTS-MS	CTS PAGING REQUEST	CTS-MSI
2	CTS-MS -> SS	CTS ACCESS REQUEST	
3	SS -> CTS-MS	CTS IMMEDIATE ASSIGNMENT	
4	CTS-MS -> SS	CTS PAGING RESPONSE	
5	SS -> CTS-MS	CTS MS AUTHENTICATION REQUEST	
6	CTS-MS -> SS	CTS MS AUTHENTICATION RESPONSE	
7	SS -> CTS-MS	CTS FP AUTHENTICATION RESPONSE	
8	SS -> CTS-MS	CTS CIPHERING MODE COMMAND	
9	CTS-MS -> SS	CTS CIPHERING MODE COMPLETE	
10	SS -> CTS-MS	CTS FREQUENCY HOPPING REDEFINITION	Starting Time = [TBD]
11	SS -> CTS-MS	CTS CHANNEL RELEASE	
12			Wait Starting Time plus n multiframes.
13	SS -> CTS-MS	CTS PAGING REQUEST	CTS-MSI
14	CTS-MS -> SS	CTS ACCESS REQUEST	
15	SS -> CTS-MS	CTS IMMEDIATE ASSIGNMENT	TCH/F
16	CTS-MS -> SS	CTS PAGING RESPONSE	
17	SS -> CTS-MS	CTS CHANNEL RELEASE	

Specific Message Contents

None

39.5.3.2 Structured Procedures

39.5.3.2.1 Attachment

39.5.3.2.1.1 CTS attachment retry with same FPBI and BCH carrier

39.5.3.2.1.1.1 Conformance requirements

If the fixed part identity is not the expected one, the mobile station shall start the timer TC3256. The mobile shall not attempt to attach to any fixed part having the same FPBI before expiration of the timer TC3256. This does not forbid attachment to fixed parts having another FPBI.

39.5.3.2.1.1.2 Test purpose

To check that the CTS-MS does not start the CTS attachment procedure if there was a failed CTS attachment with the same FPBI, same BCH carrier and same relative frame position of the BCH SB in the BCH superframe within the last 10 minutes.

References

GSM 4.56 section 5.3.2.4

GSM 4.56 section 5.2.3

39.5.3.2.1.1.3 Method of test

Related PICS/PIXIT statements

Initial conditions

SS:

Radio_Link_Timeout set to [TBC]

CTS-MS:

The CTS-MS is in the “Enrolled, idle, updated” mode, with a CTS-MSI allocated.

Foreseen Final State of the CTS-MS

The CTS-MS is in the “Enrolled, idle, updated” mode, with a CTS-MSI allocated.

Test procedure

1. The enrolled CTS-MS is made to register on a SS. The CTS-MS is locked on the BCH carrier with a known FPBI identity. It shall send at least one CTS ACCESS REQUEST message with establishment cause set to "CTS attachment", the SS sends a CTS IMMEDIATE ASSIGNMENT. The CTS-MS shall send a CTS ATTACHMENT REQUEST message. The SS does not identify the CTS-MSI so it starts an identification procedure to get the IMSI of the CTS-MS. The SS returns a CTS ATTACHMENT REJECT message with Reject cause = "not enrolled". The SS sends a CTS CHANNEL RELEASE. The CTS-MS shall not initiate a RR connection establishment during 10 mn.
2. The test is started again. Now the CTS-MSI is recognised but the keys Ka and Kinit does not match so the authentication of the CTS-MS fails. In this case, the SS shall send a CTS AUTHENTICATION REJECT, and the CTS attachment reject is implicit. The SS sends a CTS CHANNEL RELEASE. The CTS-MS shall not initiate a RR connection establishment during 10 mn.

Maximum Duration of Test

[TBD]

Expected Sequence

Step	Direction	Message	Comments
			PROCEDURE 1
1	CTS-MS -> SS	CTS ACCESS REQUEST	Establ. Cause = "CTS attachment"
2	SS -> CTS-MS	CTS IMMEDIATE ASSIGNMENT	
3	CTS-MS -> SS	CTS ATTACHMENT REQUEST	CTS-MSI is not recognised by the SS
4	SS -> CTS-MS	IDENTITY REQUEST	
5	CTS-MS -> SS	IDENTITY RESPONSE	IMSI is sent to the SS
6	SS -> CTS-MS	CTS ATTACHMENT REJECT	Reject cause = "Not enrolled"
7	SS -> CTS-MS	CTS CHANNEL RELEASE	
8			The CTS-MS shall not initiate a RR connection establishment on the same BCH carrier with the same FPBI. This is checked during 10 mn.
			PROCEDURE 2
9	CTS-MS -> SS	CTS ACCESS REQUEST	
10	SS -> CTS-MS	CTS IMMEDIATE ASSIGNMENT	
11	CTS-MS -> SS	CTS ATTACHMENT REQUEST	
12	SS -> CTS-MS	CTS MS AUTHENTICATION REQUEST	
13	CTS-MS -> SS	CTS MS AUTHENTICATION RESPONSE	SRES1 # XSRES1. The SS initiates identification procedure
14	SS -> CTS-MS	IDENTITY REQUEST	
15	CTS-MS -> SS	IDENTITY RESPONSE	IMSI is sent to the SS
16	SS -> CTS-MS	CTS MS AUTHENTICATION REQUEST	
17	CTS-MS -> SS	CTS MS AUTHENTICATION RESPONSE	
18	SS -> CTS-MS	CTS FP AUTHENTICATION REJECT	SRES1 # XSER1. Attachment reject is implicit.
19	SS -> CTS-MS	CTS CHANNEL RELEASE	
20			The CTS-MS shall not initiate a RR connection establishment on the same BCH carrier with the same FPBI. This is checked during 10 mn.

Specific Message Contents

None

39.5.3.2.2 Detachment

39.5.3.2.2.1 CTS detachment upon CTS-MS power off

The CTS detachment procedure is used to detach an enattached CTS-MS from a CTS-FP.

39.5.3.2.2.1.1 Conformance requirements

The purpose of the CTS detach procedure is to detach a mobile station from a fixed part. The mobile station may launch the detach procedure during the CTS mode deactivation (e.g. at the power off, when the SIM is extracted, when the mobile station is set in GSM mode only).

The CTS detach procedure is always initiated by the mobile station.

39.5.3.2.2.1.2 Test purpose

To check that the CTS- MS starts the CTS detachment procedure if:

- it is switched off within the range of the CTS-FP.
- the SIM is extracted.
- the mobile station is set in GSM mode only.

References:

GSM 04.56 section 5.2.1

39.5.3.2.2.1.3 Method of test

Related PICS/PIXIT statements:

Initial conditions:

SS:

Radio_Link_Timeout set to [TBC].

CTS-MS:

The CTS-MS is in the "Attached, idle, updated", with a CTS-MSI allocated. The CTS-MS is in CTS mode only.

Foreseen Final State of the CTS-MS

"Enrolled, idle, updated", with CTS-MSI allocated.

Test procedure

1. The attached CTS-MS is switched off. It shall send at least one CTS ACCESS REQUEST message with establishment cause set to " detachment ", the SS sends a CTS IMMEDIATE ASSIGNMENT. The CTS-MS shall send a CTS DETACHMENT INDICATION message. Finally the SS sends a CTS CHANNEL RELEASE to end the test.
2. The CTS-MS is switched on. It shall start the attach procedure. When the attachment procedure is completed, the SIM is removed from the CTS-MS. The CTS-MS should start the detach procedure as described in phase 1.

3. The CTS-MS is switched on. It shall start the attach procedure. When the attachment procedure is completed, the CTS-MS is switched to GSM mode only. The CTS-MS should start the detach procedure as described in phase 1.

Maximun Duration of Test

[TBD]

Expected Sequence

Step	Direction	Message	Comments
			PROCEDURE 1
1			The attached CTS-MS is switched off
2	CTS-MS -> SS	CTS ACCESS REQUEST	Establ. Cause = "CTS detachment"
3	SS -> CTS-MS	CTS IMMEDIATE ASSIGNMENT	
4	CTS-MS -> SS	CTS DETACHMENT INDICATION	CTS-MSI
5	SS -> CTS-MS	CTS CHANNEL RELEASE	
			PROCEDURE 2
6			The CTS-MS is switched on
7	SS -> CTS-MS	CTS CHANNEL RELEASE	
8	CTS-MS -> SS	CTS ACCESS REQUEST	
9	SS -> CTS-MS	CTS IMMEDIATE ASSIGNMENT	
10	CTS-MS -> SS	CTS ATTACHMENT REQUEST	
11	SS -> CTS-MS	CTS MS AUTHENTICATION REQUEST	
12	CTS-MS -> SS	CTS MS AUTHENTICATION RESPONSE	
13	SS -> CTS-MS	CTS FP AUTHENTICATION RESPONSE	
14	SS -> CTS-MS	CTS CIPHERING MODE COMMAND	
15	CTS-MS -> SS	CTS CIPHERING MODE COMPLETE	
16	SS -> CTS-MS	IDENTITY REQUEST	
17	CTS-MS -> SS	IDENTITY RESPONSE	
18	SS -> CTS-MS	CTS CTS-MSI UPDATE COMMAND	
19	CTS-MS -> SS	CTS CTS-MSI UPDATE COMPLETE	
20	SS -> CTS-MS	CTS ATTACHMENT ACCEPT	
21	SS -> CTS-MS	CTS CHANNEL RELEASE	
22			The SIM is removed from the CTS-MS
23	CTS-MS -> SS	CTS ACCESS REQUEST	Establ. Cause = "CTS detachment"
24	SS -> CTS-MS	CTS IMMEDIATE ASSIGNMENT	
25	CTS-MS -> SS	CTS DETACHMENT INDICATION	CTS-MSI
26	SS -> CTS-MS	CTS CHANNEL RELEASE	
			PROCEDURE 3
27			The SIM is inserted in the CTS-MS
28	SS -> CTS-MS	CTS CHANNEL RELEASE	
29	CTS-MS -> SS	CTS ACCESS REQUEST	
30	SS -> CTS-MS	CTS IMMEDIATE ASSIGNMENT	
31	CTS-MS -> SS	CTS ATTACHMENT REQUEST	
32	SS -> CTS-MS	CTS MS AUTHENTICATION REQUEST	
33	CTS-MS -> SS	CTS MS AUTHENTICATION RESPONSE	
34	SS -> CTS-MS	CTS FP AUTHENTICATION RESPONSE	
35	SS -> CTS-MS	CTS CIPHERING MODE COMMAND	
36	CTS-MS -> SS	CTS CIPHERING MODE COMPLETE	
37	SS -> CTS-MS	IDENTITY REQUEST	
38	CTS-MS -> SS	IDENTITY RESPONSE	
39	SS -> CTS-MS	CTS CTS-MSI UPDATE COMMAND	
40	CTS-MS -> SS	CTS CTS-MSI UPDATE COMPLETE	
41	SS -> CTS-MS	CTS ATTACHMENT ACCEPT	
42	SS -> CTS-MS	CTS CHANNEL RELEASE	
43			The CTS-MS is switched to GSM mode only
44	CTS-MS -> SS	CTS ACCESS REQUEST	Establ. Cause = "CTS detachment"
45	SS -> CTS-MS	CTS IMMEDIATE ASSIGNMENT	
46	CTS-MS -> SS	CTS DETACHMENT INDICATION	CTS-MSI
47	SS -> CTS-MS	CTS CHANNEL RELEASE	

Specific Message Contents

None

39.5.3.2.3 Reserved

39.5.3.2.4 Reserved

39.5.3.2.5 Reserved

39.5.3.2.6 Reserved

39.5.3.2.7 Handover

39.5.3.2.7.1 Handover / successful / active call / total frequency hopping

39.5.3.2.7.1.1 Conformance requirements

The MS shall correctly apply the handover procedure when a call is in progress and when handover is performed from a TCH/F with total frequency hopping towards a TCH/F with total frequency hopping.

39.5.3.2.7.1.2 Test purpose

To test that the MS correctly handles the values of any Starting Time IE in the CTS HANDOVER COMMAND message. To test that the CTS-MS activates the new channel correctly and transmits the SABM on a correct frame number.

References

GSM 4.56 section 4.4.3

39.5.3.2.7.1.3 Method of test

Related PICS/PIXIT statements

Initial conditions

SS:

Radio_Link_Timeout set to [TBC]

CTS-MS:

The CTS-MS is in the active state of a call using a full rate TCH in total frequency hopping mode.

Foreseen Final State of the CTS-MS

The CTS-MS is in the active state of a call using a full rate TCH in total frequency hopping mode.

Test procedure

The CTS-MS is in the active state of a call. The SS send a CTS INTRACELL HANDOVER COMMAND on the main DCCH. The CTS-MS shall (at the time defined by the Starting Time information element) activate the channel by sending a SABM message. The CTS-MS shall be ready to transmit a CTS HANDOVER COMPLETE message, after a UA frame has been sent by the SS.

Maximum Duration of Test

[TBD]

Expected Sequence

Step	Direction	Message	Comments
1	SS -> CTS-MS	CTS INTRACELL HANDOVER COMMAND	Indicates the frame number that will occur approximately 1.1 seconds after the CTS HANDOVER COMMAND is sent.
2	CTS-MS -> SS	SABM	The SS checks the Frame Number.
3	SS -> CTS-MS	UA	
4	CTS-MS -> SS	CTS INTRACELL HANDOVER COMPLETE	

Specific Message Contents

None

39.5.3.2.8

39.5.3.2.8.1 Handover / Layer 1 Failure

39.5.3.2.8.1.1 Conformance requirements

The MS shall return to the old channel in the case of an handover failure caused by the non establishment of the new channel. On the old channel the MS shall use the old channel description or channel mode.

39.5.3.2.8.1.2 Test purpose

To test that the CTS-MS try to activates the new channel correctly and transmits the SABM. To test that CTS-MS switch ack to the old channel if the activation of the new channel fails.

References

39.5.3.2.8.1.3 Method of test

Related PICS/PIXIT statements

Initial conditions

SS:

Radio_Link_Timeout set to [TBC]

CTS-MS:

The CTS-MS is in the active state of a call using a full rate TCH in total frequency hopping mode.

Foreseen Final State of the CTS-MS

The CTS-MS is in the active state of a call using a full rate TCH in total frequency hopping mode.

Test procedure

The CTS-MS is in the active state of a call. The SS send a CTS INTRACELL HANDOVER COMMAND on the main DCCH. The CTS-MS shall (at the time defined by the Starting Time information element) activate the channel by sending a SABM message and start timer T200. When timer T200 ends, the CTS-MS should retransmits the Layer 2 SABM up to N200 times. Then the CTS-MS sends the SABM frame on the old time slot, wait for the UA frame and sends the CTS INTRACELL HANDOVER FAILURE on the old time slot.

Maximum Duration of Test

[TBD]

Expected Sequence

Step	Direction	Message	Comments
1	SS -> CTS-MS	CTS INTRACELL HANDOVER COMMAND	Indicates the frame number that will occur approximately 1.1 seconds after the CTS HANDOVER COMMAND is sent.
2	CTS-MS -> SS	L2 SABM	
3			Timer T200
4	CTS-MS -> SS	L2 SABM	New Time Slot, N200 Times
5	CTS-MS -> SS	L2 SABM	Old Time Slot
6	CTS-MS -> SS	L2 UA	Old Time Slot
7	CTS-MS -> SS	CTS INTRACELL HANDOVER FAILURE	Old Time Slot

Specific Message Contents

None

39.5.3.3 Initialisation

39.5.3.3.1 Enrolment

39.5.3.3.1.1 Enrolment with non CTS SIM

To check that the CTS-MS does not ask for CTS services with a non CTS SIM

39.5.3.3.1.1.1 Conformance requirements

The MS-SIM verification follows the normal GSM requirements. The GSM subscription is checked whenever the CTS-MS accesses the PLMN (authentication performed using the IMSI, Ki and A3 in the MS-SIM card).

39.5.3.3.1.1.2 Test purpose

To check that the CTS-MS checks for the DF-CTS presence in the SIM before starting enrolment procedure.

References

GSM 3.20 Annexe E section 4.6

39.5.3.3.1.1.3 Method of test

Related PICS/PIXIT statements

Initial conditions

SS:

Enrolment procedure ready at the SS side

CTS-MS:

The CTS-MS is OFF.

The DF-CTS field is not available in the SIM.

Foreseen Final State of the CTS-MS

Scanning for an available Network.

Test procedure

The CTS-MS is switched ON. The CTS-MS is made to start enrolment procedure. It shall not start the enrolment procedure as long as the SIM has no DF-CTS entry.

Maximum Duration of Test

[TBD]

Expected Sequence

Step	Direction	Message	Comments
1			The CTS-MS is looking for a suitable GSM only Network.
2			Check that the CTS-MS doesn't send CTS ACCESS REQUEST for 2 minutes.

Specific Message Contents

None

39.5.3.3.1.2 CTS-FP not ready for Enrolment

The CTS-MS/CTS-FP enrolment is the procedure, which generates an association between a certain CTS-MS and a certain CTS-FP, i.e. a CTS-MS/CTS-FP pair is established.

39.5.3.3.1.2.1 Conformance requirements

In order to perform the enrolment of a CTS-MS, a special procedure shall be implemented in the CTS-FP, by which the initial synchronisation of a CTS-MS with the CTS-FP is eased. This procedure of synchronisation for CTS-MS enrolment shall be triggered by the CTS upper layers.

39.5.3.3.1.2.2 Test purpose

To check that the CTS-MS is looking at the enrolment state of the CTS-FP before starting enrolment procedure.

References

GSM 3.20 Annexe E section 3.4.1.1

GSM 5.08 section 11.1.1.2

39.5.3.3.1.2.3 Method of test

Related PICS/PIXIT statements

Initial conditions

SS:

Enrolment procedure not ready at the SS side.

CTS-MS:

The CTS-MS is not enrolled on the SS, and idle.

Foreseen Final State of the CTS-MS

Scanning for an available Network.

Test procedure

The CTS-MS is not enrolled with that SS, i.e. the CTS-IFPSI nor the CTS-IFPEI of that SS are stored in the SIM of the CTS-MS. The SS is not switched to the CTS enrolment mode. The CTS-MS is made to start enrolment to that SS. It shall not start the procedure as long as the SS is not in the enrolment mode.

Maximum Duration of Test

[TBD]

Expected Sequence

Step	Direction	Message	Comments
1			SS enrolment mode not set
2			Check that the CTS-MS doesn't send CTS ACCESS REQUEST for 2 minutes.

Specific Message Contents

None

39.5.3.3.2 Reserved

39.5.3.3.3 De-enrolment

39.5.3.3.3.1 Attached CTS-MS de-enrolment

The de-enrolment of a CTS-MS is the procedure which cancel the association between a certain CTS-MS and a certain CTS-FP.

39.5.3.3.3.1.1 Conformance requirements

The fixed part initiates the CTS de-enrolment procedure by sending a CTS DE-ENROLMENT INDICATION to the mobile station. Then the fixed part will request the RR sublayer to release the RR connection.

39.5.3.3.3.1.2 Test purpose

To check that the CTS-MS is able to execute the CTS-MS CTS de-enrolment procedure and to erase the corresponding entry in the SIM.

References

GSM 3.20 Annexe E section E.3.4.3.1

GSM 4.56 section 5.2.2.1

39.5.3.3.1.3 Method of test

Related PICS/PIXIT statements

Initial conditions

SS:

Radio_Link_Timeout set to [TBC]

CTS-MS:

The CTS-MS is in the "Attached, idle, updated" mode, with a CTS-MSI allocated.

Foreseen Final State of the CTS-MS

The CTS-MS is not enrolled one that SS, and idle

Test procedure

The attached CTS-MS shall respond to a pending CTS PAGING REQUEST message. The CTS-MS shall send CTS ACCESS REQUEST messages, with an Establishment Cause set to "Answer to Paging", until the SS answers. The general access procedure is then performed. The SS sends a CTS DE-ENROLMENT INDICATION.

Finally the SS sends a CTS CHANNEL RELEASE.

The CTS-MS should remove the corresponding data entry in the SIM.

The SS send a CTS-PAGING REQUEST with the last known CTS-MS's CTS-MSI

Maximum Duration of Test

[TBD]

Expected Sequence

Step	Direction	Message	Comments
1	SS -> CTS-MS	CTS PAGING REQUEST	
2	CTS-MS -> SS	CTS ACCES REQUEST	Establ. Cause "Answer to paging"
3	SS -> CTS-MS	CTS IMMEDIATE ASSIGNMENT	
4	CTS-MS -> SS	CTS PAGING RESPONSE	
5	SS -> CTS-MS	CTS MS AUTHENTICATION REQUEST	Mutual Authentication
6	CTS-MS -> SS	CTS MS AUTHENTICATION RESPONSE	
7	SS -> CTS-MS	CTS FP AUTHENTICATION RESPONSE	
8	SS -> CTS-MS	CTS CIPHERING MODE COMMAND	Cipher Mode Setting = "Start Cipherring; cipher with algorithm A5/2". The SS starts decipherring
9	CTS-MS -> SS	CTS CIPHERING MODE COMPLETE	Sent in ciphered mode using the cipher key determined between steps 5&7
10	SS -> CTS-MS	CTS DE-ENROLMENT INDICATION	
11	SS -> CTS-MS	CTS CHANNEL RELEASE	
12	SS -> CTS-MS	CTS PAGING REQUEST	
13			Check that the CTS-MS doesn't send CTS ACCESS REQUEST for 30 seconds

Specific Message Contents

None

40 GPRS default conditions, message contents and macros.

40.1 Default test conditions.

The following default test conditions shall apply if not otherwise stated within an individual test description.

The testcases for higher layers shall use the second set of default test conditions for channel combination v), xi) and xiii) as specified in section 40.3.

In the tables following, decimal values will normally be used. Where a hexadecimal value is used, it indicated with an "H". A binary value will be indicated with a "B".

Note: The current test conditions are using non hopping configurations for channel combination xi) and xiii). It is intended to introduce hopping channel combination xi) (PBCCH) for lower layer testing at a later date.

40.1.1 Default settings for cell A:

	GSM 900	DCS 1800	PCS 1900
General signalling conditions for all carriers			
Ciphering	Yes	Yes	Yes
General RF-conditions for all carriers			
Frequency hopping mode	Non-hopping	Non-hopping	Non-hopping
Propagation profile	Static	Static	Static
Downlink Input Level	63 dBmVemf()	63 dBmVemf()	63 dBmVemf()
Uplink output power	Minimum according to MS power class	Minimum according to MS power class	Power control level = 10
Serving cell, BCCH/CCCH carrier			
Channel ARFCN	20	590	590
Alternative channels	40 or 60	690 or 830	690 or 730
Serving cell, PDTCH, SDCCCH			
Channel ARFCN	30	650	650
Alternative channels	50 or 70	750 or 850	750 or 780
Power Control Indicator	0	0	0
Neighbouring cells BCCH/CCCH carriers			
Channel ARFCN	10, 80, 90,100, 110,120	520, 600, 700, 780, 810, 870	520, 600, 700, 720, 760, 780
Alternative channels	15, 85, 95, 105, 115, 122	530, 610, 710, 790, 820, 880	530, 610, 710, 740, 770,790
Input level	53 dBmVemf()	53 dBmVemf()	53 dBmVemf()
Network dependent parameters			
Cell identity	0001H	0001H	0001H
Mobile country code, MCC	001 (decimal)	001 (decimal)	001 (decimal)
Mobile network code, MNC	01 (decimal)	01 (decimal)	011 (decimal)
Location area code, LAC	0001H	0001H	0001H
Frequency List	Bit Map 0	Range 512	Range 512
BCCH allocation sequence number(BA_IND)	0	0	0
Cell Channel Descriptor	Bit Map 0	Range 512	Range 512
PLMN colour code, NCC	1	1	1
BS colour code, BCC	5	5	5
SMS Cell Broadcast	Not active	Not active	Not active
DTX	Not available	Not available	Not available
IMSI Attach-detach	MS shall apply IMSI attach and detach procedure	MS shall apply IMSI attach and detach procedure	MS shall apply IMSI attach and detach procedure
For Non Combined CCCH_CONF	000 (1 basic physical channel for CCCH)	000 (1 basic physical channel for CCCH)	1 basic physical channel for CCCH
BS_AG_BLKES_RES	3 blocks reserved	3 blocks reserved	3 blocks reserved
For Combined CCCH_CONF	001 (1 basic physical channel for CCCH)	001 (1 basic physical channel for CCCH)	
BS_AG_BLKES_RES	2 blocks reserved	2 blocks reserved	
BS_PA_MFRMS	6 multiframe	6 multiframe	6 multiframe
CELL_BAR_ACCESS	not barred	not barred	Not barred
Call-reestablishment (RE)	not allowed	not allowed	Not allowed
Emergency Call allowed	Allowed	allowed	Allowed
Access Control Class (AC)	access for all classes allowed	access for all classes allowed	Access for all classes allowed
Radio_Link_Time-out	8	8	8
T3212 Periodic	0 periodic updating shall not be used	0 periodic updating shall not be used	0 periodic updating shall not be used
Access control parameters			
Max retrans	1	1	1
TX-integer	5	5	5
CELL_RESELECT_HYST	12dB	12dB	12dB
ERESIS			
MS_TXPWR_MAX_CCH	10	10	10
RXLEV_ACCESS_MIN	Minimum	minimum	Minimum
NECI	New establishment causes are supported	New establishment causes are supported	New establishment causes are supported
ACS (additional reselection param IND)	No additional cell parameters are present in	No additional cell parameters are present in	No additional cell parameters are present in

P1 and C2 parameters POI and POWER OFFSET	SI messages 7 and 8 C2 parameters not present N/A	SI messages 7 and 8 C2 parameters not present POWER OFFSET Parameter not present	SI messages 7 and 8 C2 parameters not present POWER OFFSET Parameter not present
CELL_BAR_QUALIFY	0	0	0
CELL_RESELECT_OFFSET	0	0	0
PENALTY_TIME	0	0	0
TEMPORARY_OFFSET	0	0	0
BA ARFCN			
	Both P-GSM and E-GSM ARFCNs are broadcast: GSM ARFCNs 10, 20, 40, 80, 90, 100, 110, 120 broadcast in SI 2 E-GSM ARFCNs 985, 989, 995, 1010, 1014 broadcast in SI 2bis For multiband tests, the ARFCNs 10, 20, 40, 80, 90, 100, 110, 120 are broadcast in SI 2 of GSM cell and in SI 2ter of DCS cell. The ARFCNs 520, 590, 600, 700, 780, 810, 870 are broadcast in SI 2 of DCS cell and in SI 2ter of GSM cell	ARFCNs 520, 590, 600, 700, 780, 810, 870 broadcast in SI 2.	ARFCNs 520, 590, 600, 700, 720, 760, 780 broadcast in SI 2
GPRS Parameters			
RA_CODE	00000101	00000101	00000101
EXT_DYN_ALLOCATION_N_SUPPORTED	not supported	not supported	not supported
FIXED_ALLOCATION_SUPPORTED	Supported	supported	supported
ACC_BURST_TYPE	11 bits burst	11 bits burst	11 bits burst
CONTROL_ACK_TYPE	RLC/MAC control block	RLC/MAC control block	RLC/MAC control block
NETWORK_CONTROL_ORDER	normal MS control	normal MS control	normal MS control
DRX_TIMER_MAX	non-DRX not supported	non-DRX not supported	non-DRX not supported
PC_MEAS_CHAN	BCCH	BCCH	BCCH
PCCH Type	52-multiframe	52-multiframe	52-multiframe
NETWORK_OPERATION_MODE	network operation mode I	network operation mode I	network operation mode I
BS_PCC_CHAN	1 PCCCH channel	1 PCCCH channel	1 PCCCH channel
BS_PBCCH_BLK	3 blocks	3 blocks	3 blocks
BS_PAG_BLK_RES	2 blocks	2 blocks	2 blocks
BS_PRACH_BLK	1 block	1 block	1 block
T3168	2 seconds	2 seconds	2 seconds
T3192	1.5 seconds	1.5 seconds	2 seconds
GPRS Ciphering	Enabled	Enabled	Enabled

40.1.2 Default settings for cell B

The default settings for cell B are identical to those of cell A with the following exceptions:

	GSM 900	DCS 1800	PCS 1900
Downlink Input Level	53 dBmV _{emf} ()	53 dBmV _{emf} ()	53 dBmV _{emf} ()
Serving cell, BCCH/CCCH carrier			
Channel ARFCN	10	520	520
Serving cell, PDTCH, SDCCH			
Channel ARFCN	50	750	750
Cell identity	0002H	0002H	0002H

40.2 Default message contents.

40.2.1 System Information messages

40.2.1.1 Cell A

With the SYSTEM INFORMATION messages, the information elements are listed in alphabetic order (this is because some information elements occur in several SYSTEM INFORMATION types).

NOTE 1: BCCH can send 1 instance of SYSTEM INFORMATION 13.

40.2.1.1.1 Contents of information elements in SYSTEM INFORMATION TYPE 1 to 13 messages.

(CBCH) Channel Description	Not present.
(CBCH) Mobile Allocation	Not present.
Cell Channel Description	
- Format identifier	For GSM 900: Bit map 0.
	For DCS 1800 and PCS 1900: Range 512.
	For GSM 900: Channel Numbers 20, 30, 40, 50, 60 and 70.
	For DCS1800: Channel Numbers 590, 650, 690, 750, 830 and 850.
	For PCS 1900: Channel Numbers 590, 650, 690, 730, 750, 790
- Cell Allocation ARFCN	
Cell Identity	
- Cell Identity Value	0001Hex
Cell Options	
- Power Control Indicator	Power Control Indicator is not set.
- DTX Indicator	MS shall not use DTX.
- Radio_Link_Timeout	8 SACCH blocks.
Cell Selection Parameters	
- Cell_Reselect_Hysteresis	12 dB.
- MX_TXPWR_MAX_CCH	Minimum level.
- ACS	For SI3, spare (set to '0'); for SI4, No additional cell parameters are present in SYSTEM INFORMATION messages 7 and 8.
	New establishment causes are supported.
- NECI	Power control level 10.
- RXLEV_ACCESS_MIN	
Control Channel Description	
- Attach-Detach allowed	MS shall apply IMSI attach and detach procedure.
For Non Combined	
- BS_AG_BLK_RES	3 blocks reserved for access grant.
- CCCH_CONF	000 (1 basic physical channel used for CCCH, not combined with SDCCHs.)
For Combined	
- BS_AG_BLK_RES	2 blocks reserved for access grant.
- CCCH_CONF	001 (1 basic physical channel used for CCCH, combined with SDCCHs.)
- BS_PA_MFRMS	6 multiframe periods for transmission of paging messages.
- T3212 Time-out value	0
L2 pseudo length	
- System information 1	21
- System information 2	22
- System information 3	18
- System information 4	12
- System information 7	1
- System information 8	1
- System information 13	0
Location Area Identification	
- Mobile Country Code	001 (Decimal)
- Mobile Network Code	01 (Decimal)
- Location Area Code	0001(Hex)
Message Type	
- System information 1	00011001 (Binary)
- System information 2	00011010 (Binary)
- System information 2bis	00000010 (Binary)
- System information 2ter	00000011 (Binary)
- System information 3	00011011 (Binary)
- System information 4	00011100 (Binary)
- System information 5	00011101 (Binary)
- System information 5bis	00000101 (Binary)
- System information 5ter	00000110 (Binary)
- System information 7	00011111 (Binary)
- System information 8	00011000 (Binary)
- System information 13	00000000 (Binary)

Neighbour Cells Description	For SI 2
- Format identifier	For GSM 900: Bit map 0.
	For DCS 1800 and PCS 1900: Range 512.
	0
	For GSM 900:
	Channel numbers 10, 20, 40, 80, 90, 100, 110 and 120.
	For DCS 1800:
	Channel numbers 520, 590, 600, 700, 780, 810 and 870.
	For PCS 1900
	Channel numbers 520, 590, 600, 700, 720, 760, 780.
	For GSM 900, this IE carries only part of the BA.
	For DCS 1800 and PCS 1900, this IE carries complete BA.
	SI 2bis for GSM 900
	For GSM 900: Range 256
	0
	For GSM 900:
	Channel numbers 985, 989, 995, 1010 and 1014.
	This IE carries only part of the BA.
Neighbour Cells Description	SI2ter (Not relevant for PCS 1900, for multiband tests only)
- Format identifier	00 (Binary)
	For GSM 900: Range 512
	For DCS 1800: Range 1024
	0
	For GSM 900:
	Channel numbers 520, 590, 600, 700, 780, 810 and 870.
	For DCS 1800:
	Channel Numbers 10, 20, 40, 80, 90, 100, 110 and 120.
	0000 0010
- EXT-IND	
Neighbour Cells Description 2	
- Multiband Reporting	Max 1 retrans.
- Format identifier	5 slots used.
	Cell is not barred.
	Not allowed.
	Access is not barred.
	Yes.
- BCCH Allocation Sequence	0 (NCH Position not present)
- BCCH Allocation ARFCN	Spare Padding
	Spare Padding
	Spare Padding
NCC Permitted	
RACH Control Parameters	
- Max Retrans	0 (no optional selection parameters)
- Tx-integer	0 (no optional power offset)
- Cell Barred for Access	0 (for GSM 900 or DCS 1800 or PCS 1900, no SI2ter exists)
- Call Reestablishment Allowed	1 (perform early classmark sending)
- Access Control Class	0(no system information type 9)
- Emergency Call allowed	1 (GPRS supported)
SI 1 Rest Octets	001(Binary)
- {0 1<NCH Position>}	On BCCH Norm
- spare padding	Spare Padding
SI 2bis Rest Octets	
SI 2ter Rest Octets	
SI 3 Rest Octets	
- Optional Selection Parameters	0 (no optional selection parameters)
- Optional Power Offset	0 (no optional power offset)
- System Information 2ter Indicator	1 (GPRS supported)
	001(Binary)
	On BCCH Norm
	Spare Padding
- Early Classmark Sending Control	0 (no optional selection parameters)
- Scheduling if and where	0 (no optional power offset)
- GPRS Indicator	1 (GPRS supported)
- RA COLOUR	001(Binary)
- SI13 POSITION	On BCCH Norm
- spare padding	Spare Padding
SI 4 Rest Octets	
- Optional Selection Parameters	0 (no optional selection parameters)
- Optional Power Offset	0 (no optional power offset)
- GPRS Indicator	1 (GPRS supported)
- RA COLOUR	001(Binary)
- SI13 POSITION	On BCCH Norm
- spare padding	Spare Padding
SI 7 Rest Octets	Same as SI 4 Rest Octets
SI 8 Rest Octets	Same as SI 4 Rest Octets
SI 13 Rest Octets	
-	H (SI 13 Rest Octets are not spare)
- BCCH_CHANGE_MARK	000
- SI_CHANGE_FIELD	0 Update of unspecified message
- {0 1	
- SI13 CHANGE MARK	00

-HSN	000000	Sequence 0
-{0 1<RFL number list>}	1	Number list present
-RFL_NUMBER	0010	List 2
	0	no more lists
-{0	0	using MA BITMAP
-MA_LENGTH	000101	
-MA_BITMAP}	001111	4 belonging
- {0 1	1	(PBCCH present in cell)
- PSI1_REPEAT_PERIOD	0110	PSI1repeat period = 7 multiframes
- PBCCH Description		
- Pb	0110	(-12 dB)
- TSC	101	
- TN	100	Timeslot 4
- {00 01 1	01	ARFCN to follow
ARFCN}}		GSM 900: 0000011110 ARFCN 30
		DCS 1800: 1010001010 ARFCN 650
		PCS 1900: 1010001010 ARFCN 650
- spare padding		Spare Padding

40.2.1.2 Cell B

The contents of SYSTEM INFORMATION TYPE 1 to 13 messages for cell B are identical to those of cell A with the following exceptions:

GSM 900

Cell Channel Description	
- Format Identifier	Bit map 0.
- Cell Allocation ARFCN	Channel Number 10.
Cell Identity	
- Cell Identity Value	0002H

DCS 1800

Cell Channel Description	
- Format Identifier	Range 512.
- Cell Allocation ARFCN	Channel Number 520.
Cell Identity	
- Cell Identity Value	0002H

PCS 1900

Cell Channel Description	
- Format Identifier	Range 512.
- Cell Allocation ARFCN	Channel Number 520.
Cell Identity	
- Cell Identity Value	0002H

40.2.2 Packet System Information messages

40.2.2.1 Cell A

This section contains default sets of PSI message contents for two GSM GPRS neighbour cells followed by default sets of PSI message contents for two DCS GPRS neighbour cells. All cells are operating with channel combination xi).

In this section all information element values are in binary. Numeric values in comments are in decimal.

40.2.2.1.1

PACKET SYSTEM INFORMATION TYPE 1 (GSM GPRS).

MESSAGE_TYPE	110001
PAGE_MODE	00 Normal Paging
PBCCH_CHANGE_MARK	000
PSI_CHANGE_FIELD	0000
PSI1_REPEAT_PERIOD	0110
PSI_COUNT_LR	001000
{PSI_COUNT_HR}	1 PSI_COUNT_HR present
PSI_COUNT_HR	0010
MEASUREMENT_ORDER	1 PSI5 broadcast
GPRS Cell Options	
- NMO	00 Network Mode 1
- T3168	011 2 seconds
- T3192_VALUE	010 1.5 seconds
- DRX_TIMER_MAX	001 1 second
- ACCESS_BURST_TYPE	1 11 bit access burst
- CONTROL_ACK_TYPE	1 RLC/MAC Control block
- BS_CV_MAX	0111
{ PAN parameters}	1 PAN parameters present
- PAN_DEC	001
- PAN_INC	001
- PAN_MAX	000
- {Extension Bits IE}	0 Extension bits not present
PRACH Control Parameters	
- ACC_CONTR_CLASS	0000000000000000 All Access Control Classes are allowed
- MAX_RETRANS	00 Maximum 1 retransmission each priority
- S	0001 15 slots between
- TX_INT	0010 4 slots
- {0 1<PERSISTENCE_LEVEL>}	0 persistence level not present
PCCCH Organization Parameters	
- BS_PCC_REL	0 No release pending
- BS_PBCCH_BLKs	10 Blocks B0, B6, B3
- BS_PAG_BLKs_RES	0010 2 blocks reserved
- BS_PRACH_BLKs	0001 1 block (B0) reserved
Global Power Control Parameters	
- ALPH	0000 $\alpha = 0$
- T_AVG_W	00000 k = 0
- T_AVG_T	00000 k = 0
- Pb	0110 Pb = -12dB
- PC_MEAS_CHAN	0 On BCCH
- INT_MEAS_CHANNEL_LIST_AVAIL	1 PSI4 message broadcast
- N_AVG_I	0110
PSI_STATUS_IND	0
Padding	2 padding bits

40.2.2.1.2 PACKET SYSTEM INFORMATION TYPE 2 (GSM GPRS). Instance 1 of 3

MESSAGE_TYPE	110010
PAGE_MODE	00 Normal Paging
PSI2_CHANGE_MARK	01
PSI2_INDEX	000
PSI2_COUNT	010 Three instances of PSI2
Cell Identification	1 Cell Identification parameters present
-Location Area Identification IE	00001 (ID value 1 represented in 5 octets)
-RAC	00000101
-Cell Identity IE	01 (ID value 1 represented in 2 octets)
Non GPRS Cell Options	1 Non GPRS Cell Options present
-ATT	MS shall apply IMSI attach and detach procedures
-{Timeout for periodic update	1 Timeout value for periodic update included
-T3212	00000000 Timeout value
-NECI	New establishment causes supported
-PWRC	0 Power control indicator
-DTX	00
-RADIO_LINK_TIMEOUT	0001 value 8
For Non Combined	
-BS_AG_BLKES_RES	011 3 reserved
-CCCH_CONF	000
For Combined	
-BS_AG_BLKES_RES	010 2 reserved
-CCCH_CONF	001
-BS_PA_MFRMS	110 value 6
-MAX_RETRANS	01
-TX_INTEGER	0101 value 5
-EC	1
-MS_TXPWR_MAX_CCCH	01010
-{0 1<extension bits>}	0 No extension bits

40.2.2.1.3 PACKET SYSTEM INFORMATION TYPE 2 (GSM GPRS). Instance 2 of 3

MESSAGE_TYPE	110010
PAGE_MODE	00 Normal Paging
PSI2_CHANGE_MARK	01
PSI2_INDEX	001
PSI2_COUNT	010 Three instances of PSI2
Cell Identification	0 Cell Identification parameters not present
Non GPRS Cell Options	0 Non GPRS Cell Options not present
{Reference Frequency Lists}	
- Reference Frequency list 1	0001 List 1
-IE length	0011 IE length = 3 (128 format)
	10001100 format 10 + spare 00 + format 110 + ARFCN 10
	00000101 ARFCN 20
	00101000 ARFCN 40
	11011001 ARFCN 50
	11100110 ARFCN 60
	00110000 ARFCN 80
{Cell Allocation}	
-RFL_NUMBER	0001 List 1
{GPRS Mobile Allocations}	1 GPRS Mobile Allocation present
-MA_NUMBER	0001
-HSN	000000 Sequence 0
-{0 1<RFL number list>}	1 Number list present
-RFL_NUMBER	0010 List 2
-{0	0
-MA_LENGTH	000101
-MA_BITMAP	001111 4 belonging
- 1{0 1<ARFCN index list>}}	0 ARFCN index list not present
{PCCCH Description}	Same as the PCCCH Description as defined in SI13 Rest Octets
Padding	

40.2.2.1.4 PACKET SYSTEM INFORMATION TYPE 2 (GSM GPRS). Instance 3 of 3

MESSAGE_TYPE	110010
PAGE_MODE	00 Normal Paging
PSI2_CHANGE_MARK	01
PSI2_INDEX	010
PSI2_COUNT	001 Three instances of PSI2
Cell Identification	0 Cell Identification parameters not present
Non GPRS Cell Options	0 Non GPRS Cell Options not present
{Reference Frequency Lists}	
- Reference Frequency list 2	0010 List 2
- IE length	0011 IE length = 3 (128 format)
	10001100 format 10 + spare 00 + format 110 +
	ARFCN 20
	00001010 ARFCN 30
	00011110 ARFCN 40
	11011001 ARFCN 50
	01001011 ARFCN 60
	01011000 ARFCN 70
{GPRS Mobile Allocations}	
-MA_NUMBER	1 GPRS Mobile Allocation present
-HSN	0010
-{0 1<RFL number list>}	000000 Sequence 0
-RFL_NUMBER	1 Number list present
-{0	0010 List 2
-MA_LENGTH	0
-MA_BITMAP	000101
- 1{0 1<ARFCN index list>}}	101010 3 belonging
Padding	0 ARFCN index list not present

40.2.2.1.5

PACKET SYSTEM INFORMATION TYPE 3 (GSM GPRS).

MESSAGE_TYPE	110011
PAGE_MODE	00 Normal Paging
PSI3_CHANGE_MARK	00
PSI3_BIS_COUNT	0011 Three 3bis messages
Serving Cell parameters	
- CELL_BAR_ACCESS_2	0 Normal reselection
- EXC_ACC	0
- GPRS_RXLEV_ACCESS_MIN	011111 -80dBm
- GPRS_MS_TXPWR_MAX_CCH	01010
- {0 1<HCS Serving Cell parameters>}	1 HCS Serving Cell parameters present
- PRIORITY_CLASS	001
- HCS_THR	00000 -110 dBm
- MULTIBAND_REPORTING	0 – Normal Reporting of six strongest cells
General Cell Selection parameter	
- GPRS_CELL_RESELECT_HYSTERESIS	000 0 dB
- C31_HYST	0 Not used in C31
- C32_QUAL	0
- RANDOM_ACCESS_RETRY	0 No access to other cells
- {0 1<T_RESEL >}	1 present
- T_RESEL	001 10 seconds
- {0 1<RA_RESELECT_HYSTERESIS>}	1 present)
- RA_RESELECT_HYSTERESIS	000 0 dB
Neighbour Cell parameters	Containing ARFCN 10 and 80
-	1 start of neighbour cell parameters
- START_FREQUENCY	00000010 ARFCN 10 (MSB)
	10 ARFCN 10 (LS 2bits)
- Cell selection params	
- BSIC	001101
- CELL_BAR_ACCESS_2	0 Normal reselection
- EXC_ACC	0
- SAME_RA_AS_SERVING_CELL	1 same routing area
- {0 1<GPRS_RXLEV_ACCESS_MIN>}	1 GPRS_RXLEV_ACCESS_MIN present
- GPRS_RXLEV_ACCESS_MIN	011111 -80dBm
- GPRS_MS_TXPWR_MAX_CCH	01010
- {0 1<GPRS_TEMPORARY_OFFSET>}	1 GPRS_TEMPORARY_OFFSET present
- GPRS_TEMPORARY_OFFSET	000
- GPRS_PENALTY_TIME	00000
- {0 1<GPRS_RESELECT_OFFSET>}	1 GPRS_RESELECT_OFFSET present
- GPRS_RESELECT_OFFSET	10000 0dB
- {0 1<HCS params>}	1 HCS params present
- GPRS_PRIORITY_CLASS	000
- GPRS_HCS_THR	10100
- {0 1<SI13_PBCCH_LOCATION>}	1 SI13_PBCCH_LOCATION present
0- SI13 1 PBCCH Location	0 SI13 Location
	0 SI13 on BCCH Norm
:NR_OF_REMAINING_CELLS	0001
:FREQ_DIFF_LENGTH	110 7 bits
:FREQUENCY_DIFF	1000110 ARFCN 80
- Cell selection params	
- BSIC	001110
- CELL_BAR_ACCESS_2	0 Normal reselection
- SAME_RA_AS_SERVING_CELL	1 same routing area
- {0 1<GPRS_RXLEV_ACCESS_MIN>}	1 GPRS_RXLEV_ACCESS_MIN present
- GPRS_RXLEV_ACCESS_MIN	100111 -88dBm
- GPRS_MS_TXPWR_MAX_CCH	01010
- {0 1<GPRS_TEMPORARY_OFFSET>}	0 GPRS_TEMPORARY_OFFSET not present
- {0 1<GPRS_RESELECT_OFFSET>}	1 GPRS_RESELECT_OFFSET present
- GPRS_RESELECT_OFFSET	10000 0dB
- {0 1<HCS params>}	0 HCS params not present
- {0 1<SI13_PBCCH_LOCATION>}	1 SI13_PBCCH_LOCATION present
0- SI13 1 PBCCH Location	0 SI13 Location
- SI13_LOCATION	0 SI13 on BCCH Norm
End of Neighbour parameter	0
Padding	Padding

40.2.2.1.6

PACKET SYSTEM INFORMATION TYPE 3bis (GSM GPRS). (Instance 1 of 3)

MESSAGE_TYPE	110100
PAGE_MODE	00 Normal Paging
PSI3_CHANGE_MARK	00
PSI3_BIS_INDEX	0000
PSI3_BIS_COUNT	0010
Neighbour Cell parameters	Containing ARFCN 40 and 80.
-	1 start of neighbour cell parameters
- START_FREQUENCY	00001010 ARFCN 40 (MSB)
	00 ARFCN 40 (LS 2 bits)
- Cell selection params	001101
- BSIC	0 Normal reselection
- CELL_BAR_ACCESS_2	0
-EXT_ACC	1 same routing area
- SAME_RA_AS_SERVING_CELL	1 GPRS_RXLEV_ACCESS_MIN present
- {0 1<GPRS_RXLEV_ACCESS_MIN>}	101000 -89dBm
- GPRS_RXLEV_ACCESS_MIN	01010
- GPRS_MS_TXPWR_MAX_CCH	1 GPRS_TEMPORARY_OFFSET present
- {0 1<GPRS_TEMPORARY_OFFSET>}	000
- GPRS_TEMPORARY_OFFSET	00000
- GPRS_PENALTY_TIME	1 GPRS_RESELECT_OFFSET present
- {0 1<GPRS_RESELECT_OFFSET>}	10000 0dB
- GPRS_RESELECT_OFFSET	1 HCS params present
- {0 1<HCS params>}	000
- GPRS_PRIORITY_CLASS	10100
- GPRS_HCS_THR	1 SI13_PBCCH_LOCATION present
- {0 1<SI13_PBCCH_LOCATION>}	0 SI13 Location
0- SI13 1 PBCCH Location	0 SI13 on BCCH Norm
- NR_OF_REMAINING_CELLS	0001
- FREQ_DIFF_LENGTH	101 6 bits
- FREQUENCY_DIFF	101000 40d (ARFCN 80)
- Cell selection params	001101
- BSIC	0 Normal reselection
- CELL_BAR_ACCESS_2	0
-EXT_ACC	1 same routing area
- SAME_RA_AS_SERVING_CELL	1 GPRS_RXLEV_ACCESS_MIN present
- {0 1<GPRS_RXLEV_ACCESS_MIN>}	101000 -89dBm
- GPRS_RXLEV_ACCESS_MIN	01010
- GPRS_MS_TXPWR_MAX_CCH	1 GPRS_TEMPORARY_OFFSET present
- {0 1<GPRS_TEMPORARY_OFFSET>}	000
- GPRS_TEMPORARY_OFFSET	0000
- GPRS_PENALTY_TIME	1 GPRS_RESELECT_OFFSET present
- {0 1<GPRS_RESELECT_OFFSET>}	10000 0dB
- GPRS_RESELECT_OFFSET	1 HCS params present
- {0 1<HCS params>}	000
- GPRS_PRIORITY_CLASS	10100
- GPRS_HCS_THR	1 SI13_PBCCH_LOCATION present
- {0 1<SI13_PBCCH_LOCATION>}	0 SI13 Location
0- SI13 1 PBCCH Location	0 SI13 on BCCH norm
- SI13_LOCATION	0 (end of neighbour cell parameters)
-	0 Neighbour Cell parameters 2 not present
0 1<Neighbour Cell parameters 2>	Padding 11 bits
Padding	

40.2.2.1.7

PACKET SYSTEM INFORMATION TYPE 3bis (GSM GPRS) (Instance 2 of 3)

MESSAGE_TYPE	110100
PAGE_MODE	00 Normal Paging
PSI3_CHANGE_MARK	00
PSI3_BIS_INDEX	001
PSI3_BIS_COUNT	010
Neighbour Cell parameters	containing ARFCN 100 and 110
-	1 start of neighbour cell parameters
- START_FREQUENCY	00011001 ARFCN 100 (MSB) 00 ARFCN 100 (LS 2 bits)
- Cell selection params	001101
- BSIC	0 Normal reselection
- CELL_BAR_ACCESS_2	0
- EXT_ACC	1 same routing area
- SAME_RA_AS_SERVING_CELL	1 GPRS_RXLEV_ACCESS_MIN present
- {0 1<GPRS_RXLEV_ACCESS_MIN>}	101000 -89dBm
- GPRS_RXLEV_ACCESS_MIN	01010
- GPRS_MS_TXPWR_MAX_CCH	1 GPRS_TEMPORARY_OFFSET present
- {0 1<GPRS_TEMPORARY_OFFSET>}	000
- GPRS_TEMPORARY_OFFSET	00000
- GPRS_PENALTY_TIME	1 GPRS_RESELECT_OFFSET present
- {0 1<GPRS_RESELECT_OFFSET>}	10000 0dB
- GPRS_RESELECT_OFFSET	1 HCS params present
- {0 1<HCS params>}	0
- GPRS_PRIORITY_CLASS	10100
- GPRS_HCS_THR	1 SI13_PBCCH_LOCATION present
- {0 1< SI13_PBCCH_LOCATION >}	0 SI13 Location
0- SI13 1 PBCCH Location	0 SI13 on BCCH Norm
- PBCCH_LOCATION	0001
- NR_OF_REMAINING_CELLS	010
- FREQ_DIFF_LENGTH	1010 (10d - ARFCN 110)
- FREQUENCY_DIFF	
- Cell selection params	001101 (Binary)
- BSIC	0 Normal reselection
- CELL_BAR_ACCESS_2	0
- EXT_ACC	1
- SAME_RA_AS_SERVING_CELL	1 GPRS_RXLEV_ACCESS_MIN present
- {0 1<GPRS_RXLEV_ACCESS_MIN>}	101000 -89dBm
- GPRS_RXLEV_ACCESS_MIN	01010
- GPRS_MS_TXPWR_MAX_CCH	1 GPRS_TEMPORARY_OFFSET present
- {0 1<GPRS_TEMPORARY_OFFSET>}	000
- GPRS_TEMPORARY_OFFSET	0000
- GPRS_PENALTY_TIME	1 GPRS_RESELECT_OFFSET present
- {0 1<GPRS_RESELECT_OFFSET>}	10000 0dB
- GPRS_RESELECT_OFFSET	1 HCS params present
- {0 1<HCS params>}	000
- GPRS_PRIORITY_CLASS	10100
- GPRS_HCS_THR	1 SI13_PBCCH_LOCATION present
- {0 1< SI13_PBCCH_LOCATION >}	0 SI13 Location
0- SI13 1 PBCCH Location	0 SI13 on BCCH norm
- SI13_LOCATION	0 (end of neighbour cell parameters)
-	0 Neighbour Cell parameters 2 not present
0 1<Neighbour Cell parameters 2>	Padding 18 bits
Padding	

40.2.2.1.8

PACKET SYSTEM INFORMATION TYPE 3bis (GSM GPRS) (Instance 3 of 3)

MESSAGE_TYPE	110100
PAGE_MODE	00 Normal Paging
PSI3_CHANGE_MARK	00
PSI3_BIS_INDEX	010
PSI3_BIS_COUNT	010
Neighbour Cell parameters	containing ARFCN 985 and 989
-	1 start of neighbour cell parameters
- START_FREQUENCY	0011110110 ARFCN 985 (MSB)
	01 ARFCN 985 (LS 2 bits)
- Cell selection params	001101
- BSIC	0 Normal reselection
- CELL_BAR_ACCESS_2	0
- EXT_ACC	1 same routing area
- SAME_RA_AS_SERVING_CELL	1 GPRS_RXLEV_ACCESS_MIN present
- {0 1<GPRS_RXLEV_ACCESS_MIN>}	101000 -89dBm
- GPRS_RXLEV_ACCESS_MIN	01010
- GPRS_MS_TXPWR_MAX_CCH	1 GPRS_TEMPORARY_OFFSET present
- {0 1<GPRS_TEMPORARY_OFFSET>}	000
- GPRS_TEMPORARY_OFFSET	00000
- GPRS_PENALTY_TIME	1 GPRS_RESELECT_OFFSET present
- {0 1<GPRS_RESELECT_OFFSET>}	10000 0dB
- GPRS_RESELECT_OFFSET	1 HCS params present
- {0 1<HCS params>}	0
- GPRS_PRIORITY_CLASS	10100
- GPRS_HCS_THR	1 SI13_PBCCH_LOCATION present
- {0 1< SI13_PBCCH_LOCATION >}	0 SI13 Location
0- SI13 1 PBCCH Location	0 SI13 on BCCH Norm
- NR_OF_REMAINING_CELLS	0001
- FREQ_DIFF_LENGTH	010
- FREQUENCY_DIFF	100
- Cell selection params	001101 (Binary)
- BSIC	0 Normal reselection
- CELL_BAR_ACCESS_2	0
- EXT_ACC	1
- SAME_RA_AS_SERVING_CELL	1 GPRS_RXLEV_ACCESS_MIN present
- {0 1<GPRS_RXLEV_ACCESS_MIN>}	101000 -89dBm
- GPRS_RXLEV_ACCESS_MIN	01010
- GPRS_MS_TXPWR_MAX_CCH	1 GPRS_TEMPORARY_OFFSET present
- {0 1<GPRS_TEMPORARY_OFFSET>}	000
- GPRS_TEMPORARY_OFFSET	0000
- GPRS_PENALTY_TIME	1 GPRS_RESELECT_OFFSET present
- {0 1<GPRS_RESELECT_OFFSET>}	10000 0dB
- GPRS_RESELECT_OFFSET	1 HCS params present
- {0 1<HCS params>}	000
- GPRS_PRIORITY_CLASS	10100
- GPRS_HCS_THR	1 SI13_PBCCH_LOCATION present
- {0 1< SI13_PBCCH_LOCATION >}	0 SI13 Location
0- SI13 1 PBCCH Location	0 SI13 on BCCH norm
- SI13_LOCATION	0 (end of neighbour cell parameters)
-	0 Neighbour Cell parameters 2 not present
0 1<Neighbour Cell parameters 2>	Padding 17 bits
Padding	

40.2.2.1.9 PACKET SYSTEM INFORMATION TYPE 4 (GSM GPRS)

MESSAGE_TYPE	110101
PAGE_MODE	00 Normal Paging
PSI4_CHANGE_MARK	00
PSI4_COUNT	000
PSI4_INDEX	000
Channel List for interference measurements	
- Channel group struct	
- {0<ARFCN> 1<MA_NUMBER><MAIO>}	0
- ARFCN	00000111 (ARFCN 30 - MSB)
	10 (ARFCN 30 – LS 2 bits)
- TIMESLOT_ALLOCATION	00100000 Timeslot 2 assigned
- Channel group struct	1 present
- {0<ARFCN> 1<MA_NUMBER><MAIO>}	0
- ARFCN	00000111 (ARFCN 30 - MSB)
	10 (ARFCN 30 – LS 2 bits)
- TIMESLOT_ALLOCATION	00010000 Timeslot 3 assigned
-	0 (end of channel list)
Padding	Padding 121 bits

40.2.2.1.10 PACKET SYSTEM INFORMATION TYPE 5 (GSM GPRS).

Note that the following message is only sent if the MEASUREMENT_ORDER IE in PSI1 is set to 1.

MESSAGE_TYPE	110110
PAGE_MODE	00 Normal Paging
PSI5_CHANGE_MARK	00
PSI5_INDEX	000
PSI5_COUNT	000
{0 1<NC Measurement Parameters>}	1 NC Measurement Parameters present
- NETWORK_CONTROL_ORDER	00 NC0
- {	1 NC Periods present
- NC_NON_DRX_PERIOD	111
- NC_REPORTING_PERIOD_I	111
- NC_REPORTING_PERIOD_T}	011
{0 1<EXT Measurement Parameters>}	1 EXT Measurement Parameters present
- EXT_MEASUREMENT_ORDER	01 EM1 struct
- EXT_REPORTING_TYPE	01
- NCC_PERMITTED	00000010
- {EXT Frequency List struct}	0 External frequency list not included
Padding	Padding 118 bits

40.2.2.1.11 PACKET SYSTEM INFORMATION TYPE 13 (GSM GPRS).

MESSAGE_TYPE	110111
PAGE_MODE	00 Normal Paging
BCCH_CHANGE_MARK	000
SI_CHANGE_FIELD	0000 Unspecified
{0 1<SI13_CHANGE_MARK>}	1 Present
{GPRS Mobile Allocations}	1 GPRS Mobile Allocation present
-MA_NUMBER	0001
-HSN	000000 Sequence 0
-{0 1<RFL number list>}	1 Number list present
-RFL_NUMBER	0010 List 2
-{0	0
-MA_LENGTH	000101
-MA_BITMAP	001111 4 belonging
- 1{0 1<ARFCN index list>}}	0 ARFCN index list not present
- PSI1_REPEAT_PERIOD	1 PBCCH present in cell
PBCCH Description	0110 PSI1 repeat period = 7
Padding	Same as the PBCCH Description as stated in SI13 rest octets. Padding

40.2.2.1.12

PACKET SYSTEM INFORMATION TYPE 1 (DCS GPRS).

MESSAGE_TYPE	110001
PAGE_MODE	00 Normal Paging
PBCCH_CHANGE_MARK	000
PSI_CHANGE_FIELD	0000
PSI1_REPEAT_PERIOD	0110
PSI_COUNT_LR	001000
{PSI_COUNT_HR}	1 PSI_COUNT_HR present
PSI_COUNT_HR	0010
MEASUREMENT_ORDER	1 PSI5 broadcast
GPRS Cell Options	
- NMO	00 Network Mode 1
- T3168	011 2 seconds
- T3192_VALUE	010 1.5 seconds
- DRX_TIMER_MAX	001 1 second
- ACCESS_BURST_TYPE	1 11 bit access burst
- CONTROL_ACK_TYPE	1 RLC/MAC Control block
- BS_CV_MAX	0111
{PAN parameters}	1 PAN parameters present
- PAN_DEC	001
- PAN_INC	001
- PAN_MAX	000
- {Extension Bits IE}	0 Extension bits not present
PRACH Control Parameters	
- ACC_CONTR_CLASS	0000000000000000 All Access Control Classes are allowed
- MAX_RETRANS	00 Maximum 1 retransmission each priority
- S	0001 15 slots between
- TX_INT	0010 4 slots
- {0 1<PERSISTENCE_LEVEL>}	0 persistence level not present
PCCCH Organization Parameters	
- BS_PCC_REL	0 No release pending
- BS_PBCCH_BLKs	10 Blocks B0, B6, B3
- BS_PAG_BLKs_RES	0010 2 blocks reserved
- BS_PRACH_BLKs	0001 1 block (B0) reserved
Global Power Control Parameters	
- ALPH	0000 $\alpha = 0$
- T_AVG_W	00000 k = 0
- T_AVG_T	00000 k = 0
- Pb	0110 Pb = -12 dB
- PC_MEAS_CHAN	0 On BCCH
- INT_MEAS_CHANNEL_LIST_AVAIL	1 PSI4 message broadcast
- N_AVG_I	0110
PSI_STATUS_IND	0
Padding	2 padding bits

40.2.2.1.13 PACKET SYSTEM INFORMATION TYPE 2 (DCS GPRS). Instance 1 of 3

MESSAGE_TYPE	110010
PAGE_MODE	00 Normal Paging
PSI2_CHANGE_MARK	01
PSI2_INDEX	000
PSI2_COUNT	010 Three instances of PSI2
Cell Identification	1 Cell Identification parameters present
-Location Area Identification IE	00001 (ID value 1 represented in 5 octets)
-RAC	00000101
-Cell Identity IE	01 (ID value 1 represented in 2 octets)
Non GPRS Cell Options	1 Non GPRS Cell Options present
-ATT	MS shall apply IMSI attach and detach procedures
-{Timeout for periodic update	1 Timeout value for periodic update included
-T3212	00000000 Timeout value
-NECI	New establishment causes supported
-PWRC	0 Power control indicator
-DTX	00
-RADIO_LINK_TIMEOUT	0001 value 8
For Non Combined	
-BS_AG_BLK_RES	011 3 reserved
-CCCH_CONF	000
For Combined	
-BS_AG_BLK_RES	010 2 reserved
-CCCH_CONF	001
-BS_PA_MFRMS	110 value 6
-MAX_RETRANS	01
-TX_INTEGER	0101 value 5
-EC	1
-MS_TXPWR_MAX_CCCH	01010
-{0 1<extension bits>}	0 No extension bits

40.2.2.1.14 PACKET SYSTEM INFORMATION TYPE 2 (DCS GPRS). Instance 2 of 3

MESSAGE_TYPE	110010
PAGE_MODE	00 Normal Paging
PSI2_CHANGE_MARK	01
PSI2_INDEX	001
PSI2_COUNT	010 Three instances of PSI2
Cell Identification	0 Cell Identification parameters not present
Non GPRS Cell Options	0 Non GPRS Cell Options not present
{Reference Frequency Lists}	
- Reference Frequency list 1	0001 List 1
-IE length	0011 IE length = 3 (512 format)
	10001001 format 10 + spare 00 + format 100 + 1 bit
	00000100 ARFCN 520
	00000101 ARFCN 530
	00111101 ARFCN 540
	10000010 ARFCN 550
	10000000
{Cell Allocation}	
-RFL_NUMBER	0001 List 1
{GPRS Mobile Allocations}	
-MA_NUMBER	1 GPRS Mobile Allocation present
-HSN	000000 Sequence 0
-{0 1<RFL number list>}	1 Number list present
-RFL_NUMBER	0010 List 2
-{0	0
-MA_LENGTH	000101
-MA_BITMAP	001111 4 belonging
- 1{0 1<ARFCN index list>}}	0 ARFCN index list not present
{PCCCH Description}	Same as the PBCCH Description as defined in SI13 Rest Octets
Padding	

40.2.2.1.15 PACKET SYSTEM INFORMATION TYPE 2 (DCS GPRS). Instance 3 of 3

MESSAGE_TYPE	110010
PAGE_MODE	00 Normal Paging
PSI2_CHANGE_MARK	01
PSI2_INDEX	010
PSI2_COUNT	010 Three instances of PSI2
Cell Identification	0 Cell Identification parameters not present
Non GPRS Cell Options	0 Non GPRS Cell Options not present
{Reference Frequency Lists}	
- Reference Frequency list 2	0010 List 2
-IE length	0110 IE length = 6 (512 format)
	10001001 format 10 + spare 00 + format 100 + 1 bit
	00101100 ARFCN 600
	00001010 ARFCN 610
	00111011 ARFCN 620
	00000101 ARFCN 630
	00111011 ARFCN 640
	01110110 ARFCN 650
	00010100 ARFCN 660
	00101000 ARFCN 670
{GPRS Mobile Allocations}	
-MA_NUMBER	1 GPRS Mobile Allocation present
-HSN	0001
-{0 1<RFL number list>}	000000 Sequence 0
-RFL_NUMBER	1 Number list present
-{0	0010 List 2
-MA_LENGTH	0
-MA_BITMAP	000101
- 1{0 1<ARFCN index list>}}	001111 4 belonging
Padding	0 ARFCN index list not present

40.2.2.1.16

PACKET SYSTEM INFORMATION TYPE 3 (DCS GPRS).

MESSAGE_TYPE	110011
PAGE_MODE	00 Normal Paging
PSI3_CHANGE_MARK	00
PSI3_BIS_COUNT	0010 Two 3bis messages
Serving Cell parameters	
- CELL_BAR_ACCESS_2	0 Normal reselection
- EXC_ACC	0
- GPRS_RXLEV_ACCESS_MIN	011111 -80dBm
- GPRS_MS_TXPWR_MAX_CCH	01010
- {0 1<HCS Serving Cell parameters>}	1 HCS Serving Cell parameters present
- PRIORITY_CLASS	001
- HCS_THR	00000 -110 dBm
- MULTIBAND_REPORTING	0 – Normal Reporting
General Cell Selection parameter	
- GPRS_CELL_RESELECT_HYSTERESIS	000 0 dB
- C31_HYST	0 Not used in C31
- C32_QUAL	0
- RANDOM_ACCESS_RETRY	0 No access to other cells
- {0 1<T_RESEL >}	1 present)
- T_RESEL	001 10 seconds
- {0 1<RA_RESELECT_HYSTERESIS>}	1 present)
- RA_RESELECT_HYSTERESIS	000 0 dB
Neighbour Cell parameters	containing ARFCN 520 and 600
-	1 start of neighbour cell parameters
- START_FREQUENCY	10000010 (MSB) ARFCN 520
	00 (LS 2bits)
- Cell selection params	
- BSIC	001101
- CELL_BAR_ACCESS_2	0 Normal reselection
- EXC_ACC	0
- SAME_RA_AS_SERVING_CELL	1 same routing area
- {0 1<GPRS_RXLEV_ACCESS_MIN>}	1 GPRS_RXLEV_ACCESS_MIN present
- GPRS_RXLEV_ACCESS_MIN	011111 -80dBm
- GPRS_MS_TXPWR_MAX_CCH	01010
- {0 1<GPRS_TEMPORARY_OFFSET>}	1 GPRS_TEMPORARY_OFFSET present
- GPRS_TEMPORARY_OFFSET	000
- GPRS_PENALTY_TIME	00000
- {0 1<GPRS_RESELECT_OFFSET>}	1 GPRS_RESELECT_OFFSET present
- GPRS_RESELECT_OFFSET	10000 0dB
- {0 1<HCS params>}	1 HCS params present
- GPRS_PRIORITY_CLASS	000
- GPRS_HCS_THR	10100
- {0 1<SI13_PBCCH_LOCATION>}	1 SI13_PBCCH_LOCATION present
0- SI13 1 PBCCH Location	0 SI13 Location
	0 SI13 on BCCH Norm
:NR_OF_REMAINING_CELLS	0001
:FREQ_DIFF_LENGTH	110 7 bits
:FREQUENCY_DIFF	1010000 (ARFCN 600)
- Cell selection params	
- BSIC	001110
- CELL_BAR_ACCESS_2	0 Normal reselection
- SAME_RA_AS_SERVING_CELL	1 same routing area
- {0 1<GPRS_RXLEV_ACCESS_MIN>}	0 GPRS_RXLEV_ACCESS_MIN not present
- {0 1<GPRS_TEMPORARY_OFFSET>}	1 GPRS_TEMPORARY_OFFSET present
- GPRS_TEMPORARY_OFFSET	000
- GPRS_PENALTY_TIME	0000
- {0 1<GPRS_RESELECT_OFFSET>}	1 GPRS_RESELECT_OFFSET present
- GPRS_RESELECT_OFFSET	10000 0dB
- {0 1<HCS params>}	0 HCS params not present
- {0 1<SI13_PBCCH_LOCATION>}	1 SI13_PBCCH_LOCATION present
0- SI13 1 PBCCH Location	0 SI13 Location
- SI13_LOCATION	0 SI13 on BCCH norm
	0 (end of neighbour cell parameters)
Padding	Padding

40.2.2.1.17 PACKET SYSTEM INFORMATION TYPE 3bis (DCS GPRS). (Instance 1 of 2)

MESSAGE_TYPE	110100
PAGE_MODE	00 Normal Paging
PSI3_CHANGE_MARK	00
PSI3_BIS_INDEX	0000
PSI3_BIS_COUNT	0001
Neighbour Cell parameters	containing ARFCN 600 and 700
-	1 start of neighbour cell parameters
- START_FREQUENCY	0010010110 ARFCN 600 (MSB)
	00 ARFCN 600 (LS 2 bits)
- Cell selection params	001101
- BSIC	0 Normal reselection
- CELL_BAR_ACCESS_2	0
- EXT_ACC	1 same routing area
- SAME_RA_AS_SERVING_CELL	1 GPRS_RXLEV_ACCESS_MIN present
- {0 1<GPRS_RXLEV_ACCESS_MIN>}	101000 -89dBm
- GPRS_RXLEV_ACCESS_MIN	01010
- GPRS_MS_TXPWR_MAX_CCH	1 GPRS_TEMPORARY_OFFSET present
- {0 1<GPRS_TEMPORARY_OFFSET>}	000
- GPRS_TEMPORARY_OFFSET	00000
- GPRS_PENALTY_TIME	1 GPRS_RESELECT_OFFSET present
- {0 1<GPRS_RESELECT_OFFSET>}	10000 0dB
- GPRS_RESELECT_OFFSET	1 HCS params present
- {0 1<HCS params>}	0
- GPRS_PRIORITY_CLASS	10100
- GPRS_HCS_THR	1 SI13_PBCCH_LOCATION present
- {0 1<SI13_PBCCH_LOCATION>}	0 SI13 Location
0- SI13 1 PBCCH Location	0 SI13 on BCCH Norm
- NR_OF_REMAINING_CELLS	0001
- FREQ_DIFF_LENGTH	110
- FREQUENCY_DIFF	1100100 (ARFCN 700, 100 difference)
- Cell selection params	001101
- BSIC	0 Normal reselection
- CELL_BAR_ACCESS_2	0
- EXT_ACC	1 same routing area
- SAME_RA_AS_SERVING_CELL	1 GPRS_RXLEV_ACCESS_MIN present
- {0 1<GPRS_RXLEV_ACCESS_MIN>}	101000 -89dBm
- GPRS_RXLEV_ACCESS_MIN	01010
- GPRS_MS_TXPWR_MAX_CCH	1 GPRS_TEMPORARY_OFFSET present
- {0 1<GPRS_TEMPORARY_OFFSET>}	000
- GPRS_TEMPORARY_OFFSET	0000
- GPRS_PENALTY_TIME	1 GPRS_RESELECT_OFFSET present
- {0 1<GPRS_RESELECT_OFFSET>}	10000 0dB
- GPRS_RESELECT_OFFSET	1 HCS params present
- {0 1<HCS params>}	000
- GPRS_PRIORITY_CLASS	10100
- GPRS_HCS_THR	1 SI13_PBCCH_LOCATION present
- {0 1<SI13_PBCCH_LOCATION>}	0 SI13 Location
0- SI13 1 PBCCH Location	0 SI13 on BCCH norm
- SI13_LOCATION	0 (end of neighbour cell parameters)
-	Padding 11 bits
Padding	

40.2.2.1.18 PACKET SYSTEM INFORMATION TYPE 3bis (DCS GPRS)) (Instance 2 of 2)

MESSAGE_TYPE	110100
PAGE_MODE	00 Normal Paging
PSI3_CHANGE_MARK	00
PSI3_BIS_INDEX	001
PSI3_BIS_COUNT	001
Neighbour Cell parameters	containing ARFCN 810 and 850
-	1 start of neighbour cell parameters
- START_FREQUENCY	0011001010 ARFCN 810 (MSB)
	10 ARFCN 810 (LS 2 bits)
- Cell selection params	001101
- BSIC	0 Normal reselection
- CELL_BAR_ACCESS_2	0
- EXT_ACC	1 same routing area
- SAME_RA_AS_SERVING_CELL	1 GPRS_RXLEV_ACCESS_MIN present
- {0 1<GPRS_RXLEV_ACCESS_MIN>}	101000 -89dBm
- GPRS_RXLEV_ACCESS_MIN	01010
- GPRS_MS_TXPWR_MAX_CCH	1 GPRS_TEMPORARY_OFFSET present
- {0 1<GPRS_TEMPORARY_OFFSET>}	000
- GPRS_TEMPORARY_OFFSET	00000
- GPRS_PENALTY_TIME	1 GPRS_RESELECT_OFFSET present
- {0 1<GPRS_RESELECT_OFFSET>}	10000 0dB
- GPRS_RESELECT_OFFSET	001
- {0 1<HCS params>}	0
- GPRS_PRIORITY_CLASS	10100
- GPRS_HCS_THR	1 SI13_PBCCH_LOCATION present
- {0 1< SI13_PBCCH_LOCATION >}	0 SI13 Location
0- SI13 1 PBCCH Location	0 SI13 on BCCH Norm
- NR_OF_REMAINING_CELLS	0001
- FREQ_DIFF_LENGTH	101
- FREQUENCY_DIFF	101000 (ARFCN 850)
- Cell selection params	001101 (Binary)
- BSIC	0 Normal reselection
- CELL_BAR_ACCESS_2	0
- EXT_ACC	1
- SAME_RA_AS_SERVING_CELL	1 GPRS_RXLEV_ACCESS_MIN present
- {0 1<GPRS_RXLEV_ACCESS_MIN>}	101000 -89dBm
- GPRS_RXLEV_ACCESS_MIN	01010
- GPRS_MS_TXPWR_MAX_CCH	1 GPRS_TEMPORARY_OFFSET present
- {0 1<GPRS_TEMPORARY_OFFSET>}	000
- GPRS_TEMPORARY_OFFSET	0000
- GPRS_PENALTY_TIME	1 GPRS_RESELECT_OFFSET present
- {0 1<GPRS_RESELECT_OFFSET>}	10000 0dB
- GPRS_RESELECT_OFFSET	1 HCS params present
- {0 1<HCS params>}	000
- GPRS_PRIORITY_CLASS	10100
- GPRS_HCS_THR	1 SI13_PBCCH_LOCATION present
- {0 1< SI13_PBCCH_LOCATION >}	0 SI13 Location
0- SI13 1 PBCCH Location	0 SI13 on BCCH norm
- SI13_LOCATION	0 (end of neighbour cell parameters)
-	0 (end of neighbour cell parameters)
Padding	Padding 14 bits

40.2.2.1.19 PACKET SYSTEM INFORMATION TYPE 4 (DCS GPRS)

MESSAGE_TYPE	110101
PAGE_MODE	00 Normal Paging
PSI4_CHANGE_MARK	00
PSI4_COUNT	000
PSI4_INDEX	000
Channel List for interference measurements	
- Channel group struct	
- {0<ARFCN> 1<MA_NUMBER><MAIO>}	0
- ARFCN	10000100 (ARFCN 530 – MSB)
	10 (ARFCN 530 - LS 2 bits)
- TIMESLOT_ALLOCATION	00100000 Timeslot 2 assigned
- Channel group struct	1 present
- {0<ARFCN> 1<MA_NUMBER><MAIO>}	0
- ARFCN	10000100 (ARFCN 530 – MSB)
	10 (ARFCN 530 - LS 2 bits)
- TIMESLOT_ALLOCATION	00010000 Timeslot 3 assigned
-	0 (end of channel list)
Padding	Padding 121 bits

40.2.2.1.20 PACKET SYSTEM INFORMATION TYPE 5 (DCS GPRS).

Note that the following message is only sent if the MEASUREMENT_ORDER IE in PSI1 is set to 1.

MESSAGE_TYPE	110110
PAGE_MODE	00 Normal Paging
PSI5_CHANGE_MARK	00
PSI5_INDEX	000
PSI5_COUNT	000
{0 1<NC Measurement Parameters>}	1 NC Measurement Parameters present
- NETWORK_CONTROL_ORDER	00 NC0
- {<NC_NON_DRX_PERIOD>}	1 NC Periods present
- NC_NON_DRX_PERIOD	111
- NC_REPORTING_PERIOD_I	111
- NC_REPORTING_PERIOD_T	011
{0 1<EXT Measurement Parameters>}	1 EXT Measurement Parameters present
- EXT_MEASUREMENT_ORDER	00
- NCC_PERMITTED	00000010
- {0 1<INT_FREQUENCY>}	0 Interference frequencies not included
- {0 1 External Frequency List}	0 External frequency list not included
Padding	Padding 118 bits

40.2.2.1.21 PACKET SYSTEM INFORMATION TYPE 13 (DCS GPRS).

MESSAGE_TYPE	110111
PAGE_MODE	00 Normal Paging
BCCH_CHANGE_MARK	000
SI_CHANGE_FIELD	0000 Unspecified
{0 1<SI13_CHANGE_MARK>}	1 Present
{GPRS Mobile Allocations}	1 GPRS Mobile Allocation present
-MA_NUMBER	0001
-HSN	000000 Sequence 0
-{0 1<RFL number list>}	1 Number list present
-RFL_NUMBER	0010 List 2
-{0	0
-MA_LENGTH	000101
-MA_BITMAP	001111 4 belonging
- 1{0 1<ARFCN index list>}}	0 ARFCN index list not present
- PSI1_REPEAT_PERIOD	1 PBCCH present in cell
PBCCH Description	0110 PSI1 repeat period = 7
Padding	Same as the PBCCH Description is SI13 rest octets. Padding

40.2.2.1.22

PACKET SYSTEM INFORMATION TYPE 1 (PCS 1900 GPRS).

MESSAGE_TYPE	110001
PAGE_MODE	00 Normal Paging
PBCCH_CHANGE_MARK	000
PSI_CHANGE_FIELD	0000
PSI1_REPEAT_PERIOD	0110
PSI_COUNT_LR	001000
{PSI_COUNT_HR}	1 PSI_COUNT_HR present
PSI_COUNT_HR	0010
MEASUREMENT_ORDER	1 PSI5 broadcast
GPRS Cell Options	
- NMO	00 Network Mode 1
- T3168	011 2 seconds
- T3192_VALUE	001 1 second
- DRX_TIMER_MAX	001 1 second
- ACCESS_BURST_TYPE	1 11 bit access burst
- CONTROL_ACK_TYPE	1 RLC/MAC Control block
- BS_CV_MAX	0111
{PAN parameters}	1 PAN parameters present
- PAN_DEC	001
- PAN_INC	001
- PAN_MAX	000
- {Extension Bits IE}	0 Extension bits not present
PRACH Control Parameters	
- ACC_CONTR_CLASS	0000000000000000 All Access Control Classes are allowed
- MAX_RETRANS	00 Maximum 1 retransmission each priority
- S	0001 15 slots between
- TX_INT	0010 4 slots
- {0 1<PERSISTENCE_LEVEL>}	0 persistence level not present
PCCCH Organization Parameters	
- BS_PCC_REL	0 No release pending
- BS_PBCCH_BLKs	10 Blocks B0, B6, B3
- BS_PAG_BLKs_RES	0010 2 blocks reserved
- BS_PRACH_BLKs	0001 1 block (B0) reserved
Global Power Control Parameters	
- ALPH	0000 $\alpha = 0$
- T_AVG_W	00000 k = 0
- T_AVG_T	00000 k = 0
- Pb	0110 Pb = -12 dB
- PC_MEAS_CHAN	0 On BCCH
- INT_MEAS_CHANNEL_LIST_AVAIL	1 PSI4 message broadcast
- N_AVG_I	0110
PSI_STATUS_IND	0
Padding	2 padding bits

40.2.2.1.23 PACKET SYSTEM INFORMATION TYPE 2 (PCS 1900 GPRS). Instance 1 of 3

MESSAGE_TYPE	110010
PAGE_MODE	00 Normal Paging
PSI2_CHANGE_MARK	01
PSI2_INDEX	010 Three instances of PSI2
PSI2_COUNT	000
Cell Identification	1 Cell Identification parameters present
-Location Area Identification IE	00001 (ID value 1 represented in 5 octets)
-RAC	00000101
-Cell Identity IE	01 (ID value 1 represented in 2 octets)
Non GPRS Cell Options	1 Non GPRS Cell Options present
-ATT	MS shall apply IMSI attach and detach procedures
-(Timeout for periodic update	1 Timeout value for periodic update included
-T3212	00000000 Timeout value
-NECI	New establishment causes supported
-PWRC	0 Power control indicator
-DTX	00
-RADIO_LINK_TIMEOUT	0111 value 8
-BS_AG_BLK_RES	011 3 reserved
-CCCH_CONF	001
-BS_PA_MFRMS	110 value 6
-MAX_RETRANS	01
-TX_INTEGER	0101 value 5
-EC	1
-MS_TXPWR_MAX_CCCH	01010
-(0 1<extension bits>}	0 No extension bits

40.2.2.1.24 PACKET SYSTEM INFORMATION TYPE 2 (PCS 1900 GPRS). Instance 2 of 3

MESSAGE_TYPE	110010
PAGE_MODE	00 Normal Paging
PSI2_CHANGE_MARK	01
PSI2_INDEX	010 Three instances of PSI2
PSI2_COUNT	001
Cell Identification	0 Cell Identification parameters not present
Non GPRS Cell Options	0 Non GPRS Cell Options not present
{Reference Frequency Lists}	
- Reference Frequency list 1	0001 List 1
-IE length	0011 IE length = 3 (512 format)
	10001001 format 10 + spare 00 + format 100 + 1 bit
	00000100 ARFCN 520
	00000101 ARFCN 530
	00111101 ARFCN 540
	10000010 ARFCN 550
	10000000
{Cell Allocation}	
-RFL_NUMBER	0001 List 1
{GPRS Mobile Allocations}	1 GPRS Mobile Allocation present
-MA_NUMBER	0001
-HSN	000000 Sequence 0
-(0 1<RFL number list>}	1 Number list present
-RFL_NUMBER	0010 List 2
-(0	0
-MA_LENGTH	000100
-MA_BITMAP	1111 4 belonging
- 1{0 1<ARFCN index list>}}	0 ARFCN index list not present
{PCCCH Description}	1 Same as the PBCCH Description as defined in SI13 Rest Octets
Padding	

40.2.2.1.25 PACKET SYSTEM INFORMATION TYPE 2 (PCS 1900 GPRS). Instance 3 of 3

MESSAGE_TYPE	110010
PAGE_MODE	00 Normal Paging
PSI2_CHANGE_MARK	01
PSI2_INDEX	010 Three instances of PSI2
PSI2_COUNT	010
Cell Identification	0 Cell Identification parameters not present
Non GPRS Cell Options	0 Non GPRS Cell Options not present
{Reference Frequency Lists}	
- Reference Frequency list 2	0010 List 2
-IE length	0110 IE length = 6 (512 format)
	10001001 format 10 + spare 00 + format 100 + 1 bit
	00101100 ARFCN 600
	00001010 ARFCN 610
	00111011 ARFCN 620
	00000101 ARFCN 630
	00111011 ARFCN 640
	01110110 ARFCN 650
	00010100 ARFCN 660
	00101000 ARFCN 670
{GPRS Mobile Allocations}	
-MA_NUMBER	1 GPRS Mobile Allocation present
-HSN	0001
-{0 1<RFL number list>}	000000 Sequence 0
-RFL_NUMBER	1 Number list present
-{0	0001 List 2
-MA_LENGTH	0
-MA_BITMAP	001010 10 octets
- 1{0 1<ARFCN index list>}}	010101010 4 belonging
Padding	0 ARFCN index list not present

40.2.2.1.26

PACKET SYSTEM INFORMATION TYPE 3 (PCS 1900 GPRS).

MESSAGE_TYPE	110011
PAGE_MODE	00 Normal Paging
PSI3_CHANGE_MARK	00
PSI3_BIS_COUNT	0001 Two 3bis messages
Serving Cell parameters	
- CELL_BAR_ACCESS_2	0 Normal reselection
- EXC_ACC	0
- GPRS_RXLEV_ACCESS_MIN	011111 -80dBm
- GPRS_MS_TXPWR_MAX_CCH	01010
- {0 1<HCS Serving Cell parameters>}	1 HCS Serving Cell parameters present
- PRIORITY_CLASS	001
- HCS_THR	00000 -110 dBm
- MULTIBAND_REPORTING	0 – Normal Reporting of six strongest cells
General Cell Selection parameter	
- GPRS_CELL_RESELECT_HYSTERESIS	000 0 dB
- C31_HYST	0 Not used in C31
- C32_QUAL	0
- RANDOM_ACCESS_RETRY	0 No access to other cells
- {0 1<T_RESEL >}	1 present)
- T_RESEL	001 10 seconds
- {0 1<RA_RESELECT_HYSTERESIS>}	1 present)
- RA_RESELECT_HYSTERESIS	000 0 dB
Neighbour Cell parameters	containing ARFCN 520 and 600
-	1 start of neighbour cell parameters
- START_FREQUENCY	10000010 (MSB) ARFCN 520
	00 (LS 2bits)
- Cell selection params	
- BSIC	001101
- CELL_BAR_ACCESS_2	0 Normal reselection
- EXC_ACC	0
- SAME_RA_AS_SERVING_CELL	1 same routing area
- {0 1<GPRS_RXLEV_ACCESS_MIN>}	1 GPRS_RXLEV_ACCESS_MIN present
- GPRS_RXLEV_ACCESS_MIN	011111 -80dBm
- GPRS_MS_TXPWR_MAX_CCH	01010
- {0 1<GPRS_TEMPORARY_OFFSET>}	1 GPRS_TEMPORARY_OFFSET present
- GPRS_TEMPORARY_OFFSET	000
- GPRS_PENALTY_TIME	00000
- {0 1<GPRS_RESELECT_OFFSET>}	1 GPRS_RESELECT_OFFSET present
- GPRS_RESELECT_OFFSET	10000 0dB
- {0 1<HCS params>}	1 HCS params present
- GPRS_PRIORITY_CLASS	000
- GPRS_HCS_THR	10100
- {0 1<SI13_PBCCH_LOCATION>}	1 SI13_PBCCH_LOCATION present
0- SI13 1 PBCCH Location	0 SI13 Location
- PBCCH_LOCATION	0 SI13 on BCCH Norm
:NR_OF_REMAINING_CELLS	0001
:FREQ_DIFF_LENGTH	110 7 bits
:FREQUENCY_DIFF	1010000 (ARFCN 600)
- Cell selection params	
- BSIC	001110
- CELL_BAR_ACCESS_2	0 Normal reselection
- SAME_RA_AS_SERVING_CELL	1 same routing area
- {0 1<GPRS_RXLEV_ACCESS_MIN>}	0 GPRS_RXLEV_ACCESS_MIN not present
- {0 1<GPRS_TEMPORARY_OFFSET>}	1 GPRS_TEMPORARY_OFFSET present
- GPRS_TEMPORARY_OFFSET	000
- GPRS_PENALTY_TIME	0000
- {0 1<GPRS_RESELECT_OFFSET>}	1 GPRS_RESELECT_OFFSET present
- GPRS_RESELECT_OFFSET	10000 0dB
- {0 1<HCS params>}	0 HCS params not present
- {0 1<SI13_PBCCH_LOCATION>}	1 SI13_PBCCH_LOCATION present
0- SI13 1 PBCCH Location	0 SI13 Location
- SI13_LOCATION	0 SI13 on BCCH norm
	0 (end of neighbour cell parameters)
Padding	Padding

40.2.2.1.27 PACKET SYSTEM INFORMATION TYPE 3bis (PCS 1900 GPRS). (Instance 1 of 2)

MESSAGE_TYPE	110100
PAGE_MODE	00 Normal Paging
PSI3_CHANGE_MARK	00
PSI3_BIS_INDEX	0000
PSI3_BIS_COUNT	0001
Neighbour Cell parameters	containing ARFCN 600 and 700
-	1 start of neighbour cell parameters
- START_FREQUENCY	0010010110 ARFCN 600 (MSB)
	00 ARFCN 600 (LS 2 bits)
- Cell selection params	001101
- BSIC	0 Normal reselection
- CELL_BAR_ACCESS_2	0
- EXT_ACC	1 same routing area
- SAME_RA_AS_SERVING_CELL	1 GPRS_RXLEV_ACCESS_MIN present
- {0 1<GPRS_RXLEV_ACCESS_MIN>}	101000 -89dBm
- GPRS_RXLEV_ACCESS_MIN	01010
- GPRS_MS_TXPWR_MAX_CCH	1 GPRS_TEMPORARY_OFFSET present
- {0 1<GPRS_TEMPORARY_OFFSET>}	000
- GPRS_TEMPORARY_OFFSET	00000
- GPRS_PENALTY_TIME	1 GPRS_RESELECT_OFFSET present
- {0 1<GPRS_RESELECT_OFFSET>}	10000 0dB
- GPRS_RESELECT_OFFSET	1 HCS params present
- {0 1<HCS params>}	0
- GPRS_PRIORITY_CLASS	10100
- GPRS_HCS_THR	1 SI13_PBCCH_LOCATION present
- {0 1<SI13_PBCCH_LOCATION>}	0 SI13 Location
0- SI13 1 PBCCH Location	0 SI13 on BCCH Norm
- NR_OF_REMAINING_CELLS	0001
- FREQ_DIFF_LENGTH	110
- FREQUENCY_DIFF	1100100 (ARFCN 700, 100 difference)
- Cell selection params	001101
- BSIC	0 Normal reselection
- CELL_BAR_ACCESS_2	0
- EXT_ACC	1 same routing area
- SAME_RA_AS_SERVING_CELL	1 GPRS_RXLEV_ACCESS_MIN present
- {0 1<GPRS_RXLEV_ACCESS_MIN>}	101000 -89dBm
- GPRS_RXLEV_ACCESS_MIN	01010
- GPRS_MS_TXPWR_MAX_CCH	1 GPRS_TEMPORARY_OFFSET present
- {0 1<GPRS_TEMPORARY_OFFSET>}	000
- GPRS_TEMPORARY_OFFSET	0000
- GPRS_PENALTY_TIME	1 GPRS_RESELECT_OFFSET present
- {0 1<GPRS_RESELECT_OFFSET>}	10000 0dB
- GPRS_RESELECT_OFFSET	1 HCS params present
- {0 1<HCS params>}	000
- GPRS_PRIORITY_CLASS	10100
- GPRS_HCS_THR	1 SI13_PBCCH_LOCATION present
- {0 1<SI13_PBCCH_LOCATION>}	0 SI13 Location
0- SI13 1 PBCCH Location	0 SI13 on BCCH norm
- SI13_LOCATION	0 (end of neighbour cell parameters)
-	Padding 11 bits
Padding	

40.2.2.1.28 PACKET SYSTEM INFORMATION TYPE 3bis (PCS 1900 GPRS)) (Instance 2 of 2)

MESSAGE_TYPE	110100
PAGE_MODE	00 Normal Paging
PSI3_CHANGE_MARK	00
PSI3_BIS_INDEX	001
PSI3_BIS_COUNT	001
Neighbour Cell parameters	containing ARFCN 760 and 780
-	1 start of neighbour cell parameters
- START_FREQUENCY	0010111110 ARFCN 760 (MSB)
	00 ARFCN 760 (LS 2 bits)
- Cell selection params	001101
- BSIC	0 Normal reselection
- CELL_BAR_ACCESS_2	0
- EXT_ACC	1 same routing area
- SAME_RA_AS_SERVING_CELL	1 GPRS_RXLEV_ACCESS_MIN present
- {0 1<GPRS_RXLEV_ACCESS_MIN>}	101000 -89dBm
- GPRS_RXLEV_ACCESS_MIN	01010
- GPRS_MS_TXPWR_MAX_CCH	1 GPRS_TEMPORARY_OFFSET present
- {0 1<GPRS_TEMPORARY_OFFSET>}	000
- GPRS_TEMPORARY_OFFSET	00000
- GPRS_PENALTY_TIME	1 GPRS_RESELECT_OFFSET present
- {0 1<GPRS_RESELECT_OFFSET>}	10000 0dB
- GPRS_RESELECT_OFFSET	001
- {0 1<HCS params>}	0
- GPRS_PRIORITY_CLASS	10100
- GPRS_HCS_THR	1 SI13_PBCCH_LOCATION present
- {0 1< SI13_PBCCH_LOCATION >}	0 SI13 Location
0- SI13 1 PBCCH Location	0 SI13 on BCCH Norm
- NR_OF_REMAINING_CELLS	0001
- FREQ_DIFF_LENGTH	101
- FREQUENCY_DIFF	010100 (ARFCN 780)
- Cell selection params	001101 (Binary)
- BSIC	0 Normal reselection
- CELL_BAR_ACCESS_2	0
- EXT_ACC	1
- SAME_RA_AS_SERVING_CELL	1 GPRS_RXLEV_ACCESS_MIN present
- {0 1<GPRS_RXLEV_ACCESS_MIN>}	101000 -89dBm
- GPRS_RXLEV_ACCESS_MIN	01010
- GPRS_MS_TXPWR_MAX_CCH	1 GPRS_TEMPORARY_OFFSET present
- {0 1<GPRS_TEMPORARY_OFFSET>}	000
- GPRS_TEMPORARY_OFFSET	0000
- GPRS_PENALTY_TIME	1 GPRS_RESELECT_OFFSET present
- {0 1<GPRS_RESELECT_OFFSET>}	10000 0dB
- GPRS_RESELECT_OFFSET	1 HCS params present
- {0 1<HCS params>}	000
- GPRS_PRIORITY_CLASS	10100
- GPRS_HCS_THR	1 SI13_PBCCH_LOCATION present
- {0 1< SI13_PBCCH_LOCATION >}	0 SI13 Location
0- SI13 1 PBCCH Location	0 SI13 on BCCH norm
- SI13_LOCATION	0 (end of neighbour cell parameters)
-	0 (end of neighbour cell parameters)
Padding	Padding 14 bits

40.2.2.1.29 PACKET SYSTEM INFORMATION TYPE 4 (PCS 1900 GPRS)

MESSAGE_TYPE	110101
PAGE_MODE	00 Normal Paging
PSI4_CHANGE_MARK	00
PSI4_COUNT	000
PSI4_INDEX	000
Channel List for interference measurements	
- Channel group struct	
- {0<ARFCN> 1<MA_NUMBER><MAIO>}	0
- ARFCN	10000100 (ARFCN 530 – MSB)
	10 (ARFCN 530 - LS 2 bits)
- TIMESLOT_ALLOCATION	00100000 Timeslot 2 assigned
- Channel group struct	1 present
- {0<ARFCN> 1<MA_NUMBER><MAIO>}	0
- ARFCN	10000100 (ARFCN 530 – MSB)
	10 (ARFCN 530 - LS 2 bits)
- TIMESLOT_ALLOCATION	00010000 Timeslot 3 assigned
-	0 (end of channel list)
Padding	Padding 121 bits

40.2.2.1.30 PACKET SYSTEM INFORMATION TYPE 5 (PCS 1900 GPRS).

Note that the following message is only sent if the MEASUREMENT_ORDER IE in PSI1 is set to 1.

MESSAGE_TYPE	110110
PAGE_MODE	00 Normal Paging
PSI5_CHANGE_MARK	00
PSI5_INDEX	000
PSI5_COUNT	000
{0 1<NC Measurement Parameters>}	1 NC Measurement Parameters present
- NETWORK_CONTROL_ORDER	00 NC0
- {<NC_NON_DRX_PERIOD>}	1 NC Periods present
- NC_NON_DRX_PERIOD	111
- NC_REPORTING_PERIOD_I	111
- NC_REPORTING_PERIOD_T	011
{0 1<EXT Measurement Parameters>}	1 EXT Measurement Parameters present
- EXT_MEASUREMENT_ORDER	00
- NCC_PERMITTED	00000010
- {0 1<INT_FREQUENCY>}	0 Interference frequencies not included
- {0 1 External Frequency List}	0 External frequency list not included
Padding	Padding 118 bits

40.2.2.1.31 PACKET SYSTEM INFORMATION TYPE 13 (PCS 1900 GPRS).

MESSAGE_TYPE	110111
PAGE_MODE	00 Normal Paging
BCCH_CHANGE_MARK	000
SI_CHANGE_FIELD	0000 Unspecified
{0 1<SI13_CHANGE_MARK>}	1 Present
{GPRS Mobile Allocations}	1 GPRS Mobile Allocation present
-MA_NUMBER	0001
-HSN	000000 Sequence 0
-{0 1<RFL number list>}	1 Number list present
-RFL_NUMBER	0010 List 2
-{0	0
-MA_LENGTH	000100
-MA_BITMAP	1111 4 belonging
- 1{0 1<ARFCN index list>}}	0 ARFCN index list not present
- PSI1_REPEAT_PERIOD	1 PBCCH present in cell
PBCCH Description	0110 PSI1 repeat period = 7
Padding	Same as PBCCH description stated in SI13 rest octets. Padding

40.2.2.2 Cell B

The contents of Packet System Information messages for cell B are identical to those of cell A with the following exceptions:

40.2.2.2.1 PACKET SYSTEM INFORMATION TYPE 2 (GSM GPRS). Instance 1 of 2

-Cell Identity IE	02 (ID value 2 represented in 2 octets)
{Reference Frequency Lists}	
- Reference Frequency list 1	0001 List 1
- IE length	0010 IE length = 2 (128 format)
	10001100 format 10 + spare 00 + format 110 + ARFCN 40
	00010100 ARFCN 80
	00110010 ARFCN 90
	11011000 ARFCN 100
	10100000
-TSC	Dependant upon the test case.

40.2.2.2.2 PACKET SYSTEM INFORMATION TYPE 2 (GSM GPRS). Instance 2 of 2

{Reference Frequency Lists}	
- Reference Frequency list 2	0010 List 2
- IE length	0011 IE length = 3 (128 format)
	10001100 format 10 + spare 00 + format 110 + ARFCN 40
	00010100 ARFCN 50
	00011110 ARFCN 60
	11011011 ARFCN 70
	00101011 ARFCN 110
	01011000 ARFCN 120
- 1{0 1<ARFCN index list>}}	0 ARFCN index list not present
Padding	

40.2.2.2.3 PACKET SYSTEM INFORMATION TYPE 2 (DCS GPRS). Instance 1 of 2

-Cell Identity IE	02 (ID value 2 represented in 2 octets)
{Reference Frequency Lists}	
- Reference Frequency list 1	0001 List 1
-IE length	0011 IE length = 3
	10001001 ARFCN format 10 + spare 00 + format 100 + 1 bit
	00001110 ARFCN 540
	00001010 ARFCN 560
	00111011 ARFCN 580
	00000101 ARFCN 600
	00000000
-TSC	Dependant upon the test case.

40.2.2.2.4 PACKET SYSTEM INFORMATION TYPE 2 (DCS GPRS). Instance 2 of 2

{Reference Frequency Lists} - Reference Frequency list 2 -IE length	0010	List 2
	0110	IE length = 6(512 format)
	10001001	ARFCN format 10 + spare 00 + format 100 + 1 bit
	01000101	ARFCN 650
	00100011	ARFCN 690
	00101110	ARFCN 720
	10001010	ARFCN 750
	00110001	ARFCN 790
	01101100	ARFCN 810
	00111100	ARFCN 830
	01010000	ARFCN 850

40.2.2.2.5 PACKET SYSTEM INFORMATION TYPE 2 (PCS 1900 GPRS). Instance 1 of 2

-Cell Identity IE {Reference Frequency Lists} - Reference Frequency list 1 -IE length -TSC	02	(ID value 2 represented in 2 octets)
	0001	List 1
	0011	IE length = 3
	10001001	ARFCN format 10 + spare 00 + format 100 + 1 bit
	00001110	ARFCN 540
	00001010	ARFCN 560
	00111011	ARFCN 580
	00000101	ARFCN 600
	00000000	Dependant upon the test case.

40.2.2.2.6 PACKET SYSTEM INFORMATION TYPE 2 (PCS 1900 GPRS). Instance 2 of 2

{Reference Frequency Lists} - Reference Frequency list 2 -IE length	0010	List 2
	0110	IE length = 6(512 format)
	10001001	ARFCN format 10 + spare 00 + format 100 + 1 bit
	01000101	ARFCN 650
	00010110	ARFCN 680
	10110110	ARFCN 700
	00001010	ARFCN 720
	00110110	ARFCN 740
	01101100	ARFCN 760
	00101000	ARFCN 780
	01010000	ARFCN 800

40.2.3 Default contents of Layer 2 messages.

40.2.3.1 PACKET PAGING REQUEST message:

MESSAGE_TYPE	100010
PAGE_MODE	00 Normal Paging
{0 1<PERSISTENCE_LEVEL>}	0 (no persistence level present)
{0 1<NLN>}	0 (no notification list number)
{1 <Repeated Page info>}	1 (start of Repeated Page info)
-	0 (Page request for TBF establishment)
-	0 (PTMSI)
- PTMSI	00000000000000000000000000000000
-	P-TMSI allocated during GPRS attach procedure
-	0 (end of Repeated Page info)
spare padding	Spare Padding

40.2.3.2 PACKET ACCESS REJECT message:

MESSAGE_TYPE	100001
PAGE_MODE	00 Normal Paging
Reject	
-	1 (TLLI not present)
-	0(Packet Request Reference)
- Packet Request Reference	information field sent in PACKET CHANNEL REQUEST and frame number in which PACKET CHANNEL REQUEST was received
-	0 (no waiting indication)
-	0 (end of Reject IE)
spare padding	Spare Padding

40.2.3.3 PACKET QUEUEING NOTIFICATION message:

MESSAGE_TYPE	000110
PAGE_MODE	00 Normal Paging
Packet Request Reference	information field sent in PACKET CHANNEL REQUEST and frame number in which PACKET CHANNEL REQUEST was received
TQI	0010001000100010
spare padding	Spare Padding

40.2.3.4 PACKET UPLINK ASSIGNMENT message:

MESSAGE_TYPE	001010
PAGE_MODE	00 Normal Paging
Persistence Level	1 Persistence Level Present
- PERSISTENCE_LEVEL	0000
Packet Request Reference	111 Packet Request Reference Present
-RANDOM_ACCESS_INFORMATION value	Same as received value from the Packet Channel Request.
-FRAME_NUMBER	FN in which the Packet Channel Request was received.
CHANNEL_CODING_COMMAND	Dependant upon the test case.
TLLI_BLOCK_CHANNEL_CODING	1
Timing Advance value	0 Timing Advance Value not present
Timing Advance Index	1 Timing Advance Index present
-TIMING_ADVANCE_INDEX	0011
-TIMING_ADVANCE_TIMESLOT_NUMBER	010
{0 1<Frequency Parameters>}	1 (Frequency Parameters present)
- Frequency Parameters	
- TSC	011
- ARFCN	For GSM 900, 30
	For DCS 1800 and PCS 1900, 650
Single Block Allocation	01 (Single Block Allocation)
- TIMESLOT_NUMBER	0101
	1 (ALPHA, GAMMA_TN present)
- ALPHA	0011 0.5
- GAMMA_TN	For GSM 900, +9 dBm
	For DCS 1800 and PCS 1900, +6 dBm
- TBF_STARTING_TIME	indicating (current frame + 250 frames)
spare padding	Spare Padding

40.2.3.5 PACKET DOWNLINK ASSIGNMENT message:

MESSAGE_TYPE	000010
PAGE_MODE	00 Normal Paging
Persistence Level	1 Persistence Level Present
- PERSISTENCE_LEVEL	0000
Referenced Address	
-	1 (address is TLLI)
- TLLI	Same as the value received from MS
MAC_MODE	00 Dynamic Allocation
RLC_MODE	0 Acknowledged mode
CONTROL_ACK	0
TIMESLOT_ALLOCATION	00100000
Timing Advance value	0 Timing Advance Value not present
Timing Advance Index	1 Timing Advance Index present
-TIMING_ADVANCE_INDEX	0011
-TIMING_ADVANCE_TIMESLOT_NUMBER	010
{0}1<Frequency Parameters>	1 (Frequency Parameters present)
- Frequency Parameters	
- TSC	011
- ARFCN	For GSM 900, 30
	For DCS 1800 and PCS 1900, 650
{0}1<DOWNLINK_TFI_ASSIGNMENT>	1 (assign downlink TFI)
- DOWNLINK_TFI_ASSIGNMENT	00011(Binary)
{0}1<Power Control Parameters>	1 (Power Control Parameters present)
- ALPHA	0
- {0}1<GAMMA_TN0>	0 (no GAMMA_TN0)
- {0}1<GAMMA_TN1>	0 (no GAMMA_TN1)
- {0}1<GAMMA_TN2>	0 (GAMMA_TN2 present)
- GAMMA_TN2	For GSM 900, +9 dBm
	For DCS 1800 and PCS 1900, +6 dBm
- {0}1<GAMMA_TN3>	0 (no GAMMA_TN3)
- {0}1<GAMMA_TN4>	0 (no GAMMA_TN4)
- {0}1<GAMMA_TN5>	0 (no GAMMA_TN5)
- {0}1<GAMMA_TN6>	0 (no GAMMA_TN6)
- {0}1<GAMMA_TN7>	0 (no GAMMA_TN7)
{0}1<TBF_STARTING_TIME>	1 (starting time present)
- TBF_STARTING_TIME	indicating (current frame + 10 frames)
{0}1<Measurement Mapping>	0 (no measurement mapping)
spare padding	Spare Padding

40.2.3.6 PACKET DOWNLINK DUMMY CONTROL BLOCK message:

MESSAGE_TYPE	100101
PAGE_MODE	00 Normal Paging
Persistence Level	1 Persistence Level Present
- PERSISTENCE_LEVEL	0000
Spare padding	Spare Padding

40.2.4 Default contents of Layer 3 messages.

This clause contains the default values of L3 messages, which unless indicated otherwise in clause 40, shall be transmitted by the system simulator and which are required to be received from the MS under test.

In this clause, decimal values are normally used. However, sometimes a hexadecimal value, indicated by an "Hex", or a binary value, indicated by a "Binary" is used.

40.2.4.1 ACTIVATE PDP CONTEXT ACCEPT message:

Protocol discriminator	1010 (SM message for GPRS service)
Activate PDP context accept message identity	01000010
Negotiated LLC SAPI	As per corresponding Activate PDP Context Request
Negotiated QoS	Minimum
Radio priority	Arbitrary chosen
Spare half octet	Spare half octet
PDP address	Returned only if PDP address from corresponding Activate PDP Context Request is not static

40.2.4.2 ACTIVATE PDP CONTEXT REJECT message:

Protocol discriminator	1010 (SM message for GPRS service)
Activate PDP context reject message identity	01000011
SM cause	Insufficient resources

40.2.4.3 ATTACH ACCEPT message:

Protocol discriminator	1000 (MM message for GPRS service)
Skip indicator	0000
Attach accept message identity	00000010
Attach result	Copy back attach type (GPRS attach (MS class C))
Force to standby	not indicated (subject to CR)
Periodic RA update timer	timer is deactivated
Radio priority for SMS	priority level 3
Spare half octet	Spare half octet
Routing area identification	
- MCC	001 (decimal)
- MNC	For PGSM/DCS: 01 (decimal)
	For PCS: 011(decimal)
- LAC	0001H
- RAC	05H
P-TMSI signature	P-TMSI signature
Negotiated READY timer value	32 seconds
Allocated P-TMSI	P-TMSI

40.2.4.4 ATTACH REJECT message:

Protocol discriminator	MM message for GPRS
Skip indicator	0000
Attach reject message identity	00000100
GMM cause	Regular deactivation

40.2.4.5 AUTHENTICATION AND CIPHERING REJECT message:

Protocol discriminator	MM message for GPRS
Skip indicator	0000
Authentication and ciphering reject message identity	00010100

40.2.4.6 AUTHENTICATION AND CIPHERING REQUEST message:

Protocol discriminator	MM message for GPRS
Skip indicator	0000
Authentication and ciphering request message identity	00010010
Ciphering algorithm	Ciphering not used
IMEISV request	not requested
Force to standby	not indicated
A&C reference number	Arbitrary
Authentication parameter RAND	Arbitrary
GPRS ciphering key sequence number	Arbitrary

40.2.4.7 CHANNEL RELEASE message:

Protocol Discriminator	0110 (RR Management).
Skip Indicator	0000
Message Type	00001101
RR Cause	
- RR Cause Value	Normal event.

40.2.4.8 DEACTIVATE PDP CONTEXT ACCEPT message:

Protocol discriminator	1010 (SM message for GPRS service)
Deactivate PDP context accept message identity	01010100

40.2.4.9 DETACH ACCEPT message:

Protocol discriminator	MM message for GPRS
Skip indicator	0000
Detach request message identity	00000110

40.2.4.10 DETACH REQUEST message (mobile terminated detach):

Protocol discriminator	MM message for GPRS
Skip indicator	0000
Detach request message identity	00000101
Detach type	re-attach not required
Force to standby	not indicated

40.2.4.11 GMM INFORMATION message:

Protocol discriminator	MM message for GPRS
Skip indicator	0000
GMM information message identity	00100001

40.2.4.12 GMM STATUS message:

Protocol discriminator	MM message for GPRS
Skip indicator	0000
GMM status message identity	00100000
GMM cause	Arbitrary

40.2.4.13 IDENTITY REQUEST message:

Protocol discriminator	MM message for GPRS
Skip indicator	0000
Identity request message identity	00010101
Identity type	IMSI
Force to standby	not indicated

40.2.4.14 IMMEDIATE ASSIGNMENT message:

L2 pseudo length	This is the sum of the lengths of all the information elements present in the message except for the IA rest octets and L2 pseudo length IEs. For the default message the L2 pseudo length is 11.
Protocol Discriminator	RR Management.
Skip Indicator	0000
Message Type	00111111
Page Mode	
- Page Mode	Normal Paging.
Packet Response Type and Dedicated mode or TBF	
- Downlink	0
- T/D	Temporary Block Flow
- PR Type	Using Packet Channel Description
Packet Channel Description	Dependant upon the test case.
Request Reference	Copy of last received by the SS.
Timing Advance	
- Timing advance value	30 bit periods.
Mobile Allocation	
- Length	0
Starting Time	Not present.
IA rest octets	
-	HH
-	1 (Packet Downlink Assignment)
- Packet Downlink Assignment	
- TLLI	00000000000000000000000000000001
-	1
- TFI_ASSIGNMENT	Any value not used before
- RLC_MODE	RLC unacknowledged mode
- ALPHA	0.5
- GAMMA	For GSM 900, +9 dBm
	For DCS 1800 and PCS 1900, +6 dBm
- spare padding	Spare Padding

40.2.4.15 IMMEDIATE ASSIGNMENT EXTENDED message:

L2 pseudo length	This is the sum of the lengths of all the information elements present in the message except for the IAX rest octets and L2 pseudo length IEs. For the default message the L2 pseudo length is 18.
Protocol Discriminator	RR Management.
Skip Indicator	0000
Message Type	00111001
Page Mode	
- Page Mode	Normal Paging.
Channel Description 1	Dependant upon the test case.
Request Reference 1	Pertaining to last Channel Request sent by the MS.
Timing Advance 1	
- Timing advance value	Dependant upon the test case.
Channel Description 2	Dependant upon the test case.
Request Reference 2	Not pertaining to any Channel Requests sent by the MS.
Timing Advance 2	
- Timing advance value	Dependant upon the test case.
Mobile Allocation	
- Length	0
Starting Time	Not present.
IAX rest octets	All bits set to spare.

40.2.4.16 IMMEDIATE ASSIGNMENT REJECT message:

L2 pseudo length	19
Protocol Discriminator	RR Management.
Skip Indicator	0000
Message Type	00111010
Page Mode	
- Page Mode	Normal Paging.
Request Reference 1	Copy of last received by the SS.
Wait Indication 1	0 seconds.
Request Reference 2	Not pertaining to the MS under test.
Wait Indication 2	0 seconds.
Request Reference 3	Not pertaining to the MS under test.
Wait Indication 3	0 seconds.
Request Reference 4	Not pertaining to the MS under test.
Wait Indication 4	0 seconds.
IAR rest octets	All bits set to spare.

40.2.4.17 MODIFY PDP CONTEXT REQUEST message:

Protocol discriminator	1010 (SM message for GPRS service)
Modify PDP context request message identity	01001000
Radio priority	
Spare half octet	Spare half octet
Requested LLC SAPI	As per corresponding Activate PDP Context Request
New QoS	Higher than the minimum QoS

40.2.4.18 PAGING REQUEST TYPE 1 message:

L2 pseudo length	This is the sum of the lengths of all the information elements present in the message except for the P1 rest octets and L2 pseudo length IEs. For the default message the L2 pseudo length is 9.
Protocol Discriminator	RR Management.
Skip Indicator	0000
Message Type	00100001
Page Mode	
- Page Mode	Normal Paging.
Channels needed	
- first channel	00 (indicating packet paging).
- second channel	00 (indicating packet paging).
Mobile Identity 1	
- odd/even indication	Even.
- Type of Identity	P-TMSI.
- Identity Digits	P-TMSI previously allocated to MS.
Mobile Identity 2	Not present.
P1 rest octets	
- {L H<NLN(PCH)>}	L (no Notification List Number(PCH))
- {L H<Priority1>}	L (no priority specified for mobile Id 1)
- {L H<Priority2>}	L (no priority specified for mobile Id 2)
- Packet Page Indication 1	Packet Paging
- Packet Page Indication 2	L
- {L H<Group Call Information>}	L (no Group call Information)
- {L H<NLN status>}	L (no Notification List Number status)
- spare padding	Spare Padding

40.2.4.19 PAGING REQUEST TYPE 2 message:

L2 pseudo length	This is the sum of the lengths of all the information elements present in the message except for the P2 rest octets and L2 pseudo length IEs. For the default message the L2 pseudo length is 11.
Protocol Discriminator	RR Management.
Skip Indicator	0000
Message Type	00100010
Page Mode	
- Page Mode	Normal Paging.
Channels needed	
- first channel	00 (indicating packet paging).
- second channel	00 (indicating packet paging).
Mobile Identity 1	
- TMSI value	P-TMSI previously allocated to MS.
Mobile Identity 2	
- TMSI value	P-TMSI not allocated to MS.
Mobile Identity 3	IMSI not relevant to the MS under test
P2 rest octets	
- {L H<CN3>}	H (channel needed for mobile Id 3 present)
- CN3	Indicating packet paging
- {L H<NLN>}	L (no notification list number)
- {L H<Priority1>}	L (no priority specified for mobile Id 1)
- {L H<Priority2>}	L (no priority specified for mobile Id 2)
- {L H<Priority3>}	L (no priority specified for mobile Id 3)
- {L H<NLN status>}	L (no notification list number status)
- Packet Page Indication 3	Packet Paging
- spare padding	Spare Padding

40.2.4.20 PAGING REQUEST TYPE 3 message:

L2 pseudo length	19
Protocol Discriminator	RR Management.
Skip Indicator	0000
Message Type	00100100
Page Mode	
- Page Mode	Normal Paging.
Channels needed	
- first channel	00 (indicating packet paging).
- second channel	00 (indicating packet paging).
Mobile identity 1	
- TMSI value	P-TMSI previously allocated to MS.
Mobile identity 2	
- TMSI value	P-TMSI not allocated to MS.
Mobile identity 3	
- TMSI value	P-TMSI not allocated to MS.
Mobile identity 4	
- TMSI value	P-TMSI not allocated to MS.
P3 rest octets	
- {L H<CN3><CN4>}	H (channel needed for mobile Id 3 and 4 present)
- CN3	Indicating packet paging
- CN4	Indicating packet paging
- {L H<NLN>}	L (no notification list number)
- {L H<Priority1>}	L (no priority specified for mobile Id 1)
- {L H<Priority2>}	L (no priority specified for mobile Id 2)
- {L H<Priority3>}	L (no priority specified for mobile Id 3)
- {L H<Priority4>}	L (no priority specified for mobile Id 4)
- {L H<NLN status>}	L (no notification list number status)
- spare padding	Spare Padding

40.2.4.21 PDCH ASSIGNMENT COMMAND message (downlink):

Information Element	Value/Remarks
Protocol Discriminator	RR Management
Skip indicator	0000 (Binary)
Message Type	00101010 (Binary)
Description of the Channel, after time	
- Channel Description	
- Channel Type and TDMA offset	TCH/F + ACCH's
- Timeslot Number	Slot 2 ¹
- Training Sequence Code	Same as the BCC
- Hopping channel	Single RF channel
- ARFCN	Same as BCCH carrier
- RR Packet Downlink Assignment	
- LENGTH_IN_OCTETS	400
- MAC_MODE	00 (Dynamic allocation)
- RLC_MODE	1 (RLC unacknowledged mode)
- TIMESLOT_ALLOCATION	Slot 2
- Packet Timing Advance	
- { 0 1 <TIMING_ADVANCE_VALUE> }	1 (TIMING_ADVANCE_VALUE present)
- TIMING_ADVANCE_VALUE	30 bit periods
- { 0 1 <TIMING_ADVANCE_INDEX> }	0 (TIMING_ADVANCE_INDEX and TIMING_ADVANCE_TIMESLOT_NUMBER not present)
- { 0 1 <Power Control Parameters> }	1 (Power Control Parameters present)
- ALPHA	0.5
- { 0 1 <GAMMA_TN0> }	0 (GAMMA_TN0 not present)
- { 0 1 <GAMMA_TN1> }	0 (GAMMA_TN1 not present)
- { 0 1 <GAMMA_TN2> }	1 (GAMMA_TN2 present)
- GAMMA_TN2	For GSM 900: +9 dBm For DCS 1800 and PCS 1900: +6 dBm
- { 0 1 <GAMMA_TN3> }	0 (GAMMA_TN3 not present)
- { 0 1 <GAMMA_TN4> }	0 (GAMMA_TN4 not present)
- { 0 1 <GAMMA_TN5> }	0 (GAMMA_TN5 not present)
- { 0 1 <GAMMA_TN6> }	0 (GAMMA_TN6 not present)
- { 0 1 <GAMMA_TN7> }	0 (GAMMA_TN7 not present)
- { 0 1 <DOWNLINK_TFI_ASSIGNMENT> }	1 (Assign downlink TFI)
- DOWNLINK_TFI_ASSIGNMENT	00011 (Binary)
- { 0 1 <MEASUREMENT_STARTING_TI> }	0 (No measurement information)
- N_SPARE_BITS	Spare padding

40.2.4.22 REQUEST PDP CONTEXT ACTIVATION message (mobile originated detach):

Protocol discriminator	1010 (SM message for GPRS service)
Request PDP context activation message identity	01000100
Offered PDP address	Arbitrarily chosen

40.2.4.23 ROUTING AREA UPDATE ACCEPT message:

Protocol discriminator	MM message for GPRS
Skip indicator	0000
Routing area update accept message identity	00001001
Force to standby	not indicated
Update result	RA updated
Periodic RA update timer	Timer is deactivated
Routing area identification	
- MCC	001 (decimal)
- MNC	For PGSM/DCS: 01 (decimal) For PCS: 011 (decimal)
- LAC	0001H
- RAC	05H

¹ It is not clear the meaning of this field. I have just written a CR to 04.08 to make explicit that the MS shall ignore it.

40.2.4.24 RR-CELL CHANGE ORDER message:

Information Element	Value/Remarks
Protocol Discriminator	RR Management
Skip indicator	0000 (Binary)
Message Type	00001000 (Binary)
Cell description	
- PLMN colour code, NCC	1
- BS colour code, BCC	5
- BCCH ARFCN	For GSM 900: 10 For DCS 1800 and PCS 1900: 520
NC mode for target cell	
- NC mode	00 (binary, NC0 mode)
Spare half octet	Spare Padding

40.2.4.25 SM STATUS message:

Protocol discriminator	1010 (SM message for GPRS service)
SM status message identity	01010101
SM cause	Arbitrary

40.3 Default GPRS Conditions, Message Contents and Macros for the Higher Layer Test Cases

This clause details default conditions and messages that shall be used for the higher layer test cases (GPRS Mobility Management, Session Management and SMDCP).

These alternate conditions and messages are derived from the standard defaults via the changes listed in the following sub-clause. They aim to produce default conditions with permitted channel combinations of:

FCCH+SCH+BCCH+CCCH+SDCCH/4+SACCH/4 (v. from GSM 05.02 'Permitted Channel Combinations onto a Basic Physical Channel')

PBCCH+PCCCH+PDTCH+PACCH+PTCCH (xi. from GSM 05.02 'Permitted Channel Combinations onto a Basic Physical Channel')

PDTCH+PACCH+PTCCH (xiii. From GSM 05.02 'Permitted Channel Combinations onto a Basic Physical Channel')

Where values have not been specified the equivalent overall default values should be used. If values need to be removed from the overall defaults then these should be specified as 'OMITTED'.

40.3.1 Default Test Conditions for the Higher Layer Test Cases.

Network dependant parameters	
CCCH_CONF	1 basic physical channel for CCCH combined with SDCCH
BS_AG_BLKS_RES	0 blocks reserved
BS_PA_MFRMS	5 multiframes
IMSI Attach-detach	IMSI attach / detach not allowed

40.3.2 Default Message for the Higher Layer Test Cases.

40.3.2.1 Default Contents of System Information Messages for the Higher Layer Test Cases.

Default Contents of Information Elements in SYSTEM INFORMATION TYPE 1 to 13 Messages Used for the Higher Layer Test Cases.

Control Channel Description	
- BS_AG_BLKS_RES	0 blocks reserved for access grant.
- CCCH_CONF	1 basic physical channel used for CCCH, combined with SDCCHs.
- BS_PA_MFRMS	5 multiframe periods for transmission of paging messages.
- Attach-Detach allowed	IMSI attach / detach not allowed

Normal Case

SI 13 Rest Octets Routing Area Code(RAC) SPLIT_PG_CYCLE(SPGC_CCCH_SUP) PRIORITY_ACCESS_THR NETWORK_CONTROL_ORDER GPRS Cell Options NETWORK_MODE OF OPERATION T3168 T3192 DRX_TIMER_MAX ACCESS_BURST_TYPE CONTROL_ACK_TYPE BS_CV_MAX PAN_DEC PAN_INC PAN_MAX GPRS Power Control Parameters ALPHA T_AVG_W T_AVG_T PC_MEAS_CHAN N_AVG_I INT_MEAS_CHANNEL_LIST_AVAIL	For PBCCH not present case 00000101(Binary) Supported Packet access allowed for priority level 1 to 4 Normal MS control, no measurement reporting NMO I 2 seconds 1.5 seconds Non-DRX not supported 11 bits access burst RLC/MAC control block 7 3 3 010(Binary) 12 12 BCCH 7 Not Available
--	--

Alternate Case

SI 13 Rest Octets PSI1_REPEAT_PERIOD PBCCH Description TSC TN ARFCN	For PBCCH present case 0110 (Binary) Dependant upon the test case Timeslot 4 Non-Hopping Channel For GSM 900: 30 For DCS 1800 and PCS 1900: 650
--	---

40.3.3 Contents Of Packet System Information Messages for the Higher Layer Test Cases

PACKET SYSTEM INFORMATION TYPE 2 Instance 1 of 3 for Higher Layer Test Cases

Non GPRS Cell Options -BS_AG_BLK_RES -CCCH_CONF -BS_PA_MFRMS {PCCCH Description}	1 Non GPRS Cell Options present 000 0 reserved 001 100 value 5 Same as the PBCCH Description as defined in SI13 Rest Octets
--	---

PACKET SYSTEM INFORMATION TYPE 13

Normal Case

Routing Area Code(RAC) SPLIT_PG_CYCLE(SPGC_CCCH_SUP) PRIORITY_ACCESS_THR NETWORK_CONTROL_ORDER GPRS Cell Options NETWORK_MODE OF OPERATION T3168 T3192 DRX_TIMER_MAX ACCESS_BURST_TYPE CONTROL_ACK_TYPE BS_CV_MAX PAN_DEC PAN_INC PAN_MAX GPRS Power Control Parameters ALPHA T_AVG_W T_AVG_T PC_MEAS_CHAN N_AVG_I INT_MEAS_CHANNEL_LIST_AVAIL	For PBCCH not present case 00000101(Binary) Supported Packet access allowed for priority level 1 to 4 Normal MS control, no measurement reporting NMO I 2 seconds 1.5 seconds Non-DRX not supported 11 bits access burst RLC/MAC control block 7 3 3 010(Binary) 12 12 BCCH 7 Not Available
---	--

Alternate Case

PBCCH Description TSC TN ARFCN	For PBCCH present case 3 Timeslot 2 Non-Hopping Channel For GSM 900: 30 For DCS 1800 and PCS 1900: 650
---	---

40.3.4 Contents of Layer 2 Messages for the Higher Layer Test Cases.

PACKET UPLINK ASSIGNMENT message:

{0 1<Frequency Parameters>} - Frequency Parameters - ARFCN Single Block Allocation - TIMESLOT_NUMBER	1 (Frequency Parameters present) ARFCN of the PCCCH 01 (Single Block Allocation) 010 1 (ALPHA, GAMMA_TN present)
--	--

PACKET DOWNLINK ASSIGNMENT message:

{0 1<Frequency Parameters>} - Frequency Parameters - ARFCN	1 (Frequency Parameters present) ARFCN of the PCCCH
--	--

40.3.5 Contents of Layer 3 Messages for the Higher Layer Test Cases.

IMMEDIATE ASSIGNMENT message:

Packet Channel Description - TN - ARFCN	2 (Chosen arbitrarily) ARFCN of the PCCCH
---	--

IMMEDIATE ASSIGNMENT EXTENDED message:

Channel Description 1 - Channel Type and TDMA offset - Timeslot Number - ARFCN	SDCCH/4, with subchannel chosen arbitrarily by the test house. 0 ARFCN of the CCCCH
---	---

40.4 Macros.

40.4.1 Overview

This document presents macros for GPRS test cases. It is intended to be a working document forming part of the GPRS Test Specifications.

40.4.1.1 Definition

A macro is a name or sentence, possibly followed by an argument list, that is equated to a text to which it is to be expanded, possibly with the substitution of actual arguments.

Macros may be used to simplify the writing and reading of the test cases or to avoid the repetition of common sentences, message contents or message sequences. The macros defined in this section can be used throughout the test cases.

The definition of the macros is done in alphabetical order.

40.4.1.2 Syntax

40.4.1.2.1 Message contents

Any macro referencing message contents shall use the following table:

Macro reference (arguments)		
(P)SI	Information Element	Value/Remarks

The table must contain:

Macro reference: word or sentence that gives the name to the macro. It may include a list of arguments with actual values for some IE's.

(P)SI: the System Information and Packet System Information messages whose content is referenced. Several (P)SIs can be referenced in this column. The defined IE value(s) refers to the (P)SI(s) in the same row.

Information Element: IE which value is specified.

Value/Remarks: value and any other comment specific to the IE's. In particular, the mapping between an argument value and its coding shall be specified in this column.²

40.4.1.2.2 Message sequence

Any macro referencing message contents shall use the following table:

² If possible, only the meaning of the value will be shown and not the value itself; this avoids updating when the core specifications are modified.

Step	Direction	Message	Comments
		{ Macro reference }	Macro (arguments)

The table must contain:

Macro reference: word or sentence that gives the name to the macro. It may include a list of arguments with actual values for some parameters used within the macro.

Step: Number of the message. Letters may be used for general values: the same rules as in GSM 11.10 apply.

Direction: it must be either

”MS → SS”, for an uplink message or a macro containing only uplink message(s),

”SS → MS”, for a downlink message or a macro containing only downlink message(s),

”SS ↔ MS”, for a macro containing both uplink and downlink message(s),

”MS”, for an action performed on the mobile side, or

”SS”, for an action performed on the system simulator side.

Message: Message name or macro reference.

Comments: any other comment specific to the message. In particular, value of certain bits/fields of the correspondent message.

The symbol ‘:’ can be used to indicate that the previous and following message or sequence of messages (both previous and following must appear) is sent an unknown number of times, probably referenced with a letter on the ‘step’ column.

40.4.2 Default message contents

40.4.2.1 GPRS not supported

(P)SI	Information Element	Value/Remarks
SI 3 SI 4 SI 7 SI 8	GPRS Indicator	GPRS not supported

40.4.2.2 GPRS supported

(P)SI	Information Element	Value/Remarks
SI 3 SI 4 SI 7 SI 8	GPRS Indicator	GPRS supported

40.4.2.3 GPRS supported using BCCH

(P)SI	Information Element	Value/Remarks
SI 13	[Bit after RA_CODE]	PCCCH not present

40.4.2.4 GPRS supported using PBCCH

(P)SI	Information Element	Value/Remarks
SI 13	[Bit after RA_CODE]	PCCCH present

40.4.2.5 Max retrans set to {1, 2, 4, 7}

(P)SI	Information Element	Value/Remarks
SI 1 SI 2 SI 2bis SI 3 SI 9	RACH Control Parameters - Max retrans	Maximum 1 retransmission, maximum 2 retransmissions, maximum 4 retransmissions or maximum 7 retransmissions

40.4.3 Macro message sequences

40.4.3.1 Acknowledged downlink data

Step	Direction	Message	Comments
	SS ↔ MS	{ Acknowledged downlink data }	Macro
1	SS → MS	{ Downlink data }	Macro
2	MS → SS	PACKET DOWNLINK ACK/NACK	

40.4.3.2 Classmark and measurement

Step	Direction	Message	Comments
	MS → SS	{ Classmark and measurement }	Macro
1a	MS → SS	MEASUREMENT REPORT	
2a	MS → SS	CLASSMARK CHANGE	Mobile Station Classmark 2 and 3
1b	MS → SS	CLASSMARK CHANGE	Mobile Station Classmark 2 and 3
2b	MS → SS	MEASUREMENT REPORT	
3	MS → SS	{ Measurement reporting }	Macro

40.4.3.3 Downlink data

Step	Direction	Message	Comments
	SS → MS	{ Downlink data }	Macro
1	SS → MS	RLC DOWNLINK DATA	FBI bit set to '0'
2	SS → MS	RLC DOWNLINK DATA	
⋮	⋮	⋮	
N	SS → MS	RLC DOWNLINK DATA	$n \geq 1$

40.4.3.4 Downlink data transfer

Step	Direction	Message	Comments
	SS ↔ MS	{ Downlink data transfer }	Macro
a. RLC unacknowledged mode			
1	SS → MS	{ Downlink data }	Macro
2	SS → MS	RLC DOWNLINK DATA	FBI bit set to '1' and valid RRBP field
3	MS → SS	PACKET CONTROL ACKNOWLEDGMENT	In the uplink block specified by the RRBP field
b. RLC acknowledged mode			
1	SS ↔ MS	{ Acknowledged downlink data }	Macro
2	SS ↔ MS	{ Acknowledged downlink data }	Macro
⋮	⋮	⋮	
N	SS ↔ MS	{ Acknowledged downlink data }	Macro. $n \geq 1$
n+1	SS → MS	RLC DOWNLINK DATA	
n+2	SS → MS	RLC DOWNLINK DATA	
⋮	⋮	⋮	
M	SS → MS	RLC DOWNLINK DATA	$m \geq n+1$. FBI bit set to '1' and valid RRBP field
m+1	MS → SS	PACKET DOWNLINK ACK/NACK	In the uplink block specified by the RRBP field. Final Ack Indicator bit set to '1'

40.4.3.5 Measurement reporting

Step	Direction	Message	Comments
	MS → SS	{ Measurement reporting }	Macro
1	MS → SS	MEASUREMENT REPORT	See note 1
2	MS → SS	MEASUREMENT REPORT	
⋮	⋮	⋮	
N	MS → SS	MEASUREMENT REPORT	$n \geq 1$

NOTE 1: These messages are sent continuously on the ACCH. As no short messages are sent, this sequence should not be temporarily interrupted by other messages also sent on the same channel. However, other messages may be sent on the main DCCH.

40.4.3.6 Uplink data transfer

Step	Direction	Message	Comments
	MS ↔ SS	{ Uplink data transfer }	Macro (arguments: see note 4)
1	MS → SS	RLC UPLINK DATA	See notes 1 and 2
2a	MS → SS	RLC UPLINK DATA	
2b	SS → MS	PACKET UPLINK ACK/NACK	See note 3
3a	MS → SS	RLC UPLINK DATA	
3b	SS → MS	PACKET UPLINK ACK/NACK	
⋮	⋮	⋮	
N	MS → SS	RLC UPLINK DATA	$n \geq 1$. CV set to '0'
N+1	SS → MS	PACKET UPLINK ACK/NACK	Final Ack Indicator bit = '1' and valid RRBP field
N+2	MS → SS	PACKET CONTROL ACKNOWLEDGEMENT	In the uplink block specified by the RRBP field

NOTE 1: SI bit set to '0' in all data blocks.

NOTE 2: The SS sends a PACKET UPLINK ACK/NACK message at least every k-1 RLC UPLINK DATA messages, being k the window size with a value of 64 blocks.

NOTE 3: The field CV in the RLC UPLINK DATA messages verifies

$$CV' = \text{round}\left(\frac{TBC - BSN' - 1}{NTS}\right)$$

$$CV = \begin{cases} CV' & x \leq BS_CV_MAX \\ 15 & \text{otherwise} \end{cases}$$

where:

- TBC: total number of RLC data blocks that will be transmitted in the TBF,
- BSN': absolute block sequence number of the RLC data block, from 0 to (TBC - 1),
- NTS: number of timeslots assigned to the uplink TBF, with range 1 to 8,
- the function round() rounds upwards to the nearest integer,
- BS_CV_MAX is a parameter broadcast in the system information,
- the division operation is non-integer and results in zero only for (TBC - BSN' - 1) = 0.

NOTE 4: In the case of Dynamic MAC mode, the macro reference in the corresponding test case may contain a certain frequency (in seconds⁻¹ or frames⁻¹) for the SS to indicate the USF allocated to the mobile so that the MS is allowed to transmit. Otherwise, mobile's USF is indicated in every available block.

40.4.3.7 Uplink dynamic allocation one phase access

Step	Direction	Message	Comments
		{Uplink dynamic allocation one phase access}	Macro parameters: n : the number of RLC data block to be transferred, USF_GRANULARITY : 1 or 4 blocks, RLC_DATA_BLOCKS_GRANTED : 9-261 (close-end), or absent (open-end) CHANNEL_CODING_COMMAND : CS-1, -2, -3, -4 TLLI_BLOCK_CHANNEL_CODING : CS-1 or as data block REL_OR_ABS_FN : absolute or relative frame number encoding for starting time TBF_STARTING_TIME
0	MS		Trigger the MS initiating uplink transfer n octets data according to the test PDP context activated
1	MS -> SS	PACKET CHANNEL REQUEST	Received on PRACH.
2	SS -> MS	PACKET UPLINK ASSIGNMENT	uplink dynamic allocation, Sent on PAGCH.

Note: after step 2, the MS is not yet in the packet transfer mode. The contention resolution must be completed.

40.4.3.8 Uplink dynamic allocation one phase access with contention resolution

Step	Direction	Message	Comments
		{Uplink dynamic allocation one phase access with contention resolution}	Macro parameters: n : the number of RLC data block to be transferred, USF_GRANULARITY : 1 or 4 blocks, RLC_DATA_BLOCKS_GRANTED : 9-261 (close-end), or absent (open-end) CHANNEL_CODING_COMMAND : CS-1, -2, -3, -4 TLLI_BLOCK_CHANNEL_CODING : CS-1 or as data block REL_OR_ABS_FN : absolute or relative frame number encoding for starting time TBF_STARTING_TIME
0	MS		Trigger the MS initiating uplink transfer n octets data according to the test PDP context activated
1	MS -> SS	PACKET CHANNEL REQUEST	Received on PRACH.
2	SS -> MS	PACKET UPLINK ASSIGNMENT	uplink dynamic allocation, Sent on PAGCH.
3	SS -> MS	PACKET DOWNLINK DUMMY CONTROL BLOCK	Sent on the PACCH of the PDCH, the USF assigned to the MS, on 3 blocks from the last radio block containing the uplink assignment.
4A	MS -> SS	UPLINK RLC DATA BLOCK	For USF_GRANULARITY = 1, containing TLLI in the RLC/MAC header.
4B1	MS -> SS	UPLINK RLC DATA BLOCK	For USF_GRANULARITY = 4, containing TLLI in the RLC/MAC header.
4B2	MS -> SS	UPLINK RLC DATA BLOCK	For USF_GRANULARITY = 4, containing TLLI in the RLC/MAC header.
4B3	MS -> SS	UPLINK RLC DATA BLOCK	For USF_GRANULARITY = 4, containing TLLI in the RLC/MAC header.
4B4	MS -> SS	UPLINK RLC DATA BLOCK	For USF_GRANULARITY = 4, containing TLLI in the RLC/MAC header.
5	SS -> MS	PACKET UPLINK ACK/NACK	Sent on the PACCH, containing TLLI received at step 4.

40.4.3.9 Uplink dynamic allocation two phase access

Step	Direction	Message	Comments
		{Uplink dynamic allocation two phase access}	Macro parameters: n : the number of RLC data block to be transferred, USF_GRANULARITY : 1 or 4 blocks, RLC_DATA_BLOCKS_GRANTED : 9-261 (close-end), or absent (open-end) CHANNEL_CODING_COMMAND : CS-1, -2, -3, -4 TLLI_BLOCK_CHANNEL_CODING : CS-1 or as data block, TBF_STARTING_TIME
0	MS		Trigger the MS initiating uplink transfer n octets data according to the test PDP context activated
1	MS -> SS	PACKET CHANNEL REQUEST	Received on PRACH.
2	SS -> MS	PACKET UPLINK ASSIGNMENT	Single block assignment, to order the MS to follow the two phase access procedure. Sent on PAGCH.
3	MS -> SS	PACKET RESOURCE REQUEST	Two phase access procedure. Received on the single block assigned in step 2. Check that the PEAK_THROUGHPUT, RADIO_PRIORITY and RLC_MODE are compliant with the PDP context used.
4	SS -> MS	PACKET UPLINK ASSIGNMENT	uplink dynamic allocation, no starting time (as default, otherwise use TBF_STARTING_TIME), Sent on PACCH of the same PDCH assigned in step 2.

40.4.3.10 Completion of uplink RLC data block transfer

The steps 1A – 3A are applied for the 1 uplink slot with the USF granularity 1 block.

The steps 1B, 2B1-2B4 and 3B are applied for the 1 uplink slot with the USF granularity 4 blocks.

The steps 1C – 5C are applied for the 2 uplink slots with USF granularity 1 block.

The steps 6 – 7 are common the cases A, B and C.

Step	Direction	Message	Comments
		{Completion of uplink RLC data block transfer}	Macro parameters: USF_GRANULARITY : 1 or 4 blocks, the number of slots assigned in the uplink.
1A,1B	SS -> MS	PACKET UPLINK ACK/NACK	The assigned USF assigned to the MS to the MS.
2A	MS -> SS	UPLINK RLC DATA BLOCK	For USF_GRANULARITY = 1 Received on the assigned PDTCH.
2B1 2B2 2B3 2B4	MS -> SS MS -> SS MS -> SS MS -> SS	UPLINK RLC DATA BLOCK UPLINK RLC DATA BLOCK UPLINK RLC DATA BLOCK UPLINK RLC DATA BLOCK	For USF_GRANULARITY = 4 Received on the assigned PDTCH. Received on the assigned PDTCH Received on the assigned PDTCH Received on the assigned PDTCH
3A,3B			Repeat the steps 1A and 2A or 1B and 2B1-2B4 until the countdown value CV=0 in step 2A or in one of the steps 2B1 - 2B4.
1C	SS -> MS	PACKET UPLINK ACK/NACK	Sent on the PACCH of the PDCH 1, the assigned USF1 addressing the MS.
2C	SS -> MS	PACKET UPLINK ACK/NACK	Sent on the PACCH of the PDCH 2 on the same radio block as step 1C, the assigned USF2 addressing the MS.
3C	MS -> SS	UPLINK RLC DATA BLOCK	Received on the assigned PDTCH 1.
4C	MS -> SS	UPLINK RLC DATA BLOCK	Received on the assigned PDTCH 2.
5C			Repeat steps 1C – 4C until the countdown value CV=0 in step 3C or step 4C.
6	SS -> MS	PACKET UPLINK ACK/NACK	Final Ack Indicator = '1' containing valid RRBP. Sent on the PACCH of the assigned PDCH.
7	MS -> SS	PACKET CONTROL ACKNOWLEDGEMENT	Received on the block specified by RRBP on PACCH of the assigned PDCH.

40.4.3.10.1 PACKET UPLINK ACK/NACK message in step 6:

Ack/Nack Description - FINAL_ACK_INDICATION - STARTING_SEQUENCE_NUMBER - RECEIVED_BLOCK_BITMAP	1 (final ACK) No information, ignored No information, ignored
---	---

40.4.3.11 Uplink fixed allocation one phase access

Step	Direction	Message	Comments
		{Uplink fixed allocation one phase access}	Macro parameters: n : the number of RLC data block to be transferred, CHANNEL_CODING_COMMAND : CS-1, -2, -3, -4 TLLI_BLOCK_CHANNEL_CODING : CS-1 or as data block, DOWNLINK_CONTROL_TIMESLOT HALF_DUPLEX_MODE TBF_STARTING_TIME BLOCKS_OR_BLOCK_PERIODS ALLOCATION_BITMAP_LENGTH ALLOCATION_BITMAP
0	MS		Trigger the MS initiating uplink transfer n octets data according to the test PDP context activated
1	MS -> SS	PACKET CHANNEL REQUEST	Received on PRACH. Check the channel request description whether being an open-ended or close-ended TBF
2	SS -> MS	PACKET UPLINK ASSIGNMENT	uplink fixed allocation, assigning sufficient resource on a single slot (great than n blocks) Sent on PAGCH.
3	MS -> SS	PACKET RESOURCE REQUEST	Received if open-ended in step 1, ignore it

The macro is used for establishment of a TBF in acknowledged RLC mode.

40.4.3.12 Uplink fixed allocation one phase access with contention resolution

Step	Direction	Message	Comments
		{Uplink fixed allocation one phase access with contention resolution}	Macro parameters: n : the number of RLC data block to be transferred, CHANNEL_CODING_COMMAND : CS-1, -2, -3, -4 TLLI_BLOCK_CHANNEL_CODING : CS-1 or as data block, HALF_DUPLEX_MODE TBF_STARTING_TIME : BLOCKS_OR_BLOCK_PERIODS : ALLOCATION_BITMAP_LENGTH : ALLOCATION_BITMAP
0	MS		Trigger the MS initiating uplink transfer n octets data according to the test PDP context activated
1	MS -> SS	PACKET CHANNEL REQUEST	Received on PRACH. Check the channel request description whether being an open-ended or close-ended TBF
2	SS -> MS	PACKET UPLINK ASSIGNMENT	uplink fixed allocation, assigning sufficient resource on a single slot (greater than n blocks) Sent on PAGCH.
3	MS -> SS	PACKET RESOURCE REQUEST	If received, ignore it
4	MS -> SS	UPLINK RLC DATA BLOCK	containing TLLI in the RLC/MAC header
5	SS -> MS	PACKET UPLINK ACK/NACK	Acknowledge the received RLC data block with TLLI received in step 4.

The macro is used for establishment of a TBF in acknowledged RLC mode.

40.4.3.13 Uplink fixed allocation two phase access

Step	Direction	Message	Comments
		{Uplink fixed allocation two phase access}	Macro parameters: n : the number of RLC data block to be transferred, CHANNEL_CODING_COMMAND : CS-1, -2, -3, -4 HALF_DUPLEX_MODE TBF_STARTING_TIME : BLOCKS_OR_BLOCK_PERIODS : ALLOCATION_BITMAP_LENGTH : ALLOCATION_BITMAP
0	MS		Trigger the MS initiating uplink transfer n octets data according to the test PDP context activated
1	MS -> SS	PACKET CHANNEL REQUEST	Received on PRACH.
2	SS -> MS	PACKET UPLINK ASSIGNMENT	Single block assignment, to order the MS to follow the two phase access procedure. Sent on PAGCH.
3	MS -> SS	PACKET RESOURCE REQUEST	Two phase access procedure. Received on the single block assigned in step 2.
4	SS -> MS	PACKET UPLINK ASSIGNMENT	Check that the PEAK_THROUGHPUT , RADIO_PRIORITY and RLC_MODE are compliant with the PDP context used. uplink fixed allocation, no starting time (as default, otherwise use TBF_STARTING_TIME), Sent on PACCH of the same PDCH assigned in step 2.

40.4.3.14 Downlink TBF establishment

Step	Direction	Message	Comments
		{Downlink TBF establishment}	Macro parameters: RLC mode TBF_STARTING_TIME
1	SS -> MS	PACKET PAGING REQUEST	1 st Repeated Page info contains P-TMSI of the MS. Sent on PPCH.
2	MS -> SS	PACKET CHANNEL REQUEST	ACCESS TYPE = " Page Response ". Received on PRACH.
3	SS -> MS	PACKET UPLINK ASSIGNMENT	Random Reference = pertaining to the message received in step 2. Fixed allocation for 5 RLC data blocks, Sent on PAGCH.
4	MS -> SS	UPLINK RLC DATA BLOCK	LLC PDU implicitly indicating paging response, containing TLLI in the RLC/MAC header. Received on uplink PDTCH assigned in step 3.
5	SS -> MS	PACKET UPLINK ACK/NACK	Acknowledge the received RLC data block. Sent on uplink PACCH.
6	MS -> SS	PACKET CONTROL ACKNOWLEDGEMENT	Acknowledge the RLC control message. Received on uplink PACCH.
7	SS -> MS	PACKET DOWNLINK ASSIGNMENT	Downlink Assignment, TLLI value as received. Sent on PPCH. Three macro parameters as assigned in the test cases.

40.4.3.15 PDP Context Activation

Mobile initiated, for LLC mode unacknowledged:

Step	Direction	Message	Comments
		{PDP Context Activation}	
1	MS -> SS	Activate PDP Context Request	
2	SS -> MS	Activate PDP Context Accept	

Mobile initiated, for LLC mode acknowledged:

Step	Direction	Message	Comments
		{PDP Context Activation}	
1	MS -> SS	Activate PDP Context Request	
2	SS -> MS	Activate PDP Context Accept	
3	MS -> SS	SABM	Link establishment (When relevant to the test case, steps 3 and 4 are shown as a part of the test case)
4	SS -> MS	UA	

40.4.3.16 PDP Context Deactivation

Mobile initiated:

Step	Direction	Message	Comments
		{PDP Context Deactivation}	
1	MS -> SS	Deactivate PDP Context Request	
2	SS -> MS	Deactivate PDP Context Accept	

Network initiated:

Step	Direction	Message	Comments
		{PDP Context Deactivation}	
1	SS -> MS	Deactivate PDP Context Request	
2	MS -> SS	Deactivate PDP Context Accept	

40.4.3.17 Inter-SGSN Routing Area Update

Step	Direction	Message	Comments
		{Inter-SGSN Routing Area Update}	
1	SS -> MS	Packet Cell Change Order	SS requests the MS to move to a new cell in a Routing Area belonging to a different SGSN.
2	MS -> SS	Routing Area Update Request	The updating type shall be "Combined RA/LA Updating" for Class B mobiles in Network Mode I and "RA Updating" for Class C mobiles supporting GPRS.
3	SS->MS	XID	XID with RESET
4	MS->SS	XID	XID response
5	SS -> MS	Routing Area Update Accept	

40.4.3.18 PDP Context Modification

This procedure is always initiated by the network.

Step	Direction	Message	Comments
		{PDP Context Modification}	
1	SS -> MS	Modify PDP Context	
2	MS -> SS	Modify PDP Context Accept	

40.4.3.19 Location Update Procedure

This procedure is only initiated by mobile stations that are not operating in class mode C "GPRS".

Step	Direction	Message	Comments
		{Location Update Procedure}	
1	MS -> SS	LOCATION UPDATE REQUEST	
2	SS -> MS	AUTHENTICATION REQUEST	
3	MS -> SS	AUTHENTICATION RESPONSE	
4	SS -> MS	LOCATION UPDATE ACCEPT	
5	MS -> SS	TMSI REALLOCATION COMPLETE	

40.5 Test PDP contexts

The following table defines 7 PDP contexts used in the GPRS dynamic allocation and RLC testcases. Test PDP context3 is the default Test PDP context which is used in the test cases where no particular Test PDP contexts are specified. Compression is always turned off if nothing else is stated explicitly in the test case.

Table 40.5 Test PDP contexts

	PDP Context1	PDP Context2	PDP context3	PDP context4
LLC SAPI	SAPI = 3	SAPI = 11	SAPI = 11	SAPI = 9
Reliability Class	5 (RLC unacknowledged) (LLC unacknowledged)	3 (RLC acknowledged) (LLC unacknowledged)	5	3
Delay Class	4 (best effort)	4	4	4
Precedence Class	2 (normal)	2	2	2
Peak Throughput Class	5 (128 kbit/s)	5	5	6 (256 kbit/s)
Mean Throughput Class	16 (~11.1 kbit/s)	16	16	16
PDP Type	IP type	IP type	IP type	IP type
PDP Address	Dynamic	Dynamic	dynamic	dynamic
APN	smg7.etsi.fr	smg7.etsi.fr	smg7.etsi.fr	smg7.etsi.fr
Protocol Configuration Options	PPP options	PPP options	PPP options	PPP options
Radio Priority	1	4	4	4

The table continues on the next page.

	PDP context5	PDP context6	PDP Context7	PDP Context 8
LLC SAPI	SAPI = 3	SAPI = 9	SAPI = 9	SAPI = 5
Reliability Class	3	5	5	3 (RLC acknowledged) (LLC unacknowledged) (data protected)
Delay Class	4	4	4	4 (best effort)
Precedence Class	2	2	2	2 (normal)
Peak Throughput Class	5	6	6	5 (128 kbit/s)
Mean Throughput Class	16	16	16	16 (~11.1 kbit/s)
PDP Type	IP type	IP type	IP type	IP type
PDP Address	dynamic	dynamic	Dynamic	Dynamic
APN	smg7.etsi.fr	smg7.etsi.fr	smg7.etsi.fr	Smg7.etsi.fr
Protocol Configuration Options	PPP options	PPP options	PPP options	PPP options
Radio Priority	1	4	4	1

	PDP Context 9	PDP Context 10	PDP Context 11
LLC SAPI	SAPI = 11	SAPI = 5	SAPI = 3
Reliability Class	3 (RLC acknowledged) (LLC unacknowledged) (data protected)	5 (RLC unacknowledged) (LLC unacknowledged) (data unprotected)	2 (RLC acknowledged) (LLC acknowledged) (data protected)
Delay Class	4 (best effort)	4 (best effort)	4 (best effort)
Precedence Class	2 (normal)	2 (normal)	2 (normal)
Peak Throughput Class	5 (128 kbit/s)	5 (128 kbit/s)	5 (128 kbit/s)
Mean Throughput Class	16 (~11.1 kbit/s)	16 (~11.1 kbit/s)	16 (~11.1 kbit/s)
PDP Type	IP type	IP type	IP type
PDP Address	Dynamic	dynamic	Dynamic
APN	Smg7.etsi.fr	Smg7.etsi.fr	Smg7.etsi.fr
Protocol Configuration Options	PPP options	PPP options	PPP options
Radio Priority	1	1	1

The table continues on the next page.

	PDP Context 12	PDP Context 13	PDP Context 14
LLC SAPI	SAPI = 9	SAPI = 11	SAPI = 9
Reliability Class	2 (RLC acknowledged) (LLC acknowledged) (data protected)	1 (RLC acknowledged) (LLC acknowledged) (data protected)	3 (RLC acknowledged) (LLC unacknowledged) (data protected)
Delay Class	4 (best effort)	4 (best effort)	4 (best effort)
Precedence Class	2 (normal)	2 (normal)	2 (normal)
Peak Throughput Class	5 (128 kbit/s)	5 (128 kbit/s)	5 (128 kbit/s)
Mean Throughput Class	16 (~11.1 kbit/s)	16 (~11.1 kbit/s)	16 (~11.1 kbit/s)
PDP Type	IP type	IP type	IP type
PDP Address	dynamic	dynamic	Dynamic
APN	Smg7.etsi.fr	Smg7.etsi.fr	Smg7.etsi.fr
Protocol Configuration Options	PPP options	PPP options	PPP options
Radio Priority	1	1	1

40.6 Appendix A.

40.6.1 ARFCNs in different SI messages

GSM 900 and DCS 1800

		GSM 900		DCS 1 800	
		<i>Serving cell</i>	<i>Neighbouring cells</i>	<i>Serving cell</i>	<i>Neighbouring cells</i>
BCCH / CCCH	Default	20	10, 80, 90, 100, 110, 120	590	520, 600, 700, 780, 810, 870
	<i>Alternative</i>	40, 60	15, 85, 95, 105, 115, 122	690, 830	530, 610, 710, 790, 820, 880
PDTCH / SDCCH	<i>Default</i>	30		650	
	<i>Alternative</i>	50, 70		750, 850	

		GSM 900		DCS 1 800	
Cell Allocation [SI 1]	11.10	20, 30, 50, 70		590, 650, 750, 850	
	47/98	20, 30, 40, 50, 60, 70		590, 650, 690, 750, 830, 850	
	<i>Propos.</i>	20, 30, (40,) 50, (60,) 70		590, 650, (690,) 750, (830,) 850	
Neighbouring cells [SI 2]	11.10	10, 20, 40, 80, 90, 100, 110, 120		520, 590, 600, 700, 780, 810, 870	
	47/98				
	<i>Propos.</i>	10, 80, 90, 100, 110, 120 (+15, 85...)		520, 600, 700, 780, 810, 870 (+530, 610...)	
Neighbouring cells [SI 2bis]	11.10	Not present			
	47/98	985, 989, 995, 1010, 1014			
	<i>Propos.</i>	985, 989, 995, 1010, 1014			
Neighbouring cells [SI 2ter]	11.10	Not present			
	47/98	520, 590, 600, 700, 780, 810, 870		10, 20, 40, 80, 90, 100, 110, 120	
	<i>Propos.</i>	520, 600, 700, 780, 810, 870 (+530, 610...)		10, 80, 90, 100, 110, 120 (+15, 85...)	
Neighbouring cells [SI 5]	11.10	As Cell Channel Description in SI 1			
	47/98	Not present			
	<i>Propos.</i>	As BCCH Frequency list in SI 2			

PCS 1900

		PCS 1 900	
		<i>Serving cell</i>	<i>Neighbouring cells</i>
BCCH / CCCH	Default	590	520, 600, 700, 720, 760, 780
	<i>Alternative</i>	690, 730	530, 610, 710, 740, 770, 790
PDTCH / SDCCH	<i>Default</i>	650	
	<i>Alternative</i>	750, 780	

		PCS 1 900	
Cell Allocation [SI 1]	11.10	590, 650, 750, 780	

	47/98	
	<i>Propos.</i>	
Neighbouring cells [SI 2]	11.10	520, 590, 600, 700, 720, 760, 780
	47/98	
	<i>Propos.</i>	
	<i>Propos.</i>	
Neighbouring cells [SI 5]	11.10	As Cell Channel Description in SI 1
	47/98	Not present
	<i>Propos.</i>	As BCCH Frequency list in SI 2

41 GPRS Paging, TBF establishment/release and DCCH related procedures

41.1 / RR / Paging

The paging procedure is used by the network to cause the MS to establish either an RR connection for circuit switched services or a downlink GPRS packet transfer. Normally the MS listens to its paging sub-channel when DRX is used, but this can be modified by the use of different page mode. The correct monitoring of its paging sub-channel on PCCCH or CCCH in different control channel configurations and correct implementation of the paging procedure in the MS are essential. They are the test objectives of this clause.

The clause is applicable for all MS supporting GPRS service.

41.1.1 RR / Paging / on PCCCH for GPRS service successful

All test cases in this sub-clause test the MS paging behaviours in a network operating in Mode I or Mode III.

41.1.1.1 RR / Paging / on PCCCH for GPRS service / normal paging with P-TMSI successful.

41.1.1.1.1 Conformance requirements

- 1 In packet idle mode, the mobile station monitors the relevant paging sub-channels on PCCCH, if such is present in the cell. The determination of the paging group for the mobile station is defined in GSM 05.02.
- 2 MS in a specific PCCCH GROUP shall monitor the radio blocks on PCCCH corresponding to the PCCCH GROUP the mobile station belongs to and where paging may appear.
- 3 A PACKET PAGING REQUEST message on PCCCH may include more than one mobile station identification.
- 4 In response to a PACKET PAGING REQUEST, the mobile station shall initiate the uplink TBF using a PACKET CHANNEL REQUEST with cause value of 'Page Response'.

References

GSM 04.60, clause 5.5.1, 5.5.1.5, 6.1.2, 6.2, 6.2.2, 6.2.3

GSM 05.02, clause 6.5.1, 6.5.6

41.1.1.1.2 Test purpose

To verify that upon receipt of a PACKET PAGING REQUEST message for GPRS service with paging mode set to normal, the MS in packet idle mode, GPRS attached state, is able to determine its PCCCH group and PAGING group and that the MS responds correctly with PACKET CHANNEL REQUEST with cause value of 'Page Response'.

41.1.1.1.3 Method of test

Initial Conditions

System Simulator:

1 cell, CCCH combined with SDCCH, GPRS supported, PCCCH present, Max-Retrans = 2, access burst type = 11 bits, BS_PAG_BLK_RES = 2, BS_PBCCH_BLK = 3, BS_PCC_CHANS = 1, BS_PRACH_BLK = 1 in PSII.

Mobile Station:

The MS is GPRS attached with a P-TMSI allocated, SPLIT PG CYCLE negotiated.

Related PICS/PIXIT Statement(s)

Type of MS (GSM 450, GSM 480, P-, E-, R-GSM 900 or DCS 1800 or PCS 1900),

Support GPRS service

Test Procedure

The SS sends a PACKET PAGING REQUEST message to the MS. The paging message contains a P-TMSI addressing the MS for TBF establishment. The MS attempts two random accesses for PACKET CHANNEL REQUEST. The SS responds to the 2nd one by assigning an uplink channel. The MS sends a correct LLC PDU containing TLLI in the RLC/MAC header implicitly indicating a paging response.

Maximum Duration of Test

5 min.

Expected Sequence

Step	Direction	Message	Comments
1	SS -> MS	PACKET PAGING REQUEST	1 st Repeated Page info for RR connection, 2 nd Repeated Page info contains P-TMSI of the MS for TBF establishment. Sent on PPCH.
2	MS -> SS	PACKET CHANNEL REQUEST	ACCESS TYPE = " Page Response ". Received on PRACH.
3	MS -> SS	PACKET CHANNEL REQUEST	ACCESS TYPE = " Page Response ". Received on PRACH.
4	SS -> MS	PACKET UPLINK ASSIGNMENT	Random Reference = pertaining to the message received in step 3. Sent on PAGCH.
5	SS -> MS	PACKET DOWNLINK DUMMY CONTROL BLOCK	Sent on PACCH containing USF assigned to the MS.
6	MS -> SS	UPLINK RLC DATA BLOCK (not L3 Message)	LLC PDU implicitly indicating paging response, containing TLLI in the RLC/MAC header. Received on uplink PDTCH assigned in step 4.
7	SS -> MS	PACKET UPLINK ACK/NACK	acknowledge the received RLC data block, Final Ack Indicator = '1' , a valid RRBP. Sent on PACCH.
8	MS -> SS	PACKET CONTROL ACKNOWLEDGEMENT	acknowledge the RLC control message. Received on PACCH.

Specific Message Contents

Contents for SYSTEM INFORMATION and PACKET SYSTEM INFORMATION Messages:

RACH Control Parameters - Max Retrans	Max 2 retrans.
--	----------------

PACKET PAGING REQUEST message:

MESSAGE_TYPE	000101
PAGE_MODE	Normal Paging
{L H<PERSISTENCE_LEVEL>}	L (not present)
{L H<NLN>}	L (not present)
{H <Repeated Page info>}	H
-	H (Page request for RR connection establishment)
- CHANNEL_NEEDED	SDDCH
- {L H < eMLPP_PRIORITY }	L (eMLPP_PRIORITY absent)
- { L < TMSI > H < Mobile_identity > }	L (TMSI present)
- TMSI	TMSI not addressing the MS under test
-	L (Page request for TBF establishment)
- { L < PTMSI > H < Mobile_identity > }	L (PTMSI present)
- PTMSI	P-TMSI allocated during GPRS attach procedure
-	L (end of repeated page info)
spare padding	Spare Padding

41.1.1.2 RR / Paging / on PCCCH for GPRS service / normal paging with IMSI successful

41.1.1.2.1 Conformance requirements

If the MS was paged by the network with the IMSI (for GPRS service), the MS shall delete any RAI, P-TMSI, P-TMSI signature and GPRS ciphering key sequence number stored. The MS shall then perform a GPRS attach or combined GPRS attach procedure.

References

GSM 04.08, clause 4.7.9.1

41.1.1.2.2 Test purpose

To verify that the MS is able to respond to PACKET PAGING REQUEST for GPRS service when the MS is addressed with its IMSI and that the MS then performs a GPRS attach or combined GPRS attach procedure.

41.1.1.2.3 Method of test

Initial Conditions

System Simulator:

1 cell, CCCH combined with SDCCH, GPRS supported, PCCCH present, Max-Retrans = 2, access burst type = 11 bits, BS_PAG_BLK_RES = 3, BS_PBCCH_BLK = 3, BS_PCC_CHANS = 1, BS_PRACH_BLK = 1 in PSII.

Mobile Station:

The MS is GPRS attached with a P-TMSI allocated, SPLIT PG CYCLE negotiated.

Related PICS/PIXIT Statement(s)

Type of MS (GSM 450, GSM 480, P-, E-, R-GSM 900 or DCS 1800 or PCS 1900),

Support GPRS service,

Test Procedure

The SS sends a PACKET PAGING REQUEST message containing the IMSI of the MS for TBF establishment. The MS attempts two random accesses for PACKET CHANNEL REQUEST. The SS responds to the 2nd one by assigning an uplink channel for an open-end TBF. The MS sends an LLC PDU containing TLLI in the RLC/MAC header and ATTACH REQUEST, implicitly indicating a paging response. The SS verifies the completeness of ATTACH REQUEST and acknowledges the received two RLC data blocks with a valid RRBP and Final Ack indicator = '1'.

Maximum Duration of Test

5 min.

Expected Sequence

Step	Direction	Message	Comments
1	SS -> MS	PACKET PAGING REQUEST	1 st Repeated Page Info for RR connection, 2 nd Repeated Page info contains IMSI of the MS for TBF establishment. Sent on PPCH.
2	MS -> SS	PACKET CHANNEL REQUEST	ACCESS TYPE = " MM Procedure ". Received on PRACH.
3	MS -> SS	PACKET CHANNEL REQUEST	ACCESS TYPE = " MM Procedure ". Received on PRACH.
4	SS -> MS	PACKET UPLINK ASSIGNMENT	Random Reference = pertaining to the message received in step 3. Sent on PAGCH.
5	SS -> MS	PACKET DOWNLINK DUMMY CONTROL BLOCK	Sent on PACCH containing USF assigned to the MS.
6	MS -> SS	UPLINK RLC DATA BLOCK (ATTACH REQUEST)	LLC PDU containing a TLLI and the first part of ATTACH REQUEST, the implicit paging response to step 1. Received on the uplink PDTCH assigned in step 4.
7	SS -> MS	PACKET UPLINK ACK/NACK	Contention resolution, acknowledge the received RLC data blocks, USF assigned. Sent on PACCH.
8	MS -> SS	UPLINK RLC DATA BLOCK	completely receive ATTACH REQUEST
9	SS -> MS	PACKET UPLINK ACK/NACK	Final Ack indicator = '1', containing valid RRBP, sent on PACCH.
10	MS -> SS	PACKET CONTROL ACKNOWLEDGEMENT	acknowledge the RLC control messages. Received on PACCH.

Specific Message Contents

Contents for SYSTEM INFORMATION and PACKET SYSTEM INFORMATION Messages:

PRACH Control Parameters - MAX_RETRANS	Max 2 retransmission
---	----------------------

PACKET PAGING REQUEST message:

MESSAGE_TYPE	000101
PAGE_MODE	Normal Paging
{0 1<PERSISTENCE_LEVEL>}	0 (not present)
{0 1<NLN>}	0 (not present)
{1 <Repeated Page info>}	1
-	1 (Page request for RR connection establishment)
- 0 < TMSI >	TMSI not addressing the MS under test
- CHANNEL_NEEDED	SDCCH
- {0 1 < eMLPP_PRIORITY>}	0 (eMLPP_PRIORITY absent)
-	0 (Page request for TBF establishment)
- { 0 < PTMSI > 1 1 < Length of Mobile Identity contents > < Mobile Identity>}	1 (IMSI present)
-	Length, type, and IMSI value stored on the SIM of the MS (GSM 04.08, 10.5.5.13 without IEI)
-	0 (end of repeated page info)
spare padding	Spare Padding

PACKET CHANNEL REQUEST message in test step 2 and 3:

Access Type Random Reference	Mobility Management procedure Not checked.
---------------------------------	---

PACKET UPLINK ACK/NACK message in step 9

MESSAGE_TYPE	001101
UPLINK_TFI	0000110
CHANNEL_CODING_COMMAND	CS-1 coding
Ack/Nack Description	
- FINAL_ACK_INDICATION	1, no retransmissions, acknowledgement of all RLC data blocks
- STARTING_SEQUENCE_NUMBER	1
- RECEIVE_BLOCK_BITMAP	indicates the two data blocks from the MS

41.1.1.3 RR / Paging / on PCCCH for GPRS service / extended paging with P-TMSI successful

41.1.1.3.1 Conformance requirements

1. The network may send page mode information in any downlink message on PCCCH. The page mode information controls possible additional requirements on a mobile station receiving the message.
2. In packet idle mode, the paging sub-channels on PCCCH shall be monitored (by the mobile station) according to the current DRX mode and the values of the PAGING_GROUP parameter defined for the mobile station, and possible page mode information received on PCCCH.
3. The mobile station shall take into account the page mode information received in any message received in a radio block on PCCCH corresponding to one of the paging groups defined by the different PAGING_GROUP values for the mobile station.

4. In the extended paging mode, the mobile station is required in addition (to normal paging) to receive and analyse the possible message in the next but one block period on PCCCH where paging may occur (PPCH).

References

GSM 04.60, clause 5.5.1, 5.5.1.5, 5.5.1.6

41.1.1.3.2 Test purpose

1. To verify that the MS operates in the extended page mode when it is ordered by the SS in PACKET PAGING REQUEST which does not address the MS, but on the paging sub-channel corresponding to the MS identity.
2. To verify that the MS operates in the extended page mode when it is ordered by the SS in PACKET UPLINK ASSIGNMENT on the paging sub-channel corresponding to the MS identity.
3. To verify that the MS operates in the extended page mode when it is ordered by the SS in PACKET ACCESS REJECT on the paging sub-channel corresponding to the MS identity.
4. To verify that the MS operates in the extended page mode when it is ordered by the SS in PACKET DOWNLINK ASSIGNMENT on the paging sub-channel corresponding to the MS identity.
5. To verify that the MS operates in the extended page mode when it is ordered by the SS in PACKET QUEUEING NOTIFICATION on the paging sub-channel corresponding to the MS identity.
6. To verify that the MS operates in the extended page mode when it is ordered by the SS in PACKET CELL CHANGE ORDER on the paging sub-channel corresponding to the MS identity.
7. To verify that the MS operates in the extended page mode when it is ordered by the SS in PACKET DOWNLINK DUMMY CONTROL BLOCK on the paging sub-channel corresponding to the MS identity.
8. To verify that the MS operates in the extended page mode when it is ordered by the SS in PACKET PRACH PARAMETERS on the paging sub-channel corresponding to the MS identity.
9. To verify that the MS operates in the extended page mode when it is ordered by the SS in PACKET POLLING REQUEST on the paging sub-channel corresponding to the MS identity.

41.1.1.3.3 Method of test

Initial Conditions

System Simulator:

1 cell, CCCH combined with SDCCH, GPRS supported, PCCCH present, Max-Retrans = 2
BS_PAG_BLK_RES = 2, BS_PBCCH_BLKS = 4, BS_PRACH_BLKS = 1 and BS_PCC_CHANS = 2 in
PSI1.

Mobile Station:

The MS is GPRS attached with a P-TMSI allocated, SPLIT PG CYCLE negotiated.

Related PICS/PIXIT Statement(s)

Type of MS (GSM 450, GSM 480, P-, E-, R-GSM 900 or DCS 1800 or PCS 1900),

Support GPRS service,

Test Procedure

The test is repeated 9 times. Each time at the start, the SS sends one of the relevant messages listed in the corresponding test purpose to carry the Extended Paging mode. The MS is paged for TBF establishment and the paging mode is reset to Normal. After two attempts of the random access from the MS, the SS rejects the access.

Maximum Duration of Test

5 min.

Expected Sequence

The test sequence is repeated for k = 1 ... 9.

1A	SS -> MS	PACKET PAGING REQUEST	k=1 1 st Repeated Page info contains P-TMSI of another MS, no other Repeated Page info, Page_Mode = " Extended Paging ". Sent on PPCH belonging to the MS.
1B	SS -> MS	PACKET UPLINK ASSIGNMENT	k=2 Random Reference = any random value not used in previous test steps of this test case. Page_Mode = " Extended Paging ". Sent on the paging sub-channel corresponding to the MS identity (PPCH).
1C	SS -> MS	PACKET ACCESS REJECT	k=3 Random Reference = any random value not used in previous test steps of this test case. Page_Mode = " Extended Paging ". Sent on the paging sub-channel corresponding to the MS identity (PPCH).
1D	SS -> MS	PACKET DOWNLINK ASSIGNMENT	k=4 TLLI = any value other than the values used in previous test steps. Page_Mode = " Extended Paging ". Sent on the paging sub-channel corresponding to the MS identity (PPCH).
1E	SS -> MS	PACKET QUEUEING NOTIFICATION	k=5 Random Reference = any random value not used in previous test steps of this test case. Page_Mode = " Extended Paging ". Sent on the paging sub-channel corresponding to the MS identity (PPCH).
1F	SS -> MS	PACKET CELL CHANGE ORDER	k=6 TLLI = any value other than the values used in previous test steps of this test case. Page_Mode = " Extended Paging ". Sent on the paging sub-channel corresponding to the MS identity (PPCH).
1G	SS -> MS	PACKET DOWNLINK DUMMY CONTROL BLOCK	k=7 Page_Mode = " Extended Paging ". Sent on the paging sub-channel corresponding to the MS identity (PPCH).
1H	SS -> MS	PACKET PRACH PARAMETERS	k=8 Page_Mode = " Extended Paging ". Sent on the paging sub-channel corresponding to the MS identity (PPCH).
1I	SS -> MS	PACKET POLLING REQUEST	k=9 TLLI = any value other than the values used in previous test steps of this test case. Page_Mode = " Extended Paging ". Sent on the paging sub-channel corresponding to the MS identity (PPCH).
2	SS -> MS	PACKET PAGING REQUEST	1 st Repeated Page info contains P-TMSI of the MS, no other Repeated Page info, Page_Mode = "Normal Paging". Sent on the next but one block on the same PPCH as in step 1.
3	MS-> SS	PACKET CHANNEL REQUEST	ACCESS TYPE = " Page Response ". Received on PRACH.
4	MS-> SS	PACKET CHANNEL REQUEST	ACCESS TYPE = " Page Response ". Received on PRACH.
5	SS -> MS	PACKET ACCESS REJECT	Random Reference = pertaining to the message received in step 3. Sent on PAGCH.

Specific Message Contents

41.1.1.4 RR / Paging / on PCCCH for GPRS service / paging reorganisation successful

41.1.1.4.1 Conformance requirements

- 1 In the paging reorganisation mode the mobile station shall receive all messages on the PCCCH regardless of the BS_PAG_BLK_RES setting. It is required to receive all PBCCH messages.
- 2 When the mobile station receives the next message to a (possibly new) PAGING_GROUP defined for the mobile station, subsequent action is defined by the possible page mode information received in that message.
- 3 When the mobile station selects a new set of PAGING_GROUP values, the initial page mode in the mobile station shall be set to paging reorganisation.
- 4 The CONTROL_CH_REL field in PSI1 control channel description indicates, if set = 1, that the last PDCH carrying PCCCH and PBCCH will be released shortly. All mobile stations on PCCCH shall then as soon as this information has been received return to CCCH and there obey the information sent on BCCH as specified in GSM 04.08. If the field is set = 0, no channel release is pending.

References

GSM 04.60, clause 5.5.1.5, 11.2.18

41.1.1.4.2 Test purpose

- 1 To verify that the MS, after reception of a message with page mode set to "paging reorganisation", answers to paging messages (with page mode set to "normal paging") sent on its old PCCCH in paging blocks which do not belong to the MS's paging sub-channel.
- 2 To test that the MS correctly determines its new paging sub-channel when the number of allocated PBCCH blocks BS_PBCCH_BLK and the number of reserved blocks BS_PAG_BLK_RES are changed.
- 3 To test that the MS correctly determines its new paging sub-channel when the number of PCCCH channels is changed.
- 4 To test that the MS understands the control channel release bit in control channel description.

41.1.1.4.3 Method of test

Initial Conditions

System Simulator:

1 cell, CCCH combined with SDCCH, GPRS supported, PCCCH present, Max-Retrans = 2, access burst type = 8 bits, BS_PAG_BLK_RES = 2, BS_PBCCH_BLK = 3, BS_PRACH_BLK = 1 and BS_PCC_CHAN = 1.

Mobile Station:

The MS is GPRS attached with a P-TMSI allocated, SPLIT PG CYCLE negotiated.

Related PICS/PIXIT Statement(s)

Type of MS (GSM 450, GSM 480, P-, E-, R-GSM 900 or DCS 1800 or PCS 1900),

Support GPRS service.

Test Procedure

The SS sends PACKET PAGING REQUEST on PCCCH and sets Paging Mode to paging reorganisation. The MS is paged on a former access grant block. After receipt the 1st random access from the MS with the correct access type for the paging response, the SS rejects the packet access and sets the paging mode to paging reorganisation.

The test procedure is similarly repeated twice. Each time the SS changes the PCCCH organisation parameters (see the following test sequence). Then the MS is paged. The random access from the MS is rejected by the SS.

The SS resets the default system setting, but sets CONTROL_CH_REL. The MS is then paged on PCH. After the MS starting random access on RACH, the access from the MS is rejected.

Maximum Duration of Test

5 min.

Expected Sequence

Step	Direction	Message	Comments
1	SS -> MS	PACKET PAGING REQUEST	PAGE_MODE = "paging reorganisation", not specific to the MS. Sent on the paging block belonging to the MS. Wait two PSI1 repeat periods.
2	SS -> MS	PACKET PAGING REQUEST	Sent on a former access grant block. 1 st Repeated Page info contains P-TMSI of the MS, no other Repeated Page info, PAGE_MODE = "Normal paging".
3	MS-> SS	PACKET CHANNEL REQUEST	ACCESS TYPE = " Page Response ". Received on PRACH.
4	SS -> MS	PACKET ACCESS REJECT	Random Reference = pertaining to the message received in step 3, PAGE_MODE = "paging reorganisation", Sent on PAGCH.
5	SS		Set BS_PBCCH_BLKs = 4 in system information messages and wait two PSI1 repeat periods.
6	SS -> MS	PACKET DOWNLINK DUMMY CONTROL BLOCK	PAGE_MODE = "Normal paging".
7	SS -> MS	PACKET PAGING REQUEST	Sent on a new paging block belonging to the MS. 1 st Repeated Page info contains P-TMSI of the MS, no other Repeated Page info, PAGE_MODE = "Same as before".
8	MS-> SS	PACKET CHANNEL REQUEST	ACCESS TYPE = " Page Response ". Received on PRACH.
9	SS -> MS	PACKET ACCESS REJECT	Random Reference = pertaining to the message received in step 8, PAGE_MODE = "paging reorganisation", Sent on PAGCH.
10	SS		Reconfigure the SS channels so that an additional PCCCH on slot ((k-2) mod 8) is set and indicated in the system information. k is the current slot number for PBCCH. Wait two PSI1 repeat periods
11	SS -> MS	PACKET QUEUEING NOTIFICATION	Random Reference = any random value not used in previous test steps. Page_Mode = "Normal Paging". Sent on a paging sub-channel not corresponding to the MS identity (PPCH).
12	SS -> MS	PACKET PAGING REQUEST	Sent on a new paging block belonging to the MS. 1 st Repeated Page info contains P-TMSI of the MS, no other Repeated Page info, PAGE_MODE = "Normal paging".
13	MS-> SS	PACKET CHANNEL REQUEST	ACCESS TYPE = " Page Response ". Received on PRACH.
14	SS -> MS	PACKET ACCESS REJECT	Random Reference = pertaining to the message received in step 13, PAGE_MODE = "paging reorganisation", Sent on PAGCH.
15	SS		Restore the SS default configuration. Wait two PSI1 repeat periods. Then set CONTROL_CH_REL = 1 and wait two PSI1 repeat periods. SS stops sending all PSIs.
16	SS -> MS	PAGING REQUEST TYPE 1	Sent on PCH. 1 st Mobility Identity contains TMSI of the MS, 2 nd Mobility Identity absent. Packet Page Indication indicates a packet paging procedure.
17	MS-> SS	CHANNEL REQUEST	ACCESS TYPE = "one phase access". Received on RACH.
18	SS -> MS	IMMEDIATE ASSIGNMENT REJECT	Random Reference = pertaining to the message received in step 17, Sent on AGCH.

Specific Message Contents

41.1.2 RR / Paging / on PCCCH for circuit-switched services / paging successful

41.1.2.0 Definition and applicability

These test cases apply to Mobile Station supporting GPRS that can operate in mode A or mode B.

41.1.2.1 Conformance requirements

1. When answering to a paging message the purpose of which is to trigger the establishment of an RR connection, the mobile station, whatever its MS class mode of operation, shall follow the paging response procedures as specified in GSM 04.08.
2. The MS shall enter GPRS ATTACHED.SUSPENDED sub-state when entering dedicated mode and when the MS limitations makes it unable to communicate on GPRS channels. In this sub-state, no user data should be sent and no signalling information shall be sent. The MS shall leave this sub-state when leaving dedicated mode.

References

GSM 04.60, clause 6.1.4

GSM 04.08, clause 3.3.2.2, 4.1.3.1.3.2

41.1.2.2 Test purpose

1. To verify that the MS in packet idle mode, GPRS attached state, is able to determine its PCCCH group and PAGING group, and that the MS responds correctly on RACH with CHANNEL REQUEST containing cause value of 'Page Response' upon receipt of a PACKET PAGING REQUEST message for establishment of an RR connection.
2. To verify that the MS is able to respond to PACKET PAGING REQUEST for establishment of an RR connection when the MS is addressed with its TMSI and, but another field of the paging message contains an IMSI different from that of the MS.
3. To verify that the MS is able to respond to PACKET PAGING REQUEST for establishment of an RR connection when the MS is addressed with its IMSI.

41.1.2.3 Method of test

Initial Conditions

System Simulator:

1 cell, CCCH combined with SDCCH, GPRS supported, Network mode I, PCCCH present, Max-Retrans = 2, access burst type = 11 bits, BS_PAG_BLKES_RES=2, BS_PBCCH_BLKES=3, BS_PRACH_BLKES=1, BS_PCC_CHANES=1.

Mobile Station:

The MS is GPRS attached with a P-TMSI and a TMSI allocated and SPLIT PG CYCLE negotiated.

Related PICS/PIXIT Statement(s)

Type of MS (GSM 450, GSM 480, P-, E-, R-GSM 900 or DCS 1800 or PCS 1900).

Support GPRS service.

Supporting GPRS MS class A.

Supporting GPRS MS class B.

Test Procedure

The MS is paged with the TMSI on the MS's PPCH sub-channel for RR establishment. After two random accesses from the MS on RACH the SS assigns a SDCCH. The MS responses with PAGING RESPONSE. The test is repeated with PACKET PAGING REQUEST containing the IMSI of the MS.

Maximum Duration of Test

5 min.

Expected Sequence

The test sequence is repeated for k = 1 ... 2

Step	Direction	Message	Comments
1A	SS -> MS	PACKET PAGING REQUEST	k=1 1 st Repeated Page info contains TMSI of the MS for RR establishment, Channel needed = any channel. PAGE_MODE = "Normal Paging". The 2 nd Repeated Page info contains a PTMSI not addressing the MS, for TBF establishment. Sent on PPCH belonging to the MS.
1B	SS -> MS	PACKET PAGING REQUEST	k=2 1 st Repeated Page info contains IMSI of the MS, no other Repeated Page info. Channel needed = " any channel ", PAGE_MODE = " Normal Paging ". Sent on PPCH belonging to the MS.
2	MS -> SS	CHANNEL REQUEST	Establishment Cause = " Answer to paging ". Received on RACH. Establishment Cause = " Answer to paging ". Received on RACH. Request Reference = pertaining to the message received in step 3. Sent on AGCH. carried by information field of SABM. Received on assigned SDCCH. Sent on SDCCH.
3	MS -> SS	CHANNEL REQUEST	
4	SS -> MS	IMMEDIATE ASSIGNMENT	
5	MS -> SS	PAGING RESPONSE	
6	SS -> MS	CHANNEL RELEASE	

Specific Message Contents

Contents for SYSTEM INFORMATION and PACKET SYSTEM INFORMATION Messages:

PRACH Control Parameters - MAX_RETRANS	Max 2 retransmission
---	----------------------

PACKET PAGING REQUEST message in step 1A:

MESSAGE_TYPE	000101
PAGE_MODE	Normal Paging
{L H<PERSISTENCE_LEVEL>}	L (no persistence level present)
{L H<NLN>}	L (no notification list number)
{H <Repeated Page info>}	H (start of Repeated Page info)
-	H (Page request for RR connection establishment)
- CHANNEL_NEEDED	'00', any channel
-	L (no eMLPP_PRIORITY present)
-	L (TMSI)
- TMSI	TMSI allocated to the MS
-	L (Page request for TBF establishment)
- { L < PTMSI > H < Mobile_identity > }	L (PTMSI present)
- PTMS	P-TMSI not addressing the MS
-	L (end of repeated page info)
spare padding	Spare Padding

PACKET PAGING REQUEST message in step 1B:

MESSAGE_TYPE	000101
PAGE_MODE	Normal Paging
{L H<PERSISTENCE_LEVEL>}	L (no persistence level present)
{L H<NLN>}	L (no notification list number)
{H <Repeated Page info>}	H (start of Repeated Page info)
-	H (Page request for RR connection establishment)
- CHANNEL_NEEDED	any channel
-	L (no eMLPP_PRIORITY present)
-	H (mobility identity)
- LENGTH of Mobile Identity	depending on IMSI field
- Mobile identity	Length, type, and IMSI value stored on the SIM of the MS (GSM 04.08, 10.5.5.13 without IEI)
-	L (end of Repeated Page info)
spare padding	Spare Padding

IMMEDIATE ASSIGNMENT message:

L2 pseudo length	This is the sum of the lengths of all the information elements present in the message except for the IA rest octets and L2 pseudo length IEs. For the default message the L2 pseudo length is 11.
Protocol Discriminator	RR Management.
Skip Indicator	0000
Message Type	00111111
Page Mode	
- Page Mode	Normal Paging.
Packet Response Type and Dedicated mode or TBF	
- Downlink	No meaning
- T/D	dedicated mode resource
- PR Type	immediate assignment procedure for RR connection establishment
Channel Description	
- Channel Type and TDMA offset	SDCCH/4
- TN	Chosen arbitrarily
- TSC	Chosen arbitrarily
-	0
-	00 (Binary)
- ARFCN	For GSM 450: 267 For GSM 480: 315 For GSM 900: 30 For DCS 1800: 650 For PCS 1900: 650
Request Reference	Pertaining to last Channel Request sent by the MS.
Timing Advance	
- Timing advance value	30 bit periods.
Mobile Allocation	
- Length	0
Starting Time	Not present.
IA rest octets	Spare Padding

41.1.3 RR / Paging / on PCCCH / paging ignored

The MS shall ignore paging not addressing to it. If paging is not implemented correctly unnecessary accesses will be provoked on PCCCH which is shared by all MS in a same cell. This kind of the wrong paging behaviour of the same type of MS in a GSM network can block the use of PCCCH and will, therefore, cause an unacceptable degradation of the GSM services to other users of the mobile stations.

41.1.3.1 Conformance requirements

1. MS in a specific PCCCH GROUP shall monitor the radio blocks on PCCCH corresponding to the PCCCH GROUP the mobile station belongs to and where paging may appear.

2. A PACKET PAGING REQUEST message on PCCCH may include more than one mobile station identification.

References

GSM 04.60, clause 5.5.1, 6.1.2

41.1.3.2 Test purpose

1. To verify that the MS ignores PACKET PAGING REQUEST (for GPRS service) where both P-TMSI and IMSI do not address the MS although the PACKET PAGING REQUEST message is sent on specific PCCCH to which the MS belongs.
2. To verify that the MS ignores PACKET PAGING REQUEST (for circuit-switched service) where both P-TMSI and IMSI do not address the MS although the PACKET PAGING REQUEST message is sent on specific PCCCH to which the MS belongs.

Note: The 2nd test purpose is valid for GPRS MS class A and B.

41.1.3.3 Method of test

Initial Conditions

System Simulator:

1 cell, CCCH combined with SDCCH, GPRS supported, PCCCH present, Max-Retrans=2, access burst type=8 bits, BS_PAG_BLK_RES=2, BS_PBCCH_BLKS=3, BS_PRACH_BLKS=1 and BS_PCC_CHANS=1.

Mobile Station:

The MS is GPRS attached with a P-TMSI allocated and SPLIT PG CYCLE negotiated. If the MS has the class A or B of mode of operation the MS is idle, updated with a TMSI allocated.

Related PICS/PIXIT Statement(s)

Type of MS (GSM 450, GSM 480, P-, E-, R-GSM 900 or DCS 1800 or PCS 1900),

Support GPRS service,

Supporting GPRS MS class A,

Supporting GPRS MS class B,

Supporting GPRS MS class C,

Test Procedure

The MS is paged for TBF establishment. The MS attempts a random access which is rejected. The MS is paged again for TBF establishment. PACKET PAGING REQUEST contains two mobility identity which do not address the MS. The MS shall not initiate the random access. The same test is repeated, but the MS is paged for RR connection establishment.

Maximum Duration of Test

5 min.

Expected Sequence

The test sequence is repeated for k = 1, 2. The 2nd time (k=2) is executed if the MS has the class A or B of mode of operation.

Step	Direction	Message	Comments
1	SS -> MS	PACKET PAGING REQUEST	1 st Repeated Page info contains P-TMSI of the MS, no other Repeated Page info, Page_Mode = "Normal Paging". Sent on PPCH belonging to the MS. ACCESS TYPE = " Page Response ". Received on PRACH. Random Reference = pertaining to the message received in step 2. Sent on PAGCH.
2	MS-> SS	PACKET CHANNEL REQUEST	
3	SS -> MS	PACKET ACCESS REJECT	
4A	SS -> MS	PACKET PAGING REQUEST	k=1, page for TBF establishment. The two Repeated Page info do not address the MS. Sent on PPCH belonging to the MS.
4B	SS -> MS	PACKET PAGING REQUEST	k=2, page for RR connection. The two Repeated Page info do not address the MS. Channel Needed = "any channel". Sent on PPCH belonging to the MS.
5	SS		Check that there is no PACKET CHANNEL REQUEST from the MS on PRACH for 5s.

Specific Message Contents

Contents for SYSTEM INFORMATION and PACKET SYSTEM INFORMATION Messages:

PRACH Control Parameters - ACCESS_BURST_TYPE - MAX_RETRANS	8 bit access burst Max 2 retransmission
--	--

PACKET PAGING REQUEST message in step 4A:

MESSAGE_TYPE	000101
PAGE_MODE	Normal Paging
{L H<PERSISTENCE_LEVEL>}	L (no persistence level present)
{L H<NLN>}	L (no notification list number)
{H}<Repeated Page info>	H (start of Repeated Page info)
-	L (Page request for TBF establishment)
-	L (PTMSI)
- PTMSI	P-TMSI value not the assigned to the MS under test
-	L (Page request for TBF establishment)
-	H (mobility identity)
- LENGTH of Mobile Identity	depending on IMSI field
- Mobile identity	IMSI different from the value stored on the SIM of the MS
-	L (end of Repeated Page info)
spare padding	Spare Padding

PACKET PAGING REQUEST message in step 4B:

MESSAGE_TYPE	000101
PAGE_MODE	Normal Paging
{L H<PERSISTENCE_LEVEL>}	L (no persistence level present)
{L H<NLN>}	L (no notification list number)
{H <Repeated Page info>}	H (start of Repeated Page info)
-	H (Page request for RR connection establishment)
- CHANNEL_NEEDED	any channel
-	L (no eMLPP_PRIORITY present)
-	L (TMSI)
- TMSI	TMSI value not allocated to the MS
-	H (Page request for RR connection establishment)
- CHANNEL_NEEDED	any channel
-	L (no eMLPP_PRIORITY present)
-	H (IMSI)
- LENGTH of Mobile Identity	depending on IMSI field
- Mobile identity	IMSI different from the value stored on the SIM of the MS
-	L (end of Repeated Page info)
spare padding	Spare Padding

41.1.4 RR / Paging / on PACCH for circuit-switched services

This sub-clause tests the MS paging behaviours in the packet transfer mode in a network operating in Mode I. The sub-clause is applicable to mobile stations supporting GPRS MS operation mode A or B.

41.1.4.1 RR / Paging / on PACCH for circuit-switched services/ paging successful

This sub-clause is applicable for the MS in the class B of mode of operation.

41.1.4.1.1 Conformance requirements

1. Paging initiation using PACCH applies to a mobile station supporting GPRS MS class A or B when such mobile station is in packet transfer mode and when the network operates according to mode I.
2. A mobile station operating in class B mode of operation shall abort the current GPRS data transfer(s) if it was in packet transfer mode, and suspend any GPRS activity until return to idle mode.
3. (For an MS in the mode of operation of class B) when responding to a paging message for other GSM services, the MS shall establish the connection for that incoming service (i.e., enter dedicated mode) and suspend GPRS activity. GPRS activity is resumed upon return to idle mode.

References

GSM 04.60, clause 6.1.3, 6.1.4

TS 22.060, clause 6.1

41.1.4.1.2 Test purpose

- 1 To verify that upon receipt of a PACKET PAGING REQUEST message on PACCH for RR establishment, the class B mobile in packet transfer mode is able to respond correctly on RACH with CHANNEL REQUEST containing cause value of 'Page Response'.
- 2 To verify that the MS is able to respond to PACKET PAGING REQUEST when the MS is addressed with its TMSI and even if another field of PACKET PAGING REQUEST contains an IMSI different from that of the MS.
- 3 To verify that the MS is able to respond to PACKET PAGING REQUEST when the MS is addressed with its IMSI.

41.1.4.1.3 Method of test

Initial Conditions

System Simulator:

1 cell, CCCH combined with SDCCH, GPRS supported, PCCCH present, Max-Retrans = 2, access burst type = 11 bits, BS_PAG_BLK_RES = 2, BS_PBCCH_BLK = 3 and BS_PCC_CHAN = 1.

Mobile Station:

Mobile Station:

The MS is in packet transfer mode.

Related PICS/PIXIT Statement(s)

Type of MS (GSM 450, GSM 480, P-, E-, R-GSM 900 or DCS 1800 or PCS 1900),

Support GPRS service,

Supporting GPRS MS class A,

Supporting GPRS MS class B,

Supporting GPRS MS class C,

Test Procedure

The MS is in the packet transfer mode. An USF is assigned to the MS. After receiving the first uplink RLC data block from the MS it is paged on PACCH for an RR connection establishment with the allocated TMSI. The MS sends CHANNEL REQUEST for Answer to Paging. The access attempt is rejected.

The test is repeated once. The difference of the second time lies in the PACKET PAGING REQUEST on PACCH containing IMSI instead of PTMSI addressing the MS.

Maximum Duration of Test

5 min.

Expected Sequence

The test sequence is repeated for $k = 1, 2$

Step	Direction	Message	Comments
1		{Uplink dynamic allocation two phase access}	n = 440 octets in test PDP context3, without starting time, USF_GRANULARITY = 1 block, RLC_DATA_BLOCKS_GRANTED = open-end TLLI_BLOCK_CHANNEL_CODING: cs1, CHANNEL_CODING_COMMAND: cs1, PEAK_THROUGHPUT_CLASS = 5 (16k octets/s), RADIO_PRIORITY = 4, RLC_MODE = unacknowledged mode.
2	SS -> MS	PACKET DOWNLINK DUMMY CONTROL BLOCK	Sent on the PACCH, the USF assigned to the MS.
3	MS -> SS	UPLINK RLC DATA BLOCK	Received on the assigned PDTCH.
4A	SS -> MS	PACKET PAGING REQUEST	Check that the coding as specified by CHANNEL_CODING_COMMAND, the TFI is correct. k=1, for RR connection 1 st Repeated Page info contains TMSI of the MS, Channel Needed = " TCH/F ", PAGE_MODE = " same as before ", sent on downlink PACCH.
4B	SS -> MS	PACKET PAGING REQUEST	k=2, for RR connection 1 st Repeated Page info contains IMSI of the MS, Channel Needed = " TCH/F ", PAGE_MODE = " same as before ", sent on downlink PACCH.
5	MS -> SS	CHANNEL REQUEST	Establishment Cause = " Answer to Paging ". Received on RACH.
6	SS -> MS	IMMEDIATE ASSIGNMENT REJECT	Request Reference = pertaining to message received in step 5. Sent on AGCH.

41.1.4.2 RR / Paging / on PACCH for circuit-switched services/ paging ignored

The MS shall ignore paging not addressing to it. If paging is not implemented correctly unnecessary accesses will be provoked on the CCCH which is shared by all MSs in a same cell. This kind of the wrong paging behaviour of the same type of MS in a GSM network can block the use of CCCH and will, therefore, cause an unacceptable degradation of the GSM services to other users of the mobile stations.

41.1.4.2.1 Conformance requirements

The MS shall ignore paging not addressing to it.

References

GSM 04.60, clause 6

41.1.4.2.2 Test purpose

To verify that the MS ignores a PACKET PAGING REQUEST message where both TMSI and IMSI do not address the MS although the PACKET PAGING REQUEST message is sent on PACCH allocated to the MS.

41.1.4.2.3 Method of test

Initial Conditions

System Simulator:

1 cell, CCCH combined with SDCCH, GPRS supported, PCCCH present, Max-Retrans = 2, access burst type = 8 bits, BS_PAG_BLK_RES = 2, BS_PBCCH_BLK = 3, BS_PRACH_BLK = 1 and BS_PCC_CHAN = 1.

Mobile Station:

The MS is in packet transfer mode.

Related PICS/PIXIT Statement(s)

Type of MS (GSM 450, GSM 480, P-, E-, R-GSM 900 or DCS 1800 or PCS 1900),

Support GPRS service,
 Supporting GPRS MS class A,
 Supporting GPRS MS class B,
 Supporting GPRS MS class C.

Test Procedure

The MS is brought to the packet transfer mode. A PACKET PAGING message not addressing the MS is sent on PACCH for RR connection establishment. It is checked that the MS can continue sending the uplink RLC data blocks and does not attempt any random accesses on RACH for 10s.

Maximum Duration of Test

5 min.

Expected Sequence

Step	Direction	Message	Comments
1		{Uplink dynamic allocation two phase access}	n = 440 octets in test PDP context3, without starting time, USF_GRANULARITY = 1 block, RLC_DATA_BLOCKS_GRANTED = open-end TLLI_BLOCK_CHANNEL_CODING: cs1, CHANNEL_CODING_COMMAND: cs1, PEAK_THROUGHPUT_CLASS = 5 (16k octets/s), RADIO_PRIORITY = 4, RLC_MODE = unacknowledged mode.
2	SS -> MS	PACKET DOWNLINK DUMMY CONTROL BLOCK	Sent on the PACCH, the USF assigned to the MS.
3	MS -> SS	UPLINK RLC DATA BLOCK	Received on the assigned PDTCH.
4	SS -> MS	PACKET PAGING REQUEST	Check that the coding as specified by CHANNEL_CODING_COMMAND, the TFI is correct.
5	SS -> MS	PACKET DOWNLINK DUMMY CONTROL BLOCK	For RR connection, the two Repeated Page info contain a TMSI and an IMSI not addressing the MS, Channel Needed = " Any Channel ", sent on downlink PACCH. Sent on PACCH containing USF assigned.
6	MS -> SS	UPLINK RLC DATA BLOCK	It is checked that no CHANNEL REQUEST is sent from the MS on RACH for 10s.
7		{Completion of uplink RLC data block transfer}	

Specific Message Contents

41.1.5 RR / Paging / on CCCH for GPRS service

41.1.5.1 RR / Paging / on CCCH for GPRS service / normal paging

41.1.5.1.1 RR / Paging / on CCCH for GPRS service / normal paging with P-TMSI successful

41.1.5.1.1.1 Conformance requirements

- 1 The network initiates the paging procedure by sending a paging request message on an appropriate paging sub-channel on CCCH. Paging initiation using a paging sub-channel on CCCH is used when sending paging information to a mobile station and PCCCH is not present in the cell.

- 2 The mobile station in packet idle mode is required to receive and analyse the paging messages and immediate assignment messages sent on the paging sub-channels on CCCH corresponding to the paging groups determined for it in packet idle mode.
- 3 A PAGING REQUEST message may include more than one mobile station identification.
- 4 In a PAGING REQUEST message used for the packet paging procedure, the mobile station shall be identified by the P-TMSI (GPRS TMSI) or its IMSI. If the mobile station is identified by the P-TMSI, it shall indicate the receipt of a paging request to the MM sub-layer.

If the mobile station identified by its IMSI, it shall parse the message for a corresponding *Packet Page Indication* field:

- if the *Packet Page Indication* field indicates a paging procedure for RR connection establishment, or the field is not present in the message, the mobile station shall initiate the immediate assignment procedure;
 - if the *Packet Page Indication* field indicates a packet paging procedure, the mobile station shall indicate the receipt of a paging request to the MM sub-layer.
- 5 The mobile station initiates the packet access procedure by scheduling the sending of CHANNEL REQUEST messages on RACH.

References

GSM 04.08, clause 3.3.2.1.1, 3.5.1.1, 3.5.1.2, 3.5.2.1

GSM 05.02, clause 6.5.6

41.1.5.1.1.2 Test purpose

- 1 To verify that the MS in packet idle mode, GPRS attached state, is able to determine its CCCH group and PAGING group and that the MS responds correctly with CHANNEL REQUEST on RACH with cause value of 'packet access' upon receipt of a PAGING REQUEST TYPE 1 message for packet access with paging mode set to normal,.
- 2 To verify that the MS is able to respond to PAGING REQUEST TYPE 1 for packet access when the MS is addressed with its P-TMSI, but another field of the paging message contains an IMSI different from that of the MS.
- 3 To verify that the MS is able to respond to PAGING REQUEST TYPE 2 for packet access when the MS is addressed with its P-TMSI, but other fields of the paging message contain a TMSI and an IMSI different from that of the MS.
- 4 To verify that the MS is able to respond to PAGING REQUEST TYPE 3 for packet access when the MS is addressed with its P-TMSI, but other fields of the paging message contain TMSIs different from that of the MS.

41.1.5.1.1.3 Method of test

Initial Conditions

System Simulator:

1 cell, CCCH combined with SDCCH, GPRS supported, PCCCH absent, Max-Retrans = 2, BS_AG_BLK_RES = 2, BS_PA_MFRMS = 6, SPLIT_PG_CYCLE is supported on CCCH in the cell.

Mobile Station:

The MS is GPRS attached with a TMSI and a P-TMSI allocated, SPLIT PG CYCLE negotiated.

Related PICS/PIXIT Statement(s)

Type of MS (GSM 450, GSM 480, P-, E-, R-GSM 900 or DCS 1800 or PCS 1900),

Support GPRS service

Test Procedure

The test is repeated three times. Each time the MS is paged for the packet paging procedure through a different paging request type message. After receiving a CHANNEL REQUEST with the establishment cause 'one phase access', an open-end TBF is assigned. A USF is assigned to the MS to enable it to transfer an uplink RLC data block. The received data block is acknowledged by the SS with , Final Ack Indicator = '1' , a valid RRBP. The MS sends PACKET CONTROL ACKNOWLEDGEMENT.

Maximum Duration of Test

5 min.

Expected Sequence

The test sequence is repeated for k = 1 ... 3.

Step	Direction	Message	Comments
1A	SS -> MS	PAGING REQUEST TYPE 1	k=1 1 st Mobile Identity contains P-TMSI of the MS, 2 nd Mobile Identity not present. Sent on PCH.
1B	SS -> MS	PAGING REQUEST TYPE 2	k=2 1 st Mobile Identity contains P-TMSI of the MS, the other two Mobile Identities not addressing the MS. Sent on PCH.
1C	SS -> MS	PAGING REQUEST TYPE 3	k=3 1 st Mobile Identity contains P-TMSI of the MS, the remaining Mobile Identities not addressing the MS. Sent on PCH.
2	MS -> SS	CHANNEL REQUEST	Establishment Cause = "one phase access", received on RACH.
4	SS -> MS	IMMEDIATE ASSIGNMENT	Request Reference = pertaining to the message received in step 2. Uplink assignment, sent on AGCH.
5	SS -> MS	PACKET DOWNLINK DUMMY CONTROL BLOCK	Sent on PACCH containing USF assigned to the MS.
6	MS -> SS	UPLINK RLC DATA BLOCK (not L3 Message)	LLC PDU implicitly indicating paging response, containing TLLI in the RLC/MAC header. Received on uplink PDTCH assigned in step 4.
7	SS -> MS	PACKET UPLINK ACK/NACK	acknowledge the received RLC data block, Final Ack Indicator = '1' , a valid RRBP. Sent on PACCH.
8	MS -> SS	PACKET CONTROL ACKNOWLEDGEMENT	acknowledge the RLC control message. Received on PACCH.

Specific Message Contents

IMMEDIATE ASSIGNMENT message in step 4:

<p>Dedicated mode or TBF</p> <ul style="list-style-type: none"> - T/D - Downlink - TMA <p>Packet Channel Description</p> <ul style="list-style-type: none"> - Channel Type - TN - TSC - - - ARFCN <p>Request Reference</p> <p>Timing Advance</p> <ul style="list-style-type: none"> - Timing advance value <p>Mobile Allocation</p> <ul style="list-style-type: none"> - Length <p>Starting Time</p> <p>IA rest octets</p> <ul style="list-style-type: none"> - - - Packet Uplink Assignment <ul style="list-style-type: none"> - Assign a TBF - TFI_ASSIGNMENT - POLLING - - USF - USF granularity - 0 1 <P0 > - CHANNEL_CODING_COMMAND - TLLI_BLOCK CHANNEL_CODING - 0 1 <ALPHA > <ul style="list-style-type: none"> - ALPHA - GAMMA - {0 1<TIMING_ADVANCE_INDEX>} - {0 1<TBF_STARTING_TIME>} <ul style="list-style-type: none"> - TBF_STARTING_TIME - spare padding 	<p>TBF</p> <p>0 , no meaning</p> <p>0, no meaning</p> <p>'00001' spared</p> <p>Chosen arbitrarily</p> <p>Chosen arbitrarily</p> <p>0</p> <p>00 (Binary)</p> <p>For GSM 450: 267</p> <p>For GSM 480: 315</p> <p>For GSM 900: 30</p> <p>For DCS 1800: 650</p> <p>For PCS 1900: 650</p> <p>Pertaining to last Channel Request sent by the MS.</p> <p>30 bit periods.</p> <p>0</p> <p>Not present.</p> <p>HH</p> <p>00 (packet uplink assignment)</p> <p>1, Dynamic or Fixed allocation</p> <p>chosen arbitrarily</p> <p>0, no</p> <p>0, dynamic allocation</p> <p>chosen arbitrarily</p> <p>0, single block</p> <p>0</p> <p>00, CS-1</p> <p>00, CS-1</p> <p>1</p> <p>0.5</p> <p>For GSM 450, +9 dBm</p> <p>For GSM 480, +9 dBm</p> <p>For GSM 900, +9 dBm</p> <p>For DCS 1800, +6 dBm</p> <p>For PCS 1900, +6 dBm</p> <p>0 (no timing advance index)</p> <p>1 (starting time)</p> <p>current frame + 100</p> <p>Spare Padding</p>
---	---

41.1.5.1.2 RR / Paging / on CCCH for GPRS service / normal paging with IMSI successful

41.1.5.1.2.1 Conformance requirements

1. If the MS was paged by the network with the IMSI (for GPRS service), the MS shall delete any RAI, P-TMSI, P-TMSI signature and GPRS ciphering key sequence number stored. The MS shall then perform a GPRS attach or combined GPRS attach procedure.

References

GSM 04.08, clause 4.9.7.1, 3.3.1.3

41.1.5.1.2.2 Test purpose

To verify that the MS is able to respond to PAGING REQUEST TYPE 1 when the MS is addressed with its IMSI with *Packet Page Indication* set to packet paging procedure, and that the MS then performs a GPRS attach or combined GPRS attach procedure.

41.1.5.1.2.3 Method of test

Initial Conditions

System Simulator:

1 cell, CCCH combined with SDCCH, GPRS supported, PCCCH absent, Max-Retrans = 2, BS_AG_BLK_RES = 2, BS_PA_MFRMS = 9.

Mobile Station:

The MS is in GPRS attached with a TMSI and a P-TMSI allocated, SPLIT PG CYCLE negotiated.

Related PICS/PIXIT Statement(s)

Type of MS (GSM 450, GSM 480, P-, E-, R-GSM 900 or DCS 1800 or PCS 1900),

Support GPRS service.

Test Procedure

The MS is paged on PCH with IMSI for packet paging procedure. After receiving the CHANNEL REQUEST from the MS an SDCCH channel is assigned. After contention resolution and receiving CLASSMARK CHANGE from the MS, the SS assigns an uplink PDCH for an open-end TBF. The MS sends an LLC PDU containing TLLI in the RLC/MAC header and ATTACH REQUEST, implicitly indicating a paging response. The SS verifies the completeness of ATTACH REQUEST and acknowledges the received two RLC data blocks with a valid RRBP and Final Ack indicator = '1'.

Maximum Duration of Test

5 min.

Expected Sequence

Step	Direction	Message	Comments
1	SS -> MS	PAGING REQUEST TYPE 1	1 st Mobile Identity contains IMSI of the MS, second Mobile Identity not present. Packet page indication indicates packet paging procedure. Sent on PCH. Establishment Cause = = "one phase packet access". Received on RACH. Random Reference = pertaining to the message received in step 2. Assign an SDCCH channel. Sent on AGCH. containing a random TLLI. Received on the assigned SDCCH. Received on the assigned SDCCH. assign an uplink. Sent on SDCCH. Release the SDCCH channel. Sent on the SDCCH. LLC PDU containing a TLLI and the first part of ATTACH REQUEST, the implicit paging response to step 1. Received on the uplink PDTCH assigned in step 6. Contention resolution, acknowledge the received RLC data blocks, USF assigned. Sent on PACCH. completely receive ATTACH REQUEST Final Ack indicator = '1', containing valid RRBP, sent on PACCH. acknowledge the RLC control messages. Received on PACCH.
2	MS -> SS	CHANNEL REQUEST	
3	SS -> MS	IMMEDIATE ASSIGNMENT	
4	MS -> SS	RR INITIALIZATION REQUEST	
5	MS -> SS	CLASSMARK CHANGE	
6	SS -> MS	PDCH ASSIGNMENT COMMAND	
7	SS -> MS	CHANNEL RELEASE	
8	MS -> SS	UPLINK RLC DATA BLOCK (ATTACH REQUEST)	
9	SS -> MS	PACKET UPLINK ACK/NACK	
10	MS -> SS	UPLINK RLC DATA BLOCK	
11	SS -> MS	PACKET UPLINK ACK/NACK	
12	MS -> SS	PACKET CONTROL ACKNOWLEDGEMENT	

Specific Message Contents

Contents for SYSTEM INFORMATION and PACKET SYSTEM INFORMATION Messages:

RACH Control Parameters	Max 2 retransmission
- Max Retrans	
SI 13 Rest Octets	
-	0 (PCCCH absent)
- SPLIT_PG_CYCLE_CCCH_SUPPORTED	Supported
- ACC_BURST_TY	8 bit access burst
- CONTROL_ACK_TYPE	RLC/MAC control block
- NETWORK_CONTROL_ORDER	Normal MS control, no measurement reporting
- N_AVG_I	7
- T_AVG_W	12
- T_AVG_T	12
- PC_MEAS_CHAN	BCCH
- DRX_TIMER_MAX	non-DRX not supported
- PRIORITY_ACCESS_THR	Packet access allowed for priority level 1 to 4
- BS_CV_MAX	7
- T3168_T3186_VALUE	2 seconds
- T3192_VALUE	2 seconds
- PAN_DEC	3
- PAN_INC	3
- PAN_MAX	010(Binary)
- SI_1_CA_INDICATION	information from SI 1 message is not required for packet access
- NETWORK_OPERATION_MODE	Operation mode I
- {0 1}<MA_CHANGE_MARK>	0
- {0 1}<IM_CHANGE_MARK>	0
- spare padding	Spare Padding

IMMEDIATE ASSIGNMENT message in step 3:

L2 pseudo length	This is the sum of the lengths of all the information elements present in the message except for the IA rest octets and L2 pseudo length IEs. For the default message the L2 pseudo length is 11.
Protocol Discriminator	RR Management.
Skip Indicator	0000
Message Type	00111111
Page Mode	
- Page Mode	Normal Paging.
Packet Response Type and Dedicated mode or TBF	
- Downlink	No meaning
- T/D	dedicated mode resource
- PR Type	immediate assignment procedure for RR connection establishment
Channel Description	
- Channel Type and TDMA offset	SDCCH/4
- TN	Chosen arbitrarily, but not 0, 2
- TSC	Chosen arbitrarily
-	0
-	00 (Binary)
- ARFCN	For GSM 450: 267 For GSM 480: 315 For GSM 900: 30 For DCS 1800: 650 For PCS 1900: 650
Request Reference	Pertaining to last Channel Request sent by the MS.
Timing Advance	
- Timing advance value	30 bit periods.
Mobile Allocation	
- Length	0
Starting Time	Not present.
IA rest octets	Spare Padding

RR INITIALIZATION REQUEST message in step 4:

Protocol Discriminator	RR Management
Skip Indicator	0000
RR Initialisation Request Message Type	00111100
Ciphering Key Sequence Number	Not checked
MAC Mode and Channel Coding Requested	Not checked
Mobile station classmark	Not checked
TLLI	Not checked
Channel Request Description	Not checked
GPRS Measurement Results	Not checked

CLASSMARK CHANGE message in step 5:

Protocol Discriminator	RR Management
Skip Indicator	0000
Classmark Change Message Type	00010110
Mobile Station Classmark	Not checked
Additional Mobile Station Classmark Information	Not checked

PDCH ASSIGNMENT COMMAND message in step 6:

Protocol Discriminator	RR Management
Skip Indicator	0000
PDCH Assignment command Message Type	00101010
Description of the Channel, after time	
- Channel type and TDMA offset	01TTT, SDCCH
- TN	slot 2
- TSC	Chosen arbitrarily
-	0 (non-hopping)
- ARFCN	For GSM 450: 267
	For GSM 480: 315
	For GSM 900, 30
	For DCS 1800, 650
	For PCS 1900, 650
Cell Channel Description	Absent
Frequency List, after time	Absent
Cell Channel Description	Absent
Mobile Allocation, after time	Absent
Starting Time	Current frame + 20
Frequency List, before time	Absent
Description of the Channel, before time	Absent
Frequency channel sequence before time	Absent
Mobile Allocation, before time	Absent
RR Packet Uplink Assignment	
- LENGTH_IN_OTECTS	depending the rest of the IE
- MAC_MODE	TBD
- CHANNEL_CODING_COMMAND	CS-1 coding
- RESPONSE_INDICATOR	TBD
- TLLI_BLOCK_CHANNEL_CODING	use value indicated in CHANNEL_CODING_COMMAND
- { 0 1 < UPLINK_TFI_ASSIGNMENT>}	1 (assign an uplink TFI)
- UPLINK_TFI_ASSIGNMENT	0000110 (uplink TBF identifier)
- Packet Timing Advance	
-	1 (timing advance value)
- TIMING_ADVANCE_VALUE	30 bit periods
-	0 (not timing advance index)
- { 0 < TIMESLOT_ALLOCATION>	0 (TIMESLOT_ALLOCATION)
1 < Power Control Parameters>}	
- TIMESLOT_ALLOCATION	00100000 (slot 2)
- { 0 1 < RLC_DATA_BLOCKS_GRANTED	1 (this IE present)
> }	
- RLC_DATA_BLOCKS_GRANTED	9 blocks
-	1 (fixed allocation)
-	0 (ALLOCATION_MAP is blocks)
- ALLOCATION_BITMAP_LENGTH	depending on the next field
- ALLOCATION_BITMAP	allocate 10 blocks
- N_SPARE_BITS	
RR Packet Downlink Assignment	Not present

41.1.5.1.3 RR / Paging / on CCCH for GPRS service / normal paging with P-TMSI ignored

The MS shall ignore paging not addressing to it. If paging is not implemented correctly unnecessary accesses will be provoked on CCCH which is shared by all MS in a same cell. This kind of the wrong paging behaviour of the same type of MS in a GSM network can block the use of CCCH and will, therefore, cause an unacceptable degradation of the both GSM GPRS and circuit-switched services to other users of the mobile stations.

41.1.5.1.3.1 Conformance requirements

In a PAGING REQUEST message used for the packet paging procedure, the mobile station shall be identified by the TMSI (GPRS TMSI) or its IMSI. A PAGING REQUEST message may include more than one mobile station identification.

References

GSM 04.08, clause 3.3.2.1.1, 3.5.1.1

41.1.5.1.3.2 Test purpose

To verify that the MS ignores a PAGING REQUEST TYPE 1, 2 messages where both P-TMSI and IMSI do not address the MS although the paging message is sent on the CCCH to which the CCCH_GROUP belongs.

41.1.5.1.3.3 Method of test

Initial Conditions

System Simulator:

1 cell, CCCH combined with SDCCH, GPRS supported, PCCCH absent, Max-Retrans = 2, BS_AG_BLK_RES = 2, BS_PA_MFRMS = 7, .

Mobile Station:

The MS is GPRS attached with a TMSI and a P-TMSI allocated and SPLIT PG CYCLE negotiated.

Related PICS/PIXIT Statement(s)

Type of MS (GSM 450, GSM 480, P-, E-, R-GSM 900 or DCS 1800 or PCS 1900),

Support GPRS service,

Test Procedure

The test is repeated twice. Each time a different paging message not addressing the MS is sent on the PCH belonging to the MS. It is checked that the no access attempt is made by the MS for 5s.

The MS is then paged for packet paging. The MS attempts a random access which is rejected.

Maximum Duration of Test

5 min.

Expected Sequence

The test steps 1 - 2 is repeated for k = 1 .. 2

Step	Direction	Message	Comments
1A	SS -> MS	PAGING REQUEST TYPE 1	k=1, The two packet page indications are set to packet paging procedure. 1st Mobile Identity contains P-TMSI, 2nd Mobile Identity contains IMSI, both Identities do not address the MS. Sent on PCH belonging to the MS.
1B	SS -> MS	PAGING REQUEST TYPE 2	k=2, Packet page indication 3 is set to packet paging procedure. 1st Mobile Identity contains P-TMSI, 2nd Mobile Identity contains P-TMSI, 3rd Identity contains IMSI, all identities not addressing the MS. Sent on PCH belonging to the MS.
2	SS		Check that no CHANNEL REQUEST is sent from the MS for 5s.
3	SS -> MS	PAGING REQUEST TYPE 1	1 st Mobile Identity contains IMSI of the MS, second Mobile Identity not present. Packet page indication indicates packet paging procedure. Sent on PCH belonging to the MS.
4	MS -> SS	CHANNEL REQUEST	Establishment Cause "one phase packet access". Received on RACH.
5	SS -> MS	IMMEDIATE ASSIGNMENT REJECT	Random Reference = pertaining to the message received in step 4.

Specific Message Contents

PAGING REQUEST TYPE 1 message:

Mobile Identity 1 - odd/even indication - Type of Identity - Identity Digits Mobile Identity 2 P1 rest octets - Packet Page Indication 1 - Packet Page Indication 2	Even. P-TMSI. P-TMSI value not allocated to MS. IMSI different from the value stored on the SIM. H, Packet Paging H, Packet Paging
--	---

PAGING REQUEST TYPE 2 message:

Mobile Identity 1 - TMSI value P2 rest octets - Packet Page Indication 3	P-TMSI value not allocated to the MS. LLLL H, Packet Paging
---	---

41.1.5.2 RR / Paging / on CCCH for GPRS service / extended paging

41.1.5.2.1 RR / Paging / on CCCH for GPRS service / extended paging with P-TMSI successful

41.1.5.2.1.1 Conformance requirements

- 1 A given mobile station shall take into account the page mode information element of any message sent on its own paging sub-channel whatever the nature of this message (paging messages or immediate assignment messages).
- 2 In the extended paging mode, the mobile station is required in addition (to normal paging) to receive and analyse the next but one message on the PCH.

References

GSM 04.08, clause 3.3.2.1.1, 9.1.18, 9.1.19, 9.1.20

41.1.5.2.1.2 Test purpose

- 1 To verify that the MS operates in the extended page mode when it is ordered by the SS in PAGING REQUEST TYPE 1 which does not address the MS, but on the paging sub-channel corresponding to the MS identity.
- 2 To verify that the MS operates in the extended page mode when it is ordered by the SS in PAGING REQUEST TYPE 2 which does not address the MS, but on the paging sub-channel corresponding to the MS identity.
- 3 To verify that the MS operates in the extended page mode when it is ordered by the SS in PAGING REQUEST TYPE 3 which does not address the MS, but on the paging sub-channel corresponding to the MS identity.
- 4 To verify that the MS operates in the extended page mode when it is ordered by the SS in IMMEDIATE ASSIGNMENT on the paging sub-channel corresponding to the MS identity.
- 5 To verify that the MS operates in the extended page mode when it is ordered by the SS in IMMEDIATE ASSIGNMENT EXTENDED on the paging sub-channel corresponding to the MS identity.
- 6 To verify that the MS operates in the extended page mode when it is ordered by the SS in IMMEDIATE ASSIGNMENT REJECT on the paging sub-channel corresponding to the MS identity.

41.1.5.2.1.3 Method of test

Initial Conditions

System Simulator:

1 cell, GPRS supported, PCCCH absent, Max-Retrans = 2, CCCH_CONF = 1 basic physical channel used for CCCH with non-combined SDCCH, BS_AG_BLK_RES = 3, BS_PA_MFRMS = 8.

Mobile Station:

The MS is GPRS attached with a TMSI and a P-TMSI allocated and SPLIT PG CYCLE negotiated.

Related PICS/PIXIT Statement(s)

Type of MS (GSM 450, GSM 480, P-, E-, R-GSM 900 or DCS 1800 or PCS 1900),

Support GPRS service

Test Procedure

The test is repeated 6 times. Each time a different downlink message is sent on PCH or AGCH for setting the page mode to extended paging. The MS is paged on the next but one page block for the packet paging procedure. The MS starts a random accesses which are rejected by the SS.

Maximum Duration of Test

5 min.

Expected Sequence

The test sequence is repeated for $k = 1 \dots 6$

Step	Direction	Message	Comments
1A	SS -> MS	PAGING REQUEST TYPE 1	k=1, All mobile Identities do not address the MS. Page mode is set to "extended paging". Packet page indication indicates packet paging procedure. Sent on PCH.
1B	SS -> MS	PAGING REQUEST TYPE 2	k=2, All mobile Identities do not address the MS. Page mode is set to "extended paging". Packet page indication indicates packet paging procedure. Sent on PCH.
1C	SS -> MS	PAGING REQUEST TYPE 3	k=3, All mobile Identities do not address the MS. Page mode is set to "extended paging". Channel Needed IE's are coded with 00. Sent on PCH.
1D	SS -> MS	IMMEDIATE ASSIGNMENT	k=4, Page mode is set to "extended paging". Request Reference does not address any request references sent by the MS in previous test steps. Sent on paging channel (PCH).
1E	SS -> MS	IMMEDIATE ASSIGNMENT EXTENDED	Page mode is set to "extended paging". Request Reference does not address any request references sent by the MS in previous test steps. Sent on paging channel (PCH).
1F	SS -> MS	IMMEDIATE ASSIGNMENT REJECT	k=6, Page mode is set to "extended paging". Request Reference does not address any request references sent by the MS in previous test steps. Sent on paging channel (PCH).
2	SS -> MS	PAGING REQUEST TYPE 1	1st Mobile Identity contains P-TMSI of the MS, 2nd Mobile Identity not present. Page mode is set to "normal paging". Packet page indication indicates packet paging procedure. Sent on the next but one subblock on the same CCCH as previous paging message. Establishment Cause = "One phase access". Received on RACH. Establishment Cause "One phase access". Received on RACH. Request Reference = pertaining to the message received in step 4. Page mode is set to "normal paging". Sent on AGCH.
3	MS -> SS	CHANNEL REQUEST	
4	MS -> SS	CHANNEL REQUEST	
5	SS -> MS	IMMEDIATE ASSIGNMENT REJECT	

41.1.5.3 RR / Paging / on CCCH for GPRS service / paging reorganisation

41.1.5.3.1 Conformance requirements

- 1 In the paging reorganisation mode the mobile station shall receive all messages on the CCCH regardless of the BS-AG-BLKS-RES setting. It is required to receive all BCCH messages.
- 2 When the mobile station receives the next message to its (possibly new) paging subgroup the subsequent action is defined in the page mode information element in that message.
- 3 When the mobile station selects a new PCH, the initial page mode in the mobile station shall be set to paging reorganisation. If a message in the paging sub-channel is not received correctly, the message is ignored and the previous page mode is assumed.

References

GSM 04.08, clause 3.3.2.1.1

41.1.5.3.2 Test purpose

- 1 To verify that the MS, after reception of a message with page mode set to "paging reorganisation", answers to paging messages (with page mode set to "normal paging") sent on its old CCCH in paging blocks which do not belong to the MS's paging sub-channel.
- 2 To test that the MS correctly determines its new paging sub-channel when the number of reserved blocks, BS_AG_BLK_RES, and the number of 51-multiframes between transmissions of paging messages for mobile stations of the same paging group BS_PA_MFRMS are changed.
- 3 To test that the MS correctly determines its new paging sub-channel when the number of basic physical channels for CCCH is changed.
- 4 To test that the MS correctly determines its new paging sub-channel on PCCCH when PCCCH is established.

41.1.5.3.3 Method of test

Initial Conditions

System Simulator:

1 cell, GPRS supported, PCCCH absent, Max-Retrans = 2, CCCH_CONF = 1 basic physical channel used for CCCH with non-combined SDCCH, BS_AG_BLK_RES = 3, BS_PA_MFRMS = 6.

Mobile Station:

The MS is GPRS attached with a TMSI and a P-TMSI allocated and SPLIT PG CYCLE negotiated

Related PICS/PIXIT Statement(s)

Type of MS (GSM 450, GSM 480, P-, E-, R-GSM 900 or DCS 1800 or PCS 1900),

Support GPRS service

Test Procedure

The page mode is set to paging reorganisation. The MS is paged for packet paging procedure through PAGING REQUEST TYPE 1 which is sent before the MS's original paging sub-channel re-occurs, but later than the next paging block of that CCCH. The MS starts the random access. The access attempt is rejected.

The SS changes the CCCH configuration with BS_AG_BLK_RES=2 and BS_PA_MFRMS=5 and waits two SI13 repeat periods, and then sets the page mode to Normal Paging. The MS is paged for packet paging procedure through PAGING REQUEST TYPE 2 sent on the new paging sub-channel. The MS starts the random access. The access attempt is rejected via IMMEDIATE ASSIGNMENT REJECT which sets the page mode to 'paging reorganisation'.

Two additional CCCHs are activated by the SS. The same test procedure as above is repeated.

The SS restores all default radio parameters (in clause 40.1), sets a non-combined CCCH and starts to transmitting PSIs on PBCCH. The SS waits two SI3 repeat periods + two PSI1 repeat periods. The MS is paged on PPCH. The random accesses from the MS are observed and are rejected.

Maximum Duration of Test

5 min.

Expected Sequence

Step	Direction	Message	Comments
1	SS -> MS	IMMEDIATE ASSIGNMENT EXTENDED	Page mode set to "paging reorganisation"
2	SS -> MS	PAGING REQUEST TYPE 1	Sent before the MS's original paging sub-channel re-occurs, but later than the next paging block of that CCCH. Page mode set to "normal paging", for packet paging procedure.
3	MS -> SS	CHANNEL REQUEST	Establishment Cause = "one phase access", received on RACH.
4	SS -> MS	IMMEDIATE ASSIGNMENT REJECT	Request Reference = pertaining to the message received in step 3, page mode set to "paging reorganisation", Sent on AGCH.
5	SS		set BS_AG_BLKS_RES=2 and BS_PA_MFRMS=5 in SIs, wait two SI13 repeat periods.
6	SS -> MS	PAGING REQUEST TYPE 2	All L3 messages sent on any paging sub-channel are paging fill frame specify Normal Paging. 1 st Mobile Identity contains P-TMSI of the MS. 2 nd Mobile Identity contains P-TMSI, 3 rd Identity contains IMSI, the last two identities not addressing the MS. Packet page indication indicates packet paging procedure. Page mode = "same as before", sent on the new PCH belonging to the MS.
7	MS -> SS	CHANNEL REQUEST	Establishment Cause = "one phase access". Received on RACH.
8	SS -> MS	IMMEDIATE ASSIGNMENT REJECT	Request Reference = pertaining to the message received in step 7, page mode set to "paging reorganisation",.
9	SS		Reconfigure the SS channels so that additional two CCCH's are set on slot 2 and slot 4, Set CCCH_CONF = 4 in SIs. Wait two SI13 repeat periods.
10	SS -> MS	PAGING REQUEST TYPE 2	All L3 messages sent on any paging sub-channel are paging fill frame specify Normal Paging. 1 st Mobile Identity contains P-TMSI of the MS. 2 nd Mobile Identity contains P-TMSI, 3 rd Identity contains IMSI, the last two identities not addressing the MS. Packet page indication indicates packet paging procedure. Page mode = "same as before", sent on the new PCH belonging to the MS.
11	MS -> SS	CHANNEL REQUEST	Establishment Cause = "one phase access". Received on RACH.
12	SS -> MS	IMMEDIATE ASSIGNMENT REJECT	Request Reference = pertaining to the message received in step 11, page mode set to "paging reorganisation". Sent on AGCH.
13	SS		Restore the SS default radio parameters, so that there is one CCCH and one PBCCH+PCCCH, set CCCH_CONF = 0 in SIs, start PSIs broadcasting. And wait two SI3 repeat periods + two PSI1 repeat periods.
14	SS -> MS	PACKET PAGING REQUEST	1 st Repeated Page info contains P-TMSI of the MS, no other Repeated Page info. Sent on PPCH.
15	MS-> SS	PACKET CHANNEL REQUEST	ACCESS TYPE = "Page Response". Received on PRACH.
16	SS -> MS	PACKET ACCESS REJECT	Random Reference = pertaining to the message received in step 15.

Specific Message Contents

41.1.5.4 RR / Paging / on CCCH for GPRS service / default message contents

Contents for SYSTEM INFORMATION and PACKET SYSTEM INFORMATION Messages:

System information Type 13

L2 Pseudo Length	05, binary
RR management Protocol Discriminator	RR
Skip Indicator	0000
System Information Type 13 Message Type	00
SI 13 Rest Octets	H
-	0 (PCCCH absent)
- BCCH_CHANGE_MARK	
- SI_CHANGE_FIELD	
-	0
- RAC	
- SPGC_CCCH_SUP	1, Supported
- PRIORITY_ACCESS_THR	110, packet access is allowed for priority level 1-4
- NETWORK_CONTROL_ORDER	Normal MS control, no measurement reporting
- GPRS Cell Options	
- NMO	00, network mode of operation I
- T3168_T3186	2 s.
- T3192	2 s.
- DRX_TIMER_MAX	0, non-DRX not supported
- ACCESS_BURST_TYPE	0, 8 bit access burst
- CONTROL_ACK_TYPE	1, RLC/MAC control block
- BS_CV_MAX	7
-	1
- PAN_DEC	3
- PAN_INC	3
- PAN_MAX	010(Binary)
- GPRS Power Control parameters	
- ALPHA	0.5
- T_AVG_W	12
- T_AVG_T	12
- PC_MEAS_CHAN	BCCH
- N_AVG_I	7
- SI15_IND	0, SI15 absent
- spare padding	Spare Padding

41.1.6 RR / Paging / Before T3172 expiry

41.1.6.1 Conformance requirements

On receipt of a PACKET ACCESS REJECT message containing a WAIT_INDICATION field in a Reject structure addressed to the mobile station, where the Packet Request Reference in the Reject structure corresponds to one of its 3 last PACKET CHANNEL REQUEST messages, the mobile station shall stop sending PACKET CHANNEL REQUEST messages, start timer T3172 with the value indicated in the WAIT_INDICATION field. During the time T3172 is running, the mobile station shall ignore all received PACKET PAGING REQUEST messages except paging request to trigger RR connection establishment.

References

GSM 04.60, 7.1.2.2.4

41.1.6.2 Test purpose

To verify that during the time T3172 is running, the MS ignores all received PACKET PAGING REQUEST messages except paging request to trigger RR connection establishment.

41.1.6.3 Method of test

Initial Conditions

System Simulator:

1 cell, CCCH combined with SDCCH, GPRS supported, PCCCH present, Max-Retrans = 2, access burst type = 11 bits, BS_PAG_BLKES_RES = 2, BS_PBCCH_BLKES = 3, BS_PCC_CHANS = 1 and BS_PRACH_BLKES = 1.

Mobile Station:

The MS is GPRS attached with a P-TMSI allocated, SPLIT PG CYCLE negotiated.

Related PICS/PIXIT Statement(s)

Type of MS (GSM 450, GSM 480, P-, E-, R-GSM 900 or DCS 1800 or PCS 1900),

Support GPRS service,

Supporting GPRS MS class A,

Supporting GPRS MS class B,

Supporting GPRS MS class C.

Test Procedure

The MS is paged for initiation of a random access. The access attempt is rejected with a WAIT_INDICATION = 30 s. in PACKET ACCESS REJECT. The MS is then continuously paged for TBF establishment for 5s. The SS checks that there is no transmission from the MS on PRACH for 8 s. after having sent PACKET ACCESS REJECT. The MS is paged for an RR connection establishment. The MS of class A or B shall start random accesses for channel request with cause 'one phase access'. The access attempt is rejected.

Maximum Duration of Test

5 min.

Expected Sequence

Step	Direction	Message	Comments
1	SS -> MS	PACKET PAGING REQUEST	1 st Repeated Page info contains P-TMSI of the MS, 2 nd Repeated Page info contains IMSI not addressing the MS, for TBF establishment. Sent on PPCH.
2	MS -> SS	PACKET CHANNEL REQUEST	Received on PRACH.
3	SS -> MS	PACKET ACCESS REJECT	Containing WAIT_INDICATION = 12 s. and packet request reference = pertaining to the message received in step 2. Sent on PAGCH.
4	SS -> MS	PACKET PAGING REQUEST	1 st Repeated Page info contains P-TMSI of the MS, 2 nd Repeated Page info contains IMSI not addressing the MS, for TBF establishment. Sent on PPCH.
5	SS		Repeat step 4 for 5 s. and check that there is no transmission from the MS on PRACH for 8 s. after step 4.
6	SS -> MS	PACKET PAGING REQUEST	1 st Repeated Page info contains TMSI of the MS, for RR connection establishment, Channel Needed = " TCH/F ", PAGE_MODE = " normal paging ", sent on PPCH.
8A 9A	MS -> SS		For MS class C of mode of operation
8B	MS -> SS	CHANNEL REQUEST	For GPRS MS class A and B of mode of operation, one phase access, received on RACH.
9B	SS -> MS	IMMEDIATE ASSIGNMENT REJECT	Request Reference = pertaining to message received in step 8B. Sent on AGCH.

Specific Message Contents

PACKET ACCESS REJECT message:

MESSAGE_TYPE	000001
PAGE_MODE	Normal Paging
Reject	
-	10 (not TLLI, but packet request reference)
- Packet Request Reference	pertaining to what received in step 3.
-	1 (wait indication)
- WAIT_INDICATION	12
- WAIT_INDICATION_SIZE	0 (units of seconds)
-	0 (end of Reject struct)
spare padding	Spare Padding

41.2 RR procedures on CCCH related to temporary block flow establishment

This clause presents tests for “RR procedures on CCCH related to temporary block flow establishment” which are specified in GSM 04.08/3.5.

Applicability and default conditions

The clause is applicable for mobiles supporting GPRS.

The SS default conditions simulate one cell with default settings as defined in the GPRS general defaults section, except:

- SI 13 Rest Octets contains no PCCCH description (PCCCH is not supported by the network).

The MS default initial condition is GPRS attached. Unless otherwise stated, no PDP context is required.

Default message contents and signaling macros are also defined in the GPRS general defaults section, except for those messages and macros specified at the end of this clause.

41.2.1 Permission to access the network

41.2.1.1 Permission to access the network / priority classes

41.2.1.1.1 Conformance requirements

Access to the network is allowed:

- if packet access is allowed in the cell for the priority class associated with the packet transfer, as indicated by the PRIORITY_ACCESS_THR parameter broadcast in SI 13 message.

References

GSM 04.08 subclause 3.5.2.1.1

41.2.1.1.2 Test purpose

To verify that the MS accesses the network only if packet access is allowed in the cell for the priority class associated with the packet transfer.

41.2.1.1.3 Method of test

Initial conditions

System Simulator:

Mobile Station: MS is GPRS attached, a PDP context has been established and the MS is in Packet Idle mode.

Related PICS/PIXIT statement

Support of PDP context.

Test procedure

The MS is triggered to transfer data with different priority classes. The SS verifies that the MS accesses the network or not as appropriate.

Expected sequence

Step	Direction	Message	Comments
A1	SS->MS	SYS INFO 13	Including PRIORITY_ACCESS_THR = '000' (packet access not allowed in the cell) SS waits 30 s. to allow Sys Info decoding. Radio priority 4. The MS is triggered to transfer data SS verifies for 10 s. that MS does not try to access the network.
A2			
A3	SS->MS	MODIFY_PDP_CONTEXT_REQ	
A4	MS->SS	MODIFY_PDP_CONTEXT_ACC	
A5			
A6	SS		
B 1-6	SS->MS	SYS INFO 13	Repeat steps A1 to A6 except that PRIORITY_ACCESS_THR = '001' (spare, packet access not allowed in the cell)
C 1-6	SS->MS	SYS INFO 13	Repeat steps A1 to A6 except that PRIORITY_ACCESS_THR = '010' (spare, packet access not allowed in the cell)
D1	SS->MS	SYS INFO 13	Including PRIORITY_ACCESS_THR = '011' (packet access, priority level 1) SS waits 30 s. to allow Sys Info decoding. Radio priority 1. The MS is triggered to transfer data MS tries to access the network
D2			
D3	SS->MS	MODIFY_PDP_CONTEXT_REQ	
D4	MS->SS	MODIFY_PDP_CONTEXT_ACC	
D5			
D6	MS->SS	CHANNEL REQUEST	
D7	SS->MS	IMMEDIATE ASSIGNMENT REJECT	
E1	SS->MS	SYS INFO 13	Including PRIORITY_ACCESS_THR = '011' (packet access, priority level 1) SS waits 30 s. to allow Sys Info decoding. Radio priority 2 The MS is triggered to transfer data SS verifies for 10 s. that MS does not try to access the network.
E2			
E3	SS->MS	MODIFY_PDP_CONTEXT_REQ	
E4	MS->SS	MODIFY_PDP_CONTEXT_ACC	
E5			
E6	SS		
F1	SS->MS	SYS INFO 13	Including PRIORITY_ACCESS_THR = '100' (packet access, priority levels 1 to 2) SS waits 30 s. to allow Sys Info decoding. Radio priority 1. The MS is triggered to transfer data MS tries to access the network
F2			
F3	SS->MS	MODIFY_PDP_CONTEXT_REQ	
F4	MS->SS	MODIFY_PDP_CONTEXT_ACC	
F5			
F6	MS->SS	CHANNEL REQUEST	
F7	SS->MS	IMMEDIATE ASSIGNMENT REJECT	
G1	SS->MS	SYS INFO 13	Including PRIORITY_ACCESS_THR = '100' (packet access, priority levels 1 to 2) SS waits 30 s. to allow Sys Info decoding. Radio priority 3. The MS is triggered to transfer data SS verifies for 10 s. that MS does not try to access the network.
G2			
G3	SS->MS	MODIFY_PDP_CONTEXT_REQ	
G4	MS->SS	MODIFY_PDP_CONTEXT_ACC	
G5			
G6	SS		
H1	SS->MS	SYS INFO 13	Including PRIORITY_ACCESS_THR = '101' (packet access, priority levels 1 to 3) SS waits 30 s. to allow Sys Info decoding. Radio priority 1. The MS is triggered to transfer data MS tries to access the network
H2			
H3	SS->MS	MODIFY_PDP_CONTEXT_REQ	
H4	MS->SS	MODIFY_PDP_CONTEXT_ACC	
H5			
H6	MS->SS	CHANNEL REQUEST	
H7	SS->MS	IMMEDIATE ASSIGNMENT REJECT	
I1	SS->MS	SYS INFO 13	Including PRIORITY_ACCESS_THR = '101' (packet access, priority levels 1 to 3) SS waits 30 s. to allow Sys Info decoding. radio priority 4.
I2			
I3	SS->MS	MODIFY_PDP_CONTEXT_REQ	

I4 I5 I6	MS->SS SS	MODIFY_PDP_CONTEXT_ACC	The MS is triggered to transfer data SS verifies for 10 s. that MS does not try to access the network.
J1 J2 J3 J4 J5 J6 J7	SS->MS SS->MS MS->SS MS->SS SS->MS	SYS INFO 13 MODIFY_PDP_CONTEXT_REQ MODIFY_PDP_CONTEXT_ACC CHANNEL REQUEST IMMEDIATE ASSIGNMENT REJECT	Including PRIORITY_ACCESS_THR = '110' (packet access, priority levels 1 to 4) SS waits 30 s. to allow Sys Info decoding. Radio priority 1. The MS is triggered to transfer data MS tries to access the network
K 1-7			Repeat steps J1 to J7 except that LLC PDU priority is set to 4.
L 1-7	SS->MS	SYS INFO 13	repeat steps J1 to J7 except that PRIORITY_ACCESS_THR = '111' (spare, packet access allowed)
M 1-7	SS->MS	SYS INFO 13	repeat steps J1 to J7 except that PRIORITY_ACCESS_THR = '111' (spare, packet access allowed) and MS is triggered to send data with priority 4.

Note:

For sending MODIFY_PDP_CONTEXT_REQ a downlink TBF is established.

For receiving MODIFY_PDP_CONTEXT_ACC an uplink TBF is established.

41.2.2 Initiation of the packet access procedure

41.2.2.1 Initiation of the packet access procedure / establishment causes

41.2.2.1.1 Conformance requirements

The CHANNEL REQUEST messages are sent on RACH and contain the parameters:

- an establishment cause which indicates packet access, and as applicable, a request for one phase packet access or single block packet access;
- a random reference which is drawn randomly from a uniform probability distribution for every new transmission.

If the requested RLC mode is *unacknowledged mode*, the mobile station shall request a single block packet access and attempt a two phase packet access.

If the purpose of the packet access procedure is to send a Page Response, Cell Update, for a GPRS Mobility Management or a GPRS Session Management procedure the mobile station shall request a one phase packet access.

References

GSM 04.08 subclause 3.5.2.1.2

Justification

41.2.2.1.2 Test purpose

To verify that the CHANNEL REQUEST message sent by the MS contains the correct establishment cause when initiating a packet access procedure.

41.2.2.1.3 Method of test

Initial conditions

System Simulator: 1 cell, CCCH combined with SDCCH.

Mobile Station: MS is switched off.

Related PICS/PIXIT statement

Support of PDP context.

Test procedure

The MS is triggered to initiate a GPRS attach procedure. The SS verifies that the MS attempts a one phase packet access.

If the MS supports PDP context, a PDP context for RLC unacknowledged is established and the MS is triggered to transfer RLC data blocks. The SS verifies that the MS correctly sets the Establishment Cause in the CHANNEL REQUEST message.

Maximum duration of the test

-

Expected sequence

Step	Direction	Message	Comments
1	MS		MS is switched on and triggered to initiate a GPRS attach procedure.
2	MS -> SS	CHANNEL REQUEST	SS verifies that Establishment Cause is 'one phase'.
3	SS -> MS	IMMEDIATE ASSIGNMENT	
4	SS <->MS	Completion of macro {GPRS attach procedure}	SS allows MS to complete GPRS attach.
5	MS<->SS		Steps 5 to 8 apply to MSs supporting PDP context. A PDP context is established for RLC unacknowledged data transfer.
6	MS		MS is triggered to transfer data.
7	MS -> SS	CHANNEL REQUEST	SS verifies that Establishment Cause is 'single block access'.
8	SS -> MS	IMMEDIATE ASSIGNMENT REJECT	

41.2.2.2 Random references for single block packet access

41.2.2.2.1 Conformance requirements

The random reference in the CHANNEL REQUEST messages shall be randomly drawn from a uniform probability distribution for every new transmission.

References

GSM 04.08 subclause 3.5.2.1.2.

41.2.2.2.2 Test purpose

To verify that the MS produces different Random References when accessing the network for single block access.

41.2.2.2.3 Method of test

Initial conditions

System Simulator: 1 cell, CCCH combined with SDCCH, Parameter MAX_RETRANS is set to 4 retransmissions.

Mobile Station:

MS is GPRS attached, a PDP context in RLC unacknowledged mode has been established and the MS is in Packet Idle mode.

Related PICS/PIXIT statement

-

Test procedure

The MS is triggered to transfer data, it shall attempt a single block packet access (GSM 04.08 / 3.5.2.1.2). The SS does not answer to the access bursts but stores N (= 80) Random References and verifies that the MS uses all possible values (0 ... 7) in its Random Reference.

Justification

The length of the Random Reference is 3 bits for single block packet access (GSM 04.08 / Table 9.9). This test verifies that the MS uses all values (0 ... 7) in its Random Reference.

The probability that in a sequence of N samples one of the possible value does not appear is $8 \cdot (7/8)^{N-1}$ for large N.

Note

The number of samples N has been computed such that the probability of refusing a correct MS is less than 0.02 %.

Maximum duration of the test

-

Expected sequence

Step	Direction	Message	Comments
1	MS		MS is triggered to transfer data.
2	MS -> SS	CHANNEL REQUEST	SS stores the value of Request References
3	MS -> SS	CHANNEL REQUEST	SS stores the value of Request References
4	MS -> SS	CHANNEL REQUEST	SS stores the value of Request References
5	MS -> SS	CHANNEL REQUEST	SS stores the value of Request References
6	MS -> SS	CHANNEL REQUEST	SS stores the value of Request References
7	MS<->SS		Steps 1 to 6 are repeated N/5 = 16 times
8	SS		SS verifies that all Request Reference values (0 to 7) come out in the stored samples.

41.2.2.3 Random references for one phase packet access

41.2.2.3.1 Conformance requirements

The random reference in the CHANNEL REQUEST messages shall be randomly drawn from a uniform probability distribution for every new transmission.

References

GSM 04.08 subclause 3.5.2.1.2.

41.2.2.3.2 Test purpose

To verify that the MS produces different Random References when accessing the network for one phase access.

41.2.2.3.3 Method of test

Initial conditions

System Simulator: default settings except:

- Parameter MAX_RETRANS is set to 4 retransmissions.

Mobile Station: MS is switched off.

Related PICS/PIXIT statement

-

Test procedure

The MS is triggered to initiate the GPRS attach procedure, it shall attempt a one phase packet access (GSM 04.08 / 3.5.2.1.2). The SS does not answer to the access bursts but stores N (= 80) Random References and verifies that the MS uses all possible values (0 ... 6) in its Random Reference and does not use value '111' (see GSM 04.08 / Table 9.9).

Justification

Possible values for Random Reference for one phase packet access are 0 to 6 (value '111' is not allowed). This test verifies that the MS uses all values (0 ... 6) in its Random Reference.

The probability that in a sequence of N samples one of the possible value does not appear is $7*(3/4)**N$ for large N.

Note

The number of samples N has been computed such that the probability of refusing a correct MS is less than 0.02 %.

Maximum duration of the test

-

Expected sequence

Step	Direction	Message	Comments
1	MS		MS is turned on.
2	MS		MS is triggered to perform GPRS attach.
3	MS -> SS	CHANNEL REQUEST	SS stores the value of Request References
4	MS -> SS	CHANNEL REQUEST	SS stores the value of Request References
5	MS -> SS	CHANNEL REQUEST	SS stores the value of Request References
6	MS -> SS	CHANNEL REQUEST	SS stores the value of Request References
7	MS -> SS	CHANNEL REQUEST	SS stores the value of Request References
8	MS<->SS		Steps 2 to 7 are repeated N/5 = 16 times
9	SS		SS verifies that all Request Reference values (0 to 6) come out in the stored samples and that value '111' is not used.

41.2.2.4 Initiation of the packet access procedure / timer T3146

41.2.2.4.1 Conformance requirements

Having sent the maximum number of CHANNEL REQUEST messages, the mobile station starts timer T3146. At expiry of timer T3146, the packet access procedure is aborted and a packet access failure is indicated to upper layers.

Reference

GSM 04.08 subclause 3.5.2.1.2

41.2.2.4.2 Test purpose

To verify that the MS waits T3146 seconds before aborting the packet access procedure.

41.2.2.4.3 Method of test

Initial conditions

System Simulator: Default settings except:

- System Information parameter MAX_RETRANS is set to 2 retransmissions
- CCCH combined with SDCCH
- System Information parameter TX_INTEGER in RACH Control Parameters is set to 3.

Mobile Station: MS is switched off.

Related PICS/PIXIT statement

-

Test procedure

The MS is triggered to initiate the GPRS attach procedure, the SS waits until the MS sends all M+1 CHANNEL REQUEST messages, where M is the parameter Max Retrans broadcast on BCCH. The SS waits until T3146 seconds elapse and sends an IMMEDIATE ASSIGNMENT which shall be ignored by the MS since the access procedure should be aborted.

The MS shall retry the access procedure (according to 04.60/7.1.2.3). Again, the SS waits until the MS sends all M+1 CHANNEL REQUEST messages, and then sends an IMMEDIATE ASSIGNMENT before T3146 seconds elapse. In this case the MS shall correctly send the LLC PDU on the assigned PDCH.

Note:

Timer T3146 (GSM 04.08/11) depends on parameter TX_INTEGER broadcast on BCCH.

The minimum value of the timer is $2*S+TX_INTEGER$ slots, where S is given in Table 3.1/04.08.

The maximum value of this timer is 5 seconds. (41.2.3.6Section 11.1.1 in 04.08)

Maximum duration of the test

-

Expected sequence

Step	Direction	Message	Comments
1	MS -> SS	CHANNEL REQUEST	The MS turned on and triggered to initiate the GPRS attach procedure. SS waits 5.5 seconds (Maximum value of T3146 is 5 seconds) for uplink TBF, one phase access. MS shall ignore the message, SS verifies that MS does not send any RLC data or control blocks.
2	MS -> SS	CHANNEL REQUEST	
3	MS -> SS	CHANNEL REQUEST	
4	SS		
5	SS -> MS	IMMEDIATE ASSIGNMENT	
6	SS		
7	MS -> SS	CHANNEL REQUEST	MS attempts a second time to access the network. SS waits $T3146 - 0.1*T3146$ (using minimum value of T3146, which is $2*S + TX_INTEGER$ slots) for uplink TBF, one phase access. SS allows MS to complete GPRS attach.
8	MS -> SS	CHANNEL REQUEST	
9	MS -> SS	CHANNEL REQUEST	
10	SS		
11	SS -> MS	IMMEDIATE ASSIGNMENT	
12	SS <->MS	Completion of macro {GPRS attach procedure}	

The complete test is repeated for:

- TX_INTEGER set to 20 and for
- TX_INTEGER set to 32.

41.2.2.5 Initiation of the packet access procedure / Request Reference

41.2.2.5.1 Conformance requirements

On receipt of an IMMEDIATE ASSIGNMENT message corresponding to one of its 3 last CHANNEL REQUEST messages, the mobile stops sending CHANNEL REQUEST messages and switches to the assigned PDCH.

Reference

GSM 04.08 subclause 3.5.2.1.3.1

41.2.2.5.2 Test purpose

- 1 To verify that the MS continues sending CHANNEL REQUEST messages when receiving an IMMEDIATE ASSIGNMENT containing an incorrect Request Reference.
- 2 To verify that the MS stops sending CHANNEL REQUEST messages and switches to the assigned PDCH when receiving an IMMEDIATE ASSIGNMENT containing a Request Reference IE corresponding to one of its last 3 CHANNEL REQUEST messages.

41.2.2.5.3 Method of test

Initial conditions

System Simulator: 1 cell , CCCH combined with SDCCH, Parameter MAX_RETRANS is set to 7 retransmissions.

Mobile Station: The MS is switched off.

Related PICS/PIXIT statement

-

Test procedure

The MS is triggered to initiate the GPRS attach procedure. After 3 CHANNEL REQUEST messages, the SS sends an IMMEDIATE ASSIGNMENT including an incorrect Request Reference. The SS verifies that the MS continues sending CHANNEL REQUEST messages.

After the 5th CHANNEL REQUEST message the SS sends an IMMEDIATE ASSIGNMENT including a correct Request Reference. The SS verifies that the MS stops sending CHANNEL REQUEST messages, switches to the assigned PDCH and completes the attach procedure.

Maximum duration of the test

-

Expected sequence

Step	Direction	Message	Comments
0	MS		The MS is turned on and triggered to initiate the GPRS attach procedure.
1	MS -> SS	CHANNEL REQUEST	
2	MS -> SS	CHANNEL REQUEST	
3	MS -> SS	CHANNEL REQUEST	
4	SS -> MS	IMMEDIATE ASSIGNMENT	for uplink TBF, one phase access, fixed allocation and including a Request Reference different from those included in previous CHANNEL REQUEST messages.
5	MS -> SS	CHANNEL REQUEST	MS continues sending CHANNEL REQUEST messages.
6	MS -> SS	CHANNEL REQUEST	
7	SS -> MS	IMMEDIATE ASSIGNMENT	with Request Reference corresponding to step 3. MS shall stop sending further access bursts.
8	MS -> SS	RLC data block (GMM ATTACH REQUEST)	(see message contents in default section)
9	MS<->SS	Completion of macro {GPRS attach procedure}	SS allows MS to complete the attach procedure.

41.2.3 Packet immediate assignment / One phase packet access

41.2.3.1 Two-message assignment / Successful case

41.2.3.1.1 Conformance requirements

If the mobile station receives an IMMEDIATE ASSIGNMENT message and the Dedicated mode or TBF information element indicates that this is the first message in a two-message assignment, the mobile station shall continue to listen to the full CCCH. The network may send a second IMMEDIATE ASSIGNMENT message within two multiframe periods following the first IMMEDIATE ASSIGNMENT, specifying the packet channel description and, if required, a mobile allocation for the assignment.

On receipt of an IMMEDIATE ASSIGNMENT message or, in case of a two-message assignment, a matching pair of IMMEDIATE ASSIGNMENT messages corresponding to one of its 3 last CHANNEL REQUEST messages, the mobile station stops T3146 (if running), stops sending CHANNEL REQUEST messages, and switches to the assigned PDCH.

Reference

GSM 04.08 subclause 3.5.2.1.3.1

41.2.3.1.2 Test purpose

To verify that the MS correctly decodes a two-message assignment and switches to the assigned PDCH.

41.2.3.1.3 Method of test

Initial conditions

System Simulator: 1 cell, CCCH combined with SDCCH.

Mobile Station: MS is switched off.

Related PICS/PIXIT statement

-

Test procedure

The MS is triggered to initiate the GPRS attach procedure. After reception of CHANNEL REQUEST the SS sends a two-message IMMEDIATE ASSIGNMENT which actually describe a default IMMEDIATE ASSIGNMENT message, except that it is split in two parts: basically, the first part contains the IA Rest Octets, and the second part the Packet Channel Description IE.

The SS verifies that the MS correctly switches to the assigned PDCH and completes GPRS attach.

Maximum duration of the test

-

Expected sequence

Step	Direction	Message	Comments
1	MS		MS is turned on and triggered to initiate the GPRS attach procedure.
2	MS -> SS	CHANNEL REQUEST	
3	SS -> MS	IMMEDIATE ASSIGNMENT	first message of two-message assignment
4	SS -> MS	IMMEDIATE ASSIGNMENT	second message (see specific message contents), sent within two multiframe after step 3.
5	MS<->SS	Completion of macro {GPRS attach procedure}	SS allows MS to complete the GPRS attach procedure.

Specific message contents:

IMMEDIATE ASSIGNMENT (first message)

Information Element	Value
as default except:	
Dedicated mode or TBF:	
- TMA	1 (is first message of a two-message assignment)
- Downlink	0
- T/D	1 (assign a TBF)
Packet Channel Description:	all bits are set to '0'
Request Reference:	as default
Timing Advance:	as default
Starting Time:	not present
IA Rest Octets:	as default

IMMEDIATE ASSIGNMENT (second message)

Information Element	Value
as default except:	
Dedicated mode or TBF:	
- TMA	0
- Downlink	0
- T/D	1 (assign a TBF)
Packet Channel Description:	as default
Request Reference:	as default
Timing Advance:	as default
Starting Time:	not present
IA Rest Octets:	Second Part Packet Assignment

41.2.3.2 Two-message assignment / Failure cases

41.2.3.2.1 Conformance requirements

If the indirect encoding is used, the IMMEDIATE ASSIGNMENT message may contain a CHANGE_MARK_1 field. If that is present, the mobile station shall verify the validity of the SI13_CHANGE_MARK associated with the GPRS mobile allocation to which the message refers, see GSM 04.60. If the CHANGE_MARK_1 field and the SI13_CHANGE_MARK do not match, the message does not satisfactorily define a PDCH.

The two IMMEDIATE ASSIGNMENT messages in a two-message assignment shall have the same contents of the Request Reference information elements.

If the mobile station does not receive the second IMMEDIATE ASSIGNMENT messages in a two-message assignment within two multiframe periods following the first message, the mobile station shall discard the first IMMEDIATE ASSIGNMENT message received.

Reference

GSM 04.08 subclause 3.5.2.1.3.1

41.2.3.2.2 Test purpose

To verify that the MS does not respond to a two-message assignment if:

- CHANGE_MARK_1 does not match SI13 CHANGE_MARK.
- the second IMMEDIATE ASSIGNMENT message is not received within two multiframe periods after the first message.
- Request References in both messages do not have same contents.

41.2.3.2.3 Method of test

Initial conditions

System Simulator: 1 cell, CCCH combined with SDCCH, CHANGE_MARK in SI13 is set to 1.

Mobile Station: MS is switched off.

Related PICS/PIXIT statement

-

Test procedure

The MS is triggered to initiate the GPRS attach procedure. After reception of CHANNEL REQUEST the SS sends a two-message IMMEDIATE assignment:

- first attempt: CHANGE_MARK does not match SI13 CHANGE_MARK. MS shall re-initiate packet access (see GSM 04.08 / 4.7.3.1.5, GPRS attach procedure / Abnormal cases).
- second attempt: the second IMMEDIATE ASSIGNMENT message is not received within two multiframes after the first message. MS shall re-initiate packet access.
- third attempt: Request References in both messages do not have same contents. MS shall re-initiate packet access.
- fourth attempt: the second IMMEDIATE ASSIGNMENT message is received in the last access grant block before the second multiframes after the first message. In this case the MS shall successfully switch to the assigned PDCH and complete the GPRS attach procedure.

Maximum duration of the test

-

Expected sequence

Step	Direction	Message	Comments
1	MS		The MS is triggered to initiate the GPRS attach procedure.
2	MS -> SS	CHANNEL REQUEST	first message of two-message assignment with contents as specified below (see specific message contents).
3	SS -> MS	IMMEDIATE ASSIGNMENT	
4	SS -> MS	IMMEDIATE ASSIGNMENT	
5	MS -> SS	CHANNEL REQUEST	MS shall re-initiate packet access first message of two-message assignment (see specific message contents) second message (see specific message contents) sent after two multiframes after the first message.
6	SS -> MS	IMMEDIATE ASSIGNMENT	
7	SS -> MS	IMMEDIATE ASSIGNMENT	
8	MS -> SS	CHANNEL REQUEST	MS shall re-initiate packet access first message of two-message assignment (see specific message contents) including a Request Reference corresponding to step 8. second message (see specific message contents) except: Request Reference is different from that in step 8.
9	SS -> MS	IMMEDIATE ASSIGNMENT	
10	SS -> MS	IMMEDIATE ASSIGNMENT	
11	MS -> SS	CHANNEL REQUEST	MS shall re-initiate packet access first message of two-message assignment (see specific message contents) second message (see specific message contents) sent in the last access grant block before the second multiframe after the first message elapses. SS allows MS to complete the GPRS attach procedure.
12	SS -> MS	IMMEDIATE ASSIGNMENT	
13	SS -> MS	IMMEDIATE ASSIGNMENT	
14	MS<->SS	Completion of macro {GPRS attach procedure}	

Specific message contents:

IMMEDIATE ASSIGNMENT (first message)

Information Element	Value
as default except:	
Dedicated mode or TBF:	
- TMA	1 (is first message of a two-message assignment)
- Downlink	0
- T/D	1 (assign a TBF)
Packet Channel Description:	all bits are set to '0'
Request Reference:	as default
Timing Advance:	as default
Starting Time:	not present
IA Rest Octets:	as default

IMMEDIATE ASSIGNMENT (second message)

Information Element	Value
as default except:	
Dedicated mode or TBF:	
- TMA	0
- Downlink	0
- T/D	1 (assign a TBF)
Packet Channel Description:	as default
Request Reference:	as default
Timing Advance:	as default
Starting Time:	not present
IA Rest Octets:	Second Part Packet Assignment

41.2.3.3 Packet uplink assignment / Polling bit set

41.2.3.3.1 Conformance requirement

If the Polling bit is set to 1, MS shall send a PACKET CONTROL ACKNOWLEDGEMENT message (see 04.60) on the assigned PDCH, in the uplink block specified by the TBF Starting Time. In this case the TBF Starting Time is used both to indicate when the assigned PDCH becomes valid and to specify the uplink block.

Reference

GSM 04.08 subclause 3.5.2.1.3.2

41.2.3.3.2 Test purpose

To verify that the MS sends a PACKET CONTROL ACKNOWLEDGEMENT message in the correct uplink block if the Polling bit is set in packet uplink assignment construction.

41.2.3.3.3 Method of test

Initial conditions

System Simulator: 1 cell, CCCH combined with SDCCH.

Mobile Station: MS is switched off.

Related PICS/PIXIT statement

-

Test procedure

The MS is triggered to initiate the GPRS attach procedure. The SS assigns packet uplink resources in an IMMEDIATE ASSIGNMENT message indicating one phase packet access and with the Polling bit set. The MS shall send a PACKET CONTROL ACKNOWLEDGMENT on the assigned uplink block and then complete the GPRS attach procedure.

Maximum duration of the test

-

Expected sequence

Step	Direction	Message	Comments
1	MS		MS is triggered to initiate GPRS attach.
2	MS -> SS	CHANNEL REQUEST	
3	SS -> MS	IMMEDIATE ASSIGNMENT	for uplink TBF, one phase access and Polling bit set, and arbitrarily chosen TBF starting time in the future.
4	MS -> SS	PACKET CONTROL ACKNOWLEDGEMENT	sent on the block indicated by TBF starting time in step 3.
5	SS<->MS	Completion of macro {GPRS attach procedure}	SS allows MS to complete GPRS attach.

41.2.3.4 One phase packet access / Contention resolution / Successful case

41.2.3.4.1 Conformance requirements

After receiving an IMMEDIATE ASSIGNMENT message in which one phase packet access for an uplink transfer is granted, the mobile station shall start timer T3164 and proceed with the contention resolution at one phase access defined in GSM 04.60.

Reference

GSM 04.08 subclause 3.5.2.1.3.2

GSM 04.60 subclause 7.1.2.3

41.2.3.4.2 Test purpose

To verify that the MS includes the correct TLLI (Temporary Logical Link Identifier) in the first RLC data blocks until contention resolution is completed.

41.2.3.4.3 Method of test

Initial conditions

System Simulator: 1cell, CCCH combined with SDCCH.

Mobile Station: MS is GPRS attached, a PDP context has been established and the MS is in Packet Idle mode.

Related PICS/PIXIT statement

- Support of PDP context

Test procedure

The MS is triggered to transfer data. The SS assigns packet uplink resources in an IMMEDIATE ASSIGNMENT message indicating one phase packet access. The MS shall start transferring RLC data blocks including the correct TLLI in the RLC data blocks which are sent preceding the reception of PACKET UPLINK ACK/NACK.

Maximum duration of the test

5 minutes.

Expected sequence

Step	Direction	Message	Comments
0	MS		The MS is triggered to transfer 200 octets of data.
1	MS -> SS	CHANNEL REQUEST	
2	SS -> MS	IMMEDIATE ASSIGNMENT	For uplink TBF, one phase access
3	MS -> SS	3 RLC data blocks	SS verifies correct TLLI in RLC headers.
4	SS -> MS	PACKET UPLINK ACK/NACK	Including correct TLLI
5	MS<->SS	Completion of macro {Uplink data transfer}	SS allows MS to complete data transfer.

41.2.3.5 One phase packet access / Contention resolution / TLLI mismatch

41.2.3.5.1 Conformance requirement

If the TLLI in the PACKET UPLINK ACK/NACK message differs from that sent by the MS in the RLC block headers, the MS shall immediately stop transmitting on this TBF and re-initiate the packet access procedure unless it has already been repeated 4 times.

Reference

GSM 04.08 subclause 3.5.2.1.3.2

GSM 04.60 subclause 7.1.2.3

41.2.3.5.2 Test purpose

To verify that the MS immediately stops transmitting if it receives a PACKET UPLINK ACK/NACK with incorrect TLLI.

41.2.3.5.3 Method of test

Initial conditions

System Simulator: 1cell, CCCH combined with SDCCH.

Mobile Station: MS is GPRS attached, a PDP context has been established and the MS is in Packet Idle mode.

Related PICS/PIXIT statement

- Support of PDP context

Test procedure

The MS is triggered to transfer data. The SS assigns packet uplink resources in an IMMEDIATE ASSIGNMENT message indicating one phase packet access. The MS shall start transferring RLC data blocks including the correct TLLI in the first three blocks. The SS acknowledges the RLC block transfer with a PACKET UPLINK ACK/NACK including an incorrect TLLI. The SS shall verify that the MS 'immediately' stops transmitting (see note below) and retries packet access procedure.

Note: The MS is allowed to transmit n RLC blocks after the block containing the PACKET UPLINK ACK/NACK message (the exact value of n is specified in GSM 05.10 / 6.11).

Maximum duration of the test

-

Expected sequence

Step	Direction	Message	Comments
0	MS		The MS is triggered to transfer 200 octets of data.
1	MS -> SS	CHANNEL REQUEST	
2	SS -> MS	IMMEDIATE ASSIGNMENT	For uplink TBF, one phase packet access granted, fixed allocation.
3	MS -> SS	3 RLC data blocks	SS verifies correct TLLI in RLC headers.
4	SS -> MS	PACKET UPLINK ACK/NACK	Including incorrect TLLI
5	SS		The SS verifies that the MS transmits at most further n (=6) data blocks after step 4 (see Note) before re-initiating packet access.
6	MS -> SS	CHANNEL REQUEST	MS re-initiates packet access procedure.
7	SS -> MS	IMMEDIATE ASSIGNMENT	For uplink TBF, one phase packet access granted, fixed allocation.
8	MS<->SS	Completion of macro {Uplink data transfer}	SS allows MS to complete uplink data transfer.

41.2.3.6 One phase packet access / Contention resolution / Counter N3104

41.2.3.6.1 Conformance requirement

The contention resolution has failed on the mobile station when the counter N3104 has reached its maximum value.

Reference

GSM 04.60 subclause 7.1.2.3

41.2.3.6.2 Test purpose

To verify that the MS correctly sets and considers counter N3104.

Note: Counter N3104 is incremented by 1 with each new RLC/MAC block the mobile station sends until the first PACKET UPLINK ACK/NACK message is received.

Its maximum value is $N3104_MAX = 3 * (BS_CV_MAX + 3) * \text{number of uplink timeslots assigned}$, where BS_CV_MAX is broadcast in SI 13 Rest Octets.

41.2.3.6.3 Method of test

Initial conditions

System Simulator: Default settings except: 1 cell, CCCH combined with SDCCH, BS_CV_MAX value in System Information Type 13 arbitrarily chosen in the range 3 to 10.

Mobile Station: MS is GPRS attached, a PDP context has been established and the MS is in Packet Idle mode.

Related PICS/PIXIT statement

- Support of PDP context

Test procedure

The MS is triggered to transfer 1000 octets of data. The SS assigns packet uplink resources in an IMMEDIATE ASSIGNMENT message indicating one phase packet access. The MS shall start transferring RLC data blocks. The SS acknowledges the RLC block transfer with a correct PACKET UPLINK ACK/NACK sent after N3104_MAX data blocks. The SS verifies that the MS stops transmitting and restarts packet access procedure.

At the second attempt, the SS sends PACKET UPLINK ACK/NACK exactly after N3104_MAX - 1 data blocks. The SS verifies that this time the MS does not abort the access procedure and successfully completes uplink transfer.

Maximum duration of the test

-

Expected sequence

Step	Direction	Message	Comments
1	MS -> SS	CHANNEL REQUEST	MS is triggered to transfer 1000 data octets. for uplink TBF, indicating one phase packet access, fixed allocation and allocation bitmap granting 31 blocks. SS receives n = N3104_MAX data blocks SS verifies that MS does not send further RLC data blocks. with parameter REPEAT_ALLOCATION set. MS shall ignore this message SS verifies that the MS does not send further RLC data blocks.
2	SS -> MS	IMMEDIATE ASSIGNMENT	
3	MS -> SS	n RLC data blocks	
4	SS		
5	SS -> MS	PACKET UPLINK ACK/NACK	
6	SS		
7	MS -> SS	CHANNEL REQUEST	MS re-initiates packet access procedure. indicating one phase packet access granted. SS receives N3104_MAX – 1 data blocks with parameter REPEAT_ALLOCATION set. SS allows MS to complete uplink data transfer.
8	SS -> MS	IMMEDIATE ASSIGNMENT	
9	MS -> SS	n-1 RLC data blocks	
10	SS -> MS	PACKET UPLINK ACK/NACK	
11	MS<->SS	Completion of macro {Uplink data transfer}	

41.2.3.7 One phase packet access / Contention resolution / Timer T3166

41.2.3.7.1 Conformance requirement

The contention resolution has failed on the mobile station when the counter N3104 has reached its maximum value, or on expiry of timer T3166.

Reference

GSM 04.60 subclause 7.1.2.3

41.2.3.7.2 Test purpose

To verify that the MS correctly considers timer T3166.

41.2.3.7.3 Method of test

Initial conditions

System Simulator: 1 cell, CCCH combined with SDCCH, BS_CV_MAX value in System Information Type 13 is set to 15.

Mobile Station: MS is GPRS attached, a PDP context has been established and the MS is in Packet Idle mode.

Related PICS/PIXIT statement

- Support of PDP context

Test procedure

The MS is triggered to transfer 1000 octets of data. The SS assigns packet uplink resources in an IMMEDIATE ASSIGNMENT message indicating one phase packet access and dynamic allocation. The MS shall start transferring RLC data blocks. The SS reduces the block transfer rate by controlling the USF flag. In this way, the SS forces T3166

(with value 5 s.) to expire before counter N3104 reaches N3104_MAX (with value 45 blocks for current settings). The SS verifies that the MS stops transmitting and restarts packet access procedure.

At the second attempt, the SS sends PACKET UPLINK ACK/NACK before T3166 seconds. The SS verifies that this time the MS does not abort the access procedure and successfully completes the data transfer.

Maximum duration of the test

5 minutes.

Expected sequence

Step	Direction	Message	Comments	
1	MS -> SS	CHANNEL REQUEST	MS is triggered to transfer 1000 data octets. Indicating one phase packet access granted, dynamic allocation. CS1 shall be used.	
2	SS -> MS	IMMEDIATE ASSIGNMENT		
3	SS -> MS	PACKET DOWNLINK DUMMY CONTROL BLOCK	USF addressing the MS	
4	MS -> SS	RLC data block	USF not addressing the MS	
5	SS -> MS	PACKET DOWNLINK DUMMY CONTROL BLOCK		
6	SS -> MS	PACKET DOWNLINK DUMMY CONTROL BLOCK		
7	SS -> MS	PACKET DOWNLINK DUMMY CONTROL BLOCK		
8	SS -> MS	PACKET DOWNLINK DUMMY CONTROL BLOCK		
9	SS -> MS	PACKET DOWNLINK DUMMY CONTROL BLOCK		
10	SS -> MS	PACKET DOWNLINK DUMMY CONTROL BLOCK		
11	SS -> MS	PACKET DOWNLINK DUMMY CONTROL BLOCK		
12	SS -> MS	PACKET DOWNLINK DUMMY CONTROL BLOCK		
13	SS -> MS	PACKET DOWNLINK DUMMY CONTROL BLOCK		
14	SS -> MS	PACKET DOWNLINK DUMMY CONTROL BLOCK		
15	SS -> MS	PACKET DOWNLINK DUMMY CONTROL BLOCK		
16	MS<->SS			Steps 3 to 15 are repeated at most 22 times or until MS does not send further RLC data blocks at step 4. Note: steps 3 to 15 transfer one block every 52 frames, or 240 ms. 22 repetitions require about 5.5 s. (Timer T3166 shall expire)
17	MS -> SS	CHANNEL REQUEST		MS re-initiates packet access procedure. Indicating one phase packet access granted, dynamic allocation.
18	SS -> MS	IMMEDIATE ASSIGNMENT		
19	MS<->SS		Steps 3 to 15 are repeated 17 times. Note: 17 repetitions require about 4.3 s. (Timer T3166 should not expire)	
20	SS -> MS	PACKET UPLINK ACK/NACK	SS allows MS to complete uplink data transfer.	
21	MS<->SS	Completion of macro {Uplink data transfer}		

41.2.3.8 One phase packet access / Contention resolution / 4 access repetition attempts

41.2.3.8.1 Conformance requirement

If contention resolution for packet access fails, the mobile station shall reinitiate the packet access procedure unless it has already been repeated 4 times.

Reference

GSM 04.60 subclause 7.1.2.3

41.2.3.8.2 Test purpose

To verify that the MS repeats the packet access initiation 4 times.

41.2.3.8.3 Method of test

Initial conditions

System Simulator: 1cell, CCCH combined with SDCCH.

Mobile Station: MS is GPRS attached, a PDP context has been established and the MS is in Packet Idle mode.

Related PICS/PIXIT statement

- Support of PDP context

Test procedure

The MS is triggered to transfer 200 octets of data. The SS assigns packet uplink resources in an IMMEDIATE ASSIGNMENT message indicating one phase packet access. The MS shall start transferring RLC data blocks including the correct TLLI in the first three blocks. The SS acknowledges the RLC block transfer with a PACKET UPLINK ACK/NACK including a TLLI not corresponding to the MS. The SS shall verify that the MS stops transmitting blocks and reinitiates packet access, which shall be repeated four times.

Note:

The MS is allowed to transmit n RLC blocks after the block containing the PACKET UPLINK ACK/NACK message (the exact value of n is specified in GSM 05.10 / 6.11).

Maximum duration of the test

5 minutes.

Expected sequence

Step	Direction	Message	Comments
1	MS		The MS is triggered to transfer 200 octets of data.
2	MS -> SS	CHANNEL REQUEST	
3	SS -> MS	IMMEDIATE ASSIGNMENT	indicating one phase packet access granted, fixed allocation.
4	MS -> SS	3 RLC data blocks	
5	SS -> MS	PACKET UPLINK ACK/NACK	including incorrect TLLI
6	MS -> SS		MS aborts packet access procedure, and is allowed to transmit at most n RLC data blocks (see Note above).
7	MS<->SS		repetition 1: MS shall reinitiate a packet access procedure, steps 2 to 6 are repeated.
8	MS<->SS		repetition 2: MS reinitiates a packet access procedure, steps 2 to 6 are repeated.
9	MS<->SS		repetition 3: MS reinitiates a packet access procedure, steps 2 to 6 are repeated.
10	MS<->SS		repetition 4: MS reinitiates a packet access procedure, steps 2 to 6 are repeated.

Note: after step 10, the MS may reinitiate a packet access procedure, since higher layers may request to restart the access procedure.

41.2.3.9 One phase packet access / TBF starting time

41.2.3.9.1 Conformance requirement

In case the packet uplink assignment construction contains a TBF starting time and the mobile station receives the IMMEDIATE ASSIGNMENT message before the TBF starting time has expired, it shall wait until the frame number indicated by the TBF starting time before accessing the channel. If the mobile station receives the message after the TBF starting time has expired, it shall ignore the TBF starting time and may immediately access the channel.

[GSM 04.60]

- if the mobile station receives a PACKET UPLINK ASSIGNMENT, PACKET TIMESLOT RECONFIGURE, or a PACKET UPLINK ACK/NACK with an ALLOCATION_BITMAP whose TBF starting time has elapsed, the mobile station shall use whatever portion of the fixed allocation remains. If none of the fixed allocation remains, the mobile station shall ignore the message.

Reference

GSM 04.08 subclause 3.5.2.1.3.2

GSM 04.60 subclause 8.1.1.5

41.2.3.9.2 Test purpose

To verify that the MS correctly considers the TBF Starting Time included in the IMMEDIATE ASSIGNMENT message.

41.2.3.9.3 Method of test

Initial conditions

System Simulator: 1cell, CCCH combined with SDCCH.

Mobile Station: MS is GPRS attached, a PDP context has been established and the MS is in Packet Idle mode.

Related PICS/PIXIT statement

- Support of PDP context

Test procedure

The MS is triggered to transfer data. The SS assigns packet uplink resources in an IMMEDIATE ASSIGNMENT message indicating one phase packet access and containing a TBF starting time. The MS shall start transferring RLC data blocks at the exact frame specified by the TBF starting time.

The test is repeated with a TBF starting time in the past. In this case the MS shall 'immediately' (see note below) send RLC data blocks.

Note:

The MS shall start transmitting RLC blocks within n blocks after the block containing the IMMEDIATE ASSIGNMENT message (the exact value of n is specified in GSM 05.10 / 6.11).

Maximum duration of the test

-

Expected sequence

Step	Direction	Message	Comments
0	MS		The MS is triggered to transfer 200 octets of data.
1	MS -> SS	CHANNEL REQUEST	
2	SS -> MS	IMMEDIATE ASSIGNMENT	indicating one phase packet access granted, fixed allocation and an arbitrarily chosen TBF Starting Time (indicating a future frame number).
3	SS		SS verifies that MS does not transmit for frame numbers below TBF Starting Time.
4	MS -> SS	3 RLC data blocks	SS verifies that first RLC block arrives on first allowed block after TBF Starting Time.
5	SS -> MS	PACKET UPLINK ACK/NACK	Including correct TLLI.
6	MS -> SS	RLC data blocks	
7	SS<->MS	Completion of macro {Uplink data transfer}	SS allows MS to complete data transfer.
8	MS		The MS is triggered again to transfer 200 octets of data.
9	MS -> SS	CHANNEL REQUEST	
10	SS -> MS	IMMEDIATE ASSIGNMENT	indicating one phase packet access granted, fixed allocation and an arbitrarily chosen TBF Starting Time with value less than current frame number, and such that the Allocation Bitmap extends over more than 3 blocks after current frame number.
11	MS -> SS	3 RLC data blocks	SS verifies that MS 'immediately' starts sending RLC data blocks, i.e. within n (=6) blocks after step 10 (see Note above).
12	SS -> MS	PACKET UPLINK ACK/NACK	Including correct TLLI.
13	MS -> SS	RLC data blocks	
14	SS<->MS	Completion of macro {Uplink data transfer}	SS allows MS to complete data transfer.

41.2.3.10 One phase packet access / Timing Advance Index present

41.2.3.10.1 Conformance requirement

If the timing advance index (TAI) is included in the packet uplink assignment construction, the mobile station shall use the continuous update timing advance mechanism, see GSM 05.10, using PTCH in the same timeslot as the assigned PDCH.

Reference

GSM 04.08 subclause 3.5.2.1.3.2

GSM 03.64 subclause 6.5.7.2

41.2.3.10.2 Test purpose

To verify that the MS uses the continuous update timing advance mechanism and sends access bursts in the PTCCH slots as determined by the Timing Advance Index (TAI) sent in the IMMEDIATE ASSIGNMENT.

41.2.3.10.3 Method of test

Initial conditions

System Simulator: 1 cell, CCCH combined with SDCCH.

Mobile Station: MS is GPRS attached, a PDP context has been established and the MS is in Packet Idle mode.

Related PICS/PIXIT statement

- Support of PDP context

Test procedure

The MS is triggered for uplink data transfer. The SS assigns packet uplink resources in an IMMEDIATE ASSIGNMENT message indicating one phase packet access and containing a Timing Advance Index. During TBF transfer, the SS shall verify the access bursts sent by the MS in the PTCCH.

Maximum duration of the test

-

Expected sequence

Step	Direction	Message	Comments
0	MS		The MS is triggered to transfer 2000 octets of data.
1	MS -> SS	CHANNEL REQUEST	
2	SS -> MS	IMMEDIATE ASSIGNMENT	For one phase packet access, dynamic allocation and including Timing Advance Index TAI=0.
3	MS -> SS	RLC data blocks	
4	SS -> MS	PACKET UPLINK ACK/NACK	Including correct TLLI.
5	MS<->SS	Completion of macro {Uplink data transfer}	SS allows MS to complete data transfer.

Verification

During TBF transfer (steps 3 to 5) the SS monitors access bursts on PTCCH which are located on slots with numbers FN, such that $(FN \bmod (8 \cdot 52)) = 12$ for TAI = 0 (GSM 03.64/6.5.7.2 and GSM 05.02/Table 6). The access burst contents shall be '01111111'.

The test is repeated once more with an arbitrarily chosen TAI in the range 1 to 15. SS shall verify that the access bursts are sent in the correct PTCCH slots as specified in GSM 05.02/Table 6.

41.2.3.11 One phase packet access / Timing Advance Index not present

41.2.3.11.1 Conformance requirement

If a timing advance index (TAI) field is not included, the continuous update timing advance mechanism shall not be used.

Reference

GSM 04.08 subclause 3.5.2.1.3.2

41.2.3.11.2 Test purpose

To verify that the MS does not send any access bursts on PTCCH (i.e. it does not use the continuous update timing advance mechanism) if TAI is not present in the IMMEDIATE ASSIGNMENT message.

41.2.3.11.3 Method of test

Initial conditions

System Simulator: 1 cell, CCCH combined with SDCCH.

Mobile Station: MS is GPRS attached, a PDP context has been established and the MS is in Packet Idle mode.

Related PICS/PIXIT statement

- Support of PDP context

Test procedure

The MS is triggered to transfer data. The SS assigns packet uplink resources in an IMMEDIATE ASSIGNMENT message not including a Timing Advance Index. During TBF transfer, the SS shall verify that the MS does not send any access bursts in idle frames.

Maximum duration of the test

-

Expected sequence

Step	Direction	Message	Comments
0	MS		The MS is triggered to transfer 2000 octets of data.
1	MS -> SS	CHANNEL REQUEST	
2	SS -> MS	IMMEDIATE ASSIGNMENT	not including Timing Advance Index
3	MS -> SS	3 RLC data blocks	
4	SS -> MS	PACKET UPLINK ACK/NACK	Including correct TLLI.
5	MS -> SS	RLC data blocks	
6	SS<->MS	Completion of macro {Uplink data transfer}	SS allows MS to complete data transfer

Verification

The SS verifies that the MS does not transmit in idle frames during data block transfer (steps 3 to 6). Idle frame numbers are 12, 25, 38 and 51 in the 52-multiframe structure.

41.2.4 Packet immediate assignment / Single block packet access

41.2.4.1 Single block packet access / Packet Resource Request

41.2.4.1.1 Conformance requirement

The network shall use the TBF starting time to indicate the first frame number belonging to the single block period granted for packet access. The mobile station may use that block period to send a PACKET RESOURCE REQUEST message to initiate the two phase access defined in GSM 04.60, or to send a PACKET MEASUREMENT REPORT message, see GSM 04.60.

Reference

GSM 04.08 subclause 3.5.2.1.3.3

41.2.4.1.2 Test purpose

To verify that the MS sends PACKET RESOURCE REQUEST in the assigned block as indicated by the TBF starting time when it is triggered for uplink transfer.

41.2.4.1.3 Method of test

Initial conditions

System Simulator: 1 cell, CCCH combined with SDCCH.

Mobile Station: MS is GPRS attached, a PDP context has been established and the MS is in Packet Idle mode.

Related PICS/PIXIT statement

- Support of PDP context

Test procedure

The MS is triggered to initiate uplink data transfer. The SS assigns packet uplink resources for single block in an IMMEDIATE ASSIGNMENT message including a TBF starting time. The SS verifies that the MS sends a PACKET RESOURCE REQUEST at the first allowed block as indicated by the TBF starting frame.

Maximum duration of the test

-

Expected sequence

Step	Direction	Message	Comments
0	MS		The MS is triggered to transfer 200 octets of data.
1	MS -> SS	CHANNEL REQUEST	For uplink TBF, single block assignment for an arbitrarily chosen TBF Starting Time in the future. SS verifies that first block is on first allowed block starting at frame number given by TBF Starting Time.
2	SS -> MS	IMMEDIATE ASSIGNMENT	
3	MS -> SS	PACKET RESOURCE REQUEST	with default contents.
4	SS -> MS	PACKET ACCESS REJECT	

41.2.4.2 Single block packet access / Packet Measurement Report

41.2.4.2.1 Conformance requirement

The network shall use the TBF starting time to indicate the first frame number belonging to the single block period granted for packet access. The mobile station may use that block period to send a PACKET RESOURCE REQUEST message to initiate the two phase access defined in GSM 04.60, or to send a PACKET MEASUREMENT REPORT message, see GSM 04.60.

Reference

GSM 04.08 subclause 3.5.2.1.3.3

41.2.4.2.2 Test purpose

To verify that the MS sends PACKET MEASUREMENT REPORT in the assigned uplink block when performing a measurement report procedure.

Further on, this tests verifies that the MS correctly considers reporting parameter NC_REPORTING_PERIOD_I.

41.2.4.2.3 Method of test

Initial conditions

System Simulator: 1 cell, CCCH combined with SDCCH.

Mobile Station: MS is GPRS attached, in Ready state and in Packet Idle mode.

Related PICS/PIXIT statement

-

Foreseen final state of the MS

-

Test procedure

The SS requests the MS via a PACKET MEASUREMENT ORDER to periodically send measurement reports. When the MS attempts a measurement report procedure, the SS assigns a single block for uplink TBF with an arbitrarily chosen TBF starting time (not yet elapsed). The SS verifies that the MS sends PACKET MEASUREMENT REPORT in the assigned block.

Maximum duration of the test

-

Expected sequence

Step	Direction	Message	Comments
1	SS -> MS	IMMEDIATE ASSIGNMENT	for single block downlink assignment on PCH corresponding to MS. Including parameters: NETWORK_CONTROL_ORDER = '01' NC_REPORTING_PERIOD_I = '011' (3.84 s.)
2	SS -> MS	PACKET MEASUREMENT ORDER	
3	MS -> SS	CHANNEL REQUEST	with establishment cause 'single block access'. for uplink TBF, single block assignment with an arbitrarily chosen TBF starting time in the future in the range 0.5 to 2 seconds.
4	SS -> MS	IMMEDIATE ASSIGNMENT	
5	MS -> SS	PACKET MEASUREMENT REPORT	Shall be sent in the assigned block.
6	SS -> MS	CHANNEL REQUEST	SS verifies that the time interval between steps 3 and 6 corresponds to NC_REPORTING_PERIOD_I +/- 10%.
7	SS -> MS	IMMEDIATE ASSIGNMENT	for uplink TBF, single block assignment with an arbitrarily chosen TBF starting time in the future. Shall be sent in the assigned block.
8	MS -> SS	PACKET MEASUREMENT REPORT	

41.2.5 Packet immediate assignment / Packet access rejection

41.2.5.1 Packet access rejection / wait indication

41.2.5.1.1 Conformance requirement

On receipt of an IMMEDIATE ASSIGNMENT REJECT message corresponding to one of its 3 last CHANNEL REQUEST messages, the mobile station stops sending CHANNEL REQUEST messages, starts timer T3142 with the indicated value, ("wait indication" information element), starts T3146 if it has not already been started, and listens to the downlink CCCH until T3146 expires. During this time, additional IMMEDIATE ASSIGNMENT REJECT messages are ignored, but any immediate assignment corresponding to any other of its 3 last CHANNEL REQUEST messages make the mobile station follow the assignment procedure. If no such immediate assignment is received, the mobile station returns to packet idle mode.

Reference

GSM 04.08 subclause 3.5.2.1.3.4

41.2.5.1.2 Test purpose

To verify that the MS stops sending CHANNEL REQUEST messages when receiving an IMMEDIATE ASSIGNMENT REJECT containing a Request Reference IE corresponding to one of its last 3 CHANNEL REQUEST messages.

Further on, the SS verifies that the MS makes a new attempt for uplink transfer only after T3142 seconds ("wait indication" timer) after last IMMEDIATE ASSIGNMENT REJECT elapse.

41.2.5.1.3 Method of test

Initial conditions

System Simulator: 1 cell, CCCH combined with SDCCH, Parameter MAX_RETRANS is set to 7 retransmissions.

Mobile Station: MS is switched off.

Related PICS/PIXIT statement

-

Foreseen final state of the MS

-

Test procedure

The MS is triggered to initiate the GPRS attach procedure. After reception of 3 CHANNEL REQUEST messages, the SS sends an IMMEDIATE ASSIGNMENT REJECT with correct Request Reference and including a waiting indication (T3142). The SS verifies that the MS stops sending CHANNEL REQUEST messages and does not attempt a new packet access until T3142 seconds elapse.

Maximum duration of the test

-

Expected sequence

Step	Direction	Message	Comments
0	MS		MS is triggered to initiate GPRS attach procedure
1	MS -> SS	CHANNEL REQUEST	
2	MS -> SS	CHANNEL REQUEST	
3	MS -> SS	CHANNEL REQUEST	
4	SS -> MS	IMMEDIATE ASSIGNMENT REJECT	including Request Reference corresponding to the CHANNEL REQUEST in step 1, and waiting time indication with value T3142=50s.
5	SS		SS verifies that MS does not send any further access bursts (see note below).
6	MS -> SS	CHANNEL REQUEST	SS verifies that the access burst arrives after $T3142 + 0.1 \cdot T3142 (=55s.)$ after last IMMEDIATE ASSIGNMENT REJECT message.
7	SS -> MS	IMMEDIATE ASSIGNMENT	for uplink TBF, one phase access
8	MS<->SS	Completion of macro {GPRS attach procedure}	SS allows MS to complete GPRS attach.

The test is repeated with an arbitrarily chosen value of T3142 in the range 2 to 255 seconds.

Note: The number of frames between successive access bursts considering the default Sys Info parameters used in the test is larger than 58 frames (see 04.08/Table 3.1). This value is large enough to allow the MS to respond to the IMMEDIATE ASSIGNMENT REJECT message by stopping sending the next access bursts.

41.2.5.2 Packet access rejection / assignment before T3142 expires

41.2.5.2.1 Conformance requirement

On receipt of an IMMEDIATE ASSIGNMENT REJECT message corresponding to one of its 3 last CHANNEL REQUEST messages, the mobile station stops sending CHANNEL REQUEST messages, starts timer T3142 with the indicated value, ("wait indication" information element), starts T3146 if it has not already been started, and listens to the downlink CCCH until T3146 expires. During this time, additional IMMEDIATE ASSIGNMENT REJECT messages are ignored, but any immediate assignment corresponding to any other of its 3 last CHANNEL REQUEST messages make the mobile station follow the assignment procedure. If no such immediate assignment is received, the mobile station returns to packet idle mode.

Reference

GSM 04.08 subclause 3.5.2.1.3.4

41.2.5.2.2 Test purpose

To verify that the MS stops sending CHANNEL REQUEST messages when receiving an IMMEDIATE ASSIGNMENT REJECT and, if an IMMEDIATE ASSIGNMENT containing a correct Request Reference arrives before $T = \min \{T3142, T3146\}$ seconds elapse, then the MS shall accept this assignment. (See below for a note on T3146).

41.2.5.2.3 Method of test

Initial conditions

System Simulator: Default settings except:

- Parameter MAX_RETRANS is set to 7 retransmissions.
- Parameter TX_INTEGER is set to 32
- CCCH combined with SDCCH

Mobile Station: MS is switched off.

Related PICS/PIXIT statement

-

Foreseen final state of the MS

-

Test procedure

The MS is triggered to initiate GPRS attach. After reception of 3 CHANNEL REQUEST messages, the SS sends an IMMEDIATE ASSIGNMENT REJECT with correct Request Reference and including a waiting indication (T3142). The SS verifies that the MS stops sending CHANNEL REQUEST messages.

Before $T = \min \{T3142, T3146\}$ seconds elapse, the SS sends an IMMEDIATE ASSIGNMENT with correct Request Reference. The MS shall switch to the assigned PDCH and transfer the data.

Note on T3146:

T3146 is started when sending the last CHANNEL REQUEST or when receiving the IMMEDIATE ASSIGNMENT REJECT. At its expiry, the packet access is aborted.

The value of T3146 is given by $T+2*S$ (GSM 04.08/11.1.1), where T is TX_INTEGER and S is given in GSM 04.08/Table 3.1. The value of T3146 is 2.15 s. for the current settings.

Maximum duration of the test

-

Expected sequence

Step	Direction	Message	Comments
0	MS		MS is triggered to initiate GPRS attach.
1	MS -> SS	CHANNEL REQUEST	
2	MS -> SS	CHANNEL REQUEST	
3	MS -> SS	CHANNEL REQUEST	
4	SS -> MS	IMMEDIATE ASSIGNMENT REJECT	including Request Reference corresponding to the CHANNEL REQUEST in step 2, and waiting time indication with value T3142 = 2 s.
5			The SS verifies that the MS stops sending CHANNEL REQUEST messages.
6	SS -> MS	IMMEDIATE ASSIGNMENT	sent after 1.5s. (of the last IMMEDIATE ASSIGNMENT REJECT) and including Request Reference corresponding to step 1.
7	SS<->MS	Completion of macro {GPRS attach procedure}	SS allows MS to complete GPRS attach.

41.2.6 Packet downlink assignment procedure using CCCH

41.2.6.1 Initiation of packet downlink assignment procedure / MS listens to correct CCCH block

41.2.6.1.1 Conformance requirement

The network initiates the packet downlink assignment procedure by sending an IMMEDIATE ASSIGNMENT message in unacknowledged mode on the CCCH timeslot corresponding to CCCH group the mobile station belongs to.

On receipt of an IMMEDIATE ASSIGNMENT message [the MS] stops monitoring downlink CCCH and switches to the assigned PDCH and starts listening for downlink RLC/MAC blocks identified by the assigned TFI; it starts timer T3190.

Reference

GSM 04.08 subclause 3.5.3.1.2

41.2.6.1.2 Test purpose

To verify that the MS responds to an IMMEDIATE ASSIGNMENT for downlink TBF sent on PCH blocks corresponding to the MS's paging group.

41.2.6.1.3 Method of test

Initial conditions

System Simulator: Default settings except:

- Parameters CCCH_CONF, BS_AG_BLK_RES, and BS_PA_MFRMS are arbitrarily chosen.

Mobile Station:

- MS is GPRS attached, DRX have been negotiated, MS is in Ready state.
- A PDP context has been established and the MS is in Packet Idle mode.

Related PICS/PIXIT statement

- Support of PDP context
- Support of DRX

Test procedure

The SS sends an IMMEDIATE ASSIGNMENT for downlink transfer on a PCH block corresponding to its paging group (see 05.02/6.5.2) which depends on Sys Info parameters and the MS's IMSI. The MS shall switch to the assigned PDCH and exercise downlink transfer.

Maximum duration of the test

-

Expected sequence

Step	Direction	Message	Comments
1	SS -> MS	IMMEDIATE ASSIGNMENT	sent on a PCH block corresponding to the MS's paging group, including a packet downlink assignment with correct TLLI.
2	MS<->SS	Completion of macro {Downlink data transfer}	SS completes downlink transfer of 200 octets of data.

41.2.6.2 Initiation of packet downlink assignment procedure / timer T3190

41.2.6.2.1 Conformance requirement

On receipt of an IMMEDIATE ASSIGNMENT message [the MS] stops monitoring downlink CCCH and switches to the assigned PDCH and starts listening for downlink RLC/MAC blocks identified by the assigned TFI; it then starts timer T3190.

If the mobile station does not receive a RLC/MAC block on the assigned PDCHs before timer T3190 expires, then a TBF establishment failure has occurred.

Reference

GSM 04.08 subclause 3.5.3.1.2

41.2.6.2.2 Test purpose

To verify that the MS returns to packet idle updated if RLC/MAC blocks are sent after T3190 seconds, and that the MS correctly receives RLC/MAC blocks if they are sent before T3190 seconds.

41.2.6.2.3 Method of test

Initial conditions

System Simulator: 1 cell, CCCH combined with SDCCH.

Mobile Station: MS is GPRS attached, a PDP context has been established and the MS is in Packet Idle mode.

Related PICS/PIXIT statement

- Support of PDP context

Test procedure

The SS assigns a PDCH for downlink transfer but does not send any RLC/MAC blocks until T3190 seconds have elapsed. The MS shall return to packet idle updated and ignore the RLC/MAC blocks.

To verify that the MS returned to packet idle updated, the SS again assigns a PDCH and sends RLC/MAC blocks before T3190 seconds elapse. The SS shall successfully transfer all RLC data blocks.

Maximum duration of the test

-

Expected sequence

Step	Direction	Message	Comments
1	SS -> MS	IMMEDIATE ASSIGNMENT	for downlink TBF on a PCH block corresponding to the MS, including a packet downlink assignment. SS waits T3190 + 10% (=5.5s) after the last IMMEDIATE ASSIGNMENT. SS sends data SS verifies for 10s. that the MS does not respond.
2	SS		
3	SS -> MS	RLC data blocks	
4	SS		
5	SS -> MS	IMMEDIATE ASSIGNMENT	SS assigns again a PDCH. SS waits T3190 – 10% (=4.5s) after the last IMMEDIATE ASSIGNMENT SS starts sending 200 octets of data. indicating correct reception of data blocks. SS completes downlink transfer.
6	SS		
7	SS -> MS	RLC data blocks	
8	MS -> SS	PACKET DOWNLINK ACK/NACK	
9	MS<->SS	Completion of macro {Downlink data transfer}	

41.2.6.3 Initiation of packet downlink assignment procedure / TBF starting time

41.2.6.3.1 Conformance requirement

The IMMEDIATE ASSIGNMENT message may indicate a TBF starting time. If the mobile station receives the message before the TBF starting time has expired, it shall wait until the frame number indicated by the TBF starting time, start timer T3190 and switch to the assigned PDCH. If the mobile station receives the message after the TBF starting time has expired, it shall ignore the indicated TBF starting time, immediately start timer T3190 and switch to the assigned PDCH.

Reference

GSM 04.08 subclause 3.5.3.1.2

41.2.6.3.2 Test purpose

To verify that the MS correctly considers the TBF starting time during downlink assignment.

41.2.6.3.3 Method of test

Initial conditions

System Simulator: 1 cell, CCCH combined with SDCCH.

Mobile Station: MS is GPRS attached, a PDP context has been established and the MS is in Packet Idle mode.

Related PICS/PIXIT statement

- Support of PDP context

Test procedure

The SS assigns a PDCH via an IMMEDIATE ASSIGNMENT including a TBF starting time. The SS does not send RLC data blocks after TBF starting time + T3190 elapses. The MS shall return to packet idle updated and ignore the RLC data blocks.

The SS assigns again a PDCH, and this time the SS sends RLC data blocks before TBF starting time + T3190 expires. The MS shall successfully receive the RLC data blocks.

Finally, the SS assigns the third time a PDCH, but including a TBF starting time which expired. The SS immediately sends RLC data blocks which shall be acknowledged by the MS.

Maximum duration of the test

-

Expected sequence

Step	Direction	Message	Comments
1	SS -> MS	IMMEDIATE ASSIGNMENT	including a packet downlink assignment with a TBF Starting Time corresponding to 10s after the current frame number. SS waits 1.1 * (TBF Starting Time +T3190) (=16.5 s) after the last IMMEDIATE ASSIGNMENT. including Polling bit set and valid RRBP field. SS verifies for that the MS does not respond in the assigned block in step 3.
2	SS		
3	SS -> MS	RLC data block	
4	SS		
5	SS -> MS	IMMEDIATE ASSIGNMENT	SS assigns again a PDCH with TBF Starting Time corresponding to 10s after the current frame number. SS waits 0.9 * (TBF Starting Time +T3190) (= 13.5 s) after the last IMMEDIATE ASSIGNMENT. including Polling bit set and valid RRBP field. sent in the assigned block at step 7 indicating correct reception of downlink RLC block. SS completes data transfer.
6	SS		
7	SS -> MS	RLC data block	
8	MS -> SS	PACKET DOWNLINK ACK/NACK	
9	MS<->SS	Completion of macro {Downlink data transfer}	
10	SS -> MS	IMMEDIATE ASSIGNMENT	SS assigns again a PDCH with TBF Starting Time which already elapsed. sent in the third block after the block containing the message in step 10 (see note below), including Polling bit set and valid RRBP field. indicating correct reception of RLC block. SS completes data transfer.
11	SS -> MS	RLC data block	
12	MS -> SS	PACKET DOWNLINK ACK/NACK	
13	MS<->SS	Completion of macro {Downlink data transfer}	

Note:

The requirements to uplink and downlink assignment reaction times are stated in GSM 05.10 / 6.11: An MS shall be ready to transmit and receive using a new assignment no later than the next occurrence of block B((x+3) mod 12) where block B(x) is the last radio block containing the uplink assignment.

41.2.6.4 Initiation of packet downlink assignment procedure / incorrect TFI

41.2.6.4.1 Conformance requirement

On receipt of an IMMEDIATE ASSIGNMENT message [the MS] stops monitoring downlink CCCH and switches to the assigned PDCH and starts listening for downlink RLC/MAC blocks identified by the assigned Temporary Flow Identifier (TFI).

Reference

GSM 04.08 subclause 3.5.3.1.2

41.2.6.4.2 Test purpose

To verify that the MS correctly considers the TFI in the RLC/MAC blocks.

41.2.6.4.3 Method of test

Initial conditions

System Simulator: 1 cell, CCCH combined with SDCCH.

Mobile Station: MS is GPRS attached, a PDP context has been established and the MS is in Packet Idle mode.

Related PICS/PIXIT statement

- Support of PDP context

Test procedure

The SS assigns a PDCH and starts transmitting RLC/MAC blocks with incorrect TFI. The MS shall ignore these RLC/MAC blocks and, after T3190 expires, return to packet idle mode.

To prove that the MS returns to idle mode, the SS assigns again a PDCH, and this time the SS sends RLC/MAC blocks with correct TFI. The MS shall successfully receive the data packets.

Maximum duration of the test

-

Expected sequence

Step	Direction	Message	Comments
1	SS -> MS	IMMEDIATE ASSIGNMENT	for downlink TBF
2	SS -> MS	RLC data block	SS sends RLC blocks with incorrect TFI (i.e. not corresponding to the last IMMEDIATE ASSIGNMENT), including Polling bit set and valid RRBP field.
3	SS		SS verifies that the MS does not respond in the assigned block.
4	SS		SS waits value of T3190 + 10% (=5.5s).
5	SS -> MS	IMMEDIATE ASSIGNMENT	for downlink TBF
6	SS -> MS	RLC data block	with correct TFI, including Polling bit set and valid RRBP field.
7	MS -> SS	PACKET DOWNLINK ACK/NACK	indicating correct reception of RLC block.
8	MS<->SS	Completion of macro {Downlink data transfer}	SS completes downlink transfer.

41.2.7 Single block packet downlink assignment

41.2.7.1 Single block packet downlink assignment / TBF Starting Time

41.2.7.1.1 Conformance requirement

The sending of an RLC/MAC control message to a mobile station in packet idle mode may be initiated by the RR entity on network side using the packet downlink assignment procedure. The procedure is used to assign a single downlink block on a PDCH for the transfer of the RLC/MAC control message.

The packet downlink construction in the IMMEDIATE ASSIGNMENT message shall contain only:

- the TLLI; and
- the TBF starting time.

If the mobile station receives the IMMEDIATE ASSIGNMENT message before the TBF starting time has expired, it shall wait until the frame number indicated by the TBF starting time. The network shall use the TBF starting time to indicate the first frame number belonging to the single block period assigned to the mobile station. The mobile station

shall switch to the assigned PDCH and attempt to decode an RLC/MAC control message in the assigned downlink block.

Reference

GSM 04.08 subclause 3.5.3.2

41.2.7.1.2 Test purpose

To verify that the MS correctly decodes the RLC control block sent by the network on the assigned downlink block given by TBF starting time in the IMMEDIATE ASSIGNMENT message.

41.2.7.1.3 Method of test

Initial conditions

System Simulator: 1 cell, CCCH combined with SDCCH.

Mobile Station: MS is GPRS attached, in Ready state and in Packet Idle mode.

Related PICS/PIXIT statement

-

Test procedure

The SS assigns a single block for downlink via an IMMEDIATE ASSIGNMENT message on CCCH including a TBF starting time . The SS sends a PACKET MEASUREMENT ORDER message addressing the MS with Polling Bit set and a valid RRBP field.

The MS shall respond with a PACKET CONTROL ACKNOWLEDGMENT message on the assigned TBF block. This verifies that the MS correctly received the RLC control block sent in the assigned single block TBF.

Maximum duration of the test

-

Expected sequence

Step	Direction	Message	Comments
1	SS -> MS	IMMEDIATE ASSIGNMENT	for single block downlink assignment, including a TBF starting time arbitrarily chosen in the range 0.5 to 50 s. after the current frame number.
2	SS -> MS	PACKET MEASUREMENT ORDER	sent on the block indicated by TBF starting time in step 1, including Polling bit set and valid RRBP field and addressing the MS.
3	MS -> SS	PACKET CONTROL ACKNOWLEDGEMENT	sent on the block indicated by the RRBP field in step 2.

41.2.7.2 Single block packet downlink assignment / MS returns to packet idle mode

41.2.7.2.1 Conformance requirement

Unless otherwise indicated by the RLC/MAC control message, the mobile station remains in packet idle mode. If the mobile station remains in packet idle mode, it shall continue to monitor downlink CCCH once the block period indicated by the TBF starting time has passed.

Reference

GSM 04.08 subclause 3.5.3.2

41.2.7.2.2 Test purpose

To verify that the MS remains in packet idle mode and monitors downlink CCCH once the block period indicated by the TBF starting time has passed.

41.2.7.2.3 Method of test

Initial conditions

System Simulator: Default settings except:

- NETWORK_CONTROL_ORDER in SI 13 Rest Octets set to '00' (no measurement reporting)
- CCCH combined with SDCCH

Mobile Station: MS is GPRS attached, a PDP context has been established and the MS is in Packet Idle mode.

Related PICS/PIXIT statement

- Support of PDP context.

Test procedure

The SS assigns a single block for downlink via an IMMEDIATE ASSIGNMENT message on CCCH including a TBF starting time . The SS sends a PACKET MEASUREMENT ORDER message requesting the MS to periodically send measurement reports.

Next, in order to verify that the MS remains in packet idle mode, the SS assigns a downlink TBF which shall be successfully completed.

The SS shall wait until the MS attempts two periodic measurement report procedures, in order to make sure that the MS correctly decoded the PACKET MEASUREMENT ORDER on the assigned single block for downlink.

Maximum duration of the test

-

Expected sequence

Step	Direction	Message	Comments
1	SS -> MS	IMMEDIATE ASSIGNMENT	for single block downlink assignment, including a TBF starting time arbitrarily chosen. on the assigned single block. NETWORK_CONTROL_ORDER = '01' NC_REPORTING_PERIOD_I = '110' (30.72 s.)
2	SS -> MS	PACKET MEASUREMENT ORDER	
3	SS -> MS	PAGING REQUEST	This verifies that MS is in 'idle mode'. including Wait Indication set to 5 s.
4	MS -> SS	CHANNEL REQUEST	
5	SS -> MS	IMMEDIATE ASSIGNMENT REJECT	
6	MS -> SS	CHANNEL REQUEST	for uplink TBF, single block assignment
7	SS -> MS	IMMEDIATE ASSIGNMENT	
8	MS -> SS	PACKET MEASUREMENT REPORT	
9	MS -> SS	CHANNEL REQUEST	The SS verifies reporting period: the time interval between CHANNEL REQUESTS messages in steps 7 and 10 shall be in the range 30.72 s. +/- 10%.
10	SS -> MS	IMMEDIATE ASSIGNMENT	for uplink TBF, single block assignment
11	MS -> SS	PACKET MEASUREMENT REPORT	

41.2.8 Macros and default message contents

41.2.8.1 Macros

In order to simplify the process of writing and coding test cases, macros are referenced in the expected signaling tables. These macros provide all additional signaling needed to complete the particular test but are not relevant to its purpose.

41.2.8.1.1 GPRS attach procedure

The following table describes a signaling sequence performing the GPRS attach procedure. Note that there are different possible sequences implementing the GPRS attach procedure.

The macros {Completion of GPRS attach} in the test cases refer to the table below starting at the step required for the particular sequence.

{GPRS attach procedure}

Step	Direction	Message	Comments
0			MS is triggered to initiate the GPRS attach procedure.
1	MS -> SS	CHANNEL REQUEST	Establishment Cause is 'one phase packet access'.
2	SS -> MS	IMMEDIATE ASSIGNMENT	For uplink TBF, single phase access, dynamic allocation.
3	MS -> SS	RLC data blocks	Transporting: ATTACH REQUEST
4	SS -> MS	PACKET UPLINK ACK/NACK	Indicating correct reception of uplink blocks, including RRBP field set.
5	MS -> SS	PACKET CONTROL ACKNOWLEDGMENT	Sent on PACCH
6	SS -> MS	IMMEDIATE ASSIGNMENT	For downlink TBF, sent 1 s. after setp 5 on AGCH.
7	SS -> MS	RLC data blocks	Transporting: ATTACH ACCEPT. Last block containing a valid RRBP field and FBI set.
8A	MS -> SS	PACKET DOWNLINK ACK/NACK	Including Channel Request Description.
9A	SS -> MS	PACKET UPLINK ASSIGNMENT	Sent on PACH.
10A	MS -> SS	RLC data blocks	Transporting: ATTACH COMPLETE
11A	SS -> MS	PACKET UPLINK ACK/NACK	Including valid RRBP field
12A	MS -> SS	PACKET CONTROL ACKNOWLEDGMENT	
8B	MS -> SS	PACKET DOWNLINK ACK/NACK	Not including Channel Request Description.
9B	MS->SS	CHANNEL REQUEST	
10B	SS -> MS	IMMEDIATE ASSIGNMENT	For uplink TBF, single phase access, dynamic allocation.
11B	MS -> SS	RLC data blocks	Transporting: ATTACH COMPLETE
12B	SS -> MS	PACKET UPLINK ACK/NACK	Indicating correct reception of uplink blocks, including RRBP field set.
13B	MS -> SS	PACKET CONTROL ACKNOWLEDGMENT	

41.2.8.1.2 Uplink data transfer

The following table describes a sequence performing uplink data transfer in acknowledged mode.

{Uplink data transfer, acknowledged mode}

Step	Direction	Message	Comments
0			A PDP context (in acknowledged RLC mode) has been established. The MS is triggered to send data.
1	MS -> SS	CHANNEL REQUEST	
2	SS -> MS	IMMEDIATE ASSIGNMENT	for uplink TBF, single block access.
3	MS -> SS	PACKET RESOURCE REQUEST	
4	SS -> MS	PACKET UPLINK ASSIGNMENT	for fixed allocation
5			Steps 6 to 8 are executed 0 to n times as needed.
6	MS -> SS	RLC data block	
7			Step 6 is repeated at most 14 times (resulting in at most 15 uplink data blocks)
8	SS -> MS	PACKET UPLINK ACK/NACK	indicating correct reception of uplink data blocks and parameter REPEAT_ ALLOCATION set.
9			Countdown procedure: Step 10 is repeated as needed.
10	MS -> SS	RLC data block	The MS shall correctly set the CV value in the RLC header, the last one being 0.
11	SS -> MS	PACKET UPLINK ACK/NACK	indicating correct reception of uplink blocks, and valid RRBp field and Final Ack Indicator set.
12	MS -> SS	PACKET CONTROL ACKNOWLEDGEMENT	

41.2.8.1.3 Downlink data transfer

The following table describes a sequence performing downlink data transfer in acknowledged mode.

{Downlink data transfer, acknowledged mode}

Step	Direction	Message	Comments
0			A PDP context (in acknowledged RLC mode) has been established.
1	SS -> MS	IMMEDIATE ASSIGNMENT	for downlink TBF, sent on CCCH on the correct CCCH block the MS belongs to.
2			Steps 3 to 6 are executed 0 to n times as needed.
3	SS -> MS	RLC data block	
4			Step 3 is repeated at most 14 times with polling bit set.
5	SS -> MS	RLC data block	
6	MS -> SS	PACKET DOWNLINK ACK/NACK	indicating correct reception of downlink data blocks.
7	SS -> MS	RLC data block	
8			Step 7 is repeated as needed.
9	SS -> MS	RLC data block	Last data block with FBI bit set and a valid RRBp field.
10	MS -> SS	PACKET DOWNLINK ACK/NACK	indicating correct reception of downlink data blocks.

41.2.8.2 Default message contents

IMMEDIATE ASSIGNMENT for downlink TBF

Protocol Discriminator	RR Management
Skip Indicator	0000
Message Type	00111111
Page Mode	
- Page Mode	Normal Paging
Dedicated mode or TBF	
- TMA	0 (not a two-message assignment)
- Downlink	0 ('no meaning')
- T/D	1 (assign a Temporary Block Flow)
Packet Channel Description	
- Channel Type	PDCH
- TN	slot 4
- TSC	3
-	0
-	00 (Binary)
- ARFCN	30
Request Reference	Pertaining to last Channel Request sent by the MS.
Timing Advance	
- Timing advance value	30 bit periods.
Mobile Allocation	
- Length	0
Starting Time	Not present.
IA rest octets	
-	HH01 (Packet Downlink Assignment)
- Packet Downlink Assignment	
- TLLI	Corresponding to the value allocated to the MS.
-	1
- TFI_ASSIGNMENT	00001 (binary)
- RLC_MODE	1 (RLC acknowledged mode)
- ALPHA	0.5
- GAMMA	For GSM 900, +9 dBm
	For DCS 1800, +6 dBm
	For PCS 1900, +6 dBm
	0
- POLLING	1 (valid)
- TA_VALID	1
- REL_OR_ABS_FN	0 (TIMING_ADVANCE_INDEX not present)
-	1 (TBF starting time is present)
-	indicating current frame + 50 frames
- TBF_STARTING_TIME	Spare Padding
- spare padding	

IMMEDIATE ASSIGNMENT for downlink single block assignment

Protocol Discriminator	RR Management
Skip Indicator	0000
Message Type	00111111
Page Mode	
- Page Mode	Normal Paging
Dedicated mode or TBF	
- TMA	0 (not a two-message assignment)
- Downlink	0 ('no meaning')
- T/D	1 (assign a Temporary Block Flow)
Packet Channel Description	
- Channel Type	PDCH
- TN	slot 4
- TSC	3
-	0
-	00 (Binary)
- ARFCN	30
Request Reference	Pertaining to last Channel Request sent by the MS.
Timing Advance	
- Timing advance value	30 bit periods.
Mobile Allocation	
- Length	0
Starting Time	Not present.
IA rest octets	
-	HH01 (Packet Downlink Assignment)
- Packet Downlink Assignment	
- TLLI	Corresponding to the value allocated to the MS.
-	0 (parameters TFI_ASSIGNMENT, RLC_MODE, ALPHA, GAMMA, POLLING, TA_VALID and REL_OR_ABS_FN not present)
-	1 (TBF starting time is present)
- TBF_STARTING_TIME	indicating current frame + 50 frames
- spare padding	Spare Padding

IMMEDIATE ASSIGNMENT for uplink TBF, one phase access, dynamic allocation

Protocol Discriminator	RR Management
Skip Indicator	0000
Message Type	00111111
Page Mode	
- Page Mode	Normal Paging
Dedicated mode or TBF	
- TMA	0 ('no meaning')
- Downlink	0 ('no meaning')
- T/D	1 (assign a Temporary Block Flow)
Packet Channel Description	
- Channel Type	PDCH
- TN	slot 4
- TSC	3
-	0
-	00 (Binary)
- ARFCN	30 (decimal)
Request Reference	Pertaining to last Channel Request sent by the MS.
Timing Advance	
- Timing advance value	30 bit periods.
Mobile Allocation	
- Length	0
Starting Time	Not present.
IA rest octets	
-	HH00 (Packet Uplink Assignment)
- Packet Uplink Assignment	
-	1
- TFI_ASSIGNMENT	00001
- POLLING	0
-	0 (Dynamic Allocation)
- USF	001
- USF_GRANULARITY	0 (MS shall transmit one RLC/MAC block)
- CHANNEL_CODING_CMD	01 (CS-2)
- TLLI_BLOCK_CH_CODING	00 (CS-1)
-	1 (ALPHA is present)
- ALPHA	0.5
- GAMMA	For GSM 900, +9 dBm
-	For DCS 1800, +6 dBm
-	For PCS 1900, +6 dBm
-	0 (TIMING_ADVANCE_INDEX not present)
-	1 (TBF_STARTING_TIME is present)
- TBF_STARTING_TIME	indicating current frame + 50 frames
- spare padding	Spare Padding

IMMEDIATE ASSIGNMENT for uplink TBF, one phase access, fixed allocation

Protocol Discriminator	RR Management
Skip Indicator	0000
Message Type	00111111
Page Mode	
- Page Mode	Normal Paging
Dedicated mode or TBF	
- TMA	0 'no meaning'
- Downlink	0 'no meaning'
- T/D	1 assign a Temporary Block Flow
Packet Channel Description	
- Channel Type	PDCH
- TN	slot 4
- TSC	3
-	0
-	00 (Binary)
- ARFCN	30
Request Reference	Pertaining to last Channel Request sent by the MS.
Timing Advance	
- Timing advance value	30 bit periods.
Mobile Allocation	
- Length	0
Starting Time	Not present.
IA rest octets	
-	HH00 (Packet Uplink Assignment)
- Packet Uplink Assignment	
-	1
- TFI_ASSIGNMENT	00001
- POLLING	0
-	1 (Fixed Allocation)
- ALLOCATION_BITMAP_LGTH	
-	31
- ALLOCATION_BITMAP	bitmap of length 31, all bits set
- CHANNEL_CODING_CMD	01 (CS-2)
- TLLI_BLOCK_CH_CODING	00 (CS-1)
-	1 (ALPHA is present)
- ALPHA	0.5
- GAMMA	For GSM 900, +9 dBm
-	For DCS 1800, +6 dBm
-	For PCS 1900, +6 dBm
-	0 (TIMING_ADVANCE_INDEX not present)
-	1 (TBF_STARTING_TIME is present)
- TBF_STARTING_TIME	indicating (current frame + 50 frames)
- spare padding	Spare Padding

IMMEDIATE ASSIGNMENT for uplink TBF, single block access

Protocol Discriminator	RR Management
Skip Indicator	0000
Message Type	00111111
Page Mode	
- Page Mode	Normal Paging
Dedicated mode or TBF	
- TMA	0 'no meaning'
- Downlink	0 'no meaning'
- T/D	1 assign a Temporary Block Flow
Packet Channel Description	
- Channel Type	PDCH
- TN	slot 4
- TSC	3
-	0
-	00 (Binary)
- ARFCN	30
Request Reference	Pertaining to last Channel Request sent by the MS.
Timing Advance	
- Timing advance value	30 bit periods.
Mobile Allocation	
- Length	0
Starting Time	Not present.
IA rest octets	
-	HH00 (Packet Uplink Assignment)
- Packet Uplink Assignment	1
-	00001
- TFI_ASSIGNMENT	0
- POLLING	1 (Fixed Allocation)
-	1
- ALLOCATION_BITMAP_LGTH	1 (only one block granted)
- ALLOCATION_BITMAP	01 (CS-2)
- CHANNEL_CODING_CMD	00 (CS-1)
- TLLI_BLOCK_CH_CODING	1 (ALPHA is present)
-	0.5
- ALPHA	For GSM 900, +9 dBm
- GAMMA	For DCS 1800, +6 dBm
-	For PCS 1900, +6 dBm
-	0 (TIMING_ADVANCE_INDEX not present)
-	1 (TBF_STARTING_TIME is present)
- TBF_STARTING_TIME	indicating (current frame + 50 frames)
- spare padding	Spare Padding

PAGING REQUEST TYPE 1

Protocol Discriminator	RR Management.
Skip Indicator	0000
Message Type	00100001
Page Mode	
- Page Mode	Normal Paging.
Channels needed	
- first channel	00
- second channel	00
Mobile Identity 1	
- odd/even indication	Even.
- Type of Identity	P-TMSI.
- Identity Digits	P-TMSI previously allocated to MS.
Mobile Identity 2	Not present.
P1 rest octets	
-	L (no Notification List Number(PCH))
-	L (no priority specified for mobile Id 1)
-	L (no priority specified for mobile Id 2)
- Packet Page Indication 1	H
- Packet Page Indication 2	L (Not present)
-	L (no Group call Information)
-	L (no Notification List Number status)
- spare padding	Spare Padding

PACKET UPLINK ASSIGNMENT

<p>MESSAGE_TYPE</p> <p>PAGE_MODE</p> <p>Referenced Address</p> <p>-</p> <p>-</p> <p>-</p> <p>-</p> <p>- Packet Request</p> <p>Reference</p> <p>CHANNEL_CODING_COMMAND</p> <p>TLLI_BLOCK_CHANNEL_CODING</p> <p>{L H<UPLINK_TFI_ASSIGNMENT>}</p> <p>- UPLINK_TFI_ASSIGNMENT</p> <p>Packet Timing Advance</p> <p>-</p> <p>- TIMING_ADVANCE_VALUE</p> <p>-</p> <p>{L H<Frequency Parameters>}</p> <p>- Frequency Parameters</p> <p>- TSC</p> <p>-</p> <p>- ARFCN</p> <p>{0 1<List of Reference Frequency lists>}</p> <p>{0 1<Mobile Allocation list>}</p> <p>Fixed Allocation</p> <p>- FINAL_ALLOCATION</p> <p>- DOWNLINK_CONTROL_TIMESLOT</p> <p>-</p> <p>- CONTENTION_RESOLUTION_TLLI</p> <p>-</p> <p>- ALPHA</p> <p>- GAMMA_TN0</p> <p>- GAMMA_TN1</p> <p>- GAMMA_TN2</p> <p>- GAMMA_TN2</p> <p>- GAMMA_TN3</p> <p>- GAMMA_TN4</p> <p>- GAMMA_TN5</p> <p>- GAMMA_TN6</p> <p>- GAMMA_TN7</p> <p>- HALF_DUPLEX_MODE</p> <p>- TBF_STARTING_TIME</p> <p>-</p> <p>- ALLOCATION_BITMAP</p>	<p>001110</p> <p>Normal Paging</p> <p>1 (not Global TFI)</p> <p>1 (not TLLI)</p> <p>1 (not TQI)</p> <p>1 (Packet Request Reference)</p> <p>information field sent in PACKET CHANNEL REQUEST and frame number in which PACKET CHANNEL REQUEST was received</p> <p>CS-2 coding</p> <p>CS-1 coding</p> <p>H (assign an uplink TFI)</p> <p>0000110 (uplink TBF identifier)</p> <p>1 (timing advance value)</p> <p>30 bit periods</p> <p>0 (no timing advance index)</p> <p>H (Frequency Parameters present)</p> <p>5</p> <p>00 (no hopping)</p> <p>For GSM 900, 30</p> <p>For DCS 1800, 650</p> <p>For PCS 1900, 650</p> <p>HL (Fixed allocation)</p> <p>0 (no reference frequencies)</p> <p>0 (no MA)</p> <p>LL (Dynamic Allocation)</p> <p>as required in TC</p> <p>2</p> <p>H (Contention Resolution TLLI is present)</p> <p>As allocated to the MS</p> <p>H (power control parameters)</p> <p>0.5</p> <p>0 (not present)</p> <p>0 (not present)</p> <p>1</p> <p>9 dBm (GSM 900), 6 dBm (DCS 1800), 6 dBm (PCS 1900)</p> <p>0 (not present)</p> <p>0 (not present)</p> <p>0 (not present)</p> <p>0 (not present)</p> <p>0 (not present)</p> <p>0 (no half duplex mode)</p> <p>indicating (current frame + 91 frames)</p> <p>L (bit map is blocks)</p> <p>allocate 15 consecutive blocks</p>
---	--

PACKET DOWNLINK ASSIGNMENT

MESSAGE_TYPE	000100
PAGE_MODE	Normal Paging
Referenced Address	
-	
- TLLI	1 (address is TLLI)
MAC_MODE	as allocated for MS.
RLC_MODE	Dynamic Allocation
CONTROL_ACK	acknowledged mode
TIMESLOT_ALLOCATION	0
Packet Timing Advance	slot 2
-	
- TIMING_ADVANCE_VALUE	1 (timing advance value)
-	30 bit periods
{L H<Frequency Parameters>}	0 (no timing advance index)
- Frequency Parameters	H (Frequency Parameters present)
- TSC	
-	
- ARFCN	5
	00 (non-hopping channel)
	For GSM 900, 30
	For DCS 1800, 650
	For PCS 1900, 650
{L H<Power Control Parameters>}	H (Power Control Parameters present)
- ALPHA	0.5
- {0 1<GAMMA_TN0>}	0 (no GAMMA_TN0)
- {0 1<GAMMA_TN1>}	0 (no GAMMA_TN1)
- {0 1<GAMMA_TN2>}	0 (GAMMA_TN2 present)
- GAMMA_TN2	For GSM 900, +9 dBm
	For DCS 1800, +6 dBm
	For PCS 1900, +6 dBm
- {0 1<GAMMA_TN3>}	0 (no GAMMA_TN3)
- {0 1<GAMMA_TN4>}	0 (no GAMMA_TN4)
- {0 1<GAMMA_TN5>}	0 (no GAMMA_TN5)
- {0 1<GAMMA_TN6>}	0 (no GAMMA_TN6)
- {0 1<GAMMA_TN7>}	0 (no GAMMA_TN7)
{L H<DOWNLINK_TFI_ASSIGNMENT>}	H (assign downlink TFI)
- DOWNLINK_TFI_ASSIGNMENT	00011(Binary)
{L H<TBF_STARTING_TIME>}	H (TBF Starting Time present)
- TBF_STARTING_TIME	indicating (current frame + 13 frames)
{L H<Measurement Mapping>}	L (no measurement mapping)

41.3 MAC/RLC Release

All test cases in this clause apply to the Mobile Stations which support the GPRS service and are capable of activation of at least one PDP context.

The maximum duration of each test is per default 5 min.

41.3.1 TBF Release / Uplink / Normal / MS initiated

41.3.1.1 TBF Release / Uplink / Normal / MS initiated / Acknowledged mode

41.3.1.1.1 Conformance requirements

1. The mobile station initiates release of the uplink TBF by beginning the countdown process. When the mobile station has sent the RLC data block with CV = 0 and there are no elements in the V(B) array set to the value Nacked, it shall start timer T3182 and stop timer T3180, if running. The mobile station shall continue to send RLC data blocks on each assigned uplink data block, according to the algorithm defined in GSM 04.60, 9.1.3.2.
2. Upon reception of a PACKET UPLINK ACK/NACK message the mobile station shall stop timer T3182.

3. If the PACKET UPLINK ACK/NACK message has the Final Ack Indicator bit set to '1', the mobile station shall transmit the PACKET CONTROL ACKNOWLEDGEMENT message and release the TBF. If there is no ongoing downlink TBF the mobile station shall enter packet idle mode.
4. If the PACKET UPLINK ACK/NACK message requests retransmission of RLC data blocks, the mobile station shall if necessary wait for allocation of uplink resources and then retransmit the RLC data blocks requested, restarting timer T3180 after each block is transmitted. The mobile station shall then start timer T3182 and wait for a PACKET UPLINK ACK/NACK message as above.
5. Upon transition from the packet transfer mode to the packet idle mode, a mobile station shall enter the Transfer non-DRX mode period.
6. Upon a receipt of a commanding message or indication from the network requiring an action by the mobile station, if the reaction time for such action is not specified elsewhere, the mobile station shall begin to perform the required action no later than the next occurrence of block $B((x+6) \bmod 12)$, where block $B(x)$ is the radio block containing the commanding message or indication from the network.

References

GSM 04.60, 9.3.2.3, 5.5.1.5, GSM 05.10, 6.11.4

41.3.1.1.2 Test purpose

To verify that in RLC acknowledged mode:

1. the MS initiates release of an uplink TBF by beginning countdown process. After $CV = 0$ and no elements in the $V(B)$ array set to the value "Nacked" the MS continues to send RLC data blocks on each assigned uplink data block in the way defined in GSM 04.60, 9.1.3 and waits for PACKET UPLINK ACK/NACK.
2. the MS retransmits the requested RLC data blocks if the PACKET UPLINK ACK/NACK message requests to do so. The MS then waits for another PACKET UPLINK ACK/NACK message.
3. the MS transmits the PACKET CONTROL ACKNOWLEDGEMENT message and release the TBF upon reception of a PACKET UPLINK ACK/NACK with the Final Ack Indicator bit set to '1'. If there is no ongoing downlink TBF the mobile station shall enter packet idle mode.

41.3.1.1.3 Method of test

Initial Conditions

System Simulator:

1 cell, CCCH combined with SDCCH, BS_PBCCH_BLKs = 3, BS_CV_MAX = 10.

Mobile Station:

The MS is GPRS attached with a P-TMSI allocated, SPLIT PG CYCLE negotiated and PDP test context2 activated.

Related PICS/PIXIT Statement(s)

Support GPRS service,
 Support activation of at least one PDP context,
 The way to trigger the MS initiating an uplink packet transfer
 Support multislot class

Test Procedure

The test has three parts.

1. The MS is triggered to transfer user data. A TBF of dynamic allocation in acknowledged mode with $USF_GRANULARITY = 1$ block is assigned. The countdown values are checked during the RLC data transferring. The SS acknowledges the all received RLC data blocks with the Final Ack Indicator bit set to '1'. The SS assigns a downlink TBF, transfers a number of downlink data blocks and polls the MS. The MS responses the polling.

2. The MS is assigned a TBF of dynamic allocation in acknowledged mode with `USF_GRANULARITY = 4` blocks. The countdown values are checked during the RLC data transferring. The SS acknowledges the all received RLC data blocks with the Final Ack Indicator bit set to '1'.
3. The MS is triggered to transfer user data. A TBF of dynamic allocation on two timeslots in acknowledged mode with `USF_GRANULARITY = 4` block is assigned. The countdown values are checked during the RLC data transferring. The SS acknowledges the all received RLC data blocks with the Final Ack Indicator bit set to '1'.

Expected Sequence

Step	Direction	Message	Comments
1		{Uplink dynamic allocation one phase access with contention resolution}	n = 440 octets, USF_GRANULARITY = 1 block, RLC_DATA_BLOCKS_GRANTED = 30, CHANNEL_CODING_COMMAND: CS-1, TLLI_BLOCK_CHANNEL_CODING: '0'B, CS-1. RLC acknowledged mode (PDP context2), without starting time
2	SS -> MS	PACKET DOWNLINK DUMMY CONTROL BLOCK	USF assigned to the MS
3	MS -> SS	UPLINK RLC DATA BLOCK	
4			Repeat step 2 and 3 until the countdown value CV=2.
5	SS -> MS	PACKET UPLINK ACK/NACK	Acknowledge all received data blocks, USF assigned to the MS.
6	MS -> SS	UPLINK RLC DATA BLOCK	Received on the assigned PDTCH. Check that CV=1.
7	SS -> MS	PACKET DOWNLINK DUMMY CONTROL BLOCK	USF assigned to the MS.
8	MS -> SS	UPLINK RLC DATA BLOCK	Check that CV=0.
9	SS -> MS	PACKET DOWNLINK DUMMY CONTROL BLOCK	USF assigned to the MS.
10	MS -> SS	UPLINK RLC DATA BLOCK	Check that the data block is a retransmission of the data block transmitted in step 6, CV=1.
11	SS -> MS	PACKET DOWNLINK DUMMY CONTROL BLOCK	USF assigned to the MS.
12	MS -> SS	UPLINK RLC DATA BLOCK	Check that the data block is a retransmission of the data block transmitted in step 8.
13	SS -> MS	PACKET UPLINK ACK/NACK	Negatively acknowledge the data block transmitted in step 8, containing USF assigned to the MS.
14	MS -> SS	UPLINK RLC DATA BLOCK	Check that the data block is a retransmission of the data block transmitted in step 8.
15	SS -> MS	PACKET UPLINK ACK/NACK	Final Ack Indicator = '1' containing a valid RRB=26.
16	MS -> SS	PACKET CONTROL ACKNOWLEDGEMENT	Acknowledge the last two data blocks. Received on the radio block specified by RRB
17	SS -> MS	PACKET DOWNLINK ASSIGNMENT	Downlink Assignment, acknowledged mode. Sent on PCCCH.
18	SS -> MS	DOWNLINK RLC DATA BLOCKs	10 downlink data blocks, the data block with FBI = '1' and a valid RRB
19	MS -> SS	PACKET DOWNLINK ACK/NACK	Received on the block specified by RRB in step 18. Check that the Final Ack indicator = '1'.
20		{Uplink dynamic allocation one phase access with contention resolution}	n = 440 octets, USF_GRANULARITY = 4 blocks, RLC_DATA_BLOCKS_GRANTED = 30, CHANNEL_CODING_COMMAND: CS-1, TLLI_BLOCK_CHANNEL_CODING: '0'B, CS-1. RLC acknowledged mode (PDP context2), without starting time
21	SS -> MS	PACKET DOWNLINK DUMMY CONTROL BLOCK	USF assigned to the MS
22	MS -> SS	UPLINK RLC DATA BLOCK	
23	MS -> SS	UPLINK RLC DATA BLOCK	
24	MS -> SS	UPLINK RLC DATA BLOCK	
25	MS -> SS	UPLINK RLC DATA BLOCK	
26			Repeat the steps 21 - 25 as a step block. Repeat the step block until the countdown value CV = 0 in one of data blocks received.
27	SS -> MS	PACKET UPLINK ACK/NACK	USF assigned to the MS. Acknowledge all received data blocks except for the data blocks which have CV=2, CV=1, or CV=0. Set SSN value in Ack/Nack description equal to the BSN' of the received data block with CV = 2.

28	MS -> SS	UPLINK RLC DATA BLOCK	Check that the countdown value CV = 2.
29	MS -> SS	UPLINK RLC DATA BLOCK	Check that the countdown value CV = 1.
30	MS -> SS	UPLINK RLC DATA BLOCK	Check that the countdown value CV = 0.
31	MS -> SS	UPLINK RLC DATA BLOCK	Check that the countdown value CV = 2.
32	SS -> MS	PACKET UPLINK ACK/NACK	Negatively acknowledge the data blocks of CV=2, and CV=0. Acknowledge the data block of CV=1. USF assigned to the MS.
33	MS -> SS	UPLINK RLC DATA BLOCK	Check that the countdown value CV = 2.
34	MS -> SS	UPLINK RLC DATA BLOCK	Check that the countdown value CV = 0.
35	MS -> SS	UPLINK RLC DATA BLOCK	Check that the countdown value CV = 2.
36	MS -> SS	UPLINK RLC DATA BLOCK	Check that the countdown value CV = 0.
37	SS -> MS	PACKET UPLINK ACK/NACK	Final Ack Indicator = '1' containing valid RRBP. Sent on PACCH of the assigned PDCH. Acknowledge all data blocks received.
38	MS -> SS	PACKET CONTROL ACKNOWLEDGEMENT	Received on the block specified by RRBP on PACCH of the assigned PDCH.
39	SS -> MS	PACKET DOWNLINK ASSIGNMENT	Downlink Assignment, acknowledged mode. Sent on PCCCH.
40	SS -> MS	DOWNLINK RLC DATA BLOCKS	10 downlink data blocks, the data block with FBI = '1' and a valid RRBP
41	MS -> SS	PACKET DOWNLINK ACK/NACK	Received on the block specified by RRBP in step 40. Check that the Final Ack indicator = '1'.
			The following steps are not applicable to the MS in multislot class 1, 2, and 4.
42		{Uplink dynamic allocation two phase access}	n = 1000 octets, without starting time, USF_GRANULARITY = 4 blocks, RLC_DATA_BLOCKS_GRANTED = open-end, CHANNEL_CODING_COMMAND: cs4 RLC acknowledged mode (PDP context2), Two slots, USF ₀ on TN ₀ and USF ₁ on TN ₁ , are assigned.
43	SS -> MS	PACKET DOWNLINK DUMMY CONTROL BLOCK	Assigned USF ₀ on PDTCH ₀ addressing the MS.
44	SS -> MS	PACKET DOWNLINK DUMMY CONTROL BLOCK	Assigned USF ₁ on PDTCH ₁ addressing the MS, sent on the same TDMA frame as step 43.
45	MS -> SS	UPLINK RLC DATA BLOCKS	Received on the assigned PDTCH ₀ and PDTCH ₁ . Check that the coding as specified in CHANNEL_CODING_COMMAND, the TFI is correct and the block does not contain TLLI.
46	MS -> SS	UPLINK RLC DATA BLOCKS	Received on the assigned PDTCH ₀ and PDTCH ₁ .
47	MS -> SS	UPLINK RLC DATA BLOCKS	Received on the assigned PDTCH ₀ and PDTCH ₁ .
48	MS -> SS	UPLINK RLC DATA BLOCKS	Received on the assigned PDTCH ₀ and PDTCH ₁ .
49			Repeat the steps 43 - 48 as a step block. Repeat the step block until the countdown value CV = 0 in one of data blocks received.
50	SS -> MS	PACKET UPLINK ACK/NACK	Check the CV decrement from BS_CV_MAX (10) to 0. Final Ack Indicator = '1' containing a valid RRBP. Sent on PACCH of the assigned PDCH. Acknowledge all data blocks received.
51	MS -> SS	PACKET CONTROL ACKNOWLEDGEMENT	Received on the block specified by RRBP on PACCH of the assigned PDCH.

41.3.1.2 TBF Release / Uplink / Normal / MS initiated / Unacknowledged mode

41.3.1.2.1 Conformance requirements

The mobile station initiates release of the uplink TBF by beginning the countdown process. It indicates the end of the TBF by setting the CV value to 0 and starts timer T3182.

Upon reception of a PACKET UPLINK ACK/NACK message the mobile station shall stop timer T3182. If the PACKET UPLINK ACK/NACK message has the Final Ack Indicator bit set to '1', the mobile station shall transmit the

PACKET CONTROL ACKNOWLEDGEMENT message and release the TBF. If there is no ongoing downlink TBF the mobile station shall enter packet idle mode.

If timer T3182 expires the mobile station shall release the TBF as if a PACKET UPLINK ACK/NACK message was received.

References

GSM 04.60, 9.3.3.3

41.3.1.2.2 Test purpose

To verify that in RLC unacknowledged mode:

1. the MS initiates release of an uplink TBF by beginning the countdown process and indicates the end of the TBF by setting the CV value to 0.
2. the MS transmits the PACKET CONTROL ACKNOWLEDGEMENT message and release the TBF upon reception of a PACKET UPLINK ACK/NACK message with the Final Ack Indicator bit set to '1' after CV=0. If there is no ongoing downlink TBF the mobile station enters packet idle mode
3. the MS releases the TBF as if a PACKET UPLINK ACK/NACK message was received when timer T3182 expires. 41.3.1.2.3 Method of test

Initial Conditions

System Simulator:

1 cell, CCCH combined with SDCCH, BS_PBCCH_BLKs = 3, BS_CV_MAX = 12.

Mobile Station:

The MS is GPRS attached with a P-TMSI allocated, SPLIT PG CYCLE negotiated and PDP test context3 activated.

Related PICS/PIXIT Statement(s)

Support GPRS service,
Support activation of at least one PDP context,
The way to trigger the MS initiating an uplink packet transfer
Support multislot class

Test Procedure

The test procedure has two parts.

1. The MS is triggered to transfer data. A TBF of fixed allocation in unacknowledged mode is assigned. The countdown values are checked during the RLC data transferring. The SS acknowledges the all received RLC data blocks with the Final Ack Indicator bit set to '1' and polls the MS. The MS sends PACKET CONTROL ACKNOWLEDGEMENT in response of polling. After 6 blocks the SS assigns a downlink TBF in unacknowledged mode, sends a number downlink data blocks and polls the MS with a valid RRBP. The MS responses the polling.
2. The MS is triggered to transfer data. A TBF of fixed allocation in unacknowledged mode is assigned. The countdown values are checked during the RLC data transferring. The SS does not acknowledge the received RLC data blocks. After CV = 0 the SS waits for 6s (T3182 expires). Once CV=0 the SS checks that the MS does not transfer further RLC data blocks on the assigned TBF.
3. The MS is triggered to transfer data. A TBF of fixed allocation on two timeslots in unacknowledged mode is assigned. The countdown values are checked during the RLC data transferring. The SS does not acknowledge the received RLC data blocks. Once CV=0 the SS checks that the MS does not transfer further RLC data blocks on the assigned TBF.

Expected Sequence

Step	Direction	Message	Comments
1		{Uplink fixed allocation two phase access}	n = 440 octets in RLC unacknowledged mode. (PDP context3) ALLOCATION_BITMAP_LENGTH: 30 ALLOCATION_BITMAP: exact 30 bits, TLLI_BLOCK_CHANNEL_CODING = '0'B, cs-1, CHANNEL_CODING_COMMAND = cs-1.
2 3	MS -> SS	UPLINK RLC DATA BLOCK	Repeat step 2 until the countdown value CV=0. The MS may send PACKET RESOURCE REQUEST during the repetition. The SS shall ignore the requests.
4	SS -> MS	PACKET UPLINK ACK/NACK	
5	MS -> SS	PACKET CONTROL ACKNOWLEDGEMENT	Received on the block specified by RRBp on PACCH of the assigned PDCH.
6	SS		Check that no data block is transmitted by the MS in the next 3 radio blocks.
7	SS -> MS	PACKET DOWNLINK ASSIGNMENT	Downlink Assignment, acknowledged mode. Sent on PCCCH, six radio blocks from step 4. Steps 7 – 10 verify whether the MS has entered idle mode.
8 9	SS -> MS	DOWNLINK RLC DATA BLOCK	Repeat step 8 ten times. In the last data block set FBI = '1' with a valid RRBp.
10	MS -> SS	PACKET CONTROL ACKNOWLEDGEMENT	
11		{Uplink fixed allocation two phase access}	n = 600 octets in RLC unacknowledged mode. (PDP context3) ALLOCATION_BITMAP_LENGTH: 40, ALLOCATION_BITMAP: exact 40 bits, TLLI_BLOCK_CHANNEL_CODING = '1'B, cs1, CHANNEL_CODING_COMMAND = cs1.
12 13	MS -> SS	UPLINK RLC DATA BLOCK	Received on the radio block assigned in step 11. Repeat step 12 until the countdown value CV=0. The MS may send PACKET RESOURCE REQUEST during the repetition. The SS shall ignore the requests.
14 15	SS SS		
			The following steps are not applicable to the MS in multislot class 1, 2, and 4.
16	SS -> MS	{Uplink fixed allocation two phase access}	n = 1000 octets in RLC unacknowledged mode. (PDP context3) Uplink fixed allocation CHANNEL_CODING_COMMAND = cs4 DOWNLINK_CONTROL_TIMESLOT: timeslot ₇ TIMESLOT_ALLOCATION: timeslot ₇ and timeslot ₀ , HALF_DUPLEX_MODE: 0, no half duplex BLOCKS_OR_BLOCK_PERIODS: block periods ALLOCATION_BITMAP_LENGTH: 30 ALLOCATION_BITMAP: exact 30 '1'B,.
17	MS -> SS	UPLINK RLC DATA BLOCKS	Received on the assigned PDTCH ₇ and PDTCH ₀ . The MS may send PACKET RESOURCE REQUEST. The SS shall ignore the requests. Check the CV decrement from BS_CV_MAX (=12) to 0 in the received data blocks. After CV=0 no further data blocks are transmitted. The check is done for 6 s.

The MS may send PACKET RESOURCE REQUEST when repeating step 12 and 17. The SS shall ignore the requests.

41.3.1.3 TBF Release / Uplink / Normal / MS initiated / Channel coding change during countdown

41.3.1.3.1 Conformance requirements

If the mobile station receives a change in the Channel Coding Command in a PACKET UPLINK ACK/NACK message during the countdown procedure, the mobile station shall act upon the new Channel Coding Command. The mobile station shall then recalculate the CV values for any untransmitted RLC data blocks using the new RLC data block size.

References

GSM 04.60, 9.3.1

41.3.1.3.2 Test purpose

It is verified that the MS acts upon the new Channel Coding Command and recalculates the CV values for any untransmitted RLC data blocks using the new RLC data block size when the MS receives a change of Channel Coding Command in a PACKET UPLINK ACK/NACK message during the countdown procedure.

41.3.1.3.3 Method of test

Initial Conditions

System Simulator:

1 cell, CCCH combined with SDCCH, BS_PBCCH_BLKs = 3, BS_CV_MAX = 7.

Mobile Station:

The MS is GPRS attached with a P-TMSI allocated, SPLIT PG CYCLE negotiated and PDP context3 activated.

Related PICS/PIXIT Statement(s)

Support GPRS service,
Support activation of at least one PDP context,
The way to trigger the MS initiating an uplink packet transfer

Test Procedure

1. The MS is triggered to transfer data. A TBF of dynamic allocation with channel coding CS-4 in unacknowledged mode is assigned. The countdown values are checked during the RLC data transferring.
2. Once CV=7 (BS_CV_MAX) the SS acknowledges the all received RLC data blocks and changes the channel coding to CS-1. In the next received RLC data block CV=15. The countdown values are checked during the RLC data transferring.
3. When CV=7 is reached the SS acknowledges the all received RLC data blocks and changes the channel coding to CS-2. The SS checks the next received RLC data block containing CV=5. The countdown values are checked during the RLC data transferring until CV=0. The SS acknowledges the all received RLC data blocks with the Final Ack Indicator bit set to '1'.

Expected Sequence

Step	Direction	Message	Comments
1		{Uplink dynamic allocation two phase access}	n = 1800 octets, USF_GRANULARITY = 1 block, RLC_DATA_BLOCKS_GRANTED = 40, CHANNEL_CODING_COMMAND: CS-4, RLC unacknowledged mode (PDP context3), without starting time
2	SS -> MS	PACKET DOWNLINK DUMMY CONTROL BLOCK	USF assigned to the MS
3	SS -> MS	UPLINK RLC DATA BLOCK	
4			
5	SS -> MS	PACKET UPLINK ACK/NACK	
6	SS -> MS	PACKET DOWNLINK DUMMY CONTROL BLOCK	USF assigned to the MS on 3 blocks from the last radio block containing the uplink assignment.
7	MS -> SS	UPLINK RLC DATA BLOCK	
8	SS -> MS	PACKET UPLINK ACK/NACK	Received on the assigned PDTCH. Check that the countdown value CV = 15.
9	MS -> SS	UPLINK RLC DATA BLOCK	
10			Repeat step 8 and 9 until the countdown value CV=7 (BS_CV_MAX).
11	SS -> MS	PACKET UPLINK ACK/NACK	
12	SS -> MS	PACKET DOWNLINK DUMMY CONTROL BLOCK	USF assigned to the MS on 3 blocks from the last radio block containing the uplink assignment.
13	MS -> SS	UPLINK RLC DATA BLOCK	
14	SS -> MS	PACKET DOWNLINK DUMMY CONTROL BLOCK	Received on the assigned PDTCH. Check that the countdown value CV = 5.
15	MS -> SS	UPLINK RLC DATA BLOCK	
16			Repeat step 14 and 15 until the countdown value CV=0.
17	SS -> MS	PACKET UPLINK ACK/NACK	
18	MS -> SS	PACKET CONTROL ACKNOWLEDGEMENT	Final Ack Indicator = '1' containing valid RRBP, acknowledge all the received data blocks. Received on the block specified by RRBP on PACCH of the assigned PDCH.

Specific Message Contents

PACKET UPLINK ACK/NACK message in step 5:

CHANNEL_CODING_COMMAND	CS-1
------------------------	------

PACKET UPLINK ACK/NACK message in step 11:

CHANNEL_CODING_COMMAND	CS-2
------------------------	------

41.3.2 TBF Release / Uplink / Normal / Network initiated

41.3.2.1 TBF Release / Uplink / Normal / Network initiated / Acknowledged mode

41.3.2.1.1 Conformance requirements

The network may initiate release of an uplink TBF by transmitting a PACKET TBF RELEASE message to the mobile station on the PACCH. A cause value indicates the reason for release.

If the cause value is “Normal release” the mobile station shall continue to the next LLC PDU boundary, starting the count down procedure at whatever value of CV is appropriate to count down to zero at the LLC PDU boundary, and then release the TBF according to the procedures in (GSM 04.60), 9.3.2.3.

References

GSM 04.60, 8.1.1.4

41.3.2.1.2 Test purpose

To verify that when the MS, in an uplink TBF of the RLC acknowledged mode, receives a PACKET TBF RELEASE message with cause value “Normal release”:

1. the MS continues the TBF to the next LLC PDU boundary,
2. the MS starts the count down procedure at whatever value of CV is appropriate to count down to zero at the LLC PDU boundary,
3. the MS then releases the TBF according to uplink acknowledged mode release procedure.

41.3.2.1.3 Method of test

Initial Conditions

System Simulator:

1 cell, CCCH combined with SDCCH, BS_PBCCH_BLKs = 3, BS_CV_MAX = 7.

Mobile Station:

The MS is GPRS attached with a P-TMSI allocated, SPLIT PG CYCLE negotiated and PDP context2 activated, L2 is reset via the XID parameter Reset command.

Related PICS/PIXIT Statement(s)

Support GPRS service,
Support activation of at least one PDP context,
The way to trigger the MS initiating an uplink packet transfer

Test Procedure

1. The MS is triggered to transfer 1200 octets user data. A TBF of dynamic allocation in acknowledged mode is assigned. After the MS transfers several RLC data blocks the SS sends PACKET TBF RELEASE with cause value “Normal release. The length indicator, M and E bit in data block headers are checked during the RLC data transferring until CV=0 to ensure that the MS has transmitted only the RLC data block of the first LLC PDU.

Expected Sequence

Step	Direction	Message	Comments
1		{Uplink dynamic allocation one phase access with contention resolution}	n = 1200 octets (Note: more than one LLC PDU is needed for the test. The default N201-U = 500 octets for an information field of the UI frame is reset at the test beginning.) USF_GRANULARITY = 1 block, RLC_DATA_BLOCKS_GRANTED = 62, CHANNEL_CODING_COMMAND: CS-1, TLLI_BLOCK_CHANNEL_CODING: '1'B, CS-1. RLC acknowledged mode (PDP context2), without starting time
2	SS -> MS	PACKET DOWNLINK DUMMY CONTROL BLOCK	USF assigned to the MS.
3	MS -> SS	UPLINK RLC DATA BLOCK	
4			Repeat step 2 and 3 three times
5	SS -> MS	PACKET TBF RELEASE	
6	SS -> MS	PACKET UPLINK ACK/NACK	
7	MS -> SS	UPLINK RLC DATA BLOCK	USF assigned to the MS, on PACCH of the assigned PDCH in step 1.
8			
9	SS -> MS	PACKET UPLINK ACK/NACK	Repeat step 6 and 7 until the countdown value CV=0 in step 7. Use of the Length indicator, M bit and E bit of the received data headers to determine that only the 1 st LLC PDU is transmitted.
10	MS -> SS	PACKET CONTROL ACKNOWLEDGEMENT	Final Ack Indicator = '1' containing valid RRBP. Acknowledge all data blocks.
11	SS -> MS	PACKET UPLINK ACK/NACK	Received on the block specified by RRBP on PACCH of the assigned PDCH.
12	SS		Sent on the PACCH of the PDCH assigned in step 1, containing USF assigned to the MS. Check that no data block is transmitted by the MS in the next radio block to step 11.

41.3.2.2 TBF Release / Uplink / Normal / Network initiated / Unacknowledged mode

41.3.2.2.1 Conformance requirements

The network may initiate release of an uplink TBF by transmitting a PACKET TBF RELEASE message to the mobile station on the PACCH. A cause value indicates the reason for release.

If the cause value is "Normal release" a mobile station shall continue to the next LLC PDU boundary, starting the count down procedure at whatever value of CV is appropriate to count down to zero at the LLC PDU boundary, and then release the TBF according to the procedures in GSM 04.60, 9.3.3.3.

References

GSM 04.60, 8.1.1.4, 9.3.3.3

41.3.2.2.2 Test purpose

To verify that when the MS receives a PACKET TBF RELEASE message with cause value "Normal release" during an unacknowledged mode uplink TBF:

1. the MS continues the TBF to the next LLC PDU boundary,
2. the MS starts the count down procedure at whatever value of CV is appropriate to count down to zero at the LLC PDU boundary,

- the MS then releases the TBF according to uplink unacknowledged mode release procedure.

41.3.2.2.3 Method of test

Initial Conditions

System Simulator:

1 cell, CCCH combined with SDCCH, BS_PBCCH_BLKs = 3, BS_CV_MAX = 15.

Mobile Station:

The MS is GPRS attached with a P-TMSI allocated, SPLIT PG CYCLE negotiated and PDP context3 activated.

Related PICS/PIXIT Statement(s)

Support GPRS service,
Support activation of at least one PDP context,
The way to trigger the MS initiating an uplink packet transfer

Test Procedure

- The MS is triggered to transfer 1200 octets user data. A TBF of fixed allocation in unacknowledged mode is assigned. After the MS transfers several RLC data blocks the SS sends PACKET TBF RELEASE with cause value "Normal release. The length indicator, M and E bit in data block headers are checked during the RLC data transferring until CV=0 to ensure that the MS has transmitted only the RLC data block of the first LLC PDU.

Expected Sequence

Step	Direction	Message	Comments
1		{Uplink fixed allocation two phase access}	n = 1200 octets in RLC unacknowledged mode. (PDP context3) ALLOCATION_BITMAP_LENGTH: 60 ALLOCATION_BITMAP: exact 60 bits, TLLI_BLOCK_CHANNEL_CODING = '0'B, cs-1, CHANNEL_CODING_COMMAND = cs1.
2	MS -> SS	UPLINK RLC DATA BLOCK	Repeat step 2 five times. The MS may send PACKET RESOURCE REQUEST during the repetition. The SS shall ignore the requests.
3			
4	SS -> MS	PACKET TBF RELEASE	
5	MS -> SS	UPLINK RLC DATA BLOCK	Repeat step 5 until the countdown value CV=0 in step 5. Use of the Length indicator, M bit and E bit of the received data headers to determine that only the 1 st LLC PDU is transmitted.
6			
7	SS -> MS	PACKET UPLINK ACK/NACK	Final Ack Indicator = '1' containing valid RRBp, No retransmission needed. Sent on PACCH of the assigned PDCH.
8	MS -> SS	PACKET CONTROL ACKNOWLEDGEMENT	Received on the block specified by RRBp on PACCH of the assigned PDCH.

41.3.3 TBF Release / Uplink / Network initiated / Abnormal release

41.3.3.1 Conformance requirements

The network may initiate release of an uplink TBF by transmitting a PACKET TBF RELEASE message to the mobile station on the PACCH. If the cause value is "Abnormal release" the mobile station shall immediately stop transmitting and follow the abnormal release with random access procedure.

References

GSM 04.60, 8.1.1.4

41.3.3.2 Test purpose

To verify that the MS immediately stops transmitting and follows the abnormal release with random access procedure when it receives a PACKET TBF RELEASE message on the PACCH with cause value "Abnormal release".

41.3.3.3 Method of test

Initial Conditions

System Simulator:

1 cell, CCCH combined with SDCCH, BS_PBCCH_BLKs = 3, BS_CV_MAX = 9.

Mobile Station:

The MS is GPRS attached with a P-TMSI allocated, SPLIT PG CYCLE negotiated and PDP context2 activated.

Related PICS/PIXIT Statement(s)

Support GPRS service,
Support activation of at least one PDP context,
The way to trigger the MS initiating an uplink packet transfer

Test Procedure

The MS is triggered to transfer user data. A TBF of fixed allocation in acknowledged mode is assigned. After the MS transfers several RLC data blocks the SS sends PACKET TBF RELEASE with cause value "Abnormal release". The MS reinitiates a random access for one or two phase access request.

Expected Sequence

Step	Direction	Message	Comments
1		{Uplink fixed allocation on phase access with contention resolution}	n = 1200 octets in RLC acknowledged mode. (PDP context2) TLLI_BLOCK_CHANNEL_CODING = '0'B, cs-1, CHANNEL_CODING_COMMAND = cs-1. ALLOCATION_BITMAP_LENGTH: 60 ALLOCATION_BITMAP: exact 60 bits.
2	MS -> SS	UPLINK RLC DATA BLOCK	Received on the assigned PDTCH.
3			Repeat step 2 five times. The MS may send PACKET RESOURCE REQUEST during the repetition.
4	SS -> MS	PACKET TBF RELEASE	Sent on the PACCH of the PDCH assigned, Global TFI is same as the assigned one in step 1, Uplink_Release = yes, Cause value = "Abnormal release".
5	MS -> SS	UPLINK RLC DATA BLOCK	MS is allowed to send max. 6 blocks Received on the assigned PDTCH.
6	MS -> SS	PACKET CHANNEL REQUEST	Received on PRACH.

41.3.4 TBF Release / Downlink / Normal / Network initiated

41.3.4.1 TBF Release / Downlink / Normal / Network initiated / Acknowledged mode

41.3.4.1.1 Conformance requirements

If the mobile station receives an RLC data block with the FBI bit set the value '1' and with a valid RRBP field, the mobile station shall transmit a PACKET DOWNLINK ACK/NACK message in the specified uplink block. The mobile station shall continue to monitor all assigned PDCHs.

Whenever the mobile station receives an RLC data block with a valid RRBP and the mobile station has received all RLC data blocks of the TBF, the mobile station shall send the PACKET DOWNLINK ACK/NACK message with the Final Ack Indicator bit set to '1', stop timer T3190 and start or restart timer T3192.

If the mobile station receives more than one RLC data block with the FBI set to '1', it shall accept the data from only the first one of these blocks.

If the mobile station, after sending the PACKET DOWNLINK ACK/NACK message with the Final Ack Indicator bit set to '1', receives a PACKET DOWNLINK ASSIGNMENT or PACKET TIMESLOT RECONFIGURE message with the Control Ack bit set to '1' while timer T3192 is running, the mobile station shall stop timer T3192, consider the previous downlink TBF released and act upon the new assignment.

When timer T3192 expires the mobile station shall stop monitoring its assigned downlink PDCHs. If the mobile station is operating in half duplex mode and received an uplink assignment during the TBF release procedure, the mobile station shall then immediately act upon the assignment. Otherwise, and if there is no ongoing uplink TBF, enter packet idle mode.

References

GSM 04.60, 9.3.2.5

41.3.4.1.2 Test purpose

To verify that in a downlink TBF of acknowledged mode:

1. The MS sends PACKET DOWNLINK ACK/NACK in the specified uplink block and continues monitoring all assigned PDCHs when it receives an RLC data block with a valid RRBP field and the Final Block Indicator (FBI) = '1'.
2. Whenever the MS receives an RLC data block with a valid RRBP and has received all RLC data blocks of the TBF, it sends PACKET DOWNLINK ACK/NACK with the Final Ack Indicator bit set to '1'.
3. If the MS receives more than one RLC data block with the FBI set to '1', it accepts the data from only the first one of these blocks.
4. While timer T3192 is running, if the MS receives, after sending PACKET DOWNLINK ACK/NACK with the Final Ack Indicator bit set to '1', PACKET DOWNLINK ASSIGNMENT with the Control Ack bit set to '1', the MS acts upon the new downlink assignment.
5. The MS stops monitoring its assigned downlink PDCHs and enters packet idle mode when timer T3192 expires if there is no ongoing uplink TBF.

41.3.4.1.3 Method of test

Initial Conditions

System Simulator:

1 cell, CCCH combined with SDCCH, BS_PBCCH_BLKs = 3, BS_CV_MAX = 15, T3192 = 1.5s.

Mobile Station:

The MS is GPRS attached with a P-TMSI allocated, SPLIT PG CYCLE negotiated and PDP context2 activated.

Related PICS/PIXIT Statement(s)

Support GPRS service,
Support activation of at least one PDP context

Test Procedure

1. The MS receives PACKET DOWNLINK ASSIGNMENT on its PPCH. The SS transmits 10 downlink RLC data blocks with consecutive BSN. The SS then transmits a downlink RLC data block with the highest BSN which is ten higher than the BSN of the last RLC data block. The SS sets FBI bit and polls the MS with a valid RRBP in the header of the RLC data block. The MS acknowledges the received data blocks and request a retransmission for the missing 9 data blocks in SSN and RBB fields.
2. The SS sends another 5 RLC data blocks and polls the MS with a valid RRBP. The MS acknowledges the received data blocks and request the retransmission of the missing 4 RLC data blocks. The SS transmits the last 4 RLC data block and polls the MS with RRBP=N+26. While the MS is waiting for transmission of the final Acknowledgement the SS transmits a RLC data block which sets FBI bit and has the same BSN value as the highest one in the test procedure 1. The MS ignores the downlink data and acknowledges the entire TBF with FINAL_ACK_INDICATION set. The SS transmits another data block with FBI set and polls the MS. The MS acknowledges the entire TBF with FINAL_ACK_INDICATION set. The SS waits 3 s.
3. The MS receives PACKET DOWNLINK ASSIGNMENT on its PPCH. The SS transmits a number of downlink RLC data blocks, sets FBI bit and polls the MS with a valid RRBP. The MS acknowledges the entire TBF with FINAL_ACK_INDICATION set.
4. The SS sends another PACKET DOWNLINK ASSIGNMENT on the assigned PACCH with Control ACK bit set. The SS transmits a number of downlink RLC data blocks on the new assigned PDTCH, sets FBI bit and polls the MS with a valid RRBP. The MS acknowledges the entire TBF with FINAL_ACK_INDICATION set.

Expected Sequence

Step	Direction	Message	Comments
1	SS -> MS	PACKET DOWNLINK ASSIGNMENT	Downlink Assignment, acknowledged mode. Sent on PPCH.
2	SS -> MS	DOWNLINK RLC DATA BLOCK	Sent on downlink PDTCH assigned.
3			Repeat step 2 ten times, each time BSN is incremented by 1
4	SS -> MS	DOWNLINK RLC DATA BLOCK	One data block with valid RRBP, FBI bit is set. BSN is incremented by 10. The MS has missed 9 consecutive RLC data blocks. BSN of this data block = (BSN of the last data block in step 3 + 10) mod 128
5	MS -> SS	PACKET DOWNLINK ACK/NACK	Received on the block specified by RRBP in step 4. Check that the Final Ack indicator = '0' and the SSN and RBB values for the 9 missing data blocks .
6	SS -> MS	DOWNLINK RLC DATA BLOCK	BSN of the data block = (BSN of the last data block in step 3 + 1) mod 128
7			Repeat step 6 three times, each time BSN is incremented by 1 on the basis of the last BSN in step 6
8	SS -> MS	DOWNLINK RLC DATA BLOCK	A valid RRBP, BSN is incremented by 1.
9	MS -> SS	PACKET DOWNLINK ACK/NACK	Received on the block specified by RRBP in step 8. Check that the Final Ack indicator = '0' and SSN and RBB values for the 4 missing data blocks.
10	SS -> MS	DOWNLINK RLC DATA BLOCK	BSN is incremented by 1
11			Repeat step 10 twice
12	SS -> MS	DOWNLINK RLC DATA BLOCK	RRBP.= N+26, BSN is incremented by 1
13	SS -> MS	DOWNLINK RLC DATA BLOCK	FBI bit is set, BSN is same as in step 4, RRBP.= N+26, sent on next radio block from step 12.
14	MS -> SS	PACKET DOWNLINK ACK/NACK	Received on the block specified by RRBP in step 12. Check that the Final Ack indicator = '1'.
15	MS -> SS	PACKET DOWNLINK ACK/NACK	Received on the block specified by RRBP in step 13. Check that the Final Ack indicator = '1'.
16	SS		Wait 2s for expiry of T3192.
17	SS -> MS	DOWNLINK RLC DATA BLOCK	FBI bit is set, a valid RRBP. Sent on downlink PDTCH assigned in step 1.
18	SS		Check that the MS does not respond on RRBP in step 17, the MS is now in packet idle mode.
19	SS -> MS	PACKET DOWNLINK ASSIGNMENT	Downlink Assignment, acknowledged mode. Sent on PCCCH.
20	SS -> MS	DOWNLINK RLC DATA BLOCK	Repeat step 20 ten times
21			One data block with FBI = '1' and valid RRBP.
22	SS -> MS	DOWNLINK RLC DATA BLOCK	Repeat step 20 ten times
23	MS -> SS	PACKET DOWNLINK ACK/NACK	Received on the block specified by RRBP in step 25. Check that the Final Ack indicator = '1'.
24	SS		Wait for 80% of expiry of T3192 (1.2s)
25	SS -> MS	PACKET DOWNLINK ASSIGNMENT	Downlink Assignment, acknowledged mode. A different slot assigned. Control Ack Bit = 1. Sent on PACCH.
26	SS -> MS	DOWNLINK RLC DATA BLOCK	Repeat step 26 ten times
27			One data block with FBI = '1' and valid RRBP.
28	SS -> MS	DOWNLINK RLC DATA BLOCK	Repeat step 26 ten times
29	MS -> SS	PACKET DOWNLINK ACK/NACK	Received on the block specified by RRBP in step 30. Check that the Final Ack indicator = '1'.

Specific Message Contents

PACKET DOWNLINK ACK/NACK message in step 15:

Ack/Nack Description - FINAL_ACK_INDICATION - STARTING_SEQUENCE_NUMBER - RECEIVED_BLOCK_BITMAP	1 (final ack) V(R) Acknowledges all data blocks transmitted by the MS
---	---

PACKET DOWNLINK ASSIGNMET message in step 25:

CONTROL_ACK TIMESLOT_ALLOCATION {L H<DOWNLINK_TFI_ASSIGNMENT>} - DOWNLINK_TFI_ASSIGNMENT	1 Single slot arbitrarily chosen but different from the value in step 19 H (assign downlink TFI) Arbitrarily chosen but different from the value in step 19
---	--

41.3.4.2 TBF Release / Downlink / Normal / Network initiated / Unacknowledged mode

41.3.4.2.1 Conformance requirements

For each RLC data block with the FBI bit set to '1' and with a valid RRBP field, the mobile station shall transmit the PACKET CONTROL ACKNOWLEDGEMENT message in the uplink block specified by the RRBP field. The mobile station shall continue to read the assigned downlink PDCHs until the block period pointed to by the RRBP. If the mobile station receives more than one RLC data block with the FBI bit set to '1' and with valid RRBP fields that point the same uplink block period, the mobile station shall transmit the PACKET CONTROL ACKNOWLEDGEMENT message only once. The mobile station shall then stop timer T3190, start timer T3192 and continue to monitor all assigned downlink PDCHs. If the mobile station then receives a subsequent RLC data block with a valid RRBP and the FBI bit set to '1', the mobile station shall retransmit the PACKET CONTROL ACKNOWLEDGEMENT message and restart timer T3192.

If the mobile station receives more than one RLC data block with the FBI set to '1', it shall accept the data from only the first one of these blocks.

If the mobile station, after sending the PACKET CONTROL ACKNOWLEDGEMENT message, receives a PACKET DOWNLINK ASSIGNMENT or PACKET TIMESLOT RECONFIGURE message with the Control Ack bit set to '1' while timer T3192 is running, the mobile station shall stop timer T3192, consider the previous downlink TBF released and act upon the new assignment.

When timer T3192 expires the mobile station shall stop monitoring its assigned downlink PDCHs.

References

GSM 04.60, 9.3.3.5

41.3.4.2.2 Test purpose

To verify that in a downlink TBF of unacknowledged mode:

1. The MS transmits PACKET CONTROL ACKNOWLEDGEMENT in the uplink block specified by the RRBP field whenever it receives an RLC data block with a valid RRBP field and the Final Block Indicator (FBI) set to the value '1'.
2. After sending PACKET CONTROL ACKNOWLEDGEMENT the MS continues to monitor all assigned downlink PDCHs.
3. While timer T3192 is running, if the MS receives, after sending PACKET DOWNLINK ACK/NACK with the Final Ack Indicator bit set to '1', PACKET DOWNLINK ASSIGNMENT with the Control Ack bit set to '1', the MS acts upon the new downlink assignment.

4. The MS stops monitoring its assigned downlink PDCHs and enters packet idle mode when timer T3192 expires.

41.3.4.2.3 Method of test

Initial Conditions

System Simulator:

1 cell, CCCH combined with SDCCH, BS_PBCCH_BLKs = 3, BS_CV_MAX = 15, T3192 = 1.5s.

Mobile Station:

The MS is GPRS attached with a P-TMSI allocated, SPLIT PG CYCLE negotiated and PDP context3 activated.

Related PICS/PIXIT Statement(s)

Support GPRS service,
Support activation of at least one PDP context

Test Procedure

1. The MS receives PACKET DOWNLINK ASSIGNMENT on its PPCH. The SS transmits 11 downlink RLC data blocks with consecutive BSN. The SS then transmits a downlink RLC data block with the BSN which is ten higher than the BSN of the last RLC data block. The SS polls the MS with a valid RRBp in the header of the RLC data block. The MS acknowledges the received data blocks.
2. The SS sends another RLC data block and polls the MS with a valid RRBp and with the FBI bit set. The MS sends PACKET CONTROL ACKNOWLEDGEMENT.
3. The SS sends another RLC data block and polls the MS with a valid RRBp and with the FBI bit set. The MS sends PACKET CONTROL ACKNOWLEDGEMENT. The SS waits 1.2s and sends another RLC data block and polls the MS with a valid RRBp and with the FBI bit set. The MS responds with PACKET CONTROL ACKNOWLEDGEMENT. The SS waits till T3192 expires. The SS sends a RLC data block with FBI set and a valid RRBp and checks that the MS does not transmit any data block on RRBp block.
4. The MS receives PACKET DOWNLINK ASSIGNMENT on its PPCH. The SS transmits a number of downlink RLC data blocks, sets FBI bit and polls the MS with a valid RRBp. The MS responds with PACKET CONTROL ACKNOWLEDGEMENT.
5. The SS sends another PACKET DOWNLINK ASSIGNMENT on the assigned PACCH with Control ACK bit set. The SS transmits a number of downlink RLC data blocks on the new assigned PDTCH, sets FBI bit and polls the MS with a valid RRBp. The MS responds with PACKET CONTROL ACKNOWLEDGEMENT.

Expected Sequence

Step	Direction	Message	Comments
1	SS -> MS	PACKET DOWNLINK ASSIGNMENT	Unacknowledged mode. Sent on its PPCH.
2	SS -> MS	DOWNLINK RLC DATA BLOCK	Sent on downlink PDTCH assigned.
3			Repeat step 2 ten times, each time BSN is incremented by 1
4	SS -> MS	DOWNLINK RLC DATA BLOCK	One data block with valid RRBP, BSN is incremented by 10. The MS has missed 9 consecutive RLC data blocks. BSN of this data block = (BSN of the last data block in step 3 + 10) mod 128
5	MS -> SS	PACKET DOWNLINK ACK/NACK	Received on the block specified by RRBP in step 4. Check that the Final Ack indicator = '0'
8	SS -> MS	DOWNLINK RLC DATA BLOCK	A valid RRBP, BSN is incremented by 1, FBI bit is set.
9	MS -> SS	PACKET CONTROL ACKNOWLEDGEMENT	Received on the block specified by RRBP in step 8.
10			Repeat step 8 and 9 once
11	SS		Wait 1.2 seconds (T3192 not expired).
12	SS -> MS	DOWNLINK RLC DATA BLOCK	One data block with FBI = '1' and valid RRBP, BSN is incremented by 1.
13	MS -> SS	PACKET CONTROL ACKNOWLEDGEMENT	Received on the block specified by RRBP in step 12.
14	SS		Wait for expiry of T3192
15	SS -> MS	DOWNLINK RLC DATA BLOCK	One data block with FBI = '1' and valid RRBP. Sent on downlink PDTCH assigned in step 1.
16	SS		Check that the MS does not transmit any data block on the RRBP block. Wait 1.2 seconds (T3192 not expired).
17	SS -> MS	PACKET DOWNLINK ASSIGNMENT	Downlink Assignment, unacknowledged mode, a different timeslot assigned.
18	SS -> MS	DOWNLINK RLC DATA BLOCK	Sent 5 blocks from last block containing PACKET DOWNLINK ASSIGNMENT
19			Repeat step 18 ten times
20	SS -> MS	DOWNLINK RLC DATA BLOCK	One data block with FBI = '1' and valid RRBP.
21	MS -> SS	PACKET CONTROL ACKNOWLEDGEMENT	
22	SS -> MS	PACKET DOWNLINK ASSIGNMENT	Wait 1.2 seconds (T3192 not expired). Downlink Assignment, unacknowledged mode. A different timeslot assigned. Control Ack Bit = 1. Sent on PACCH.
23	SS -> MS	DOWNLINK RLC DATA BLOCK	Sent 5 blocks from last block containing PACKET TIMESLOT RECONFIGURE
24			Repeat step 23 ten times
25	SS -> MS	DOWNLINK RLC DATA BLOCK	One data block with FBI = '1' and valid RRBP.
26	MS -> SS	PACKET CONTROL ACKNOWLEDGEMENT	Received on the block specified by RRBP in step 25. Check that the Final Ack indicator = '1'.

PACKET DOWNLINK ASSIGNMENT message in step 22:

RLC_MODE CONTROL_ACK {L H<DOWNLINK_TFI_ASSIGNMENT>} - DOWNLINK_TFI_ASSIGNMENT TIMESLOT_ALLOCATION	Unacknowledged mode 1 H (assign downlink TFI) Arbitrarily chosen but different from the value in step 17 Single slot arbitrarily chosen but different from the values already assigned.
---	---

41.3.5 PDCH Release

41.3.5.1 Void

41.3.5.2 PDCH Release / With TIMESLOTS_AVAILABLE

41.3.5.2.1 Conformance requirements

When a mobile station receives a PACKET PDCH RELEASE message containing a TIMESLOTS_AVAILABLE field, it shall immediately stop transmitting and receiving on all assigned PDCHs, which are indicated as not present in the TIMESLOTS_AVAILABLE field, remove those PDCHs from its list of assigned PDCHs.

If all of the mobile station's assigned PDCHs are removed from its list of assigned PDCH, and, if an uplink TBF was in progress, the mobile station shall perform an abnormal release with random access. If no uplink TBF was in progress, the mobile station shall perform an abnormal release with return to CCCH or PCCCH.

If an uplink TBF in fixed allocation mode was in progress and if one of timeslots that are being released is its downlink PACCH timeslot, the mobile station shall temporarily read all downlink blocks that it is able to decode according to its multislot capability, on all of its remaining assigned PDCHs, and act upon any RLC/MAC control message that is addressed to it, until another downlink PACCH timeslot is assigned. If the mobile station's multislot capability does not allow it to monitor the downlink of any of its assigned PDCHs, it shall perform an abnormal release with random access.

References

GSM 04.60, 8.2

41.3.5.2.2 Test purpose

To verify that when the MS receives a PACKET PDCH RELEASE message with a TIMESLOTS_AVAILABLE field indicating that one or more timeslots is no longer available for packet data service:

1. it immediately stops transmitting and receiving on all assigned PDCHs which are not presented in the TIMESLOTS_AVAILABLE field.
2. it performs an abnormal release with random access when all of the MS's assigned PDCHs are removed, and an uplink TBF was in progress.
3. it performs an abnormal release with return to CCCH or PCCCH when all of the MS's assigned PDCHs are removed, and no uplink TBF was in progress.
4. If an uplink TBF in fixed allocation mode was in progress and if one of timeslots that are being released is its downlink PACCH timeslot, the mobile station temporarily reads all downlink blocks that it is able to decode according to its multislot capability, on all of its remaining assigned PDCHs, and acts upon any RLC/MAC control message that is addressed to it.

41.3.5.2.3 Method of test

Initial Conditions

System Simulator:

1 cell, CCCH combined with SDCCH, BS_PBCCH_BLKs = 3, BS_CV_MAX = 15.

Mobile Station:

The MS is GPRS attached with a P-TMSI allocated, SPLIT PG CYCLE negotiated and PDP context2 activated.

Related PICS/PIXIT Statement(s)

Support GPRS service,

Support multislot class
Support activation of at least one PDP context
The way to trigger the MS initiating an uplink packet transfer

Test Procedure

1. The MS is triggered to transfer user data. A TBF on one slot of fixed allocation in acknowledged mode is assigned. After the MS transfers several RLC data blocks the SS sends PACKET PDCH RELEASE with TIMESLOTS_AVAILABLE indicating no timeslot available. It is checked that the MS initiates a random access request for one or two phase access request. A TBF is assigned to the MS to allow it to complete the uplink data transferring.
2. The MS is triggered to transfer user data. A TBF on two consecutive slots of fixed allocation in acknowledged mode is assigned. After the MS transfers several RLC data blocks the SS sends PACKET PDCH RELEASE with TIMESLOTS_AVAILABLE indicating that only a timeslot is available and the assigned downlink control timeslot is no more available. The MS uses the available timeslot to complete the uplink data transferring.
3. The MS receives PACKET DOWNLINK ASSIGNMENT on its PPCH. A downlink TBF with a timeslot is assigned. The SS transmits several downlink RLC data blocks. Then SS sends PACKET PDCH RELEASE with TIMESLOTS_AVAILABLE indicating no timeslot available and polls the MS with a valid RRB for acknowledgement. It is checked that the MS does not react upon the polling.
4. A downlink TBF with two timeslots is assigned. The SS transmits several downlink RLC data blocks. Then SS sends PACKET PDCH RELEASE with TIMESLOTS_AVAILABLE indicating only a timeslot available and polls the MS with a valid RRB for acknowledgement. It is checked that the MS does not react upon the polling and continues receiving the downlink data on the available timeslot. The SS sends another PACKET PDCH RELEASE with TIMESLOTS_AVAILABLE indicating no timeslot available and polls the MS with a valid RRB for acknowledgement. It is checked that the MS does not react upon the polling.

Expected Sequence

Step	Direction	Message	Comments
1		{Uplink fixed allocation one phase access with contention resolution}	n = 1000 octets in RLC acknowledged mode. (Test PDP context2) CHANNEL_CODING_COMMAND = cs4. DOWNLINK_CONTROL_TIMESLOT: timeslot ₇ TIMESLOT_ALLOCATION: timeslot ₇ , HALF_DUPLEX_MODE: 0, no half duplex BLOCKS_OR_BLOCK_PERIODS: blocks ALLOCATION_BITMAP_LENGTH: 30 ALLOCATION_BITMAP: exact 30 '1'B,
2	MS -> SS	UPLINK RLC DATA BLOCKS	Received 6 data blocks on the assigned PDTCH. The MS may send PACKET RESOURCE REQUEST. The SS shall ignore the requests.
3	SS -> MS	PACKET PDCH RELEASE	Sent on the PACCH of the PDCH assigned in step 2. With TIMESLOTS_AVAILABLE indicating no timeslot available, RRBP = N + 26.
4	SS		SS may receive max. 5 data blocks on the released timeslot. SS checks that no PACKET CONTROL ACKNOWLEDGEMENT is received.
5	MS -> SS	PACKET CHANNEL REQUEST	Received on PRACH.
6	SS -> MS	PACKET UPLINK ASSIGNMENT	Single block assignment, to order the MS making two phase access procedure. Sent on PAGCH.
7	MS -> SS	PACKET RESOURCE REQUEST	Two phase access procedure. Received on the single block assigned in step 6.
8	SS -> MS	PACKET UPLINK ASSIGNMENT	Open-ended uplink dynamic allocation with one time slot, USF_GRANULARITY = single block, CHANNEL_CODING_COMMAND = cs4, Sent on PACCH of the same PDCH assigned in step 7.
9	SS -> MS	PACKET DOWNLINK DUMMY CONTROL BLOCK	Sent on the PACCH of the PDCH assigned in step 9, containing USF assigned to the MS.
10	MS -> SS	UPLINK RLC DATA BLOCK	Received on the assigned PDTCH.
11		{Completion of uplink RLC data block transfer}	
12		{Uplink fixed allocation one phase access with contention resolution}	The step 12 to step 30 are applicable to the MS in multislot classes 3, 5, 6, 9, 10, 19, 24. The MS of the multislot class 1, 2, 4, 8 skips the steps. n = 1100 octets in RLC acknowledged mode. (Test PDP context2), CHANNEL_CODING_COMMAND = cs2 DOWNLINK_CONTROL_TIMESLOT: timeslot ₆ TIMESLOT_ALLOCATION: timeslot ₆ and timeslot ₇ , HALF_DUPLEX_MODE: 0, no half duplex BLOCKS_OR_BLOCK_PERIODS: block periods ALLOCATION_BITMAP_LENGTH: 30 ALLOCATION_BITMAP: exact 30 '1'B,
13	MS -> SS	UPLINK RLC DATA BLOCK	Received on the assigned PDTCH ₆ and PDTCH ₇ . The MS may send PACKET RESOURCE REQUEST. The SS shall ignore the requests.
14			Repeat step 13 three times
15	SS -> MS	PACKET PDCH RELEASE	Sent on the PACCH of the PDCH ₆ assigned in step 12. With TIMESLOTS_AVAILABLE indicating no timeslot available.
16	MS -> SS	UPLINK RLC DATA BLOCK	SS may receive maximum of 6 data blocks on each assigned channel. SS checks that no PACKET CONTROL ACKNOWLEDGEMENT is received.
17	MS -> SS	PACKET CHANNEL REQUEST	Received on PRACH.
18	SS -> MS	PACKET UPLINK ASSIGNMENT	Single block assignment, to order the MS making two phase access procedure. Sent on PAGCH.
19	MS -> SS	PACKET RESOURCE REQUEST	Two phase access procedure. Received on the single block assigned in step 18.

20	SS -> MS	PACKET UPLINK ASSIGNMENT	Uplink fixed allocation CHANNEL_CODING_COMMAND = cs4 DOWNLINK_CONTROL_TIMESLOT: timeslot ₇ TIMESLOT_ALLOCATION: timeslot ₇ and timeslot ₀ , HALF_DUPLEX_MODE: 0, no half duplex BLOCKS_OR_BLOCK_PERIODS: block periods ALLOCATION_BITMAP_LENGTH: 30 ALLOCATION_BITMAP: exact 30 '1'B.
21	MS -> SS	UPLINK RLC DATA BLOCKS	Four data blocks received on the assigned PDTCH ₇ and PDTCH ₀ . The MS may send PACKET RESOURCE REQUEST. The SS shall ignore the requests.
22	SS -> MS	PACKET PDCH RELEASE	Sent on the PACCH of the PDCH ₇ assigned in step 20. With TIMESLOTS_AVAILABLE indicating only the timeslot corresponding to PDCH ₀ available.
23	MS -> SS	UPLINK RLC DATA BLOCK	Received on the assigned PDTCH ₀ . The MS may send maximum of six data blocks on PDTCH ₇ after step 22. Repeat step 23 three times
24			
25	SS -> MS	PACKET UPLINK ACK/NACK	Acknowledge all data blocks received on PDCH ₀ except the RLC data blocks received on PDTCH ₇ after step 22. Sent on PACCH ₀
26	MS -> SS	UPLINK RLC DATA BLOCKs	until the countdown value CV=0, The MS may send PACKET RESOURCE REQUEST. The SS shall ignore the requests.
27	SS -> MS	PACKET UPLINK ACK/NACK	Acknowledge all data blocks received on PDCH ₀ . The SS sets Final Ack Indicator = '1' containing a valid RRBp.
28	MS -> SS	PACKET CONTROL ACKNOWLEDGEMENT	Received on the block specified by RRBp on PDCH ₀
28	SS -> MS	PACKET DOWNLINK ASSIGNMENT	Downlink Assignment with one timeslot assigned, acknowledged mode. Sent on PPCH.
30	SS -> MS	DOWNLINK RLC DATA BLOCK	A valid RRBp
31	MS -> SS	PACKET DOWNLINK ACK/NACK	Received on the block specified by RRBp in step 30.
32	SS -> MS	DOWNLINK RLC DATA BLOCK	Repeat the step three times.
33	SS -> MS	PACKET PDCH RELEASE	Sent on the next radio block from step 32 with TIMESLOTS_AVAILABLE indicating no timeslot available.
34	SS -> MS	DOWNLINK RLC DATA BLOCK	Sent on the next radio block from step 33 on PDTCH released, a valid RRBp = N + 21 or 22.
35	SS		Check that no PACKET DOWNLINK ACK/NACK received on the block specified in step 33.
			The steps from 36 onwards are applicable to all multislot classes except the multislot class1.
36	SS -> MS	PACKET DOWNLINK ASSIGNMENT	Downlink Assignment with timeslot ₇ and timeslot ₀ assigned, acknowledged mode. Sent on PPCH.
37	SS -> MS	DOWNLINK RLC DATA BLOCK	Repeat the step five times. The RLC data blocks are received on PDTCH ₇ and PDTCH ₀ . The last data block on PDTCH ₇ containing a valid RRBp.
38	MS -> SS	PACKET DOWNLINK ACK/NACK	Received on the block specified by RRBp on PDTCH ₇ Check whether all data blocks in step 37 are acknowledged.
39	SS -> MS	PACKET PDCH RELEASE	With TIMESLOTS_AVAILABLE indicating only timeslot ₀ available. Sent on the PACCH of PDCH ₇ .
40	SS -> MS	DOWNLINK RLC DATA BLOCK	Repeat the step five times. The RLC data blocks are received on PDTCH ₀ . The last data block on PDTCH ₀ containing a valid RRBp.
41	MS -> SS	PACKET DOWNLINK ACK/NACK	On the block specified by RRBp on PDTCH ₀ . Check whether all data blocks sent in step 40 are acknowledged.
42	SS -> MS	DOWNLINK RLC DATA BLOCK	One data block with a valid RRBp = N + 26 on PDTCH ₇ .
43	SS		Check that no PACKET DOWNLINK ACK/NACK received on the block specified.
44	SS -> MS	DOWNLINK RLC DATA BLOCK	Repeat the step five times on PDTCH ₀ .
45	SS -> MS	PACKET PDCH RELEASE	With TIMESLOTS_AVAILABLE indicating no timeslot available sent on the next block from step 44.

46	SS -> MS	DOWNLINK RLC DATA BLOCK	Sent on the next radio block of step 45 on PDTCH ₀ , a valid RRBP = N + 21 or 22. Check that no PACKET DOWNLINK ACK/NACK is received on the block specified in step 46.
47	SS		

41.3.6 Default message contents

The default message contents defined in clause 42.3.4 are applied for the all tests in 41.3.

41.4 DCCH related RR procedures for TBF establishment

The clause is applicable for all MS supporting GPRS service.

41.4.1 Default conditions and message contents

The default conditions and default message contents not specified in this clause must be set as in “GPRS default conditions”. Those conditions or message contents presented here are applicable to all the test cases described in this section. Conditions or message contents specific to a test case or a set of test cases described in this section are explicitly defined in the correspondent test case(s).

Conditions or message contents specified in a test case have the highest precedence. In addition, the default conditions and message contents described in this clause override those specified in “GPRS default conditions”.

41.4.1.1 Default conditions

1. Related PICS/PIXIT statements

- GPRS supported (Y/N).
- Supported frequencies (GSM 450, GSM 480, P-GSM, E-GSM, R-GSM or DCS 1 800 or PCS 1900).
- Multislot class type.
- Means of triggering GPRS attach.

2. Initial conditions: SS and MS

System Simulator:

T3117 set to infinite³.

T3119 set to infinite.

³ The term “infinite” will be understood here as “disabled” or the largest possible value

41.4.1.2 Default message contents

41.4.1.2.1 Default contents of system information messages

SYSTEM INFORMATION TYPE 3

As default except:

Information Element	Value/Remarks
Control Channel Description - CCCH_CONF	001 (1 basic physical channel used for CCCH, combined with SDCCHs)
SI 3 Rest Octets - System Information 2ter Indicator	H (SI 2ter exists)

SYSTEM INFORMATION TYPE 5

As default except:

Information Element	Value/Remarks
Neighbour Cell Description - BCCH allocation ARFCN	As in SI 2

SYSTEM INFORMATION TYPE 13

As default except:

Information Element	Value/Remarks
SI 13 Rest Octets - { 0 1 } - SPLIT_PG_CYCLE_CCCH_SUPPORTED - ACC_BURST_TY - SI_1_CA_INDICATION	0 (PCCCH not supported) 0 (Split pg cycle CCCH is not supported in the cell) 0 (8 bit access burst shall be used by the MS) 1 (information from SI 1 message is required for packet access)

41.4.1.2.2 Default contents of L3 messages

IMMEDIATE ASSIGNMENT message:

As default except:

Information Element	Value/Remarks
Packet Response Type and Dedicated mode or TBF - T/D - PR Type	0 (This message assigns a dedicated mode resource) 00 (Immediate Assignment procedure for RR connection establishment)

41.4.2 Immediate Assignment of a DCCH

41.4.2.1 Immediate Assignment / Contention resolution failure

41.4.2.1.1 Conformance requirements

1. On receipt of an IMMEDIATE ASSIGNMENT message assigning a DCCH corresponding to one of its 3 last CHANNEL REQUEST messages, the mobile station shall switch to the assigned channel, set the channel mode to signalling only and activate the assigned channel. It then shall establish the main signalling link with an L2-SABM frame.

2. If an information field mismatch occurs in the first contention resolution procedure, the allocated channel is released and the immediate assignment procedure shall be repeated. If an information field mismatch occurs in the repeated contention resolution procedure, the MS shall release the allocated channel and return to the ready state.
3. When establishing the main signalling link the information field in the SABM shall contain an RR INITIALISATION REQUEST message

References

GSM 04.08, clauses 3.3.1.1.5 and 3.3.1.3

41.4.2.1.2 Test purpose

1. To verify that the MS can correctly set up a SDCCH/4 and send an RR INITIALISATION REQUEST message containing its identity.
2. To verify that the MS can correctly set up a frequency hopping SDCCH/8 and send an RR INITIALISATION REQUEST message containing its identity.
3. To verify that the MS can correctly set up a TCH/F and send an RR INITIALISATION REQUEST message containing its identity.
4. To verify that the MS stops transmitting on the allocated channel and restarts the immediate assignment procedure after the first identity mismatch in the contention resolution procedure.
5. To verify that the MS stops transmitting on the allocated channel and returns to the "ready" state after the second identity mismatch in the contention resolution procedure.

41.4.2.1.3 Method of test

Initial Conditions

System Simulator:

1 cell, GPRS supported using BCCH

Mobile Station:

The MS is switched off.

Related PICS/PIXIT Statement(s)

As default.

Test Procedure

The MS is triggered to perform a GPRS attach procedure and shall start an access procedure. The SS assigns a DCCH. The MS is triggered to perform a GPRS attach procedure and shall start an access procedure. The SS assigns a DCCH. The MS shall go to the correct channel and send an RR INITIALISATION REQUEST message containing its identity. The SS answers with a different TLLI. The MS shall stop transmitting on the assigned DCCH and restart the access procedure and the SS answers again with a different TLLI. The MS shall return to the "ready" state and stop transmission. The SS checks that there is no transmission either on the DCCH or on the RACH during 10 seconds.

For K = 1, the test is done with the SS sending an IMMEDIATE ASSIGNMENT message describing an SDCCH/4.

For K = 2, the test is repeated with the SS sending an IMMEDIATE ASSIGNMENT message describing an SDCCH/8.

For K = 3, the test is repeated with the SS sending an IMMEDIATE ASSIGNMENT message describing a TCH/F.

Maximum Duration of Test

5 minutes

Expected Sequence

This sequence is performed for execution counter K = 1 to 3.

Step	Direction	Message	Comments
1	MS		The MS is triggered to perform a GPRS attach procedure
2	MS → SS	CHANNEL REQUEST	Establishment Cause = "One phase packet access"
3	SS → MS	IMMEDIATE ASSIGNMENT	See 'specific message contents'
4	MS → SS	RR INITIALISATION REQUEST	Contains TLLI
5	SS → MS	L2-UA	Contains TLLI different to the previous step
6	SS		The SS checks that there is no transmission on the DCCH until the CHANNEL REQUEST is received
7	MS → SS	CHANNEL REQUEST	Establishment Cause = "One phase packet access"
8	SS → MS	IMMEDIATE ASSIGNMENT	Channel Type: same as step 3
9	MS → SS	RR INITIALISATION REQUEST	Contains TLLI
10	SS → MS	L2-UA	Contains TLLI different to the previous step
11	SS		The SS checks that there is no transmission either on the DCCH or on the RACH during 10 seconds

Specific Message Contents

IMMEDIATE ASSIGNMENT

K=1: SDCCH/4:

Information Element	Value/Remarks
Channel Description	
- Channel Type and TDMA offset	SDCCH/4
TDMA offset	Chosen arbitrarily
- Timeslot Number	Zero
- Training Sequence Code	Same as the BCC
- Hopping channel	Single RF channel
- ARFCN	Same as the BCCH carrier
Mobile Allocation	Not included (length = 0)

K=2: SDCCH/8 FH:

Information Element	Value/Remarks
Channel Description	
- Channel Type and TDMA offset	SDCCH/8
TDMA offset	Chosen arbitrarily
- Timeslot Number	Chosen arbitrarily, but not zero
- Training Sequence Code	Same as the BCC
- Hopping channel	RF hopping channel
- MAIO	Chosen arbitrarily from 0 to (N-1). See note 1
- HSN	Chosen arbitrarily from the set (1 to 63)
Mobile Allocation	Same as the CA

K=3: TCH/F:

Information Element	Value/Remarks
Channel Description	
- Channel Type and TDMA offset	TCH/F + ACCHs
- Timeslot Number	Chosen arbitrarily, but not zero
- Training Sequence Code	Same as the BCC
- Hopping channel	Single RF channel
- ARFCN	Same as the BCCH carrier
Mobile Allocation	Not included (length = 0)

NOTE 1: N is the number of frequencies in the Mobile Allocation IE.

41.4.2.2 Immediate Assignment / Use of DCCH for Uplink TBF Establishment

41.4.2.2.1 Conformance requirements

1. A mobile station supporting the «GPRS» option whose CHANNEL REQUEST message contained a packet access establishment cause shall obey an IMMEDIATE ASSIGNMENT message to a channel which is to be used in dedicated mode.
2. When establishing the main signalling link the information field in the SABM shall contain an RR INITIALISATION REQUEST message.
3. Following a successful contention resolution procedure, the mobile station shall implement the Early Classmark Sending option. Early classmark sending consists in the mobile station sending as soon as possible after access a CLASSMARK CHANGE message to provide the network with additional classmark information.
4. While on the dedicated channel the mobile station shall send measurement reports on the SACCH.

References

GSM 04.08, clause 3.3.1.3

41.4.2.2.2 Test purpose

1. To verify that the in an uplink TBF establishment procedure the GPRS mobile obeys an IMMEDIATE ASSIGNMENT message which commands it to use an SDCCH/4.
2. To verify that the in an uplink TBF establishment procedure the GPRS mobile obeys an IMMEDIATE ASSIGNMENT message which commands it to use a TCH/F.
3. To verify that the mobile correctly formats the RR INITIALISATION REQUEST message.
4. To verify that the mobile performs the Early Classmark Sending procedure.
5. To verify that while on the dedicated channel the mobile correctly sends measurement reports.

41.4.2.2.3 Method of test

Initial Conditions

System Simulator:

For GSM 900 and DCS 1800 MS: 4 cells:

Transmitter	Level	NCC	BSCC	ARFCN		Cell identity	LAC	RAC
				GSM900	DCS1800			
Serving, S1	-80	1	1	20	590	0001H	0001H	0001H
Neighbour, N1	-80	1	3	10	520	0002H	0001H	0001H
Neighbour, N2	-80	1	5	80	600	0003H	0001H	0001H
Neighbour, N3	-80	1	7	90	700	0004H	0001H	0001H

For GSM 450 and GSM 480 MS: 4 cells:

Transmitter	Level	NCC	BSCC	ARFCN		Cell identity	LAC	RAC
				GSM450	GSM480			
Serving, S1	-80	1	1	263	310	0001H	0001H	0001H
Neighbour, N1	-80	1	3	261	308	0002H	0001H	0001H
Neighbour, N2	-80	1	5	282	329	0003H	0001H	0001H
Neighbour, N3	-80	1	7	284	331	0004H	0001H	0001H

For 450/900 and 480/900 MS: 4 cells:

<i>Transmitter</i>	<i>Level</i>	<i>NCC</i>	<i>BSCC</i>	<i>ARFCN</i>	<i>ARFCN</i>	<i>Cell identity</i>	<i>LAC</i>	<i>RAC</i>
				<i>450/900</i>	<i>480/900</i>			
<i>Serving, S1</i>	-80	1	1	263	310	0001H	0001H	0001H
<i>Neighbour, N1</i>	-80	1	3	10	10	0002H	0001H	0001H
<i>Neighbour, N2</i>	-80	1	5	282	329	0003H	0001H	0001H
<i>Neighbour, N3</i>	-80	1	7	90	90	0004H	0001H	0001H

For 450/1800 and 480/1800 MS: 4 cells:

<i>Transmitter</i>	<i>Level</i>	<i>NCC</i>	<i>BSCC</i>	<i>ARFCN</i>	<i>ARFCN</i>	<i>Cell identity</i>	<i>LAC</i>	<i>RAC</i>
				<i>450/1800</i>	<i>480/1800</i>			
<i>Serving, S1</i>	-80	1	1	263	310	0001H	0001H	0001H
<i>Neighbour, N1</i>	-80	1	3	520	520	0002H	0001H	0001H
<i>Neighbour, N2</i>	-80	1	5	282	329	0003H	0001H	0001H
<i>Neighbour, N3</i>	-80	1	7	700	700	0004H	0001H	0001H

For 900/1800 MS: 4 cells:

<i>Transmitter</i>	<i>Level</i>	<i>NCC</i>	<i>BSCC</i>	<i>ARFCN</i>	<i>ARFCN</i>	<i>Cell identity</i>	<i>LAC</i>	<i>RAC</i>
				<i>900/1800</i>				
<i>Serving, S1</i>	-80	1	1	20	-	0001H	0001H	0001H
<i>Neighbour, N1</i>	-80	1	3	520	-	0002H	0001H	0001H
<i>Neighbour, N2</i>	-80	1	5	80	-	0003H	0001H	0001H
<i>Neighbour, N3</i>	-80	1	7	700	-	0004H	0001H	0001H

For PCS 1900 MS: 4 cells:

<i>Transmitter</i>	<i>Level</i>	<i>NCC</i>	<i>BSCC</i>	<i>ARFCN</i>	<i>ARFCN</i>	<i>Cell identity</i>	<i>LAC</i>	<i>RAC</i>
				<i>900/1800</i>				
<i>Serving, S1</i>	-80	1	1	590	-	0001H	0001H	0001H
<i>Neighbour, N1</i>	-80	1	3	520	-	0002H	0001H	0001H
<i>Neighbour, N2</i>	-80	1	5	600	-	0003H	0001H	0001H
<i>Neighbour, N3</i>	-80	1	7	700	-	0004H	0001H	0001H

S1 and N1 with BCCH indicating GPRS supported; BCCHs of N2 and N3 indicate not support of GPRS.

Mobile Station:

The MS is GMM-DEREGISTERED, in "packet idle" mode and camped on S1.

Related PICS/PIXIT Statement(s)

As default.

Foreseen Final State of the MS

GMM-DEREGISTERED, in "packet idle" mode and camped on S1.

Test Procedure

The MS is triggered to perform a GPRS attach procedure. The SS assigns a DCCH. The MS shall go to the correct channel and send an RR INITIALISATION REQUEST message. The MS shall send a CLASSMARK CHANGE message containing an MS Classmark 2 and 3. The MS shall send continuously MEASUREMENT REPORT messages on the SACCH. Ten seconds after having sent the IMMEDIATE ASSIGNMENT message, the SS initiates RR-release by sending a CHANNEL RELEASE message. The MS shall have sent then measurements for all neighbours, irrespective of their support of GPRS.

For K = 1, the test is done with the SS sending an IMMEDIATE ASSIGNMENT message describing an SDCCH/4.

For K = 2, the test is repeated with the SS sending an IMMEDIATE ASSIGNMENT message describing a TCH/F.

Maximum Duration of Test

5 minutes

Expected Sequence

This sequence is performed for execution counter K = 1 to 2.

Step	Direction	Message	Comments
1	MS		The MS is triggered to perform a GPRS attach procedure
2	MS → SS	CHANNEL REQUEST	Establishment Cause = "One phase packet access"
3	SS → MS	IMMEDIATE ASSIGNMENT	See 'specific message contents'
4	MS → SS	RR INITIALISATION REQUEST	Sent on the correct channel after establishment of the main signalling link
5		{ Classmark and measurement }	Macro
6	SS		10 seconds after sending the IMMEDIATE ASSIGNMENT message, the SS checks that measurements for all neighbours have been received
7	SS → MS	CHANNEL RELEASE	

Specific Message Contents

IMMEDIATE ASSIGNMENT

K=1: SDCCH:

Information Element	Value/Remarks
Channel Description	SDCCH/4
- Channel Type and TDMA offset	Chosen arbitrarily
TDMA offset	Zero
- Timeslot Number	Same as BCC
- Training Sequence Code	Single RF channel
- Hopping channel	Same as the BCCH carrier
- ARFCN	Not included (length = 0)
Mobile Allocation	

K=2: TCH/F:

Information Element	Value/Remarks
Channel Description	TCH/F + ACCHs
- Channel Type and TDMA offset	Chosen arbitrarily, but not zero
- Timeslot Number	Same as the BCC
- Training Sequence Code	Single RF channel
- Hopping channel	Same as the BCCH carrier
- ARFCN	Not included (length = 0)
Mobile Allocation	

41.4.2.3 Immediate Assignment / Use of DCCH for Downlink TBF Establishment

41.4.2.3.1 Conformance requirements

1. A mobile station supporting the «GPRS» option whose CHANNEL REQUEST message contained a packet access establishment cause shall obey an IMMEDIATE ASSIGNMENT message to a channel which is to be used in dedicated mode.
2. When establishing the main signalling link the information field in the SABM shall contain an RR INITIALISATION REQUEST message.
3. Following a successful contention resolution procedure, the mobile station shall implement the Early Classmark Sending option. Early classmark sending consists in the mobile station sending as early as possible after access a CLASSMARK CHANGE message to provide the network with additional classmark information.
4. While on the dedicated channel the mobile station shall send measurement reports on the SACCH.

References

GSM 04.08, clause 3.3.1.3

41.4.2.3.2 Test purpose

1. To verify that in a downlink TBF establishment procedure the GPRS mobile obeys an IMMEDIATE ASSIGNMENT message which commands it to use a hopping SDCCH/8.
2. To verify that the mobile correctly formats the RR INITIALISATION REQUEST message.
3. To verify that the mobile performs the Early Classmark Sending procedure.
4. To verify that while on the dedicated channel the mobile correctly sends measurement reports.

41.4.2.3.3 Method of test

Initial Conditions

System Simulator:

For GSM 900 and DCS 1800 MS: 4 cells:

Transmitter	Level	NCC	BSCC	ARFCN	ARFCN	Cell identity	LAC	RAC
				GSM900	DCS1800			
Serving, S1	-80	1	1	20	590	0001H	0001H	0001H
Neighbour, N1	-80	1	3	10	520	0002H	0001H	0001H
Neighbour, N2	-80	1	5	80	600	0003H	0001H	0001H
Neighbour, N3	-80	1	7	90	700	0004H	0001H	0001H

For GSM 450 and GSM 480 MS: 4 cells:

Transmitter	Level	NCC	BSCC	ARFCN	ARFCN	Cell identity	LAC	RAC
				GSM450	GSM480			
Serving, S1	-80	1	1	263	310	0001H	0001H	0001H
Neighbour, N1	-80	1	3	261	308	0002H	0001H	0001H
Neighbour, N2	-80	1	5	282	329	0003H	0001H	0001H
Neighbour, N3	-80	1	7	284	331	0004H	0001H	0001H

For 450/900 and 480/900 MS: 4 cells:

<i>Transmitter</i>	<i>Level</i>	<i>NCC</i>	<i>BSCC</i>	<i>ARFCN</i>	<i>ARFCN</i>	<i>Cell identity</i>	<i>LAC</i>	<i>RAC</i>
				<i>450/900</i>	<i>480/900</i>			
<i>Serving, S1</i>	-80	1	1	263	310	0001H	0001H	0001H
<i>Neighbour, N1</i>	-80	1	3	10	10	0002H	0001H	0001H
<i>Neighbour, N2</i>	-80	1	5	282	329	0003H	0001H	0001H
<i>Neighbour, N3</i>	-80	1	7	90	90	0004H	0001H	0001H

For 450/1800 and 480/1800 MS: 4 cells:

<i>Transmitter</i>	<i>Level</i>	<i>NCC</i>	<i>BSCC</i>	<i>ARFCN</i>	<i>ARFCN</i>	<i>Cell identity</i>	<i>LAC</i>	<i>RAC</i>
				<i>450/1800</i>	<i>480/1800</i>			
<i>Serving, S1</i>	-80	1	1	263	310	0001H	0001H	0001H
<i>Neighbour, N1</i>	-80	1	3	520	520	0002H	0001H	0001H
<i>Neighbour, N2</i>	-80	1	5	282	329	0003H	0001H	0001H
<i>Neighbour, N3</i>	-80	1	7	700	700	0004H	0001H	0001H

For 900/1800 MS: 4 cells:

<i>Transmitter</i>	<i>Level</i>	<i>NCC</i>	<i>BSCC</i>	<i>ARFCN</i>	<i>ARFCN</i>	<i>Cell identity</i>	<i>LAC</i>	<i>RAC</i>
				<i>900/1800</i>				
<i>Serving, S1</i>	-80	1	1	20	-	0001H	0001H	0001H
<i>Neighbour, N1</i>	-80	1	3	520	-	0002H	0001H	0001H
<i>Neighbour, N2</i>	-80	1	5	80	-	0003H	0001H	0001H
<i>Neighbour, N3</i>	-80	1	7	700	-	0004H	0001H	0001H

For PCS 1900 MS: 4 cells:

<i>Transmitter</i>	<i>Level</i>	<i>NCC</i>	<i>BSCC</i>	<i>ARFCN</i>	<i>ARFCN</i>	<i>Cell identity</i>	<i>LAC</i>	<i>RAC</i>
				<i>900/1800</i>				
<i>Serving, S1</i>	-80	1	1	590	-	0001H	0001H	0001H
<i>Neighbour, N1</i>	-80	1	3	520	-	0002H	0001H	0001H
<i>Neighbour, N2</i>	-80	1	5	600	-	0003H	0001H	0001H
<i>Neighbour, N3</i>	-80	1	7	700	-	0004H	0001H	0001H

N2 and N3 with BCCH indicating GPRS supported; BCCHs of S1 and N1 indicate not support of GPRS.

Mobile Station:

The MS is GMM-DEREGISTERED, in “packet idle” mode and camped on S1.

Related PICS/PIXIT Statement(s)

As default.

Foreseen Final State of the MS

GMM-DEREGISTERED, in “packet idle” mode and camped on S1.

Test Procedure

The MS is triggered to perform a GPRS attach procedure and after the MS has responded with a CHANNEL REQUEST message the SS assigns a hopping SDCCH. The MS shall go to the correct channel and send an RR INITIALISATION REQUEST message. The MS shall send a CLASSMARK CHANGE message containing an MS Classmark 2 and 3. The MS shall send continuously MEASUREMENT REPORT messages on the SACCH. Ten seconds after having sent the IMMEDIATE ASSIGNMENT message, the SS initiates RR-release by sending a CHANNEL RELEASE message. The MS shall have sent measurements for all neighbours, irrespective of their support of GPRS.

Maximum Duration of Test

5 minutes

Expected Sequence

Step	Direction	Message	Comments
1	MS		The MS is triggered to perform a GPRS attach procedure
2	MS → SS	CHANNEL REQUEST	Establishment Cause = "One phase packet access"
3	SS → MS	IMMEDIATE ASSIGNMENT	See 'specific message contents'
4	MS → SS	RR INITIALISATION REQUEST	Sent on the correct channel after establishment of the main signalling link
5		{ Classmark and measurement }	Macro
6	SS		10 seconds after sending the IMMEDIATE ASSIGNMENT message, the SS checks that measurements for all neighbours have been received
7	SS → MS	CHANNEL RELEASE	

Specific Message Contents

IMMEDIATE ASSIGNMENT

Information Element	Value/Remarks
Channel Description	
- Channel Type and TDMA offset	SDCCH/8
TDMA offset	Chosen arbitrarily
- Timeslot Number	Zero
- Training Sequence Code	Same as the BCC
- Hopping channel	RF hopping channel
- MAIO	Chosen arbitrarily from 0 to (N-1). See note 1
- HSN	Chosen arbitrarily from the set (1 to 63)
Mobile Allocation	Same as the CA except for the BCCH carrier.

NOTE 1: N is the number of frequencies in the Mobile Allocation IE.

41.4.3 RR commands while on DCCH

41.4.3.1 Assignment Command

41.4.3.1.1 Conformance requirements

1. The mobile shall obey the RR management procedures while on the dedicated channel.
2. The channel assignment procedure shall modify the physical channel configuration of the mobile station without frequency redefinition or change in synchronisation while staying in the same cell.
3. The mobile station shall release the main signalling link, disconnect TCHs if any is allocated, deactivate previously assigned channels, activate new channels and their connections —if applicable— and trigger the establishment of the data link connections for SAPI = 0.

4. If frequency hopping is applied, the mobile station shall use its current CA to decode the mobile allocation.

References

GSM 04.08, clauses 3.3.1.3 and 3.4.3.

41.4.3.1.2 Test purpose

To verify that while on a dedicated channel the mobile correctly obeys ASSIGNMENT COMMAND messages.

41.4.3.1.3 Method of test

Initial Conditions

System Simulator:

1 cell. GPRS supported using BCCH

For multiband tests, it will operate in upper band.

Mobile Station:

The MS is GMM-DEREGISTERED and in "packet idle" mode.

Related PICS/PIXIT Statement(s)

As default.

Foreseen Final State of the MS

GMM-DEREGISTERED and in "packet idle" mode.

Test Procedure

The MS is triggered to perform a GPRS attach procedure. The MS shall go to the correct channel and send an RR INITIALISATION REQUEST message. As soon as the DCCH is established, the SS sends an ASSIGNMENT COMMAND message and the MS shall switch to the assigned channel and return an ASSIGNMENT COMPLETE message on the new channel. The MS shall send MEASUREMENT REPORT messages on the SACCH associated with the new DCCH. The SS clears the new DCCH by sending a CHANNEL RELEASE message 10 seconds after sending the ASSIGNMENT COMMAND.

For $K = 1$, the test is done with the SS sending an IMMEDIATE ASSIGNMENT message describing a hopping SDCCH/8 and the ASSIGNMENT COMMAND message describing an SDCCH/8.

For $K = 2$, the test is repeated with the SS sending an IMMEDIATE ASSIGNMENT message describing an SDCCH/4 and the ASSIGNMENT COMMAND message describing an SDCCH/8.

For $K = 3$, and the test is repeated with the SS sending an IMMEDIATE ASSIGNMENT message describing an SDCCH/8 and the ASSIGNMENT COMMAND message describing a TCH/F.

Maximum Duration of Test

5 minutes

Expected Sequence

This sequence is performed for execution counter K = 1 to 3.

Step	Direction	Message	Comments
1	MS		The MS is triggered to perform a GPRS attach procedure
2	MS → SS	CHANNEL REQUEST	See 'specific message contents'
3	SS → MS	IMMEDIATE ASSIGNMENT	
4	MS → SS	RR INITIALISATION REQUEST	Macro
5		{ Classmark and measurement }	
6	SS → MS	ASSIGNMENT COMMAND	See 'specific message contents'
7	MS → SS	ASSIGNMENT COMPLETE	Sent on the correct channel after establishment of the main signalling link. Cause = "normal event"
8		{ Measurement reporting }	
9	SS → MS	CHANNEL RELEASE	Macro. Messages sent on the SACCH associated with the new DCCH 10 seconds after sending the ASSIGNMENT COMMAND

Specific Message Contents

IMMEDIATE ASSIGNMENT

K=1: SDCCH/8 FH:

Information Element	Value/Remarks
Channel Description	
- Channel Type and TDMA offset	SDCCH/8
- TDMA offset	Chosen arbitrarily
- Timeslot Number	Chosen arbitrarily, but not zero
- Training Sequence Code	Same as the BCC
- Hopping channel	RF hopping channel
- MAIO	Chosen arbitrarily from 0 to (N-1). See note 1
- HSN	Chosen arbitrarily from the set (1 to 63)
Mobile Allocation	Same as the CA

NOTE 1: N is the number of frequencies in the Mobile Allocation IE.

K=2: SDCCH/4:

Information Element	Value/Remarks
Channel Description	
- Channel Type and TDMA offset	SDCCH/4
- TDMA offset	Chosen arbitrarily
- Timeslot Number	Zero
- Training Sequence Code	Same as the BCC
- Hopping channel	Single RF channel
- ARFCN	For GSM 450: 263 For GSM 480: 310 For GSM 900, 450/900 and 480/900: 20 For DCS 1 800, 450/900, 480/900 and for 900/1800: 590 For PCS 1900: 590
Mobile Allocation	Not included (length = 0)

K=3: SDCCH/8:

Information Element	Value/Remarks
Channel Description - Channel Type and TDMA offset TDMA offset - Timeslot Number - Training Sequence Code - Hopping channel - ARFCN	SDCCH/8 Chosen arbitrarily Zero Same as the BCC Single RF channel For GSM 450: 267 For GSM 480: 315 For GSM 900, 450/900 and 480/900: 30 For DCS 1 800/450/1800, 480/1800 and for 900/1800: 650 For PCS 1900: 590
Mobile Allocation	Not included (length = 0)

ASSIGNMENT COMMAND

K=1, 2: SDCCH/8:

Information Element	Value/Remarks
Channel Description 2 - Channel Type and TDMA offset TDMA offset - Timeslot Number - Training Sequence Code - Hopping channel - ARFCN	SDCCH/8 Chosen arbitrarily Chosen arbitrarily, but not zero Same as the BCC Single RF channel For GSM 450: 267 For GSM 480: 315 For GSM 900, 450/900 and 480/900: 30 For DCS 1 800, 450/1800, 480/1800 and for 900/1800: 650 For PCS 1900: 650
Mobile Allocation	Not included (length = 0)

K=3: TCH/F:

Information Element	Value/Remarks
Channel Description 2 - Channel Type and TDMA offset - Timeslot Number - Training Sequence Code - Hopping channel - ARFCN	TCH/F + ACCHs Chosen arbitrarily, but not zero Same as the BCC Single RF channel For GSM 450: 263 For GSM 480: 310 For GSM 900, 450/900 and 480/900: 20 For DCS 1 800, 450/1800, 480/1800 and for 900/1800: 590 For PCS 1900: 590
Mobile Allocation	Not included (length = 0)

41.4.3.2 Handover

41.4.3.2.1 Conformance requirements

1. The mobile shall obey the RR management procedures while on the dedicated channel.
2. The handover procedure shall modify the physical channel configuration of the mobile station.
3. During the handover procedure the mobile station shall release the main signalling link, disconnect TCHs if any is allocated, deactivate previously assigned channels, activate new channels and their connections—if applicable—and trigger the establishment of the data link connections for SAPI=0.

References

GSM 04.08, clauses 3.3.1.3 and 3.4.4

GSM 04.13, clause 5.2.6.2

41.4.3.2.2 Test purpose

To verify that while on a dedicated channel the GPRS mobile correctly obeys HANDOVER COMMAND messages in the particular cases of

1. hopping SDCCH/8 to SDCCH/4,
2. SDCCH/4 to TCH/F.

41.4.3.2.3 Method of test

Initial Conditions

System Simulator:

2 cells, A and B with same LAI and RAC. GPRS supported using BCCH in both cells.

For multiband test, cell A will operate in lower band and cell B in upper band.

The frame numbers of cells A and B shall be different by 100. The timebase of cells A and B shall be such that the edges of their timeslots are not coincident at the antenna connector.

For DCS 1 800, the Cell Allocation of both Cell A and Cell B shall be coded using range 256 format.

Mobile Station:

The MS is GMM-DEREGISTERED, in "packet idle" mode and camped on cell A.

Related PICS/PIXIT Statement(s)

As default.

Foreseen Final State of the MS

GMM-DEREGISTERED, in "packet idle" mode and camped on cell B.

Test Procedure

The MS is triggered to perform a GPRS attach procedure and shall send a CHANNEL REQUEST message. The SS then assigns a DCCH to the MS. Once that this channel has been allocated, the SS waits 5 seconds for the MS to synchronise to the neighbouring cells and sends a HANDOVER COMMAND message on the main DCCH demanding the MS to move to a DCCH in another cell. The MS shall begin to send access bursts on the new DCCH of the target cell. After receiving one access burst, the SS sends a PHYSICAL INFORMATION message. The MS shall activate the channel in sending and receiving mode. The MS shall establish a signalling link. The MS shall be ready to transmit⁴ a HANDOVER COMPLETE message, before "x" MS after the end of the PHYSICAL INFORMATION message, but not before an UA frame has been sent by the SS. The value of "x" depends upon the target channel and is specified in the specific message contents section. The SS clears the new DCCH by sending a CHANNEL RELEASE message 10 seconds after sending the HANDOVER COMMAND

For K = 1, the test is done with the SS sending an IMMEDIATE ASSIGNMENT message describing a hopping SDCCH/8 and handing over to an SDCCH/4.

For K = 2 the test is repeated with the SS sending an IMMEDIATE ASSIGNMENT message describing an SDCCH/4 and handing over to a TCH/F.

⁴ The term "ready to transmit" is defined in GSM 04.13

Maximum Duration of Test

5 minutes

Expected Sequence

This sequence is performed for execution counter K = 1 to 2

Step	Direction	Message	Comments
1	MS		The MS is triggered to perform a GPRS attach procedure
2	MS → SS	CHANNEL REQUEST	
3	SS → MS	IMMEDIATE ASSIGNMENT	Channel Type: see 'specific message contents'
4	MS → SS	RR INITIALISATION REQUEST	
5		{ Classmark and measurement }	Macro
6	SS		The SS waits 5 seconds
7	SS → MS	HANDOVER COMMAND	See 'specific message contents'
8	MS → SS	HANDOVER ACCESS	Repeated on every burst of the uplink main DCCH until reception of PHYSICAL INFORMATION
9	SS → MS	PHYSICAL INFORMATION	
10	MS → SS	L2-SABM	Sent without information field
11	MS → SS	L2-UA	
12	MS → SS	HANDOVER COMPLETE	On the new DCCH. This message shall be ready to be transmitted before "x" ms after the completion of step 1. See specific message contents. RR cause = "Normal event". Handover reference must be the same as in HANDOVER COMMAND
13		{ Measurement reporting }	Sent on the SACCH associated with the new DCCH
14	SS → MS	CHANNEL RELEASE	10 seconds after sending the HANDOVER COMMAND

Specific Message Contents

IMMEDIATE ASSIGNMENT

K=1: SDCCH/8 FH

Information Element	Value/Remarks
Channel Description	
- Channel Type and TDMA offset	SDCCH/8
TDMA offset	Chosen arbitrarily
- Timeslot Number	Chosen arbitrarily, but not zero
- Training Sequence Code	Same as the BCC of the cell A
- Hopping channel	RF hopping channel
- MAIO	Chosen arbitrarily from 0 to (N-1). See note 1
- HSN	Chosen arbitrarily from the set (1 to 63)
Mobile Allocation	Same as the CA of the cell A

NOTE 1: N is the number of frequencies in the Mobile Allocation IE.

K=2: SDCCH/4

Information Element	Value/Remarks
Channel Description	
- Channel Type and TDMA offset	SDCCH/4
TDMA offset	Chosen arbitrarily
- Timeslot Number	Zero
- Training Sequence Code	Same as the BCC of the cell A
- Hopping channel	Single RF channel
- ARFCN	Same as the BCCH carrier of the cell A
Mobile Allocation	Not included (length = 0)

HANDOVER COMMAND

K=1: SDCCH/4

Information Element	Value/Remarks
Cell Description - BCCH Carrier Number	For GSM 450: 261 For GSM 480: 308 For GSM 900, 450/900 and 480/900: 10 For DCS 1 800, 450/1800, 480/1800 and for 900/1800: 520 For PCS 1900: 520
Channel Description - Channel Type and TDMA offset TDMA offset - Timeslot Number - Training Sequence Code - Hopping channel - ARFCN	SDCCH/4 Chosen arbitrarily Zero Same as the BCC of the cell B Single RF channel Same as the BCCH carrier of the cell B
Handover reference	Chosen arbitrarily
Synchronisation Indication	IE not included or set to "non-synchronised"

K=2: TCH/F

Information Element	Value/Remarks
Cell Description - BCCH Carrier Number	For GSM 450: 261 For GSM 480: 308 For GSM 900, 450/900 and 480/900: 10 For DCS 1 800, 450/1800, 480/1800 and for 900/1800: 520 For PCS 1900: 520
Channel Description - Channel Type and TDMA offset - Timeslot Number - Training Sequence Code - Hopping channel - ARFCN	TCH/F Chosen arbitrarily, but not zero Same as the BCC of the cell B Single RF channel Same as the BCCH carrier of the cell B
Handover reference	Chosen arbitrarily
Synchronisation Indication	IE not included or set to "non-synchronised"

Step 12:

x = 500 ms.

41.4.3.3 PDCH Assignment Command

41.4.3.3.1 Successful case

41.4.3.3.1.1 Conformance requirements

When in dedicated mode, the network may change the resources of a mobile station that supports the «GPRS» option through the Packet Data Channel procedure.

References

GSM 04.08, clause 3.4.19

41.4.3.3.1.2 Test purpose

To verify that while on a dedicated channel the GPRS mobile correctly obeys the PDCH ASSIGNMENT COMMAND message.

41.4.3.3.1.3 Method of test

Initial Conditions

System Simulator:

1 cell. GPRS supported using BCCH

Mobile Station:

The MS is GMM-DEREGISTERED and in “packet idle” mode.

Related PICS/PIXIT Statement(s)

As default plus

- MAC Extended Fixed Allocation supported (Y/N).

Foreseen Final State of the MS

GMM-REGISTERED and in “packet idle” mode.

Test Procedure

The MS is triggered to perform a GPRS attach procedure and shall send CHANNEL REQUEST message. The SS then assigns a DCCH to the MS. On this channel, the SS sends a PDCH ASSIGNMENT COMMAND message assigning a downlink TBF to the MS. The mobile shall move to the TBF and send at least one LLC frame. The SS checks during 10 seconds that the MS does not transmit on the old DCCH.

For K = 1, the test is done with the SS sending an IMMEDIATE ASSIGNMENT message describing an SDCCH/4 and a PDCH ASSIGNMENT COMMAND message describing a hopping TBF with dynamic allocation.

For K = 2, the test is repeated with the SS sending an IMMEDIATE ASSIGNMENT message describing a TCH/F and a PDCH ASSIGNMENT COMMAND message describing a TBF on the same frequency as the BCCH and with fixed allocation.

For K = 3, the test is repeated with the SS sending an IMMEDIATE ASSIGNMENT message describing a hopping SDCCH/8 and a PDCH ASSIGNMENT COMMAND message describing a TBF on a frequency different from the BCCH carrier with extended fixed allocation, if supported, or dynamic allocation, if not.

Maximum Duration of Test

5 minutes

Expected Sequence

Step	Direction	Message	Comments
1	MS		The MS is triggered to perform a GPRS attach procedure
2	MS → SS	CHANNEL REQUEST	
3	SS → MS	IMMEDIATE ASSIGNMENT	See ‘specific message contents’
4	MS → SS	RR INITIALISATION REQUEST	
5		{ Classmark and measurement }	Macro
6	SS → MS	PDCH ASSIGNMENT COMMAND	See ‘specific message contents’
7	MS → SS	LLC frame	Sent on the assigned TBF.
8	SS		The SS checks during 10 seconds that the MS does not transmit on the old channel

Specific Message Contents

IMMEDIATE ASSIGNMENT

K=1: SDCCH/4:

Information Element	Value/Remarks
Channel Description	
- Channel Type and TDMA offset	SDCCH/4
TDMA offset	Chosen arbitrarily
- Timeslot Number	Zero
- Training Sequence Code	Same as the BCC
- Hopping channel	Single RF channel
- ARFCN	Same as the BCCH carrier
Mobile Allocation	Not included (length = 0)

K=2: TCH/F:

Information Element	Value/Remarks
Channel Description	
- Channel Type and TDMA offset	TCH/F + ACCHs
- Timeslot Number	Chosen arbitrarily, but not zero
- Training Sequence Code	Same as the BCC
- Hopping channel	Single RF channel
- ARFCN	Same as the BCCH carrier
Mobile Allocation	Not included (length = 0)

K=3: SDCCH/8 FH:

Information Element	Value/Remarks
Channel Description	
- Channel Type and TDMA offset	SDCCH/8
TDMA offset	Chosen arbitrarily
- Timeslot Number	Chosen arbitrarily, but not zero
- Training Sequence Code	Same as the BCC
- Hopping channel	RF hopping channel
- MAIO	Chosen arbitrarily from 0 to (N-1). See note 1
- HSN	Chosen arbitrarily from the set (1 to 63)
Mobile Allocation	Same as the CA

NOTE 1: N is the number of frequencies in the Mobile Allocation IE.

PDCH ASSIGNMENT COMMAND

K=1: hopping TBF, MAC Dynamic Allocation

Information Element	Value/Remarks
Channel Description	
- Channel Type and TDMA offset	TCH/F + ACCHs
- Timeslot Number	Chosen arbitrarily
- Training Sequence Code	Same as the BCC
- Hopping channel	RF hopping channel
- MAIO	Chosen arbitrarily from 0 to (N-1). See note 1
- HSN	Chosen arbitrarily from the set (1 to 63)
RR Packet Downlink Assignment	
- MAC_MODE	00 (Dynamic allocation)

K=2: TBF on the BCCH carrier, MAC Fixed Allocation

Information Element	Value/Remarks
Channel Description - Channel Type and TDMA offset - Timeslot Number - Training Sequence Code - Hopping channel - ARFCN	TCH/F + ACCHs Chosen arbitrarily. Same as the BCC Single RF channel
RR Packet Downlink Assignment - MAC_MODE	01 (Fixed allocation)

K=3: TBF on a frequency different from the BCCH carrier

Information Element	Value/Remarks
Channel Description - Channel Type and TDMA offset - Timeslot Number - Training Sequence Code - Hopping channel - ARFCN	TCH/F + ACCHs Chosen arbitrarily Same as the BCC Single RF channel For GSM 450: 267 For GSM 480: 315 For GSM 900: 30 For DCS 1 800: 650 For PCS 1 900: 650
RR Packet Downlink Assignment - MAC_MODE	10 (Extended Fixed Allocation), if supported 00 (Dynamic Allocation), otherwise

NOTE 1: N is the number of frequencies in the Mobile Allocation IE.

41.4.3.3.2 Failure / T3132 expires

41.4.3.3.2.1 Conformance requirements

1. If the mobile does not successfully receive RLC/MAC blocks within T3132 seconds after PDCH ASSIGNMENT COMMAND message, it shall reactivate the old channels, reconnect the TCHs, if any, and trigger the establishment of the main signalling link.
2. The mobile shall send an ASSIGNMENT FAILURE message with cause "protocol error unspecified" on the DCCH and resumes normal operation as if no assignment attempt had occurred.

References

GSM 04.08, clause 3.4.19

41.4.3.3.2.2 Test purpose

1. To verify that the GPRS mobile returns to the old channels if the SS does not send data or control blocks in the PDCH ASSIGNMENT procedure.
2. To verify that the mobile correctly formats and sends an ASSIGNMENT FAILURE message.

41.4.3.3.2.3 Method of test

Initial Conditions

System Simulator:

1 cell. GPRS supported using BCCH

Mobile Station:

The MS is GMM-DEREGISTERED and in "packet idle" mode.

Related PICS/PIXIT Statement(s)

As default.

Foreseen Final State of the MS

GMM-DEREGISTERED and in "packet idle" mode.

Test Procedure

The MS is triggered to perform a GPRS attach procedure and shall send a CHANNEL REQUEST message. The SS then assigns an SDCCH/8 to the MS. On this channel, the SS sends a PDCH ASSIGNMENT COMMAND message assigning a downlink TBF to the MS. The MS shall stop sending measurement reports on the old SACCH, go to the TBF and wait. The SS checks that the MS does not transmit anything on the SDCCH before establishing it again with a layer 2 SABM frame, which shall not be sent before T3132 seconds after the PDCH ASSIGNMENT COMMAND message was sent. Once the old dedicated channel is re-established, the MS shall send an ASSIGNMENT FAILURE message with cause "protocol error unspecified". The MS shall continue sending MEASUREMENT REPORT messages. The SS finally clears the SDCCH with a CHANNEL RELEASE message 10 seconds after sending the PDCH ASSIGNMENT COMMAND.

Maximum Duration of Test

5 minutes

Expected Sequence

Step	Direction	Message	Comments
1	MS		The MS is triggered to perform a GPRS attach procedure
2	MS → SS	CHANNEL REQUEST	
3	SS → MS	IMMEDIATE ASSIGNMENT	Channel Type = SDCCH/8
4	MS → SS	RR INITIALISATION REQUEST	
5		{ Classmark and measurement }	Macro
6	SS → MS	PDCH ASSIGNMENT COMMAND	The SS does not transmit any RLC/MAC blocks to the mobile on the assigned TBF.
7	MS → SS	L2-SABM	Sent on the old DCCH. The SS checks that it is not sent before T3132 seconds after the PDCH ASSIGNMENT COMMAND message
8	SS → MS	L2-UA	
9	MS → SS	ASSIGNMENT FAILURE	Cause = "Protocol error unspecified"
10		{ Measurement reporting }	Macro. The SS verifies that the MS sends these messages on the SACCH associated with the SDCCH assigned in step 3
11	SS → MS	CHANNEL RELEASE	10 seconds after sending the PDCH ASSIGNMENT COMMAND

Specific Message Contents

None.

41.4.3.4 Cell change order

41.4.3.4.1 Successful case / Normal procedure

41.4.3.4.1.1 Conformance requirements

When in dedicated mode, the network may modify the channels allocated to a mobile station that supports the «GPRS» option through the RR-Network Commanded Cell Change Order. The mobile station shall obey the RR-Cell Change

Order irrespective of whether or not the mobile has any knowledge of the relative synchronisation of the target cell to the serving cell.

References

GSM 04.08, clause 3.4.20

41.4.3.4.1.2 Test purpose

1. To verify that, while on a dedicated channel, the GPRS mobile correctly obeys the RR-CELL CHANGE ORDER message.
2. To verify that the GPRS mobile successfully establish a TBF in the target cell.
3. To verify that the GPRS mobile obeys the RR-CELL CHANGE ORDER message both when the target BCCH ARFCN is contained in the SI messages of the serving cell and when it is excluded.

41.4.3.4.1.3 Method of test

Initial Conditions

System Simulator:

2 cells: Cell A supports GPRS using the BCCH

As defaults except:

CELL A		
(P)SI	Information Element	Value/Remarks
	BCCH ARFCN	For GSM 450, 450/900 and 450/1800: 263 For GSM 480, 480/900 and 480/1800: 310 For GSM 900 and 900/1800: 20 For DCS 1 800: 590 For PCS 1 900: 590
SI 2	Neighbour Cell Description - BCCH allocation ARFCN	For GSM 450: channel numbers 261,290 and 293 For GSM 480: channel numbers 308, 337 and 340 For GSM 900, 450/900 and 480/900: channel numbers 10, 110 and 120 For DCS 1 800, 450/1800, 480/1800 and 900/1800: channel numbers 520, 810 and 870 For PCS 1 900: channel numbers 520, 760 and 780
SI 2ter	Neighbour Cell Description 2 - BCCH allocation ARFCN	For GSM 450 cells: channel numbers 520, 810 and 870 For GSM 480 cells: channel numbers 520, 810 and 870 For GSM 900 cells: channel numbers 520, 810 and 870 For DCS 1 800 cells: channel numbers 10, 110 and 120
SI 3	Control Channel Description - CCCH_CONF	For execution counter K = 1 and 2, 001 (1 basic physical channel used for CCCH, combined with SDCCHs) For execution counter K = 3, 000 (1 basic physical channel used for CCCH, not combined with SDCCHs)

CELL B		
(P)SI	Information Element	Value/Remarks
	BCCH ARFCN	For GSM 450: For execution counter K = 1 and 3, 284 For execution counter K = 2, 261 For GSM 480: For execution counter K = 1 and 3, 331 For execution counter K = 2, 308 For GSM 900, 450/900 and 480/900: For execution counter K = 1 and 3, 90 For execution counter K = 2, 10 For DCS 1 800, 450/1800, 480/1800 and 900/1800: For execution counter K = 1 and 3, 700 For execution counter K = 2, 520 For PCS 1 900: For execution counter K = 1 and 3, 700 For execution counter K = 2, 520
SI 1	Cell Channel Description - Cell allocation ARFCN	For GSM 450: channel numbers 261, 282, 284 and 287 For GSM 480: channel numbers 308, 329, 331 and 334 For GSM 900, 450/900 and 480/900: channel numbers 10, 80, 90 and 100 For DCS 1 800, 450/1800, 480/1800 and 900/1800: channel numbers 520, 600, 700 and 780 For PCS 1 900: channel numbers 520, 600, 700 and 780
SI 13	SI 13 Rest Octets - { L H } - RA_CODE - { 0 1 }	H 00000101 For execution counter K = 1: 0 (PBCCH not present) For execution counter K = 2 and 3: 1 (PBCCH present)
	- PBCCH Description - TN	(Only for PBCCH present) For execution counter K = 2: 4 For execution counter K = 3: 0
	- TSC - { 0 1 } - ARFCN	3 For execution counter K = 2: 0 (Single RF channel) For GSM 450: 284 For GSM 480: 331 For GSM 900: 90 For DCS 1 800 and PCS 1 900: 700
	- { 0 1 } - MAIO - HSN - Length of MA - Mobile Allocation	For execution counter K = 3: 1 (RF hopping channel) Chosen arbitrarily from 0 to (N-1). See note 1 Chosen arbitrarily from the set (1 to 63) 3 (Number of frequencies = 4) Same as CA

NOTE 1: N is the number of frequencies in the Mobile Allocation IE.

Mobile Station:

The MS is GMM-DEREGISTERED, in “packet idle” mode and camped on cell A.

Related PICS/PIXIT Statement(s)

As default.

Foreseen Final State of the MS

GMM-REGISTERED, in “packet idle” mode and camped on cell B.

Test Procedure

The MS is triggered to perform a GPRS attach procedure. The MS shall send a CHANNEL REQUEST message. The SS then assigns a DCCH to the MS and waits 10 seconds to allow the MS to decode SI 5 messages and send (on the DCCH) a CLASSMARK CHANGE message containing an MS Classmark 2 and 3 and (on the SACCH) measurement reports on related to the neighbouring cells. On this channel, the SS sends an RR-CELL CHANGE ORDER message describing the BCCH carrier of a neighbouring cell. The MS shall go to this cell and initiate an access procedure by sending a CHANNEL REQUEST message or a PACKET CHANNEL REQUEST message in a valid TDMA frame belonging to the RACH or PRACH of the new cell. The SS sends an IMMEDIATE ASSIGNMENT message or a PACKET UPLINK ASSIGNMENT message describing an uplink TBF. The MS shall move to the TBF and send at least one LLC frame.

For K = 1, the test is done with the SS sending an IMMEDIATE ASSIGNMENT message on cell A describing an SDCCH/4 and an IMMEDIATE ASSIGNMENT message on cell B describing a TBF on the BCCH carrier.

For K = 2, the test is repeated with the SS sending an IMMEDIATE ASSIGNMENT message on cell A describing an SDCCH/8 on a different frequency from the BCCH carrier and a PACKET UPLINK ASSIGNMENT message on cell B describing a hopping TBF.

For K = 3, the test is repeated with the SS sending an IMMEDIATE ASSIGNMENT message on cell A describing a TCH/F and a PACKET DOWNLINK ASSIGNMENT message on cell B describing a TBF on a different frequency from the BCCH carrier.

Maximum Duration of Test

5 minutes

Expected Sequence

This sequence is performed for execution counter K = 1 to 3.

Step	Direction	Message	Comments
1	MS		The MS is triggered to perform a GPRS attach procedure
2	MS → SS	CHANNEL REQUEST	Establishment Cause = "One phase packet access"
3	SS → MS	IMMEDIATE ASSIGNMENT	See 'specific message contents'
4	MS → SS	RR INITIALISATION REQUEST	Sent on the correct channel after establishment of the main signalling link
5		{ Classmark and measurement }	Macro
6	SS		The SS waits 10 seconds
7	SS → MS	RR-CELL CHANGE ORDER	See 'specific message contents'
8a	MS → SS	CHANNEL REQUEST	Only for K = 1 On cell B. Establishment Cause = "One phase packet access"
9a	SS → MS	IMMEDIATE ASSIGNMENT	See 'specific message contents'
8b	MS → SS	PACKET CHANNEL REQUEST	Only for K = 2 and 3 On cell B. Establishment Cause = "One phase packet access"
9b	SS → MS	PACKET DOWNLINK ASSIGNMENT	See 'specific message contents'
10	MS → SS	LLC frame	Sent on the assigned TBF.

Specific Message Contents

IMMEDIATE ASSIGNMENT (Step 3)

K=1: SDCCH/4:

Information Element	Value/Remarks
Channel Description - Channel Type and TDMA offset TDMA offset - Timeslot Number - Training Sequence Code - Hopping channel - ARFCN	SDCCH/4 Chosen arbitrarily Zero Same as the BCC Single RF channel
Mobile Allocation	Same as the BCCH carrier Not included (length = 0)

K=2: SDCCH/8, not on the BCCH carrier:

Information Element	Value/Remarks
Channel Description - Channel Type and TDMA offset TDMA offset - Timeslot Number - Training Sequence Code - Hopping channel - ARFCN	SDCCH/8 Chosen arbitrarily Chosen arbitrarily Same as the BCC Single RF channel For GSM 450, 450/900 and 450/1800: 267 For GSM 480, 480/900 and 480/1800: 315 For GSM 900 and 900/1800: 30 For DCS 1 800 and PCS 1 900: 650
Mobile Allocation	Not included (length = 0)

K=3: TCH/F:

Information Element	Value/Remarks
Channel Description - Channel Type and TDMA offset - Timeslot Number - Training Sequence Code - Hopping channel - ARFCN	TCH/F Chosen arbitrarily Same as the BCC Single RF channel Same as the BCCH carrier
Mobile Allocation	Not included (length = 0)

RR-CELL CHANGE ORDER

K=1, 3: Non-synchronised case:

Information Element	Value/Remarks
Cell description - BCCH ARFCN	For GSM 450: 284 For GSM 480: 331 For GSM 900, 450/900 and 480/900: 90 For DCS 1 800, 450/1800, 480/1800 and 900/1800: 700 For PCS 1 900: 700

K=2: Synchronised case:

Information Element	Value/Remarks
Cell description - BCCH ARFCN	For GSM 450: 261 For GSM 480: 308 For GSM 900, 450/900 and 480/900: 10 For DCS 1 800, 450/1800, 480/1800 and 900/1800: 520 For PCS 1 900: 520

IMMEDIATE ASSIGNMENT (Step 9a)

K=1: TBF on the BCCH carrier:

Information Element	Value/Remarks
Packet Response Type and Dedicated Mode or TBF	
- Downlink	0
- PR Type	10 (Binary, packet immediate assignment or packet downlink assignment procedure using the <i>Packet Channel Description</i> IE)
- T/D	1 (This message assigns a Temporary Block Flow)
Packet Channel Description	
- Channel type	00001 (Binary: PDCH)
- TN	Chosen arbitrarily, but not zero
- TSC	5
- { 0 1 }	0 (Single RF channel)
-	00
- ARFCN	For GSM 450: 284 For GSM 480: 331 For GSM 900, 450/900 and 480/900: 90 For DCS 1 800, 450/1800, 480/1800 and 900/1800: 700 For PCS 1 900: 700

PACKET DOWNLINK ASSIGNMENT

K=2: TBF FH:

Information Element	Value/Remarks
{ L H <Frequency Parameters> }	H (Frequency Parameters present)
- { 0 1 }	1 (RF hopping channel)
- MA_NUMBER	Chosen arbitrarily
- MAIO	Chosen arbitrarily
- MA_CHANGE_MARK	Chosen arbitrarily

K=3: TBF on a different frequency from the BCCH carrier:

Information Element	Value/Remarks
{ L H <Frequency Parameters> }	H (Frequency Parameters present)
- { 0 1 }	0 (Single RF channel)
- ARFCN	For GSM 450: 282 For GSM 480: 329 For GSM 900, 450/900 and 480/900: 80 For DCS 1 800, 450/1800, 480/1800 and 900/1800: 600 For PCS 1 900: 600
- TSC	5

41.4.3.4.2 Successful case / DCCH on the target cell

41.4.3.4.2.1 Conformance requirements

When in dedicated mode, the network may modify the channels allocated to a mobile station that supports the «GPRS» option through the RR-Network Commanded Cell Change Order.

References

GSM 04.08, clause 3.4.20

41.4.3.4.2.2 Test purpose

1. To verify that while on a dedicated channel, the GPRS mobile correctly obeys the RR-CELL CHANGE ORDER message.
2. To verify that the GPRS mobile correctly establish a DCCH in the target cell after the access procedure.
3. To verify that the GPRS mobile successfully establish a TBF in the target cell from the DCCH.

41.4.3.4.2.3 Method of test

Initial Conditions

System Simulator:

2 cells: Cells A and B. Both cells support GPRS using the BCCH.

As defaults except:

CELL A		
(P)SI	Information Element	Value/Remarks
	BCCH ARFCN	For GSM 450: 263 For GSM 480: 310 For GSM 900, 450/900 and 480/900: 20 For DCS 1 800, 450/1800, 480/1800 and 900/1800: 590 For PCS 1 900: 590
SI 2	Neighbour Cell Description - BCCH allocation ARFCN	For GSM 450, 450/900 and 450/1800: channel numbers 261, 290 and 293 For GSM 480, 480/900 and 480/1800: channel numbers 308, 337 and 340 For GSM 900 and 900/1800: channel numbers 10, 110 and 120 For DCS 1 800: channel numbers 520, 810 and 870 For PCS 1 900: channel numbers 520, 760 and 780
SI 2ter	Neighbour Cell Description 2 - BCCH allocation ARFCN	For GSM 450 cells: channel numbers 520, 810 and 870 For GSM 480 cells: channel numbers 520, 810 and 870

CELL B		
(P)SI	Information Element	Value/Remarks
	BCCH ARFCN	For GSM 450, 450/900 and 450/1800: 284 For GSM 480, 480/900 and 480/1800: 331 For GSM 900 and 900/1800: 90 For DCS 1 800: 700 For PCS 1 900: 700
SI 1	Cell Channel Description - Cell allocation ARFCN	For GSM 450, 450/900 and 450/1800: channel numbers 261, 282, 284 and 287 For GSM 480, 480/900 and 480/1800: channel numbers 308, 329, 331 and 334 For GSM 900 and 900/1800: channel numbers 10, 80, 90 and 100 For DCS 1 800: channel numbers 520, 600, 700 and 780 For PCS 1 900: channel numbers 520, 600, 700 and 780

NOTE 1: N is the number of frequencies in the Mobile Allocation IE.

Mobile Station:

The MS is GMM-DEREGISTERED, in "packet idle" mode and camped on cell A.

Related PICS/PIXIT Statement(s)

As default.

Foreseen Final State of the MS

GMM-REGISTERED, in “packet idle” mode and camped on cell B.

Test Procedure

The MS is triggered to perform a GPRS attach procedure. The MS shall send a CHANNEL REQUEST message. The SS then assigns an SDCCH/8 to the MS and waits 10 seconds to allow the MS to decode SI 5 messages and send (on the assigned SDCCH/8) a CLASSMARK CHANGE message containing an MS Classmark 2 and 3 and (on the SACCH associated with the assigned SDCCH/8) measurement reports related to the neighbouring cells. The SS sends an RR-CELL CHANGE ORDER message on the SDCCH/8 describing the BCCH carrier of a neighbouring cell. The MS shall go to this cell and initiate an access procedure sending a CHANNEL REQUEST message in a valid TDMA frame belonging to the RACH of the new cell. The SS sends an IMMEDIATE ASSIGNMENT message describing an SDCCH/4. The MS shall connect this channel and send on it a CLASSMARK CHANGE message containing MS Classmark 2 and 3 and the MS shall send measurement reports on the associated SACCH. The SS then sends a PDCH ASSIGNMENT COMMAND message on the SDCCH/4 describing an uplink TBF. The MS shall move to this TBF and send at least one LLC frame on the assigned TBF.

Maximum Duration of Test

5 minutes

Expected Sequence

Step	Direction	Message	Comments
1	MS		The MS is triggered to perform a GPRS attach procedure
2	MS → SS	CHANNEL REQUEST	Establishment Cause = “One phase packet access”
3	SS → MS	IMMEDIATE ASSIGNMENT	See ‘specific message contents’
4	MS → SS	RR INITIALISATION REQUEST	Sent on the correct channel after establishment of the main signalling link
5		{ Classmark and measurement }	Macro
6	SS		The SS waits 10 seconds
7	SS → MS	RR-CELL CHANGE ORDER	See ‘specific message contents’
8	MS → SS	CHANNEL REQUEST	On cell B. Establishment Cause = “One phase packet access”
9	SS → MS	IMMEDIATE ASSIGNMENT	See ‘specific message contents’
10	MS → SS	RR INITIALISATION REQUEST	Sent on the new DCCH
11		{ Classmark and measurement }	Macro. Sent on the SACCH associated with the new DCCH
12	SS → MS	PDCH ASSIGNMENT COMMAND	See ‘specific message contents’
13	MS → SS	LLC frame	Sent on the assigned TBF.

Specific Message Contents

IMMEDIATE ASSIGNMENT (Step 3)

Information Element	Value/Remarks
Packet Response Type and Dedicated mode or TBF -T/D	Dedicated mode
Channel Description	
- Channel Type and TDMA offset	SDCCH/8
- TDMA offset	Chosen arbitrarily
- Timeslot Number	Zero
- Training Sequence Code	Same as the BCC
- Hopping channel	Single RF channel
- ARFCN	For GSM 450: 267 For GSM 480: 315 For GSM 900, 450/900 and 480/900: 30 For DCS 1 800, 450/1800, 480/1800 and 900/1800: 650 For PCS 1 900: 650
Mobile Allocation	Not included (length = 0)

RR-CELL CHANGE ORDER

Information Element	Value/Remarks
Cell description - BCCH ARFCN	For GSM 450, 450/900 and 450/1800: 284 For GSM 480, 480/900 and 480/1800: 331 For GSM 900 and 900/1800: 90 For DCS 1 800 For PCS 1 900: 650: 700

IMMEDIATE ASSIGNMENT (Step 9)

Information Element	Value/Remarks
Packet Response Type and Dedicated mode or TBF -T/D	Dedicated mode
Channel Description - Channel Type and TDMA offset TDMA offset - Timeslot Number - Training Sequence Code - Hopping channel - ARFCN	SDCCH/4 Chosen arbitrarily Zero Same as the BCC Single RF channel For GSM 450, 450/900 and 450/1800: 284 For GSM 480, 480/900 and 480/1800: 331 For GSM 900 and 900/1800: 90 For DCS 1 800 and PCS 1 900: 700
Mobile Allocation	Not included (length = 0)

PDCH ASSIGNMENT COMMAND

Information Element	Value/Remarks
Channel Description - Channel Type and TDMA offset - Timeslot Number - Training Sequence Code - Hopping channel - ARFCN	TCH/F + ACCHs Chosen arbitrarily Same as the BCC Single RF channel For GSM 450, 450/900 and 450/1800: 284 For GSm 480, 480/900 and 480/1800: 331 For GSM 900 and 900/1800: 90 For DCS 1 800 and PCS 1 900: 700

41.4.3.4.3 Failure / Immediate Assignment Reject on CCCH of the target cell

41.4.3.4.3.1 Conformance requirements

1. On receipt of an IMMEDIATE ASSIGNMENT REJECT message corresponding to one of its 3 last CHANNEL REQUEST messages, the mobile station, stops sending CHANNEL REQUEST messages.
2. If an IMMEDIATE ASSIGNMENT REJECT message is received from the new cell then the mobile station shall reactivate the old channels, reconnect the TCHs if any and trigger the establishment of the main signalling link. It then sends a HANDOVER FAILURE message on the main signalling link and resumes normal operation as if no handover attempt had occurred.

References

GSM 04.08, clauses 3.3.1.1.3.2 and 3.4.20.3

41.4.3.4.3.2 Test purpose

1. To verify that the GPRS mobile stops transmitting CHANNEL REQUEST messages when receiving in an access procedure an IMMEDIATE ASSIGNMENT REJECT message within an RR-Network Commanded Cell Change Order procedure.
2. To verify that the GPRS mobile re-establishes the old DCCH.

3. To verify that the GPRS mobile correctly formats the HANOVER FAILURE message and sends it on the old DCCH.

41.4.3.4.3.3 Method of test

Initial Conditions

System Simulator:

2 cells: cell A and cell B. Both cells support GPRS on the BCCH.

Mobile Station:

The MS is GMM-DEREGISTERED, in “packet idle” mode and camped on cell A.

Related PICS/PIXIT Statement(s)

As default.

Foreseen Final State of the MS

GMM-DEREGISTERED, in “packet idle” mode and camped on cell A.

Test Procedure

The MS is triggered to perform a GPRS attach procedure. The MS shall send a CHANNEL REQUEST message. The SS then assigns an SDCCH/4 to the MS and waits 10 seconds to allow the MS to decode SI 5 messages and send (on the assigned SDCCH/4) a CLASSMARK CHANGE message containing an MS Classmark 2 and 3, and (on the SACCH associated with the assigned SDCCH/4) measurement reports related to the neighbouring cells. On this channel, the SS sends an RR-CELL CHANGE ORDER message describing the BCCH carrier of a neighbouring cell. The MS shall go to this cell and initiate an access procedure sending a CHANNEL REQUEST message in a valid TDMA frame belonging to the RACH of the new cell. The SS sends an IMMEDIATE ASSIGNMENT REJECT message. The MS shall re-establish the old SDCCH/4 and send a HANOVER FAILURE message on it and continue sending MEASUREMENT REPORT messages on the SACCH associated with the old SDCCH/4. The SS finally clears the SDCCH/4 with a CHANNEL RELEASE message 10 seconds after sending the RR-CELL CHANGE ORDER.

Maximum Duration of Test

5 minutes

Expected Sequence

Step	Direction	Message	Comments
1	MS		The MS is triggered to perform a GPRS attach procedure
2	MS → SS	CHANNEL REQUEST	Establishment Cause = “One phase packet access”
3	SS → MS	IMMEDIATE ASSIGNMENT	Channel Type = SDCCH/4
4	MS → SS	RR INITIALISATION REQUEST	Sent on the correct channel after establishment of the main signalling link
5		{ Classmark and measurement }	Macro
6	SS		The SS waits 10 seconds
7	SS → MS	RR-CELL CHANGE ORDER	
8	MS → SS	CHANNEL REQUEST	On cell B. Establishment Cause = “One phase packet access”
9	SS → MS	IMMEDIATE ASSIGNMENT REJECT	
10	MS → SS	L2-SABM	Sent on the old DCCH
11	SS → MS	L2-UA	
12	MS → SS	HANOVER FAILURE	Sent on the old DCCH
13		{ Measurement reporting }	Macro. Sent on the SACCH associated with the old DCCH
14	SS → MS	CHANNEL RELEASE	10 seconds after sending the RR-CELL CHANGE ORDER

Specific Message Contents

None

41.4.3.4.4 Failure / Packet Access Reject on PCCCH of the target cell

41.4.3.4.4.1 Conformance requirements

1. On receipt of a PACKET ACCESS REJECT message the mobile station shall stop sending PACKET CHANNEL REQUEST messages.
2. If a PACKET ACCESS REJECT message is received from the new cell then the mobile station shall reactivate the old channels, reconnect the TCHs if any and trigger the establishment of the main signalling link. It then sends a HANDOVER FAILURE message on the main signalling link and resumes normal operation as if no handover attempt had occurred.

References

1. GSM 04.60, clause 7.1.2.2.4
2. GSM 04.08, clause 3.4.20.3 + CR04.08A452

41.4.3.4.4.2 Test purpose

1. To verify that the GPRS mobile stops transmitting PACKET CHANNEL REQUEST messages when receiving in an access procedure a PACKET ACCESS REJECT message after a successful RR-Network Commanded Cell Change Order procedure.
2. To verify that the GPRS mobile re-establishes the old DCCH.
3. To verify that the GPRS mobile correctly formats the HANDOVER FAILURE message and sends it on the old DCCH.

41.4.3.4.4.3 Method of test

Initial Conditions

System Simulator:

2 cells: cell A and cell B. Cell A supports GPRS using the BCCH; cell B supports GPRS using the PBCCH.

Mobile Station:

The MS is GMM-DEREGISTERED, in "packet idle" mode and camped on cell A.

Related PICS/PIXIT Statement(s)

As default.

Foreseen Final State of the MS

GMM-DEREGISTERED, in "packet idle" mode and camped on cell A.

Test Procedure

The MS is triggered to perform a GPRS attach procedure. The MS shall send a CHANNEL REQUEST message. The SS then assigns an SDCCH/4 to the MS and waits 10 seconds to allow the MS to decode SI 5 messages and send (on the assigned SDCCH/4) a CLASSMARK CHANGE message containing an MS Classmark 2 and 3, and (on the SACCH associated with the assigned SDCCH/4) measurement reports related to the neighbouring cells. On this channel, the SS sends an RR-CELL CHANGE ORDER message describing the BCCH carrier of a neighbouring cell. The MS shall go to this cell and initiate a packet access procedure sending a PACKET CHANNEL REQUEST message in a valid TDMA frame belonging to the PRACH of the new cell. The SS sends a PACKET ACCESS REJECT message. The MS shall re-establish the old SDCCH/4 and send a HANDOVER FAILURE message on it and continue sending MEASUREMENT REPORT messages on the SACCH associated with the old SDCCH/4. The SS finally clears the SDCCH/4 with a CHANNEL RELEASE message 10 seconds after sending the RR-CELL CHANGE ORDER.

Maximum Duration of Test

5 minutes

Expected Sequence

Step	Direction	Message	Comments
1	MS		The MS is triggered to perform a GPRS attach procedure
2	MS → SS	CHANNEL REQUEST	Establishment Cause = "One phase packet access"
3	SS → MS	IMMEDIATE ASSIGNMENT	Channel Type = SDCCH/4
4	MS → SS	RR INITIALISATION REQUEST	Sent on the correct channel after establishment of the main signalling link
5		{ Classmark and measurement }	Macro
6	SS		The SS waits 10 seconds
7	SS → MS	RR-CELL CHANGE ORDER	
8	MS → SS	PACKET CHANNEL REQUEST	On cell B. Establishment Cause = "One phase packet access"
9	SS → MS	PACKET ACCESS REJECT	
10	MS → SS	L2-SABM	Sent on the old DCCH
11	SS → MS	L2-UA	
12	MS → SS	HANDOVER FAILURE	Sent on the old DCCH
13		{ Measurement reporting }	Macro. Sent on the SACCH associated with the old DCCH
14	SS → MS	CHANNEL RELEASE	10 seconds after sending the RR-CELL CHANGE ORDER

Specific Message Contents

None

41.4.3.4.5 Failure / T3134 expiry

41.4.3.4.5.1 Conformance requirements

If timer T3134 times out before a response to the (PACKET) CHANNEL REQUEST message has been received from the new cell, then the mobile station shall reactivate the old channels, reconnect the TCHs if any and trigger the establishment of the main signalling link. It then sends a HANDOVER FAILURE message on the main signalling link and resumes normal operation as if no handover attempt had occurred.

References

GSM 04.08, clause 3.4.20.3 + CR04.08A452

41.4.3.4.5.2 Test purpose

1. To verify that the GPRS mobile waits for T3134 seconds for an answer to the (PACKET) CHANNEL REQUEST after a successful RR-Network Commanded Cell Change Order procedure.

2. To verify that the GPRS mobile re-establishes the old DCCH.
3. To verify that the GPRS mobile correctly formats the HANDOVER FAILURE message and sends it on the old DCCH.

41.4.3.4.5.3 Method of test

Initial Conditions

System Simulator:

2 cells: cell A and cell B. Cell A supports GPRS on the BCCH.

MAX_RETRANS is set to 1.

Mobile Station:

The MS is GMM-DEREGISTERED, in "packet idle" mode and camped on cell A.

Related PICS/PIXIT Statement(s)

As default.

Foreseen Final State of the MS

GMM-DEREGISTERED, in "packet idle" mode and camped on cell A.

Test Procedure

The MS is triggered to perform a GPRS attach procedure. The MS shall send a CHANNEL REQUEST message. The SS then assigns an SDCCH/8 to the MS and waits 10 seconds to allow the MS to decode SI 5 messages and send (on the assigned SDCCH/8) a CLASSMARK CHANGE message containing an MS Classmark 2 and 3, and (on the SACCH associated with the assigned SDCCH/8) measurement reports related to the neighbouring cells. On this channel, the SS sends an RR-CELL CHANGE ORDER message describing the BCCH carrier of a neighbouring cell. The MS shall go to this cell and initiate a (packet) access procedure sending a (PACKET) CHANNEL REQUEST message in a valid TDMA frame belonging to the (P)RACH of the new cell. The MS shall retransmit the (PACKET) CHANNEL REQUEST message. The SS does not answer these (PACKET) CHANNEL REQUEST messages. The SS checks that the mobile reconnects the old SDCCH/8 and sends a HANDOVER FAILURE message, but not before T3134 seconds after the first (PACKET) CHANNEL REQUEST message. The MS shall send MEASUREMENT REPORT messages on the SACCH associated with the old SDCCH/8. The SS finally clears the SDCCH/8 with a CHANNEL RELEASE message 10 seconds after sending the RR-CELL CHANGE ORDER.

For K = 1, the test is done with cell B supporting GRPS using the BCCH.

For K = 2, the test is repeated with cell B supporting GRPS using the PBCCH.

Maximum Duration of Test

5 minutes

Expected Sequence

This sequence is performed for execution counter K = 1 to 2.

Step	Direction	Message	Comments
1	MS		The MS is triggered to perform a GPRS attach procedure
2	MS → SS	CHANNEL REQUEST	Establishment Cause = "One phase packet access"
3	SS → MS	IMMEDIATE ASSIGNMENT	Channel Type = SDCCH/8
4	MS → SS	RR INITIALISATION REQUEST	Sent on the correct channel after establishment of the main signalling link
5		{ Classmark and measurement }	Macro
6	SS		The SS waits 10 seconds
7	SS → MS	RR-CELL CHANGE ORDER	
8a	MS → SS	CHANNEL REQUEST	Only for K = 1 On cell B. Establishment Cause = "One phase packet access"
9a	MS → SS	CHANNEL REQUEST	On cell B. Establishment Cause = "One phase packet access"
8b	MS → SS	PACKET CHANNEL REQUEST	Only for K = 2 On cell B. Establishment Cause = "One phase packet access"
9b	MS → SS	PACKET CHANNEL REQUEST	On cell B. Establishment Cause = "One phase packet access"
10	MS → SS	L2-SABM	Sent on the old DCCH
11	SS → MS	L2-UA	
12	MS → SS	HANDOVER FAILURE	Sent on the old DCCH not before T3134 seconds after the first (PACKET) CHANNEL REQUEST message
13		{ Measurement reporting }	Macro. Sent on the SACCH associated with the old DCCH
14	SS → MS	CHANNEL RELEASE	10 seconds after sending the RR-CELL CHANGE ORDER

Specific Message Contents

None

41.4.3.4.6 Contention resolution failure / GPRS supported using BCCH

41.4.3.4.6.1 Conformance requirements

1. If the contention resolution procedure fails on the new cell then the mobile station shall reactivate the old channels, reconnect the TCHs if any and trigger the establishment of the main signalling link. It then sends a HANDOVER FAILURE message on the main signalling link and resumes normal operation as if no handover attempt had occurred.
2. If an information field mismatch occurs in the first contention resolution procedure on the target cell, the allocated channel is released and the immediate assignment procedure shall be repeated. If an information field mismatch occurs in the repeated contention resolution procedure, the MS shall release the allocated channel and return to the old cell.

References

GSM 04.08, clauses 3.3.1.1.5 and 3.4.20

41.4.3.4.6.2 Test purpose

1. To verify that the MS stops transmitting on the allocated channel in the target cell and restarts the immediate assignment procedure after the first identity mismatch in the contention resolution procedure.
2. To verify that the MS stops transmitting on the allocated channel in the target after the second identity mismatch in the contention resolution procedure.

3. To verify that the GPRS mobile re-establishes the old DCCH.
4. To verify that the GPRS mobile correctly formats the HANDOVER FAILURE message and sends it on the old DCCH.

41.4.3.4.6.3 Method of test

Initial Conditions

System Simulator:

2 cells: cell A and cell B. Both cells support GPRS on the BCCH.

Mobile Station:

The MS is GMM-DEREGISTERED, in “packet idle” mode and camped on cell A.

Related PICS/PIXIT Statement(s)

As default.

Foreseen Final State of the MS

GMM-DEREGISTERED, in “packet idle” mode and camped on cell A.

Test Procedure

The MS is triggered to perform a GPRS attach procedure. The MS shall send a CHANNEL REQUEST message. The SS then assigns an SDCCH/4 to the MS and waits 10 seconds to allow the MS to decode SI 5 messages and send (on the assigned SDCCH/4) a CLASSMARK CHANGE message containing an MS Classmark 2 and 3, and (on the SACCH associated with the assigned SDCCH/4) measurement reports related to the neighbouring cells. On this channel, the SS sends an RR-CELL CHANGE ORDER message describing the BCCH carrier of a neighbouring cell. The MS shall go to this cell and initiate an access procedure sending a CHANNEL REQUEST message in a valid TDMA frame belonging to the RACH of the new cell. The SS assigns an SDCCH/4. The MS shall go to the correct channel and send an RR INITIALISATION REQUEST message containing its identity. The SS answers with a P-TMSI not corresponding to the MS. The MS shall stop transmitting on the assigned SDCCH/4 and restart the access procedure. The SS answers again with a P-TMSI not corresponding to the MS and checks that the mobile re-establishes the SDCCH/4 of cell A and sends a HANDOVER FAILURE message on the old SDCCH/4. The MS shall continue sending MEASUREMENT REPORT messages on SACCH associated with the old SDCCH/4. The SS finally clears the SDCCH/4 with a CHANNEL RELEASE message 20 seconds after sending the RR-CELL CHANGE ORDER.

Maximum Duration of Test

5 minutes

Expected Sequence

Step	Direction	Message	Comments
1	MS		The MS is triggered to perform a GPRS attach procedure
2	MS → SS	CHANNEL REQUEST	Establishment Cause = "One phase packet access"
3	SS → MS	IMMEDIATE ASSIGNMENT	Channel Type = SDCCH/4
4	MS → SS	RR INITIALISATION REQUEST	Sent on the correct channel after establishment of the main signalling link
5		{ Classmark and measurement }	Macro
6	SS		The SS waits 10 seconds
7	SS → MS	RR-CELL CHANGE ORDER	
8	MS → SS	CHANNEL REQUEST	On cell B. Establishment Cause = "One phase packet access"
9	SS → MS	IMMEDIATE ASSIGNMENT	Channel Type = SDCCH/4
10	MS → SS	RR INITIALISATION REQUEST	Contains P-TMSI of the MS
11	SS → MS	L2-UA	UA frame: contains P-TMSI different to the MS's
12	SS		The SS checks that there is no transmission on the DCCH until the CHANNEL REQUEST is received
13	MS → SS	CHANNEL REQUEST	On cell B. Establishment Cause = "One phase packet access"
14	SS → MS	IMMEDIATE ASSIGNMENT	Channel Type = SDCCH/4
15	MS → SS	RR INITIALISATION REQUEST	Contains P-TMSI of the MS
16	SS → MS	L2-UA	UA frame: contains P-TMSI different to the MS's
17	MS → SS	L2-SABM	Sent on the old DCCH
18	SS → MS	L2-UA	
19	MS → SS	HANDOVER FAILURE	Sent on the old DCCH
20		{ Measurement reporting }	Macro. Sent on the SACCH associated with the old DCCH
21	SS → MS	CHANNEL RELEASE	20 seconds after sending the RR-CELL CHANGE ORDER

Specific Message Contents

None

41.4.3.4.7 Contention resolution failure / GPRS supported using PBCCH / Timer or counter expiry

41.4.3.4.7.1 Conformance requirements

1. The contention resolution has failed on the mobile station side when the counter N3104 has reached its maximum value, or on expiry of timer. The mobile station shall then reset the counter N3104, stop timer T3166 if not expired, immediately stop transmitting on this TBF and reinitiate the packet access procedure unless it has already been repeated 4 times. In that case, TBF failure has occurred.
2. On the mobile station side if the contention resolution procedure fails on the new cell then the mobile station shall reactivate the old channels, reconnect the TCHs if any and trigger the establishment of the main signalling link. It then sends a HANDOVER FAILURE message on the main signalling link and resumes normal operation as if no handover attempt had occurred. The operational parameters (e.g. ciphering mode) when returning on the old channel are those applied before the RR-CELL CHANGE ORDER message was received.

References

GSM 04.60, clauses 7.1.2.3 and 7.1.4 + CR 04.60A223

GSM 04.08, clause 3.4.20.3

41.4.3.4.7.2 Test purpose

To verify that during an RR-cell change order procedure, if the SS does not acknowledge any of the uplink RLC/MAC data blocks on the target cell, the mobile repeats the packet access procedure four times and then returns to the DCCH in the old cell.

41.4.3.4.7.3 Method of test

Initial Conditions

System Simulator:

2 cells, A and B. Cell A supports GPRS using BCCH; cell B supports GPRS using PBCCH.

For multiband test, cell A will operate in lower band and cell B in upper band.

Mobile Station:

The MS is GMM-DEREGISTERED, in "packet idle" mode and camped on cell A.

Related PICS/PIXIT Statement(s)

As default.

Foreseen Final State of the MS

GMM-DEREGISTERED, in "packet idle" mode and camped on cell A.

Test Procedure

The MS is triggered to perform a GPRS attach procedure. The MS shall send a CHANNEL REQUEST message. The SS assigns an SDCCH/8. The MS shall go to the correct channel, send an RR INITIALISATION REQUEST message, send (on the assigned SDCCH/8) a CLASSMARK CHANGE containing an MS Classmark 2 and 3 and send (on the SACCH associated with the assigned SDCCH/8) continuously MEASUREMENT REPORT messages. Five seconds after having received the RR INITIALISATION REQUEST message, the SS sends an RR-CELL CHANGE ORDER message, containing the ARFCN of the BCCH carrier of cell B. The MS shall then start the packet access procedure by sending a PACKET CHANNEL REQUEST message on the PRACH of the target cell. The SS assigns an uplink TBF to the mobile with a PACKET UPLINK ASSIGNMENT message. The mobile shall then start to transmit uplink data blocks. The first three blocks, and only them, shall contain the TLLI of the MS. The SS waits and does not send any acknowledgement message. The MS shall stop transmitting on the TBF and restart the packet access procedure with a new PACKET CHANNEL REQUEST message on the target cell. This sequence is performed five times. After the fifth failed attempt, the mobile shall re-establish the old SDCCH by sending a layer 2 SABM frame. Once on the old dedicated channel, the MS shall continue sending MEASUREMENT REPORT messages; the SS checks this during 5 seconds and then clears the SDCCH with a CHANNEL RELEASE message 30 seconds after sending the RR-CELL CHANGE ORDER.

For K = 1, the test is done with:

- BS_CV_MAX set to 1
- the SS includes the USF of the mobile in the header of every available block transmitted downlink in the same PDCH that the MS is using

For K = 2, the test is repeated with:

- BS_CV_MAX set to 15
- the SS includes the USF of the mobile in the header of blocks transmitted downlink in the same PDCH that the MS is using, at the rate of one per second

Maximum Duration of Test

5 minutes

Expected Sequence

This sequence is performed for execution counter K = 1 to 2.

Step	Direction	Message	Comments
1	MS		The MS is triggered to perform a GPRS attach procedure.
2	MS → SS	CHANNEL REQUEST	Establishment Cause = "One phase packet access"
3	SS → MS	IMMEDIATE ASSIGNMENT	Channel type = 'SDCCH/8'
4	MS → SS	RR INITIALISATION REQUEST	Sent on the correct channel after establishment of the main signalling link
5		{ Classmark and measurement }	Macro
6	SS		The SS waits 5 seconds
7	SS → MS	RR-CELL CHANGE ORDER	
8	MS → SS	PACKET CHANNEL REQUEST	On cell B. Establishment Cause = "One phase packet access"
9	SS → MS	PACKET UPLINK ASSIGNMENT	See 'Specific Message Contents'
10		{ Uplink data transfer }	Macro. The first three data blocks, and only them, must contain the MS's TLLI. The SS does not send any acknowledgement message
11	MS		The MS stops transmitting on the TBF
12	MS → SS	PACKET CHANNEL REQUEST	On cell B. Establishment Cause = "One phase packet access"
13	SS → MS	PACKET UPLINK ASSIGNMENT	See 'Specific Message Contents'
14		{ Uplink data transfer }	Macro. The first three data blocks, and only them, must contain the MS's TLLI. The SS does not send any acknowledgement message
15	MS		The MS stops transmitting on the TBF
16	MS → SS	PACKET CHANNEL REQUEST	On cell B. Establishment Cause = "One phase packet access"
17	SS → MS	PACKET UPLINK ASSIGNMENT	See 'Specific Message Contents'
18		{ Uplink data transfer }	Macro. The first three data blocks, and only them, must contain the MS's TLLI. The SS does not send any acknowledgement message
19	MS		The MS stops transmitting on the TBF
20	MS → SS	PACKET CHANNEL REQUEST	On cell B. Establishment Cause = "One phase packet access"
21	SS → MS	PACKET UPLINK ASSIGNMENT	See 'Specific Message Contents'
22		{ Uplink data transfer }	Macro. The first three data blocks, and only them, must contain the MS's TLLI. The SS does not send any acknowledgement message
23	MS		The MS stops transmitting on the TBF
24	MS → SS	PACKET CHANNEL REQUEST	On cell B. Establishment Cause = "One phase packet access"
25	SS → MS	PACKET UPLINK ASSIGNMENT	Fixed allocation struct present
26		{ Uplink data transfer }	Macro. The first three data blocks, and only them, must contain the MS's TLLI. The SS does not send any acknowledgement message
27	MS		The MS stops transmitting on the TBF
28	MS → SS	L2-SABM	On the old SDCCH/8 assigned in step 3
29	SS → MS	L2-UA	
30		{ Measurement reporting }	Macro. On the SACCH associated with the SDCCH/8. The SS checks 5 seconds.
31	SS → MS	CHANNEL RELEASE	30 seconds after sending the RR-CELL CHANGE ORDER

Specific Message Contents

None

41.4.3.4.8 Contention resolution failure / GPRS supported using PBCCH / TLLI mismatch

41.4.3.4.8.1 Conformance requirements

1. The contention resolution has failed on the mobile station side when the mobile station receives a PACKET UPLINK ASSIGNMENT message with the same TFI but with another TLLI than the one the mobile station has included in the PACKET RESOURCE REQUEST message. The mobile station shall then stop timer T3168 and reinitiate the packet access procedure unless it has already been repeated 4 times. In that case, TBF failure has occurred.
2. On the mobile station side if the contention resolution procedure fails on the new cell then the mobile station shall reactivate the old channels, reconnect the TCHs if any and trigger the establishment of the main signalling link. It then sends a HANDOVER FAILURE message on the main signalling link and resumes normal operation as if no handover attempt had occurred. The operational parameters (e.g. ciphering mode) when returning on the old channel are those applied before the RR-CELL CHANGE ORDER message was received.

References

GSM 04.60, clauses 7.1.3.2.1 and 7.1.4 + CR 04.60A223

GSM 04.08, clause 3.4.20.3

41.4.3.4.8.2 Test purpose

To verify that during an RR-cell change order procedure, if the SS sends

1. a PACKET UPLINK ACK/NACK message in response to the first RLC/MAC data block, in the case of one phase packet access procedure, or
2. a PACKET UPLINK ASSIGNMENT message in response to the PACKET RESOURCE REQUEST message, in the case of two phase packet access procedure,

the mobile repeats the packet access procedure four times and then returns to the DCCH in the old cell.

41.4.3.4.8.3 Method of test

Initial Conditions

System Simulator:

2 cells, A and B. Cell A supports GPRS using BCCH; Cell B supports GPRS using PBCCH.

For multiband test, cell A will operate in lower band and cell B in upper band.

Mobile Station:

The MS is GMM-DEREGISTERED, in "packet idle" mode and camped on cell A.

Related PICS/PIXIT Statement(s)

As default.

Foreseen Final State of the MS

GMM-DEREGISTERED, in "packet idle" mode and camped on cell A.

Test Procedure

The MS is triggered to perform a GPRS attach procedure. The MS shall send a CHANNEL REQUEST message. The SS assigns an SDCCH/4. The MS shall go to the correct channel, send an RR INITIALISATION REQUEST message, send (on the assigned SDCCH/4) a CLASSMARK CHANGE containing an MS Classmark 2 and 3 and send (on the SACCH associated with the assigned SDCCH/4) continuously MEASUREMENT REPORT messages. Five seconds after having received the RR INITIALISATION REQUEST message, the SS sends an RR-CELL CHANGE ORDER message, containing the ARFCN of the BCCH carrier of cell B. The MS shall then start the packet access procedure by sending a PACKET CHANNEL REQUEST message on the PRACH of the target cell. The SS assigns an uplink TBF to the mobile with a PACKET UPLINK ASSIGNMENT message.

The mobile shall send a PACKET RESOURCE REQUEST message containing its TLLI. The SS then answers with a PACKET UPLINK ASSIGNMENT message containing a different TLLI.

The MS shall stop transmitting on the TBF and restart the packet access procedure with a new PACKET CHANNEL REQUEST message on the target cell. This sequence is performed five times. After the fifth failed attempt, the mobile shall re-establish the old SDCCH by sending a layer 2 SABM frame. Once on the old dedicated channel, the MS shall continue sending MEASUREMENT REPORT messages. The SS clears the SDCCH with a CHANNEL RELEASE message 30 seconds after sending the RR-CELL CHANGE ORDER.

Maximum Duration of Test

5 minutes

Expected Sequence

Step	Direction	Message	Comments
1	MS		The MS is triggered to perform a GPRS attach procedure.
2	MS → SS	CHANNEL REQUEST	Establishment Cause = "One phase packet access"
3	SS → MS	IMMEDIATE ASSIGNMENT	Channel type = 'SDCCH/4'
4	MS → SS	RR INITIALISATION REQUEST	Sent on the correct channel after establishment of the main signalling link
5		{ Classmark and measurement }	Macro
6	SS		The SS waits 5 seconds
7	SS → MS	RR-CELL CHANGE ORDER	
8	MS → SS	PACKET CHANNEL REQUEST	On cell B. Establishment Cause = "One phase packet access"
9	SS → MS	PACKET UPLINK ASSIGNMENT	See 'Specific Message Contents'
10	MS → SS	PACKET RESOURCE REQUEST	It must contain the TLLI
11	SS → MS	PACKET UPLINK ASSIGNMENT	With a different TLLI
12	MS		The MS stops transmitting on the TBF
13	MS → SS	PACKET CHANNEL REQUEST	On cell B. Establishment Cause = "One phase packet access"
14	SS → MS	PACKET UPLINK ASSIGNMENT	See 'Specific Message Contents'
15	MS → SS	PACKET RESOURCE REQUEST	It must contain the TLLI
16	SS → MS	PACKET UPLINK ASSIGNMENT	With a different TLLI
17	MS		The MS stops transmitting on the TBF
18	MS → SS	PACKET CHANNEL REQUEST	On cell B. Establishment Cause = "One phase packet access"
19	SS → MS	PACKET UPLINK ASSIGNMENT	See 'Specific Message Contents'
20	MS → SS	PACKET RESOURCE REQUEST	It must contain the TLLI
21	SS → MS	PACKET UPLINK ASSIGNMENT	With a different TLLI
22	MS		The MS stops transmitting on the TBF
23	MS → SS	PACKET CHANNEL REQUEST	On cell B. Establishment Cause = "One phase packet access"
24	SS → MS	PACKET UPLINK ASSIGNMENT	Single block allocation struct present
25	MS → SS	PACKET RESOURCE REQUEST	It must contain the TLLI
26	SS → MS	PACKET UPLINK ASSIGNMENT	With a different TLLI
27	MS		The MS stops transmitting on the TBF
28	MS → SS	PACKET CHANNEL REQUEST	On cell B. Establishment Cause = "One phase packet access"
29	SS → MS	PACKET UPLINK ASSIGNMENT	See 'Specific Message Contents'
30	MS → SS	PACKET RESOURCE REQUEST	It must contain the TLLI
31	SS → MS	PACKET UPLINK ASSIGNMENT	With a different TLLI
32	MS		The MS stops transmitting on the TBF
33	MS → SS	L2-SABM	On the old SDCCH/8 assigned in step 3
34	SS → MS	L2-UA	
35		{ Measurement reporting }	Macro. Sent on the SACCH associated with the old SDCCH/8
36	SS → MS	CHANNEL RELEASE	30 seconds after sending the RR-CELL CHANGE ORDER

Specific Message Contents

PACKET UPLINK ASSIGNMENT

None

41.4.3.5 Release

41.4.3.5.1 Conformance requirements

1. The mobile shall obey the RR management procedures while on the dedicated channel.
2. Upon receipt of CHANNEL RELEASE message, the mobile shall release the dedicated channels and return to idle mode. If the mobile station is IMSI attached for GPRS services at release of the RR connection, the mobile station shall return to packet idle mode, or if a temporary block flow is established, continue in packet transfer mode.

References

GSM 04.08, clauses 3.3.1.3 and 3.4.13

41.4.3.5.2 Test purpose

To verify that the mobile while on a DCCH correctly obeys a CHANNEL RELEASE message, releasing the dedicated channels and returning to packet idle mode.

41.4.3.5.3 Method of test

Initial Conditions

System Simulator:

1 cell, GPRS supported using BCCH

Mobile Station:

The MS is GMM-DEREGISTERED and in "packet idle" mode.

Related PICS/PIXIT Statement(s)

As default.

Foreseen Final State of the MS

GMM-DEREGISTERED and in "packet idle" mode.

Test Procedure

The MS is triggered to perform a GPRS attach procedure. The SS assigns a DCCH to the MS and then sends a CHANNEL RELEASE message. The MS shall initiate a Layer 2 disconnection process on the main signalling link and stop the transmission of Layer 2 messages, which is verified by the SS during 5 seconds. The SS then waits 10 seconds to allow cell reselection on the MS side. The MS shall return to ready state, which is verified with a normal paging procedure.

For K = 1, the test is done with the SS sending an IMMEDIATE ASSIGNMENT message describing an SDCCH/4.

For K = 2, the test is repeated with the SS sending an IMMEDIATE ASSIGNMENT message describing an SDCCH/8.

For K = 3, the test is repeated with the SS sending an IMMEDIATE ASSIGNMENT message describing a TCH/F.

Maximum Duration of Test

5 minutes

Expected Sequence

This sequence is performed for execution counter K = 1 to 3.

Step	Direction	Message	Comments
1	MS		The MS is triggered to perform a GPRS attach procedure
2	MS → SS	CHANNEL REQUEST	Establishment Cause = "One phase packet access" See 'specific message contents'
3	SS → MS	IMMEDIATE ASSIGNMENT	
4	MS → SS	RR INITIALISATION REQUEST	
5	SS → MS	CHANNEL RELEASE	
6	MS → SS	L2-DISC	
7	SS → MS	L2-UA	
8	SS		
9	SS		
10	SS → MS	PAGING REQUEST Type 1	Establishment Cause = "One phase packet access" See 'specific message contents'
11	MS → SS	CHANNEL REQUEST	
12	SS → MS	IMMEDIATE ASSIGNMENT	
13	MS → SS	RR INITIALISATION REQUEST	
14	SS → MS	CHANNEL RELEASE	

Specific Message Contents

IMMEDIATE ASSIGNMENT (step 3)

K=1: SDCCH/4

Information Element	Value/Remarks
Channel description	
- Channel Type and TDMA offset	SDCCH/4
TDMA offset	Chosen arbitrarily
- Timeslot Number	Zero
- Training Sequence Code	Same as the BCC
- Hopping channel	Single RF channel
- ARFCN	Same as the BCCH carrier
Mobile Allocation	Not included (length = 0)

K=2: SDCCH/8

Information Element	Value/Remarks
Channel description	
- Channel Type and TDMA offset	SDCCH/8
TDMA offset	Chosen arbitrarily
- Timeslot Number	Zero
- Training Sequence Code	Same as the BCC
- Hopping channel	Single RF channel
- ARFCN	Same as the BCCH carrier
Mobile Allocation	Not included (length = 0)

K=3: TCH/F

Information Element	Value/Remarks
Channel description	
- Channel Type and TDMA offset	SDCCH/4
TDMA offset	Chosen arbitrarily
- Timeslot Number	Zero
- Training Sequence Code	Same as the BCC
- Hopping channel	Single RF channel
- ARFCN	Same as the BCCH carrier
Mobile Allocation	Not included (length = 0)

41.4.3.6 Radio link failure

41.4.3.6.1 Conformance requirements

1. A radio link failure can be detected by several ways, in particular, when a lower layer failure happens while the mobile station attempts to connect back to the old channels in a channel assignment procedure, handover procedure, PDCH Assignment Command procedure or an RR-Cell Change Order procedure.⁵
2. When a radio link failure is detected by the mobile station,
 - the MS shall perform a local end release on all signalling links unless otherwise specified;
 - deactivate all channels;
 - the RR sublayer of the mobile station shall indicate an RR connection failure to the MM sublayer, unless otherwise specified.

References

GSM 04.08, clause 3.4.13.2.

41.4.3.6.2 Test purpose

To verify that the MS releases and deactivates the old channel after a radio link failure during the following procedures:

- Assignment
- Handover
- PDCH Assignment
- RR-Cell Change Order

41.4.3.6.3 Method of test

Initial Conditions

System Simulator:

2 cells, A and B with same LAI and RAC. GPRS supported using BCCH in both cells

MAX_RETRANS is set to 1 in cell B

For multiband test, cell A will operate in upper band and cell B in lower band.

Mobile Station:

The MS is GMM-DEREGISTERED and in "packet idle" mode.

Related PICS/PIXIT Statement(s)

As default.

Foreseen Final State of the MS

GMM-DEREGISTERED and in "packet idle" mode.

⁵ After CR to 04.08

Test Procedure

The MS is triggered to perform a GPRS attach procedure. The SS then assigns a SDCCH/8. On the dedicated channel, the SS sends

- for K = 1, an ASSIGNMENT COMMAND message, describing an SDCCH/4,
- for K = 2, a HANDOVER COMMAND message, describing a hopping SDCCH/8 on cell B,
- for K = 3, a PDCH ASSIGNMENT COMMAND message, describing a downlink TBF,
- for K = 4, an RR-CELL CHANGE ORDER message, describing the BCCH ARFCN of cell B.

The mobile then shall go to the described channel or cell and try to establish the new main signalling link. The SS does not answer any of the MS attempts of connection, either as layer 2 SABM frames on the target DCCH or CHANNEL REQUEST messages on the target cell, and checks during 30 seconds that the MS does not transmit either on the target DCCH or TBF or cell or on the old DCCH.

Maximum Duration of Test

5 minutes

Expected Sequence

This sequence is performed for execution counter K = 1 to 4.

Step	Direction	Message	Comments
1	MS		The MS is triggered to perform a GPRS attach procedure
2	MS → SS	CHANNEL REQUEST	Establishment Cause = "One phase packet access" Describes an SDCCH/8 Macro
3	SS → MS	IMMEDIATE ASSIGNMENT	
4	MS → SS	RR INITIALISATION REQUEST	
5		{ Classmark and measurement }	
6a	SS → MS	ASSIGNMENT COMMAND	
7a	MS → SS	RR INITIALISATION REQUEST	On the target DCCH. The SS does not send L2-UA frame
8a	MS → SS	RR INITIALISATION REQUEST	On the target DCCH. The SS does not send L2-UA frame
9a	MS → SS	RR INITIALISATION REQUEST	On the target DCCH. The SS does not send L2-UA frame
10a	MS → SS	RR INITIALISATION REQUEST	On the target DCCH. The SS does not send L2-UA frame
11a	MS → SS	RR INITIALISATION REQUEST	On the target DCCH. The SS does not send L2-UA frame
12a	MS → SS	RR INITIALISATION REQUEST	On the target DCCH. The SS does not send L2-UA frame
6b	SS → MS	HANDOVER COMMAND	K = 2
7b	MS → SS	RR INITIALISATION REQUEST	On the target DCCH. The SS does not send L2-UA frame
8b	MS → SS	RR INITIALISATION REQUEST	On the target DCCH. The SS does not send L2-UA frame
9b	MS → SS	RR INITIALISATION REQUEST	On the target DCCH. The SS does not send L2-UA frame
10b	MS → SS	RR INITIALISATION REQUEST	On the target DCCH. The SS does not send L2-UA frame
11b	MS → SS	RR INITIALISATION REQUEST	On the target DCCH. The SS does not send L2-UA frame
12b	MS → SS	RR INITIALISATION REQUEST	On the target DCCH. The SS does not send L2-UA frame
6c	SS → MS	PDCH ASSIGNMENT COMMAND	K = 3. Describes a downlink TBF
7c	SS		The SS does not transmit on the described TBF
6d	SS → MS	RR-CELL CHANGE ORDER	K = 4
7d	MS → SS	CHANNEL REQUEST	On the target cell
8d	MS → SS	CHANNEL REQUEST	On the target cell
n	MS → SS	L2-SABM	On the old DCCH. The SS does not send L2-UA frame
n+1	MS → SS	L2-SABM	On the old DCCH. The SS does not send L2-UA frame
n+2	MS → SS	L2-SABM	On the old DCCH. The SS does not send L2-UA frame
n+3	MS → SS	L2-SABM	On the old DCCH. The SS does not send L2-UA frame
n+4	MS → SS	L2-SABM	On the old DCCH. The SS does not send L2-UA frame
n+5	MS → SS	L2-SABM	On the old DCCH. The SS does not send L2-UA frame
n+6	SS		The SS checks that the MS does not transmit either on the target DCCH or on the old DCCH

NOTE: n = 13, for K = 1 and 2

n = 7, for K = 3

n = 9, for K = 4

Specific Message Contents

None.

42 Test of Medium Access Control (MAC) protocol

42.1 Test of Medium Access Control (MAC) Procedures on PCCCH in idle mode

This clause presents tests for “Medium Access Control (MAC) Procedures on PCCCH in idle mode” which are specified in GSM 04.60/7.

Applicability and default conditions

The clause is applicable for all mobiles supporting GPRS unless otherwise stated in a specific test.

The SS default conditions simulate one cell with default settings as defined in the GPRS general default section.

The MS default initial condition is GPRS attached. Unless otherwise stated, no PDP context is required.

The default message contents and signaling macro not specified in the end of this section shall be set as in “GPRS default conditions” Chapter 40. Specific message contents for a test case is specified in each test case.

Conditions or message contents specified in a test case have the highest precedence. In addition, the default message contents described in the end of this section override those specified in “GPRS default conditions”.

In case the test case not expected “short access” as access type for Packet Channel Request the amount of RLC data specified in the comments in expected sequence is not necessary to be exactly the specified amount of data. It only has to be more than the limit for short access. If the test case need a specific amount of data this is specified in the test case.

42.1.1 Packet Channel Request

42.1.1.1 Packet Channel Request / Message format

42.1.1.1.1 Conformance requirements

There are two formats of the PACKET CHANNEL REQUEST message containing either 8 bits or 11 bits of information. The format to be applied on PRACH is controlled by the parameter ACC_BURST_TYPE that is broadcast on PBCCH.

Reference

GSM 04.60 subclause 7.1.2.1

42.1.1.1.2 Test purpose

To verify that the mobile station applies the correct PACKET CHANNEL REQUEST message format on PRACH according to the ACC_BURST_TYPE parameter broadcast on PBCCH.

42.1.1.1.3 Method of test

Initial conditions

System Simulator:

1 cell supporting GPRS. The packet system information ACCESS_BURST_TYPE indicates 11 bit access.

Mobile Station:

The MS is switched off.

Related PICS/PIXIT statement

Support GPRS service.

Method of trigger GPRS attach.

Switch On/off Yes / No.

Test procedure

The MS is switched on and triggered to perform a GPRS attach. The MS shall send PACKET CHANNEL REQUEST message. The SS verifies that the MS requests 11 bit access format. Switch off the MS.

Change the ACCESS_BURST_TYPE parameter in Packet System Information to 8 bit format and repeat the test procedure. The SS verifies that the MS requests 8 bit access format.

Maximum duration of the test

1 min.

Expected sequence

Step	Direction	Message	Comments
1	MS		The MS is switched on and triggered to perform a GPRS attach.
2	MS -> SS	PACKET CHANNEL REQUEST	ACCESS TYPE = "Mobility Management procedure". Received on PRACH.
3	SS		SS verifies the requested access bit format.
4	MS		If possible the MS is powered down or switched off otherwise it has its power source removed and then restored.
5	SS	PACKET SYSTEM INFORMATION Type 1	Change ACCESS_BURST_TYPE to indicate 8 bit access. Sent on PBCCH.
6			Repeat step 1 to 3.

Specific message contents

None.

42.1.1.2 Packet Channel Request / Response to Packet Paging

42.1.1.2.1 Conformance requirements

A mobile station in class A or class B mode of operation shall respond to a PACKET PAGING REQUEST message indicating an RR connection establishment. A mobile station in class B mode of operation may abort the packet access procedure at the receipt of a PACKET PAGING REQUEST message indicating an establishment of a RR connection. PACKET PAGING REQUEST messages indicating a non-RR connection shall be ignored.

Mobile stations in class C mode of operating shall not respond to any type of PACKET PAGING REQUEST messages during the packet access procedure but decode the PERSISTENCE_LEVEL parameter if included in the message.

Reference

GSM 04.60 subclause 7.1.2.1

42.1.1.2.2 Test purpose

To verify that the mobile station ignores PACKET PAGING REQUEST messages indicating a non-RR connection after scheduling the sending of PACKET CHANNEL REQUEST messages.

To verify that a mobile station in class A or class B mode of operation shall respond to a PACKET PAGING REQUEST message indicating an RR connection establishment after scheduling the sending of PACKET CHANNEL REQUEST messages.

To verify that a mobile station in class C mode of operating shall not respond to any type of PACKET PAGING REQUEST messages during the packet access procedure.

42.1.1.2.3 Method of test

Initial conditions

System Simulator:

1 cell supporting GPRS. The packet system information ACCESS_BURST_TYPE indicates 8 bit access and MAX_RETRANS indicates 7 allowed retransmission.

Mobile Station:

The MS is GPRS attached and in packet idle mode. PDP context 2 has been established.

Related PICS/PIXIT statement

Support GPRS service.

Supporting GPRS MS class A, B or C Yes/No

Support PDP context.

Method of triggering the MS to initiate an uplink packet transfer.

Test procedure

All MS classes, non-RR connection paging.

The MS is triggered to initiate an uplink packet transfer. When SS has received the first PACKET CHANNEL REQUEST message shall PACKET PAGING REQUEST message indicating a non-RR connection be sent to the MS. The MS shall ignore the PACKET PAGING REQUEST message and continue to send PACKET CHANNEL REQUEST messages requesting one or two phase access. The SS sends PACKET ACCESS REJECT to end the test case.

MS class A and class B, RR connection paging.

The MS is triggered to initiate an uplink packet transfer. When SS has received the first PACKET CHANNEL REQUEST message shall PACKET PAGING REQUEST message indicating a RR connection be sent to the MS. The MS shall send CHANNEL REQUEST messages with establishment cause = "Answer to paging". SS verify that the MS request RR connection. The SS sends IMMEDIATE ASSIGNMENT REJECT to end the test case.

MS class C, RR connection paging.

The MS is triggered to initiate an uplink packet transfer. When SS has received the first PACKET CHANNEL REQUEST message shall PACKET PAGING REQUEST message indicating a RR connection be sent to the MS. The MS shall ignore the PACKET PAGING REQUEST message and continue to send PACKET CHANNEL REQUEST messages requesting one or two phase access. The SS sends PACKET ACCESS REJECT to end the test case.

Maximum duration of the test

1 min.

Expected sequence

All MS classes, non-RR connection paging.

Step	Direction	Message	Comments
1	MS		The MS is triggered to send 200 octets data.
2	MS -> SS	PACKET CHANNEL REQUEST	ACCESS TYPE = "One or Two Phase Access Request". Received on PRACH.
3	SS -> MS	PACKET PAGING REQUEST	Sent on PPCH for TBF establishment.
4	MS -> SS	PACKET CHANNEL REQUEST	ACCESS TYPE = "One or Two Phase Access Request". Received on PRACH. The SS verifies that the MS continue request One or Two Phase packet Access.
5	SS -> MS	PACKET ACCESS REJECT	Sent on PAGCH.

MS class A and class B, RR connection paging.

Only Network mode I.

Step	Direction	Message	Comments
1	MS		The MS is triggered to send 200 octets data.
2	MS -> SS	PACKET CHANNEL REQUEST	ACCESS TYPE = "One or Two Phase Access Request". Received on PRACH.
3	SS -> MS	PACKET PAGING REQUEST (1)	See specific message contents. Sent on PPCH for RR connection.
4	MS -> SS	CHANNEL REQUEST	Establishment cause = Answer to paging". Received on RACH. The SS verifies that the MS request RR connection.
5	SS -> MS	IMMEDIATE ASSIGNMENT REJECT	

MS class C, RR connection paging.

Step	Direction	Message	Comments
1	MS		The MS is triggered to send 200 octets data.
2	MS -> SS	PACKET CHANNEL REQUEST	ACCESS TYPE = "One or Two Phase Access Request". Received on PRACH.
3	SS -> MS	PACKET PAGING REQUEST (1)	See specific message contents. Sent on PPCH for RR connection.
4	MS -> SS	PACKET CHANNEL REQUEST	ACCESS TYPE = "One or Two Phase Access Request". Received on PRACH. The SS verifies that the MS request One or Two Phase packet Access.
5	SS -> MS	PACKET ACCESS REJECT	Sent on PAGCH.

Specific message contents

As default messages contents, except:

PACKET PAGING REQUEST (1)

Information element	Value/remark
{1 < Repeated Page info >}	1 (start of Repeated Page info)
{1	1 (page request for RR connection establ.)
{0 < TMSI >	0 (allocated TMSI)
< CHANNEL_NEEDED >	00 (any channel type)
{0 1 < eMLPP_PRIORITY >	1 (page request to trigger RR connection)
-eMLPP_PRIORITY}	000 (no priority specified)

42.1.1.3 Packet Channel Request / Access type

42.1.1.3.1 Conformance requirements

If the mobile station intends to use the TBF to send user data, it shall request two phase access if the requested RLC mode is unacknowledged mode. If the requested RLC mode is acknowledged mode and the amount of data can fit in 8 or less than 8 RLC/MAC blocks, the mobile station shall indicate Short Access as access type. The number of blocks shall be calculated assuming channel coding scheme CS-1. If the requested RLC mode is acknowledged mode and amount of data to send takes more than 8 RLC/MAC blocks, the mobile station shall request either one phase access or two phase access.

Reference

GSM 04.60 subclause 7.1.2.1

42.1.1.3.2 Test purpose

- 1 To verify that the mobile station indicates Short Access as access type if the amount of data to send can fit in 8 or less than 8 RLC/MAC blocks if the requested RLC mode is acknowledged mode.
- 2 To verify that the mobile station requests either one phase or two phase access if the amount of data to send takes more than 8 RLC/MAC blocks if the requested RLC mode is acknowledged mode.
- 3 To verify that the mobile station requests two phase access if the requested RLC mode is unacknowledged mode.

42.1.1.3.3 Method of test

Initial conditions

System Simulator:

1 cell supporting GPRS.

Mobile Station:

The MS is GPRS attached and in packet idle mode. PDP context 2 has been established.

Related PICS/PIXIT statement

Support GPRS service.

Support PDP context.

Method of triggering the MS to initiate an uplink packet data transfer.

Test procedure

The MS is triggered to send data that can fit in 8 or less RLC data blocks. The SS verifies that the MS indicates Short Access Request as the access type in the PACKET CHANNEL REQUEST message. The SS sends PACKET ACCESS REJECT to end the test case.

The MS is triggered to send data where the amount of data takes more than 8 RLC blocks. The SS verifies that the MS indicates One or Two Phase Access Request as the access type in the PACKET CHANNEL REQUEST message. The SS sends PACKET ACCESS REJECT to end the test case.

Repeat above tests with RLC unacknowledged mode.

Maximum duration of the test

20 s.

Expected sequence

Step	Direction	Message	Comments
1	MS		The MS is triggered to send data that can fit in 8 or less RLC data blocks.
2	MS -> SS	PACKET CHANNEL REQUEST	SS verifies that the MS indicates Short Access Request as access type. Received on PRACH.
3	SS -> MS	PACKET ACCESS REJECT	Sent on PAGCH.
4	MS		The MS is triggered to send data where the amount of data takes more than 8 RLC/MAC blocks.
5	MS -> SS	PACKET CHANNEL REQUEST	SS verifies that the MS indicate One or Two Phase Access Request. Received on PRACH.
6	SS -> MS	PACKET ACCESS REJECT	Sent on PAGCH.

Repeat above tests with RLC unacknowledged mode. The SS shall verify that the MS request Two Phase Access in the PACKET CHANNEL REQUEST messages.

Specific message contents

None.

42.1.1.4 Packet Channel Request / Access persistence control on PRACH

42.1.1.4.1 Packet Channel Request / Access persistence control on PRACH / M+1 attempts

42.1.1.4.1.1 Conformance requirements

The mobile station shall make maximally $M + 1$ attempts to send a PACKET CHANNEL REQUEST message.

Having made $M + 1$ attempts to send a PACKET CHANNEL REQUEST, the mobile station shall stop timer T3186 and start timer T3170. At expiry of timer T3170, the packet access procedure shall be aborted, a packet access failure shall be indicated to the upper layer and the mobile station shall return to packet idle mode.

Reference

GSM 04.60 subclause 7.1.2.1.1

42.1.1.4.1.2 Test purpose

To verify that the mobile station makes a maximum of $M + 1$ attempts to send a PACKET CHANNEL REQUEST message, M is the parameter MAX_RETRANS broadcast on PBCCH.

To verify that the mobile station aborts the packet access procedure when the network does not respond to the PACKET CHANNEL REQUEST messages.

42.1.3.1.1.3 Method of test

Initial conditions

System Simulator:

1 cell supporting GPRS. The packet system information ACCESS_BURST_TYPE indicates 8 bit access, MAX_RETRANS indicate 1 retransmission and PERSISTENCE_LEVEL $P(i)=0$.

Mobile Station:

The MS is GPRS attached and in packet idle mode. PDP context 2 has been established.

Related PICS/PIXIT statement

Support GPRS service.

Support PDP context.

Test procedure

The SS send PACKET PAGING REQUEST message. The MS is expected to send M+1 PACKET CHANNEL REQUEST messages, M is the parameter MAX_RETRANS broadcast on PBCCH. The SS monitors the MS transmission for a period equal to the maximum length of time it can take to send M+1 PACKET CHANNEL REQUEST messages plus the duration of timer T3170. The SS verifies that the MS makes maximally M+1 attempts to send PACKET CHANNEL REQUEST messages in this period. When the SS not respond the MS shall abort the packet access procedure and perform an abnormal release. The SS sends PACKET UPLINK ASSIGNMENT message corresponding to one of its 3 last PACKET CHANNEL REQUEST messages after a time higher than the duration of timer T3170 and the MS shall not respond to the message.

Repeat the test procedure with the different MAX_RETRANS parameters {2, 4, 7} sent in Packet System Information.

Maximum duration of the test

4 min.

Expected sequence

Step	Direction	Message	Comments
1	SS -> MS	PACKET PAGING REQUEST	Sent on PPCH.
2	MS -> SS	PACKET CHANNEL REQUEST(n)	n = 1, ..., M+1. ACCESS TYPE = "Page response". Received on PRACH.
.	.	.	
.	.	.	
3	SS		The SS waits M+1 PACKET CHANNEL REQUESTs+ timer T3170 + 0.5s. The SS verifies that the MS makes maximally M+1 attempts to send PACKET CHANNEL REQUEST messages in this period.
4	SS -> MS	PACKET UPLINK ASSIGNMENT	Correspond to one of the last 3 messages in step 2. The MS shall not respond to this message. Sent on PAGCH.
5	SS		Change MAX_RETRANS in PSI1 to 2 retransmission.
6			Repeat step 1 to 4 after 30 seconds.
7	SS		Change MAX_RETRANS in PSI1 to 4 retransmission.
8			Repeat step 1 to 4 after 30 seconds.
9	SS		Change MAX_RETRANS in PSI1 to 7 retransmission.
10			Repeat step 1 to 4 after 30 seconds.

Specific message contents

None.

42.1.1.4.2 Packet Channel Request / Access persistence control on PRACH / Persistence level

42.1.1.4.2.1 Conformance requirements

The first attempt to send a PACKET CHANNEL REQUEST message, may be initiated at the first possible TDMA frame containing PRACH on PDCH defined by the PCCCH_GROUP for the mobile station (see GSM 05.02). For each attempt, the mobile station shall draw a random value R with uniform probability distribution in the set {0, 1, ..., 15}. The mobile station is allowed to transmit a PACKET CHANNEL REQUEST message if P(i), where i is the radio priority of the TBF being established, is less than or equal to R.

Reference

GSM 04.60 subclause 7.1.2.1.1

42.1.1.4.2.2 Test purpose

To verify that for each attempt, the mobile station shall draw a random value R with uniform probability distribution in the set {0, 1, ..., 15}. The mobile station is only allowed to transmit a PACKET CHANNEL REQUEST message if P(i), where i is the radio priority of the TBF being established, is less than or equal to R.

42.1.1.4.2.3 Method of test

Initial conditions

System Simulator:

1 cell supporting GPRS. The packet system information indicates BS_PCC_CHANS = 1, BS_PAG_BLKES_RES = 2 and BS_PBCCH_BLKES = 3, BS_PRACH_BLKES = 12 (all Blocks reserved for PRACH).

Mobile Station:

The MS is GPRS attached and in packet idle mode.

Related PICS/PIXIT statement

Support GPRS service.

Test procedure

Specific test parameters:

K equals the value of $120/(MAX_RETRANS+1)$.

MAX_RETRANS is chosen from {1, 2, 4, 7}

PERSISTENCE_LEVEL P(i) is chosen from {0, 1, 2, ..., 14, 16}

Counter J is initialized with 0 (total number of received Packet Channel Requests)

The SS sends PACKET PAGING REQUEST message. The MS shall send between 0 and M+1 PACKET CHANNEL REQUEST message indicating page response. The SS verifies that the MS draw a random value R for each attach. Every received Packet Channel Request in response to Packet Paging Request increment counter J by 1. This test sequence is performed K times.

The test is performed with Persistence level set to at least P(i)=0, P(i)=8 and P(i)=16.

Maximum duration of the test

The execution of one sequence (for one value k): 30s

Between two consecutive executions (for k and k+1), the SS must wait for amount of time which is enough to guarantee that the MS is in service (listening to its paging subchannel).

Expected sequence

The sequence is executed for execution counter $k = 1, \dots, K$.

Step	Direction	Message	Comments
1	SS -> MS	PACKET PAGING REQUEST	Sent on PPCH.
2	MS -> SS	PACKET CHANNEL REQUEST	N_0 := number of received Packet Channel Requests in response to step1; Count for 10 sec. N_0 ; $J = J + N_0$; $0 \leq N_0 \leq M+1$; ACCESS TYPE = "Page Response". Received on PRACH.
3	MS -> SS	PACKET CHANNEL REQUEST	
:	:	:	
:	:	:	
M+2	MS -> SS	PACKET CHANNEL REQUEST	
M+3	SS		SS waits for expiry of T3170
M+4	SS		SS waits to allow Cell Reselection

Editors note:

The 10 sec in steps 2 to M+2 is derived from the following consideration:

Answer time for the first Packet Channel Request: 0,7 sec + 8*4,615 ms

Maximum TDMA frame spread between two successive Packet Channel Requests:

$\max\{S+T-1\} * 4,615\text{ms} = 266 * 4,615\text{ms} \Rightarrow$ maximum time to send M+1 Packet Channel Requests

$0,7 \text{ sec} + 8 * 4,615\text{ms} + M * 266 * 4,615\text{ms} = 9,33 \text{ sec.}$

Verification

According the test procedure J is $B(120; 1-P(i)/16)$ distributed. i.e. we will accept MSs, when the following inequality holds $(1-P(i)/16) - 0,0161 * \sqrt{P(i)*(16-P(i))} \leq J/120 \leq (1-P(i)/16) + 0,0161 * \sqrt{P(i)*(16-P(i))}$

this confidence interval is chosen in such a way that the possibility of non accepting a correct MS is less than 0,5 %.

Remark: If $P(i) = 0$ the above inequality is simplified to $1 \leq J/120 \leq 1$, i.e. $J = 120$, i.e. the MS has to answer every PACKET PAGING REQUEST with M+1 PACKET CHANNEL REQUESTS. And if $P(i) = 16$ the above inequality is simplified to $0 \leq J/120 \leq 0$, i.e. $J = 0$, i.e. the MS is not allowed to send PACKET CHANNEL REQUESTS.

Specific message contents

None.

42.1.1.4.3 Packet Channel Request / Access persistence control on PRACH / Successive Attempts

42.1.1.4.3.1 Conformance requirements

The first attempt to send a PACKET CHANNEL REQUEST message, may be initiated at the first possible TDMA frame containing PRACH on PDCH defined by the PCCCH_GROUP for the mobile station (see GSM 05.02). For each attempt, the mobile station shall draw a random value R with uniform probability distribution in the set $\{0, 1, \dots, 15\}$. The mobile station is allowed to transmit a PACKET CHANNEL REQUEST message if $P(i)$, where i is the radio priority of the TBF being established, is less than or equal to R.

After each attempt, the S and T parameters are used to determine the next TDMA frame in which it may be allowed to make a successive attempt. The number of TDMA frames belonging to the PRACH on the PDCH defined by the PCCCH group for the mobile station between two successive attempts to send a PACKET CHANNEL REQUEST message excluding the TDMA frames potentially containing the messages themselves is a random value drawn for each transmission with uniform probability distribution in the set $\{S, S + 1, \dots, S + T - 1\}$.

Reference

GSM 04.60 subclause 7.1.2.1.1

42.1.1.4.3.2 Test purpose

To verify that the number of TDMA frames belonging to the PRACH on the PDCH defined by the PCCCH group for the mobile station between two successive attempts to send a PACKET CHANNEL REQUEST message excluding the TDMA frames potentially containing the messages themselves is a random value drawn for each transmission with uniform probability distribution in the set $\{S, S + 1, \dots, S + T - 1\}$.

42.1.1.4.3.3 Method of test

Initial conditions

System Simulator:

1 cell supporting GPRS. The packet system information:

BS_PCC_CHANS = 1, BS_PAG_BLKES_RES = 2 and BS_PBCCH_BLKES = 3. MAX_RETRANS is arbitrarily chosen in the set $\{1, 2, 4, 7\}$.

TX_INT is arbitrarily chosen in the set $\{6, 7, 8, 9, 10, 12, 14, 16, 20, 25, 32, 50\}$.

S is arbitrarily chosen in the set $\{12, 15, 20, 30, 41, 55, 76, 109, 163, 217\}$.

PERSISTENCE_LEVEL $P(i) = 0$.

Mobile Station:

The MS is GPRS attached and in packet idle mode.

Related PICS/PIXIT statement

Support GPRS service.

Test procedure

Specific test parameters:

K equals the upper rounded value of $230/M$.

The SS sends PACKET PAGING REQUEST message. The MS shall send PACKET CHANNEL REQUEST messages $M+1$ times indicating page response. After each attempt, the S and T parameters are used to determine the next TDMA frame in which it may be allowed to make a successive attempt. The SS measure the number of TDMA frames $f(n,k)$ between each attempt, excluding the slots containing the messages themselves. The SS does not answer the PACKET CHANNEL REQUEST messages MAX_RETRANS times. The SS sends an PACKET ACCESS REJECT message. The test sequence is executed K times.

M is the value of the parameter MAX_RETRANS,

T is the value of the parameter TX_INT,

S is the value of the parameter S.

Maximum duration of the test

The execution of one sequence (for one value k): 10s

Between two consecutive executions (for k and k+1), the SS must wait for amount of time which is enough to guarantee that the MS is in service (listening to its paging subchannel).

Expected sequence

The sequence is executed for execution counter $k = 1, \dots, K$.

Step	Direction	Message	Comments
1	SS -> MS	PACKET PAGING REQUEST	Sent on PPCH.
2	MS -> SS	PACKET CHANNEL REQUEST	ACCESS TYPE = "Page Response". Received on PRACH.
3	MS -> SS	PACKET CHANNEL REQUEST	Step 3-5 are executed for execution counter $n=1, \dots, \text{MAX_RETRANS}$. ACCESS TYPE = "Page Response". Received on PRACH.
4	SS		See verification.
5	SS -> MS	PACKET ACCESS REJECT	Sent on PAGCH.

Verification

In step 4 the SS measure the number of TDMA frames belonging to the PRACH on the PDCH defined by the PCCCH group for the MS between two successive attempts to send a PACKET CHANNEL REQUEST message excluding the TDMA frames potentially containing the messages themselves. $f(n,k)$ shall be in the set $\{S, S + 1, \dots, S + T - 1\}$. The SS stores f .

Test:

The following requirement shall be met

$$(((\text{sq}(\text{Sum}(S)) + \text{sq}(\text{Sum}(S+1)) + \dots + \text{sq}(\text{Sum}(S+T-1))) * T / (K * M)) - (K * M)) \leq$$

$$\frac{1}{2} * \text{sq}(\text{sqrt}(2T-3) + 2,58) + 1,1$$

$\text{Sum}(X) := \text{CARD} \{ k \mid f(n,k) = X \} :=$ the number of times that $f(n,k)$ equals X .

The test and the number of sample are chosen in such a way that the possibility of non-accepting a correct MS is less than [0,5%].

Specific message contents

None.

42.1.2 Packet Uplink/Downlink Assignment

42.1.2.1 Packet uplink assignment procedure

42.1.2.1.1 Packet Uplink Assignment / Packet access queuing notification procedure

42.1.2.1.1.1 Packet Uplink Assignment / Packet queuing notification / Stop sending Packet Channel Requests

42.1.2.1.1.1.1 Conformance requirements

On receipt of a PACKET QUEUING NOTIFICATION message corresponding to one of its 3 last PACKET CHANNEL REQUEST messages, the mobile station shall stop timers T3186 and T3170 if running, start timer T3162, and stop sending PACKET CHANNEL REQUEST messages.

Reference

GSM 04.60 subclause 7.1.2.2.2

42.1.2.1.1.1.2 Test purpose

To verify that the mobile station stops sending PACKET CHANNEL REQUEST messages on receipt of a PACKET QUEUING NOTIFICATION message.

42.1.2.1.1.1.3 Method of test

Initial conditions

System Simulator:

1 cell supporting GPRS. The packet system information MAX_RETRANS indicates 7 allowed retransmission.

Mobile Station:

The MS is switched off.

Related PICS/PIXIT statement

Support GPRS service.

Switch off on button Yes/No.

Method of trigger GPRS attach.

Test procedure

The MS is switched on and triggered to perform a GPRS attach. The SS sends PACKET QUEUING NOTIFICATION message corresponding to one of the last three PACKET CHANNEL REQUEST messages. The SS verifies that the MS stops sending PACKET CHANNEL REQUEST messages. The SS sends PACKET ACCESS REJECT message to end the test procedure.

Maximum duration of the test

15 s.

Expected sequence

Step	Direction	Message	Comments
1	MS		The MS is powered up or switched on and triggered to perform a GPRS attach.
2	MS -> SS	PACKET CHANNEL REQUEST	Received on PRACH.
3	MS -> SS	PACKET CHANNEL REQUEST	Received on PRACH.
4	SS -> MS	PACKET QUEUING NOTIFICATION	Corresponding to message in step 2. FRAME_NUMBER set to indicating + 2200 frames. Sent on PAGCH. The SS verifies during 10 seconds that MS stop sending PACKET CHANNEL REQUEST messages.
5	SS -> MS	PACKET ACCESS REJECT	Sent on PAGCH.

Specific message contents

None.

42.1.2.1.1.2 Packet Uplink Assignment / Packet queuing notification / Ignoring Packet Queuing Notification

42.1.2.1.1.2.1 Conformance requirements

If the mobile station receives a PACKET QUEUING NOTIFICATION message while waiting for the TBF Starting Time of a valid PACKET UPLINK ASSIGNMENT message, the mobile station shall ignore the PACKET QUEUING NOTIFICATION.

Reference

GSM 04.60 subclause 7.1.2.2.2

42.1.2.1.1.2.2 Test purpose

To verify that the mobile station ignores the PACKET QUEUING NOTIFICATION if the mobile station receives a PACKET QUEUING NOTIFICATION message while waiting for the TBF Starting Time of a valid PACKET UPLINK ASSIGNMENT message.

42.1.2.1.1.2.3 Method of test

Initial conditions

System Simulator:

1 cell supporting GPRS.

Mobile Station:

The MS is switched off.

Related PICS/PIXIT statement

Support GPRS service.

Switch off on button Yes/No.

Method of trigger GPRS attach.

Test procedure

The MS is switched on and triggered to perform a GPRS attach. The SS sends PACKET UPLINK ASSIGNMENT message containing a TBF Starting Time. While the MS is waiting for the TBF Starting Time the SS sends a PACKET QUEUING NOTIFICATION message. The MS shall ignore PACKET QUEUING NOTIFICATION message and at the frame number indicated by the TBF Starting Time, the MS shall start to send the uplink RLC data in the allocated uplink resources. The SS allows the MS to complete the GPRS attach procedure.

Maximum duration of the test

15 s.

Expected sequence

step	direction	message	comments
1	MS		the MS is switched on and triggered to perform a GPRS attach.
2	MS -> SS	PACKET CHANNEL REQUEST	received on PRACH.
3	SS -> MS	PACKET UPLINK ASSIGNMENT	see specific message contents. Sent on PAGCH.
4	SS -> MS	PACKET QUEUING NOTIFICATION	sent on PAGCH before starting time in step 3 have lapsed.
5		GPRS Attach procedure}	macro. Completion from step 4 in the attach procedure. the SS verifies that the first RLC data block sends according to the indicated starting time in step 3.

Specific message contents

As default messages contents, except:

PACKET UPLINK ASSIGNMENT in step 3

Information element	Value/remark
Fixed Allocation < TBF_Starting_Time >	[Arbitrarily chosen]

42.1.2.1.1.3 Packet Uplink Assignment / Packet queuing notification / Assigned PDCHs

42.1.2.1.1.3.1 Conformance requirements

On receipt of a PACKET UPLINK ASSIGNMENT message following a PACKET QUEUING NOTIFICATION message, the mobile station shall stop timer T3162, and follow the procedures defined in subclause 7.1.2.2.1.

If the PACKET UPLINK ASSIGNMENT message does not specify a TBF starting time, the mobile station shall switch to the assigned PDCHs, start timer T3164 and proceed with contention resolution of the one phase access procedure according to subclause 7.1.2.3.

Reference

GSM 04.60 subclause 7.1.2.2.2 and subclause 7.1.2.2.1.

42.1.2.1.1.3.2 Test purpose

To verify that the mobile station switches to the assigned PDCHs on receipt of a PACKET UPLINK ASSIGNMENT message after a PACKET QUEUING NOTIFICATION message.

42.1.2.1.1.3.3 Method of test

Initial conditions

System Simulator:

1 cell supporting GPRS. The packet system information ACCESS_BURST_TYPE indicates 8 bit access.

Mobile Station:

The MS is switched off.

Related PICS/PIXIT statement

Support GPRS service.

Switch off on button Yes/No.

Method of trigger GPRS attach.

Test procedure

The MS is switched on and triggered to perform a GPRS attach. The SS send PACKET QUEUING NOTIFICATION message and sends then PACKET UPLINK ASSIGNMENT message. The SS allows the MS to complete the GPRS attach procedure.

Maximum duration of the test

15 s.

Expected sequence

Step	Direction	Message	Comments
1	MS		The MS is switched on and triggered to perform a GPRS attach procedure.
2	MS -> SS	PACKET CHANNEL REQUEST	Received on PRACH.
3	SS -> MS	PACKET QUEUING NOTIFICATION	Sent on PAGCH.
4	SS -> MS	PACKET UPLINK ASSIGNMENT	Include same TQI as step 3. Sent on PAGCH before timer T3162 expires.
5		{GPRS attach procedure }	Macro. Completion from step 4 in the attach procedure.

Specific message contents

None.

42.1.2.1.1.4 Packet Uplink Assignment / Packet queuing notification / Expiry of timer T3162

42.1.2.1.1.4.1 Conformance requirements

On receipt of a PACKET QUEUING NOTIFICATION message corresponding to one of its 3 last PACKET CHANNEL REQUEST messages the mobile station shall stop timer T3170 and T3186 if running and stop sending PACKET CHANNEL REQUEST messages. On receipt of a PACKET UPLINK ASSIGNMENT message following a PACKET QUEUING NOTIFICATION message, the mobile station shall stop timer T3162 and follow the procedures defined in subclause 7.1.2.2.1. At expiry of timer T3162, the packet access procedure shall be aborted and a packet access failure indicated to the upper layer and the mobile station shall return to packet idle mode.

Reference

GSM 04.60 subclause 7.1.2.2.2, subclause 13.1.

42.1.2.1.1.4.2 Test purpose

- 1 To verify that the MS waits T3162 seconds before aborting the packet access procedure on receipt of a PACKET QUEUING NOTIFICATION message.
- 2 To verify that the mobile station listening to its paging channel after a time greater than timer T3162.

42.1.2.1.1.4.3 Method of test

Initial conditions

System Simulator:

1 cell supporting GPRS.

Mobile Station:

The MS is GPRS attached and in packet idle mode.

Related PICS/PIXIT statement

Support GPRS service.

Test procedure

The SS page the MS with a PACKET PAGING REQUEST message. The SS sends PACKET QUEUING NOTIFICATION message corresponding to one of its 3 last PACKET CHANNEL REQUEST messages. The SS waits until T3162 seconds elapse and sends an PACKET UPLINK ASSIGNMENT message which shall be ignored by the MS since the access procedure should be aborted.

The SS page the MS with a PACKET PAGING REQUEST message. The SS verifies that the MS respond to the paging request and sends PACKET QUEUING NOTIFICATION message corresponding to one of its 3 last PACKET CHANNEL REQUEST messages. The SS sends a PACKET UPLINK ASSIGNMENT message before T3162 seconds elapse and the MS shall complete the uplink data transfer containing the paging response.

Maximum duration of the test

1 min.

Expected sequence

Step	Direction	Message	Comments
1	SS -> MS	PACKET PAGING REQUEST	Sent on PPCH.
2	MS -> SS	PACKET CHANNEL REQUEST	ACCESS TYPE = "Page response". Received on PRACH.
3	SS -> MS	PACKET QUEUING NOTIFICATION	Allocate a TQI to the MS. Sent on PAGCH.
4	SS		The SS waits T3162 + 0.1*T3162 .
5	SS -> MS	PACKET UPLINK ASSIGNMENT	Include same TQI as in step 3 and dynamic allocation struct. Sent on PAGCH.
6	SS		The SS verifies for 5 s that the MS does not respond.
7	SS -> MS	PACKET PAGING REQUEST	Sent on PPCH.
8	MS -> SS	PACKET CHANNEL REQUEST	ACCESS TYPE = "Page response". Received on PRACH.
9	SS -> MS	PACKET QUEUING NOTIFICATION	Allocate a TQI to the MS. Sent on PAGCH.
10	SS		The SS waits T3162 - 0.1*T3162 .
11	SS -> MS	PACKET UPLINK ASSIGNMENT	Include same TQI as in step 9, dynamic allocation struct. Sent on PAGCH.
12	MS -> SS	UPLINK RLC DATA BLOCK	LLC PDU implicitly indicating paging response. Received on uplink PDTCH assigned in step 11.
13	SS -> MS	PACKET UPLINK ACK/NACK	Acknowledge the received RLC data block, Final Ack Indicator = "1". Sent on PACCH
14	MS -> SS	PACKET CONTROL ACKNOWLEDGEMENT	Acknowledge the RLC control message. Received on PACCH.

Specific message contents

None.

42.1.2.1.2 Packet Uplink Assignment / Response to packet polling request

42.1.2.1.2.1 Conformance requirements

On receipt of a PACKET POLLING REQUEST message, the mobile station shall respond to the network with the PACKET CONTROL ACKNOWLEDGEMENT message in the reserved uplink radio block specified by the RRB field.

Reference

GSM 04.60 subclause 7.1.2.2.3

42.1.2.1.2.2 Test purpose

To verify that the mobile station responds to the Network with a PACKET CONTROL ACKNOWLEDGEMENT message in the reserved uplink radio block specified by the RRBP field on receipt of a PACKET POLLING REQUEST message.

42.1.2.1.2.3 Method of test

Initial conditions

System Simulator:

1 cell supporting GPRS. The packet system information ACCESS_BURST_TYPE indicates 8 bit access and CONTROL_ACK_TYPE indicates four access bursts.

Mobile Station:

The MS is GPRS attached and in packet idle mode. PDP context 2 has been established.

Related PICS/PIXIT statement

Support GPRS service.

Support PDP context.

Method of triggering the MS to initiate an uplink packet data transfer.

Test procedure

The MS is triggered to transfer data. The SS sends a PACKET QUEUING NOTIFICATION message and sends then a PACKET POLLING REQUEST message. On receipt of PACKET POLLING REQUEST message the MS shall respond with PACKET CONTROL ACKNOWLEDGEMENT message as four access bursts. The SS verifies that MS sends the PACKET CONTROL ACKNOWLEDGEMENT and send PACKET UPLINK ASSIGNMENT message. The uplink data transfer is completed.

Maximum duration of the test

30 s.

Expected sequence

Step	Direction	Message	Comments
1	MS		The MS is triggered to transfer 200 octets data.
2	MS -> SS	PACKET CHANNEL REQUEST	Received on PRACH.
3	SS -> MS	PACKET QUEUING NOTIFICATION	Allocate a TQI to the MS. Sent on PAGCH.
4	SS -> MS	PACKET POLLING REQUEST	Include same TQI as step 3. Sent on PAGCH.
5	MS -> SS	PACKET CONTROL ACKNOWLEDGEMENT	Received on the uplink block specified by the RRBP field on PACCH as four access bursts.
6	SS		SS verifies that the message in step 5 was received.
7	SS -> MS	PACKET UPLINK ASSIGNMENT	Include same TQI as step 3, dynamic allocation struct and USF_GRANULARITY = four blocks. Sent on PAGCH.
8		{Uplink data transfer, dynamic allocation}	Macro. Completion from step 4 in the TBF procedure.

Specific message contents

None.

42.1.2.1.3 Packet Uplink Assignment / Packet access reject procedure

42.1.2.1.3.1 Packet Uplink Assignment / Packet access reject / Action during Wait_Indication

42.1.2.1.3.1.1 Conformance requirements

On receipt of a PACKET ACCESS REJECT message containing a Reject structure addressed to the mobile station, where the Packet Request Reference in the Reject structure corresponds to one of its three last PACKET CHANNEL REQUEST messages, the mobile station shall stop sending PACKET CHANNEL REQUEST messages, start timer T3172 with the value indicated in the WAIT_INDICATION field if present, start timer T3170 if it has not already been started and listen to the downlink PCCCH until timer T3170 expires. During this time, the mobile station shall ignore additional PACKET ACCESS REJECT message, but on reception of any PACKET UPLINK ASSIGNMENT message corresponding to any other of its 3 last PACKET CHANNEL REQUEST MESSAGE the mobile station shall stop timers T3170 and T3172 if running and follow the procedure defined in subclause 7.1.2.2.1.

Reference

GSM 04.60 subclause 7.1.2.2.4

42.1.2.1.3.1.2 Test purpose

To verify that the mobile station stops sending PACKET CHANNEL REQUEST messages on receipt of a PACKET ACCESS REJECT message containing a WAIT_INDICATION field.

To verify that the mobile station ignores additional PACKET ACCESS REJECT messages, but on reception of any PACKET UPLINK ASSIGNMENT message corresponding to any other of its 3 last PACKET CHANNEL REQUEST messages the mobile station shall switch to the assigned PDCHs if the message is received before timer T3170 expire.

42.1.2.1.3.1.3 Method of test

Initial conditions

System Simulator:

1 cell supporting GPRS. The packet system information MAX_RETRANS indicates 7 retransmissions, TX_INT indicates 50 slots to spread transmission and parameter S indicates the value 217.

Mobile Station:

The MS is switched off.

Related PICS/PIXIT statement

Support GPRS service.

Switch off on button Yes/No.

Method of trigger GPRS attach.

Test procedures

The MS is switched on and triggered to perform a GPRS attach. The SS sends PACKET ACCESS REJECT message with WAIT_INDICATION field corresponding to one of the last three PACKET CHANNEL REQUEST messages. The SS verifies that the MS does not send further PACKET CHANNEL REQUEST messages. The SS sends a new PACKET ACCESS REJECT message without WAIT_INDICATION field. The SS shall then send a PACKET UPLINK ASSIGNMENT message corresponding to one of the last three sent PACKET CHANNEL REQUEST messages before the timer T3170 expire ($T+2*S$ TDMA frames). The SS allows the MS to complete the GPRS attach procedure.

Maximum duration of the test

15 s.

Expected sequence

Step	Direction	Message	Comments
1	MS		The MS is switched on and triggered to perform a GPRS attach.
2	MS -> SS	PACKET CHANNEL REQUEST	Received on PRACH.
3	MS -> SS	PACKET CHANNEL REQUEST	Received on PRACH.
4	MS -> SS	PACKET CHANNEL REQUEST	Received on PRACH.
5	SS -> MS	PACKET ACCESS REJECT	Containing WAIT_INDICATION = 15 seconds and packet request reference = pertaining to message received in step 2. Sent on PAGCH.
6	SS		The SS checks 0,8*T3170 that the MS does not send further PACKET CHANNEL REQUEST messages.
7	SS -> MS	PACKET ACCESS REJECT	Without WAIT_INDICATION. Sent 0,8*T3170 on PAGCH. The MS shall not consider this message.
8	SS -> MS	PACKET UPLINK ASSIGNMENT	Random Reference = pertaining to message received in step 2. Sent 0,9*T3170 on PAGCH.
9		{GPRS attach procedure}	Macro. Completion from step 4 in the attach procedure.

Specific message contents

None.

42.1.2.1.3.2 Packet Uplink Assignment / Packet access reject / No respond

42.1.2.1.3.2.1 Conformance requirements

On receipt of a PACKET ACCESS REJECT message containing a Reject structure addressed to the mobile station, where the Packet Request Reference in the Reject structure corresponds to one of its 3 last PACKET CHANNEL REQUEST messages,

- the mobile station is not allowed to make a new attempt for packet access in the same cell until timer T3172 expires, but may attempt packet access in an other cell after successful cell reselection for radio conditions reasons (see GSM 05.08). A mobile station in class A or B mode of operation may attempt to enter the dedicated mode in the same cell before timer T3172 has expired. During the timer T3172 is running, the mobile station shall ignore all received PACKET PAGING REQUEST messages except paging request to trigger RR connection establishment.

Reference

GSM 04.60 subclause 7.1.2.2.4

42.1.2.1.3.2.2 Test purpose

To verify that the mobile station ignores PACKET PAGING REQUEST messages requesting TBF establishment when T3172 is running.

42.1.2.1.3.2.3 Method of test

Initial conditions

System Simulator:

1 cell supporting GPRS. The packet system information ACCESS_BURST_TYPE indicates 8 bit access.

Mobile Station:

The MS is GPRS attached and in packet idle mode.

Related PICS/PIXIT statement

Support GPRS service.

Supporting GPRS MS class A and MS class B.

Test procedure

The SS sends a PACKET PAGING REQUEST message. After response from the MS the SS sends PACKET ACCESS REJECT message with WAIT_INDICATION set to a value between 1-255 seconds (see specific message contents). The SS sends then a PACKET UPLINK ASSIGNMENT message after timer T3170 has elapse. The SS verifies that the MS not respond to the message. The SS sends a PACKET PAGING REQUEST message request TBF establishment before the wait indication has elapse. The SS verifies that the MS not respond to the message. The SS sends a PACKET PAGING REQUEST message request TBF establishment after the wait indication has elapse. The SS verifies that the MS respond to the message.

The test procedures shall be repeated with different chosen values of WAIT INDICATION.

Maximum duration of the test

10 min.

Expected sequence

Step	Direction	Message	Comments
1	SS -> MS	PACKET PAGING REQUEST	Sent on PPCH.
2	MS -> SS	PACKET CHANNEL REQUEST	Received on PRACH.
3	SS -> MS	PACKET ACCESS REJECT	See specific message contents. Sent on PAGCH.
4	SS -> MS	PACKET UPLINK ASSIGNMENT	Send this message 1,1*T3170on PAGCH.
5	SS		Verify for 5 seconds that the MS does not respond to message in step 4.
6	SS -> MS	PACKET PAGING REQUEST	Request TBF establishment. Send this message after (0,9*WAIT INDICATION (step 3)) on PPCH.
7	SS		Verify that the MS does not respond to message in step 6.
8	SS -> MS	PACKET PAGING REQUEST	Request TBF establishment. Send this message after (1,1*WAIT INDICATION (step 3)) on PPCH.
9	MS -> SS	PACKET CHANNEL REQUEST	Received on PRACH.

The test is repeated with different values of WAIT INDICATION, see specific message contents.

Specific message contents

As default messages contents, except:

PACKET ACCESS REJECT in step 3

Information element	Value/remark
< WAIT_INDICATION >	Set values between 1-255, see below.
< WAIT_INDICATION_SIZE >	0 (units of seconds)

Case 1 : WAIT_INDICATION = 60.

Case 2 : WAIT_INDICATION = 240.

42.1.2.1.3.3 Packet Uplink Assignment / Packet access reject / Trigger RR connection

Applicability

This test is only applicable to GPRS mobiles that can operate in mode B in network mode 1.

42.1.2.1.3.3.1 Conformance requirements

On receipt of a PACKET ACCESS REJECT message containing a Reject structure addressed to the mobile station, where the Packet Request Reference in the Reject structure corresponds to one of its 3 last PACKET CHANNEL REQUEST messages,

- the mobile station is not allowed to make a new attempt for packet access in the same cell until timer T3172 expires, but may attempt packet access in an other cell after successful cell reselection for radio conditions reasons (see GSM 05.08). A mobile station in class A or B mode of operation may attempt to enter the dedicated mode in the same cell before timer T3172 has expired. During the timer T3172 is running, the mobile station shall ignore all received PACKET PAGING REQUEST messages except paging request to trigger RR connection establishment.

Reference

GSM 04.60 subclause 7.1.2.2.4

42.1.2.1.3.3.2 Test purpose

To verify that when T3172 is running, the mobile station ignores all received PACKET PAGING REQUEST messages except paging request to trigger RR connection establishment.

42.1.2.1.3.3.3 Method of test

Initial conditions

System Simulator:

1 cell supporting GPRS. The packet system information ACCESS_BURST_TYPE indicates 8 bit access.

Mobile Station:

The MS is GPRS attached and in packet idle mode. The MS shall have a valid TMSI.

Related PICS/PIXIT statement

Support GPRS service.

Supporting GPRS MS class B.

Test procedure

The SS sends a PACKET PAGING REQUEST message request TBF connection establishment. After response from the MS the SS sends PACKET ACCESS REJECT message with a WAIT_INDICATION value. The SS trigger first paging with TBF connection establishment and then RR connection establishment before the wait indication has elapse. The SS verifies that the MS not respond to the TBF connection establishment but respond to the RR connection establishment.

Maximum duration of the test

1 min.

Expected sequence

Step	Direction	Message	Comments
1	SS -> MS	PACKET PAGING REQUEST	Request TBF connection establishment sent on PPCH.
2	MS -> SS	PACKET CHANNEL REQUEST	Received on PRACH.
3	SS -> MS	PACKET ACCESS REJECT	See specific message contents. Sent on PAGCH.
4	SS -> MS	PACKET PAGING REQUEST	Request TBF connection establishment sent on PPCH.
5	SS		Verify no respond from MS.
6	SS -> MS	PACKET PAGING REQUEST	Request RR connection establishment see specific message contents. Send this message after 0,5*WAIT_INDICATION on PPCH.
7	MS -> SS	CHANNEL REQUEST	Request RR connection. Received on RACH.

Specific message contents

As default messages contents, except:

PACKET ACCESS REJECT in step 3

Information element	Value/remark
< WAIT_INDICATION >	30
< WAIT_INDICATION_SIZE >	0 (units of seconds)

PACKET PAGING REQUEST in step 6:

< MESSAGE_TYPE >	100010
< PAGE_MODE >	00 (Normal Paging)
{0 1< PERSISTENCE_LEVEL >}	0 (no persistence level present)
{0 1< NLN >}	0 (no notification list number)
{1 < Repeated Page info>}	1 (start of Repeated Page info)
{1	1 (Page request for Rrconn. establishment)
{0< TMSI >	0 (TMSI)
- TMSI	allocated TMSI
< padding bits >	spare Padding

42.1.2.1.4 Packet Uplink Assignment / Packet Uplink Assignment handling

42.1.2.1.4.1 Conformance requirements

On receipt of a PACKET UPLINK ASSIGNMENT message corresponding to one of its 3 last PACKET CHANNEL REQUEST messages, the mobile station shall stop timers T3186 and T3170 if running, stop sending PACKET CHANNEL REQUEST messages.

Reference

GSM 04.60 subclause 7.1.2.2.1

42.1.2.1.4.2 Test purpose

To verify that the mobile station stops sending PACKET CHANNEL REQUEST messages on receipt of a PACKET UPLINK ASSIGNMENT message.

42.1.2.1.4.3 Method of test

Initial conditions

System Simulator:

1 cell supporting GPRS. The packet system information MAX_RETRANS indicates 7 allowed retransmission.

Mobile Station:

The MS is switched off.

Related PICS/PIXIT statement

Support GPRS service.

Switch off on button Yes/No.

Method of trigger GPRS attach.

Foreseen final state of the MS

Packet idle mode.

Test procedure

The MS is switched on and triggered to perform a GPRS attach. The SS send a PACKET UPLINK ASSIGNMENT message corresponding to one of the last 3 PACKET CHANNEL REQUEST messages from the MS. The SS verifies that the MS stops sending PACKET CHANNEL REQUEST messages. The SS allows the MS to complete the GPRS attach procedure.

Maximum duration of the test

15 s.

Expected sequence

Step	Direction	Message	Comments
1	MS		The MS is switched on and triggered to perform a PRS attach.
2	MS -> SS	PACKET CHANNEL REQUEST	Received on PRACH.
3	MS -> SS	PACKET CHANNEL REQUEST	Received on PRACH.
4	SS -> MS	PACKET UPLINK ASSIGNMENT	Respond to requests message in step 2. Sent on AGCH with dynamic allocation struct. The SS shall verify for 4.5 seconds that the MS stops sending packet channel request messages.
5		{GPRS attach procedure }	Macro. Completion from step 4 in the attach procedure.

Specific message contents

None.

42.1.2.1.5 Packet Uplink Assignment / One or two phase access

42.1.2.1.5.1 Conformance requirements

A mobile station that has not indicated Single Block Without TBF Establishment in the PACKET CHANNEL REQUEST message shall perform a two phase access if the Single Block Allocation struct is included in the PACKET UPLINK ASSIGNMENT message, or a one phase access if the Dynamic Allocation or Fixed Allocation struct is included.

Reference

GSM 04.60 subclause 7.1.2.2.1

42.1.2.1.5.2 Test purpose

To verify that the mobile station proceeds with one phase access or two phase access according to the parameters in the PACKET UPLINK ASSIGNMENT message.

42.1.2.1.5.3 Method of test

Initial conditions

System Simulator:

1 cell supporting GPRS. The packet system information ACCESS_BURST_TYPE indicates 8 bit access.

Mobile Station:

The MS is switched off.

Related PICS/PIXIT statement

Support GPRS service.

Switch off on button Yes/No.

Method of trigger GPRS attach.

Test procedures

The MS is switched on and triggered to perform a GPRS attach. The SS send a PACKET UPLINK ASSIGNMENT message with Dynamic Allocation struct information field, the MS shall proceed with a one-phase access. The SS allows the MS to complete the GPRS attach procedure. Switch off the MS.

The MS is switched on and triggered to perform a GPRS attach. The SS send a PACKET UPLINK ASSIGNMENT message with Fixed Allocation struct information field, the MS shall proceed with a one-phase access. The SS allows the MS to complete the GPRS attach procedure. Switch off the MS.

The MS is switched on and triggered to perform a GPRS attach. The SS send a PACKET UPLINK ASSIGNMENT message with Single Block Allocation struct information field, the MS shall perform a two-phase access i.e. it should transmit a PACKET RESOURCE REQUEST message on the allocated uplink resource. The SS responds with a PACKET UPLINK ASSIGNMENT message with Dynamic Allocation struct information field. The SS allows the MS to complete the GPRS attach procedure. Switch off the MS.

The MS is switched on and triggered to perform a GPRS attach. The SS send a PACKET UPLINK ASSIGNMENT message with Single Block Allocation struct information field, the MS shall perform a two-phase access i.e. it should transmit a PACKET RESOURCE REQUEST message on the allocated uplink resource. The SS responds with a PACKET UPLINK ASSIGNMENT message with Fixed Allocation struct information field. The SS allows the MS to complete the GPRS attach procedure.

Maximum duration of the test

2 min.

Expected sequences

Step	Direction	Message	Comments
1	MS		The MS is switched on and triggered to perform a GPRS attach.
2	MS -> SS	PACKET CHANNEL REQUEST	Received on PRACH.
3	SS -> MS	PACKET UPLINK ASSIGNMENT	Dynamic Allocation struct information. Sent on PAGCH.
4		{GPRS attach procedure }	Macro. Completions from step 4 in the attach procedure as one phase access.
5	MS		Switch off the MS.
6	MS		The MS is switched on and triggered to perform a GPRS attach.
7	MS -> SS	PACKET CHANNEL REQUEST	Received on PRACH.
8	SS -> MS	PACKET UPLINK ASSIGNMENT	Fixed Allocation struct information. Sent on PAGCH.
9	MS -> SS	Uplink RLC data blocks (GMM ATTACH REQUEST)	
10	SS -> MS	PACKET UPLINK ACK/NACK	Sent on PACCH to acknowledge the data blocks.
11	SS -> MS	PACKET DOWNLINK ASSIGNMENT	
12	SS -> MS	Downlink RLC data blocks (GMM ATTACH ACCEPT)	
13	MS -> SS	PACKET DOWNLINK ACK/NACK	Received on PACCH.
14	MS -> SS	PACKET CHANNEL REQUEST	Received on PRACH.
15	SS -> MS	PACKET UPLINK ASSIGNMENT	Fixed Allocation struct information. Sent on PAGCH.
16	MS -> SS	Uplink RLC data blocks (GMM ATTACH COMPLETE)	
17	SS -> MS	PACKET UPLINK ACK/NACK	Sent on PACCH to acknowledge the data blocks.
18	MS -> SS	PACKET CONTROL ACKNOWLEDGEMENT	
19	MS		Switch off the MS.
20	MS		The MS is switched on and triggered to perform a GPRS attach.
21	MS -> SS	PACKET CHANNEL REQUEST	Received on PRACH.
22	SS -> MS	PACKET UPLINK ASSIGNMENT	Single Block Allocation struct information. Sent on PAGCH.
23	MS -> SS	PACKET RESOURCE REQUEST	Received on the single block assigned in step 22.
24	SS -> MS	PACKET UPLINK ASSIGNMENT	Dynamic Allocation struct information. Sent on PACCH.
25		{ GPRS attach procedure }	Macro. Completion from step 4 in the attach procedure.
26	MS		Switch off the MS.
27	MS		The MS is switched on and triggered to perform a GPRS attach.
28	MS -> SS	PACKET CHANNEL REQUEST	Received on PRACH.
29	SS -> MS	PACKET UPLINK ASSIGNMENT	Single Block Allocation struct information. Sent on PAGCH.
30	MS -> SS	PACKET RESOURCE REQUEST	Received on the single block assigned in step 29.
31	SS -> MS	PACKET UPLINK ASSIGNMENT	Fixed Allocation struct information. Sent on PACCH.
32	MS -> SS	Uplink RLC data blocks (GMM ATTACH REQUEST)	
33	SS -> MS	PACKET UPLINK ACK/NACK	Sent on PACCH to acknowledge the data blocks.
34	SS -> MS	PACKET DOWNLINK ASSIGNMENT	
35	SS -> MS	Downlink RLC data blocks (GMM ATTACH ACCEPT)	
36	MS -> SS	PACKET DOWNLINK ACK/NACK	Received on PACCH.
37	MS -> SS	PACKET CHANNEL REQUEST	Received on PRACH.
38	SS -> MS	PACKET UPLINK ASSIGNMENT	Single Block Allocation struct information. Sent on PAGCH.
39	MS -> SS	PACKET RESOURCE REQUEST	Received on the single block assigned in step 38.
40	SS -> MS	PACKET UPLINK ASSIGNMENT	Fixed Allocation struct information. Sent on PACCH.
41	MS -> SS	Uplink RLC data blocks (GMM ATTACH COMPLETE)	
42	SS -> MS	PACKET UPLINK ACK/NACK	Sent on PACCH to acknowledge the data blocks.
43	MS -> SS	PACKET CONTROL ACKNOWLEDGEMENT	

Specific message contents

PACKET UPLINK ASSIGNMENT dynamic allocation struct specified in 42.1.3.2.8

PACKET UPLINK ASSIGNMENT fixed allocation struct specified in 42.1.3.2.9

PACKET UPLINK ASSIGNMENT single block allocation struct specified in 42.1.3.2.10

42.1.2.1.6 Packet Uplink Assignment / Decoding of frequency parameters

42.1.2.1.6.1 Conformance requirements

The mobile station may use information received on PBCCH, BCCH or a previous assignment message to decode the frequency parameters contained in the assignment message. If the mobile station detects an invalid Frequency Parameters information element in the assignment message, it shall abort the procedure, if required initiate a partial acquisition of PBCCH or BCCH, and may then re-initiate this procedure.

When the indirect encoding is used, the network may include a CHANGE_MARK_1 and a CHANGE_MARK_2 in the Frequency Parameters information element. The mobile station shall then verify that it is using a set of PBCCH or BCCH information identified by a PSI or SI *change mark* corresponding to one of the CHANGE_MARK_1 or 2 parameters, for the decoding of the frequency information. If that is not the case, an abnormal condition occurs.

Reference

GSM 04.60 subclause 7.1.2.2.1, subclause 5.5.1.7.

42.1.2.1.6.2 Test purpose

To verify that the mobile station uses information received on PBCCH to decode the frequency parameters contained in the assignment message and when the mobile station receives a PACKET UPLINK ASSIGNMENT message with an invalid frequency parameters information element the mobile station shall abort the procedure.

42.1.2.1.6.3 Method of test

Initial conditions

System Simulator:

1 cell supporting GPRS. Packet system information PSI2 including frequency hopping parameters.

Mobile Station:

The MS is switched off.

Related PICS/PIXIT statement

Support GPRS service.

Switch off on button Yes/No.

Method of trigger GPRS attach.

Test procedure

The MS is switched on and triggered to perform a GPRS attach. The SS send a PACKET UPLINK ASSIGNMENT message containing frequency parameter information elements. The SS allows the MS to complete the GPRS attach procedure. The MS is switched off, then switched on again and triggered to perform a GPRS attach. The SS sends PACKET UPLINK ASSIGNMENT message containing an invalid frequency parameter as respond to the PACKET CHANNEL REQUEST message from the MS. The SS verifies that the MS abort the GPRS attach procedure.

Maximum duration of the test

30 s.

Expected sequence

Step	Direction	Message	Comments
1	MS		The MS is switched on and triggered to perform a GPRS attach.
2	MS -> SS	PACKET CHANNEL REQUEST	Received on PRACH.
3	SS -> MS	PACKET UPLINK ASSIGNMENT	Include frequency parameters see specific message contents. Sent on PAGCH.
4		{GPRS attach procedure}	Macro. Completion from step 4 in the attach procedure.
5	MS		Switch off the MS.
6	MS		The MS is switched on and triggered to perform a GPRS attach.
7	MS -> SS	PACKET CHANNEL REQUEST	Received on PRACH.
8	SS -> MS	PACKET UPLINK ASSIGNMENT	Include invalid frequency parameter see specific message contents. Sent on PAGCH.
9	SS		The SS verifies that the MS abort the GPRS attach procedure.

Specific message contents

As default messages contents, except:

PACKET SYSTEM INFORMATION type 2 in initial condition

Information element	Value/remark
< PSI2_CHANGE_MARK >	00
< PCCCH Description List struct >	
< TSC >	arbitrarily chosen
{0 1< Hopping PCCCH carriers >	1
< MA_NUMBER	0001 (List 1)
< Hopping PCCCH carriers struct >	
< Hopping PCCCH carriers struct >	
< MAIO >	arbitrarily chosen
< TIMESLOT_ALLOCATION	00100000 (timeslot 2)

PACKET UPLINK ASSIGNMENT in step 3

Information element	Value/remark
{0 1< Frequency Parameters >}	1 (hopping channel)
< Frequency Parameters IE >	
< TSC >	Same as PSI2.
< Indirect encoding struct >	01 (Indirect encoding)
< MAIO >	Same as PSI2.
< MA_NUMBER >	Same as PSI2.
{0 1< CHANGE_MARK_1 >	1 (CHANGE_MARK_1 present)
- CHANGE_MARK_1}	00 (same change mark as PSI2_CHANGE_MARK)
{0 1< CHANGE_MARK_2 >}	0 (no CHANGE_MARK_2)

PACKET UPLINK ASSIGNMENT in step 8

Information element	Value/remark
{0 1< Frequency Parameters > < Frequency Parameters IE > < TSC > < Indirect encoding struct > < MAIO > < MA_NUMBER > {0 1< CHANGE_MARK_1 > - CHANGE_MARK_1} {0 1< CHANGE_MARK_2 >}	1 (hopping channel) Same as PSI2. 01 (Indirect encoding) Same as PSI2. Same as PSI2. 1 (CHANGE_MARK_1 present) 01 (which mismatches PSI2_CHANGE_MARK) 0 (no CHANGE_MARK_2)

42.1.2.1.7 Packet Uplink Assignment / Most recently received Packet Uplink Assignment

42.1.2.1.7.1 Conformance requirements

A PACKET UPLINK ASSIGNMENT message may indicate an assignment starting time in the TBF Starting Time parameter. The mobile station shall monitor PCCCH until the point in time denoted by the TBF Starting Time. If while monitoring the PCCCH the mobile station receives more than one PACKET UPLINK ASSIGNMENT message, it shall act upon the most recently received message and shall ignore the previous message.

Reference

GSM 04.60 subclause 7.1.2.2.1

42.1.2.1.7.2 Test purpose

To verify that the mobile station monitors PCCCH until the point in time denoted by the TBF Starting Time and that the mobile station acts on the most recently received Packet Uplink Assignment.

42.1.2.1.7.3 Method of test

Initial conditions

System Simulator:

1 cell supporting GPRS. The packet system information ACCESS_BURST_TYPE indicates 8 bit access.

Mobile Station:

The MS is switched off.

Related PICS/PIXIT statement

Support GPRS service.

Switch off on button Yes/No.

Method of trigger GPRS attach.

Test procedure

The MS is switched on and triggered to perform a GPRS attach. The SS sends PACKET UPLINK ASSIGNMENT message with a TBF starting time. Then send a new PACKET UPLINK ASSIGNMENT message with another TBF starting time and a different timeslot on PCCCH before the first TBF starting time has elapse. The MS shall start to send the RLC data block on the allocated uplink according to the second TBF starting time. The SS allows the MS to complete the GPRS attach procedure.

Maximum duration of the test

15 s.

Expected sequence

Step	Direction	Message	Comments
1	MS		The MS is switched on and triggered to perform a GPRS attach procedure.
2	MS -> SS	PACKET CHANNEL REQUEST	Received on PRACH.
3	SS -> MS	PACKET UPLINK ASSIGNMENT	See specific message contents. Sent on PAGCH.
4	SS -> MS	PACKET UPLINK ASSIGNMENT	See specific message contents. Sent on PAGCH.
5		{GPRS attach procedure}	Macro. Completion from step 4 in the attach procedure. Sent on allocated uplink resource. The SS verifies that the MS starts to send data according to information in step 4.

Specific message contents

As default messages contents, except:

PACKET UPLINK ASSIGNMENT in step 3

Information element	Value/remark
Dynamic allocation struct < TIMESLOT_ALLOCATION > < TBF_STARTING_TIME >	00010000, allocate timeslot 3. Arbitrarily chosen, high enough so the next message will be sent before the time has elapsed.

PACKET UPLINK ASSIGNMENT in step 4

Information element	Value/remark
Dynamic allocation struct < TIMESLOT_ALLOCATION > < TBF_STARTING_TIME >	00000010, allocate timeslot 6. Arbitrarily chosen.

42.1.2.1.8 Packet Uplink Assignment / One phase access

42.1.2.1.8.1 Packet Uplink Assignment / One phase access / Contention Resolution

The contention resolution is completed on the mobile station when the mobile station receives a PACKET UPLINK ACK/NACK message with the same TLLI as the mobile station has included in the RLC header of the first RLC data blocks. The mobile station shall then stop timer T3166 and counter N3104.

At sending of the first RLC data block, the mobile station shall stop timer T3164, set counter N3104 to 1, and start timer T3166. Counter N3104 shall be stepped each time the mobile station sends an RLC data block.

42.1.2.1.8.1.1 Packet Uplink Assignment / One phase access / Contention resolution / Inclusion of TLLI in RLC data blocks

42.1.2.1.8.1.1.1 Conformance requirements

In order to uniquely identify the mobile station when sending on uplink, the RLC Header is extended to include the TLLI of the mobile station until contention resolution is completed on the mobile station side.

All the RLC data blocks of an uplink TBF initiated by one phase access shall each contain a TLLI field in the RLC data block header until the contention resolution is completed on the mobile station side. After the reaction time specified in GSM 05.10 no other RLC data blocks shall contain a TLLI field.

The TLLI_BLOCK_CHANNEL_CODING parameter in the PACKET UPLINK ASSIGNMENT message indicates whether a RLC data block containing a TLLI field in the RLC data block header shall be encoded using CS-1 or using the channel coding scheme commanded.

The mobile station shall send all other RLC data blocks using the channel coding scheme commanded.

Upon contention resolution during one phase access, the mobile station shall start transmitting RLC data blocks without the TLLI field no later than the next occurrence of block $B((x+3) \bmod 12)$ where block $B(x)$ is the radio block containing the contention resolution message.

Reference

GSM 04.60 subclause 7.1.2.3, subclause 8.1.1, GSM 05.10 subclause 6.11.3.

42.1.2.1.8.1.1.2 Test purpose

1. To verify that in one phase access the first RLC data blocks of an uplink TBF contain a TLLI field in the RLC data block header and that these blocks are encoded according to the TLLI_BLOCK_CHANNEL_CODING parameter specified in the PACKET UPLINK ASSIGNMENT message.
2. To verify that upon contention resolution during one phase access the RLC data blocks not contain a TLLI field and are encoded using the CHANNEL_CODING_COMMAND parameter included in the PACKET_UPLINK_ASSIGNMENT after the contention resolution reaction time.

42.1.2.1.8.1.1.3 Method of test

Initial conditions

System Simulator:

1 cell supporting GPRS. The packet system information ACCESS_BURST_TYPE indicates 8 bit access.

Mobile Station:

The MS is GPRS attached and in packet idle mode. PDP context 2 has been established.

Related PICS/PIXIT statement

Support GPRS service.

Support PDP context.

Method of triggering the MS to initiate an uplink packet data transfer.

Test procedure

The MS is triggered to transfer an LLC PDU. The SS sends PACKET UPLINK ASSIGNMENT message containing Dynamic Allocation struct. The MS shall start to send RLC data and RLC/MAC control blocks on the allocated uplink. The SS allows the MS to send the uplink data transfer. The SS verifies the coding is the scheme specified by TLLI_BLOCK_CHANNEL_CODING, the TFI is correct and the block contains TLLI in the first RLC data blocks. After contention resolution reaction time shall the remaining RLC data blocks contain coding scheme specified by CHANNEL_CODING_COMMAND, the TFI shall be correct and the blocks do not contain TLLI.

Maximum duration of the test

3 min.

Expected sequence

Step	Direction	Message	Comments
1	MS		The MS is triggered to initiate packet uplink transfer of an LLC PDU consisting of 500 octets data.
2	MS -> SS	PACKET CHANNEL REQUEST	Received on PRACH.
3	SS -> MS	PACKET UPLINK ASSIGNMENT	Dynamic allocation struct, USF_GRANULARITY = one block, Sent on PAGCH.
4	SS -> MS	PACKET DOWNLINK DUMMY CONTROL BLOCK	Sent on the PACCH of the PDCH assigned in step 3, containing USF assigned to the MS.
5	MS -> SS	UPLINK RLC DATA BLOCK	Received on the assigned PDTCH. Check that the coding is the scheme specified by TLLI_BLOCK_CHANNEL_CODING, the TFI is correct and the block contains TLLI.
6	SS		Check that there is no RLC data block transmitted by the MS in the next radio block on PDTCH.
7	SS -> MS	PACKET UPLINK ACK/NACK	Sent on the PACCH of the PDCH 3 blocks after step 4, containing USF assigned to the MS.
8	MS -> SS	UPLINK RLC DATA BLOCK	Received on the assigned PDTCH. Check that if the RLC data block is received after the contention resolution reaction time the coding is the scheme specified by CHANNEL_CODING_COMMAND, the TFI is correct and the block does not contain TLLI otherwise the content should be as comments in step 5.
9	SS -> MS	PACKET UPLINK ACK/NACK	Sent on the PACCH of the PDCH assigned in step 3, containing USF assigned to the MS.
10	MS -> SS	UPLINK RLC DATA BLOCK	Received on the assigned PDTCH. Check that the coding is the scheme specified by CHANNEL_CODING_COMMAND, the TFI is correct and the block does not contain TLLI.
11			Repeat step 9 and 10 until the countdown value CV=0 in step 10.
12	SS -> MS	PACKET UPLINK ACK/NACK	Final Ack Indicator = '1' containing valid RRBP. Sent on PACCH of the assigned PDCH.
13	MS -> SS	PACKET CONTROL ACKNOWLEDGEMENT	Received on the block specified by RRBP on PACCH of the assigned PDCH.

Specific message contents

PACKET UPLINK ASSIGNMET message in step 3:

{0 < Global TFI > 10 < TLLI > 110 < TQI > 111 < Packet Request Reference >} < CHANNEL_CODING_COMMAND > < TLLI_BLOCK_CHANNEL_CODING >	111 (Packet Request Reference, information field sent in PACKET CHANNEL REQUEST and frame number in which PACKET CHANNEL REQUEST was received) arbitrarily chosen but different from TLLI_BLOCK_CHANNEL_CODING CS-1
--	---

PACKET UPLINK ACK/NACK message in step 7:

{0 1< CONTENTION_RESOLUTION_TLLI > - CONTENTION_RESOLUTION_TLLI}	1 the value received in step 5.
---	------------------------------------

42.1.2.1.8.1.2 Packet Uplink Assignment / One phase access / Contention resolution / Counter N3104

42.1.2.1.8.1.2.1 Conformance requirements

The contention resolution has failed on the mobile station side when the counter N3104 has reached its maximum value, or on expiry of timer T3166, or if the mobile station receives a PACKET UPLINK ACK/NACK message with the right TFI but with a another TLLI than the mobile station has included in the RLC header of the first RLC data blocks. The mobile station shall then reset the counter N3104, stop timer T3166 if not expired, immediately stop transmitting on this TBF and reinitiate the packet access procedure unless it has already been repeated 4 times.

Reference

GSM 04.60 subclause 7.1.2.3

42.1.2.1.8.1.2.2 Test purpose

To verify that the mobile station correctly sets and considers counter N3104.

Note

Counter N3104 is incremented by 1 with each new RLC/MAC block the mobile station sends until the first PACKET UPLINK ACK/NACK message is received.

Its maximum value is $N3104_MAX = 3 * BS_CV_MAX * \text{no-of-timeslots-assigned}$, where BS_CV_MAX is broadcast in PSI1.

42.1.2.1.8.1.2.3 Method of test

Initial conditions

System Simulator:

1 cell supporting GPRS. The packet system information BS_CV_MAX value = 1.

Mobile Station:

The MS is GPRS attached and in packet idle mode. PDP context 2 has been established.

Related PICS/PIXIT statement

Support GPRS service.

Support PDP context.

Method of triggering the MS to initiate an uplink packet data transfer.

Test procedure

The MS is triggered to initiate packet uplink transfer of an LLC PDU. The SS assigns packet uplink resources in a PACKET UPLINK ASSIGNMENT message indicating one phase packet access. The MS shall start transferring RLC data blocks.. The SS verifies that the MS stops transmitting and re-initiates the packet access procedure.

At the second attempt, the SS sends PACKET UPLINK ACK/NACK exactly after $N3104_MAX - 1$ data blocks. The SS verifies that this time the MS does not abort the access procedure and successfully completes uplink transfer.

Maximum duration of the test

5 min.

Expected sequence

Step	Direction	Message	Comments
1	MS		The MS is triggered to initiate packet uplink transfer of an LLC PDU consisting of 500 octets data.
2	MS -> SS	PACKET CHANNEL REQUEST	Received on PRACH.
3	SS -> MS	PACKET UPLINK ASSIGNMENT	Indicating one phase packet access granted and CS-1. Sent on PAGCH.
4	MS -> SS	n RLC data blocks	SS receives n = N3104_MAX data blocks. Received on the assigned PDTCH.
5	SS		SS verifies that MS does not send further RLC data blocks.
6	MS -> SS	PACKET CHANNEL REQUEST	MS re-initiates packet access procedure. Received on PRACH.
7	SS -> MS	PACKET UPLINK ASSIGNMENT	Indicating one phase packet access granted. Sent on PAGCH.
8	MS -> SS	n-1 RLC data blocks	SS receives N3104_MAX – 1 data blocks. Received on the assigned PDTCH.
9	SS -> MS	PACKET UPLINK ACK/NACK	Sent on PACCH.
10		{Uplink data transfer, dynamic allocation}	Macro. Completion of the macro procedure.

Specific message contents

None.

42.1.2.1.8.1.3 Packet Uplink Assignment / One phase access / Contention resolution / Timer T3166

42.1.2.1.8.1.3.1 Conformance requirements

The contention resolution has failed on the mobile station side when the counter N3104 has reached its maximum value, or on expiry of timer T3166, or if the mobile station receives a PACKET UPLINK ACK/NACK message with the right TFI but with a another TLLI than the mobile station has included in the RLC header of the first RLC data blocks. The mobile station shall then reset the counter N3104, stop timer T3166 if not expired, immediately stop transmitting on this TBF and reinitiate the packet access procedure unless it has already been repeated 4 times.

Reference

GSM 04.60 subclause 7.1.2.3

42.1.2.1.8.1.3.2 Test purpose

To verify that the mobile station correctly considers timer T3166.

42.1.2.1.8.1.3.3 Method of test

Initial conditions

System Simulator:

1 cell supporting GPRS. The packet system information ACCESS_BURST_TYPE indicates 8 bit access and BS_CV_MAX value = 15.

Mobile Station:

The MS is GPRS attached and in packet idle mode. PDP context 2 has been established.

Related PICS/PIXIT statement

Support GPRS service.

Support PDP context.

Method of triggering the MS to initiate an uplink packet data transfer.

Foreseen final state of the MS

Packet idle mode.

Test procedure

The MS is triggered to initiate packet uplink transfer of an LLC PDU. The SS assigns packet uplink resources in a PACKET UPLINK ASSIGNMENT message indicating one phase packet access. The MS shall start transferring RLC data blocks. The SS reduces the block transfer rate by controlling the USF flag. In this way, the SS forces T3166 (with value 5 s.) to expire before counter N3104 reaches N3104_MAX (with value 45 blocks for current settings). The SS verifies that the MS stops transmitting and re-initiates the packet access procedure.

At the second attempt, the SS sends PACKET UPLINK ACK/NACK before T3166 expire. The SS verifies that this time the MS does not abort the access procedure and successfully completes the data transfer.

Maximum duration of the test

5 min.

Expected sequence

Step	Direction	Message	Comments
1	MS		The MS is triggered to initiate packet uplink transfer of an LLC PDU consisting of 1000 octets data.
2	MS -> SS	PACKET CHANNEL REQUEST	Received on PRACH.
3	SS -> MS	PACKET UPLINK ASSIGNMENT	Indicating one phase packet access granted, CS-1 shall be used and USF_GRANULARITY = one block. Sent on PAGCH.
4	SS -> MS	PACKET DOWNLINK DUMMY CONTROL BLOCK	USF addressing the MS. Sent on PACCH of PDCH assigned in step 3.
5	MS -> SS	RLC data block	Received on the assigned PDTCH.
6	SS -> MS	PACKET DOWNLINK DUMMY CONTROL BLOCK	USF not addressing the MS. Sent on PACCH.
7	SS -> MS	PACKET DOWNLINK DUMMY CONTROL BLOCK	USF not addressing the MS. Sent on PACCH.
8	SS -> MS	PACKET DOWNLINK DUMMY CONTROL BLOCK	USF not addressing the MS. Sent on PACCH.
9	SS -> MS	PACKET DOWNLINK DUMMY CONTROL BLOCK	USF not addressing the MS. Sent on PACCH.
10	SS -> MS	PACKET DOWNLINK DUMMY CONTROL BLOCK	USF not addressing the MS. Sent on PACCH.
11	SS -> MS	PACKET DOWNLINK DUMMY CONTROL BLOCK	USF not addressing the MS. Sent on PACCH.
12	SS -> MS	PACKET DOWNLINK DUMMY CONTROL BLOCK	USF not addressing the MS. Sent on PACCH.
13	SS -> MS	PACKET DOWNLINK DUMMY CONTROL BLOCK	USF not addressing the MS. Sent on PACCH.
14	SS -> MS	PACKET DOWNLINK DUMMY CONTROL BLOCK	USF not addressing the MS. Sent on PACCH.
15	SS -> MS	PACKET DOWNLINK DUMMY CONTROL BLOCK	USF not addressing the MS. Sent on PACCH.
16	SS -> MS	PACKET DOWNLINK DUMMY CONTROL BLOCK	USF not addressing the MS. Sent on PACCH.
17	MS<->SS		Steps 4 to 16 are repeated at most 22 times or until MS does not send further RLC data blocks at step 5. Note: steps 4 to 16 transfer one block every 52 frames, or 240 ms. 22 repetitions require about 5.5 s. (Timer T3166 shall expire).
19	MS -> SS	PACKET CHANNEL REQUEST	MS re-initiates packet access procedure. Received on PRACH.
20	SS -> MS	PACKET UPLINK ASSIGNMENT	Indicating one phase packet access granted, CS-1 shall be used and USF_GRANULARITY = one block. Sent on PAGCH.
21	MS<->SS		Steps 4 to 16 are repeated 17 times. Note: 17 repetitions require about 4.3 s. (Timer T3166 should not expire).
22	SS -> MS	PACKET UPLINK ACK/NACK	Sent on PACCH.
23		{Uplink data transfer, dynamic allocation}	Macro. Completion of the TBF procedure.

42.1.2.1.8.1.4 Packet Uplink Assignment / One phase access / Contention resolution / TLLI mismatch

42.1.2.1.8.1.4.1 Conformance requirements

The contention resolution has failed on the mobile station side when the counter N3104 has reached its maximum value, or on expiry of timer T3166, or if the mobile station receives a PACKET UPLINK ACK/NACK message with the right TFI but with a another TLLI than the mobile station has included in the RLC header of the first RLC data blocks. The mobile station shall then reset the counter N3104, stop timer T3166 if not expired, immediately stop transmitting on this TBF and reinitiate the packet access procedure unless it has already been repeated 4 times.

Reference

GSM 04.60 subclause 7.1.2.3

42.1.2.1.8.1.4.2 Test purpose

To verify that the mobile station reinitiates packet access when it receives a PACKET UPLINK ACK/NACK message with the correct TFI but with a TLLI other than the mobile station has included in the RLC header.

42.1.2.1.8.1.4.3 Method of test

Initial conditions

System Simulator:

1 cell supporting GPRS.

Mobile Station:

The MS is GPRS attached and in packet idle mode. PDP context 2 has been established.

Related PICS/PIXIT statement

Support GPRS service.

Support PDP context.

Method of triggering the MS to initiate an uplink packet data transfer.

Test procedure

The MS is triggered to initiate packet uplink transfer of an LLC PDU. The SS assigns packet uplink resources in a PACKET UPLINK ASSIGNMENT message indicating one phase packet access. The MS shall start transferring RLC data block after SS has assigned USF to the MS. The SS acknowledges the RLC block transfer with a PACKET UPLINK ACK/NACK including correct TFI and incorrect TLLI. The SS continue to assign USF to the MS. The SS shall verify that the MS immediately stops transmitting (see note below) and retries packet access procedure.

At the second attempt, the SS sends PACKET UPLINK ACK/NACK including a correct TLLI. The SS verifies that this time the MS does not abort the access procedure and successfully completes the data transfer.

Note:

A mobile station, receiving a commanding message in block number N, shall take an "immediate" action as a result of the command, starting in any block from block number N+1 to N+6 (inclusive).

Maximum duration of the test

5 min.

Expected sequence

Step	Direction	Message	Comments
1	MS		The MS is triggered to initiate packet uplink transfer of an LLC PDU consisting of 200 octets data.
2	MS -> SS	PACKET CHANNEL REQUEST	Received on PRACH.
3	SS -> MS	PACKET UPLINK ASSIGNMENT	Indicating one phase packet access granted, dynamic allocation struct and USF_GRANULARITY = one block. Sent on PAGCH.
4	SS -> MS	PACKET DOWNLINK DUMMY CONTROL BLOCK	Contained USF assigned to the MS.
5	MS -> SS	UPLINK RLC DATA BLOCK	Received on the assigned PDTCH.
6	SS -> MS	PACKET UPLINK ACK/NACK	Assign USF to the MS, include correct TFI and incorrect TLLI. Sent on PACCH.
7	SS -> MS	PACKET DOWNLINK DUMMY CONTROL BLOCK	Execute step 7 six times with USF assigned to the MS or until the MS sends Packet Channel request in step 8. The SS verifies that the MS does not transmit more than 6 uplink RLC data block after step 6 and before step 8.
8	MS -> SS	PACKET CHANNEL REQUEST	MS re-initiates packet access procedure. Received on PRACH.
9	SS -> MS	PACKET UPLINK ASSIGNMENT	Indicating one phase packet access granted, dynamic allocation struct and USF_GRANULARITY = one block. Sent on PAGCH.
10	SS -> MS	PACKET DOWNLINK DUMMY CONTROL BLOCK	Contained USF assigned to the MS.
11	MS -> SS	UPLINK RLC DATA BLOCK	Received on the assigned PDTCH.
12	SS -> MS	PACKET UPLINK ACK/NACK	Including correct TLLI. Sent on PACCH.
13		{Uplink data transfer, dynamic allocation}	Macro. Completion of the TBF procedure.

42.1.2.1.8.1.5 Packet Uplink Assignment / One phase access / Contention resolution / 4 access repetition attempts

42.1.2.1.8.1.5.1 Conformance requirement

The contention resolution has failed on the mobile station side when the counter N3104 has reached its maximum value, or on expiry of timer T3166, or if the mobile station receives a PACKET UPLINK ACK/NACK message with the right TFI but with a another TLLI than the mobile station has included in the RLC header of the first RLC data blocks.

The mobile station shall then reset the counter N3104, stop timer T3166 if not expired, immediately stop transmitting on this TBF and reinitiate the packet access procedure unless it has already been repeated 4 times.

Reference

GSM 04.60 subclause 7.1.2.3

42.1.2.1.8.1.5.2 Test purpose

To verify that the mobile station repeats the packet access initiation 4 times.

42.1.2.1.8.1.5.3 Method of test

Initial conditions

System Simulator:

1 cell supporting GPRS.

Mobile Station:

The MS is GPRS attached and in packet idle mode. PDP context 2 has been established.

Related PICS/PIXIT statement

Support GPRS service.

Support PDP context.

Method of triggering the MS to initiate an uplink packet data transfer.

Test procedure

The MS is triggered to initiate packet uplink transfer of an LLC PDU. The SS assigns packet uplink resources in a PACKET UPLINK ASSIGNMENT message indicating one phase packet access. The MS shall start transferring RLC data blocks after SS has assigned USF to the MS. The SS acknowledges the RLC block transfer with a PACKET UPLINK ACK/NACK including a TLLI not corresponding to the MS. The SS shall verify that the MS stops transmitting blocks and reinitiates packet access. This test sequence shall be repeated four times.

Maximum duration of the test

5 min.

Expected sequence

Step	Direction	Message	Comments
1	MS		The MS is triggered to initiate packet uplink transfer of an LLC PDU consisting of 200 octets data.
2	MS -> SS	PACKET CHANNEL REQUEST	Received on PRACH.
3	SS -> MS	PACKET UPLINK ASSIGNMENT	Indicating one phase packet access granted, dynamic allocation struct and USF_GRANULARITY = one block. Sent on PAGCH.
4	SS -> MS	PACKET DOWNLINK DUMMY CONTROL BLOCK	Contained USF assigned to the MS.
5	MS -> SS	UPLINK RLC DATA BLOCK	Received on the assigned PDTCH.
6	SS -> MS	PACKET UPLINK ACK/NACK	Assign USF to the MS, include a incorrect TLLI. Sent on PACCH.
7	SS		The SS verifies that the MS reinitiates the packet access procedure from step 2 four times.

Specific message contents

None.

42.1.2.1.8.2 Packet Uplink Assignment / One phase access / Timing Advance

42.1.2.1.8.2.1 Packet Uplink Assignment / One phase access / Timing Advance / TA Index present

42.1.2.1.8.2.1.1 Conformance requirements

If a Timing Advance Index is included in the assignment message, the mobile station shall use the continuous update timing advance mechanism, using its allocation on PTCCH (see GSM 05.10).

Reference

GSM 04.60 subclause 7.1.2.5, GSM 03.64 subclause 6.5.7.2

42.1.2.1.8.2.1.2 Test purpose

To verify that the mobile station uses the continuous update timing advance mechanism and sends access bursts on the PTCCH slots as determined by the Timing Advance Index sent in the PACKET UPLINK ASSIGNMENT message.

42.1.2.1.8.2.1.3 Method of test

Initial conditions

System Simulator:

1 cell supporting GPRS. The packet system information ACCESS_BURST_TYPE indicates 8 bit access.

Mobile Station:

The MS is GPRS attached and in packet idle mode. PDP context 2 has been established.

Related PICS/PIXIT statement

Support GPRS service.

Support PDP context.

Method of triggering the MS to initiate an uplink packet data transfer.

Test procedure

The MS is triggered to initiate uplink data packet transfer. The SS responds with PACKET UPLINK ASSIGNMENT message indicating one phase access and containing a Timing Advance Index. The MS shall start to send data on the allocated uplink. The SS allows the MS to send the uplink data transfer. During the Uplink data transfer, the SS shall verify that the access bursts are sent correctly by the MS in the PTCCH.

Maximum duration of the test

2 min.

Expected sequence

Step	Direction	Message	Comments
1	MS		The MS is triggered to initiate packet uplink transfer of an LLC PDU consisting of 500 octets data.
2	MS -> SS	PACKET CHANNEL REQUEST	Received on PRACH.
3	SS -> MS	PACKET UPLINK ASSIGNMENT	Including Timing Advance Index = 0, Dynamic allocation struct. Sent on PAGCH.
4		{Uplink data transfer, dynamic allocation}	Macro. Completion from step 4 in the TBF procedure. Verification, see below.

Verification

During the uplink data transfer (step 4) the SS monitors the access burst on PTCCH which are located on slots with numbers FN, such that $(FN \bmod (8 \cdot 52)) = 12$ for Timing Advance Index = 0 (GSM 03.64/6.5.7.2 and GSM 05.02/Table 6). The access burst contents shall be MESSAGE_TYPE = 011111 and CTRL_ACK = 11.

The test is repeated with an arbitrarily chosen Timing Advance Index in the range 1 to 15. SS shall verify that the access burst are sent in the correct idle slots as specified in GSM 05.02/Table 6.

Specific message contents

None.

42.1.2.1.8.2.2 Packet Uplink Assignment / One phase access / Timing Advance / TA Index not present

42.1.2.1.8.2.2.1 Conformance requirements

If a Timing Advance Index is included in the assignment message, the mobile station shall use the continuous update timing advance mechanism, using its allocation on PTCCH (see GSM 05.10). Otherwise, the continuous update timing advance mechanism shall not be used.

Reference

GSM 04.60 subclause 7.1.2.5.

42.1.2.1.8.2.2.2 Test purpose

To verify that the mobile station does not send any access bursts on the PTCCH if Timing Advance Index is not present in the PACKET UPLINK ASSIGNMENT message.

42.1.2.1.8.2.2.3 Method of test

Initial conditions

System Simulator:

1 cell supporting GPRS.

Mobile Station:

The MS is GPRS attached and in packet idle mode. PDP context 2 has been established.

Related PICS/PIXIT statement

Support GPRS service.

Support PDP context.

Method of triggering the MS to initiate an uplink data transfer.

Test procedure

The MS is triggered to initiate uplink data transfer. The SS responds with PACKET UPLINK ASSIGNMENT message that request one phase access and not including a Timing Advance Index. The MS shall start to send data on the allocated uplink. The SS allows the MS to send the uplink data transfer. During the uplink data transfer, the SS shall verify that the MS not send any access bursts on PTCCH.

Maximum duration of the test

2 min.

Expected sequence

Step	Direction	Message	Comments
1	MS		The MS is triggered to initiate packet uplink transfer of an LLC PDU consisting of 500 octets data..
2	MS -> SS	PACKET CHANNEL REQUEST	Received on PRACH.
3	SS -> MS	PACKET UPLINK ASSIGNMENT	Not include Timing Advance Index. Indicating Dynamic allocation struct. Sent on PAGCH.
4		{Uplink data transfer, dynamic allocation}	Macro. Completion from step 4 in the TBF procedure. Verification, see below.

Verification

The SS verifies that the MS does not transmit in idle frames during data block transfer (steps 4). Idle frame numbers are 12, 25, 38 and 51 in the 52-multiframe structure.

Specific message contents

None.

42.1.2.1.8.2.3 Packet Uplink Assignment / One phase access / Timing Advance / TA value field not provided

42.1.2.1.8.2.3.1 Conformance requirements

For the case where a TIMING_ADVANCE_VALUE field is not provided in the assignment message, the mobile station is not allowed to send normal bursts on the uplink until it receives a valid timing advance either through the continuous timing advance procedure or in a PACKET TIMING ADVANCE/POWER CONTROL message.

Reference

GSM 04.60 subclause 7.1.2.5.

42.1.2.1.8.2.2.2 Test purpose

To verify that the mobile station does not send normal bursts on the uplink until it receives a valid timing advance in a PACKET POWER CONTROL/TIMING ADVANCE message if Timing Advance Value field is not provided in the PACKET UPLINK ASSIGNMENT message.

42.1.2.1.8.2.2.3 Method of test

Initial conditions

System Simulator:

1 cell supporting GPRS.

Mobile Station:

The MS is GPRS attached and in packet idle mode. PDP context 2 has been established.

Related PICS/PIXIT statement

Support GPRS service.

Support PDP context.

Method of triggering the MS to initiate an uplink data transfer.

Test procedure

The MS is triggered to initiate uplink data transfer. The SS responds with PACKET UPLINK ASSIGNMENT message that request one phase access and does not include Timing Advance Value field. The SS shall wait 2 seconds and then send a PACKET POWER CONTROL/TIMING ADVANCE message with a valid timing advance information. The MS shall start to send data on the allocated uplink. The SS allows the MS to send the uplink data transfer. The SS verifies that the MS not send any normal burst on the uplink until the SS sends a valid timing advance.

Maximum duration of the test

2 min.

Expected sequence

Step	Direction	Message	Comments
1	MS		The MS is triggered to initiate packet uplink transfer of an LLC PDU consisting of 500 octets data.
2	MS -> SS	PACKET CHANNEL REQUEST	Received on PRACH.
3	SS -> MS	PACKET UPLINK ASSIGNMENT	No Timing Advance Value. Indicating Dynamic allocation struct. Sent on PAGCH.
4	SS		Wait 2 seconds and verifies that the MS not send any normal burst on the uplink.
5	SS -> MS	PACKET POWER CONTROL/TIMING ADVANCE	Include a valid Timing Advance information. Sent on PACCH.
6		{Uplink data transfer, dynamic allocation}	Macro. Completion of the TBF procedure.

Specific message contents

None.

42.1.2.1.9 Packet Uplink Assignment / Two phase access

42.1.2.1.9.1 Packet Uplink Assignment / Two phase access / Packet Resource Request / RLC Octet Count

42.1.2.1.9.1.1 Conformance requirements

The mobile station may request an open-ended or a close-ended TBF. If a close-ended TBF is requested, the number of octets of user data that the MS has to transfer in the TBF shall be indicated in the PACKET RESOURCE REQUEST message.

Reference

GSM 04.60 subclause 7.1.3.1

42.1.2.1.9.1.2 Test purpose

To verify that the mobile station indicates the number of octets of user data that it has to be transferred in the TBF.

42.1.2.1.9.1.3 Method of test

Initial conditions

System Simulator:

1 cell supporting GPRS. The packet system information ACCESS_BURST_TYPE indicates 8 bit access.

Mobile Station:

The MS is GPRS attached and in packet idle mode. PDP context 1 has been established.

Related PICS/PIXIT statement

Support GPRS service.

Support PDP context.

Method of triggering the MS to initiate an uplink data transfer.

Test procedure

The MS is triggered to initiate unacknowledged uplink data transfer. The SS shall send PACKET UPLINK ASSIGNMENT message including Single Block Allocation struct information to instruct the MS to send PACKET RESOURCE REQUEST. The MS should perform a two-phase access i.e. the MS shall transmit a PACKET RESOURCE REQUEST message on the allocated uplink resource.

The RLC_OCTET_COUNT field shall indicate the number of LLC data octets the MS wishes to transfer.

The SS should then respond with PACKET UPLINK ASSIGNMENT message and the MS should begin transmitting RLC data blocks on the allocated uplink resources. The SS allows the MS to complete the sending of the data.

Maximum duration of the test

2 min.

Expected sequence

Step	Direction	Message	Comments
1	MS		The MS is triggered to initiate the transfer of 100 user data octets.
2	MS -> SS	PACKET CHANNEL REQUEST	Two Phase Access Request. Received on PRACH.
3	SS -> MS	PACKET UPLINK ASSIGNMENT	Single block allocation struct. Sent on PAGCH.
4	MS -> SS	PACKET RESOURCE REQUEST	Received on the single block assigned in step 3.
5	SS -> MS	PACKET UPLINK ASSIGNMENT	Dynamic allocation struct. Sent on the PACCH of the assigned PDCH.
6		{Uplink data transfer, dynamic allocation}	Macro. Completion from step 4 in the TBF procedure.
7	SS		The SS verifies that the MS has transferred the number of user data octets indicated in step 4 as RLC_OCTET_COUNT value.

Specific message contents

None.

42.1.2.1.9.2 Packet Uplink Assignment / Two phase access / Contention resolution

42.1.2.1.9.2.1 Packet Uplink Assignment / Two phase access / Contention resolution / Expiry of timer T3168

42.1.2.1.9.2.1.1 Conformance requirements

The contention resolution has failed on the mobile station side when the mobile station does not receive a PACKET UPLINK ASSIGNMENT message with its TLLI before expiry of timer T3168. The mobile station shall then reinitiate the packet access procedure unless it has already been repeated 4 times. In that case, TBF failure has occurred.

Reference

GSM 04.60 subclause 7.1.3.3

42.1.2.1.9.2.1.2 Test purpose

To verify that the mobile station reinitiates the packet access procedure after a time equal to timer T3168 and the procedure shall be repeated 4 times.

42.1.2.1.9.2.1.3 Method of test

Initial conditions

System Simulator:

1 cell supporting GPRS. PSI GPRS Cell Options, T3168 = 7

Mobile Station:

The MS is GPRS attached and in packet idle mode. PDP context 1 has been established.

Related PICS/PIXIT statement

Support GPRS service.

Support PDP context.

Method of triggering the MS to initiate an uplink data transfer.

Test procedure

The MS is triggered to initiate unacknowledged uplink data transfer. The SS sends PACKET UPLINK ASSIGNMENT message including Single Block Allocation struct information to order the MS to send PACKET RESOURCE REQUEST message. The MS shall perform a two-phase access i.e. the MS shall transmit a PACKET RESOURCE REQUEST message on the allocated uplink resource. The SS wait for a time greater than timer T3168 so the MS shall reinitiate packet access procedure. This procedure shall be repeated 4 times.

Maximum duration of the test

2 min.

Expected sequence

Step	Direction	Message	Comments
1	MS		The MS is triggered to initiate packet uplink transfer of an LLC PDU consisting of 200 octets data.
2	MS -> SS	PACKET CHANNEL REQUEST	Two Phase Access Request. Received on PRACH.
3	SS -> MS	PACKET UPLINK ASSIGNMENT	Single Block Allocation struct. Sent on PAGCH.
4	MS -> SS	PACKET RESOURCE REQUEST	ACCESS_TYPE = "Two Phase Access Request". Received on the single block assigned in step 3.
5	SS		The SS waits T3168 expiry.
6			The SS verifies that the MS reinitiate packet access procedure four times.

Specific message contents

None.

42.1.2.1.9.2.2 Packet Uplink Assignment / Two phase access / Contention resolution / TLLI mismatch

The contention resolution is completed on the mobile station side when the mobile station receives a PACKET UPLINK ASSIGNMENT message with the same TLLI as the mobile station has included in the PACKET RESOURCE REQUEST message.

42.1.2.1.9.2.2.1 Conformance requirements

If the failure is due to a TLLI mismatch, or to the expiry of timers T3166 or T3168, or to the fact that the counter N3104 reached its maximum value in the contention resolution procedure, and repetition as described in subclause 7.1.3.3 has been performed, the mobile station shall remain in packet idle mode, notify higher layer (TBF establishment failure), transactions in progress shall be aborted and cell reselection continued.

Reference

GSM 04.60 subclause 7.1.4, subclause 7.1.3.3

42.1.2.1.9.2.2.2 Test purpose

To verify that the MS reinitiates packet access procedure with failure due to a TLLI mismatch in the contention resolution procedure, unless it has already been repeated 4 times. In that case, TBF failure has occurred.

42.1.2.1.9.2.2.3 Method of test

Initial conditions

System Simulator:

1 cell supporting GPRS. The packet system information ACCESS_BURST_TYPE indicates 8 bit access.

Mobile Station:

The MS is GPRS attached and in packet idle mode. PDP context 1 has been established.

Related PICS/PIXIT statement

Support GPRS service.

Support PDP context.

Method of triggering the MS to initiate an uplink data transfer.

Test procedure

The MS is triggered to initiate unacknowledged uplink data transfer. The SS responds with PACKET UPLINK ASSIGNMENT message that request two phase access. The MS shall then send PACKET RESOURCE REQUEST message. The SS responds with PACKET UPLINK ASSIGNMENT message with a TLLI different to that the MS has sent in PACKET RESOURCE REQUEST message. The MS shall reinitiate the packet access procedure.

This procedure shall be repeated 4 times.

Maximum duration of the test

2 min.

Expected sequence

Step	Direction	Message	Comments
1	MS		The MS is triggered to initiate packet uplink transfer of an LLC PDU consisting of 200 octets data.
2	MS -> SS	PACKET CHANNEL REQUEST	Two Phase Access Request. Received on PRACH.
3	SS -> MS	PACKET UPLINK ASSIGNMENT	Single Block Allocation struct. Sent on PAGCH.
4	MS -> SS	PACKET RESOURCE REQUEST	ACCESS_TYPE = "Two Phase Access Request". Include TLLI. Received on the single block assigned in step 3.
5	SS -> MS	PACKET UPLINK ASSIGNMENT	Include incorrect TLLI according to step 4. Sent on the PACCH of the assigned PDCH.
6			The SS verifies that the MS reinitiate packet access procedure four times.

Specific message contents

None.

42.1.2.1.9.3 Packet Uplink Assignment / Two phase access / Packet Resource Request / No respond to Packet Downlink Assignment

42.1.2.1.9.3.1 Conformance requirements

When the mobile station has received a PACKET UPLINK ASSIGNMENT message it shall respond with a PACKET RESOURCE REQUEST message in the allocated single radio block. At sending of the PACKET RESOURCE REQUEST message, the mobile station shall start timer T3168. Further more, the mobile station shall not respond to PACKET DOWNLINK ASSIGNMENT messages while timer T3168 is running.

Reference

GSM 04.60 subclause 7.1.3.1

42.1.2.1.9.3.2 Test purpose

To verify that the mobile station does not respond to PACKET DOWNLINK ASSIGNMENT messages while timer T3168 is running after sending of the PACKET RESOURCE REQUEST message.

42.1.2.1.9.1.3 Method of test

Initial conditions

System Simulator:

1 cell supporting GPRS. The packet system information ACCESS_BURST_TYPE indicates 8 bit access, T3168 indicates value 7 in GPRS Cell Options.

Mobile Station:

The MS is GPRS attached and in packet idle mode. PDP context 2 has been established.

Related PICS/PIXIT statement

Support GPRS service.

Support PDP context.

Method of triggering the MS to initiate an uplink data transfer.

Test procedure

The MS is triggered to initiate unacknowledged uplink data transfer. The SS shall send PACKET UPLINK ASSIGNMENT message including Single Block Allocation struct information to instruct the MS to send PACKET RESOURCE REQUEST. The MS should perform a two-phase access i.e. the MS shall transmit a PACKET RESOURCE REQUEST message on the allocated uplink resource.

While timer T3186 is running the SS send PACKET DOWNLINK ASSIGNMENT message and starts to send data on the allocated downlink before the timer expire. The MS shall not respond to the Downlink data transfer.

The SS should then send PACKET UPLINK ASSIGNMENT message before the timer T3186 expire and the MS should then begin transmitting RLC data blocks on the allocated uplink resources. The SS allows the MS to complete the sending of the data.

Maximum duration of the test

2 min.

Expected sequence

Step	Direction	Message	Comments
1	MS		The MS is triggered to initiate packet uplink transfer of an LLC PDU containing 400 octets of data.
2	MS -> SS	PACKET CHANNEL REQUEST	Two Phase Access Request. Received on PRACH.
3	SS -> MS	PACKET UPLINK ASSIGNMENT	Single block allocation struct. Sent on PAGCH.
4	MS -> SS	PACKET RESOURCE REQUEST	Received on the single block assigned in step 3.
5	SS -> MS	PACKET DOWNLINK ASSIGNMENT	Sent on PACCH.
6	SS -> MS	DOWNLINK RLC DATA BLOCK	Sent on the assigned PDTCH with poll bit set to 1.
7	SS -> MS	PACKET UPLINK ASSIGNMENT	Verify no response from the MS. Dynamic allocation struct. Sent on the PACCH of the assigned PDCH 0,9* T3186.
8		{Uplink data transfer, dynamic allocation}	Macro. Completion from step 4 in the TBF procedure.

Specific message contents

None.

42.1.2.1.10 Packet Uplink Assignment / Abnormal cases

42.1.2.1.10.1 Packet Uplink Assignment / Abnormal cases / Incorrect PDCH assignment

42.1.2.1.10.1.1 Conformance requirements

If the mobile station has been assigned more PDCHs than it supports according to its MS multislot class, the mobile station shall reinitiate the packet access procedure unless it has already been repeated 4 times. In that case, TBF failure has occurred.

Reference

GSM 04.60 subclause 7.1.4

42.1.2.1.10.1.2 Test purpose

To verify that the mobile station reinitiates the packet access procedure when the mobile station has been assigned more PDCHs than it supports and after 4 repetitions of the packet access procedure the mobile station shall initiate TBF failure.

42.1.2.1.10.1.3 Method of test

Initial conditions

System Simulator:

1 cell supporting GPRS.

Mobile Station:

The MS is switched off.

Related PICS/PIXIT statement

Support GPRS service.

Switch off on button Yes/No.

Multislot class.

Method of trigger GPRS attach.

Test procedure

Convert the MS Multislot Class to number of uplink timeslot supported.

The MS is switched on and triggered to perform a GPRS attach. The SS sends PACKET UPLINK ASSIGNMENT message containing more assigned PDCHs than the MS supports according to its multislot class. The MS shall reinitiate packet access procedure; this procedure shall be repeated 4 times.

Maximum duration of the test

2 min.

Expected sequence

Step	Direction	Message	Comments
1	MS		The MS is switched on and triggered to perform a GPRS attach.
2	MS -> SS	PACKET CHANNEL REQUEST	Received on PRACH.
3	SS -> MS	PACKET UPLINK ASSIGNMENT	Assign one more Tx than the MS supported . Sent on PAGCH.
4			The SS verifies that the MS reinitiate packet access procedure four times.

Specific message contents

None.

42.1.2.1.10.2 Packet Uplink Assignment / Abnormal cases / Expiry of timer T3164

42.1.2.1.10.2.1 Conformance requirements

On expiry of timer T3164, the mobile station shall reinitiate the packet access procedure unless it has already been reinitiated 3 times, in which case the mobile station shall return to packet idle mode and notify higher layers.

Reference

GSM 04.60 subclause 7.1.4

42.1.2.1.10.2.2 Test purpose

To verify that the mobile station reinitiate the packet access procedure when the network have sent a PACKET UPLINK ASSIGNMENT message but the MS has not sent the first block within the time equal to the timer T3164. This packet access procedure shall at most be reinitiated 3 times.

42.1.2.1.10.2.3 Method of test

Initial conditions

System Simulator:

1 cell supporting GPRS. The packet system information ACCESS_BURST_TYPE indicates 8 bit access.

Mobile Station:

The MS is GPRS attached and in packet idle mode. PDP context 2 has been established.

Related PICS/PIXIT statement

Support GPRS service.

Support PDP context.

Method of triggering the MS to initiate an uplink data transfer.

Test procedure

The MS is triggered to initiate uplink data transfer. The SS sends PACKET UPLINK ASSIGNMENT message with a USF assigned to the MS. The SS shall send PACKET DOWNLINK DUMMY CONTROL BLOCK messages with USF not assigned to the MS. The SS verifies that the MS reinitiate packet access procedure after a time equal to timer T3164; this shall be repeated 3 times.

Maximum duration of the test

1 min.

Expected sequence

Step	Direction	Message	Comments
1	MS		The MS is triggered to initiate packet uplink transfer of an LLC PDU consisting of 200 octets data.
2	MS -> SS	PACKET CHANNEL REQUEST	Received on PRACH.
3	SS -> MS	PACKET UPLINK ASSIGNMENT	Allocate a USF for the MS. Sent on PAGCH.
4	SS -> MS	PACKET DOWNLINK DUMMY CONTROL BLOCKs	Don't contain the assigned USF in step 3. Repeat step 4 during timer T3164 is running.
5	MS		The SS verifies that the packet access procedure is reinitiated after a time equal to timer T3164 four times.

Specific message contents

None.

42.1.2.2 Packet Downlink Assignment

42.1.2.2.1 Packet Downlink Assignment / Response to poll bit

42.1.2.2.1.1 Conformance requirements

In case valid timing advance for the mobile station is not available, the network may use one of the following two methods to trigger the mobile station to transmit a PACKET CONTROL ACKNOWLEDGEMENT:

- if the PACKET DOWNLINK ASSIGNMENT message is not segmented and the CONTROL_ACK_TYPE parameter in the System Information indicates acknowledgement is access bursts, the network may set the poll bit in the PACKET DOWNLINK ASSIGNMENT message.
- if the PACKET DOWNLINK ASSIGNMENT message is segmented or the CONTROL_ACK_TYPE parameter in the System Information does not indicate acknowledgement is access bursts, the network may send PACKET POLLING REQUEST with TYPE_OF_ACK parameter set to access bursts (see 11.2.12).

Reference

GSM 04.60 subclause 7.2.1.1

42.1.2.2.1.2 Test purpose

To verify that the mobile station sends PACKET CONTROL ACKNOWLEDGEMENT as four access bursts if the network sets the poll bit in the PACKET DOWNLINK ASSIGNMENT message when CONTROL_ACK_TYPE is set to four access bursts.

42.1.2.2.1.3 Method of test

Initial conditions

System Simulator:

1 cell supporting GPRS. The packet system information CONTROL_ACK_TYPE is set to indicate PACKET CONTROL ACKNOWLEDGEMENT format as four access bursts and the ACCESS_BURST_TYPE indicates 11 bit access.

Mobile Station:

The MS is GPRS attached and in packet idle mode and Ready state.

Related PICS/PIXIT statement

Support GPRS service.

Test procedure

The SS initiate a downlink data transfer. The SS sends PACKET DOWNLINK ASSIGNMENT message. The poll bit in the MAC header of the PACKET DOWNLINK ASSIGNMENT message will be set to indicate RRBP field is valid. The SS verifies that the MS sends PACKET CONTROL ACKNOWLEDGEMENT as four access bursts.

Maximum duration of the test

2 min.

Expected sequence

Step	Direction	Message	Comments
1	SS		The SS initiate a downlink transfer of 200 octets data.
2	SS -> MS	PACKET DOWNLINK ASSIGNMENT	Poll bit in the MAC header is set to indicate a valid RRBP = 1. Sent on PCCCH.
3	MS -> SS	PACKET CONTROL ACKNOWLEDGEMENT	As four access bursts. Received on PACCH.
4	SS		The SS verifies that the MS sends the PACKET CONTROL ACKNOWLEDGEMENT as four access bursts, one per TDMA frame of the uplink radio block and the RRBP = 1.

Specific message contents

None.

42.1.2.2.2 Packet Downlink Assignment / PCCCH monitoring

42.1.2.2.2.1 Conformance requirements

A PACKET DOWNLINK ASSIGNMENT message may indicate an assignment starting time in the TBF Starting Time parameter. The mobile station shall monitor PCCCH until the point in time denoted by the TBF Starting Time. Thereafter it shall switch to the assigned PDCHs. If while monitoring the PCCCH the mobile station receives more than one PACKET DOWNLINK ASSIGNMENT message, it shall act upon the most recently received message and shall ignore the previous message.

Reference

GSM 04.60 subclause 7.2.1.1

42.1.2.2.2 Test purpose

To verify that the mobile station monitors PCCCH until the point in time denoted by the TBF Starting Time.

To verify that the mobile station considers the most recently received PACKET DOWNLINK ASSIGNMENT message.

42.1.2.2.3 Method of test

Initial conditions

System Simulator:

1 cell supporting GPRS. The packet system information ACCESS_BURST_TYPE indicates 8 bit access.

Mobile Station:

The MS is GPRS attached and in packet idle mode and Ready state.

Related PICS/PIXIT statement

Support of GPRS Yes/No.

Test procedure

The SS initiate a downlink data transfer. The SS sends PACKET DOWNLINK ASSIGNMENT message to the MS with a TBF starting time. Then send a new PACKET DOWNLINK ASSIGNMENT message on PCCCH with another TBF starting time and a different timeslot before the first starting time has occurred. The SS starts to send RLC/MAC data blocks according to the second PACKET DOWNLINK ASSIGNMENT message. The MS shall send PACKET DOWNLINK ACK/NACK message to indicate correct reception of data blocks.

Maximum duration of the test

2 min.

Expected sequence

Step	Direction	Message	Comments
1	SS		The SS initiate a downlink transfer of 200 octets data.
2	SS -> MS	PACKET DOWNLINK ASSIGNMENT	See specific message contents. Sent on PCCCH.
3	SS -> MS	PACKET DOWNLINK ASSIGNMENT	Sent 3 blocks before TBF starting time in step 2 has elapsed. See specific message contents. Sent on PCCCH.
4	SS -> MS	DOWNLINK RLC DATA BLOCK	SS sends data starting at frame as indicated by TBF starting time in step 3 on assigned PDTCH.
5	MS -> SS	PACKET DOWNLINK ACK/NACK	Indicating correct reception of downlink data block. Received on PACCH.

Specific message contents

As default messages contents, except:

PACKET DOWNLINK ASSIGNMENT in step 2

Information element	Value/remark
< TIMESLOT_ALLOCATION > {0 1< TBF Starting Time > -TBF_STARTING_TIME}	00010000, allocate timeslot 3. 1 arbitrarily chosen

PACKET DOWNLINK ASSIGNMENT in step 3

Information element	Value/remark
< TIMESLOT_ALLOCATION > {0 1< TBF Starting Time > -TBF_STARTING_TIME}	00000010, allocate timeslot 6. 1 arbitrarily chosen different from step 2

42.1.2.2.3 Packet Downlink Assignment / Frequency hopping

42.1.2.2.3.1 Conformance requirements

The mobile station shall use information received on the PBCCH to decode the channel descriptions contained in the assignment. If frequency hopping is applied, the mobile station shall use the last CA received on PBCCH to decode the Mobile Allocation.

Reference

GSM 04.60 subclause 7.2.1.1

42.1.2.2.3.2 Test purpose

To verify that, if frequency hopping is applied, the mobile station uses the last CA received on PBCCH to decode the Mobile Allocation.

To verify that, if frequency hopping is applied, indirect encoding, direct encoding 1 and direct encoding 2 worked as intend together with the information received on PBCCH.

42.1.2.2.3.3 Method of test

Initial conditions

System Simulator:

1 cell supporting GPRS. PACKET SYSTEM INFORMATION Type 2 (PSI2) sent on PBCCH indicate frequency hopping parameters, see specific message contents.

Mobile Station:

The MS is GPRS attached and in packet idle mode.

Related PICS/PIXIT statement

Support GPRS service.

Test procedure

The SS initiate a downlink data transfer. The SS send PACKET DOWNLINK ASSIGNMENT message indicating indirect encoding in frequency parameters. The SS shall start to transmit the downlink data to the MS. The MS and SS complete the downlink data transfer. The SS verifies that the MS use the last CA information received on PBCCH to decode the Mobile Allocation. Repeat the test with frequency parameters Direct encoding 1 and Direct encoding 2.

Maximum duration of the test

5 min

Expected sequence

Step	Direction	Message	Comments
1	SS		Wait until MS has read initial PSI2.
2	SS -> MS	PACKET SYSTEM INFORMATION Type 2	Change Reference Frequency List, CA and MA see specific message contents.
3	SS		Wait 35 seconds.
4	SS		The SS initiate a downlink transfer of 200 octets data.
5	SS -> MS	PACKET DOWNLINK ASSIGNMENT	See specific message contents. Sent on PCCCH.
6	SS -> MS	DOWNLINK RLC DATA BLOCKs	Sent on assigned PDTCHs.
7	MS -> SS	PACKET DOWNLINK ACK/NACK	The SS verifies that the MS use the last CA information received on PBCCH. Received on PACCH.
8			Repeat step 6 to 7 five times.
9	SS -> MS	PACKET PDCH RELEASE	

Repeat the test with frequency parameters Direct encoding 1 and Direct encoding 2.

Specific message contents

As default messages contents, except:

PACKET SYSTEM INFORMATION Type 2 in initial condition

Information element	Value/remark
< PSI2_CHANGE_MARK >	00
< PCCCH Description List struct >	
< TSC >	value arbitrarily chosen from valid values (default 5)
{0 1< Hopping PCCCH carriers >	1
< MA_NUMBER	0001 (list 1)
< Hopping PCCCH carriers struct >	
< Hopping PCCCH carriers struct >	
< MAIO >	arbitrarily chosen
< TIMESLOT_ALLOCATION	00001000 (timeslot 4)

PACKET SYSTEM INFORMATION Type 2 in step 2

Information element	Value/remark
< PSI2_CHANGE_MARK >	01
{0 1< Reference Frequency Lists>	1 Reference Frequency lists present
-RFL_NUMBER	0010 List 2
-Length of RFL contents	1111 IE length = 16
-RFL contents}	For GSM900, in bit map 0, (10, 25, 40, 55, 70, 85, 100) For DCS1800, in range 512, (740, 755, 770, 785, 800, 810, 825) For PCS 1900, in Range 512, (710, 725, 740, 755, 770, 785, 800)
{0 1<Cell Allocation>	1 Cell Allocation present
-RFL_NUMBER	0010 List 2
-{0 1<Cell Allocation>}}	0 No Further Cell Allocation present
{0 1<GPRS Mobile Allocations>	1 GPRS Mobile Allocation present
-MA_NUMBER	0010 List 2
-HSN	000000 Sequence 0
-{0 1<RFL number list>}	1 Number list present
-RFL_NUMBER	0010 List 2
-{0	0
-MA_LENGTH	000111 7 octets
-MA_BITMAP}	1010101 4 belonging

42.1.2.2.4 Packet Downlink Assignment / Response to Packet Polling

42.1.2.2.4.1 Conformance requirements

In case valid timing advance for the mobile station is not available, the network may use one of the following two methods to trigger the mobile station to transmit a PACKET CONTROL ACKNOWLEDGEMENT:

- if the PACKET DOWNLINK ASSIGNMENT message is not segmented and the CONTROL_ACK_TYPE parameter in the System Information indicates acknowledgement is access bursts, the network may set the poll bit in the PACKET DOWNLINK ASSIGNMENT message.
- if the PACKET DOWNLINK ASSIGNMENT message is segmented or the CONTROL_ACK_TYPE parameter in the System Information does not indicate acknowledgement is access bursts, the network may send PACKET POLLING REQUEST with TYPE_OF_ACK parameter set to access bursts (see 11.2.12).

On receipt of a PACKET POLLING REQUEST message, the mobile station shall respond to the network with the PACKET CONTROL ACKNOWLEDGEMENT message in the block period specified by the RRBP field. If the MS has received a PACKET DOWNLINK ASSIGNMENT message with no starting time or with a starting time that has already elapsed, the PACKET POLLING REQUEST message shall be sent on PACCH. Otherwise the PACKET POLLING REQUEST message shall be sent on PAGCH.

Reference

GSM 04.60 subclause 7.2.1.3 and subclause 7.2.1.1

42.1.2.2.4.2 Test purpose

To verify that on receipt of a PACKET POLLING REQUEST message, the mobile station responds with PACKET CONTROL ACKNOWLEDGEMENT message in the block period specified by the RRBP field.

42.1.2.2.4.3 Method of test

Initial conditions

System Simulator:

1 cell supporting GPRS. The packet system information CONTROL_ACK_TYPE is set to not indicate acknowledgement as four access bursts and ACCESS_BURST_TYPE indicate 8 bit access.

Mobile Station:

The MS is GPRS attached and in packet idle mode and Ready state.

Related PICS/PIXIT statement

Support GPRS service.

Test procedure

The SS initiate a downlink data transfer. The SS sends PACKET DOWNLINK ASSIGNMENT message to the MS with a TBF starting time. The SS sends a PACKET POLLING REQUEST message containing a valid RRBP field. The SS verifies that the MS sends a PACKET CONTROL ACKNOWLEDGEMENT message in the block period specified by the RRBP field. The SS sends PACKET PDCH RELEASE message to the MS. The SS initiate a downlink data transfer. The SS sends PACKET DOWNLINK ASSIGNMENT message to the MS without TBF starting time. The SS sends a PACKET POLLING REQUEST message containing a valid RRBP field. The SS verifies that the MS sends a PACKET CONTROL ACKNOWLEDGEMENT message in the block period specified by the RRBP field.

Maximum duration of the test

5 min.

Expected sequence

Step	Direction	Message	Comments
1	SS		The SS initiate a downlink transfer of 200 octets data.
2	SS -> MS	PACKET DOWNLINK ASSIGNMENT	See specific message contents. Sent on PCCCH.
3	SS -> MS	PACKET POLLING REQUEST	Sent on PACCH before TBF starting time in step 2 has elapsed. See specific message contents.
4	MS -> SS	PACKET CONTROL ACKNOWLEDGEMENT	The SS verifies that the MS send this message in the block period specified by the RRBp field as four access bursts. Received on PACCH.
5	SS -> MS	PACKET PDCH RELEASE	Sent on PACCH.
6	SS		Wait 20 seconds.
7	SS		The SS initiate a downlink transfer of 200 octets data.
8	SS -> MS	PACKET DOWNLINK ASSIGNMENT	See specific message contents. Sent on PCCCH.
9	SS -> MS	PACKET POLLING REQUEST	Sent on PACCH. See specific message contents.
10	MS -> SS	PACKET CONTROL ACKNOWLEDGEMENT	The SS verifies that the MS send this message in the block period specified by the RRBp field as four access bursts. Received on PACCH.

Specific message contents

As default messages contents, except:

PACKET DOWNLINK ASSIGNMENT in step 2

Information element	Value/remark
< TIMESLOT_ALLOCATION > {0 1< TBF Starting Time > -TBF_STARTING_TIME}	00000100, allocate timeslot 5. 1 arbitrarily chosen

PACKET DOWNLINK ASSIGNMENT in step 8

Information element	Value/remark
< TIMESLOT_ALLOCATION > {0 1< TBF Starting Time >}	00000001, allocate timeslot 7. 0 (No TBF starting time)

PACKET POLLING REQUEST in step 3 and 9

Information element	Value/remark
RRBP in MAC header	Set to 1
S/P in MAC header	Set to 1 : RRBp field is valid
< MESSAGE_TYPE >	000100
< PAGE_MODE	Normal Paging
{ 0 < Global TFI > 10 < TLLI > 110 < TQI >}	10 (TLLI)
< TYPE_OF_ACK >	0 as four access bursts

42.1.2.2.5 Packet Downlink Assignment / Abnormal cases

42.1.2.2.5.1 Packet Downlink Assignment / Abnormal cases / Incorrect PDCH assignment

42.1.2.2.5.1.1 Conformance requirements

If the mobile station has been assigned more PDCHs than it supports according to its MS multislot class, the mobile station shall return to packet idle mode.

Reference

GSM 04.60 subclause 7.2.2

42.1.2.2.5.1.2 Test purpose

To verify that the mobile station return to packet idle mode if the mobile station is assigned more PDCHs than it supports according to its MS multislot class.

42.1.2.2.5.1.3 Method of test

Initial conditions

System Simulator:

1 cell supporting GPRS.

Mobile Station:

The MS is GPRS attached and in packet idle mode and Ready state.

Related PICS/PIXIT statement

Support GPRS service.

Multislot Class.

Test procedure

Convert MS Multislot Class to number of downlink timeslot supported.

The SS initiated a downlink data transfer. The SS sends PACKET DOWNLINK ASSIGNMENT message containing one more assigned Rx than the MS supports according to its multislot class. The SS sends RLC data blocks. The SS verify that the MS not respond to the RLC data blocks sent by SS. Verify that the MS return to packet idle mode.

The SS sends PACKET DOWNLINK ASSIGNMENT message again containing correct multislot class. The SS starts to send RLC data blocks and the MS complete the downlink data transfer.

Maximum duration of the test

2 min.

Expected sequence

Step	Direction	Message	Comments
1	SS		The SS initiate a downlink transfer of 200 octets data.
2	SS -> MS	PACKET DOWNLINK ASSIGNMENT	Assign one more Rx timeslot than the MS support. Sent on PCCCH.
3	SS		Wait one block period.
4	SS -> MS	DOWNLINK RLC DATA BLOCK	Sent on assigned PDTCHs.
5	SS		Verify for 10 seconds that the MS not respond.
6	SS -> MS	PACKET DOWNLINK ASSIGNMENT	Assign Rx timeslot according to the MS multislot class. Sent on PCCCH.
7	SS -> MS	DOWNLINK RLC DATA BLOCK	Sent on assigned PDTCHs with a valid RRBP field.
8	MS -> SS	PACKET DOWNLINK ACK/NACK	The SS verifies that the MS indicating correct reception of downlink data blocks. Received on PACCH.

Specific message contents

None.

42.1.2.2.5.2 Packet Downlink Assignment / Abnormal cases / Expiry of timer T3190

42.1.2.2.5.2.1 Conformance requirements

When receiving the PACKET DOWNLINK ASSIGNMENT message and after waiting the TBF Starting Time when applicable, the mobile station starts timer T3190. The timer is reset when receiving the first valid RLC/MAC block.

On expiry of timer T3190, the mobile station shall return to packet idle mode.

Reference

GSM 04.60 subclause 7.2.1.1 and subclause 7.2.2.

42.1.2.2.5.2.2 Test purpose

To verify that the mobile station aborts the TBF and returns to packet idle mode if a valid RLC block is not received within the duration of timer T3190.

42.1.2.2.5.2.3 Method of test

Initial conditions

System Simulator:

1 cell supporting GPRS. The packet system information ACCESS_BURST_TYPE indicates 8 bit access.

Mobile Station:

The MS is GPRS attached and in packet idle mode and Ready state.

Related PICS/PIXIT statement

Support GPRS service.

Test procedure

The SS initiate a downlink data transfer. The SS sends PACKET DOWNLINK ASSIGNMENT message to the MS. The SS wait to send RLC data blocks for a time greater than timer T3190. The SS verifies that the MS not respond to the RLC data blocks sent by SS.

The SS reinitiate the sending of downlink data transfer. The SS sends PACKET DOWNLINK ASSIGNMENT message again and starts to send RLC data blocks after a time less than timer T3190. The MS shall complete the downlink data transfer.

Maximum duration of the test

2 min.

Expected sequence

Step	Direction	Message	Comments
1	SS		The SS initiate a downlink transfer of 200 octets data.
2	SS -> MS	PACKET DOWNLINK ASSIGNMENT	Not indicating any TBF Starting Time. Sent on PCCCH.
3	SS		The SS waits timer T3190 + 0.1*T3190.
4	SS -> MS	DOWNLINK RLC DATA BLOCK	Sent on assigned PDTCHs.
5	SS		Verify for 10 seconds that the MS not respond.
6	SS -> MS	PACKET DOWNLINK ASSIGNMENT	Reinitiate the downlink data transfer. Sent on PCCCH.
7	SS		The SS waits timer T3190 – 0.1*T3190.
8	SS -> MS	DOWNLINK RLC DATA BLOCK	Sent on assigned PDTCHs with a valid RRBP field.
9	MS -> SS	PACKET DOWNLINK ACK/NACK	Indicating correct reception of downlink data blocks. SS verifies that ACK/NACK is sent from the MS.

Specific message contents

None.

42.1.3 Macro and default message contents

42.1.3.1 Macro

In order to simplify the process of writing and coding test cases, macros are referenced in the expected signaling tables. These macros provide all additional signaling needed to complete the particular test but are not relevant to its purpose. This Macro is only applicable to test case in clause 42.1.1 and 42.1.2.

42.1.3.1.1 GPRS attach procedure

The following table describes a signaling sequence performing the GPRS attach procedure when PCCCH is present. Note that there are different possible sequences implementing the GPRS attach procedure. In this case we use dynamic allocation and simultaneous uplink and downlink TBFs.

{GPRS attach procedure}

Step	Direction	Message	Comments
1			MS is triggered to initiate the GPRS attach procedure.
2	MS -> SS	PACKET CHANNEL REQUEST	Mobility Management procedure request.
3	SS -> MS	PACKET UPLINK ASSIGNMENT	Indicate dynamic allocation struct.
4	SS -> MS	PACKET DOWNLINK DUMMY CONTROL BLOCK	Containing USF assigned to the MS.
5	MS -> SS	UPLINK RLC DATA BLOCKs (GMM ATTACH REQUEST)	
6	SS -> MS	PACKET UPLINK ACK/NACK	Containing Final Ack Indicator bit = 1, and valid RRBp field.
7	MS -> SS	PACKET CONTROL ACKNOWLEDGEMENT	Sent in the block assigned by the RRBp field in step 6.
8	SS -> MS	PACKET DOWNLINK ASSIGNMENT	Assign a downlink TBF, "MAC mode" = dynamic allocation.
9	SS -> MS	DOWNLINK RLC DATA BLOCKs (GMM ATTACH ACCEPT)	Containing USF assigned to the MS. Last block shall contain Final Block Indicator bit = 1, and valid RRBp field.
10	MS -> SS	PACKET DOWNLINK ACK/NACK	Sent in the block assigned by the RRBp field in step 9.
11	MS -> SS	PACKET CHANNEL REQUEST	Mobility Management procedure request.
12	SS -> MS	PACKET UPLINK ASSIGNMENT	Indicate dynamic allocation struct.
13	SS -> MS	PACKET DOWNLINK DUMMY CONTROL BLOCK	Containing USF assigned to the MS.
14	MS -> SS	UPLINK RLC DATA BLOCKs (GMM ATTACH COMPLETE)	
15	SS -> MS	PACKET UPLINK ACK/NACK	Containing Final Ack Indicator bit = 1, and valid RRBp field.
16	MS -> SS	PACKET CONTROL ACKNOWLEDGEMENT	Sent in the block assigned by the RRBp field in step 15.

42.1.3.1.2 Uplink data transfer, dynamic allocation

The following table describes a sequence performing uplink data transfer with one phase access dynamic allocation when PCCCH is present.

{Uplink data transfer, dynamic allocation}

Step	Direction	Message	Comments
1			PDP context 2 has been established. The MS is triggered to send data.
2	MS -> SS	PACKET CHANNEL REQUEST	One phase access, dynamic allocation struct. Containing USF assigned to the MS.
3	SS -> MS	PACKET UPLINK ASSIGNMENT	
4	SS -> MS	PACKET DOWNLINK DUMMY CONTROL BLOCK	
5	MS -> SS	UPLINK RLC DATA BLOCK(S)	
6	SS -> MS	PACKET UPLINK ACK/NACK	If USF_GRANULARITY = four blocks, 4 RLC data block will be sent. Containing USF assigned to the MS.
7	MS -> SS	UPLINK RLC DATA BLOCK(S)	
8			If USF_GRANULARITY = four blocks, 4 RLC data block will be sent. Repeat step 6 and 7 until the countdown value CV=0 in step 7 .
9	SS -> MS	PACKET UPLINK ACK/NACK	Final Ack Indicator = 1 containing valid RRBP.
10	MS -> SS	PACKET CONTROL ACKNOWLEDGEMENT	

42.1.3.2 Default Messages

These default message contents override those specified in “GPRS default conditions” but messages specified in a test case have always the highest precedence.

42.1.3.2.1 PACKET CHANNEL REQUEST message:

< Access Type >	"One phase access request" or "Two phase access request"
< Multislot class >	Not checked
< Radio priority >	Not checked
< Random Reference >	Not checked.

42.1.3.2.2 PACKET CONTROL ACKNOWLEDGEMENT message:

< MESSAGE_TYPE >	000001
< TLLI >	not checked
< CTRL_ACK >	not checked
< padding bits >	Spare Padding

42.1.3.2.3

PACKET DOWNLINK ACK/NACK message:

< MESSAGE_TYPE >	000010
< DOWNLINK_TFI >	pertaining to the downlink TBF
< Ack/Nack Description >	
< FINAL_ACK_INDICATION >	0 (not final ack)
< STARTING_SEQUENCE_NUMBER >	not checked
< RECEIVED_BLOCK_BITMAP >	not checked
{0 1 < Channel Request Description >}	0 (no channel request)
< Channel Quality Report >	
< C_VALUE >	not checked
< RXQUAL >	not checked
< SIGN_VAR >	not checked
{0 1<I_LEVEL_TN0>}	not checked
{0 1<I_LEVEL_TN1>}	not checked
{0 1<I_LEVEL_TN2>}	not checked
{0 1<I_LEVEL_TN3>}	not checked
{0 1<I_LEVEL_TN4>}	not checked
{0 1<I_LEVEL_TN5>}	not checked
{0 1<I_LEVEL_TN6>}	not checked
{0 1<I_LEVEL_TN7>}	not checked
< padding bits >	Spare Padding

42.1.3.2.4 PACKET DOWNLINK ASSIGNMET message:

<pre> < MESSAGE_TYPE > < PAGE_MODE > {0 1< PERSISTENCE_LEVEL >} { {0 < Global TFI 10 < TLLI >} < MAC_MODE < RLC_MODE < CONTROL_ACK < TIMESLOT_ALLOCATION < Packet Timing Advance > {0 1< TIMING_ADVANCE_VALUE >} - TIMING_ADVANCE_VALUE {0 1< DOWNLINK_TIMING_ADVANCE_INDEX> {0 1 < P0 > {0 1< Frequency Parameters >} < TSC > { 00 < ARFCN >} - ARFCN {0 1< DOWNLINK_TFI_ASSIGNMENT >} < DOWNLINK_TFI_ASSIGNMENT > {0 1< Power Control Parameters >} < ALPHA > {0 1< GAMMA_TN0 >} {0 1< GAMMA_TN1 >} {0 1< GAMMA_TN2 >} - GAMMA_TN2 {0 1< GAMMA_TN3 >} {0 1< GAMMA_TN4 >} {0 1< GAMMA_TN5 >} {0 1< GAMMA_TN6 >} {0 1< GAMMA_TN7 >} {0 1< TBF_STARTING_TIME >} {0 1< Measurement Mapping >} < padding bits > </pre>	<pre> 000010 Normal Paging 0 (no persistence level present) 10 (address is TLLI) same as the value received from MS Dynamic Allocation acknowledged mode 0 single slot arbitrarily chosen from valid values (default slot 2) 1 (timing advance value) 30 bit periods 0 (no timing advance index) 0 (no power control parameter) 1 (Frequency Parameters present) value arbitrarily chosen from valid values (default 5) 00 (ARFCN no hopping) For GSM 900, 30 For DCS 1800, 650 For PCS 1900, 650 1 (assign downlink TFI) arbitrarily chosen from valid values (default 3) 1 (Power Control Parameters present) 0.5 depending on the value in TIMESLOT_ALLOCATION (default 0 no GAMMA_TN0) depending on the value in TIMESLOT_ALLOCATION (default 0 no GAMMA_TN1) depending on the value in TIMESLOT_ALLOCATION (default 1 GAMMA_TN2) For GSM 900, +9 dBm For DCS 1800, +6 dBm For PCS 1900, +6 dBm depending on the value in TIMESLOT_ALLOCATION (default 0 no GAMMA_TN0) depending on the value in TIMESLOT_ALLOCATION (default 0 no GAMMA_TN4) depending on the value in TIMESLOT_ALLOCATION (default 0 no GAMMA_TN5) depending on the value in TIMESLOT_ALLOCATION (default 0 no GAMMA_TN6) depending on the value in TIMESLOT_ALLOCATION (default 0 no GAMMA_TN7) 0 (no starting time present) 0 (no measurement mapping) Spare Padding </pre>
---	--

42.1.3.2.5 PACKET PAGING REQUEST message:

<pre> < MESSAGE_TYPE > < PAGE_MODE > {0 1< PERSISTENCE_LEVEL >} {0 1< NLN >} {1< Repeated Page info>} {0 {0< PTMSI > - PTMSI < padding bits > </pre>	<pre> 100010 00 (Normal Paging) 0 (no persistence level present) 0 (no notification list number) 1 (start of Repeated Page info) 0 (Page request for TBF establishment) 0 (PTMSI) P-TMSI allocated during GPRS attach procedure Spare Padding </pre>
--	--

42.1.3.2.6 PACKET RESOURCE REQUEST message (two phase access):

< MESSAGE_TYPE >	000101
{0 1< ACCESS_TYPE >}	1 (response to single block assignment)
- ACCESS_TYPE	00 (two phase access)
{0< Global TFI >}	1 (TLLI)
1 < TLLI >	
- TLLI	not checked
{0 1< MS Radio Access Capability >}	1 (MS Radio Access Capability)
- MS Radio Access Capability	not checked
< Channel Request Description >	
- PEAK_THROUGHPUT_CLASS	not checked
- RADIO_PRIORITY	not checked
- RLC_MODE	not checked
- LLC_PDU_TYPE	1 (not SACK or ACK)
- RLC_OCTET_COUNT	not checked
{0 1< CHANGE_MARK >}	not checked
< C_VALUE >	not checked
{0 1< SIGN_VAR >	not checked
{0 1< I_LEVEL_TN0 >}	not checked
{0 1< I_LEVEL_TN1 >}	not checked
{0 1< I_LEVEL_TN2 >}	not checked
{0 1< I_LEVEL_TN3 >}	not checked
{0 1< I_LEVEL_TN4 >}	not checked
{0 1< I_LEVEL_TN5 >}	not checked
{0 1< I_LEVEL_TN6 >}	not checked
{0 1< I_LEVEL_TN7 >}	not checked
< padding bits >	Spare Padding

42.1.3.2.7 PACKET UPLINK ACK/NACK message:

< MESSAGE_TYPE >	001001
< UPLINK_TFI >	same as the TFI value of the TBF which the message applies
< CHANNEL_CODING_COMMAND >	same as the coding scheme of the TBF which the message applies
< Ack/Nack Description >	
< FINAL_ACK_INDICATION >	0 (not a final ACK)
< STARTING_SEQUENCE_NUMBER >	V(R)
< RECEIVED_BLOCK_BITMAP >	acknowledges all data blocks transmitted by the MS
{0 1< CONTENTION_RESOLUTION_TLLI >}	0 (no contention resolution TLLI)
{0 1< Packet Timing Advance >}	0 (no packet timing advance)
{0 1< Power Control Parameters >}	0 (no power control parameters)
{0 1< Fixed Allocation parameters >}	0 (no fixed allocation parameters present)
< padding bits >	Spare Padding

42.1.3.2.8 PACKET UPLINK ASSIGNMENT message (dynamic allocation)

<pre> < MESSAGE_TYPE > < PAGE_MODE > {0 1< PERSISTENCE_LEVEL > Referenced Address struct { 0 < Global TFI > 10 < TLLI > 110 < TQI > 111 <Packet Request Reference >} < CHANNEL_CODING_COMMAND > < TLLI_BLOCK_CHANNEL_CODING > < Packet Timing Advance > { 0 1< TIMING_ADVANCE_VALUE > - TIMING_ADVANCE_VALUE } { 0 1< TIMING_ADVANCE_INDEX > <TIMING_ADVANCE_TIMESLOT_NUMBER > } {0 1< Frequency Parameters > < TSC > { 00< ARFCN >} - ARFCN } { 01 < Dynamic Allocation > < Extended Dynamic Allocation > { 0 1< P0 > -P0 < PR_MODE : bit (1) > } < USF_GRANULARITY > {0 1< UPLINK_TFI_ASSIGNMENT > - UPLINK_TFI_ASSIGNMENT } {0 1< RLC_DATA_BLOCKS_GRANTED >} {0 1< TBF_STARTING_TIME >} {0 1< Timeslot Allocation > < ALPHA > {0 1< USF_TN0><GAMMA_TN0 >} {0 1< USF_TN1><GAMMA_TN1 >} {0 1< USF_TN2><GAMMA_TN2 > - USF_TN2 - GAMMA_TN2 } {0 1< USF_TN3><GAMMA_TN3 >} {0 1< USF_TN4><GAMMA_TN4 >} {0 1< USF_TN5><GAMMA_TN5 >} {0 1< USF_TN6><GAMMA_TN6 >} {0 1< USF_TN7><GAMMA_TN7>}} < padding bits > </pre>	<pre> 001010 Normal Paging 0 (no persistence level present) 10 (TLLI, the value received from the MS) arbitrarily chosen from the valid values (default CS-1) arbitrarily chosen but different from CHANNEL_CODING_COMMAND 1 (timing advance value) 30 bit periods 0 (no timing advance index) 1 (Frequency Parameters present) arbitrarily chosen (default 5) 00 (ARFCN no hopping) For GSM 900, 30 For DCS 1800, 650 For PCS 1900, 650 01 (Dynamic allocation) 0 (Dynamic allocation) 1 0 dB 0 (PR mode A) 0 (one block) 1 (uplink TFI assignment) arbitrarily chosen (default 00101) 0 (no RLC_DATA_BLOCKS_GRANTED, open-ended TBF) 0 (no starting time) 1 (Timeslot Allocation with Power Control Parameters) one slot arbitrarily chosen and the following USF_TNx and GAMMA_TNx shall be corresponding to the chosen value (default slot 2) 0.5 0 (timeslot 0 not assigned) 0 (timeslot 1 not assigned) 1 (timeslot 2 assigned) arbitrarily chosen (default 101) For GSM 900, +9 dBm For DCS 1800, +6 dBm For PCS 1900, +6 dBm 0 (timeslot 3 not assigned) 0 (timeslot 4 not assigned) 0 (timeslot 5 not assigned) 0 (timeslot 6 not assigned) 0 (timeslot 7 not assigned) Spare Padding </pre>
---	--

42.1.3.2.9

PACKET UPLINK ASSIGNMENT message (fixed allocation)

<pre> < MESSAGE_TYPE > < PAGE_MODE > {0 1< PERSISTENCE_LEVEL > Referenced Address struct { 0 < Global TFI > 10 < TLLI > 110 < TQI > 111 <Packet Request Reference >} < CHANNEL_CODING_COMMAND > < TLLI_BLOCK_CHANNEL_CODING > < Packet Timing Advance > {0 1< TIMING_ADVANCE_VALUE > - TIMING_ADVANCE_VALUE} {0 1<TIMING_ADVANCE_INDEX> <TIMING_ADVANCE_TIMESLOT_NUMBER >} {0 1< Frequency Parameters > < TSC > { 00< ARFCN >} - ARFCN } { 11 < Fixed Allocation > {0 1< UPLINK_TFI_ASSIGNMENT >} -UPLINK_TFI_ASSIGNMENT < FINAL_ALLOCATION > < DOWNLINK_CONTROL_TIMESLOT > { 0 1 < P0 > < BTS_PWR_CTRL_MODE >} < PR_MODE : bit (1) > } {0 1 < Timeslot Allocation > < ALPHA > < GAMMA_TN0 > < GAMMA_TN1 > < GAMMA_TN2 > - GAMMA_TN2 < GAMMA_TN3 > < GAMMA_TN4 > < GAMMA_TN5 > < GAMMA_TN6 > < GAMMA_TN7 >} < HALF_DUPLEX_MODE > < TBF_STARTING_TIME > {0 1 <Length of Allocation Bitmap > < ALLOCATION_BITMAP >} </pre>	<pre> 001010 Normal Paging 0 (no persistence level present) 111 (Packet Request Reference, information field sent in PACKET CHANNEL REQUEST and frame number in which PACKET CHANNEL REQUEST was received 00 (CS-1 coding) 0 (CS-1) 1 (timing advance value) 30 bit periods 0 (no timing advance index) 1 (Frequency Parameters present) arbitrarily chosen (default 5) 00 (ARFCN no hopping) For GSM 900, 30 For DCS 1800, 650 For PCS 1900, 650 11 (Fixed allocation) 1 arbitrarily chosen Final allocation arbitrarily chosen (default 2) 1 0 dB 0 (mode A) 0 (PR mode A) 1 (Timeslot Allocation with Power Control Parameters) one slot arbitrarily chosen and the following GAMMA_TNx shall be corresponding to the chosen value (default slot 2) 0.5 0 (no GAMMA_TN0) 0 (no GAMMA_TN1) 1 (GAMMA_TN2) For GSM 900, +9 dBm For DCS 1800, +6 dBm For DCS 1900, +6 dBm 0 (no GAMMA_TN3) 0 (no GAMMA_TN4) 0 (no GAMMA_TN5) 0 (no GAMMA_TN6) 0 (no GAMMA_TN7) 0 (no half duplex mode) no TBF starting time 1 (without length of Allocation Bitmap) allocate 5 blocks </pre>
--	---

42.1.3.2.10 PACKET UPLINK ASSIGNMENT message (single block allocation):

<pre> < MESSAGE_TYPE > < PAGE_MODE > {0 1< PERSISTENCE_LEVEL > Referenced Address struct { 0 < Global TFI > 10 < TLLI > 110 < TQI > 111 <Packet Request Reference >} < CHANNEL_CODING_COMMAND > < TLLI_BLOCK_CHANNEL_CODING > < Packet Timing Advance > - {0 1< TIMING_ADVANCE_VALUE > - TIMING_ADVANCE_VALUE } - {0 1< TIMING_ADVANCE_INDEX> <TIMING_ADVANCE_TIMESLOT_NUMBER >} {0 1< Frequency Parameters > < TSC > { 00< ARFCN > - ARFCN} { 10 < Single Block Allocation > < TIMESLOT_NUMBER > {0 1 < ALPHA > < GAMMA_TN >} {0 1 < P0 > < BTS_PWR_CTRL_MODE > < PR_MODE: bit (1) > } < TBF_STARTING_TIME > < padding bits > </pre>	<pre> 001010 Normal Paging 111 (Packet Request Reference, information field sent in PACKET CHANNEL REQUEST and frame number in which PACKET CHANNEL REQUEST was received) arbitrarily chosen (default CS-1) arbitrarily chosen but different from CHANNEL_CODING_COMMAND 1 (timing advance value) 30 bit periods 0 (no timing advance index) 1 (Frequency Parameters present) arbitrarily chosen (default 5) 00 (ARFCN no hopping) For GSM 900, 30 For DCS 1800, 650 For PCS 1900, 650 10 (Single block allocation) arbitrarily chosen (default slot 2) 1 (power control parameters) 0.5 For GSM 900, +9 dBm For DCS 1800, +6 dBm For PCS 1900, +6 dBm 1 (downlink power control parameters) 0 dB 0 (mode A) 0 (PR mode A) no TBF starting time Spare padding </pre>
---	---

42.2 Fixed Allocation in Packet Transfer Mode

This clause is applicable for all MS supporting GPRS service.

42.2.1 Generic procedures to bring the MS into uplink transfer mode

For most test cases in sub-clause 42.2.2 the test starts when the MS is in packet uplink transfer mode. This sub-clause defines several generic test procedures to establish an uplink TBF and to bring the MS into the packet transfer mode. Fixed allocation MAC mode is used for the uplink RLC data block transfer.

Before one of the generic test procedures is used, it is necessary in a test to describe the way to trigger the MS for the relevant uplink access.

42.2.1.1 One phase access

The tables below describe message exchanges which bring the MS into the packet uplink transfer mode with the one phase access procedure. In fixed allocation, the one phase access procedure always indicates an open-ended TBF, because the SS does not know how much data the MS intends to transfer.

Table 42.2.1.1/1a: Generic procedure for MS entering uplink transfer mode, one phase access, fixed allocation, open-ended TBF (PBCCH present)

Step	Direction	Message	Comments
1	MS -> SS	PACKET CHANNEL REQUEST	Received on PRACH. 11-bit, one phase access requested.
2	SS -> MS	PACKET UPLINK ASSIGNMENT	Uplink fixed allocation. More than one block is allocated, which indicates open-ended TBF. Sent on PAGCH. The fixed allocation parameters are indicated in each test case which uses this generic procedure.
3	MS -> SS	UPLINK RLC DATA BLOCK	Received on the assigned PDTCH. Check that the coding is the scheme specified by TLLI_BLOCK_CHANNEL_CODING, the TFI is correct and the block contains TLLI.
4	SS -> MS	PACKET UPLINK ACK/NACK	With contention resolution TLLI, Sent on the PACCH of the PDCH assigned in step 2.

Table 42.2.1.1/1b: Generic procedure for MS entering uplink transfer mode, one phase access, fixed allocation, open-ended TBF (PBCCH not present)

Step	Direction	Message	Comments
1	MS -> SS	CHANNEL REQUEST	Received on RACH. 11-bit, one phase access requested.
2	SS -> MS	IMMEDIATE ASSIGNMENT	Uplink fixed allocation. More than one block is allocated, which indicates open-ended TBF. Sent on AGCH. The fixed allocation parameters are indicated in each test case which uses this generic procedure.
3	MS -> SS	UPLINK RLC DATA BLOCK	Received on the assigned PDTCH. Check that the coding is the scheme specified by TLLI_BLOCK_CHANNEL_CODING, the TFI is correct and the block contains TLLI.
4	SS -> MS	PACKET UPLINK ACK/NACK	With contention resolution TLLI, Sent on the PACCH of the PDCH assigned in step 2.

42.2.1.2 Two phase access

The tables below describe message exchanges which bring the MS into the packet uplink transfer mode by two phase access procedure.

Note that the value of RLC_OCTET_COUNT in step 3 in each procedure is MS implementation dependent. Therefore, it is MS implementation dependent whether the TBF is open-ended or closed-ended.

Also, the MS may send additional PACKET RESOURCE REQUEST messages at any time after the initial PACKET UPLINK ASSIGNMENT. This is MS implementation dependent.

Table 42.2.1.2/1a: Generic procedure for MS entering uplink transfer mode, two phase access, fixed allocation, open-ended uplink TBF (PBCCH present)

Step	Direction	Message	Comments
1	MS -> SS	PACKET CHANNEL REQUEST	Received on PRACH. 11-bit, two phase access requested.
2	SS -> MS	PACKET UPLINK ASSIGNMENT	Single block assignment, to force the MS into a two phase access procedure. Sent on PAGCH.
3	MS -> SS	PACKET RESOURCE REQUEST	Two phase access procedure. RLC_OCTET_COUNT = 0. Received on the single block assigned in step 2. Check that the PEAK_THROUGHPUT, RADIO_PRIORITY and RLC_MODE are compliant with the PDP context used.
4	SS -> MS	PACKET UPLINK ASSIGNMENT	Open-ended uplink fixed allocation. Sent on PACCH of the same PDCH assigned in step 2. The fixed allocation parameters are indicated in each test case that uses this generic procedure.
5	MS -> SS	UPLINK RLC DATA BLOCK	Received on the assigned PDTCH. Check that the coding is the scheme specified by CHANNEL_CODING_COMMAND in step 4, and the TFI is correct.

Table 42.2.1.2/1b: Generic procedure for MS entering uplink transfer mode, two phase access, fixed allocation, open-ended uplink TBF (PBCCH not present)

Step	Direction	Message	Comments
1	MS -> SS	CHANNEL REQUEST	Received on RACH. 11-bit, two phase access requested.
2	SS -> MS	IMMEDIATE ASSIGNMENT	Single block assignment, to force the MS into a two phase access procedure. Sent on AGCH.
3	MS -> SS	PACKET RESOURCE REQUEST	Two phase access procedure. RLC_OCTET_COUNT = 0. Received on the single block assigned in step 2. Check that the PEAK_THROUGHPUT, RADIO_PRIORITY and RLC_MODE are compliant with the PDP context used.
4	SS -> MS	PACKET UPLINK ASSIGNMENT	Open-ended uplink fixed allocation. Sent on PACCH of the same PDCH assigned in step 2. The fixed allocation parameters are indicated in each test case that uses this generic procedure.
5	MS -> SS	UPLINK RLC DATA BLOCK	Received on the assigned PDTCH. Check that the coding is the scheme specified by CHANNEL_CODING_COMMAND in step 4, and the TFI is correct.

Table 42.2.1.2/2a: Generic procedure for MS entering uplink transfer mode, two phase access, Fixed allocation, close-ended uplink TBF (PBCCH present)

Step	Direction	Message	Comments
1	MS -> SS	PACKET CHANNEL REQUEST	Received on PRACH. 11-bit two phase access requested.
2	SS -> MS	PACKET UPLINK ASSIGNMENT	Single block assignment, to force the MS into a two phase access procedure. Sent on PAGCH.
3	MS -> SS	PACKET RESOURCE REQUEST	Two phase access procedure. RLC_OCTET_COUNT <> 0. Received on the single block assigned in step 2. Check that the PEAK_THROUGHPUT, RADIO_PRIORITY and RLC_MODE are compliant with the PDP context used.
4	SS -> MS	PACKET UPLINK ASSIGNMENT	Close-ended uplink fixed allocation, Sent on PACCH of the same PDCH assigned in step 2. The fixed allocation parameters are indicated in each test case that uses this generic procedure.
5	MS -> SS	UPLINK RLC DATA BLOCK	Received on the assigned PDTCH. Check that the coding is the scheme specified by CHANNEL_CODING_COMMAND in step 4, and the TFI is correct.

Table 42.2.1.2/2b: Generic procedure for MS entering uplink transfer mode, two phase access, Fixed allocation, close-ended uplink TBF (PBCCH not present)

Step	Direction	Message	Comments
1	MS -> SS	CHANNEL REQUEST	Received on RACH. 11-bit two phase access requested.
2	SS -> MS	IMMEDIATE ASSIGNMENT	Single block assignment, to force the MS into a two phase access procedure. Sent on AGCH.
3	MS -> SS	PACKET RESOURCE REQUEST	Two phase access procedure. RLC_OCTET_COUNT <> 0. Received on the single block assigned in step 2. Check that the PEAK_THROUGHPUT, RADIO_PRIORITY and RLC_MODE are compliant with the PDP context used.
4	SS -> MS	PACKET UPLINK ASSIGNMENT	Close-ended uplink fixed allocation, Sent on PACCH of the same PDCH assigned in step 2. The fixed allocation parameters are indicated in each test case that uses this generic procedure.
5	MS -> SS	UPLINK RLC DATA BLOCK	Received on the assigned PDTCH. Check that the coding is the scheme specified by CHANNEL_CODING_COMMAND in step 4, and the TFI is correct.

42.2.2 Fixed Allocation / Uplink Transfer

42.2.2.1 Fixed Allocation / Uplink Transfer / Normal operation

42.2.2.1.1 Fixed Allocation / Uplink Transfer / Normal operation / Blocks

42.2.2.1.1.1 Definition and applicability

This test case applies to all Mobile Station supporting GPRS.

42.2.2.1.1.2 Conformance Requirement

If the BLOCKS_OR_BLOCK_PERIODS field indicates blocks, then the bits in the ALLOCATION_BITMAP correspond to radio blocks. Bits are included in the bitmap only for radio blocks on assigned PDCHs. Each bit in the bitmap indicates whether the corresponding radio block is assigned to the fixed allocation. The mobile station shall transmit an RLC/MAC block in each radio block assigned by the ALLOCATION_BITMAP.

References

GSM 04.60, subclause 8.1.1.3.1, 11.2.29

42.2.2.1.1.3 Test purpose

To verify that when BLOCK_OR_BLOCK_PERIODS field is 0 in the PACKET UPLINK ASSIGNMENT, the MS transmits RLC/MAC blocks strictly according to radio blocks allocated in ALLOCATION_BITMAP array.

42.2.2.1.1.4 Method of test

Initial Conditions

System Simulator:

1 cell, GPRS supported, PCCCH present

Mobile Station:

The MS is in the state "idle, GMM-registered" with a P-TMSI allocated, SPLIT PG CYCLE negotiated, and PDP context 3 activated.

Related PICS/PIXIT Statement(s)

Support GPRS service,
The way to initiate an uplink transfer,

Test Procedure

MS is triggered to begin an uplink data transfer. Verify that the MS sends uplink RLC data blocks only in the blocks specified by the ALLOCATION_BITMAP.

Maximum Duration of Test

5 min.

Expected Sequence

Step	Direction	Message	Comments
1	MS		Trigger the MS to initiate an uplink packet transfer containing 1000 octets.
2			Bring the MS into packet uplink transfer mode by the generic procedure defined in the table 42.2.1.2/1a or 42.2.1.2/2a.
3	MS -> SS	UPLINK RLC DATA BLOCK	Received on the assigned PDTCH.
4	SS		Verify that step 3 is repeated until current allocation is exhausted. Verify MS is treating each bit in the ALLOCATION_BITMAP as a block, and only using timeslots allocated in ALLOCATION_BITMAP.
5	SS -> MS	PACKET UPLINK ACK/NACK	Sent when current allocation is exhausted. Containing valid RRBP. Sent on PACCH.
6	MS -> SS	PACKET CONTROL ACKNOWLEDGEMENT	Received on the block specified by RRBP on PACCH of the assigned PDCH.

Specific Message Contents

PACKET UPLINK ASSIGNMENT message as part of macro in step 2:

Fixed Allocation - TIMESLOT ALLOCATION - BLOCKS_OR_BLOCK_PERIODS - ALLOCATION_BITMAP_LENGTH - ALLOCATION_BITMAP	One timeslot is assigned 0 – blocks Length of ALLOCATION_BITMAP (exactly 10 bits are set to 1)
---	---

PACKET UPLINK ACK/NACK message in step 5:

Ack/Nack Description - FINAL_ACK_INDICATION - STARTING_SEQUENCE_NUMBER - RECEIVED_BLOCK_BITMAP	1 (final ACK) V(R) Acknowledge all data blocks transmitted by the MS
---	--

42.2.2.1.2 Fixed Allocation / Uplink Transfer / Normal operation / Block Periods

42.2.2.1.2.1 Definition and applicability

Procedure 1 of this test case applies to all MSs supporting GPRS.

Procedure 2 of this test case applies to all MSs supporting GPRS except those MSs in multi-slot classes 1,2,4 or 8. Multi-slot classes 1, 2, 4, and 8 are untestable for part 2 because they have Tx = 1.

42.2.2.1.2.2 Conformance requirements

If the BLOCKS_OR_BLOCK_PERIODS field (=1) indicates block periods, then the bits in the bitmap indicate which block periods are assigned to the allocation. The mobile station shall transmit an RLC/MAC block on each timeslot assigned in the TIMESLOT_ALLOCATION field in each block period assigned to the allocation.

References

GSM 04.60, subclause 8.1.1.3.1, 11.2.29

42.2.2.1.2.3 Test purpose

Verify that when BLOCK_OR_BLOCK_PERIODS parameter is set to 1, the MS transmits RLC/MAC blocks strictly according to timeslots allocated in TIMESLOT_ALLOCATION array and block periods allocated in the ALLOCATION_BITMAP array.

42.2.2.1.2.4 Method of test

Initial Conditions

System Simulator:

1 cell, GPRS supported, PCCCH present

Mobile Station:

The MS is in the state "idle, GMM-registered" with a P-TMSI allocated, SPLIT PG CYCLE negotiated, and PDP context 3 activated.

Related PICS/PIXIT Statement(s)

Support GPRS service,

The way to initiate an uplink transfer,

Test Procedure

1. MS is triggered to begin an uplink data transfer. Verify that the MS sends uplink RLC data blocks only in the block periods specified by the ALLOCATION_BITMAP.
2. MS is triggered to begin an uplink data transfer. Verify that the MS sends uplink RLC data blocks in each timeslot allocated to the MS in the TIMESLOT_ALLOCATION, if the bit for this block period in the ALLOCATION_BITMAP is set to 1.

Maximum Duration of Test

5 min.

Expected Sequence – Procedure 1

Step	Direction	Message	Comments
1	MS		Trigger the MS to initiate an uplink packet transfer containing 1000 octets.
2			Bring the MS into packet uplink transfer mode by the generic procedure defined in the table 42.2.1.2/1a or 42.2.1.2/2a.
3	MS -> SS	UPLINK RLC DATA BLOCK	Received on the assigned PDTCH. Check the TFI is correct.
4	SS		Verify that step 3 is repeated until current allocation is exhausted. Verify MS is treating each bit in the ALLOCATION_BITMAP as a block period, and only using timeslots allocated in TIMESLOT_ALLOCATION.
5	SS -> MS	PACKET UPLINK ACK/NACK	Sent when current allocation is exhausted. Containing valid RRBP. Sent on PACCH.
6	MS -> SS	PACKET CONTROL ACKNOWLEDGEMENT	Received on the block specified by RRBP on PACCH of the assigned PDCH.

Expected Sequence – Procedure 2

Step	Direction	Message	Comments
1	MS		Trigger the MS to initiate an uplink packet transfer containing 1000 octets.
2			Bring the MS into packet uplink transfer mode by the generic procedure defined in the table 42.2.1.2/1a or 42.2.1.2/2a.
3	MS -> SS	UPLINK RLC DATA BLOCK	Received on the assigned PDTCH. Check the TFI is correct.
4	SS		Verify that step 3 is repeated until current allocation is exhausted. Verify MS is treating each bit in the ALLOCATION_BITMAP as a block period, and only using timeslots allocated in TIMESLOT_ALLOCATION.
5	SS -> MS	PACKET UPLINK ACK/NACK	Sent when current allocation is exhausted. Containing valid RRBP. Sent on PACCH.
6	MS -> SS	PACKET CONTROL ACKNOWLEDGEMENT	Received on the block specified by RRBP on PACCH of the assigned PDCH.

Specific Message Contents

PACKET UPLINK ASSIGNMENT message as part of macro in step 2 (Procedure 1):

Fixed Allocation - TIMESLOT ALLOCATION - BLOCKS_OR_BLOCK_PERIODS - ALLOCATION_BITMAP_LENGTH - ALLOCATION_BITMAP	One timeslot is assigned 1 – block periods 25 exactly 10 bits (out of 25) are set to 1
---	---

PACKET UPLINK ASSIGNMENT message as part of macro in step 2 (Procedure 2):

Fixed Allocation - TIMESLOT ALLOCATION - BLOCKS_OR_BLOCK_PERIODS - ALLOCATION_BITMAP_LENGTH - ALLOCATION_BITMAP	Two timeslots assigned 1 – block periods 25 exactly 10 bits (out of 25) are set to 1
---	---

PACKET UPLINK ACK/NACK message in step 5:

Ack/Nack Description - FINAL_ACK_INDICATION - STARTING_SEQUENCE_NUMBER - RECEIVED_BLOCK_BITMAP	1 (final ACK) V(R) Acknowledge all data blocks transmitted by the MS
---	--

42.2.2.2 Fixed Allocation / Uplink Transfer / Operation with TS_OVERRIDE for single-slot TX

42.2.2.2.1 Definition and applicability

This test case applies to all MSs supporting GPRS.

42.2.2.2.2 Conformance requirements

The network may also specify a TS_OVERRIDE indication in the PACKET UPLINK ACK/NACK. TS_OVERRIDE applies to the next allocation after the current allocation expires. The TS_OVERRIDE field is a bitmap with a bit corresponding to each timeslot. For each bit set in the TS_OVERRIDE, the mobile shall disregard the ALLOCATION_BITMAP for that timeslot and shall transmit on all uplink radio blocks for that timeslot for the duration of the next allocation. If a bit is not set in the TS_OVERRIDE field, then the ALLOCATION_BITMAP shall apply to that timeslot.

References

GSM 04.60, subclause 8.1.1.3.2.2

42.2.2.2.3 Test purpose

To verify that this new allocation begins immediately after the current allocation ends and uses the most recently received ALLOCATION_BITMAP in consultation with TS_OVERRIDE as the following:

1. Until the next allocation begins, the mobile disregards the TS_OVERRIDE field.
2. For each bit set in the TS_OVERRIDE, the mobile disregards the ALLOCATION_BITMAP for that timeslot and transmits on all uplink radio blocks for that timeslot for the duration of the next allocation.
3. If a bit is not set in the TS_OVERRIDE field, then the ALLOCATION_BITMAP applies to that timeslot.

42.2.2.2.4 Method of test

Initial Conditions

System Simulator:

1 cell, GPRS supported, PCCCH present

Mobile Station:

The MS is in the state "idle, GMM-registered" with a P-TMSI allocated, SPLIT PG CYCLE negotiated and PDP context2 activated.

Related PICS/PIXIT Statement(s)

Support GPRS service,

The way to trigger the MS to initiate an uplink packet transfer

Test Procedure

MS is triggered to begin an uplink data transfer. Verify that the MS sends uplink RLC data blocks only in the radio blocks specified by the ALLOCATION_BITMAP. Network sends a repeat allocation with TS_OVERRIDE corresponding to the assigned timeslot. Verify the MS finishes the current allocation as specified in the bitmap, then begins the new allocation with the application of TS_OVERRIDE.

Maximum Duration of Test

5 min.

Expected Sequence

Step	Direction	Message	Comments
1	MS		Trigger the MS to initiate an uplink packet transfer containing 1000 octets.
2			Bring the MS into packet uplink transfer mode by the generic procedure defined in the table 42.2.1.2/1a or 42.2.1.2/2a.
3	MS -> SS	RLC DATA BLOCK	MS transmits RLC block only when TBF starting time occurs
4	SS -> MS	PACKET UPLINK ACK/NACK	TS_OVERRIDE corresponding to the one slot allocated to the MS in step 2. (Repeat allocation)
5			Step 3 is repeated 4 times. (Allowing the MS to exhaust the allocation in step 2.) Verify the MS obeys the allocation bitmap assigned in step 2 and ignores TS_OVERRIDE.
6	MS -> SS	RLC DATA BLOCKS	At the next natural allocation boundary. Verify the MS is transmitting in every block (due to application of TS_OVERRIDE)
7	SS		After the MS exhausts the second allocation, verify the network has received exactly 11 RLC data blocks after step 5.

Specific Message Contents

PACKET UPLINK ASSIGNMENT message in step 2 :

Fixed allocation - TIMESLOT ALLOCATION - BLOCKS_OR_BLOCK_PERIODS - ALLOCATION_BITMAP_LENGTH - ALLOCATION_BITMAP	One timeslot is assigned 0 – blocks 11 010101010
---	---

PACKET UPLINK ACK/NACK message in step 4:

Fixed allocation - TS_OVERRIDE	<8 bits, with only the bit corresponding to the assigned timeslot set to '1'>
-----------------------------------	---

42.2.2.3 Fixed Allocation / Uplink Transfer / Operation with TS_OVERRIDE for multi-slot TX

42.2.2.3.1 Definition and applicability

This test case applies to all MSs supporting GPRS except those MSs in multi-slot classes 1,2,4 or 8. Multi-slot classes 1, 2, 4, and 8 are not applicable for this test case because they have Tx = 1.

42.2.2.3.2 Conformance requirements

The network may also specify a TS_OVERRIDE indication in the PACKET UPLINK ACK/NACK. TS_OVERRIDE applies to the next allocation after the current allocation expires. The TS_OVERRIDE field is a bitmap with a bit corresponding to each timeslot. For each bit set in the TS_OVERRIDE, the mobile shall disregard the ALLOCATION_BITMAP for that timeslot and shall transmit on all uplink radio blocks for that timeslot for the duration of the next allocation. If a bit is not set in the TS_OVERRIDE field, then the ALLOCATION_BITMAP shall apply to that timeslot.

References

GSM 04.60, subclause 8.1.1.3.2.2

42.2.2.3.3 Test purpose

To verify that this new allocation begins immediately after the old allocation ends and uses the most recently received ALLOCATION_BITMAP in consultation with TS_OVERRIDE as the following:

1. Until the next allocation begins, the mobile disregards the TS_OVERRIDE field.
2. For each bit set in the TS_OVERRIDE, the mobile disregards the ALLOCATION_BITMAP for that timeslot and transmits on all uplink radio blocks for that timeslot for the duration of the next allocation.
3. If a bit is not set in the TS_OVERRIDE field, then the ALLOCATION_BITMAP applies to that timeslot.

42.2.2.3.4 Method of test

Initial Conditions

System Simulator:

1 cell, GPRS supported, PCCCH present

Mobile Station:

The MS is in the state "idle, GMM-registered" with a P-TMSI allocated, SPLIT PG CYCLE negotiated and PDP context2 activated.

Related PICS/PIXIT Statement(s)

Support GPRS service,

The way to trigger the MS to initiate an uplink packet transfer,

Test Procedure

MS is triggered to begin an uplink data transfer on 2 timeslots. Verify that the MS sends uplink RLC data blocks only in the radio blocks specified by the ALLOCATION_BITMAP. Network sends a repeat allocation with TS_OVERRIDE corresponding to one of the assigned timeslots. Verify the MS finishes the current allocation as specified in the bitmap, then begins the new allocation with the application of TS_OVERRIDE.

Maximum Duration of Test

5 min.

Expected Sequence

Step	Direction	Message	Comments
1	MS		Trigger the MS to initiate an uplink packet transfer containing 1000 octets.
2			Bring the MS into packet uplink transfer mode by the generic procedure defined in the table 42.2.1.2/1a or 42.2.1.2/2a.
3	MS -> SS	RLC DATA BLOCKS	MS starts transmitting RLC blocks on 2 timeslots only when TBF starting time occurs
4	SS -> MS	PACKET UPLINK ACK/NACK	TS_OVERRIDE corresponding to one of the slots allocated to the MS in step 2. (Repeat allocation)
5			Step 3 is repeated 4 times. (Allowing the MS to exhaust the allocation in step 2.) Verify the MS obeys the allocation bitmap assigned in step 2 and ignores TS_OVERRIDE.
6	MS -> SS	RLC DATA BLOCKS	At the next natural allocation boundary. Verify the MS is transmitting in every block on one assigned timeslot (due to application of TS_OVERRIDE), plus following the application bitmap for the other assigned timeslot.
7	SS		After the MS exhausts the second allocation, verify the network has received exactly 14 RLC data blocks after step 5.

Specific Message Contents

PACKET UPLINK ASSIGNMENT message in step 2 :

Fixed allocation - TIMESLOT ALLOCATION - BLOCKS_OR_BLOCK_PERIODS - ALLOCATION_BITMAP_LENGTH - ALLOCATION_BITMAP	Two timeslots assigned 0 – blocks 18 001100110011001111
---	--

PACKET UPLINK ACK/NACK message in step 4:

Fixed allocation - TS_OVERRIDE	<8 bits, with only one bit corresponding to one of the assigned timeslots set to '1'>
-----------------------------------	---

42.2.2.4 Fixed Allocation / Uplink Transfer / T3184 Expiry

42.2.2.4.1 Definition and applicability

This test case applies to all MSs supporting GPRS.

42.2.2.4.2 Conformance requirements

A mobile station operating with a fixed allocation shall start or restart timer T3184 upon reception of a PACKET UPLINK ACK/NACK message. If timer T3184 expires, the mobile station shall perform an abnormal release with cell re-selection.

[To perform abnormal release with cell re-selection] the mobile station shall abort all TBFs in progress. If access to another cell is allowed, i.e. the RANDOM_ACCESS_RETRY bit is set, the mobile station shall perform abnormal cell reselection (see GSM 05.08) and initiate establishment of an uplink TBF as defined in subclause 7.1 on the new cell. The mobile station shall not reselect back to the original cell for T_RESEL seconds if another suitable cell is available. The parameters RANDOM_ACCESS_RETRY and T_RESEL (default value 5 s) are broadcast in PSI 3.

If access to another cell is not allowed, i.e. the RANDOM_ACCESS_RETRY bit is not set, or if no neighbour cells are available, the mobile station shall go to the CCCH or PCCCH and report an RLC/MAC failure to the higher layer.

References

GSM 04.60, subclause 9.3.2.2, 9.4.2

42.2.2.4.3 Test purpose

1. To verify that the mobile starts timer T3184 upon reception of PACKET UPLINK ACK/NACK message during the mobile's transmission if the timer is not running.
2. To verify that the mobile restarts timer T3184 upon reception of PACKET UPLINK ACK/NACK message during the mobile's transmission if the timer is running.
3. To verify that upon expiry of timer T3184, the mobile performs an abnormal release procedure with cell re-selection by initiating establishment of an uplink TBF on a new cell. (This is the case where RANDOM_ACCESS_RETRY bit is set.)

42.2.2.4.4 Method of test

Initial Conditions

System Simulator:

2 cells, GPRS supported, PCCCH not present, CCCH with SI13

Mobile Station:

The MS is in the state "idle, GMM-registered" with a P-TMSI allocated, SPLIT PG CYCLE negotiated and PDP context2 activated.

Related PICS/PIXIT Statement(s)

Support GPRS service,

The way to trigger the MS to initiate an uplink packet transfer,

Test Procedure

MS is triggered to begin an uplink data transfer. Periodic PACKET UPLINK ACK/NACK messages are sent to verify that the T3184 timer is restarted at the correct times, and to verify that when the T3184 timer expires, the MS performs an abnormal release with cell re-selection.

Maximum Duration of Test

5 min.

Expected Sequence

Step	Direction	Message	Comments
1	MS		Trigger the MS to initiate an uplink packet transfer containing 1000 octets.
2			Bring the MS into packet uplink transfer mode on cell A by the generic procedure defined in the table 42.2.1.2/1b or 42.2.1.2/2b.
3	MS -> SS	RLC DATA BLOCK	Cell A: MS transmits RLC block only when TBF starting time occurs
4			Step 3 is repeated 4 times. (Allowing the MS to exhaust the allocation in step 2.)
5	SS -> MS	PACKET UPLINK ACK/NACK	Cell A: No REPEAT_ALLOCATION or ALLOCATION_BITMAP - MS starts timer T3184
6	SS		Wait (0.8 * T3184) seconds Verify no access on Cell A or Cell B.
7	SS -> MS	PACKET UPLINK ACK/NACK	Cell A: With REPEAT_ALLOCATION - MS restarts T3184
8	MS -> SS	RLC DATA BLOCK	Cell A: MS transmits RLC blocks according to repeat allocation until allocation is exhausted.
9	MS -> SS	CHANNEL REQUEST	Cell B: Sent more than T3184 – (.1*T3184) seconds after step 7.

Specific Message Contents

PACKET SYSTEM INFORMATION MESSAGE 3 (throughout):

RANDOM_ACCESS_RETRY	1 – Retry allowed
---------------------	-------------------

PACKET UPLINK ASSIGNMENT message in step 2 :

Fixed allocation - TIMESLOT ALLOCATION - BLOCKS_OR_BLOCK_PERIODS - ALLOCATION_BITMAP_LENGTH - ALLOCATION_BITMAP	One timeslot assigned 0 – blocks 10 0101011100
---	---

PACKET UPLINK ACK/NACK message in step 5:

Fixed allocation - Repeat Allocation - ALLOCATION_BITMAP	<not present> <not present>
--	--------------------------------

PACKET UPLINK ACK/NACK message in step 7:

Fixed allocation - Repeat Allocation	1
---	---

42.2.2.5 Fixed Allocation / Uplink Transfer / T3188

Applicability of T3188 tests:

All T3168 tests assigns a bit map that is long enough to guarantee that the MS will not return to idle mode before the test is finished.

The MS is supposed to send the PACKET RESOURCE REQUEST at the beginning of the allocation (during the first half of the allocation bitmap) see GSM 04.60 clause 8.1.1.3.2.1

42.2.2.5.1 Fixed Allocation / Uplink Transfer / T3188/Expiry

42.2.2.5.1.1 Definition and applicability

This test case applies to all MSs supporting GPRS.

42.2.2.5.1.2 Conformance requirements

If the mobile station exhausts its assigned fixed allocation and has more RLC data blocks to transmit, it shall start timer T3188 and monitor the downlink of all assigned PDCHs

If timer T3188 expires, the mobile station shall perform an abnormal release with random access (see 8.7.2).

References

GSM 04.60, subclause 8.1.1.3.2.3

42.2.2.5.1.3 Test purpose

Verify that when the current fixed allocation is exhausted, the MS starts T3188. Verify that if T3188 expires, the MS performs abnormal release with random access and not perform a cell reselection.

42.2.2.5.1.4 Method of test

Initial Conditions

System Simulator:

2 cells, GPRS supported, PCCCH not present

Mobile Station:

The MS is in the state "idle, GMM-registered" with a P-TMSI allocated, SPLIT PG CYCLE negotiated, and PDP context 3 activated.

Related PICS/PIXIT Statement(s)

Support GPRS service,

The way to initiate an uplink transfer,

Test Procedure

1. MS is triggered to begin an uplink data transfer.
2. T3188 expires and MS performs abnormal release with random access.

Maximum Duration of Test

5 min.

Expected Sequence

Step	Direction	Message	Comments
1	MS		Trigger the MS to initiate an uplink packet transfer containing 1000 octets.
2			Bring the MS into packet uplink transfer mode on cell A by the generic procedure defined in the table 42.2.1.2/1b or 42.2.1.2/2b.
3	MS -> SS	RLC DATA BLOCK	Cell A: MS transmits RLC block only when TBF starting time occurs
4			Step 3 is repeated 4 times. (Allowing the MS to exhaust the allocation in step 2.)
5	SS -> MS	PACKET UPLINK ACK/NACK	Cell A: No REPEAT_ALLOCATION or ALLOCATION_BITMAP - MS starts timer T3188
6	MS -> SS	CHANNEL REQUEST	Cell A: Sent at least T3188 – (.1*T3188) seconds after step 5.
7	SS		Verify no access on Cell B.

Specific Message Contents

PACKET UPLINK ASSIGNMENT message in step 2 :

Fixed allocation - TIMESLOT ALLOCATION - BLOCKS_OR_BLOCK_PERIODS - ALLOCATION_BITMAP_LENGTH - ALLOCATION_BITMAP	One timeslot assigned 0 – blocks 10 0101011100
---	---

42.2.2.5.2 Fixed Allocation / Uplink Transfer / T3188/Stop with Packet Uplink Assignment

42.2.2.5.2.1 Definition and applicability

This test case applies to all MSs supporting GPRS.

42.2.2.5.2.2 Conformance requirements

If the mobile station exhausts its assigned fixed allocation and has more RLC data blocks to transmit, it shall start timer T3188 and monitor the downlink of all assigned PDCHs. If the mobile station receives an assignment message containing a fixed allocation, the mobile station shall stop timer T3188 and use the new allocation at the assigned starting time.

References

GSM 04.60, subclause 8.1.1.3.2.3

42.2.2.5.2.3 Test purpose

Verify that when the current fixed allocation is exhausted, the MS starts T3188. Verify that T3188 is stopped when a PACKET UPLINK ASSIGNMENT is received.

42.2.2.5.2.4 Method of test

Initial Conditions

System Simulator:

2 cells, GPRS supported, PCCCH not present

Mobile Station:

The MS is in the state "idle, GMM-registered" with a P-TMSI allocated, SPLIT PG CYCLE negotiated, and PDP context 3 activated.

Related PICS/PIXIT Statement(s)

- Support GPRS service,
- The way to initiate an uplink transfer,

Test Procedure

1. MS is triggered to begin an uplink data transfer. When the MS exhausts the current allocation, it shall start T3188.
2. When a Packet Uplink Assignment is received, verify that the MS uses the new allocation and stops T3188.

Maximum Duration of Test

5 min.

Expected Sequence

Step	Direction	Message	Comments
1	MS		Trigger the MS to initiate an uplink packet transfer containing 1000 octets.
2			Bring the MS into packet uplink transfer mode on cell A by the generic procedure defined in the table 42.2.1.2/1b or 42.2.1.2/2b.
3	MS -> SS	RLC DATA BLOCK	Cell A: MS transmits RLC block only when TBF starting time occurs
4			Step 3 is repeated 4 times. (Allowing the MS to exhaust the allocation in step 2.)
5	SS -> MS	PACKET UPLINK ACK/NACK	Cell A: No REPEAT_ALLOCATION or ALLOCATION_BITMAP - MS starts timer T3188
6	SS		Wait (.8 * T3188) seconds Verify no access on Cell A or Cell B.
7	SS -> MS	PACKET UPLINK ASSIGNMENT	Cell A: With ALLOCATION_BITMAP. Sent within T3188 of step 5. - MS stops T3188
8	MS -> SS	RLC DATA BLOCK	Cell A: MS transmits RLC blocks according to new allocation until allocation is exhausted.

Specific Message Contents

PACKET UPLINK ASSIGNMENT message in step 2 and step 7:

Fixed allocation - TIMESLOT ALLOCATION - BLOCKS_OR_BLOCK_PERIODS - ALLOCATION_BITMAP_LENGTH - ALLOCATION_BITMAP	One timeslot assigned 0 – blocks 10 0101011100
---	---

42.2.2.5.3 Fixed Allocation / Uplink Transfer / T3188/Stop with Packet Uplink Ack/Nack with REPEAT_ALLOCATION

42.2.2.5.3.1 Definition and applicability

This test case applies to all MSs supporting GPRS.

42.2.2.5.3.2 Conformance requirements

If the mobile station exhausts its assigned fixed allocation and has more RLC data blocks to transmit, it shall start timer T3188 and monitor the downlink of all assigned PDCHs.

If the mobile station receives a PACKET UPLINK ACK/NACK with a REPEAT ALLOCATION after its current allocation has been exhausted, it shall stop timer T3188, wait until the next repeated allocation boundary and then begin transmitting using the repeated ALLOCATION_BITMAP.

References

GSM 04.60, subclause 8.1.1.3.2.3

42.2.2.5.3.3 Test purpose

Verify that when the current fixed allocation is exhausted, the MS starts T3188. Verify that T3188 is stopped when a PACKET UPLINK ACK/NACK with REPEAT_ALLOCATION is received.

42.2.2.5.3.4 Method of test

Initial Conditions

System Simulator:

2 cells, GPRS supported, PCCCH not present

Mobile Station:

The MS is in the state "idle, GMM-registered" with a P-TMSI allocated, SPLIT PG CYCLE negotiated, and PDP context 3 activated.

Related PICS/PIXIT Statement(s)

Support GPRS service,

The way to initiate an uplink transfer,

Test Procedure

1. MS is triggered to begin an uplink data transfer. When the MS exhausts the current allocation, it shall start T3188.
2. When a Packet Uplink Ack/Nack with ALLOCATION_BITMAP is received, verify that the MS uses the new allocation and stops T3188.

Maximum Duration of Test

5 min.

Expected Sequence

Step	Direction	Message	Comments
1	MS		Trigger the MS to initiate an uplink packet transfer containing 1000 octets.
2			Bring the MS into packet uplink transfer mode on cell A by the generic procedure defined in the table 42.2.1.2/1b or 42.2.1.2/2b.
3	MS -> SS	RLC DATA BLOCK	Cell A: MS transmits RLC block only when TBF starting time occurs
4			Step 3 is repeated 4 times. (Allowing the MS to exhaust the allocation in step 2.)
5	SS -> MS	PACKET UPLINK ACK/NACK	Cell A: No REPEAT_ALLOCATION or ALLOCATION_BITMAP - MS starts timer T3188
6	SS		Wait (.8*T3188) seconds Verify no access on Cell A or Cell B.
7	SS -> MS	PACKET UPLINK ACK/NACK	Cell A: With REPEAT_ALLOCATION - MS stops T3188
8	MS -> SS	RLC DATA BLOCK	Cell A: MS transmits RLC blocks according to new allocation until allocation is exhausted.

Specific Message Contents

PACKET UPLINK ASSIGNMENT message in step 2:

Fixed allocation - TIMESLOT ALLOCATION - BLOCKS_OR_BLOCK_PERIODS - ALLOCATION_BITMAP_LENGTH - ALLOCATION_BITMAP	One timeslot assigned 0 – blocks 10 0101011100
---	---

PACKET UPLINK ACK/NACK message in step 7:

Fixed allocation - Repeat Allocation	1
---	---

42.2.2.5 Fixed Allocation / Uplink Transfer / MS requests new resources/ T3168

Applicability of T3168 tests:

If the MS requests a closed-ended TBF, and does not send PACKET RESOURCE REQUEST at any time during the test, then the test is considered “passed” for that MS. However, a “pass” for one T3168 test should not be considered as a “pass” for all T3168 tests, as the MS operation is not constrained to one particular implementation method for all executions.

If the MS requests an open-ended TBF at the start of the test, then the test is applicable as written.

This applicability clause is necessary because it is MS implementation dependent whether to start the TBF in open-ended mode (where MS will send periodic PRRs), or in closed-ended mode (where the MS may optionally send a PRR to convert the TBF to open-ended mode). The purpose of T3168 is to test operation when the MS sends PRR and then waits for new uplink resources to be assigned. If the MS does not send a PRR, then T3168 is not applicable.

42.2.2.6.1 Fixed Allocation / Uplink Transfer / MS requests new resources/ T3168/Expiry

42.2.2.6.1.1 Definition and applicability

This test case applies to all MSs supporting GPRS.

42.2.2.6.1.2 Conformance requirements

At sending of the PACKET RESOURCE REQUEST message, the mobile station shall start timer T3168.

On receipt of a PACKET UPLINK ASSIGNMENT or PACKET TIMESLOT RECONFIGURE message the mobile station shall stop timer T3168 and switch to the assigned PDCHs.

On expiry of timer T3168, the mobile station shall retransmit the PACKET RESOURCE REQUEST message unless the PACKET RESOURCE REQUEST message has already been transmitted four times in which case the mobile station shall perform an abnormal release with random access.

If no PACKET UPLINK ASSIGNMENT or PACKET TIMESLOT RECONFIGURE message is received before the mobile station has completed its currently assigned TBFs the mobile station shall stop timer T3168 and return to packet idle mode (listening to its paging channel).

On receipt of a PACKET ACCESS REJECT message, the mobile station shall stop timer T3168 if running and return to packet idle mode. Before initiating a new packet access procedure the mobile station shall decode the PRACH Control Parameters if they are broadcast.

References

GSM 04.60, subclause 7.1.3.1, 8.1.1.3.2, 8.7.2, 12.24

42.2.2.6.1.3 Test purpose

Verify that when T3168 expires, the MS retransmits the PACKET RESOURCE REQUEST again (up to four times total). Verify that when T3168 expires after the fourth transmission of the PACKET RESOURCE REQUEST, that the MS performs abnormal release with random access.

42.2.2.6.1.4 Method of test

Initial Conditions

System Simulator:

1 cell, GPRS supported, PCCCH present

Mobile Station:

The MS is in the state "idle, GMM-registered" with a P-TMSI allocated, SPLIT PG CYCLE negotiated, and PDP context 3 activated.

Related PICS/PIXIT Statement(s)

Support GPRS service,

The way to initiate an uplink transfer,

Test Procedure

1. MS is triggered to begin an uplink data transfer and enters a open-ended TBF.
2. Before the current allocation expires, MS sends PACKET RESOURCE REQUEST.
3. When T3168 expires, MS resends PACKET RESOURCE REQUEST (up to 4 times)
4. When T3168 expires the fourth time, MS performs abnormal release with random access.

Maximum Duration of Test

5 min.

Expected Sequence

Step	Direction	Message	Comments
1	MS		Trigger the MS to initiate an uplink packet transfer containing 2500 octets.
2			Bring the MS into packet uplink transfer mode by the generic procedure defined in the table 42.2.1.1/1a.
3	MS -> SS	RLC DATA BLOCKS	MS transmits RLC blocks only when TBF starting time occurs
4	MS -> SS	PACKET RESOURCE REQUEST	MS requests additional resources - MS starts timer T3168
5	MS -> SS	RLC DATA BLOCKS	MS continues to transmit RLC data blocks according to allocation from step 2.
6	MS -> SS	PACKET RESOURCE REQUEST	MS requests additional resources - This is sent T3168 seconds after previous PRR. - MS re-starts timer T3168
7			Steps 5 and 6 are repeated 2 more times such that a total of 4 PRRs are sent.
8	MS -> SS	PACKET CHANNEL REQUEST	Verify MS sends Random Access

Note: the MS may not send PACKET CHANNEL REQUEST in step 8 (the first allocation is exhausted and the MS return to idle mode before expiry of T3168 the fourth time).

Specific Message Contents

PACKET SYSTEM INFORMATION MESSAGE 1 (throughout):

T3168	0 (.5 second)
-------	---------------

PACKET UPLINK ASSIGNMENT message in step 2:

Fixed allocation - TIMESLOT ALLOCATION - BLOCKS_OR_BLOCK_PERIODS - ALLOCATION_BITMAP_LENGTH - ALLOCATION_BITMAP	One timeslot assigned 0 – blocks 120 Exactly 100 bits are set to 1 (this allocation is exhausted after sending 4 PRR)
---	--

42.2.2.6.2 Fixed Allocation / Uplink Transfer / MS requests new resources/ T3168/Stop with Packet Uplink Assignment

42.2.2.6.2.1 Definition and applicability

This test case applies to all MSs supporting GPRS.

42.2.2.6.2.2 Conformance requirements

At sending of the PACKET RESOURCE REQUEST message, the mobile station shall start timer T3168.

On receipt of a PACKET UPLINK ASSIGNMENT or PACKET TIMESLOT RECONFIGURE message the mobile station shall stop timer T3168 and switch to the assigned PDCHs.

References

GSM 04.60, subclause 7.1.3.1, 8.1.1.3.2, 12.24

42.2.2.6.2.3 Test purpose

Verify that when PACKET UPLINK ASSIGNMENT is received, MS stops T3168.

42.2.2.6.2.4 Method of test

Initial Conditions

System Simulator:

1 cell, GPRS supported, PCCCH present

Mobile Station:

The MS is in the state "idle, GMM-registered" with a P-TMSI allocated, SPLIT PG CYCLE negotiated, and PDP context 3 activated.

Related PICS/PIXIT Statement(s)

Support GPRS service,

The way to initiate an uplink transfer,

Test Procedure

1. MS is triggered to begin an uplink data transfer and enters a open-ended TBF.
2. Before the current allocation expires, MS sends PACKET RESOURCE REQUEST.
3. Prior to T3168 expiring, MS receives a new allocation.

Maximum Duration of Test

5 min.

Expected Sequence

Step	Direction	Message	Comments
1	MS		Trigger the MS to initiate an uplink packet transfer containing 2500 octets.
2			Bring the MS into packet uplink transfer mode by the generic procedure defined in the table 42.2.1.1/1a.
3	MS -> SS	RLC DATA BLOCKS	MS transmits RLC blocks only when TBF starting time occurs
4	MS -> SS	PACKET RESOURCE REQUEST	MS requests additional resources - MS starts timer T3168
5	MS -> SS	RLC DATA BLOCKS	MS continues to transmit RLC data blocks according to allocation from step 2.
6	SS -> MS	PACKET UPLINK ASSIGNMENT	Sent (.8*T3168) seconds after step 4. - MS stops timer T3168
7	MS		Step 5 is repeated until current allocation is exhausted.
8	MS		MS starts to use the new allocation from step 6 at the next allocation boundary.

Specific Message Contents

PACKET SYSTEM INFORMATION MESSAGE 1 (throughout):

T3168	0 (0.5 seconds)
-------	-----------------

PACKET UPLINK ASSIGNMENT message in step 2 and step 6.

Fixed allocation - TIMESLOT ALLOCATION - BLOCKS_OR_BLOCK_PERIODS - ALLOCATION_BITMAP_LENGTH - ALLOCATION_BITMAP	One timeslot assigned 0 – blocks 120 Exactly 100 bits are set to 1.
---	--

42.2.2.6.3 Fixed Allocation / Uplink Transfer / MS requests new resources/ T3168/Stop with Packet Uplink Ack/Nack with REPEAT_ALLOCATION

42.2.2.6.3.1 Definition and applicability

This test case applies to all MSs supporting GPRS.

42.2.2.6.3.2 Conformance requirements

At sending of the PACKET RESOURCE REQUEST message, the mobile station shall start timer T3168.

References

GSM 04.60, subclause 7.1.3.1, 12.24

42.2.2.6.3.3 Test purpose

Verify that when PACKET UPLINK ACK/NACK is received, the MS stops T3168.

42.2.2.6.3.4 Method of test

Initial Conditions

System Simulator:

1 cell, GPRS supported, PCCCH present

Mobile Station:

The MS is in the state "idle, GMM-registered" with a P-TMSI allocated, SPLIT PG CYCLE negotiated, and PDP context 3 activated.

Related PICS/PIXIT Statement(s)

Support GPRS service,

The way to initiate an uplink transfer,

Test Procedure

1. MS is triggered to begin an uplink data transfer and enters a open-ended TBF.
2. Before the current allocation expires, MS sends PACKET RESOURCE REQUEST.
3. Prior to T3168 expiring, MS receives a REPEAT_ALLOCATION.

Maximum Duration of Test

5 min.

Expected Sequence

Step	Direction	Message	Comments
1	MS		Trigger the MS to initiate an uplink packet transfer containing 2500 octets.
2			Bring the MS into packet uplink transfer mode by the generic procedure defined in the table 42.2.1.1/1a.
3	MS -> SS	RLC DATA BLOCKS	MS transmits RLC blocks only when TBF starting time occurs
4	MS -> SS	PACKET RESOURCE REQUEST	MS requests additional resources - MS starts timer T3168
5	MS -> SS	RLC DATA BLOCKS	MS continues to transmit RLC data blocks according to allocation from step 2.
6	SS -> MS	PACKET UPLINK ACK/NACK	Sent (.8*T3168) seconds after step 4. - MS stops timer T3168
7	MS		Step 5 is repeated until current allocation is exhausted.
8	MS		MS starts to use the new allocation from step 6 at the next allocation boundary.

Specific Message Contents

PACKET SYSTEM INFORMATION MESSAGE 1 (throughout):

T3168	0 (0.5 seconds)
-------	-----------------

PACKET UPLINK ASSIGNMENT message in step 2:

Fixed allocation - TIMESLOT ALLOCATION - BLOCKS_OR_BLOCK_PERIODS - ALLOCATION_BITMAP_LENGTH - ALLOCATION_BITMAP	One timeslot assigned 0 – blocks 120 Exactly 100 bits are set to 1
---	---

PACKET UPLINK ACK/NACK message in step 6:

REPEAT_ALLOCATION	1
-------------------	---

42.2.2.6.4 Fixed Allocation / Uplink Transfer / MS requests new resources/ T3168/Stop with Packet Access Reject

42.2.2.6.4.1 Definition and applicability

This test case applies to all MSs supporting GPRS.

42.2.2.6.4.2 Conformance requirements

At sending of the PACKET RESOURCE REQUEST message, the mobile station shall start timer T3168.

On receipt of a PACKET ACCESS REJECT message, the mobile station shall stop timer T3168 if running and return to packet idle mode. Before initiating a new packet access procedure the mobile station shall decode the PRACH Control Parameters if they are broadcast.

References

GSM 04.60, subclause 7.1.3.1, 12.24

42.2.2.6.4.3 Test purpose

Verify that when PACKET ACCESS REJECT is received, the MS does not complete the current allocation.

42.2.2.6.4.4 Method of test

Initial Conditions

System Simulator:

1 cell, GPRS supported, PCCCH present

Mobile Station:

The MS is in the state "idle, GMM-registered" with a P-TMSI allocated, SPLIT PG CYCLE negotiated, and PDP context 3 activated.

Related PICS/PIXIT Statement(s)

Support GPRS service,

The way to initiate an uplink transfer,

Test Procedure

1. MS is triggered to begin an uplink data transfer and enters a open-ended TBF.
2. Before the current allocation expires, MS sends PACKET RESOURCE REQUEST.

3. Prior to T3168 expiring, MS receives a PACKET ACCESS REJECT.
4. MS returns to packet idle mode without finishing the current allocation.

Maximum Duration of Test

5 min.

Expected Sequence

Step	Direction	Message	Comments
1	MS		Trigger the MS to initiate an uplink packet transfer containing 2500 octets.
2			Bring the MS into packet uplink transfer mode by the generic procedure defined in the table 42.2.1.1/1a.
3	MS -> SS	RLC DATA BLOCKS	MS transmits RLC blocks only when TBF starting time occurs
4	MS -> SS	PACKET RESOURCE REQUEST	MS requests additional resources - MS starts timer T3168
5	MS -> SS	RLC DATA BLOCKS	MS continues to transmit RLC data blocks according to allocation from step 2.
6	SS -> MS	PACKET ACCESS REJECT	Sent (.8*T3168) seconds after step 4 on PACCH. - No waiting time - MS stops timer T3168
7	SS		Verify MS does not continue to use the assigned PDCH or finish the current allocation. (MS may choose to initiate access again.)

Specific Message Contents

PACKET SYSTEM INFORMATION MESSAGE 1 (throughout):

T3168	0 (0.5 seconds)
-------	-----------------

PACKET UPLINK ASSIGNMENT message in step 2:

Fixed allocation - TIMESLOT ALLOCATION - BLOCKS_OR_BLOCK_PERIODS - ALLOCATION_BITMAP_LENGTH - ALLOCATION_BITMAP	One timeslot assigned 0 – blocks 120 Exactly 100 bits are set to 1.
---	--

42.2.2.6.5 Fixed Allocation / Uplink Transfer / MS requests new resources/ T3168/Continue with Packet Uplink Ack/Nack without REPEAT_ALLOCATION and without ALLOCATION_BITMAP

42.2.2.6.5.1 Definition and applicability

This test case applies to all MSs supporting GPRS.

42.2.2.6.5.2 Conformance requirements

At sending of the PACKET RESOURCE REQUEST message, the mobile station shall start timer T3168.

On expiry of timer T3168, the mobile station shall retransmit the PACKET RESOURCE REQUEST message unless the PACKET RESOURCE REQUEST message has already been transmitted four times in which case the mobile station shall perform an abnormal release with random access.

References

GSM 04.60, subclause 8.1.1.3.2, 12.24

42.2.2.6.5.3 Test purpose

Verify that when MS receives a PACKET UPLINK ACK/NACK without an allocation, T3168 continues to run, and then expires, causing the MS to transmit the PACKET RESOURCE REQUEST again.

42.2.2.6.5.4 Method of test

Initial Conditions

System Simulator:

1 cell, GPRS supported, PCCCH present

Mobile Station:

The MS is in the state "idle, GMM-registered" with a P-TMSI allocated, SPLIT PG CYCLE negotiated, and PDP context 3 activated.

Related PICS/PIXIT Statement(s)

Support GPRS service,

The way to initiate an uplink transfer,

Test Procedure

1. MS is triggered to begin an uplink data transfer and enters a open-ended TBF.
2. Before the current allocation expires, MS sends PACKET RESOURCE REQUEST.
3. MS receives a PACKET UPLINK ACK/NACK with no REPEAT_ALLOCATION and no ALLOCATION_BITMAP. When T3168 expires, MS resends PACKET RESOURCE REQUEST.

Maximum Duration of Test

5 min.

Expected Sequence

Step	Direction	Message	Comments
1	MS		Trigger the MS to initiate an uplink packet transfer containing 2500 octets.
2			Bring the MS into packet uplink transfer mode by the generic procedure defined in the table 42.2.1.1/1a.
3	MS -> SS	RLC DATA BLOCKS	MS transmits RLC blocks only when TBF starting time occurs
4	MS -> SS	PACKET RESOURCE REQUEST	MS requests additional resources - MS starts timer T3168
5	MS -> SS	RLC DATA BLOCKS	MS continues to transmit RLC data blocks according to allocation from step 2.
6	SS -> MS	PACKET UPLINK ACK/NACK	No resources assigned - This is sent within (.2*T3168) after previous PRR.
7	MS -> SS	PACKET RESOURCE REQUEST	MS requests additional resources - This is sent T3168 +/- (.1*T3168) after previous PRR. - MS re-starts timer T3168

Specific Message Contents

PACKET SYSTEM INFORMATION MESSAGE 1 (throughout):

T3168	0 (0.5 second)
-------	----------------

PACKET UPLINK ASSIGNMENT message in step 2:

Fixed allocation - TIMESLOT ALLOCATION - BLOCKS_OR_BLOCK_PERIODS - ALLOCATION_BITMAP_LENGTH - ALLOCATION_BITMAP	One timeslot assigned 0 – blocks 120 Exactly 100 bits are set to 1.
---	--

42.2.2.7 Fixed Allocation / Uplink Transfer / MS requests new resources/ Successful

42.2.2.7.1 Fixed Allocation / Uplink Transfer / MS requests new resources/
Successful/ Packet Uplink Assignment with ALLOCATION_BITMAP

42.2.2.7.1.1 Definition and applicability

This test case applies to all MSs supporting GPRS.

42.2.2.7.1.2 Conformance requirements

At sending of the PACKET RESOURCE REQUEST message, the mobile station shall start timer T3168.

On receipt of a PACKET UPLINK ASSIGNMENT or PACKET TIMESLOT RECONFIGURE message the mobile station shall stop timer T3168 and switch to the assigned PDCHs.

References

GSM 04.60, subclause 8.1.1.3.2

42.2.2.7.1.3 Test purpose

Verify that when PACKET UPLINK ASSIGNMENT is received, MS switches to new resources after current allocation is exhausted.

42.2.2.7.1.4 Method of test

Initial Conditions

System Simulator:

1 cell, GPRS supported, PCCCH present

Mobile Station:

The MS is in the state "idle, GMM-registered" with a P-TMSI allocated, SPLIT PG CYCLE negotiated, and PDP context 3 activated.

Related PICS/PIXIT Statement(s)

Support GPRS service,

The way to initiate an uplink transfer,

Test Procedure

1. MS is triggered to begin an uplink data transfer and enters a open-ended TBF.
2. Before the current allocation expires, MS sends PACKET RESOURCE REQUEST.
3. Prior to T3168 expiring, MS receives a PACKET UPLINK ASSIGNMENT (with ALLOCATION_BITMAP).

Maximum Duration of Test

5 min.

Expected Sequence

Step	Direction	Message	Comments
1	MS		Trigger the MS to initiate an uplink packet transfer containing 2500 octets.
2			Bring the MS into packet uplink transfer mode by the generic procedure defined in the table 42.2.1.1/1a.
3	MS -> SS	RLC DATA BLOCKS	MS transmits RLC blocks only when TBF starting time occurs
4	MS -> SS	PACKET RESOURCE REQUEST	MS requests additional resources
5	MS -> SS	RLC DATA BLOCKS	MS continues to transmit RLC data blocks according to allocation from step 2.
6	SS -> MS	PACKET UPLINK ASSIGNMENT	Sent (.5*T3168) after step 4.
7	MS		Step 5 is repeated until current allocation is exhausted.
8	MS		MS uses allocation from step 6.

Specific Message Contents

PACKET SYSTEM INFORMATION MESSAGE 1 (throughout):

T3168	0 (0.5 second)
-------	----------------

PACKET UPLINK ASSIGNMENT message in step 2 and step 6:

Fixed allocation - TIMESLOT ALLOCATION - BLOCKS_OR_BLOCK_PERIODS - ALLOCATION_BITMAP_LENGTH - ALLOCATION_BITMAP	One timeslot assigned 0 – blocks 120 Exactly 100 bits are set to 1.
---	--

42.2.2.7.2 Fixed Allocation / Uplink Transfer / MS requests new resources/
Successful/Multiple Packet Uplink Assignments

42.2.2.7.2.1 Definition and applicability

This test case applies to all MSs supporting GPRS.

42.2.2.7.2.2 Conformance requirements

Upon receipt of a complete uplink assignment containing an ALLOCATION_BITMAP, the mobile station shall begin transmitting on the new resources at the indicated TBF Starting Time. If there is a conflict between a previous allocation and the new allocation, the new allocation shall take precedence.

References

GSM 04.60, subclause 8.1.1.3.2.2

42.2.2.7.2.3 Test purpose

Verify that when the new PACKET UPLINK ASSIGNMENT is received, MS switches to new resources at the starting time if there is a conflict with the current assignment.

42.2.2.7.2.4 Method of test

Initial Conditions

System Simulator:

1 cell, GPRS supported, PCCCH present

Mobile Station:

The MS is in the state "idle, GMM-registered" with a P-TMSI allocated, SPLIT PG CYCLE negotiated, and PDP context 3 activated.

Related PICS/PIXIT Statement(s)

Support GPRS service,

The way to initiate an uplink transfer,

Test Procedure

1. MS is triggered to begin an uplink data transfer and enters a open-ended TBF.

2. Before the current allocation expires, MS sends PACKET RESOURCE REQUEST.
3. MS receives a PACKET UPLINK ASSIGNMENT with starting time prior to the end of the current allocation.

Maximum Duration of Test

5 min.

Expected Sequence

Step	Direction	Message	Comments
1	MS		Trigger the MS to initiate an uplink packet transfer containing 2500 octets.
2			Bring the MS into packet uplink transfer mode by the generic procedure defined in the table 42.2.1.1/1a.
3	MS -> SS	RLC DATA BLOCKS	MS transmits RLC blocks only when TBF starting time occurs
4	MS -> SS	PACKET RESOURCE REQUEST	MS requests additional resources
5	MS -> SS	RLC DATA BLOCKS	MS continues to transmit RLC data blocks according to allocation from step 2.
6	SS -> MS	PACKET UPLINK ASSIGNMENT	Sent .5 second after step 4.
7	MS -> SS	RLC_DATA_BLOCKS	- Starting time conflicts with current allocation. Verify MS sends no more than 6 data blocks after step 6 using the allocation from step 2.
8	MS -> SS	RLC DATA BLOCKS	MS uses new allocation from step 6 at the starting time specified in step 6.

Specific Message Contents

PACKET SYSTEM INFORMATION MESSAGE 1 (throughout):

T3168	1 (1second)
-------	-------------

PACKET UPLINK ASSIGNMENT message in step 2:

Fixed allocation - TIMESLOT ALLOCATION - BLOCKS_OR_BLOCK_PERIODS - ALLOCATION_BITMAP_LENGTH - ALLOCATION_BITMAP	One timeslot assigned 0 – blocks 120 Exactly 100 bits are set to 1.
---	--

PACKET UPLINK ASSIGNMENT message in step 6:

Starting_time Fixed allocation - TIMESLOT ALLOCATION - BLOCKS_OR_BLOCK_PERIODS - ALLOCATION_BITMAP_LENGTH - ALLOCATION_BITMAP	<26 frames after current frame> One timeslot assigned <different from previous> 0 – blocks 48 Exactly 40 bits are set to 1.
--	---

42.2.2.7.3 Fixed Allocation / Uplink Transfer / MS requests new resources/ Successful/Packet Uplink Ack/Nack with ALLOCATION_BITMAP

42.2.2.7.3.1 Definition and applicability

This test case applies to all MSs supporting GPRS.

42.2.2.7.3.2 Conformance requirements

Upon receipt of a PACKET UPLINK ACK/NACK with a REPEAT_ALLOCATION, the mobile station shall start a new allocation when the current allocation ends. This new allocation shall begin immediately after the current allocation ends and shall use the most recently received ALLOCATION_BITMAP. If the mobile station receives multiple PACKET UPLINK ACK/NACK messages with REPEAT_ALLOCATION during an allocation, the mobile shall repeat the ALLOCATION_BITMAP only once.

References

GSM 04.60, subclause 8.1.1.3.2.2

42.2.2.7.3.3 Test purpose

Verify that the MS uses the new ALLOCATION_BITMAP from the PACKET UPLINK ACK/NACK message.

42.2.2.7.3.4 Method of test

Initial Conditions

System Simulator:

1 cell, GPRS supported, PCCCH present

Mobile Station:

The MS is in the state "idle, GMM-registered" with a P-TMSI allocated, SPLIT PG CYCLE negotiated, and PDP context 3 activated.

Related PICS/PIXIT Statement(s)

Support GPRS service,

The way to initiate an uplink transfer,

Test Procedure

1. MS is triggered to begin an uplink data transfer and enters an open-ended TBF.
2. Before the current allocation expires, MS sends PACKET RESOURCE REQUEST.
3. After the current allocation expires, MS receives a new allocation in a PACKET UPLINK ACK/NACK.

Maximum Duration of Test

5 min.

Expected Sequence

Step	Direction	Message	Comments
1	MS		Trigger the MS to initiate an uplink packet transfer containing 2500 octets.
2			Bring the MS into packet uplink transfer mode by the generic procedure defined in the table 42.2.1.1/1a.
3	MS -> SS	RLC DATA BLOCKS	MS transmits RLC blocks only when TBF starting time occurs
4	MS -> SS	PACKET RESOURCE REQUEST	MS requests additional resources
5	MS -> SS	RLC DATA BLOCKS	MS continues to transmit RLC data blocks according to allocation from step 2, until current allocation is exhausted.
6	SS -> MS	PACKET UPLINK ACK/NACK	Sent 1 second after step 4, with new ALLOCATION_BITMAP.
7	MS		MS starts to use the new allocation from step 6 at the next allocation boundary.

Specific Message Contents

PACKET UPLINK ASSIGNMENT message in step 2:

Fixed allocation - TIMESLOT ALLOCATION - BLOCKS_OR_BLOCK_PERIODS - ALLOCATION_BITMAP_LENGTH - ALLOCATION_BITMAP	One timeslot assigned 0 – blocks 120 Exactly 1000 bits are set to 1.
---	---

PACKET UPLINK ACK/NACK message in step 6:

Fixed allocation - TIMESLOT ALLOCATION - BLOCKS_OR_BLOCK_PERIODS - ALLOCATION_BITMAP_LENGTH - ALLOCATION_BITMAP	One timeslot assigned <different from previous> 0 – blocks 48 Exactly 40 bits are set to 1.
---	--

42.2.2.7.4 Fixed Allocation / Uplink Transfer / MS requests new resources/
Successful/Multiple Packet Uplink Ack/Nack with ALLOCATION_BITMAP

42.2.2.7.4.1 Definition and applicability

This test case applies to all MSs supporting GPRS.

42.2.2.7.4.2 Conformance requirements

Upon receipt of a PACKET UPLINK ACK/NACK with a REPEAT_ALLOCATION, the mobile station shall start a new allocation when the current allocation ends. This new allocation shall begin immediately after the current allocation ends and shall use the most recently received ALLOCATION_BITMAP. If the mobile station receives multiple PACKET UPLINK ACK/NACK messages with REPEAT_ALLOCATION during an allocation, the mobile shall repeat the ALLOCATION_BITMAP only once.

References

GSM 04.60, subclause 8.1.1.3.2.2

42.2.2.7.4.3 Test purpose

Verify that the MS uses the ALLOCATION_BITMAP currently being used as the allocation bitmap that applies to the REPEAT_ALLOCATION.

42.2.2.7.4.4 Method of test

Initial Conditions

System Simulator:

1 cell, GPRS supported, PCCCH present

Mobile Station:

The MS is in the state "idle, GMM-registered" with a P-TMSI allocated, SPLIT PG CYCLE negotiated, and PDP context 3 activated.

Related PICS/PIXIT Statement(s)

Support GPRS service,

The way to initiate an uplink transfer,

Test Procedure

1. MS is triggered to begin an uplink data transfer and enters a open-ended TBF.
2. Before current allocation expires, MS sends PACKET RESOURCE REQUEST.
3. MS receives a series of PACKET UPLINK ACK/NACK messages before the current allocation expires, containing a new allocation, followed by a repeat allocation, followed by a different new allocation, followed by a repeat allocation.

Maximum Duration of Test

5 min.

Expected Sequence

Step	Direction	Message	Comments
1	MS		Trigger the MS to initiate an uplink packet transfer containing 2500 octets.
2			Bring the MS into packet uplink transfer mode by the generic procedure defined in the table 42.2.1.1/1a.
3	MS -> SS	RLC DATA BLOCKS	MS transmits RLC blocks only when TBF starting time occurs
4	MS -> SS	PACKET RESOURCE REQUEST	MS requests additional resources (can come any time during the allocation)
5	MS -> SS	RLC DATA BLOCKS	MS continues to transmit RLC data blocks according to allocation from step 2.
6	SS -> MS	PACKET UPLINK ACK/NACK	Sent 1 second after step 4, with new ALLOCATION_BITMAP.
7	SS -> MS	PACKET UPLINK ACK/NACK	REPEAT_ALLOCATION
8	SS -> MS	PACKET UPLINK ACK/NACK	Different ALLOCATION_BITMAP than step 6.
9	SS -> MS	PACKET UPLINK ACK/NACK	REPEAT_ALLOCATION (This repeat only applies to the allocation in progress.)
10	MS		Step 5 is repeated until current allocation is exhausted.
11	MS		MS starts to repeat the allocation from step 2 at the next allocation boundary.

Specific Message Contents

PACKET UPLINK ASSIGNMENT message in step 2:

Fixed allocation - TIMESLOT ALLOCATION - BLOCKS_OR_BLOCK_PERIODS - ALLOCATION_BITMAP_LENGTH - ALLOCATION_BITMAP	One timeslot assigned 0 – blocks 120 Exactly 100 bits are set to 1.
---	--

PACKET UPLINK ACK/NACK message in step 6:

Fixed allocation - TIMESLOT ALLOCATION - BLOCKS_OR_BLOCK_PERIODS - ALLOCATION_BITMAP_LENGTH - ALLOCATION_BITMAP	One timeslot assigned <different from previous> 0 – blocks 48 Exactly 40 bits are set to 1. <different from previous>
---	--

PACKET UPLINK ACK/NACK message in step 7 and 9:

REPEAT_ALLOCATION	1
-------------------	---

PACKET UPLINK ACK/NACK message in step 8:

Fixed allocation - TIMESLOT ALLOCATION - BLOCKS_OR_BLOCK_PERIODS - ALLOCATION_BITMAP_LENGTH - ALLOCATION_BITMAP	One timeslot assigned <different from steps 2 and 6> 0 – blocks 48 Exactly 40 bits are set to 1. <different from previous>
---	---

42.2.2.7.5 Fixed Allocation / Uplink Transfer / MS requests new resources/ Successful/Multiple Packet Uplink Ack/Nack with REPEAT_ALLOCATION

42.2.2.7.5.1 Definition and applicability

This test case applies to all MSs supporting GPRS.

42.2.2.7.5.2 Conformance requirements

Upon receipt of a PACKET UPLINK ACK/NACK with a REPEAT_ALLOCATION, the mobile station shall start a new allocation when the current allocation ends. This new allocation shall begin immediately after the current allocation ends and shall use the most recently received ALLOCATION_BITMAP. If the mobile station receives multiple PACKET UPLINK ACK/NACK messages with REPEAT_ALLOCATION during an allocation, the mobile shall repeat the ALLOCATION_BITMAP only once.

References

GSM 04.60, subclause 8.1.1.3.2.2

42.2.2.7.5.3 Test purpose

Verify that the MS repeats the current allocation only once.

42.2.2.7.5.4 Method of test

Initial Conditions

System Simulator:

1 cell, GPRS supported, PCCCH present

Mobile Station:

The MS is in the state "idle, GMM-registered" with a P-TMSI allocated, SPLIT PG CYCLE negotiated, and PDP context 3 activated.

Related PICS/PIXIT Statement(s)

Support GPRS service,

The way to initiate an uplink transfer,

Test Procedure

1. MS is triggered to begin an uplink data transfer and enters an open-ended TBF.
2. Before current allocation expires, MS sends PACKET RESOURCE REQUEST.
3. MS receives a series of PACKET UPLINK ACK/NACK messages before the current allocation expires, each containing a repeat allocation.
4. MS responds at the next allocation boundary by using the previous allocation but only once.

Maximum Duration of Test

5 min.

Expected Sequence

Step	Direction	Message	Comments
1	MS		Trigger the MS to initiate an uplink packet transfer containing 2500 octets.
2			Bring the MS into packet uplink transfer mode by the generic procedure defined in the table 42.2.1.1/1a.
3	MS -> SS	RLC DATA BLOCKS	MS transmits RLC blocks only when TBF starting time occurs
4	MS -> SS	PACKET RESOURCE REQUEST	MS requests additional resources (sent sometime during current allocation)
5	MS -> SS	RLC DATA BLOCKS	MS continues to transmit RLC data blocks according to allocation from step 2.
6	SS -> MS	PACKET UPLINK ACK/NACK	Sent (.5*T3168) after step 4, with REPEAT_ALLOCATION.
7	SS -> MS	PACKET UPLINK ACK/NACK	REPEAT_ALLOCATION
8	SS -> MS	PACKET UPLINK ACK/NACK	REPEAT_ALLOCATION
9	MS		Step 5 is repeated until current allocation is exhausted.
10	MS		MS starts to repeat the allocation from step 2 at the next allocation boundary. If MS sends PACKET_RESOURCE_REQUEST anytime during step 10, SS sends a different PACKET_UPLINK_ASSIGNMENT than sent previously.
11	SS		Verify MS does not use the allocation from step 2 after step 10.

Specific Message Contents

PACKET SYSTEM INFORMATION MESSAGE 1 (throughout):

T3168	1 (1second)
-------	-------------

PACKET UPLINK ASSIGNMENT message in step 2:

Fixed allocation - TIMESLOT ALLOCATION - BLOCKS_OR_BLOCK_PERIODS - ALLOCATION_BITMAP_LENGTH - ALLOCATION_BITMAP	One timeslot assigned 0 – blocks 120 Exactly 100 bits are set to 1.
---	--

PACKET UPLINK ACK/NACK message in step 10:

Fixed allocation - TIMESLOT ALLOCATION - BLOCKS_OR_BLOCK_PERIODS - ALLOCATION_BITMAP_LENGTH - ALLOCATION_BITMAP	One timeslot assigned <different from previous> 0 – blocks 48 Exactly 40 bits are set to 1. <different from previous>
---	--

PACKET UPLINK ACK/NACK message in step 6,7 and 8:

REPEAT_ALLOCATION	1
-------------------	---

42.2.2.8 Fixed Allocation / Uplink Transfer / MS requests new resources/ Failure

42.2.2.8.1 Fixed Allocation / Uplink Transfer / MS requests new resources/ Failure/Packet Access Reject

42.2.2.8.1.1 Definition and applicability

This test case applies to all MSs supporting GPRS.

42.2.2.8.1.2 Conformance requirements

On receipt of a PACKET ACCESS REJECT message , the mobile station shall stop timer T3168 if running and indicate a packet access failure to upper layer.

References

GSM 04.60, subclause 8.1.1.3.2

42.2.2.8.1.3 Test purpose

Verify that the MS returns to packet idle mode when PACKET ACCESS REJECT is received.

42.2.2.8.1.4 Method of test

Initial Conditions

System Simulator:

1 cell, GPRS supported, PCCCH not present

Mobile Station:

The MS is in the state "idle, GMM-registered" with a P-TMSI allocated, SPLIT PG CYCLE negotiated, and PDP context 3 activated.

Related PICS/PIXIT Statement(s)

Support GPRS service,

The way to initiate an uplink transfer,

Test Procedure

1. MS is triggered to begin an uplink data transfer and enters a open-ended TBF.
2. Before current allocation expires, MS sends PACKET RESOURCE REQUEST.
3. After the current allocation expires, MS receives a PACKET ACCESS REJECT message.
4. MS returns to packet idle mode.

Maximum Duration of Test

5 min.

Expected Sequence

Step	Direction	Message	Comments
1	MS		Trigger the MS to initiate an uplink packet transfer containing 1000 octets.
2			Bring the MS into packet uplink transfer mode by the generic procedure defined in the table 42.2.1.1/1b.
3	MS -> SS	RLC DATA BLOCKS	MS transmits RLC blocks only when TBF starting time occurs
4	MS -> SS	PACKET RESOURCE REQUEST	MS requests additional resources
5	SS -> MS	PACKET ACCESS REJECT	
6	MS -> SS	RLC DATA BLOCKS	MS sends no more than 6 RLC data blocks after step 5.
7	SS		Verify that MS is not transmitting on the previous PDCH.

Specific Message Contents

IMMEDIATE ASSIGNMENT message in step 2:

Fixed allocation - TIMESLOT ALLOCATION - BLOCKS_OR_BLOCK_PERIODS - ALLOCATION_BITMAP_LENGTH - ALLOCATION_BITMAP	One timeslot assigned 0 – blocks 48 Exactly 10 bits are set to 1.
---	--

42.2.2.8.2 Fixed Allocation / Uplink Transfer / MS requests new resources/ Failure/ Packet Access Reject with WAIT_INDICATION during allocation in progress

42.2.2.8.2.1 Definition and applicability

This test case applies to all MSs supporting GPRS.

42.2.2.8.2.2 Conformance requirements

If the PACKET ACCESS REJECT message contains a WAIT_INDICATION field in a Reject structure addressed to the mobile station, the mobile station shall

- start timer T3172 and if the mobile station has additional RLC data blocks to transmit, it shall initiate a new TBF establishment procedure on the RACH or PRACH, but the mobile station is not allowed to make a new attempt for packet access in the same cell until timer T3172 expires, it may, however, attempt packet access in another cell after successful cell reselection. A mobile station in GPRS MS class A or B mode of operation may attempt to enter the dedicated mode in the same cell before timer T3172 has expired. During the time T3172 is running, the mobile station shall ignore all received PACKET PAGING REQUEST messages except paging request to trigger RR connection establishment.

The value of the WAIT_INDICATION field (i.e. timer T3172) relates to the cell from which it was received.

References

GSM 04.60, subclause 8.1.1.3.2

42.2.2.8.2.3 Test purpose

Verify that the MS waits T3172 before sending additional PACKET RESOURCE REQUEST messages, when PACKET ACCESS REJECT is received with a WAIT_INDICATION.

42.2.2.8.2.4 Method of test

Initial Conditions

System Simulator:

1 cell, GPRS supported, PCCCH present

Mobile Station:

The MS is in the state "idle, GMM-registered" with a P-TMSI allocated, SPLIT PG CYCLE negotiated, and PDP context 3 activated.

Related PICS/PIXIT Statement(s)

Support GPRS service,

The way to initiate an uplink transfer,

Test Procedure

1. MS is triggered to begin an uplink data transfer and enters a open-ended TBF.
2. Before current allocation expires, MS sends PACKET RESOURCE REQUEST.
3. Before the current allocation expires, MS receives a PACKET ACCESS REJECT message.
4. MS waits T3172 before sending additional PACKET RESOURCE REQUEST messages.

Maximum Duration of Test

5 min.

Expected Sequence

Step	Direction	Message	Comments
1	MS		Trigger the MS to initiate an uplink packet transfer containing 2500 octets.
2			Bring the MS into packet uplink transfer mode by the generic procedure defined in the table 42.2.1.1/1a.
3	MS -> SS	RLC DATA BLOCKS	MS transmits RLC blocks only when TBF starting time occurs
4	MS -> SS	PACKET RESOURCE REQUEST	MS requests additional resources
5	MS -> SS	RLC DATA BLOCK	MS continues to transmit RLC data blocks according to allocation from step 2.
6	SS -> MS	PACKET ACCESS REJECT	Sent (.5*T3168) after step 4. - MS starts T3172
7	MS -> SS	RLC DATA BLOCK	MS sends no more than 6 RLC data blocks after step 6.
8	MS -> SS	PACKET CHANNEL REQUEST	Sent more than 2 seconds after step 6.

Specific Message Contents

PACKET UPLINK ASSIGNMENT message in step 2:

Fixed allocation - TIMESLOT ALLOCATION - BLOCKS_OR_BLOCK_PERIODS - ALLOCATION_BITMAP_LENGTH - ALLOCATION_BITMAP	One timeslot assigned 0 – blocks 120 Exactly 100 bits are set to 1.
---	--

PACKET ACCESS REJECT message in step 6:

WAIT_INDICATION WAIT_INDICATION_SIZE	2 0 – WAIT_INDICATION in units of seconds
---	--

42.2.2.9 Fixed Allocation / Uplink Transfer / Network initiates new resources

42.2.2.9.1 Definition and applicability

This test case applies to all MSs supporting GPRS.

42.2.2.9.2 Conformance requirements

The network may at any time during the uplink TBF initiate a change of resources by sending on the downlink PACCH monitored by the MS, an unsolicited PACKET UPLINK ASSIGNMENT or PACKET TIMESLOT RECONFIGURE, or an uplink resource reassignment in a PACKET UPLINK ACK/NACK message to the mobile station.

References

GSM 04.60, subclause 8.1.1.3.2

42.2.2.9.3 Test purpose

Verify that the MS obeys unsolicited PACKET UPLINK ASSIGNMENT message during an uplink TBF.

42.2.2.9.4 Method of test

Initial Conditions

System Simulator:

1 cell, GPRS supported, PCCCH not present

Mobile Station:

The MS is in the state "idle, GMM-registered" with a P-TMSI allocated, SPLIT PG CYCLE negotiated, and PDP context 3 activated.

Related PICS/PIXIT Statement(s)

Support GPRS service,

The way to initiate an uplink transfer,

Test Procedure

1. MS is triggered to begin an uplink data transfer and enters a open-ended TBF.
2. Before current allocation expires, SS sends unsolicited PACKET UPLINK ASSIGNMENT.

3. After the current allocation expires, MS uses the newly assigned resources.

Maximum Duration of Test

5 min.

Expected Sequence

Step	Direction	Message	Comments
1	MS		Trigger the MS to initiate an uplink packet transfer containing 1000 octets.
2			Bring the MS into packet uplink transfer mode by the generic procedure defined in the table 42.2.1.2/1b.
3	MS -> SS	RLC DATA BLOCK	MS transmits RLC block only when TBF starting time occurs
4	MS -> SS	RLC DATA BLOCKS	MS continues to transmit RLC data blocks according to allocation from step 2.
4A	MS -> SS	PACKET RESOURCE REQUEST	Optional: MS may request new resources. If this occurs, SS proceeds with step 4B.
4B	SS -> MS	PACKET UPLINK ASSIGNMENT	Assign uplink resources in response to MS request.
5	SS -> MS	PACKET UPLINK ASSIGNMENT	Unsolicited – sent on PACCH. Different from step 4B.
6	MS -> SS	RLC DATA BLOCK	MS continues to transmit RLC data blocks according to allocation from step 2, until the allocation is exhausted.
7	MS -> SS	RLC DATA BLOCK	MS starts to use the new allocation from step 5 at the given starting time.

Specific Message Contents

PACKET UPLINK ASSIGNMENT message in step 2:

Fixed allocation - TIMESLOT ALLOCATION - BLOCKS_OR_BLOCK_PERIODS - ALLOCATION_BITMAP_LENGTH - ALLOCATION_BITMAP	One timeslot assigned 0 – blocks <any suitable value > Exactly 40 bits are set to 1.
---	---

PACKET UPLINK ASSIGNMENT message in step 5:

Fixed allocation - TIMESLOT ALLOCATION - BLOCKS_OR_BLOCK_PERIODS - ALLOCATION_BITMAP_LENGTH - ALLOCATION_BITMAP Starting Time	One timeslot assigned <different than previous> 0 – blocks <any suitable value > Exactly 40 bits are set to 1. 100 frames after current allocation expires
--	--

42.2.2.10 Fixed Allocation / Uplink Transfer / PACCH operation

42.2.2.10.1 Fixed Allocation / Uplink Transfer / PACCH operation/ Normal Operation

42.2.2.10.1.1 Definition and applicability

This test case applies to all MSs supporting GPRS multi-slot class 3 and higher.

42.2.2.10.1.2 Conformance requirements

A mobile station shall monitor one PDCH in the allocation for downlink PACCH except during the measurement gap. The network shall indicate that PDCH on uplink resource assignment (DOWNLINK_CONTROL_TIMESLOT parameter) according to MS multislot class.

References

GSM 04.60, subclause 8.1.1.3.4, Annex D

GSM 5.02, Annex B.1

42.2.2.10.1.3 Test purpose

Verify that the MS monitors the correct PDCH for PACCH during an uplink TBF.

42.2.2.10.1.4 Method of test

Initial Conditions

System Simulator:

1 cell, GPRS supported, PCCCH not present

Mobile Station:

The MS is in the state "idle, GMM-registered" with a P-TMSI allocated, SPLIT PG CYCLE negotiated, and PDP context 3 activated.

Related PICS/PIXIT Statement(s)

Support GPRS service,

The way to initiate an uplink transfer,

Test Procedure

1. MS is triggered to begin an uplink data transfer and enters a open-ended TBF on 2 timeslots.
2. MS receives PACKET POLLING REQUEST on the PDCH corresponding to its downlink PACCH.
3. MS responds to the poll by sending PACKET CONTROL ACKNOWLEDGEMENT.

Maximum Duration of Test

5 min.

Expected Sequence

Step	Direction	Message	Comments
1	MS		Trigger the MS to initiate an uplink packet transfer containing 1000 octets.
2			Bring the MS into packet uplink transfer mode by the generic procedure defined in the table 42.2.1.2/1b.
3	MS -> SS	RLC DATA BLOCK	MS transmits RLC block only when TBF starting time occurs
4	MS -> SS	RLC DATA BLOCK	MS continues to transmit RLC data blocks according to allocation from step 2.
5	SS -> MS	PACKET POLLING REQUEST	Sent on PACCH, PDCH 0.
6	MS -> SS	PACKET CONTROL ACKNOWLEDGEMENT	Sent in next but one block after step 5, on PDCH 0.
7	MS -> SS	RLC DATA BLOCKS	MS continues to transmit RLC data blocks according to allocation from step 2, until the allocation is exhausted.

Specific Message Contents

PACKET UPLINK ASSIGNMENT message in step 2:

Fixed allocation - TIMESLOT ALLOCATION - BLOCKS_OR_BLOCK_PERIODS - ALLOCATION_BITMAP_LENGTH - ALLOCATION_BITMAP - DOWNLINK_CONTROL_TIMESLOT	Two timeslot assigned (0 and 1) 0 – blocks <any suitable value > Exactly 40 bits are set to 1. 000
--	--

PACKET POLLING REQUEST message in step 5:

TYPE_OF_ACK TFI	1 (Respond with RLC/MAC control block) Addressing this MS
--------------------	--

42.2.2.10.2 Fixed Allocation / Uplink Transfer / PACCH operation/ PACCH message addressed to another MS

42.2.2.10.2.1 Definition and applicability

This test case applies to all MSs supporting GPRS multi-slot class 3 and higher.

42.2.2.10.2.2 Conformance Requirements

A mobile station shall monitor one PDCH in the allocation for downlink PACCH except during the measurement gap. The network shall indicate that PDCH on uplink resource assignment (DOWNLINK_CONTROL_TIMESLOT parameter) according to MS multislot class.

References

GSM 04.60, subclause 8.1.1.3.4, Annex D

GSM 5.02, Annex B.1

42.2.2.10.2.3 Test purpose

Verify that the MS ignores the PACCH message if addressed to another MS.

42.2.2.10.2.4 Method of test

Initial Conditions

System Simulator:

1 cell, GPRS supported, PCCCH not present

Mobile Station:

The MS is in the state "idle, GMM-registered" with a P-TMSI allocated, SPLIT PG CYCLE negotiated, and PDP context 3 activated.

Related PICS/PIXIT Statement(s)

Support GPRS service,

The way to initiate an uplink transfer,

Test Procedure

1. MS is triggered to begin an uplink data transfer and enters a open-ended TBF on 2 timeslots.
2. MS receives PACKET POLLING REQUEST on the PDCH corresponding to its downlink PACCH, addressed to another MS.
3. MS does not respond to the poll.

Maximum Duration of Test

5 min.

Expected Sequence

Step	Direction	Message	Comments
1	MS		Trigger the MS to initiate an uplink packet transfer containing 1000 octets.
2			Bring the MS into packet uplink transfer mode by the generic procedure defined in the table 42.2.1.2/1b.
3	MS -> SS	RLC DATA BLOCK	MS transmits RLC block only when TBF starting time occurs
4	MS -> SS	RLC DATA BLOCK	MS continues to transmit RLC data blocks according to allocation from step 2.
5	SS -> MS	PACKET POLLING REQUEST	Sent on PACCH, PDCH 0.
6	MS -> SS	RLC DATA BLOCKS	MS continues to transmit RLC data blocks according to allocation from step 2, until the allocation is exhausted. - Verify no PACKET CONTROL ACKNOWLEDGEMENT is sent by MS.

Specific Message Contents

PACKET UPLINK ASSIGNMENT message in step 2:

Fixed allocation - TIMESLOT ALLOCATION - BLOCKS_OR_BLOCK_PERIODS - ALLOCATION_BITMAP_LENGTH - ALLOCATION_BITMAP - DOWNLINK_CONTROL_TIMESLOT	Two timeslots assigned (0 and 1) 0 – blocks <any suitable value > Exactly 40 bits are set to 1. 000
--	---

PACKET POLLING REQUEST message in step 5:

TYPE_OF_ACK TFI	1 (Respond with RLC/MAC control block) Not matching this MS.
--------------------	---

42.2.2.10.3 Fixed Allocation/ Uplink Transfer / Abnormal cases / PACCH timeslot removed

42.2.2.10.3.1 Definition and applicability

This test case applies to all MSs supporting GPRS multi-slot class 3 and higher.

42.2.2.10.3.2 Conformance requirements

If an uplink TBF in fixed allocation mode was in progress and if one of timeslots that are being released is its downlink PACCH timeslot, the mobile station shall temporarily read all downlink blocks that it is able to decode according to its multislot capability, on all of its remaining assigned PDCHs, and act upon any RLC/MAC control message that is addressed to it, until another downlink PACCH timeslot is assigned. If the mobile station's multislot capability does not allow it to monitor the downlink of any of its assigned PDCHs, it shall perform an abnormal release with random access.

References

GSM 04.60, subclause 8.2

GSM 5.02, Annex B.1

42.2.2.10.3.3 Test purpose

Verify that the MS monitors the correct PDCH for PACCH during an uplink TBF after the previously assigned downlink PACCH timeslot is released.

42.2.2.10.3.4 Method of test

Initial Conditions

System Simulator:

1 cell, GPRS supported, PCCCH not present

Mobile Station:

The MS is in the state "idle, GMM-registered" with a P-TMSI allocated, SPLIT PG CYCLE negotiated, and PDP context 3 activated.

Related PICS/PIXIT Statement(s)

Support GPRS service,

The way to initiate an uplink transfer,

Test Procedure

1. MS is triggered to begin an uplink data transfer (via CCCH) and enters a open-ended TBF on 2 timeslots, with one timeslot assigned for its downlink PACCH.
2. MS receives PACKET PDCH RELEASE message on its assigned PACCH.
3. MS receives PACKET POLLING REQUEST on the PDCH that was just released, corresponding to its downlink PACCH.
4. MS does not respond to the poll.
5. MS receives PACKET POLLING REQUEST on another downlink PDCH to which it is assigned.
6. MS responds to the poll.

Maximum Duration of Test

5 min.

Expected Sequence

Step	Direction	Message	Comments
1	MS		Trigger the MS to initiate an uplink packet transfer containing 1000 octets.
2			Bring the MS into packet uplink transfer mode by the generic procedure defined in the table 42.2.1.2/1b.
3	MS -> SS	RLC DATA BLOCK	MS transmits RLC block only when TBF starting time occurs
4	MS -> SS	RLC DATA BLOCK	MS continues to transmit RLC data blocks according to allocation from step 2.
5	SS -> MS	PACKET PDCH RELEASE	Sent on PACCH, PDCH 0.
6	SS -> MS	PACKET POLLING REQUEST	Sent on PACCH, PDCH 0.
7	MS -> SS	RLC DATA BLOCKS	MS continues to transmit RLC data blocks according to allocation from step 2, but without any transmission on PDCH 0. - Verify no PACKET CONTROL ACKNOWLEDGEMENT is sent by MS on PDCH0.
8	SS -> MS	PACKET POLLING REQUEST	Sent on PACCH, PDCH 1.
9	MS -> SS	PACKET CONTROL ACKNOWLEDGEMENT	Sent in next but one block after step 8, on PDCH 1.
10	MS -> SS	RLC DATA BLOCKS	MS continues to transmit RLC data blocks according to allocation from step 2, until the allocation is exhausted.

Specific Message Contents

PACKET UPLINK ASSIGNMENT message in step 2:

Fixed allocation	
- TIMESLOT ALLOCATION	Two timeslots assigned (0 and 1)
- BLOCKS_OR_BLOCK_PERIODS	0 – blocks
- ALLOCATION_BITMAP_LENGTH	<any suitable value >
- ALLOCATION_BITMAP	Exactly 40 bits are set to 1.
- DOWNLINK_CONTROL_TIMESLOT	000

PACKET POLLING REQUEST message in step 6 and 8:

TYPE_OF_ACK TFI	1 (Respond with RLC/MAC control block matching this MS)
--------------------	--

PACKET PDCH RELEASE message in step 5:

PAGE_MODE TIMESLOTS_AVAILABLE	00 – Normal Paging <not present>
----------------------------------	-------------------------------------

42.2.2.11 Fixed Allocation/ Uplink Transfer / Abnormal cases

42.2.2.11.1 Fixed Allocation/ Uplink Transfer / Abnormal cases / Assignment without fixed allocation

42.2.2.11.1.1 Definition and applicability

This test case applies to all MSs supporting GPRS.

42.1.2.11.1.2 Conformance requirements

- If the mobile station receives an assignment message containing an allocation other than a fixed allocation, the mobile station shall perform an abnormal release with random access.

References

GSM 04.60, subclause 8.1.1.3.2.5

42.2.2.11.1.3 Test purpose

Verify that an MS in a fixed allocation uplink transfer performs an abnormal release with random access when an assignment message without a fixed allocation is received.

42.2.2.11.1.4 Method of test

Initial Conditions

System Simulator:

2 cells, GPRS supported, PCCCH not present

Mobile Station:

The MS is in the state "idle, GMM-registered" with a P-TMSI allocated, SPLIT PG CYCLE negotiated, and PDP context 3 activated.

Related PICS/PIXIT Statement(s)

Support GPRS service,

The way to initiate an uplink transfer,

Test Procedure

1. MS is triggered to begin an uplink data transfer (via CCCH) and enters a fixed allocation open-ended TBF.
2. Before the current allocation expires, MS sends PACKET RESOURCE REQUEST.
3. Prior to T3168 expiring, MS receives a new allocation containing dynamic allocation.

4. MS performs an abnormal release with random access.

Maximum Duration of Test

5 min.

Expected Sequence

Step	Direction	Message	Comments
1	MS		Trigger the MS to initiate an uplink packet transfer containing 1000 octets.
2			Bring the MS into packet uplink transfer mode on cell A by the generic procedure defined in the table 42.2.1.2/1b or 42.2.1.2/2b.
3	MS -> SS	RLC DATA BLOCK	Cell A: MS transmits RLC block only when TBF starting time occurs
4	MS -> SS	RLC DATA BLOCK	MS continues to transmit RLC data blocks according to allocation from step 2.
5	SS -> MS	PACKET UPLINK ASSIGNMENT	Cell A: With Dynamic Allocation. Sent on PACCH.
6	SS		Verify MS does not send more than 2 RLC data blocks from previous allocation.
7	MS -> SS	CHANNEL REQUEST	Verify Ms does not access cell B. Cell A: Random access

Specific Message Contents

PACKET UPLINK ASSIGNMENT message in step 2:

Fixed allocation - TIMESLOT ALLOCATION - BLOCKS_OR_BLOCK_PERIODS - ALLOCATION_BITMAP_LENGTH - ALLOCATION_BITMAP	One timeslot assigned 0 – blocks <any suitable value > Exactly the 40 first bits are set to 1.
---	---

PACKET UPLINK ASSIGNMENT message in step 5:

Dynamic Allocation structure	<any dynamic allocation>
------------------------------	--------------------------

42.2.2.11.2 Fixed Allocation/ Uplink Transfer / Abnormal cases / Frequency not supported

42.2.2.11.2.1 Definition and applicability

This test case applies to all MSs supporting GPRS.

42.2.2.11.2.1 Conformance requirements

- if the mobile station receives a PACKET UPLINK ASSIGNMENT message containing a Frequency Parameters information element specifying a frequency that is in a frequency band not supported by the mobile station then the mobile station shall perform an abnormal release with random access.
- If a mobile station receives a PACKET UPLINK ASSIGNMENT or PACKET TIMESLOT RECONFIGURE message and detects an invalid Frequency Parameters information element in the message, it shall perform an abnormal release. If PCCCH is present in the cell the mobile station shall perform an abnormal release with system information (see subclause 8.7.3). If PCCCH is not present, the mobile station shall perform an abnormal release with random access (see subclause 8.7.2).

References

GSM 04.60, subclause 8.1.1.1.2.1, 8.1.1.3.2.5

42.2.2.11.2.3 Test purpose

Verify that an MS in a fixed allocation uplink transfer performs an abnormal release with random access when an assignment message specifying an unsupported frequency is received.

42.2.2.11.2.4 Method of test

Initial Conditions

System Simulator:

2 cells, GPRS supported, PCCCH not present

Mobile Station:

The MS is in the state "idle, GMM-registered" with a P-TMSI allocated, SPLIT PG CYCLE negotiated, and PDP context 3 activated. The MS supports only a single band of frequencies.

Related PICS/PIXIT Statement(s)

Support GPRS service,

The way to initiate an uplink transfer,

Test Procedure

1. MS is triggered to begin an uplink data transfer (via CCCH) and enters a fixed allocation open-ended TBF.
2. Before the current allocation expires, MS sends PACKET RESOURCE REQUEST.
3. Prior to T3168 expiring, MS receives a new allocation containing Frequency Parameters IE with frequency not supported by the MS.
4. MS performs an abnormal release with random access.

Maximum Duration of Test

5 min.

Expected Sequence

Step	Direction	Message	Comments
1	MS		Trigger the MS to initiate an uplink packet transfer containing 1000 octets.
2			Bring the MS into packet uplink transfer mode on cell A by the generic procedure defined in the table 42.2.1.2/1b or 42.2.1.2/2b.
3	MS -> SS	RLC DATA BLOCK	Cell A: MS transmits RLC block only when TBF starting time occurs
4	MS -> SS	RLC DATA BLOCK	MS continues to transmit RLC data blocks according to allocation from step 2.
5	SS -> MS	PACKET UPLINK ASSIGNMENT	Cell A: With frequency not supported by the MS. Sent on PACCH.
6	SS		Verify MS does not send more than 2 RLC data blocks from previous allocation. Verify MS does not access cell B.
7	MS -> SS	CHANNEL REQUEST	Cell A: Random access

Specific Message Contents

PACKET UPLINK ASSIGNMENT message in step 2:

Fixed allocation - TIMESLOT ALLOCATION - BLOCKS_OR_BLOCK_PERIODS - ALLOCATION_BITMAP_LENGTH - ALLOCATION_BITMAP	One timeslot assigned 0 – blocks <any suitable value > Exactly the 40 first bits are set to 1.
---	---

PACKET UPLINK ASSIGNMENT message in step 5:

Frequency Parameters IE - ARFCN	<some frequency not supported by the MS>
------------------------------------	--

42.2.2.11.3 Fixed Allocation/ Uplink Transfer / Abnormal cases / Invalid MA_NUMBER

42.2.2.11.3.1 Definition and applicability

This test case applies to all MSs supporting GPRS.

42.2.2.11.3.2 Conformance Requirement

- If a mobile station receives a PACKET UPLINK ASSIGNMENT or PACKET TIMESLOT RECONFIGURE message and detects an invalid Frequency Parameters information element in the message, it shall perform an abnormal release. If PCCCH is present in the cell the mobile station shall perform an abnormal release with system information (see subclause 8.7.3). If PCCCH is not present, the mobile station shall perform an abnormal release with random access (see subclause 8.7.2).

The MA_NUMBER shall use the following coding:

MA_NUMBER = 0–13 shall be used to reference a GPRS mobile allocation received in a PSI2 message;

MA_NUMBER = 14 shall be used to reference a GPRS mobile allocation received in a SI13 or PSI13 message;

MA_NUMBER = 15 shall be used to reference a GPRS mobile allocation received in a previous assignment message using the direct encoding.

References

GSM 04.60, subclause 8.1.1.3.2.5, 5.5.1.7

42.2.2.11.3.3 Test purpose

Verify that an MS in a fixed allocation uplink transfer performs an abnormal release with random access when an assignment message specifying an invalid MA_NUMBER as part of the Frequency Parameters IE is received.

42.2.2.11.3.4 Method of test

Initial Conditions

System Simulator:

2 cells, GPRS supported, PCCCH not present, no PSI2 broadcast in the cell

Mobile Station:

The MS is in the state "idle, GMM-registered" with a P-TMSI allocated, and PDP context 3 activated.

Related PICS/PIXIT Statement(s)

Support GPRS service,

The way to initiate an uplink transfer,

Test Procedure

1. MS is triggered to begin an uplink data transfer and enters a fixed allocation open-ended TBF.
2. Before the current allocation expires, MS sends PACKET RESOURCE REQUEST.
3. Prior to T3168 expiring, MS receives a new allocation containing Frequency Parameters IE with MA_NUMBER not supported. (PSI2 is not present.)
4. MS performs an abnormal release with random access.

Maximum Duration of Test

5 min.

Expected Sequence

Step	Direction	Message	Comments
1	MS		Trigger the MS to initiate an uplink packet transfer containing 1000 octets.
2			Bring the MS into packet uplink transfer mode on cell A by the generic procedure defined in the table 42.2.1.2/1b or 42.2.1.2/2b.
3	MS -> SS	RLC DATA BLOCK	Cell A: MS transmits RLC block only when TBF starting time occurs
4	MS -> SS	RLC DATA BLOCK	MS continues to transmit RLC data blocks according to allocation from step 2.
5	SS -> MS	PACKET UPLINK ASSIGNMENT	Cell A: With unsupported MA_NUMBER.
6	SS		Verify MS does not transmit more than 2 RLC data blocks from previous allocation. Verify MS does not access cell B.
7	MS -> SS	CHANNEL REQUEST	Cell A: Random access

Specific Message Contents

PACKET UPLINK ASSIGNMENT message in step 2:

Fixed allocation - TIMESLOT ALLOCATION - BLOCKS_OR_BLOCK_PERIODS - ALLOCATION_BITMAP_LENGTH - ALLOCATION_BITMAP	One timeslot assigned 0 – blocks <any suitable value > Exactly the 40 first bits are set to 1.
---	---

PACKET UPLINK ASSIGNMENT message in step 5:

Frequency Parameters IE - ARFCN - MA_NUMBER	<some frequency supported by the MS> 0 - a GPRS mobile allocation received in a PSI2 message
---	---

42.2.3 Fixed Allocation / Uplink Transfer with Downlink TBF Establishment

42.2.3.1 Fixed Allocation / Uplink Transfer with Downlink TBF Establishment/T3190

42.2.3.1.1 Fixed Allocation / Uplink Transfer with Downlink TBF Establishment/ T3190/Half-Duplex

42.2.3.1.1.1 Definition and applicability

This test case applies to all MSs supporting GPRS multislots class 19 and 24.

42.2.3.1.1.2 Conformance Requirement

During an uplink fixed allocation TBF, the network may initiate a downlink TBF by sending the PACKET DOWNLINK ASSIGNMENT or PACKET TIMESLOT RECONFIGURE message on the PACCH.

The downlink radio resource is assigned to the mobile station in a PACKET DOWNLINK ASSIGNMENT or PACKET TIMESLOT RECONFIGURE message. The assigned timeslot configuration of the simultaneous uplink and downlink TBF must be compliant with the mobile station's multislots class, and must allow the performing of neighbour cell power measurements as described in 8.1.2.7.

On receipt of an assignment message the mobile station shall follow the procedure below.

If the mobile station is assigned to operate in half duplex mode, the network shall wait for the mobile station to finish its current uplink resource allocation, and for the TBF starting time to elapse, if present, before sending RLC data blocks on the downlink.

Whenever a mobile station operating on an uplink TBF in half duplex mode receives a complete assignment on the PACCH the mobile station shall complete the currently assigned fixed allocation. If the uplink TBF is not completed the mobile station shall, after expiry of the TBF starting time, if present, or if the TBF starting time has already expired, save the RLC state variables associated with the uplink TBF and suspend and save the state of the following timers :

T3182 - Wait for Acknowledgement

T3184 - No Ack/Nack Received

T3188 - Allocation Exhausted

Whenever a mobile station operating on an uplink TBF in half duplex mode receives a complete downlink assignment on the PACCH and has previously saved the state of the downlink TBF and has not since entered idle mode, the mobile station shall restore the saved downlink RLC state variables and timer values.

The mobile station shall then act upon the PACKET DOWNLINK ASSIGNMENT or PACKET TIMESLOT RECONFIGURE message.

When receiving the PACKET DOWNLINK ASSIGNMENT message and after waiting the TBF Starting Time when applicable, the mobile station starts timer T3190. The timer is reset when receiving the first valid RLC/MAC block.

References

GSM 04.60, subclause 8.1.1.3.5, 7.2.1.1

42.2.3.1.1.3 Test purpose

Verify that an MS operating an uplink TBF in half duplex mode can correctly respond to a PACKET DOWNLINK ASSIGNMENT by completing the current fixed allocation and then act upon the PACKET DOWNLINK ASSIGNMENT. Verify that the MS receives downlink RLC data blocks when the first one is received within T3190.

42.2.3.1.1.4 Method of test

Initial Conditions

System Simulator:

2 cells, GPRS supported, PCCCH not present

Mobile Station:

The MS is in the state "idle, GMM-registered" with a P-TMSI allocated, SPLIT PG CYCLE negotiated, and PDP context 3 activated.

Related PICS/PIXIT Statement(s)

Support GPRS service,

The way to initiate an uplink transfer,

Test Procedure

1. MS is triggered to begin an uplink data transfer and enters a fixed allocation open-ended TBF in half duplex mode. This is a TBF with 2 timeslots uplink with the assignment forcing the MS into half duplex mode. In this mode, the MS is not required to read the downlink PACCH, except when there are gaps in the uplink allocation.
2. Before the current allocation expires, the MS receives a PACKET DOWNLINK ASSIGNMENT on the PACCH, during a gap in the uplink allocation.
3. After the current allocation expires, the MS acts on the PACKET DOWNLINK ASSIGNMENT and receives the first RLC data block within T3190. During the downlink TBF, the MS does not continue the uplink TBF or request new resources.

Maximum Duration of Test

5 min.

Expected Sequence

Step	Direction	Message	Comments
1	MS		Trigger the MS to initiate an uplink packet transfer containing 1000 octets.
2			Bring the MS into packet uplink transfer mode on cell A by the generic procedure defined in the table 42.2.1.2/1b or 42.2.1.2/2b.
3	MS -> SS	RLC DATA BLOCK	MS transmits RLC block only when TBF starting time occurs
4	MS -> SS	RLC DATA BLOCKS	MS continues to transmit RLC data blocks according to allocation from step 2.
5	SS -> MS	PACKET DOWNLINK ASSIGNMENT	With starting time after current uplink allocation expires.
6	MS -> SS	RLC DATA BLOCKS	Verify MS continues to transmit RLC data blocks from previous allocation until the allocation is exhausted.
7	MS		Waits until starting time in step 5 arrives. - MS starts T3190
8	SS -> MS	RLC DATA BLOCK	Sent (.8*T3190) seconds after step 7.
9	SS -> MS	RLC DATA BLOCKS	SS transmits RLC data blocks
10	SS		Verify MS does not request new uplink resources, or continue the uplink TBF during the downlink.
11	SS -> MS	RLC DATA BLOCK	SS transmits RLC data block with valid RRBp field (polling).
12	MS -> SS	PACKET DOWNLINK ACK/NACK	MS acknowledges the previously received RLC data blocks. Sent in block specified by RRBp field.

Specific Message Contents

PACKET UPLINK ASSIGNMENT message in step 2:

Fixed allocation - HALF_DUPLEX_MODE - TIMESLOT ALLOCATION - BLOCKS_OR_BLOCK_PERIODS - ALLOCATION_BITMAP_LENGTH - ALLOCATION_BITMAP	1 – half duplex TBF Two timeslots assigned 0 – blocks <any suitable value > Allocates 100 RLC blocks, with periodic gaps to receive PACCH.
---	--

PACKET DOWNLINK ASSIGNMENT message in step 5:

- TIMESLOT ALLOCATION Frequency Parameters IE - TBF_STARTING_TIME	Six timeslots assigned <some AFN after the current fixed allocation bitmap expires>
---	--

42.2.3.1.2 Fixed Allocation / Uplink Transfer with Downlink TBF Establishment/ T3190/Non Half-Duplex

42.2.3.1.2.1 Definition and applicability

This test case applies to all MSs supporting GPRS multislots class 10 and higher.

42.2.3.1.2.2 Conformance Requirement

During an uplink fixed allocation TBF, the network may initiate a downlink TBF by sending the PACKET DOWNLINK ASSIGNMENT or PACKET TIMESLOT RECONFIGURE message on the PACCH.

The downlink radio resource is assigned to the mobile station in a PACKET DOWNLINK ASSIGNMENT or PACKET TIMESLOT RECONFIGURE message. The assigned timeslot configuration of the simultaneous uplink and downlink TBF must be compliant with the mobile station's multislot class, and must allow the performing of neighbour cell power measurements as described in 8.1.2.7.

On receipt of an assignment message the mobile station shall follow the procedure below.

If the mobile station is not assigned to operate half duplex mode, the mobile station shall, after expiry of the TBF starting time, if present, act upon the complete downlink assignment, and start timer T3190.

The mobile station shall then act upon the PACKET DOWNLINK ASSIGNMENT or PACKET TIMESLOT RECONFIGURE message.

When receiving the PACKET DOWNLINK ASSIGNMENT message and after waiting the TBF Starting Time when applicable, the mobile station starts timer T3190. The timer is reset when receiving the first valid RLC/MAC block.

References

GSM 04.60, subclause 8.1.1.3.5, 7.2.1.1

42.2.3.1.2.3 Test purpose

Verify that an MS operating an uplink TBF in non half duplex mode can correctly respond to a PACKET DOWNLINK ASSIGNMENT by acting upon the PACKET DOWNLINK ASSIGNMENT during the uplink TBF. Verify that the MS receives downlink RLC data blocks when the first one is received within T3190.

42.2.3.1.2.4 Method of test

Initial Conditions

System Simulator:

2 cells, GPRS supported, PCCCH not present

Mobile Station:

The MS is in the state "idle, GMM-registered" with a P-TMSI allocated, SPLIT PG CYCLE negotiated, and PDP context 3 activated.

Related PICS/PIXIT Statement(s)

Support GPRS service,

The way to initiate an uplink transfer,

Test Procedure

1. MS is triggered to begin an uplink data transfer and enters a fixed allocation open-ended TBF in non half duplex mode. This is a TBF with 2 timeslots uplink with the assignment forcing the MS into non half duplex mode. In this mode, the MS reads the downlink PACCH on the natural timeslot.
2. Before the current allocation expires, the MS receives a PACKET DOWNLINK ASSIGNMENT on the PACCH, with starting time before the current allocation expires.
3. Before the current allocation expires, the MS acts on the PACKET DOWNLINK ASSIGNMENT and receives the first RLC data block within T3190. During the downlink TBF, the MS continues the uplink TBF.

Maximum Duration of Test

5 min.

Expected Sequence

Step	Direction	Message	Comments
1	MS		Trigger the MS to initiate an uplink packet transfer containing 1000 octets.
2			Bring the MS into packet uplink transfer mode on cell A by the generic procedure defined in the table 42.2.1.2/1b or 42.2.1.2/2b.
3	MS -> SS	RLC DATA BLOCK	MS transmits RLC block only when TBF starting time occurs
4	MS -> SS	RLC DATA BLOCKS	MS continues to transmit RLC data blocks according to allocation from step 2.
5	SS -> MS	PACKET DOWNLINK ASSIGNMENT	With starting time before current uplink allocation expires. Sent on assigned PACCH.
6	MS -> SS	RLC DATA BLOCKS	Verify MS continues to transmit RLC data blocks from previous allocation until the starting time in step 5 arrives.
7	MS		.- MS starts T3190
8	MS -> SS	RLC DATA BLOCKS	Verify MS continues to transmit RLC data blocks from previous allocation.
9	SS -> MS	RLC DATA BLOCK	Sent 4.5sec after step 7.
10	SS -> MS	RLC DATA BLOCKS	SS transmits RLC data blocks
11	SS -> MS	RLC DATA BLOCK	SS transmits RLC data block with valid RRBp field (polling).
12	MS -> SS	PACKET DOWNLINK ACK/NACK	MS acknowledges the previously received RLC data blocks. Sent in block specified by RRBp field.
13	SS		Verify MS continues the uplink TBF from the previous allocation, during the downlink TBF.

Specific Message Contents

PACKET UPLINK ASSIGNMENT message in step 2:

Fixed allocation	
- HALF_DUPLEX_MODE	0 – non half duplex TBF
- TIMESLOT_ALLOCATION	Two timeslots assigned - PDCH2 and PDCH3
- BLOCKS_OR_BLOCK_PERIODS	0 – blocks
- ALLOCATION_BITMAP_LENGTH	<any suitable value >
- ALLOCATION_BITMAP	Allocates 100 RLC blocks

PACKET DOWNLINK ASSIGNMENT message in step 5:

TIMESLOT_ALLOCATION	3 timeslots assigned – PDCH1, PDCH2 and PDCH3 (multislot class is not violated)
Frequency Parameters IE	
- TBF_STARTING_TIME	<some AFN before the current fixed allocation bitmap expires>

42.2.3.2 Fixed Allocation / Uplink Transfer with Downlink TBF Establishment/ Ending uplink TBF

42.2.3.2.1 Fixed Allocation / Uplink Transfer with Downlink TBF Establishment/ Ending uplink TBF/ Half-Duplex

42.2.3.2.1.1 Definition and applicability

This test case applies to all MSs supporting GPRS multislot class 19 and 24.

42.2.3.2.1.2 Conformance Requirement

The network may initiate release of an uplink TBF by transmitting a PACKET TBF RELEASE message to the mobile station on the PACCH. A cause value indicates the reason for release.

If the cause value is "Normal release" the mobile station shall continue to the next LLC PDU boundary, starting the count down procedure (see subclause 9.3.1) at whatever value of CV is appropriate to count down to zero at the LLC PDU boundary, and then release the TBF according to the procedures in subclause 9.3.2.3 or 9.3.3.3.

If the PACKET UPLINK ACK/NACK message has the Final Ack Indicator bit set to '1', the mobile station shall transmit the PACKET CONTROL ACKNOWLEDGEMENT message and release the TBF. If the mobile station is operating in half duplex mode and received a downlink assignment during the countdown or while timer T3182 was running, it shall then act on the downlink assignment.

References

GSM 04.60, subclause 8.1.1.4, 9.3.2.3

42.2.3.2.1.3 Test purpose

Verify that an MS operating an uplink TBF in half duplex mode can correctly respond to a PACKET TBF RELEASE message to end the uplink TBF before starting the downlink TBF.

42.2.3.2.1.4 Method of test

Initial Conditions

System Simulator:

2 cells, GPRS supported, PCCCH not present

Mobile Station:

The MS is in the state "idle, GMM-registered" with a P-TMSI allocated, SPLIT PG CYCLE negotiated, and PDP context 3 activated.

Related PICS/PIXIT Statement(s)

Support GPRS service,

The way to initiate an uplink transfer,

Test Procedure

1. MS is triggered to begin an uplink data transfer and enters a fixed allocation open-ended TBF in half duplex mode.
2. Before the current allocation expires, the MS receives a PACKET TBF RELEASE.
3. During the countdown procedure, the MS receives a PACKET DOWNLINK ASSIGNMENT.
4. After the uplink TBF is ended, the MS acts on the PACKET DOWNLINK ASSIGNMENT and begins the downlink TBF.

Maximum Duration of Test

5 min.

Expected Sequence

Step	Direction	Message	Comments
1	MS		Trigger the MS to initiate an uplink packet transfer containing 1000 octets.
2			Bring the MS into packet uplink transfer mode on cell A by the generic procedure defined in the table 42.2.1.2/1b or 42.2.1.2/2b.
3	MS -> SS	RLC DATA BLOCK	MS transmits RLC block only when TBF starting time occurs
4	MS -> SS	RLC DATA BLOCKS	MS continues to transmit RLC data blocks according to allocation from step 2.
5	SS -> MS	PACKET DOWNLINK ASSIGNMENT	With starting time after current uplink allocation expires.
6	MS -> SS	RLC DATA BLOCKS	Verify MS continues to transmit RLC data blocks from previous allocation.
7	SS -> MS	PACKET TBF RELEASE	Release of the uplink TBF. Sent when 200 octets left to send in the PDU. Cause value – normal release
8	MS -> SS	RLC DATA BLOCKS	MS starts countdown procedure so that uplink TBF ends at the LLC PDU boundary. Any extra remaining bytes are filled with 2B.
9	SS		Verify MS does not request new uplink resources, or continue the uplink TBF during the downlink.
10	SS -> MS	RLC DATA BLOCKS	SS transmits RLC data blocks after the starting time
11	SS -> MS	RLC DATA BLOCK	SS transmits RLC data block with valid RRBp field (polling).
12	MS -> SS	PACKET DOWNLINK ACK/NACK	MS acknowledges the previously received RLC data blocks. Sent in block specified by RRBp field.
13	SS		SS ends the downlink TBF

Specific Message Contents

PACKET UPLINK ASSIGNMENT message in step 2:

Fixed allocation - HALF_DUPLEX_MODE - TIMESLOT_ALLOCATION - BLOCKS_OR_BLOCK_PERIODS - ALLOCATION_BITMAP_LENGTH - ALLOCATION_BITMAP	1 – half duplex TBF Two timeslots assigned 0 – blocks <any suitable value > Allocates 100 RLC blocks, with periodic gaps to receive PACCH.
---	--

PACKET DOWNLINK ASSIGNMENT message in step 5:

TIMESLOT_ALLOCATION Frequency Parameters IE - TBF_STARTING_TIME	6 timeslots assigned <some AFN after the current fixed allocation bitmap expires>
---	--

PACKET TBF RELEASE message in step 7:

Cause Value UPLINK_RELEASE	0000 – Normal release 1 – Uplink TBF is released
-------------------------------	---

42.2.3.2.2 Fixed Allocation / Uplink Transfer with Downlink TBF Establishment/ Ending uplink TBF/ Non Half-Duplex

42.2.3.2.2.1 Definition and applicability

This test case applies to all MSs supporting GPRS multislot class 10 and above.

42.2.3.2.2.2 Conformance Requirement

During an uplink fixed allocation TBF, the network may initiate a downlink TBF by sending the PACKET DOWNLINK ASSIGNMENT or PACKET TIMESLOT RECONFIGURE message on the PACCH.

The downlink radio resource is assigned to the mobile station in a PACKET DOWNLINK ASSIGNMENT or PACKET TIMESLOT RECONFIGURE message. The assigned timeslot configuration of the simultaneous uplink and downlink TBF must be compliant with the mobile station's multislot class, and must allow the performing of neighbour cell power measurements as described in 8.1.2.7.

On receipt of an assignment message the mobile station shall follow the procedure below.

If the mobile station is not assigned to operate half duplex mode, the mobile station shall, after expiry of the TBF starting time, if present, act upon the complete downlink assignment, and start timer T3190.

The mobile station shall then act upon the PACKET DOWNLINK ASSIGNMENT or PACKET TIMESLOT RECONFIGURE message.

When receiving the PACKET DOWNLINK ASSIGNMENT message and after waiting the TBF Starting Time when applicable, the mobile station starts timer T3190. The timer is reset when receiving the first valid RLC/MAC block.

References

GSM 04.60, subclause 8.1.1.3.5, 7.2.1.1

42.2.3.2.3.3 Test purpose

Verify that an MS operating an uplink and downlink TBF in non half duplex mode can correctly respond to a PACKET TBF RELEASE by using the countdown procedure.

42.2.3.2.3.4 Method of test

Initial Conditions

System Simulator:

2 cells, GPRS supported, PCCCH not present

Mobile Station:

The MS is in the state "idle, GMM-registered" with a P-TMSI allocated, SPLIT PG CYCLE negotiated, and PDP context 3 activated.

Related PICS/PIXIT Statement(s)

Support GPRS service,

The way to initiate an uplink transfer,

Test Procedure

1. MS is triggered to begin an uplink data transfer and enters a fixed allocation open-ended TBF in non half duplex mode.
2. Before the current allocation expires, the MS receives a PACKET DOWNLINK ASSIGNMENT on the PACCH, with starting time before the current allocation expires.

3. Before the starting time occurs, the MS receives a PACKET TBF RELEASE.
4. The MS starts the downlink TBF during the countdown procedure, and ends the uplink TBF when the countdown procedure is over.

Maximum Duration of Test

5 min.

Expected Sequence

Step	Direction	Message	Comments
1	MS		Trigger the MS to initiate an uplink packet transfer containing 1000 octets.
2			Bring the MS into packet uplink transfer mode on cell A by the generic procedure defined in the table 42.2.1.2/1b or 42.2.1.2/2b.
3	MS -> SS	RLC DATA BLOCK	MS transmits RLC block only when TBF starting time occurs
4	MS -> SS	RLC DATA BLOCKS	MS continues to transmit RLC data blocks according to allocation from step 2.
5	SS -> MS	PACKET DOWNLINK ASSIGNMENT	With starting time before current uplink allocation expires. Sent on assigned PACCH.
6	MS -> SS	RLC DATA BLOCKS	Verify MS continues to transmit RLC data blocks from previous allocation.
7	SS -> MS	PACKET TBF RELEASE	Release of the uplink TBF. Sent when 200 octets left to send in the PDU. Cause value – normal release
8	MS -> SS	RLC DATA BLOCKS	MS starts countdown procedure so that uplink TBF ends at the LLC PDU boundary.
9	SS -> MS	RLC DATA BLOCKS	SS transmits RLC data blocks at the starting time
10	SS -> MS	PACKET UPLINK ACK/NACK	Final Ack = 1
11	MS -> SS	PACKET CONTROL ACKNOWLEDGEMENT	
12	MS -> SS	PACKET DOWNLINK ACK/NACK	Verify MS sends at least one Ack/Nack to verify it is receiving downlink RLC data blocks.

Specific Message Contents

PACKET UPLINK ASSIGNMENT message in step 2:

Fixed allocation - HALF_DUPLEX_MODE - TIMESLOT_ALLOCATION - BLOCKS_OR_BLOCK_PERIODS - ALLOCATION_BITMAP_LENGTH - ALLOCATION_BITMAP	0 – non half duplex TBF Two timeslots assigned – PDCH2 and PDCH3 0 – blocks <any suitable value > Allocates 100 RLC blocks
---	--

PACKET DOWNLINK ASSIGNMENT message in step 5:

TIMESLOT_ALLOCATION Frequency Parameters IE - TBF_STARTING_TIME	3 timeslots assigned – PDCH1, PDCH2 and PDCH3 (multislot class is not violated) <some AFN before the current fixed allocation bitmap expires>
---	--

42.2.3.3 Fixed Allocation/ Uplink Transfer with Downlink TBF Establishment/ Abnormal cases

42.2.3.3.1 Fixed Allocation/ Uplink Transfer with Downlink TBF Establishment/ Abnormal cases / Violation of multi-slot capabilities

42.2.3.3.1.1 Definition and applicability

This test case applies to all MSs supporting GPRS.

42.2.3.3.1.2 Conformance Requirement

During an uplink fixed allocation TBF, the network may initiate a downlink TBF by sending the PACKET DOWNLINK ASSIGNMENT or PACKET TIMESLOT RECONFIGURE message on the PACCH.

- If the information in the PACKET TIMESLOT RECONFIGURE does not properly specify an uplink and downlink PDCH or violates the mobile station's multislot capabilities, the mobile station shall perform an abnormal release with random access (see subclause 8.7.2).

Abnormal Release with Random Access: The mobile station shall abort all TBFs in progress and its associated resources, return to the CCCH or PCCCH and initiate establishment of a new uplink TBF as defined in subclause 7.1.

References

GSM 04.60, subclause 8.1.1.3.5, 8.1.1.3.5.1, 8.7.2

42.2.3.3.1.3 Test purpose

Verify that an MS in an uplink TBF performs abnormal release with random access upon receipt of a PACKET TIMESLOT RECONFIGURE message that violates its multislot capabilities.

42.2.3.3.1.4 Method of test

Initial Conditions

System Simulator:

2 cells, GPRS supported, PCCCH not present

Mobile Station:

The MS is in the state "idle, GMM-registered" with a P-TMSI allocated, SPLIT PG CYCLE negotiated, and PDP context 3 activated.

Related PICS/PIXIT Statement(s)

Support GPRS service,

The way to initiate an uplink transfer,

Test Procedure

1. MS is triggered to begin an uplink data transfer and enters a fixed allocation open-ended TBF in non half duplex mode on one PDCH.
2. Before the current allocation expires, the MS receives a PACKET TIMESLOT RECONFIGURE message on the PACCH, with downlink assignment violating its multislot class capabilities.
3. MS performs abnormal release (stops the uplink TBF in progress) with random access.

Maximum Duration of Test

5 min.

Expected Sequence

Step	Direction	Message	Comments
1	MS		Trigger the MS to initiate an uplink packet transfer containing 1000 octets.
2			Bring the MS into packet uplink transfer mode on cell A by the generic procedure defined in the table 42.2.1.2/1b or 42.2.1.2/2b.
3	MS -> SS	RLC DATA BLOCK	MS transmits RLC block only when TBF starting time occurs
4	MS -> SS	RLC DATA BLOCKS	MS continues to transmit RLC data blocks according to allocation from step 2.
5	SS -> MS	PACKET TIMESLOT RECONFIGURE	With downlink assignment violating the multislot class capabilities of the MS.
6	SS		Verify MS does not transmit on previously assigned PDCH.
7	MS -> SS	PACKET CHANNEL REQUEST	Sent on cell A.

Specific Message Contents

Based on the multislot class of the MS, assign uplink and downlink timeslots as follows in order to violate the multislot class of the MS by violating the Ttb parameter.

Multislot Class	RX slots assigned	TX slots assigned
1	1	0
2	2,3	2
3	0,1	0
4	1,2,3	1
5	1,2	0,1
6	1,2,3	1
7	1,2,3	1
8	2,3,4,5	3
9	1,2,3	1,2
10	1,2,3,4	2
11	1,2,3,4	2
12	1,2,3,4	2

PACKET UPLINK ASSIGNMENT message in step 2:

Fixed allocation - HALF_DUPLEX_MODE - TIMESLOT_ALLOCATION - BLOCKS_OR_BLOCK_PERIODS - ALLOCATION_BITMAP_LENGTH - ALLOCATION_BITMAP	0 – non half duplex TBF <see above chart> 0 – blocks <any suitable value > Allocates 100 RLC blocks
---	---

PACKET TIMESLOT RECONFIGURE message in step 5:

DOWNLINK_TIMESLOT_ALLOCATION Frequency Parameters IE - TBF_STARTING_TIME	<see above chart> <some AFN before the current fixed allocation bitmap expires>
--	--

42.2.3.3.2 Fixed Allocation/ Uplink Transfer with Downlink TBF Establishment/ Abnormal cases / No defined PDCH

42.2.3.3.2.1 Definition and applicability

This test case applies to all MSs supporting GPRS multislot class 2.

42.2.3.3.2.2 Conformance Requirement

During an uplink fixed allocation TBF, the network may initiate a downlink TBF by sending the PACKET DOWNLINK ASSIGNMENT or PACKET TIMESLOT RECONFIGURE message on the PACCH.

- If the information available in the mobile station, after the reception of a PACKET DOWNLINK ASSIGNMENT message does not satisfactorily define a PDCH, the mobile station shall ignore the PACKET DOWNLINK ASSIGNMENT message.

References

GSM 04.60, subclause 8.1.1.3.5, 8.1.1.3.5.1

42.2.3.3.2.3 Test purpose

Verify that an MS in an uplink TBF ignores a PACKET DOWNLINK ASSIGNMENT message that does not define a PDCH.

42.2.3.3.2.4 Method of test

Initial Conditions

System Simulator:

2 cells, GPRS supported, PCCCH not present

Mobile Station:

The MS is in the state "idle, GMM-registered" with a P-TMSI allocated, SPLIT PG CYCLE negotiated, and PDP context 3 activated.

Related PICS/PIXIT Statement(s)

Support GPRS service,

The way to initiate an uplink transfer,

Test Procedure

1. MS is triggered to begin an uplink data transfer and enters a fixed allocation open-ended TBF in non half duplex mode on one PDCH.
2. Before the current allocation expires, the MS receives a PACKET DOWNLINK ASSIGNMENT message on the PACCH, with no defined PDCH.
3. MS continues uplink TBF and does not begin a downlink TBF.

Maximum Duration of Test

5 min.

Expected Sequence

Step	Direction	Message	Comments
1	MS		Trigger the MS to initiate an uplink packet transfer containing 1000 octets.
2			Bring the MS into packet uplink transfer mode on cell A by the generic procedure defined in the table 42.2.1.2/1b or 42.2.1.2/2b.
3	MS -> SS	RLC DATA BLOCK	MS transmits RLC block only when TBF starting time occurs
4	MS -> SS	RLC DATA BLOCKS	MS continues to transmit RLC data blocks according to allocation from step 2.
5	SS -> MS	PACKET DOWNLINK ASSIGNMENT	With insufficiently defined PDCH in the message.
6	MS -> SS	RLC DATA BLOCKS	MS continues to transmit RLC data blocks according to allocation from step 2.

Specific Message Contents

PACKET UPLINK ASSIGNMENT message in step 2:

Fixed allocation	
- HALF_DUPLEX_MODE	0 – non half duplex TBF
- TIMESLOT_ALLOCATION	One timeslot assigned
- BLOCKS_OR_BLOCK_PERIODS	0 – blocks
- ALLOCATION_BITMAP_LENGTH	<any suitable value >
- ALLOCATION_BITMAP	Allocates 100 RLC blocks

PACKET DOWNLINK ASSIGNMENT message in step 5:

DOWNLINK_TIMESLOT_ALLOCATION	<one timeslot, such that multislot class is not violated>
Frequency Parameters IE	
- ARFCN	300 (invalid ARFCN)

42.2.4 Fixed Allocation / Downlink Transfer with Uplink TBF Establishment

42.2.4.1 Fixed Allocation/ Downlink Transfer with Uplink TBF Establishment/ T3168

42.2.4.1.1 Fixed Allocation/ Downlink Transfer with Uplink TBF Establishment/ T3168/ Expiry

42.2.4.1.1.1 Definition and applicability

This test case applies to all MSs supporting GPRS.

42.2.4.1.1.2 Conformance Requirement

The mobile station may request establishment of an uplink transfer during a downlink TBF by including a Channel Request Description information element in the PACKET DOWNLINK ACK/NACK message. Initiation is triggered by a request from upper layers to transfer a LLC PDU. The request from upper layers specifies a Radio Priority to be associated with the packet transfer. Upon such a request,

- if access to the network is allowed, according to the latest values for authorized special access classes that the mobile station has received (see subclause 7.1.1), the mobile station shall initiate the packet access procedure.
- otherwise, the RR sublayer in the mobile station shall reject the request.

The mobile station initiates the packet access procedure by sending the Channel Request Description information element in the PACKET DOWNLINK ACK/NACK message on the PACCH and starting timer T3168.

- If timer T3168 expires, the mobile station shall retransmit the Channel Request Description information element in the next PACKET DOWNLINK ACK/NACK message unless it has been transmitted four times in which case the mobile station shall perform an abnormal release with random access. If the downlink TBF is released, including expiry of timer T3192, before expiry of timer T3168 the mobile station shall stop timer T3168 and perform an abnormal release with random access.
- Abnormal Release with Random Access: The mobile station shall abort all TBFs in progress and its associated resources, return to the CCCH or PCCCH and initiate establishment of a new uplink TBF as defined in subclause 7.1.

References

GSM 04.60, subclause 8.1.2.5, 8.7.2

42.2.4.1.1.3 Test purpose

Verify that during a downlink TBF, when the MS requests uplink resources, that the MS makes the request 4 times. Verify that if uplink resources are not assigned within T3168, the MS performs abnormal release with random access.

42.2.4.1.1.4 Method of test

Initial Conditions

System Simulator:

1 cell, GPRS supported, PCCCH present

Mobile Station:

The MS is in the state "idle, GMM-registered" with a P-TMSI allocated, SPLIT PG CYCLE negotiated, and PDP context 3 activated.

Related PICS/PIXIT Statement(s)

Support GPRS service

Test Procedure

1. MS receives a PACKET DOWNLINK ASSIGNMENT message on its assigned PCCCH, containing no starting time.
2. SS transmits downlink RLC data blocks for the downlink allocation, 1 in 10 specifying RRB field (polling).
3. MS responds by sending PACKET DOWNLINK ACK/NACK messages in response to the polls.
4. MS is triggered to begin an uplink transfer.
5. MS sends next PACKET DOWNLINK ACK/NACK message with a Channel Request Description field, and starts timer T3168.
6. When T3168 expires, MS repeats the Channel Request Description request. (This step is done 3 times, for a total of 4 Channel Request Descriptions.)
7. MS sends PACKET CHANNEL REQUEST again after returning to packet idle mode.

Maximum Duration of Test

5 min.

Expected Sequence

Step	Direction	Message	Comments
1	SS -> MS	PACKET DOWNLINK ASSIGNMENT	Triggers the MS to switch to assigned PDCH. (no starting time)
2	SS -> MS	RLC DATA BLOCKS	Starting 3 blocks after the previous message, on assigned PDCH, addressed to MS, 1/10 with valid RRBP field (polling).
3	MS -> SS	PACKET DOWNLINK ACK/NACK	MS acknowledges the previously received RLC data blocks.
4			Steps 2 and 3 are repeated throughout
5	MS		MS is triggered to begin an uplink data transfer.
6	MS -> SS	PACKET DOWNLINK ACK/NACK	Message contains Channel Request Description IE. - MS starts timer T3168
7			Steps 2 and 3 are repeated until the next Channel Request Description is sent in step 8.
8	MS -> SS	PACKET DOWNLINK ACK/NACK	MS requests additional resources (message contains Channel Request Description IE) - Sent more than T3168 seconds after previous request for additional resources - MS re-starts timer T3168
9			Steps 7 and 8 are repeated 2 more times such that a total of 4 Channel Request Descriptions are sent.
10	MS -> SS	PACKET CHANNEL REQUEST	Sent after T3168 seconds after step 8 is executed the last time.

PACKET SYSTEM INFORMATION MESSAGE 1 (throughout):

T3168	1 (1 second)
-------	--------------

42.2.4.1.2 Fixed Allocation/ Downlink Transfer with Uplink TBF Establishment/ T3168/ Stop with Packet Uplink Assignment

42.2.4.1.2.1 Definition and applicability

This test case applies to all MSs supporting GPRS.

42.2.4.1.2.2 Conformance Requirement

The mobile station may request establishment of an uplink transfer during a downlink TBF by including a Channel Request Description information element in the PACKET DOWNLINK ACK/NACK message. Initiation is triggered by a request from upper layers to transfer a LLC PDU. The request from upper layers specifies a Radio Priority to be associated with the packet transfer. Upon such a request,

- if access to the network is allowed, according to the latest values for authorized special access classes that the mobile station has received (see subclause 7.1.1), the mobile station shall initiate the packet access procedure.
- otherwise, the RR sublayer in the mobile station shall reject the request.

The mobile station initiates the packet access procedure by sending the Channel Request Description information element in the PACKET DOWNLINK ACK/NACK message on the PACCH and starting timer T3168.

On receipt of a PACKET UPLINK ASSIGNMENT or PACKET TIMESLOT RECONFIGURE message the mobile station shall follow the procedure below. On reception of a complete uplink assignment the mobile station shall stop timer T3168.

References

GSM 04.60, subclause 8.1.2.5

42.2.4.1.2.3 Test purpose

Verify that during a downlink TBF, when the MS requests additional resources, that the MS stops timer T3168 when a PACKET UPLINK ASSIGNMENT is received.

42.2.4.1.2.4 Method of test

Initial Conditions

System Simulator:

1 cell, GPRS supported, PCCCH present

Mobile Station:

The MS is in the state "idle, GMM-registered" with a P-TMSI allocated, SPLIT PG CYCLE negotiated, and PDP context 3 activated.

Related PICS/PIXIT Statement(s)

Support GPRS service

Test Procedure

1. MS receives a PACKET DOWNLINK ASSIGNMENT message on its assigned PCCCH, containing no starting time.
2. SS transmits downlink RLC data blocks for the downlink allocation, 1 in 10 specifying RRBP field (polling).
3. MS responds by sending PACKET DOWNLINK ACK/NACK messages in response to the polls.
4. MS is triggered to begin an uplink transfer.
5. MS sends next PACKET DOWNLINK ACK/NACK message with a Channel Request Description field, and starts timer T3168.
6. When T3168 expires, MS repeats the Channel Request Description request.
7. MS receives a PACKET UPLINK ASSIGNMENT message with a starting time such that more Channel Requests could be sent before the starting time.
8. MS does not repeat the Channel Request Description request.

Maximum Duration of Test

5 min.

Expected Sequence

Step	Direction	Message	Comments
1	SS -> MS	PACKET DOWNLINK ASSIGNMENT	Triggers the MS to switch to assigned PDCH. (no starting time)
2	SS -> MS	RLC DATA BLOCKS	Starting 3 blocks after the previous message, on assigned PDCH, addressed to MS, 1/10 with valid RRBP field (polling).
3	MS -> SS	PACKET DOWNLINK ACK/NACK	MS acknowledges the previously received RLC data blocks.
4			Steps 2 and 3 are repeated throughout
5	MS		MS is triggered to begin an uplink data transfer.
6	MS -> SS	PACKET DOWNLINK ACK/NACK	Message contains Channel Request Description IE. - MS starts timer T3168
7			Steps 2 and 3 are repeated until the next Channel Request Description is sent in step 8.
8	MS -> SS	PACKET DOWNLINK ACK/NACK	MS requests additional resources (message contains Channel Request Description IE) - Sent after T3168seconds after previous request for additional resources - MS re-starts timer T3168
9	SS -> MS	PACKET UPLINK ASSIGNMENT	Sent (.5*T3168) seconds after step 8. Allocates one uplink timeslot (same timeslot as the downlink assignment) With valid RRBP field (polling).
10	MS -> SS	PACKET CONTROL ACK	With starting time T3168*2 seconds from now. Verify MS does not send additional Channel Request Description IE.

PACKET SYSTEM INFORMATION MESSAGE 1 (throughout):

T3168	1 (1 second)
-------	--------------

42.2.4.2 Fixed Allocation/ Downlink Transfer with Uplink TBF Establishment/ Packet Uplink Assignment

42.2.4.2.1 Fixed Allocation/ Downlink Transfer with Uplink TBF Establishment/ Packet Uplink Assignment/ Non half-duplex

42.2.4.2.1.1 Definition and applicability

This test case applies to all MSs supporting GPRS.

42.2.4.2.1.2 Conformance Requirement

The mobile station may request establishment of an uplink transfer during a downlink TBF by including a Channel Request Description information element in the PACKET DOWNLINK ACK/NACK message. Initiation is triggered by a request from upper layers to transfer a LLC PDU. The request from upper layers specifies a Radio Priority to be associated with the packet transfer. Upon such a request,

- if access to the network is allowed, according to the latest values for authorized special access classes that the mobile station has received (see subclause 7.1.1), the mobile station shall initiate the packet access procedure.
- otherwise, the RR sublayer in the mobile station shall reject the request.

The mobile station initiates the packet access procedure by sending the Channel Request Description information element in the PACKET DOWNLINK ACK/NACK message on the PACCH and starting timer T3168.

On receipt of a PACKET UPLINK ASSIGNMENT or PACKET TIMESLOT RECONFIGURE message the mobile station shall follow the procedure below. On reception of a complete uplink assignment the mobile station shall stop timer T3168.

If the mobile station is not assigned to operate half duplex mode, the mobile station shall, after expiry of the TBF starting time, if present, act upon the complete uplink assignment.

The mobile station shall then switch to the assigned uplink PDCHs and begin to send RLC data blocks on the assigned PDCH(s). The TLLI shall not be included in any of the uplink RLC data blocks in that case.

References

GSM 04.60, subclause 8.1.2.5

42.2.4.2.1.3 Test purpose

Verify that during a downlink TBF, when the MS requests uplink resources, that the MS obeys the uplink assignment while maintaining the downlink TBF.

42.2.4.2.1.4 Method of test

Initial Conditions

System Simulator:

2 cells, GPRS supported, PCCCH present

Mobile Station:

The MS is in the state "idle, GMM-registered" with a P-TMSI allocated, SPLIT PG CYCLE negotiated, and PDP context 3 activated.

Related PICS/PIXIT Statement(s)

Support GPRS service

Test Procedure

1. MS receives a PACKET DOWNLINK ASSIGNMENT message on its assigned PCCCH, containing no starting time.
2. SS transmits downlink RLC data blocks for the downlink allocation, 1 in 10 specifying RRBP field (polling).
3. MS responds by sending PACKET DOWNLINK ACK/NACK messages in response to the polls.
4. MS is triggered to begin an uplink transfer.
5. MS sends next PACKET DOWNLINK ACK/NACK message with a Channel Request Description field.
6. MS receives a PACKET UPLINK ASSIGNMENT message.
7. MS acts on the PACKET UPLINK ASSIGNMENT, and enters a concurrent TBF.

Maximum Duration of Test

5 min.

Expected Sequence

Step	Direction	Message	Comments
1	SS -> MS	PACKET DOWNLINK ASSIGNMENT	Triggers the MS to switch to assigned PDCH. (no starting time)
2	SS -> MS	RLC DATA BLOCKS	Starting 3 blocks after the previous message, on assigned PDCH, addressed to MS, 1 in 10 with valid RRBP field (polling).
3	MS -> SS	PACKET DOWNLINK ACK/NACK	MS acknowledges the previously received RLC data blocks.
4			Steps 2 and 3 are repeated throughout until step 8.
5	MS		MS is triggered to begin an uplink data transfer.
6	MS -> SS	PACKET DOWNLINK ACK/NACK	Message contains Channel Request Description IE. - MS starts timer T3168
7			Steps 2 and 3 are repeated until the next Channel Request Description is sent in step 8.
8	SS -> MS	PACKET UPLINK ASSIGNMENT	Sent (0.5*T3168) seconds after step 7. Allocates one uplink PDCH.
9	MS -> SS	RLC DATA BLOCK	Verify MS sends data block on uplink resource assigned in step 8 at the starting time.
10	SS -> MS	RLC DATA BLOCK	In same block as step 9: with valid RRBP field (polling)
11	MS -> SS	RLC DATA BLOCKS	Verify MS sends data block on uplink resource assigned in step 8 (next block following step 9).
12	MS -> SS	PACKET DOWNLINK ACK/NACK	In block specified by step 10. (4 th block of allocation assigned in step 8)
13	SS		Verify no uplink data sent by MS in 5 th and 6 th blocks of allocation assigned in step 8.
14	MS -> SS	RLC DATA BLOCK	Sent in 7 th block of uplink allocation assigned in step 8.
15	SS -> MS	RLC DATA BLOCK	Sent in 7 th block of allocation (same block as step 14) With valid RRBP field (polling).
16	MS -> SS	RLC DATA BLOCK	Sent in 8 th and 9 th block of uplink allocation assigned in step 8.
17	MS -> SS	PACKET DOWNLINK ACK/NACK	Sent in 10 th block of allocation, in response to poll from step 15.

PACKET DOWNLINK ASSIGNMENT message in step 1:

TIMESLOT_ALLOCATION	10000000
TBF STARTING TIME	<IE not present>

PACKET UPLINK ASSIGNMENT message in step 8:

TBF STARTING TIME	<some suitable value within 100 frames of current frame>
Fixed allocation	
- TIMESLOT_ALLOCATION	10000000
- BLOCKS_OR_BLOCK_PERIODS	0 – blocks
- ALLOCATION_BITMAP_LENGTH	10
- ALLOCATION_BITMAP	0111000011

DOWNLINK RLC DATA BLOCK in step 10 and 15:

RRBP	00 – Response shall be sent by MS in N+13 frames.
S/P	1 – RRBP field is valid

42.2.4.2.2 Fixed Allocation/ Downlink Transfer with Uplink TBF Establishment/ Packet Uplink Assignment/ Half-duplex

42.2.4.2.2.1 Definition and applicability

This test case applies to all MSs supporting GPRS multi-slot classes 19-29.

42.2.4.2.2.2 Conformance Requirement

The mobile station may request establishment of an uplink transfer during a downlink TBF by including a Channel Request Description information element in the PACKET DOWNLINK ACK/NACK message. Initiation is triggered by a request from upper layers to transfer a LLC PDU. The request from upper layers specifies a Radio Priority to be associated with the packet transfer. Upon such a request,

- if access to the network is allowed, according to the latest values for authorized special access classes that the mobile station has received (see subclause 7.1.1), the mobile station shall initiate the packet access procedure.
- otherwise, the RR sublayer in the mobile station shall reject the request.

The mobile station initiates the packet access procedure by sending the Channel Request Description information element in the PACKET DOWNLINK ACK/NACK message on the PACCH and starting timer T3168.

On receipt of a PACKET UPLINK ASSIGNMENT or PACKET TIMESLOT RECONFIGURE message the mobile station shall follow the procedure below. On reception of a complete uplink assignment the mobile station shall stop timer T3168.

If the mobile station is assigned to operate in half duplex mode, the mobile station shall, after expiry of the TBF starting time, if present, stop the downlink TBF, save the RLC state variables associated with the downlink TBF and save the state of the following timers:

T3190 - Wait for Valid Downlink Data Received from the Network

T3192 - Wait for Release of the TBF after reception of the final block

The mobile station shall then switch to the assigned uplink PDCHs and begin to send RLC data blocks on the assigned PDCH(s). The TLLI shall not be included in any of the uplink RLC data blocks in that case.

References

GSM 04.60, subclause 8.1.2.5

42.2.4.2.2.3 Test purpose

Verify that during a downlink TBF, when the MS requests additional resources, that the MS stops the downlink TBF when the uplink TBF is assigned to operate in half-duplex mode.

42.2.4.2.2.4 Method of test

Initial Conditions

System Simulator:

2 cells, GPRS supported, PCCCH present

Mobile Station:

The MS is in the state "idle, GMM-registered" with a P-TMSI allocated, SPLIT PG CYCLE negotiated, and PDP context 3 activated.

Related PICS/PIXIT Statement(s)

Support GPRS service

Test Procedure

1. MS receives a PACKET DOWNLINK ASSIGNMENT message on its assigned PCCCH, containing no starting time.
2. SS transmits downlink RLC data blocks for the downlink allocation, 1 in 10 specifying RRBP field (polling).
3. MS responds by sending PACKET DOWNLINK ACK/NACK messages in response to each poll.
4. MS is triggered to begin an uplink transfer.
5. MS sends next PACKET DOWNLINK ACK/NACK message with a Channel Request Description field.
6. MS receives a PACKET UPLINK ASSIGNMENT message.
7. MS acts on the PACKET UPLINK ASSIGNMENT, by stopping the downlink TBF, and starting the uplink TBF.

Maximum Duration of Test

5 min.

Expected Sequence

Step	Direction	Message	Comments
1	SS -> MS	PACKET DOWNLINK ASSIGNMENT	Triggers the MS to switch to assigned PDCH. (no starting time)
2	SS -> MS	RLC DATA BLOCKS	Starting 3 blocks after the previous message, on assigned PDCH, addressed to MS, 1 in 10 with valid RRBP field (polling).
3	MS -> SS	PACKET DOWNLINK ACK/NACK	MS acknowledges the previously received RLC data blocks.
4			Steps 2 and 3 are repeated throughout until step 8.
5	MS		MS is triggered to begin an uplink data transfer.
6	MS -> SS	PACKET DOWNLINK ACK/NACK	Message contains Channel Request Description IE - MS starts timer T3168
7			Steps 2 and 3 are repeated as often as necessary until step 8.
8	SS -> MS	PACKET UPLINK ASSIGNMENT	Sent (.5*T3168) seconds after step 7. Allocates one uplink PDCH.
9	MS -> SS	RLC DATA BLOCK	Verify MS sends data block on uplink resource assigned in step 8 at the starting time.
10	SS -> MS	RLC DATA BLOCK	In same block as step 9: with valid RRBP field (polling)
11	MS -> SS	RLC DATA BLOCK	Verify MS sends data block on uplink resource assigned in step 8 (next block following step 9).
12	SS		Verify MS does not send DOWNLINK ACK/NACK in response to downlink data block in step 10.
13	SS		Verify no uplink data sent by MS in 5 th and 6 th blocks of allocation assigned in step 8.
14	MS -> SS	RLC DATA BLOCK	Sent in 7 th block of uplink allocation assigned in step 8.
15	SS -> MS	RLC DATA BLOCK	Sent in 7 th block of allocation (same block as step 14) With valid RRBP field (polling).
16	MS -> SS	RLC DATA BLOCKS	Sent in 8 th and 9 th block of uplink allocation assigned in step 8.
17	SS		Verify MS does not send DOWNLINK ACK/NACK in response to downlink data block in step 15.

PACKET DOWNLINK ASSIGNMENT message in step 1:

TIMESLOT_ALLOCATION	10000000
TBF STARTING TIME	<IE not present>

PACKET UPLINK ASSIGNMENT message in step 8:

TBF STARTING TIME	<some suitable value within 100 frames of current frame>
Fixed allocation	
- HALF_DUPLEX_MODE	1 – MS operates in half-duplex mode
- TIMESLOT_ALLOCATION	10000000
- BLOCKS_OR_BLOCK_PERIODS	0 – blocks
- ALLOCATION_BITMAP_LENGTH	10
- ALLOCATION_BITMAP	0111000011

DOWNLINK RLC DATA BLOCK in step 10 and 15:

RRBP S/P	00 – Response shall be sent by MS in N+13 frames. 1 – RRBP field is valid
-------------	--

42.2.4.3 Fixed Allocation/ Downlink Transfer with Uplink TBF Establishment/Packet Timeslot Reconfigure

42.2.4.3.1 Fixed Allocation/ Downlink Transfer with Uplink TBF Establishment/Packet Timeslot Reconfigure/Starting time with AFN encoding

42.2.4.3.1.1 Definition and applicability

This test case applies to all MSs supporting GPRS.

42.2.4.3.1.2 Conformance Requirement

The mobile station may request establishment of an uplink transfer during a downlink TBF by including a Channel Request Description information element in the PACKET DOWNLINK ACK/NACK message. Initiation is triggered by a request from upper layers to transfer a LLC PDU. The request from upper layers specifies a Radio Priority to be associated with the packet transfer. Upon such a request,

- if access to the network is allowed, according to the latest values for authorized special access classes that the mobile station has received (see subclause 7.1.1), the mobile station shall initiate the packet access procedure.
- otherwise, the RR sublayer in the mobile station shall reject the request.

The mobile station initiates the packet access procedure by sending the Channel Request Description information element in the PACKET DOWNLINK ACK/NACK message on the PACCH and starting timer T3168.

On receipt of a PACKET UPLINK ASSIGNMENT or PACKET TIMESLOT RECONFIGURE message the mobile station shall follow the procedure below. On reception of a complete uplink assignment the mobile station shall stop timer T3168.

If the mobile station is not assigned to operate half duplex mode, the mobile station shall, after expiry of the TBF starting time, if present, act upon the complete uplink assignment.

The mobile station shall then switch to the assigned uplink PDCHs and begin to send RLC data blocks on the assigned PDCH(s). The TLLI shall not be included in any of the uplink RLC data blocks in that case.

References

GSM 04.60, subclause 8.1.2.5

42.2.4.3.1.3 Test purpose

Verify that during a downlink TBF, when the MS requests uplink resources, that the MS obeys the PACKET TIMESLOT RECONFIGURE message at the starting time and enters the uplink TBF.

42.2.4.3.1.4 Method of test

Initial Conditions

System Simulator:

2 cells, GPRS supported, PCCCH present

Mobile Station:

The MS is in the state "idle, GMM-registered" with a P-TMSI allocated, SPLIT PG CYCLE negotiated, and PDP context 3 activated.

Related PICS/PIXIT Statement(s)

Support GPRS service

Test Procedure

1. MS receives a PACKET DOWNLINK ASSIGNMENT message on its assigned PCCCH, containing no starting time.
2. SS transmits downlink RLC data blocks for the downlink allocation, 1 in 10 specifying RRBP field (polling).
3. MS responds by sending PACKET DOWNLINK ACK/NACK messages in response to each poll.
4. MS is triggered to begin an uplink transfer.
5. MS sends next PACKET DOWNLINK ACK/NACK message with a Channel Request Description field.
6. MS receives a PACKET TIMESLOT RECONFIGURE message.
7. MS acts on the PACKET TIMESLOT RECONFIGURE at the appropriate starting time and enters a concurrent TBF.

Maximum Duration of Test

5 min.

Expected Sequence

Step	Direction	Message	Comments
1	SS -> MS	PACKET DOWNLINK ASSIGNMENT	Triggers the MS to switch to assigned PDCH. (no starting time)
2	SS -> MS	RLC DATA BLOCKS	Starting 3 blocks after the previous message, on assigned PDCH, addressed to MS, 1 in 10 with valid RRBP field (polling).
3	MS -> SS	PACKET DOWNLINK ACK/NACK	MS acknowledges the previously received RLC data blocks.
4			Steps 2 and 3 are repeated throughout until step 8.
5	MS		MS is triggered to begin an uplink data transfer.
6	MS -> SS	PACKET DOWNLINK ACK/NACK	Message contains Channel Request Description IE. - MS starts timer T3168
7			Steps 2 and 3 are repeated as often as necessary until step 8.
8	SS -> MS	PACKET TIMESLOT RECONFIGURE	Sent (0.5*T3168) seconds after step 7. Allocates one uplink PDCH.
9	MS -> SS	RLC DATA BLOCK	Verify MS sends data block on uplink resource assigned in step 8 at the starting time.
10	SS -> MS	RLC DATA BLOCK	In same block as step 9: with valid RRBP field (polling)
11	MS -> SS	RLC DATA BLOCK	Verify MS sends data block on uplink resource assigned in step 8 (next block following step 9).
12	MS -> SS	PACKET DOWNLINK ACK/NACK	In block specified by step 10. (4 th block of allocation assigned in step 8)
13	SS		Verify no uplink data sent by MS in 5 th and 6 th blocks of allocation assigned in step 8.
14	MS -> SS	RLC DATA BLOCK	Sent in 7 th block of uplink allocation assigned in step 8.
15	SS -> MS	RLC DATA BLOCK	Sent in 7 th block of allocation (same block as step 14) With valid RRBP field (polling).
16	MS -> SS	RLC DATA BLOCKS	Sent in 8 th and 9 th block of uplink allocation assigned in step 8.
17	MS -> SS	PACKET DOWNLINK ACK/NACK	Sent in 10 th block of allocation, in response to poll from step 15.

PACKET DOWNLINK ASSIGNMENT message in step 1:

TIMESLOT_ALLOCATION	10000000
TBF STARTING TIME	<IE not present>

PACKET TIMESLOT RECONFIGURE message in step 8:

TBF STARTING TIME	0 – AFN encoding
- AFN	<some AFN within 50 frames of current AFN>
Fixed allocation	
- TIMESLOT_ALLOCATION	10000000
- BLOCKS_OR_BLOCK_PERIODS	0 – blocks
- ALLOCATION_BITMAP_LENGTH	10
- ALLOCATION_BITMAP	0111000011
Downlink Allocation	Same as already assigned

DOWNLINK RLC DATA BLOCK in step 10 and 15:

RRBP	00 – Response shall be sent by MS in N+13 frames.
S/P	1 – RRBP field is valid

42.2.4.3.2 Fixed Allocation/ Downlink Transfer with Uplink TBF Establishment/ Packet Timeslot Reconfigure/ Starting time with relative encoding

42.2.4.3.2.1 Definition and applicability

This test case applies to all MSs supporting GPRS.

42.2.4.3.2.2 Conformance Requirement

The mobile station may request establishment of an uplink transfer during a downlink TBF by including a Channel Request Description information element in the PACKET DOWNLINK ACK/NACK message. Initiation is triggered by a request from upper layers to transfer a LLC PDU. The request from upper layers specifies a Radio Priority to be associated with the packet transfer. Upon such a request,

- if access to the network is allowed, according to the latest values for authorized special access classes that the mobile station has received (see subclause 7.1.1), the mobile station shall initiate the packet access procedure.
- otherwise, the RR sublayer in the mobile station shall reject the request.

The mobile station initiates the packet access procedure by sending the Channel Request Description information element in the PACKET DOWNLINK ACK/NACK message on the PACCH and starting timer T3168.

On receipt of a PACKET UPLINK ASSIGNMENT or PACKET TIMESLOT RECONFIGURE message the mobile station shall follow the procedure below. On reception of a complete uplink assignment the mobile station shall stop timer T3168.

If the mobile station is not assigned to operate half duplex mode, the mobile station shall, after expiry of the TBF starting time, if present, act upon the complete uplink assignment.

The mobile station shall then switch to the assigned uplink PDCHs and begin to send RLC data blocks on the assigned PDCH(s). The TLLI shall not be included in any of the uplink RLC data blocks in that case.

References

GSM 04.60, subclause 8.1.2.5

42.2.4.3.2.3 Test purpose

Verify that during a downlink TBF, when the MS requests uplink resources, that the MS obeys the PACKET TIMESLOT RECONFIGURE message at the starting time and enters the uplink TBF.

42.2.4.3.2.4 Method of test

Initial Conditions

System Simulator:

2 cells, GPRS supported, PCCCH present

Mobile Station:

The MS is in the state "idle, GMM-registered" with a P-TMSI allocated, SPLIT PG CYCLE negotiated, and PDP context 3 activated.

Related PICS/PIXIT Statement(s)

Support GPRS service

Test Procedure

1. MS receives a PACKET DOWNLINK ASSIGNMENT message on its assigned PCCCH, containing no starting time.
2. SS transmits downlink RLC data blocks for the downlink allocation, 1 in 10 specifying RRBP field (polling).
3. MS responds by sending PACKET DOWNLINK ACK/NACK messages in response to each poll.
4. MS is triggered to begin an uplink transfer.
5. MS sends next PACKET DOWNLINK ACK/NACK message with a Channel Request Description field.
6. MS receives a PACKET TIMESLOT RECONFIGURE message.
7. MS acts on the PACKET TIMESLOT RECONFIGURE message at the starting time and enters a concurrent TBF.

Maximum Duration of Test

5 min.

Expected Sequence

Step	Direction	Message	Comments
1	SS -> MS	PACKET DOWNLINK ASSIGNMENT	Triggers the MS to switch to assigned PDCH. (no starting time)
2	SS -> MS	RLC DATA BLOCKS	Starting 3 blocks after the previous message, on assigned PDCH, addressed to MS, 1 in 10 with valid RRBp field (polling).
3	MS -> SS	PACKET DOWNLINK ACK/NACK	MS acknowledges the previously received RLC data blocks.
4			Steps 2 and 3 are repeated throughout until step 8.
5	MS		MS is triggered to begin an uplink data transfer.
6	MS -> SS	PACKET DOWNLINK ACK/NACK	Message contains Channel Request Description IE. - MS starts timer T3168
7			Steps 2 and 3 are repeated as often as necessary until step 8.
8	SS -> MS	PACKET TIMESLOT RECONFIGURE	Sent (0.5*T3168) seconds after step 7. Allocates one uplink PDCH.
9	MS -> SS	RLC DATA BLOCKS	Verify MS sends data block on uplink resource assigned in step 8 at the starting time.
10	SS -> MS	RLC DATA BLOCK	In same block as step 9: with valid RRBp field (polling)
11	MS -> SS	RLC DATA BLOCK	Verify MS sends data block on uplink resource assigned in step 8 (next block following step 9).
12	MS -> SS	PACKET DOWNLINK ACK/NACK	In block specified by step 10. (4 th block of allocation assigned in step 8)
13	SS		Verify no uplink data sent by MS in 5 th and 6 th blocks of allocation assigned in step 8.
14	MS -> SS	RLC DATA BLOCK	Sent in 7 th block of uplink allocation assigned in step 8.
15	SS -> MS	RLC DATA BLOCK	Sent in 7 th block of allocation (same block as step 14) With valid RRBp field (polling).
16	MS -> SS	RLC DATA BLOCKS	Sent in 8 th and 9 th block of uplink allocation assigned in step 8.
17	MS -> SS	PACKET DOWNLINK ACK/NACK	Sent in 10 th block of allocation, in response to poll from step 15.

PACKET DOWNLINK ASSIGNMENT message in step 1:

TIMESLOT_ALLOCATION	10000000
TBF STARTING TIME	<IE not present>

PACKET TIMESLOT RECONFIGURE message in step 8:

TBF STARTING TIME	1 – Relative FN encoding
- AFN	<some AFN within 50 frames of current AFN>
Fixed allocation	
- TIMESLOT_ALLOCATION	10000000
- BLOCKS_OR_BLOCK_PERIODS	0 – blocks
- ALLOCATION_BITMAP_LENGTH	10
- ALLOCATION_BITMAP	0111000011

DOWNLINK RLC DATA BLOCK in step 10 and 15:

RRBP S/P	00 – Response shall be sent by MS in N+13 frames. 1 – RRBP field is valid
-------------	--

42.2.4.4 Fixed Allocation/ Downlink Transfer with Uplink TBF Establishment/ Packet Access Reject

42.2.4.4.1 Fixed Allocation/ Downlink Transfer with Uplink TBF Establishment/ Packet Access Reject/ With WAIT_INDICATION

42.2.4.4.1.1 Definition and applicability

This test case applies to all MSs supporting GPRS.

42.2.4.4.1.2 Conformance Requirement

The mobile station may request establishment of an uplink transfer during a downlink TBF by including a Channel Request Description information element in the PACKET DOWNLINK ACK/NACK message. Initiation is triggered by a request from upper layers to transfer a LLC PDU. The request from upper layers specifies a Radio Priority to be associated with the packet transfer. Upon such a request,

- if access to the network is allowed, according to the latest values for authorized special access classes that the mobile station has received (see subclause 7.1.1), the mobile station shall initiate the packet access procedure.
- otherwise, the RR sublayer in the mobile station shall reject the request.

The mobile station initiates the packet access procedure by sending the Channel Request Description information element in the PACKET DOWNLINK ACK/NACK message on the PACCH and starting timer T3168.

On receipt of a PACKET ACCESS REJECT message containing a WAIT_INDICATION field in a Reject structure addressed to the mobile station, the mobile station shall stop timer T3168 and start timer T3172 with the indicated value (Wait Indication). The mobile station is not allowed to make a new attempt for packet access in the same cell until timer T3172 expires, but may attempt packet access in an other cell after successful cell reselection. When timer T3172 expires, if the downlink TBF is still active the mobile station shall initiate the establishment of an uplink TBF using the procedure in this subclause. If no TBF is active, the mobile station shall initiate the establishment of an uplink TBF on CCCH or PCCCH.

References

GSM 04.60, subclause 8.1.2.5

42.2.4.4.1.3 Test purpose

Verify that during a downlink TBF, when the MS requests uplink resources, that the MS obeys a PACKET ACCESS REJECT message with WAIT_INDICATION by waiting the specified time and then requesting uplink resources again.

42.2.4.4.1.4 Method of test

Initial Conditions

System Simulator:

2 cells, GPRS supported, PCCCH present

Mobile Station:

The MS is in the state "idle, GMM-registered" with a P-TMSI allocated, SPLIT PG CYCLE negotiated, and PDP context 3 activated.

Related PICS/PIXIT Statement(s)

Support GPRS service

Test Procedure

1. MS receives a PACKET DOWNLINK ASSIGNMENT message on its assigned PCCCH, containing no starting time.
2. SS transmits downlink RLC data blocks for the downlink allocation, 1 in 10 specifying RRBP field (polling).
3. MS responds by sending PACKET DOWNLINK ACK/NACK messages in response to each poll.
4. MS is triggered to begin an uplink transfer.
5. MS sends next PACKET DOWNLINK ACK/NACK message with a Channel Request Description field.
6. MS receives a PACKET ACCESS REJECT message with WAIT_INDICATION.
7. MS acts on the PACKET ACCESS REJECT by waiting the indicated time, and then requests resources again.

Maximum Duration of Test

5 min.

Expected Sequence

Step	Direction	Message	Comments
1	SS -> MS	PACKET DOWNLINK ASSIGNMENT	Triggers the MS to switch to assigned PDCH. (no starting time)
2	SS -> MS	RLC DATA BLOCKS	Starting 3 blocks after the previous message, on assigned PDCH, addressed to MS, 1 in 10 with valid RRBP field (polling).
3	MS -> SS	PACKET DOWNLINK ACK/NACK	MS acknowledges the previously received RLC data blocks.
4			Steps 2 and 3 are repeated throughout until step 8.
5	MS		MS is triggered to begin an uplink data transfer.
6	MS -> SS	PACKET DOWNLINK ACK/NACK	Message contains Channel Request Description IE. - MS starts timer T3168
7			Steps 2 and 3 are repeated as often as necessary until step 8.
8	SS -> MS	PACKET ACCESS REJECT	Sent (0.5 * T3168) seconds after step 7. - MS starts T3172
9			Steps 2 and 3 are repeated as often as necessary until step 10.
10	MS -> SS	PACKET DOWNLINK ACK/NACK	Sent after T3172 seconds after step 8. Message contains Channel Request Description IE.

PACKET DOWNLINK ASSIGNMENT message in step 1:

TIMESLOT_ALLOCATION	10000000
TBF STARTING TIME	<IE not present>

PACKET ACCESS REJECT message in step 8:

TLLI	Addressing this MS
WAIT_INDICATION	2
WAIT_INDICATION_SIZE	0 – WAIT_INDICATION in units of seconds

42.2.4.4.2 Fixed Allocation/ Downlink Transfer with Uplink TBF Establishment/ Packet Access Reject/No WAIT_INDICATION

42.2.4.4.2.1 Definition and applicability

This test case applies to all MSs supporting GPRS.

42.2.4.4.2.2 Conformance Requirement

The mobile station may request establishment of an uplink transfer during a downlink TBF by including a Channel Request Description information element in the PACKET DOWNLINK ACK/NACK message. Initiation is triggered by a request from upper layers to transfer a LLC PDU. The request from upper layers specifies a Radio Priority to be associated with the packet transfer. Upon such a request,

- if access to the network is allowed, according to the latest values for authorized special access classes that the mobile station has received (see subclause 7.1.1), the mobile station shall initiate the packet access procedure.
- otherwise, the RR sublayer in the mobile station shall reject the request.

The mobile station initiates the packet access procedure by sending the Channel Request Description information element in the PACKET DOWNLINK ACK/NACK message on the PACCH and starting timer T3168.

On receipt of a PACKET ACCESS REJECT message that contains a Reject structure addressed to the mobile station without a WAIT_INDICATION field, the mobile station shall stop timer T3168 and shall perform an abnormal release with system information (see subclause 8.7.3).

References

GSM 04.60, subclause 8.1.2.5

42.2.4.4.2.3 Test purpose

Verify that during a downlink TBF, when the MS requests uplink resources, that the MS obeys a PACKET ACCESS REJECT message without WAIT_INDICATION by performing abnormal release.

42.2.4.4.2.4 Method of test

Initial Conditions

System Simulator:

2 cells, GPRS supported, PCCCH present

Mobile Station:

The MS is in the state "idle, GMM-registered" with a P-TMSI allocated, SPLIT PG CYCLE negotiated, and PDP context 3 activated.

Related PICS/PIXIT Statement(s)

Support GPRS service

Test Procedure

1. MS receives a PACKET DOWNLINK ASSIGNMENT message on its assigned PCCCH, containing no starting time.
2. SS transmits downlink RLC data blocks for the downlink allocation, 1 in 10 specifying RRBP field (polling).
3. MS responds by sending PACKET DOWNLINK ACK/NACK messages in response to each poll.
4. MS is triggered to begin an uplink transfer.
5. MS sends next PACKET DOWNLINK ACK/NACK message with a Channel Request Description field.
6. MS receives a PACKET ACCESS REJECT message without WAIT_INDICATION.
7. MS performs abnormal release.

Maximum Duration of Test

5 min.

Expected Sequence

Step	Direction	Message	Comments
1	SS -> MS	PACKET DOWNLINK ASSIGNMENT	Triggers the MS to switch to assigned PDCH. (no starting time)
2	SS -> MS	RLC DATA BLOCKS	Starting 3 blocks after the previous message, on assigned PDCH, addressed to MS, 1 in 10 with valid RRBP field (polling).
3	MS -> SS	PACKET DOWNLINK ACK/NACK	MS acknowledges the previously received RLC data blocks.
4			Steps 2 and 3 are repeated throughout until step 8.
5	MS		MS is triggered to begin an uplink data transfer.
6	MS -> SS	PACKET DOWNLINK ACK/NACK	Message contains Channel Request Description IE. - MS starts timer T3168
7			Steps 2 and 3 are repeated as often as necessary until step 8.
8	SS -> MS	PACKET ACCESS REJECT	Sent (0.5*T3168) seconds after step 7 (no wait time) - MS performs abnormal release.
9	SS -> MS	RLC DATA BLOCKS	Sent on assigned downlink PDCH, addressed to MS, 1 in 10 with valid RRBP field (polling).
10	SS		Verify MS does not respond to poll.

PACKET DOWNLINK ASSIGNMENT message in step 1:

TIMESLOT_ALLOCATION	10000000
TBF STARTING TIME	<IE not present>

PACKET ACCESS REJECT message in step 8:

TLLI	Addressing this MS
WAIT_INDICATION	<not present>

42.2.4.4.3 Fixed Allocation/ Downlink Transfer with Uplink TBF Establishment/ Packet Access Reject/With Polling

42.2.4.4.3.1 Definition and applicability

This test case applies to all MSs supporting GPRS.

42.2.4.4.3.2 Conformance Requirement

If the RRBP field is received as part of an RLC/MAC block containing an RLC/MAC control block containing any message except Packet Paging Request, Packet Access Reject, and Packet Queueing Notification, the mobile station shall transmit a PACKET CONTROL ACKNOWLEDGEMENT message in the uplink radio block specified. If the RRBP field is received as part of an RLC/MAC block containing an RLC/MAC control block containing a Packet Paging Request, Packet Access Reject, or Packet Queueing Notification message, the mobile station shall ignore this RRBP field.

References

GSM 04.60, subclause 10.4.5

42.2.4.4.3.3 Test purpose

Verify that during a downlink TBF, when the MS requests uplink resources, that the MS ignores a poll in a PACKET ACCESS REJECT message.

42.2.4.4.3.4 Method of test

Initial Conditions

System Simulator:

2 cells, GPRS supported, PCCCH present

Mobile Station:

The MS is in the state "idle, GMM-registered" with a P-TMSI allocated, SPLIT PG CYCLE negotiated, and PDP context 3 activated.

Related PICS/PIXIT Statement(s)

Support GPRS service

Test Procedure

1. MS receives a PACKET DOWNLINK ASSIGNMENT message on its assigned PCCCH, containing no starting time.
2. SS transmits downlink RLC data blocks for the downlink allocation, 1 in 10 specifying RRBP field (polling).

3. MS responds by sending PACKET DOWNLINK ACK/NACK messages in response to each poll.
4. MS is triggered to begin an uplink transfer.
5. MS sends next PACKET DOWNLINK ACK/NACK message with a Channel Request Description field.
6. MS receives a PACKET ACCESS REJECT message without WAIT_INDICATION and with RRBP field indicating polling.
7. MS performs abnormal release (ignoring the poll request).

Maximum Duration of Test

5 min.

Expected Sequence

Step	Direction	Message	Comments
1	SS -> MS	PACKET DOWNLINK ASSIGNMENT	Triggers the MS to switch to assigned PDCH. (no starting time)
2	SS -> MS	RLC DATA BLOCKS	Starting 3 blocks after the previous message, on assigned PDCH, addressed to MS, 1 in 10 with valid RRBP field (polling).
3	MS -> SS	PACKET DOWNLINK ACK/NACK	MS acknowledges the previously received RLC data blocks.
4			Steps 2 and 3 are repeated throughout until step 8.
5	MS		MS is triggered to begin an uplink data transfer.
6	MS -> SS	PACKET DOWNLINK ACK/NACK	Message contains Channel Request Description IE. - MS starts timer T3168
7			Steps 2 and 3 are repeated as often as necessary until step 8.
8	SS -> MS	PACKET ACCESS REJECT	Sent (0.5*T3168) seconds after step 7 (no wait time), with valid RRBP field (polling). - MS performs abnormal release.
9	SS -> MS	RLC DATA BLOCKS	Sent on assigned downlink PDCH, addressed to MS, 1 in 10 with valid RRBP field (polling).
10	SS		Verify MS does not respond to previous message, and does not send a response to the poll in step 8.

PACKET DOWNLINK ASSIGNMENT message in step 1:

TIMESLOT_ALLOCATION	10000000
TBF STARTING TIME	<IE not present>

PACKET ACCESS REJECT message in step 8:

RRBP	00 – Response shall be sent by MS in N+13 frames.
S/P (MAC Header)	1 – RRBP field is valid
WAIT_INDICATION	<not present>

42.2.5 Default message contents

42.2.5.1 Default message contents

The following default values of messages and the default contents of messages defined in clause 40 are used in clause 42.2. Unless indicated otherwise in clause 42.2 these shall be transmitted by the system simulator.

In this clause, decimal values are normally used. However, sometimes a hexadecimal value, indicated by an "Hex", or a binary value, indicated by a "Binary" is used.

Get rid of all uplink messages.

PACKET CHANNEL REQUEST message:

Access Type	"One phase access request" or "Two phase access request"
Multislot class	Not checked
Radio priority	Not checked
Random Reference	Not checked.

PACKET CONTROL ACKNOWLEDGEMENT message:

MESSAGE_TYPE	000001
TLLI	not checked
CTRL_ACK	not checked
spare padding	Spare Padding

PACKET DOWNLINK ASSIGNMENT message:

MESSAGE_TYPE	000100
PAGE_MODE	Normal Paging
Referenced Address	1 (address is TLLI)
-	same as the value received from MS
- TLLI	Fixed Allocation
MAC_MODE	acknowledged mode
RLC_MODE	0
CONTROL_ACK	Assigns slot 0
TIMESLOT_ALLOCATION	Absolute FN
REL_OR_ABS_FN	
Packet Timing Advance	1 (timing advance value)
- {0 1<TIMING_ADVANCE_VALUE>}	30 bit periods
- TIMING_ADVANCE_VALUE	0 (no timing advance index)
- {0 1<TIMING_ADVANCE_INDEX>	
<TIMING_ADVANCE_TIMESLOT_NUMBER >}	
{L H<Frequency Parameters>}	1 (Frequency Parameters present)
- Frequency Parameters	
- TSC	value arbitrarily chosen from valid values (default 5)
-	00 (ARFCN no hopping)
- ARFCN	For GSM 900, 30
	For DCS 1800, 650
	For PCS 1900, 650
{L H<Power Control Parameters>}	H (Power Control Parameters present)
- ALPHA	0.5
- {0 1<GAMMA_TN0>}	depending on the value in TIMESLOT_ALLOCATION (default 0 no GAMMA_TN0)
- {0 1<GAMMA_TN1>}	depending on the value in TIMESLOT_ALLOCATION (default 0 no GAMMA_TN1)
- {0 1<GAMMA_TN2>}	depending on the value in TIMESLOT_ALLOCATION (default 1 GAMMA_TN2)
- GAMMA_TN2	For GSM 900, +9 dBm
	For DCS 1800, +6 dBm
	For PCS 1900, +6 dBm
- {0 1<GAMMA_TN3>}	depending on the value in TIMESLOT_ALLOCATION (default 0 no GAMMA_TN0)
- {0 1<GAMMA_TN4>}	depending on the value in TIMESLOT_ALLOCATION (default 0 no GAMMA_TN4)
- {0 1<GAMMA_TN5>}	depending on the value in TIMESLOT_ALLOCATION (default 0 no GAMMA_TN5)
- {0 1<GAMMA_TN6>}	depending on the value in TIMESLOT_ALLOCATION (default 0 no GAMMA_TN6)
- {0 1<GAMMA_TN7>}	depending on the value in TIMESLOT_ALLOCATION (default 0 no GAMMA_TN7)
{L H<DOWNLINK_TFI_ASSIGNMENT>}	H (assign downlink TFI)
- DOWNLINK_TFI_ASSIGNMENT	arbitrarily chosen from valid values (default 3)
{L H<TBF_STARTING_TIME>}	H (starting time present)
- TBF_STARTING_TIME	indicating (current frame + 13 frames)

{L H<Measurement Mapping>}	L (no measurement mapping)
Spare padding	Spare Padding

PACKET DOWNLINK DUMMY CONTROL BLOCK message:

MESSAGE_TYPE	010000
PAGE_MODE	Normal Paging
Spare padding	Spare Padding

PACKET PAGING REQUEST message:

MESSAGE_TYPE	000101
PAGE_MODE	Normal Paging
{L H<PERSISTENCE_LEVEL>}	L (no persistence level present)
{L H<NLN>}	L (no notification list number)
{H <Repeated Page info>}	H (start of Repeated Page info)
-	L (Page request for TBF establishment)
-	L (PTMSI)
- PTMSI	P-TMSI allocated during GPRS attach procedure
-	L (end of Repeated Page info)
Spare padding	Spare Padding

PACKET TIMESLOT RECONFIGURE message:

MESSAGE_TYPE GLOBAL_TFI	001011 the TFI value of the uplink TBF or downlink TBF which this message applies (default 00101)
CHANNEL_CODING_COMMAND Packet Timing Advance - {0 1<TIMING_ADVANCE_VALUE>} - TIMING_ADVANCE_VALUE - {0 1<TIMING_ADVANCE_INDEX> <TIMING_ADVANCE_TIMESLOT_NUMBER >}	arbitrarily chosen from valid values (default CS-1) 1 (timing advance value) 30 bit periods 0 (no timing advance index)
DOWNLINK_RLC_MODE CONTROL_ACK {L H<GLOBAL_TFI_ASSIGNMENT> <REL_OR_ABS_FN>}	unacknowledged mode 0 L (not assign new TFI)
DOWNLINK_TIMESLOT_ALLOCATION {L H<Frequency Parameters>}	arbitrarily chosen from valid values (default 2) L (use current parameters) H (Fixed allocation)
Fixed Allocation - Uplink timeslot allocation - FINAL_ALLOCATION - DOWNLINK_CONTROL_TIMESLOT - Starting Frame Number Desc IE - BLOCKS_OR_BLOCK_PERIODS	0 – uplink timeslot allocation 0 000 – PDCH0. 0 (AFN encoding) (indicating current frame + 104) 1 – Block Periods
spare padding	Spare Padding

PACKET UPLINK ACK/NACK message:

MESSAGE_TYPE UPLINK_TFI	001101 same as the TFI value of the TBF which the message applies
CHANNEL_CODING_COMMAND	same as the coding scheme of the TBF which the message applies
Ack/Nack Description - FINAL_ACK_INDICATION - STARTING_SEQUENCE_NUMBER - RECEIVED_BLOCK_BITMAP {L H<CONTENTION_RESOLUTION_TLLI>} {L H<Packet Timing Advance>} {L H<Power Control Parameters>} {L H<Fixed Allocation parameters>}	0 (not a final ACK) V(R) acknowledges all data blocks transmitted by the MS L (no contention resolution TLLI) L (no packet timing advance) L (no power control parameters) L (no fixed allocation parameters present)
spare padding	Spare Padding

PACKET UPLINK ASSIGNMENT message (fixed allocation):

MESSAGE_TYPE	001110
PAGE_MODE	Normal Paging
Referenced Address	
-	1 (not Global TFI)
-	0 (TLLI)
- TLLI	the value received from the MS
CHANNEL_CODING_COMMAND	arbitrarily chosen from the valid values (default CS-1)
TLLI_BLOCK_CHANNEL_CODING	arbitrarily chosen but different from CHANNEL_CODING_COMMAND
REL_OR_ABS_FN	Absolute FN
Packet Timing Advance	
- {0 1<TIMING_ADVANCE_VALUE>}	1 (timing advance value)
- TIMING_ADVANCE_VALUE	30 bit periods
- {0 1<TIMING_ADVANCE_INDEX>	0 (no timing advance index)
<TIMING_ADVANCE_TIMESLOT_NUMBER >}	
{L H<Frequency Parameters>}	H (Frequency Parameters present)
- Frequency Parameters	
- TSC	arbitrarily chosen (default 5)
-	00 (ARFCN no hopping)
- ARFCN	For GSM 900, 30
	For DCS 1800, 650
Fixed Allocation:	H (Fixed allocation)
- Uplink timeslot allocation	0 – uplink timeslot allocation
- FINAL_ALLOCATION	0
- DOWNLINK_CONTROL_TIMESLOT	000 – PDCH0.
- Starting Frame Number Desc IE	0 (AFN encoding) (indicating current frame + 104)
- BLOCKS_OR_BLOCK_PERIODS	1 – Block Periods
spare padding	Spare Padding

PACKET UPLINK ASSIGNMENT message (single block allocation):

MESSAGE_TYPE	001110
PAGE_MODE	Normal Paging
Referenced Address	
-	1 (not Global TFI)
-	1 (not TLLI)
-	1 (not TQI)
-	1 (Packet Request Reference)
- Packet Request	information field sent in PACKET CHANNEL REQUEST and frame number in which PACKET CHANNEL REQUEST was received
Reference	
CHANNEL_CODING_COMMAND	arbitrarily chosen (default CS-1)
TLLI_BLOCK_CHANNEL_CODING	arbitrarily chosen but different from CHANNEL_CODING_COMMAND
REL_OR_ABS_FN	Absolute FN
Packet Timing Advance	
- {0 1<TIMING_ADVANCE_VALUE>}	1 (timing advance value)
- TIMING_ADVANCE_VALUE	30 bit periods
- {0 1<TIMING_ADVANCE_INDEX>	0 (no timing advance index)
<TIMING_ADVANCE_TIMESLOT_NUMBER >}	
{L H<Frequency Parameters>}	H (Frequency Parameters present)
- Frequency Parameters	
- TSC	arbitrarily chosen (default 5)
-	00 (ARFCN no hopping)
- ARFCN	For GSM 900, 30
	For DCS 1800, 650
	For PCS 1900, 650
Single block allocation	LH (Single block allocation)
- TIMESLOT_NUMBER	arbitrarily chosen (default slot 2)
-	H (power control parameters)
- ALPHA	0.5

- GAMMA_TN	For GSM 900, +9 dBm For DCS 1800, +6 dBm For PCS 1900, +6 dBm
- TBF_STARTING_TIME	indicating (current frame + 91 frames)
spare pending	Spare pending

ATTACH ACCEPT message:

Protocol discriminator	1000 (MM message for GPRS service)
Skip indicator	0000
Attach accept message identity	00000010
Attach result	For MS class A and B, Combined GPRS/IMSI attached For MS class C, GPRS only attached
Force to standby	not indicated
Periodic RA update timer	timer is deactivated
Radio priority for SMS	priority level 3
Spare half octet	Spare half octet
Routing area identification	
- MCC	001 (decimal)
- MNC	01 (decimal)
- LAC	0001H
- RAC	05H
P-TMSI signature	P-TMSI signature
Negotiated READY timer value	32 seconds
Allocated P-TMSI	P-TMSI
MS identity	TMSI

ATTACH COMPLETE message:

Protocol discriminator	MM message for GPRS
Skip indicator	0000
Attach complete message identity	00000011
Force to standby	not checked
Spare half octet	Spare half octet

42.3 Dynamic Allocation in Packet Transfer Mode

All test cases in this clause are applicable to the MS supporting the GPRS service and the activation of at least one PDP context.

42.3.1 Dynamic Allocation / Uplink Transfer

42.3.1.1 Dynamic Allocation / Uplink Transfer / Normal

42.3.1.1.1 Dynamic Allocation / Uplink Transfer / Normal / Successful

42.3.1.1.1.1 Conformance requirements

1. The mobile station shall set the TFI field of each uplink RLC data block to the TFI value assigned to the mobile station in the PACKET UPLINK ASSIGNMENT or PACKET TIMESLOT RECONFIGURE message.
2. Whenever the mobile station detects an assigned USF value on an assigned PDCH, the mobile station shall transmit either a single RLC/MAC block or a sequence of four RLC/MAC blocks on the same PDCH in the next block period(s). The time relation between an uplink block, which the mobile station shall use for transmission, and the occurrence of the USF value is defined in GSM 05.02. The number of RLC/MAC blocks to transmit is controlled by the USF_GRANULARITY parameter characterising the uplink TBF.
3. At two-phase access the mobile station does not include its TLLI in any RLC data block.

References

GSM 04.60, 8.1.1, 8.1.1.1, 7.1.3.3

GSM 05.02, 6.3.2.2.1

42.3.1.1.1.2 Test purposes

To verify that the MS

1. depending on the parameter USF_GRANULARITY, transmits one or a sequence of four RLC/MAC data block(s) in the next block period(s) on the PDCH on which it has detected its corresponding assigned USF.
2. includes the assigned TFI in each uplink RLC data blocks.
3. does not include its TLLI in any RLC data block at two phase access.

42.3.1.1.1.3 Method of test

Initial Conditions

System Simulator:

1 cell, default setting, BS_PBCCH_BLKs = 3.

Mobile Station:

The MS is GPRS attached with a P-TMSI allocated and the test PDP context3 activated.

Related PICS/PIXIT Statement(s)

Support GPRS service,

Support activation of at least one PDP context,

The way to trigger the MS initiating an uplink packet transfer

Test Procedure

The MS is triggered to initiate packet uplink transfer data in RLC unacknowledged mode. The SS orders the MS to have two-phase access, in PACKET UPLINK ASSIGNMENT message the USF_GRANULARITY is set to 4 blocks. The SS sends the assigned USF assigned to the MS and checks that a sequence of four RLC/MAC data blocks in the next radio block period is received, and that each data block contains the correct TFI, but without TLLI. The SS assigns the USF assigned to the MS again. The check is repeated. The procedure is going on until the MS completes the packet data transfer.

The above test procedure is repeated once for USF_GRANULARITY set to one block.

Maximum Duration of Test

5 min.

Expected Sequence

Step	Direction	Message	Comments
1		{Uplink dynamic allocation two phase access}	n =600 octets, without starting time, USF_GRANULARITY = 4 blocks, RLC_DATA_BLOCKS_GRANTED = open-end TLLI_BLOCK_CHANNEL_CODING: arbitrarily chosen CHANNEL_CODING_COMMAND: arbitrarily chosen but different from above.
2	SS -> MS	PACKET DOWNLINK DUMMY CONTROL BLOCK	Sent on the PACCH, the USF assigned to the MS, on 3 blocks from the last radio block containing the uplink assignment.
3	MS -> SS	UPLINK RLC DATA BLOCK	Received on the assigned PDTCH. Check that the coding as specified by CHANNEL_CODING_COMMAND, the TFI is correct and the block does not contain TLLI.
4	MS -> SS	UPLINK RLC DATA BLOCK	Received on the assigned PDTCH in the next radio block to step 3. Check that the coding as specified by CHANNEL_CODING_COMMAND, the TFI is correct and the block does not contain TLLI.
5	MS -> SS	UPLINK RLC DATA BLOCK	Received on the assigned PDTCH in the next radio block to step 4. Check that the coding is the scheme specified by CHANNEL_CODING_COMMAND, the TFI is correct and the block does not contain TLLI.
6	MS -> SS	UPLINK RLC DATA BLOCK	Received on the assigned PDTCH in the next radio block to step 5. Check that the coding as specified by CHANNEL_CODING_COMMAND, the TFI is correct and the block does not contain TLLI.
7	SS -> MS	PACKET UPLINK ACK/NACK	Sent on the PACCH of the PDCH, the USF not addressing the MS.
8	SS		Check that no RLC data blocks are transmitted from the MS in the next radio block to step 7.
9	SS -> MS	PACKET DOWNLINK DUMMY CONTROL BLOCK	The USF assigned to the MS.
10	MS -> SS	UPLINK RLC DATA BLOCK	Received on the assigned PDTCH.
11	MS -> SS	UPLINK RLC DATA BLOCK	Received on the assigned PDTCH in the next radio block to step 10. Check that the TFI is correct.
12	MS -> SS	UPLINK RLC DATA BLOCK	Received on the assigned PDTCH in the next radio block to step 11. Check that the TFI is correct.
13	MS -> SS	UPLINK RLC DATA BLOCK	Received on the assigned PDTCH in the next radio block to step 12. Check that the TFI is correct.
14		{Completion of uplink RLC data block transfer}	USF_GRANULARITY = 4 blocks
15		{Uplink dynamic allocation two phase access}	Similar parameter values to step 1 Except USF_GRANULARITY = 1 blocks
16	SS -> MS	PACKET DOWNLINK DUMMY CONTROL BLOCK	Sent on the PACCH of the PDCH, the USF assigned to the MS on 3 blocks from the last radio block containing the uplink assignment.
17	MS -> SS	UPLINK RLC DATA BLOCK	Received on the assigned PDTCH. Check that the coding as specified in CHANNEL_CODING_COMMAND, the TFI is correct and the block does not contain TLLI.
18	SS -> MS	PACKET UPLINK ACK/NACK	Sent on the PACCH, the USF not addressing the MS.
19	SS		Check that no RLC data blocks are transmitted from the MS in the next radio block to step 18.
20	SS -> MS	PACKET UPLINK ACK/NACK	Sent on a PDCH with any different time slot as the assigned PDCH, the USF assigned to the MS.
21	SS		Check that no RLC data block is transmitted from the MS on the next radio block to step 20.
22	SS -> MS	PACKET DOWNLINK DUMMY CONTROL BLOCK	Sent on the PACCH of the PDCH, the USF assigned to the MS.
23	MS -> SS	UPLINK RLC DATA BLOCK	Received on the assigned PDTCH. Check that the coding as specified in CHANNEL_CODING_COMMAND, the TFI is correct and the block does not contain TLLI.
24		{Completion of uplink RLC data block transfer}	USF_GRANULARITY = 1 block

42.3.1.1.2 Dynamic Allocation / Uplink Transfer / Normal / Request new resources

42.3.1.1.2.1 Conformance requirements

During the TBF, if the countdown procedure has not started, the mobile station shall ask for new or different radio resources, by sending a PACKET RESOURCE REQUEST in the following cases;

1. When the mobile station has more blocks to send than indicated in the PACKET CHANNEL REQUEST message with access type short access.
2. When the mobile station has indicated Page Response, Cell update or Mobility Management procedure as access type in the PACKET CHANNEL REQUEST and it has data to send.

References

GSM 04.60, 8.1.1

42.3.1.1.2.2 Test purposes

To verify that the MS requests for new or different radio resources by sending a PACKET RESOURCE REQUEST when the countdown procedure has not started and the MS has more blocks to send than indicated in the PACKET CHANNEL REQUEST message with access type short access.

42.3.1.1.2.3 Method of test

Initial Conditions

System Simulator:

1 cell, default setting, BS_PBCCH_BLKs = 3, BS_CV_MAX = 3.

Mobile Station:

The MS is GPRS attached with a P-TMSI allocated in cell A and Test PDP context2 activated.

Related PICS/PIXIT Statement(s)

Support GPRS service,

Support activation of at least one PDP context,

The way to trigger the MS initiating an uplink packet transfer

Test Procedure

The MS is triggered to initiate packet uplink transfer 150 octets for a short access in RLC acknowledged mode. After the MS sends the first RLC data block, the MS is triggered to send another 220 octets data. The MS requests new radio resource by sending PACKET RESOURCE REQUEST.

Maximum Duration of Test

5 min.

Expected Sequence

Step	Direction	Message	Comments
1		{Uplink dynamic allocation one phase access}	n = 150 octets (for a short access), USF_GRANULARITY = 1 block, RLC_DATA_BLOCKS_GRANTED = 9, CHANNEL_CODING_COMMAND: CS-1, TLLI_BLOCK_CHANNEL_CODING: CS-1.
2	SS -> MS	PACKET DOWNLINK DUMMY CONTROL BLOCK	RLC acknowledged mode, without starting time Sent on the PACCH of the PDCH, the USF assigned to the MS, on 3 blocks from the last radio block containing the uplink assignment.
3	MS -> SS	UPLINK RLC DATA BLOCK	Received on the assigned PDTCH.
4	MS		To trigger the MS sending another 220 octets. The radio priority, RLC mode and throughput class are the same as the previous one.
5	SS -> MS	PACKET UPLINK ACK/NACK	Sent on the PACCH, the USF assigned to the MS.
6	MS -> SS	PACKET RESOURCE REQUEST	
7	SS -> MS	PACKET UPLINK ASSIGNMENT	Close-ended uplink dynamic allocation, RLC_DATA_BLOCKS_GRANTED = 20, USF_GRANULARITY = 1 block, TLLI_BLOCK_CHANNEL_CODING = cs1, CHANNEL_CODING_COMMAND = cs1, the same USF_TN assigned on the same time slot as in step 1. Sent on PRACH.
8	SS -> MS	PACKET DOWNLINK DUMMY CONTROL BLOCK	Sent on the PACCH of the PDCH, the USF assigned to the MS, on 3 blocks from the last radio block containing the uplink assignment.
9	MS -> SS	UPLINK RLC DATA BLOCK	Received on the assigned PDTCH.
10		{Completion of uplink RLC data block transfer}	

Specific Message Contents

PACKET RESOURCE REQUEST message in step 6:

{0 1<ACCESS_TYPE>} {0<GLOBAL TFI> - GLOBAL TFI	0 (no access type IE) 1 (Global TFI) The same TFI value assigned
--	--

PACKET UPLINK ASSIGNMET message in step 7:

Referenced Address - - Global TFI CHANNEL_CODING_COMMAND TLLI_BLOCK_CHANNEL_CODING Dynamic allocation - {0 1<UPLINK_TFI_ASSIGNMENT>} - {0 1<RLC_DATA_BLOCKS_GRANTED>} - RLC_DATA_BLOCKS_GRANTED	0 (Global TFI) The TFI value assigned in step 1 CS-1 coding CS-1 coding 010 0 (no TFI assignment) 1 (close-ended TBF) 20
---	--

42.3.1.1.3 Dynamic Allocation / Uplink Transfer / Normal / Starting frame number encoding

42.3.1.1.3.1 Conformance requirements

1. In case of dynamic allocation, if no uplink TBF is in progress, the MS needs not monitor the USF field until the TDMA frame number occurs. When the indicated TDMA frame number occurs, the mobile station shall immediately begin to monitor the USF field and use the new assigned uplink TBF parameters when its USF occurs.

2. If an uplink TBF is already in progress, the MS shall continue to use the parameters of the existing TBF until the TDMA frame number occurs. When the indicated TDMA frame number occurs, the mobile station shall immediately begin to monitor the USF field and use the new assigned uplink TBF parameters when its USF occurs.
3. In case of single block allocation, the mobile station shall use the assigned timeslot during the RLC/MAC block whose first TDMA burst occurs in the indicated TDMA frame number.
4. If the mobile station is in packet transfer mode during the block immediately before the starting time and the lowest numbered PDCH assigned to the MS is different immediately before and after the starting time then the mobile station shall be ready to receive or transmit no later than one radio block from the starting time
5. If the Starting FN (in absolute frame number encoding) is not aligned to the start of a block period and the mobile station is in packet transfer mode during the TDMA immediately before the Starting FN, then the mobile station shall align the starting time to the next block boundary and continue to use the currently assigned allocation up to the next block boundary.

References

GSM 04.60, 11.2.29, 12.21, 12.21.1

42.3.1.1.3.2 Test purposes

To verify that the MS, in transfer mode,

1. correctly uses the starting frame number description in PACKET UPLINK ASSIGNMENT and PACKET TIMESLOT RECONFIGURE, and in all subsequent RLC/MAC control messages which are sent on the uplink TBF,
2. is ready to receive or transmit no later than one radio block from the starting time,
3. is able to align the starting time to the next block boundary and continue to use the currently assigned allocation up to the next block boundary.

42.3.1.1.3.3 Method of test

Initial Conditions

System Simulator:

1 cell, default setting, BS_PBCCH_BLKs = 3.

Mobile Station:

The MS is GPRS attached with a P-TMSI allocated and the test PDP context3 activated.

Related PICS/PIXIT Statement(s)

Support GPRS service,

Support activation of at least one PDP context,

The way to trigger the MS initiating an uplink packet transfer.

Test Procedure

The MS is triggered to initiate packet uplink transfer 440 octets in the RLC unacknowledged mode. The PACKET UPLINK ASSIGNMENT message contains a starting time encoded in absolute frame number format for the single block allocation. It is checked that the MS uses the time slot at the assigned frame number. In the two-phase access a starting time is included in PACKET UPLINK ASSIGNMENT. The assigned USF is on a radio block before the starting time. The MS does not react upon that. The assigned USF is on one block after the starting time. The MS sends a RLC data block.

The SS sends PACKET TIMESLOT RECONFIGURE containing a starting time encoded in absolute frame number format. The assigned USF is on a block before the starting time. The MS does not react upon that. The assigned USF is sent on one block after the starting time. The MS sends a RLC data block.

The test procedure is repeated once. The starting time is encoded in relative frame number format.

Maximum Duration of Test

5 min.

Expected Sequence

The expected sequence is repeated once. In the 2nd execution the starting frame numbers in the specific message contents are encoded in the relative format.

Step	Direction	Message	Comments
1		{Uplink dynamic allocation two phase access}	n = 440 octets, USF_GRANULARITY = 1 block, RLC_DATA_BLOCKS_GRANTED = open-end TLLI_BLOCK_CHANNEL_CODING: same as channel coding CHANNEL_CODING_COMMAND: cs-3 The 1st PACKET UPLINK ASSIGNMENT contains starting time specified in absolute frame number encoding, current frame + 1001. It is checked that PACKET RESOURCE REQUEST in the macro is sent at the starting time. The 2 nd PACKET UPLINK ASSIGNMENT contains starting time specified in absolute frame number encoding, current frame + 91, The timeslot TN ₇ assigned.
2	SS -> MS	PACKET DOWNLINK DUMMY CONTROL BLOCK	The USF assigned to the MS, Sent on one radio block before the starting time.
3	SS		Check that there is no RLC data block sent by the MS on the assigned PDTCH.
4	SS -> MS	PACKET DOWNLINK DUMMY CONTROL BLOCK	The USF assigned to the MS. Sent on one block after the starting time.
5	MS -> SS	UPLINK RLC DATA BLOCK	Received on the assigned PDTCH. Check that the coding is the scheme specified by CHANNEL_CODING_COMMAND in step 1, and TFI is correct.
6	SS -> MS	PACKET TIMESLOT RECONFIGURE	Sent on the PACCH, reassign timeslot TN ₀ with Starting Time For the 1 st execution: in absolute frame number encoding, current frame + 102. For the 2 nd execution: in relative frame number encoding, current frame + 104
7	SS -> MS	PACKET DOWNLINK DUMMY CONTROL BLOCK	The USF assigned to the MS. Sent on PACCH of PDCH assigned in step 6, on a radio block before the starting time Note: for the 1 st execution, i.e. 99 or 100 frames from the 1 st frame containing PACKET TIMESLOT RECONFIGURE in step 6.
8	SS		Check that no RLC data block is sent by the MS on the assigned PDTCH.
9	SS -> MS	PACKET DOWNLINK DUMMY CONTROL BLOCK	The USF assigned to the MS, sent on one block after the starting time Note: for the 1 st execution, i.e. 108 or 109 frames from the 1 st frame containing PACKET TIMESLOT RECONFIGURE in step 6.
10	MS -> SS	UPLINK RLC DATA BLOCK	Received on the assigned PDTCH. Check that the coding is the scheme specified by CHANNEL_CODING_COMMAND in step 6, and TFI is correct.
11		{Completion of uplink RLC data block transfer}	

42.3.1.1.4 Dynamic Allocation / Uplink Transfer / Normal / Starting time

42.3.1.1.4.1 Conformance requirements

- 1 If a TBF starting time information element is present and no uplink TBF is in progress, but a downlink TBF is in progress, the mobile station shall wait until the starting time before beginning to monitor the USFs. While waiting for the starting time, the mobile station shall monitor the assigned PDCHs.
- 2 If an uplink TBF is already in progress, the mobile station shall continue to use the assigned parameters of the uplink TBF until the TDMA frame number indicated by the TBF starting time occurs. At that time the mobile station shall immediately begin to use the newly assigned uplink TBF parameters.

- 3 While waiting for the frame number indicated by the TBF starting time if the mobile station receives another uplink assignment, the mobile station shall act upon the most recently received uplink assignment and shall ignore the previous uplink assignment.

References

GSM 04.60, 8.1.1.1

42.3.1.1.4.2 Test purposes

To verify that after the MS receives an uplink assignment with starting time:

1. if a downlink TBF is in progress and no uplink TBF is in progress it monitors the assigned PDCHs while waiting for the starting time. If another uplink assignment received while waiting, the mobile station acts upon that and ignores the previous uplink assignment.
2. if an uplink TBF is already in progress, it continues to use the assigned parameters of the uplink TBF until the TDMA frame number indicated by the TBF starting time occurs. While waiting for the frame number indicated by the TBF starting time the mobile station receives another uplink assignment, the mobile station acts upon that and ignores the previous uplink assignment. As soon as the starting time occurs the MS immediately begins to use the newly assigned uplink TBF parameters.

42.3.1.1.4.3 Method of test

Initial Conditions

System Simulator:

1 cell, default setting, BS_PBCCH_BLKs = 3.

Mobile Station:

The MS is GPRS attached with a P-TMSI allocated and the test PDP context2 activated.

Related PICS/PIXIT Statement(s)

Support GPRS service,

Support activation of at least one PDP context,

The way to trigger the MS initiating an uplink packet transfer.

Test Procedure

A downlink TBF is established and in progress. An uplink TBF is established with a starting time which does not yet elapse. The SS sends two downlink data blocks before the starting time to the MS and signals the assigned TBF addressing the MS for uplink transfer. It is checked that no uplink RLC data blocks are sent by the MS. The SS sends PACKET TIMESLOT RECONFIGURE on one radio block before the starting time, assigning a new starting time. Two downlink data blocks are then sent to the MS before the new starting time occurs. Each data block contains one of the assigned USFs addressing the MS. It is checked that no uplink data blocks are sent from the MS. After the new starting time elapses the SS sends a downlink data block containing the USF assigned to the MS. The MS sends an uplink data block. The MS is brought to Idle mode.

An uplink TBF is established and in progress. The SS sends PACKET TIMESLOT RECONFIGURE assigning a reconfigured PDCH with a starting time and a new USF associated. Before the starting time the SS signals the USF of the ongoing TBF addressing the MS. The SS receives an uplink data block from the MS. The SS sends UPLINK ASSIGNMENT on one radio block before the starting time, assigning a new reconfigured PDCH with a starting time and a different USF associated. The later assignment overwrites the earlier one. While waiting for the frame number of the newly assigned starting time the SS signals the USF of the previous assignment on both the ongoing PDCH and on the previous assigned PDCH. The MS ignores it. The SS signals the USF of the ongoing TBF addressing the MS. An uplink data block can be received. On one radio block before the starting time the SS signals the later assigned USF assigned to the MS on the later assigned PDCH. No uplink data block is received. On one radio block after the starting time the

SS signals the just expired USF. No uplink data block is received. Then the SS signals the valid USF assigned to the MS. An uplink data block is received.

Maximum Duration of Test

5 min.

Expected Sequence

Step	Direction	Message	Comments
1		{Downlink TBF establishment}	RLC mode: acknowledged, without starting time
2	SS -> MS	DOWNLINK RLC DATA BLOCK	The data block contains FBI=0 and a valid RRBP, sent on 2 blocks from the last radio block containing the downlink assignment.
3	MS -> SS	PACKET DOWNLINK ACK/NACK	Received on the specified RRBP of downlink PACCH.
4		{Uplink dynamic allocation two phase access}	n = 440 octets, USF_GRANULARITY = 1 block, RLC_DATA_BLOCKS_GRANTED = open-end TLLI_BLOCK_CHANNEL_CODING: arbitrarily chosen CHANNEL_CODING_COMMAND: arbitrarily chosen but different from above. The 2 nd PACKET UPLINK ASSIGNMENT contains starting time ₁ , the current frame + 104 frames, encoded in absolute frame number. The uplink TBF is assigned on the same timeslot as the downlink TBF. Note: If the triggering of an uplink access in the macro involves a manual operation and the manual operation takes more than 5s, step 2 and 3 are repeated at least once every 5s during the triggering, in order to keep the downlink transfer being in progress.
5	SS -> MS	DOWNLINK RLC DATA BLOCK	FBI=0, the assigned USF ₁ to the MS. Sent on downlink PDTCH, 12 data blocks (52 TDMA frames) before the starting time ₁ .
6	SS -> MS	DOWNLINK RLC DATA BLOCK	FBI=0, the assigned USF ₁ to the MS. Sent on downlink PDTCH, 5 blocks before the starting time ₁ , a valid RRBP = N+13.
7	MS -> SS	PACKET DOWNLINK ACK/NACK	Received on the specified RRBP on downlink PACCH.
8	SS -> MS	PACKET TIMESLOT RECONFIGURE	Assigned USF ₁ addressing the MS, sent on one block before the starting time ₁ . Assigned a new USF ₂ on the same timeslot, with starting time ₂ , current frame + 104 frames in relative frame number encoding.
9	SS -> MS	DOWNLINK RLC DATA BLOCK	On 4 blocks from the last radio block containing the uplink assignment in step 8, with FBI=0, the assigned previous USF ₁ addressing the MS. Sent on downlink PDTCH.
10	SS -> MS	DOWNLINK RLC DATA BLOCK	One data block with FBI=0, the assigned USF ₂ addressing the MS. Sent on downlink PDTCH, one radio block before the starting time ₂ .
11	SS		Check that from the step 4 onwards till the starting time ₂ , there is no RLC data block sent by the MS on the assigned uplink PDTCH.
12	SS -> MS	DOWNLINK RLC DATA BLOCK	One data block with FBI=0, a valid RRBP, the assigned USF ₂ addressing the MS. Sent on downlink PDTCH, on the frame number specified in the starting time ₂ .
13	MS -> SS	UPLINK RLC DATA BLOCK	Received on the assigned uplink PDTCH.
14	MS -> SS	PACKET DOWNLINK ACK/NACK	Received on the specified RRBP of downlink PACCH.
15	SS -> MS	DOWNLINK RLC DATA BLOCK	One data block with FBI=1 and a valid RRBP. Sent on downlink PDTCH.
16	MS -> SS	PACKET DOWNLINK ACK/NACK	Received on the specified RRBP of the downlink PACCH.
17		{Completion of uplink RLC data block transfer}	
18		{Uplink dynamic allocation two phase access}	n = 440 octets, without starting time, USF_GRANULARITY = 1 block, RLC_DATA_BLOCKS_GRANTED = open-end TLLI_BLOCK_CHANNEL_CODING: arbitrarily chosen CHANNEL_CODING_COMMAND: cs-1 The timeslot TN ₃ assigned
19	SS -> MS	PACKET DOWNLINK DUMMY CONTROL BLOCK	Assigned USF ₁ addressing the MS, sent on 3 blocks from the last radio block containing the uplink assignment in step 18.
20	MS -> SS	UPLINK RLC DATA BLOCK	Check that the coding is cs1, the TFI is correct.
21	SS -> MS	PACKET UPLINK ACK/NACK	Assigned USF ₁ addressing the MS.
22	MS -> SS	UPLINK RLC DATA BLOCK	Received on the assigned PDTCH.

23	SS -> MS	PACKET TIMESLOT RECONFIGURE	Assign an uplink TBF on the timeslot TN ₂ , containing new TFI ₂ , USF ₂ , starting time ₃ , current frame + 117 in relative encoding. Sent on PACCH assigned.
24	SS -> MS	PACKET UPLINK ACK/NACK	USF ₁ addressing the MS, sent on 5 radio blocks before the starting time ₃ , on PACCH assigned in step 18.
25	MS -> SS	UPLINK RLC DATA BLOCK	Check that the coding is cs1, the TFI is correct.
26	SS -> MS	PACKET UPLINK ASSIGNMENT	Assign a TBF on the timeslot TN ₁ , containing new TFI ₃ , USF ₃ , cs-3 coding, starting time ₄ , current frame + 325 in relative encoding. Sent on one radio block before the starting time ₃ , on PACCH assigned in step 18.
27	SS -> MS	PACKET UPLINK ACK/NACK	USF ₂ addressing the MS, sent on 4 blocks from the last radio block containing the uplink assignment in step 26 on the both PACCHs assigned in step 18 and 23.
28	SS		Check that no data block is sent from the MS on the assigned radio block on the two PDTCHs assigned in step 18 and 23.
29	SS -> MS	PACKET DOWNLINK DUMMY CONTROL BLOCK	USF ₁ addressing the MS, sent on 5 radio blocks before the starting time ₄ , on PACCH assigned in step 18.
30	MS -> SS	UPLINK RLC DATA BLOCK	Check that the coding is cs1, the TFI is correct.
31	SS -> MS	PACKET DOWNLINK DUMMY CONTROL BLOCK	The USF ₃ addressing the MS, sent on one radio block before the starting time ₄ , on PACCH assigned in step 23.
32	SS -> MS	PACKET DOWNLINK DUMMY CONTROL BLOCK	The USF ₁ addressing the MS, sent on one radio block after the starting time ₄ , on PACCH assigned in step 18.
33	SS		Check that no data blocks are sent from the MS on the radio blocks assigned in steps 31 and 32, or any intermediate radio blocks, on any of the three PDTCHs assigned
34	SS -> MS	PACKET UPLINK ACK/NACK	Containing USF ₃ . Sent on PACCH of assigned in step 26.
35	MS -> SS	UPLINK RLC DATA BLOCK	Received on the PDTCH assigned in step 26. Check that the coding cs-3 and TFI ₃ are correct.
36		{Completion of uplink RLC data block transfer}	

42.3.1.1.5 Dynamic Allocation / Uplink Transfer / Normal / Close-ended TBF

42.3.1.1.5.1 Conformance requirements

1. During a close-ended TBF the mobile station shall transmit only the number of RLC data blocks indicated in the RLC_DATA_BLOCKS_GRANTED field. RLC/MAC control blocks and retransmissions of RLC data blocks do not count toward the limit.
2. In the case the access type in Channel Request was 'Short Access', only the number of RLC data blocks requested in the Channel Request are allowed to be transmitted within the TBF, unless additional resources have been requested and assigned before the countdown procedure has started.
3. When the mobile station nears the end of the fixed length TBF, it shall begin the count down procedure so that it sends the last RLC data block when CV = 0. The mobile station and network shall then follow the appropriate procedure for release of TBF defined in GSM 04.60 9.3.2.3 or 9.3.3.3.
4. If the number of RLC data blocks granted is not sufficient to empty the mobile station's send buffer, the mobile station shall attempt to establish a new uplink TBF for the transmission of the outstanding LLC frames following the end of the fixed length TBF.

References

GSM 04.60, 8.1.1.1

42.3.1.1.5.2 Test purposes

To verify that during a close-ended TBF:

- 1 The MS transmits only the number of RLC data blocks indicated in the RLC_DATA_BLOCKS_GRANTED field. RLC/MAC control blocks and retransmissions of RLC data blocks do not count toward the limit indicated by RLC_DATA_BLOCKS_GRANTED.
- 2 When the MS nears the end of the close-ended TBF, it begins the count down procedure and sends the last RLC data block when CV = 0.
- 3 If the number of RLC data blocks granted is not sufficient to empty the MS's send buffer, the MS attempts to establish a new uplink TBF for the transmission of the outstanding LLC frames following the end of the close-ended TBF.

It is also verified that

4. When the access type in Channel Request was "Short Access", the MS transmits only the number of RLC data blocks requested in the Channel Request.

42.3.1.1.5.3 Method of test

Initial Conditions

System Simulator:

1 cell, default setting, BS_PBCCH_BLKs = 3.

Mobile Station:

The MS is GPRS attached with a P-TMSI allocated and the test PDP context2 activated.

Related PICS/PIXIT Statement(s)

Support GPRS service,

Support activation of at least one PDP context,

The way to trigger the MS initiating an uplink packet transfer.

Test Procedure

The MS is triggered to send 570 octets data in acknowledged mode. Only 10 RLC data blocks are granted for a closed TBF in a assignment. After the MS sends the first data block the SS negatively acknowledges the received data. The MS resends the data block. The MS is polled and the USF assigned to the MS. The MS sends another data block and PACKET CONTROL ACKNOWLEDGEMENT. The resent data block and the RLC/MAC control block do not count toward the granted blocks limit. The SS gives the USF assigned to the MS 8 times so that the MS is allowed to send another 8 data blocks. It is checked that the last data block contains the countdown variable CV=0. The MS sends PACKET CHANNEL REQUEST for new resource in order to empty the sending buffer. The request is granted and a new PDCH is assigned for empty the MS data buffer.

The MS is triggered to send 89 octets data in acknowledged mode. It is checked that the MS requests five RLC data blocks for short access. Although 10 data blocks are granted in the assignment and the assigned USF is addressing the MS 6 times, it is checked that the MS sends only five RLC data blocks.

Maximum Duration of Test

5 min.

Expected Sequence

Step	Direction	Message	Comments
1		{Uplink dynamic allocation two phase access}	n = 600 octets, test PDP context2, USF_GRANULARITY = 1 block, RLC_DATA_BLOCKS_GRANTED = 10 CHANNEL_CODING_COMMAND = CS-1
2	SS -> MS	PACKET DOWNLINK DUMMY CONTROL BLOCK	USF assigned to the MS, sent on 3 blocks from the last radio block containing the uplink assignment.
3	MS -> SS	UPLINK RLC DATA BLOCK	Check that the coding is cs1, the TFI is correct.
4	SS -> MS	PACKET UPLINK ACK/NACK	Nack the received data block after BS_CV_MAX block periods,
5	SS -> MS	PACKET DOWNLINK DUMMY CONTROL BLOCK	USF assigned to the MS, sent on 6 blocks from step 4
6	MS -> SS	UPLINK RLC DATA BLOCK	Received on the assigned PDTCH. Check that the coding and the TFI are correct. The retransmitted data block does not count toward the granted blocks limit.
7	SS -> MS	PACKET UPLINK ACK/NACK	Containing valid RRBP and USF assigned to the MS. Sent on the PACCH.
8	MS -> SS	UPLINK RLC DATA BLOCK	Received on the assigned PDTCH. Check that the coding and the TFI are correct.
9	MS -> SS	PACKET CONTROL ACKNOWLEDGEMENT	Received on the assigned PACCH. This block does not count toward the granted blocks limit.
10	SS -> MS	PACKET UPLINK ACK/NACK	USF assigned to the MS.
11	MS -> SS	UPLINK RLC DATA BLOCK	Received on the assigned PDTCH. Check that the coding and the TFI are correct.
12			Repeat steps 10 to 11 seven times. Check that the last RLC data block contains CV=0 (the count down procedure executed correctly).
13	SS -> MS	PACKET UPLINK ACK/NACK	FINAL_ACK_INDICATION = '1', containing valid RRBP acknowledged all received data blocks. Sent on PACCH.
14	MS -> SS	PACKET CONTROL ACKNOWLEDGEMENT	Received on the block specified by RRBP on PACCH of the assigned PDCH.
15	MS -> SS	PACKET CHANNEL REQUEST	Received on PRACH. Request new resource to empty the sending buffer.
16	SS -> MS	PACKET UPLINK ASSIGNMENT	Single block assignment, to force the MS making two phase access procedure. Sent on PAGCH.
17	MS -> SS	PACKET RESOURCE REQUEST	Two phase access procedure. Received on the single block assigned in step 16.
18	SS -> MS	PACKET UPLINK ASSIGNMENT	Open-ended uplink dynamic allocation, no starting time, USF_GRANULARITY = single block, TLLI_BLOCK_CHANNEL_CODING = use channel coding command, CHANNEL_CODING_COMMAND = cs2. Sent on PACCH of the same PDCH assigned in step 16.
19	SS -> MS	PACKET DOWNLINK DUMMY CONTROL BLOCK	The USF assigned to the MS. sent on 3 blocks from the last radio block containing the uplink assignment in step 18.
20	MS -> SS	UPLINK RLC DATA BLOCK	
21		{Completion of uplink RLC data block transfer}	
22		{Uplink dynamic allocation one phase access}	n = 89 octets, test PDP context2, USF_GRANULARITY = 1 block, RLC_DATA_BLOCKS_GRANTED = 10, CHANNEL_CODING_COMMAND = CS-1. Check that the access type in PACKET CHANNEL REQUEST is "Short Access", and NumberOfBlocks indicates between 5 - 8 RLC data blocks.
23	SS -> MS	PACKET DOWNLINK DUMMY CONTROL BLOCK	Sent on the PACCH of the PDCH assigned, the USF assigned to the MS.

24	MS -> SS	UPLINK RLC DATA BLOCK	Received on the assigned PDTCH. Check that the coding and the TFI are correct.
25	SS -> MS	PACKET UPLINK ACK/NACK	With TLLI, USF assigned to the MS.
26	MS -> SS	UPLINK RLC DATA BLOCK	Received on the assigned PDTCH. Check that the coding and the TFI are correct.
27			Repeat step 25 and 26 3 – 6 times depending on the value of NumberOfBlocks in step 22.
28	SS -> MS	PACKET DOWNLINK DUMMY CONTROL BLOCK	USF assigned to the MS
29	MS - SS	PACKET UPLINK DUMMY CONTROL BLOCK	No data block transmitted from the MS.
30	SS -> MS	PACKET UPLINK ACK/NACK	FINAL_ACK_INDICATION = '1', containing valid RRBP. Sent on PACCH.
31	MS -> SS	PACKET CONTROL ACKNOWLEDGEMENT	Received on the block specified by RRBP on PACCH.

42.3.1.1.6 Dynamic Allocation / Uplink Transfer / Normal / T3180 expiry

42.3.1.1.6.1 Conformance requirements

When the mobile station transmits an RLC/MAC block to the network, it shall start timer T3180. When the mobile station detects an assigned USF value on an assigned PDCH, the mobile station shall reset timer T3180. If timer T3180 expires, the mobile station shall perform the abnormal release with random access procedure.

References

GSM 04.60, 8.1.1.1

42.3.1.1.6.2 Test purposes

To verify that

1. Timer T3180 will not expire as long as an USF for the MS under test is detected in the downlink blocks within the defined time period of the timer. (It is implicitly verified).
2. Timer T3180 expires if no USF for the MS under test is detected during a time period longer than T3180.
3. The MS performs an abnormal release with random access procedure after T3180 expires.

42.3.1.1.6.3 Method of test

Initial Conditions

System Simulator:

1 cell, default setting, BS_PBCCH_BLKs = 3.

Mobile Station:

The MS is GPRS attached with a P-TMSI allocated and the test PDP context3 activated.

Related PICS/PIXIT Statement(s)

Support GPRS service,

Support activation of at least one PDP context,

The way to trigger the MS initiating an uplink packet transfer

Test Procedure

An uplink TBF is established and in progress. After the MS sends an uplink data block the SS repeatedly sends PACKET UPLINK ACK/NACK containing any USF and any TFI which do not address the MS for 4.5s. Before T3180 times out the SS signals the USF assigned to the MS. The MS sends a data block. Then the SS repeatedly sends PACKET UPLINK ACK/NACK containing any USF and any TFI which do not address the MS until receiving PACKET CHANNEL REQUEST from the MS for establishment of a new TBF.

Maximum Duration of Test

5 min.

Expected Sequence

Step	Direction	Message	Comments
1		{Uplink dynamic allocation two phase access}	n = 220 octets, without starting time, USF_GRANULARITY = 1 block, RLC_DATA_BLOCKS_GRANTED = open-end TLLI_BLOCK_CHANNEL_CODING: arbitrarily chosen CHANNEL_CODING_COMMAND: arbitrarily chosen but different from above.
2	SS -> MS	PACKET DOWNLINK DUMMY CONTROL BLOCK	The USF assigned to the MS sent on 3 blocks from the last radio block containing the uplink assignment.
3	MS -> SS	UPLINK RLC DATA BLOCK	Received on the assigned PDTCH. Check that the TFI is correct.
4	SS -> MS	PACKET UPLINK ACK/NACK	Sent on the PACCH of the PDCH assigned in step 2, the USF assigned to the MS.
5	MS -> SS	UPLINK RLC DATA BLOCK	Received on the assigned PDTCH. Check that the TFI is correct.
6	SS -> MS	PACKET DOWNLINK DUMMY CONTROL BLOCK	Sent on the PACCH, containing a different TFI and USF from the assigned ones to the MS.
7	SS		Repeat step 6 every 5 radio blocks for 4.5 s. (T3180 * 90%) the SS signals different USFs on the assigned PDCH, but none of them addressing the MS.
8	SS -> MS	PACKET UPLINK ACK/NACK	Sent on the PACCH of the PDCH assigned in step 2, the USF assigned to the MS.
9	MS -> SS	UPLINK RLC DATA BLOCK	Received on the assigned PDTCH. Check that the TFI is correct.
10	SS		Repeat step 6 every 5 radio blocks until step 11 occurs. The maximum period for the repetition is of 8s (5s timer + two PSI1 periods). None of the signalled USFs addresses the MS on the assigned PDCH.
11	MS -> SS	PACKET CHANNEL REQUEST	Received on PRACH within 7.5 seconds (T3180 * 110% + PSI1 repeat period) from step 9.
12	SS -> MS	PACKET UPLINK ASSIGNMENT	Single block assignment, to order the MS making two-phase access procedure. Sent on PAGCH.
13	MS -> SS	PACKET RESOURCE REQUEST	Two phase access procedure. Received on the single block assigned in step 12.
14	SS -> MS	PACKET UPLINK ASSIGNMENT	Open-ended uplink dynamic allocation, no starting time, USF_GRANULARITY = single block, Sent on PACCH of the same PDCH assigned in step 12.
15	SS -> MS	PACKET DOWNLINK DUMMY CONTROL BLOCK	The USF assigned to the MS. Sent on PACCH of PDCH assigned in step 14.
16	MS -> SS	UPLINK RLC DATA BLOCK	Received on the assigned PDTCH. Check that the coding scheme is that specified in step 14 by CHANNEL_CODING_COMMAND and the TFI is correct.
17		{Completion of uplink RLC data block transfer}	

Specific Message Contents

PACKET UPLINK ASSIGNMET message in step 14:

CHANNEL_CODING_COMMAND	Arbitrarily chosen but different the value in step 2
TLLI_BLOCK_CHANNEL_CODING	Arbitrarily chosen but different from CHANNEL_CODING_COMMAND
Dynamic allocation	01
- Extended Dynamic Allocation	0 (Dynamic allocation)
-	0
- USF granularity	0 (1 block)
- {0 1<UPLINK_TFI_ASSIGNMENT>}	0 (uplink TFI assignment)
- {0 1<RLC_DATA_BLOCKS_GRANTED>}	0 (no RLC_DATA_BLOCKS_GRANTED, open-ended TBF)
- {0 1<TBF_STARTING_TIME>}	0 (no starting time)
-	0 (Timeslot Allocation Parameters)
	one slot arbitrarily chosen but different from the value in step 2

42.3.1.1.7 Dynamic Allocation / Uplink Transfer / Normal / PACCH operation

42.3.1.1.7.1 Conformance requirements

1. The mobile station shall attempt to decode every downlink RLC/MAC block on all assigned PDCHs. Whenever the mobile station receives an RLC/MAC block containing an RLC/MAC control block, the mobile station shall attempt to interpret the message contained therein. If the message addresses the mobile station, the mobile station shall act on the message. The mobile station shall not transmit an RLC data block in any uplink radio block allocated via the polling mechanism.
2. PACKET POLLING REQUEST is sent on the PCCCH or PACCH by the network to the mobile station to solicit a PACKET CONTROL ACKNOWLEDGEMENT message from the mobile station.
3. In downlink RLC/MAC control blocks, the TFI identifies the Temporary Block Flow (TBF) to which the RLC/MAC control message contained in the downlink RLC/MAC control block relates. If present, this field indicates the mobile station to which the control message is addressed, and all other mobile stations shall ignore the control message. If this field is present and the contents of the control message also contain a TFI addressing the mobile station, the mobile station shall ignore the TFI in the control message contents.

References

GSM 04.60, 8.1.1.1.1, 11.2.12, 10.4.10

42.3.1.1.7.2 Test purposes

To verify that:

1. The MS attempts to decode every downlink RLC/MAC block on all assigned PDCHs whenever the MS receives an RLC/MAC block containing an RLC/MAC control block, the MS attempts to interpret the message contained therein, such as Payload type and TFI in the optional fields. If the message addresses the MS, it acts upon the message.
2. When receiving PACKET POLLING REQUEST on PACCH the MS responds with four PACKET CONTROL ACKNOWLEDGEMENT messages of access burst format and does not transmit an RLC data block in any uplink radio block allocated via the polling mechanism.

42.3.1.1.7.3 Method of test

Initial Conditions

System Simulator:

1 cell, default setting, BS_PBCCH_BLKs = 3.

Mobile Station:

The MS is GPRS attached with a P-TMSI allocated and the test PDP context3 activated.

Related PICS/PIXIT Statement(s)

Support GPRS service,

Support activation of at least one PDP context,

The way to initiate an uplink transfer

Test Procedure

A TBF is established. It is polled with PACKET POLLING REQUEST containing a global TFI not addressing the MS. The assigned USF addresses the MS. The MS transmits a data block. The SS polls the MS with PACKET POLLING REQUEST containing any global TFI not addressing the MS. The message has optional octets where TFI does address the MS. The MS responds with PACKET CONTROL ACKNOWLEDGEMENT four times in access burst formats. The SS polls again the MS with PACKET POLLING REQUEST containing the global TFI addressing the MS. The MS responds with PACKET CONTROL ACKNOWLEDGEMENT four times in access burst formats.

Maximum Duration of Test

5 min.

Expected Sequence

Step	Direction	Message	Comments
1		{Uplink dynamic allocation two phase access}	n = 440 octets, without starting time, USF_GRANULARITY = 1 block, RLC_DATA_BLOCKS_GRANTED = open-end TLLI_BLOCK_CHANNEL_CODING: arbitrarily chosen CHANNEL_CODING_COMMAND: arbitrarily chosen but different from above.
2	SS -> MS	PACKET POLLING REQUEST	the USF assigned to the MS, the TFI in the message not addressing the MS, no optional octets in RLC/MAC header, a valid RRBP
3	MS -> SS	UPLINK RLC DATA BLOCK	Check the TFI is correct as assigned in step 1.
4	SS -> MS	PACKET POLLING REQUEST	NOT the USF assigned to the MS, the global TFI in the message contents NOT addressing the MS, Payload type indicates the RLC/MAC header containing optional octets where TFI DOES address the MS, RBSN='0'. TYPE_OF_ACK = '0', a valid RRBP=N+13 4 access bursts. Received on PACCH, CTRL_ACK = '10'.
5	MS -> SS	PACKET CONTROL ACKNOWLEDGEMENT	
6	SS -> MS	PACKET POLLING REQUEST	Not the USF assigned to the MS. The global TFI in the message contents addressing the MS. Payload type indicates the RLC/MAC header containing optional octets where TFI not addressing the MS. a valid RRBP
7	SS		Check the MS ignores the polling .
8	SS -> MS	PACKET POLLING REQUEST	Not the USF assigned to the MS. the Global TFI addresses the MS, RLC/MAC header containing no optional octets. TYPE_OF_ACK = '0', a valid RRBP
9	MS -> SS	PACKET CONTROL ACKNOWLEDGEMENT	4 access bursts, received on PACCH.
10		{Completion of uplink RLC data block transfer}	

42.3.1.1.8 Dynamic Allocation / Uplink Transfer / Normal / Two uplink timeslots

This test case verifies the multislot capabilities and applies to all Mobile Station belonging to the multislot class 3, 5, 6, 7 and 9 - 29.

42.3.1.1.8.1 Conformance requirements

Mobile station belonging to multislot class 3, 5, 6, 7 and 9 – 29 shall support at least two transmit timeslots per TDMA frame (refer to GSM 05.02, Annex B1).

References

GSM 05.02, Annex B1

42.3.1.1.8.2 Test purposes

To verify that an MS belonging to multislot class 3, 5, 6, 7 and 9 – 29 supports an uplink TBF using two timeslots per TDMA frame.

42.3.1.1.8.3 Method of test

Initial Conditions

System Simulator:

1 cell, default setting, BS_PBCCH_BLKs = 3.

Mobile Station:

The MS is GPRS attached with a P-TMSI allocated and the test PDP context2 activated.

Related PICS/PIXIT Statement(s)

Support GPRS service,

Support activation of at least one PDP context,

The way to initiate an uplink packet transfer,

The multislot classes supported.

Test Procedure

The MS is triggered to initiate packet uplink transfer data in RLC acknowledged mode. The SS orders the MS to use two-phase access procedure, in PACKET UPLINK ASSIGNMENT two timeslots are assigned. On the same TDMA frame the SS signals to the MS the assigned USFs addressing the MS on the two assigned PDTCHs. It is checked that the two RLC/MAC data blocks in the next radio block period are received on the respective PDTCH channels and that each data block contains the correct TFI without TLLI.

The SS acknowledges the received data and assigns the USFs addressing the MS. The check is repeated. The same procedure is going on until the MS completes the packet data transfer.

Maximum Duration of Test

5 min

Expected Sequence

Step	Direction	Message	Comments
1		{Uplink dynamic allocation two phase access}	n = 440 octets, without starting time, USF_GRANULARITY = 1 block, RLC_DATA_BLOCKS_GRANTED = open-end TLLI_BLOCK_CHANNEL_CODING: arbitrarily chosen, CHANNEL_CODING_COMMAND: arbitrarily chosen but different from above. Two timeslots, USF ₀ on TN ₀ and USF ₁ on TN ₁ , are assigned.
2	SS -> MS	PACKET DOWNLINK DUMMY CONTROL BLOCK	Assigned USF ₀ on PDTCH ₀ addressing the MS on 3 blocks from the last radio block containing the uplink assignment.
3	SS -> MS	PACKET DOWNLINK DUMMY CONTROL BLOCK	Assigned USF ₁ on PDTCH ₁ addressing the MS, sent on the same TDMA frame as step 2.
4	MS -> SS	UPLINK RLC DATA BLOCK	Received on the assigned PDTCH ₀ . Check that the coding as specified in CHANNEL_CODING_COMMAND, the TFI is correct and the block does not contain TLLI.
5	MS -> SS	UPLINK RLC DATA BLOCK	Received on the assigned PDTCH ₁ on the same TDMA frame as step 4. Check that the coding as specified in CHANNEL_CODING_COMMAND, the TFI is correct and the block does not contain TLLI.
6	SS -> MS	PACKET UPLINK ACK/NACK	Assigned USF ₀ on PDTCH ₀ addressing the MS.
7	SS -> MS	PACKET UPLINK ACK/NACK	Assigned USF ₁ on PDTCH ₁ addressing the MS, sent on the same TDMA frame as step 6.
8	MS -> SS	UPLINK RLC DATA BLOCK	Received on the assigned PDTCH ₀ . Check that the coding as specified in CHANNEL_CODING_COMMAND, the TFI is correct and the block does not contain TLLI.
9	MS -> SS	UPLINK RLC DATA BLOCK	Received on the assigned PDTCH ₁ , on the same TDMA frame as step 8. Check that the coding as specified in CHANNEL_CODING_COMMAND, the TFI is correct and the block does not contain TLLI.
10		{Completion of uplink RLC data block transfer}	

Specific Message Contents

The 2nd PACKET UPLINK ASSIGNMET message in step 1:

CHANNEL_CODING_COMMAND	CS-1
TLLI_BLOCK_CHANNEL_CODING	CS-1
Dynamic allocation	01
-	000000
-	1 (Timeslot Allocation with Power Control Parameters for two timeslots assigned)
- ALPHA	0.5
- {0 1<USF_TN0><GAMMA_TN0>}	1 (timeslot 0 assigned)
- USF_TN0	Arbitrarily chosen
- GAMMA_TN0	For GSM 900, +9 dBm
	For DCS 1800, +6 dBm
	For PCS 1900, +6 dBm
- {0 1<USF_TN1><GAMMA_TN1>}	1 (timeslot 1 assigned)
- USF_TN1	Arbitrarily chosen but different from timeslot 0
- GAMMA_TN1	For GSM 900, +9 dBm
	For DCS 1800, +6 dBm
	For PCS 1900, +6 dBm
- {0 1<USF_TN2><GAMMA_TN2>}	0 (timeslot 2 not assigned)
- {0 1<USF_TN3><GAMMA_TN3>}	0 (timeslot 3 not assigned)
- {0 1<USF_TN4><GAMMA_TN4>}	0 (timeslot 4 not assigned)
- {0 1<USF_TN5><GAMMA_TN5>}	0 (timeslot 5 not assigned)
- {0 1<USF_TN6><GAMMA_TN6>}	0 (timeslot 6 not assigned)
- {0 1<USF_TN7><GAMMA_TN7>}	0 (timeslot 7 not assigned)

42.3.1.1.9 Dynamic Allocation / Uplink Transfer / Normal / Frequency parameters

42.3.1.1.9.1 Conformance requirements

1. Frequency parameters are included in the assignment messages (i.e., PACKET DOWNLINK ASSIGNMENT, PACKET UPLINK ASSIGNMENT, or PACKET TIMESLOT RECONFIGURE) and define the radio frequency channels or set of radio frequency channels the mobile station is to use during the assigned TBF. The first assignment message, sent to the mobile station when it enters packet transfer mode, shall include the frequency parameters. Subsequent assignment messages, sent to the mobile station during packet transfer mode, may omit the frequency parameters. If a mobile station receives a subsequent assignment message, during packet transfer mode, without the frequency parameters, the mobile station shall continue to use the previously assigned frequency parameters.
2. The frequency parameters may use an ARFCN defining a non-hopping radio frequency channel, or use the indirect encoding, direct encoding 1 or direct encoding 2 defining a hopping radio frequency channel.
3. The indirect encoding defines the assigned set of radio frequency channels by referencing information stored within the mobile station. Such information may be received on PBCCH or BCCH or be received in a previous assignment message using one of the direct encoding options. An MA_NUMBER identifies which of up to eight stored sets of frequency parameters is to be used.
4. When the indirect encoding is used, the network may include a CHANGE_MARK_1 and a CHANGE_MARK_2 in the Frequency Parameters information element. The mobile station shall then verify that it is using a set of PBCCH or BCCH information identified by a PSI or SI *change mark* corresponding to one of the CHANGE_MARK_1 or 2 parameters, for the decoding of the frequency information. If that is not the case, an abnormal condition occurs.
5. The direct encoding defines the assigned set of radio frequency channels by using information contained within the assignment message. The direct encoding 1 references the cell allocation or reference frequency lists received on PBCCH for the decoding of this information. The direct encoding 2 is self contained. When the direct encoding 1 or 2 is used, the mobile station shall store the received GPRS mobile allocation for possible later reference in an assignment message using the indirect encoding.

References

GSM 04.60, 5.5.1.7, 11.2.19, 12.8 and 12.10a

42.3.1.1.9.2 Test purposes

To verify that

1. The MS in the packet transfer mode understands correctly the frequency parameters in the indirect encoding format in PACKET UPLINK ASSIGNMENT and PACKET TIMESLOT RECONFIGURATION, and correctly uses the information received on PBCCH in PSI13, SI13 and a consistent set of PSI2 for the assigned TBF.
2. The MS in the packet transfer mode understands and uses correctly the frequency parameters in the direct encoding 1 and 2 formats in PACKET UPLINK ASSIGNMENT and PACKET TIMESLOT RECONFIGURATION and stores the received GPRS mobile allocation for a possible later reference in an assignment message using the indirect encoding.

42.3.1.1.9.3 Method of test

Initial Conditions

System Simulator:

1 cell, default setting, BS_PBCCH_BLKs = 3, PSI_COUNT_HR = 1, REPEAT_PERIOD = 1, the initial SI13, PSI13 and the 1st consistent set of PSI2 including 5 instances(see specific message contents). The PSI2s are transmitted with the high repetition.

Mobile Station:

The MS is GPRS attached with a P-TMSI allocated and the test PDP context3 activated.

Related PICS/PIXIT Statement(s)

Support GPRS service,

Support activation of at least one PDP context,

The way to initiate an uplink packet transfer

Test Procedure

The test sequence is repeated three times. Each time before starting PSI13, SI13 and a consistent set of PSI2 are firstly broadcast. The MS is given 3s for reading partially the modified PSI13 and PSI2s.

The test sequence consists of seven resource assignments to the MS. The MS is triggered to initiate packet uplink transfer 462K octets in the RLC unacknowledged mode. Each assignment (either via PACKET UPLINK ASSIGNMENT, or via PACKET TIMESLOT RECONFIGURATION) contains a specific frequency parameter. The MS is allowed to transfer 3000 radio blocks data on the assigned hopping PDCH. It is checked that coding cs1 and TFI are correct in the received data. The frequency hopping check on the assigned PDCH takes about 3 min.

Test parameters:

For GSM900, CA in PSI13 includes the frequencies:

(10, 17, 20, 26, 34, 42, 45, 46, 52, 59, 66, 73, 74, 76, 108, 114).

For DCS1800, CA in PS13 includes the frequencies:

(739,743, 746, 749, 756, 758, 761,764, 771, 779, 782, 791, 798, 829, 832, 844).

For PCS1900, CA in PS13 includes the frequencies:

(718, 721, 724, 727, 734, 739,743, 746, 749, 756, 758, 761,764, 771, 779, 782).

The algorithm for the calculation of array CA (j, k) and MA (j, k) are following:

P-GSM 900:

For $k = 1, 2, 3$:

$ca_{PGSM}(1, k)$ is set to 64.

An arbitrary subset $CA_{PGSM}(1, k)$ of the set $\{1, \dots, 124\}$ containing $ca_{PGSM}(1, k)$ elements is drawn.

An element B of the set $CA_{PGSM}(1, k)$ is arbitrarily chosen.

An arbitrary value $ca_{PGSM}(2, k)$ in the range $20, \dots, 63$ is chosen.

An arbitrary subset $CA_{PGSM}(2, k)$ of the set $\{1, \dots, 124\}$ with $ca_{PGSM}(2, k)$ elements and containing B is chosen.

An arbitrary value $ca_{PGSM}(3, k)$ in the range $4, \dots, 19$ is chosen.

An arbitrary subset $CA_{PGSM}(3, k)$ of the set $\{1, \dots, 124\}$ with $ca_{PGSM}(3, k)$ elements and containing B is chosen.

For $j = 1, 2, 3$, values $ma_{PGSM}(j, k)$ in the range $j, \dots, ca_{PGSM}(j, k) - 1$ and values $MAIO_{PGSM}(j, k)$ in the range $0, \dots, ma_{PGSM}(j, k) - 1$ are arbitrarily chosen.

Subsets $MA_{PGSM}(j, k)$ of $CA_{PGSM}(j, k)$ not containing B and having $ma(j, k)$ elements are arbitrarily chosen.

DCS 1 800:

for $k = 1, 2, 3$:

$ca_{DCS}(1, k)$ is set to 64.

An arbitrary subset $CA_{DCS}(1, k)$ of the set $\{700, \dots, 812\}$ containing $ca_{DCS}(1, k)$ elements is chosen.

An element B of the set $CA_{DCS}(1, k)$ is arbitrarily chosen.

An arbitrary value $ca_{DCS}(2, k)$ in the range $17, \dots, 63$ is chosen.

An arbitrary subset $CA_{DCS}(2, k)$ of the set $\{700, \dots, 812\}$ with $ca_{DCS}(2, k)$ elements and containing B is chosen.

An arbitrary value $ca_{DCS}(3, k)$ in the range $4, \dots, 16$ is chosen.

An arbitrary subset $CA_{DCS}(3, k)$ of the set $\{700, \dots, 812\}$ with $ca_{DCS}(3, k)$ elements and containing B is chosen.

For $j = 1, 2, 3$, values $ma_{DCS}(j, k)$ in the range $j, \dots, ca_{DCS}(j, k) - 1$ and values $MAIO_{DCS}(j, k)$ in the range $0, \dots, ma_{DCS}(j, k) - 1$ are arbitrarily chosen.

Subsets $MA_{DCS}(j, k)$ of $CA_{DCS}(j, k)$ not containing B and having $ma_{DCS}(j, k)$ elements are arbitrarily chosen.

PCS 1 900:

for $k = 1, 2, 3$:

$ca_{PCS}(1, k)$ is set to 64.

An arbitrary subset $CA_{PCS}(1, k)$ of the set $\{700, \dots, 810\}$ containing $ca_{PCS}(1, k)$ elements is chosen.

An element B of the set $CA_{PCS}(1, k)$ is arbitrarily chosen.

An arbitrary value $ca_{PCS}(2, k)$ in the range $17, \dots, 63$ is chosen.

An arbitrary subset $CA_{PCS}(2, k)$ of the set $\{700, \dots, 810\}$ with $ca_{PCS}(2, k)$ elements and containing B is chosen.

An arbitrary value $ca_{PCS}(3, k)$ in the range $4, \dots, 16$ is chosen.

An arbitrary subset $CA_{PCS}(3, k)$ of the set $\{700, \dots, 810\}$ with $ca_{PCS}(3, k)$ elements and containing B is chosen.

For $j = 1, 2, 3$, values $ma_{PCS}(j, k)$ in the range $j, \dots, ca_{PCS}(j, k) - 1$ and values $MAIO_{PCS}(j, k)$ in the range $0, \dots, ma_{PCS}(j, k) - 1$ are arbitrarily chosen.

Subsets $MA_{PCS}(j, k)$ of $CA_{PCS}(j, k)$ not containing B and having $ma_{PCS}(j, k)$ elements are arbitrarily chosen.

GSM 900 and DCS 1 800 and PCS 1 900

$T(1) = 91$,

$T(2) = 42\ 000$,

$T(3) =$ An arbitrary value chosen in the range $92, \dots, 29999$.

Maximum Duration of Test

70 min

Expected Sequence

This sequence is performed for $k = 1, 2, 3$:

Step	Direction	Message	Comments
1		{Uplink dynamic allocation two phase access}	n = 462K octets in RLC unacknowledged mode, without starting time, USF_GRANULARITY = 1 block, RLC_DATA_BLOCKS_GRANTED = open-end TLLI_BLOCK_CHANNEL_CODING: cs1, CHANNEL_CODING_COMMAND: cs1 The 2 nd PACKET UPLINK ASSIGNMENT contains a specific frequency parameter in indirect encoding.
2	SS -> MS	PACKET DOWNLINK DUMMY CONTROL BLOCK	Assigned USF on PDTCH addressing the MS on 3 blocks from the last radio block containing the uplink assignment.
3	MS -> SS	UPLINK RLC DATA BLOCK	Received on the assigned PDTCH. Check that the coding as specified in CHANNEL_CODING_COMMAND, the TFI is correct and the block does not contain TLLI.
4	SS -> MS	PACKET UPLINK ACK/NACK	Assigned USF assigned to the MS, sent on the next radio block of step 3.
5			Repeat step 3, 4 for 3000 times. The last PACKET UPLINK ACK/NACK does not contain the assigned USF.
6	SS -> MS	PACKET UPLINK ASSIGNMENT	Assign a new PDCH with the frequency parameter in direct encoding 1 referred to the CA and MA in PSI13. MA numbered 15 is made same as MA numbered 14.
7	SS -> MS	PACKET DOWNLINK DUMMY CONTROL BLOCK	Assigned USF assigned to the MS on the new PDTCH, on 3 blocks from the last radio block containing the uplink assignment.
8	MS -> SS	UPLINK RLC DATA BLOCK	Received on the assigned PDTCH. Check that the coding as specified in CHANNEL_CODING_COMMAND, the TFI is correct and the block does not contain TLLI.
9	SS -> MS	PACKET UPLINK ACK/NACK	Assigned USF assigned to the MS, sent on the next radio block of step 8.
10			Repeat step 8, 9 for 3000 times. The last PACKET UPLINK ACK/NACK does not contain the assigned USF.
11	SS -> MS	PACKET TIMESLOT RECONFIGURE	Assign a new PDCH with the frequency parameter in indirect encoding referred to CA(1, k).
12	SS -> MS	PACKET DOWNLINK DUMMY CONTROL BLOCK	Sent on the PACCH of the PDCH assigned in step 11 after the starting time, the USF assigned to the MS.
13	MS -> SS	UPLINK RLC DATA BLOCK	Received on the assigned PDTCH.
14	SS -> MS	PACKET UPLINK ACK/NACK	Sent on the PACCH of the PDCH assigned in step 11 after the starting time, the USF assigned to the MS.
15			Repeat step 13, 14 for 3000 times. The last PACKET UPLINK ACK/NACK does not contain the assigned USF.
16	SS -> MS	PACKET UPLINK ASSIGNMENT	Assign a PDCH with the frequency parameter in indirect encoding, MA referred to the number 15.
17	SS -> MS	PACKET DOWNLINK DUMMY CONTROL BLOCK	Assigned USF assigned to the MS on the new PDTCH.
18	MS -> SS	UPLINK RLC DATA BLOCK	Received on the assigned PDTCH. Check that the coding as specified in CHANNEL_CODING_COMMAND, the TFI is correct and the block does not contain TLLI.
19	SS -> MS	PACKET UPLINK ACK/NACK	Sent on the PACCH of the PDCH assigned in step 16 after the starting time, the USF assigned to the MS.
20			Repeat step 18, 19 for 3000 times. The last PACKET UPLINK ACK/NACK does not contain the assigned USF.
21	SS -> MS	PACKET TIMESLOT RECONFIGURE	Assign a new PDCH with the frequency parameter in direct encoding 2 referred to CA(3, k).
22	SS -> MS	PACKET DOWNLINK DUMMY CONTROL BLOCK	Sent on the PACCH of the PDCH assigned in step 21 after the starting time, the USF assigned to the MS.
23	MS -> SS	UPLINK RLC DATA BLOCK	Received on the assigned PDTCH.
24	SS -> MS	PACKET UPLINK ACK/NACK	Sent on the PACCH of the PDCH assigned in step 21 after the starting time, the USF assigned to the MS.
25			Repeat step 23, 24 for 3000 times. The last PACKET UPLINK ACK/NACK does not contain the assigned USF.
26	SS -> MS	PACKET TIMESLOT RECONFIGURE	Assign a new PDCH with the frequency parameter in indirect encoding referred to CA(2, k).
27	SS -> MS	PACKET DOWNLINK DUMMY CONTROL BLOCK	Sent on the PACCH of the PDCH assigned in step 26 after the starting time, the USF assigned to the MS.

28	MS -> SS	UPLINK RLC DATA BLOCK	Received on the assigned PDTCH.
29	SS -> MS	PACKET UPLINK ACK/NACK	Sent on the PACCH of the PDCH assigned in step 26 after the starting time, the USF assigned to the MS.
30			Repeat step 28, 29 for 3000 times. The last PACKET UPLINK ACK/NACK does not contain the assigned USF.
31	SS -> MS	PACKET TIMESLOT RECONFIGURE	Assign a new PDCH with the frequency parameter in indirect encoding referred to the MA numbered 15.
32	SS -> MS	PACKET DOWNLINK DUMMY CONTROL BLOCK	Sent on the PACCH of the PDCH assigned in step 31, the USF assigned to the MS.
33	MS -> SS	UPLINK RLC DATA BLOCK	Received on the assigned PDTCH.
34		{Completion of uplink RLC data block transfer}	

For $k=1$, $T(k) = T(1)$,
 $k=2$, $T(k) = T(2)$,
 $k=3$, $T(k) = T(3)$.

Specific Message Contents

PACKET SYSTEM INFORMATION TYPE 13 message:

PAGE_MODE	Normal paging
BCCH_CHANGE_MARK	As default
SI_CHANGE_FIELD	Updated of unknown SI message type
{0 1<SI13_CHANGE_MARK>}	1, '10'
GPRS Mobile Allocation	
- HSN	'000000', cyclic hopping
- {0 1<RLF number list>}	0, CA in PSI2 used
- {1 0 1<ARFCN index list>}	1 0, MA including all ARFCNs in CA
	1, PBCCH present
PSI_REPEATED_PERIOD	As default
PBCCH Description	
- Pb	As default
- TSC	'011'
- TN	'001', slot 1
- {11<MAIO>}	11, '000101'

SI 13 Rest octets:

PAGE_MODE	Normal paging
BCCH_CHANGE_MARK	As default
SI_CHANGE_FIELD	Updated of unknown SI message type
{0 1<SI13_CHANGE_MARK>}	1, '10'
GPRS Mobile Allocation	
- HSN	'000000', cyclic hopping
- {0 1<RLF number list>}	0, refer to CA in PSI2
- {1 0 1<ARFCN index list>}	10, MA including all ARFCNs in CA, ARFCN index list absent.
	1, PBCCH present
PSI_REPEATED_PERIOD	As default
PBCCH Description	
- Pb	As default
- TSC	'011'
- TN	'001', slot 1
- {11<MAIO>}	11, '000101'

Three sets of SI2 are transmitted (k = 1 ... 3).

The 1st set (k=1) of PACKET SYSTEM INFORMATION TYPE 2 messages

The 1st PSI2 instance:

PAGE_MODE	Normal paging
PSI2_CHANGE_MARK	(k + 1) mod 4
PSI2_INDEX	0
PSI2_COUNT	5
{0 1<Cell Identification>}	1, as default
{0 1<Non GPRS Cell Options>}	1, as default
{0 1<Reference Frequency Lists>}	0
{0 1<Cell Allocation>}	1
- 1<RFL_NNUMBER>	1, 1
- 1<RFL_NNUMBER>	1, 2
-	0 (end of cell allocation List)
{0 1<GPRS Mobile Allocation>}	0
{0 1<PCCCH Description>}	1
TSC	1, begin of PCCCH description structure
1< MA_NUMBER >	'011', same as PBCCH
1< Hopping PCCCH carrier struct>	'1', 14
MAIO	1, begin of Hopping PCCCH carrier struct
TIMESLOT_ALLOCATION	5, same as PBCCH
	6, (5 timeslots distance from PBCCH)
	0, end of Hopping PCCCH carrier struct
	0, end of PCCCH description structure

The 2nd PSI2 instance:

PAGE_MODE	Normal paging
PSI2_CHANGE_MARK	(k + 1) mod 4
PSI2_INDEX	1
PSI2_COUNT	4
{0 1<Cell Identification>}	0
{0 1<Non GPRS Cell Options>}	0
{0 1<Reference Frequency Lists>}	1
-	1
- RFL_NUMBER	0
- Length of RFL contents	For GSM900, in bit map 0, (10, 17, 20, 26, 42, 45, 59, 66, 76, 108)
- RFL contents	For DCS1800, in 256 format, (739,743, 746, 749, 758, 761, 779, 782, 829, 832)
	For PCS1900, in 256 format, (718,721, 724, 727, 739, 743, 756, 758, 771, 779)
-	1
- RFL_NUMBER	1
- Length of RFL contents	For GSM900, in bit map 0, (17, 34, 45, 46, 52, 59, 73, 74, 108, 114)
- RFL contents	For DCS1800, in 512 format (743, 756, 761, 764, 771, 779, 791, 798, 832, 844)
	For PCS1900, in 512 format(721, 734, 743, 746, 749, 756, 761, 764, 779, 782)
-	0 (end of Reference frequency List)
{0 1<Cell Allocation>}	0
{0 1<GPRS Mobile Allocation>}	1
- MA_NUMBER	1
- GPRS Mobile Allocation	
- HSN	Arbitrarily chosen, greater than 0
- {0 1< RFL number list>}	1

- RFL_NUMBER	2
-	1 (ARFCN index list)
- {0 1< ARFCN index list>}	1
- ARFCN_INDEX	For GSM: 17 For DCS 1800: 743 For PCS 1900: 721
- {0 1< ARFCN index list>}	1
- ARFCN_INDEX	For GSM: 74 For DCS 1800: 798 For PCS 1900: 764
-	0 (end of ARFCN index lists)
{0 1<PCCH Description>}	0

The 3rd PSI2 instance:

PAGE_MODE	Normal paging
PSI2_CHANGE_MARK	(k + 1) mod 4
PSI2_INDEX	2
PSI2_COUNT	4
{0 1<Cell Identification>}	0
{0 1<Non GPRS Cell Options>}	0
{0 1<Reference Frequency Lists>}	
-	1
- RFL_NUMBER	2
- Length of RFL contents	
- RFL contents	For GSM900, in bit map 0, (17, 34, 45, 46, 52, 59, 73, 74, 108, 114) For DCS1800, in 512 format (743, 756, 761, 764, 771, 779, 791, 798, 832, 844) For PCS1900, in 512 format (721, 734, 743, 746, 749, 756, 761, 764, 779, 782)
-	0 (end of Reference frequency List)
{0 1<Cell Allocation>}	0
{0 1<GPRS Mobile Allocation>}	1
- MA_NUMBER	2
- GPRS Mobile Allocation	
- HSN	Arbitrarily chosen, greater than 0
- {0 1< RFL number list>}	1
- RFL_NUMBER	2
-	1 (ARFCN index list)
- {0 1< ARFCN index list>}	1
- ARFCN_INDEX	For GSM: 45 For DCS 1800: 761 For PCS 1900: 743
- {0 1< ARFCN index list>}	1
- ARFCN_INDEX	For GSM: 74 For DCS 1800: 798 For PCS 1900: 764
-	0 (end of ARFCN index lists)
{0 1<PCCH Description>}	0

The 4th PSI2 instance:

PAGE_MODE	Normal paging
PSI2_CHANGE_MARK	$(k + 1) \bmod 4$
PSI2_INDEX	3
PSI2_COUNT	4
{0 1<Cell Identification>}	0
{0 1<Non GPRS Cell Options>}	0
{0 1<Reference Frequency Lists>}	1
-	1
- RFL_NUMBER	3
- Length of RFL contents	
- RFL contents	For GSM900: frequencies in $CA_{pgsm}(1, k)$ coded by bit map 0 format
	For DCS1800: frequencies in $CA_{dcs}(1, k)$ coded by variable bit map format
	For PCS1900: frequencies in $CA_{pcc}(1, k)$ coded by variable bit map format
-	0 (end of Reference frequency Lists)
{0 1<Cell Allocation>}	0
{0 1<GPRS Mobile Allocations>}	1
- MA_NUMBER	3
- GPRS Mobile Allocation	
- HSN	Arbitrarily chosen
- {0 1<RFL number list>}	1
- RFL_NUMBER	3 (corresponding to $CA(1, k)$)
-	0 (MA BITMAP)
- MA_LENGTH	
- MA_BITMAP	For GSM900 corresponding to $MA_{pgsm}(1, k)$
	For DCS1800 corresponding to $MA_{dcs}(1, k)$
	For PCS1900 corresponding to $MA_{pcc}(1, k)$
-	0 (end of GPRS Mobile Allocations)
{0 1<PCCH Description>}	0

The 5th PSI2 instance:

PAGE_MODE	Normal paging
PSI2_CHANGE_MARK	$(k + 1) \bmod 4$
PSI2_INDEX	4
PSI2_COUNT	4
{0 1<Cell Identification>}	0
{0 1<Non GPRS Cell Options>}	0
{0 1<Reference Frequency Lists>}	1
-	1
- RFL_NUMBER	4
- Length of RFL contents	
- RFL contents	For GSM900: frequencies in $CA_{pgsm}(2, k)$ coded by bit map 0 format
	For DCS1800: frequencies in $CA_{dcs}(2, k)$ coded by variable bit map format
	For PCS1900: frequencies in $CA_{pcc}(2, k)$ coded by variable bit map format
-	0 (end of Reference frequency Lists)
{0 1<Cell Allocation>}	0
{0 1<GPRS Mobile Allocations>}	1
- MA_NUMBER	4
- GPRS Mobile Allocation	
- HSN	Arbitrarily chosen
- {0 1<RFL number list>}	1

- RFL_NUMBER	4 (corresponding to CA(2, k))
-	0 (MA BITMAP)
- MA_LENGTH	For GSM900 corresponding to MA _{pgsm} (2, k)
- MA_BITMAP	For DCS1800 corresponding to MA _{dcs} (2, k)
-	For PCS1900 corresponding to MA _{pacs} (2, k)
-	0 (end of GPRS Mobile Allocations)
{0 1<PCCH Description>}	0

The 2nd (k=2) and 3rd (k=3) set of PACKET SYSTEM INFORMATION TYPE 2 messages

The SI2 instances in the two sets are identical to the 1st set except the value k (k = 2, 3) and the corresponding values CA_{pgsm}(1, k), CA_{pgsm}(2, k), MA_{pgsm}(1, k), MA_{pgsm}(2, k), CA_{dcs}(1, k), CA_{dcs}(2, k), MA_{dcs}(1, k), MA_{dcs}(2, k), CA_{pacs}(1, k), CA_{pacs}(2, k), MA_{pacs}(1, k), MA_{pacs}(2, k).

The 2nd PACKET UPLINK ASSIGNMENT message in step 1 (the macro):

{0 1<Frequency Parameters>}	1 (frequency parameters present)
- TSC	5
-	01 (indirect encoding)
- MAIO	5
- MA_NUMBER	1
- {0 1<CHANGE_MARK_1>}	1 (present)
- CHANGE_MARK_1	k mod 4
- {0 1<CHANGE_MARK_2>}	1
- CHANGE_MARK_2	(k + 1) mod 4

PACKET UPLINK ASSIGNMENT message in step 6:

{0 1<Frequency Parameters>}	1 (frequency parameters present)
- TSC	'011', same as PBCCH
-	10 (direct encoding 1)
- MAIO	5
- MA_NUMBER	14
- HSN	'000000', cyclic hopping
- {0 1<RLF number list>}	0, refer to CA in PSI2
- {1 0 1<ARFCN index list>}	10, MA including all ARFCNs in CA, ARFCN index list absent.
Dynamic allocation	01
-	0, timeslot allocation
- USF_TN0 - USF_TN5	0000001, TN6 assigned
- USF_TN6	110
- USF_TN7	0

PACKET UPLINK ASSIGNMENT message in step 16:

{0 1<Frequency Parameters>}	1 (frequency parameters present)
- TSC	'011', same as PBCCH
-	01 (indirect encoding)
- MAIO	5
- MA_NUMBER	14
- {0 1<CHANGE_MARK_1>}	1 (present)
- CHANGE_MARK_1	k mod 4
- {0 1<CHANGE_MARK_2>}	1
- CHANGE_MARK_2	(k + 1) mod 4
Dynamic allocation	01 (Dynamic allocation)
-	0, timeslot allocation
- USF_TN0 - USF_TN5	0000001, TN6 assigned
- USF_TN6	110
- USF_TN7	0

PACKET TIMESLOT RECONFIGURE message in step 26:

<ul style="list-style-type: none"> {0 1<Frequency Parameters>} - TSC - - MAIO - - MA_NUMBER - {0 1<CHANGE_MARK_1>} - CHANGE_MARK_1 - {0 1<CHANGE_MARK_2>} Dynamic allocation - Extended Dynamic Allocation - {0 1<P0>} - {0 1<RLC_DATA_BLOCKS_GRANTED>} - {0 1<TBF_STARTING_TIME>} - Starting Number Description - - - USF_TN₃ - GAMMA_TN₃ - 	<p>1 (frequency parameters presents)</p> <p>01 (indirect encoding) For GSM900: MAIO_{pgsm}(2, k) For DCS1800: MAIO_{dcs}(2, k) For PCS1900: MAIO_{pccs}(2, k) 4, referred to MA_{pgsm}(2, k) / MA_{dcs}(2, k) / MA_{pccs}(2, k)</p> <p>1 (k + 1) mod 4</p> <p>0</p> <p>0</p> <p>0 (Dynamic allocation)</p> <p>0</p> <p>0 (open-ended TBF)</p> <p>1</p> <p>0, absolute encoding (current frame + T(k)) modulo 42 432</p> <p>1 (Timeslot Allocation with Power Control Parameters) 0001, assign timeslot 3</p> <p>For GSM 900, +9 dBm For DCS 1800, +6 dBm For PCS 1900, +6 dBm</p> <p>0000, no other timeslots assigned</p>
--	--

PACKET TIMESLOT RECONFIGURE message in step 31:

<ul style="list-style-type: none"> {0 1<Frequency Parameters>} - TSC - - MAIO - - MA_NUMBER - {0 1<CHANGE_MARK_1>} - CHANGE_MARK_1 - {0 1<CHANGE_MARK_2>} Dynamic allocation - Extended Dynamic Allocation - {0 1<P0>} - {0 1<RLC_DATA_BLOCKS_GRANTED>} - {0 1<TBF_STARTING_TIME>} - Starting Number Description - - - USF_TN₆ - GAMMA_TN₆ - 	<p>1 (frequency parameters presents)</p> <p>01 (indirect encoding) For GSM900: MAIO_{pgsm}(3, k) For DCS1800: MAIO_{dcs}(3, k) For PCS1900: MAIO_{pccs}(3, k) 15, referred to MA_{pgsm}(3, k) / MA_{dcs}(3, k) / MA_{pccs}(3, k)</p> <p>1 (k + 1) mod 4</p> <p>0</p> <p>0</p> <p>0 (Dynamic allocation)</p> <p>0</p> <p>0 (open-ended TBF)</p> <p>1</p> <p>0, absolute encoding (current frame + T(k)) modulo 42 432</p> <p>1 (Timeslot Allocation with Power Control Parameters) 0000001, assign timeslot 6</p> <p>For GSM 900, +9 dBm For DCS 1800, +6 dBm For DCS 1900, +3 dBm</p> <p>0, no other timeslots assigned</p>
--	--

42.3.1.2 Dynamic Allocation / Uplink Transfer / Abnormal

42.3.1.2.1 Void

42.3.1.2.2 Dynamic Allocation / Uplink Transfer / Abnormal / with cell reselection in acknowledged mode

42.3.1.2.2.1 Conformance requirements

Upon detecting the stall condition the mobile station shall start timer T3182. If timer T3182 expires, the mobile station shall decrement counter N3102 by PAN_DEC, and perform an abnormal release with random access.

When $N3102 \leq 0$ is reached, the mobile station shall perform an abnormal release with cell re-selection.

References

GSM 04.60, 9.3.2.2

42.3.1.2.2.2 Test purposes

To verify that while in uplink unacknowledged mode operation the MS performs an abnormal release with cell reselection if the $N3102 \leq 0$ is reached.

42.3.1.2.2.3 Method of test

Initial Conditions

System Simulator:

2 cells, GPRS supported, PCCCH present, Max-Retrans = 2, access burst type = 11 bits, BS_PAG_BLKES_RES = 2, BS_PBCCH_BLKES = 3, BS_PCC_CHANS = 1, BS_PRACH_BLKES = 1, PAN_MAX = 8, PAN_DEC = 5 and PAN_INC = 2.

Cell A: power level = 63 dB μ Vemf(), GPRS_RXLEV_ACCESS_MIN = 33 dB μ Vemf(), PRIORITY_CLASS = 3, GPRS_PENALTY_TIME = 0, GPRS_RESELECT_OFFSET = 0 dB μ Vemf(), RANDOM_ACCESS_RETRY = 1;

Cell B: power level = 53 dB μ Vemf(), GPRS_RXLEV_ACCESS_MIN = 33 dB μ Vemf(), PRIORITY_CLASS = 3, GPRS_PENALTY_TIME = 0, GPRS_RESELECT_OFFSET = 16 dB μ Vemf().

Mobile Station:

The MS is GPRS attached on cell A, a P-TMSI allocated and test PDP context2 activated.

Related PICS/PIXIT Statement(s)

Support GPRS service,

Support activation of at least one PDP context,

The way to initiate an uplink packet transfer

Test Procedure

The MS is triggered to initiate packet uplink transfer 1500 octets in the RLC acknowledged mode on cell A. After a successful uplink PDCH assignment the SS sends PACKET DOWNLINK DUMMY indicating the assigned USF assigned to the MS. The MS sends a RLC radio block. The SS allows the MS to transfer so many data blocks without acknowledgement until the stall indication bit is set.

The MS requests the necessary radio resources by PACKET CHANNEL REQUEST on cell A. The SS assigns a new PDCH to the MS. The SS sends PACKET DOWNLINK DUMMY indicating the assigned USF assigned to the MS.

The MS sends a RLC radio block. The SS allows the MS to transfer so many data blocks without acknowledgement until the stall indication bit is set.

The MS requests the necessary radio resources by PACKET CHANNEL REQUEST on cell B. The SS then assigns a new PDCH to the MS for completion of the requested uplink data transfer.

Maximum Duration of Test

5 min.

Expected Sequence

Step	Direction	Message	Comments
1		{Uplink dynamic allocation two phase access}	The following messages received on cell A. n = 2000 octets in RLC acknowledged mode (Test PDP context2), without starting time, USF_GRANULARITY = 1 block, RLC_DATA_BLOCKS_GRANTED = open-end TLLI_BLOCK_CHANNEL_CODING: cs1, CHANNEL_CODING_COMMAND: cs1
2	SS -> MS	PACKET DOWNLINK DUMMY CONTROL BLOCK	USF assigned to the MS on 3 blocks from the last radio block containing the uplink assignment.
3	MS -> SS	UPLINK RLC DATA BLOCK	Received on the assigned PDTCH. Check that the coding and the TFI are correct.
4			Repeat step 2 and 3 until the stall indication bit is set in the data block received in step 3.
5	SS		Wait 5s for T3182 time-out.
6	MS -> SS	PACKET CHANNEL REQUEST	Received on PRACH of cell A.
7	SS -> MS	PACKET UPLINK ASSIGNMENT	Single block assignment, to order the MS making two-phase access procedure. Sent on PAGCH.
8	MS -> SS	PACKET RESOURCE REQUEST	Two phase access procedure. Received on the single block assigned.
9	SS -> MS	PACKET UPLINK ASSIGNMENT	Open-ended uplink dynamic allocation, no starting time, Sent on PAGCH.
10	SS -> MS	PACKET DOWNLINK DUMMY CONTROL BLOCK	USF assigned to the MS. on 3 blocks from the last radio block containing the uplink assignment.
11	MS -> SS	UPLINK RLC DATA BLOCK	Received on the assigned PDTCH.
12			Repeat step 10 and 11 until the stall indication bit is set in the data block received in the step 11.
13	SS		Wait for 5 seconds for T3182 time-out.
14	MS -> SS	PACKET CHANNEL REQUEST	The following messages received on cell B. Received on PRACH of cell B.
15	SS -> MS	PACKET UPLINK ASSIGNMENT	Single block assignment, to order the MS making two-phase access procedure. Sent on PAGCH.
16	MS -> SS	PACKET RESOURCE REQUEST	Two phase access procedure. Received on the single block assigned.
17	SS -> MS	PACKET UPLINK ASSIGNMENT	Open-ended uplink dynamic allocation, no starting time, Sent on PAGCH.
18	SS -> MS	PACKET DOWNLINK DUMMY CONTROL BLOCK	The USF assigned to the MS.
19	MS -> SS	UPLINK RLC DATA BLOCK	Received on the assigned PDTCH.
20		{Completion of uplink RLC data block transfer}	

42.3.1.2.3 Dynamic Allocation / Uplink Transfer / Abnormal / with cell reselection in unacknowledged mode

42.3.1.2.3.1 Conformance requirements

If the mobile station transmits k RLC data blocks without receiving a Packet Ack/Nack message the mobile station shall start timer T3182. If timer T3182 expires, the mobile station shall decrement counter N3102 by PAN_DEC, and perform an abnormal release with random access.

When $N3102 \leq 0$ is reached, the mobile station shall perform an abnormal release with cell re-selection.

References

GSM 04.60, 9.3.3.2

42.3.1.2.3.2 Test purposes

To verify that while in uplink unacknowledged mode operation the MS performs an abnormal release with cell reselection if the $N3102 \leq 0$ is reached.

42.3.1.2.3.3 Method of test

Initial Conditions

System Simulator:

2 cells, GPRS supported, PCCCH present, Max-Retrans = 2, access burst type = 11 bits, BS_PAG_BLKES_RES = 2, BS_PBCCH_BLKES = 3, BS_PCC_CHANS = 1, BS_PRACH_BLKES = 1, PAN_MAX = 8, PAN_DEC = 5 and PAN_INC = 2.

Cell A: power level = 63 dB μ Vemf(), GPRS_RXLEV_ACCESS_MIN = 33 dB μ Vemf(), PRIORITY_CLASS = 3, GPRS_PENALTY_TIME = 0, GPRS_RESELECT_OFFSET = 0 dB μ Vemf(), RANDOM_ACCESS_RETRY = 1;

Cell B: power level = 53 dB μ Vemf(), GPRS_RXLEV_ACCESS_MIN = 33 dB μ Vemf(), PRIORITY_CLASS = 3, GPRS_PENALTY_TIME = 0, GPRS_RESELECT_OFFSET = 16 dB μ Vemf().

Mobile Station:

The MS is GPRS attached with cell A, a P-TMSI allocated and Test PDP context3 activated.

Related PICS/PIXIT Statement(s)

Type of MS (P-, E-, R-GSM 900 or DCS 1800 or PCS 1900),

Support GPRS service,

Support activation of at least one PDP context,

The way to initiate an uplink packet transfer

Test Procedure

The MS is triggered to initiate packet uplink transfer 1500 octets in the RLC unacknowledged mode on cell A. After a successful uplink PDCH assignment the SS sends PACKET DOWNLINK DUMMY indicating the assigned USF assigned to the MS. The MS sends a RLC radio block. The SS allows the MS to transfer 64 data blocks without acknowledgement.

The MS requests the necessary radio resources by PACKET CHANNEL REQUEST on cell A. The SS assigns a new PDCH to the MS. The SS sends PACKET DOWNLINK DUMMY indicating the assigned USF assigned to the MS. The MS sends a RLC radio block. The SS allows the MS to transfer 64 data blocks without acknowledgement

The MS requests the necessary radio resources by PACKET CHANNEL REQUEST on cell B. The SS then assigns a new PDCH to the MS for completion of the requested uplink data transfer.

Maximum Duration of Test

5 min.

Expected Sequence

Step	Direction	Message	Comments
1		{Uplink dynamic allocation two phase access}	The following messages received on cell A. n = 1500 octets in RLC unacknowledged mode (Test PDP context3), without starting time, USF_GRANULARITY = 1 block, RLC_DATA_BLOCKS_GRANTED = open-end TLLI_BLOCK_CHANNEL_CODING: cs1, CHANNEL_CODING_COMMAND: cs1
2	SS -> MS	PACKET DOWNLINK DUMMY CONTROL BLOCK	Sent on the PACCH of the PDCH assigned in step 2, the USF assigned to the MS.
3	MS -> SS	UPLINK RLC DATA BLOCK	Received on the assigned PDTCH. Check that the coding and the TFI are correct.
4			Repeat step 2 and 3 in total of 64 times.
5	SS		Wait 5s for T3182 time-out.
6	MS -> SS	PACKET CHANNEL REQUEST	Received on PRACH of cell A.
7	SS -> MS	PACKET UPLINK ASSIGNMENT	Single block assignment, to order the MS making two-phase access procedure. Sent on PAGCH.
8	MS -> SS	PACKET RESOURCE REQUEST	Two phase access procedure. Received on the single block assigned.
9	SS -> MS	PACKET UPLINK ASSIGNMENT	Open-ended uplink dynamic allocation, no starting time, Sent on PAGCH.
10	SS -> MS	PACKET DOWNLINK DUMMY CONTROL BLOCK	The USF assigned to the MS.
11	MS -> SS	UPLINK RLC DATA BLOCK	Received on the assigned PDTCH.
12			Repeat step 10 and 11 in total of 63 times.
13	SS		Wait for 5 seconds for T3182 time-out.
14	MS -> SS	PACKET CHANNEL REQUEST	The following messages received on cell B. Received on PRACH of cell B.
15	SS -> MS	PACKET UPLINK ASSIGNMENT	Open-ended uplink dynamic allocation, no starting time, Sent on PAGCH.
16	SS -> MS	PACKET DOWNLINK DUMMY CONTROL BLOCK	The USF assigned to the MS. Sent on PACCH of PDCH assigned.
17	MS -> SS	UPLINK RLC DATA BLOCK	Received on the assigned PDTCH.
18		{Completion of uplink RLC data block transfer}	

42.3.2 Dynamic Allocation / Uplink Transfer with Downlink TBF establishment (concurrent)

42.3.2.1 Dynamic Allocation / Uplink Transfer with Downlink TBF establishment / Normal

42.3.2.1.1 Dynamic Allocation / Uplink Transfer with Downlink TBF establishment / Normal / Successful

42.3.2.1.1.1 Conformance requirements

During uplink transfer, the network may initiate a downlink TBF by sending a PACKET DOWNLINK ASSIGNMENT message, or a PACKET TIMESLOT RECONFIGURE, to the mobile station on the PACCH. If a PACKET TIMESLOT RECONFIGURE message is sent, then the message shall contain the DOWNLINK_TFI_ASSIGNMENT field. On receipt of an assignment message, and after the TBF starting time, if present, the mobile station shall switch to the assigned PDCHs. The operation of the downlink TBF follows the procedures in GSM 04.60, 8.1.2 with the following additions:

1. If a timer or counter expiry causes the uplink TBF to be aborted in the mobile station, the mobile station shall also abort the downlink TBF and perform an abnormal release with random access.

2. If uplink and downlink TBFs are already established, then the network may send a PACKET TIMESLOT RECONFIGURE message without DOWNLINK_TFI_ASSIGNMENT. The mobile station shall interpret this as a reassignment of the timeslot allocations of the concurrent uplink and downlink TBFs and the downlink TFI is not changed.

References

GSM 04.60, 8.1.1.1.3, 8.1.2

42.3.2.1.1.2 Test purposes

To verify that during uplink transfer:

1. The MS switches to the assigned PDCHs when the network initiates a downlink TBF by sending PACKET DOWNLINK ASSIGNMENT or PACKET TIMESLOT RECONFIGURE to the MS on PACCH.
2. When the MS receives PACKET TIMESLOT RECONFIGURE without DOWNLINK_TFI_ASSIGNMENT in the case of uplink and downlink TBFs established already, the MS interprets this message as a reassignment of the timeslot allocations of the concurrent uplink and downlink TBFs.
3. The MS also aborts the downlink TBF and performs an abnormal release with random access if a timer or a counter expiry causes the uplink TBF to be aborted in the MS.

42.3.2.1.1.3 Method of test

Initial Conditions

System Simulator:

1 cell, default setting, BS_PBCCH_BLKs = 3.

Mobile Station:

The MS is GPRS attached with a P-TMSI allocated and the test PDP context3 activated.

Related PICS/PIXIT Statement(s)

Support GPRS service,

Support activation of at least one PDP context,

The way to initiate an uplink packet transfer

Test Procedure

An uplink TBF is established and in progress. After the MS sends an uplink data block the SS assigns a downlink TBF on the same timeslot as the uplink TBF. The SS sends a downlink data block with polling for acknowledgement and the assigned USF assigned to the MS for the MS, and indicates FBI=1 for the final data block. The MS sends an uplink data block and acknowledges the received downlink data block on the correct frame. The SS waits 2.5s for the MS releasing the downlink PDCH. The SS sends PACKET TIMESLOT RECONFIGURE assigning a new downlink PDCH. A downlink data block is sent, the assigned USF assigned to the MS and the MS is polled for acknowledgement. The MS sends an uplink data block and acknowledges the last received downlink data block on the correct frame.

The SS sends PACKET TIMESLOT RECONFIGURE without DOWNLINK_TFI_ASSIGNMENT replacing the existing uplink and downlink PDCH with another pair of concurrent PDCH. A downlink data block is sent on the replaced PDCH and the MS is polled for acknowledgement. The MS shall not react upon it. Another downlink data block is sent on the assigned PDCH, the assigned USF assigned to the MS and the MS is polled for acknowledgement. The MS sends an uplink data block and acknowledges the received downlink data block on the correct frame.

The SS sends downlink data blocks with USF not addressing the MS until receives PACKET CHANNEL REQUEST.

Maximum Duration of Test

5 min.

Expected Sequence

Step	Direction	Message	Comments
1		{Uplink dynamic allocation two phase access}	n = 440 octets, without starting time, USF_GRANULARITY = 1 block, RLC_DATA_BLOCKS_GRANTED = open-end TLLI_BLOCK_CHANNEL_CODING: arbitrarily chosen CHANNEL_CODING_COMMAND: arbitrarily chosen but different from above.
2	SS -> MS	PACKET DOWNLINK DUMMY CONTROL BLOCK	The assigned USF assigned to the MS on 3 blocks from the last radio block containing the uplink assignment.
3	MS -> SS	UPLINK RLC DATA BLOCK	
4	SS -> MS	PACKET DOWNLINK ASSIGNMENT	Sent on the PACCH, assigning a downlink TBF, MAC mode = dynamic allocation, RLC mode = unacknowledged, single timeslot, TFI ₂ , no starting time.
5	SS -> MS	DOWNLINK RLC DATA BLOCK	Containing RRB _P = N+13 and USF assigned to the MS. FBI = '1'. Sent on the downlink PDTCH on 2 blocks from the last radio block containing the downlink assignment.
6	MS -> SS	UPLINK RLC DATA BLOCK	Received on the uplink PDTCH assigned in step 1.
7	MS -> SS	PACKET DOWNLINK ACK/NACK	Received on the frame number = N+13, N is the frame number of the first burst of the data block in step 5.
8	SS -> MS	PACKET UPLINK ACK/NACK	Containing USF assigned to the MS
9	MS -> SS	UPLINK RLC DATA BLOCK	Received on the uplink PDTCH assigned in step 1.
10	SS		Wait 2.5 s for T3192 timeout.
11	SS -> MS	PACKET TIMESLOT RECONFIGURE	Sent on the PACCH of the PDCH assigned in step 1. Assign a downlink TBF, MAC mode = dynamic allocation, RLC mode = unacknowledged, single slot, TFI ₂ , no starting time.
12	SS -> MS	DOWNLINK RLC DATA BLOCK	Containing RRB _P = N+21 or +22 and USF assigned to the MS. FBI = '0'. Sent on the downlink PDTCH assigned on 2 blocks from the last radio block containing the downlink assignment in step 11.
13	MS -> SS	UPLINK RLC DATA BLOCK	Received on the uplink PDTCH assigned in step 1.
14	MS -> SS	PACKET DOWNLINK ACK/NACK	Received on the block of frame number = N+21 or +22, N is the frame number of the first burst of the data block in step 12.
15	SS -> MS	PACKET TIMESLOT RECONFIGURE	Without DOWNLINK_TFI_ASSIGNMENT, Assign new uplink and downlink time slots, no starting time, sent on the PACCH of the PDCH assigned in step 11.
16	SS -> MS	DOWNLINK RLC DATA BLOCK	Containing USF assigned to the MS. Sent on the downlink PDTCH assigned in step 11 on 2 blocks from the last radio block containing the assignment in step 15.
17	SS		Check that neither data blocks, nor control blocks are sent by the MS within the next seven radio blocks.
18	SS -> MS	DOWNLINK RLC DATA BLOCK	Containing a valid RRB _P = N+26 and USF assigned to the MS. Sent on the downlink PDTCH assigned in step 15.
19	MS -> SS	UPLINK RLC DATA BLOCK	Received on the uplink PDTCH assigned in step 15.
20	MS -> SS	PACKET DOWNLINK ACK/NACK	Received on the block of frame number = N+26, N is the frame number of the first burst of the data block in step 18, on the PACCH of the downlink PDCH.
21	SS -> MS	DOWNLINK RLC DATA BLOCK	USF not addressing the MS.
22	SS -> MS		Repeat step 21 until receives PACKET CHANNEL REQUEST in step 23.
23	MS -> SS	PACKET CHANNEL REQUEST	Received on PRACH within 7.5 seconds (T3180 * 110% + PSI1 repeat period, 2 s) from step 20.
24	SS -> MS	PACKET UPLINK ASSIGNMENT	Single block assignment,
25	MS -> SS	PACKET RESOURCE REQUEST	Two phase access procedure. Received on the single block assigned in step 24.
26	SS -> MS	PACKET UPLINK ASSIGNMENT	Open-ended uplink dynamic allocation, no starting time, USF_GRANULARITY = 4 blocks, Sent on PACCH of the same PDCH assigned in step 24.

27	SS -> MS	PACKET DOWNLINK DUMMY CONTROL BLOCK	The USF assigned to the MS. Sent on PACCH of PDCH assigned on 3 blocks from the last radio block containing the uplink assignment in step 26. Received 4 consecutive data blocks
28	MS -> SS	UPLINK RLC DATA BLOCK	
29		{Completion of uplink RLC data block transfer}	

Specific Message Contents

PACKET DOWNLINK ASSIGNMET message in step 4:

PAGE_MODE {0 1<PERSISTENCE_LEVEL>}	Normal 0
- Global TFI	0, Global TFI as reference 0, uplink TFI same value as assigned in the uplink in step 1
MAC_MODE	Dynamic allocation
RLC_MODE	Unacknowledged
CONTROL_ACK	0
TIMESLOT_ALLOCATION	same slot number as assigned in the uplink TBF
Packet Timing Advance	
- {0 1<TIMING_ADVANCE_VALUE>}	1
- TIMING_ADVANCE_VALUE	30 bit periods
- {0 1<TIMING_ADVANCE_INDEX>	0 (no timing advance index)
<TIMING_ADVANCE_TIMESLOT_NUMBER >}	
{0 1<P0><BTS_PWR_CTR_MODE >}	0
{0 1<Frequency Parameters>}	0 (no Frequency Parameters present)
{0 1<DOWNLINK_TFI_ASSIGNMENT>}	1 (assign downlink TFI)
- DOWNLINK_TFI_ASSIGNMENT	arbitrarily chosen from valid values but different from the value for uplink TBF
{0 1<Power Control Parameters>}	0 (no Power Control Parameters present)
{0 1<TBF_STARTING_TIME>}	0 (no starting time)
{0 1<Measurement Mapping>}	0 (no starting time)

PACKET TIMESLOT RECONFIGURE message in step 11:

PAGE_MODE	Normal
- Global TFI	0, Global TFI as reference 0, uplink TFI same value as assigned in the uplink in step 1
CHANNEL_CODING_COMMAND	Arbitrarily chosen from valid values
Global packet Timing Advance	
- {0 1<TIMING_ADVANCE_VALUE>}	1 (timing advance value)
- TIMING_ADVANCE_VALUE	30 bit periods
- {0 1<UPLINK_TIMING_ADVANCE_INDEX>	0 (no uplink timing advance index)
<UPLINK_TIMING_ADVANCE_TIMESLOT_NUMBER>}	The MS stops the operation of the continuous timing advance procedure.
- {0 1<DOWNLINK_TIMING_ADVANCE_INDEX>	0 (no downlink timing advance index)
<DOWNLINK_TIMING_ADVANCE_TIMESLOT_NUMBER>}	The MS stops the operation of the continuous timing advance procedure.
DOWNLINK_RLC_MODE	Unacknowledged mode
CONTROL_ACK	0
{0 1<DOWNLINK_TFI_ASSIGNMENT>}	1 (assign a new TFI for downlink TBF)
- GLOBAL_TFI_ASSIGNMENT	Arbitrarily chosen but different from the value for uplink TBF
{0 1<UPLINK_TFI_ASSIGNMENT>}	0
DOWNLINK_TIMESLOT_ALLOCATION	Same as the slot of the uplink TBF
{0 1<Frequency parameters>}	0
{0 <Dynamic allocation> 1<Fixed allocation>}	See note

PACKET TIMESLOT RECONFIGURE message in step 15:

PAGE_MODE	Normal
- Global TFI	0, Global TFI as reference 0, uplink TFI same value as assigned in the uplink in step 1
CHANNEL_CODING_COMMAND	Arbitrarily chosen from valid values
Global packet Timing Advance	
- {0 1<TIMING_ADVANCE_VALUE>}	1 (timing advance value)
- TIMING_ADVANCE_VALUE	30 bit periods
- {0 1<UPLINK_TIMING_ADVANCE_INDEX>	0 (no uplink timing advance index)
<UPLINK_TIMING_ADVANCE_TIMESLOT_NUMBER>}	The MS stops the operation of the continuous timing advance procedure.
- {0 1<DOWNLINK_TIMING_ADVANCE_INDEX>	0 (no downlink timing advance index)
<DOWNLINK_TIMING_ADVANCE_TIMESLOT_NUMBER>}	The MS stops the operation of the continuous timing advance procedure.
DOWNLINK_RLC_MODE	Unacknowledged mode
CONTROL_ACK	0
{0 1<DOWNLINK_TFI_ASSIGNMENT>}	0
{0 1<UPLINK_TFI_ASSIGNMENT>}	0
DOWNLINK_TIMESLOT_ALLOCATION	Timeslot 5 assigned
{0 1<Frequency parameters>}	0
Dynamic allocation	0
- Extended Dynamic Allocation	0 (Dynamic allocation)
{0 1<P0>}	0
- USF GRANULARITY	0 (1 RLC block)
- {0 1<RLC_DATA_BLOCKS_GRANTED>}	0 (open-ended TBF)
- {0 1<TBF_STARTING_TIME>}	0 (no starting time)
-	1 (Timeslot Allocation with Power Control Parameters)
- ALPHA	0.5
- {0 1<USF_TN _x ><GAMMA_TN _x >}	000001 (timeslot 5 assigned)
- USF_TN ₅	Arbitrarily chosen but different from current value
- GAMMA_TN ₅	For GSM 900, +9 dBm For DCS 1800 and PCS 1900, +6 dBm
	00

42.3.2.1.2 Dynamic Allocation / Uplink Transfer with Downlink TBF establishment / Normal / Multislot capabilities

This test case applies to all Mobile Station belonging to multislot class 2, 3, 4, 5, 6, 8, 9, 10, 19 and 24.

42.3.2.1.2.1 Conformance requirements

1. Mobile station belonging to multislot class 2, 3, 4, 5, 6, 8, 9, 10, 19 and 24 shall support as many uplink and downlink timeslots as indicated in GSM 05.02 Annex B1.
2. If transmission of the PACKET CONTROL ACKNOWLEDGEMENT would result in more than the maximum Tx timeslots per TDMA frame allowed by the multislot class, transmission of the highest numbered PDCH(s) shall be omitted.

References

GSM 05.02, Annex B1, GSM 04.60, 8.6

42.3.2.1.2.2 Test purposes

To verify that the multislot MS supports as many uplink and downlink TBFs per TDMA frame as indicated. Especially, it is verified that the Type 1 MS in a multislot class declared has the capability of supporting

1. T_{th} , the minimum number of slots allowed between the end of the previous transmit or receive TS and the next transmit TS when measurement is to be performed for type 1 MS,
2. T_{ra} , the minimum number of slots allowed between the previous transmit or receive TS and the next receive TS when measurement is to be performed for type 1 MS,

3. the maximum number of Rx and Tx supported,
4. the sum of slots supported.

It is also verified that the MS of a multislot class transmits PACKET CONTROL ACKNOWLEDGEMENT when polled, and omits the transmission of the highest numbered PDCH(s) if the transmission would result in more than the maximum Tx timeslots per TDMA frame allowed by the multislot class.

42.3.2.1.2.3 Method of test

Initial Conditions

System Simulator:

1 cell, default setting, BS_PBCCH_BLKs = 3.

Mobile Station:

The MS is GPRS attached with a P-TMSI allocated and the test PDP context3 activated.

Related PICS/PIXIT Statement(s)

Support GPRS service,
Support activation of at least one PDP context,
The way to initiate an uplink packet transfer,
The multislot class with maximum capability supported.

Test Procedure

The following multislot configurations are tested in the test case:

- Class 2 and 3 support two downlink timeslots and one uplink timeslot, $T_{tb}=2$, $T_{ra}=3$,
- Class 4 and 6 support three downlink timeslots and one uplink timeslot, $T_{tb}=1$, $T_{ra}=3$,
- Class 5 and 9 supports two downlink timeslots and two uplink timeslots, $T_{tb}=1$, $T_{ra}=3$,
- Class 8 and 10 support four downlink timeslots and one uplink timeslot, $T_{tb}=1$, $T_{ra}=2$,
- Class 19 and 24 support five downlink timeslots and one uplink timeslot, $T_{tb}=1$, $T_{ra}=2$.

In the multislot configurations all assigned channels are frequency hopped except for the class 19 and 24 test where non-hopping channels are assigned for PDCHs. The class 3, 6, 9 and 10 are tested in a reduced uplink configuration.

According to the multislot configurations an uplink TBF with one or two timeslots assigned is established and in progress. The SS establishes a concurrent downlink TBF with multiple timeslots assigned. The basic test procedure is executed on four consecutive radio blocks.

On the 1st radio block the SS sends downlink data in the maximum capability allowed under the configuration, signals to the MS the assigned USFs addressing the MS and polls the MS. On the 2nd radio block the MS sends RLC data in response of the addressing the MS USFs. On the 3rd radio block the SS sends downlink data in the maximum capability allowed under the configuration and signals to the MS the assigned USFs addressing the MS. On the 4th radio block the MS responses PACKET DOWNLINK ACK/NACK and sends RLC data in response of one of the USFs addressing the MS if the configuration is allowed.

The basic test procedure is repeated until CV=1. The SS sends the last RLC data block with FBI=1 and polls the MS for acknowledgement. The SS sends PACKET UPLINK ACK/NACK setting FINAL_ACK_INDICATION=1. The MS sends two separate PACKET CONTROL ACKNOWLEDGEMENT messages to release the uplink and downlink TBFs.

Maximum Duration of Test

5 min.

Expected Sequence for multislot class 2 and class 3 (2 downlink timeslots + 1 uplink timeslot)

Step	Direction	Message	Comments
1		{Uplink dynamic allocation two phase access}	n = 440 octets, without starting time, USF_GRANULARITY = 1 block, RLC_DATA_BLOCKS_GRANTED = open-end TLLI_BLOCK_CHANNEL_CODING: cs1 CHANNEL_CODING_COMMAND: cs1 An uplink timeslot is assigned (see specific message contents).
2	SS -> MS	PACKET DOWNLINK DUMMY CONTROL BLOCK	The USF assigned to the MS. Sent on PACCH of PDCH assigned in step 1.
3	MS -> SS	UPLINK RLC DATA BLOCK	Received on the uplink PDTCH.
4	SS -> MS	PACKET DOWNLINK ASSIGNMENT	Sent on PACCH of the uplink PDCH. Assigning a downlink TBF, MAC mode = dynamic allocation, RLC mode = unacknowledged mode, TFI _d (different from the uplink one), no starting time, assigning TN ₁ and TN ₂ .
5	SS -> MS	DOWNLINK RLC DATA BLOCK	Sent on TN ₁ of the downlink PDTCH, RRBp invalid.
6	SS -> MS	DOWNLINK RLC DATA BLOCK	Sent on TN ₂ of the downlink PDTCH, a valid RRBp = N + 13, the assigned USF assigned to the MS, on the same radio block as step 5.
7	MS -> SS	UPLINK RLC DATA BLOCK	Received on the uplink PDTCH, on the next radio block from step 6.
8	SS -> MS	DOWNLINK RLC DATA BLOCK	Sent on TN ₁ of the downlink PDTCH, RRBp invalid, on the next radio block from step 7.
9	SS -> MS	DOWNLINK RLC DATA BLOCK	Sent on TN ₂ of the downlink PDTCH, the assigned USF assigned to the MS and RRBp invalid, on the same radio block as in step 8. Note: The next uplink radio will not be used for the uplink data. It is reserved for a control block answering the polling in step 5.
10	MS -> SS	PACKET DOWNLINK ACK/NACK	Received on the RRBp block on TN ₂ specified in step 6.
11			Repeat step 5 to 10, until CV=0 in step 7.
12	SS -> MS	DOWNLINK RLC DATA BLOCK	Sent on TN ₁ with FBI = 1 and a valid RRBp.
13	SS -> MS	PACKET UPLINK ACK/NACK	FINAL_ACK_INDICATION = 1. Sent on TN ₂ PACCH of the uplink PDCH.
14	MS -> SS	PACKET CONTROL ACKNOWLEDGEMENT	CTRL_ACK = 01. The MS releases the uplink TBF.
15	MS -> SS	PACKET CONTROL ACKNOWLEDGEMENT	Received on the block specified by RRBp in step 12. CTRL_ACK = 11. The MS releases the downlink TBF.

Specific Message Contents

PACKET UPLINK ASSIGNMENT message in step 1 (in macro):

CHANNEL_CODING_COMMAND	CS-1
TLLI_BLOCK_CHANNEL_CODING	CS-1
Dynamic allocation	01
-	000000
-	1 (Timeslot Allocation with Power Control Parameters for 1 slot assigned)
- ALPHA	0.5
-	001 (timeslot 2 assigned)
- USF_TN2	Arbitrarily chosen
- GAMMA_TN2	For GSM 900, +9 dBm
	For DCS 1800 and PCS 1900, +6 dBm
-	00000

PACKET DOWNLINK ASSIGNMET message in step 4:

PAGE_MODE	Normal
{0 1<PERSISTENCE_LEVEL>}	0
- Global TFI	0, Global TFI as reference 0, uplink TFI same value as assigned in the uplink in step 1
MAC_MODE	Dynamic allocation
RLC_MODE	Unacknowledged
CONTROL_ACK	0
TIMESLOT_ALLOCATION	Timeslot 1 and 2 assigned
Packet Timing Advance	
- {0 1<TIMING_ADVANCE_VALUE>}	1
- TIMING_ADVANCE_VALUE	30 bit periods
- {0 1<TIMING_ADVANCE_INDEX>	0 (no timing advance index)
<TIMING_ADVANCE_TIMESLOT_NUMBER >}	
{0 1<P0><BTS_PWR_CTR_MODE >}	0
{0 1<Frequency Parameters>}	0 (no Frequency Parameters present)
{0 1<DOWNLINK_TFI_ASSIGNMENT>}	1 (assign downlink TFI)
- DOWNLINK_TFI_ASSIGNMENT	Arbitrarily chosen from valid values but different from the value for uplink TBF
{0 1<Power Control Parameters>}	0 (no Power Control Parameters present)
{0 1<TBF_STARTING_TIME>}	0 (no starting time)
{0 1<Measurement Mapping>}	0 (no starting time)

Expected Sequence for multislot class 4 and 6 (3 downlink timeslots + 1 uplink timeslot)

Step	Direction	Message	Comments
1		{Uplink dynamic allocation two phase access}	n = 330 octets, without starting time, USF_GRANULARITY = 1 block, RLC_DATA_BLOCKS_GRANTED = open-end TLLI_BLOCK_CHANNEL_CODING: cs1 CHANNEL_CODING_COMMAND: cs1 An uplink timeslot is assigned (see specific message contents).
2	SS -> MS	PACKET DOWNLINK DUMMY CONTROL BLOCK	The USF assigned to the MS. Sent on PACCH of PDCH assigned in step 1.
3	MS -> SS	UPLINK RLC DATA BLOCK	Received on the uplink PDTCH.
4	SS -> MS	PACKET DOWNLINK ASSIGNMENT	Sent on PACCH of the uplink PDCH. Assigning a downlink TBF, MAC mode = dynamic allocation, RLC mode = unacknowledged mode, TFI _d (different from the uplink one), no starting time, assigning the timeslots TN ₁ , TN ₂ and TN ₃ .
5	SS -> MS	DOWNLINK RLC DATA BLOCK	Sent on TN ₁ of the downlink PDTCH, RRBP invalid.
6	SS -> MS	DOWNLINK RLC DATA BLOCK	Sent on TN ₂ of the downlink PDTCH, the assigned USF assigned to the MS and a valid RRBP = N + 13, on the same radio block as step 5.
7	SS -> MS	DOWNLINK RLC DATA BLOCK	Sent on TN ₃ of the downlink PDTCH, RRBP invalid, on the same radio block as step 5.
8	MS -> SS	UPLINK RLC DATA BLOCK	Received on the uplink PDTCH, on the next radio block from step 5.
9	SS -> MS	DOWNLINK RLC DATA BLOCK	Sent on TN ₁ of the downlink PDTCH, RRBP invalid, on the next radio block from step 8.
10	SS -> MS	DOWNLINK RLC DATA BLOCK	Sent on TN ₂ of the downlink PDTCH, the assigned USF assigned to the MS and an invalid RRBP, on the same radio block as step 9. Note: The next uplink radio block will not be used for the uplink data. It is reserved for a control block answering the polling in step 6.
11	SS -> MS	DOWNLINK RLC DATA BLOCK	Sent on TN ₃ of the downlink PDTCH, RRBP invalid, on the same radio block as step 9.
12	MS -> SS	PACKET DOWNLINK ACK/NACK	Received on the RRBP block on TN ₂ specified in step 6.
13			Repeat step 5 to 12, until CV=0 in step 8.
14	SS -> MS	DOWNLINK RLC DATA BLOCK	Sent on TN ₁ with FBI = 1 and a valid RRBP.
15	SS -> MS	PACKET UPLINK ACK/NACK	FINAL_ACK_INDICATION = 1. Sent on PACCH of the uplink PDCH.
16	MS -> SS	PACKET CONTROL ACKNOWLEDGEMENT	CTRL_ACK = 01. The MS releases the uplink TBF.
17	MS -> SS	PACKET CONTROL ACKNOWLEDGEMENT	Received on the block specified by RRBP in step 14. CTRL_ACK = 11. The MS releases the downlink TBF.

Specific Message Contents

PACKET UPLINK ASSIGNMENT message in step 1 (in macro):

Same as in the test for the multiclass 2 & 3

PACKET DOWNLINK ASSIGNMET message in step 4:

Same as in the test for the multiclass 2 & 3 except

TIMESLOT_ALLOCATION	Timeslot 1, 2 and 3 assigned
---------------------	------------------------------

Expected Sequence for multislot class 5, 9 (2 downlink timeslots + 2 uplink timeslots)

Step	Direction	Message	Comments
1		{Uplink dynamic allocation two phase access}	n = 440 octets, without starting time, USF_GRANULARITY = 1 block, RLC_DATA_BLOCKS_GRANTED = open-end TLLI_BLOCK_CHANNEL_CODING: cs1 CHANNEL_CODING_COMMAND: cs1 Two uplink timeslots are assigned (see specific message contents).
2	SS -> MS	PACKET DOWNLINK DUMMY CONTROL BLOCK	The USF ₁ assigned to the MS. Sent in TN ₁ on PACCH of PDCH assigned in step 1.
3	SS -> MS	PACKET DOWNLINK DUMMY CONTROL BLOCK	The USF ₂ assigned to the MS. Sent in TN ₂ on the same radio block as step 2, on PACCH of PDCH assigned in step 1.
4	MS -> SS	UPLINK RLC DATA BLOCK	Received on TN ₁ on the PDTCH assigned in step 1.
5	MS -> SS	UPLINK RLC DATA BLOCK	Received on TN ₂ on the same radio block as step 4, on PDTCH assigned in step 1.
6	SS -> MS	PACKET DOWNLINK ASSIGNMENT	Sent on PACCH of PDCH assigned in step 5. Assign a downlink TBF, MAC mode = dynamic allocation, RLC mode = unacknowledged mode, TFI _d , no starting time, assigning the timeslots TN ₁ and TN ₂ .
7	SS -> MS	DOWNLINK RLC DATA BLOCK	Sent on TN ₁ of the downlink PDTCH, RRBP invalid, the assigned USF ₁ addressing the MS.
8	SS -> MS	DOWNLINK RLC DATA BLOCK	Sent on TN ₂ of the downlink PDTCH, a valid RRBP = N + 13, the assigned USF ₂ addressing the MS, on the same radio block as step 7.
9	MS -> SS	UPLINK RLC DATA BLOCK	Received on TN ₁ on the next radio block from step 7.
10	MS -> SS	UPLINK RLC DATA BLOCK	Received on TN ₂ on the next radio block from step 7.
11	SS -> MS	DOWNLINK RLC DATA BLOCK	Sent on TN ₁ of the downlink PDTCH on the next radio block from step 9, an invalid RRBP, the assigned USF ₁ addressing the MS.
12	SS -> MS	DOWNLINK RLC DATA BLOCK	Sent on TN ₂ of the downlink PDTCH on the next radio block from step 9, an invalid RRBP, the assigned USF ₂ addressing the MS.
13	MS -> SS	UPLINK RLC DATA BLOCK	Received on TN ₁ on the PDTCH assigned in step 5.
14	MS -> SS	PACKET DOWNLINK ACK/NACK	Received on the RRBP block on TN ₂ specified in step 8.
15			Repeat step 7 to 14, until CV=0 in step 9, 10 or 13.
16	SS -> MS	DOWNLINK RLC DATA BLOCK	Sent on TN ₁ with FBI = 1 and a valid RRBP.
17	SS -> MS	PACKET UPLINK ACK/NACK	FINAL_ACK_INDICATION = 1. Sent on PACCH of the uplink PDCH.
18	MS -> SS	PACKET CONTROL ACKNOWLEDGEMENT	CTRL_ACK = 01. The MS releases the uplink TBF.
19	MS -> SS	PACKET CONTROL ACKNOWLEDGEMENT	Received on the block specified by RRBP in step 16. CTRL_ACK = 11. The MS releases the downlink TBF.

Specific Message Contents

PACKET UPLINK ASSIGNMENT message in step 1 (in macro):

Same as in the test for the multiclass 2 & 3 except

-	1 (Timeslot Allocation with Power Control Parameters for two slots assigned)
- ALPHA	0.5
-	01 (timeslot 1 assigned)
- USF_TN1	Arbitrarily chosen
- GAMMA_TN1	For GSM 900, +9 dBm
	For DCS 1800 and PCS 1900, +6 dBm
- {0 1<USF_TN2><GAMMA_TN2>}	1 (timeslot 2 assigned)
- USF_TN2	Arbitrarily chosen but different from USF_TN1
- GAMMA_TN2	For GSM 900, +9 dBm
	For DCS 1800 and PCS 1900, +6 dBm
-	00000

PACKET DOWNLINK ASSIGNMET message in step 10:

Same as in the test for the multiclass 2 & 3

Expected Sequence for multislot class 8, 10 (4 downlink timeslots + 1 uplink timeslot)

Step	Direction	Message	Comments
1		{Uplink dynamic allocation two phase access}	n = 220 octets, without starting time, USF_GRANULARITY = 1 block, RLC_DATA_BLOCKS_GRANTED = open-end TLLI_BLOCK_CHANNEL_CODING: cs1 CHANNEL_CODING_COMMAND: cs1 1 uplink timeslot is assigned (see specific message contents).
2	SS -> MS	PACKET DOWNLINK DUMMY CONTROL BLOCK	The USF assigned to the MS. Sent in TN ₃ on PACCH of PDCH assigned in step 1.
3	MS -> SS	UPLINK RLC DATA BLOCK	Received on TN ₃ on the PDTCH.
4	SS -> MS	PACKET DOWNLINK ASSIGNMENT	Sent on PACCH of PDCH assigned in step 1. Assign a downlink TBF, MAC mode = dynamic allocation, RLC mode = unacknowledged mode, four slots TN ₁ – TN ₄ , TFI _d , no starting time.
5	SS -> MS	DOWNLINK RLC DATA BLOCK	Sent on TN ₁ of the PDTCH assigned in step 4, with an invalid RRBp
6	SS -> MS	DOWNLINK RLC DATA BLOCK	Sent on TN ₂ of the PDTCH assigned in step 4, an invalid RRBp on the same radio block as step 5.
7	SS -> MS	DOWNLINK RLC DATA BLOCK	Sent on TN ₃ of the PDTCH assigned in step 4, the assigned USF assigned to the MS, a valid RRBp = N + 13, on the same radio block as step 5.
8	SS -> MS	DOWNLINK RLC DATA BLOCK	Sent on TN ₄ of the PDTCH assigned in step 4, an invalid RRBp, on the same radio block as step 5.
9	MS -> SS	UPLINK RLC DATA BLOCK	Received on TN ₃ on the PDTCH assigned in step 1, on the next radio block from step 5.
10	SS -> MS	DOWNLINK RLC DATA BLOCK	Sent on TN ₁ of the PDTCH assigned in step 4, with an invalid RRBp, on the next radio block from step 9.
11	SS -> MS	DOWNLINK RLC DATA BLOCK	Sent on TN ₂ of the PDTCH assigned in step 4, an invalid RRBp, on the next radio block from step 9.
12	SS -> MS	DOWNLINK RLC DATA BLOCK	Sent on TN ₃ of the PDTCH assigned in step 4, the assigned USF assigned to the MS, on the next radio block from step 9.
13	SS -> MS	DOWNLINK RLC DATA BLOCK	Sent on TN ₄ of the PDTCH assigned in step 4, an invalid RRBp, on the next radio block from step 9.
14	MS -> SS	PACKET DOWNLINK ACK/NACK	Received on the RRBp block of TN ₃ specified in step 7, on the next radio block from step 10.
15			Repeat step 5 to 14, until CV=0 in step 9.
16	SS -> MS	DOWNLINK RLC DATA BLOCK	Sent on TN ₁ with FBI = 1 and a valid RRBp.
17	SS -> MS	PACKET UPLINK ACK/NACK	FINAL_ACK_INDICATION = 1. Sent on PACCH of the uplink PDCH.
18	MS -> SS	PACKET CONTROL ACKNOWLEDGEMENT	CTRL_ACK = 01. The MS releases the uplink TBF.
19	MS -> SS	PACKET CONTROL ACKNOWLEDGEMENT	Received on the block specified by RRBp in step 16. CTRL_ACK = 11. The MS releases the downlink TBF.

Specific Message Contents

PACKET UPLINK ASSIGNMENT message in step 1:

Same as in the test for the multiclass 2 & 3 except that instead of timeslot 2, the timeslot 3 is assigned.

PACKET DOWNLINK ASSIGNMENT message in step 4:

Same as in the test for the multiclass 2 & 3 except 4 timeslots assigned.

TIMESLOT_ALLOCATION	TN ₁ – TN ₄ assigned
---------------------	--

Expected Sequence for multislot class 19, 24 (5 downlink + 2 uplink timeslots)

Step	Direction	Message	Comments
1		{Uplink dynamic allocation two phase access}	n = 160 octets, without starting time, without frequency hopping, USF_GRANULARITY = 1 block, RLC_DATA_BLOCKS_GRANTED = open-end TLLI_BLOCK_CHANNEL_CODING: cs1 CHANNEL_CODING_COMMAND: cs1 1 uplink timeslot is assigned (see specific message contents).
2	SS -> MS	PACKET DOWNLINK DUMMY CONTROL BLOCK	The assigned USF assigned to the MS, sent in TN ₃ on PACCH of PDCH assigned in step 1.
3	MS -> SS	UPLINK RLC DATA BLOCK	Received on TN ₃ on the PDTCH assigned in step 1.
4	SS -> MS	PACKET DOWNLINK ASSIGNMENT	Sent on PACCH of PDCH assigned in step 1. Assign a downlink TBF, MAC mode = dynamic allocation, RLC mode = unacknowledged mode, TN ₁ – TN ₅ assigned, TFI _d , no starting time.
5	SS - MS	DOWNLINK RLC DATA BLOCK	Sent on TN ₁ of the PDTCH assigned in step 4, with an invalid RRBP.
6	SS - MS	DOWNLINK RLC DATA BLOCK	Sent on TN ₂ of the PDTCH assigned in step 4, with an invalid RRBP, on the same radio block as step 5.
7	SS - MS	DOWNLINK RLC DATA BLOCK	Sent on TN ₃ of the PDTCH assigned in step 4, the assigned USF assigned to the MS, a valid RRBP = N + 13, on the same radio block as step 5.
8	SS - MS	DOWNLINK RLC DATA BLOCK	Sent on TN ₄ of the PDTCH assigned in step 4, with an invalid RRBP, on the same radio block as step 5.
9	SS - MS	DOWNLINK RLC DATA BLOCK	Sent on TN ₅ of the PDTCH assigned in step 4, with an invalid RRBP, on the same radio block as step 5.
10	MS -> SS	UPLINK RLC DATA BLOCK	Received on TN ₃ on the PDTCH assigned in step 5, on the next radio block from step 5.
11	SS - MS	DOWNLINK RLC DATA BLOCK	Sent on TN ₁ of the PDTCH assigned in step 4, with an invalid RRBP on the next radio block from step 10.
12	SS - MS	DOWNLINK RLC DATA BLOCK	Sent on TN ₂ of the PDTCH assigned in step 4, with an invalid RRBP on the same radio block as step 11.
13	SS - MS	DOWNLINK RLC DATA BLOCK	Sent on TN ₃ of the PDTCH assigned in step 4, with an invalid RRBP on the same radio block as step 11.
14	SS - MS	DOWNLINK RLC DATA BLOCK	Sent on TN ₄ of the PDTCH assigned in step 4, with an invalid RRBP on the same radio block as step 11.
15	SS - MS	DOWNLINK RLC DATA BLOCK	Sent on TN ₅ of the PDTCH assigned in step 4, with an invalid RRBP on the same radio block as step 11.
16	MS -> SS	PACKET DOWNLINK ACK/NACK	Received on the RRBP block of TN ₃ specified in step 7.
15			Repeat step 5 to 16, until CV=0 in step 10.
16	SS -> MS	DOWNLINK RLC DATA BLOCK	Sent on TN ₁ with FBI = 1 and a valid RRBP.
17	SS -> MS	PACKET UPLINK ACK/NACK	FINAL_ACK_INDICATION = 1. Sent on PACCH of the uplink PDCH.
18	MS -> SS	PACKET CONTROL ACKNOWLEDGEMENT	CTRL_ACK = 01. The MS releases the uplink TBF.
19	MS -> SS	PACKET CONTROL ACKNOWLEDGEMENT	Received on the block specified by RRBP in step 16. CTRL_ACK = 11. The MS releases the downlink TBF.

Specific Message Contents

PACKET UPLINK ASSIGNMENT message in step 1:

Same as in the test for the multiclass 2 & 3 except

{0 1<Frequency Parameters> - TSC - - ARFCN Dynamic allocation - {0 1<USF_TN0>} ... {0 1<USF_TN3>} - USF_TN3 -	1 (frequency parameters presents) 6 00, non hopping For GSM900: 30 For DCS1800 and PCS 1900: 650 01 0001 arbitrarily chosen 0000, none of the other timeslots assigned.
--	---

PACKET DOWNLINK ASSIGNMET message in step 4:

Same as in the test for the multiclass 2 & 3 except 5 timeslots assigned.

TIMESLOT_ALLOCATION	TN ₁ – TN ₅ assigned
---------------------	--

42.3.2.2 Dynamic Allocation / Uplink Transfer with Downlink TBF establishment / Abnormal

42.3.2.2.1 Dynamic Allocation / Uplink Transfer with Downlink TBF establishment / Abnormal / with random access

42.3.2.2.1.1 Conformance requirements

- 1 If a failure occurs on the mobile station side before the new TBF has been successfully established, the newly reserved resources are released.
- 2 If the information in the PACKET TIMESLOT RECONFIGURE does not properly specify an uplink and downlink PDCH or violates the mobile station’s multislot capabilities, the mobile station shall perform an abnormal release with random access.
- 3 If uplink and downlink TBFs are not already established and the PACKET TIMESLOT RECONFIGURE message does not include a DOWNLINK_TFI_ASSIGNMENT field, then the mobile station shall perform an abnormal release with random access.
- 4 If a failure in the PACKET TIMESLOT RECONFIGURE is due to any other reason, the mobile station shall abort the procedure and perform an abnormal release with random access.
- 5 If the mobile station receives a PACKET UPLINK ASSIGNMENT or PACKET TIMESLOT RECONFIGURE message specifying frequencies that are not all in one frequency band then the mobile station shall perform an abnormal release with random access.
- 6 To perform an abnormal release with random access, the mobile station shall abort all TBFs in progress and its associated resources, return to the CCCH or PCCCH and initiate establishment of a new uplink TBF.

References

GSM 04.60, 8.1.1.1.3.1, 8.1.1.1.2.1, 8.7.2

42.3.2.2.1.2 Test purposes

To verify that the MS, in downlink TBF establishment during uplink transfer, performs an abnormal release with random access, when the information in the PACKET TIMESLOT RECONFIGURE

- 1 does not properly specify an uplink and downlink PDCH,
- 2 violates the mobile station's multislot capabilities,
- 3 does not include a DOWNLINK_TFI_ASSIGNMENT field,
- 4 has a failure due to any other reason other than the reasons listed above.

42.3.2.2.1.3 Method of test

Initial Conditions

System Simulator:

- 1 cell, default setting, BS_PBCCH_BLKs = 3.

Mobile Station:

The MS is GPRS attached with a P-TMSI allocated and the test PDP context3 activated.

Related PICS/PIXIT Statement(s)

Support GPRS service,
Support activation of at least one PDP context,
The way to initiate an uplink transfer,
Multislot class of the MS

Test Procedure

An uplink TBF is established and in progress. The SS sends PACKET TIMESLOT RECONFIGURE for establishment a downlink TBF. A failure occurs at the mobile station side before the new downlink TBF has been successfully established. The MS starts a random access for uplink establishment. The SS assigns a new uplink PDCH to the MS. The SS signals the USF of the preceding uplink TBF addressing the MS on the preceding PDCH which shall have been released by the MS. It is checked that no RLC data block is received on the next three radio blocks. The SS signals the assigned USF assigned to the MS on the uplink PDCH assigned. The MS sends a RLC data block.

The test procedure is repeated 4 times. The message contents of PACKET TIMESLOT RECONFIGURE are varied as defined below.

- 1st execution, improper PDCH: hopping frequencies not all in one band,
- 2nd execution, violating the multislot capabilities,
- 3rd execution, no DOWNLINK_TFI_ASSIGNMENT,
- 4th execution, CONTROL_ACK = '1' (shall be set to '0' as the SS has not yet sent the final downlink RLC data block).

Maximum Duration of Test

10 min.

Expected Sequence

The sequence is repeated 4 times. The 2nd execution is not applicable for the MS multislot class 18, 29.

Step	Direction	Message	Comments
1		{Uplink dynamic allocation two phase access}	n = 220 octets, without starting time, USF_GRANULARITY = 1 block, RLC_DATA_BLOCKS_GRANTED = open-end TLLI_BLOCK_CHANNEL_CODING: arbitrarily chosen CHANNEL_CODING_COMMAND: arbitrarily chosen but different from above.
2	SS -> MS	PACKET DOWNLINK DUMMY CONTROL BLOCK	The assigned USF assigned to the MS
3	MS -> SS	UPLINK RLC DATA BLOCK	Received on the assigned PDTCH. Check that the coding and the TFI are correct.
4	SS -> MS	PACKET TIMESLOT RECONFIGURE	See specific message contents.
5	MS -> SS	PACKET CHANNEL REQUEST	Received on PRACH.
6	SS -> MS	PACKET UPLINK ASSIGNMENT	Single block assignment, to force the MS making the two-phase access procedure. Sent on PAGCH.
7	MS -> SS	PACKET RESOURCE REQUEST	Two phase access procedure. Received on the single block assigned in step 6.
8	SS -> MS	PACKET UPLINK ASSIGNMENT	Open-ended uplink dynamic allocation, no starting time, USF_GRANULARITY = single block, the assigned slot and USF different from TN ₂ (as in the default)
9	SS -> MS	PACKET DOWNLINK DUMMY CONTROL BLOCK	The USF assigned to the MS in step 1, sent on TN ₂ , on PACCH in step 1.
10	SS		Check that no RLC data block is received on the next three radio blocks from step 9.
11	SS -> MS	PACKET DOWNLINK DUMMY CONTROL BLOCK	The USF assigned to the MS sent on the PACCH assigned in step 8.
12	MS -> SS	UPLINK RLC DATA BLOCK	Received on the correct radio block of the assigned PDTCH.
13		{Completion of uplink RLC data block transfer}	

Specific Message Contents

PACKET TIMESLOT RECONFIGURE message in step 4 (1st execution)

PAGE_MODE	Normal
GLOBAL_TFI	0, the TFI value of the uplink TBF assigned 0
CHANNEL_CODING_COMMAND	arbitrarily chosen from valid values
DOWNLINK_RLC_MODE	unacknowledged mode
CONTROL_ACK	0
{0 1<DOWNLINK_TFI_ASSIGNMENT> - DOWNLINK_TFI_ASSIGNMENT	1 (assign TFI to the downlink TBF) arbitrarily chosen but different from the value for the uplink TBF
{0 1<UPLINK_TFI_ASSIGNMENT> DOWNLINK_TIMESLOT_ALLOCATION	0 The same timeslot as the uplink
{0 1<Frequency Parameters> - TSC	1 (frequency parameters) Any valid value
-	11 (Direct encoding 2)
- MAIO	arbitrarily chosen from (0, 1, 2, ..., 9)
- HSN	arbitrarily chosen
- Length of MA Frequency List contents	11
- MA Frequency List contents	containing ARFCNs 10, 20, 40, 80, 90, 520, 590, 600, 700, 780 by range 1024 format
Dynamic allocation	0
- Extended Dynamic Allocation	0 (Dynamic allocation)
{0 1<P0>}	0
- USF GRANULARITY	0 (1 RLC block)
- {0 1<RLC_DATA_BLOCKS_GRANTED>}	0 (open-ended TBF)
- {0 1<TBF_STARTING_TIME>}	0 (no starting time)
-	0 (Timeslot Allocation)
- {0 1<USF_TN _x >	001 (timeslot 2 assigned)
- USF_TN ₂	Arbitrarily chosen but different from the current value 00000

PACKET TIMESLOT RECONFIGURE message in step 4 (2nd execution)

PAGE_MODE	Normal
GLOBAL_TFI	0, the TFI value of the uplink TBF assigned 0
CHANNEL_CODING_COMMAND	arbitrarily chosen from valid values
DOWNLINK_RLC_MODE	unacknowledged mode
CONTROL_ACK	0
{0 1<DOWNLINK_TFI_ASSIGNMENT> - DOWNLINK_TFI_ASSIGNMENT	1 (assign TFI to the downlink TBF) arbitrarily chosen but different from the value for the uplink TBF
{0 1<UPLINK_TFI_ASSIGNMENT> DOWNLINK_TIMESLOT_ALLOCATION	0 Timeslots 0-7 assigned
{0 1<Frequency Parameters>	0
Dynamic allocation	0
- Extended Dynamic Allocation	0 (Dynamic allocation)
{0 1<P0>}	0
- USF GRANULARITY	0 (1 RLC block)
- {0 1<RLC_DATA_BLOCKS_GRANTED>}	0 (open-ended TBF)
- {0 1<TBF_STARTING_TIME>}	0 (no starting time)
-	0 (Timeslot Allocation)
- {0 1<USF_TN0>}	1, a valid value
- {0 1<USF_TN1>}	1, a valid value
- {0 1<USF_TN2>}	1, a valid value
- {0 1<USF_TN3>}	1, a valid value
- {0 1<USF_TN4>}	1, a valid value
- {0 1<USF_TN5>}	1, a valid value
- {0 1<USF_TN6>}	1, a valid value
- {0 1<USF_TN7>}	1, a valid value

PACKET TIMESLOT RECONFIGURE message in step 4 (3rd execution)

PAGE_MODE	Normal
GLOBAL_TFI	0, the TFI value of the uplink TBF assigned
	0
CHANNEL_CODING_COMMAND	arbitrarily chosen from valid values
DOWNLINK_RLC_MODE	unacknowledged mode
CONTROL_ACK	0
{0 1<DOWNLINK_TFI_ASSIGNMENT>}	0, no DOWNLINK_TFI_ASSIGNMENT
{0 1<UPLINK_TFI_ASSIGNMENT>}	0
DOWNLINK_TIMESLOT_ALLOCATION	The same timeslot as the uplink
{0 1<Frequency Parameters>}	0
Dynamic allocation	0
- Extended Dynamic Allocation	0 (Dynamic allocation)
{0 1<P0>}	0
- USF GRANULARITY	0 (1 RLC block)
- {0 1<RLC_DATA_BLOCKS_GRANTED>}	0 (open-ended TBF)
- {0 1<TBF_STARTING_TIME>}	0 (no starting time)
-	0 (Timeslot Allocation)
- {0 1<USF_TNx>	001 (timeslot 2 assigned)
- USF_TN ₂	Arbitrarily chosen but different from the current value
	00000

PACKET TIMESLOT RECONFIGURE message in step 4 (4th execution):

Same as in 3rd execution except

CONTROL_ACK	1
-------------	---

42.3.2.2.2 Dynamic Allocation / Uplink Transfer with Downlink TBF establishment / Abnormal / Continuation of normal operation

42.3.2.2.2.1 Conformance requirements

- 1 If a failure occurs on the mobile station side before the new TBF has been successfully established, the newly reserved resources are released.
- 2 If a failure in the PACKET DOWNLINK ASSIGNMENT is due to any reason, the mobile station shall abort the procedure and continue the normal operation of the uplink TBF.
- 3 If a mobile station receives a PACKET DOWNLINK ASSIGNMENT assigning a different MAC mode than the MAC mode of an already operating uplink TBF, the PACKET DOWNLINK ASSIGNMENT message shall be ignored.

References

GSM 04.60, 8.1.1.1.3.1, 8.7

42.3.2.2.2.2 Test purposes

- 1 To verify that the MS aborts the downlink TBF establishment and continues the normal operation of the uplink TBF when the PACKET DOWNLINK ASSIGNMENT fails due to any reason in downlink TBF establishment during uplink transfer.
- 2 To verify that the MS ignores the PACKET DOWNLINK ASSIGNMENT message if it assigns a different MAC mode than the MAC mode of an already operating uplink TBF.

42.3.2.2.2.3 Method of test

Initial Conditions

System Simulator:

1 cell, default setting, BS_PBCCH_BLKs = 3.

Mobile Station:

The MS is GPRS attached with a P-TMSI allocated and the test PDP context3 activated.

Related PICS/PIXIT Statement(s)

Type of MS (P-, E-, R-GSM 900 or DCS 1800 and PCS 1900),
Support GPRS service,
Support activation of at least one PDP context,
The way to initiate an uplink packet transfer

Test Procedure

An uplink TBF is established and in progress. The SS sends PACKET DOWNLINK ASSIGNMENT assigning a downlink TBF while a fault occurs in the downlink assignment message.

The SS sends a downlink RLC data block on the downlink PDCH assigned and polls the MS for acknowledgement. It is checked that no PACKET DOWNLINK ACK/NACK is received. The SS signals the assigned USF assigned to the MS on the uplink PDCH assigned. The MS sends a RLC data block.

The test procedure is executed twice. The message contents of PACKET DOWNLINK ASSIGNMENT are varied as defined below.

- 1 Without DOWNLINK_TFI_ASSIGNMENT,
- 2 MAC mode = Fixed Allocation, an inconsistent MAC mode.

Maximum Duration of Test

5 min.

Expected Sequence

The test sequence is executed twice.

Step	Direction	Message	Comments
1		{Uplink dynamic allocation two phase access}	n = 440 octets, without starting time, USF_GRANULARITY = 1 block, RLC_DATA_BLOCKS_GRANTED = open-end TLLI_BLOCK_CHANNEL_CODING: arbitrarily chosen CHANNEL_CODING_COMMAND: arbitrarily chosen but different from above.
2	SS -> MS	PACKET DOWNLINK DUMMY CONTROL BLOCK	The assigned USF assigned to the MS
3	MS -> SS	UPLINK RLC DATA BLOCK	Received on the assigned PDTCH.
4	SS -> MS	PACKET DOWNLINK ASSIGNMENT	See specific message contents
5	SS -> MS	DOWNLINK RLC DATA BLOCK	Containing RRBP= N+13, Sent on the downlink PDTCH assigned in step 4.
6	SS		for 1 st execution, TFI is set to the uplink one; for 2 nd execution, use the assigned TFI in step 4. Check that no PACKET DOWNLINK ACK/NACK received on the block of frame number = N+13, N is the frame number of the first burst of the data block in step 5.
7	SS -> MS	PACKET UPLINK ACK/NACK	The USF assigned to the MS. Sent on PACCH of the uplink PDCH assigned.
8	MS -> SS	UPLINK RLC DATA BLOCK	Received on the assigned PDTCH.
9		{Completion of uplink RLC data block transfer}	

Specific Message Contents

PACKET DOWNLINK ASSIGNMET message in step 4 (1st execution):

Referenced Address	
-	0 (address is Global TFI)
- TFI	same as the value for uplink TBF
{0 1<DOWNLINK_TFI_ASSIGNMENT>}	L (no downlink TFI assignment)

PACKET DOWNLINK ASSIGNMET message in step 4 (2nd execution):

Referenced Address	
-	0 (address is Global TFI)
- TFI	same as the value for uplink TBF
MAC_MODE	Fixed Allocation, half duplex mode

42.3.3 Dynamic Allocation / Resource reallocation

The clause is applicable to the MS either supporting two PDP contexts or supporting SMS over GPRS and at least one PDP context.

42.3.3.1 Dynamic Allocation / Resource reallocation / Successful

During an uplink packet transfer, upper layer may request to transfer another LLC PDU with a different Radio Priority, a different peak throughput class or a different RLC mode than the current one, the MS may require the allocation of new uplink resources.

42.3.3.1.1 Dynamic Allocation / Resource reallocation / Successful / Higher throughput class or higher radio priority

42.3.3.1.1.1 Conformance requirements

1. During an uplink packet transfer, upper layer may request to transfer another LLC PDU. If the mobile station has not started the countdown procedure and the new LLC PDU has the same RLC mode as the current uplink TBF and either a higher radio priority or the same radio priority but a higher peak throughput class, the mobile station shall immediately request a resource reallocation for uplink according to the new Radio Priority and peak throughput class of the new LLC PDU by sending a PACKET RESOURCE REQUEST message on the PACCH and starting timer T3168.
2. Then the mobile station shall complete the transmission of the current LLC PDU.
3. After the transmission of the PACKET RESOURCE REQUEST message with the reason for changing the priority or peak throughput class of an assigned uplink TBF the mobile station shall continue to use the currently assigned uplink TBF assuming that the requested priority or peak throughput class is already assigned to that TBF.

References

GSM 04.60 8.1.1.1.2

42.3.3.1.1.2 Test purposes

It is verified that:

1. Having an uplink TBF in progress without starting the countdown procedure, the MS will immediately send PACKET RESOURCE REQUEST if upper layer requests to transfer another LLC PDU which has the same RLC mode as the current uplink TBF and either a higher radio priority or the same radio priority but a higher peak throughput class.
2. After the request of the resource reallocation for uplink the MS completes the transmission of the current LLC PDU independent of whether or not a new resource is allocated.
3. After the transmission of the PACKET RESOURCE REQUEST the MS continues to use the currently assigned uplink TBF.

42.3.3.1.1.3 Method of test

Initial Conditions

System Simulator:

1 cell, default setting, BS_PBCCH_BLKs = 3, T3168 timeout value=7 (4s), N201-U=500 for SAPI 3, 5, 9, 11, N201-U=270 for SAPI 7.

Mobile Station:

The MS is GPRS attached with a P-TMSI allocated, SPLIT PG CYCLE negotiated,

- for the MS supporting two PDP contexts: the test PDP context3 and context6 activated,

- for the MS supporting one PDP context and SMS over GPRS: the test PDP context5 activated.

Related PICS/PIXIT Statement(s)

Type of MS (P-, E-, R-GSM 900 or DCS 1800 and PCS 1900),
Support GPRS service,
Support activation of at least one PDP context,
Support two PDP contexts,
Support Short Message Service,
Support SMS over GPRS,

The way to initiate an uplink packet transfer,
The way to trigger transferring new user data in a different PDP context while an uplink transfer is in progress,
The way to trigger sending an MO short message over GPRS

Test Procedure

1. Test procedure for the MS supporting two PDP contexts.

An uplink TBF is established and in progress. The MS is triggered to transfer data with a higher throughput in the same RLC mode and the same radio priority.

The MS sends PACKET RESOURCE REQUEST. The current TBF is maintained and SS assigns the USFs allowing the MS transmit more data blocks. It is verified that the MS completes the transmission of the current LLC PDU and then starts transmitting a new LLC PDU with the higher throughput. A new PDCH is assigned to MS to complete the RLC data block transferring.

The test procedure is executed twice. In the 2nd execution, after the MS requests a resource reallocation for transferring the data block with a higher throughput a new PDCH is assigned. It is verified that the MS switches on the new PDCH, completes the transmission of the current LLC PDU and then starts transmitting a new LLC PDU with the higher throughput.

2. Test procedure for the MS supporting SMS over GPRS and one PDP context.

Similar to the 1st test procedure except that the MS is triggered firstly to send MO SMS over GPRS. After an uplink TBF is established for SMS and is in progress the MS is triggered to transfer data with a higher radio priority in the same RLC mode (SMS has the radio priority level = 3 defined in the attach accept message).

Maximum Duration of Test

5 min.

Expected Sequence

The test sequence is applied to the MS supporting two PDP contexts and executed twice for $k = 1$ and 2 .

When $k=1$ testing that the MS continues to use the currently assigned uplink TBF, while $k=2$ testing that the MS to use newly assigned the resource to complete transmission of the current PDU before starting transmission the PDU with a higher radio priority or a higher throughput.

Step	Direction	Message	Comments
1		{Uplink dynamic allocation two phase access}	n = 440 octets in test PDP context3, without starting time, USF_GRANULARITY = 1 block, RLC_DATA_BLOCKS_GRANTED = open-end TLLI_BLOCK_CHANNEL_CODING: cs1, CHANNEL_CODING_COMMAND: cs1, PEAK_THROUGHPUT_CLASS = 5 (16k octets/s), RADIO_PRIORITY = 4, RLC_MODE = unacknowledged mode.
2	SS -> MS	PACKET DOWNLINK DUMMY CONTROL BLOCK	Sent on the PACCH, the USF assigned to the MS.
3	MS -> SS	UPLINK RLC DATA BLOCK	Received on the assigned PDTCH. Check that the coding as specified by CHANNEL_CODING_COMMAND, the TFI is correct.
4	MS		To trigger the MS to transfer 440 octets with the peak throughput class 6 (32k octets/s) in the same RLC mode and the same radio priority as the current uplink TBF (test PDP context6).
5	MS -> SS	PACKET RESOURCE REQUEST	Received on the PACCH of the assigned PDCH, radio priority level = 4, peak throughput class = 6, unacknowledged mode.
6	SS -> MS	PACKET DOWNLINK DUMMY CONTROL BLOCK	Sent on the PACCH of the PDCH assigned, the USF assigned to the MS.
7	MS -> SS	UPLINK RLC DATA BLOCK	Received on the assigned PDTCH. Check that the coding and the TFI are correct.
8	SS		Repeat step 6 and 7 n times. Observe the Length indicator, M bit and E bit of the received data headers. For k=1 n=30 Check that the transmission of the 1 st LLC PDU in PDP context3 is completed. The 2 nd LLC PDU in PDP context6 is started. For k=2 n=5 Check that only the data of the 1 st LLC PDU in PDP context3 are transmitted.
9	SS -> MS	PACKET UPLINK ACK/NACK	Sent on the PACCH of the PDCH assigned, acknowledge all received data, without setting FINAL_ACK_INDICATION.
10	SS -> MS	PACKET UPLINK ASSIGNMENT	Sent on PACCH of the PDCH assigned in step 1, assigning a new PDCH.
11	SS -> MS	PACKET DOWNLINK DUMMY CONTROL BLOCK	Sent on the PACCH of the PDCH assigned in step 10, the USF assigned to the MS.
12	MS -> SS	UPLINK RLC DATA BLOCK	Received on the PDTCH assigned in step 10.
13		{Completion of uplink RLC data block transfer}	For k=1, as defined in the macro. For k=2, Observe the Length indicator, M bit and E bit of the received data headers. Check that the MS completes firstly the transmission of the 1 st LLC PDU in PDP context3 and then transmits the 2 nd LLC PDU in PDP context6.

Specific Message Contents

PACKET RESOURCE REQUEST message in step 5:

Channel Request Description	
- PEAK_THROUGHPUT_CLASS	6
- RADIO_PRIORITY	4
- RLC_MODE	Unacknowledged mode
- LLC_PDU_TYPE	1 (not SACK or ACK)
- RLC_OCTET_COUNT	Any value

PACKET UPLINK ASSIGNMET message in step 10:

PAGE_MODE	Normal
{0 1<PERSISTENCE_LEVEL>	0
- Uplink TFI	0, Global TFI Same as the current value
CHANNEL_CODING_COMMAND	0
TLLI_BLOCK_CHANNEL_CODING	CS-1
<Packet Timing Advance>	CS-1
{0 1<Frequency Parameters>	As default
Dynamic allocation	0
-	01
-	000000
-	0 (Timeslot Allocation)
-	00000001 (timeslot 7 assigned)
- USF_TN7	Arbitrarily chosen

Expected Sequence for the MS supporting one PDP context and SMS over GPRS

The test sequence is applied to the MS supporting SMS over GPRS and one PDP context. The sequence is executed twice for k = 1 and 2.

Step	Direction	Message	Comments
1	MS	{Uplink dynamic allocation two phase access}	To trigger the MS to send a short message of 110 octets. n = 110 octets, without starting time, USF_GRANULARITY = 1 block, RLC_DATA_BLOCKS_GRANTED = open-end TLLI_BLOCK_CHANNEL_CODING: cs1, CHANNEL_CODING_COMMAND: cs1, RLC_MODE = acknowledged mode.
2	SS -> MS	PACKET DOWNLINK DUMMY CONTROL BLOCK	Sent on the PACCH, the USF assigned to the MS.
3	MS -> SS	UPLINK RLC DATA BLOCK	Received on the assigned PDTCH. Check that the coding as specified by CHANNEL_CODING_COMMAND, the TFI is correct.
4	MS		To trigger the MS to transfer 440 octets with the peak throughput class 5 (16k octets/s) and the radio priority 1 in acknowledge RLC mode of the PDP context5.
5	MS -> SS	PACKET RESOURCE REQUEST	Received on the PACCH of the assigned PDCH, radio priority level = 1, peak throughput class = 5, acknowledged mode.
6	SS -> MS	PACKET DOWNLINK DUMMY CONTROL BLOCK	Sent on the PACCH of the PDCH assigned, the USF assigned to the MS.
7	MS -> SS	UPLINK RLC DATA BLOCK	Received on the assigned PDTCH. Check that the coding and the TFI are correct.
8	SS		Repeat step 6 and 7 n times. Observe the Length indicator, M bit and E bit of the received data headers. For k=1: n=8. Check that the transmission of the 1 st LLC PDU for short message is completed. The 2 nd LLC PDU in PDP context6 is started. For k=2: n=2.
9	SS -> MS	PACKET UPLINK ACK/NACK	Check that only the data of the 1 st LLC are transmitted. Sent on the PACCH of the PDCH assigned, acknowledge all received data, without setting FINAL_ACK_INDICATION.
10	SS -> MS	PACKET UPLINK ASSIGNMENT	Sent on PACCH of the PDCH assigned in step 1, assigning a new PDCH.
11	SS -> MS	PACKET DOWNLINK DUMMY CONTROL BLOCK	Sent on the PACCH of the PDCH assigned in step 10, the USF assigned to the MS.
12	MS -> SS	UPLINK RLC DATA BLOCK	Received on the PDTCH assigned in step 10.
13	MS -> SS	{Completion of uplink RLC data block transfer}	For k=1, as defined in the macro. For k=2, Observe the Length indicator, M bit and E bit of the received data headers. Check that the MS completes firstly the transmission of the 1 st LLC PDU in PDP context3 and then transmits the 2 nd LLC PDU in PDP context6.
14	MS		Switch off

Specific Message Contents

PACKET RESOURCE REQUEST message in step 5:

Channel Request Description	
- PEAK_THROUGHPUT_CLASS	Any value
- RADIO_PRIORITY	Any value
- RLC_MODE	Acknowledged mode
- LLC_PDU_TYPE	1 (not SACK or ACK)
- RLC_OCTET_COUNT	Any value

PACKET UPLINK ASSIGNMET message in step 8:

Same as in step 10 of the test sequence testing the MS supporting two PDP contexts.

42.3.3.1.2 Dynamic Allocation / Resource reallocation / Successful / Lower throughput class

42.3.3.1.2.1 Conformance requirements

1. During an uplink packet transfer, upper layer may request to transfer another LLC PDU. If the new LLC PDU has the same RLC mode as the current uplink TBF and either a lower Radio Priority or the same radio priority but a lower peak throughput class, the mobile station shall first complete the sending of the LLC PDU in transfer.
2. When the sending of LLC PDUs at the higher Radio Priority or the same radio priority but higher peak throughput class stops, without waiting for the acknowledgement from the network if in RLC acknowledged mode, the mobile station shall then perform the request of a resource reallocation for uplink for any remaining LLC PDU(s) by sending a PACKET RESOURCE REQUEST message on the PACCH and start timer T3168.

References

GSM 04.60, 8.1.1.1.2

42.3.3.1.2.2 Test purposes

To verify that during an uplink packet transfer, upper layer requests to transfer another LLC PDU and the new LLC PDU has the same RLC mode as the current uplink TBF and either a lower Radio Priority or the same radio priority but a lower peak throughput class,

1. The MS first complete the sending of the LLC PDU in transfer, including acknowledgement from the network if in RLC acknowledged mode.
2. After the sending of LLC PDUs at the higher Radio Priority or the same radio priority but higher peak throughput class stops, the MS performs the request of a resource reallocation for uplink for any remaining LLC PDU(s).

42.3.3.1.2.3 Method of test

Initial Conditions

System Simulator:

1 cell, default setting, BS_PBCCH_BLKs = 3, T3168 timeout value=7 (4s), N201-U=500 for SAPI 3, 5, 9, 11, N201-U=270 for SAPI 7.

Mobile Station:

The MS is GPRS attached with a P-TMSI allocated, SPLIT PG CYCLE negotiated,

- for the MS supporting two PDP contexts: test PDP context2 and context4 activated,

- for the MS supporting one PDP context and SMS over GPRS: Test PDP context5 activated.

Related PICS/PIXIT Statement(s)

Type of MS (P-, E-, R-GSM 900 or DCS 1800 and PCS 1900),
Support GPRS service,
Support activation of at least one PDP context,
Support two PDP contexts,
Support SMS,
Support SMS over GPRS,
The way to initiate an uplink packet transfer,

The way to trigger transferring new user data in a different PDP context while an uplink transfer is in progress,
The way to trigger sending short message over GPRS

Test Procedure

An uplink TBF is established and in progress. The MS is triggered to transfer data with a lower throughput or a lower radio priority in the same RLC mode.

The current TBF is maintained and SS assigns the USFs allowing the MS to transmit more data blocks. It is verified that the MS completes the transmission of the current LLC PDU and then sends PACKET RESOURCE REQUEST.

Maximum Duration of Test

5 min.

Expected Sequence

The branch A is applicable for the MS supporting two PDP contexts. The branch B is applicable for the MS supporting SMS over GPRS and one PDP context.

Step	Direction	Message	Comments
1A		{Uplink dynamic allocation two phase access}	In PDP context4, n = 880 octets, without starting time, USF_GRANULARITY = 1 block, RLC_DATA_BLOCKS_GRANTED = open-end TLLI_BLOCK_CHANNEL_CODING: cs1, CHANNEL_CODING_COMMAND: cs1, PEAK_THROUGHPUT_CLASS = 6, RADIO_PRIORITY = 4, RLC_MODE = acknowledged mode.
1B		{Uplink dynamic allocation two phase access}	To trigger the MS to send a short message of 110 octets over GPRS. n = 110 octets, without starting time, USF_GRANULARITY = 1 block, RLC_DATA_BLOCKS_GRANTED = open-end TLLI_BLOCK_CHANNEL_CODING: cs1, CHANNEL_CODING_COMMAND: cs1, RLC_MODE = acknowledged mode.
2	SS -> MS	PACKET DOWNLINK DUMMY CONTROL BLOCK	Sent on the PACCH, the USF assigned to the MS.
3	MS -> SS	UPLINK RLC DATA BLOCK	Received on the assigned PDTCH. Check that the coding as specified by CHANNEL_CODING_COMMAND, the TFI is correct.
4	MS		To trigger the MS to transfer 220 octets with the test PDP context2 in the same RLC mode as the current uplink TBF.
5	SS -> MS	PACKET DOWNLINK DUMMY CONTROL BLOCK	Sent on the PACCH of the PDCH assigned, the USF assigned to the MS.
6-1	MS -> SS	UPLINK RLC DATA BLOCK	Received on the assigned PDTCH. Check that the coding and the TFI are correct.
6-2	MS -> SS	PACKET RESOURCE REQUEST	Received on the PACCH of the assigned PDCH, acknowledged mode.
7	SS		Repeat step 5 and 6-1 until PACKET RESOURCE REQUEST in 6-2, instead of a RLC data block in 6-1, is received. Observe the Length indicator, M bit and E bit of the received data headers. Check that the transmission of the 1 st LLC PDU in PDP context6 is completed and the transmission of the 2 nd LLC PDU in PDP context3 is not yet started.
8	SS -> MS	PACKET UPLINK ACK/NACK	Sent on the PACCH of the PDCH assigned, acknowledge all received data
9	SS -> MS	PACKET UPLINK ASSIGNMENT	Sent on PACCH of the PDCH assigned in step 1, assigning a new PDCH.
10	SS -> MS	PACKET DOWNLINK DUMMY CONTROL BLOCK	Sent on the PACCH of the PDCH assigned in step 10, the USF assigned to the MS.
11	MS -> SS	UPLINK RLC DATA BLOCK	Received on the PDTCH assigned in step 10.
12		{Completion of uplink RLC data block transfer}	
13	MS		Switch off

Specific Message Contents

PACKET RESOURCE REQUEST message in step 6-2:

Channel Request Description	
- PEAK_THROUGHPUT_CLASS	For branch A: 5 For branch B: any allowed value
- RADIO_PRIORITY	For branch A: 4 For branch B: any allowed value different from 1
- RLC_MODE	acknowledged mode
- LLC_PDU_TYPE	1 (not SACK or ACK)
- RLC_OCTET_COUNT	Any allowed value

PACKET UPLINK ASSIGNMET message in step 9:

Same as in 42.3.3.1.1.3, step 10 of the test sequence testing the MS supporting two PDP contexts.

42.3.3.1.3 Dynamic Allocation / Resource reallocation / Successful / Different RLC mode and higher radio priority

42.3.3.1.3.1 Conformance requirements

During an uplink packet transfer, upper layer may request to transfer another LLC PDU. If the new LLC PDU does not have the same RLC mode as the current uplink TBF but has a higher radio priority, the mobile station shall complete the transmission of the current LLC PDU using the countdown procedure including acknowledgement from the network, if in RLC acknowledged mode. The mobile station shall then release the TBF and establish a new uplink TBF for transmission of the new LLC PDU. When the sending of LLC PDUs with a higher radio priority is completed using the countdown procedure, including acknowledgement from the network if in RLC acknowledged mode, the mobile station shall try to establish an uplink TBF for the transmission of any remaining LLC PDU(s).

References

GSM 04.60, 8.1.1.1.2

42.3.3.1.3.2 Test purposes

To verify that during an uplink packet transfer, upper layer requests to transfer another LLC PDU and the new LLC PDU has a different RLC mode from the current uplink TBF but has a higher radio priority,

1. The mobile station completes the transmission of the current LLC PDU using the countdown procedure including acknowledgement from the network, if in RLC acknowledged mode.
2. Then the MS releases the TBF and establishes a new uplink TBF for transmission of the new LLC PDU.
3. When the sending of the new LLC PDUs with a higher radio priority is completed using the countdown procedure, including acknowledgement from the network if in RLC acknowledged mode, the mobile station tries to establish an uplink TBF for the transmission of any remaining LLC PDU(s).

42.3.3.1.3.3 Method of test

Initial Conditions

System Simulator:

1 cell, default setting, BS_PBCCH_BLKs = 3, T3168 timeout value=7 (4s), N201-U=500 for SAPI 3, 5, 9, 11, N201-U=270 for SAPI 7.

Mobile Station:

The MS is GPRS attached with a P-TMSI allocated, SPLIT PG CYCLE negotiated,

- for the MS supporting two PDP contexts: Test PDP context1 and context2 activated,

- for the MS supporting SMS over GPRS and one PDP context: Test PDP context1 activated.

Related PICS/PIXIT Statement(s)

Support GPRS service,

Support activation of at least one PDP context,

Support two PDP contexts,

Support SMS,

Support SMS over GPRS,

The way to initiate an uplink packet transfer,

The way to trigger transferring new user data in a different PDP context while an uplink transfer is in progress,

The way to trigger sending an MO short message over GPRS.

Test Procedure

An uplink TBF is established and in progress. The MS is triggered to transfer 220 octets user data with a higher throughput or a higher radio priority, but in a different RLC mode.

SS assigns the USFs allowing the MS transmit more data blocks until the MS complete the countdown procedure. It is verified that the MS has transmitted only one LLC PDU.

Random accesses are received from the MS for packet channel request. SS assigns a PDCH to it. SS assigns USFs addressing to the MS allowing more data blocks are transmitted by the MS until the countdown value CV=0. It is checked that the MS sends 11 RLC data blocks in total.

The MS requests more resources through random accesses of channel requests for the remaining LLC PDU in the initial test PDP context. SS starts a two-phase dynamic allocation. It is checked that the values of PEAK_THROUGHPUT_CLASS, RADIO_PRIORITY and RLC_MODE requested by the MS in the PACKET RESOURCE REQUEST are in consistence with the initial test PDP context2.

Maximum Duration of Test

5 min.

Expected Sequence

The branch A is applicable for the MS supporting two PDP contexts. The branch B is applicable for the MS supporting SMS over GPRS and one PDP context.

Step	Direction	Message	Comments
1A	MS	{Uplink dynamic allocation two phase access}	In PDP context2, n = 880 octets, without starting time, USF_GRANULARITY = 1 block, RLC_DATA_BLOCKS_GRANTED = open-end TLLI_BLOCK_CHANNEL_CODING: cs1, CHANNEL_CODING_COMMAND: cs1, PEAK_THROUGHPUT_CLASS = 5, RADIO_PRIORITY = 4, RLC_MODE = acknowledged mode.
1B		{Uplink dynamic allocation two phase access}	To trigger the MS to send a short message of 110 octets over GPRS. n = 110 octets, without starting time, USF_GRANULARITY = 1 block, RLC_DATA_BLOCKS_GRANTED = open-end TLLI_BLOCK_CHANNEL_CODING: cs1, CHANNEL_CODING_COMMAND: cs1, RLC_MODE = acknowledged mode.
2	SS -> MS	PACKET DOWNLINK DUMMY CONTROL BLOCK	Sent on the PACCH, the USF assigned to the MS.
3	MS -> SS	UPLINK RLC DATA BLOCK	Received on the assigned PDTCH. Check that the coding as specified by CHANNEL_CODING_COMMAND, the TFI is correct.
4	MS		To trigger the MS to transfer 220 octets in test PDP context1, unacknowledged RLC mode and a higher radio priority.
5	SS -> MS	PACKET DOWNLINK DUMMY CONTROL BLOCK	Sent on the PACCH of the PDCH assigned, the USF assigned to the MS.
6	MS -> SS	UPLINK RLC DATA BLOCK	Received on the assigned PDTCH. Check that the coding and the TFI are correct.
7	SS		Repeat step 5 and 6 until countdown value CV=0. Observe the Length indicator, M bit and E bit of the received data headers. Check that transmitted is only the 1 st LLC PDU, Note: for branch A: the 1 st LLC PDU is in PDP context2, the 2 nd LLC PDU is waiting for transferring. for branch B: the LLC PDU containing the short message.
8	SS -> MS	PACKET UPLINK ACK/NACK	FINAL_ACK_INDICATION = '1'. Acknowledge all received data, containing valid RRBP, sent on PACCH.
9	MS -> SS	PACKET CONTROL ACKNOWLEDGEMENT	Received on the block specified by RRBP on PACCH of the assigned PDCH.
10	MS -> SS	PACKET CHANNEL REQUEST	Received on PRACH for TBF establishment for transferring of the LLC PDU in PDP context1.
11	SS -> MS	PACKET UPLINK ASSIGNMENT	Single block assignment, to force the MS making two-phase access procedure. Sent on PAGCH.
12	MS -> SS	PACKET RESOURCE REQUEST	Received on the single block assigned in step 11. Check that radio priority level = 1, peak throughput class = 5, unacknowledged RLC mode.
13	SS -> MS	PACKET UPLINK ASSIGNMENT	Open-ended uplink dynamic allocation, no starting time, USF_GRANULARITY = single block. Sent on PACCH of the same PDCH assigned in step 11.
14	SS -> MS	PACKET DOWNLINK DUMMY CONTROL BLOCK	The USF assigned to the MS. Sent on PACCH of PDCH assigned in step 13.
15	MS -> SS	UPLINK RLC DATA BLOCK	Received on the PDTCH assigned.
16			Repeat step 14 and 15 until countdown value CV=0. Check that the repeat number is 10, i.e.11 RLC data blocks in total.
17	SS -> MS	PACKET UPLINK ACK/NACK	FINAL_ACK_INDICATION = '1', a valid RRBP, acknowledge all received data, sent on PACCH.
18	MS -> SS	PACKET CONTROL ACKNOWLEDGEMENT	Received on the block specified by RRBP on PACCH of the assigned PDCH.

19B	MS		Switch off the MS.
			The following test steps are applied to the branch A.
19A	MS -> SS	PACKET CHANNEL REQUEST	Received on PRACH, TBF establishment for transmission of a remaining LLC PDU in PDP context2 for branch A.
20A	SS -> MS	PACKET UPLINK ASSIGNMENT	Single block assignment, to force the MS making two-phase access procedure. Sent on PAGCH.
21A	MS -> SS	PACKET RESOURCE REQUEST	Received on the single block assigned in step 20A. Check that PEAK_THROUGHPUT_CLASS = 5, RADIO_PRIORITY = 4, RLC_MODE = acknowledged mode.
22A	SS -> MS	PACKET UPLINK ASSIGNMENT	Open-ended uplink dynamic allocation, no starting time, USF_GRANULARITY = single block. Sent on PACCH of the same PDCH assigned in step 20A.
23A	SS -> MS	PACKET DOWNLINK DUMMY CONTROL BLOCK	The USF assigned to the MS. Sent on PACCH of PDCH assigned in step 20A.
24A	MS -> SS	UPLINK RLC DATA BLOCK	Received on the PDTCH assigned in step 20A.
25A	SS		Repeat step 23A and 24A until countdown value CV=0. Observe the Length indicator, M bit and E bit of the received data headers.
26A	SS -> MS	PACKET UPLINK ACK/NACK	Check that only one LLC PDU is transmitted. Note: the 2nd ¹ LLC PDU in PDP context2. FINAL_ACK_INDICATION = '1'. Acknowledge all received data, containing valid RRBp, sent on PACCH.
27A	MS -> SS	PACKET CONTROL ACKNOWLEDGEMENT	Received on the block specified by RRBp on PACCH of the assigned PDCH.

Specific Message Contents

PACKET UPLINK ASSIGNMET message in step 13:

Same as in 42.3.3.1.1.3, step 10 of the test sequence testing the MS supporting two PDP contexts.

42.3.3.2 Dynamic Allocation / Resource reallocation / Abnormal

42.3.3.2.1 Dynamic Allocation / Resource reallocation / Abnormal / T3168 expiry

42.3.3.2.1.1 Conformance requirements

On expiry of timer T3168 the mobile station shall retransmit the PACKET RESOURCE REQUEST message unless the PACKET RESOURCE REQUEST has already been transmitted four times in which case the mobile station shall return to packet idle mode and indicate a packet access failure to upper layer.

References

GSM 04.60, 8.1.1.1.2

42.3.3.2.1.2 Test purposes

To verify that during uplink resource reallocation on expiry of timer T3168:

1. The MS retransmits the PACKET RESOURCE REQUEST message unless the PACKET RESOURCE REQUEST has already been transmitted four times,
2. The MS returns to idle mode after PACKET RESOURCE REQUEST has been transmitted four times.

42.3.3.2.1.3 Method of test

Initial Conditions

System Simulator:

1 cell, default setting, BS_PBCCH_BLKs = 3, T3168 timeout value=0 (0.5s), N201-U=500 for SAPI 3, 5, 9, 11, N201-U=270 for SAPI 7.

Mobile Station:

The MS is GPRS attached with a P-TMSI allocated, SPLIT PG CYCLE negotiated,

- for the MS supporting two PDP contexts: test PDP context2 and context5 activated,

- for the MS supporting one PDP context and SMS over GPRS: test PDP context5 activated.

Related PICS/PIXIT Statement(s)

Support GPRS service,

Support activation of at least one PDP context,

Support two PDP contexts,

Support SMS,

Support SMS over GPRS

The way to initiate an uplink packet transfer,

The way to trigger transferring new user data in a different PDP context while an uplink transfer is in progress,

The way to trigger sending an MO short message.

Test Procedure

An uplink TBF is established and in progress. The MS is triggered to transfer data with a higher radio priority in the same RLC mode.

The MS sends PACKET RESOURCE REQUEST. The current TBF is maintained and SS assigns the USFs allowing the MS transmit more data blocks, but does not answers to the requested resources. The MS repeatedly sends PACKET RESOURCE REQUEST three times after T3168 expires each time.

SS waits 0,55 s after receiving the 4th PACKET RESOURCE REQUEST and then sends PACKET DOWNLINK ASSIGNMENT and polls the MS. The MS answers with PACKET DOWNLINK ACK/NACK.

Maximum Duration of Test

5 min.

Expected Sequence

The branch A is applicable for the MS supporting two PDP contexts. The branch B is applicable for the MS supporting SMS over GPRS and one PDP context.

Step	Direction	Message	Comments
1A	MS	{Uplink dynamic allocation two phase access}	In PDP context2, n = 220 octets, without starting time, USF_GRANULARITY = 1 block, RLC_DATA_BLOCKS_GRANTED = open-end TLLI_BLOCK_CHANNEL_CODING: cs1, CHANNEL_CODING_COMMAND: cs1, PEAK_THROUGHPUT_CLASS = 5, RADIO_PRIORITY = 4, RLC_MODE = acknowledged mode.
1B	MS	{Uplink dynamic allocation two phase access}	To trigger the MS to send a short message of 110 octets over GPRS. n = 110 octets, without starting time, USF_GRANULARITY = 1 block, RLC_DATA_BLOCKS_GRANTED = open-end TLLI_BLOCK_CHANNEL_CODING: cs1, CHANNEL_CODING_COMMAND: cs1, RLC_MODE = acknowledged mode.
2	SS -> MS	PACKET DOWNLINK DUMMY CONTROL BLOCK	Sent on the PACCH, the USF assigned to the MS.
3	MS -> SS	UPLINK RLC DATA BLOCK	Received on the assigned PDTCH. Check that the coding as specified by CHANNEL_CODING_COMMAND, the TFI is correct.
4	MS		To trigger the MS to transfer 440 octets with the peak throughput class 5 (16k octets/s) and the radio priority 1 in acknowledge RLC mode of the PDP context5.
5	MS -> SS	PACKET RESOURCE REQUEST	Received on the PACCH of the PDCH assigned
6	SS -> MS	PACKET DOWNLINK DUMMY CONTROL BLOCK	Sent on the PACCH, the USF assigned to the MS.
7	MS -> SS	UPLINK RLC DATA BLOCK	Received on the assigned PDTCH. Check that the coding as specified by CHANNEL_CODING_COMMAND, the TFI is correct.
8			Repeat steps 6 and 7 three times
9			Repeat steps 5 - 8 twice, Note: the 1 st LLC PDU is sent out and the sending 2 nd PDU in the PDP context5 is started
10	SS -> MS	PACKET UPLINK ACK/NACK	Sent on the PACCH of the PDCH assigned, acknowledge all received data.
11	MS -> SS	PACKET RESOURCE REQUEST	Received on the PACCH of the PDCH assigned, the 4 th time to send PACKET RESOURCE REQUEST.
12	SS -> MS	PACKET DOWNLINK ASSIGNMENT	Sent 0,55s after step 11 on PCCCH, a valid RRBPN=N+13.
13	MS -> SS	PACKET CONTROL ACKNOWLEDGEMENT	

Specific Message Contents

PACKET RESOURCE REQUEST message in step 5 and 11:

Channel Request Description	
- PEAK_THROUGHPUT_CLASS	5
- RADIO_PRIORITY	1
- RLC_MODE	acknowledged mode
- LLC_PDU_TYPE	1 (not SACK or ACK)
- RLC_OCTET_COUNT	Any allowed value

42.3.3.2.2 Dynamic Allocation / Resource reallocation / Abnormal / Invalid assignment

42.3.3.2.2.1 Conformance requirements

1. If the mobile station receives a PACKET UPLINK ASSIGNMENT or PACKET TIMESLOT RECONFIGURE message and detects an invalid Frequency Parameters information element in the message, it shall perform an abnormal release. If PCCCH is present in the cell the mobile station shall perform an abnormal release with system information. If PCCCH is not present, the mobile station shall perform an abnormal release with random access.
2. If the mobile station receives a PACKET UPLINK ASSIGNMENT or PACKET TIMESLOT RECONFIGURE message specifying frequencies that are not all in one frequency band then the mobile station shall perform an abnormal release with random access.
3. If the mobile station receives a PACKET UPLINK ASSIGNMENT or PACKET TIMESLOT RECONFIGURE message assigning fixed allocation MAC mode, the MS shall perform an abnormal release with random access.
4. If the mobile station receives a PACKET UPLINK ASSIGNMENT message containing a Frequency Parameters information element specifying a frequency that is in a frequency band not supported by the mobile station then the mobile station shall perform an abnormal release with random access.

References

GSM 04.60, 8.1.1.1.2.1

42.3.3.2.2.2 Test purposes

To verify that during uplink resource reallocation:

1. The MS performs an abnormal release with random access if it receives a PACKET UPLINK ASSIGNMENT or PACKET TIMESLOT RECONFIGURE message specifying frequencies that are not all in one frequency band.
2. The MS performs an abnormal release with random access if it receives a PACKET UPLINK ASSIGNMENT message containing a Frequency Parameters information element specifying a frequency in the frequency band not supported.
3. The MS performs an abnormal release with random access if it receives a PACKET UPLINK ASSIGNMENT message assigning fixed allocation MAC mode.
4. The MS performs an abnormal release with system information if it receives a PACKET UPLINK ASSIGNMENT or PACKET TIMESLOT RECONFIGURE message containing an Invalid Frequency Parameters information element, and if PCCCH is present in the cell.

42.3.3.2.2.3 Method of test

Initial Conditions

System Simulator:

1 cell, default setting, BS_PBCCH_BLKs = 3, N201-U=500 for SAPI 3, 5, 9, 11, N201-U=270 for SAPI 7.

Mobile Station:

The MS is GPRS attached with a P-TMSI allocated, SPLIT PG CYCLE negotiated

- for the MS supporting two PDP contexts: test PDP context2 and context5 activated,

- for the MS supporting one PDP context and SMS over GPRS: test PDP context5 activated.

Related PICS/PIXIT Statement(s)

Support GPRS service,
Support activation of at least one PDP context,

Support two PDP contexts,
Support SMS
Support SMS over GPRS
The way to initiate an uplink packet transfer,
The way to trigger transferring new user data in a different PDP context while an uplink transfer is in progress.

Test Procedure

An uplink TBF is established and in progress. The MS is triggered to transfer data with a higher radio priority in the same RLC mode. The MS sends PACKET RESOURCE REQUEST. SS sends PACKET UPLINK ASSIGNMENT or PACKET TIMESLOT RECONFIGURE containing an invalid assignment ($k=1\dots 7$, see step 6 in expected sequences).

The MS starts random accesses. SS assigns a two-phase dynamic allocation. It is checked that the requested radio priority, throughput and the RLC mode in PACKET RESOURCE REQUEST are in consistence with the test PDP context 5. SS grants the sufficient resources to the MS for transmission of the RLC data blocks until the MS sends PACKET RESOURCE REQUEST. It is checked that the MS has sent only one complete LLC PDU.

The SS assigns new resources to MS for completion the total data transferring.

Maximum Duration of Test

10 min.

Expected Sequence

The branch A in the sequence is applicable for the MS supporting two PDP contexts. The branch B is applicable for the MS supporting SMS over GPRS and one PDP context. The test sequence is executed in total five times, $k = 1 \dots 7$. The 7th execution is applicable to the single band MS, but not to the multi-band one.

Step	Direction	Message	Comments
1A	MS	{Uplink dynamic allocation two phase access}	In PDP context2, n = 220 octets, without starting time, USF_GRANULARITY = 1 block, RLC_DATA_BLOCKS_GRANTED = open-end TLLI_BLOCK_CHANNEL_CODING: cs1, CHANNEL_CODING_COMMAND: cs1, PEAK_THROUGHPUT_CLASS = 5, RADIO_PRIORITY = 4, RLC_MODE = acknowledged mode.
1B	MS	{Uplink dynamic allocation two phase access}	To trigger the MS to send a short message of 110 octets over GPRS. n = 110 octets, without starting time, USF_GRANULARITY = 1 block, RLC_DATA_BLOCKS_GRANTED = open-end TLLI_BLOCK_CHANNEL_CODING: cs1, CHANNEL_CODING_COMMAND: cs1, RLC_MODE = acknowledged mode.
2	SS -> MS	PACKET DOWNLINK DUMMY CONTROL BLOCK	Sent on the PACCH, the USF assigned to the MS.
3	MS -> SS	UPLINK RLC DATA BLOCK	Received on the assigned PDTCH. Check that the coding as specified by CHANNEL_CODING_COMMAND, the TFI is correct.
4	MS		To trigger the MS to transfer 440 octets with the peak throughput class 5 (16k octets/s) and the radio priority 1 in acknowledge RLC mode of the PDP context5.
5	MS -> SS	PACKET RESOURCE REQUEST	Received on the PACCH of the PDCH assigned
6	SS -> MS	PACKET UPLINK ASSIGNMENT	Assign a frequency hopping PDCH, but not all frequencies are in one frequency band.
k=1 6	SS -> MS	PACKET TIMESLOT RECONFIGURE	Assign a frequency hopping PDCH, but not all frequencies are in one frequency band.
k=2 6	SS -> MS	PACKET UPLINK ASSIGNMENT	Assign a frequency hopping PDCH, the MA_NUMBER and MA_CHANGE_MARK_1 mismatch the values of MA_NUMBER and MA_CHANGE_MARK stored in the MS.
k=3 6	SS -> MS	PACKET TIMESLOT RECONFIGURE	Assign a frequency hopping PDCH, the MA_NUMBER and MA_CHANGE_MARK_1 mismatch the values of MA_NUMBER and MA_CHANGE_MARK stored in the MS.
k=4 6	SS -> MS	PACKETUPLINK ASSIGNMENT	Assign fixed allocation MAC mode.
k=5 6	SS -> MS	PACKET TIMESLOT RECONFIGURE	Assign fixed allocation MAC mode
k=6 6	SS -> MS	PACKETUPLINK ASSIGNMENT	Assigned ARFCN on PDCH is not in the frequency band supported by the MS.
k=7 6	SS -> MS	PACKETUPLINK ASSIGNMENT	Assigned ARFCN on PDCH is not in the frequency band supported by the MS.
7	MS -> SS	PACKET CHANNEL REQUEST	Received on PRACH.
8	SS -> MS	PACKET UPLINK ASSIGNMENT	Single block assignment, to force the MS making two-phase access procedure. Sent on PAGCH.
9	MS -> SS	PACKET RESOURCE REQUEST	Received on the single block assigned in step 8. Check that PEAK_THROUGHPUT_CLASS = 5, RADIO_PRIORITY = 1, RLC_MODE = acknowledged mode
10	SS -> MS	PACKET UPLINK ASSIGNMENT	Open-ended uplink dynamic allocation, no starting time, USF_GRANULARITY = single block. Sent on PACCH of the same PDCH assigned in step 8.
11	SS -> MS	PACKET DOWNLINK DUMMY CONTROL BLOCK	Sent on the PACCH of the PDCH assigned, the USF assigned to the MS.
12-1	MS -> SS	UPLINK RLC DATA BLOCK	Received on the assigned PDTCH. Check that the coding and the TFI are correct.
12-2	MS -> SS	PACKET RESOURCE REQUEST	Received on the PACCH of the assigned PDCH, acknowledged mode for LLC PDU in a lower radio priority.

13	SS		Repeat step 11 and 12-1 until PACKET RESOURCE REQUEST in 12-2, instead of a RLC data block in 12-1, is received. Observe the Length indicator, M bit and E bit of the received data headers. Check that a complete LLC PDU is transmitted and the transmission of another LLC PDU is not yet started.
14	SS -> MS	PACKET UPLINK ACK/NACK	Sent on the PACCH of the PDCH assigned, acknowledge all received data
15	SS -> MS	PACKET TIMESLOT RECONFIGURE	Sent on PACCH of the PDCH assigned in step 10, assigning a new PDCH, USF_GRANULARITY=4.
16	SS -> MS	PACKET DOWNLINK DUMMY CONTROL BLOCK	Sent on the PACCH of the PDCH assigned in step 15, the USF assigned to the MS.
17	MS -> SS	UPLINK RLC DATA BLOCK	Received on the PDTCH assigned in step 15.
18	MS -> SS	UPLINK RLC DATA BLOCK	Received on the PDTCH assigned in step 15.
19	MS -> SS	UPLINK RLC DATA BLOCK	Received on the PDTCH assigned in step 15.
20	MS -> SS	UPLINK RLC DATA BLOCK	Received on the PDTCH assigned in step 15.
21		{Completion of uplink RLC data block transfer}	
22B	MS		Switch off

Note: After the abnormal release for random access in step 7 there are two LLC PDUs waiting for sending. It is assumed in step 9 that the MS requests an uplink PDCH for the LLC PDU in a higher radio priority.

Specific Message Contents

PACKET UPLINK ASSIGNMET message in step 6 for k=1:

{0 1<Frequency Parameters>} - Frequency Parameters - TSC - - MAIO - HSN - Length of MA Frequency List contents - MA Frequency List contents Dynamic allocation	1 (Frequency Parameters present) Arbitrarily chosen 11 (Direct encoding 2) Arbitrarily chosen Arbitrarily chosen 12 octets Contain following ARFCNs in 1024 range format: 20, 40, 80, 90, 520, 590, 600, 700 01 As default
--	--

PACKET TIMESLOT RECONFIGURE message in step 6 for k=2:

{0 1<Frequency Parameters>} - Frequency Parameters - TSC - - MAIO - HSN - Length of MA Frequency List contents - MA Frequency List contents Dynamic allocation	H (hopping channel) Arbitrarily chosen 11 (Direct encoding 2) arbitrarily chosen but different from the value in step 7 arbitrarily chosen but different from the value in step 7 12 octets Contain following ARFCNs in 1024 range format: 20, 40, 80, 90, 520, 590, 600, 700 0 As default
--	--

PACKET UPLINK ASSIGNMET message in step 6 for k=3:

<pre>{0 1<Frequency Parameters>} - Frequency Parameters - TSC - - MAIO - MA_NUMBER - {0 1<CHANGE_MARK_1>} - CHANGE_MARK_1 - {0 1<CHANGE_MARK_2>} - CHANGE_MARK_2 Dynamic allocation</pre>	<pre>1 (Frequency Parameters present) Arbitrarily chosen 01 (Indirect encoding) Arbitrarily chosen Arbitrarily select a value that does not present in PSI2 message and different from 14 and 15 1 (present) Arbitrarily select a value that mismatches PSI2_CHANGE_MARK 1 (CHANGE_MARK_2 present) Arbitrarily select a value that is different from CHANGE_MARK_1 and mismatches PSI2_CHANGE_MARK 01 As default</pre>
--	---

PACKET TIMESLOT RECONFIGURE message in step 6 for k=4:

<pre>{0 1<Frequency Parameters>} - Frequency Parameters - TSC - - MAIO - MA_NUMBER - {0 1<CHANGE_MARK_1>} - CHANGE_MARK_1 - {0 1<CHANGE_MARK_2>} Dynamic allocation</pre>	<pre>1 (hopping channel) Arbitrarily chosen 01 (Indirect encoding) Arbitrarily chosen Arbitrarily select a value that does not present in PSI2 message and different from 14 and 15 1 (CHANGE_MARK_1 present) Arbitrarily choose a value which mismatches PSI2_CHANGE_MARK 0 (no CHANGE_MARK_2) 0 As default</pre>
--	---

PACKET UPLINK ASSIGNMET message in step 6 for k=5:

As default PACKET UPLINK ASSIGNMET for fixed allocation.

PACKET TIMESLOT RECONFIGURE message in step 6 for k=6:

Any message contents of PACKET TIMESLOT RECONFIGURE for the fixed allocation.

PACKET UPLINK ASSIGNMET message in step 6 for k=7:

<pre>{0 1<Frequency Parameters>} - Frequency Parameters - TSC - - ARFCN Dynamic allocation</pre>	<pre>1 (Frequency Parameters present) Arbitrarily chosen 00 (ARFCN no hopping) For GSM 900, 650 For DCS 1800, 30 01 (Dynamic allocation) As default</pre>
---	--

PACKET RESOURCE REQUEST message in step 9:

Channel Request Description	
- PEAK_THROUGHPUT_CLASS	5
- RADIO_PRIORITY	1
- RLC_MODE	acknowledged mode
- LLC_PDU_TYPE	1 (not SACK or ACK)
- RLC_OCTET_COUNT	Any allowed value

PACKET RESOURCE REQUEST message in step 12-2:

Channel Request Description	
- PEAK_THROUGHPUT_CLASS	For the branch A: 5 For the branch B: any allowed value
- RADIO_PRIORITY	For the branch A: 4 For the branch B: any allowed value
- RLC_MODE	acknowledged mode
- LLC_PDU_TYPE	1 (not SACK or ACK)
- RLC_OCTET_COUNT	Any allowed value

PACKET TIMESLOT RECONFIGURE message in step 15

PAGE_MODE	Normal
- Global TFI	0, Global TFI as reference 0, uplink TFI a different value as assigned in the current uplink Arbitrarily chosen from valid values
CHANNEL_CODING_COMMAND	
Global packet Timing Advance	
- {0 1<TIMING_ADVANCE_VALUE>}	1 (timing advance value)
- TIMING_ADVANCE_VALUE	30 bit periods
- {0 1<TIMING_ADVANCE_INDEX>}	0 (no timing advance index)
<TIMING_ADVANCE_TIMESLOT_NUMBER >}	
DOWNLINK_RLC_MODE	acknowledged mode
CONTROL_ACK	0
{0 1<DOWNLINK_TFI_ASSIGNMENT>}	0
{0 1<UPLINK_TFI_ASSIGNMENT>}	0
DOWNLINK_TIMESLOT_ALLOCATION	No Timeslot assigned
{0 1<Frequency parameters>}	0
Dynamic allocation	0
- Extended Dynamic Allocation	0 (Dynamic allocation)
{0 1<P0>}	0
- USF GRANULARITY	1 (4 RLC block)
- {0 1<RLC_DATA_BLOCKS_GRANTED>}	0 (open-ended TBF)
- {0 1<TBF_STARTING_TIME>}	0 (no starting time)
-	1 (Timeslot Allocation with Power Control Parameters)
- ALPHA	0.5
- {0 1<USF_TNx><GAMMA_TNx>}	00000001 (timeslot 7 assigned)
- USF_TN ₇	Arbitrarily chosen but different from current value
- GAMMA_TN ₇	For GSM 900, +9 dBm For DCS 1800, +6 dBm
	00

42.3.3.3 Dynamic Allocation / Resource reallocation / Reject

42.3.3.3.1 Conformance requirements

1. On receipt of a PACKET ACCESS REJECT message, the mobile station shall stop timer T3168 if running and indicate a packet access failure to upper layers. If no downlink TBF exists, the mobile station shall return to packet idle mode.

2. If the PACKET ACCESS REJECT message contains a WAIT_INDICATION field in a Reject structure addressed to the mobile station, the mobile station shall start timer T3172 and if the mobile station has additional RLC data blocks to transmit, it shall initiate a new TBF establishment procedure on the RACH or PRACH, but the mobile station is not allowed to make a new attempt for packet access in the same cell until timer T3172 expires, it may, however, attempt packet access in an other cell after successful cell reselection. A mobile station in GPRS MS class A or B mode of operation may attempt to enter the dedicated mode in the same cell before timer T3172 has expired. During the time T3172 is running, the mobile station shall ignore all received PACKET PAGING REQUEST messages except paging request to trigger RR connection establishment.

References

GSM 04.60, 8.1.1.1.2

42.3.3.3.2 Test purposes

To verify that during the uplink resource reallocation:

1. The MS returns to packet idle mode when it receives PACKET ACCESS REJECT without WAIT_INDICATION.
2. On receipt of a PACKET ACCESS REJECT with a WAIT_INDICATION the MS waits until T3172 expires. The MS, having another RLC data blocks to transmit, initiates a new TBF establishment procedure on the PRACH.

42.3.3.3.3 Method of test

Initial Conditions

System Simulator:

1 cell, default setting, BS_PBCCH_BLKs = 3, N201-U=500 for SAPI 3, 5, 9, 11, N201-U=270 for SAPI 7.

Mobile Station:

The MS is GPRS attached with a P-TMSI allocated, SPLIT PG CYCLE negotiated,

- for the MS supporting two PDP contexts: test PDP context2 and context5 activated,

- for the MS supporting one PDP context and SMS over GPRS: test PDP context5 activated.

Related PICS/PIXIT Statement(s)

Support GPRS service,
Support activation of at least one PDP context,
Support two PDP contexts,
Support SMS,
Support SMS over GPRS,
The way to initiate an uplink packet transfer,
The way to trigger transferring new user data in a different PDP context while an uplink transfer is in progress,
The way to trigger the MS sending an MO short message over GPRS.

Test Procedure

An uplink TBF is established and in progress. The MS is triggered to transfer data with a higher radio priority in the same RLC mode.

The MS sends PACKET RESOURCE REQUEST. SS sends PACKET ACCESS REJECT without containing WAIT_INDICATION. The MS attempts a new random access because of the user data from the upper layer.

SS assigns a two-phase dynamic allocation. It is checked that the requested radio priority, throughput and the RLC mode in PACKET RESOURCE REQUEST are in consistence with the test PDP context 5. SS grants the sufficient

resources to the MS for transmission of the RLC data blocks until the MS sends PACKET RESOURCE REQUEST. It is checked that the MS has sent only one complete LLC PDU.

SS acknowledges all received data and assigns new resources to the MS to complete the RLC data block transferring..

The test procedure is repeated once. The difference between the two executions is that in the 2nd execution, PACKET ACCESS REJECT contains WAIT_INDICATION. The MS starts the random access after T3172 expires.

Maximum Duration of Test

5 min.

Expected Sequence

The test sequence is executed twice for $k = 1 \dots 2$. The branch A in the sequence is applicable for the MS supporting two PDP contexts. The branch B is applicable for the MS supporting SMS over GPRS and one PDP context.

Step	Direction	Message	Comments
1A	MS	{Uplink dynamic allocation two phase access}	In PDP context2, n = 220 octets, without starting time, USF_GRANULARITY = 1 block, RLC_DATA_BLOCKS_GRANTED = open-end TLLI_BLOCK_CHANNEL_CODING: cs1, CHANNEL_CODING_COMMAND: cs1, PEAK_THROUGHPUT_CLASS = 5, RADIO_PRIORITY = 4, RLC_MODE = acknowledged mode.
1B	MS	{Uplink dynamic allocation two phase access}	To trigger the MS to send a short message of 110 octets over GPRS. n = 110 octets, without starting time, USF_GRANULARITY = 1 block, RLC_DATA_BLOCKS_GRANTED = open-end TLLI_BLOCK_CHANNEL_CODING: cs1, CHANNEL_CODING_COMMAND: cs1, RLC_MODE = acknowledged mode.
2	SS -> MS	PACKET DOWNLINK DUMMY CONTROL BLOCK	Sent on the PACCH, the USF assigned to the MS.
3	MS -> SS	UPLINK RLC DATA BLOCK	Received on the assigned PDTCH. Check that the coding as specified by CHANNEL_CODING_COMMAND, the TFI is correct.
4	MS		To trigger the MS to transfer 440 octets with the peak throughput class 5 (16k octets/s) and the radio priority 1 in acknowledge RLC mode of the PDP context5.
5	MS -> SS	PACKET RESOURCE REQUEST	Received on the PACCH of the PDCH assigned
6	SS -> MS	PACKET DOWNLINK DUMMY CONTROL BLOCK	Sent on the PACCH, the USF assigned to the MS.
7	MS -> SS	UPLINK RLC DATA BLOCK	Received on the assigned PDTCH. Check that the coding as specified by CHANNEL_CODING_COMMAND, the TFI is correct.
8	SS -> MS	PACKET ACCESS REJECT	Sent on the PACCH of the PDCH, including the same address reference received from step 5 addressing the MS, For k = 1 without WAIT_INDICATION For k = 2 with WAIT_INDICATION.
9	MS -> SS	PACKET CHANNEL REQUEST	Received on PRACH. For k=2, check that the random access is received not before 28.5s from step 8
10	SS -> MS	PACKET UPLINK ASSIGNMENT	Single block assignment, to force the MS making two-phase access procedure. Sent on PAGCH.
11	MS -> SS	PACKET RESOURCE REQUEST	Received on the single block assigned in step 8. Check that PEAK_THROUGHPUT_CLASS = 5, RADIO_PRIORITY = 1, RLC_MODE = acknowledged mode
12	SS -> MS	PACKET UPLINK ASSIGNMENT	Open-ended uplink dynamic allocation, no starting time, USF_GRANULARITY = single block. Sent on PACCH of the same PDCH assigned in step 8.
13	SS -> MS	PACKET DOWNLINK DUMMY CONTROL BLOCK	Sent on the PACCH of the PDCH assigned, the USF assigned to the MS.
14-1	MS -> SS	UPLINK RLC DATA BLOCK	Received on the assigned PDTCH. Check that the coding and the TFI are correct.
14-2	MS -> SS	PACKET RESOURCE REQUEST	Received on the PACCH of the assigned PDCH, acknowledged mode for LLC PDU in a lower radio priority.
15	SS		Repeat step 13 and 14-1 until PACKET RESOURCE REQUEST in 14-2, instead of a RLC data block in 14-1, is received. Observe the Length indicator, M bit and E bit of the received data headers. Check that a complete LLC PDU is transmitted and the transmission of another LLC PDU is not yet started.

16	SS -> MS	PACKET UPLINK ACK/NACK	Sent on the PACCH of the PDCH assigned, acknowledge all received data
17	SS -> MS	PACKET TIMESLOT RECONFIGURE	Sent on PACCH of the PDCH assigned in step 12, assigning a new PDCH, USF_GRANULARITY=4.
18	SS -> MS	PACKET DOWNLINK DUMMY CONTROL BLOCK	Sent on the PACCH of the PDCH assigned in step 17, the USF assigned to the MS.
19	MS -> SS	UPLINK RLC DATA BLOCK	Received on the PDTCH assigned in step 17.
20	MS -> SS	UPLINK RLC DATA BLOCK	Received on the PDTCH assigned in step 17.
21	MS -> SS	UPLINK RLC DATA BLOCK	Received on the PDTCH assigned in step 17.
22	MS -> SS	UPLINK RLC DATA BLOCK	Received on the PDTCH assigned in step 17.
23		{Completion of uplink RLC data block transfer}	
24B	MS		Switch off

Specific Message Contents

PACKET ACCESS REJECT message in step 8 for k=1:

MESSAGE_TYPE	1 00001
PAGE_MODE	Normal Paging
Reject	
-	0 (TLLI)
- TLLI	the same value as the TLLI received
-	0 (no WAIT_INDICATION)
-	0

PACKET ACCESS REJECT message in step 8 for k=2:

MESSAGE_TYPE	1 00001
PAGE_MODE	Normal Paging
Reject	
-	0 (TLLI)
- TLLI	The same value as the TLLI received
-	1 (WAIT_INDICATION present)
- WAIT_INDICATION	30 seconds
- WAIT_INDICATION_SIZE	0 (unites of seconds)
-	0 (end of reject IE)

PACKET RESOURCE REQUEST message in step 9:

Same as in 42.3.3.2.2, step 11.

PACKET RESOURCE REQUEST message in step 14-2

Same as in 42.3.3.2.2, step 12-2.

PACKET TIMESLOT RECONFIGURE message in step 17

Same as in 42.3.3.2.2, step 15.

42.3.4 Default message contents

The following default values of messages and the default contents of messages are defined for clause 42.3. They, unless indicated otherwise in clause 42.3, shall be transmitted by the system simulator and are required to be received from the MS under test.

In this clause, decimal values are normally used. However, sometimes a hexadecimal value, indicated by an "Hex", or a binary value, indicated by a "Binary" is used.

All macro definitions are referred to clause 40.5 and test PDP contexts are referred to clause 40.6.

The default initial conditions used in clause 42.3 are that PBCCH is present.

PACKET CHANNEL REQUEST message:

Access Type	"One phase access request" or "Two phase access request"
Multislot class	As declared (valid for one phase access request)
Radio priority	Same as in the test PDP context applied to the test, or, Priority level 3 for SMS
Random Reference	Any value

PACKET CONTROL ACKNOWLEDGEMENT message:

MESSAGE_TYPE	000001
TLLI	Any value
CTRL_ACK	Any value
Spare padding	Spare Padding

MESSAGE_TYPE for 11 bit: 1111 1100 1, MESSAGE_TYPE for 8 bit: 0111 11, without TLLI.

PACKET DOWNLINK ACK/NACK message:

MESSAGE_TYPE	000010
DOWNLINK_TFI	pertaining to the downlink TBF
Ack/Nack Description	
- FINAL_ACK_INDICATION	0 (not final ack)
- STARTING_SEQUENCE_NUMBER	Any value
- RECEIVED_BLOCK_BITMAP	Any value
{0 1<Channel Request Description>}	0 (no channel request)
Channel Quality Report	
- C_VALUE	Any value
- RXQUAL	Any value
- SIGN_VAR	Any value
- {0 1<I_LEVEL_TN0>}	Any value
- {0 1<I_LEVEL_TN1>}	Any value
- {0 1<I_LEVEL_TN2>}	Any value
- {0 1<I_LEVEL_TN3>}	Any value
- {0 1<I_LEVEL_TN4>}	Any value
- {0 1<I_LEVEL_TN5>}	Any value
- {0 1<I_LEVEL_TN6>}	Any value
- {0 1<I_LEVEL_TN7>}	Any value
spare padding	Spare Padding

PACKET DOWNLINK ASSIGNMET message:

MESSAGE_TYPE	000010
PAGE_MODE	Normal Paging
{0 1<PERSISTENCE_LEVEL>}	0
-	10 (address is TLLI)
- TLLI	same value as received from MS since GPRS attached
MAC_MODE	0, message escape
RLC_MODE	Dynamic Allocation
CONTROL_ACK	acknowledged mode
TIMESLOT_ALLOCATION	0
Packet Timing Advance	single slot arbitrarily chosen from valid values, default slot 2
- {0 1<TIMING_ADVANCE_VALUE>}	1 (presence of the timing advance value)
- TIMING_ADVANCE_VALUE	30 bit periods
- {0 1<TIMING_ADVANCE_INDEX>	0 (no timing advance index)
<TIMING_ADVANCE_TIMESLOT_NUMBER >}	
- {0 1<P0><BTS_PWR_CTRL_MODE>}	0
{0 1<Frequency Parameters>}	1 (Frequency Parameters present)
- Frequency Parameters	
- TSC	Value arbitrarily chosen from valid values (default 5)
-	01 (indirect encoding)
- MAIO	Value arbitrarily chosen
- MA_NUMBER	Value arbitrarily chosen from PSI2s defined
- {0 1<CHANGE_MARK_1>	0
{0 1<CHANGE_MARK_2>}}	
{0 1<DOWNLINK_TFI_ASSIGNMENT>}	1 (assign downlink TFI)
- DOWNLINK_TFI_ASSIGNMENT	Arbitrarily chosen from valid values (default 3)
{0 1<Power Control Parameters>}	1 (Power Control Parameters present)
- ALPHA	0.5
- {0 1<GAMMA_TN0>}	Depending on the value in TIMESLOT_ALLOCATION (default 0 no GAMMA_TN0)
- {0 1<GAMMA_TN1>}	Depending on the value in TIMESLOT_ALLOCATION (default 0 no GAMMA_TN1)
- {0 1<GAMMA_TN2>}	Depending on the value in TIMESLOT_ALLOCATION (default 1 GAMMA_TN2)
- GAMMA_TN2	For GSM 900, +9 dBm
	For DCS 1800, +6 dBm
	For PCS 1900, +6 dBm
- {0 1<GAMMA_TN3>}	Depending on the value in TIMESLOT_ALLOCATION (default 0 no GAMMA_TN0)
- {0 1<GAMMA_TN4>}	Depending on the value in TIMESLOT_ALLOCATION (default 0 no GAMMA_TN4)
- {0 1<GAMMA_TN5>}	Depending on the value in TIMESLOT_ALLOCATION (default 0 no GAMMA_TN5)
- {0 1<GAMMA_TN6>}	Depending on the value in TIMESLOT_ALLOCATION (default 0 no GAMMA_TN6)
- {0 1<GAMMA_TN7>}	Depending on the value in TIMESLOT_ALLOCATION (default 0 no GAMMA_TN7)
{0 1<TBF_STARTING_TIME>}	1 (starting time present)
- TBF_STARTING_TIME	0, absolute frame number encoding, indicating (current frame + 13 frames)
{0 1<Measurement Mapping>}	0 (no measurement mapping)
spare padding	Spare Padding

PACKET DOWNLINK DUMMY CONTROL BLOCK message:

MESSAGE_TYPE	1 00101
PAGE_MODE	Normal Paging
{0 1<PERSISTENCE_LEVEL>}	0
spare padding	Spare Padding

PACKET PAGING REQUEST message:

MESSAGE_TYPE	1 00010
PAGE_MODE	Normal Paging
{0 1<PERSISTENCE_LEVEL>}	0 (no persistence level present)
{0 1<NLN>}	0 (no notification list number)
{1 <Repeated Page info>}	1 (start of Repeated Page info)
-	0 (Page request for TBF establishment)
-	0 (PTMSI)
- PTMSI	P-TMSI allocated during GPRS attach procedure
-	0 (end of Repeated Page info)
spare padding	Spare Padding

PACKET RESOURCE REQUEST message (two phase access):

MESSAGE_TYPE	000101
{0 1<ACCESS_TYPE>}	1 (response to single block assignment)
- ACCESS_TYPE	00 (two phase access)
{0<Global TFI> 1 <TLLI>}	1 (TLLI)
- TLLI	Any value
{0 1<MS Radio Access Capability>}	1 (MS Radio Access Capability)
- MS Radio Access Capability	Any value
Channel Request Description	
- PEAK_THROUGHPUT_CLASS	As defined in the Test PDP context in the test case
- RADIO_PRIORITY	As defined in the Test PDP context in the test case
- RLC_MODE	As defined in the Test PDP context in the test case
- LLC_PDU_TYPE	1 (not SACK or ACK)
- RLC_OCTET_COUNT	Any value
{0 1<MA_CHANGE_MARK>}	1, same as PSI2 change mark
C_VALUE	Any value
{0 1<SIGN_VAR>}	Any value
{0 1<I_LEVEL_TN0>}	Any value
{0 1<I_LEVEL_TN1>}	Any value
{0 1<I_LEVEL_TN2>}	Any value
{0 1<I_LEVEL_TN3>}	Any value
{0 1<I_LEVEL_TN4>}	Any value
{0 1<I_LEVEL_TN5>}	Any value
{0 1<I_LEVEL_TN6>}	Any value
{0 1<I_LEVEL_TN7>}	Any value
spare padding	Spare Padding

PACKET TIMESLOT RECONFIGURE message (dynamic allocation without assigning a new TBF):

MESSAGE_TYPE	000111
PAGE_MODE	Normal Paging
0<GLOBAL_TFI>	0 The TFI value of the uplink TBF or downlink TBF which this message applies to (default 00101) 0, message escape arbitrarily chosen from valid values (default CS-1)
CHANNEL_CODING_COMMAND	
Global Packet Timing Advance	
- {0 1<TIMING_ADVANCE_VALUE>}	1 (timing advance value present)
- TIMING_ADVANCE_VALUE	30 bit periods
- {0 1<UPLINK_TIMING_ADVANCE_INDEX>	0 (no uplink timing advance index)
<UPLINK_TIMING_ADVANCE_TIMESLOT_NUMBER>}	The MS stops the operation of the continuous timing advance procedure.
- {0 1<DOWNLINK_TIMING_ADVANCE_INDEX>	0 (no downlink timing advance index)
<DOWNLINK_TIMING_ADVANCE_TIMESLOT_NUMBER>}	The MS stops the operation of the continuous timing advance procedure.
DOWNLINK_RLC_MODE	Same as in the Test PDP context used
CONTROL_ACK	0
{0 1<DOWNLINK_TFI_ASSIGNMENT>	0
{0 1<UPLINK_TFI_ASSIGNMENT>	0
DOWNLINK_TIMESLOT_ALLOCATION	arbitrarily chosen from valid values (default 2)
{0 1<Frequency Parameters>}	0 (use current parameters)
Dynamic allocation	0
- Extended Dynamic Allocation	0 (Dynamic allocation)
- {0 1<P0><PR_MODE>}	0
- USF_GRANULARITY	0, one block
- {0 1<RLC_DATA_BLOCKS_GRANTED>}	0 (no RLC_DATA_BLOCKS_GRANTED, open-ended TBF)
- {0 1<TBF_STARTING_TIME>}	1 (starting time)
- TBF_STARTING_TIME	1, relative frame number encoding indicating current frame + 104 by absolute encoding
-	1 (Timeslot Allocation with Power Control Parameters)
- ALPHA	one slot arbitrarily chosen and different from current slot, the following USF_TNx and GAMMA_TNx shall be corresponding to the chosen value, default timeslot 3.
- {0 1<USF_TN0><GAMMA_TN0>}	0.5
- {0 1<USF_TN1><GAMMA_TN1>}	L (timeslot 0 not assigned)
- {0 1<USF_TN2><GAMMA_TN2>}	L (timeslot 1 not assigned)
- {0 1<USF_TN3><GAMMA_TN3>}	L (timeslot 2 not assigned)
- USF_TN3	H (timeslot 3 assigned)
- GAMMA_TN3	arbitrarily chosen and different from current value, default 4
- {0 1<USF_TN4><GAMMA_TN4>}	For GSM 900, +9 dBm
- {0 1<USF_TN5><GAMMA_TN5>}	For DCS 1800, +6 dBm
- {0 1<USF_TN6><GAMMA_TN6>}	For PCS 1900, +6 dBm
- {0 1<USF_TN7><GAMMA_TN7>}	L (timeslot 4 not assigned)
spare padding	L (timeslot 5 not assigned)
	L (timeslot 6 not assigned)
	L (timeslot 7 not assigned)
	Spare Padding

For assignment of an uplink TBF while a downlink TBF has been established, the address information should be changed to DOWNLINK_TFI of Global_TFI. UPLINK_TFI_ASSIGNMENT is present.

PACKET UPLINK ACK/NACK message:

MESSAGE_TYPE	001001
PAGE_MODE	Normal Paging
UPLINK_TFI	00, same as the TFI value of the TBF which the message applies
CHANNEL_CODING_COMMAND	0, message escape same coding scheme as in the assigned TBF which the message applies to
Ack/Nack Description	
- FINAL_ACK_INDICATION	0 (not a final ACK)
- STARTING_SEQUENCE_NUMBER	V(R)
- RECEIVED_BLOCK_BITMAP	acknowledge the all data blocks transmitted by the MS
{0 1<CONTENTION_RESOLUTION_TLLI>}	0 (no contention resolution TLLI)
{0 1<Packet Timing Advance>}	0 (no packet timing advance)
{0 1<Power Control Parameters>}	0 (no power control parameters)
{0 1<Extension bits>}	0 (no extension bits present)
{0 1<Fixed Allocation parameters>}	0 (no fixed allocation parameters present)
spare padding	Spare Padding

PACKET UPLINK ASSIGNMENT message (two-phase dynamic allocation assigning a TBF):

MESSAGE_TYPE	001010
PAGE_MODE	Normal Paging
{0 1<PERSISTENCE_LEVEL>}	0 (no persistence level present)
- Address information	10 (TLLI)
- TLLI	The value received from the MS
CHANNEL_CODING_COMMAND	0, message escape
TLLI_BLOCK_CHANNEL_CODING	Arbitrarily chosen from the valid values (default CS-1)
Packet Timing Advance	'0'B, cs-1
- {0 1<TIMING_ADVANCE_VALUE>}	1 (timing advance value)
- TIMING_ADVANCE_VALUE	30 bit periods
- {0 1<TIMING_ADVANCE_INDEX>	0 (no timing advance index)
<TIMING_ADVANCE_TIMESLOT_NUMBER >}	
{0 1<Frequency Parameters>}	1 (Frequency Parameters present)
- Frequency Parameters	
- TSC	Arbitrarily chosen (default 5)
-	01 (indirect encoding)
- MAIO	Value arbitrarily chosen
- MA_NUMBER	Value arbitrarily chosen from PSI2s defined (default 0001)
- {0 1<CHANGE_MARK_1>	0
{0 1<CHANGE_MARK_2>}}	
Dynamic allocation	01
- Extended Dynamic Allocation	0 (Dynamic allocation)
- {0 1<P0><PR_MODE>}	0
- USF_GRANULARITY	0, one block
- {0 1<UPLINK_TFI_ASSIGNMENT>}	1 (uplink TFI assignment)
- UPLINK_TFI_ASSIGNMENT	Arbitrarily chosen (default 00101)
- {0 1<RLC_DATA_BLOCKS_GRANTED>}	0 (no RLC_DATA_BLOCKS_GRANTED, open-ended TBF)
- {0 1<TBF_STARTING_TIME>}	0 (no starting time)
-	1 (Timeslot Allocation with Power Control Parameters)
	one slot arbitrarily chosen and the following USF_TNx and GAMMA_TNx shall be corresponding to the chosen value, default timeslot 2 assigned)
- ALPHA	0.5
- {0 1<USF_TN0><GAMMA_TN0>}	0 (timeslot 0 not assigned)
- {0 1<USF_TN1><GAMMA_TN1>}	0 (timeslot 1 not assigned)
- {0 1<USF_TN2><GAMMA_TN2>}	1 (timeslot 2 assigned)
- USF_TN2	Arbitrarily chosen (default 101)
- GAMMA_TN2	For GSM 900, +9 dBm
	For DCS 1800, +6 dBm
	For PCS 1900, +6 dBm
- {0 1<USF_TN3><GAMMA_TN3>}	0 (timeslot 3 not assigned)
- {0 1<USF_TN4><GAMMA_TN4>}	0 (timeslot 4 not assigned)
- {0 1<USF_TN5><GAMMA_TN5>}	0 (timeslot 5 not assigned)
- {0 1<USF_TN6><GAMMA_TN6>}	0 (timeslot 6 not assigned)
- {0 1<USF_TN7><GAMMA_TN7>}	0 (timeslot 7 not assigned)
spare padding	Spare Padding

1. For one-phase uplink assignment, the Packet Request reference is used for addressing the MS.
2. For re-assignment of an uplink TBF, the address information should be changed to UPLINK_TFI of Global_TFI. UPLINK_TFI_ASSIGNMENT is absent.
3. For assignment of an uplink TBF while a downlink TBF has been established, the address information should be changed to DOWNLINK_TFI of Global_TFI. UPLINK_TFI_ASSIGNMENT is present.

PACKET UPLINK ASSIGNMENT message (one-phase fixed allocation of n blocks):

MESSAGE_TYPE	001010
PAGE_MODE	Normal Paging
{0 1<PERSISTENCE_LEVEL>}	0 (no persistence level present) 111 (Packet Request Reference)
-	As received in PACKET CHANNEL REQUEST
- RANDOM_ACCESS_INFORMATION value	The frame number which PACKET CHANNEL REQUEST was received on
- FRAME_NUMBER	0, message escape Arbitrarily chosen (default CS-1 coding) '0'B, cs-1
CHANNEL_CODING_COMMAND	
TLLI_BLOCK_CHANNEL_CODING	
Packet Timing Advance	
- {0 1<TIMING_ADVANCE_VALUE>}	1 (timing advance value) 30 bit periods
- TIMING_ADVANCE_VALUE	
- {0 1<TIMING_ADVANCE_INDEX>	0 (no timing advance index)
<TIMING_ADVANCE_TIMESLOT_NUMBER >}	
{0 1<Frequency Parameters>}	1 (Frequency Parameters present)
- Frequency Parameters	
- TSC	Arbitrarily chosen (default 5)
-	01 (indirect encoding)
- MAIO	Value arbitrarily chosen
- MA	Value arbitrarily chosen from PSI2s defined
- {0 1<CHANGE_MARK_1>	0
{0 1<CHANGE_MARK_2>}}	
Fixed allocation	11
- {0 1<UPLINK_TFI_ASSIGNMENT>}	1 (uplink TFI assignment)
- UPLINK_TFI_ASSIGNMENT	Arbitrarily chosen (default 00101)
- FINAL_ALLOCATION	1, last allocation of the TBF
- DOWNLINK_CONTROL_TIMESLOT	Same as the timeslot assigned (default 2)
- {0 1<P0>	0
<BTS_PWR_CTRL_MODE><PR_MODE>}	
-	0 (timeslot allocation), one slot arbitrarily chosen, default timeslot 2 assigned.
- HALF_DUPLEX_MODE	0 (no half duplex mode)
- TBF_STARTING_TIME	1, relative frame number encoding indicating current frame + 91 by absolute encoding
-	01 (bit map is blocks without length)
- ALLOCATION_BITMAP	n blocks

1. For two-phase uplink assignment, the TLLI is used for addressing the MS.

2. For assignment of an uplink TBF while a downlink TBF has been established, the address information should be changed to DOWNLINK_TFI of Global_TFI. UPLINK_TFI_ASSIGNMENT is present.

PACKET UPLINK ASSIGNMENT message (single block allocation):

MESSAGE_TYPE	001010
PAGE_MODE	Normal Paging
{0 1<PERSISTENCE_LEVEL>}	0 (no persistence level present)
-	111 (Packet Request Reference)
- RANDOM_ACCESS_INFORMATION value	As received in PACKET CHANNEL REQUEST
- FRAME_NUMBER	The frame number which PACKET CHANNEL REQUEST was received on
CHANNEL_CODING_COMMAND	0, message escape
TLLI_BLOCK_CHANNEL_CODING	Arbitrarily chosen from the valid values (default CS-1)
Packet Timing Advance	'0'B
- {0 1<TIMING_ADVANCE_VALUE>}	1 (timing advance value)
- TIMING_ADVANCE_VALUE	30 bit periods
- {0 1<TIMING_ADVANCE_INDEX>	0 (no timing advance index)
<TIMING_ADVANCE_TIMESLOT_NUMBER >}	
{0 1<Frequency Parameters>}	1 (Frequency Parameters present)
- Frequency Parameters	
- TSC	Arbitrarily chosen (default 5)
-	00 (ARFCN no hopping)
- ARFCN	For GSM 900, 30
	For DCS 1800, 650
	For PCS 1900, 650
Single block allocation	10
- TIMESLOT_NUMBER	Arbitrarily chosen (default slot 2)
- {0 1<ALPHA><GAMMA_TN>}	1
- ALPHA	0.5
- GAMMA_TN	For GSM 900, +9 dBm
	For DCS 1800, +6 dBm
	For PCS 1900, +6 dBm
- {0 1<P0>	0
<BTS_PWR_CTRL_MODE><PR_MODE>}	
- TBF_STARTING_TIME	1, relative frame number encoding
	indicating current frame + 91 by absolute encoding
spare pending	Spare pending

ATTACH REQUEST message:

Protocol discriminator	1000
Skip indicator	0000
Attach request message identity	00000001
MS network capability	
- IE length	
- GEA bits	1, GEA 1 available
- SM capabilities via dedicated channels	Any value
- SM capabilities via GPRS channels	Any value
- USC2 support	Any value
- SS screening Indicator	Any value
- Padding bit	Spare Padding
Attach type	GPRS attach (MS class C) or Combined GPRS/IMSI attach (MS class A or B)
GPRS ciphering key sequence number	no key available
DRX parameter	Any value
P-TMSI or IMSI	IMSI
Old routing area identification	Any value
MS Radio Access capability	Any value
Old P-TMSI signature	Any or omit
Requested READY timer value	Any or omit

ATTACH ACCEPT message:

Protocol discriminator	1000
Skip indicator	0000
Attach accept message identity	00000010
Attach result	For MS class A and B, Combined GPRS/IMSI attached For MS class C, GPRS only attached
Force to standby	not indicated
Periodic RA update timer	Timer is deactivated
Radio priority for SMS	Priority level 3
Spare half octet	Spare half octet
Routing area identification	
- MCC	001 (decimal)
- MNC	01 (decimal)
- LAC	0001H
- RAC	05H
P-TMSI signature	P-TMSI signature
Negotiated READY timer value	32 seconds
Allocated P-TMSI	P-TMSI
MS identity	TMSI
GMM cause	Omit

ATTACH COMPLETE message:

Protocol discriminator	1000
Skip indicator	0000
Attach complete message identity	00000011
Force to standby	Any value
Spare half octet	Spare half octet

42.4 Measurement reports and Cell change order procedures

This clause presents tests for “Measurement Reports and Cell Change Order Procedures” which are specified in GSM 04.60/5.6 and 8.4.

Applicability and default conditions

The clause is applicable for mobiles supporting GPRS.

Default message contents and signalling macros are defined in the GPRS general defaults section, except for those messages and macros specified at the end of this clause.

42.4.1 Measurement reports

42.4.1.1 Network Control measurement reporting / Uplink / Normal case

42.4.1.1.1 Conformance requirement

The behaviour of the mobile station is controlled by the NETWORK_CONTROL_ORDER parameter in a PACKET MEASUREMENT ORDER message. The reporting periods are indicated in the NC_REPORTING_PARAMETER_T field of the PACKET MEASUREMENT ORDER message. The mobile station shall apply to the timer T3158 the NC_REPORTING_PARAMETER_T when in packet transfer mode.

The procedure for NC measurement report sending shall be initiated by the mobile station at the expiry of the NC measurement report interval timer T3158. At expiry of the timer T3158 the mobile station shall restart the timer T3158, perform the measurements and send the PACKET MEASUREMENT REPORT message containing the ‘NC measurement report struct’ on PACCH.

A mobile station in mode NC1 may receive a new indicated reporting period or change packet mode while timer T3158 is active. If the new indicated reporting period is less than the time to expiry of timer T3158, the mobile station shall

immediately restart timer T3158 with the new indicated reporting period. Otherwise, the timer T3158 shall continue to run.

42.4.1.1.2 Test Purpose

To verify that the MS sends the measurement report of the NC measurements according to the indicated reporting periods, when the T3158 expires.

To verify that the MS restarts the timer T3158 when it expires.

Reference

GSM 04.60, Chapters 5.6.1 and 8.3.

42.4.1.1.3 Method of test

Initial conditions

System Simulator:

- 1 cell, GPRS supported

Mobile Station:

- MS is in Packet Idle mode and GPRS attached.
- PDP context established

Related PICS/PIXIT statement

Support of GPRS.

The way to trigger the MS initiating an uplink packet transfer.

Foreseen final state of the MS

- MS is in transfer mode

Test procedure

MS is brought into uplink packet transfer mode. SS sends a PACKET MEASUREMENT ORDER message. MS sends continuously data blocks and PACKET MEASUREMENT REPORT messages according to the indicated reporting period. A PACKET MEASUREMENT ORDER message is sent again with new reporting period. MS sends data blocks and PACKET MEASUREMENT REPORT messages according to the new reporting period.

Maximum duration of the test

-

Expected sequence

Step	Direction	Message	Comments
1		{Uplink packet transfer mode (dyn)}	MS is brought into uplink packet transfer mode.
2	SS->MS	PACKET MEASUREMENT ORDER	-Sent on PACCH. -Contains NETWORK_CONTROL_ORDER and NC_REPORTING_PERIOD_T See specific message contents
3	MS -> SS	RLC data blocks	MS sends data
4	SS -> MS	PACKET UPLINK ACK/NACK	Sent on PACCH.
5			Repeat steps 3 and 4 until the reporting period has expired.
6	MS->SS	PACKET MEASUREMENT REPORT	- Sent on PACCH. - Contains the "NC measurement report struct" on PACCH
7	MS -> SS	RLC data blocks	MS sends data.
8	SS -> MS	PACKET UPLINK ACK/NACK	Sent on PACCH.
9			Repeat steps 7 and 8 until the reporting period has expired.
10	MS->SS	PACKET MEASUREMENT REPORT	- Sent on PACCH. - Contains the "NC measurement report struct" on PACCH
11	MS -> SS	RLC data blocks	MS sends data.
12	SS -> MS	PACKET UPLINK ACK/NACK	Sent on PACCH.
13	SS ->MS	PACKET MEASUREMENT ORDER	- Sent on PACCH. -Contains NETWORK_CONTROL_ORDER and NC_REPORTING_PERIOD_T with new reporting period, which is greater than time to expiry of the timer T3158. See specific message contents
14	MS -> SS	RLC data blocks	MS sends data.
15	SS -> MS	PACKET UPLINK ACK/NACK	Sent on PACCH.
16			Repeat steps 14 and 15 until the old reporting period has expired.
17	MS->SS	PACKET MEASUREMENT REPORT	- Sent on PACCH. - Contains the "NC measurement report struct" on PACCH
18	MS -> SS	RLC data blocks	MS sends data.
19	SS -> MS	PACKET UPLINK ACK/NACK	Sent on PACCH.
20			Repeat steps 18 and 19 until the new reporting period has expired.
21	MS->SS	PACKET MEASUREMENT REPORT	- Sent on PACCH. - Contains the "NC measurement report struct" on PACCH

Specific message contents

PACKET MEASUREMENT ORDER in step 2:

NC Measurement parameters NETWORK_CONTROL_ORDER NC_REPORTING_PERIOD_T	01 (NC1) 001 (0,96 s)
---	--------------------------

PACKET MEASUREMENT ORDER in step 13:

NC Measurement parameters NETWORK_CONTROL_ORDER NC_REPORTING_PERIOD_T	01 (NC1) 100 (7,68 s)
---	--------------------------

42.4.1.2 Network Control measurement reporting / Idle mode / New cell reselection

42.4.1.2.1 Conformance requirement

The procedure for measurement report sending shall be initiated by the mobile station at expiry of the NC measurement report interval timer T3158. At expiry of the timer T3158 the mobile station shall restart the expired timer T3158, perform the measurements and initiate the packet access. The packet access procedure is initiated by the RR entity in the mobile station with access type 'Single block without TBF establishment' indicated in the PACKET CHANNEL REQUEST message. The radio resource is assigned to the mobile station in a PACKET UPLINK ASSIGNMENT message sent on any PAGCH on the same PCCCH on which the network has received the PACKET CHANNEL REQUEST message.

When receiving a PACKET UPLINK ASSIGNMENT message the mobile station shall send PACKET MEASUREMENT REPORT in the allocated radio block on the assigned PDCH and immediately switch back to the PCCCH in non-DRX mode. No TBF is established and the network shall not acknowledge the reception of the PACKET MEASUREMENT REPORT.

A mobile station may reselect a new cell or may be ordered to reselect a new cell while timer T3158 is active. If time to expiry of timer T3158 is greater than the indicated reporting period for the new cell, the mobile station shall immediately restart timer T3158 with the indicated reporting period for the new cell. Otherwise the timer T3158 shall continue to run.

42.4.1.2.2 Test Purpose

To verify that if the MS reselects a new cell while timer T3158 is active, and the time to expiry of timer T3158 is greater than the indicated reporting period for the new cell, the MS shall immediately restart timer T3158 with the indicated reporting period for the new cell.

To verify that if the MS reselects a new cell while timer T3158 is active, and the time to expiry of timer T3158 is shorter than the indicated reporting period for the new cell, the timer T3158 shall continue to run.

Reference

GSM 04.60, Chapters 7.3 and 5.6.1.

42.4.1.2.3 Method of test

Initial conditions

System Simulator:

- 3 cells, GPRS supported, PCCCH is present

Mobile Station:

- MS is in Packet Idle mode and GPRS attached.
- PDP context established

Related PICS/PIXIT statement

Support of GPRS .

Foreseen final state of the MS

- MS is in idle mode

Test procedure

SS sends PACKET MEASUREMENT ORDER message to MS. SS sends PACKET CELL CHANGE ORDER message to MS with new reporting period before the old reporting period has expired. MS initiates a packet access and sends the PACKET MEASUREMENT REPORT to SS. Another measurement report is sent before new PACKET CELL CHANGE ORDER message with new reporting period is sent to MS. Two more measurement reports are sent using correct reporting periods.

Maximum duration of the test

-

Expected sequence

Step	Direction	Message	Comments
1	SS->MS	PACKET MEASUREMENT ORDER	-Sent on PCCCH. -Contains NETWORK_CONTROL_ORDER and NC_REPORTING_PERIOD_I of cell A See specific message contents
2	SS		SS waits 0.5 * the indicated reporting period.
3	SS->MS	PACKET CELL CHANGE ORDER	-Sent on PCCCH. -Contains NETWORK_CONTROL_ORDER and NC_REPORTING_PERIOD_I of cell B with new reporting period, which is shorter than remaining time of the old reporting period. See specific message contents
4	MS ->SS	PACKET CHANNEL REQUEST	To the new cell. 'Single block without TBF establishment.' SS verifies that PACKET CHANNEL REQUEST arrives at the end of correct reporting period.
5	SS -> MS	PACKET UPLINK ASSIGNMENT	Sent on PAGCH.
6	MS ->SS	PACKET MEASUREMENT REPORT	Sent on the allocated PDCH.
7	MS ->SS	PACKET CHANNEL REQUEST	'Single block without TBF establishment.' SS verifies that PACKET CHANNEL REQUEST arrives at the end of correct reporting period.
8	SS -> MS	PACKET UPLINK ASSIGNMENT	Sent on PAGCH.
9	MS ->SS	PACKET MEASUREMENT REPORT	Sent on the allocated PDCH.
10	SS->MS	PACKET CELL CHANGE ORDER	-Sent on PCCCH. -Contains NETWORK_CONTROL_ORDER and NC_REPORTING_PERIOD_I of cell C with new reporting period, which is longer than remaining time of the old reporting period. See specific message contents
11	MS ->SS	PACKET CHANNEL REQUEST	'Single block without TBF establishment.' SS verifies that PACKET CHANNEL REQUEST arrives at the end of correct reporting period.
12	SS -> MS	PACKET UPLINK ASSIGNMENT	Sent on PAGCH.
13	MS ->SS	PACKET MEASUREMENT REPORT	Sent on the allocated PDCH.
14	MS ->SS	PACKET CHANNEL REQUEST	'Single block without TBF establishment.' SS verifies that PACKET CHANNEL REQUEST arrives at the end of correct reporting period.
15	SS -> MS	PACKET UPLINK ASSIGNMENT	Sent on PAGCH.
16	MS ->SS	PACKET MEASUREMENT REPORT	Sent on the allocated PDCH.

Specific message contents

PACKET MEASUREMENT ORDER in step 1:

NC Measurement parameters NETWORK_CONTROL_ORDER NC_REPORTING_PERIOD_I	01 (NC1) 100 (7,68 s)
---	--------------------------

PACKET CELL CHANGE ORDER in step 3:

NC Measurement parameters NETWORK_CONTROL_ORDER NC_REPORTING_PERIOD_I	01 (NC1) 001 (0,96 s)
---	--------------------------

PACKET CELL CHANGE ORDER in step 10:

NC Measurement parameters NETWORK_CONTROL_ORDER NC_REPORTING_PERIOD_I	01 (NC1) 010 (1,92 s)
---	--------------------------

42.4.1.3 Network Control measurement reporting / Downlink transfer / Normal case

42.4.1.3.1 Conformance requirement

The procedure for NC measurement report sending shall be initiated by the mobile station at the expiry of the NC measurement report interval timer T3158. At expiry of the timer T3158 the mobile station shall restart the timer T3158, perform the measurements and send the PACKET MEASUREMENT REPORT message containing the 'NC measurement report struct' on PACCH.

Following a downlink TBF establishment, the PACKET MEASUREMENT REPORT message shall not be sent on the uplink PACCH associated with this TBF until two PACKET DOWNLINK ACK/NACK messages has been sent to the network.

The mobile station shall transmit an RLC/MAC control message other than a PACKET DOWNLINK ACK/NACK message at most every second time it is polled.

42.4.1.3.2 Test Purpose

To verify that the MS sends the measurement report of the NC measurements according to the indicated reporting periods, when the T3158 expires.

To verify that the MS restarts the timer T3158 when it expires.

To verify that the MS sends at least two PACKET DOWNLINK ACK/NACK messages before transmitting a PACKET MEASUREMENT REPORT message upon entering transfer state.

Reference

GSM 04.60, Chapters 8.1.2.2, 8.3 and 5.6.1.

42.4.1.3.3 Method of test

Initial conditions

System Simulator:

- 1 cell, GPRS supported

Mobile Station:

- MS is in Packet Idle mode and GPRS attached.
- PDP context established

Related PICS/PIXIT statement

Support of GPRS .

Foreseen final state of the MS

- MS is in transfer mode

Test procedure

MS is brought into downlink packet transfer mode. SS sends a PACKET MEASUREMENT ORDER message. SS sends data blocks and MS answers with PACKET DOWNLINK ACK/NACK. When reporting period has expired and at least two PACKET DOWNLINK ACK/NACK messages has been sent, MS sends a PACKET MEASUREMENT REPORT message. SS sends data blocks continuously and MS sends PACKET MEASUREMENT REPORT messages when reporting period has expired and at least one PACKET DOWNLINK ACK/NACK messages have been sent after the last PACKET MEASUREMENT REPORT message.

Maximum duration of the test

-

Expected sequence

Step	Direction	Message	Comments
1	SS->MS	PACKET DOWNLINK ASSIGNMENT	Sent on the PCCCH.
2	SS->MS	PACKET MEASUREMENT ORDER	-Sent on PACCH. -Contains NETWORK_CONTROL_ORDER and NC_REPORTING_PERIOD_T See specific message contents
3	SS		Wait for 0.5 seconds.
4	SS -> MS	10 RLC data blocks	SS sends data, last block is polling.
5	MS -> SS	PACKET DOWNLINK ACK/NACK	Sent on PACCH.
6	SS->MS	10 RLC data blocks	SS sends data, last block is polling.
7	MS -> SS	PACKET DOWNLINK ACK/NACK	Sent on PACCH.
8	SS->MS	10 RLC data blocks	SS sends data, last block is polling.
9	MS->SS	PACKET MEASUREMENT REPORT	- Sent on PACCH. - Contains the "NC measurement report struct" on PACCH
10	SS		Wait for 0.5 seconds.
11	SS -> MS	10 RLC data blocks	SS sends data, last block is polling.
12	MS -> SS	PACKET DOWNLINK ACK/NACK	Sent on PACCH.
13	SS -> MS	10 RLC data blocks	SS sends data, last block is polling.
14	MS->SS	PACKET MEASUREMENT REPORT	- Sent on PACCH. - Contains the "NC measurement report struct" on PACCH
15	SS -> MS	10 RLC data blocks	SS sends data, last block is polling.
16	MS -> SS	PACKET DOWNLINK ACK/NACK	Sent on PACCH.
17	SS->MS	PACKET MEASUREMENT ORDER	- Sent on PACCH. -Contains NETWORK_CONTROL_ORDER and NC_REPORTING_PERIOD_T with new reporting period. See specific message contents
18	SS		Wait for 0.5 seconds.
19	SS -> MS	10 RLC data blocks	SS sends data, last block is polling.
20	MS -> SS	PACKET DOWNLINK ACK/NACK	Sent on PACCH.
21	SS		Wait for 0.5 seconds.
22	SS -> MS	10 RLC data blocks	SS sends data, last block is polling.
23	MS->SS	PACKET MEASUREMENT REPORT	- Sent on PACCH. - Contains the "NC measurement report struct" on PACCH
24	SS		Wait for 1.0 seconds.
25	SS -> MS	10 RLC data blocks	SS sends data, last block is polling.
26	MS -> SS	PACKET DOWNLINK ACK/NACK	Sent on PACCH.
27	SS -> MS	10 RLC data blocks	SS sends data, last block is polling.
28	MS -> SS	PACKET MEASUREMENT REPORT	- Sent on PACCH. - Contains the "NC measurement report struct" on PACCH

Specific message contents

PACKET MEASUREMENT ORDER in step 2:

NC Measurement parameters NETWORK_CONTROL_ORDER NC_REPORTING_PERIOD_T	01 (NC1) 000 (0,48 s)
---	--------------------------

PACKET MEASUREMENT ORDER in step 17:

NC Measurement parameters NETWORK_CONTROL_ORDER NC_REPORTING_PERIOD_T	01 (NC1) 001 (0,96 s)
---	--------------------------

42.4.2 Cell change order procedures

42.4.2.1 Cell change order procedure / Uplink transfer

42.4.2.1.1 Cell change order procedure / Uplink transfer / Normal case

42.4.2.1.1.1 Conformance requirement

The cell change order procedure is started by sending a PACKET CELL CHANGE ORDER message to the mobile station on the PCCCH or PACCH. Upon receipt of the PACKET CELL CHANGE ORDER message the mobile station shall start timer T3174.

When a cell reselection is made controlled by the network, the mobile station shall act upon the IMMEDIATE_REL value which has been received in the Packet Cell Change Order: if required, the mobile station shall abort any TBF in progress by immediately ceasing to decode the downlink, ceasing to transmit on the uplink, stopping all RLC/MAC timers except for timers related to measurement reporting. The mobile station shall then switch to the identified specified new cell and shall obey the relevant RLC/MAC procedures on this new cell.

42.4.2.1.1.2 Test Purpose

To verify that when the cell change order procedure is started by sending a PACKET CELL CHANGE ORDER message, the MS shall abort any TBF in progress and stop transmitting.

To verify that the MS shall switch to the new cell.

Reference

GSM 04.60, Chapter 8.4 and 5.5.1.1.

42.4.2.1.1.3 Method of test

Initial conditions

System Simulator:

- 2 cells, GPRS supported

Mobile Station:

- MS is in Packet Idle mode and GPRS attached.
- PDP context established

Related PICS/PIXIT statement

Support of GPRS .

The way to trigger the MS initiating an uplink packet transfer.

Foreseen final state of the MS

- MS is in transfer mode

Test procedure

MS is brought into uplink packet transfer mode. SS sends a PACKET CELL CHANGE ORDER message. SS checks that there is no traffic on the old cell. MS switches to the new cell and re-establishes the uplink TBF.

Maximum duration of the test

-

Expected sequence

Step	Direction	Message	Comments
1		{Uplink packet transfer mode (fixed)}	MS is brought into uplink packet transfer mode. (Fixed allocation)
2	MS -> SS	RLC data blocks	MS sends data
3	SS -> MS	PACKET UPLINK ACK/NACK	Sent on PACCH.
4	SS -> MS	PACKET CELL CHANGE ORDER	Sent on the PACCH. Contains -BSIC + BCCH frequency -The network control order - USF
5	SS		Check that no more than six data blocks are transmitted from the MS on the old channel.
6		{Uplink packet transfer mode (fixed)}	
7	MS -> SS	RLC data blocks	MS sends data
8	SS -> MS	PACKET UPLINK ACK/NACK	Sent on PACCH.

Specific message contents

None.

42.4.2.1.2 Cell change order procedure / Uplink transfer / Failure cases / T3174 expiry

42.4.2.1.2.1 Conformance requirement

If timer T3174 expires before a response to the PACKET CHANNEL REQUEST message has been received from the new cell, the mobile station shall start timer T3176 and return to the old cell. The mobile station shall send a PACKET CELL CHANGE FAILURE message to the network.

If the mobile station was in uplink packet transfer before the cell change, the mobile station shall establish a new uplink TBF and send the PACKET CELL CHANGE FAILURE message on this TBF. The mobile station shall then resume its uplink transfer on this TBF.

42.4.2.1.2.2 Test Purpose

To verify that the mobile station sends a PACKET CELL CHANGE FAILURE message to the network, if timer T3174 expires before a response from the new cell, and returns to the old cell.

Reference

GSM 04.60, Chapter 8.4.1.

42.4.2.1.2.3 Method of test

Initial conditions

System Simulator:

- 2 cells, GPRS supported

Mobile Station:

- MS is in Packet Idle mode and GPRS attached.
- PDP context established

Related PICS/PIXIT statement

Support of GPRS .

The way to trigger the MS initiating an uplink packet transfer.

Foreseen final state of the MS

- MS is in Transfer mode

Test procedure

MS is brought into uplink packet transfer mode. SS sends the PACKET CELL CHANGE ORDER message to the MS. MS sends several PACKET CHANNEL REQUESTs on the new cell, but the timer T3174 expires before a response to PACKET CHANNEL REQUEST message has been received from the new cell. MS returns to the old cell, sends a PACKET CELL CHANGE FAILURE message to the SS and continues data transfer on the old cell.

Maximum duration of the test

-

Expected sequence

Step	Direction	Message	Comments
1		{Uplink packet transfer mode (dyn)}	MS is brought into uplink packet transfer mode.
2	MS -> SS	RLC data blocks	MS sends data
3	SS -> MS	PACKET UPLINK ACK/NACK	Sent on PACCH.
4	SS -> MS	PACKET CELL CHANGE ORDER	Sent on the PACCH. Contains -BSIC + BCCH frequency -The network control order
5	MS -> SS	PACKET CHANNEL REQUEST	To the new cell.
6	MS		MS sends PACKET CHANNEL REQUESTs until timer T3174 has expired.
7	MS -> SS	PACKET CHANNEL REQUEST	To the old cell.
8	SS -> MS	PACKET UPLINK ASSIGNMENT	Sent on PACCH.
9	MS -> SS	PACKET CELL CHANGE FAILURE	Error cause:" No response on target cell " See specific message contents
10	MS->SS	RLC data blocks	MS sends data
11	SS -> MS	PACKET UPLINK ACK/NACK	Sent on PACCH.

Specific message contents

PACKET CELL CHANGE FAILURE in step 9:

Packet Cell Change Failure message content: CAUSE	0001
--	------

42.4.2.1.3 Cell change order procedure / Uplink transfer / Failure cases / REJECT from the new cell

42.4.2.1.3.1 Conformance requirement

If a PACKET ACCESS REJECT message is received from the new cell, the mobile station shall start timer T3176, return to the old cell and send a PACKET CELL CHANGE FAILURE message to the network.

If the mobile station was in uplink packet transfer before the cell change, the mobile station shall establish a new uplink TBF and send the PACKET CELL CHANGE FAILURE message on this TBF. The mobile station shall then resume its uplink transfer on this TBF.

42.4.2.1.3.2 Test Purpose

To verify that the mobile station sends a PACKET CELL CHANGE FAILURE message to the network from the old cell, if a PACKET ACCESS REJECT message is received from the new cell.

Reference

GSM 04.60, Chapter 8.4.1

42.4.2.1.3.3 Method of test

Initial conditions

System Simulator:

- 2 cells, GPRS supported

Mobile Station:

- MS is in Packet Idle mode and GPRS attached.
- PDP context established

Related PICS/PIXIT statement

Support of GPRS.

The way to trigger the MS initiating an uplink packet transfer.

Foreseen final state of the MS

- MS is in Transfer mode

Test procedure

MS is brought into uplink packet transfer mode. SS sends the PACKET CELL CHANGE ORDER message to the MS. MS sends the PACKET CHANNEL REQUEST. SS sends PACKET ACCESS REJECT message. MS returns to the old cell and sends PACKET CELL CHANGE FAILURE message to the network.

Maximum duration of the test

-

Expected sequence

Step	Direction	Message	Comments
1		{Uplink packet transfer mode}	MS is brought into uplink packet transfer mode.
2	MS -> SS	RLC data blocks	MS sends data
3	SS -> MS	PACKET UPLINK ACK/NACK	Sent on PACCH.
4	SS -> MS	PACKET CELL CHANGE ORDER	Sent on the PACCH. Contains -BSIC + BCCH frequency -The network control order
5	MS -> SS	PACKET CHANNEL REQUEST	To the new cell.
6	SS -> MS	PACKET ACCESS REJECT	Received from the new cell
7	MS -> SS	PACKET CHANNEL REQUEST	To the old cell.
8	SS -> MS	PACKET UPLINK ASSIGNMENT	Sent on PACCH.
9	MS -> SS	PACKET CELL CHANGE FAILURE	Error cause:" Packet Access Reject on target cell " See specific message content
10	MS -> SS	RLC data blocks	MS sends data
11	SS -> MS	PACKET UPLINK ACK/NACK	Sent on PACCH.

Specific message contents

PACKET CELL CHANGE FAILURE in step 9:

Packet Cell Change Failure message content: CAUSE	0010
--	------

42.4.2.1.4 Cell change order procedure / Uplink transfer / Failure cases / Contention resolution failure

42.4.2.1.4.1 Conformance requirement

If the contention resolution procedure fails on the new cell, then the mobile station shall start timer T3176 and return to the old cell. The mobile station shall send a PACKET CELL CHANGE FAILURE message to the network.

If the mobile station was in uplink packet transfer before the cell change, the mobile station shall establish a new uplink TBF and send the PACKET CELL CHANGE FAILURE message on this TBF. The mobile station shall then resume its uplink transfer on this TBF.

42.4.2.1.4.2 Test Purpose

To verify that the mobile station initiates a random access to the old cell, if the contention resolution procedure fails on the new cell.

Reference

GSM 04.60, Chapter 8.4.1.

42.4.2.1.4.3 Method of test

Initial conditions

System Simulator:

- 2 cells, GPRS supported

Mobile Station:

- MS is in Packet Idle mode and GPRS attached.

- PDP context established

Related PICS/PIXIT statement

Support of GPRS.

The way to trigger the MS initiating an uplink packet transfer.

Foreseen final state of the MS

- MS is in Transfer mode

Test procedure

MS is brought into uplink packet transfer mode. SS sends the PACKET CELL CHANGE ORDER message to the MS. MS sends the PACKET CHANNEL REQUEST to the new cell. Contention resolution procedure fails in the new cell. MS initiates a random access to the old cell and sends PACKET CELL CHANGE FAILURE message to the network.

Maximum duration of the test

-

Expected sequence

Step	Direction	Message	Comments
1		{Uplink packet transfer mode (dyn)}	MS is brought into uplink packet transfer mode.
2	MS -> SS	RLC data blocks	MS sends data
3	SS -> MS	PACKET UPLINK ACK/NACK	Sent on PACCH.
4	SS -> MS	PACKET CELL CHANGE ORDER	Sent on the PCCCH or PACCH. Contains -BSIC + BCCH frequency -The network control order
5	MS -> SS	PACKET CHANNEL REQUEST	To the new cell.
6	SS -> MS	PACKET UPLINK ASSIGNMENT	Sent on the PACCH.
7	MS -> SS	RLC/MAC data and control blocks	The data blocks contain the TLLI. The TLLI should be the same in each RLC data block header.
8	SS -> MS	PACKET UPLINK ACK/NACK	Contention resolution procedure fails in the new cell. Message has wrong TLLI.
9	MS -> SS	PACKET CHANNEL REQUEST	To the old cell.
10	SS -> MS	PACKET UPLINK ASSIGNMENT	Sent on the PACCH.
11	MS -> SS	PACKET CELL CHANGE FAILURE	No error cause.
12	MS -> SS	RLC data blocks	MS sends data
13	SS -> MS	PACKET UPLINK ACK/NACK	Sent on PACCH.

Specific message contents

None.

42.4.2.1.5 Cell change order procedure / Uplink transfer / Failure cases / REJECT from the new cell and T3176 expiry

42.4.2.1.5.1 Conformance requirement

If a PACKET ACCESS REJECT message is received from the new cell, the mobile station shall start timer T3176, return to the old cell and send a PACKET CELL CHANGE FAILURE message to the network.

If the mobile station was in uplink packet transfer before the cell change, the mobile station shall establish a new uplink TBF and send the PACKET CELL CHANGE FAILURE message on this TBF. When the mobile station has sent a PACKET CELL CHANGE FAILURE message, timer T3176 shall be stopped.

If T3176 expires and the mobile station was previous in an uplink packet transfer on the old cell, the mobile station shall perform the abnormal release with random access.

42.4.2.1.5.2 Test Purpose

To verify that the mobile station shall perform the abnormal release with random access, if a PACKET ACCESS REJECT message is received from the new cell and timer T3176 expires.

Reference

GSM 04.60, Chapter 8.4.1

42.4.2.1.5.3 Method of test

Initial conditions

System Simulator:

- 2 cells, GPRS supported

Mobile Station:

- MS is in Packet Idle mode and GPRS attached.
- PDP context established

Related PICS/PIXIT statement

Support of GPRS.

The way to trigger the MS initiating an uplink packet transfer.

Foreseen final state of the MS

- MS is in idle mode.

Test procedure

MS is brought into uplink packet transfer mode. SS sends the PACKET CELL CHANGE ORDER message to the MS. MS sends the PACKET CHANNEL REQUEST. SS sends PACKET ACCESS REJECT message. MS performs the abnormal release with random access.

Maximum duration of the test

-

Expected sequence

Step	Direction	Message	Comments
1		{Uplink packet transfer mode}	MS is brought into uplink packet transfer mode.
2	MS -> SS	RLC data blocks	MS sends data
3	SS -> MS	PACKET UPLINK ACK/NACK	Sent on PACCH.
4	SS->MS	PACKET CELL CHANGE ORDER	Sent on the PACCH. Contains -BSIC + BCCH frequency -The network control order
5	MS->SS	PACKET CHANNEL REQUEST	To the new cell.
6	SS->MS	PACKET ACCESS REJECT	Received from the new cell.
7	MS ->SS	PACKET CHANNEL REQUEST	To the old cell. Timer T3176 expires.
8	MS ->SS	PACKET CHANNEL REQUEST	To the old cell.

Specific message contents

None.

42.4.2.1.6 Cell change order procedure / Uplink transfer / Failure cases / Frequency not implemented

42.4.2.1.6.1 Conformance requirement

If the network message instructs the mobile station to use a frequency that it is not capable of using, the mobile station shall send a PACKET CELL CHANGE FAILURE message with cause "frequency not implemented" and remain on the current PDCH(s).

42.4.2.1.6.2 Test Purpose

To verify that the mobile station returns a PACKET CELL CHANGE FAILURE message, if the ordered frequency cannot be used.

Reference

GSM 04.60, Chapter 8.4.2.

42.4.2.1.6.3 Method of test

System Simulator:

- 2 cells, GPRS supported

Mobile Station:

- MS is in Packet Idle mode and GPRS attached.
- PDP context established

Related PICS/PIXIT statement

Support of GPRS.

The way to trigger the MS initiating an uplink packet transfer.

Foreseen final state of the MS

- MS is in Transfer mode

Test procedure

MS is brought into uplink packet transfer mode. SS sends the PACKET CELL CHANGE ORDER message. MS is not capable of using the ordered frequency and sends a PACKET CELL CHANGE FAILURE message to the network. MS shall remain on the current PDCH(s).

Maximum duration of the test

-

Expected sequence

Step	Direction	Message	Comments
1		{Uplink packet transfer mode (dyn)}	MS is brought into uplink packet transfer mode.
2	MS -> SS	RLC data blocks	MS sends data
3	SS -> MS	PACKET UPLINK ACK/NACK	Sent on PACCH.
4	SS -> MS	PACKET CELL CHANGE ORDER	Contains -BSIC + BCCH frequency -The network control order MS is not capable of using the ordered frequency.
5	MS -> SS	PACKET CELL CHANGE FAILURE	Sent on the PACCH. Error cause "frequency not implemented". See specific message content.
6	MS		MS shall remain on the current PDCH(s).
7	MS -> SS	RLC data blocks	MS sends data
8	SS -> MS	PACKET UPLINK ACK/NACK	Sent on PACCH.

Specific message contents

PACKET CELL CHANGE FAILURE in step 5:

Packet Cell Change Failure message content: CAUSE	0000
--	------

42.4.2.2 Cell change order procedure / Downlink transfer

42.4.2.2.1 Cell change order procedure / Downlink transfer / Normal case

42.4.2.2.1.1 Conformance requirement

The cell change order procedure is started by sending a PACKET CELL CHANGE ORDER message to the mobile station on the PCCCH or PACCH. Upon receipt of the PACKET CELL CHANGE ORDER message the mobile station shall start timer T3174.

When a cell reselection is made controlled by the network, the mobile station shall act upon the IMMEDIATE_REL value which has been received in the Packet Cell Change Order: if required, the mobile station shall abort any TBF in progress by immediately ceasing to decode the downlink, ceasing to transmit on the uplink, stopping all RLC/MAC timers except for timers related to measurement reporting. The mobile station shall then switch to the identified specified new cell and shall obey the relevant RLC/MAC procedures on this new cell.

42.4.2.2.1.2 Test Purpose

To verify that the cell change order procedure is started when the MS receives a PACKET CELL CHANGE ORDER message.

To verify that the MS switches to the new cell.

Reference

GSM 04.60, Chapters 8.4 and 5.5.1.1

42.4.2.2.1.3 Method of test

Initial conditions

System Simulator:

- 2 cells, GPRS supported

Mobile Station:

- MS is in Packet Idle mode and GPRS attached.
- PDP context established

Related PICS/PIXIT statement

Support of GPRS.

Foreseen final state of the MS

- MS is in Transfer mode

Test procedure

MS is brought into downlink packet transfer mode. SS sends a PACKET CELL CHANGE ORDER message. MS switches to the new cell and SS establishes a new downlink TBF.

Maximum duration of the test

-

Expected sequence

Step	Direction	Message	Comments
1	SS->MS	PACKET DOWNLINK ASSIGNMENT	Sent on the PCCCH.
2	SS->MS	10 RLC data blocks	SS sends data, last block is polling.
3	MS->SS	PACKET DOWNLINK ACK/NACK	Sent on PACCH.
4	SS->MS	PACKET CELL CHANGE ORDER	Sent on the PACCH. Contains -BSIC + BCCH frequency -The network control order
5	MS->SS	PACKET CHANNEL REQUEST	To the new cell. Single block without TBF.
6	SS->MS	PACKET UPLINK ASSIGNMENT	Sent on PAGCH.
7	MS->SS	RLC data block	Sent on the PDCH
8	SS->MS	PACKET DOWNLINK ASSIGNMENT	Sent on PCCCH. On the new cell. Addressing the MS with TLLI.
9	SS->MS	10 RLC data blocks	SS sends data, last block is polling.
10	MS->SS	PACKET DOWNLINK ACK/NACK	Sent on PACCH.

Specific message contents

None

42.4.2.2.2 Cell change order procedure / Downlink transfer / Failure cases / REJECT from the new cell

42.4.2.2.2.1 Conformance requirement

If a PACKET ACCESS REJECT message is received from the new cell, the mobile station shall start timer T3176, return to the old cell and send a PACKET CELL CHANGE FAILURE message to the network.

If the mobile station was in downlink packet transfer mode before the cell change, the mobile station shall initiate a random access to the old cell, with access type "single block without TBF establishment", and then transmit the PACKET CELL CHANGE FAILURE message on the single block.

42.4.2.2.2 Test Purpose

To verify that the mobile station sends a PACKET CELL CHANGE FAILURE message to the network in the old cell, if a PACKET ACCESS REJECT message is received from the new cell.

Reference

GSM 04.60, Chapter 8.4.1

42.4.2.2.3 Method of test

Initial conditions

System Simulator:

- 2 cells, GPRS supported

Mobile Station:

- MS is in Packet Idle mode and GPRS attached.
- PDP context established

Related PICS/PIXIT statement

Support of GPRS.

Foreseen final state of the MS

- MS is in idle mode

Test procedure

MS is brought into downlink packet transfer mode. SS sends the PACKET CELL CHANGE ORDER message to the MS. MS sends the PACKET CHANNEL REQUEST. SS sends PACKET ACCESS REJECT message. MS returns to the old cell and sends PACKET CELL CHANGE FAILURE message to the network.

Maximum duration of the test

-

Expected sequence

Step	Direction	Message	Comments
1	SS -> MS	PACKET DOWNLINK ASSIGNMENT	Sent on the PCCCH.
2	SS -> MS	10 RLC data blocks	SS sends data, last block is polling.
3	MS -> SS	PACKET DOWNLINK ACK/NACK	Sent on PACCH.
4	SS -> MS	PACKET CELL CHANGE ORDER	Sent on the PACCH. Contains -BSIC + BCCH frequency -The network control order
5	MS -> SS	PACKET CHANNEL REQUEST	To the new cell.
6	SS -> MS	PACKET ACCESS REJECT	Received from the new cell
7	MS -> SS	PACKET CHANNEL REQUEST	To the old cell. 'Single block without TBF establishment.'
8	SS -> MS	PACKET UPLINK ASSIGNMENT	Sent on PACCH.
9	MS -> SS	PACKET CELL CHANGE FAILURE	Single block. Error cause:" Packet Access Reject on target cell " See specific message content

Specific message contents

PACKET CELL CHANGE FAILURE in step 9:

Packet Cell Change Failure message content: CAUSE	0010 (Packet Access Reject on target cell)
--	--

42.4.2.2.3 Cell change order procedure / Downlink transfer / Failure cases / Frequency not implemented

42.4.2.2.3.1 Conformance requirement

If the network message instructs the mobile station to use a frequency that it is not capable of using, the mobile station shall send a PACKET CELL CHANGE FAILURE message and remain on the current PDCH(s).

42.4.2.2.3.2 Test Purpose

To verify that the mobile station returns a PACKET CELL CHANGE FAILURE message if it is not capable of using the ordered frequency.

Reference

GSM 04.60, Chapter 8.4.2.

42.4.2.2.3.3 Method of test

Initial conditions

System Simulator:

- 2 cells, GPRS supported

Mobile Station:

- MS is in Packet Idle mode and GPRS attached.
- PDP context established

Related PICS/PIXIT statement

Support of GPRS.

Foreseen final state of the MS

- MS is in idle mode

Test procedure

MS is brought into downlink packet transfer mode. SS sends the PACKET CELL CHANGE ORDER message. The ordered frequency is not capable of using. The MS sends a PACKET CELL CHANGE FAILURE message to the network.

Maximum duration of the test

-

Expected sequence

Step	Direction	Message	Comments
1	SS->MS	PACKET DOWNLINK ASSIGNMENT	Sent on the PCCCH.
2	SS->MS	10 RLC data blocks	SS sends data, last block is polling.
3	MS->SS	PACKET DOWNLINK ACK/NACK	Sent on PACCH.
4	SS->MS	PACKET CELL CHANGE ORDER	Sent on the PACCH. Contains -BSIC + BCCH frequency -The network control order The frequency is not capable of using.
5	SS -> MS	RLC data block	Data block with polling,
6	MS->SS	PACKET CELL CHANGE FAILURE	Sent on PACCH. Error cause: "Frequency not implemented". See specific message content.

Specific message contents

PACKET CELL CHANGE FAILURE in step 6:

Packet Cell Change Failure message content: CAUSE	0000 (Frequency not implemented)
--	----------------------------------

42.4.2.3 Cell change order procedure / Simultaneous uplink and downlink transfer

42.4.2.3.1 Cell change order procedure / Simultaneous uplink and downlink transfer / Normal case

42.4.2.3.1.1 Conformance requirement

The cell change order procedure is started by sending a PACKET CELL CHANGE ORDER message to the mobile station on the PCCCH or PACCH. Upon receipt of the PACKET CELL CHANGE ORDER message the mobile station shall start timer T3174.

When a cell reselection is made controlled by the network, the mobile station shall act upon the IMMEDIATE_REL value which has been received in the Packet Cell Change Order: if required, the mobile station shall abort any TBF in progress by immediately ceasing to decode the downlink, ceasing to transmit on the uplink, stopping all RLC/MAC timers except for timers related to measurement reporting. The mobile station shall then switch to the identified specified new cell and shall obey the relevant RLC/MAC procedures on this new cell.

When cell reselection is controlled by the network, the mobile station in packet transfer mode shall act upon the IMMEDIATE_REL value: it may continue its operation in the old serving cell, as in mobile steered cell reselection, or it shall immediately abort its TBF if it is indicated by the IMMEDIATE_REL value.

Under no circumstances, operations in the old cell shall be continued more than 5 seconds after a cell reselection has been determined.

42.4.2.3.1.2 Test Purpose

To verify that when the cell change order procedure is started by sending a PACKET CELL CHANGE ORDER message, the MS shall abort any TBF in progress and stop transmitting.

To verify that the MS shall switch to the new cell.

To verify that the MS shall act upon the IMMEDIATE_REL value.

Reference

GSM 04.60, Chapters 5.5.1.1, 8.4 and 8.4.1

42.4.2.3.1.3 Method of test

Initial conditions

System Simulator:

- 2 cells, GPRS supported

Mobile Station:

- MS is in Packet Idle mode and GPRS attached.
- PDP context established

Related PICS/PIXIT statement

Support of GPRS.

The way to trigger the MS initiating an uplink packet transfer.

Foreseen final state of the MS

- MS is in simultaneous uplink and downlink packet transfer mode.

Test procedure

MS is brought into simultaneous uplink and downlink packet transfer mode. SS sends a PACKET CELL CHANGE ORDER message with IMMEDIATE_REL value set to 1 to force the mobile to release all ongoing TBFs. MS switches to the new cell and simultaneous uplink and downlink TBF is re-established.

SS sends a PACKET CELL CHANGE ORDER message with IMMEDIATE_REL value set to 0. The MS continues its operation in the old serving cell.

Maximum duration of the test

-

Expected sequence

Step	Direction	Message	Comments
1		{Uplink packet transfer mode (fixed)}	MS is brought into uplink packet transfer mode. (Fixed allocation)
2	SS -> MS	PACKET DOWNLINK ASSIGNMENT	Sent on the PACCH.
3	MS -> SS	RLC data blocks	MS sends data.
4	SS -> MS	PACKET UPLINK ACK/NACK	Sent on PACCH.
5	SS -> MS	10 RLC data blocks	SS sends data, last block is polling.
6	MS -> SS	PACKET DOWNLINK ACK/NACK	Sent on PACCH.
7	SS -> MS	PACKET CELL CHANGE ORDER	Sent on the PACCH. Contains -BSIC + BCCH frequency -The network control order -USF IMMEDIATE_REL bit is set to 1. See specific message content.
8	SS		Check that no more than six data blocks are transmitted from the MS on old channel.
9	MS -> SS	PACKET CHANNEL REQUEST	Sent on the PRACH. To the new cell.
10	SS->MS	PACKET UPLINK ASSIGNMENT	Sent on the PCCCH.
11	MS->SS	RLC data block	MS sends data.
12	SS -> MS	PACKET UPLINK ACK/NACK	Sent on PACCH.
13	SS -> MS	PACKET DOWNLINK ASSIGNMENT	Sent on PACCH. On the new cell.
14	SS -> MS	10 RLC data blocks	SS sends data, last block is polling.
15	MS -> SS	PACKET DOWNLINK ACK/NACK	Sent on PACCH.
16	MS -> SS	RLC data blocks	MS sends data.
17	SS -> MS	PACKET UPLINK ACK/NACK	Sent on PACCH.
18	SS -> MS	PACKET CELL CHANGE ORDER	Sent on the PACCH. Contains -BSIC + BCCH frequency -The network control order -USF IMMEDIATE_REL bit is not set. See specific message contents.
19	MS -> SS	RLC data blocks	MS sends data.
20	SS -> MS	PACKET UPLINK ACK/NACK	Sent on PACCH.
21			Steps 13 and 14 are optional and can be repeated, but not more than 5 seconds.
22	MS -> SS	PACKET CHANNEL REQUEST	Sent on the PRACH. To the new cell.
23	SS -> MS	PACKET UPLINK ASSIGNMENT	Sent on the PCCCH.
24	MS -> SS	RLC data block	MS sends data.
25	SS -> MS	PACKET UPLINK ACK/NACK	Sent on PACCH.
26	SS -> MS	PACKET DOWNLINK ASSIGNMENT	Sent on PACCH. On the new cell.
27	SS -> MS	10 RLC data blocks	SS sends data, last block is polling.
28	MS -> SS	PACKET DOWNLINK ACK/NACK	Sent on PACCH.
29	MS -> SS	RLC data blocks	MS sends data.
30	SS -> MS	PACKET UPLINK ACK/NACK	Sent on PACCH.

Specific message contents

PACKET CELL CHANGE ORDER in Step 7:

Packet Cell Change Order message content: IMMEDIATE_REL	1 (Immediate abort of operation in the old cell is required.)
--	---

PACKET CELL CHANGE ORDER in Step 18:

Packet Cell Change Order message content: IMMEDIATE_REL	0 (No immediate abort of operation in the old cell is required)
--	---

42.4.2.3.2 Cell change order procedure / Simultaneous uplink and downlink transfer / Failure case / T3174 expiry

42.4.2.3.2.1 Conformance requirement

If timer T3174 expires before a response to the PACKET CHANNEL REQUEST message has been received from the new cell, the mobile station shall start timer T3176 and return to the old cell. The mobile station shall send a PACKET CELL CHANGE FAILURE message to the network.

If the mobile station was in a simultaneous uplink and downlink packet transfer mode before the cell change, the mobile station shall establish a new uplink TBF and send the PACKET CELL CHANGE FAILURE message on this TBF. The mobile station shall then resume its uplink transfer on this TBF. When the mobile station has sent a PACKET CELL CHANGE FAILURE message, timer T3176 shall be stopped. The mobile station shall then resume its uplink transfer on this TBF.

42.4.2.3.2.2 Test Purpose

To verify that the mobile station sends a PACKET CELL CHANGE FAILURE message to the network and returns to the old cell if timer T3174 expires before a response from the new cell.

Reference

GSM 04.60, Chapter 8.4.1.

42.4.2.3.2.3 Method of test

Initial conditions

System Simulator:

- 2 cells, GPRS supported

Mobile Station:

- MS is in Packet Idle mode and GPRS attached.
- PDP context established

Related PICS/PIXIT statement

Support of GPRS.

The way to trigger the MS initiating an uplink packet transfer.

Foreseen final state of the MS

- MS is in Idle mode

Test procedure

MS is brought into simultaneous uplink and downlink packet transfer mode. SS sends the PACKET CELL CHANGE ORDER message to the MS. MS sends several PACKET CHANNEL REQUESTs to the new cell, but the timer T3174

expires before a response to PACKET CHANNEL REQUEST message has been received from the new cell. MS returns to the old cell and sends a PACKET CELL CHANGE FAILURE message to the SS.

Maximum duration of the test

-

Expected sequence

Step	Direction	Message	Comments
1		{Uplink packet transfer mode (fixed)}	MS is brought into uplink packet transfer mode. (Fixed allocation)
2	SS -> MS	PACKET DOWNLINK ASSIGNMENT	Sent on the PACCH.
3	MS -> SS	RLC data blocks	MS sends data.
4	SS -> MS	PACKET UPLINK ACK/NACK	Sent on PACCH.
5	SS -> MS	10 RLC data blocks	SS sends data, last block is polling.
6	MS -> SS	PACKET DOWNLINK ACK/NACK	Sent on PACCH.
7	SS -> MS	PACKET CELL CHANGE ORDER	Sent on the PACCH. Contains -BSIC + BCCH frequency -The network control order
8	MS -> SS	PACKET CHANNEL REQUEST	To the new cell.
9	MS		MS sends PACKET CHANNEL REQUESTS until timer T3174 has expired.
10	MS -> SS	PACKET CHANNEL REQUEST	To the old cell.
11	SS -> MS	PACKET UPLINK ASSIGNMENT	Sent on the PACCH.
12	MS -> SS	PACKET CELL CHANGE FAILURE	Error cause:" No response on target cell " See specific message content.
13	MS -> SS	RLC data blocks	MS sends data.
14	SS -> MS	PACKET UPLINK ACK/NACK	Sent on PACCH.

Specific message contents

PACKET CELL CHANGE FAILURE in step 12:

Packet Cell Change Failure message content: CAUSE	0001
--	------

42.4.3 Macros and Default Message contents

42.4.3.1 Macros

In order to simplify the process of writing and coding test cases, macros are referenced in the expected signalling tables. These macros provide all additional signalling needed to complete the particular test but are not relevant to its purpose.

42.4.3.1.1 Uplink packet transfer mode / Dynamic allocation

Step	Direction	Message	Comments
	MS → SS	{ Uplink packet transfer mode (dyn) }	Macro
1	MS → SS	PACKET CHANNEL REQUEST	Received on PRACH.
2	SS → MS	PACKET UPLINK ASSIGNMENT	Sent on PAGCH. (Dynamic allocation)

42.4.3.1.2 Uplink packet transfer mode / Fixed allocation

Step	Direction	Message	Comments
	MS → SS	{ Uplink packet transfer mode (fixed) }	Macro
1	MS → SS	PACKET CHANNEL REQUEST	Received on PRACH.
2	SS → MS	PACKET UPLINK ASSIGNMENT	Sent on PAGCH. (Fixed allocation)

42.4.3.2 Default Messages

42.4.3.2.1 PACKET CELL CHANGE ORDER message

MESSAGE_TYPE	0000 01
PAGE_MODE	00 Normal Paging
Referenced Address	
-	10 (address is TLLI)
- TLLI	ed from MS
IMMEDIATE_REL	1 (Immediate release of the on-going TBF.)
ARFCN	For GSM 900, 00 0001 0100 (ARFCN 20) For DCS 1800 and PCS 1900, 10 0100 1110 (ARFCN 590)
BSIC	For GSM 900, 001101 For DCS 1800 and PCS 1900, 001101
NC Measurement Parameters	
NETWORK_CONTROL_ORDER	0 0 NC0
{ 0 1 < NC_NON_DRX_PERIOD < NC_REPORTING_PERIOD_I < NC_REPORTING_PERIOD_T }	0 No additional NC parameters
NC Frequency list struct	
{ 0 1 < NC_FREQUENCY_LIST }	0 No NC_FREQUENCY_LIST
< padding bits >	Spare Padding

42.4.3.2.2 PACKET CELL CHANGE FAILURE message

MESSAGE_TYPE	0000 00
TLLI	same as the value received from MS
ARFCN	For GSM 900, 00 0001 0100 (ARFCN 20) For DCS 1800 and PCS 1900, 10 0100 1110 (ARFCN 590)
BSIC	For GSM 900, 001101 For DCS 1800 and PCS 1900, 001101
CAUSE	0 0 0 1 No response on target cell
spare padding	Spare Padding

42.4.3.2.3 PACKET MEASUREMENT ORDER message

MESSAGE_TYPE	0000 11
PAGE_MODE	00 Normal Paging
TLLI	10 (address is TLLI)
-	Same as the value received from MS
PMO_INDEX	0 0 0 first message of two messages
PMO_COUNT	0 0 1 two messages expected
{ 0 1 < NC Measurement Parameters }	1 NC Measurement Parameters available
NC Measurement Parameters	
NETWORK_CONTROL_ORDER	0 1 NC1
{ 0 1 < NC_NON_DRX_PERIOD	1 Additional NC parameters available
< NC_REPORTING_PERIOD_I	NC_NON_DRX_PERIOD = 000
< NC_REPORTING_PERIOD_T }	(No non-DRX mode after a measurement report has been sent)
	NC_REPORTING_PERIOD_I = 111
	(61.44 sec)
	NC_REPORTING_PERIOD_T = 011
	(3.84 sec)
	1 NC Frequency list struct available
{ 0 1 < NC_FREQUENCY_LIST }	
NC Frequency list	
{ 0 1 { < NR_OF_REMOVED_FREQ	1 Frequencies have been removed
NR_OF_REMOVED_FREQ	00001
REMOVED_FREQ_INDEX	000000
{ 1 < List of added Frequency struct	
Add Frequency list	
START_FREQUENCY	00 0101 1000 (ARFCN 88)
BSIC	001101
{ 0 1 < Cell selection params	1 cell selection parameters available
Cell selection params	
EXC_ACC	0
CELL_BAR_ACCESS_2	0 normal reselection
SAME_RA_AS_SERVING_CELL	1 same RA as serving cell
{ 0 1 < GPRS_RXLEV_ACCESS_MIN }	1 GPRS_RXLEV_ACCESS_MIN present
GPRS_RXLEV_ACCESS_MIN	011111 -80dBm
GPRS_MS_TXPWR_MAX_CCH	10001 Mid level
{ 0 1 < GPRS_TEMPORARY_OFFSET }	1 GPRS_TEMPORARY_OFFSET present
GPRS_TEMPORARY_OFFSET	000
GPRS_PENALTY_TIME	0000
{ 0 1 < GPRS_RESELECT_OFFSET }	1 GPRS_RESELECT_OFFSET present
GPRS_RESELECT_OFFSET	10000 0dBm
{ 0 1 < HCS params }	1 HCS params present
GPRS_PRIORITY_CLASS	000
GPRS_HCS_THR	10100
{ 0 1 < SI13_PBCCH_LOCATION }	1 SI13_PBCCH_LOCATION present
{ 0 < SI13_LOCATION }	0
SI13_LOCATION	0 SI13 is sent on BCCH norm
NR_OF_FREQUENCIES	0001
FREQ_DIFF_LENGTH	010
FREQUENCY_DIFF	111 (ARFCN 95)
BSIC	001101
{ 0 1 < Cell selection params }	1 cell selection parameters available
Cell selection params	
EXC_ACC	0
CELL_BAR_ACCESS_2	0 Normal reselection
SAME_RA_AS_SERVING_CELL	0 Not RA as serving cell
{ 0 1 < GPRS_RXLEV_ACCESS_MIN }	0 GPRS_RXLEV_ACCESS_MIN not present
{ 0 1 < GPRS_TEMPORARY_OFFSET }	0 GPRS_TEMPORARY_OFFSET not present
{ 0 1 < GPRS_RESELECT_OFFSET }	0 GPRS_RESELECT_OFFSET not present
{ 0 1 < HCS params }	0 HCS params not present
{ 0 1 < SI13_PBCCH_LOCATION }	1 SI13_PBCCH_LOCATION present
{ 0 < SI13_LOCATION }	0
SI13_LOCATION	1 SI13 is sent on BCCH norm
} 0	End of list
< padding bits >	Spare Padding

42.4.4 Cell Change Order Procedures without PBCCH

42.4.4.1 Network Controlled Cell Reselection – Packet Measurement Order Procedure

42.4.4.1.1 Conformance requirement

A cell re-selection command may be sent from the network to an MS. When the MS receives the command, it shall immediately re-select the cell according to the included cell description and change the network control mode according to the command.

Reference:

GSM 04.60 Section 8.4.0, GSM 05.08 Section 10.1.4.2

42.4.4.1.2 Test purpose

To verify that when the Network initiates the Packet Measurement Order Procedure, the MS correctly interprets the Packet Measurement Order Message and reselects to the cell given in Packet Measurement Order.

42.4.4.1.3 Method of test

Initial conditions

Parameter	Carrier1	Carrier2	Carrier3
RF Signal Level (dBm)	-70	-80	-50
GPRS_RXLEV_ACCE SS_MIN	-100	-100	-100
NETWORK_CONTRO L_ORDER	NC2	NC2	NC2
C1	30	20	50
C2	30	20	50

System simulator:

3 cells, GPRS supported, PBCCH not present (Carrier 1 & 2 is active. Carrier 3 is off.)

Mobile Station:

MS is GPRS attached on carrier 1 (with Ready timer value unit set to '111' in the ATTACH ACCEPT message, thus the MS is always in Ready state)

Related PICS/PIXIT statement

Support of GPRS.

Test Procedure

The SS establishes single block down link TBF and then initiates the Packet Measurement Order Procedure on carrier 1 with the Packet Measurement Order (PMO) changing NC2 to NC0. The MS shall reselect to carrier 3 and initiate channel request procedure.

Expected Sequence

Step	Direction	Message	Comments
1	SS		Activate carrier 3
2	SS->MS	IMMEDIATE ASSIGNMENT	SS establishes a single block down link TBF on carrier 1.
3	SS->MS	PACKET MEASUREMENT ORDER	Sent on PACCH of carrier 1. PMO message contains Network Control Order 0
4	MS->SS	CHANNEL REQUEST	Verify MS sends channel request on carrier 3 within 30 seconds of step 3.
5	SS->MS	IMMEDIATE ASSIGNMENT REJECT.	Network sends immediate assignment reject on carrier 3.

42.4.4.2 Network Controlled Cell Reselection/validity of reselection parameters/MS enters standby state

42.4.4.2.1 Conformance requirement

A set of measurement reporting parameters (`NETWORK_CONTROL_ORDER` and `NC_REPORTING_PERIOD(s)`) is broadcast on PBCCH. The parameters may also be sent individually to an MS on PCCCH or PACCH, in which case it overrides the broadcast parameters. The individual parameters are valid until the RESET command is sent to MS., there is a downlink signaling failure or the MS enters Standby State.

Reference:

GSM 05.08 Section 10.1.4

42.4.4.2.2 Test purpose

To verify that the measurement reporting parameters are valid till the MS enters the standby state.

42.4.4.2.3 Method of test

Initial conditions

Parameter	Carrier1	Carrier2
RF Signal Level (dBm)	-80	-70
GPRS_RXLEV_ACCE SS_MIN	-100	-100
NETWORK_CONTRO L_ORDER	NC0	NC2
C1	20	30
C32	20	30

System simulator:

2 cells, GPRS supported, PBCCH not present (Carrier 1 is active. Carrier 2 is off.)

Mobile Station:

MS is off

Related PICS/PIXIT statement

Support of GPRS.

Test Procedure

The SS establishes single block down link TBF and then initiates the Packet Measurement Order Procedure on carrier 1 with the Packet Measurement Order (PMO) changing NC0 to NC2. The SS activates carrier 2 with higher RF signal strength than carrier 1. After the Ready Timer expires in the mobile, the MS shall reselect carrier 2 as NC2 is not applicable in standby mode.

Expected Sequence

Step	Direction	Message	Comments
1	MS		The MS is powered up or switched on and initiates an attach (see PICS).
2	MS -> SS	ATTACH REQUEST	
3	SS -> MS	ATTACH ACCEPT	Ready timer set to 60 seconds.
4	SS->MS	IMMEDIATE ASSIGNMENT	SS establishes a single block down link TBF on carrier 1.
5	SS->MS	PACKET MEASUREMENT ORDER	Sent on PACCH of carrier 1 PMO message contains Network Control Order 2
6	SS		Activate carrier 2
7	SS		Wait for 30 seconds
8	SS->MS	PAGING REQUEST TYPE 1	MS paged continuously on carrier 2
9	SS		Verify no response from MS on carrier 2 for 25 seconds.
10	MS -> SS	CHANNEL REQUEST	Verify MS has camped on carrier 2. Sent within 80 seconds of step 3.

42.5 Downlink Transfer

42.5.1 Downlink Transfer / Normal Operation

42.5.1.1 Downlink Transfer/ Normal Operation / Relative Encoding TBF starting time

42.5.1.1.1 Definition and applicability

This test case applies to all MSs supporting GPRS.

42.5.1.1.2 Conformance Requirement

The allocated radio resource is assigned to the mobile station in a PACKET DOWNLINK ASSIGNMENT message to the mobile station. The PACKET DOWNLINK ASSIGNMENT message is transmitted on an appropriate paging subchannel on PCCCH, considering the DRX parameters valid for each targeted mobile (see GSM 05.02). The multislot capabilities of the mobile station must be considered.

A PACKET DOWNLINK ASSIGNMENT message may indicate an assignment starting time in the TBF Starting Time parameter. The mobile station shall monitor PCCCH until the point in time denoted by the TBF Starting Time. Thereafter it shall switch to the assigned PDCHs. If while monitoring the PCCCH the mobile station receives more than one PACKET DOWNLINK ASSIGNMENT message, it shall act upon the most recently received message and shall ignore the previous message.

The Packet downlink assignment procedure is completed when the mobile station receives a valid RLC/MAC block. The mobile station has entered the packet transfer mode.

References

GSM 04.60, subclause 7.2.1.1, 7.2.1.2, 10.4.5

42.5.1.1.3 Test purpose

Verify that an MS switches to the assigned PDCH at the relative-encoded starting time.

42.5.1.1.4 Method of test

Initial Conditions

System Simulator:

1 cell, GPRS supported, PCCCH present

Mobile Station:

The MS is in the state "idle, GMM-registered" with a P-TMSI allocated, SPLIT PG CYCLE negotiated, and PDP context 2 activated.

Related PICS/PIXIT Statement(s)

Support GPRS service

Test Procedure

1. MS receives a PACKET DOWNLINK ASSIGNMENT message on its assigned PCCCH, containing a starting time with relative encoding.
2. Before the starting time, SS transmits a downlink RLC data block.
3. MS ignores the block.
4. At the starting time block, the MS receives a downlink RLC data block with polling indicated.
5. MS responds by sending a PACKET DOWNLINK ACK/NACK.

Maximum Duration of Test

5 min.

Expected Sequence

Step	Direction	Message	Comments
1	SS -> MS	PACKET DOWNLINK ASSIGNMENT	Triggers the MS to wait until the starting time before monitoring the assigned PDCH. Without valid RRBP. 3 blocks before the starting time, with valid RRBP field, on assigned PDCH, addressed to MS.
2	SS -> MS	RLC DATA BLOCK	
3	SS		Verify the MS does not respond to the previous RLC block, and that the MS does not transmit on the PACCH of the assigned PDCH.
4	SS -> MS	RLC DATA BLOCK	At the starting time, with valid RRBP field.
5	MS -> SS	PACKET DOWNLINK ACK/NACK	MS acknowledges on PACCH the RLC data block sent at the starting time.
6		{Completion of downlink data transfer}	Macro

Specific Message Contents

PACKET DOWNLINK ASSIGNMENT message in step 1:

TIMESLOT_ALLOCATION	<one timeslot assigned>
TBF STARTING TIME	1 - Relative frame number encoding:
- Starting Frame Number Description IE	0000000101101 – k=45: first frame of block is N+199 or N+200

DOWNLINK RLC DATA BLOCKS (various steps):

RRBP S/P (MAC Header)	00 – Response shall be sent by MS in N+13 frames. 1 – RRBP field is valid
--------------------------	--

42.5.1.2 Downlink Transfer/ Normal Operation / Without TBF starting time

42.5.1.2.1 Definition and applicability

This test case applies to all MSs supporting GPRS.

42.5.1.2.2 Conformance Requirement

The allocated radio resource is assigned to the mobile station in a PACKET DOWNLINK ASSIGNMENT message to the mobile station. The PACKET DOWNLINK ASSIGNMENT message is transmitted on an appropriate paging subchannel on PCCCH, considering the DRX parameters valid for each targeted mobile (see GSM 05.02). The multislot capabilities of the mobile station must be considered.

On receipt of a PACKET DOWNLINK ASSIGNMENT message, the mobile station shall switch to the assigned PDCHs.

The Packet downlink assignment procedure is completed when the mobile station receives a valid RLC/MAC block. The mobile station has entered the packet transfer mode.

If the MS is required to transmit a PACKET CONTROL ACKNOWLEDGEMENT subsequent to a PACKET DOWNLINK ASSIGNMENT, the MS shall be ready to receive on the new assignment no later than the next occurrence of block B((x+2) mod 12) where block B(x) is radio block containing the PACKET CONTROL ACKNOWLEDGEMENT.

References

GSM 04.60, subclause 7.2.1.1, 7.2.1.2, 10.4.5

GSM 5.10, subclause 6.11.1

42.5.1.2.3 Test purpose

Verify that an MS switches to the assigned PDCH when assigned to it without a starting time, within 3 blocks.

42.5.1.2.4 Method of test

Initial Conditions

System Simulator:

1 cell, GPRS supported, PCCCH present

Mobile Station:

The MS is in the state "idle, GMM-registered" with a P-TMSI allocated, SPLIT PG CYCLE negotiated, and PDP context 3 activated.

Related PICS/PIXIT Statement(s)

Support GPRS service

Test Procedure

1. MS receives a PACKET DOWNLINK ASSIGNMENT message on its assigned PCCCH, containing no starting time.

2. SS transmits a downlink RLC data block.
3. MS responds by sending a PACKET DOWNLINK ACK/NACK.

Maximum Duration of Test

5 min.

Expected Sequence

Step	Direction	Message	Comments
1	SS -> MS	PACKET DOWNLINK ASSIGNMENT	Triggers the MS to switch to the assigned PDCH. (no starting time) With valid RRBP field
2	MS->SS	PACKET CONTROL ACK	Sent on PACCH in block specified by RRBP field in step 1.
3	SS -> MS	RLC DATA BLOCK	2 blocks after the previous message, with valid RRBP field, on assigned PDCH, addressed to MS.
4	MS -> SS	PACKET DOWNLINK ACK/NACK	MS acknowledges on PACCH the RLC data block sent at the starting time.
5	SS -> MS	RLC DATA BLOCKS	SS continues to transmit RLC data blocks according to assignment from step 1.
5	MS -> SS	PACKET DOWNLINK ACK/NACK	MS acknowledges on PACCH all blocks sent.

Specific Message Contents

PACKET DOWNLINK ASSIGNMENT message in step 1:

TIMESLOT_ALLOCATION	<one timeslot assigned>
TBF STARTING TIME	<IE not present>

DOWNLINK RLC DATA BLOCKS (various steps):

RRBP S/P	00 – Response shall be sent by MS in N+13 frames. 1 – RRBP field is valid
-------------	--

42.5.2 Downlink Transfer / Polling

42.5.2.1 Downlink Transfer/ Polling/ Normal operation/RLC data block

42.5.2.1.1 Definition and applicability

This test case applies to all MSs supporting GPRS.

42.5.2.1.2 Conformance Requirement

Whenever the mobile station receives an RLC data block addressed to itself and with a valid RRBP field in the RLC data block header (i.e., is polled), the mobile station shall transmit a PACKET DOWNLINK ACK/NACK message in the uplink radio block specified by the RRBP field whatever the BSN value of the received RLC data block, unless another RLC/MAC control message is waiting to be transmitted, in which case the other RLC/MAC control message shall be sent.

The RRBP value specifies a single uplink block in which the mobile station shall transmit either a PACKET CONTROL ACKNOWLEDGEMENT message or a PACCH block to the network. If the RRBP field is received as part of an RLC/MAC block containing an RLC/MAC control block containing any message except Packet Paging Request, Packet Access Reject, and Packet Queueing Notification, the mobile station shall transmit a PACKET CONTROL ACKNOWLEDGEMENT message in the uplink radio block specified. If the RRBP field is received as part of an

RLC/MAC block containing an RLC/MAC control block containing a Packet Paging Request, Packet Access Reject, or Packet Queueing Notification message, the mobile station shall ignore this RRBP field. The mobile station shall only react on RLC/MAC control blocks containing a valid RRBP field if the mobile station is unambiguously addressed either in the downlink RLC/MAC control block header or in the control message itself.

References

GSM 04.60, subclause 8.1.2.2, 10.4.5

42.5.2.1.3 Test purpose

Verify that an MS responds to a poll with a PACKET DOWNLINK ACK/NACK message in the block specified by the RRBP field.

42.5.2.1.4 Method of test

Initial Conditions

System Simulator:

1 cell, GPRS supported, PCCCH present

Mobile Station:

The MS is in the state "idle, GMM-registered" with a P-TMSI allocated, SPLIT PG CYCLE negotiated, and PDP context 3 activated.

Related PICS/PIXIT Statement(s)

Support GPRS service

Test Procedure

1. MS receives a PACKET DOWNLINK ASSIGNMENT message on its assigned PCCCH, containing no starting time.
2. SS transmits a downlink RLC data block.
3. MS responds by sending a PACKET DOWNLINK ACK/NACK in the block specified by the RRBP field of the RLC data block.

Maximum Duration of Test

5 min.

Expected Sequence

Step	Direction	Message	Comments
1	SS -> MS	PACKET DOWNLINK ASSIGNMENT	Triggers the MS to switch to assigned PDCH.
2	SS -> MS	RLC DATA BLOCK	6 blocks after the previous message, with valid RRBP field, on assigned PDCH, addressed to MS.
3	MS -> SS	PACKET DOWNLINK ACK/NACK	MS acknowledges the RLC DATA BLOCK 26 frames after step 2.

Specific Message Contents

PACKET DOWNLINK ASSIGNMENT message in step 1:

TIMESLOT_ALLOCATION	<one timeslot assigned>
TBF STARTING TIME	<IE not present>

DOWNLINK RLC DATA BLOCK in step 2:

RRBP S/P	11 – Response shall be sent by MS in N+26 frames. 1 – RRBP field is valid
-------------	--

42.5.2.2 Downlink Transfer/ Polling/ Packet Polling Request/ Access Burst format

42.5.2.2.1 Definition and applicability

This test case applies to all MSs supporting GPRS.

42.5.2.2.2 Conformance Requirement

The network may send to the mobile station a PACKET POLLING REQUEST message. If the MS has received a PACKET DOWNLINK ASSIGNMENT message with no starting time or with a starting time that has already elapsed, the PACKET POLLING REQUEST message shall be sent on PACCH. Otherwise the PACKET POLLING message shall be sent on PAGCH. The mobile station shall be addressed by its TLLI or TFI.

On receipt of a PACKET POLLING REQUEST message, the mobile station shall respond to the network with the PACKET CONTROL ACKNOWLEDGEMENT message in the reserved uplink radio block specified by the RRBP field. The reserved block is considered as a one block PACCH allocation.

References

GSM 04.60, subclause 7.2.1.3

42.5.2.2.3 Test purpose

Verify that an MS responds to a PACKET POLLING REQUEST message (requesting access burst format) with a PACKET CONTROL ACKNOWLEDGEMENT message in access burst format.

42.5.2.2.4 Method of test

Initial Conditions

System Simulator:

1 cell, GPRS supported, PCCCH present

Mobile Station:

The MS is in the state "idle, GMM-registered" with a P-TMSI allocated, SPLIT PG CYCLE negotiated, and PDP context 3 activated.

Related PICS/PIXIT Statement(s)

Support GPRS service

Test Procedure

1. MS receives a PACKET DOWNLINK ASSIGNMENT message on its assigned PCCCH, containing no starting time.

2. SS transmits downlink RLC data blocks.
3. SS transmits a PACKET POLLING REQUEST message, requesting access burst format.
4. MS responds by sending a PACKET CONTROL ACKNOWLEDGE message in access burst format.

Maximum Duration of Test

5 min.

Expected Sequence

Step	Direction	Message	Comments
1	SS -> MS	PACKET DOWNLINK ASSIGNMENT	Triggers the MS to switch to assigned PDCH.
2	SS -> MS	RLC DATA BLOCKS	Starting 6 blocks after the previous message, on assigned PDCH, addressed to MS.
3	SS -> MS	PACKET POLLING REQUEST	Requesting access burst format
4	MS -> SS	PACKET CONTROL ACKNOWLEDGEMENT	MS acknowledges using 11-bit access burst format.

Specific Message Contents

PACKET DOWNLINK ASSIGNMENT message in step 1:

TIMESLOT_ALLOCATION	<one timeslot assigned>
TBF STARTING TIME	<IE not present>

PACKET POLLING REQUEST in step 3:

TYPE_OF_ACK Global TFI (downlink)	0 – MS response sent as 4 access bursts Addressing MS
--------------------------------------	--

PACKET CONTROL ACKNOWLEDGMENT access bursts in step 4:

MESSAGE_TYPE CTRL_ACK	1111 1100 1 01
--------------------------	-------------------

42.5.2.3 Downlink Transfer/ Polling/ Packet Polling Request/ Control block format

42.5.2.3.1 Definition and applicability

This test case applies to all MSs supporting GPRS.

42.5.2.3.2 Conformance Requirement

The network may send to the mobile station a PACKET POLLING REQUEST message. If the MS has received a PACKET DOWNLINK ASSIGNMENT message with no starting time or with a starting time that has already elapsed, the PACKET POLLING REQUEST message shall be sent on PACCH. Otherwise the PACKET POLLING message shall be sent on PAGCH. The mobile station shall be addressed by its TLLI or TFI.

On receipt of a PACKET POLLING REQUEST message, the mobile station shall respond to the network with the PACKET CONTROL ACKNOWLEDGEMENT message in the reserved uplink radio block specified by the RRBP field. The reserved block is considered as a one block PACCH allocation.

References

GSM 04.60, subclause 7.2.1.3

42.5.2.3.3 Test purpose

Verify that an MS responds to a PACKET POLLING REQUEST message (requesting control block format) with a PACKET CONTROL ACKNOWLEDGEMENT message in control block format, in the uplink block specified by the RRBP field.

42.5.2.3.4 Method of test

Initial Conditions

System Simulator:

1 cell, GPRS supported, PCCCH present

Mobile Station:

The MS is in the state "idle, GMM-registered" with a P-TMSI allocated, SPLIT PG CYCLE negotiated, and PDP context 3 activated.

Related PICS/PIXIT Statement(s)

Support GPRS service

Test Procedure

1. MS receives a PACKET DOWNLINK ASSIGNMENT message on its assigned PCCCH, containing no starting time.
2. SS transmits downlink RLC data blocks.
3. SS transmits a PACKET POLLING REQUEST message, requesting control block format.
4. MS responds by sending a PACKET CONTROL ACKNOWLEDGE message in control block format.

Maximum Duration of Test

5 min.

Expected Sequence

Step	Direction	Message	Comments
1	SS -> MS	PACKET DOWNLINK ASSIGNMENT	Triggers the MS to switch to assigned PDCH.
2	SS -> MS	RLC DATA BLOCKS	Starting 3 blocks after the previous message, on assigned PDCH, addressed to MS.
3	SS -> MS	PACKET POLLING REQUEST	Requesting control block format; RRBP field specifies N+21 (or N+22 frames)
4	MS -> SS	PACKET CONTROL ACKNOWLEDGEMENT	MS acknowledges in the uplink block N+21 (or N+22 frames)

Specific Message Contents

PACKET DOWNLINK ASSIGNMENT message in step 1:

TIMESLOT_ALLOCATION	<one timeslot assigned>
TBF STARTING TIME	<IE not present>

PACKET POLLING REQUEST in step 3:

RRBP	10 – MS response sent in N+21 or N+22 frames
S/P	1 – RRBP field is valid
TYPE_OF_ACK	1 – MS response sent in RLC/MAC control block
TFI	Addressing MS

PACKET CONTROL ACKNOWLEDGMENT in step 4:

TLLI (32)	<of this MS>
CTRL_ACK	11

42.5.3 Downlink Transfer / T3190 Expiry / Initial allocation

42.5.3.1 Downlink Transfer/ T3190 Expiry / Initial allocation / Restart with valid RLC data block

42.5.3.1.1 Definition and applicability

This test case applies to all MSs supporting GPRS.

42.5.3.1.2 Conformance Requirement

When receiving the PACKET DOWNLINK ASSIGNMENT message and after waiting the TBF Starting Time when applicable, the mobile station starts timer T3190. The timer is reset when receiving the first valid RLC/MAC block.

On expiry of timer T3190, the mobile station shall abort the procedure and return to packet idle mode.

If the mobile station receives a valid RLC data block addressed to itself, the mobile station shall reset and restart timer T3190. If timer T3190 expires, the mobile station shall perform an abnormal release with return to CCCH or PCCCH (see subclause 8.7.1).

References

GSM 04.60, subclause 7.2.1.1, 8.1.2.1, 10.4.5

42.5.3.1.3 Test purpose

Verify that an MS starts T3190 when receiving the PACKET DOWNLINK ASSIGNMENT, resets and restarts the timer when a valid RLC/MAC block is received, and returns to packet idle mode when T3190 expires.

42.5.3.1.4 Method of test

Initial Conditions

System Simulator:

1 cell, GPRS supported, PCCCH present

Mobile Station:

The MS is in the state "idle, GMM-registered" with a P-TMSI allocated, SPLIT PG CYCLE negotiated, and PDP context 3 activated.

Related PICS/PIXIT Statement(s)

Support GPRS service

Test Procedure

1. MS receives a PACKET DOWNLINK ASSIGNMENT message on its assigned PCCCH, containing relative-encoded starting time.
2. $(0.8 \cdot T3190)$ seconds after the starting time occurs, the SS transmits a downlink RLC data block with polling indicated.
3. MS sends PACKET DOWNLINK ACK/NACK on PACCH in response to the RLC data block.
4. $(1.2 \cdot T3190)$ seconds after the previous downlink RLC data block, the SS transmits another downlink RLC data block with polling indicated.
5. The MS ignores the downlink block (because it has already returned to packet idle mode upon expiry of T3190).

Maximum Duration of Test

5 min.

Expected Sequence

Step	Direction	Message	Comments
1	SS -> MS	PACKET DOWNLINK ASSIGNMENT	Triggers the MS to switch to the assigned PDCH and start T3190 at the starting time indicated.
2	SS -> MS	RLC DATA BLOCK	Sent on assigned PDCH, $(T3190 \cdot 0.8)$ seconds after step 1, with valid RRBP field, addressed to MS.
3	MS -> SS	PACKET DOWNLINK ACK/NACK	MS acknowledges the previous RLC data block, and restarts T3190.
4	SS -> MS	RLC DATA BLOCK	Sent on assigned PDCH, $(T3190 \cdot 1.2)$ seconds after step 2, with valid RRBP field, addressed to MS.
5	SS		Verify the MS does not respond to the previous RLC block, and that the MS does not transmit on the PACCH of the assigned PDCH.
6	SS->MS	PACKET DOWNLINK ASSIGNMENT	Sent on assigned packet paging channel. This is to verify the MS is in packet idle mode.
7	SS->MS	RLC DATA BLOCK	Sent on assigned PDCH, $(T3190 \cdot 0.8)$ seconds after step 6, with valid RRBP field, addressed to MS.
8	MS -> SS	PACKET DOWNLINK ACK/NACK	MS acknowledges the previous RLC data block.

Specific Message Contents

PACKET DOWNLINK ASSIGNMENT message in step 1:

TIMESLOT_ALLOCATION	<one timeslot assigned>
TBF STARTING TIME - Starting Frame Number Description IE	1 - Relative frame number encoding: 0000000101101 – k=45: first frame of block is N+199 or N+200

DOWNLINK RLC DATA BLOCKS (various steps):

RRBP S/P	00 – Response shall be sent by MS in N+13 frames. 1 – RRBP field is valid
-------------	--

42.5.4 Downlink Transfer / T3190 Expiry / Resource reallocation

42.5.4.1 Downlink Transfer/ T3190 Expiry / Resource reallocation / Without TBF starting time

42.5.4.1.1 Definition and applicability

This test case applies to all MSs supporting GPRS.

42.5.4.1.2 Conformance Requirement

On receipt of a PACKET DOWNLINK ASSIGNMENT or PACKET TIMESLOT RECONFIGURE message, and after the TBF starting time, if present, the mobile station shall switch to the assigned PDCHs. Upon switching to the new PDCHs the mobile station shall restart timer T3190.

When the mobile station receives an RLC/MAC block addressed to itself on any of the new assigned resources it shall restart timer T3190. If timer T3190 expires, the mobile station shall perform an abnormal release with return to CCCH or PCCCH (see subclause 8.7.1).

References

GSM 04.60, subclause 8.1.2.4

42.5.4.1.3 Test purpose

Verify that an MS switches to the newly assigned PDCH when no starting time is present, and release the PDCH when T3190 expires.

42.5.4.1.4 Method of test

Initial Conditions

System Simulator:

1 cell, GPRS supported, PCCCH present

Mobile Station:

The MS is in the state "idle, GMM-registered" with a P-TMSI allocated, SPLIT PG CYCLE negotiated, and PDP context 3 activated.

Related PICS/PIXIT Statement(s)

Support GPRS service

Test Procedure

1. MS receives a PACKET DOWNLINK ASSIGNMENT message on its assigned PCCCH, containing no starting time.
2. SS transmits a downlink RLC data block.
3. MS responds by sending a PACKET DOWNLINK ACK/NACK.
4. SS transmits another PACKET DOWNLINK ASSIGNMENT message on PACCH, containing no starting time.
5. (T3190 * 1.2) seconds later, SS transmits a downlink RLC data block on the newly assigned resources.
6. MS ignores the downlink block (because it has already returned to packet idle mode because T3190 expired).

Maximum Duration of Test

5 min.

Expected Sequence

Step	Direction	Message	Comments
1	SS -> MS	PACKET DOWNLINK ASSIGNMENT	Triggers the MS to switch to PDCH0. (no starting time)
2	SS -> MS	RLC DATA BLOCK	6 blocks after the previous message, with valid RRBp field, on assigned PDCH0, addressed to MS.
3	MS -> SS	PACKET DOWNLINK ACK/NACK	MS acknowledges on PACCH the RLC data block sent at the starting time.
4	SS -> MS	RLC DATA BLOCKS	SS continues to transmit RLC data blocks according to allocation from step 1.
5	SS -> MS	PACKET DOWNLINK ASSIGNMENT	Triggers the MS to switch to PDCH1. (no starting time)
6	SS -> MS	RLC DATA BLOCK	(T3190 * 1.2) seconds after the previous message, with valid RRBp field, on PDCH1, addressed to MS.
7	SS		Verify the MS does not transmit on the PACCH of PDCH1.

Specific Message Contents

PACKET DOWNLINK ASSIGNMENT message in step 1:

TIMESLOT_ALLOCATION	<one timeslot assigned – PDCH0>
TBF STARTING TIME	<IE not present>

PACKET DOWNLINK ASSIGNMENT message in step 5:

TIMESLOT_ALLOCATION	<one timeslot assigned – PDCH1>
TBF STARTING TIME	<IE not present>

DOWNLINK RLC DATA BLOCKS (various steps):

RRBP S/P	00 – Response shall be sent by MS in N+13 frames. 1 – RRBp field is valid
-------------	--

42.5.4.2 Downlink Transfer/ T3190 Expiry / Resource reallocation / With TBF starting time

42.5.4.2.1 Definition and applicability

This test case applies to all MSs supporting GPRS.

42.5.4.2.2 Conformance Requirement

On receipt of a PACKET DOWNLINK ASSIGNMENT or PACKET TIMESLOT RECONFIGURE message, and after the TBF starting time, if present, the mobile station shall switch to the assigned PDCHs. Upon switching to the new PDCHs the mobile station shall restart timer T3190.

When the mobile station receives an RLC/MAC block addressed to itself on any of the new assigned resources it shall restart timer T3190. If timer T3190 expires, the mobile station shall perform an abnormal release with return to CCCH or PCCCH (see subclause 8.7.1).

References

GSM 04.60, subclause 8.1.2.4

42.5.4.2.3 Test purpose

Verify that an MS switches to the newly assigned PDCH at the starting time given, and returns to packet idle mode when T3190 expires.

42.5.4.2.4 Method of test

Initial Conditions

System Simulator:

1 cell, GPRS supported, PCCCH present

Mobile Station:

The MS is in the state "idle, GMM-registered" with a P-TMSI allocated, SPLIT PG CYCLE negotiated, and PDP context 3 activated.

Related PICS/PIXIT Statement(s)

Support GPRS service

Test Procedure

1. MS receives a PACKET DOWNLINK ASSIGNMENT message on its assigned PCCCH, containing no starting time.
2. SS transmits a downlink RLC data block.
3. MS responds by sending a PACKET DOWNLINK ACK/NACK.
4. SS transmits another PACKET DOWNLINK ASSIGNMENT message on PACCH, containing a starting time.
5. (T3190 * 1.2) seconds later, SS transmits a downlink RLC data block on the newly assigned resources.
6. MS ignores the downlink block (because it has already returned to packet idle mode because T3190 expired).

Maximum Duration of Test

5 min.

Expected Sequence

Step	Direction	Message	Comments
1	SS -> MS	PACKET DOWNLINK ASSIGNMENT	Triggers the MS to switch to PDCH0. (no starting time)
2	SS -> MS	RLC DATA BLOCK	6 blocks after the previous message, with valid RRBP field, on assigned PDCH0, addressed to MS.
3	MS -> SS	PACKET DOWNLINK ACK/NACK	MS acknowledges on PACCH the RLC data block sent at the starting time.
4	SS -> MS	RLC DATA BLOCKS	SS continues to transmit RLC data blocks according to allocation from step 1.
5	SS -> MS	PACKET DOWNLINK ASSIGNMENT	Triggers the MS to switch to PDCH1 at the given starting time.
6	SS -> MS	RLC DATA BLOCK	(T3190 * 1.2)seconds after the starting time in the previous message, with valid RRBP field, on PDCH1, addressed to MS.
7	SS		Verify the MS does not transmit on the PACCH of PDCH1.

Specific Message Contents

PACKET DOWNLINK ASSIGNMENT message in step 1:

TIMESLOT_ALLOCATION	<one timeslot assigned – PDCH0>
TBF STARTING TIME	<IE not present>

PACKET DOWNLINK ASSIGNMENT message in step 5:

TIMESLOT_ALLOCATION	<one timeslot assigned – PDCH1>
TBF STARTING TIME - Starting Frame Number Description IE	1 - Relative frame number encoding: 0000000101101 – k=45: first frame of block is N+199 or N+200

DOWNLINK RLC DATA BLOCKS (various steps):

RRBP S/P	00 – Response shall be sent by MS in N+13 frames. 1 – RRBP field is valid
-------------	--

42.5.4.3 Downlink Transfer/ T3190 Expiry / Resource reallocation / Restart with valid RLC data block

42.5.4.3.1 Definition and applicability

This test case applies to all MSs supporting GPRS.

42.5.4.3.2 Conformance Requirement

On receipt of a PACKET DOWNLINK ASSIGNMENT or PACKET TIMESLOT RECONFIGURE message, and after the TBF starting time, if present, the mobile station shall switch to the assigned PDCHs. Upon switching to the new PDCHs the mobile station shall restart timer T3190.

When the mobile station receives an RLC/MAC block addressed to itself on any of the new assigned resources it shall restart timer T3190. If timer T3190 expires, the mobile station shall perform an abnormal release with return to CCCH or PCCCH (see subclause 8.7.1).

References

GSM 04.60, subclause 8.1.2.4

42.5.4.3.3 Test purpose

Verify that an MS switches to the newly assigned PDCH at the starting time given, and returns to packet idle mode when T3190 expires.

42.5.4.3.4 Method of test

Initial Conditions

System Simulator:

2 cells, GPRS supported, PCCCH present

Mobile Station:

The MS is in the state "idle, GMM-registered" with a P-TMSI allocated, SPLIT PG CYCLE negotiated, and PDP context 3 activated.

Related PICS/PIXIT Statement(s)

Support GPRS service

Test Procedure

1. MS receives a PACKET DOWNLINK ASSIGNMENT message on its assigned PCCCH, containing no starting time.
2. SS transmits a downlink RLC data block.
3. MS responds by sending a PACKET DOWNLINK ACK/NACK.
4. SS transmits another PACKET DOWNLINK ASSIGNMENT message on PACCH, containing a starting time.
5. (T3190 * 0.8) seconds later, SS transmits a downlink RLC data block on the newly assigned resources.
6. MS responds by sending a PACKET DOWNLINK ACK/NACK.
7. (T3190 * 1.2) seconds later, SS transmits a downlink RLC data block (using the same resources).
8. MS ignores the downlink block (because it has already returned to packet idle mode because T3190 expired).

Maximum Duration of Test

5 min.

Expected Sequence

Step	Direction	Message	Comments
1	SS -> MS	PACKET DOWNLINK ASSIGNMENT	Triggers the MS to switch to PDCH0. (no starting time)
2	SS -> MS	RLC DATA BLOCK	3 blocks after the previous message, with valid RRB field, on assigned PDCH0, addressed to MS.
3	MS -> SS	PACKET DOWNLINK ACK/NACK	MS acknowledges on PACCH the RLC data block.
4	SS -> MS	RLC DATA BLOCKS	SS continues to transmit RLC data blocks according to allocation from step 1.
5	SS -> MS	PACKET DOWNLINK ASSIGNMENT	Triggers the MS to switch to PDCH1 at the given starting time.
6	SS -> MS	RLC DATA BLOCK	(T3190 * 0.8) seconds after the starting time in the previous message, with valid RRB field, on PDCH1, addressed to MS.
7	MS -> SS	PACKET DOWNLINK ACK/NACK	MS acknowledges on PACCH the RLC data block.
8	SS -> MS	RLC DATA BLOCK	(T3190 * 1.2) seconds after the starting time in the previous message, with valid RRB field, on PDCH1, addressed to MS.
9	SS		Verify the MS does not transmit on the PACCH of PDCH1.

Specific Message Contents

PACKET DOWNLINK ASSIGNMENT message in step 1:

TIMESLOT_ALLOCATION	<one timeslot assigned – PDCH0>
TBF STARTING TIME	<IE not present>

PACKET DOWNLINK ASSIGNMENT message in step 5:

TIMESLOT_ALLOCATION	<one timeslot assigned – PDCH1>
TBF STARTING TIME - Starting Frame Number Description IE	1 – Relative frame number encoding: 0000000101101 – k=45: first frame of block is N+199 or N+200

DOWNLINK RLC DATA BLOCKS (various steps):

RRBP S/P	00 – Response shall be sent by MS in N+13 frames. 1 – RRB field is valid
-------------	---

42.5.5 Downlink Transfer / Reestablishment

42.5.5.1 Downlink Transfer/ Reestablishment/ T3192 Expiry

42.5.5.1.1 Definition and applicability

This test case applies to all MSs supporting GPRS.

42.5.5.1.2 Conformance Requirement

After the network has initiated the release of a downlink TBF and the mobile station has received all the RLC blocks, the mobile station shall send the PACKET DOWNLINK ACK/NACK message with the Final Ack Indicator bit set to '1', start timer T3192 and continue to monitor all assigned PDCHs.

If the network receives a PACKET DOWNLINK ACK/NACK message with the Final Ack Indicator bit set to '1' and has new data to transmit for the mobile station, the network may establish a new downlink TBF for the mobile station by sending the PACKET DOWNLINK ASSIGNMENT or PACKET TIMESLOT RECONFIGURE message with the Control Ack bit set to '1' on PACCH.

If the mobile station, after sending the PACKET DOWNLINK ACK/NACK message with the Final Ack Indicator bit set to '1', receives a PACKET DOWNLINK ASSIGNMENT or PACKET TIMESLOT RECONFIGURE message with the Control Ack bit set to '1' while timer T3192 is running, the mobile station shall stop timer T3192, consider the previous downlink TBF released and act upon the new assignment.

When timer T3192 expires the mobile station shall stop monitoring its assigned downlink PDCHs. If the mobile station is operating in half duplex mode and received an uplink assignment during the TBF release procedure, the mobile station shall then immediately act upon the assignment. Otherwise, if there is no ongoing uplink TBF the mobile station shall enter packet idle mode. Upon entering packet idle mode, the mobile shall apply DRX mode procedures as specified in subclause 5.5.1.4.

References

GSM 04.60, subclause 8.1.2.4, 9.3.3.5

42.5.5.1.3 Test purpose

Verify that after a downlink TBF is released, MS returns to packet idle mode when T3192 expires.

42.5.5.1.4 Method of test

Initial Conditions

System Simulator:

1 cell, GPRS supported, PCCCH present

Mobile Station:

The MS is in the state "idle, GMM-registered" with a P-TMSI allocated, SPLIT PG CYCLE negotiated, and PDP context 3 activated.

Related PICS/PIXIT Statement(s)

Support GPRS service

Test Procedure

1. MS receives a PACKET DOWNLINK ASSIGNMENT message on its assigned PCCCH, containing no starting time.
2. SS transmits downlink RLC data blocks for the downlink allocation.
3. SS transmits a downlink RLC data block, with valid RRBP field (polling), with Final Block indicator set to 1.
4. MS responds by sending a PACKET DOWNLINK ACK/NACK with Final Ack indicator set to 1 and starting T3192.
5. When T3192 expires, MS returns to packet idle mode.
6. SS transmits a downlink RLC data block (using previous resources).
7. MS ignores this block, because it has returned to packet idle mode.
8. SS transmits a PACKET DOWNLINK ASSIGNMENT, followed by RLC data blocks for the downlink allocation.
9. MS responds with a PACKET DOWNLINK ACK/NACK.

Maximum Duration of Test

5 min.

Expected Sequence

Step	Direction	Message	Comments
1	SS -> MS	PACKET DOWNLINK ASSIGNMENT	Triggers the MS to switch to assigned PDCH. (no starting time)
2	SS -> MS	RLC DATA BLOCKS	Starting 3 blocks after the previous message, on assigned PDCH, addressed to MS.
3	SS -> MS	RLC DATA BLOCK	With valid RRBP field, addressed to MS, with Final Block indication set to 1.
4	MS -> SS	PACKET DOWNLINK ACK/NACK	MS acknowledges the previously received RLC data blocks, with final ack set to 1.
5	SS		MS starts T3192 Wait T3192 * 0.7 seconds
6			Repeat steps 3 and 4.
7	SS		Wait T3192 * 1.2 seconds.
8	SS -> MS	RLC DATA BLOCK	On previously assigned PDCH. With valid RRBP field, addressed to MS.
9	SS		Verify no response from MS on previously assigned PDCH.
10	SS -> MS	PACKET DOWNLINK ASSIGNMENT	Triggers the MS to switch to assigned PDCH (no starting time)
11	SS -> MS	RLC DATA BLOCK	With valid RRBP field, addressed to MS, on new resources assigned in step 10.
12	MS -> SS	PACKET DOWNLINK ACK/NACK	MS acknowledges the previously received RLC data block.

Specific Message Contents

PACKET DOWNLINK ASSIGNMENT message in step 1:

TIMESLOT_ALLOCATION	<one timeslot assigned>
TBF STARTING TIME	<IE not present>

PACKET DOWNLINK ASSIGNMENT message in step 8:

TIMESLOT_ALLOCATION	<one timeslot assigned – different than previous>
TBF STARTING TIME	<IE not present>

GPRS Cell Options IE (throughout, on sys-infos):

T3192	101 – (5+1)*500ms = 3 second timeout value
-------	--

DOWNLINK RLC DATA BLOCK in step 3:

RRBP	00 – Response shall be sent by MS in N+13 frames.
S/P	1 – RRBP field is valid
FBI	1

PACKET DOWNLINK ACK/NACK in step 4:

Ack/Nack Description IE - FINAL_ACK_INDICATION	1
---	---

42.5.5.2 Downlink Transfer/ Reestablishment/ Packet Downlink Assignment

42.5.5.2.1 Definition and applicability

This test case applies to all MSs supporting GPRS.

42.5.5.2.2 Conformance Requirement

After the network has initiated the release of a downlink TBF and the mobile station has received all the RLC blocks, the mobile station shall send the PACKET DOWNLINK ACK/NACK message with the Final Ack Indicator bit set to '1', start timer T3192 and continue to monitor all assigned PDCHs.

If the network receives a PACKET DOWNLINK ACK/NACK message with the Final Ack Indicator bit set to '1' and has new data to transmit for the mobile station, the network may establish a new downlink TBF for the mobile station by sending the PACKET DOWNLINK ASSIGNMENT or PACKET TIMESLOT RECONFIGURE message with the Control Ack bit set to '1' on PACCH.

If the mobile station, after sending the PACKET DOWNLINK ACK/NACK message with the Final Ack Indicator bit set to '1', receives a PACKET DOWNLINK ASSIGNMENT or PACKET TIMESLOT RECONFIGURE message with the Control Ack bit set to '1' while timer T3192 is running, the mobile station shall stop timer T3192, consider the previous downlink TBF released and act upon the new assignment.

References

GSM 04.60, subclause 8.1.2.4

42.5.5.2.3 Test purpose

Verify that after a downlink TBF is released, MS acts on a PACKET DOWNLINK ASSIGNMENT message.

42.5.5.2.4 Method of test

Initial Conditions

System Simulator:

2 cells, GPRS supported, PCCCH present

Mobile Station:

The MS is in the state "idle, GMM-registered" with a P-TMSI allocated, SPLIT PG CYCLE negotiated, and PDP context 3 activated.

Related PICS/PIXIT Statement(s)

Support GPRS service

Test Procedure

1. MS receives a PACKET DOWNLINK ASSIGNMENT message on its assigned PCCCH, containing no starting time.
2. SS transmits downlink RLC data blocks for the downlink allocation.
3. SS transmits a downlink RLC data block, with valid RRBP field (polling), with Final Block indicator set to 1.
4. MS responds by sending a PACKET DOWNLINK ACK/NACK with Final Ack indicator set to 1.
5. SS transmits a PACKET DOWNLINK ASSIGNMENT, assigning a new PDCH.
6. SS transmits a downlink RLC data block on newly assigned PDCH, with valid RRBP field.
7. MS responds by sending a PACKET DOWNLINK ACK/NACK.

Maximum Duration of Test

5 min.

Expected Sequence

Step	Direction	Message	Comments
1	SS -> MS	PACKET DOWNLINK ASSIGNMENT	Triggers the MS to switch to assigned PDCH. (no starting time)
2	SS -> MS	RLC DATA BLOCKS	Starting 3 blocks after the previous message, on assigned PDCH, addressed to MS.
3	SS -> MS	RLC DATA BLOCK	With valid RRBP field, addressed to MS, with Final Block indication set to 1.
4	MS -> SS	PACKET DOWNLINK ACK/NACK	MS acknowledges the previously received RLC data blocks, with final ack set to 1.
5	SS		Wait (T3192 * 0.8) seconds
6	SS -> MS	PACKET DOWNLINK ASSIGNMENT	Sent on PACCH. Triggers the MS to switch to a new PDCH. (no starting time)
7	SS -> MS	RLC DATA BLOCK	6 blocks after step 6, on PDCH assigned in step 6. With valid RRBP field, addressed to MS.
8	MS -> SS	PACKET DOWNLINK ACK/NACK	MS acknowledges the previously received RLC data blocks.

Specific Message Contents

PACKET DOWNLINK ASSIGNMENT message in step 1:

TIMESLOT_ALLOCATION	<one timeslot assigned>
TBF STARTING TIME	<IE not present>

PACKET DOWNLINK ASSIGNMENT message in step 6:

TIMESLOT_ALLOCATION	<one timeslot assigned – different than previous assignment>
TBF STARTING TIME	<IE not present>

GPRS Cell Options IE (throughout, on sys-infos):

T3192	$101 - (5+1) * 500\text{ms} = 3 \text{ second timeout value}$
-------	---

DOWNLINK RLC DATA BLOCK in step 3:

RRBP	00 – Response shall be sent by MS in N+13 frames.
S/P	1 – RRBP field is valid
FBI	1

PACKET DOWNLINK ACK/NACK in step 4:

Ack/Nack Description IE - FINAL_ACK_INDICATION	1
--	---

42.5.5.3 Downlink Transfer/ Reestablishment/ Invalid Frequency Parameters IE

42.5.5.3.1 Definition and applicability

This test case applies to all MSs supporting GPRS.

42.5.5.3.2 Conformance Requirement

After the network has initiated the release of a downlink TBF and the mobile station has received all the RLC blocks, the mobile station shall send the PACKET DOWNLINK ACK/NACK message with the Final Ack Indicator bit set to '1', start timer T3192 and continue to monitor all assigned PDCHs.

If the network receives a PACKET DOWNLINK ACK/NACK message with the Final Ack Indicator bit set to '1' and has new data to transmit for the mobile station, the network may establish a new downlink TBF for the mobile station by sending the PACKET DOWNLINK ASSIGNMENT or PACKET TIMESLOT RECONFIGURE message with the Control Ack bit set to '1' on PACCH.

If the mobile station, after sending the PACKET DOWNLINK ACK/NACK message with the Final Ack Indicator bit set to '1', receives a PACKET DOWNLINK ASSIGNMENT or PACKET TIMESLOT RECONFIGURE message with the Control Ack bit set to '1' while timer T3192 is running, the mobile station shall stop timer T3192, consider the previous downlink TBF released and act upon the new assignment.

- If a mobile station receives a PACKET DOWNLINK ASSIGNMENT or PACKET TIMESLOT RECONFIGURE message and detects an invalid Frequency Parameters information element in the message, it shall perform an abnormal release. If PCCCH is present in the cell the mobile station shall perform an abnormal

release with system information (see subclause 8.7.3). If PCCCH is not present, the mobile station shall perform an abnormal release with random access (see subclause 8.7.2).

References

GSM 04.60, subclause 8.1.2.4, 8.1.2.4.1

42.5.5.3.3 Test purpose

Verify that after a downlink TBF is released, MS returns to packet idle mode if a PACKET DOWNLINK ASSIGNMENT with invalid frequency parameters IE is received.

42.5.5.3.4 Method of test

Initial Conditions

System Simulator:

2 cells, GPRS supported, PCCCH present

Mobile Station:

The MS is in the state "idle, GMM-registered" with a P-TMSI allocated, SPLIT PG CYCLE negotiated, and PDP context 3 activated.

Related PICS/PIXIT Statement(s)

Support GPRS service

Test Procedure

1. MS receives a PACKET DOWNLINK ASSIGNMENT message on its assigned PCCCH, containing no starting time.
2. SS transmits downlink RLC data blocks for the downlink allocation.
3. SS transmits a downlink RLC data block, with valid RRBp field (polling), with Final Ack indicator set to 1.
4. MS responds by sending a PACKET DOWNLINK ACK/NACK.
5. SS transmits a PACKET DOWNLINK ASSIGNMENT, assigning a new PDCH, but with invalid frequency parameters.
6. SS transmits a downlink RLC data block on previously assigned PDCH, with valid RRBp field.
7. MS ignores the block because it has returned to packet idle mode.

Maximum Duration of Test

5 min.

Expected Sequence

Step	Direction	Message	Comments
1	SS -> MS	PACKET DOWNLINK ASSIGNMENT	Triggers the MS to switch to assigned PDCH. (no starting time)
2	SS -> MS	RLC DATA BLOCKS	Starting 3 blocks after the previous message, on assigned PDCH, addressed to MS.
3	SS -> MS	RLC DATA BLOCK	With valid RRBP field, addressed to MS, with Final Block indication set to 1.
4	MS -> SS	PACKET DOWNLINK ACK/NACK	MS acknowledges the previously received RLC data blocks.
5	SS		Wait 2 seconds
6	SS -> MS	PACKET DOWNLINK ASSIGNMENT	Sent on PACCH. Triggers the MS to switch to a new PDCH. (no starting time)
7	SS -> MS	RLC DATA BLOCK	Invalid frequency in message. On PDCH assigned in step 1. With valid RRBP field, addressed to MS.
7a	SS		Change the PSI2_CHANGE_MARK and the Reference Frequency List in PSI2.
8	SS		Verify MS does not transmit on previously assigned PDCH.
9	SS -> MS	PACKET DOWNLINK ASSIGNMENT	Sent 10 seconds after step 7. These steps verify the MS has re-read the sys-infos, and is using the new PSI2 parameters.
10	SS -> MS	RLC DATA BLOCK	With valid RRBP field, addressed to MS.
11	MS -> SS	PACKET DOWNLINK ACK/NACK	MS acknowledges the previously received RLC data block.

Specific Message Contents

PACKET DOWNLINK ASSIGNMENT message in step 1 and step 9:

TIMESLOT_ALLOCATION	<one timeslot assigned>
TBF STARTING TIME	<IE not present>

PACKET DOWNLINK ASSIGNMENT message in step 6:

TIMESLOT_ALLOCATION	<one timeslot assigned – different than previous assignment>
TBF STARTING TIME	<IE not present>
Frequency Parameters IE - ARFCN	00 – ARFCN 300 (invalid)

GPRS Cell Options IE (throughout, on sys-infos):

T3192	101 – (5+1)*500ms = 3 second timeout value
-------	--

DOWNLINK RLC DATA BLOCK in step 3:

RRBP	00 – Response shall be sent by MS in N+13 frames.
S/P	1 – RRBP field is valid
FBI	1

PACKET DOWNLINK ACK/NACK in step 4:

Ack/Nack Description IE - FINAL_ACK_INDICATION	1
---	---

43 RLC Test Cases

Applicability

All test cases in this section are applicable for the MS supporting GPRS service with RLC/MAC in acknowledged mode.

Default conditions and messages

The default conditions, message contents and macros not specified in this section must be set as in section 40.

Initial conditions

Unless otherwise indicated, the initial conditions for all acknowledged mode tests, as a minimum, are as follows. Other initial conditions may apply. In the event of conflict between initial conditions stated here and those stated in a test case, the test case shall take precedence.

- The MS is GPRS attached.
- A PDP context has been established with RLC acknowledged mode operation.

43.1 Acknowledged Mode

43.1.1 Acknowledged mode / Uplink TBF

43.1.1.1 Acknowledged mode / Uplink TBF / Send state variable V(S)

43.1.1.1.1 Conformance requirements

1. The send state variable, V(S), can take on the values 0 through 127. Each RLC data block contains a block sequence number (BSN) field that is 7 bits in length. At the time that an in-sequence RLC data block is designated for transmission, the value of BSN is set equal to the value of the send state variable.
2. V(S) shall be set to the value 0 at the beginning of each TBF in which the RLC endpoint is the transmitter.
3. The value of V(S) shall be incremented by 1 after transmission of the RLC data block with BSN = V(S).

References

GSM 04.60, section 9.1.1.

43.1.1.1.2 Test purpose

1. To verify that the mobile station sets the V(S) to 0 at the beginning of each TBF.

2. To verify that the mobile station increases the V(S) by 1 after transmission of the RLC data block with BSN set to V(S).
3. To verify that the mobile station wraps the V(S) to 0 after 127.

43.1.1.1.3 Method of test

Initial Conditions

System Simulator:

1 cell, default setting, PBCCH not present

Mobile Station:

The MS is GPRS updated with a P-TMSI allocated, SPLIT PG CYCLE negotiated and the test PDP context2 activated.

Related PICS/PIXIT Statement(s)

The way to initiate an acknowledged uplink transfer.

Test Procedure

The MS is made to send RLC data blocks. SS checks that the BSN in the RLC data block:

1. is set to the value 0 at the beginning of each TBF in which the mobile station is the transmitter;
2. is incremented by 1 in each subsequent RLC data block in the TBF; and
3. takes on all values in the range 0 to 127 and then back to 0.

Maximum Duration of Test

5 min.

Expected Sequence

Step	Direction	Message	Comments
1		{ Uplink dynamic allocation two phase access}	n = 3500 octets, USF_GRANULARITY = 1 block CHANNEL_CODING_COMMAND: cs1
2	SS -> MS	PACKET DOWNLINK DUMMY CONTROL BLOCK	Sent on the PACCH of the PDCH assigned, containing USF assigned to the MS.
3	MS -> SS	UPLINK RLC DATA BLOCK	Received on the assigned PDTCH SS verifies that the BSN starts from 0.
4	SS -> MS	PACKET UPLINK ACK/NACK	SS acknowledges each RLC data block, RBB set to 1, containing USF assigned to the MS
5	MS -> SS	UPLINK RLC DATA BLOCK	Received on the assigned PDTCH SS verifies that the BSN is updated according to $BSN(n) = (BSN(n-1) + 1) \text{ mod } 128$
6	-	Steps 4 & 5 are repeated atleast 128 times	
7		{ Completion of uplink RLC data block transfer}	

43.1.1.2 Acknowledged mode / Uplink TBF / Transmit window size

43.1.1.2.1 Conformance requirements

1. $V(S)$ shall not exceed $V(A)$ modulo 128 by more than the maximum allowed number of outstanding RLC data blocks k (window size k is defined in GSM 04.60 section 9.1.9).
2. If $V(S) = V(A) + k$ modulo 128 (i.e., the transmit window is stalled), the mobile station shall set the stall indicator to 1 in each RLC data block transmitted and transmit the oldest RLC data block whose corresponding element in $V(B)$ has the value PENDING_ACK, then the next oldest RLC data block whose corresponding element in $V(B)$ has the value PENDING_ACK, etc.

References

GSM 04.60, sections 9.1.1, 9.1.3 and 9.1.9.

43.1.1.2.2 Test purpose

1. To verify that the mobile station sets the stall indicator to 1 in each RLC data block transmitted once the transmit window is stalled.
2. To verify that the mobile station retransmits data blocks that are pending acknowledgment.
3. To verify that the mobile station retransmits unacknowledged RLC data blocks in correct order while the transmit window is stalled.

43.1.1.2.3 Method of test

Initial Conditions

System Simulator:

1 cell, default setting, PBCCH not present

Mobile Station:

The MS is GPRS updated with a P-TMSI allocated, SPLIT PG CYCLE negotiated and the test PDP Context2 activated.

Related PICS/PIXIT Statement(s)

The way to initiate an acknowledged uplink transfer.

Test Procedure

The MS transmits k (window size) blocks without acknowledgement from SS. Confirm that the MS:

- a) sets the stall indicator bit once the window is stalled; and
- b) retransmits blocks that are pending acknowledgement, oldest first.

Maximum Duration of Test

5 min.

Expected Sequence

Step	Direction	Message	Comments
1		{ Uplink dynamic allocation two phase access}	n = 1500 octets USF_GRANULARITY = 1 block CHANNEL_CODING_COMMAND: cs1
2	SS -> MS	PACKET DOWNLINK DUMMY CONTROL BLOCK	Sent on the PACCH of the PDCH, containing USF assigned to the MS.
3	MS -> SS	UPLINK RLC DATA BLOCK	Received on the assigned PDTCH SI=0
4			Repeat steps 2 and 3 for BSN=1 to 63. SS doesn't acknowledge any of the data blocks with BSN from 0 to 63
5	SS -> MS	PACKET DOWNLINK DUMMY CONTROL BLOCK	Sent on the PACCH of the PDCH assigned, USF assigned to the MS.
6	MS -> SS	UPLINK RLC DATA BLOCK	Received on the assigned PDTCH SI=1
7			Repeat steps 5 & 6 until all unacknowledged blocks are retransmitted. SS verifies that the unacknowledged data blocks are retransmitted with SI field set to 1. SS verifies that in the retransmitted blocks the BSN is from 0 to 63
8	SS->MS	Packet Uplink Ack/Nack	SS acknowledges all the data blocks USF not assigned to the MS
9			Wait for 6 blocks with no assigned USF
10	SS -> MS	PACKET DOWNLINK DUMMY CONTROL BLOCK	Sent on the PACCH of the PDCH assigned, USF assigned to the MS.
11	MS -> SS	UPLINK RLC DATA BLOCK	Received on the assigned PDTCH
12	SS		Verify that MS is not retransmitting any acknowledged blocks Verify transmitted data blocks are BSNs 64 and higher
13		{ Completion of uplink RLC data block transfer}	

43.1.1.3 Acknowledged mode / Uplink TBF / Acknowledge state variable V(A)

43.1.1.3.1 Conformance requirements

1. The Acknowledge state variable V(A) contains the BSN value of the oldest RLC data block that has not been positively acknowledged by its peer. V(A) can take on the values 0 through 127.
2. V(A) shall be set to the value 0 at the beginning of each TBF in which the RLC endpoint is the transmitter.
3. The value of V(A) shall be updated from the values received from its peer in the received block bitmap (RBB) of the Packet Ack/Nack message (see subclause 9.1.8).

References

GSM 04.60, sections 9.1.2 and 9.1.8.

43.1.1.3.2 Test purpose

1. To verify that the mobile station correctly decodes the RBB and updates the values of V(A).

43.1.1.3.3 Method of test

Initial Conditions

System Simulator:

1 cell, default setting, PBCCH not present

Mobile Station:

The MS is GPRS updated with a P-TMSI allocated, SPLIT PG CYCLE negotiated and the test PDP Context2 activated.

Related PICS/PIXIT Statement(s)

The way to initiate an acknowledged uplink transfer.

Test Procedure

1. The mobile station transmits k (window size) blocks without acknowledgment from SS. SS then acknowledges the first n blocks. The mobile station then shall transmit n more data blocks.
2. The test is performed for the values of N = 10,15 and 20.

Maximum Duration of Test

5 min.

Expected Sequence

Step	Direction	Message	Comments
1		{ Uplink dynamic allocation two phase access}	n = 3000 octets USF_GRANULARITY = 1 block CHANNEL_CODING_COMMAND: cs1
2	SS -> MS	PACKET DOWNLINK DUMMY CONTROL BLOCK	Sent on the PACCH of the PDCH, containing USF assigned to the MS.
3	MS -> SS	UPLINK RLC DATA BLOCK	Received on the assigned PDTCH SI=0
4			Repeat steps 2 and 3 for BSN=1 to 63. SS doesn't acknowledge any of the data blocks with BSN from 0 to 63
5	SS -> MS	PACKET DOWNLINK DUMMY CONTROL BLOCK	Sent on the PACCH of the PDCH assigned, USF assigned to the MS.
6	MS -> SS	UPLINK RLC DATA BLOCK	Received on the assigned PDTCH SI=1
7			Repeat steps 5 and 6 until unacknowledged data blocks (BSN = 0 to 30) are retransmitted with SI field set to 1
8			Wait BS_CV_MAX periods without granting USF.
9	SS -> MS	PACKET UPLINK ACK/NACK	SS acknowledges first N (=10) RLC data blocks, RBB set to 1 and negatively acknowledges the rest with RBB set to 0 USF not assigned to the MS
10			Wait for 6 blocks with no USF
11	SS -> MS	PACKET DOWNLINK DUMMY CONTROL BLOCK	Sent on the PACCH of the PDCH assigned, USF assigned to the MS.
12	MS -> SS	UPLINK RLC DATA BLOCK	Received on the assigned PDTCH BSN = N & SI = 0
13	SS -> MS	PACKET DOWNLINK DUMMY CONTROL BLOCK	Sent on the PACCH of the PDCH assigned, USF assigned to the MS.
14	MS -> SS	UPLINK RLC DATA BLOCK	Received on the assigned PDTCH BSN = N + 1 & SI = 0
15	SS		Repeat steps 13 and 14 until all negatively acknowledged data blocks are retransmitted followed by new data blocks SS verifies that the negatively acknowledged data blocks are retransmitted before new data blocks are sent, by verifying that RLC data blocks with BSN from N to 63 are received first, then RLC data blocks with BSN from 64 to 63+N are received.
16		{ Completion of uplink RLC data block transfer}	
17	-	-	The procedure is repeated for different values of N

43.1.1.4 Acknowledged mode / Uplink TBF / Negatively acknowledged RLC data blocks

43.1.1.4.1 Conformance requirements

1. The transmitter shall transmit the oldest RLC data block whose corresponding element in V(B) indexed relative to V(A) has the value NACKED.
2. If $[V(S) < V(A) + k]$ modulo 128 and no RLC data blocks have a corresponding element in V(B) with the value NACKED, the RLC data block with BSN = V(S) shall be transmitted.
3. As each RLC data block is transmitted the corresponding element in V(B) shall be set to the value PENDING_ACK.

References

GSM 04.60, section 9.1.3.

43.1.1.4.2 Test purpose

1. To verify that the mobile station retransmits Naked data blocks before transmission of new information.
2. To verify that the mobile station retransmits Naked blocks in order of age, older first.
3. To verify that the mobile station only retransmit Naked blocks once per negative acknowledgment.

43.1.1.4.3 Method of test

Initial Conditions

System Simulator:

1 cell, default setting, , PBCCH not present, BS_CV_MAX = 0

Mobile Station:

The MS is GPRS updated with a P-TMSI allocated, SPLIT PG CYCLE negotiated and the test PDP Context2 activated.

Related PICS/PIXIT Statement(s)

The way to initiate an acknowledged uplink transfer.

Test Procedure

The MS is made to transmit RLC data blocks. The SS randomly negatively acknowledges RLC data blocks. The MS retransmits the negatively acknowledged RLC data blocks, oldest first before transmitting new RLC data blocks.

The SS does not send further acknowledgements. The MS does not retransmit the previously negatively acknowledged RLC data blocks.

Maximum Duration of Test

5 min.

Expected Sequence

Step	Direction	Message	Comments
1		{ Uplink dynamic allocation two phase access}	n = 1500 octets USF_GRANULARITY = 1 block CHANNEL_CODING_COMMAND: cs1
2	SS -> MS	PACKET DOWNLINK DUMMY CONTROL BLOCK	Sent on the PACCH of the PDCH assigned, USF assigned to the MS.
3	MS -> SS	UPLINK RLC DATA BLOCK	Received on the assigned PDTCH
4			Repeat steps 2 and 3 until received data block BSN = 30
5	SS -> MS	PACKET UPLINK ACK/NACK	SS acknowledges RLC data blocks with BSN 10 to 30, RBB set to 1 and negatively acknowledges the rest with RBB set to 0 USF not assigned to the MS
6			Wait for 6 blocks with no USF
7	SS -> MS	PACKET DOWNLINK DUMMY CONTROL BLOCK	Sent on the PACCH of the PDCH assigned, USF assigned to the MS.
8	MS -> SS	UPLINK RLC DATA BLOCK	Received on the assigned PDTCH BSN = 0..9
9	SS		Repeat steps 7 & 8 ten times SS verifies that the Naked data blocks are received before new data block once per negative acknowledgment. After these data blocks new data block BSN=31 should be received
10	SS -> MS	PACKET UPLINK ACK/NACK	SS acknowledges retransmitted (BSN 0..9) RLC data blocks, RBB set to 1
11	SS -> MS	PACKET DOWNLINK DUMMY CONTROL BLOCK	Sent on the PACCH of the PDCH, containing USF assigned to the MS.
12	MS -> SS	UPLINK RLC DATA BLOCK	Received on the assigned PDTCH
13	SS		Repeat steps 11 and 12 until the stall indication bit is set in the data block received in step 12. SS verifies that acknowledged blocks are not retransmitted
14	SS -> MS	PACKET UPLINK ACK/NACK	SS negatively acknowledges RLC data blocks with BSN 55 to 60, RBB set to 0 and acknowledges the rest with RBB set to 1 USF not assigned to the MS
15			Wait for 6 blocks with no USF.
16	SS -> MS	PACKET DOWNLINK DUMMY CONTROL BLOCK	Sent on the PACCH of the PDCH assigned, USF assigned to the MS.
17	MS -> SS	UPLINK RLC DATA BLOCK	Received on the assigned PDTCH BSN = 55..60
18	SS		Repeat steps 16 & 17 until all Naked blocks are received SS verifies that the Naked data blocks are received before new data blocks once per negative acknowledgment.
19		{Completion of uplink RLC data block transfer}	

43.1.1.5 Acknowledged mode / Uplink TBF / Invalid Negative Acknowledgment

43.1.1.5.1 Conformance requirements

1. If the mobile station is the transmitter, it shall set an instance of timer T3198 for each RLC data block sent (section 9.1.3 GSM 04.60).
2. The timer T3198 shall have the expiry value set to BS_CV_MAX block periods (section 9.1.3 GSM 04.60).

3. The mobile station shall not modify the element in the acknowledge state array, $V(B)$, corresponding to an RLC data block that cannot be validly negatively acknowledged (section 9.1.8 GSM 04.60).

References

GSM 04.60, sections 9.1.3 and 9.1.8.

43.1.1.5.2 Test purpose

1. To verify the operation of the timer T3198.
2. To verify the correct response of the mobile station to an invalid negative acknowledgement.

43.1.1.5.3 Method of test

Initial Conditions

System Simulator:

1 cell, default setting, , PBCCH not present, BS_CV_MAX = 15.

Mobile Station:

The MS is GPRS updated with a P-TMSI allocated, SPLIT PG CYCLE negotiated and the test PDP Context2 activated.

Related PICS/PIXIT Statement(s)

The way to initiate an acknowledged uplink transfer.

Test Procedure

The MS is made to send RLC data blocks. The SS negatively acknowledges some RLC data blocks within BS_CV_MAX block periods. The MS shall not retransmit the RLC data blocks that were negatively acknowledged.

Maximum Duration of Test

5 min.

Expected Sequence

Step	Direction	Message	Comments
1		{ Uplink dynamic allocation two phase access}	n = 440 octets USF GRANULARITY = 1 block CHANNEL_CODING_COMMAND: cs1
2	SS -> MS	PACKET DOWNLINK DUMMY CONTROL BLOCK	Sent on the PACCH of the PDCH assigned, USF assigned to the MS.
3	MS -> SS	UPLINK RLC DATA BLOCK	Received on the assigned PDTCH BSN = 0
4	SS -> MS	PACKET DOWNLINK DUMMY CONTROL BLOCK	Sent on the PACCH of the PDCH assigned, USF assigned to the MS.
5	MS -> SS	UPLINK RLC DATA BLOCK	Received on the assigned PDTCH BSN = 1
6	SS -> MS	PACKET DOWNLINK DUMMY CONTROL BLOCK	Sent on the PACCH of the PDCH assigned, USF assigned to the MS.
7	MS -> SS	UPLINK RLC DATA BLOCK	Received on the assigned PDTCH BSN = 2
8	SS -> MS	PACKET DOWNLINK DUMMY CONTROL BLOCK	Sent on the PACCH of the PDCH assigned, USF assigned to the MS.
9	MS -> SS	UPLINK RLC DATA BLOCK	Received on the assigned PDTCH BSN = 3
			Wait for BS_CV_MAX block period of Block BSN = 0 to expire
10	SS -> MS	PACKET UPLINK ACK/NACK	SS negatively acknowledges blocks BSN = 0 and BSN = 3, RBB = 0 and acknowledges blocks BSN = 1 and BSN = 2, RBB = 1 USF not assigned to the MS
11			Wait for 6 blocks with no USF.
12	SS -> MS	PACKET DOWNLINK DUMMY CONTROL BLOCK	Sent on the PACCH of the PDCH assigned, USF assigned to the MS.
13	MS -> SS	UPLINK RLC DATA BLOCK	Received on the assigned PDTCH SS verifies that data block BSN = 0 is retransmitted
14	SS -> MS	PACKET DOWNLINK DUMMY CONTROL BLOCK	Sent on the PACCH of the PDCH assigned, USF assigned to the MS.
15	MS -> SS	UPLINK RLC DATA BLOCK	Received on the assigned PDTCH SS verifies that data block BSN = 3 is not retransmitted New data block received with BSN = 4
16		{ Completion of uplink RLC data block transfer}	

43.1.1.6 Acknowledged mode / Uplink TBF / Decoding of Received Block Bitmap

43.1.1.6.1 Conformance requirements

For each bit in the RBB whose corresponding BSN value is within the transmit window, if the bit contains the value '1', the corresponding element in V(B) indexed relative to SSN shall be set to the value ACKED. If the bit contains the value '0', the element in V(B) shall be set to the value NACKED. A bit within the RBB whose corresponding BSN is not within the transmit window, shall be ignored.

References

GSM 04.60, section 9.1.8.

43.1.1.6.2 Test purpose

1. To verify the decoding of the received block bitmap of the Packet Uplink Ack/Nack message.

43.1.1.6.3 Method of test

Initial Conditions

System Simulator:

1 cell, default setting, PBCCH not present

Mobile Station:

The MS is GPRS updated with a P-TMSI allocated, SPLIT PG CYCLE negotiated and the test PDP Context2 activated.

Related PICS/PIXIT Statement(s)

The way to initiate an acknowledged uplink transfer.

Test Procedure

The MS is made to send RLC data blocks. The SS negatively acknowledges one or more RLC data blocks after BS_CV_MAX block periods. The MS retransmits these blocks.

The SS negatively acknowledges data blocks outside the transmit window. The MS ignores these negative acknowledgments.

Maximum Duration of Test

5 min.

Expected Sequence

Step	Direction	Message	Comments
1		{ Uplink dynamic allocation two phase access}	n = 4000 octets USF_GRANULARITY = 1 block CHANNEL_CODING_COMMAND: cs1
2	SS -> MS	PACKET DOWNLINK DUMMY CONTROL BLOCK	Sent on the PACCH of the PDCH assigned, USF assigned to the MS.
3	MS -> SS	UPLINK RLC DATA BLOCK	Received on the assigned PDTCH
4			Repeat steps 2 and 3 until received data block BSN = 19 SS doesn't acknowledge any of the data blocks with BSN from 0 to 19
5			Wait BS_CV_MAX periods without granting USF.
6	SS -> MS	PACKET UPLINK ACK/NACK	SS negatively acknowledges RLC data block with BSN 0, RBB set to 0 and acknowledges data blocks with BSN from 1 to 19, RBB set to 1 USF not assigned to the MS
7			Wait for 6 blocks with no USF.
8	SS -> MS	PACKET DOWNLINK DUMMY CONTROL BLOCK	Sent on the PACCH of the PDCH assigned, USF assigned to the MS.
9	MS -> SS	UPLINK RLC DATA BLOCK	Received on the assigned PDTCH SS verifies that the Naked data block (BSN = 0) is received before new data blocks
10	SS -> MS	PACKET DOWNLINK DUMMY CONTROL BLOCK	Sent on the PACCH of the PDCH, containing USF assigned to the MS.
11	MS -> SS	UPLINK RLC DATA BLOCK	Received on the assigned PDTCH
12			Repeat steps 10 and 11 until BSN=63 SS doesn't acknowledge any of the data blocks until BSN = 63
13	SS -> MS	PACKET UPLINK ACK/NACK	SS acknowledges all RLC data blocks with RBB set to 1
14			Wait for 6 blocks with no USF.
15	SS -> MS	PACKET DOWNLINK DUMMY CONTROL BLOCK	Sent on the PACCH of the PDCH assigned, USF assigned to the MS.
16	MS -> SS	UPLINK RLC DATA BLOCK	Received on the assigned PDTCH SS receives new data block with BSN = 64
17	SS -> MS	PACKET DOWNLINK DUMMY CONTROL BLOCK	Sent on the PACCH of the PDCH, containing USF assigned to the MS.
18	MS -> SS	UPLINK RLC DATA BLOCK	Received on the assigned PDTCH
19			Repeat steps 17 and 18 until BSN=80 SS doesn't acknowledge any of the data blocks
20			Wait BS_CV_MAX periods without granting USF.
21	SS -> MS	PACKET UPLINK ACK/NACK	SS negatively acknowledges RLC data block with bit corresponding to BSN 50 in RBB set to 0 and all other bits set to 1 USF not assigned to the MS
22			Wait for 6 blocks with no USF.
23	SS -> MS	PACKET DOWNLINK DUMMY CONTROL BLOCK	Sent on the PACCH of the PDCH, containing USF assigned to the MS.
24	MS -> SS	UPLINK RLC DATA BLOCK	Received on the assigned PDTCH
25	SS		Repeat steps 23 and 24 until BSN=127 SS verifies that the MS ignored negative acknowledgment outside the window and sends new data blocks BSN=81 to 127
26		{ Completion of uplink RLC data block transfer}	

43.1.2 Acknowledged mode / Downlink TBF

43.1.2.1 Acknowledged mode / Downlink TBF / Receive state variable V(R)

43.1.2.1.1 Conformance requirements

1. In RLC acknowledged mode, each RLC endpoint receiver shall have an associated receive state variable V(R). The receive state variable denotes the BSN of the next in-sequence RLC data block expected to be received.
2. The mobile station shall set V(R) to the value 0 at the beginning of each TBF in which the RLC endpoint is the receiver.

References

GSM 04.60, section 9.1.5.

43.1.2.1.2 Test purpose

1. To verify correct initialisation of the receive state variable, V(R).
2. To verify the receive state variable, V(R) is set to the next in sequence RLC data block expected to be received.

43.1.2.1.3 Method of test

Initial Conditions

System Simulator:

1 cell, default setting, PBCCH not present

Mobile Station:

The MS is GPRS updated with a P-TMSI allocated, SPLIT PG CYCLE negotiated and the test PDP Context2 activated.

Related PICS/PIXIT Statement(s)

Support GPRS service.

Test Procedure

SS establishes a downlink TBF and sends RLC data blocks with BSN values between 0 to N in sequence. The MS is polled in each RLC data block by setting the S/P bit. SS verifies that the SSN in the Packet Downlink Ack/Nack messages sent by the MS are set to [BSN+1] modulo 128. SS then sends RLC data block with random BSN N1 that holds a value between [N+1] modulo 128 and [N+64] modulo 128. The MS is polled in the last RLC data block by setting the S/P bit. SS verifies that the SSN in the Packet Downlink Ack/Nack message sent by the MS is set to [N1+1] modulo 128.

The test is performed for the values of N = 1,10,63,64,126,127.

Maximum Duration of Test

5 min.

Expected Sequence

1		{Downlink TBF establishment}	Macro parameters: Acknowledged mode
2	SS -> MS	DOWNLINK RLC DATA BLOCK	MS is polled S/P bit '1' RRBP 00
3	MS -> SS	Packet Downlink Ack/ Nack	SS verifies that SSN = [BSN + 1] modulo 128
4			Repeat steps 2 and 3 until BSN = N
5	SS -> MS	DOWNLINK RLC DATA BLOCK	BSN = N1 a random number between [N+1] mod 128 and [N+64] modulo 128 MS is polled S/P bit '1' RRBP 00
6	MS -> SS	Packet Downlink Ack/ Nack	SS verifies that SSN = [N1+1] modulo 128.

43.1.2.2 Acknowledged mode / Downlink TBF / Receive window state variable V(Q)

43.1.2.2.1 Conformance requirements

In RLC acknowledged mode, each RLC endpoint receiver shall have an associated receive window state variable, V(Q). The mobile station shall set V(Q) to the value 0 at the beginning of each TBF in which the RLC endpoint is the receiver.

The value of V(Q) shall be updated when the RLC receiver receives the RLC data block whose BSN is equal to V(Q).

References

GSM 04.60, section 9.1.6.

43.1.2.2.2 Test purpose

1. To verify that V(Q) is not updated when data blocks with BSN not equal to V(Q) are received.

43.1.2.2.3 Method of test

Initial Conditions

System Simulator:

1 cell, default setting, PBCCH not present

Mobile Station:

The MS is GPRS updated with a P-TMSI allocated, SPLIT PG CYCLE negotiated and the test PDP Context2 activated.

Related PICS/PIXIT Statement(s)

None

Test Procedure

SS establishes a downlink TBF and sends an RLC data block with BSN value N (N in the range 1..63) and polls the MS. The MS shall accept the block and sends a Packet Downlink Ack/Nack message. SS verifies that SSN is set to [N+1] and RBB bit corresponding to N is set to 1. SS sends another RLC data block to the MS with BSN value 64 and polls the MS. SS verifies that the SSN and RBB fields in the Packet Downlink Ack/Nack message sent by the MS are not updated.

Maximum Duration of Test

5 min.

Expected Sequence

1		{Downlink TBF establishment}	Macro parameters: Acknowledged mode
2	SS -> MS	DOWNLINK RLC DATA BLOCK	BSN = N (N is in the range of [1..63]) polls the MS
3	MS -> SS	Packet Downlink Ack/ Nack	SSN value should be [N+1] RBB set for block N
4	SS -> MS	DOWNLINK RLC DATA BLOCK	BSN = 64, polls the MS
5	MS -> SS	Packet Downlink Ack/ Nack	SSN value should be [N+1]. No change in RBB
6	SS -> MS	DOWNLINK RLC DATA BLOCK	BSN = 0, polls the MS
7	MS -> SS	Packet Downlink Ack/ Nack	SSN value should be [N+1]. RBB updated
8	SS -> MS	DOWNLINK RLC DATA BLOCK	BSN = 64, polls the MS
9	MS -> SS	Packet Downlink Ack/ Nack	SSN value should be 65.

43.1.2.3 Acknowledged mode / Downlink TBF / Re-assembly of RLC data blocks

43.1.2.3.1 Conformance requirements

RLC data blocks shall be collected at the receiver until all RLC data blocks comprising an LLC PDU have been received. The RLC headers shall be removed from each RLC data block at this time and the RLC data units re-assembled into an LLC PDU and passed to the next higher layer.

References

GSM 04.60, section 9.1.11.

43.1.2.3.2 Test purpose

To verify the correct re-assembly of the RLC data blocks.

43.1.2.3.3 Method of test

Initial Conditions

System Simulator:

1 cell, default setting, PBCCH not present

Mobile Station:

The MS is GPRS updated with a P-TMSI allocated, SPLIT PG CYCLE negotiated and PDPCContext7 is activated. .

Related PICS/PIXIT Statement(s)

None

Test Procedure

SS establishes a downlink TBF and sends several data blocks in random sequence , but within the range of transmit and receive window.

Maximum Duration of Test

5 min.

Expected Sequence

1		{Downlink TBF establishment}	Macro parameters: Acknowledged mode
2	SS -> MS	DOWNLINK RLC DATA BLOCK	, A bit set (A=1) in LLC frame SS sends datablocks in random sequence
3			Repeat step 2 until all the data blocks in one LLC frame is transmitted
4	MS -> SS	Packet Downlink Ack/ Nack	
4		{Uplink dynamic allocation two phase access}	USF_GRANULARITY = 1 block
5	SS -> MS	PACKET DOWNLINK DUMMY CONTROL BLOCK	Sent on the PACCH of the PDCH assigned, USF assigned to the MS.
6	MS -> SS	UPLINK RLC DATA BLOCK	LLC Supervisory frame (RR) acknowledging a valid LLC frame
7		{ Completion of uplink RLC data block transfer}	

43.1.2.4 Acknowledged mode / Downlink TBF / Re-assembly / Length Indicator

43.1.2.4.1 Conformance requirements

1. The Extension (E) bit is used to indicate the presence of an optional extension octet in the RLC data block header. The More (M) bit is used to indicate the presence of an LLC frame following the current LLC frame. The M bit, the E bit, and the Length Indicator, are used to delimit LLC frames within a TBF.
2. The Length Indicator (LI) field is six bits in length and shall be encoded as a binary number. The value 0 shall indicate that no LLC frame boundary does exist, that the M bit shall be ignored and that the E bit shall be interpreted as having the value 1.
3. A singular case occurs when the end of the LLC PDU would fit within the RLC data block but the addition of the Length Indicator octet (to indicate the LLC PDU boundary) causes the LLC PDU to extend into the next RLC data block. In this case, this additional LI field shall take the value 0 whatever is the length of the last but one LLC PDU segment.

References

GSM 04.60, section 9.1.11, Annexure B 2.

43.1.2.4.2 Test purpose

To verify the correct decoding of RLC data block length indication, more(M) and extension(E) bit fields during re-assembly of LLC frames into RLC data blocks.

43.1.2.4.3 Method of test

Initial Conditions

System Simulator:

1 cell, default setting.

Mobile Station:

The MS is GPRS updated with a P-TMSI allocated, SPLIT PG CYCLE negotiated and PDPContext7 activated.

Related PICS/PIXIT Statement(s)

None

Test Procedure

SS establishes a downlink TBF and sends data blocks containing two LLC frames (A bit set) with length indicator encoded. The MS is expected to decode these fields and re-assemble LLC frames correctly.

The size of the first LLC frame is 15 octets and second is 24 octets .

Maximum Duration of Test

5 min.

Expected Sequence

1		{Downlink TBF establishment}	Macro parameters: Acknowledged mode
2	SS -> MS	DOWNLINK RLC DATA BLOCK	15 octets of first LLC frame and 4 octets of second LLC frame Length Indicator = 15, M = 1, E = 1 A bit set (A = 1) in both LLC frames
3		{Uplink dynamic allocation two phase access}	USF_GRANULARITY = 1 block
4	SS -> MS	PACKET DOWNLINK DUMMY CONTROL BLOCK	Sent on the PACCH of the PDCH assigned, USF assigned to the MS.
5	MS -> SS	UPLINK RLC DATA BLOCK	LLC Supervisory frame (RR) acknowledging first LLC frame
6		{Completion of uplink RLC data block transfer}	
7	SS -> MS	DOWNLINK RLC DATA BLOCK	19 octets from second LLC frame Length indicator = 0, M = 0, E = 1
8	SS -> MS	DOWNLINK RLC DATA BLOCK	1 octet from second LLC frame Length indicator = 1, M = 0, E = 1, FBI=1
9		{Uplink dynamic allocation two phase access}	USF_GRANULARITY = 1 block
10	SS -> MS	PACKET DOWNLINK DUMMY CONTROL BLOCK	Sent on the PACCH of the PDCH assigned, USF assigned to the MS.
11	MS -> SS	UPLINK RLC DATA BLOCK	LLC Supervisory frame (RR) acknowledging second LLC frame
12		{Completion of uplink RLC data block transfer}	

43.2 Control Blocks

43.2.1 Control Blocks Re-assembly

43.2.1.1 Conformance requirements

The network may segment RLC/MAC control messages into one or two RLC/MAC control blocks depending on the length of the RLC/MAC control message.

RLC/MAC control blocks shall be collected at the receiver until all RLC/MAC control blocks comprising a RLC/MAC control message have been received. The receiving side shall determine the length of the RLC/MAC control message contents by interpreting the RLC/MAC control block contents.

References

GSM 04.60, sections 9.1.11a, 9.1.11b and 9.1.2.

43.2.1.2 Test purpose

To verify that the MS re-assembles a RLC control message If it spans across more than one RLC control block.

43.2.1.3 Method of test

Initial Conditions

System Simulator:

1 cell, default setting, PBCCH not present

Mobile Station:

The MS is switched off.

Related PICS/PIXIT Statement(s)

Method of trigger GPRS attach at power on.

Test Procedure

The MS is switched on and triggered to perform a GPRS attach. The SS sends a PACKET UPLINK ASSIGNMENT message that spans more than one RLC control block. The PACKET UPLINK ASSIGNMENT message contains Dynamic Allocation struct (Timeslot allocation with power control parameters included) and frequency parameters with direct encoding 2 struct information fields. The SS verifies that RLC data blocks containing Attach Request message are received from the MS.. Switch off the MS.

Maximum Duration of Test

5 min.

Expected sequence

1	MS		The MS is switched on and triggered to perform a GPRS attach.
2	MS -> SS	CHANNEL REQUEST	
3	SS -> MS	IMMEDIATE ASSIGNMENT	Indicating two phase access
4	MS -> SS	PACKET RESOURCE REQUEST	
5	SS -> MS	PACKET UPLINK ASSIGNMENT	Frequency Parameter direct encoding 2 information element. Dynamic Allocation struct information element (Timeslot allocation and Power Control parameters included) Payload type = 10, Sent on PACCH.
6	SS -> MS	PACKET DOWNLINK DUMMY CONTROL BLOCK	USF assigned to the MS
7	MS -> SS	UPLINK RLC DATA BLOCKS	Attach Request received on PDTCH assigned in step 5

43.3 Default Message Contents and Macros

43.3.1 Message Contents

43.3.1.1 Packet Uplink Assignment

MESSAGE_TYPE	001110
PAGE_MODE	Normal Paging
Referenced Address	
-	10 (TLLI)
CHANNEL_CODING_COMMAND	CS-1 coding
TLLI_BLOCK_CHANNEL_CODING	use value indicated in CHANNEL_CODING_COMMAND
Packet Timing Advance	
-	1 (timing advance value)
- TIMING_ADVANCE_VALUE	30 bit periods
-	0 (no timing advance index)
{L H<Frequency Parameters>}	H (Frequency Parameters present)
- Frequency Parameters	
-	1 hopping)
-	
- TSC	5
Direct Encoding Struct 2	11 (Direct Encoding Struct 2)
MAIO	arbitrarily chosen
HSN	arbitrarily chosen
Length of MA Frequency lists	Length of frequency list chosen for the bit map 0 format
MA Frequency list contents	arbitrarily chosen (bit map 0 format)
Dynamic Allocation	0 (Dynamic Allocation)
- Extended_Dynamic_Allocation	0
-	1
P0 Bit	0
P0	0 db
PR mode	
USF Granularity	0 (one block)
{L H<UPLINK_TFI_ASSIGNMENT>}	1 (assign an uplink TFI)
- UPLINK_TFI_ASSIGNMENT	0000110 (uplink TBF identifier)
{0 1 RLC Data Blocks Granted}	1
RLC Data Blocks Granted	00000000
{0 1 TBF Starting time description}	1
TBF Starting time	arbitrarily chosen
TIMESLOT_ALLOCATION with Power Control Parameters	1
ALPHA	0.5
- USF_TN0	0
- GAMMA_TN0	0
- USF_TN1	0
- GAMMA_TN1	0
- USF_TN2	1
USF_TN2	arbitrarily chosen
- GAMMA_TN2	1
GAMMA_TN2	arbitrarily chosen
- USF_TN3	0
- GAMMA_TN3	0
- USF_TN4	0
- GAMMA_TN4	0
- USF_TN5	0
- GAMMA_TN5	0
- USF_TN6	0
- GAMMA_TN6	0
- USF_TN7	0
- GAMMA_TN7	0
spare padding	Spare Padding

43.3.2 Macros

43.3.2.1 Macro for uplink dynamic allocation two phase access (PBCCH not present)

Step	Direction	Message	Comments
		{Uplink dynamic allocation two phase access}	Macro parameters: n: the number of data octets to be transferred, USF_GRANULARITY: 1 or 4 blocks, RLC_DATA_BLOCKS_GRANTED: 9-261 (close-end), or absent (open-end) CHANNEL_CODING_COMMAND: CS-1, -2, -3, -4 TBF_STARTING_TIME
0	MS		Trigger the MS initiating uplink transfer n octets data according to the test PDP context activated
1	MS -> SS	CHANNEL REQUEST	Received on RACH.
2	SS -> MS	IMMEDIATE ASSIGNMENT	Single block assignment, to order the MS to follow the two phase access procedure. Sent on AGCH.
3	MS -> SS	PACKET RESOURCE REQUEST	Two phase access procedure. Received on the single block assigned in step 2. Check that the PEAK_THROUGHPUT, RADIO_PRIORITY and RLC_MODE are compliant with the PDP context used.
4	SS -> MS	PACKET UPLINK ASSIGNMENT	uplink dynamic allocation, no starting time (as default, otherwise use TBF_STARTING_TIME), Sent on PACCH of the same PDCH assigned in step 2.

43.3.2.2 Macro for downlink TBF establishment (PBCCH not present)

Step	Direction	Message	Comments
		{Downlink TBF establishment}	Macro parameters: TBF_STARTING_TIME
1	SS -> MS	PAGING REQUEST	Page info contains P-TMSI of the MS. Sent on PCH.
2	MS -> SS	CHANNEL REQUEST	Establishment cause = "One phase access". Received on RACH.
3	SS -> MS	IMMEDIATE ASSIGNMENT	Random Reference = pertaining to the message received in step 2. Fixed allocation for RLC data blocks, Sent on AGCH.
4	MS -> SS	UPLINK RLC DATA BLOCK	LLC PDU implicitly indicating paging response, containing TLLI in the RLC/MAC header. Received on uplink PDTCH assigned in step 3.
5	SS -> MS	PACKET UPLINK ACK/NACK	Acknowledge the received RLC data block. Sent on uplink PACCH.
6	MS -> SS	PACKET CONTROL ACKNOWLEDGEMENT	Acknowledge the RLC control message. Received on uplink PACCH.
7	SS -> MS	IMMEDIATE ASSIGNMENT	Downlink Assignment, TLLI value as received. Sent on AGCH. Macro parameter as assigned in the test case.

44 Test case requirements for GPRS mobility management

44.1 Applicability, default conditions and default messages

All test cases for GPRS mobility management apply for all GPRS mobiles unless otherwise stated in a specific test. Within each test case, the PICS statement indicates whether the test shall be performed for mobiles that can only

operate in mode - class B, only in mode - class C , or in both mode - class B and C. For some procedures, the mobile class is of no importance.

Note that only the layer 3 messages are described in the document. The mapping of the layer 3 messages to lower layers and the use of logical channels is not described in this document.

The default conditions and default message contents not specified in this clause must be set as in "GPRS default conditions"

Below is a list of the RAI values and the corresponding RAC, LAC and MCC used in the test cases:

RAI-1: MCC1/MNC1/LAC1/RAC1 (Used if only one cell)

RAI-2: MCC2/MNC1/LAC1/RAC1

RAI-3: MCC1/MNC1/LAC2/RAC1

RAI-4: MCC1/MNC1/LAC1/RAC2

RAI-5: MCC1/MNC1/LAC1/RAC3

If the mobile station initial condition specifies that the mobile has a valid IMSI but the initial condition does not mention P-TMSI, than that shall be interpreted as that the mobile has no valid P-TMSI.

44.2 Elementary procedures of GPRS mobility management

The tests are based on GSM 04.08.

44.2.1 GPRS attach procedure

This procedure is used to indicate for the network that the IMSI is available for traffic by establishment of a GMM context.

44.2.1.1 Normal GPRS attach

The normal GPRS attach procedure is a GMM procedure used by GPRS MSs of MS operation mode B or C to IMSI attach for GPRS services only.

44.2.1.1.1 GPRS attach / accepted

44.2.1.1.1.1 Conformance requirement

- 1) If the network accepts the GPRS attach procedure (signalled by an IMSI) and allocates a P-TMSI, the MS shall acknowledge the P-TMSI and continue communication with the P-TMSI.
- 2) If the network accepts the GPRS attach procedure (signalled by P-TMSI) and reallocates a new P-TMSI, the MS shall acknowledge the new P-TMSI and continue communication with the new P-TMSI.
- 3) If the network accepts the GPRS attach procedure (signalled by a P-TMSI) from the MS without reallocation of the old P-TMSI, the MS shall continue communication with the old P-TMSI.

Reference(s):

GSM 04.08 section 4.7.3.1

44.2.1.1.1.2 Test purpose

To test the behaviour of the MS if the network accepts the GPRS attach procedure.

The following cases are identified:

- 1) P-TMSI / P-TMSI signature is allocated
- 2) P-TMSI / P-TMSI signature is reallocated
- 3) Old P-TMSI / P-TMSI signature is not changed

44.2.1.1.1.3 Method of test

Initial conditions

System Simulator:

One cell operating in network operation mode III.

Mobile Station:

The MS has a valid IMSI. MS is Idle Updated.

Related PICS/PIXIT statement(s)

Support of GPRS service Yes/No

MS operation mode B Yes/No

MS operation mode C Yes/No

Switch off on button Yes/No

Automatic GPRS attach procedure at switch on or power on Yes/No

Test procedure

- 1) The MS sends an ATTACH REQUEST message with identity IMSI. The SS allocates a P-TMSI and returns ATTACH ACCEPT message with a P-TMSI. The MS acknowledge the P-TMSI by sending ATTACH COMPLETE message. Further communication MS - SS is performed by the new P-TMSI.
- 2) The MS sends an ATTACH REQUEST message with identity P-TMSI. The SS reallocates a new P-TMSI and returns ATTACH ACCEPT message with the new P-TMSI. The MS acknowledge the P-TMSI by sending ATTACH COMPLETE message. Further communication MS - SS is performed by the new P-TMSI. The MS will not answer signalling addressed to the old P-TMSI.
- 3) The MS sends an ATTACH REQUEST message with identity P-TMSI. The SS accepts the P-TMSI and returns ATTACH ACCEPT message without any P-TMSI. Further communication MS - SS is performed by the old P-TMSI.

Maximum duration of test

10 minutes.

Expected sequence

Step	Direction	Message	Comments
1	MS		The MS is set in MS operation mode C (see PICS). If MS operation mode C not supported, goto step 26.
2	MS		The MS is powered up or switched on and initiates an attach (see PICS).
3	MS -> SS	ATTACH REQUEST	Attach type = 'GPRS attach' Mobile identity = IMSI
4	SS -> MS	ATTACH ACCEPT	Attach result = 'GPRS only attached' Mobile identity = P-TMSI-2 P-TMSI-2 signature Routing area identity = RAI-1
5	MS -> SS	ATTACH COMPLETE	
6	SS -> MS	PACKET PAGING REQUEST Or PAGING REQUEST TYPE 1	Mobile identity = P-TMSI-2 Both paging orders are for TBF establishment PACKET PAGING REQUEST (used for NW mode III) PAGING REQUEST TYPE 1 (used for NW mode II)
7	MS -> SS	UPLINK RLC DATA BLOCK	LLC PDU implicitly indicating paging response.
8	MS		The MS is switched off or power is removed (see PICS).
9	MS -> SS	DETACH REQUEST	Message not sent if power is removed. Detach type = 'power switched off, GPRS detach'
10	MS		The MS is powered up or switched on and initiates an attach (see PICS).
11	MS -> SS	ATTACH REQUEST	Attach type = 'GPRS attach' Mobile identity = P-TMSI-2 P-TMSI-2 signature Routing area identity = RAI-1
12	SS -> MS	ATTACH ACCEPT	Attach result = 'GPRS only attached' Mobile identity = P-TMSI-1 P-TMSI-1 signature Routing area identity = RAI-1
13	MS -> SS	ATTACH COMPLETE	
14	SS -> MS	GMM INFORMATION	Message sent with P-TMSI-1
14b	MS -> SS	GMM STATUS	Message sent in case the MS does not support reception of GMM information message Cause #97
15	SS -> MS	PACKET PAGING REQUEST Or PAGING REQUEST TYPE 1	Mobile identity = P-TMSI-2 Both paging orders are for TBF establishment. PACKET PAGING REQUEST (used for NW mode III) PAGING REQUEST TYPE 1 (used for NW-mode II).
16	MS		No response from the MS to the request. This is checked for 10 seconds.
17	MS		The MS is switched off or power is removed (see PICS).
18	MS -> SS	DETACH REQUEST	Message not sent if power is removed. Detach type = 'power switched off, GPRS detach'
19	MS		The MS is powered up or switched on and initiates an attach (see PICS).
20	MS -> SS	ATTACH REQUEST	Attach type = 'GPRS attach' Mobile identity = P-TMSI-1 P-TMSI-1 signature Routing area identity = RAI-1
21	SS -> MS	ATTACH ACCEPT	No new mobile identity assigned. P-TMSI and P-TMSI signature not included. Routing area identity = RAI-1 Attach result = 'GPRS only attached'

22	SS -> MS	PACKET PAGING REQUEST Or PAGING REQUEST TYPE 1	Mobile identity = P-TMSI-1 Both paging orders are for TBF establishment. PACKET PAGING REQUEST (used for NW mode III) PAGING REQUEST TYPE 1 (used for NW-mode II).
23 24	MS -> SS MS	UPLINK RLC DATA BLOCK	LLC PDU implicitly indicating paging response. The MS is switched off or power is removed (see PICS).
25	MS -> SS	DETACH REQUEST	Message not sent if power is removed. Detach type = 'power switched off, GPRS detach'
26 27	SS MS		The SS is set in network operation mode II. The MS is set in MS operation mode B (see PICS) and the test is repeated from step 2 to step 25.

Specific message contents

None.

44.2.1.1.2 GPRS attach / rejected / IMSI invalid / illegal MS

44.2.1.1.2.1 Conformance requirements

- 1) If the network rejects a GPRS attach procedure from the Mobile Station with the cause 'Illegal MS', the Mobile Station shall consider SIM invalid for GPRS services until power is switched off or SIM is removed.
- 2) If the network rejects a GPRS attach procedure from the Mobile Station with the cause 'Illegal MS' the Mobile Station shall delete the stored RAI, GPRS-CKSN, P-TMSI and P-TMSI signature.

Reference(s):

GSM 04.08 section 4.7.3.1

44.2.1.1.2.2 Test purpose

To test the behaviour of the MS if the network rejects the GPRS attach procedure of the MS with the cause 'illegal MS'.

44.2.1.1.2.3 Method of test

Initial conditions

System Simulator:

Three cells (not simultaneously activated), cell A with MCC1/MNC1/LAC1/RAC1, cell B in MCC1/MNC1/LAC2/RAC1, cell C in MCC2/MNC1/LAC1/RAC1.

All three cells are operating in network operation mode II (in case of MS operation mode B), or in network operation mode III (in case of MS operation mode C).

Mobile Station:

The MS has a valid P-TMSI-1, P-TMSI-1 signature and RAI-1. MS is Idle Updated on cell A.

Related PICS/PIXIT statement(s)

Support of GPRS service Yes/No

MS operation mode C Yes/No

MS operation mode B Yes/No (only if mode C not supported)

Switch off on button Yes/No

Automatic GPRS attach procedure at switch on or power on Yes/No

Test procedure

The SS rejects a GPRS attach with the cause value 'Illegal MS'. The SS checks that the MS does not perform GPRS attach in the same or another PLMN.

Maximum duration of test

5 minutes.

Expected sequence

Step	Direction	Message	Comments
1	MS		The following messages are sent and shall be received on cell A.
2	SS		The MS is set in MS operation mode C or B (see PICS).
3	MS		The SS is set in network operation mode II or III and activates cell A.
4	MS -> SS	ATTACH REQUEST	The MS is powered up or switched on and initiates an attach (see PICS). Cell A is preferred by the MS. Attach type = 'GPRS attach' Mobile identity = P-TMSI-1 P-TMSI-1 signature Routing area identity = RAI-1
5	SS -> MS	ATTACH REJECT	GMM cause = 'Illegal MS'.
6	SS		The following messages are sent and shall be received on cell B.
7	MS		The SS deactivates cell A and activates cell B.
8	MS		Cell B is preferred by the MS.
9	MS		No ATTACH REQUEST sent to the SS (SS waits 30 seconds).
10	MS		The MS initiates an attach by MMI or by AT command. No ATTACH REQUEST sent to the SS (SS waits 30 seconds).
11	SS		The following messages are sent and shall be received on cell C.
12	MS		The SS deactivates cell B and activates cell C.
13	MS		Cell C is preferred by the MS.
14	MS		No ATTACH REQUEST sent to the SS (SS waits 30 seconds).
15	MS		The MS initiates an attach by MMI or by AT command.
16	MS		No ATTACH REQUEST sent to the SS (SS waits 30 seconds).
17	MS		If possible (see PICS) switch off is performed. Otherwise the power is removed.
18	MS -> SS	ATTACH REQUEST	The MS is powered up or switched on and initiates an attach (see PICS). Attach type = 'GPRS attach' Mobile identity = IMSI
19	SS -> MS	ATTACH ACCEPT	Attach result = 'GPRS only attached' Mobile identity = P-TMSI-1 P-TMSI-1 signature Routing area identity = RAI-2
20	MS -> SS	ATTACH COMPLETE	
21	MS		The MS is switched off or power is removed (see PICS).
22	MS -> SS	DETACH REQUEST	Message not sent if power is removed. Detach type = 'power switched off, GPRS detach'

Specific message contents

None.

44.2.1.1.3 GPRS attach / rejected / IMSI invalid / GPRS services not allowed

44.2.1.1.3.1 Conformance requirement

- 1) If the network rejects a GPRS attach procedure from the Mobile Station with the cause 'GPRS services not allowed', the Mobile Station shall consider SIM invalid for GPRS services until power is switched off or SIM is removed.
- 2) If the network rejects a GPRS attach procedure from the Mobile Station with the cause 'GPRS services not allowed' the Mobile Station shall delete the stored RAI, GPRS-CKSN, P-TMSI and P-TMSI signature.

Reference(s):

GSM 04.08 section 4.7.3.1

44.2.1.1.3.2 Test purpose

To test the behaviour of the MS if the network rejects the GPRS attach procedure of the MS with the cause 'GPRS services not allowed' (no valid GPRS-subscription for the IMSI).

44.2.1.1.3.3 Method of test

Initial conditions

System Simulator:

Two cells (not simultaneously activated), cell A in MCC1/MNC1/LAC1/RAC1 (HPLMN) and cell B in MCC2/MNC1/LAC1/RAC1.

Both cells are operating in network operation mode II.

Mobile Station:

The MS has a valid P-TMSI-1, P-TMSI-1 signature and RAI-1. MS is Idle Updated on cell A.

Related PICS/PIXIT statement(s)

Support of GPRS service Yes/No

MS operation mode C Yes/No

MS operation mode B Yes/No

SIM removal possible without powering down Yes/No

Switch off on button Yes/No

Automatic GPRS attach procedure at switch on or power on Yes/No

Test procedure

The SS rejects a normal attach with the cause value 'GPRS services not allowed'. The SS checks that the MS does not perform GPRS attach in another PLMN.

Maximum duration of test

10 minutes.

Expected sequence

Step	Direction	Message	Comments
1 2	SS MS		The following messages are sent and shall be received on cell A. The SS activates cell A.
3	MS		The MS is set in MS operation mode C (see PICS). If MS operation mode C not supported, goto step 16.
4	MS -> SS	ATTACH REQUEST	The MS is powered up or switched on and initiates an attach (see PICS). Cell A is preferred by the MS. Attach type = 'GPRS attach' Mobile identity = P-TMSI-1 P-TMSI-1 signature Routing area identity = RAI-1
5	SS -> MS	ATTACH REJECT	GMM cause = 'GPRS services not allowed'
6 7 8 9	SS MS MS MS		The following messages are sent and shall be received on cell B. The SS deactivates cell A and activates cell B. Cell B is preferred by the MS. No ATTACH REQUEST sent to the SS (SS waits 30 seconds). If possible (see PICS) SIM removal is performed. Otherwise if possible (see PICS) switch off is performed. Otherwise the power is removed.
10	MS		The MS gets the SIM replaced, is powered up or switched on and initiates an attach (see PICS).
11	MS -> SS	ATTACH REQUEST	Attach type = 'GPRS attach' Mobile identity = IMSI
12	SS -> MS	ATTACH ACCEPT	Attach result = 'GPRS only attached' Mobile identity = P-TMSI-1 P-TMSI-1 signature Routing area identity = RAI-2
13 14	MS -> SS MS	ATTACH COMPLETE	
15	MS -> SS	DETACH REQUEST	The MS is switched off or power is removed (see PICS). Message not sent if power is removed. Detach type = 'power switched off, GPRS detach'
16 17	MS		The SS deactivates cell B and activates cell A. The MS is set in MS operation mode B (see PICS) and the test is repeated from step 3 to step 15.

Specific message contents

None.

44.2.1.1.4 GPRS attach / rejected / PLMN not allowed

44.2.1.1.4.1 Conformance requirement

- 1) If the network rejects a GPRS attach procedure from the Mobile Station with the cause 'PLMN not allowed' the Mobile Station shall:
 - 1.1 not perform GPRS attach when switched on in the same routing area or location area.
 - 1.2 not perform GPRS attach when in the same PLMN and when that PLMN is not selected manually.
 - 1.3 delete the stored RAI, GPRS-CKSN, P-TMSI and P-TMSI signature.

- 1.4 store the PLMN in the 'forbidden PLMN' list.
- 2) If the network rejects a GPRS attach procedure from the Mobile Station with the cause 'PLMN not allowed' the Mobile Station shall perform GPRS attach when a new PLMN is entered.
- 3) If the network rejects a GPRS attach procedure from the Mobile Station with the cause 'PLMN not allowed' and if after that the PLMN from which this rejection was received, is manually selected, the Mobile Station shall perform a GPRS attach procedure.

Reference(s):

GSM 04.08 section 4.7.3.1

44.2.1.1.4.2 Test purpose

To test the behaviour of the MS if the network rejects the GPRS attach procedure of the MS with the cause 'PLMN not allowed'.

44.2.1.1.4.3 Method of test

44.2.1.1.4.3.1 Test procedure 1

Initial conditions

System Simulator:

Four cells (not simultaneously activated), cell A in MCC1/MNC1/LAC1/RAC1, cell B in MCC1/MNC1/LAC1/RAC1, cell C in MCC1/MNC1/LAC2/RAC1 and cell D in MCC2/MNC1/LAC1/RAC1.

All four cells are operating in network operation mode II (in case of MS operation mode B), or in network operation mode III (in case of MS operation mode C). The PLMN of the four cells should NOT be that of the Mobile Station Home PLMN.

Mobile Station:

The MS has a valid P-TMSI-1, P-TMSI-1 signature and RAI-1. MS is Idle Updated on cell A.

Related PICS/PIXIT statement(s)

Support	of	GPRS	service	Yes/No
MS	operation	mode	C	Yes/No
MS	operation	mode B	(only if mode C not supported)	Yes/No
Switch	off	on	button	Yes/No
Automatic GPRS attach procedure at switch on or power on				Yes/No

Test procedure

The SS rejects a GPRS attach with the cause value 'PLMN not allowed'. The SS checks that the MS does not perform GPRS attach if activated in the same routing area or location area and performs GPRS attach only when a new PLMN is entered.

Maximum duration of test

10 minutes.

Expected sequence

Step	Direction	Message	Comments
1	SS MS		The following messages are sent and shall be received on cell A. The MS is set in MS operation mode C or B (see PICS).
2	SS		The SS is set in network operation mode II or III and activates cell A.
3	MS		The MS is powered up or switched on and initiates an attach (see PICS). Cell A is preferred by the MS.
4	MS -> SS	ATTACH REQUEST	Attach type = 'GPRS attach' Mobile identity = P-TMSI-1 P-TMSI-1 signature Routing area identity = RAI-1
5	SS -> MS	ATTACH REJECT	GMM cause = 'PLMN not allowed'
6	MS		No ATTACH REQUEST sent to SS (SS waits 30 seconds).
7	SS		The following messages are sent and shall be received on cell B.
8	MS		The SS deactivates cell A and activates cell B. Cell B is preferred by the MS.
9	MS		No ATTACH REQUEST sent to SS (SS waits 30 seconds).
10	SS		The following messages are sent and shall be received on cell C.
11	MS		The SS deactivates cell B and activates cell C. Cell C is preferred by the MS.
12	MS		No ATTACH REQUEST sent to SS (SS waits 30 seconds).
13	SS		The following messages are sent and shall be received on cell D.
14	MS		The SS deactivates cell C and activates cell D. Cell D is preferred by the MS.
15		{Location Update Procedure}	Macro. Location Update Procedure initiated from the MS.
16	MS		The MS initiates an attach automatically, by MMI or by AT command.
17	MS -> SS	ATTACH REQUEST	Attach type = 'GPRS attach' Mobile identity = IMSI
18	SS -> MS	ATTACH ACCEPT	Attach result = 'GPRS only attached' Mobile identity = P-TMSI-1 P-TMSI-1 signature Routing area identity = RAI-2
19	MS -> SS	ATTACH COMPLETE	
20	MS		The MS is switched off or power is removed (see PICS).
21	MS -> SS	DETACH REQUEST	Message not sent if power is removed. Detach type = 'power switched off, GPRS detach'

Specific message contents

None.

44.2.1.1.4.3.2 Test procedure 2

Initial conditions

System Simulator:

One cell operating in network operation mode II. The PLMN of the cell should NOT be that of the Mobile Station Home PLMN.

Mobile Station:

The MS has a valid P-TMSI-1, P-TMSI-1 signature and RAI-1. MS is Idle Updated.

Related PICS/PIXIT statement(s)

Support of GPRS service Yes/No

MS operation mode C Yes/No

MS operation mode B Yes/No (only if mode C not supported)

Switch off on button Yes/No

Automatic GPRS attach procedure at switch on or power on Yes/No

Test procedure

The SS rejects a GPRS attach with the cause value 'PLMN not allowed'. The subscribers access rights is changed to allow GPRS attach. Then the PLMN from which this rejection was received is manually selected and the SS check that a GPRS attach is performed.

Maximum duration of test

5 minutes.

Expected sequence

Step	Direction	Message	Comments
1	MS		The MS is set in MS operation mode C or B (see PICS).
2	MS		The MS is powered up or switched on and initiates an attach (see PICS).
3	MS -> SS	ATTACH REQUEST	Attach type = 'GPRS attach' Mobile identity = P-TMSI-1 P-TMSI-1 signature Routing area identity = RAI-1
4	SS -> MS	ATTACH REJECT	GMM cause = 'PLMN not allowed'
5	MS		No ATTACH REQUEST sent to SS (SS waits 30 seconds)
6	MS		The current PLMN is selected manually.
7		{Location Update Procedure}	Macro. Location Update Procedure initiated from the MS.
8	MS		The MS initiates an attach automatically, by MMI or by AT command.
9	MS -> SS	ATTACH REQUEST	Attach type = 'GPRS attach' Mobile identity = IMSI
10	SS -> MS	ATTACH ACCEPT	Attach result = 'GPRS only attached' Mobile identity = P-TMSI-1 P-TMSI-1 signature Routing area identity = RAI-1
11	MS -> SS	ATTACH COMPLETE	
12	MS		The MS is switched off or power is removed (see PICS).
13	MS -> SS	DETACH REQUEST	Message not sent if power is removed. Detach type = 'power switched off, GPRS detach'

Specific message contents

None.

44.2.1.1.5 GPRS attach / rejected / roaming not allowed in this location area

44.2.1.1.5.1 Conformance requirement

- 1) If the network rejects a GPRS attach procedure from the Mobile Station with the cause 'roaming not allowed in this location area' the Mobile Station shall:
 - 1.1 not perform GPRS attach when in the same location area.
 - 1.2 delete the stored RAI, GPRS-CKSN, P-TMSI and P-TMSI signature.
 - 1.3 store the LA in the 'forbidden location areas for roaming' list.
 - 1.4 perform GPRS attach when a new location area is entered.
 - 1.5 Periodically search for its HPLMN.
- 2) The mobile station shall reset the list of 'Forbidden location areas for roaming' when switched off or when the SIM is removed.
- 3) The MS shall be capable of storing at least 6 entries in the list of 'Forbidden location areas for roaming'.

Reference(s):

GSM 04.08 section 4.7.3.1

44.2.1.1.5.2 Test purpose

Test purpose 1

To test that on receipt of a rejection using the 'roaming not allowed in this location area' cause code, the MS ceases trying to attach on that location area. Successful GPRS attach procedure is possible in other location areas.

Test purpose 2

To test that if the MS is switched off or the SIM is removed the list of 'forbidden location areas for roaming' is cleared.

Test purpose 3

To test that at least 6 entries can be held in the list of 'forbidden location areas for roaming' (the requirement in TS GSM 04.08 is to store at least 10 entries. This is not fully tested by the third procedure).

Test purpose 4

To test that if a cell of the Home PLMN is available then the MS returns to it in preference to any other available cell.

44.2.1.1.5.3 Method of test

44.2.1.1.5.3.1 Test procedure 1

Initial conditions

System Simulator:

Three cells (not simultaneously activated), cell A in MCC1/MNC1/LAC1/RAC1, cell B in MCC1/MNC/LAC2/RAC1 and cell C in MCC1/MNC1/LAC1/RAC2.

All three cells are operating in network operation mode III.

Mobile Station:

The MS has a valid P-TMSI-1, P-TMSI-1 signature and RAI-1. MS is Idle Updated on cell A.

Related PICS/PIXIT statement(s)

Support of GPRS service Yes/No

MS operation mode C Yes/No

MS operation mode B Yes/No

Switch off on button Yes/No

Automatic GPRS attach procedure at switch on or power on Yes/No

Test procedure

The SS rejects a GPRS attach with the cause value 'Roaming not allowed in this area'. A new attempt for a GPRS attach is not possible. Successful GPRS attach / detach procedures are performed in another location area. A new attempt for a GPRS attach is performed in the 1st location area. This attempt shall not succeed, as the LA is on the forbidden list.

Maximum duration of test

10 minutes.

Expected sequence

Step	Direction	Message	Comments
1	SS MS		The following messages are sent and shall be received on cell A. The MS is set in MS operation mode C (see PICS). If MS operation mode C not supported, go to step 21.
2	SS		The SS activates cell A.
3	MS		The MS is powered up or switched on and initiates an attach (see PICS). Cell A is preferred by the MS.
4	MS -> SS	ATTACH REQUEST	Attach type = 'GPRS attach' Mobile identity = P-TMSI-1 P-TMSI-1 signature Routing area identity = RAI-1
5	SS -> MS	ATTACH REJECT	GMM cause = 'Roaming not allowed in this area'
6	MS		No ATTACH REQUEST sent to SS (SS waits 30 seconds).
7	SS		The following messages are sent and shall be received on cell B.
8	MS		The SS Deactivates cell A and activates cell B. Cell B is preferred by the MS.
9		{Location Update Procedure}	Macro. Location Update Procedure initiated from the MS.
10	MS		The MS initiates an attach automatically, by MMI or by AT command.
11	MS -> SS	ATTACH REQUEST	Attach type = 'GPRS attach' Mobile identity = IMSI
12	SS -> MS	ATTACH ACCEPT	Attach result = 'GPRS only attached' Mobile identity = P-TMSI-1 P-TMSI-1 signature Routing area identity = RAI-3
13	MS -> SS	ATTACH COMPLETE	
14	MS		The MS initiates a GPRS detach (without power off) by MMI or by AT command .
15	MS -> SS	DETACH REQUEST	Detach type = 'normal detach, GPRS detach'
16	SS -> MS	DETACH ACCEPT	
17	SS		The following messages are sent and shall be received on cell C.
18	MS		The SS deactivates cell B and activates cell C. Cell C is preferred by the MS.
19	MS		No ATTACH REQUEST sent to SS (SS waits 30 seconds). The MS is switched off or power is removed (see PICS).
20	SS		The SS deactivates cell C.
21	SS		The SS is set in network operation mode II.
22	MS		The MS is set in MS operation mode B, if supported (see PICS) and the test is repeated from step 2 to step 20.

Specific message contents

None.

44.2.1.1.5.3.2 Test procedure 2

Initial conditions

System Simulator:

One cell operating in network operation mode II.

Mobile Station:

The MS has a valid P-TMSI-1, P-TMSI-1 signature and RAI-1. MS is Idle Updated.

Related PICS/PIXIT statement(s)

Support of GPRS service Yes/No

MS operation mode C Yes/No

MS operation mode B Yes/No (only if mode C not supported)

Switch off on button Yes/No

Automatic GPRS attach procedure at switch on or power on Yes/No

Test procedure

The SS rejects a GPRS attach updating with the cause value 'Roaming not allowed in this area'. The MS is switched off for 10 seconds and switched on again. The SS check that a GPRS attach is possible on the cell on which the GPRS attach had been rejected.

If SIM removal is possible without switching off: The SS rejects a GPRS attach with the cause value 'Roaming not allowed in this area'. The SIM is removed and inserted in the MS. The SS check that a GPRS attach is possible on the cell on which the GPRS attach had been rejected.

Maximum duration of test

5 minutes.

Expected sequence

Step	Direction	Message	Comments
1	MS		If MS operation mode C is supported, the MS is set in MS operation mode C (see PICS). If MS operation mode C is not supported, the MS is set in MS operation mode B.
2	MS		The MS is powered up or switched on and initiates an attach (see PICS).
3	MS -> SS	ATTACH REQUEST	Attach type = 'GPRS attach' Mobile identity = P-TMSI-1 P-TMSI-1 signature Routing area identity = RAI-1
4	SS -> MS	ATTACH REJECT	GMM cause = 'Roaming not allowed in this area'
5	MS		No ATTACH REQUEST sent to the SS (SS waits 30 seconds).
6	MS		If possible (see PICS) switch off is performed. Otherwise the power is removed.
7	MS		The MS is powered up or switched on and initiates an attach (see PICS).
8		{Location Update Procedure}	Macro. Location Update Procedure initiated from the MS.
9	MS -> SS	ATTACH REQUEST	Attach type = 'GPRS attach' Mobile identity = IMSI
10	SS -> MS	ATTACH ACCEPT	Attach result = 'GPRS only attached' Mobile identity = P-TMSI-1 P-TMSI-1 signature Routing area identity = RAI-1
11	MS -> SS	ATTACH COMPLETE	
12	MS		The MS is switched off or power is removed (see PICS).
13	MS -> SS	DETACH REQUEST	Message not sent if power is removed. Detach type = 'power switched off, GPRS detach'

Specific message contents

None.

44.2.1.1.5.3.3 Test procedure 3

Initial conditions

System Simulator:

Six cells (not simultaneously activated), cell A in MCC1/MNC1/LAC1/RAC1, cell B in MCC1/MNC1/LAC2/RAC1, cell C in MCC1/MNC1/LAC3/RAC1, cell D in MCC1/MNC1/LAC4/RAC1, cell E in MCC1/MNC1/LAC5/RAC1, cell F in MCC1/MNC1/LAC6/RAC1.

All six cells are operating in network operation mode II (in case of MS operation mode B), or in network operation mode III (in case of MS operation mode C).

Mobile Station:

The MS has a valid P-TMSI-1, P-TMSI-1 signature and RAI-1. MS is Idle Updated on cell A.

Related PICS/PIXIT statement(s)

Support of GPRS service Yes/No

MS operation mode C Yes/No

MS operation mode B Yes/No (only if mode C not supported)

Switch off on button Yes/No

Automatic GPRS attach procedure at switch on or power on Yes/No

Test procedure

The SS rejects a GPRS attach with the cause value 'Roaming not allowed in this area'. This is done for 6 different location areas. Then the SS checks that the MS does not attempt to perform an attach procedure on the non-allowed location areas.

Different types of MS may use different methods to periodically clear the list of forbidden areas (e.g. every day at 12am) for roaming. If the list is cleared while the test is being run, it may be necessary to re-run the test.

Maximum duration of test

20 minutes.

Expected sequence

Step	Direction	Message	Comments
1	SS		The following messages are sent and shall be received on cell A.
2	SS		The SS is set in network operation mode II or III and activates cell A.
3	MS		The MS is set in MS operation mode C or B (see PICS).
4	MS -> SS	ATTACH REQUEST	The MS is powered up or switched on and initiates an attach (see PICS). Cell A is preferred by the MS. Attach type = 'GPRS attach' Mobile identity = P-TMSI-1 P-TMSI-1 signature
5	SS -> MS	ATTACH REJECT	Routing area identity = RAI-1 GMM cause = 'Roaming not allowed in this area'
6	MS		No ATTACH REQUEST sent to SS (SS waits 30 seconds)
7	SS		The following messages are sent and shall be received on cell B.
8	MS		The SS deactivates cell A and activates cell B. Cell B is preferred by the MS.
9		{Location Update Procedure}	Macro. Location Update Procedure initiated from the MS.
10	MS		The MS initiates an attach automatically, by MMI or by AT command.
11	MS -> SS	ATTACH REQUEST	Attach type = 'GPRS attach' Mobile identity = IMSI
12	SS -> MS	ATTACH REJECT	GMM cause = 'Roaming not allowed in this area'
13	MS		No ATTACH REQUEST sent to SS (SS waits 30 seconds).
14	SS		The following messages are sent and shall be received on cell C.
15	MS		The SS deactivates cell B and activates cell C. Cell C is preferred by the MS.
16		{Location Update Procedure}	Macro. Location Update Procedure initiated from the MS.
17	MS		The MS initiates an attach automatically, by MMI or by AT command.
18	MS -> SS	ATTACH REQUEST	Attach type = 'GPRS attach' Mobile identity = IMSI
19	SS -> MS	ATTACH REJECT	GMM cause = 'Roaming not allowed in this area'
20	MS		No ATTACH REQUEST sent to SS (SS waits 30 seconds).
21	SS		The following messages are sent and shall be received on cell D.
22	MS		The SS deactivates cell C and activates cell D. Cell D is preferred by the MS.
23		{Location Update Procedure}	Macro. Location Update Procedure initiated from the MS.
24	MS		The MS initiates an attach automatically, by MMI or by AT command.
25	MS -> SS	ATTACH REQUEST	Attach type = 'GPRS attach' Mobile identity = IMSI
26	SS -> MS	ATTACH REJECT	GMM cause = 'Roaming not allowed in this area'
27	MS		No ATTACH REQUEST sent to SS (SS waits 30 seconds).
28	SS		The following messages are sent and shall be received on cell E.
29	MS		The SS deactivates cell D and activates cell E. Cell E is preferred by the MS.
30		{Location Update Procedure}	Macro. Location Update Procedure initiated from the MS.

31	MS		The MS initiates an attach automatically, by MMI or by AT command.
32	MS -> SS	ATTACH REQUEST	Attach type = 'GPRS attach'
33	SS -> MS	ATTACH REJECT	Mobile identity = IMSI
34	MS		GMM cause = 'Roaming not allowed in this area'
			No ATTACH REQUEST sent to SS (SS waits 30 seconds).
35	SS		The following messages are sent and shall be received on cell F.
36	MS		The SS deactivates cell E and activates cell F.
33	MS		Cell F is preferred by the MS.
38	MS -> SS	ATTACH REQUEST	The MS initiates an attach automatically, by MMI or by AT command.
38	SS -> MS	ATTACH REJECT	Attach type = 'GPRS attach'
40	MS		Mobile identity = IMSI
			GMM cause = 'Roaming not allowed in this area'
			No ATTACH REQUEST sent to SS (SS waits 30 seconds)
41	SS		The following messages are sent and shall be received on cell E.
42	SS		The SS deactivates cell F and activates cell E.
43	MS		Cell E is preferred by the MS.
44	MS		The MS initiates an attach automatically, by MMI or by AT command.
			No ATTACH REQUEST sent to SS (SS waits 30 seconds).
45	SS		The following messages are sent and shall be received on cell C.
46	SS		The SS deactivates cell E and activates cell C.
47	MS		Cell C is preferred by the MS.
48	MS		The MS initiates an attach automatically, by MMI or by AT command.
			No ATTACH REQUEST sent to SS (SS waits 30 seconds).
49	SS		The following messages are sent and shall be received on cell A.
50	SS		The SS deactivates cell C and activates cell A.
51	MS		Cell A will be preferred by the MS.
52	MS		The MS initiates an attach automatically, by MMI or by AT command.
			No ATTACH REQUEST sent to SS (SS waits 30 seconds).

Specific message contents

None.

44.2.1.1.5.3.4 Test procedure 4

Initial conditions

System Simulator:

Two cells, cell A in MCC2/MNC1/LAC1/RAC1 (not HPLMN) and cell B in MCC1/MNC1/LAC1/RAC1 (HPLMN). Both cells are operating in network operation mode II (in case of MS operation mode B), or in network operation mode III (in case of MS operation mode C).

Mobile Station:

The MS has a valid P-TMSI-1, P-TMSI-1 signature and RAI-2. MS is Idle Updated on cell A.

Related PICS/PIXIT statement(s)

Support of GPRS service Yes/No

MS operation mode C Yes/No

MS operation mode B Yes/No (only if mode C not supported)

Switch off on button Yes/No

Automatic GPRS attach procedure at switch on or power on Yes/No

Test procedure

The SS rejects a GPRS attach with the cause value 'Roaming not allowed in this area. Two cells are then available. The cell with the weakest level belongs to the HPLMN. It is checked that the MS returns to its HPLMN.

Maximum duration of test

5 minutes.

Expected sequence

Step	Direction	Message	Comments
	SS		The following messages are sent and shall be received on cell A.
1	MS		The MS is set in MS operation mode C or B (see PICS).
2	SS		The SS is set in network operation mode II or III and activates cell A.
3	MS		The MS is powered up or switched on and initiates an attach (see PICS). Cell A is preferred by the MS.
4	MS -> SS	ATTACH REQUEST	Attach type = 'GPRS attach' Mobile identity = P-TMSI-1 P-TMSI-1 signature Routing area identity = RAI-2
5	SS -> MS	ATTACH REJECT	GMM cause = 'Roaming not allowed in this area'
6	MS		No ATTACH REQUEST sent to SS (SS waits 30 seconds).
			The following messages are sent and shall be received on cell B.
7	SS		Activate cell B with a lower signal strength than cell A.
8	MS		The RF level of cell A is lowered until cell B is preferred by the MS.
9		{Location Update Procedure}	Macro. Location Update Procedure initiated from the MS.
10	MS		The MS initiates an attach automatically, by MMI or by AT command.
11	MS -> SS	ATTACH REQUEST	Attach type = 'GPRS attach' Mobile identity = IMSI
12	SS -> MS	ATTACH ACCEPT	Attach result = 'GPRS only attached' Mobile identity = P-TMSI-1 P-TMSI-1 signature Routing area identity = RAI-1
13	MS -> SS	ATTACH COMPLETE	
14	MS		The MS is switched off or power is removed (see PICS).
15	MS -> SS	DETACH REQUEST	Message not sent if power is removed. Detach type = 'power switched off, GPRS detach'

Specific message contents

None.

44.2.1.1.6 GPRS attach / abnormal cases / access barred due to access class control

44.2.1.1.6.1 Conformance requirement

- 1) The MS shall not perform GPRS attach procedure, but stays in the current serving cell and applies normal cell reselection process.
- 2) The Mobile Station shall perform the GPRS attach procedure when:
 - 2.1 Access is granted.
 - 2.2 Cell is changed.

Reference(s):

GSM 04.08 section 4.7.3.1

44.2.1.1.6.2 Test purpose

Test purpose 1

To test the behaviour of the MS in case of access class control (access is granted).

Test purpose 2

To test the behaviour of the MS in case of access class control (cell is changed).

44.2.1.1.6.3 Method of test

44.2.1.1.6.3.1 Test procedure 1

Initial conditions

A random access class x (0-15) is selected. The SIM is programmed with this access class x. Communication with mobile stations using access class x is initially indicated to be barred.

System Simulator:

One cell operating in network operation mode III.

Access class x barred.

Mobile Station:

The MS has a valid P-TMSI-1, P-TMSI-1 signature and RAI-1. MS is Idle Updated.

Related PICS/PIXIT statement(s)

Support of GPRS service Yes/No

MS operation mode C Yes/No

MS operation mode B Yes/No

Switch off on button Yes/No

Automatic GPRS attach procedure at switch on or power on Yes/No

Test procedure

The SS indicates access class x barred. A GPRS attach procedure is not performed.

The SS indicates that access class x is not barred. A GPRS attach procedure is performed.

Maximum duration of test

10 minutes.

Expected sequence

Step	Direction	Message	Comments
1	MS		The SIM is programmed with access class x.
2	MS		The MS is set in MS operation mode C or B (see PICS). If MS operation mode C not supported, goto step 12.
3	MS		The MS is powered up or switched on and attempts to initiate an attach (see PICS).
4	MS		No ATTACH REQUEST sent to SS, as access class X is barred (SS waits 30 seconds).
5	SS		The access class x is not barred anymore.
6	MS		The MS automatically initiates a GPRS attach.
7	MS -> SS	ATTACH REQUEST	Attach type = 'GPRS attach' Mobile identity = P-TMSI-1 P-TMSI-1 signature Routing area identity = RAI-1
8	SS -> MS	ATTACH ACCEPT	Attach result = 'GPRS only attached' Mobile identity = P-TMSI-2 P-TMSI-2 signature Routing area identity = RAI-1
9	MS -> SS	ATTACH COMPLETE	
10	MS		The MS is switched off or power is removed (see PICS).
11	MS -> SS	DETACH REQUEST	Message not sent if power is removed. Detach type = 'power switched off, GPRS detach'
12	SS		The SS is set in network operation mode II.
13	MS		The MS is set in MS operation mode B (see PICS) and the test is repeated from step 2 to step 11.

Specific message contents

None.

44.2.1.1.6.3.2 Test procedure 2

Initial conditions

A random access class x (0-15) is selected. The SIM is programmed with this access class x. Communication with mobile stations using access class x is indicated to be barred on cell A.

System Simulator:

Two cells, cell A in MCC1/MNC1/LAC1/RAC1 has access class x barred, cell B in MCC1/MNC1/LAC1/RAC1 has access class x not barred.

Both cells are operating in network operation mode II (in case of MS operation mode B), or in network operation mode III (in case of MS operation mode C).

Mobile Station:

The MS has a valid P-TMSI-1, P-TMSI-2 signature and RAI-1. MS is Idle Updated on cell A.

Related PICS/PIXIT statement(s)

Support of GPRS service Yes/No

MS operation mode C Yes/No

MS operation mode B Yes/No (only if mode B not supported)

Switch off on button Yes/No

Automatic GPRS attach procedure at switch on or power on Yes/No

Test procedure

The SS indicates access class x barred. A GPRS attach procedure is not performed.

A cell change is performed into a cell where access class x is not barred. A GPRS attach procedure is performed.

Maximum duration of test

10 minutes.

Expected sequence

Step	Direction	Message	Comments
1	MS SS		The SIM is programmed with access class x. The following messages are sent and shall be received on cell A.
2	SS		The SS is set in network operation mode II or III and activates cell A.
3	MS		The MS is set in MS operation mode C or B (see PICS).
4	MS		The MS is powered up or switched on and attempts to initiate an attach (see PICS).
5	MS		No ATTACH REQUEST sent to SS, as access class X is barred (SS waits 30 seconds).
6	SS		The following messages are sent and shall be received on cell B.
7	MS		Activate cell B with a lower signal strength than cell A The RF level of cell A is lowered until cell B is preferred by the MS.
8	MS -> SS	ATTACH REQUEST	The MS automatically initiates an attach. Attach type = 'GPRS attach' Mobile identity = P-TMSI-2 P-TMSI-2 signature
9	SS -> MS	ATTACH ACCEPT	Routing area identity = RAI-1 Attach result = 'GPRS only attached' Mobile identity = P-TMSI-1 P-TMSI-1 signature
10	MS -> SS	ATTACH COMPLETE	Routing area identity = RAI-1
11	MS		The MS is switched off or power is removed (see PICS).
12	MS -> SS	DETACH REQUEST	Message not sent if power is removed. Detach type = 'power switched off, GPRS detach'

Specific message contents

None.

44.2.1.1.7 GPRS attach / abnormal cases / change of cell into new routing area

44.2.1.1.7.1 Conformance requirement

When a change of cell into a new routing area is performed before ATTACH ACCEPT message is received by the MS, the MS shall abort the GPRS attach procedure and re-initiate it immediately.

Reference(s):

GSM 04.08 section 4.7.3.1

44.2.1.1.7.2 Test purpose

To test the behaviour of the MS in case of procedure collision.

44.2.1.1.7.3 Method of test

Initial conditions

System Simulator:

Two cells (not simultaneously activated), cell A in MCC1/MNC1/LAC1/RAC1 and cell B in MCC1/MNC1/LAC1/RAC2.

Both cells are operating in network operation mode II (in case of MS operation mode B), or in network operation mode III (in case of MS operation mode C).

Mobile Station:

The MS has a valid P-TMSI-1, P-TMSI-1 signature and RAI-1. MS is Idle Updated on cell A.

Related PICS/PIXIT statement(s)

Support of GPRS service Yes/No

MS operation mode C Yes/No

MS operation mode B Yes/No (only if mode C not supported)

Switch off on button Yes/No

Automatic GPRS attach procedure at switch on or power on Yes/No

Test procedure

The MS initiates a GPRS attach procedure. The ATTACH ACCEPT message is delayed from the SS. The MS performs a cell reselection to a cell in a new routing area. The MS shall re-initiate a GPRS attach procedure in the new routing area.

Maximum duration of test

5 minutes.

Expected sequence

Step	Direction	Message	Comments
1	SS		The following messages are sent and shall be received on cell A.
2	MS		The MS is set in MS operation mode C or B (see PICS).
3	SS		The SS is set in network operation mode II or III and activates cell A.
4	MS -> SS	ATTACH REQUEST	The MS is powered up or switched on and initiates an attach (see PICS). Cell A is preferred by the MS. Attach type = 'GPRS attach' Mobile identity = P-TMSI-1 P-TMSI-1 signature Routing area identity = RAI-1
5	SS		No response to the ATTACH REQUEST message is given by the SS.
6	SS		The following messages are sent and shall be received on cell B.
7	MS		The SS deactivates cell A and activates cell B. Cell B is preferred by the MS.
8	MS -> SS	ATTACH REQUEST	The MS automatically re-initiates the attach in the new cell. Attach type = 'GPRS attach' Mobile identity = P-TMSI-1 P-TMSI-1 signature Routing area identity = RAI-1
9	SS -> MS	ATTACH ACCEPT	No new mobile identity assigned. P-TMSI and P-TMSI signature not included. Attach result = 'GPRS only attached' Routing area identity = RAI-4
10	MS		The MS is switched off or power is removed (see PICS).
11	MS -> SS	DETACH REQUEST	Message not sent if power is removed. Detach type = 'power switched off, GPRS detach'

Specific message contents

None.

44.2.1.1.8 GPRS attach / abnormal cases / power off

44.2.1.1.8.1 Conformance requirement

When power is switched off before ATTACH ACCEPT message is received by the MS, the MS shall abort the GPRS attach procedure and perform a GPRS detach procedure.

Reference(s):

GSM 04.08 section 4.7.3.1

44.2.1.1.8.2 Test purpose

To test the behaviour of the MS in case of procedure collision.

44.2.1.1.8.3 Method of test

Initial conditions

System Simulator:

One cell operating in network operation mode III.

Mobile Station:

The MS has a valid P-TMSI-1, P-TMSI-1 signature and RAI-1. MS is Idle Updated.

Related PICS/PIXIT statement(s)

Support of GPRS service Yes/No

MS operation mode C Yes/No

MS operation mode B Yes/No

Switch off on button Yes/No

Automatic GPRS attach procedure at switch on or power on Yes/No

Test procedure

The MS is switched off after initiating an attach procedure. A GPRS detach is automatically performed by the MS before power is switched off.

Maximum duration of test

5 minutes.

Expected sequence

Step	Direction	Message	Comments
1	MS		The MS is set in MS operation mode C (see PICS). If MS operation mode C not supported, goto step 7.
2	MS		The MS is powered up or switched on and initiates an attach (see PICS).
3	MS -> SS	ATTACH REQUEST	Attach type = 'GPRS attach' Mobile identity = P-TMSI-1 P-TMSI-1 signature
4	SS		Routing area identity = RAI-1 No response to the ATTACH REQUEST message is given by the SS.
5	MS		The MS is powered off and initiates a GPRS detach (with power off) by
6	MS -> SS	DETACH REQUEST	Detach type = 'power switched off, GPRS detach'
7	SS		The SS is set in network operation mode II.
8	MS		The MS is set in MS operation mode B (see PICS) and the test is repeated from step 2 to step 6.

Specific message contents

None.

44.2.1.1.9 GPRS attach / abnormal cases / GPRS detach procedure collision

44.2.1.1.9.1 Conformance requirement

- 1) When a DETACH REQUEST message is received by the MS (Detach type 're-attach not required') while waiting for an ATTACH ACCEPT message, the MS shall terminate the GPRS attach procedure and continue with the GPRS detach procedure.
- 2) When a DETACH REQUEST message is received by the MS (Detach type 're-attach required') while waiting for an ATTACH ACCEPT message, the MS shall ignore the GPRS detach procedure and continue with the GPRS attach procedure.

Reference(s):

GSM 04.08 section 4.7.3.1

44.2.1.1.9.2 Test purpose

To test the behaviour of the MS in case of procedure collision.

44.2.1.1.9.3 Method of test

Initial conditions

System Simulator:

One cell operating in network operation mode II.

Mobile Station:

The MS has a valid P-TMSI-1, P-TMSI-1 signature and RAI-1. MS is Idle Updated.

Related PICS/PIXIT statement(s)

Support of GPRS service Yes/No

MS operation mode C Yes/No

MS operation mode B Yes/No (only if mode C not supported)

Switch off on button Yes/No

Automatic GPRS attach procedure at switch on or power on Yes/No

Test procedure

The MS initiates a GPRS attach procedure. The SS does not answer the GPRS attach procedure, but initiates a GPRS detach procedure (Detach type 're-attach not required'). The MS shall terminate the GPRS attach procedure and continue with the GPRS detach procedure.

The MS initiates a GPRS attach procedure. The SS does not answer the GPRS attach procedure, but initiates a GPRS detach procedure (Detach type 're-attach required'). The MS shall ignore the GPRS detach procedure and continue with the GPRS attach.

Maximum duration of test

5 minutes.

Expected sequence

Step	Direction	Message	Comments
1	MS		The MS is set in MS operation mode C or B (see PICS).
2	MS		The MS is powered up or switched on and initiates an attach (see PICS).
3	MS -> SS	ATTACH REQUEST	Attach type = 'GPRS attach' Mobile identity = P-TMSI-1 P-TMSI-1 signature Routing area identity = RAI-1
4	SS		The SS ignores the ATTACH REQUEST message and initiates a detach procedure.
5	SS -> MS	DETACH REQUEST	Detach type = 're-attach not required'
6	MS -> SS	DETACH ACCEPT	
7	MS		The MS initiates the attach procedure by MMI or AT command.
8	MS -> SS	ATTACH REQUEST	Attach type = 'GPRS attach' Mobile identity = P-TMSI-1 P-TMSI-1 signature Routing area identity = RAI-1
9	SS		The SS ignores the ATTACH REQUEST message and initiates a detach procedure.
10	SS-> MS	DETACH REQUEST	Detach type = 're-attach required'
11	MS		The MS ignores the DETACH REQUEST message and continue with the attach procedure.
12	SS -> MS	ATTACH ACCEPT	Attach result = 'GPRS only attached' Mobile identity = P-TMSI-2 P-TMSI-2 signature Routing area identity = RAI-1
13	MS -> SS	ATTACH COMPLETE	
14	MS		The MS is switched off or power is removed (see PICS).
15	MS -> SS	DETACH REQUEST	Message not sent if power is removed. Detach type = 'power switched off, GPRS detach'

Specific message contents

None.

44.2.1.2 Combined GPRS attach

The combined GPRS attach procedure is a GMM procedure used by GPRS MSs of MS operation mode B to IMSI attach for GPRS or non-GPRS services. In order to use the combined GPRS attach procedure, the network must be in network operation mode I. All Combined GPRS test case are only applicable when the MS operates in Class-B mode.

44.2.1.2.1 Combined GPRS attach / GPRS and non-GPRS attach accepted

44.2.1.2.1.1 Conformance requirement

- 1) If the network accepts the combined GPRS attach procedure (signalled by an IMSI) and allocates a P-TMSI, the MS shall acknowledge the P-TMSI and continue communication with the P-TMSI.
- 2) If the network accepts the combined GPRS attach procedure (signalled by P-TMSI) and reallocates a new P-TMSI, the MS shall acknowledge the new P-TMSI and continue communication with the new P-TMSI.
- 3) If the network accepts the combined GPRS attach procedure (signalled by a P-TMSI) from the MS without reallocation of the previously used P-TMSI, the MS shall continue communication with the previously used P-TMSI.
- 4) If the network accepts the combined GPRS attach procedure and determines that IMSI shall be used in CS operations, the MS shall continue communication with the IMSI for CS operations.

- 5) If the network accepts the combined GPRS attach procedure and determines that a TMSI shall be used in CS operations, the MS shall continue communication with the TMSI for CS operations.

Reference(s):

GSM 04.08 section 4.7.3.2

44.2.1.2.1.2 Test purpose

To test the behaviour of the MS if the network accepts the GPRS attach procedure.

The following cases are identified:

- 1) P-TMSI / P-TMSI signature is allocated
- 2) P-TMSI / P-TMSI signature is reallocated
- 3) Old P-TMSI / P-TMSI signature is not changed
- 4) Mobile terminating CS call is allowed with IMSI
- 5) Mobile terminating CS call is not allowed with TMSI

44.2.1.2.1.3 Method of test

Initial conditions

System Simulator:

One cell operating in network operation mode I.

Mobile Station:

The MS has a valid IMSI. MS is Idle Updated.

Related PICS/PIXIT statement(s)

Support of GPRS service Yes/No

MS operation mode B Yes/No

Switch off on button Yes/No

Automatic GPRS attach procedure at switch on or power on Yes/No

Test procedure

- 1) The MS sends an ATTACH REQUEST message with identity IMSI. The SS allocates a P-TMSI and returns ATTACH ACCEPT message with a P-TMSI. The MS acknowledge the P-TMSI by sending ATTACH COMPLETE message. Further communication MS - SS is performed by the new P-TMSI. For CS calls, the IMSI is used.
- 2) The MS is CS paged in order to verify that the IMSI is used for CS calls.
- 3) The MS is GPRS paged in order to verify that the new P-TMSI is used for GPRS services.
- 4) The MS sends an ATTACH REQUEST message with identity P-TMSI. The SS allocates a new P-TMSI and returns ATTACH ACCEPT message with the new P-TMSI and a new TMSI. The MS acknowledge the P-TMSI and the TMSI by sending ATTACH COMPLETE message. Further communication MS - SS is performed by the new P-TMSI. For CS calls, the new TMSI is used. The MS is CS paged in order to verify that the new TMSI is used for CS services.
- 5) The MS is GPRS paged in order to verify that the new P-TMSI is used for GPRS services. The MS will not answer signalling addressed to the old P-TMSI.
- 6) The MS sends an ATTACH REQUEST message with identity P-TMSI. The SS accepts the P-TMSI and returns ATTACH ACCEPT message without any P-TMSI. Further communication MS - SS is performed by the previously used P-TMSI.

- 7) The MS is GPRS paged in order to verify that the previously used P-TMSI is used for GPRS services.

Maximum duration of test

10 minutes.

Expected sequence

Step	Direction	Message	Comments
1	MS		The MS is set in MS operation mode B (see PICS).
2	MS		The MS is powered up or switched on and initiates an attach (see PICS).
3	MS -> SS	ATTACH REQUEST	Attach type = 'Combined GPRS / IMSI attach' Mobile identity = IMSI
4	SS -> MS	ATTACH ACCEPT	TMSI status = no valid TMSI available Attach result = 'Combined GPRS / IMSI attached' Mobile identity = P-TMSI-1 P-TMSI-1 signature Mobile identity = IMSI Routing area identity = RAI-1
5	MS -> SS	ATTACH COMPLETE	
6	SS		SS pages the MS with mobile identity of IMSI and paging order for RR connection according to the channel combination of the cell.
7	MS		Verify that the MS initiates a RR connection and sends a PAGING RESPONSE with mobile identity with IMSI.
8	SS		SS releases the RR connection and pages the MS with mobile identity of P-TMSI-1 and paging order for TBF establishment according to the channel combination of the cell. Comment: A TBF will be established on lower layers.
9	MS		Verify that the MS initiates a TBF connection and sends an UPLINK RLC DATA BLOCK as a response to the paging request. Comment: The TBF will be released on lower layers.
10	MS		The MS is switched off or power is removed (see PICS).
11	MS -> SS	DETACH REQUEST	Message not sent if power is removed. Detach type = 'power switched off, combined GPRS / IMSI detach'
12	MS		The MS is powered up or switched on and initiates an attach (see PICS).
13	MS -> SS	ATTACH REQUEST	Attach type = 'Combined GPRS / IMSI attach' Mobile identity = P-TMSI-1 P-TMSI-1 signature
14	SS -> MS	ATTACH ACCEPT	TMSI status = no valid TMSI available Routing area identity = RAI-1 Attach result = 'Combined GPRS / IMSI attached' Mobile identity = P-TMSI-2 P-TMSI-2 signature Mobile identity = TMSI-1 Routing area identity = RAI-1
15	MS -> SS	ATTACH COMPLETE	
16	SS -> MS	GMM INFORMATION	Message sent with P-TMSI-2
16b	MS -> SS	GMM STATUS	Message sent in case the MS does not support reception of GMM information message Cause #97
17	SS		SS pages the MS with mobile identity of TMSI-1 and paging order for RR connection according to the channel combination of the cell.
18	MS		Verify that the MS initiates a RR connection and sends a PAGING RESPONSE with mobile identity with TMSI-1.
19	SS		SS releases the RR connection and pages the MS with mobile identity of P-TMSI-2 and paging order for TBF establishment according to the channel combination of the cell.

20	MS		Verify that the MS initiates a TBF connection and sends an UPLINK RLC DATA BLOCK as a response to the paging request.
21	SS		SS pages the MS with mobile identity of P-TMSI-1 and paging order for TBF establishment according to the channel combination of the cell.
22	MS		No response from the MS to the request. This is checked for 10 seconds.
23	MS		The MS is switched off or power is removed (see PICS).
24	MS -> SS	DETACH REQUEST	Message not sent if power is removed. Detach type = 'power switched off, combined GPRS / IMSI detach'
25	MS		The MS is powered up or switched on and initiates an attach (see PICS).
26	MS -> SS	ATTACH REQUEST	Attach type = 'Combined GPRS / IMSI attach' Mobile identity = P-TMSI-2 P-TMSI-2 signature Routing area identity = RAI-1
27	SS -> MS	ATTACH ACCEPT	TMSI status = valid TMSI available No new mobile identity assigned. TMSI and P-TMSI not included. Attach result = 'Combined GPRS / IMSI attached' P-TMSI-3 signature Routing area identity = RAI-1
28	SS		SS pages the MS with mobile identity of P-TMSI-2 and paging order for TBF establishment according to the channel combination of the cell.
29	MS		Verify that the MS initiates a TBF connection and sends an UPLINK RLC DATA BLOCK as a response to the paging request.
30	MS		The MS is switched off or power is removed (see PICS).
31	MS -> SS	DETACH REQUEST	Message not sent if power is removed. Detach type = 'power switched off, combined GPRS / IMSI detach'

Specific message contents

None.

44.2.1.2.2 Combined GPRS attach / GPRS only attach accepted

44.2.1.2.2.1 Conformance requirement

- 1) If the network accepts the combined GPRS attach procedure, but GMM cause code 'IMSI unknown in HLR' is sent to the MS the Mobile Station shall delete the stored TMSI, LAI and CKSN. The Mobile Station shall consider SIM invalid for non-GPRS services until power is switched off or SIM is removed.
- 2) If the network accepts the combined GPRS attach procedure, but GMM cause code 'MSC temporarily not reachable', 'Network failure' or 'Congestion' is sent to the MS, an MS operation mode B MS may perform an MM IMSI attach procedure.

Reference(s):

GSM 04.08 section 4.7.3.2

44.2.1.2.2.2 Test Purpose

Test purpose 1

To test the behaviour of the MS if the network accepts the GPRS attach procedure with indication GPRS only, GMM cause 'IMSI unknown in HLR'.

Test purpose 2

To test the behaviour of the MS if the network accepts the GPRS attach procedure with indication GPRS only, GMM cause 'MSC temporarily not reachable', 'Network failure' or 'Congestion'.

44.2.1.2.2.3 Method of test

44.2.1.2.2.3.1 Test Procedure 1

Initial conditions

System Simulator:

One cell operating in network operation mode I.

Mobile Station:

The MS has a valid IMSI. MS is Idle Updated.

Related PICS/PIXIT statement(s)

Support of GPRS service Yes/No

MS operation mode B Yes/No

Switch off on button Yes/No

Automatic GPRS attach procedure at switch on or power on Yes/No

Test procedure

The MS sends an ATTACH REQUEST message with identity IMSI. The SS allocates a P-TMSI and returns ATTACH ACCEPT message with a P-TMSI. GMM cause 'IMSI unknown in HLR' is indicated from SS. Further communication MS - SS is performed by the P-TMSI. CS services are not possible.

Maximum duration of test

5 minutes.

Expected sequence

Step	Direction	Message	Comments
1	MS		The MS is set in MS operation mode B.
2	MS		The MS is powered up or switched on and initiates an attach (see PICS).
3	MS -> SS	ATTACH REQUEST	Attach type = 'Combined GPRS / IMSI attach' Mobile identity = IMSI
4	SS -> MS	ATTACH ACCEPT	TMSI status = no valid TMSI available Attach result = 'GPRS only attached' Mobile identity = P-TMSI-1 P-TMSI-1 signature GMM cause = 'IMSI unknown in HLR'
5	MS -> SS	ATTACH COMPLETE	
6	SS -> MS	PACKET PAGING REQUEST	Mobile identity = IMSI Paging order is for RR-connection.
7	MS		The MS shall not initiate an RR connection. This is checked during 3 seconds.
8	MS		The MS is switched off or power is removed (see PICS).
9	MS -> SS	DETACH REQUEST	Message not sent if power is removed. Detach type = 'power switched off, GPRS detach'

Specific message contents

None.

44.2.1.2.2.3.2 Test Procedure 2

Initial conditions

System Simulator:

One cell operating in network operation mode I.

Mobile Station:

The MS has a valid TMSI, P-TMSI, P-TMSI signature and RAI. MS is Idle Updated.

Related PICS/PIXIT statement(s)

Support of GPRS service Yes/No

MS operation mode B Yes/No

Automatic MM IMSI attach procedure for MS operation mode B MS Yes/No

Switch off on button Yes/No

Automatic GPRS attach procedure at switch on or power on Yes/No

Test procedure

The MS sends an ATTACH REQUEST message. The SS allocates a P-TMSI and returns ATTACH ACCEPT message with a P-TMSI. GMM cause 'MSC temporarily not reachable', 'Network failure' or 'Congestion' is indicated from SS. The cause code is arbitrarily chosen. This procedure is repeated four times. An MS operation mode B MS may then perform an MM IMSI attach procedure (according to the PICS statement). Further communication MS - SS is performed by the P-TMSI. The existence of a signalling channel is verified by a request for mobile identity. CS services are not possible as an IMSI attach procedure is not performed.

Maximum duration of test

15 minutes.

Expected sequence

Dependent whether the option 'Automatic MM IMSI attach procedure for MS operation mode B MS' is supported or not, the steps 1-22 or 23-53 apply depending on manufacturer (see PICS).

Step	Direction	Message	Comments
1	MS		The MS is set in MS operation mode B and no automatic MM IMSI attach procedure is indicated (see PICS).
2	MS		The MS is powered up or switched on and initiates an attach (see PICS).
3	MS -> SS	ATTACH REQUEST	Attach type = 'Combined GPRS / IMSI attach' Mobile identity = P-TMSI-1 P-TMSI-1 signature Routing area identity = RAI-1 TMSI status = valid TMSI available
4	SS -> MS	ATTACH ACCEPT	Attach result = 'GPRS only attached' Mobile identity = P-TMSI-2 P-TMSI-2 signature Routing area identity = RAI-1 GMM cause = 'MSC temporarily not reachable', 'Network failure' or 'Congestion' (arbitrarily chosen)
5	MS -> SS	ATTACH COMPLETE	
7	MS -> SS	ROUTING AREA UPDATE REQUEST	Update type = 'Combined RA / LA updating with IMSI attach' P-TMSI-2 signature Routing area identity = RAI-1 TMSI status = no valid TMSI available
8	SS -> MS	ROUTING AREA UPDATE ACCEPT	No new mobile identity assigned. P-TMSI not included. Update result = 'RA updated' P-TMSI-3 signature Routing area identity = RAI-1 GMM cause = 'MSC temporarily not reachable', 'Network failure' or 'Congestion' (arbitrarily chosen)
10	MS -> SS	ROUTING AREA UPDATE REQUEST	Update type = 'Combined RA / LA updating with IMSI attach' P-TMSI-3 signature Routing area identity = RAI-1 TMSI status = no valid TMSI available
11	SS -> MS	ROUTING AREA UPDATE ACCEPT	No new mobile identity assigned. P-TMSI not included. Update result = 'RA updated' P-TMSI-4 signature Routing area identity = RAI-1 GMM cause = 'MSC temporarily not reachable', 'Network failure' or 'Congestion' (arbitrarily chosen)
12	SS		The SS verifies that the time between the requests are T3311 (+/- 10%)
13	MS -> SS	ROUTING AREA UPDATE REQUEST	Update type = 'Combined RA / LA updating with IMSI attach' P-TMSI-4 signature Routing area identity = RAI-1 TMSI status = no valid TMSI available
14	SS -> MS	ROUTING AREA UPDATE ACCEPT	No new mobile identity assigned. P-TMSI not included. Update result = 'RA updated' P-TMSI-5 signature Routing area identity = RAI-1 GMM cause = 'MSC temporarily not reachable', 'Network failure' or 'Congestion' (arbitrarily chosen)
16	MS -> SS	ROUTING AREA UPDATE REQUEST	Update type = 'Combined RA / LA updating with IMSI attach' P-TMSI-5 signature Routing area identity = RAI-1 TMSI status = no valid TMSI available

17	SS -> MS	ROUTING AREA UPDATE ACCEPT	No new mobile identity assigned. P-TMSI not included. Update result = 'RA updated' P-TMSI-6 signature Routing area identity = RAI-1 GMM cause = 'MSC temporarily not reachable', 'Network failure' or 'Congestion' (arbitrarily chosen)
19	SS -> MS	PACKET PAGING REQUEST	Mobile identity = IMSI Paging order is for RR-connection.
20	MS		The MS shall not initiate an RR connection. This is checked during 3 seconds.
21	MS		The MS is switched off or power is removed (see PICS).
22	MS -> SS	DETACH REQUEST	Message not sent if power is removed. Detach type = 'power switched off, GPRS detach'. Stop the sequence.
23	MS		Automatic MM IMSI attach procedure is indicated (see PICS).
24	MS		The MS is powered up or switched on and initiates an attach (see PICS).
25	MS -> SS	ATTACH REQUEST	Attach type = 'Combined GPRS / IMSI attach' Mobile identity = P-TMSI-1 P-TMSI-1 signature Routing area identity = RAI-1 TMSI status = valid TMSI available
26	SS -> MS	ATTACH ACCEPT	No new mobile identity assigned. P-TMSI not included. Attach result = 'GPRS only attached' P-TMSI-2 signature Routing area identity = RAI-1 GMM cause = 'MSC temporarily not reachable', 'Network failure' or 'Congestion' (arbitrarily chosen)
28	MS -> SS	ROUTING AREA UPDATE REQUEST	Update type = 'Combined RA / LA updating with IMSI attach' P-TMSI-2 signature Routing area identity = RAI-1 TMSI status = no valid TMSI available
29	SS -> MS	ROUTING AREA UPDATE ACCEPT	No new mobile identity assigned. P-TMSI not included. Update result = 'RA updated' P-TMSI-3 signature Routing area identity = RAI-1 GMM cause = 'MSC temporarily not reachable', 'Network failure' or 'Congestion' (arbitrarily chosen)
31	MS -> SS	ROUTING AREA UPDATE REQUEST	Update type = 'Combined RA / LA updating with IMSI attach' P-TMSI-3 signature Routing area identity = RAI-1 TMSI status = no valid TMSI available
32	SS -> MS	ROUTING AREA UPDATE ACCEPT	No new mobile identity assigned. P-TMSI not included. Update result = 'RA updated' P-TMSI-4 signature Routing area identity = RAI-1 GMM cause = 'MSC temporarily not reachable', 'Network failure' or 'Congestion' (arbitrarily chosen)
33	SS		The SS verifies that the time between the requests are T3311 (+/- 10%)
34	MS -> SS	ROUTING AREA UPDATE REQUEST	Update type = 'Combined RA / LA updating with IMSI attach' P-TMSI-4 signature Routing area identity = RAI-1 TMSI status = no valid TMSI available

35	SS -> MS	ROUTING AREA UPDATE ACCEPT	No new mobile identity assigned. P-TMSI not included. Update result = 'RA updated' P-TMSI-5 signature Routing area identity = RAI-1 GMM cause = 'MSC temporarily not reachable', 'Network failure' or 'Congestion' (arbitrarily chosen)
37	MS -> SS	ROUTING AREA UPDATE REQUEST	Update type = 'Combined RA / LA updating with IMSI attach' P-TMSI-5 signature Routing area identity = RAI-1 TMSI status = no valid TMSI available
38	SS -> MS	ROUTING AREA UPDATE ACCEPT	No new mobile identity assigned. P No new mobile identity assigned. P-TMSI not included. Update result = 'RA updated' P-TMSI-6 signature Routing area identity = RAI-1 GMM cause = 'MSC temporarily not reachable', 'Network failure' or 'Congestion' (arbitrarily chosen)
39	SS		The SS verifies that the time between the requests are T3311 (+/- 10%)
40	MS		An automatic MM IMSI attach procedure is initiated.
41	MS -> SS	CHANNEL REQUEST	
42	SS -> MS	IMMEDIATE ASSIGNMENT	
43	MS -> SS	LOCATION UPDATING REQ	Location updating type = IMSI attach.
44	SS -> MS	LOCATION UPDATING ACC	The SS allocates a new TMSI.
45	MS -> SS	TMSI REALLOCATION COMP	Location updating type = IMSI attach.
46	SS -> MS	CHANNEL RELEASE	After sending of this message, the SS waits for disconnection of the CS signalling link.
47	SS -> MS	PACKET PAGING REQUEST	Mobile identity = TMSI-1 Paging order is for RR-connection.
48	MS -> SS	CHANNEL REQUEST	
49	SS -> MS	IMMEDIATE ASSIGNMENT	
50	MS -> SS	PAGING RESPONSE	Mobile identity = TMSI-1
51	SS -> MS	CHANNEL RELEASE	After sending of this message, the SS waits for disconnection of the CS signalling link.
52	MS		The MS is switched off or power is removed (see PICS).
53	MS -> SS	DETACH REQUEST	Message not sent if power is removed. Detach type = 'power switched off, GPRS detach'

Specific message contents

None.

44.2.1.2.3 Combined GPRS attach / GPRS attach while IMSI attach

44.2.1.2.3.1 Applicability

This test is only applicable to mobiles that can first operate in mode C and then switch to mode B.

44.2.1.2.3.2 Conformance requirement

If the GPRS MS is already attached for non-GPRS services by the MM specific attach procedure, but wants to perform an attach for GPRS services, the combined GPRS attach procedure is performed.

Reference(s):

GSM 04.08 section 4.7.3.2

44.2.1.2.3.3 Test Purpose

To test the behaviour of the MS if GPRS attach performed while IMSI attached.

44.2.1.2.3.4 Method of test

Initial conditions

System Simulator:

One cell operating in network operation mode I. ATT flag is set.

Mobile Station:

The MS has a valid TMSI-1, P-TMSI-1, P-TMSI signature and RAI-1.

Related PICS/PIXIT statement(s)

Support of GPRS service Yes/No

MS operation mode B Yes/No

Switch off on button Yes/No

Automatic GPRS attach procedure at switch on or power on Yes/No

Test procedure

The MS attach for non-GPRS services. The MS does not answer to paging orders for GPRS. The MS attach for GPRS services. Paging orders for GPRS are answered.

Maximum duration of test

5 minutes.

Expected sequence

Step	Direction	Message	Comments
1	MS		The MS is set in MS operation mode C (see PICS) and configured not to perform a GPRS attach.
2	MS		The MS is powered up or switched on. No GPRS attach is performed (see PICS).
3	MS -> SS	CHANNEL REQUEST	
4	SS -> MS	IMMEDIATE ASSIGNMENT	
5	MS -> SS	LOCATION UPDATING REQ	Location updating type = IMSI attach.
6	SS -> MS	LOCATION UPDATING ACC	The SS allocates a new TMSI.
7	MS -> SS	TMSI REALLOCATION COMP	Location updating type = IMSI attach.
8	SS -> MS	CHANNEL RELEASE	After sending of this message, the SS waits for disconnection of the CS signalling link.
9	SS -> MS	PACKET PAGING REQUEST	Mobile identity = P-TMSI-1
10	MS		Paging order is for TBF establishment. No response from the MS to the request. This is checked for 10 seconds.
11	MS		The MS is triggered to perform a GPRS attach (in combination with IMSI attach).
12	MS -> SS	ATTACH REQUEST	Attach type = 'GPRS attach while IMSI attached' Mobile identity = P-TMSI-1 P-TMSI-1 signature Mobile identity = TMSI-1
13	SS -> MS	ATTACH ACCEPT	Routing area identity = RAI-1 Attach result = 'Combined GPRS / IMSI attached' No new mobile identity assigned. TMSI and P-TMSI not included P-TMSI-2 signature Routing area identity = RAI-1
14	MS -> SS	ATTACH COMPLETE	
15	SS -> MS	PACKET PAGING REQUEST	Mobile identity = P-TMSI-1
16	MS -> SS	UPLINK RLC DATA BLOCK	Paging order is for TBF establishment. LLC PDU implicitly indicating paging response.
17	MS		The MS is switched off or power is removed (see PICS).
18	MS -> SS	DETACH REQUEST	Message not sent if power is removed. Detach type = 'power switched off, combined GPRS / IMSI detach'

Specific message contents

None.

44.2.1.2.4 Combined GPRS attach / rejected / IMSI invalid / illegal ME

44.2.1.2.4.1 Conformance requirement

- 1) If the network rejects a combined GPRS attach procedure from the Mobile Station with the cause 'Illegal ME', the Mobile Station shall consider SIM invalid for GPRS and non-GPRS services until power is switched off or SIM is removed.
- 2) If the network rejects a combined GPRS attach procedure from the Mobile Station with the cause 'Illegal ME', the Mobile Station shall delete the stored TMSI, LAI, CSKN, RAI, GPRS-CKSN, P-TMSI and P-TMSI signature.

Reference(s):

GSM 04.08 section 4.7.3.2

44.2.1.2.4.2 Test purpose

To test the behaviour of the MS if the network rejects the combined GPRS attach procedure of the MS with the cause 'Illegal ME'.

44.2.1.2.4.3 Method of test

Initial conditions

System Simulator:

Three cells (not simultaneously activated), cell A in MCC1/MNC1/LAC1/RAC1, cell B in MCC1/MNC1/LAC1/RAC2, cell C in MCC2/MNC1/LAC1/RAC1.

All three cells are operating in network operation mode I.

Mobile Station:

The MS has a valid TMSI, P-TMSI, P-TMSI signature and RAI. MS is Idle Updated on cell A.

Related PICS/PIXIT statement(s)

Support of GPRS service Yes/No

MS operation mode B Yes/No

SIM removal possible without powering down Yes/No

Switch off on button Yes/No

Automatic GPRS attach procedure at switch on or power on Yes/No

Test procedure

The SS rejects a GPRS attach with the cause value 'Illegal ME'. The SS checks that the MS does not perform GPRS attach in the same or another PLMN. CS services are not possible as the SIM is blocked for CS services. GPRS services are not possible as the SIM is blocked for GPRS services.

Maximum duration of test

5 minutes.

Expected sequence

Step	Direction	Message	Comments
1	SS		The following messages are sent and shall be received on cell A.
2	MS		The SS activates cell A.
3	MS		The MS is set in MS operation mode B (see PICS).
4	MS -> SS	ATTACH REQUEST	The MS is powered up or switched on and initiates an attach (see PICS). Cell A is preferred by the MS. Attach type = 'Combined GPRS / IMSI attach' Mobile identity = P-TMSI-1 P-TMSI-1 signature Routing area identity = RAI-1 TMSI status = valid TMSI available
5	SS -> MS	ATTACH REJECT	GMM cause 'Illegal ME'.
6	SS -> MS	PACKET PAGING REQUEST	Mobile identity = IMSI Paging order is for RR-connection.
7	MS		The MS shall not initiate an RR connection. This is checked during 3 seconds.
8	SS -> MS	PACKET PAGING REQUEST	Mobile identity = P-TMSI-1 Paging order is for TBF establishment.
9	MS		No response from the MS to the request. This is checked for 10 seconds.
10	SS		The following messages are sent and shall be received on cell B.
11	MS		The SS deactivates cell A and activates cell B.
12	MS		Cell B is preferred by the MS.
13	SS -> MS	PACKET PAGING REQUEST	No ATTACH REQUEST sent to the SS (SS waits 30 seconds). Mobile identity = IMSI Paging order is for RR-connection.
14	MS		The MS shall not initiate an RR connection. This is checked during 3 seconds.
15	SS		The following messages are sent and shall be received on cell C.
16	MS		The SS deactivates cell B and activates cell C.
17	MS		Cell C is preferred by the MS.
18	SS -> MS	PACKET PAGING REQUEST	No ATTACH REQUEST sent to the SS (SS waits 30 seconds). Mobile identity = IMSI Paging order is for TBF establishment.
19	MS		No response from the MS to the request. This is checked for 10seconds.
20	MS		If possible (see PICS) SIM removal is performed. Otherwise if possible (see PICS) switch off is performed. Otherwise the power is removed.
21	MS		The MS gets the SIM replaced, is powered up or switched on and initiates an attach (see PICS).
22	MS -> SS	ATTACH REQUEST	Attach type = 'Combined GPRS / IMSI attach' Mobile identity = IMSI TMSI status = no valid TMSI available
23	SS -> MS	ATTACH ACCEPT	Attach result = 'Combined GPRS / IMSI attached' Mobile identity = P-TMSI-1 P-TMSI-1 signature Mobile identity = TMSI-1 Routing area identity = RAI-2
24	MS -> SS	ATTACH COMPLETE	
25	SS -> MS	PACKET PAGING REQUEST	Mobile identity = TMSI-1 Paging order is for RR-connection.
26	MS -> SS	CHANNEL REQUEST	
27	SS -> MS	IMMEDIATE ASSIGNMENT	
28	MS -> SS	PAGING RESPONSE	Mobile identity = TMSI-1

29	SS -> MS	CHANNEL RELEASE	After sending of this message, the SS waits for disconnection of the CS signalling link. The MS is switched off or power is removed (see PICS). Message not sent if power is removed. Detach type = 'power switched off, combined GPRS / IMSI detach'
30	MS		
31	MS -> SS	DETACH REQUEST	

Specific message contents

None.

44.2.1.2.5 Combined GPRS attach / rejected / GPRS services and non-GPRS services not allowed

44.2.1.2.5.1 Conformance requirement

- 1) If the network rejects a combined GPRS attach procedure from the Mobile Station with the cause 'GPRS services and non-GPRS services not allowed', the Mobile Station shall consider SIM invalid for GPRS and non-GPRS services until power is switched off or SIM is removed.
- 2) If the network rejects a combined GPRS attach procedure from the Mobile Station with the cause 'GPRS services and non-GPRS services not allowed', the Mobile Station shall delete the stored TMSI, LAI, CSKN, RAI, GPRS-CKSN, P-TMSI and P-TMSI signature.

Reference(s):

GSM 04.08 section 4.7.3.2

44.2.1.2.5.2 Test purpose

To test the behaviour of the MS if the network rejects the combined GPRS attach procedure of the MS with the cause 'GPRS services and non-GPRS services not allowed'.

44.2.1.2.5.3 Method of test

Initial conditions

System Simulator:

Two cells (not simultaneously activated), cell A in MCC1/MNC1/LAC1/RAC1 and cell B in MCC2/MNC1/LAC1/RAC1.

Both cells are operating in network operation mode I.

Mobile Station:

The MS has a valid TMSI, P-TMSI, P-TMSI signature and RAI. MS is Idle Updated on cell A.

Related PICS/PIXIT statement(s)

Support of GPRS service Yes/No

MS operation mode B Yes/No

Switch off on button Yes/No

Automatic GPRS attach procedure at switch on or power on Yes/No

Test procedure

The SS rejects a GPRS attach with the cause value 'GPRS services and non-GPRS services not allowed'. The SS checks that the MS does not perform GPRS attach in the same or another PLMN. CS services are not possible as the SIM is blocked for CS services. GPRS services are not possible as the SIM is blocked for GPRS services.

Maximum duration of test

5 minutes.

Expected sequence

Step	Direction	Message	Comments
1	SS		The following messages are sent and shall be received on cell A.
2	MS		The SS activates cell A.
3	MS		The MS is set in MS operation mode B (see PICS).
4	MS -> SS	ATTACH REQUEST	The MS is powered up or switched on and initiates an attach (see PICS). Cell A is preferred by the MS.
5	SS -> MS	ATTACH REJECT	Attach type = 'Combined GPRS / IMSI attach' Mobile identity = P-TMSI-1 P-TMSI-1 signature Routing area identity = RAI-1 TMSI status = valid TMSI available
6	MS		GMM cause 'GPRS services and non-GPRS services not allowed'
7	SS -> MS	PACKET PAGING REQUEST	No LOCATION UPDATING REQ with type 'IMSI attach' is sent to the SS (SS waits 30 seconds).
8	MS		Mobile identity = IMSI Paging order is for RR-connection.
9	SS -> MS	PACKET PAGING REQUEST	The MS shall not initiate an RR connection. This is checked during 3 seconds.
10	MS -> SS		Mobile identity = P-TMSI-1 Paging order is for TBF establishment. No response from the MS to the request. This is checked for 10 seconds
11	MS		Cell B is preferred by the MS.
12	MS		No ATTACH REQUEST sent to the SS (SS waits 30 seconds).
13	MS		No LOCATION UPDATING REQ with type 'IMSI attach' is sent to the SS (SS waits 30 seconds).
14	SS -> MS	PACKET PAGING REQUEST	Mobile identity = IMSI Paging order is for RR-connection.
15	MS		The MS shall not initiate an RR connection. This is checked during 3 seconds.
16	SS -> MS	PACKET PAGING REQUEST	Mobile identity = TMSI-1 Paging order is for TBF establishment.
17	MS		No response from the MS to the request. This is checked for 10seconds.
18	MS		If possible (see PICS) switch off is performed. Otherwise the power is removed.
19	MS		The MS is powered up or switched on and initiates an attach (see PICS).
20	MS -> SS	ATTACH REQUEST	Attach type = 'Combined GPRS / IMSI attach' Mobile identity = IMSI
21	SS -> MS	ATTACH ACCEPT	TMSI status = no valid TMSI available Attach result = 'Combined GPRS / IMSI attached' Mobile identity = P-TMSI-1 P-TMSI-1 signature Mobile identity = TMSI-1 Routing area identity = RAI-2
22	MS -> SS	ATTACH COMPLETE	
23	SS -> MS	PACKET PAGING REQUEST	Mobile identity = TMSI-1 Paging order is for RR-connection.
24	MS -> SS	CHANNEL REQUEST	
25	SS -> MS	IMMEDIATE ASSIGNMENT	
26	MS -> SS	PAGING RESPONSE	Mobile identity = TMSI-1
27	SS -> MS	CHANNEL RELEASE	After sending of this message, the SS waits for disconnection of the CS signalling link.
28	SS -> MS	PACKET PAGING REQUEST	Mobile identity = TMSI-1 Paging order is for TBF establishment.
29	MS -> SS	UPLINK RLC DATA BLOCK	LLC PDU implicitly indicating paging response.

30	MS		The MS is switched off or power is removed (see PICS).
31	MS -> SS	DETACH REQUEST	Message not sent if power is removed. Detach type = 'power switched off, combined GPRS / IMSI detach'

Specific message contents

None.

44.2.1.2.6 Combined GPRS attach / rejected / GPRS services not allowed

44.2.1.2.6.1 Conformance requirement

- 1) If the network rejects a combined GPRS attach procedure from the Mobile Station with the cause 'GPRS services not allowed', the Mobile Station shall consider SIM invalid for GPRS services until power is switched off or SIM is removed.
- 2) If the network rejects a combined GPRS attach procedure from the Mobile Station with the cause 'GPRS services not allowed' the Mobile Station shall delete the stored RAI, GPRS-CKSN, P-TMSI and P-TMSI signature.
- 3) A GPRS class B MS shall perform an MM IMSI attach procedure.

Reference(s):

GSM 04.08 section 4.7.3.2

44.2.1.2.6.2 Test purpose

To test the behaviour of the MS if the network rejects the GPRS attach procedure of the MS with the cause 'GPRS services not allowed'.

44.2.1.2.6.3 Method of test

Initial conditions

System Simulator:

Two cells (not simultaneously activated), cell A in MCC1/MNC1/LAC1/RAC1 and cell B in MCC2/MNC1/LAC1/RAC1.

Both cells are operating in network operation mode I.

Mobile Station:

The MS has a valid TMSI, P-TMSI, P-TMSI signature and RAI. MS is Idle Updated on cell A.

Related PICS/PIXIT statement(s)

Support of GPRS service Yes/No

MS operation mode B Yes/No

Switch off on button Yes/No

Automatic GPRS attach procedure at switch on or power on Yes/No

Test procedure

The SS rejects a normal attach with the cause value 'GPRS services not allowed'. The SS checks that the MS does not perform GPRS attach. GPRS services are not possible. An MS operation mode B MS shall perform an MM IMSI attach.

Maximum duration of test

10 minutes.

Expected sequence

Step	Direction	Message	Comments
1	MS		The following messages are sent and shall be received on cell A.
2	SS		The MS is set in MS operation mode B (see PICS).
3	MS		The SS activates cell A.
4	MS -> SS	ATTACH REQUEST	The MS is powered up or switched on and initiates an attach (see PICS). Attach type = 'Combined GPRS / IMSI attach' Mobile identity = P-TMSI-1 P-TMSI-1 signature Routing area identity = RAI-2 TMSI status = valid TMSI available
5	SS -> MS	ATTACH REJECT	GMM cause 'GPRS services not allowed'
6	MS		An automatic MM IMSI attach procedure is initiated.
7	MS -> SS	CHANNEL REQUEST	
8	SS -> MS	IMMEDIATE ASSIGNMENT	
9	MS -> SS	LOCATION UPDATING REQ	Location updating type = IMSI attach.
10	SS -> MS	LOCATION UPDATING ACC	The SS allocates TMSI-2.
11	MS -> SS	TMSI REALLOCATION COMP	
12	SS -> MS	CHANNEL RELEASE	After sending of this message, the SS waits for disconnection of the CS signalling link.
13	SS -> MS	PACKET PAGING REQUEST	Mobile identity = TMSI-2 Paging order is for RR-connection.
14	MS -> SS	CHANNEL REQUEST	
15	SS -> MS	IMMEDIATE ASSIGNMENT	
16	MS -> SS	PAGING RESPONSE	Mobile identity = TMSI-2
17	SS -> MS	CHANNEL RELEASE	After sending of this message, the SS waits for disconnection of the CS signalling link.
18	SS		The following messages are sent and shall be received on cell B.
19	MS		The SS deactivates cell A and activates cell B.
20	MS		Cell B is preferred by the MS.
21	MS -> SS	CHANNEL REQUEST	A location updating procedure is initiated.
22	SS -> MS	IMMEDIATE ASSIGNMENT	
23	MS -> SS	LOCATION UPDATING REQ	Location updating type = normal.
24	SS -> MS	LOCATION UPDATING ACC	The SS allocates TMSI-1.
25	MS -> SS	TMSI REALLOCATION COMP	
26	SS -> MS	CHANNEL RELEASE	After sending of this message, the SS waits for disconnection of the CS signalling link.
27	SS -> MS	PACKET PAGING REQUEST	Mobile identity = TMSI-1 Paging order is for RR-connection.
28	MS -> SS	CHANNEL REQUEST	
29	SS -> MS	IMMEDIATE ASSIGNMENT	
30	MS -> SS	PAGING RESPONSE	Mobile identity = TMSI-1
31	SS -> MS	CHANNEL RELEASE	After sending of this message, the SS waits for disconnection of the CS signalling link.
32	SS -> MS	PACKET PAGING REQUEST	Mobile identity = TMSI-1 Paging order is for TBF establishment.
33	MS		No response from the MS to the request. This is checked for 10seconds.
34	MS		If possible (see PICS) switch off is performed. Otherwise the power is removed.
35	MS		The MS is powered up or switched on and initiates an attach (see PICS).
36	MS -> SS	ATTACH REQUEST	Attach type = 'Combined GPRS / IMSI attach' Mobile identity = IMSI TMSI status = no valid TMSI available
37	SS -> MS	ATTACH ACCEPT	Attach result = 'Combined GPRS / IMSI attached' Mobile identity = P-TMSI-1 P-TMSI-1 signature Mobile identity = TMSI-2 Routing area identity = RAI-2

38	MS -> SS	ATTACH COMPLETE	Mobile identity = TMSI-2 Paging order is for RR-connection.
39	SS -> MS	PACKET PAGING REQUEST	
40	MS -> SS	CHANNEL REQUEST	Mobile identity = TMSI-2 After sending of this message, the SS waits for disconnection of the CS signalling link. The MS is switched off or power is removed (see PICS).
41	SS -> MS	IMMEDIATE ASSIGNMENT	
42	MS -> SS	PAGING RESPONSE	
43	SS -> MS	CHANNEL RELEASE	
44	MS		
45	MS -> SS	DETACH REQUEST	Message not sent if power is removed. Detach type = 'power switched off, combined GPRS / IMSI detach'

Specific message contents

None.

44.2.1.2.7 Combined GPRS attach / rejected / location area not allowed

44.2.1.2.7.1 Conformance requirement

- 1) If the network rejects a combined GPRS attach procedure from the Mobile Station with the cause 'location area not allowed' the Mobile Station shall:
 - 1.1 not perform combined GPRS attach when in the same location area.
 - 1.2 delete the stored LAI, CKSN, TMSI, RAI, GPRS-CKSN, P-TMSI and P-TMSI signature.
 - 1.3 store the LA in the 'forbidden location areas for regional provision of service'.
- 2) If the network rejects a combined GPRS attach procedure from the Mobile Station with the cause 'location area not allowed' the Mobile Station shall:
 - 2.1 perform combined GPRS attach when a new location area is entered.
 - 2.2 delete the list of forbidden LAs when power is switched off.

Reference(s):

GSM 04.08 sections 4.7.3.2

44.2.1.2.7.2 Test purpose

To test the behaviour of the MS if the network rejects the combined GPRS attach procedure with the cause 'Location Area not allowed'.

To test that the MS deletes the list of forbidden LAs when power is switched off.

44.2.1.2.7.3 Method of test

Initial conditions

System Simulator:

Three cells (not simultaneously activated), cell A in MCC1/MNC1/LAC1/RAC1, cell B in MCC1/MNC1/LAC1/RAC2, cell C in MCC1/MNC1/LAC2/RAC1.

All cells are operating in network operation mode I.

Mobile Station:

The MS has a valid TMSI, P-TMSI, P-TMSI signature and RAI. MS is Idle Updated on cell A.

Related PICS/PIXIT statement(s)

Support of GPRS service Yes/No

MS operation mode B Yes/No

Switch off on button Yes/No

Automatic GPRS attach procedure at switch on or power on Yes/No

Test procedure

The SS rejects a combined GPRS attach with the cause value 'Location Area not allowed'. The SS checks that the MS does not perform combined GPRS attach while in the location area, performs GPRS attach when a new location area is entered and deletes the list of forbidden LAs when switched off. CS services are not possible unless an IMSI attach procedure is performed.

Different types of MS may use different methods to periodically clear the list of forbidden location areas (e.g. every day at 12am). If the list is cleared while the test is being run, it may be necessary to re-run the test.

Maximum duration of test

10 minutes.

Expected sequence

Step	Direction	Message	Comments
1	SS		The following messages are sent and shall be received on cell A.
2	SS		The SS activates cell A.
3	MS		The MS is set in MS operation mode B (see PICS).
4	MS -> SS	ATTACH REQUEST	The MS is powered up or switched on and initiates an attach (see PICS). Cell A is preferred by the MS.
5	SS -> MS	ATTACH REJECT	Attach type = 'Combined GPRS / IMSI attach'
6	MS		Mobile identity = P-TMSI-1 P-TMSI-1 signature Routing area identity = RAI-1
7	SS -> MS	PACKET PAGING REQUEST	GMM cause 'Location Area not allowed'
8	MS		No LOCATION UPDATING REQ with type 'IMSI attach' is sent to the SS (SS waits 30 seconds).
9	SS -> MS	PACKET PAGING REQUEST	Mobile identity = TMSI Paging order is for RR-connection.
10	MS -> SS		The MS shall not initiate an RR connection. This is checked during 3 seconds.
11	SS		Mobile identity = P-TMSI-1 Paging order is for TBF establishment.
12	MS		No response from the MS to the request.
13	MS		This is checked for 10 seconds
14	MS		The following messages are sent and shall be received on cell B.
15	SS -> MS	PACKET PAGING REQUEST	The SS deactivates cell A and activates cell B. Cell B is preferred by the MS.
16	MS		No ATTACH REQUEST sent to SS (SS waits 30 seconds)
17	MS		No LOCATION UPDATING REQ with type 'IMSI attach' is sent to the SS (SS waits 30 seconds).
18	MS		Mobile identity = TMSI-1 Paging order is for TBF establishment.
19	SS		No response from the MS to the request. This is checked for 10seconds.
20	MS		The MS initiates an attach by MMI or AT command.
21	MS -> SS	ATTACH REQUEST	No attach is performed by the MS. This is checked for 10 seconds.
22	SS -> MS	ATTACH ACCEPT	The following messages are sent and shall be received on cell C.
23	MS -> SS	ATTACH COMPLETE	The SS deactivates cell B and activates cell C. Cell C is preferred by the MS.
24	SS -> MS	PACKET PAGING REQUEST	Attach type = 'Combined GPRS / IMSI attach'
25	MS -> SS	CHANNEL REQUEST	Mobile identity = IMSI
26	SS -> MS	IMMEDIATE ASSIGNMENT	TMSI status = no valid TMSI available
27	MS -> SS	PAGING RESPONSE	Attach result = 'Combined GPRS / IMSI attached'
28	SS -> MS	CHANNEL RELEASE	Mobile identity = P-TMSI1 P-TMSI-1 signature Mobile identity = TMSI-1 Routing area identity = RAI-3
29	SS -> MS	PACKET PAGING REQUEST	Mobile identity = TMSI-1 Paging order is for RR-connection.
30	MS -> SS	UPLINK RLC DATA BLOCK	Mobile identity = TMSI-1 After sending of this message, the SS waits for disconnection of the CS signalling link.

31	MS		The MS is switched off or power is removed (see PICS).
32	MS -> SS	DETACH REQUEST	Message not sent if power is removed. Detach type = 'power switched off, combined GPRS / IMSI detach'
33	MS		The following messages are sent and shall be received on cell B. The SS deactivates cell C and activates cell B. Cell B is preferred by the MS.
34	MS		The MS is powered up or switched on and initiates an attach (see PICS).
35	MS -> SS	ATTACH REQUEST	Attach type = 'Combined GPRS / IMSI attach' Mobile identity = P-TMSI-1 P-TMSI-1 signature Routing area identity = RAI-3
36	SS -> MS	ATTACH ACCEPT	Attach result = 'Combined GPRS / IMSI attached' Mobile identity = P-TMSI-2 P-TMSI-2 signature Mobile identity = TMSI-2 Routing area identity = RAI-4
37	MS -> SS	ATTACH COMPLETE	
38	SS -> MS	PACKET PAGING REQUEST	Mobile identity = TMSI-2 Paging order is for RR-connection.
39	MS -> SS	CHANNEL REQUEST	
40	SS -> MS	IMMEDIATE ASSIGNMENT	
41	MS -> SS	PAGING RESPONSE	Mobile identity = TMSI-2
42	SS -> MS	CHANNEL RELEASE	After sending of this message, the SS waits for disconnection of the CS signalling link.
43	SS -> MS	PACKET PAGING REQUEST	Mobile identity = TMSI-1 Paging order is for TBF establishment.
44	MS -> SS	UPLINK RLC DATA BLOCK	LLC PDU implicitly indicating paging response.
45	MS		The MS is switched off or power is removed (see PICS).
46	MS -> SS	DETACH REQUEST	Message not sent if power is removed. Detach type = 'power switched off, combined GPRS / IMSI detach'

Specific message contents

None.

44.2.1.2.8 Combined GPRS attach / abnormal cases / attempt counter check / miscellaneous reject causes

44.2.1.2.8.1 Conformance requirement

- 1) When a combined GPRS attach procedure is rejected with the attach attempt counter less than five, the Mobile Station shall repeat the combined GPRS attach procedure after T3311 timeout.
- 2) When a combined GPRS attach procedure is rejected with the attach attempt counter five, the Mobile Station shall delete the stored TMSI, LAI, CKSN, P-TMSI, P-TMSI signature, GPRS CKSN and RAI and start T3302.
- 3) When the T3302 expire, a new combined GPRS attach procedure shall be initiated.

GMM cause codes that can be selected are:

'IMSI unknown in HLR'
'IMEI not accepted'
'Illegal ME'
'MS identity cannot be derived by the network'
'Network failure'
'Congestion'
'retry upon entry into a new cell'
'Semantically incorrect message'
'Invalid mandatory information'
'Message type non-existent or not implemented'
'Message type not compatible with the protocol state'
'Information element non-existent or not implemented'
'Conditional IE error'
'Message not compatible with the protocol state'
'Protocol error, unspecified'

Reference(s):

GSM 04.08 section 4.7.3.2

44.2.1.2.8.2 Test purpose

To test the behaviour of the MS with respect to the attach attempt counter.

44.2.1.2.8.3 Method of test

Initial conditions

System Simulator:

One cell operating in network operation mode I. T3302 is set to 12 minutes.

Mobile Station:

The MS has a valid TMSI, P-TMSI, P-TMSI signature and RAI. MS is Idle Updated.

Related PICS/PIXIT statement(s)

Support of GPRS service Yes/No

MS operation mode B Yes/No

Automatic GPRS attach procedure at switch on or power on Yes/No

Test procedure

The MS initiates a combined GPRS attach procedure (attach attempt counter zero). The SS rejects the attach with a random cause code. The attach attempt counter is incremented and T3311 is started.

The MS initiates a new combined GPRS attach procedure (attach attempt counter one) after T3311 expires. The SS rejects the attach with a random cause code. The attach attempt counter is incremented and T3311 is started.

The MS initiates a new combined GPRS attach procedure (attach attempt counter two) after T3311 expires. The SS rejects the attach with a random cause code. The attach attempt counter is incremented and T3311 is started.

The MS initiates a new combined GPRS attach procedure (attach attempt counter three) after T3311 expires. The SS rejects the attach with a random cause code. The attach attempt counter is incremented and T3311 is started.

The MS initiates a new combined GPRS attach procedure (attach attempt counter four) after T3311 expires. The SS rejects the attach with a random cause code. The attach attempt counter is incremented and T3311 is not started, as the attach attempt counter is five. T3302 is started.

The MS initiates a combined GPRS attach procedure with attach attempt counter zero after T3302 expires without P-TMSI, P-TMSI signature, GPRS CKSN and RAI.

Maximum duration of test

20 minutes.

Expected sequence

Step	Direction	Message	Comments
1	MS		The MS is set in MS operation mode B (see PICS).
2	MS		The MS is powered up or switched on and initiates an attach (see PICS).
3	MS -> SS	ATTACH REQUEST	Attach type = 'Combined GPRS / IMSI attach' Mobile identity = P-TMSI-1 P-TMSI-1 signature Routing area identity = RAI-1 TMSI status = valid TMSI available
4	SS -> MS	ATTACH REJECT	Random GMM cause
5	SS		The SS verifies that the time between the attach requests is T3311 (+/- 10%)
6	MS -> SS	ATTACH REQUEST	Attach type = 'Combined GPRS / IMSI attach' Mobile identity = P-TMSI-1 P-TMSI-1 signature Routing area identity = RAI-1 TMSI status = valid TMSI available
7	SS -> MS	ATTACH REJECT	Random GMM cause
8	SS		The SS verifies that the time between the attach requests is T3311 (+/- 10%)
9	MS -> SS	ATTACH REQUEST	Attach type = 'Combined GPRS / IMSI attach' Mobile identity = P-TMSI-1 P-TMSI-1 signature Routing area identity = RAI-1 TMSI status = valid TMSI available
10	SS -> MS	ATTACH REJECT	Random GMM cause
11	SS		The SS verifies that the time between the attach requests is T3311 (+/- 10%)
12	MS -> SS	ATTACH REQUEST	Attach type = 'Combined GPRS / IMSI attach' Mobile identity = P-TMSI-1 P-TMSI-1 signature Routing area identity = RAI-1 TMSI status = valid TMSI available
13	SS -> MS	ATTACH REJECT	Random GMM cause
14	SS		The SS verifies that the time between the attach requests is T3311 (+/- 10%)
15	MS -> SS	ATTACH REQUEST	Attach type = 'Combined GPRS / IMSI attach' Mobile identity = P-TMSI-1 P-TMSI-1 signature Routing area identity = RAI-1 TMSI status = valid TMSI available
16	SS -> MS	ATTACH REJECT	Random GMM cause
17	MS		No LOCATION UPDATING REQ with type 'IMSI attach' is sent to the SS (SS waits 30 seconds).
18	SS -> MS	PACKET PAGING REQUEST	Mobile identity = TMSI Paging order is for RR-connection.
19	MS		The MS shall not initiate an RR connection. This is checked during 3 seconds.
20	SS -> MS	PACKET PAGING REQUEST	Mobile identity = TMSI-1 Paging order is for TBF establishment.
21	MS		No response from the MS to the request. This is checked for 10seconds.
22	SS		The SS verifies that the MS does not attempt to attach for T3302 (+/- 10%).
23	MS -> SS	ATTACH REQUEST	Attach type = 'Combined GPRS / IMSI attach' Mobile identity = IMSI TMSI status = no valid TMSI available
24	SS -> MS	ATTACH ACCEPT	Attach result = 'Combined GPRS / IMSI attached' Mobile identity P-TMSI-1 P-TMSI signature Mobile identity = TMSI-1 Routing area identity = RAI-1
25	MS -> SS	ATTACH COMPLETE	

26	SS -> MS	PACKET PAGING REQUEST	Mobile identity = TMSI-1 Paging order is for RR-connection.
27	MS -> SS	CHANNEL REQUEST	
28	SS -> MS	IMMEDIATE ASSIGNMENT	
29	MS -> SS	PAGING RESPONSE	Mobile identity = TMSI-1
30	SS -> MS	CHANNEL RELEASE	After sending of this message, the SS waits for disconnection of the CS signalling link.
31	SS -> MS	PACKET PAGING REQUEST	Mobile identity = TMSI-1 Paging order is for TBF establishment.
32	MS -> SS	UPLINK RLC DATA BLOCK	LLC PDU implicitly indicating paging response.
33	MS		The MS is switched off or power is removed (see PICS).
34	MS -> SS	DETACH REQUEST	Message not sent if power is removed. Detach type = 'power switched off, combined GPRS / IMSI detach'

Specific message contents

None.

44.2.1.2.9 Combined GPRS attach / abnormal cases / GPRS detach procedure collision

44.2.1.2.9.1 Conformance requirement

44.2.1.2.9.1 Conformance requirement

- 1) When a DETACH REQUEST message is received by the MS (Detach type 're-attach not required') while waiting for an ATTACH ACCEPT message or ATTACH REJECT message, the MS shall terminate the combined GPRS attach procedure and continue with the combined GPRS detach procedure.
- 2) When a DETACH REQUEST message is received by the MS (Detach type 're-attach required') while waiting for an ATTACH ACCEPT message or ATTACH REJECT message, the MS shall ignore the combined GPRS detach procedure and continue with the combined GPRS attach procedure.

Reference(s):

GSM 04.08 section 4.7.3.2

44.2.1.2.9.2 Test purpose

To test the behaviour of the MS in case of procedure collision.

44.2.1.2.9.3 Method of test

Initial conditions

System Simulator:

One cell operating in network operation mode I.

Mobile Station:

The MS has a valid TMSI, P-TMSI, P-TMSI signature and RAI. MS is Idle Updated.

Related PICS/PIXIT statement(s)

Support of GPRS service Yes/No

MS operation mode B Yes/No

Switch off on button Yes/No

Automatic GPRS attach procedure at switch on or power on Yes/No

Test procedure

The MS initiates a combined GPRS attach procedure. The SS does not answer the combined GPRS attach procedure, but initiates a combined GPRS detach procedure (Detach type 're-attach not required'). The MS shall terminate the combined GPRS attach procedure and continue with the combined GPRS detach procedure. CS services are not possible as an IMSI attach procedure is not performed.

The MS initiates a combined GPRS attach procedure. The SS does not answer the combined GPRS attach procedure, but initiates a combined GPRS detach procedure (Detach type 're-attach required'). The MS shall ignore the combined GPRS detach procedure and continue with the combined GPRS attach. CS services are also possible.

Maximum duration of test

5 minutes.

Expected sequence

Step	Direction	Message	Comments
1	MS		The MS is set in MS operation mode B (see PICS).
2	MS		The MS is powered up or switched on and initiates an attach (see PICS).
3	MS -> SS	ATTACH REQUEST	Attach type = 'Combined GPRS / IMSI attach' Mobile identity = P-TMSI-1 P-TMSI-1 signature Routing area identity = RAI-1 TMSI status = valid TMSI available
4	SS		The SS ignores the ATTACH REQUEST message and initiates a detach procedure.
5	SS -> MS	DETACH REQUEST	Detach type = 're-attach not required'
6	MS -> SS	DETACH ACCEPT	
7	SS -> MS	PACKET PAGING REQUEST	Mobile identity = IMSI Paging order is for RR-connection.
8	MS		The MS shall not initiate an RR connection. This is checked during 3 seconds.
9	MS		The MS is attached by MMI or AT command
10	MS -> SS	ATTACH REQUEST	Attach type = 'Combined GPRS / IMSI attach' Mobile identity = P-TMSI-1 P-TMSI-1 signature Routing area identity = RAI-1 TMSI status = valid TMSI available
11	SS		The SS ignores the ATTACH REQUEST message and initiates a detach procedure.
12	SS -> MS	DETACH REQUEST	Detach type = 're-attach required'
13	MS		The MS ignores the DETACH REQUEST message and continue with the attach procedure
14	SS -> MS	ATTACH ACCEPT	Attach result = 'Combined GPRS / IMSI attached' Mobile identity = P-TMSI-2 P-TMSI-2 signature Mobile identity = TMSI-2 Routing area identity = RAI-1 TMSI status = valid TMSI available
15	MS -> SS	ATTACH COMPLETE	
16	SS -> MS	PACKET PAGING REQUEST	Mobile identity = TMSI-2 Paging order is for RR-connection.
17	MS -> SS	CHANNEL REQUEST	
18	SS -> MS	IMMEDIATE ASSIGNMENT	
19	MS -> SS	PAGING RESPONSE	Mobile identity = TMSI-2
20	SS -> MS	CHANNEL RELEASE	After sending of this message, the SS waits for disconnection of the CS signalling link.
21	SS -> MS	PACKET PAGING REQUEST	Mobile identity = TMSI-2 Paging order is for TBF establishment.
22	MS -> SS	UPLINK RLC DATA BLOCK	LLC PDU implicitly indicating paging response.
23	MS		The MS is switched off or power is removed (see PICS).
24	MS -> SS	DETACH REQUEST	Message not sent if power is removed. Detach type = 'power switched off, combined GPRS / IMSI detach'

Specific message contents

None.

44.2.2 GPRS detach procedure

This procedure is used to indicate for the network that the IMSI is not available for traffic. The GMM context is removed.

44.2.2.1 MS initiated GPRS detach procedure

44.2.2.1.1 GPRS detach / power off / accepted

44.2.2.1.1.1 Conformance requirement

The MS detaches the IMSI for GPRS services if the MS is switched off.

Reference(s):

GSM 04.08 section 4.7.4.1

44.2.2.1.1.2 Test purpose

To test the behaviour of the MS for the detach procedure.

44.2.2.1.1.3 Method of test

Initial conditions

System Simulator:

One cell operating in network operation mode II.

Mobile Station:

The MS has a valid P-TMSI-1, P-TMSI-1 signature and RAI-1. MS is Idle Updated.

Related PICS/PIXIT statement(s)

Support of GPRS service Yes/No

MS operation mode C Yes/No

MS operation mode B Yes/No

Switch off on button Yes/No

Automatic GPRS attach procedure at switch on or power on Yes/No

Test procedure

The MS performs a GPRS attach procedure.

The MS sends a DETACH REQUEST message to the SS.

Maximum duration of test

5 minutes.

Expected sequence

Step	Direction	Message	Comments
1	MS		The MS is set in MS operation mode C (see PICS). If MS operation mode C not supported, goto step 8.
2	MS		The MS is powered up or switched on and initiates an attach (see PICS).
3	MS -> SS	ATTACH REQUEST	Attach type = 'GPRS attach' Mobile identity = P-TMSI-1 P-TMSI-1 signature
4	SS -> MS	ATTACH ACCEPT	Routing area identity = RAI-1 Attach result = 'GPRS only attached' Mobile identity = P-TMSI-2 P-TMSI-2 signature Routing area identity = RAI-1
5	MS -> SS	ATTACH COMPLETE	
6	MS		The MS is switched off (see PICS).
7	MS -> SS	DETACH REQUEST	Detach type = 'power switched off, GPRS detach'
8	MS		The MS is set in MS operation mode B (see PICS) and the test is repeated from step 2 to step 7.

Specific message contents

None.

44.2.2.1.2 GPRS detach / accepted

44.2.2.1.2.1 Conformance requirement

The MS detaches the IMSI for GPRS services if the MS is ordered to do so with MMI or AT commands.

Reference(s):

GSM 04.08 section 4.7.4.1

44.2.2.1.2.2 Test purpose

To test the behaviour of the MS for the detach procedure.

44.2.2.1.2.3 Method of test

Initial conditions

System Simulator:

One cell operating in network operation mode III.

Mobile Station:

The MS has a valid P-TMSI-1, P-TMSI-1 signature and RAI-1. MS is Idle Updated.

Related PICS/PIXIT statement(s)

Support of GPRS service Yes/No

MS operation mode C Yes/No

MS operation mode B Yes/No

Switch off on button Yes/No

Automatic GPRS attach procedure at switch on or power on Yes/No

Test procedure

The MS performs a GPRS attach procedure and activates a PDP context.

The MS sends a DETACH REQUEST message to the SS.

The SS signal to the MS, but no response is received, as the signalling link is disconnected.

Maximum duration of test

5 minutes.

Expected sequence

Step	Direction	Message	Comments
1	MS		The MS is set in MS operation mode C (see PICS). If MS operation mode C not supported, goto step 11.
2	MS		The MS is powered up or switched on and initiates an attach (see PICS).
3	MS -> SS	ATTACH REQUEST	Attach type = 'GPRS attach' Mobile identity = P-TMSI-1 P-TMSI-1 signature Routing area identity = RAI-1
4	SS -> MS	ATTACH ACCEPT	No new mobile identity assigned. P-TMSI and P-TMSI signature not included. Attach result = 'GPRS only attached' Routing area identity = RAI-1
5	MS		The MS initiates a GPRS detach (without power off) by MMI or AT command.
6	MS -> SS	DETACH REQUEST	Detach type = 'normal detach, GPRS detach'
7	SS -> MS	DETACH ACCEPT	
8	SS -> MS	PACKET PAGING REQUEST Or PAGING REQUEST TYPE 1	Mobile identity = P-TMSI-1 Both paging orders are for TBF establishment. PACKET PAGING REQUEST (used for NW mode III) PAGING REQUEST TYPE 1 (used for NW-mode II).
9	MS		No response from the MS to the request. This is checked for 10 seconds.
10	SS		The SS is set in network operation mode II.
11	MS		The MS is set in MS operation mode B (see PICS) and the test is repeated from step 2 to step 10.

Specific message contents

None.

44.2.2.1.3 GPRS detach / abnormal cases / attempt counter check / procedure timeout

44.2.2.1.3.1 Conformance requirement

- 1) When a T3321 timeout has occurred during a GPRS detach procedure with the retransmission counter less than five, the Mobile Station shall repeat the GPRS detach procedure.
- 2) When a T3321 timeout has occurred during a GPRS detach procedure with the retransmission counter five, the Mobile Station shall not repeat the procedure.

Reference(s):

GSM 04.08 section 4.7.4.1

44.2.2.1.3.2 Test purpose

To test the behaviour of the MS with respect to the retransmission counter.

44.2.2.1.3.3 Method of test

Initial conditions

System Simulator:

One cell operating in network operation mode III.

Mobile Station:

The MS has a valid P-TMSI-1, P-TMSI-1 signature and RAI-1. MS is Idle Updated.

Related PICS/PIXIT statement(s)

Support of GPRS service Yes/No

MS operation mode C Yes/No

MS operation mode B Yes/No

Automatic GPRS attach procedure at switch on or power on Yes/No

Test procedure

The MS initiates a GPRS detach procedure. The SS does not answer with DETACH ACCEPT message before T3321 timeout. The retransmission counter is set to one.

The MS initiates a new GPRS detach procedure (retransmission counter one) after T3321 expires. The SS does not answer with DETACH ACCEPT message before T3321 timeout. The retransmission counter is incremented.

The MS initiates a new GPRS detach procedure (retransmission counter two) after T3321 expires. The SS does not answer with DETACH ACCEPT message before T3321 timeout. The retransmission counter is incremented.

The MS initiates a new GPRS detach procedure (retransmission counter three) after T3321 expires. The SS does not answer with DETACH ACCEPT message before T3321 timeout. The retransmission counter is incremented.

The MS initiates a new GPRS detach procedure (retransmission counter four) after T3321 expires. The SS does not answer with DETACH ACCEPT message before T3321 timeout. The retransmission counter is incremented.

The MS then deletes the logical link since the retransmission has been repeated four times.

The MS performs a new GPRS attach procedure.

Maximum duration of test

5 minutes.

Expected sequence

Step	Direction	Message	Comments
1	MS		The MS is set in MS operation mode C (see PICS). If MS operation mode C not supported, goto step 21.
2	MS		The MS is powered up or switched on and initiates an attach (see PICS).
3	MS -> SS	ATTACH REQUEST	Attach type = 'GPRS attach' Mobile identity = P-TMSI-1 P-TMSI-1 signature
4	SS -> MS	ATTACH ACCEPT	Routing area identity = RAI-1 No new mobile identity assigned. P-TMSI and P-TMSI signature not included. Attach result = 'GPRS only attached' Routing area identity = RAI-1
5	MS		The MS initiates a GPRS detach (without power off) by MMI or AT command.
6	MS -> SS	DETACH REQUEST	Detach type = 'normal detach, GPRS detach'
7	SS		No response is given from the SS.
8	SS		The SS verifies that the time between the detach requests is T3321 seconds (+/- 10%)
9	MS -> SS	DETACH REQUEST	Detach type = 'normal detach, GPRS detach'
10	SS		No response is given from the SS.
11	SS		The SS verifies that the time between the detach requests is T3321 seconds (+/- 10%)
12	MS -> SS	DETACH REQUEST	Detach type = 'normal detach, GPRS detach'
13	SS		No response is given from the SS.
14	SS		The SS verifies that the time between the detach requests is T3321 seconds (+/- 10%)
15	MS -> SS	DETACH REQUEST	Detach type = 'normal detach, GPRS detach'
16	SS		No response is given from the SS.
17	SS		The SS verifies that the time between the detach requests is T3321 seconds (+/- 10%)
18	MS -> SS	DETACH REQUEST	Detach type = 'normal detach, GPRS detach'
19	SS		No response is given from the SS within 40 seconds and SS verifies that the MS will not send a DETACH REQUEST again.
20	MS		Initiate a GPRS attach
21	MS -> SS	ATTACH REQUEST	Attach type = 'GPRS attach' Mobile identity = P-TMSI-1 P-TMSI-1 signature
22	SS -> MS	ATTACH ACCEPT	Routing area identity = RAI-1 No new mobile identity assigned. P-TMSI and P-TMSI signature not included. Attach result = 'GPRS only attached' Routing area identity = RAI-1
23			MS is switched off or power is removed (see PICS)
24	MS -> SS	DETACH REQUEST	Message not sent if power is removed. Detach type = 'power switched off, GPRS detach'
25	SS		The SS is set in network operation mode II.
26	MS		The MS is set in MS operation mode B (see PICS) and the test is repeated from step 2 to step 24.

Specific message contents

None.

44.2.2.1.4 GPRS detach / abnormal cases / GMM common procedure collision

44.2.2.1.4.1 Conformance requirement

When any of the GMM common messages P-TMSI REALLOCATION COMMAND, GMM STATUS or GMM INFORMATION is received by the MS while waiting for a DETACH ACCEPT message with detach cause different from "power off", the MS shall ignore the GMM common message.

Reference(s):

GSM 04.08 section 4.7.4.1

44.2.2.1.4.2 Test purpose

To test the behaviour of the MS in case of procedure collision.

44.2.2.1.4.3 Method of test

Initial conditions

System Simulator:

One cell operating in network operation mode II.

Mobile Station:

The MS has a valid IMSI. MS is Idle Updated.

Related PICS/PIXIT statement(s)

Support of GPRS service Yes/No

MS operation mode C Yes/No

MS operation mode B Yes/No (only if mode C not supported)

Switch off on button Yes/No

Automatic GPRS attach procedure at switch on or power on Yes/No

Test procedure

The MS performs a GPRS attach.

The MS initiates a GPRS detach. The SS initiates a P-TMSI REALLOCATION COMMAND message, a GMM STATUS message and a GMM INFORMATION message. The MS shall ignore the GMM common messages and continue with the GPRS detach procedure.

The SS signal to the MS, but no response is received, as the signalling link is disconnected.

Maximum duration of test

5 minutes.

Expected sequence

Step	Direction	Message	Comments
1	MS		The MS is set in MS operation mode C or B (see PICS).
2	MS		The MS is powered up or switched on and initiates an attach (see PICS).
3	MS -> SS	ATTACH REQUEST	Attach type = 'GPRS attach'
4	SS -> MS	ATTACH ACCEPT	Mobile identity = IMSI Attach result = 'GPRS only attached'
5	MS -> SS	ATTACH COMPLETE	Mobile identity = P-TMSI-1 P-TMSI-1 signature Routing area identity = RAI-1
6	MS		The MS initiates a detach (without power off) by MMI or AT command.
7	MS -> SS	DETACH REQUEST	Detach type = 'normal detach, GPRS detach'
8	SS		The SS sends a P-TMSI REALLOCATION COMMAND message
9	SS -> MS	P-TMSI REALLOCATION COMMAND	
10	MS		The MS ignores the message.
11	SS		The SS sends a GMM STATUS message
12	SS -> MS	GMM STATUS	
13	MS		The MS ignores the message.
14	SS		The SS sends a GMM INFORMATION message
15	SS -> MS	GMM INFORMATION	
16	MS		The MS ignores the message.
17	SS -> MS	DETACH ACCEPT	The SS responds to the DETACH REQUEST
18	SS -> MS	PAGING REQUEST TYPE 1	Mobile identity = P-TMSI-1 Paging order is for TBF establishment.
19	MS		No response from the MS to the request. This is checked for 10 seconds.

Specific message contents

None.

44.2.2.1.5 GPRS detach / power off / accepted

44.2.2.1.5.1 Conformance requirement

The MS detach the IMSI for GPRS and non-GPRS services.

Reference(s):

GSM 04.08 section 4.7.4.1

44.2.2.1.5.2 Test purpose

To test the behaviour of the MS for the detach procedure.

44.2.2.1.5.3 Method of test

Initial conditions

System Simulator:

One cell operating in network operation mode I.

Mobile Station:

The MS has a valid IMSI. MS is Idle Updated.

Related PICS/PIXIT statement(s)

Support of GPRS service Yes/No

MS operation mode B Yes/No

Switch off on button Yes/No

Automatic GPRS attach procedure at switch on or power on Yes/No

Test procedure

The MS performs a combined GPRS attach procedure (for GPRS and non-GPRS services).

The MS sends a DETACH REQUEST message to the SS. The MS then deletes the logical link.

Maximum duration of test

5 minutes.

Expected sequence

Step	Direction	Message	Comments
1	MS		The MS is set in MS operation mode B (see PICS).
2	MS		The MS is powered up or switched on and initiates an attach (see PICS).
3	MS -> SS	ATTACH REQUEST	Attach type = 'Combined GPRS / IMSI attach' Mobile identity = IMSI
4	SS -> MS	ATTACH ACCEPT	TMSI status = no valid TMSI available Attach result = 'Combined GPRS / IMSI attached' Mobile identity = P-TMSI-1 P-TMSI-1 signature Routing area identity = RAI-1
5	MS -> SS	ATTACH COMPLETE	
6	MS		The MS is switched off (see PICS).
7	MS -> SS	DETACH REQUEST	Detach type = 'power switched off, combined GPRS / IMSI detach'

Specific message contents

None.

44.2.2.1.6 GPRS detach / accepted / GPRS/IMSI detach

44.2.2.1.6.1 Conformance requirement

The MS detach the IMSI for GPRS and non-GPRS services.

Reference(s):

GSM 04.08 section 4.7.4.1

44.2.2.1.6.2 Test purpose

To test the behaviour of the MS for the detach procedure.

44.2.2.1.6.3 Method of test

Initial conditions

System Simulator:

One cell operating in network operation mode I.

Mobile Station:

The MS has a valid IMSI. MS is Idle Updated.

Related PICS/PIXIT statement(s)

Support of GPRS service Yes/No

MS operation mode B Yes/No

Switch off on button Yes/No

Automatic GPRS attach procedure at switch on or power on Yes/No

Test procedure

The MS performs a combined GPRS attach procedure (for GPRS and non-GPRS services).

The MS sends a DETACH REQUEST message to the SS. When the MS receives the DETACH ACCEPT, the MS then deletes the logical link.

The SS signal to the MS, but no response is received, as the signalling link is disconnected.

Maximum duration of test

5 minutes.

Expected sequence

Step	Direction	Message	Comments
1	MS		The MS is set in MS operation mode B (see PICS).
2	MS		The MS is powered up or switched on and initiates an attach (see PICS).
3	MS -> SS	ATTACH REQUEST	Attach type = 'Combined GPRS / IMSI attach' Mobile identity = IMSI
4	SS -> MS	ATTACH ACCEPT	TMSI status = no valid TMSI available Attach result = 'Combined GPRS / IMSI attached' Mobile identity = P-TMSI-1 P-TMSI-1 signature Mobile identity = TMSI-1 Routing area identity = RAI-1
5	MS -> SS	ATTACH COMPLETE	
6	MS		The MS initiates a detach (without power off) by MMI or AT command.
7	MS -> SS	DETACH REQUEST	Detach type = 'normal detach, combined GPRS / IMSI detach'
8	SS -> MS	DETACH ACCEPT	
9	SS -> MS	PACKET PAGING REQUEST	Mobile identity = P-TMSI-1 Paging order is for TBF establishment.
10	MS		No response from the MS to the request. This is checked for 10 seconds.
11	SS -> MS	PACKET PAGING REQUEST	Mobile identity = IMSI Paging order is for RR connection.
12	MS		The MS shall not initiate an RR connection. This is checked during 3 seconds.

Specific message contents

None.

44.2.2.1.7 GPRS detach / accepted / IMSI detach

44.2.2.1.7.1 Conformance requirement

The MS shall detach for CS services.

Reference(s):

GSM 04.08 section 4.7.4.1

44.2.2.1.7.2 Test purpose

To test the behaviour of the MS for the detach procedure.

44.2.2.1.7.3 Method of test

Initial conditions

System Simulator:

One cell operating in network operation mode I.

Mobile Station:

The MS has a valid IMSI. MS is Idle Updated.

Related PICS/PIXIT statement(s)

Support of GPRS service Yes/No

MS operation mode B Yes/No

Switch off on button Yes/No

Automatic GPRS attach procedure at switch on or power on Yes/No

MMI controlled attach / detach procedures for non-GPRS services Yes/No

Test procedure

The MS performs a combined GPRS attach procedure (for GPRS and non-GPRS services).

The MS performs an GPRS detach (for non-GPRS services).

CS services are not possible.

The MS attach for non-GPRS services by a routing area update procedure and CS services are again possible.

Maximum duration of test

5 minutes.

Expected sequence

Step	Direction	Message	Comments
1	MS		The MS is set in MS operation mode B (see PICS).
2	MS		The MS is powered up or switched on and initiates an attach (see PICS).
3	MS -> SS	ATTACH REQUEST	Attach type = 'Combined GPRS / IMSI attach' Mobile identity = IMSI
4	SS -> MS	ATTACH ACCEPT	TMSI status = no valid TMSI available Attach result = 'Combined GPRS / IMSI attached' Mobile identity = P-TMSI-1 P-TMSI-1 signature Mobile identity = TMSI-1 Routing area identity = RAI-1
5	MS -> SS	ATTACH COMPLETE	
6	MS		The MS initiates a detach for non-GPRS services (without power off) (see PICS).
7	MS -> SS	DETACH REQUEST	Detach type = 'normal detach, IMSI detach'
8	MS -> SS	DETACH ACCEPT	
9	SS -> MS	PACKET PAGING REQUEST	Mobile identity = P-TMSI-1 Paging order is for TBF establishment.
10	MS -> SS	UPLINK RLC DATA BLOCK	LLC PDU implicitly indicating paging response.
11	SS -> MS	PACKET PAGING REQUEST	Mobile identity = TMSI-1 Paging order is for RR connection.
12	MS		The MS shall not initiate an RR connection.
13	MS		This is checked during 3 seconds.
14	MS -> SS	ROUTING AREA UPDATE REQUEST	The MS initiates an attach for non-GPRS services by a RA update procedure (see PICS). Update type = 'Combined RA/LA updating' P-TMSI-1 signature
15	SS -> MS	ROUTING AREA UPDATE ACCEPT	Routing area identity = RAI-1 TMSI status = valid TMSI available Update result = 'Combined RA/LA updated' Mobile identity = P-TMSI-2 P-TMSI-2 signature Mobile identity = TMSI-1 Routing area identity = RAI-1
16	MS -> SS	ROUTING AREA UPDATE COMPLETE	
17	SS -> MS	PACKET PAGING REQUEST	Mobile identity = TMSI-1 Paging order is for RR connection.
18	MS -> SS	CHANNEL REQUEST	
19	SS -> MS	IMMEDIATE ASSIGNMENT	
20	MS -> SS	PAGING RESPONSE	
21	SS -> MS	CHANNEL RELEASE	Mobile identity = TMSI-1 After sending of this message, the SS waits for disconnection of the CS signalling link.
22	MS		The MS is switched off or power is removed (see PICS).
23	MS -> SS	DETACH REQUEST	Message not sent if power is removed. Detach type = 'power switched off, combined GPRS / IMSI detach'

Specific message contents

None.

44.2.2.1.8 GPRS detach / abnormal cases / change of cell into new routing area

44.2.2.1.8.1 Conformance requirement

When a change of cell into a new routing area is performed before DETACH ACCEPT message is received by the MS, the MS shall abort the GPRS detach procedure and re-initiate it after the routing area update procedure.

Reference(s):

GSM 04.08 section 4.7.4.1

44.2.2.1.8.2 Test purpose

To test the behaviour of the MS in case of procedure collision.

44.2.2.1.8.3 Method of test

Initial conditions

System Simulator:

Two cells (not simultaneously activated), cell A in MCC1/MNC1/LAC1/RAC1 and cell B in MCC1/MNC1/LAC1/RAC2.

Both cells are operating in network operation mode I.

Mobile Station:

The MS has a valid IMSI. MS is Idle Updated on cell A.

Related PICS/PIXIT statement(s)

Support of GPRS service Yes/No

MS operation mode B Yes/No

Switch off on button Yes/No

Automatic GPRS attach procedure at switch on or power on Yes/No

Test procedure

The MS performs a combined GPRS attach procedure (for GPRS and non-GPRS services).

The MS initiates a GPRS detach procedure. The DETACH ACCEPT message is delayed from the SS. The MS performs a cell update into a new routing area.

The Ms shall re-initiate a GPRS detach procedure when the routing area update procedure is finished.

The MS deletes the logical link.

Maximum duration of test

5 minutes.

Expected sequence

Step	Direction	Message	Comments
	SS		The following messages are sent and shall be received on cell A.
1	SS		The SS activates cell A.
2	MS		The MS is set in MS operation mode B (see PICS).
3	MS		The MS is powered up or switched on and initiates an attach (see PICS). Cell A is preferred by the MS.
4	MS -> SS	ATTACH REQUEST	Attach type = 'Combined GPRS / IMSI attach' Mobile identity = IMSI
5	SS -> MS	ATTACH ACCEPT	TMSI status = no valid TMSI available Attach result = 'Combined GPRS / IMSI attached' Mobile identity = P-TMSI-1 P-TMSI-1 signature Mobile identity = TMSI-1 Routing area identity = RAI-1
6	MS -> SS	ATTACH COMPLETE	
7	MS		The MS initiates a GPRS detach (without power off) by MMI or AT command.
8	MS -> SS	DETACH REQUEST	Detach type = 'normal detach, combined GPRS / IMSI detach'
9	SS		No response to the DETACH REQUEST message is given by the SS
	SS		The following messages are sent and shall be received on cell B.
10	SS		The SS deactivates cell A and activates cell B. Cell B is preferred by the MS.
11	MS		The MS performs a RA update in the new cell.
12	MS -> SS	ROUTING AREA UPDATE REQUEST	Update type = 'Combined RA/LA updating' Mobile identity = P-TMSI-1 P-TMSI-1 signature Routing area identity = RAI-1 TMSI status = valid TMSI available
13	SS -> MS	ROUTING AREA UPDATE ACCEPT	Update result = 'Combined RA/LA updated' Mobile identity = P-TMSI-2 P-TMSI-2 signature Routing area identity = RAI-4
14	MS -> SS	ROUTING AREA UPDATE COMPLETE	
15	MS -> SS	DETACH REQUEST	The detach is automatically re-attempted.
16	MS -> SS	DETACH ACCEPT	Detach type = 'normal detach, combined GPRS / IMSI detach'

Specific message contents

None.

44.2.2.1.9 GPRS detach / abnormal cases / GPRS detach procedure collision

44.2.2.1.9.1 Conformance requirement

When a DETACH REQUEST is received by the MS while waiting for a DETACH ACCEPT message, the MS shall answer the network initiated GPRS detach procedure.

Reference(s):

GSM 04.08 section 4.7.4.1

44.2.2.1.9.2 Test purpose

To test the behaviour of the MS in case of procedure collision.

44.2.2.1.9.3 Method of test

Initial conditions

System Simulator:

One cell operating in network operation mode I.

Mobile Station:

The MS has a valid IMSI. MS is Idle Updated.

Related PICS/PIXIT statement(s)

Support of GPRS service Yes/No

MS operation mode B Yes/No

Switch off on button Yes/No

Automatic GPRS attach procedure at switch on or power on Yes/No

Test procedure

The MS performs a combined GPRS attach procedure (for GPRS and non-GPRS services).

The MS initiates a GPRS detach. The SS does not answer the detach procedure, but initiates a detach procedure (cause re-attach not required). The MS shall continue with the network initiated detach procedure.

The MS deletes the logical link.

GPRS and CS services are not possible.

Maximum duration of test

5 minutes.

Expected sequence

Step	Direction	Message	Comments
1	MS		The MS is set in MS operation mode B (see PICS).
2	MS		The MS is powered up or switched on and initiates an attach (see PICS).
3	MS -> SS	ATTACH REQUEST	Attach type = 'Combined GPRS / IMSI attach' Mobile identity = IMSI
4	SS -> MS	ATTACH ACCEPT	TMSI status = no valid TMSI available Attach result = 'Combined GPRS / IMSI attached' Mobile identity = P-TMSI-1 P-TMSI-1 signature Mobile identity = TMSI-1 Routing area identity = RAI-1
5	MS -> SS	ATTACH COMPLETE	
6	MS		The MS initiates a GPRS detach (without power off) by MMI or AT command.
7	MS -> SS	DETACH REQUEST	Detach type = 'normal detach, combined GPRS / IMSI detach'
8	SS -> MS	DETACH REQUEST	Detach type = 're-attach not required'
9	MS -> SS	DETACH ACCEPT	The MS answers the network initiated detach.
10	SS -> MS	DETACH ACCEPT	The SS answers the MS initiated detach.
11	SS -> MS	PACKET PAGING REQUEST	Mobile identity = P-TMSI-1 Paging order is for TBF establishment.
12	MS		No response from the MS to the request. This is checked for 10 seconds.
13	SS -> MS	PAGING REQUEST TYPE 1	Mobile identity = TMSI-1 Paging order is for RR connection.
14	MS		The MS shall not initiate an RR connection. This is checked during 3 seconds.

Specific message contents

None.

44.2.2.2 Network initiated GPRS detach procedure

44.2.2.2.1 GPRS detach / re-attach not required / accepted

44.2.2.2.1.1 Conformance requirement

The MS detach the IMSI for GPRS services.

Reference(s):

GSM 04.08 section 4.7.4.2

44.2.2.2.1.2 Test purpose

To test the behaviour of the MS for the detach procedure.

44.2.2.2.1.3 Method of test

Initial conditions

System Simulator:

One cell operating in network operation mode II (in case of MS operation mode B), or in network operation mode III (in case of MS operation mode C).

Mobile Station:

The MS has a valid IMSI. MS is Idle Updated.

Related PICS/PIXIT statement(s)

Support of GPRS service Yes/No

MS operation mode C Yes/No

MS operation mode B Yes/No (only if mode C not supported)

Switch off on button Yes/No

Automatic GPRS attach procedure at switch on or power on Yes/No

Test procedure

The MS performs a GPRS attach procedure.

The SS sends a DETACH REQUEST message to the MS. The MS then deletes the logical link.

The SS signal to the MS, but no response is received, as the signalling link is disconnected.

Maximum duration of test

5 minutes.

Expected sequence

Step	Direction	Message	Comments
1	SS		The SS is set in network operation mode II or III.
2	MS		The MS is set in MS operation mode B or C (see PICS).
3	MS		The MS is powered up or switched on and initiates an attach (see PICS).
4	MS -> SS	ATTACH REQUEST	Attach type = 'GPRS attach'
5	SS -> MS	ATTACH ACCEPT	Mobile identity = IMSI Attach result = 'GPRS only attached'
6	MS -> SS	ATTACH COMPLETE	Mobile identity = P-TMSI-1 P-TMSI-1 signature Routing area identity = RAI-1
7	SS -> MS	DETACH REQUEST	
8	MS -> SS	DETACH ACCEPT	Detach type = 're-attach not required'
9	SS -> MS	PACKET PAGING REQUEST Or PAGING REQUEST TYPE 1	Mobile identity = P-TMSI-1 Both paging orders are for TBF establishment. PACKET PAGING REQUEST (used for NW mode III) PAGING REQUEST TYPE 1 (used for NW-mode II).
10	MS		No response from the MS to the request. This is checked for 10 seconds.

Specific message contents

None.

44.2.2.2.2 GPRS detach / rejected / IMSI invalid / GPRS services not allowed

44.2.2.2.2.1 Conformance requirement

- 1) If the network performs a GPRS detach procedure with the cause 'GPRS services not allowed', the Mobile Station shall consider SIM invalid for GPRS services until power is switched off or SIM is removed.

- 2) If the network performs a GPRS detach procedure with the cause 'GPRS services not allowed' the Mobile Station shall delete the stored RAI, GPRS-CKSN, P-TMSI and P-TMSI signature.

Reference(s):

GSM 04.08 section 4.7.4.2

44.2.2.2.2 Test purpose

To test the behaviour of the MS if the network order a GPRS detach procedure with the cause 'GPRS services not allowed' (no valid GPRS-subscription for the IMSI).

44.2.2.2.3 Method of test**Initial conditions****System Simulator:**

Two cells (not simultaneously activated), cell A in MCC1/MNC1/LAC1/RAC1 (HPLMN) and cell B in MCC2/MNC1/LAC1/RAC1.

Both cells are operating in network operation mode II.

Mobile Station:

The MS has a valid P-TMSI-1, P-TMSI-1 signature and RAI-1. MS is Idle Updated on cell A.

Related PICS/PIXIT statement(s)

Support of GPRS service Yes/No

MS operation mode C Yes/No

MS operation mode B Yes/No

SIM removal possible without powering down Yes/No

Switch off on button Yes/No

Automatic GPRS attach procedure at switch on or power on Yes/No

Test procedure

The SS performs a detach with the cause value 'GPRS services not allowed'. The SS checks that the MS does not perform GPRS attach in another PLMN.

Maximum duration of test

10 minutes.

Expected sequence

Step	Direction	Message	Comments
1	SS		The following messages are sent and shall be received on cell A.
2	MS		The SS activates cell A.
3	MS		The MS is set in MS operation mode C (see PICS). If MS operation mode C not supported, goto step 19.
4	MS -> SS	ATTACH REQUEST	The MS is powered up or switched on and initiates an attach (see PICS). Cell A is preferred by the MS. Attach type = 'GPRS attach' Mobile identity = P-TMSI-1 P-TMSI-1 signature
5	SS -> MS	ATTACH ACCEPT	Routing area identity = RAI-1 Attach result = 'GPRS only attached' Mobile identity = P-TMSI-2 P-TMSI-2 signature
6	MS -> SS	ATTACH COMPLETE	Routing area identity = RAI-1
7	SS -> MS	DETACH REQUEST	Detach type = 're-attach not required'
8	MS -> SS	DETACH ACCEPT	Cause = 'GPRS services not allowed'
9	SS		The following messages are sent and shall be received on cell B.
10	MS		The SS deactivates cell A and activates cell B.
11	MS		Cell B is preferred by the MS.
12	MS		No ATTACH REQUEST sent to the SS (SS waits 30 seconds). If possible (see PICS) SIM removal is performed. Otherwise if possible (see PICS) switch off is performed. Otherwise the power is removed.
13	MS		The MS gets the SIM replaced, is powered up or switched on and initiates an attach (see PICS).
14	MS -> SS	ATTACH REQUEST	Attach type = 'GPRS attach' Mobile identity = IMSI
15	SS -> MS	ATTACH ACCEPT	Attach result = 'GPRS only attached' Mobile identity = P-TMSI-1 P-TMSI-1 signature
16	MS -> SS	ATTACH COMPLETE	Routing area identity = RAI-2
17	MS		The MS is switched off or power is removed (see PICS).
18	MS -> SS	DETACH REQUEST	Message not sent if power is removed. Detach type = 'power switched off, GPRS detach'
19			The SS deactivates cell B and activates cell A.
20	MS		The MS is set in MS operation mode B (see PICS) and the test is repeated from step 3 to step 18.

Specific message contents

None.

44.2.2.2.3 GPRS detach / IMSI detach / accepted

44.2.2.2.3.1 Conformance requirement

The MS detach the IMSI for GPRS services.

Reference(s):

GSM 04.08 section 4.7.4.2

44.2.2.2.3.2 Test purpose

To test the behaviour of the MS for the detach procedure.

44.2.2.2.3.3 Method of test

Initial conditions

System Simulator:

One cell operating in network operation mode I.

Mobile Station:

The MS has a valid IMSI. MS is Idle Updated.

Related PICS/PIXIT statement(s)

Support of GPRS service Yes/No

MS operation mode B Yes/No

Switch off on button Yes/No

Automatic GPRS attach procedure at switch on or power on Yes/No

MMI controlled attach / detach procedures for non-GPRS services Yes/No

Test procedure

The MS performs a combined GPRS attach procedure (for GPRS and non-GPRS services).

The SS sends a DETACH REQUEST message to the MS. The MS then performs an IMSI detach (detach for non-GPRS services) .

The SS signal to the MS, but no response is received, as the signalling link is disconnected.

The MS attach for non-GPRS services by a routing area update procedure. Both GPRS and CS services are possible.

Maximum duration of test

5 minutes.

Expected sequence

Step	Direction	Message	Comments
1	MS		The MS is set in MS operation mode B (see PICS).
2	MS		The MS is powered up or switched on and initiates an attach (see PICS).
3	MS -> SS	ATTACH REQUEST	Attach type = 'Combined GPRS / IMSI attach' Mobile identity = IMSI
4	SS -> MS	ATTACH ACCEPT	TMSI status = no valid TMSI available Attach result = 'Combined GPRS / IMSI attached' Mobile identity = P-TMSI-1 P-TMSI-1 signature Mobile identity = IMSI Routing area identity = RAI-1
5	MS -> SS	ATTACH COMPLETE	
6	SS		The SS initiates a detach for non-GPRS services.
7	SS -> MS	DETACH REQUEST	Detach type = 'IMSI detach'
8	MS -> SS	DETACH ACCEPT	
9	SS -> MS	PACKET PAGING REQUEST	Mobile identity = P-TMSI-1 Paging order is for TBF establishment.
10	MS -> SS	UPLINK RLC DATA BLOCK	LLC PDU implicitly indicating paging response.
11	SS -> MS	PACKET PAGING REQUEST	Mobile identity = IMSI Paging order is for RR-connection.
12	MS		The MS shall not initiate an RR connection.
13	MS		This is checked during 3 seconds.
14	MS -> SS	ROUTING AREA UPDATE REQUEST	The MS initiates an attach for non-GPRS services (see PICS). Update type = 'Combined RA/LA updating with IMSI attach' P-TMSI-1 signature Routing area identity = RAI-1
15	SS -> MS	ROUTING AREA UPDATE ACCEPT	TMSI status = no valid TMSI available Update result = 'Combined RA/LA updating' Mobile identity = P-TMSI-2 P-TMSI-2 signature Mobile identity = TMSI-1 Routing area identity = RAI-1
16	MS -> SS	ROUTING AREA UPDATE COMPLETE	
17	SS -> MS	PACKET PAGING REQUEST	Mobile identity = TMSI-1 Paging order is for RR-connection.
18	MS -> SS	CHANNEL REQUEST	
19	SS -> MS	IMMEDIATE ASSIGNMENT	
20	MS -> SS	PAGING RESPONSE	Mobile identity = TMSI-1
21	SS -> MS	CHANNEL RELEASE	After sending of this message, the SS waits for disconnection of the CS signalling link.
22	MS		The MS is switched off or power is removed (see PICS).
23	MS -> SS	DETACH REQUEST	Message not sent if power is removed. Detach type = 'power switched off, combined GPRS / IMSI detach'

Specific message contents

None.

44.2.2.2.4 GPRS detach / re-attach requested / accepted

44.2.2.2.4.1 Conformance requirement

The MS shall deactivate the logical link and re-activate it.

Reference(s):

GSM 04.08 section 4.7.4.2

44.2.2.2.4.2 Test purpose

To test the behaviour of the MS for the detach procedure in case automatic re-attach.

44.2.2.2.4.3 Method of test

Initial conditions

System Simulator:

One cell in operating in network operation mode I.

Mobile Station:

The MS has a valid TMSI, P-TMSI, P-TMSI signature and RAI. MS is Idle Updated.

Related PICS/PIXIT statement(s)

Support of GPRS service Yes/No

MS operation mode B Yes/No

Switch off on button Yes/No

Automatic GPRS attach procedure at switch on or power on Yes/No

Test procedure

The MS performs a combined GPRS attach procedure (for GPRS and non-GPRS services).

The SS sends a DETACH REQUEST message to the MS with cause re-attach. The MS then detach for GPRS and non-GPRS services. The MS automatically performs a new combined GPRS attach procedure (for GPRS and non-GPRS services) and GPRS and CS services are again possible.

Maximum duration of test

5 minutes.

Expected sequence

Step	Direction	Message	Comments
1	MS		The MS is set in MS operation mode B (see PICS).
2	MS		The MS is powered up or switched on and initiates an attach (see PICS).
3	MS -> SS	ATTACH REQUEST	Attach type = 'Combined GPRS / IMSI attach' Mobile identity = P-TMSI-1 P-TMSI-1 signature Routing area identity = RAI-1
4	SS -> MS	ATTACH ACCEPT	TMSI status = valid TMSI available Attach result = 'Combined GPRS / IMSI attached' Mobile identity = TMSI-1 Routing area identity = RAI-1 No new P-TMSI and P-TMSI signature assigned
5	MS -> SS	ATTACH COMPLETE	
6	SS		The SS initiates a detach with re-attach.
7	SS -> MS	DETACH REQUEST	Detach type = 're-attach required'
8	MS -> SS	DETACH ACCEPT	
9	MS -> SS	ATTACH REQUEST	Attach type = 'Combined GPRS / IMSI attach' Mobile identity = P-TMSI-1 P-TMSI-1 signature Mobile identity = TMSI-1 Routing area identity = RAI-1
10	SS -> MS	ATTACH ACCEPT	TMSI status = valid TMSI available Attach result = 'Combined GPRS / IMSI attached' Mobile identity = TMSI-1 Mobile identity = P-TMSI-2 P-TMSI-2 signature Routing area identity = RAI-1
11	MS -> SS	ATTACH COMPLETE	
12	SS -> MS	PACKET PAGING REQUEST	Mobile identity = P-TMSI-2 Paging order is for TBF establishment.
13	MS -> SS	UPLINK RLC DATA BLOCK	LLC PDU implicitly indicating paging response.
14	SS -> MS	PACKET PAGING REQUEST	Mobile identity = TMSI-1 Paging order is for RR-connection.
15	MS -> SS	CHANNEL REQUEST	
16	SS -> MS	IMMEDIATE ASSIGNMENT	
17	MS -> SS	PAGING RESPONSE	Mobile identity = TMSI-1
18	SS -> MS	CHANNEL RELEASE	After sending of this message, the SS waits for disconnection of the CS signalling link.
19	MS		The MS is switched off or power is removed (see PICS).
20	MS -> SS	DETACH REQUEST	Message not sent if power is removed. Detach type = 'power switched off, combined GPRS / IMSI detach'

Specific message contents

None.

44.2.2.2.5 GPRS detach / rejected / location area not allowed

44.2.2.2.5.1 Conformance requirement

- 1) If the network performs a GPRS detach procedure with the cause 'location area not allowed' the Mobile Station shall:
 - 1.1 not perform combined GPRS attach when in the same location area.
 - 1.2 delete the stored LAI, CKSN, TMSI, RAI, GPRS-CKSN, P-TMSI and P-TMSI signature.

- 1.3 store the LA in the 'forbidden location areas for regional provision of service'.
- 2) If the network performs a GPRS detach procedure with the cause 'location area not allowed' the Mobile Station shall:
 - 2.1 perform combined GPRS attach when a new location area is entered.
 - 2.2 delete the list of forbidden LAs when power is switched off.

Reference(s):

GSM 04.08 sections 4.7.4.2

44.2.2.2.5.2 Test purpose

To test the behaviour of the MS if the network orders the GPRS detach procedure with the cause 'Location Area not allowed'.

To test that the MS deletes the list of forbidden LAs when power is switched off.

44.2.2.2.5.3 Method of test**Initial conditions****System Simulator:**

Three cells (not simultaneously activated), cell A in MCC1/MNC1/LAC1/RAC1, cell B in MCC1/MNC1/LAC1/RAC2, cell C in MCC1/MNC1/LAC2/RAC1.

All cells are operating in network operation mode I.

Mobile Station:

The MS has a valid IMSI. MS is Idle Updated on cell A.

Related PICS/PIXIT statement(s)

Support of GPRS service Yes/No

MS operation mode B Yes/No

Switch off on button Yes/No

Automatic GPRS attach procedure at switch on or power on Yes/No

Test procedure

The SS orders a GPRS detach with the cause value 'Location Area not allowed'. The SS checks that the MS does not perform combined GPRS attach while in the location area, performs GPRS attach when a new location area is entered and deletes the list of forbidden LAs when switched off. CS services are not possible unless an IMSI attach procedure is performed.

Different types of MS may use different methods to periodically clear the list of forbidden location areas (e.g. every day at 12am). If the list is cleared while the test is being run, it may be necessary to re-run the test.

Maximum duration of test

10 minutes.

Expected sequence

Step	Direction	Message	Comments
	SS		The following messages are sent and shall be received on cell A.
1	SS		The SS activates cell A.
2	MS		The MS is set in MS operation mode B (see PICS).
3	MS		The MS is powered up or switched on and initiates an attach (see PICS). Cell A is preferred by the MS.
4	MS -> SS	ATTACH REQUEST	Attach type = 'Combined GPRS / IMSI attach' Mobile identity = IMSI
5	SS -> MS	ATTACH ACCEPT	TMSI status = no valid TMSI available Attach result = 'Combined GPRS / IMSI attached' Mobile identity = P-TMSI-1 P-TMSI-1 signature Mobile identity = TMSI-1 Routing area identity = RAI-1
6	MS -> SS	ATTACH COMPLETE	
7	SS -> MS	DETACH REQUEST	Detach type = 're-attach not required' Cause 'Location Area not allowed'
8	MS -> SS	DETACH COMPLETE	
9	MS		No LOCATION UPDATING REQ with type 'IMSI attach' is sent to the SS (SS waits 30 seconds).
10	SS -> MS	PACKET PAGING REQUEST	Mobile identity = IMSI Paging order is for RR-connection.
11	MS		The MS shall not initiate an RR connection. This is checked during 3 seconds.
12	SS -> MS	PACKET PAGING REQUEST	Mobile identity = P-TMSI-1 Paging order is for TBF establishment.
13	MS -> SS		No response from the MS to the request. This is checked for 10 seconds
			The following messages are sent and shall be received on cell B.
14	SS		The SS deactivates cell A and activates cell B. Cell B is preferred by the MS.
15	MS		The MS initiates an attach automatically, by MMI or by AT command.
16	MS		No ATTACH REQUEST sent to SS (SS waits 30 seconds)
17	MS		No LOCATION UPDATING REQ with type 'IMSI attach' is sent to the SS (SS waits 30 seconds).
18	MS		Mobile identity = IMSI Paging order is for RR-connection.
19	SS -> MS	PACKET PAGING REQUEST	The MS shall not initiate an RR connection. This is checked during 3 seconds.
20	MS		Mobile identity = P-TMSI-1 Paging order is for TBF establishment.
21	SS -> MS	PACKET PAGING REQUEST	No response from the MS to the request. This is checked for 10 seconds
22			
			The following messages are sent and shall be received on cell C.
23	SS		The SS deactivates cell B and activates cell C. Cell C is preferred by the MS.
24	MS		The MS initiates an attach automatically, by MMI or by AT command.
25	MS		Attach type = 'Combined GPRS / IMSI attach' Mobile identity = IMSI
26	MS -> SS	ATTACH REQUEST	TMSI status = no valid TMSI available

27	SS -> MS	ATTACH ACCEPT	Attach result = 'Combined GPRS / IMSI attached' Mobile identity = P-TMSI1 P-TMSI-1 signature Mobile identity = TMSI-1 Routing area identity = RAI-3
28	MS -> SS	ATTACH COMPLETE	
29	SS -> MS	PACKET PAGING REQUEST	Mobile identity = TMSI-1 Paging order is for RR-connection.
30	MS -> SS	CHANNEL REQUEST	
31	SS -> MS	IMMEDIATE ASSIGNMENT	
32	MS -> SS	PAGING RESPONSE	Mobile identity = TMSI-1
33	SS -> MS	CHANNEL RELEASE	After sending of this message, the SS waits for disconnection of the CS signalling link.
34	SS -> MS	PACKET PAGING REQUEST	Mobile identity = P-TMSI-1 Paging order is for TBF establishment.
35	MS -> SS	UPLINK RLC DATA BLOCK	LLC PDU implicitly indicating paging response.
36	MS		The MS is switched off or power is removed (see PICS).
37	MS -> SS	DETACH REQUEST	Message not sent if power is removed. Detach type = 'power switched off, combined GPRS / IMSI detach'
38	MS		The following messages are sent and shall be received on cell B. The SS deactivates cell C and activates cell B. Cell B is preferred by the MS.
39	MS		The MS is powered up or switched on and initiates an attach (see PICS).
40	MS -> SS	ATTACH REQUEST	Attach type = 'Combined GPRS / IMSI attach' Mobile identity = P-TMSI-1 P-TMSI-1 signature Routing area identity = RAI-3 TMSI status = valid TMSI available
41	SS -> MS	ATTACH ACCEPT	Attach result = 'Combined GPRS / IMSI attached' Mobile identity = P-TMSI-2 P-TMSI-2 signature Mobile identity = TMSI-2 Routing area identity = RAI-4
42	MS -> SS	ATTACH COMPLETE	
43	SS -> MS	PACKET PAGING REQUEST	Mobile identity = TMSI-2 Paging order is for RR-connection.
44	MS -> SS	CHANNEL REQUEST	
45	SS -> MS	IMMEDIATE ASSIGNMENT	
46	MS -> SS	PAGING RESPONSE	Mobile identity = TMSI-2
47	SS -> MS	CHANNEL RELEASE	After sending of this message, the SS waits for disconnection of the CS signalling link.
48	SS -> MS	PACKET PAGING REQUEST	Mobile identity = P-TMSI-2 Paging order is for TBF establishment.
49	MS -> SS	UPLINK RLC DATA BLOCK	LLC PDU implicitly indicating paging response.
50	MS		The MS is switched off or power is removed (see PICS).
51	MS -> SS	DETACH REQUEST	Message not sent if power is removed. Detach type = 'power switched off, combined GPRS / IMSI detach'

Specific message contents

None.

44.2.3 Routing area updating procedure

This procedure is used to update the actual routing area of an MS in the network.

44.2.3.1 Normal routing area updating

The routing area updating procedure is a GMM procedure used by GPRS MSs of MS operation mode B or C that are IMSI attached for GPRS services only.

44.2.3.1.1 Routing area updating / accepted

44.2.3.1.1.1 Conformance requirement

- 1) If the network accepts the routing area updating procedure and reallocates a P-TMSI, the MS shall acknowledge the new P-TMSI and continue communication with the new P-TMSI.
- 2) If the network accepts the routing area updating procedure from the MS without reallocation of the old P-TMSI, the MS shall continue communication with the old P-TMSI.

Reference(s):

GSM 04.08 section 4.7.5.1

44.2.3.1.1.2 Test purpose

To test the behaviour of the MS if the network accepts the routing area updating procedure.

The following cases are identified:

- 1) P-TMSI / P-TMSI signature is reallocated
- 2) Old P-TMSI / P-TMSI signature is not changed

44.2.3.1.1.3 Method of test

Initial conditions

System Simulator:

Two cells, cell A in MCC1/MNC1/LAC1/RAC1, cell B in MCC1/MNC1/LAC1/RAC2.

Both cells are operating in network operation mode II.

Mobile Station:

The MS has a valid IMSI. MS is Idle Updated on cell A.

Related PICS/PIXIT statement(s)

Support of GPRS service Yes/No

MS operation mode B Yes/No

MS operation mode C Yes/No

Switch off on button Yes/No

Automatic GPRS attach procedure at switch on or power on Yes/No

Test procedure

- 1) The MS sends a ROUTING AREA UPDATE REQUEST message. The SS reallocates the P-TMSI and returns ROUTING AREA UPDATE ACCEPT message with a new P-TMSI. The MS acknowledge the new P-TMSI by sending ROUTING AREA UPDATING COMPLETE message. Further communication MS - SS is performed by the new P-TMSI. The MS will not answer signalling addressed to the old P-TMSI.
- 2) The MS sends a ROUTING AREA UPDATING REQUEST message. The SS accepts the P-TMSI and returns ROUTING AREA UPDATING ACCEPT message without any P-TMSI. Further communication MS - SS is performed by the P-TMSI.

Maximum duration of test

10 minutes.

Expected sequence

Step	Direction	Message	Comments
1	SS		The following messages are sent and shall be received on cell A.
2	MS		The SS activates cell A but not cell B.
3	MS		The MS is set in MS operation mode C (see PICS). If MS operation mode C not supported, goto step 22.
4	MS -> SS	ATTACH REQUEST	The MS is powered up or switched on and initiates an attach (see PICS).
5	SS -> MS	ATTACH ACCEPT	Attach type = 'GPRS attach' Mobile identity = IMSI
6	MS -> SS	ATTACH COMPLETE	Attach result = 'GPRS only attached' Mobile identity = P-TMSI-2 P-TMSI-2 signature Routing area identity = RAI-1
7	SS		The following messages are sent and shall be received on cell B.
8	MS -> SS	ROUTING AREA UPDATING REQUEST	Activate cell B with a lower signal strength than cell A The RF level of cell A is lowered until cell B is preferred by the MS.
9	SS -> MS	ROUTING AREA UPDATING ACCEPT	Update type = 'RA updating' P-TMSI-2 signature Routing area identity = RAI-1
10	MS -> SS	ROUTING AREA UPDATING COMPLETE	Update result = 'RA updated' Mobile identity = P-TMSI-1 P-TMSI-1 signature Routing area identity = RAI-4
11	SS->MS	GMM INFORMATION	
11b	MS->SS	GMM STATUS	Message sent in case the MS does not support reception of GMM information message. Cause #97
12	SS -> MS	PAGING REQUEST TYPE 1	Mobile identity = P-TMSI-2 Paging order is for TBF establishment.
13	MS		No response from the MS to the request. This is checked for 10 seconds.
14	SS		The following messages are sent and shall be received on cell A.
15	MS		The RF level of cell B is lowered until cell A is preferred by the MS.
16	MS -> SS	ROUTING AREA UPDATING REQUEST	Cell A is preferred by the MS.
17	SS -> MS	ROUTING AREA UPDATING ACCEPT	Update type = 'RA updating' P-TMSI-1 signature Routing area identity = RAI-4 No new mobile identity assigned. P-TMSI not included.
18	SS -> MS	PAGING REQUEST TYPE 1	Update result = 'RA updated' P-TMSI-2 signature Routing area identity = RAI-1 Mobile identity = P-TMSI-1 Paging order is for TBF establishment.
19	MS -> SS	UPLINK RLC DATA BLOCK	LLC PDU implicitly indicating paging response.
20	MS		The MS is switched off or power is removed (see PICS).
21	MS -> SS	DETACH REQUEST	Message not sent if power is removed. Detach type = 'power switched off, GPRS detach'
22	MS		The MS is set in MS operation mode B (see PICS), reset the RF level of Cell A to default state, deactivate Cell B and the test is repeated from step 3 to step 21.

Specific message contents

None.

44.2.3.1.2 Routing area updating / rejected / IMSI invalid / illegal ME

44.2.3.1.2.1 Conformance requirement

- 1) If the network rejects a routing area updating procedure from the Mobile Station with the cause 'Illegal ME', the Mobile Station shall consider SIM invalid for GPRS services until power is switched off or SIM is removed.
- 2) If the network rejects a routing area updating procedure from the Mobile Station with the cause 'Illegal ME', the Mobile Station shall delete the stored RAI, GPRS-CKSN, P-TMSI and P-TMSI signature.

Reference(s):

GSM 04.08 section 4.7.5.1

44.2.3.1.2.2 Test purpose

To test the behaviour of the MS if the network rejects the routing area updating procedure of the MS with the cause 'Illegal ME'.

44.2.3.1.2.3 Method of test

Initial conditions

System Simulator:

Three cells (not simultaneously activated), cell A in MCC1/MNC1/LAC1/RAC1, cell B in MCC1/MNC1/LAC1/RAC2, cell C in MCC2/MNC1/LAC1/RAC1.

All three cells are operating in network operation mode II (in case of MS operation mode B), or in network operation mode III (in case of MS operation mode C).

Mobile Station:

The MS has a valid P-TMSI-1, P-TMSI-1 signature and RAI-1. MS is Idle Updated on cell A.

Related PICS/PIXIT statement(s)

Support of GPRS service Yes/No

MS operation mode C Yes/No

MS operation mode B Yes/No (only if mode C not supported)

SIM removal possible without powering down Yes/No

Switch off on button Yes/No

Automatic GPRS attach procedure at switch on or power on Yes/No

Test procedure

The SS rejects a routing area updating with the cause value 'Illegal ME'. The SS checks that the MS does not perform GPRS attach in the same or another PLMN.

Maximum duration of test

5 minutes.

Expected sequence

Step	Direction	Message	Comments
1	MS		The following messages are sent and shall be received on cell A.
2	SS		The MS is set in MS operation mode C or B (see PICS).
3	MS		The SS is set in network operation mode II or III and activates cell A.
4	MS -> SS	ATTACH REQUEST	The MS is powered up or switched on and initiates an attach (see PICS). Cell A is preferred by the MS. Attach type = 'GPRS attach' Mobile identity = P-TMSI-1 P-TMSI-1 signature
5	SS -> MS	ATTACH ACCEPT	Routing area identity = RAI-1 No new mobile identity assigned.P-TMSI and P-TMSI signature not included.Attach result = 'GPRS only attached' Routing area identity = RAI-1
6	SS		The following messages are sent and shall be received on cell B.
7	MS		The SS deactivates cell A and activates cell B. Cell B is preferred by the MS.
8	MS -> SS	ROUTING AREA UPDATING REQUEST	Update type = 'RA updating' Routing area identity = RAI-1
9	SS -> MS	ROUTING AREA UPDATING REJECT	GMM cause = 'Illegal ME'
10	SS -> MS	PACKET PAGING REQUEST Or PAGING REQUEST TYPE 1	Mobile identity = P-TMSI-1 Both paging orders are for TBF establishment. PACKET PAGING REQUEST (used for NW mode III) PAGING REQUEST TYPE 1 (used for NW-mode II).
11	MS		No response from the MS to the request. This is checked for 10 seconds.
12	SS		The following messages are sent and shall be received on cell C.
13	MS		The SS deactivates cell B and activates cell C. Cell C is preferred by the MS.
14	MS		No ATTACH REQUEST sent to the SS (SS waits 30 seconds).
15	MS		If possible (see PICS) SIM removal is performed. Otherwise if possible (see PICS) switch off is performed. Otherwise the power is removed.
16	MS		The MS gets the SIM replaced, is powered up or switched on and initiates an attach (see PICS).
17	MS -> SS	ATTACH REQUEST	Attach type = 'GPRS only attached' Mobile identity = IMSI
18	SS -> MS	ATTACH ACCEPT	Attach result = 'GPRS attach' Mobile identity = P-TMSI-1 P-TMSI-1 signature
19	MS -> SS	ATTACH COMPLETE	Routing area identity = RAI-2
20	MS		The MS is switched off or power is removed (see PICS).
21	MS -> SS	DETACH REQUEST	Message not sent if power is removed.

Specific message contents

None.

44.2.3.1.3 Routing area updating / rejected / MS identity cannot be derived by the network

44.2.3.1.3.1 Conformance requirement

If the network rejects a routing area updating procedure from the Mobile Station with the cause 'MS identity cannot be derived by the network', the Mobile Station shall delete the stored RAI, GPRS-CKSN, P-TMSI and P-TMSI signature.

Depending on the manufacturer the MS may or may not perform a GPRS attach procedure.

Reference(s):

GSM 04.08 section 4.7.5.1

44.2.3.1.3.2 Test purpose

To test the behaviour of the MS if the network rejects the routing area updating procedure of the MS with the cause 'MS identity cannot be derived by the network'.

44.2.3.1.3.3 Method of test

Initial conditions

System Simulator:

Two cells (not simultaneously activated), cell A in MCC1/MNC1/LAC1/RAC1, cell B in MCC1/MNC1/LAC1/RAC2. Both cells are operating in network operation mode II (in case of MS operation mode B), or in network operation mode III (in case of MS operation mode C).

Mobile Station:

The MS has a valid P-TMSI-1, P-TMSI-1 signature and RAI-1. MS is Idle Updated on cell A.

Related PICS/PIXIT statement(s)

Support of GPRS service Yes/No

MS operation mode C Yes/No

MS operation mode B Yes/No (only if mode C not supported)

Automatic attach procedure when MS identity cannot be derived by the network Yes/No

Switch off on button Yes/No

Automatic GPRS attach procedure at switch on or power on Yes/No

Test procedure

The SS rejects a normal routing area updating with the cause value 'MS identity cannot be derived by the network'. The MS detach locally. A new GPRS attach may be performed.

Maximum duration of test

5 minutes.

Expected sequence

Step	Direction	Message	Comments
1	SS		The following messages are sent and shall be received on cell A.
2	MS		The SS is set in network operation mode II or III and activates cell A.
3	MS		The MS is set in MS operation mode C or B (see PICS).
4	MS -> SS	ATTACH REQUEST	The MS is powered up or switched on and initiates an attach (see PICS). Cell A is preferred by the MS. Attach type = 'GPRS attach' Mobile identity = P-TMSI-1 P-TMSI-1 signature
5	SS -> MS	ATTACH ACCEPT	Routing area identity = RAI-1 Attach result = 'GPRS only attached' Mobile identity = P-TMSI-2 P-TMSI-2 signature
6	MS -> SS	ATTACH COMPLETE	Routing area identity = RAI-1
7	SS		The following messages are sent and shall be received on cell B.
8	MS		The SS deactivates cell A and activates cell B. Cell B is preferred by the MS.
9	MS -> SS	ROUTING AREA UPDATING REQUEST	Update type = 'RA updating' P-TMSI-2 signature
10	SS -> MS	ROUTING AREA UPDATING REJECT	Routing area identity = RAI-1 GMM cause = 'MS identity cannot be derived by the network'
11	MS		If an automatic attach procedure by the MS is not possible when the MS identity cannot be derived by the network (see PICS) goto step 19.
12	MS		An Automatic GPRS attach procedure is initiated (see PICS).
13	MS -> SS	ATTACH REQUEST	Attach type = 'GPRS attach' Mobile identity = IMSI
14	SS -> MS	ATTACH ACCEPT	Attach result = 'GPRS only attached' Mobile identity = P-TMSI-1 P-TMSI-1 signature
15	MS -> SS	ATTACH COMPLETE	Routing area identity = RAI-4
16	MS		The MS is switched off or power is removed (see PICS).
17	MS -> SS	DETACH REQUEST	Message not sent if power is removed. Detach type = 'power switched off, GPRS detach'
18			Stop the sequence
19	SS -> MS	PACKET PAGING REQUEST Or PAGING REQUEST TYPE 1	Mobile identity = P-TMSI-2 Both paging orders are for TBF establishment. PACKET PAGING REQUEST (used for NW mode III) PAGING REQUEST TYPE 1 (used for NW-mode II).
20	MS		No response from the MS to the request, as the MS has detached locally. This is checked for 10 seconds.

Specific message contents

None.

44.2.3.1.4 Routing area updating / rejected / location area not allowed

44.2.3.1.4.1 Conformance requirement

- 1) If the network rejects a routing area updating procedure from the Mobile Station with the cause 'location area not allowed' the Mobile Station shall:
 - 1.1 not perform GPRS attach when in the same location area.
 - 1.2 delete the stored RAI, GPRS-CKSN, P-TMSI and P-TMSI signature.
 - 1.3 store the LA in the 'forbidden location areas for regional provision of service'.
- 2) If the network rejects a routing area updating procedure from the Mobile Station with the cause 'location area not allowed' the Mobile Station shall:
 - 2.1 perform GPRS attach when a new location area is entered.
 - 2.2 delete the list of forbidden LAs after switch off (power off).

Reference(s):

GSM 04.08 sections 4.7.5.1

44.2.3.1.4.2 Test purpose

To test the behaviour of the MS if the network rejects the routing area updating procedure of the MS with the cause 'Location Area not allowed'.

To test that the MS deletes the list of forbidden LAs when power is switched off.

44.2.3.1.4.3 Method of test

Initial conditions

System Simulator:

Three cells (not simultaneously activated), cell A in MCC1/MNC1/LAC1/RAC1, cell B in MCC1/MNC1/LAC1/RAC2, cell C in MCC1/MNC1/LAC2/RAC1.

All cells are operating in network operation mode III.

Mobile Station:

The MS has a valid IMSI. MS is Idle Updated on cell C.

Related PICS/PIXIT statement(s)

Support of GPRS service Yes/No

MS operation mode B Yes/No

MS operation mode C Yes/No

SIM removal possible without powering down Yes/No

Switch off on button Yes/No

Automatic GPRS attach procedure at switch on or power on Yes/No

Test procedure

The SS rejects a routing area updating with the cause value 'Location Area not allowed'. The SS checks that the MS does not perform GPRS attach while in the location area, performs GPRS attach when a new location area is entered and deletes the list of forbidden LAs when switched off.

Different types of MS may use different methods to periodically clear the list of forbidden location areas (e.g. every day at 12am). If the list is cleared while the test is being run, it may be necessary to re-run the test.

Maximum duration of test

15 minutes.

Expected sequence

Step	Direction	Message	Comments
1	SS MS		The following messages are sent and shall be received on cell C. The MS is set in MS operation mode C (see PICS). If MS operation mode C not supported, goto step 33.
2	SS		The SS activates cell C.
3	MS		The MS is powered up or switched on and initiates an attach (see PICS). Cell C is preferred by the MS.
4	MS -> SS	ATTACH REQUEST	Attach type = 'GPRS attach'
5	SS -> MS	ATTACH ACCEPT	Mobile identity = IMSI Attach result = 'GPRS only attached'
6	MS -> SS	ATTACH COMPLETE	Mobile identity = P-TMSI-1 P-TMSI-1 signature Routing area identity = RAI-3
7	SS		The following messages are sent and shall be received on cell B.
8	SS		The SS deactivates cell C and activates cell B.
9	MS -> SS	ROUTING AREA UPDATING REQUEST	Cell B is preferred by the MS. Update type = 'RA updating'
10	SS -> MS	ROUTING AREA UPDATING REJECT	P-TMSI-1 signature Routing area identity = RAI-3
11	SS -> MS	PACKET PAGING REQUEST Or PAGING REQUEST TYPE 1	GMM cause = 'Location Area not allowed'
12	MS		Mobile identity = P-TMSI-1 Both paging orders are for TBF establishment. PACKET PAGING REQUEST (used for NW mode III) PAGING REQUEST TYPE 1 (used for NW-mode II). No response from the MS to the request. This is checked for 10 seconds.
13	SS		The following messages are sent and shall be received on cell A.
14	MS		The SS deactivates cell B and activates cell A.
15	MS		Cell A is preferred by the MS. No ATTACH REQUEST sent to SS (SS waits 30 seconds)
16	SS		The following messages are sent and shall be received on cell C.
17	MS		The SS deactivates cell B and activates cell C.
18	MS -> SS	ATTACH REQUEST	Cell C is preferred by the MS. Attach type = 'GPRS attach'
19	SS -> MS	ATTACH ACCEPT	Mobile identity = IMSI Attach result = 'GPRS only attached'
20	MS -> SS	ATTACH COMPLETE	Mobile identity = P-TMSI-2 P-TMSI-2 signature Routing area identity = RAI-3
21	MS		If possible (see PICS) SIM removal is performed. Otherwise if possible (see PICS) switch off is performed. Otherwise the power is removed.
22	MS -> SS	DETACH REQUEST	Message not sent if power is removed. Detach type = 'power switched off, GPRS detach'
23	MS		The MS gets the SIM replaced, is powered up or switched on and initiates an attach (see PICS).
24	MS -> SS	ATTACH REQUEST	Attach type = 'GPRS attach' Mobile identity = P-TMSI-2 P-TMSI-2 signature Routing area identity = RAI-3

25	SS -> MS	ATTACH ACCEPT	Attach result = 'GPRS only attached' Mobile identity = P-TMSI-1 P-TMSI-1 signature Routing area identity = RAI-3
26	MS -> SS	ATTACH COMPLETE	
27	SS		The following messages are sent and shall be received on cell A. The SS deactivates cell C and activates cell A. Cell A is preferred by the MS.
28			
29	MS -> SS	ROUTING AREA UPDATING REQUEST	Update type = 'RA updating' P-TMSI-1 signature Routing area identity = RAI-3
30	SS -> MS	ROUTING AREA UPDATING ACCEPT	No new mobile identity assigned.P-TMSI and P-TMSI signature not included.Update result = 'RA updated' Routing area identity = RAI-1
31	MS		The MS is switched off or power is removed (see PICS).
32	MS -> SS	DETACH REQUEST	Message not sent if power is removed. Detach type = 'power switched off, GPRS detach'
33	SS		The SS is set in network operation mode II.
34	MS		The MS is set in MS operation mode B (see PICS), cell A is switched off and the test is repeated from step 2 to step 32.

Specific message contents

None.

44.2.3.1.5 Routing area updating / abnormal cases / attempt counter check / miscellaneous reject causes

44.2.3.1.5.1 Conformance requirement

- 1) When a routing area updating procedure is rejected with the routing area updating attempt counter less than five, the Mobile Station shall repeat the routing area updating procedure after T3330 timeout.
- 2) When a routing area updating procedure is rejected with the routing area updating attempt counter five, the Mobile Station shall start timer T3302.
- 3) When the T3302 expire, a new routing area updating procedure shall be initiated.

GMM cause codes that can be selected are:

'IMSI unknown in HLR'
 'IMEI not accepted'
 'Illegal ME'
 'MS identity cannot be derived by the network'
 'Network failure'
 'Congestion'
 'retry upon entry into a new cell'
 'Semantically incorrect message'
 'Invalid mandatory information'
 'Message type non-existent or not implemented'
 'Message type not compatible with the protocol state'
 'Information element non-existent or not implemented'
 'Conditional IE error'
 'Message not compatible with the protocol state'
 'Protocol error, unspecified'

Reference(s):

GSM 04.08 section 4.7.5.1

44.2.3.1.5.2 Test purpose

To test the behaviour of the MS with respect to the routing area updating attempt counter.

44.2.3.1.5.3 Method of test

Initial conditions

System Simulator:

Two cells (not simultaneously activated), cell A in MCC1/MNC1/LAC1/RAC1, cell B in MCC1/MNC1/LAC1/RAC2. T3302 is set to 12 minutes.

Both cells are operating in network operation mode II (in case of MS operation mode B), or in network operation mode III (in case of MS operation mode C).

Mobile Station:

The MS has a valid P-TMSI-1, P-TMSI-1 signature and RAI-1. MS is Idle Updated on cell A.

Related PICS/PIXIT statement(s)

Support of GPRS service Yes/No

MS operation mode C Yes/No

MS operation mode B Yes/No (only if mode C not supported)

Switch off on button Yes/No

Automatic GPRS attach procedure at switch on or power on Yes/No

Test procedure

The MS initiates a routing area updating procedure (routing area updating attempt counter zero). The SS rejects the routing area updating procedure with a random cause code. The routing area updating attempt counter is incremented and T3311 is started.

The MS initiates a new routing area updating procedure (routing area updating attempt counter one) after T3311 expires. The SS rejects the routing area updating procedure with a random cause code. The routing area updating attempt counter is incremented and T3311 is started.

The MS initiates a new routing area updating procedure (attempt counter two) after T3311 expires. The SS rejects the routing area updating procedure with a random cause code. The routing area updating attempt counter is incremented and T3311 is started.

The MS initiates a new routing area updating procedure (attempt counter three) after T3311 expires. The SS rejects the routing area updating procedure with a random cause code. The routing area updating attempt counter is incremented and T3311 is started.

The MS initiates a new routing area updating procedure (attempt counter four) after T3311 expires. The SS rejects the routing area updating procedure with a random cause code. The routing area updating attempt counter is incremented but T3311 is not started, as the routing area updating attempt counter is five. T3302 is started.

The MS initiates a routing area updating procedure with routing area updating attempt counter zero after T3302 expires with the stored P-TMSI, P-TMSI signature, GPRS CKSN and RAI.

Maximum duration of test

15 minutes.

Expected sequence

Step	Direction	Message	Comments
	SS		The following messages are sent and shall be received on cell A.
1	MS		The MS is set in MS operation mode C or B (see PICS).
2	SS		The SS is set in network operation mode II or III and activates cell A.
3	MS		The MS is powered up or switched on and initiates an attach (see PICS). Cell A is preferred by the MS.
4	MS -> SS	ATTACH REQUEST	Attach type = 'GPRS attach' Mobile identity = P-TMSI-1 P-TMSI-1 signature Routing area identity = RAI-1
5	SS -> MS	ATTACH ACCEPT	No new mobile identity assigned. P-TMSI not included. Attach result = 'GPRS only attached' P-TMSI-2 signature Routing area identity = RAI-1
			The following messages are sent and shall be received on cell B.
6	SS		The SS deactivates cell A and activates cell B. Cell B is preferred by the MS.
7	SS		
8	MS -> SS	ROUTING AREA UPDATING REQUEST	Update type = 'RA updating' P-TMSI-2 signature Routing area identity = RAI-1
9	SS -> MS	ROUTING AREA UPDATING REJECT	Random GMM cause
10	SS		The SS verifies that the time between the routing area updating requests is T3311 seconds (+/- 10%)
11	MS -> SS	ROUTING AREA UPDATING REQUEST	Update type = 'RA updating' P-TMSI-2 signature Routing area identity = RAI-1
12	SS -> MS	ROUTING AREA UPDATING REJECT	Random GMM cause
13	SS		The SS verifies that the time between the routing area updating requests is T3311 seconds (+/- 10%)
14	MS -> SS	ROUTING AREA UPDATING REQUEST	Update type = 'RA updating' P-TMSI-2 signature Routing area identity = RAI-1
15	SS -> MS	ROUTING AREA UPDATING REJECT	Random GMM cause
16	SS		The SS verifies that the time between the routing area updating requests is T3311 seconds (+/- 10%)
17	MS -> SS	ROUTING AREA UPDATING REQUEST	Update type = 'RA updating' P-TMSI-2 signature Routing area identity = RAI-1
18	SS -> MS	ROUTING AREA UPDATING REJECT	Random GMM cause
19	SS		The SS verifies that the time between the routing area updating requests is 15 seconds (+/- 10%)
20	MS -> SS	ROUTING AREA UPDATING REQUEST	Update type = 'RA updating' P-TMSI-2 signature Routing area identity = RAI-1
21	SS -> MS	ROUTING AREA UPDATING REJECT	Random GMM cause
22	SS		The SS verifies that the MS does not attempt to attach for T3302 minutes (+/- 10%).

23	MS -> SS	ROUTING AREA UPDATING REQUEST	Update type = 'RA updating' P-TMSI-2 signature Routing area identity = RAI-1
24	SS -> MS	ROUTING AREA UPDATING ACCEPT	Update result = 'RA updated' Mobile identity = P-TMSI-2 P-TMSI-3 signature Routing area identity = RAI-4
25	MS -> SS	ROUTING AREA UPDATING COMPLETE	
26	MS		The MS is switched off or power is removed (see PICS).
27	MS -> SS	DETACH REQUEST	Message not sent if power is removed. Detach type = 'power switched off, GPRS detach'

Specific message contents

None.

44.2.3.1.6 Routing area updating / abnormal cases / change of cell into new routing area

44.2.3.1.6.1 Conformance requirement

When a change of cell into a new routing area is performed before the routing area updating procedure is finished, the MS shall abort the routing area updating procedure and re-initiate it in the new routing area.

Reference(s):

GSM 04.08 section 4.7.5.1

44.2.3.1.6.2 Test purpose

To test the behaviour of the MS in case of procedure collision.

44.2.3.1.6.3 Method of test

Initial conditions

System Simulator:

Three cells (not simultaneously activated), cell A in MCC1/MNC1/LAC1/RAC1, cell B in MCC1/MNC1/LAC1/RAC2 and cell C In MCC1/MNC1/LAC1/RAC3.

All cells are operating in network operation mode II (in case of MS operation mode B), or in network operation mode III (in case of MS operation mode C).

Mobile Station:

The MS has a valid P-TMSI-1, P-TMSI-1 signature and RAI-1. MS is Idle Updated on cell A.

Related PICS/PIXIT statement(s)

Support of GPRS service Yes/No

MS operation mode C Yes/No

MS operation mode B Yes/No (only if mode C not supported)

Switch off on button Yes/No

Automatic GPRS attach procedure at switch on or power on Yes/No

Test procedure

The MS initiates a routing area updating procedure. The ROUTING AREA UPDATE ACCEPT message is delayed from the SS. The MS performs a cell update into a new routing area. The MS shall re-initiate a routing area updating procedure in the new routing area.

Maximum duration of test

5 minutes.

Expected sequence

Step	Direction	Message	Comments
1	SS		The following messages are sent and shall be received on cell A.
2	SS		The SS activates cell A.
3	MS		The MS is set in MS operation mode C (see PICS). If MS operation mode C not supported, goto step 18.
4	MS -> SS	ATTACH REQUEST	The MS is powered up or switched on and initiates an attach (see PICS). Cell A is preferred by the MS. Attach type = 'GPRS attach' Mobile identity = P-TMSI-1 P-TMSI-1 signature
5	SS -> MS	ATTACH ACCEPT	Routing area identity = RAI-1 Attach result = 'GPRS only attached' Mobile identity = P-TMSI-2 P-TMSI-2 signature
6	MS -> SS	ATTACH COMPLETE	Routing area identity = RAI-1
7	SS		The following messages are sent and shall be received on cell B.
8	SS		The SS deactivates cell A and activates cell B.
9	MS -> SS	ROUTING AREA UPDATING REQUEST	Cell B is preferred by the MS. Update type = 'RA updating' P-TMSI-2 signature
10	SS		Routing area identity = RAI-1 No response to the ROUTING AREA UPDATING REQUEST message is given by the SS
11	SS		The following messages are sent and shall be received on cell C.
12	SS		The SS deactivates cell B and activates cell C.
13	MS -> SS	ROUTING AREA UPDATING REQUEST	Cell C is preferred by the MS. Update type = 'RA updating' P-TMSI-2 signature
14	SS -> MS	ROUTING AREA UPDATING ACCEPT	Routing area identity = RAI-1 Update result = 'RA updated' Mobile identity = P-TMSI-2 P-TMSI-3 signature
15	MS -> SS	ROUTING AREA UPDATING COMPLETE	Routing area identity = RAI-5
16	MS		The MS is switched off or power is removed (see PICS).
17	MS -> SS	DETACH REQUEST	Message not sent if power is removed. Detach type = 'power switched off, GPRS detach'
18	SS		The SS is set in network operation mode II.
19	MS		The MS is set in MS operation mode B (see PICS) and the test is repeated from step 3 to step 17.

Specific message contents

None.

44.2.3.1.7 Routing area updating / abnormal cases / change of cell during routing area updating procedure

44.2.3.1.7.1 Conformance requirement

When a change of cell within a new routing area is performed before the routing area updating procedure is finished, the MS shall perform the cell update before the routing area updating procedure is finished.

Reference(s):

GSM 04.08 section 4.7.5.1

44.2.3.1.7.2 Test purpose

To test the behaviour of the MS in case of procedure collision.

44.2.3.1.7.3 Method of test

Initial conditions

System Simulator:

Three cells (not simultaneously activated), cell A in MCC1/MNC1/LAC1/RAC1, cell B in MCC1/MNC1/LAC1/RAC2 and cell C in MCC1/MNC1/LAC1/RAC2.

All three cells are operating in network operation mode III.

Mobile Station:

The MS has a valid P-TMSI-1, P-TMSI-1 signature and RAI-1. MS is Idle Updated on cell A.

Related PICS/PIXIT statement(s)

Support of GPRS service Yes/No

MS operation mode C Yes/No

MS operation mode B Yes/No

Switch off on button Yes/No

Automatic GPRS attach procedure at switch on or power on Yes/No

Test procedure

The MS initiates a routing area updating procedure. The ROUTING AREA UPDATE ACCEPT message is delayed from the SS. The MS performs a cell update within the routing area. The MS then waits for the ROUTING AREA UPDATE ACCEPT message.

Maximum duration of test

5 minutes.

Expected sequence

Step	Direction	Message	Comments
1	SS		The following messages are sent and shall be received on cell A.
2	MS		The MS is set in MS operation mode C or B (see PICS).
3	SS		The SS is set in network operation mode II or III and activates cell A.
4	MS -> SS	ATTACH REQUEST	The MS is powered up or switched on and initiates an attach (see PICS). Cell A is preferred by the MS. Attach result = 'GPRS attach' Mobile identity = P-TMSI-1 P-TMSI-1 signature
5	SS -> MS	ATTACH ACCEPT	Routing area identity = RAI-1 No new mobile identity assigned. P-TMSI not included. Attach result = 'GPRS only attached' P-TMSI-2 signature Routing area identity = RAI-1
6	SS		The following messages are sent and shall be received on cell B.
7	SS		The SS deactivates cell A and activates cell B. Cell B is preferred by the MS.
8	MS -> SS	ROUTING AREA UPDATING REQUEST	Update type = 'RA updating' P-TMSI-2 signature
9	SS		Routing area identity = RAI-1 No response to the ROUTING AREA UPDATING REQUEST message is given by the SS
10	SS		The following messages are sent and shall be received on cell C.
11	SS		The SS deactivates cell B and activates cell C. Cell C is preferred by the MS.
12	MS -> SS	UPLINK RLC DATA BLOCK	LLC PDU implicitly indicating cell update.
13	SS -> MS	ROUTING AREA UPDATING ACCEPT	Update result = 'RA updated' Mobile identity = P-TMSI-2 P-TMSI-3 signature Routing area identity = RAI-4
14	MS -> SS	ROUTING AREA UPDATING COMPLETE	
15	MS		The MS is switched off or power is removed (see PICS).
16	MS -> SS	DETACH REQUEST	Message not sent if power is removed. Detach type = 'power switched off, GPRS detach'

Specific message contents

None.

44.2.3.1.8 Routing area updating / abnormal cases / P-TMSI reallocation procedure collision

44.2.3.1.8.1 Conformance requirement

When a P-TMSI REALLOCATION REQUEST message is received by the MS while waiting for a ROUTING AREA UPDATE ACCEPT message, the MS shall ignore the P-TMSI reallocation procedure and continue with the routing area updating procedure.

Reference(s):

GSM 04.08 section 4.7.5.1

44.2.3.1.8.2 Test purpose

To test the behaviour of the MS in case of procedure collision.

44.2.3.1.8.3 Method of test

Initial conditions

System Simulator:

Two cells (not simultaneously activated), cell A in MCC1/MNC1/LAC1/RAC1 and cell B in MCC1/MNC1/LAC1/RAC2.

Both cells are operating in network operation mode II (in case of MS operation mode B), or in network operation mode III (in case of MS operation mode C).

Mobile Station:

The MS has a valid IMSI. MS is Idle Updated on cell A.

Related PICS/PIXIT statement(s)

Support of GPRS service Yes/No

MS operation mode C Yes/No

MS operation mode B Yes/No (only if mode C not supported)

Switch off on button Yes/No

Automatic GPRS attach procedure at switch on or power on Yes/No

Test procedure

The MS initiates a routing area updating procedure. The SS does not answer the routing area updating procedure, but initiates a P-TMSI reallocation procedure. The MS shall ignore the P-TMSI reallocation procedure and continue with the routing area updating procedure.

Maximum duration of test

5 minutes.

Expected sequence

Step	Direction	Message	Comments
1	SS MS		The following messages are sent and shall be received on cell A. The MS is set in MS operation mode C or B (see PICS).
2	SS		The SS is set in network operation mode II or III and activates cell A.
3	MS		The MS is powered up or switched on and initiates an attach (see PICS). Cell A is preferred by the MS.
4	MS -> SS	ATTACH REQUEST	Attach result = 'GPRS attach' Mobile identity = IMSI
5	SS -> MS	ATTACH ACCEPT	Attach result = 'GPRS only attached' Mobile identity = P-TMSI-1 P-TMSI-1 signature
6	MS -> SS	ATTACH COMPLETE	Routing area identity = RAI-1
7	SS		The following messages are sent and shall be received on cell B.
8	SS		The SS deactivates cell A and activates cell B. Cell B is preferred by the MS.
9	MS -> SS	ROUTING AREA UPDATING REQUEST	Update type = 'RA updating' P-TMSI-1 signature Routing area identity = RAI-1
10	SS -> MS	P-TMSI REALLOCATION REQUEST	Mobile identity = P-TMSI-1 P-TMSI-1 signature Routing area identity = RAI-1
11	MS		The MS ignores the P-TMSI reallocation request.
12	SS -> MS	ROUTING AREA UPDATING ACCEPT	Update result = 'RA updated' Mobile identity = P-TMSI-2 P-TMSI-2 signature Routing area identity = RAI-4
13	MS -> SS	ROUTING AREA UPDATING COMPLETE	
14	MS		The MS is switched off or power is removed (see PICS).
15	MS -> SS	DETACH REQUEST	Message not sent if power is removed. Detach type = 'power switched off, GPRS detach'

Specific message contents

None.

44.2.3.2 Combined routing area updating

The combined routing area updating procedure is a GMM procedure used by GPRS MSs of MS operation mode B that are IMSI attached for GPRS and non-GPRS services. In order to use the combined routing area updating procedure, the network must operate in network operation mode I.

44.2.3.2.1 Combined routing area updating / combined RA/LA accepted

44.2.3.2.1.1 Conformance requirement

- 1) If the network accepts the combined routing area updating procedure and reallocates a P-TMSI, the MS shall acknowledge the new P-TMSI and continue communication with the new P-TMSI.
- 2) If the network accepts the combined routing area updating procedure from the MS without reallocation of the old P-TMSI, the MS shall continue communication with the old P-TMSI.

Reference(s):

GSM 04.08 section 4.7.5.2

44.2.3.2.1.2 Test purpose

To test the behaviour of the MS if the network accepts the combined routing area updating procedure.

The following cases are identified:

- 1) P-TMSI / P-TMSI signature is reallocated
- 2) Old P-TMSI / P-TMSI signature is not changed
- 3) Mobile terminating CS call is allowed with IMSI
- 4) Mobile terminating CS call is allowed with TMSI

44.2.3.2.1.3 Method of test

Initial conditions

System Simulator:

Two cells, cell A in MCC1/MNC1/LAC1/RAC1, cell B in MCC1/MNC1/LAC1/RAC2.

Both cells operating in network operation mode I.

Mobile Station:

The MS has a valid IMSI. MS is Idle Updated on cell A.

Related PICS/PIXIT statement(s)

Support of GPRS service Yes/No

MS operation mode B Yes/No

Switch off on button Yes/No

Automatic GPRS attach procedure at switch on or power on Yes/No

Test procedure

- 1) A combined GPRS attach procedure is performed. The MS sends a ROUTING AREA UPDATE REQUEST message. The SS reallocates the P-TMSI, unassigns the TMSI and returns ROUTING AREA UPDATE ACCEPT message with a new P-TMSI and IMSI. The MS acknowledge the new P-TMSI by sending ROUTING AREA UPDATING COMPLETE message. Further communication MS - SS is performed by the new P-TMSI. For CS calls, the IMSI is used
- 2) The MS is CS paged in order to verify that the IMSI is used for CS calls.
- 3) The MS sends an ROUTING AREA UPDATING REQUEST message. The SS accepts the P-TMSI signature and returns ROUTING AREA UPDATING ACCEPT message without any P-TMSI and with a new TMSI. The MS acknowledge the new TMSI by sending ROUTING AREA UPDATING COMPLETE message. Further communication MS-SS is performed by the old P-TMSI. For CS calls, the new TMSI is used.
- 4) The MS is CS paged in order to verify that the TMSI is used for CS calls.

Maximum duration of test

15 minutes.

Expected sequence

Step	Direction	Message	Comments
1	MS		The MS is set in MS operation mode B (see PICS).
2	MS		The MS is powered up or switched on and initiates an attach (see PICS).
3	MS -> SS	ATTACH REQUEST	Attach type = 'Combined GPRS / IMSI attach' Mobile identity = IMSI
4	SS -> MS	ATTACH ACCEPT	TMSI status = no valid TMSI available Attach result = 'Combined GPRS / IMSI attached' Mobile identity = P-TMSI-2 P-TMSI-2 signature Routing area identity = RAI-1
5	MS -> SS	ATTACH COMPLETE	
6	SS		The following messages are sent and shall be received on cell B. Activate cell B with a lower signal strength than cell A. The RF level of cell A is lowered until cell B is preferred by the MS.
7	MS -> SS	ROUTING AREA UPDATING REQUEST	Update type = 'Combined RA/LA updating' P-TMSI-2 signature Routing area identity = RAI-1
8	SS -> MS	ROUTING AREA UPDATING ACCEPT	TMSI status = no valid TMSI available Update result = 'Combined RA/LA updated' Mobile identity = P-TMSI-1 P-TMSI-1 signature Mobile identity = IMSI Routing area identity = RAI-4
9	MS -> SS	ROUTING AREA UPDATING COMPLETE	
10	SS -> MS	PACKET PAGING REQUEST	Mobile identity = P-TMSI-1 Paging order is for TBF establishment.
11	MS -> SS	UPLINK RLC DATA BLOCK	LLC PDU implicitly indicating paging response.
12	SS -> MS	PACKET PAGING REQUEST	Mobile identity = IMSI Paging order is for RR-connection.
13	MS -> SS	CHANNEL REQUEST	
14	SS -> MS	IMMEDIATE ASSIGNMENT	
15	MS -> SS	PAGING RESPONSE	Mobile identity = IMSI
16	SS -> MS	CHANNEL RELEASE	After sending of this message, the SS waits for disconnection of the CS signalling link.
17	SS		The following messages are sent and shall be received on cell A. The RF level of cell A is increased and the RF level of cell B is lowered until cell A is preferred by the MS.
18	MS -> SS	ROUTING AREA UPDATING REQUEST	Update type = 'Combined RA/LA updating' P-TMSI-1 signature Routing area identity = RAI-4
19	SS -> MS	ROUTING AREA UPDATING ACCEPT	TMSI status = no valid TMSI available Update result = 'Combined RA/LA updated' No P-TMSI Mobile identity = TMSI-1 Routing area identity = RAI-1
20	MS -> SS	ROUTING AREA UPDATING COMPLETE	
21	SS -> MS	PACKET PAGING REQUEST	Mobile identity = P-TMSI-1 Paging order is for TBF establishment.
22	MS -> SS	UPLINK RLC DATA BLOCK	LLC PDU implicitly indicating paging response.
23	SS -> MS	PACKET PAGING REQUEST	Mobile identity = TMSI-1 Paging order is for RR-connection.
24	MS -> SS	CHANNEL REQUEST	
25	SS -> MS	IMMEDIATE ASSIGNMENT	
26	MS -> SS	PAGING RESPONSE	Mobile identity = TMSI-1

27	SS -> MS	CHANNEL RELEASE	After sending of this message, the SS waits for disconnection of the CS signalling link. Mobile identity = P-TMSI-2 Paging order is for TBF establishment. No response from the MS to the request. This is checked for 10 seconds. The MS is switched off or power is removed (see PICS). Message not sent if power is removed. Detach type = 'power switched off, combined GPRS / IMSI detach'
28	SS -> MS	PACKET PAGING REQUEST	
29	MS		
30	MS		
31	MS -> SS	DETACH REQUEST	

Specific message contents

None.

44.2.3.2.2 Combined routing area updating / MS in CS operation at change of RA

44.2.3.2.2.1 Conformance requirement

GPRS MS that is in an ongoing CS transaction at change of routing area shall initiate the routing area updating procedure only after the CS transaction has been released.

Reference(s):

GSM 04.08 section 4.7.5.2

44.2.3.2.2.2 Test purpose

To test the behaviour of the MS when using the combined routing area updating procedure in cases where the MS is CS connected at change of RA.

44.2.3.2.2.3 Method of test

Initial conditions

System Simulator:

Two cells, cell A in MCC1/MNC1/LAC1/RAC1, cell B in MCC1/MNC1/LAC1/RAC2.
Both cells operating in network operation mode I.

Mobile Station:

The MS has a valid IMSI. MS is Idle Updated on cell A.

Related PICS/PIXIT statement(s)

Support of GPRS service Yes/No

MS operation mode B Yes/No

Switch off on button Yes/No

Automatic GPRS attach procedure at switch on or power on Yes/No

Test procedure

A combined GPRS attach procedure is performed. The MS initiates a CS call. The routing area change. MS will not send a ROUTING AREA UPDATE REQUEST message until the CS operation is terminated.

Maximum duration of test

15 minutes.

Expected sequence

Step	Direction	Message	Comments
1	MS		The MS is set in MS operation mode B (see PICS).
2	MS		The MS is powered up or switched on and initiates an attach (see PICS).
3	MS -> SS	ATTACH REQUEST	Attach type = 'Combined GPRS / IMSI attach' Mobile identity = IMSI
4	SS -> MS	ATTACH ACCEPT	TMSI status = no valid TMSI available Attach result = 'Combined GPRS / IMSI attached' Mobile identity = P-TMSI-2 P-TMSI-2 signature Routing area identity = RAI-1
5	MS -> SS	ATTACH COMPLETE	
6	MS		A CS call is initiated.
7	SS		The following messages are sent and shall be received on cell B. Activate cell B with a lower signal strength than cell A The RF level of cell A is lowered until cell B is preferred by the MS.
8	MS		No RA updating procedure is initiated. This is checked for 60 seconds.
9	MS		The CS call is terminated
10	MS -> SS	ROUTING AREA UPDATING REQUEST	Update type = 'Combined RA/LA updating' P-TMSI-2 signature Routing area identity = RAI-1
11	SS -> MS	ROUTING AREA UPDATING ACCEPT	TMSI status = no valid TMSI available Update result = 'Combined RA/LA updated' Mobile identity = P-TMSI-1 P-TMSI-1 signature Mobile identity = IMSI Routing area identity = RAI-4
12	MS -> SS	ROUTING AREA UPDATING COMPLETE	
13	SS -> MS	PACKET PAGING REQUEST	Mobile identity = P-TMSI-1
14	MS -> SS	UPLINK RLC DATA BLOCK	Paging order is for TBF establishment. LLC PDU implicitly indicating paging response.
15	SS -> MS	PACKET PAGING REQUEST	Mobile identity = IMSI Paging order is for RR-connection.
16	MS -> SS	CHANNEL REQUEST	
17	SS -> MS	IMMEDIATE ASSIGNMENT	
18	MS -> SS	PAGING RESPONSE	Mobile identity = IMSI
19	SS -> MS	CHANNEL RELEASE	After sending of this message, the SS waits for disconnection of the CS signalling link.
20	MS		The MS is switched off or power is removed (see PICS).
21	MS -> SS	DETACH REQUEST	Message not sent if power is removed. Detach type = 'power switched off, combined GPRS / IMSI detach'

Specific message contents

None.

44.2.3.2.3 Combined routing area updating / RA only accepted

44.2.3.2.3.1 Conformance requirement

- 1) If the network accepts the combined GPRS attach procedure, but GMM cause code 'IMSI unknown in HLR' is sent to the MS the Mobile Station shall delete the stored TMSI, LAI and CKSN. The Mobile Station shall consider SIM invalid for non-GPRS services until power is switched off or SIM is removed.

- 2) If the network accepts the combined GPRS attach procedure, but GMM cause code 'MSC temporarily not reachable', 'Network failure' or 'Congestion' is sent to the MS, an MS operation mode B MS may perform an MM IMSI attach procedure.

Reference(s):

GSM 04.08 section 4.7.3.2

44.2.3.2.3.2 Test Purpose**Test purpose 1**

To test the behaviour of the MS if the network accepts the routing area updating procedure with indication RA only, GMM cause 'IMSI unknown in HLR'.

Test purpose 2

To test the behaviour of the MS if the network accepts the routing area updating procedure with indication RA only, GMM cause 'MSC temporarily not reachable', 'Network failure' or 'Congestion'.

44.2.3.2.3.3 Method of test**44.2.3.2.3.3.1 Test Procedure 1****Initial conditions****System Simulator:**

Two cells (not simultaneously activated), cell A in MCC1/MNC1/LAC1/RAC1, cell B in MCC1/MNC1/LAC1/RAC2. Both cells operating in network operation mode I.

Mobile Station:

The MS has a valid ITMSI. MS is Idle Updated on cell A.

Related PICS/PIXIT statement(s)

Support of GPRS service Yes/No

MS operation mode B Yes/No

Switch off on button Yes/No

Automatic GPRS attach procedure at switch on or power on Yes/No

Test procedure

After attach, the MS sends an ROUTING AREA UPDATE REQUEST message. The SS allocates a P-TMSI and returns ROUTING AREA UPDATE ACCEPT message with a P-TMSI. GMM cause 'IMSI unknown in HLR' is indicated from SS. Further communication MS - SS is performed by the P-TMSI. CS services are not possible.

Maximum duration of test

5 minutes.

Expected sequence

Step	Direction	Message	Comments
1	MS		The MS is set in MS operation mode B (see PICS).
2	MS		The MS is powered up or switched on and initiates an attach (see PICS).
3	MS -> SS	ATTACH REQUEST	Attach type = 'Combined GPRS / IMSI attach' Mobile identity = IMSI
4	SS -> MS	ATTACH ACCEPT	TMSI status = no valid TMSI available Attach result = 'Combined GPRS / IMSI attached' Mobile identity = P-TMSI-2 P-TMSI-2 signature Routing area identity = RAI-1
5	MS -> SS	ATTACH COMPLETE	
6	SS		The following messages are sent and shall be received on cell B. The SS deactivates cell A and activates cell B.
7	MS -> SS	ROUTING AREA UPDATING REQUEST	Update type = 'Combined RA/LA updating' P-TMSI-2 signature Routing area identity = RAI-1 TMSI status = no valid TMSI available
8	SS -> MS	ROUTING AREA UPDATING ACCEPT	Update result = 'RA updated' Mobile identity = P-TMSI-1 P-TMSI-1 signature Routing area identity = RAI-4 GMM cause = 'IMSI unknown in HLR'
9	MS -> SS	ROUTING AREA UPDATING COMPLETE	
10	SS -> MS	PACKET PAGING REQUEST	Mobile identity = P-TMSI-1 Paging order is for TBF establishment.
11	MS -> SS	UPLINK RLC DATA BLOCK	LLC PDU implicitly indicating paging response.
12	SS -> MS	PACKET PAGING REQUEST	Mobile identity = IMSI Paging order is for RR-connection.
13	MS		The MS shall not initiate an RR connection. This is checked during 3 seconds.
14	MS		The MS is switched off or power is removed (see PICS).
15	MS -> SS	DETACH REQUEST	Message not sent if power is removed. Detach type = 'power switched off, GPRS detach'

Specific message contents

None.

44.2.3.2.3.3.2 Test Procedure 2

Initial conditions

System Simulator:

Two cells (not simultaneously activated), cell A in MCC1/MNC1/LAC1/RAC1, cell B in MCC1/MNC1/LAC1/RAC2.
Both cells operating in network operation mode I.

Mobile Station:

The MS has a valid IMSI. MS is Idle Updated on cell A.

Related PICS/PIXIT statement(s)

Support of GPRS service Yes/No

MS operation mode B Yes/No

Automatic MM IMSI attach procedure for MS operation mode B MS Yes/No

Switch off on button Yes/No

Automatic GPRS attach procedure at switch on or power on Yes/No

Test procedure

After attach, the MS sends an ROUTING AREA UPDATE REQUEST message . The SS allocates a new P-TMSI signature and returns ROUTING AREA UPDATE ACCEPT message. GMM cause 'MSC temporarily not reachable', 'Network failure' or 'Congestion' is indicated from SS. The cause code is arbitrarily chosen. An MS operation mode B MS may perform an MM IMSI attach procedure (according to the PICS statement). Further communication MS - SS is performed by the P-TMSI. The existence of a signalling channel is verified by a request for mobile identity. CS services are not possible unless an IMSI attach procedure is performed.

Maximum duration of test

5 minutes.

Expected sequence

Dependent whether the option 'Automatic MM IMSI attach procedure for MS operation mode B MS' is not supported or not, the steps 1-13 or 14-35 apply depending on manufacturer (see PICS).

Step	Direction	Message	Comments
1	MS		The following messages are sent and shall be received on cell A
2	MS		The MS is set in MS operation mode B and no automatic MM IMSI attach procedure is indicated (see PICS).
3	MS -> SS	ATTACH REQUEST	The MS is powered up or switched on and initiates an attach (see PICS).
4	SS -> MS	ATTACH ACCEPT	Attach type = 'Combined GPRS / IMSI attach' Mobile identity = IMSI TMSI status = no valid TMSI available Attach result = 'Combined GPRS / IMSI attached' Mobile identity = P-TMSI-2 P-TMSI-2 signature Routing area identity = RAI-1
5	MS -> SS	ATTACH COMPLETE	
6	SS		The following messages are sent and shall be received on cell B.
7	MS -> SS	ROUTING AREA UPDATING REQUEST	The SS deactivates cell A and activates cell B. Update type = 'Combined RA/LA updating' P-TMSI-2 signature Routing area identity = RAI-1 TMSI status = no valid TMSI available
8	SS -> MS	ROUTING AREA UPDATING ACCEPT	Update result = 'RA updated' Mobile identity = P-TMSI-1 P-TMSI-1 signature Routing area identity = RAI-4 GMM cause = 'MSC temporarily not reachable', 'Network failure' or 'Congestion' (arbitrarily chosen)
9	MS -> SS	ROUTING AREA UPDATING COMPLETE	
10	SS -> MS	PACKET PAGING REQUEST	Mobile identity = IMSI Paging order is for RR-connection.
11	MS		The MS shall not initiate an RR connection.
12	MS		This is checked during 3 seconds.
13	MS -> SS	DETACH REQUEST	The MS is switched off or power is removed (see PICS). Message not sent if power is removed. Detach type = 'power switched off, GPRS detach' Stop the sequence.
14	MS		The following messages are sent and shall be received on cell B
15	MS		Automatic MM IMSI attach procedure is indicated (see PICS).
16	MS -> SS	ATTACH REQUEST	The MS is powered up or switched on and initiates an attach (see PICS).
17	SS -> MS	ATTACH ACCEPT	Attach type = 'Combined GPRS / IMSI attach' Mobile identity = IMSI TMSI status = no valid TMSI available Attach result = 'Combined GPRS / IMSI attached' Mobile identity = P-TMSI-2 P-TMSI-2 signature Routing area identity = RAI-4
18	MS -> SS	ATTACH COMPLETE	
19	SS		The following messages are sent and shall be received on cell A.
20	MS -> SS	ROUTING AREA UPDATING REQUEST	The SS deactivates cell B and activates cell A. Update type = 'Combined RA/LA updating' P-TMSI-2 signature Routing area identity = RAI-4 TMSI status = no valid TMSI available

21	SS -> MS	ROUTING AREA UPDATING ACCEPT	Update result = 'RA updated' Mobile identity = P-TMSI-1 P-TMSI-1 signature Routing area identity = RAI-1 GMM cause = 'MSC temporarily not reachable', 'Network failure' or 'Congestion' (arbitrarily chosen)
22	MS -> SS	ROUTING AREA UPDATING COMPLETE	
23	MS -> SS	CHANNEL REQUEST	
24	SS -> MS	IMMEDIATE ASSIGNMENT	
25	MS -> SS	LOCATION UPDATING REQ	Location updating type = IMSI attach.
26	SS -> MS	LOCATION UPDATING ACC	The SS allocates a new TMSI.
27	MS -> SS	TMSI REALLOCATION COMP	Location updating type = IMSI attach.
28	SS -> MS	CHANNEL RELEASE	After sending of this message, the SS waits for disconnection of the CS signalling link.
29	SS -> MS	PACKET PAGING REQUEST	Mobile identity = TMSI-1 Paging order is for RR-connection.
30	MS -> SS	CHANNEL REQUEST	
31	SS -> MS	IMMEDIATE ASSIGNMENT	
32	MS -> SS	PAGING RESPONSE	Mobile identity = TMSI-1
33	SS -> MS	CHANNEL RELEASE	After sending of this message, the SS waits for disconnection of the CS signalling link.
34	MS		The MS is switched off or power is removed (see PICS).
35	MS -> SS	DETACH REQUEST	Message not sent if power is removed. Detach type = 'power switched off, GPRS detach'

Specific message contents

None.

44.2.3.2.4 Combined routing area updating / rejected / PLMN not allowed

44.2.3.2.4.1 Conformance requirement

- 1) If the network rejects a combined routing area updating procedure from the Mobile Station with the cause 'PLMN not allowed' the Mobile Station shall:
 - 1.1. not perform combined GPRA attach when switched on in the same location area or PLMN.
 - 1.2. delete the stored RAI, GPRS-CKSN, P-TMSI, P-TMSI signature, TMSI CKSN and LAI.
 - 1.3. store the PLMN in the 'forbidden PLMN list'.

Reference(s):

GSM 04.08 section 4.7.5.2

44.2.3.2.4.2 Test purpose

To test the behaviour of the MS if the network rejects the combined routing area updating procedure of the MS with the cause 'PLMN not allowed'.

44.2.3.2.4.3 Method of test

Initial conditions

System Simulator:

Four cells (not simultaneously activated), cell A in MCC1/MNC1/LAC1/RAC1, cell B in MCC1/MNC1/LAC1/RAC2, cell C in MCC1/MNC1/LAC2/RAC1 and cell D in MCC2/MNC1/LAC1/RAC1.

All four cells are operating in network operation mode I

Mobile Station:

The MS has a valid IMSI. MS is Idle Updated on cell A.

Related PICS/PIXIT statement(s)

Support of GPRS service Yes/No

MS operation mode B Yes/No

Switch off on button Yes/No

Automatic GPRS attach procedure at switch on or power on Yes/No

Test Procedure

The SS rejects a combined routing area updating with the cause value 'PLMN not allowed'. The SS checks that the MS does not perform GPRS attach if activated in the same PLMN. The SS checks that the MS does not perform IMSI attach if activated in the same PLMN.

Maximum duration of test

10 minutes.

Expected sequence

Step	Direction	Message	Comments
1	SS		The following messages are sent and shall be received on cell A.
2	MS		The SS activates cell A.
3	MS -> SS	ATTACH REQUEST	The MS is powered up or switched on and initiates an attach (see PICS. Attach type = 'Combined GPRS / IMSI attach' Mobile identity = IMSI
4	SS -> MS	ATTACH ACCEPT	TMSI status = no valid TMSI available Attach result = 'Combined GPRS / IMSI attached' Mobile identity = P-TMSI-2 P-TMSI-2 signature Routing area identity = RAI-1
5	MS -> SS	ATTACH COMPLETE	Mobile identity = TMSI-1
7	SS		The following messages are sent and shall be received on cell B.
8	MS		The SS deactivates cell A and activates cell B.
9	MS -> SS	ROUTING AREA UPDATING REQUEST	Cell B is preferred by the MS. Update type = 'Combined RA/LA updating' P-TMSI-2 signature
10	SS -> MS	ROUTING AREA UPDATING REJECT	Routing area identity = RAI-1 TMSI status = valid TMSI available
11	MS		GMM cause = 'PLMN not allowed'
12	MS		The MS initiates an attach by MMI or AT command.
13	SS -> MS	PACKET PAGING REQUEST	No ATTACH REQUEST sent to SS (SS waits 30 seconds). Mobile identity = P-TMSI-2
14	MS		Paging order is for TBF establishment. No response from the MS to the request. This is checked for 10 seconds.
15	SS		The following messages are sent and shall be received on cell C.
16	MS		The SS deactivates cell B and activates cell C.
17	MS		Cell C is preferred by the MS.
18	MS		The MS initiates an attach by MMI or by AT command.
19	SS -> MS	PACKET PAGING REQUEST	No ATTACH REQUEST sent to SS (SS waits 30 seconds). Mobile identity = TMSI-1
20	MS		Paging order is for RR-connection. The MS shall not initiate an RR connection. This is checked during 3 seconds.
21	SS		The following messages are sent and shall be received on cell A.
22	MS		The SS deactivates cell C and activates cell A.
23	MS		Cell A is preferred by the MS.
24	MS		The MS initiates an attach by MMI or by AT command.
25	SS -> MS	PACKET PAGING REQUEST	No ATTACH REQUEST sent to SS (SS waits 30 seconds). Mobile identity = P-TMSI-2
26	MS		Paging order is for TBF establishment. No response from the MS to the request. This is checked for 10 seconds.
27	SS		The following messages are sent and shall be received on cell D.
28	MS		The SS deactivates cell A and activates cell D.
29	MS		Cell D is preferred by the MS.
30	MS -> SS	ATTACH REQUEST	The MS initiates an attach automatically, by MMI or by AT command. Attach type = 'Combined GPRS / IMSI attach' Mobile identity = IMSI TMSI status = no valid TMSI available

31	SS -> MS	ATTACH ACCEPT	Attach result = 'Combined GPRS / IMSI attached' Mobile identity = P-TMSI-1 P-TMSI-1 signature Routing area identity = RAI-2 Mobile identity = IMSI
32	MS -> SS	ATTACH COMPLETE	The MS is switched off or power is removed (see PICS).
33	MS		
34	MS -> SS	DETACH REQUEST	Message not sent if power is removed. Detach type = 'power switched off, combined GPRS / IMSI detach'

Specific message contents

None.

44.2.3.2.5 Combined routing area updating / rejected / roaming not allowed in this location area

44.2.3.2.5.1 Conformance requirement

- 1) If the network rejects a combined routing area updating procedure from the Mobile Station with the cause 'roaming not allowed in this location area' the Mobile Station shall:
 - 1.1 not perform combined GPRS attach when in the same location area.
 - 1.2 delete the stored RAI, GPRS-CKSN, P-TMSI P-TMSI signature, TMSI, CKSN and LAI.
 - 1.3 store the LA in the 'forbidden location areas for roaming'.
 - 1.4 perform combined GPRS attach when a new location area is entered.
- 2) The mobile station shall reset the list of 'Forbidden location areas for roaming' when switched off or when the SIM is removed.

Reference(s):

GSM 04.08 section 4.7.5.2

44.2.3.2.5.2 Test purpose

Test purpose 1

To test that on receipt of a rejection using the 'Roaming not allowed in this area' cause code, the MS ceases trying a routing area updating procedure on that location area. Successful combined routing area updating procedure is possible in other location areas.

Test purpose 2

To test that if the MS is switched off or the SIM is removed the list of 'forbidden location areas for roaming' is cleared.

44.2.3.2.5.3 Method of test

44.2.3.2.5.3.1 Test procedure 1

Initial conditions

System Simulator:

Two cells (not simultaneously activated), cell A in MCC1/MNC1/LAC1/RAC1, cell B in MCC1/MNC/LAC2/RAC1. Both cells are operating in network operation mode I.

Mobile Station:

The MS has a valid IMSI. MS is Idle Updated on cell A.

Related PICS/PIXIT statement(s)

Support of GPRS service Yes/No

MS operation mode B Yes/No

Switch off on button Yes/No

Automatic GPRS attach procedure at switch on or power on Yes/No

Test procedure

The SS rejects a combined routing area updating with the cause value 'Roaming not allowed in this area'. A new attempt for a combined GPRS attach is not possible. Successful combined GPRS attach procedure is performed in another location area. The MS is mobed back to the 1st location area. A combined routing area updating shall not be performed, as the LA is on the forbidden list.

Maximum duration of test

10 minutes.

Expected sequence

Step	Direction	Message	Comments
1	SS		The following messages are sent and shall be received on cell A.
2	SS		The SS activates cell A.
3	MS -> SS	ATTACH REQUEST	The MS is powered up or switched on and initiates an attach (see PICS). Attach type = 'Combined GPRS / IMSI attach' Mobile identity = IMSI
4	SS -> MS	ATTACH ACCEPT	TMSI status = no valid TMSI available Attach result = 'Combined GPRS / IMSI attached' Mobile identity = P-TMSI-2 P-TMSI-2 signature Routing area identity = RAI-1
5	MS -> SS	ATTACH COMPLETE	Mobile identity = IMSI
7	SS		The following messages are sent and shall be received on cell B.
8	MS		The SS deactivates cell A and activates cell B. Cell B is preferred by the MS.
9	MS -> SS	ROUTING AREA UPDATING REQUEST	Update type = 'Combined RA/LA updating' P-TMSI-2 signature Routing area identity = RAI-1
10	SS -> MS	ROUTING AREA UPDATING REJECT	TMSI status = no valid TMSI available GMM cause = 'Roaming not allowed in this area'
11	MS		The MS initiates an attach by MMI or by AT command.
12	MS		No ATTACH REQUEST sent to SS (SS waits 30 seconds).
13	SS -> MS	PACKET PAGING REQUEST	Mobile identity = P-TMSI-2 Paging order is for TBF establishment.
14	MS		No response from the MS to the request. This is checked for 10 seconds.
15	SS -> MS	PACKET PAGING REQUEST	Mobile identity = IMSI Paging order is for RR-connection.
16	MS		The MS shall not initiate an RR connection. This is checked during 3 seconds.
17	SS		The following messages are sent and shall be received on cell A.
18	MS		The SS deactivates cell B and activates cell A. Cell A is preferred by the MS.
19	MS		The MS initiates an attach automatically, by MMI or by AT command.
20	MS -> SS	ATTACH REQUEST	Attach type = 'Combined GPRS / IMSI attach' Mobile identity = IMSI
21	SS -> MS	ATTACH ACCEPT	TMSI status = no valid TMSI available Attach result = 'Combined GPRS / IMSI attached' Mobile identity = P-TMSI-1 P-TMSI-1 signature Routing area identity = RAI-1
22	MS -> SS	ATTACH COMPLETE	Mobile identity = TMSI-1
23	SS -> MS	PACKET PAGING REQUEST	Paging order is for RR-connection.
24	MS -> SS	CHANNEL REQUEST	
25	SS -> MS	IMMEDIATE ASSIGNMENT	
26	MS -> SS	PAGING RESPONSE	Mobile identity = TMSI-1
27	SS -> MS	CHANNEL RELEASE	After sending of this message, the SS waits for disconnection of the CS signalling link.
28	SS -> MS	PACKET PAGING REQUEST	Mobile identity = P-TMSI-1 Paging order is for TBF establishment.
29	MS -> SS	UPLINK RLC DATA BLOCK	LLC PDU implicitly indicating paging response.

30	SS		The following messages are sent and shall be received on cell B.
31	MS		The SS deactivates cell A and activates cell B.
32	SS -> MS	PACKET PAGING REQUEST	No ROUTING AREA UPDATING REQUEST sent to SS
33	MS		(SS waits 30 seconds). Mobile identity = P-TMSI-2 Paging order is for TBF establishment.
34	SS -> MS	PACKET PAGING REQUEST	No response from the MS to the request. This is checked for 10 seconds.
35	MS		Mobile identity = IMSI Paging order is for RR-connection. The MS shall not initiate an RR connection. This is checked during 3 seconds.

Specific message contents

None.

44.2.3.2.5.3.2 Test procedure 2

Initial conditions

System Simulator:

Two cells (not simultaneously activated), cell A in MCC1/MNC1/LAC1/RAC1, cell B in MCC1/MNC/LAC2/RAC1. Both cells are operating in network operation mode I.

Mobile Station:

The MS has a valid P-TMSI-1, P-TMSI-1 signature and RAI-1. MS is Idle Updated on cell A.

Related PICS/PIXIT statement(s)

Support of GPRS service Yes/No

MS operation mode B Yes/No

SIM removal possible without powering down Yes/No

Switch off on button Yes/No

Automatic GPRS attach procedure at switch on or power on Yes/No

Test procedure

The SS rejects a combined routing area updating with the cause value 'Roaming not allowed in this area'. The MS is switched off for 10 seconds and switched on again. The SS checks that a combined GPRS attach is possible on the cell on which the previous combined routing area updating had been rejected.

If SIM removal is possible without switching off: The SS rejects a routing area updating with the cause value 'Roaming not allowed in this area'. The SIM is removed and inserted in the MS. The SS checks that a GPRS attach procedure and routing area updating procedure is possible on the cell on which the routing area updating had previously been rejected.

Maximum duration of test

10 minutes.

Expected sequence

Step	Direction	Message	Comments
1	SS		The following messages are sent and shall be received on cell A.
2	MS		The SS activates cell A.
3	MS -> SS	ATTACH REQUEST	The MS is powered up or switched on and initiates an attach (see PICS). Attach type = 'Combined GPRS / IMSI attach' Mobile identity = IMSI
4	SS -> MS	ATTACH ACCEPT	TMSI status = no valid TMSI available Attach result = 'Combined GPRS / IMSI attached' Mobile identity = P-TMSI-2 P-TMSI-2 signature Routing area identity = RAI-1
5	MS -> SS	ATTACH COMPLETE	Mobile identity = IMSI
7	SS		The following messages are sent and shall be received on cell B.
8	MS		The SS deactivates cell A and activates cell B.
9	MS -> SS	ROUTING AREA UPDATING REQUEST	Cell B is preferred by the MS. Update type = 'Combined RA/LA updating' P-TMSI-2 signature Routing area identity = RAI-1
10	SS -> MS	ROUTING AREA UPDATING REJECT	TMSI status = no valid TMSI available GMM cause = 'Roaming not allowed in this area'
11	MS		The MS initiates an attach by MMI or by AT command.
12	MS		No ATTACH REQUEST sent to SS (SS waits 30 seconds).
13	SS -> MS	PACKET PAGING REQUEST	Mobile identity = P-TMSI-2 Paging order is for TBF establishment.
14	MS		No response from the MS to the request. This is checked for 10 seconds.
15	SS -> MS	PACKET PAGING REQUEST	Mobile identity = IMSI Paging order is for RR-connection.
16	MS		The MS shall not initiate an RR connection. This is checked during 3 seconds.
17	MS		If possible (see PICS) SIM removal is performed. Otherwise if possible (see PICS) switch off is performed. Otherwise the power is removed.
18	MS		The MS gets the SIM replaced, is powered up or switched on and initiates an attach (see PICS).
19	MS -> SS	ATTACH REQUEST	Attach type = 'Combined GPRS / IMSI attach' Mobile identity = IMSI
20	SS -> MS	ATTACH ACCEPT	TMSI status = no valid TMSI available Attach result = 'Combined GPRS / IMSI attached' Mobile identity = P-TMSI-1 P-TMSI-1 signature Routing area identity = RAI-3
21	MS -> SS	ATTACH COMPLETE	Mobile identity = TMSI-1
22	SS -> MS	PACKET PAGING REQUEST	Paging order is for RR-connection.
23	MS -> SS	CHANNEL REQUEST	
24	SS -> MS	IMMEDIATE ASSIGNMENT	
25	MS -> SS	PAGING RESPONSE	Mobile identity = TMSI-1
26	SS -> MS	CHANNEL RELEASE	After sending of this message, the SS waits for disconnection of the CS signalling link.
27	SS -> MS	PACKET PAGING REQUEST	Mobile identity = P-TMSI-1 Paging order is for TBF establishment.
28	MS -> SS	UPLINK RLC DATA BLOCK	LLC PDU implicitly indicating paging response.

29	MS		The MS is switched off or power is removed (see PICS). Message not sent if power is removed. Detach type = 'power switched off, combined GPRS/IMSI detach'
30	MS -> SS	DETACH REQUEST	

Specific message contents

None.

44.2.3.2.6 Combined routing area updating / abnormal cases / access barred due to access class control

44.2.3.2.6.1 Conformance requirement

- 1) The MS shall not perform combined routing area updating procedure, but stays in the current serving cell and applies normal cell reselection process.
- 2) The Mobile Station shall perform the combined routing area updating procedure when:
 - 2.1 Access is granted.
 - 2.2 Cell is changed.

Reference(s):

GSM 04.08 section 4.7.5.2

44.2.3.2.6.2 Test purpose

Test purpose 1

To test the behaviour of the MS in case of access class control (access is granted).

Test purpose 2

To test the behaviour of the MS in case of access class control (cell is changed).

44.2.3.2.6.3 Method of test

44.2.3.2.6.3.1 Test procedure 1

Initial conditions

A random access class x (0-15) is selected. The SIM is programmed with this access class x. Communication with mobile stations using access class x is initially indicated to be barred.

System Simulator:

Two cells (not simultaneously activated), cell A in MCC1/MNC1/LAC1/RAC1, cell B in MCC1/MNC/LAC1/RAC2. Both cells are operating in network operation mode I.
Access class x barred.

Mobile Station:

The MS has a valid P-TMSI, P-TMSI signature and RAI. MS is Idle Updated on cell A.

Related PICS/PIXIT statement(s)

Support of GPRS service Yes/No
MS operation mode B Yes/No

Switch off on button Yes/No

Automatic GPRS attach procedure at switch on or power on Yes/No

Test procedure

A GPRS attach procedure is performed. The routing area is changed. The SS indicates access class x barred. A routing area updating procedure is not performed.

The SS indicates that access class x is not barred. A routing area updating procedure is performed.

Maximum duration of test

10 minutes.

Expected sequence

Step	Direction	Message	Comments
1	SS		The following messages are sent and shall be received on cell A.
2	MS		The MS activates cell A.
3	MS -> SS	ATTACH REQUEST	The MS is powered up or switched on and initiates an attach (see PICS). Attach type = 'Combined GPRS / IMSI attach' Mobile identity = IMSI
4	SS -> MS	ATTACH ACCEPT	TMSI status = no valid TMSI available Attach result = 'Combined GPRS / IMSI attached' Mobile identity = P-TMSI-2 P-TMSI-2 signature Routing area identity = RAI-1 Mobile identity = IMSI
5	MS -> SS	ATTACH COMPLETE	
7	SS		The following messages are sent and shall be received on cell B.
8	MS		The SS deactivates cell A and activates cell B.
9	MS		Cell B is preferred by the MS.
10	SS		No ROUTING AREA UPDATE REQUEST sent to SS, as access class X is barred (SS waits 30 seconds).
11	MS -> SS	ROUTING AREA UPDATING REQUEST	The access class x is not barred anymore. Update type = 'Combined RA/LA updating' P-TMSI-2 signature Routing area identity = RAI-1 TMSI status = no valid TMSI available
12	SS -> MS	ROUTING AREA UPDATING ACCEPT	Update result = 'Combined RA/LA updated' Mobile identity = P-TMSI-1 P-TMSI-1 signature Mobile identity = TMSI-1 Routing area identity = RAI-4
13	MS -> SS	ROUTING AREA UPDATING COMPLETE	
14	MS		The MS is switched off or power is removed (see PICS).
15	MS -> SS	DETACH REQUEST	Message not sent if power is removed. Detach type = 'power switched off, combined GPRS/IMSI detach'

Specific message contents

None.

44.2.3.2.6.3.2 Test procedure 2

Initial conditions

A random access class x (0-15) is selected. The SIM is programmed with this access class x. Communication with mobile stations using access class x is indicated to be barred on cell A.

System Simulator:

Three cells, cell A in MCC1/MNC1/LAC1/RAC1 has access class x not barred, cell B in MCC1/MNC1/LAC1/RAC2 has access class x barred, cell C in MCC1/MNC1/LAC1/RAC2 has access class x not barred.
All three cells are operating in network operation mode I.

Mobile Station:

The MS has a valid IMSI. MS is Idle Updated on cell A.

Related PICS/PIXIT statement(s)

Support of GPRS service Yes/No

MS operation mode B Yes/No

Switch off on button Yes/No

Automatic GPRS attach procedure at switch on or power on Yes/No

Test procedure

A GPRS attach procedure is performed. The routing area is changed. The SS indicates access class x barred. A routing area updating procedure is not performed.

A cell change is performed into a cell where access class x is not barred. A routing area updating procedure is performed.

Maximum duration of test

10 minutes.

Expected sequence

Step	Direction	Message	Comments
1	SS		The following messages are sent and shall be received on cell A.
2	SS		The SS activates cell A.
3	MS -> SS	ATTACH REQUEST	The MS is powered up or switched on and initiates an attach (see PICS). Attach type = 'Combined GPRS / IMSI attach' Mobile identity = IMSI
4	SS -> MS	ATTACH ACCEPT	TMSI status = no valid TMSI available Attach result = 'Combined GPRS / IMSI attached' Mobile identity = P-TMSI-2 P-TMSI-2 signature Routing area identity = RAI-1
5	MS -> SS	ATTACH COMPLETE	Mobile identity = IMSI
7	SS		The following messages are sent and shall be received on cell B.
8	SS		The SS deactivates cell A and activates cell B.
9	MS		Cell B is preferred by the MS. No ROUTING AREA UPDATING REQUEST sent to SS, as access class X is barred (SS waits 30 seconds).
10	SS		The following messages are sent and shall be received on cell C.
11	SS		The SS deactivates cell B and activates cell C.
12	MS -> SS	ROUTING AREA UPDATING REQUEST	Cell C is preferred by the MS. Update type = 'Combined RA/LA updating' P-TMSI-2 signature Routing area identity = RAI-1
13	SS -> MS	ROUTING AREA UPDATING ACCEPT	TMSI status = no valid TMSI available Update result = 'Combined RA/LA updated' Mobile identity = P-TMSI-1 P-TMSI-1 signature Mobile identity = IMSI
14	MS -> SS	ROUTING AREA UPDATING COMPLETE	Routing area identity = RAI-4
15	MS		The MS is switched off or power is removed (see PICS).
16	MS -> SS	DETACH REQUEST	Message not sent if power is removed. Detach type = 'power switched off, combined GPRS/IMSI detach'

Specific message contents

None.

44.2.3.2.7 Combined routing area updating / abnormal cases / attempt counter check / procedure timeout

44.2.3.2.7.1 Conformance requirement

- 1) When a T3330 timeout has occurred during a routing area updating procedure, the Mobile Station shall repeat the routing area updating procedure after T3330 timeout until the procedure is repeated five times.
- 2) When a routing area updating procedure is repeated five times, the routing area updating attempt counter is incremented and five more routing area updating procedures are performed. This procedure is repeated until the routing area updating attempt counter is five, the Mobile Station shall then start timer T3302.
- 3) When the T3302 expire, a new routing area updating procedure shall be initiated.

Reference(s):

GSM 04.08 section 4.7.5.2

44.2.3.2.7.2 Test purpose

To test the behaviour of the MS with respect to the routing area updating attempt counter.

44.2.3.2.7.3 Method of test

Initial conditions

System Simulator:

Two cells (not simultaneously activated), cell A in MCC1/MNC1/LAC1/RAC1, cell B in MCC1/MNC/LAC1/RAC2. T3302 is set to 12 minutes.

Both cells are operating in network operation mode I.

Mobile Station:

The MS has a valid TMSI, P-TMSI, P-TMSI signature and RAI. MS is Idle Updated on cell A.

Related PICS/PIXIT statement(s)

Support of GPRS service Yes/No

MS operation mode B Yes/No

Switch off on button Yes/No

Automatic GPRS attach procedure at switch on or power on Yes/No

Test procedure

The MS initiates a routing area updating procedure (routing area updating attempt counter zero). The SS does not answer with ROUTING AREA UPDATE ACCEPT message before T3330 timeout. The MS restarts the routing area updating procedure four times. The SS never answers with ROUTING AREA UPDATE ACCEPT message before T3330 timeout. After five consecutive routing area update procedures, the routing area updating attempt counter is incremented and T3311 is started.

The MS initiates a new routing area updating procedure (routing area updating attempt counter one) after T3311 expires. The SS does not answer with ROUTING AREA UPDATE ACCEPT message before T3330 timeout. The MS restarts the routing area updating procedure four times. The SS never answers with ROUTING AREA UPDATE ACCEPT message before T3330 timeout. After five consecutive routing area update procedures, the routing area updating attempt counter is incremented and T3311 is started.

The MS initiates a new routing area updating procedure (routing area updating attempt counter two) after T3311 expires. The SS does not answer with ROUTING AREA UPDATE ACCEPT message before T3330 timeout. The MS restarts the routing area updating procedure four times. The SS never answers with ROUTING AREA UPDATE ACCEPT message before T3330 timeout. After five consecutive routing area update procedures, the routing area updating attempt counter is incremented and T3311 is started.

The MS initiates a new routing area updating procedure (routing area updating attempt counter three) after T3311 expires. The SS does not answer with ROUTING AREA UPDATE ACCEPT message before T3330 timeout. The MS restarts the routing area updating procedure four times. The SS never answers with ROUTING AREA UPDATE ACCEPT message before T3330 timeout. After five consecutive routing area update procedures, the routing area updating attempt counter is incremented and T3311 is started.

The MS initiates a new routing area updating procedure (routing area updating attempt counter four) after T3311 expires. The SS does not answer with ROUTING AREA UPDATE ACCEPT message before T3330 timeout. The MS restarts the routing area updating procedure four times. The SS never answers with ROUTING AREA UPDATE ACCEPT message before T3330 timeout. After five consecutive routing area update procedures, the routing area updating attempt counter is incremented and as the routing area updating attempt counter is five. T3302 is started.

The MS initiates a routing area updating procedure with routing area updating attempt counter zero after T3302 expires with the stored P-TMSI, P-TMSI signature, GPRS CKSN and RAI.

Maximum duration of test

20 minutes.

Expected sequence

Step	Direction	Message	Comments
1	SS		The following messages are sent and shall be received on cell A.
2	SS		The SS activates cell A.
3	MS -> SS	ATTACH REQUEST	The MS is powered up or switched on and initiates an attach (see PICS). Attach type = 'Combined GPRS / IMSI attach' Mobile identity = IMSI
4	SS -> MS	ATTACH ACCEPT	TMSI status = no valid TMSI available Attach result = 'Combined GPRS / IMSI attached' Mobile identity = P-TMSI-2 P-TMSI-2 signature Routing area identity = RAI-1
5	MS -> SS	ATTACH COMPLETE	Mobile identity = IMSI
7	SS		The following messages are sent and shall be received on cell B.
8	SS		The SS deactivates cell A and activates cell B.
9	MS -> SS	ROUTING AREA UPDATING REQUEST	Cell B is preferred by the MS. k= 1 Update type = 'Combined RA/LA updating' P-TMSI-2 signature Routing area identity = RAI-1 TMSI status = no valid TMSI available routing area updating attempt counter = k (k is not visible. It is only used for clarifying the sequence.) Retransmission counter = 0
10	SS		No response is given from the SS.
11	SS		The SS verifies that the time between the RA update requests is T3330 seconds (+/- 10%)
12	MS -> SS	ROUTING AREA UPDATING REQUEST	Update type = 'Combined RA/LA updating' P-TMSI-2 signature Routing area identity = RAI-1 TMSI status = no valid TMSI available routing area updating attempt counter = k Retransmission counter = 1
13	SS		No response is given from the SS.
14	SS		The SS verifies that the time between the RA update requests is T3330 seconds (+/- 10%)
15	MS -> SS	ROUTING AREA UPDATING REQUEST	Update type = 'Combined RA/LA updating' P-TMSI-2 signature Routing area identity = RAI-1 TMSI status = no valid TMSI available routing area updating attempt counter = k Retransmission counter = 2
16	SS		No response is given from the SS.
17	SS		The SS verifies that the time between the RA update requests is T3330 seconds (+/- 10%)
18	MS -> SS	ROUTING AREA UPDATING REQUEST	Update type = 'Combined RA/LA updating' P-TMSI-2 signature Routing area identity = RAI-1 TMSI status = no valid TMSI available routing area updating attempt counter = k Retransmission counter = 3
19	SS		No response is given from the SS.
20	SS		The SS verifies that the time between the RA update requests is T3330 seconds (+/- 10%)
21	MS -> SS	ROUTING AREA UPDATING REQUEST	Update type = 'Combined RA/LA updating' P-TMSI-2 signature Routing area identity = RAI-1 TMSI status = no valid TMSI available routing area updating attempt counter = k Retransmission counter = 4
22	SS		No response is given from the SS.

23	SS		The SS verifies that the time between the RA update requests is T3311 + T3330 seconds (+/- 10%)
24	SS		Step 9 – 23 is repeated four times with k = 2, k = 3, k = 4 and k = 5
25	SS		The SS verifies that the time between the RA update requests is T3302 minutes + T3330 seconds (+/- 10%)
26	MS -> SS	ROUTING AREA UPDATING REQUEST	Update type = 'Combined RA/LA updating' P-TMSI-2 signature Routing area identity = RAI-1 TMSI status = no valid TMSI available
27	SS -> MS	ROUTING AREA UPDATING ACCEPT	Update result = 'Combined RA/LA updated' Mobile identity = P-TMSI-1 P-TMSI-1 signature Mobile identity = IMSI Routing area identity = RAI-4
28	MS -> SS	ROUTING AREA UPDATING COMPLETE	
29	MS		The MS is switched off or power is removed (see PICS).
30	MS -> SS	DETACH REQUEST	Message not sent if power is removed. Detach type = 'power switched off, combined GPRS/IMSI detach'

Specific message contents

None.

44.2.3.2.8 Combined routing area updating / abnormal cases / change of cell into new routing area

44.2.3.2.8.1 Conformance requirement

When a change of cell into a new routing area is performed before the routing area updating procedure is finished, the MS shall abort the routing area updating procedure and re-initiate it in the new routing area.

Reference(s):

GSM 04.08 section 4.7.5.2

44.2.3.2.8.2 Test purpose

To test the behaviour of the MS in case of procedure collision.

44.2.3.2.8.3 Method of test

Initial conditions

System

Three cells, cell A in MCC1/MNC1/LAC1/RAC1, cell B in MCC1/MNC1/LAC1/RAC2, cell C in MCC1/MNC1/LAC1/RAC3.
All three cells are operating in network operation mode I.

Simulator:

Mobile

The MS has a valid IMSI. MS is Idle Updated on cell A.

Station:

Related PICS/PIXIT statement(s)

Support of GPRS service Yes/No

MS operation mode B Yes/No

Switch off on button Yes/No

Automatic GPRS attach procedure at switch on or power on Yes/No

Test procedure

The MS initiates a routing area updating procedure. The ROUTING AREA UPDATE ACCEPT message is delayed from the SS. The MS performs a cell update into a new routing area. The Ms shall re-initiate a routing area updating procedure in the new routing area. The MS shall not increment the attempt counter.

Maximum duration of test

10 minutes.

Expected sequence

Step	Direction	Message	Comments
1	SS		The following messages are sent and shall be received on cell A.
2	SS		The SS activates cell A.
3	MS -> SS	ATTACH REQUEST	The MS is powered up or switched on and initiates an attach (see PICS). Attach type = 'Combined GPRS / IMSI attach' Mobile identity = IMSI
4	SS -> MS	ATTACH ACCEPT	TMSI status = no valid TMSI available Attach result = 'Combined GPRS / IMSI attached' Mobile identity = P-TMSI-2 P-TMSI-2 signature Routing area identity = RAI-1
5	MS -> SS	ATTACH COMPLETE	Mobile identity = IMSI
6	SS		The following messages are sent and shall be received on cell B.
7	SS		The SS deactivates cell A and activates cell B.
8	MS -> SS	ROUTING AREA UPDATING REQUEST	Cell B is preferred by the MS. Update type = 'Combined RA/LA updating' P-TMSI-2 signature Routing area identity = RAI-1
9	SS		TMSI status = no valid TMSI available No response id given from the SS.
10	SS		The following messages are sent and shall be received on cell C.
11	MS		Activate cell C with a lower signal strength than cell B.
12	MS -> SS	ROUTING AREA UPDATING REQUEST	The RF level of cell B is lowered, and the RF level of cell C is increased, until cell C is preferred by the MS. Update type = 'Combined RA/LA updating' P-TMSI-2 signature Routing area identity = RAI-1
13	SS -> MS	ROUTING AREA UPDATING ACCEPT	TMSI status = no valid TMSI available Update result = 'Combined RA/LA updated' Mobile identity = P-TMSI-1 P-TMSI-1 signature Mobile identity = IMSI
14	MS -> SS	ROUTING AREA UPDATING COMPLETE	Routing area identity = RAI-5
15	MS		The MS is switched off or power is removed (see PICS).
16	MS -> SS	DETACH REQUEST	Message not sent if power is removed. Detach type = 'power switched off, combined GPRS/IMSI detach'

Specific message contents

None.

44.2.3.2.9 Combined routing area updating / abnormal cases / change of cell during routing area updating procedure

44.2.3.2.9.1 Conformance requirement

When a change of cell within new routing area is performed before the routing area updating procedure is finished, the MS shall perform the cell update before the routing area updating procedure is finished.

Reference(s):

GSM 04.08 section 4.7.5.2

44.2.3.2.9.2 Test purpose

To test the behaviour of the MS in case of procedure collision.

44.2.3.2.9.3 Method of test

Initial conditions

System Simulator:

Three cells, cell A in MCC1/MNC1/LAC1/RAC1, cell B in MCC1/MNC1/LAC1/RAC2, cell C in MCC1/MNC1/LAC1/RAC2.

All three cells are operating in network operation mode I.

Mobile Station:

The MS has a valid IMSI. MS is Idle Updated on cell A.

Related PICS/PIXIT statement(s)

Support of GPRS service Yes/No

MS operation mode B Yes/No

Switch off on button Yes/No

Automatic GPRS attach procedure at switch on or power on Yes/No

Test procedure

The MS initiates a routing area updating procedure. The ROUTING AREA UPDATE ACCEPT message is delayed from the SS. The MS performs a cell update within the routing area. The MS then waits for the ROUTING AREA UPDATE ACCEPT message.

Maximum duration of test

10 minutes.

Expected sequence

Step	Direction	Message	Comments
1	SS		The following messages are sent and shall be received on cell A.
2	SS		The SS activates cell A.
3	MS -> SS	ATTACH REQUEST	The MS is powered up or switched on and initiates an attach (see PICS).
4	SS -> MS	ATTACH ACCEPT	Attach type = 'Combined GPRS / IMSI attach' Mobile identity = IMSI TMSI status = no valid TMSI available Attach result = 'Combined GPRS / IMSI attached'
5	MS -> SS	ATTACH COMPLETE	Mobile identity = P-TMSI-2 P-TMSI-2 signature Routing area identity = RAI-1 Mobile identity = IMSI
6	SS		The following messages are sent and shall be received on cell B.
7	MS		The SS deactivates cell A and activates cell B.
8	MS -> SS	ROUTING AREA UPDATING REQUEST	Cell B is preferred by the MS. Update type = 'Combined RA/LA updating' P-TMSI-2 signature Routing area identity = RAI-1 TMSI status = no valid TMSI available
9	SS		No response id given from the SS.
10	SS		The following messages are sent and shall be received on cell C.
11	MS		Activate cell C with a lower signal strength than cell B.
12	MS -> SS	UPLINK RLC DATA BLOCK	The RF level of cell B is lowered until cell C is preferred by the MS.
13	SS -> MS	ROUTING AREA UPDATING ACCEPT	LLC PDU implicitly indicating cell update. Update result = 'Combined RA/LA updated' Mobile identity = P-TMSI-1 P-TMSI-1 signature Mobile identity = IMSI Routing area identity = RAI-4
14	MS -> SS	ROUTING AREA UPDATING COMPLETE	
15	MS		The MS is switched off or power is removed (see PICS).
16	MS -> SS	DETACH REQUEST	Message not sent if power is removed. Detach type = 'power switched off, combined GPRS/IMSI detach'

Specific message contents

None.

44.2.3.2.10 Combined routing area updating / abnormal cases / GPRS detach procedure collision

44.2.3.2.10.1 Conformance requirement

- 1) When a detach request is received with cause 'GPRS detach' or 'combined GPRS/IMSI detach' by the MS while waiting for a ROUTING AREA UPDATE ACCEPT message, the MS shall terminate the routing area updating procedure and continue with the GPRS detach procedure.
- 2) When a detach request is received with cause 'IMSI detach' by the MS while waiting for a ROUTING AREA UPDATE ACCEPT message, the MS shall ignore the detach request and continue with the routing area updating procedure.

Reference(s):

GSM 04.08 section 4.7.5.2

44.2.3.2.10.2 Test purpose

To test the behaviour of the MS in case of procedure collision.

44.2.3.2.10.3 Method of test

44.2.3.2.10.3.1 Test procedure 1

Initial conditions

System Simulator:

Two cells, cell A in MCC1/MNC1/LAC1/RAC1, cell B in MCC1/MNC1/LAC1/RAC2.

Both cells are operating in network operation mode I.

Mobile Station:

The MS has a valid IMSI. MS is Idle Updated on cell A.

Related PICS/PIXIT statement(s)

Support of GPRS service Yes/No

MS operation mode B Yes/No

Switch off on button Yes/No

Automatic GPRS attach procedure at switch on or power on Yes/No

Test procedure

The MS initiates a routing area updating procedure. The SS does not answer the routing area updating procedure, but initiates a GPRS detach procedure with cause 'GPRS detach' or 'combined GPRS/IMSI detach'. The MS shall terminate the routing area updating procedure and continue with the GPRS detach procedure.

Maximum duration of test

10 minutes.

Expected sequence

Step	Direction	Message	Comments
1	SS		The following messages are sent and shall be received on cell A.
2	SS		The SS activates cell A.
3	MS -> SS	ATTACH REQUEST	The MS is powered up or switched on and initiates an attach (see PICS).
4	SS -> MS	ATTACH ACCEPT	Attach type = 'Combined GPRS / IMSI attach' Mobile identity = IMSI TMSI status = no valid TMSI available Attach result = 'Combined GPRS / IMSI attached'
5	MS -> SS	ATTACH COMPLETE	Mobile identity = P-TMSI-2 P-TMSI-2 signature Routing area identity = RAI-1 Mobile identity = IMSI
6	SS		The following messages are sent and shall be received on cell B.
7	SS		The SS deactivates cell A and activates cell B.
8	MS -> SS	ROUTING AREA UPDATING REQUEST	Cell B is preferred by the MS. Update type = 'Combined RA/LA updating' P-TMSI-2 signature
9	SS		Routing area identity = RAI-1 TMSI status = no valid TMSI available The SS ignores the ROUTING AREA UPDATING REQUEST message and initiates a detach procedure.
10	SS -> MS	DETACH REQUEST	Detach type = 're-attach not required'
11	MS -> SS	DETACH ACCEPT	

Specific message contents

None.

44.2.3.2.10.3.2 Test procedure 2

Initial conditions

System Simulator:

Two cells, cell A in MCC1/MNC1/LAC1/RAC1, cell B in MCC1/MNC1/LAC1/RAC2.
Both cells are operating in network operation mode I.

Mobile Station:

The MS has a valid P-TMSI, P-TMSI signature and RAI. MS is Idle Updated on cell A.

Related PICS/PIXIT statement(s)

Support of GPRS service Yes/No

MS operation mode B Yes/No

Switch off on button Yes/No

Automatic GPRS attach procedure at switch on or power on Yes/No

Test procedure

The MS initiates a routing area updating procedure. The SS does not answer the routing area updating procedure, but initiates a GPRS detach procedure with cause 'IMSI detach'. The MS shall ignore the detach procedure and continue with the routing area updating procedure.

Maximum duration of test

10 minutes.

Expected sequence

Step	Direction	Message	Comments
1	SS		The following messages are sent and shall be received on cell A.
2	SS		The SS activates cell A.
3	MS -> SS	ATTACH REQUEST	The MS is powered up or switched on and initiates an attach (see PICS). Attach type = 'Combined GPRS / IMSI attach' Mobile identity = IMSI
4	SS -> MS	ATTACH ACCEPT	TMSI status = no valid TMSI available Attach result = 'Combined GPRS / IMSI attached' Mobile identity = P-TMSI-2 P-TMSI-2 signature Routing area identity = RAI-1
5	MS -> SS	ATTACH COMPLETE	Mobile identity = IMSI
6	SS		The following messages are sent and shall be received on cell B.
7	SS		The SS deactivates cell A and activates cell B.
8	MS -> SS	ROUTING AREA UPDATING REQUEST	Cell B is preferred by the MS. Update type = 'Combined RA/LA updating' P-TMSI-2 signature Routing area identity = RAI-1
9	SS		TMSI status = no valid TMSI available The SS ignores the ROUTING AREA UPDATING REQUEST message and initiates a detach procedure.
10	SS -> MS	DETACH REQUEST	Detach type = 'IMSI detach'
11	MS		The MS ignores the DETACH REQUEST message and continue the routing area updating procedure.
12	SS -> MS	ROUTING AREA UPDATING ACCEPT	Update result = 'Combined RA/LA updated' Mobile identity = P-TMSI-1 P-TMSI-1 signature Mobile identity = IMSI
13	MS -> SS	ROUTING AREA UPDATING COMPLETE	Routing area identity = RAI-4
14	MS		The MS is switched off or power is removed (see PICS).
15	MS -> SS	DETACH REQUEST	Message not sent if power is removed. Detach type = 'power switched off, combined GPRS/IMSI detach'

Specific message contents

None.

44.2.3.3 Periodic routing area updating

44.2.3.3.1 Periodic routing area updating / accepted

44.2.3.3.1.1 Conformance requirement

The Mobile Station shall perform a periodic routing area update procedure after a T3312 timeout.

Reference(s):

GSM 04.08 section 4.7.2.2 and 4.7.5.1

44.2.3.3.1.2 Test purpose

To test the behaviour of the MS with respect to the periodic routing area updating procedure.

44.2.3.3.1.3 Method of test

Initial conditions

System Simulator:

One cell operating in network operation mode II (in case of MS operation mode B), or in network operation mode III (in case of MS operation mode C).

Mobile Station:

The MS has a valid P-TMSI-1, P-TMSI-1 signature and RAI-1. MS is Idle Updated.

Related PICS/PIXIT statement(s)

Support of GPRS service Yes/No

MS operation mode C Yes/No

MS operation mode B Yes/No

SIM removal possible without powering down Yes/No

Switch off on button Yes/No

Automatic GPRS attach procedure at switch on or power on Yes/No

Test procedure

The MS initiates a GPRS attach procedure with identity P-TMSI. The SS reallocates the P-TMSI and returns ATTACH ACCEPT message with a new P-TMSI and timer T3312. The MS acknowledge the new P-TMSI by sending ATTACH COMPLETE message. A routing area updating procedure is performed at T3312 timeout.

T3312; set to 6 minutes.

Maximum duration of test

20 minutes.

Expected sequence

Step	Direction	Message	Comments
1	SS		The MS is set in MS operation mode C (see PICS). If MS operation mode C not supported, goto step 11.
2	MS		The MS is powered up or switched on and initiates an attach (see PICS).
3	MS -> SS	ATTACH REQUEST	Attach type = 'GPRS attach' Mobile identity = P-TMSI-1 P-TMSI-1 signature
4	SS -> MS	ATTACH ACCEPT	Routing area identity = RAI-1 Attach result = 'GPRS only attached' Mobile identity = P-TMSI-2 P-TMSI-2 signature Routing area identity = RAI-1 T3312 = 6 minutes
5	MS -> SS	ATTACH COMPLETE	
6	MS -> SS	ROUTING AREA UPDATING REQUEST	Update type = 'Periodic updating' P-TMSI-2 signature
7	SS		Routing area identity = RAI-1 The SS verifies that the time between the attach and the periodic RA updating is Ready Timer Period (T3314) + Periodic Routing Area Updating timer (T3312) (+/- 10%)
8	SS -> MS	ROUTING AREA UPDATING ACCEPT	No new mobile identity assigned. P-TMSI not included. Update result = 'RA updated' P-TMSI-3 signature
9	MS		Routing area identity = RAI-1 The MS is switched off or power is removed (see PICS).
10	MS -> SS	DETACH REQUEST	Message not sent if power is removed. Detach type = 'power switched off, GPRS detach'
11			The SS is set in network operation mode II.
12	MS		The MS is set in MS operation mode B (see PICS) and the test is repeated from step 3 to step 10.

Specific message contents

None.

44.2.3.3.2 Periodic routing area updating / accepted / T3312 default value

44.2.3.3.2.1 Conformance requirement

The Mobile Station shall perform a periodic routing area update procedure after a T3312 timeout.

Reference(s):

GSM 04.08 section 4.7.2.2 and 4.7.5.2

44.2.3.3.2.2 Test purpose

To test the behaviour of the MS with respect to the periodic routing area updating procedure.

44.2.3.3.2.3 Method of test

Initial conditions

System Simulator:

One cell operating in network operation mode I.

Mobile Station:

The MS has a valid P-TMSI-1, P-TMSI-1 signature and RAI-1. MS is Idle Updated.

Related PICS/PIXIT statement(s)

Support of GPRS service Yes/No

MS operation mode B Yes/No

Switch off on button Yes/No

Automatic GPRS attach procedure at switch on or power on Yes/No

Test procedure

The MS initiates a combined GPRS attach procedure. The SS reallocates the P-TMSI and returns ATTACH ACCEPT message with a new P-TMSI. The MS acknowledge the new P-TMSI by sending ATTACH COMPLETE message. After 54 minutes, a periodic routing area updating procedure is initiated by the MS.

T3312; default value 54 minutes.

Maximum duration of test

60 minutes.

Expected sequence

Step	Direction	Message	Comments
1	MS		The MS is powered up or switched on and initiates an attach (see PICS).
2	MS -> SS	ATTACH REQUEST	Attach type = 'Combined GPRS / IMSI attach' Mobile identity = P-TMSI-1 P-TMSI-1 signature
3	SS -> MS	ATTACH ACCEPT	Routing area identity = RAI-1 Attach result = 'Combined GPRS /IMSI attached' Mobile identity = P-TMSI-2 P-TMSI-2 signature Mobile identity = TMSI-1 Routing area identity = RAI-1 T3312 = 54 min
4	MS -> SS	ATTACH COMPLETE	
5	MS -> SS	ROUTING AREA UPDATING REQUEST	Update type = 'Periodic updating' P-TMSI-2 signature Routing area identity = RAI-1 TMSI status = valid TMSI available
6	SS		The SS verifies that the time between the attach request and the periodic RA updating is T3312 (+/- 10%)
7	SS -> MS	ROUTING AREA UPDATING ACCEPT	No new mobile identity assigned. P-TMSI and TMSI not included. Update result = 'RAupdated' P-TMSI-3 signature Routing area identity = RAI-1
8	MS		The MS is switched off or power is removed (see PICS).
9	MS -> SS	DETACH REQUEST	Message not sent if power is removed. Detach type = 'power switched off, combined GPRS/IMSI detach'

Specific message contents

None.

44.2.3.3.3 Periodic routing area updating / no cell available / network mode I

44.2.3.3.3.1 Conformance requirement

If the MS is both IMSI attached for GPRS and non-GPRS services, and if the MS lost coverage of the registered PLMN and timer T3312 expires; if the MS returns to coverage in a cell that supports GPRS and the network is in network operation mode I, then the MS shall perform a combined routing area update procedure.

Reference(s):

GSM 04.08 section 4.7.2.2 and 4.7.5.1.

44.2.3.3.3.2 Test purpose

To test the behaviour of the MS with respect to the periodic routing area updating procedure.

44.2.3.3.3.3 Method of test

Initial conditions

System Simulator:

Two cells, cell A in MCC1/MNC1/LAC1/RAC1, cell B in MCC1/MNC1/LAC1/RAC2.

Cell A is in are operating in network operation mode II and cell B is in network operation mode I.

Mobile Station:

The MS has a valid P-TMSI-1, P-TMSI-1 signature and RAI-1. MS is Idle Updated on cell A.

Related PICS/PIXIT statement(s)

Support of GPRS service Yes/No

MS operation mode B Yes/No

Switch off on button Yes/No

Automatic GPRS attach procedure at switch on or power on Yes/No

Test procedure

The MS initiates a GPRS attach procedure. The SS reallocates the P-TMSI and returns ATTACH ACCEPT message with a new P-TMSI and timer T3312. The MS acknowledge the new P-TMSI by sending ATTACH COMPLETE message. GPRS radio contact is distorted before T3312 timeout. GPRS radio contact is established again (after T3312 timeout), and a routing area updating procedure is performed immediately.

T3312; set to 6 minutes.

Maximum duration of test

15 minutes.

Expected sequence

Step	Direction	Message	Comments
	SS		The following messages are sent and shall be received on cell A.
1	SS		The SS activates cell A.
2	SS		The MS is set in MS operation mode B (see PICS).
3	MS		The MS is powered up or switched on and initiates an attach (see PICS).
4	MS -> SS	ATTACH REQUEST	Attach type = 'GPRS attach' Mobile identity = P-TMSI-1 P-TMSI-1 signature
5	SS -> MS	ATTACH ACCEPT	Routing area identity = RAI-1 Attach result = 'GPRS only attached' Mobile identity = P-TMSI-2 P-TMSI-2 signature
6	MS -> SS	ATTACH COMPLETE	Routing area identity = RAI-1 T3312 = 6 minutes
13	SS		After 5 minutes, the signal strength is lowered until the MS have lost contact with the SS.
14	SS		Wait 2 minutes.
			The following messages are sent and shall be received on cell B.
15	SS		The SS deactivates cell A and activates cell B.
16	MS		Cell B is preferred by the MS.
17	MS		The MS immediately start a combined RA updating procedure
18	MS -> SS	ROUTING AREA UPDATING REQUEST	Update type = 'Combined RA/LA updating' P-TMSI-2 signature Routing area identity = RAI-1
19	SS -> MS	ROUTING AREA UPDATING ACCEPT	TMSI status = valid TMSI available Update result = 'Combined RA/LA updated' Mobile identity = P-TMSI-3 P-TMSI-3 signature
20	MS		Mobile identity = TMSI-2 Routing area identity = RAI-4 The MS is switched off or power is removed (see PICS).
21	MS -> SS	DETACH REQUEST	Message not sent if power is removed. Detach type = 'power switched off, combined GPRS / IMSI detach'

Specific message contents

None.

44.2.3.3.4 Combined periodic routing area updating / no cell available

44.2.3.3.4.1 Conformance requirement

If the MS is both IMSI attached for GPRS and non-GPRS services, and if the MS lost coverage of the registered PLMN and timer T3312 expires; if the MS returns to coverage in a cell that supports GPRS and the network is in network operation mode II, then the MS shall perform a periodic routing area update procedure and a periodic location update procedure.

Reference(s):

GSM 04.08 section 4.7.2.2 and 4.7.5.2

44.2.3.3.4.2 Test purpose

To test the behaviour of the MS with respect to the periodic routing area updating procedure.

44.2.3.3.4.3 Method of test

Initial conditions

System Simulator:

One cell operating in network operation mode II.

Mobile Station:

The MS has a valid P-TMSI-1, P-TMSI-1 signature and RAI-1. MS is Idle Updated.

Related PICS/PIXIT statement(s)

Support of GPRS service Yes/No

MS operation mode B Yes/No

Switch off on button Yes/No

Automatic GPRS attach procedure at switch on or power on Yes/No

Test procedure

The MS initiates a GPRS attach procedure. The SS reallocates the P-TMSI and returns ATTACH ACCEPT message with a new P-TMSI and timer T3312. The MS acknowledge the new P-TMSI by sending ATTACH COMPLETE message. GPRS radio contact is distorted before T3312 timeout. GPRS radio contact is established again (after T3312 timeout), and a periodic routing area updating procedure and a periodic location update procedure is performed immediately.

T3312; set to 6 minutes.

Maximum duration of test

15 minutes.

Expected sequence

Step	Direction	Message	Comments
1	MS		The MS is powered up or switched on and initiates an attach (see PICS).
2	MS -> SS	ATTACH REQUEST	Attach type = 'GPRS attach' Mobile identity = P-TMSI-1 P-TMSI-1 signature
3	SS -> MS	ATTACH ACCEPT	Routing area identity = RAI-1 Attach result = 'GPRS only attached' Mobile identity = P-TMSI-2 P-TMSI-2 signature Routing area identity = RAI-1 T3312 = 6 minutes
4	MS -> SS	ATTACH COMPLETE	
11	SS		After 5 minutes, the signal strength is lowered until the MS have lost contact with the SS.
12	SS		After 2 minutes, the signal strength is increased until the MS have got contact with the SS.
13	MS		The MS immediately start the periodic RA updating procedure
14	MS -> SS	ROUTING AREA UPDATING REQUEST	Update type = 'Periodic updating' P-TMSI-2 signature Routing area identity = RAI-1
15	SS -> MS	ROUTING AREA UPDATING ACCEPT	No new mobile identity assigned. P-TMSI not included. Update result = 'RAupdated' P-TMSI-3 signature Routing area identity = RAI-1
16	MS -> SS	CHANNEL REQUEST	
17	SS -> MS	IMMEDIATE ASSIGNMENT	
18	MS -> SS	LOCATION UPDATING REQ	Location updating type = Periodic LA updating.
19	SS -> MS	LOCATION UPDATING ACC	
20	SS -> MS	CHANNEL RELEASE	After sending of this message, the SS waits for disconnection of the CS signalling link.
21	MS		The MS is switched off or power is removed (see PICS).
22	MS -> SS	DETACH REQUEST	Message not sent if power is removed. Detach type = 'power switched off, GPRS detach'

Specific message contents

None.

44.2.4 P-TMSI reallocation

44.2.4.1 Conformance requirement

- 1) A Mobile Station shall acknowledge a new P-TMSI when explicitly allocated.
- 2) The P-TMSI shall be updated on the SIM when the Mobile Station is correctly deactivated in accordance with the manufacturer's instructions.
- 3) A Mobile Station shall use the given P-TMSI in further communication with the network.

Reference(s):

GSM 04.08 section 4.7.6

44.2.4.2 Test Purpose

To verify that the MS is able to receive and acknowledge a new P-TMSI by means of an explicit P-TMSI reallocation procedure.

To verify that the MS has stored the P-TMSI in a non-volatile memory.

The implicit reallocation procedure is tested in the attach procedure.

44.2.4.3 Method of test

Initial conditions

System Simulator:

One cell operating in network operation mode II.

Mobile Station:

The MS has a valid IMSI. MS is Idle Updated.

Related PICS/PIXIT statement(s)

Support of GPRS service Yes/No

MS operation mode B Yes/No

MS operation mode C Yes/No (only if mode B not supported)

Switch off on button Yes/No

Automatic GPRS attach procedure at switch on or power on Yes/No

Test procedure

An explicit P-TMSI reallocation procedure is performed (P-TMSI reallocation command sent from the SS and acknowledged from the MS by P-TMSI reallocation complete). The MS is GPRS detached and switched off. Its power supply is interrupted for 10 seconds. The power supply is resumed and then the MS is switched on. A GPRS attach procedure is performed with the given P-TMSI as identity.

Maximum duration of test

10 minutes.

Expected sequence

Step	Direction	Message	Comments
1	MS		The MS is set in MS operation mode B (see PICS). If MS operation mode B not supported set the MS in operation mode C.
2	MS		The MS is powered up or switched on and initiates an attach (see PICS).
3	MS -> SS	ATTACH REQUEST	Attach type = 'GPRS attach'
4	SS -> MS	ATTACH ACCEPT	Mobile identity = IMSI Attach result = 'GPRS only attached'
5	MS -> SS	ATTACH COMPLETE	Mobile identity = P-TMSI-1
6	SS -> MS	P-TMSI REALLOCATION COMMAND	P-TMSI-1 signature Routing area identity = RAI-1
7	MS -> SS	P-TMSI REALLOCATION COMPLETE	Mobile identity = P-TMSI-2
8	MS		P-TMSI-2 signature Routing area identity = RAI-1
9	MS -> SS	DETACH REQUEST	The MS is switched off or power is removed (see PICS). Message not sent if power is removed. Detach type = 'power switched off, GPRS detach'
10	MS		The MS is powered up or switched on and initiates an attach (see PICS).
11	MS -> SS	ATTACH REQUEST	Attach type = 'GPRS attach'
12	SS -> MS	ATTACH ACCEPT	Mobile identity = P-TMSI-2 P-TMSI-2 signature Routing area identity = RAI-1 No new mobile identity assigned. P-TMSI not included. Attach result = 'GPRS only attached'
13	SS -> MS	PAGING REQUEST TYPE 1	P-TMSI-3 signature Routing area identity = RAI-1
14	MS -> SS	UPLINK RLC DATA BLOCK	Mobile identity = P-TMSI-2 Paging order is for TBF establishment. LLC PDU implicitly indicating paging response.
15	MS		The MS is switched off or power is removed (see PICS).
16	MS -> SS	DETACH REQUEST	Message not sent if power is removed. Detach type = 'power switched off, GPRS detach'

Specific message contents

None.

44.2.5 GPRS authentication and ciphering

44.2.5.1 Test of authentication

The purpose of this procedure is to verify the user identity. A correct response is essential to guarantee the establishment of the connection. If not, the connection will drop.

44.2.5.1.1 Authentication accepted

44.2.5.1.1.1 Conformance requirement

A Mobile Station shall correctly respond in an authentication and ciphering procedure by sending a response with the SRES information field set to the same value as the one produced by the authentication and ciphering algorithm in the network.

Reference(s):

GSM 04.08 section 4.7.7

44.2.5.1.1.2 Test purpose

To test the behaviour of the MS if the network accepts the authentication and ciphering procedure.

44.2.5.1.1.3 Method of test

Initial conditions

System Simulator:

Two cells (not simultaneously activated), cell A in MCC1/MNC1/LAC1/RAC1, cell B in MCC1/MNC1/LAC1/RAC2. Both cells are operating in network operation mode II.

Mobile Station:

The MS has a valid IMSI. MS is Idle Updated on cell A.

Related PICS/PIXIT statement(s)

Support of GPRS service Yes/No

MS operation mode B Yes/No

MS operation mode C Yes/No

Switch off on button Yes/No

Automatic GPRS attach procedure at switch on or power on Yes/No

Test procedure

A GPRS attach is performed, and the SS initiates an authentication and ciphering procedure.

The SS checks the value SRES sent by the MS in the AUTHENTICATION AND CIPHERING RESPONSE message.

The MS initiates a routing area updating procedure and the SS checks the value of the GPRS Ciphering Key Sequence Number sent by the MS in the ROUTING AREA REQUEST message.

Maximum duration of test

10 minutes.

Expected sequence

Step	Direction	Message	Comments
1	SS		The following messages are sent and shall be received on cell A.
2	MS		The SS activates cell A.
3	MS		The MS is set in MS operation mode C (see PICS). If MS operation mode C not supported, goto step 18.
4	MS -> SS	ATTACH REQUEST	The MS is powered up or switched on and initiates an attach (see PICS). Attach type = 'GPRS attach' Mobile identity = IMSI
5	SS -> MS	AUTHENTICATION AND CIPHERING REQUEST	Request authentication. Set GPRS-CKSN-1
6	MS -> SS	AUTHENTICATION AND CIPHERING RESPONSE	RAND SRES
7	SS		The SS checks the SRES value.
8	SS -> MS	ATTACH ACCEPT	Attach result = 'GPRS only attached' Mobile identity = P-TMSI-2 P-TMSI-2 signature
9	MS -> SS	ATTACH COMPLETE	Routing area identity = RAI-1
10	SS		The following messages are sent and shall be received on cell B.
11	MS -> SS	ROUTING AREA UPDATING REQUEST	Activate cell B with a lower signal strength than cell A The RF level of cell A is lowered until cell B is preferred by the MS. Update type = 'RA updating' P-TMSI-2 signature Routing area identity = RAI-1 GPRS-CKSN-1
12	SS		The value of GPRS-CKSN is checked
13	SS -> MS	ROUTING AREA UPDATING ACCEPT	Update result = 'RA updated' Mobile identity = P-TMSI-1 P-TMSI-1 signature
14	MS -> SS	ROUTING AREA UPDATING COMPLETE	Routing area identity = RAI-4
15	MS		The MS is switched off or power is removed (see PICS).
16	MS -> SS	DETACH REQUEST	Message not sent if power is removed. Detach type = 'power switched off, GPRS detach'
17	SS		Reset the RF level of cell A to default state. Deactivate cell B.
18	MS		The MS is set in MS operation mode B (see PICS) and the test is repeated from step 3 to step 16.

Specific message contents

None.

44.2.5.1.2 Authentication rejected

44.2.5.1.2.1 Conformance requirement

1) After reception of an Authentication Reject message the Mobile Station shall:

- 1.1 not perform normal routing area updating
- 1.2 not perform periodic routing area updating

1.3 not perform GPRS detach if switched off

- 2) The Mobile Station shall delete the stored RAI, GPRS-CKSN P-TMSI and P-TMSI signature. SIM shall be considered invalid until power is switched off or SIM is removed.

Reference(s):

GSM 04.08 sections 4.7.7

44.2.5.1.2.2 Test purpose

To test the behaviour of the MS if the network rejects the authentication and ciphering procedure.

44.2.5.1.2.3 Method of test

Initial conditions

System Simulator:

Two cells (not simultaneously activated), cell A in MCC1/MNC1/LAC1/RAC1, cell B in MCC1/MNC1/LAC1/RAC2. Both cells are operating in network operation mode II.

Mobile Station:

The MS has a valid IMSI. MS is Idle Updated on cell A.

Related PICS/PIXIT statement(s)

Support of GPRS service Yes/No

MS operation mode B Yes/No

MS operation mode C Yes/No

Switch off on button Yes/No

Automatic GPRS attach procedure at switch on or power on Yes/No

Test procedure

A GPRS attach is performed, and the SS rejects the authentication and ciphering procedure.

The SS checks that the MS does not perform normal routing area updating, does not perform periodic routing area updating and does not perform GPRS detach if switched off.

T3312; set to 10 minutes.

Maximum duration of test

30 minutes.

Expected sequence

Step	Direction	Message	Comments
1	SS		The following messages are sent and shall be received on cell A.
2	MS		The SS activates cell A.
3	MS		The MS is set in MS operation mode C (see PICS). If MS operation mode C not supported, goto step 15.
4	MS -> SS	ATTACH REQUEST	The MS is powered up or switched on and initiates an attach (see PICS). Attach type = 'GPRS attach' Mobile identity = IMSI
5	SS -> MS	AUTHENTICATION AND CIPHERING REQUEST	Request authentication. Set GPRS-CKSN-1
6	MS -> SS	AUTHENTICATION AND CIPHERING RESPONSE	RAND
7	SS -> MS	AUTHENTICATION AND CIPHERING REJECT	SRES
8	SS -> MS	PAGING REQUEST TYPE 1	Mobile identity = IMSI
9	MS		Paging order is for TBF establishment. No response from the MS to the request. This is checked for 10 seconds.
10	SS		The following messages are sent and shall be received on cell B.
11	MS		Activate cell B with a lower signal strength than cell A The RF level of cell A is lowered until cell B is preferred by the MS.
12	MS		No ROUTING AREA UPDATING REQUEST sent to the SS (SS waits 30 seconds).
13	MS		No periodic ROUTING AREA UPDATING REQUEST sent to the SS (SS waits T3310 (+/- 10%).
14	SS		The MS is switched off (see PICS). No DETACH REQUEST sent to the SS (SS waits 30 seconds).
15	MS		The MS is set in MS operation mode B (see PICS) and the test is repeated from step 1 to step 14

Specific message contents

None.

44.2.5.2 Test of ciphering mode setting

The purpose of this procedure is to let the network to trigger the start and stop of stream ciphering.

The SS shall start and synchronise ciphering and deciphering according to GSM 03.20. The bitstream shall be generated by algorithm GEA/1.

44.2.5.2.1 Ciphering mode / start ciphering

44.2.5.2.1.1 Conformance requirements

1. When the MS receives the AUTHENTICATION AND CIPHERING REQUEST message during the attach procedure, with Ciphering indicator information element set to 'ciphering mode off', the Mobile Station shall:
 - 1.1. responds with an AUTHENTICATION AND CIPHERING RESPONSE message
 - 1.2. not start ciphering

2. When the MS receives the AUTHENTICATION AND CIPHERING REQUEST message during the routing area updating procedure, with Ciphering indicator information element set to 'ciphering mode on', the Mobile Station shall:
 - 2.1. responds with an AUTHENTICATION AND CIPHERING RESPONSE message
 - 2.2. start ciphering and deciphering with the algorithm indicated by the Ciphering algorithm information element
 - 2.3. the ciphering uses the cipher key determined during the authentication procedure

Reference(s):

GSM 04.08 section 4.7.7

44.2.5.2.1.2 Test purpose

To test the behaviour of the MS if the network accepts the authentication and ciphering procedure with ciphering.

44.2.5.2.1.3 Method of test**Initial conditions****System Simulator:**

Two cells (not simultaneously activated), cell A in MCC1/MNC1/LAC1/RAC1, cell B in MCC1/MNC1/LAC1/RAC2. Both cells are operating in network operation mode II.

Mobile Station:

The MS has a valid IMSI. MS is Idle Updated on cell A.

Related PICS/PIXIT statement(s)

Support of GPRS service Yes/No

MS operation mode B Yes/No

MS operation mode C Yes/No

Switch off on button Yes/No

Automatic GPRS attach procedure at switch on or power on Yes/No

Test procedure

A GPRS attach is performed. Authentication procedure without ciphering is performed.

The MS initiates a routing area updating procedure, and the SS initiates an authentication and ciphering procedure to start ciphering.

Maximum duration of test

15 minutes.

Expected sequence

Step	Direction	Message	Comments
1	SS		The following messages are sent and shall be received on cell A.
2	MS		The SS activates cell A.
3	MS		The MS is set in MS operation mode C (see PICS). If MS operation mode C not supported, goto step 28.
4	MS -> SS	ATTACH REQUEST	The MS is powered up or switched on and initiates an attach (see PICS). Attach type = 'GPRS attach' Mobile identity = IMSI Message not ciphered
5	SS -> MS	AUTHENTICATION AND CIPHERING REQUEST	Request authentication. Ciphering off Set GPRS-CKSN-1 RAND
6	MS -> SS	AUTHENTICATION AND CIPHERING RESPONSE	Message not ciphered SRES
7	SS -> MS	ATTACH ACCEPT	Message not ciphered Attach result = 'GPRS only attached' Mobile identity = P-TMSI-2 P-TMSI-2 signature Routing area identity = RAI-1
8	MS -> SS	ATTACH COMPLETE	Message not ciphered
9	SS -> MS	PAGING REQUEST TYPE 1	Mobile identity = P-TMSI-2 Paging order is for TBF establishment. Message not ciphered
10	MS -> SS	UPLINK RLC DATA BLOCK	LLC PDU implicitly indicating paging response. Message not ciphered
11	SS		The following messages are sent and shall be received on cell B.
12	MS -> SS	ROUTING AREA UPDATING REQUEST	Activate cell B with a lower signal strength than cell A The RF level of cell A is lowered until cell B is preferred by the MS. Update type = 'RA updating' P-TMSI-2 signature Routing area identity = RAI-1
13	SS -> MS	AUTHENTICATION AND CIPHERING REQUEST	Message not ciphered Request authentication. Ciphering on Set GPRS-CKSN-2 RAND
14	MS -> SS	AUTHENTICATION AND CIPHERING RESPONSE	Message not ciphered SRES
15	SS -> MS	ROUTING AREA UPDATING ACCEPT	Update result = 'RA updated' Mobile identity = P-TMSI-1 P-TMSI-1 signature Routing area identity = RAI-4
16	MS -> SS	ROUTING AREA UPDATING COMPLETE	Message ciphered Message ciphered
17	SS -> MS	PAGING REQUEST TYPE 1	Mobile identity = P-TMSI-1 Paging order is for TBF establishment. Message not ciphered
18	MS -> SS	UPLINK RLC DATA BLOCK	LLC PDU implicitly indicating paging response. Message ciphered
19	SS -> MS	P-TMSI REALLOCATION COMMAND	Mobile identity = P-TMSI-2 P-TMSI-2 signature Routing area identity = RAI-4
20	MS -> SS	P-TMSI REALLOCATION COMPLETE	Message ciphered Message ciphered
21	SS -> MS	IDENTITY REQUEST	Identity type = IMEI Message not ciphered

22	MS -> SS	IDENTITY RESPONSE	Mobile identity = IMEI Message not ciphered
23	SS -> MS	P-TMSI REALLOCATION COMMAND	Mobile identity = P-TMSI-1 P-TMSI-1 signature Routing area identity = RAI-4 Message ciphered
24	MS -> SS	P-TMSI REALLOCATION COMPLETE	Message ciphered
25	MS		The MS is switched off or power is removed (see PICS).
26	MS -> SS	DETACH REQUEST	Message not sent if power is removed. Detach type = 'power switched off, GPRS detach' Message ciphered
27	SS		Cell B is powered down and Cell A is restored to full power.
28	MS		The MS is set in MS operation mode B (see PICS) and the test is repeated from step 3 to step 26.

Note that due to the test of ciphering, it is in this test case indicated whether each message is ciphered or not.

Specific message contents

None.

44.2.5.2.2 Ciphering mode / stop ciphering

44.2.5.2.2.1 Conformance requirements

1. When the MS receives the AUTHENTICATION AND CIPHERING REQUEST message during the attach procedure, with Ciphering indicator information element set to 'ciphering mode on', the Mobile Station shall:
 - 1.1. responds with an AUTHENTICATION AND CIPHERING RESPONSE message
 - 1.2. start ciphering and deciphering with the algorithm indicated by the Ciphering algorithm information element
 - 1.3. the ciphering uses the cipher key determined during the authentication procedure
2. When the MS receives the AUTHENTICATION AND CIPHERING REQUEST message during the routing area updating procedure, with Ciphering indicator information element set to 'ciphering mode on', the Mobile Station shall:
 - 2.1. responds with an AUTHENTICATION AND CIPHERING RESPONSE message
 - 2.2. start ciphering and deciphering with the algorithm indicated by the Ciphering algorithm information element
 - 2.3. the ciphering uses the cipher key determined during the authentication procedure

Reference(s):

GSM 04.08 section 4.7.7

44.2.5.2.2.2 Test purpose

To test the behaviour of the MS if the network accepts the authentication and ciphering procedure without ciphering.

44.2.5.2.2.2 Method of test

Initial conditions

System Simulator:

Two cells (not simultaneously activated), cell A in MCC1/MNC1/LAC1/RAC1, cell B in MCC1/MNC1/LAC1/RAC2.
Both cells are operating in network operation mode II.

Mobile Station:

The MS has a valid IMSI.. MS is Idle Updated on cell A.

Related PICS/PIXIT statement(s)

Support of GPRS service Yes/No

MS operation mode B Yes/No

MS operation mode C Yes/No

Switch off on button Yes/No

Automatic GPRS attach procedure at switch on or power on Yes/No

Test procedure

A GPRS attach is performed, and the SS initiates an authentication and ciphering procedure to start ciphering.

The MS initiates a routing area updating procedure. A RA updating procedure is initiated, and authentication procedure without ciphering is performed. Ciphering is turned off.

Maximum duration of test

15 minutes.

Expected sequence

Step	Direction	Message	Comments
1	SS		The following messages are sent and shall be received on cell A.
2	MS		The SS activates cell A.
3	MS		The MS is set in MS operation mode C (see PICS). If MS operation mode C not supported, goto step 21.
4	MS -> SS	ATTACH REQUEST	The MS is powered up or switched on and initiates an attach (see PICS). Attach type = 'GPRS attach' Mobile identity = IMSI Message not ciphered
5	SS -> MS	AUTHENTICATION AND CIPHERING REQUEST	Request authentication. Ciphering on Set GPRS-CKSN-1 RAND
6	MS -> SS	AUTHENTICATION AND CIPHERING RESPONSE	Message not ciphered SRES
7	SS -> MS	ATTACH ACCEPT	Message not ciphered Attach result = 'GPRS only attached' Mobile identity = P-TMSI-2 P-TMSI-2 signature Routing area identity = RAI-1
8	MS -> SS	ATTACH COMPLETE	Message ciphered Message ciphered
9	SS -> MS	PAGING REQUEST TYPE 1	Mobile identity = P-TMSI-2 Paging order is for TBF establishment. Message not ciphered
10	MS -> SS	UPLINK RLC DATA BLOCK	LLC PDU implicitly indicating paging response. Message ciphered
11	SS		The following messages are sent and shall be received on cell B.
12	MS -> SS	ROUTING AREA UPDATING REQUEST	Activate cell B with a lower signal strength than cell A The RF level of cell A is lowered until cell B is preferred by the MS. Update type = 'RA updating' P-TMSI-2 signature Routing area identity = RAI-1 Message not ciphered
13	SS -> MS	AUTHENTICATION AND CIPHERING REQUEST	Request authentication. Ciphering off Set GPRS-CKSN-2 RAND
14	MS -> SS	AUTHENTICATION AND CIPHERING RESPONSE	Message not ciphered SRES
15	SS -> MS	ROUTING AREA UPDATING ACCEPT	Message not ciphered Update result = 'RA updated' Mobile identity = P-TMSI-1 P-TMSI-1 signature Routing area identity = RAI-4
16	MS -> SS	ROUTING AREA UPDATING COMPLETE	Message not ciphered Message not ciphered
17	SS -> MS	PAGING REQUEST TYPE 1	Mobile identity = P-TMSI-1 Paging order is for TBF establishment. Message not ciphered
18	MS -> SS	UPLINK RLC DATA BLOCK	LLC PDU implicitly indicating paging response. Message not ciphered
19	MS		The MS is switched off or power is removed (see PICS).
20	MS -> SS	DETACH REQUEST	Message not sent if power is removed. Detach type = 'power switched off, GPRS detach' Message not ciphered

21	MS	Cell B is switched off and Cell A is restored to full power. The MS is set in MS operation mode B (see PICS) and the test is repeated from step 3 to step 20.
----	----	--

Note that due to the test of ciphering, it is in this test case indicated whether each message is ciphered or not.

Specific message contents

None.

44.2.5.2.3 Ciphering mode / IMEISV request

44.2.5.2.3.1 Conformance requirements

- 1 When the MS receives the AUTHENTICATION AND CIPHERING REQUEST message during the attach procedure, with Ciphering indicator information element set to 'ciphering mode on' and 'IMEISV requested', the Mobile Station shall:
 - 1.1 responds with an AUTHENTICATION AND CIPHERING RESPONSE message
 - 1.2 include IMEISV
 - 1.3 start ciphering and deciphering with the algorithm indicated by the Ciphering algorithm information element
 - 1.4 the ciphering uses the cipher key determined during the authentication procedure
- 2 When the MS receives the AUTHENTICATION AND CIPHERING REQUEST message during the routing area updating procedure, with Ciphering indicator information element set to 'ciphering mode off' and 'IMEISV not requested', the Mobile Station shall:
 - 2.1 responds with an AUTHENTICATION AND CIPHERING RESPONSE message
 - 2.2 not include IMEISV
 - 2.3 not start ciphering

Reference(s):

GSM 04.08 section 4.7.7

44.2.5.2.3.2 Test purpose

To test the behaviour of the MS with respect to return IMEISV on request only.

44.2.5.2.3.3 Method of test

Initial conditions

System Simulator:

Two cells (not simultaneously activated), cell A in MCC1/MNC1/LAC1/RAC1, cell B in MCC1/MNC1/LAC1/RAC2. Both cells are operating in network operation mode II.

Mobile Station:

The MS has a valid IMSI. MS is Idle Updated on cell A.

Related PICS/PIXIT statement(s)

Support of GPRS service Yes/No

MS operation mode B Yes/No

MS operation mode C Yes/No

Switch off on button Yes/No

Automatic GPRS attach procedure at switch on or power on Yes/No

Test procedure

A GPRS attach is performed, and the SS initiates an authentication and ciphering procedure. IMEISV is requested.

The MS initiates a routing area updating procedure, and the SS initiates a new authentication and ciphering procedure without requesting IMEISV.

Maximum duration of test

15 minutes.

Expected sequence

Step	Direction	Message	Comments
1	SS		The following messages are sent and shall be received on cell A.
2	MS		The SS activates cell A.
3	MS		The MS is set in MS operation mode C (see PICS). If MS operation mode C not supported, goto step 21.
4	MS -> SS	ATTACH REQUEST	The MS is powered up or switched on and initiates an attach (see PICS). Attach type = 'GPRS attach' Mobile identity = IMSI Message not ciphered
5	SS -> MS	AUTHENTICATION AND CIPHERING REQUEST	Request authentication. Ciphering on IMEISV requested Message not ciphered
6	MS -> SS	AUTHENTICATION AND CIPHERING RESPONSE	SRES Mobile identity = IMEISV Message not ciphered
7	SS -> MS	ATTACH ACCEPT	Attach result = 'GPRS attach' Mobile identity = P-TMSI-2 P-TMSI-2 signature Routing area identity = RAI-1 Message ciphered
8	MS -> SS	ATTACH COMPLETE	Message ciphered
9	SS -> MS	PAGING REQUEST TYPE 1	Mobile identity = P-TMSI-2 Paging order is for TBF establishment. Message not ciphered
10	MS -> SS	UPLINK RLC DATA BLOCK	LLC PDU implicitly indicating paging response. Message ciphered
11	SS		The following messages are sent and shall be received on cell B.
12	MS -> SS	ROUTING AREA UPDATING REQUEST	Activate cell B with a lower signal strength than cell A The RF level of cell A is lowered until cell B is preferred by the MS. Update type = 'RA updating' P-TMSI-2 signature Routing area identity = RAI-1 Message not ciphered
13	SS -> MS	AUTHENTICATION AND CIPHERING REQUEST	Request authentication. Ciphering off IMEISV not requested Message not ciphered
14	MS -> SS	AUTHENTICATION AND CIPHERING RESPONSE	SRES No IMEISV included Message not ciphered
15	SS -> MS	ROUTING AREA UPDATING ACCEPT	Update result = 'RA updated' Mobile identity = P-TMSI-1 P-TMSI-1 signature Routing area identity = RAI-4 Message not ciphered
16	MS -> SS	ROUTING AREA UPDATING COMPLETE	Message not ciphered
17	SS -> MS	PAGING REQUEST TYPE 1	Mobile identity = P-TMSI-1 Paging order is for TBF establishment. Message not ciphered
18	MS -> SS	UPLINK RLC DATA BLOCK	LLC PDU implicitly indicating paging response. Message not ciphered
19	MS		The MS is switched off or power is removed (see PICS).
20	MS -> SS	DETACH REQUEST	Message not sent if power is removed. Detach type = 'power switched off, GPRS detach' Message not ciphered

21	MS	The MS is set in MS operation mode B (see PICS), cell B is switched off, Cell A is restored to full power and the test is repeated from step 3 to step 20.
----	----	--

Note that due to the test of ciphering, it is in this test case indicated whether each message is ciphered or not.

Specific message contents

None.

44.2.6 Identification procedure

The purpose of this procedure is to check that the MS gives its identity as requested by the network. If this procedure does not work, it will not be possible for the network to rely on the identity claimed by the MS.

44.2.6.1 General Identification

44.2.6.1.1 Conformance requirement

- 1) When requested by the network the Mobile Station shall send its IMSI.
- 2) When requested by the network the Mobile Station shall send its IMEI as stored in the Mobile Equipment.
- 3) When requested by the network the Mobile Station shall send its IMEISV as stored in the Mobile Equipment.

Reference(s):

GSM 04.08 sections 4.7.8

44.2.6.1.2 Test purpose

To verify that the MS sends identity information as requested by the system. The following identities can be requested: IMSI, IMEI and IMEISV.

44.2.6.1.3 Method of test

Initial conditions

System Simulator:

One cell operating in network mode II.

Mobile Station:

The MS has a valid IMSI.. MS is Idle Updated.

Related PICS/PIXIT statement(s)

Support of GPRS service Yes/No

MS operation mode B Yes/No

MS operation mode C Yes/No

Switch off on button Yes/No

Automatic GPRS attach procedure at switch on or power on Yes/No

Test procedure

The SS requests identity information from the MS:

- IMSI
- IMEI
- IMEISV

Maximum duration of test

10 minutes.

Expected sequence

Step	Direction	Message	Comments
1	SS		The MS is set in MS operation mode C (see PICS). If MS operation mode C not supported, goto step 14.
2	MS		The MS is powered up or switched on and initiates an attach (see PICS).
3	MS -> SS	ATTACH REQUEST	Attach type = 'GPRS attach'
4	SS -> MS	ATTACH ACCEPT	Mobile identity = IMSI Attach result = 'GPRS only attached'
5	MS -> SS	ATTACH COMPLETE	Mobile identity = P-TMSI-1 P-TMSI-1 signature Routing area identity = RAI-1
6	SS -> MS	IDENTITY REQUEST	Identity type = IMSI
7	MS -> SS	IDENTITY RESPONSE	Mobile identity = IMSI
8	SS -> MS	IDENTITY REQUEST	Identity type = IMEI
9	MS -> SS	IDENTITY RESPONSE	Mobile identity = IMEI
10	SS -> MS	IDENTITY REQUEST	Identity type = IMEISV
11	MS -> SS	IDENTITY RESPONSE	Mobile identity = IMEISV
12	MS		The MS is switched off or power is removed (see PICS).
13	MS -> SS	DETACH REQUEST	Message not sent if power is removed. Detach type = 'power switched off, GPRS detach'
14	MS		The MS is set in MS operation mode B (see PICS) and the test is repeated from step 2 to step 13.

Specific message contents

None.

44.2.7 GMM READY timer handling

The READY timer, T3314 is used in the MS and in the network per each assigned P-TMSI to control the cell updating and paging procedure.

When the READY timer is running the MS shall perform cell update each time a new cell is selected (see GSM 03.22 [3]). If a routing area border is crossed a routing area updating procedure shall be performed instead of a cell update.

44.2.7.1 Conformance requirement

- 1) When the READY timer is running the MS shall perform cell update each time a new cell is selected
- 2) The READY timer shall be restarted in the MS when the GMM entity receives an indication from lower layers that user data or GMM or SM signalling messages have been transmitted
- 3) The READY timer shall be stopped when force to standby is received in a signalling message from the network, after successful completion of the signalling procedure.

- 4) if the negotiated READY timer value indicates that the ready timer function is deactivated, then the MS shall behave as if READY timer never expires (i.e. the MS remains in READY state all the time)

Reference(s):

GSM 04.08 section 4.7.2.1

44.2.7.2 Test Purpose

To verify the functionality of the READY timer.

44.2.7.3 Method of test**44.2.7.3.1 Test procedure 1****Initial conditions****System Simulator:**

Two cells (not simultaneously activated), cell A in MCC1/MNC1/LAC1/RAC1, cell B in MCC1/MNC1/LAC1/RAC1. Both cells are operating in network operation mode II.

Mobile Station:

The MS has a valid IMSI.. MS is Idle Updated on cell A.

Related PICS/PIXIT statement(s)

Support of GPRS service Yes/No

MS operation mode B Yes/No

MS operation mode C Yes/No (only if mode B not supported)

Switch off on button Yes/No

Automatic GPRS attach procedure at switch on or power on Yes/No

Test procedure

An attach is performed. The SS negotiates T3314. The MS selects a new cell within the old RA. A cell update is performed.

T3314; set to 60 seconds

Maximum duration of test

5 minutes.

Expected sequence

Step	Direction	Message	Comments
1	SS		The following messages are sent and shall be received on cell A.
2	MS		The SS activates cell A.
			The MS is set in MS operation mode B (see PICS). If MS operation mode B not supported set the MS in operation mode C.
			The MS is powered up or switched on and initiates an attach (see PICS).
3	MS -> SS	ATTACH REQUEST	Attach type = 'GPRS attach'
			Mobile identity = IMSI
4	SS -> MS	ATTACH ACCEPT	Attach result = 'GPRS only attached'
			Mobile identity = P-TMSI-2
			P-TMSI-2 signature
			Routing area identity = RAI-1
			T3314 = 60 seconds
5	MS -> SS	ATTACH COMPLETE	
6	SS		The following messages are sent and shall be received on cell B.
			Activate cell B with a lower signal strength than cell A The RF level of cell A is lowered until cell B is preferred by the MS.
7	MS -> SS	UPLINK RLC DATA BLOCK	LLC PDU implicitly indicating cell update.
8	MS		The MS is switched off or power is removed (see PICS).
9	MS -> SS	DETACH REQUEST	Message not sent if power is removed.
			Detach type = 'power switched off, GPRS detach'

Specific message contents

None.

44.2.7.3.2 Test procedure 2

Initial conditions

System Simulator:

Two cells (not simultaneously activated), cell A in MCC1/MNC1/LAC1/RAC1, cell B in MCC1/MNC1/LAC1/RAC1. Both cells are operating in network operation mode II.

Mobile Station:

The MS has a valid IMSI.. MS is Idle Updated on cell A.

Related PICS/PIXIT statement(s)

Support of GPRS service Yes/No

MS operation mode C Yes/No

MS operation mode B Yes/No (only if mode C not supported)

Switch off on button Yes/No

Automatic GPRS attach procedure at switch on or power on Yes/No

Test procedure

An attach is performed. The SS negotiates T3314. A page is responded by the MS. The MS selects a new cell within the old RA. A cell update is performed, as T3314 is reset by the paging response.

T3314; set to 60 seconds

Maximum duration of test

5 minutes.

Expected sequence

Step	Direction	Message	Comments
1	SS		The following messages are sent and shall be received on cell A.
2	MS		The SS activates cell A.
3	MS -> SS	ATTACH REQUEST	The MS is set in MS operation mode C (see PICS). If MS operation mode C not supported set the MS in operation mode B.
4	SS -> MS	ATTACH ACCEPT	The MS is powered up or switched on and initiates an attach (see PICS). Attach type = 'GPRS attach' Mobile identity = IMSI
5	MS -> SS	ATTACH COMPLETE	Attach result = 'GPRS only attached' Mobile identity = P-TMSI-2 P-TMSI-2 signature Routing area identity = RAI-1 T3314 = 60 seconds
6	SS		No action for 90 seconds
7	SS -> MS	PAGING REQUEST TYPE 1	Mobile identity = P-TMSI-2
8	MS -> SS	UPLINK RLC DATA BLOCK	Paging order is for TBF establishment. LLC PDU implicitly indicating paging response. T3314 reset.
9	SS		The following messages are sent and shall be received on cell B.
10	MS -> SS	UPLINK RLC DATA BLOCK	Activate cell B with a lower signal strength than cell A The RF level of cell A is lowered until cell B is preferred by the MS. LLC PDU implicitly indicating cell update.
11	MS		The MS is switched off or power is removed (see PICS).
12	MS -> SS	DETACH REQUEST	Message not sent if power is removed. Detach type = 'power switched off, GPRS detach'

Specific message contents

None.

44.2.7.3.3 Test procedure 3

Initial conditions

System Simulator:

Two cells (not simultaneously activated), cell A in MCC1/MNC1/LAC1/RAC1, cell B in MCC1/MNC1/LAC1/RAC1. Both cells are operating in network operation mode II.

Mobile Station:

The MS has a valid IMSI.. MS is Idle Updated on cell A.

Related PICS/PIXIT statement(s)

Support of GPRS service Yes/No

MS operation mode B Yes/No

MS operation mode C Yes/No (only if mode B not supported)

Switch off on button Yes/No

Automatic GPRS attach procedure at switch on or power on Yes/No

Test procedure

An attach is performed. The SS indicates 'force to standby'. The MS selects a new cell within the old RA. No cell update is performed as the MS is in STANDBY state.

Maximum duration of test

5 minutes.

Expected sequence

Step	Direction	Message	Comments
1	SS		The following messages are sent and shall be received on cell A.
2	MS		The SS activates cell A.
			The MS is set in MS operation mode B (see PICS). If MS operation mode B not supported set the MS in operation mode C.
			The MS is powered up or switched on and initiates an attach (see PICS).
3	MS -> SS	ATTACH REQUEST	Attach type = 'GPRS attach'
			Mobile identity = IMSI
4	SS -> MS	ATTACH ACCEPT	Attach result = 'GPRS only attached'
			Mobile identity = P-TMSI-2
			P-TMSI-2 signature
			Routing area identity = RAI-1
			Force to standby indicator set
5	MS -> SS	ATTACH COMPLETE	
6	SS		The following messages are sent and shall be received on cell B.
			Activate cell B with a lower signal strength than cell A The RF level of cell A is lowered until cell B is preferred by the MS.
7	SS		The SS verifies for 45 seconds that no cell update is received, as the MS is in STANDBY state
8	MS		The MS is switched off or power is removed (see PICS).
9	MS -> SS	DETACH REQUEST	Message not sent if power is removed.
			Detach type = 'power switched off, GPRS detach'

Specific message contents

None.

44.2.7.3.4 Test procedure 4

Initial conditions

System Simulator:

Two cells (not simultaneously activated), cell A in MCC1/MNC1/LAC1/RAC1, cell B in MCC1/MNC1/LAC1/RAC1. Both cells are operating in network operation mode II.

Mobile Station:

The MS has a valid IMSI.. MS is Idle Updated on cell A.

Related PICS/PIXIT statement(s)

Support of GPRS service Yes/No

MS operation mode C Yes/No

MS operation mode B Yes/No (only if mode C not supported)

Switch off on button Yes/No

Automatic GPRS attach procedure at switch on or power on Yes/No

Test procedure

An attach is performed. The SS negotiates T3314. The MS selects a new cell within the old RA. A cell update is performed.

T3314; set to deactivated

Maximum duration of test

5 minutes.

Expected sequence

Step	Direction	Message	Comments
1	SS		The following messages are sent and shall be received on cell A.
2	MS		The SS activates cell A. The MS is set in MS operation mode C (see PICS). If MS operation mode C not supported set the MS in operation mode B.
3	MS -> SS	ATTACH REQUEST	The MS is powered up or switched on and initiates an attach (see PICS). Attach type = 'GPRS attach'
4	SS -> MS	ATTACH ACCEPT	Mobile identity = IMSI Attach result = 'GPRS only attached'
5	MS -> SS	ATTACH COMPLETE	Mobile identity = P-TMSI-2 P-TMSI-2 signature Routing area identity = RAI-1 T3314 deactivated
6	SS		The following messages are sent and shall be received on cell B. Activate cell B with a lower signal strength than cell A The RF level of cell A is lowered until cell B is preferred by the MS.
7	MS -> SS	UPLINK RLC DATA BLOCK	LLC PDU implicitly indicating cell update.
8	SS		No action for 120 seconds.
9	SS		The following messages are sent and shall be received on cell A. The RF level of cell A is increased and the RF level of cell B is lowered until cell A is preferred by the MS.
10	MS -> SS	UPLINK RLC DATA BLOCK	LLC PDU implicitly indicating cell update.
11	MS		The MS is switched off or power is removed (see PICS).
12	MS -> SS	DETACH REQUEST	Message not sent if power is removed. Detach type = 'power switched off, GPRS detach'

Specific message contents

None.

45 Session Management Procedures

45.1 Definition and applicability

This clause is applicable for MS supporting GPRS.

45.2 PDP context activation

45.2.1 Initiated by the mobile station

45.2.1.1 Attach initiated by context activation/QoS Offered by Network is the QoS Requested

45.2.1.1.1 Conformance requirement

PDP context activation shall initiate GPRS Attach by the MS when the MS is GPRS Detached.

In order to request a PDP context activation, the MS sends an ACTIVATE PDP CONTEXT REQUEST message to the network. If the QoS offered by the network is the same as the QoS requested by the mobile, then upon receipt of the message ACTIVATE PDP CONTEXT ACCEPT the MS shall stop timer T3380 and shall initiate establishment of the logical link with the offered QoS.

Reference

GSM 04.08 sections 6.1.1 and 6.1.3.1.1

45.2.1.1.2 Test purpose

To check the MS initiates a GPRS ATTACH if one is not already active. To test the behaviour of the MS when the network responds to a PDP context activation request with the requested QoS.

45.2.1.1.3 Method of test

Related PICS/PIXIT statements

- GPRS Supported yes/no
- GPRS Auto Attach
- Method of context activation

Initial conditions

System Simulator:

1 cell, default parameters.

Mobile Station:

The MS is in GMM-state "GMM-DEREGISTERED, normal service" with valid P-TMSI and CKSN.

Test procedure

If the MS is attached a detach request is sent from the SS. A context activation is then requested by the user. On receipt of the ACTIVATE PDP CONTEXT REQUEST message a ACTIVATE PDP CONTEXT ACCEPT is returned by the SS with the same requested QoS. The contents of the ACTIVATE PDP CONTEXT REQUEST message shall then be checked. The SS then waits for T3380 +10% seconds to ensure T3380 has been stopped and no more ACTIVATE PDP

CONTEXT REQUEST messages are sent by the MS. The SS then sends a MODIFY PDP CONTEXT REQUEST message to which the MS shall reply with a MODIFY PDP CONTEXT ACCEPT message to ensure the context has been set up.

Expected sequence

Step	Direction	Message	Comments
1	MS		If MS is configured for GPRS auto attachment (see PICS) initiate a context activation and go to step 7
2	SS -> MS	DETACH REQUEST	MS accepts the detach Initiate a context activation
3	MS -> SS	DETACH ACCEPT	
4	MS		
5	MS -> SS	ATTACH REQUEST	
6	SS -> MS	ATTACH ACCEPT	Request attach Accept attach
7	MS -> SS	ACTIVATE PDP CONTEXT REQUEST	Request a pdp context activation (with static PDP address)
8	SS -> MS	ACTIVATE PDP CONTEXT ACCEPT	Accept the pdp context activation
9	SS		Wait for T3380 +10% seconds to ensure no further activate request messages come from the MS
10	SS -> MS	MODIFY PDP CONTEXT REQUEST	Send a modify request for the activated context
11	MS -> SS	MODIFY PDP CONTEXT ACCEPT	Accept the modification request to show context is activated

Specific message contents

As default except:

Activate PDP Context Request

Information Element	Value/remark
Transaction identifier	In the range 0-6
Transaction identifier flag	0
NSAPI	In the range 5-15
Requested LLC SAPI	3, 5, 9 or 11
Requested QoS	Arbitrarily chosen
Requested PDP address	Arbitrarily chosen

Activate PDP Context Accept

Information Element	Value/remark
Transaction identifier	As above
Transaction identifier flag	1
Negotiated LLC SAPI	As above
Negotiated QoS	As above
Radio priority level	Arbitrarily chosen
Spare half octet	0

Modify PDP Context Request

Information Element	Value/remark
Transaction identifier	As above
Transaction identifier flag	1
Radio priority level	As above
Spare half octet	0
Requested LLC SAPI	As above
New QoS	As above

Modify PDP Context Accept

Information Element	Value/remark
Transaction identifier	As above
Transaction identifier flag	0

45.2.1.2 QoS Offered by Network is a lower QoS

45.2.1.2.1 QoS Accepted by MS

45.2.1.2.1.1 Conformance requirement

In order to request a PDP context activation, the MS sends an ACTIVATE PDP CONTEXT REQUEST message to the network. If the QoS offered by the network is acceptable to mobile, then upon receipt of the message ACTIVATE PDP CONTEXT ACCEPT the MS shall initiate establishment of the logical link with the offered QoS.

Reference

GSM 04.08 section 6.1.3.1.1

45.2.1.2.1.2 Test purpose

To test the behaviour of the MS when the network responds to a PDP context activation request with a lower QoS than that requested.

45.2.1.2.1.3 Method of test

Related PICS/PIXIT statements

- GPRS Supported yes/no
- User setting of Minimum QoS supported yes/no
- Method of setting minimum QoS

- Method of context activation

Initial conditions

System Simulator:

1 cell, default parameters.

Mobile Station:

The MS is in GMM-state "GMM-REGISTERED, normal service" with valid P-TMSI and CKSN.

Test procedure

The requested QoS and Minimum QoS are set. A context activation is requested by the user. On receipt of the ACTIVATE PDP CONTEXT REQUEST message a ACTIVATE PDP CONTEXT ACCEPT is returned by the SS with a QoS lower than the requested but higher than or equal to the minimum. The SS then sends a MODIFY PDP CONTEXT REQUEST message and the MS shall respond with a MODIFY PDP CONTEXT ACCEPT message to confirm the context is active.

Maximum duration of test

5 mins

Expected sequence

Step	Direction	Message	Comments
1	MS		Initiate a context activation
2	MS -> SS	ACTIVATE PDP CONTEXT REQUEST	Request a pdp context activation
3	SS -> MS	ACTIVATE PDP CONTEXT ACCEPT	Accept a pdp context activation (with dynamic PDP address)
4	SS -> MS	MODIFY PDP CONTEXT REQUEST	Send a modify request for the activated context
5	MS -> SS	MODIFY PDP CONTEXT ACCEPT	Accept the modification request to show context is activated

Specific message contents

As default except:

Activate PDP Context Request

Information Element	Value/remark
Transaction identifier	In the range 0-6
Transaction identifier flag	0
NSAPI	In the range 5-15
Requested LLC SAPI	3, 5, 9 or 11
Requested QoS	Arbitrarily chosen

Activate PDP Context Accept

Information Element	Value/remark
Transaction identifier	As above
Transaction identifier flag	1
Negotiated LLC SAPI	As above
Negotiated QoS	At least one value lower than in above but higher than or equal to minimum
Radio priority level	Arbitrarily chosen
Spare half octet	0
PDP address	Arbitrarily chosen

Modify PDP Context Request

Information Element	Value/remark
Transaction identifier	As above
Transaction identifier flag	1
Radio priority level	As above
Spare half octet	0
Requested LLC SAPI	As above
New QoS	As above

Modify PDP Context Accept

Information Element	Value/remark
Transaction identifier	As above
Transaction identifier flag	0

45.2.1.2.2 QoS Rejected by MS

Applicability

This test may not be applicable to some mobiles which support all QoS and it is not possible to configure the mobile to reject any QoS.

45.2.1.2.2.1 Conformance requirement

In order to request a PDP context activation, the MS sends an ACTIVATE PDP CONTEXT REQUEST message to the network.

Upon receipt of the message ACTIVATE PDP CONTEXT ACCEPT offering a QoS which is not acceptable to the mobile, the MS shall initiate the PDP context deactivation procedure.

Reference

GSM 04.08 section 6.1.3.1.1

45.2.1.2.2.2 Test purpose

To test the behaviour of the MS when the QoS offered by the network in response to a PDP context activation request is not acceptable to the MS.

45.2.1.2.2.3 Method of test

Related PICS/PIXIT statements

- GPRS Supported yes/no
- User setting of Minimum QoS supported yes/no
- Method of setting minimum QoS
- Method of context activation

Initial conditions

System Simulator:

1 cell, default parameters.

Mobile Station:

The MS is in GMM-state "GMM-REGISTERED, normal service" with valid P-TMSI and CKSN.

Test procedure

The requested QoS and Minimum QoS are set. A context activation is requested by the user. On receipt of the ACTIVATE PDP CONTEXT REQUEST message an ACTIVATE PDP CONTEXT ACCEPT message is returned by the SS with a QoS lower than the minimum. The MS shall then send a DEACTIVATE PDP CONTEXT REQUEST message. A DEACTIVATE PDP CONTEXT ACCEPT message will be sent in return by the SS.

Maximum duration of test

5 mins

Expected sequence

Step	Direction	Message	Comments
1	MS		Initiate a context activation
2	MS -> SS	ACTIVATE PDP CONTEXT REQUEST	Request a pdp context activation (with static PDP address)
3	SS -> MS	ACTIVATE PDP CONTEXT ACCEPT	Accept the pdp context activation
4	MS -> SS	DEACTIVATE PDP CONTEXT REQUEST	Deactivate the pdp context
5	SS -> MS	DEACTIVATE PDP CONTEXT ACCEPT	Accept the pdp context deactivation

Specific message contents

As default except:

Activate PDP Context Request

Information Element	Value/remark
Transaction identifier	In the range 0-6
Transaction identifier flag	0
NSAPI	In the range 5-15
Requested LLC SAPI	3, 5, 9 or 11
Requested QoS	Arbitrarily chosen
Requested PDP address	Arbitrarily chosen

Activate PDP Context Accept

Information Element	Value/remark
Transaction identifier	As above
Transaction identifier flag	1
Negotiated LLC SAPI	As above
Negotiated QoS	At least one value lower than in above and lower than minimum
Radio priority level	Arbitrarily chosen
Spare half octet	0

Deactivate PDP Context Request

Information Element	Value/remark
Transaction identifier	As above
Transaction identifier flag	0
SM cause	QoS not acceptable

Deactivate PDP Context Accept

Information Element	Value/remark
Transaction identifier	As above
Transaction identifier flag	1

45.2.2 PDP context activation requested by the network, successful and unsuccessful

Applicability

This test needs to take into account the number of contexts supported by the MS to be able to test the response when all contexts are activated and the network tries to initiate a new context.

45.2.2.1 Conformance requirement

- 1) Upon receipt of a REQUEST PDP CONTEXT ACTIVATION message:
 - If the MS accepts the request the MS shall then initiate the PDP context activation procedure.
 - If the MS rejects the request, the MS shall send a REQUEST PDP CONTEXT ACTIVATION REJECT message with one of the following causes:
 - #26: insufficient resources;
 - #31: activation rejected, unspecified;
 - #40: feature not supported; or
 - #95 – 111: protocol errors.
- 2) The MS shall not ignore the request.
- 3) If the MS accepts the request, the ACTIVATE PDP CONTEXT REQUEST message sent by the MS shall contain the parameters requested by the network in the REQUEST PDP CONTEXT ACTIVATION message, except for the offered QoS which may be changed by the MS.
- 4) Whenever a REQUEST PDP CONTEXT ACTIVATION message is received by the MS specifying a transaction identifier relating to a PDP context not in state PDP-INACTIVE, the MS shall locally deactivate the old PDP

context relating to the received transaction identifier. Furthermore, the MS shall continue with the activation procedure of a new PDP context as indicated in the received message.

Reference

GSM 04.08 section 6.1.3.1.2, 6.1.3.1.4 & 8.3.2 (f).

45.2.2.2 Test purpose

To test the behaviour of the MS upon receipt of a context activation request from the network.

45.2.2.3 Method of test

Related PICS/PIXIT statements

- GPRS Supported yes/no
- Network requested pdp context activation supported yes/no
- Number of network initiated pdp contexts supported

Initial conditions

System Simulator:

1 cell, default parameters.

Mobile Station:

The MS is in GMM-state "GMM-REGISTERED, normal service" with valid P-TMSI and CKSN.

Case 1

For an MS that supports PDP Context Activation requested by the network.

Test procedure

A REQUEST PDP CONTEXT ACTIVATION message is sent by the SS. On receipt of the ACTIVATE PDP CONTEXT REQUEST message an ACTIVATE PDP CONTEXT ACCEPT message is returned by the SS. This is repeated until the maximum number of contexts supported by the MS are activated. If the MS cannot support seven PDP contexts then one greater than the maximum supported by the MS should be requested. In response to this activation request the MS shall return a REQUEST PDP CONTEXT ACTIVATION REJECT message with cause set to 'insufficient resources'. A REQUEST PDP CONTEXT ACTIVATION message is then sent using a currently activated context transaction identifier. The MS shall activate this context in place of the previous context.

Maximum duration of test

5 mins

Expected sequence

Step	Direction	Message	Comments
1	SS -> MS	REQUEST PDP CONTEXT ACTIVATION	Request a pdp context activation request
2	MS -> SS	ACTIVATE PDP CONTEXT REQUEST	Request a pdp context activation
3	SS -> MS	ACTIVATE PDP CONTEXT ACCEPT	Accept the pdp context activation
4	SS		Steps 1-3 are repeated for the number of Network Initiated contexts supported NOTE: If all 7 contexts are supported steps 5 and 6 should not be performed
5	SS -> MS	REQUEST PDP CONTEXT ACTIVATION	Request a pdp context activation request
6	MS -> SS	REQUEST PDP CONTEXT ACTIVATION REJECT	The context activation request is rejected with cause 'insufficient resources'.
7	SS -> MS	REQUEST PDP CONTEXT ACTIVATION	Request a pdp context activation request for an existing context
8	MS -> SS	ACTIVATE PDP CONTEXT REQUEST	Request a pdp context activation to replace the existing context
9	SS -> MS	ACTIVATE PDP CONTEXT ACCEPT	Accept the pdp context activation

Case 2

For an MS that does not support PDP Context Activation requested by the network.

Test procedure

A REQUEST PDP CONTEXT ACTIVATION message is sent by the SS. The MS shall then send an REQUEST PDP CONTEXT ACTIVATION REJECT message.

Maximum duration of test

5 mins

Expected sequence

Step	Direction	Message	Comments
1	SS -> MS	REQUEST PDP CONTEXT ACTIVATION	Request a pdp context activation request
2	MS -> SS	REQUEST PDP CONTEXT ACTIVATION REJECT	Reject the pdp context activation request with cause 'insufficient resources' or 'feature not supported'.

Specific message contents

As default except:

Request PDP Context Activation

Information Element	Value/remark
Transaction identifier	In the range 0-6
Transaction identifier flag	0
Offered PDP address	Arbitrarily chosen

Activate PDP Context Request

Information Element	Value/remark
Transaction identifier	As above
Transaction identifier flag	1
NSAPI	In the range 5-15
Requested LLC SAPI	3, 5, 9 or 11
Requested QoS	Arbitrarily chosen
Requested PDP address	As above

Activate PDP Context Accept

Information Element	Value/remark
Transaction identifier	As above
Transaction identifier flag	0
Negotiated LLC SAPI	As above
Negotiated QoS	As above
Radio priority level	Arbitrarily chosen
Spare half octet	0

Request PDP Context Activation Reject

Information Element	Value/remark
Transaction identifier	As above
Transaction identifier flag	1
PDP address	As above
SM cause	

45.2.4 Abnormal cases

45.2.4.1 T3380 Expiry

45.2.4.1.1 Conformance requirement

- 1) On the first expiry of the timer T3380, the MS shall resend the PDP CONTEXT ACTIVATION REQUEST
- 2) On the second expiry of the timer T3380, the MS shall resend the PDP CONTEXT ACTIVATION REQUEST
- 3) On the third expiry of the timer T3380, the MS shall resend the PDP CONTEXT ACTIVATION REQUEST
- 4) On the fourth expiry of the timer T3380, the MS shall resend the PDP CONTEXT ACTIVATION REQUEST
- 5) On the fifth expiry of the timer T3380, the MS shall release all resources possibly allocated for this invocation and shall abort the procedure; no automatic PDP context activation re-attempt shall be performed.

Reference

GSM 04.08 section 6.1.3.1.5

45.2.4.1.2 Test purpose

To test the behaviour of the MS when the network does not reply to PDP CONTEXT ACTIVATION REQUEST

45.2.4.1.3 Method of test

Related PICS/PIXIT statements

- GPRS Supported yes/no
- Method of activating a context

Initial conditions

System Simulator:

1 cell, default parameters.

Mobile Station:

The MS is in GMM-state "GMM-REGISTERED, normal service" with valid P-TMSI and CKSN.

Test procedure

A context activation is requested by the user. The MS shall send the ACTIVATE PDP CONTEXT REQUEST message five times with $T3380 \pm 10\%$ seconds between each message. After this no further ACTIVATE PDP CONTEXT REQUEST messages shall be sent by the MS.

Maximum duration of test

5 mins

Expected sequence

Step	Direction	Message	Comments
1	MS		Initiate a context activation
2	MS -> SS	ACTIVATE PDP CONTEXT REQUEST	Request a pdp context activation
3	SS		$T3380 \pm 10\%$ seconds
4	MS -> SS	ACTIVATE PDP CONTEXT REQUEST	Request a pdp context activation
5	SS		$T3380 \pm 10\%$ seconds
6	MS -> SS	ACTIVATE PDP CONTEXT REQUEST	Request a pdp context activation
7	SS		$T3380 \pm 10\%$ seconds
8	MS -> SS	ACTIVATE PDP CONTEXT REQUEST	Request a pdp context activation
9	SS		$T3380 \pm 10\%$ seconds
10	MS -> SS	ACTIVATE PDP CONTEXT REQUEST	Request a pdp context activation
11	SS		Wait for $T3380 + 10\%$ seconds to ensure no further ACTIVATE PDP CONTEXT REQUEST messages are sent by the MS

Specific message contents

As default except:

Activate PDP Context Request

Information Element	Value/remark
Transaction identifier	In the range 0-6
Transaction identifier flag	0
NSAPI	In the range 5-15
Requested LLC SAPI	3, 5, 9 or 11
Requested QoS	Arbitrarily chosen
Requested PDP address	Arbitrarily chosen

45.2.4.2 Collision of MS initiated and network requested PDP context activation

45.2.4.2.1 Conformance requirement

In the event of collision between MS initiated and network initiated PDP context activation requests, the MS shall discard the REQUEST PDP CONTEXT ACTIVATION message and shall wait for an ACTIVATE PDP CONTEXT ACCEPT message.

Reference

GSM 04.08 section 6.1.3.1.5

45.2.4.2.2 Test purpose

To test the behaviour of the MS when there is a collision between an MS initiated and network requested PDP context activation.

45.2.4.2.3 Method of test

Related PICS/PIXIT statements

- GPRS Supported yes/no
- Method of pdp context activation

Initial conditions

System Simulator:

1 cell, default parameters.

Mobile Station:

The MS is in GMM-state "GMM-REGISTERED, normal service" with valid P-TMSI and CKSN.

Case 1

For an MS that supports PDP Context Activation requested by the network.

Test procedure

A context activation is requested by the user with a static PDP address. After receipt of the ACTIVATE PDP CONTEXT REQUEST message the SS sends a REQUEST PDP CONTEXT ACTIVATION message followed by an ACTIVATE PDP CONTEXT ACCEPT message in a time less than T3380 (Use T3380/2). The MS shall send no messages within this time.

Maximum duration of test

5 mins

Expected sequence

Step	Direction	Message	Comments
1	MS		Initiate a context activation
2	MS -> SS	ACTIVATE PDP CONTEXT REQUEST	Request a pdp context activation
3	SS -> MS	REQUEST PDP CONTEXT ACTIVATION	Request a pdp context activation request
4	SS		Wait for T3380/2 seconds to ensure MS does not resend ACTIVATE PDP CONTEXT REQUEST
5	SS -> MS	ACTIVATE PDP CONTEXT ACCEPT	Accept the pdp context activation

Case 2

For an MS that does not support PDP Context Activation requested by the network.

Test procedure

A context activation is requested by the user. After receipt of the ACTIVATE PDP CONTEXT REQUEST message the SS sends a REQUEST PDP CONTEXT ACTIVATION message. The MS shall send a REQUEST PDP CONTEXT ACTIVATION REJECT message with cause set to 'insufficient resources' or 'feature not supported'. The SS then sends an ACTIVATE PDP CONTEXT ACCEPT.

Maximum duration of test

5 mins

Expected sequence

Step	Direction	Message	Comments
1	MS		Initiate a context activation
2	MS -> SS	ACTIVATE PDP CONTEXT REQUEST	Request a pdp context activation
3	SS -> MS	REQUEST PDP CONTEXT ACTIVATION	Request a pdp context activation request
4	MS -> SS	REQUEST PDP CONTEXT ACTIVATION REJECT	Cause set to 'insufficient resources' or 'feature not supported'.
5	SS -> MS	ACTIVATE PDP CONTEXT ACCEPT	Accept the pdp context activation

Specific message contents

As default except:

Activate PDP Context Request

Information Element	Value/remark
Transaction identifier	In the range 0-6
Transaction identifier flag	0
NSAPI	In the range 5-15
Requested LLC SAPI	3, 5, 9 or 11
Requested QoS	Arbitrarily chosen
Requested PDP address	Arbitrarily chosen

Request PDP Context Activation

Information Element	Value/remark
Transaction identifier	In the range 0-6
Transaction identifier flag	0
Offered PDP address	As above

Activate PDP Context Accept

Information Element	Value/remark
Transaction identifier	As above
Transaction identifier flag	1
Negotiated LLC SAPI	As above
Negotiated QoS	As above
Radio priority level	Arbitrarily chosen
Spare half octet	0

Request PDP Context Activation Reject

Information Element	Value/remark
Transaction identifier	As above
Transaction identifier flag	1
PDP address	As above
SM cause	'insufficient resources' or 'feature not supported'

45.3 PDP context modification procedure

45.3.1 PDP context modification

Applicability

This test can only be performed if the minimum QoS can be set by the user.

45.3.1.1 Conformance requirement

- 1) Upon receipt of a MODIFY PDP CONTEXT REQUEST message
 - If the MS can accept the modification requested, the MS shall reply with the MODIFY PDP CONTEXT ACCEPT message.
 - If the MS is unable to accept the modification requested, the MS shall initiate the PDP context deactivation procedure for the NSAPI that has been indicated in the message MODIFY PDP CONTEXT REQUEST - the reject cause IE value of the DEACTIVATE PDP CONTEXT REQUEST message shall indicate "QoS not accepted".
- 2) The MS shall either accept the modification request or deactivate the PDP context, it shall not ignore the modification request.

Reference

GSM 04.08 section 6.1.3.2

45.3.1.2 Test purpose

To test the behaviour of the MS upon receipt of a MODIFY PDP CONTEXT REQUEST message.

45.3.1.3 Method of test

Related PICS/PIXIT statements

- GPRS Supported yes/no
- User setting of Minimum QoS supported yes/no
- Method of setting minimum QoS
- Method of activating a pdp context

Initial conditions

System Simulator:

1 cell, default parameters.

Mobile Station:

The MS is in GMM-state "GMM-REGISTERED, normal service" with valid P-TMSI and CKSN.

Test procedure

A PDP context is activated by the user and accepted by the SS. A MODIFY PDP CONTEXT REQUEST message is then sent to the MS with a QoS that is acceptable to the MS (higher than or equal to the minimum QoS set in the MS). The MS shall send a MODIFY PDP CONTEXT ACCEPT message in return. A MODIFY PDP CONTEXT REQUEST message is then sent to the MS with a QoS that is not acceptable to the MS (lower than the minimum QoS set in the MS). The MS shall send a DEACTIVATE PDP CONTEXT REQUEST message in return.

Maximum duration of test

5 mins

Expected sequence

Step	Direction	Message	Comments
1	MS		Initiate a context activation
2	MS -> SS	ACTIVATE PDP CONTEXT REQUEST	Activate a PDP context
3	SS -> MS	ACTIVATE PDP CONTEXT ACCEPT	Accept the PDP context
4	SS -> MS	MODIFY PDP CONTEXT REQUEST	Request the modification of a pdp context
5	MS -> SS	MODIFY PDP CONTEXT ACCEPT	Accept the pdp context modification
6	SS -> MS	MODIFY PDP CONTEXT REQUEST	Request the modification of a pdp context
7	MS -> SS	DEACTIVATE PDP CONTEXT REQUEST	Reject the pdp context modification by deactivating the pdp context. Cause set to 'QoS not acceptable'
8	SS -> MS	DEACTIVATE PDP CONTEXT ACCEPT	Accept the pdp context deactivation

Specific message contents

As default except:

Activate PDP Context Request

Information Element	Value/remark
Transaction identifier	In the range 0-6
Transaction identifier flag	0
NSAPI	In the range 5-15
Requested LLC SAPI	3, 5, 9 or 11
Requested QoS	Arbitrarily chosen
Requested PDP address	Arbitrarily chosen

Activate PDP Context Accept

Information Element	Value/remark
Transaction identifier	As above
Transaction identifier flag	1
Negotiated LLC SAPI	As above
Negotiated QoS	As above
Radio priority level	Arbitrarily chosen
Spare half octet	0

Modify PDP Context Request (used in step 4)

Information Element	Value/remark
Transaction identifier	As above
Transaction identifier flag	1
Radio priority level	As above
Spare half octet	0
Requested LLC SAPI	As above
New QoS	Higher than or equal to the minimum QoS

Modify PDP Context Request (used in step 6)

Information Element	Value/remark
Transaction identifier	As above
Transaction identifier flag	1
Radio priority level	As above
Spare half octet	0
Requested LLC SAPI	As above
New QoS	Lower than the minimum QoS

Modify PDP Context Accept

Information Element	Value/remark
Transaction identifier	As above
Transaction identifier flag	0

Deactivate PDP Context Request

Information Element	Value/remark
Transaction identifier	As above
Transaction identifier flag	0
SM cause	QoS not acceptable

Deactivate PDP Context Accept

Information Element	Value/remark
Transaction identifier	As above
Transaction identifier flag	1

45.4 PDP context deactivation procedure

45.4.1 PDP context deactivation initiated by the MS

45.4.1.1 Conformance requirement

The message contains the transaction identifier in use for the PDP context to be deactivated and a cause code that typically indicates one of the following causes:

- #26: insufficient resources;
- #36: regular PDP context deactivation; or
- #37: QoS not accepted.

Upon receipt of the DEACTIVATE PDP CONTEXT ACCEPT message, the MS shall stop timer T3390.

- Whenever any session management message except REQUEST PDP CONTEXT ACTIVATION or SM-STATUS is received by the MS specifying a transaction identifier which is not recognised as relating to an active context or to a context that is in the process of activation or deactivation or has been [recently] deactivated, the MS shall send a SM-STATUS message with cause #81 "invalid transaction identifier value" using the received transaction identifier value and remain in the PDP-INACTIVE state.

Reference

GSM 04.08 sections 6.1.3.3.1 & 8.3.2 (b)

45.4.1.2 Test purpose

To test the behaviour of the MS upon receipt of a DEACTIVATE PDP CONTEXT ACCEPT message from the network.

45.4.1.3 Method of test

Related PICS/PIXIT statements

- GPRS Supported yes/no
- Method of activating a pdp context
- Method of deactivating the pdp context

Initial conditions

System Simulator:

1 cell, default parameters.

Mobile Station:

The MS is in GMM-state "GMM-REGISTERED, normal service" with valid P-TMSI and CKSN.

Test procedure

A PDP context is activated by the user and accepted by the SS. The context deactivation is then requested by the user. The MS shall send a DEACTIVATE PDP CONTEXT REQUEST message to the SS. The SS shall then reply with a DEACTIVATE PDP CONTEXT ACCEPT message. The SS shall then wait for T3390 +10% seconds to ensure T3390 has been stopped and that no further messages are sent from the MS. The SS shall then send a MODIFY PDP CONTEXT REQUEST for the deactivated context and the MS shall reply with an SM STATUS message with cause #81 'transaction identifier not known'.

Maximum duration of test

5 mins

Expected sequence

Step	Direction	Message	Comments
1	MS		Initiate a context activation
2	MS -> SS	ACTIVATE PDP CONTEXT REQUEST	Activate a pdp context
3	SS -> MS	ACTIVATE PDP CONTEXT ACCEPT	Accept the pdp context
4	MS		Initiate a context deactivation
5	MS -> SS	DEACTIVATE PDP CONTEXT REQUEST	Request a deactivation of a pdp context
6	SS -> MS	DEACTIVATE PDP CONTEXT ACCEPT	Accept the pdp context deactivation
7	SS		Wait for T3390 +10% seconds to ensure no further deactivate request messages are sent
8	SS -> MS	MODIFY PDP CONTEXT REQUEST	Send a modify request for the deactivated context.
9	MS -> SS	SM STATUS	Cause set to #81

Specific message contents

As default except:

Activate PDP Context Request

Information Element	Value/remark
Transaction identifier	In the range 0-6
Transaction identifier flag	0
NSAPI	In the range 5-15
Requested LLC SAPI	3, 5, 9 or 11
Requested QoS	Arbitrarily chosen
Requested PDP address	Arbitrarily chosen

Activate PDP Context Accept

Information Element	Value/remark
Transaction identifier	As above
Transaction identifier flag	1
Negotiated LLC SAPI	As above
Negotiated QoS	As above
Radio priority level	Arbitrarily chosen
Spare half octet	0

Deactivate PDP Context Request

Information Element	Value/remark
Transaction identifier	As above
Transaction identifier flag	0
SM cause	Regular Deactivation

Deactivate PDP Context Accept

Information Element	Value/remark
Transaction identifier	As above
Transaction identifier flag	1

Modify PDP Context Request

Information Element	Value/remark
Transaction identifier	As above
Transaction identifier flag	1
Radio priority level	As above
Spare half octet	0
Requested LLC SAPI	As above
New QoS	As above

SM Status

Information Element	Value/remark
Transaction identifier	As above
Transaction identifier flag	0
SM Cause	#81

45.4.2 PDP context deactivation initiated by the network

45.4.2.1 Conformance requirement

The MS shall, upon receipt of the DEACTIVATE PDP CONTEXT REQUEST message, reply with a DEACTIVATE PDP CONTEXT ACCEPT message.

- Whenever any session management message except REQUEST PDP CONTEXT ACTIVATION or SM-STATUS is received by the MS specifying a transaction identifier which is not recognised as relating to an active context or to a context that is in the process of activation or deactivation or has been [recently] deactivated, the MS shall send a SM-STATUS message with cause #81 "invalid transaction identifier value" using the received transaction identifier value and remain in the PDP-INACTIVE state.

Reference

GSM 04.08 sections 6.1.3.3.2 & 8.3.2 (b)

45.4.2.2 Test purpose

To test the behaviour of the MS upon receipt of a DEACTIVATE PDP CONTEXT REQUEST message from the network.

45.4.2.3 Method of test

Related PICS/PIXIT statements

- GPRS Supported yes/no
- Method of activating a pdp context

Initial conditions

System Simulator:

1 cell, default parameters.

Mobile Station:

The MS is in GMM-state "GMM-REGISTERED, normal service" with valid P-TMSI and CKSN.

Test procedure

A PDP context is activated by the user and accepted by the SS. A DEACTIVATE PDP CONTEXT REQUEST message is then sent by the SS. The MS shall reply with a DEACTIVATE PDP CONTEXT ACCEPT message. The SS shall then send a MODIFY PDP CONTEXT REQUEST for the deactivated context and the MS shall reply with an SM STATUS message with cause #81 'transaction identifier not known'.

Maximum duration of test

5 mins

Expected sequence

Step	Direction	Message	Comments
1	MS		Initiate a context activation
2	MS -> SS	ACTIVATE PDP CONTEXT REQUEST	Activate a PDP context
3	SS -> MS	ACTIVATE PDP CONTEXT ACCEPT	Accept the PDP context
4	SS -> MS	DEACTIVATE PDP CONTEXT REQUEST	Request a deactivation of a pdp context
5	MS -> SS	DEACTIVATE PDP CONTEXT ACCEPT	Accept the pdp context deactivation.
6	SS -> MS	MODIFY PDP CONTEXT REQUEST	Send a modify request for the deactivated context.
7	MS -> SS	SM STATUS	Cause set to #81

Specific message contents

As default except:

Activate PDP Context Request

Information Element	Value/remark
Transaction identifier	In the range 0-6
Transaction identifier flag	0
NSAPI	In the range 5-15
Requested LLC SAPI	3, 5, 9 or 11
Requested QoS	Arbitrarily chosen
Requested PDP address	Arbitrarily chosen

Activate PDP Context Accept

Information Element	Value/remark
Transaction identifier	As above
Transaction identifier flag	1
Negotiated LLC SAPI	As above
Negotiated QoS	As above
Radio priority level	Arbitrarily chosen
Spare half octet	0

Deactivate PDP Context Request

Information Element	Value/remark
Transaction identifier	As above
Transaction identifier flag	1
SM cause	Regular Deactivation

Deactivate PDP Context Accept

Information Element	Value/remark
Transaction identifier	As above
Transaction identifier flag	0

Modify PDP Context Request

Information Element	Value/remark
Transaction identifier	As above
Transaction identifier flag	1
Radio priority level	As above
Spare half octet	0
Requested LLC SAPI	As above
New QoS	As above

SM Status

Information Element	Value/remark
Transaction identifier	As above
Transaction identifier flag	0
SM Cause	#81

45.4.3 Abnormal cases

45.4.3.1 T3390 Expiry

45.4.3.1.1 Conformance requirement

- 1) On the first expiry of timer T3390, the MS shall resend the message DEACTIVATE PDP CONTEXT REQUEST
- 2) On the second expiry of timer T3390, the MS shall resend the message DEACTIVATE PDP CONTEXT REQUEST

- 3) On the third expiry of timer T3390, the MS shall resend the message DEACTIVATE PDP CONTEXT REQUEST
- 4) On the fourth expiry of timer T3390, the MS shall resend the message DEACTIVATE PDP CONTEXT REQUEST
- 5) On the fifth expiry of timer T3390, the MS shall release all resources allocated and shall erase the PDP context related data.

Reference

GSM 04.08 section 6.1.3.3.3

45.4.3.1.2 Test purpose

To test the behaviour of the MS when the network does not reply to a DEACTIVATE PDP CONTEXT REQUEST message from the MS.

45.4.3.1.3 Method of test

Related PICS/PIXIT statements

- GPRS Supported yes/no
- Method of activating a pdp context
- Method of deactivating a pdp context

Initial conditions

System Simulator:

1 cell, default parameters.

Mobile Station:

The MS is in GMM-state "GMM-REGISTERED, normal service" with valid P-TMSI and CKSN.

Test procedure

A PDP context is activated by the user and accepted by the SS. A context deactivation is then requested by the user. The MS shall send a DEACTIVATE PDP CONTEXT REQUEST message five times with T3390 \pm 10% seconds between each message. T3390 +10% seconds after the fifth message the SS shall send a MODIFY PDP CONTEXT REQUEST message for the deactivated context and the MS shall reply with SM STATUS with cause set to #81 'Transaction identifier not known'.

Maximum duration of test

5 mins

Expected sequence

Step	Direction	Message	Comments
1	MS		Initiate a context activation
2	MS -> SS	ACTIVATE PDP CONTEXT REQUEST	Activate a PDP context
3	SS -> MS	ACTIVATE PDP CONTEXT ACCEPT	Accept the PDP context
4	MS		Initiate a context deactivation
5	MS -> SS	DEACTIVATE PDP CONTEXT REQUEST	Request a deactivation of a pdp context
6	SS		T3390 ±10% seconds
7	MS -> SS	DEACTIVATE PDP CONTEXT REQUEST	Request a deactivation of a pdp context
8	SS		T3390 ±10% seconds
9	MS -> SS	DEACTIVATE PDP CONTEXT REQUEST	Request a deactivation of a pdp context
10	SS		T3390 ±10% seconds
11	MS -> SS	DEACTIVATE PDP CONTEXT REQUEST	Request a deactivation of a pdp context
12	SS		T3390 ±10% seconds
13	MS -> SS	DEACTIVATE PDP CONTEXT REQUEST	Request a deactivation of a pdp context
14	SS		Wait T3390 +10% seconds
15	SS -> MS	MODIFY PDP CONTEXT REQUEST	Try to modify the deactivated context.
16	MS -> SS	SM STATUS	Cause set to #81

Specific message contents

As default except:

Activate PDP Context Request

Information Element	Value/remark
Transaction identifier	In the range 0-6
Transaction identifier flag	0
NSAPI	In the range 5-15
Requested LLC SAPI	3, 5, 9 or 11
Requested QoS	Arbitrarily chosen
Requested PDP address	Arbitrarily chosen

Activate PDP Context Accept

Information Element	Value/remark
Transaction identifier	As above
Transaction identifier flag	1
Negotiated LLC SAPI	As above
Negotiated QoS	As above
Radio priority level	Arbitrarily chosen
Spare half octet	0

Deactivate PDP Context Request

Information Element	Value/remark
Transaction identifier	As above
Transaction identifier flag	0
SM cause	Regular Deactivation

Modify PDP Context Request

Information Element	Value/remark
Transaction identifier	As above
Transaction identifier flag	1
Radio priority level	As above
Spare half octet	0
Requested LLC SAPI	As above
New QoS	As above

SM Status

Information Element	Value/remark
Transaction identifier	As above
Transaction identifier flag	0
SM Cause	#81

45.4.3.2 Collision of MS and network initiated PDP context deactivation requests

45.4.3.2.1 Conformance requirement

If the MS and the network initiated PDP context deactivation requests collide, the MS and the network shall each reply with the message DEACTIVATE PDP CONTEXT ACCEPT and shall stop timer T3390 and T3395, respectively.

Reference

GSM 04.08 section 6.1.3.3.3

45.4.3.2.2 Test purpose

To test the behaviour of the MS when there is a collision between an MS initiated and a network initiated context deactivation.

45.4.3.2.3 Method of test

Related PICS/PIXIT statements

- GPRS Supported yes/no
- Method of activating a pdp context
- Method of deactivating a pdp context

Initial conditions

System Simulator:

1 cell, default parameters.

Mobile Station:

The MS is in GMM-state "GMM-REGISTERED, normal service" with valid P-TMSI and CKSN.

Test procedure

A PDP context is activated by the user and accepted by the SS. A context deactivation is then requested by the user. Upon receipt of the DEACTIVATE PDP CONTEXT REQUEST message the SS sends a DEACTIVATE PDP CONTEXT REQUEST message. The MS shall reply with only one DEACTIVATE PDP CONTEXT ACCEPT message. Upon receipt of this message the SS sends a DEACTIVATE PDP CONTEXT ACCEPT message.

Maximum duration of test

5 mins

Expected sequence

Step	Direction	Message	Comments
1	MS		Initiate a context activation
2	MS -> SS	ACTIVATE PDP CONTEXT REQUEST	Activate a PDP context
3	SS -> MS	ACTIVATE PDP CONTEXT ACCEPT	Accept the PDP context
4	MS		Initiate a context deactivation
5	MS -> SS	DEACTIVATE PDP CONTEXT REQUEST	Request a deactivation of a pdp context
6	SS -> MS	DEACTIVATE PDP CONTEXT REQUEST	Request a deactivation of a pdp context
7	MS -> SS	DEACTIVATE PDP CONTEXT ACCEPT	Accept the pdp context deactivation
8	SS -> MS	DEACTIVATE PDP CONTEXT ACCEPT	Accept the pdp context deactivation

Specific message contents

As default except:

Activate PDP Context Request

Information Element	Value/remark
Transaction identifier	In the range 0-6
Transaction identifier flag	0
NSAPI	In the range 5-15
Requested LLC SAPI	3, 5, 9 or 11
Requested QoS	Arbitrarily chosen
Requested PDP address	Arbitrarily chosen

Activate PDP Context Accept

Information Element	Value/remark
Transaction identifier	As above
Transaction identifier flag	1
Negotiated LLC SAPI	As above
Negotiated QoS	As above
Radio priority level	Arbitrarily chosen
Spare half octet	0

Deactivate PDP Context Request (used in step 5)

Information Element	Value/remark
Transaction identifier	As above
Transaction identifier flag	0
SM cause	Regular Deactivation

Deactivate PDP Context Request (used in step 6)

Information Element	Value/remark
Transaction identifier	As above
Transaction identifier flag	1
SM cause	Regular Deactivation

Deactivate PDP Context Accept (used in step 7)

Information Element	Value/remark
Transaction identifier	As above
Transaction identifier flag	0

Deactivate PDP Context Accept (used in step 8)

Information Element	Value/remark
Transaction identifier	As above
Transaction identifier flag	1

45.5 Unknown or Unforeseen Transaction Identifier/Non-semantic Mandatory Information Element Errors

45.5.1 Error cases

45.5.1.1 Conformance requirement

The mobile station shall reject a session management message other than SM-STATUS received with TI value "111" by immediately sending an SM-STATUS message with TI value "111". For a session management message received with TI different from "111", the following procedures shall apply:

- Whenever any session management message except REQUEST PDP CONTEXT ACTIVATION or SM-STATUS is received by the MS specifying a transaction identifier which is not recognised as relating to an active context or to a context that is in the process of activation or deactivation or has been [recently] deactivated, the MS shall send a SM-STATUS message with cause #81 "invalid transaction identifier value" using the received transaction identifier value and remain in the PDP-INACTIVE state.
- When a REQUEST PDP CONTEXT ACTIVATION message is received with a transaction identifier flag set to "1", this message shall be ignored.

When on receipt of a message,

- an "imperative message part" error; or
- a "missing mandatory IE" error

is diagnosed or when a message containing:

- a syntactically incorrect mandatory IE; or
- an IE unknown in the message, but encoded as "comprehension required" or
- an out of sequence IE encoded as "comprehension required"

is received, the mobile station shall proceed as follows:

If the message was an SM message the SM-STATUS message with cause # 96 "invalid mandatory information" shall be returned.

If a mobile station receives a GMM message or SM message with message type not defined for the PD or not implemented by the receiver, it shall return a status message (GMM STATUS or SM STATUS depending on the protocol discriminator) with cause #97 'message type non-existent or not implemented'.

If the mobile station receives a message not compatible with the protocol state, the mobile station shall ignore the message except for the fact that when the message was a SM message the SM-STATUS message with cause #98 'Message type not compatible with protocol state' shall be returned.

Other syntactic errors

This section applies to the analysis of the value part of an information element. It defines the following terminology:

- An IE is defined to be syntactically incorrect in a message if it contains at least one value defined as 'reserved', or if its value part violates syntactic rules given in the specification of the value part. However it is not a syntactical error that a type 4 standard IE specifies in its length indicator a greater length than possible according to the value part specification: extra bits are ignored.

Reference

GSM 04.08 sections 8.3.2 and 8.5.

GSM 04.07 section 11.4.2

45.5.1.2 Test Purpose

To test the behaviour of the MS when messages with unknown or unforeseen transaction identifiers or non-semantic mandatory information element errors occur.

45.5.1.3 Method of test

Related PICS/PIXIT statements

-

Initial conditions

System Simulator:

1 cell, default parameters.

Mobile Station:

The MS is in GMM-state "GMM-REGISTERED, normal service" with valid P-TMSI and CKSN.

Test procedure

A PDP context activation is requested by the SS with the transaction identifier set to '1'. The MS shall not respond to this request.

A PDP context is then activated from the MS. An invalid accept message is then sent by the SS. The MS shall then send an SM STATUS message. After the MS has sent an ACTIVATE PDP CONTEXT REQUEST message the SS sends a MODIFY PDP CONTEXT REQUEST message with the same transaction identifier. The MS shall reply with an SM STATUS message with the cause set to #98 'Message type not compatible with protocol state'.

After $T3380 \pm 10\%$ seconds the MS shall send another ACTIVATE PDP CONTEXT REQUEST message. The SS sends back a Session Management message with an unknown message type. The MS shall reply with an SM STATUS message with the cause set to #97 'Message type non-existent or not implemented'.

After a further $T3380 \pm 10\%$ seconds another invalid accept message is sent by the SS.

After a further $T3380 \pm 10\%$ seconds a valid accept message with QoS length greater than 3 is sent by the SS. This shall be accepted by the MS

A deactivate message is then sent from the SS with the transaction identifier set to '111'. The MS shall reply with an SM STATUS message with transaction identifier set to '111'.

A deactivate message is then sent from the SS with a different transaction identifier to the one used in the activate request message sent by the MS. The MS shall reply with an SM STATUS message with cause #81 'invalid transaction identifier value'.

Two invalid modification messages are then sent to the MS in turn. The MS shall respond each time with an SM-STATUS message with cause # 96 "invalid mandatory information".

Maximum duration of test

5 mins

Expected sequence

Step	Direction	Message	Comments
1	SS -> MS	REQUEST PDP CONTEXT ACTIVATION	Request the activation of a PDP context with the transaction identifier flag set to "1"
2	SS		Wait 30 seconds to ensure MS does not request context activation
3	MS		Initiate a context request
4	MS -> SS	ACTIVATE PDP CONTEXT REQUEST	Activate a PDP context from the MS
5	SS -> MS	ACTIVATE PDP CONTEXT ACCEPT	Unknown IE encoded as 'comprehension required'
6	MS -> SS	SM STATUS	Cause set to #96
7	SS		Wait T3380 seconds ±10%
8	MS -> SS	ACTIVATE PDP CONTEXT REQUEST	Activate a PDP context from the MS (auto-generated)
9	SS -> MS	MODIFY PDP CONTEXT REQUEST	Request the modification of the PDP context
10	MS -> SS	SM STATUS	Cause set to #98 'Message type not compatible with protocol state'. Wait T3380 seconds ±10%
11	MS -> SS	ACTIVATE PDP CONTEXT REQUEST	Activate a PDP context from the MS (auto-generated)
12	SS -> MS	UNKNOWN MESSAGE	Message with unknown message type
13	MS -> SS	SM STATUS	Cause set to #97 'message type non-existent or not implemented'. Wait T3380 seconds ±10%
14	MS -> SS	ACTIVATE PDP CONTEXT REQUEST	Activate a PDP context from the MS (auto-generated)
15	SS -> MS	ACTIVATE PDP CONTEXT ACCEPT	Out of sequence IE encoded as 'comprehension required'
16	MS -> SS	SM STATUS	Cause set to #96
17	SS		Wait T3380 seconds ±10%
18	MS -> SS	ACTIVATE PDP CONTEXT REQUEST	Activate a PDP context from the MS (auto-generated)
19	SS -> MS	ACTIVATE PDP CONTEXT ACCEPT	Accept the PDP context
20	SS -> MS	DEACTIVATE PDP CONTEXT REQUEST	TI set to "111"
21	MS -> SS	SM STATUS	TI set to "111", cause value not checked
22	SS -> MS	DEACTIVATE PDP CONTEXT REQUEST	Try to deactivate the context with a different transaction identifier to that used to activate the context
23	MS -> SS	SM STATUS	Cause set to # 81
24	SS -> MS	MODIFY PDP CONTEXT REQUEST	Request the modification of the PDP context
25	MS -> SS	SM STATUS	Cause set to # 96
26	SS -> MS	MODIFY PDP CONTEXT REQUEST	Request the modification of the PDP context
27	MS -> SS	SM STATUS	Cause set to # 96

Specific message contents

As default except:

Request PDP Context Activation

Information Element	Value/remark
Transaction identifier	In the range 0-6
Transaction identifier flag	1
Offered PDP address	Arbitrarily chosen

Activate PDP Context Request

Information Element	Value/remark
Transaction identifier	In the range 0-6
Transaction identifier flag	0
NSAPI	In the range 5-15
Requested LLC SAPI	3, 5, 9 or 11
Requested QoS	Arbitrarily chosen
Requested PDP address	Arbitrarily chosen

Activate PDP Context Accept (used in step 5)

Information Element	Value/remark
Transaction identifier	As above
Transaction identifier flag	1
Negotiated LLC SAPI	As above
Negotiated QoS	As above
Radio priority level	Arbitrarily chosen
Spare half octet	0
PDP address	As above
'Comprehension required IE'	0Fh NOTE: first four bits encoded as 'comprehension required'

Activate PDP Context Accept (used in step 15)

Information Element	Value/remark
Transaction identifier	As above
Transaction identifier flag	1
Negotiated LLC SAPI	As above
Negotiated QoS	As above
Radio priority level	Arbitrarily chosen
Spare half octet	0
PDP address	As above
'Comprehension required IE'	0Fh NOTE: first four bits encoded as 'comprehension required'
Protocol configuration options	Minimum length with Configuration protocol of 'PPP'

Activate PDP Context Accept (used in step 19)

Information Element	Value/remark
Transaction identifier	As above
Transaction identifier flag	1
Negotiated LLC SAPI	As above
Negotiated QoS	As above but with length set to 5 and 2 extra octets set to 0 after the normal QoS octets
Radio priority level	Arbitrarily chosen
Spare half octet	0
PDP address	As above

Deactivate PDP Context Request (used in step 20)

Information Element	Value/remark
Transaction identifier	111
Transaction identifier flag	1
SM cause	24h, regular deactivation

Deactivate PDP Context Request (used in step 22)

Information Element	Value/remark
Transaction identifier	In the range 2-8, but different from the TI in the Activate PDP Context Request message
Transaction identifier flag	1
SM cause	24h, regular deactivation

Modify PDP Context Request (used in step 24)

Information Element	Value/remark
Transaction identifier	As above
Transaction identifier flag	1
Radio priority level	As above
Spare half octet	0
Requested LLC SAPI	As above
New QoS	This IE will NOT be present

Modify PDP Context Request (used in step 26)

Information Element	Value/remark
Transaction identifier	As above
Transaction identifier flag	1
Radio priority level	As above
Spare half octet	0
Requested LLC SAPI	0 NOTE: this is a reserved value
New QoS	Arbitrary value

46

46.1 LLC Tests

This clause contains the test case requirements for Logical Link Control (LLC) procedures in the General Packet Radio Service (GPRS).

46.1.1 Default Conditions

The default values of LLC layer parameters are as per "Table 9: LLC layer parameter default values" in clause 8.9.8 of GSM 04.64. It is possible that the MS negotiates values different from what is given in the table. In the case where the negotiated value affects the test operation, this is noted in the test.

- The MS default initial condition is that it is GPRS attached and ciphering disabled.

Unless stated otherwise, the default conditions shall apply. N_{MS} denotes the frames sent from the MS and N_{SS} denotes the frames sent from the SS.

For all timers, a measurement tolerance of +/- 10% shall be applied.

The MS may send an XID command any time. The SS shall send an XID response accepting the values proposed by the MS, unless stated otherwise in the test case.

46.1.2 Test cases

46.1.2.1 Unacknowledged data transfer

46.1.2.1.1 Data transmission in protected mode

46.1.2.1.1.1 Conformance requirement

LLC has two modes of operation - acknowledged and unacknowledged. In the unacknowledged mode of operation, layer3 information is transmitted in numbered Unconfirmed Information (UI) frames. The UI frames are not acknowledged at the LLC layer. Neither error recovery nor reordering mechanisms is defined, but transmission and format errors are detected. Duplicate UI frames are discarded.

In the protected mode of unacknowledged operation, the FCS field protects the frame header and the information field.

Unacknowledged mode of operation is defined for all SAPIs that are not reserved.

Reference

GSM 04.64, clause 4.3.

46.1.2.1.1.2 Test purpose

To verify that the MS performs unacknowledged data transfer for SAPIs 3, 5 and 11 in the protected mode to the network

46.1.2.1.1.3 Method of test

Initial conditions

The MS shall be GPRS attached with ciphering enabled.

Related PICS/PIXIT Statement

-

Test procedure

During GPRS attach and PDP context activation, the GMM messages are sent and received by the LLC layer at the MS using UI frames in the unacknowledged mode, on SAPI 1. This implicitly verifies bi-directional unacknowledged data transmission on SAPI 1.

After the PDP context is activated, the MS is made to initiate unacknowledged data transfer on SAPI 3. MS shall transmit UI frames with the E and PM bits set to 1, indicating that encryption and protection are on. Transmit 5000 octets from the MS.

Repeat the test case for SAPIs 5 and 11.

Maximum duration of the test

3 minutes.

Expected sequence

Step	Direction	Message	Comments
1		{PDP Context Activation}	Macro. PDP context activation from the MS. The PDP context used here is PDP context 5.
2			Initiate data transfer of 5000 octets from the MS.
3	MS -> SS	UI frame	Verify that the number of octets in the UI frame does not exceed N201-U. Verify that E=1 and PM=1, PD=0, C/R = 0 and the FCS is correct. Check whether the SAPI is 3, 5 or 11 when data is sent from the MS on these SAPIs. Verify that the sequence numbers are correct and that there are no duplicate or missing frames
4			Repeat step 3 until 5000 octets are sent.
5			Repeat the test case for SAPIs 5 and 11. The PDP context used for SAPI 5 is PDP Context 8 and the one for SAPI 11 is PDP Context 9.

46.1.2.1.2 Data transmission in unprotected mode

46.1.2.1.2.1 Conformance requirement

LLC has two modes of operation - acknowledged and unacknowledged. In the unacknowledged mode of operation, layer3 information is transmitted in numbered Unconfirmed Information (UI) frames. The UI frames are not acknowledged at the LLC layer. Neither error recovery nor reordering mechanisms is defined, but transmission and format errors are detected. Duplicate UI frames are discarded.

In the unprotected mode of unacknowledged operation, the FCS field protects the frame header and the first N202 octets of the information field

Unacknowledged mode of operation is defined for all SAPIs that are not reserved.

Reference

GSM 04.64, clause 4.3.

46.1.2.1.2.2 Test purpose

To verify that the MS performs unacknowledged data transfer without protection in the correct manner, on SAPIs 5 and 9.

46.1.2.1.2.3 Method of test

Initial conditions

-

Related PICS/PIXIT Statement

-

Test procedure

After the PDP context is activated, the MS initiates unacknowledged data transfer on SAPI 5. The MS shall transmit UI frames with the E and PM bits set to 0, indicating that encryption and protection are off.

Repeat the test case for SAPI 9.

Maximum duration of the test

3 minutes.

Expected sequence

Step	Direction	Message	Comments
1		{PDP Context Activation}	Macro.Initiate PDP context activation from the MS. Use PDP context 10.
2			Initiate unacknowledged data transfer for 5000 octets, from the MS.
3	MS -> SS	UI frame	Verify that the number of octets received at the MS in the UI frame does not exceed N201-U. Verify that E=0 and PM=0, PD=0, C/R = 0 and the FCS is correct. Verify that SAPI = 3 for the first run of the test case and SAPI=9 for the second run of the test case. Verify that the sequence numbers are correct and that there are no duplicate frames.
4	MS -> SS		Repeat step 3 until data transfer is complete.
5		.	Repeat the test case with PDP Context 6. This will use SAPI 9.

46.1.2.1.3 Reception of I frame in ADM

46.1.2.1.3.1 Conformance requirement

The DM unnumbered response shall be used by an LLE to report to its peer entity that the LLE is in a state such that ABM operation cannot be performed. An LLE shall transmit a DM response to any valid command received that it cannot action.

No information field is permitted within the DM response.

Reference

GSM 04.64, clause 6.4.1.4

46.1.2.1.3.2 Test purpose

To verify that the MS sends a DM response if an I frame is received while in unacknowledged mode.

46.1.2.1.3.3 Method of test

Initial conditions

-

Related PICS/PIXIT Statement

-

Test procedure

After sending data to the MS in unacknowledged mode, send an I frame from the SS. The MS shall send a DM response to indicate that it cannot perform an ABM operation.

Maximum duration of the test

3 minutes.

Expected sequence

Step	Direction	Message	Comments
1		{PDP Context Activation}	Macro. Initiate PDP context activation from the MS. Use PDP context 1.
2			Initiate unacknowledged data transfer for 2000 octets, from the SS.
3	SS -> MS	UI frame	
4			Repeat step 3 until 1500 octets are transmitted.
5	SS -> MS	I frame	Send an I frame from the SS
6	MS -> SS	DM response	Verify that the MS sends a DM response with F = 0.
7			Repeat step 3 until all 2000 octets are transmitted. The MS must not send anymore DM frames.

46.1.2.2 Acknowledged data transfer

46.1.2.2.1 Link establishment

46.1.2.2.1.1 Link establishment from MS to SS

46.1.2.2.1.1.1 Conformance requirement

In the acknowledged operation, layer 3 information is transmitted in numbered Information (I) frames. The I frames are acknowledged at the LLC layer. Error recovery and reordering procedures based on retransmission of unacknowledged I frames are specified.

Acknowledged operation requires that ABM operation has been initiated by an establishment procedure using the Set Asynchronous Balanced Mode (SABM) command.

Acknowledged operation is allowed for all SAPIs that are not reserved except SAPIs 1 and 7 for Release 97-98 and 1,2,7 and 8 for Release 99.

Reference

GSM 4.64, clause 4.4, and clause 8.5.2.

46.1.2.2.1.1.2 Test purpose

To test the establishment and release of acknowledged mode data transfer from the MS to the SS.

46.1.2.2.1.1.3 Method of test

Initial conditions

-

Related PICS/PIXIT Statement

-

Test procedure

Initiate acknowledged data transfer from the MS on SAPI 3. Verify that the MS establishes a link before initiating data transfer.

Initiate data transfer from the MS and ensure that the data sent from the MS is received at the SS.

Maximum duration of the test

5 minutes.

Expected sequence

Step	Direction	Message	Comments
1		{PDP Context Activation}	Macro. Initiate PDP context activation from the MS using PDP Context11. Initiate data transfer of 5000 octets from the MS.
2	MS -> SS	SABM	Verify that P/F =1.
3	SS -> MS	UA	Send UA from the SS before T200 can expire at the MS. Verify that the MS does not resend SABM.
4	MS -> SS	I + S	
5	SS -> MS	RR	Acknowledge whenever requested by the MS. Ensure that the MS does not retransmit the data.
6			Repeat steps 4 and 5 until 5000 octets are transferred from the MS.

46.1.2.2.1.2 Link establishment from SS to MS

46.1.2.2.1.2.1 Conformance requirement

In the acknowledged operation, layer 3 information is transmitted in numbered Information (I) frames. The I frames are acknowledged at the LLC layer. Error recovery and reordering procedures based on retransmission of unacknowledged I frames are specified.

Acknowledged operation requires that ABM operation has been initiated by an establishment procedure using the Set Asynchronous Balanced Mode (SABM) command.

Acknowledged operation is allowed for all SAPIs that are not reserved except SAPIs 1 and 7.

An LLE shall initiate a request for release of the ABM operation by transmitting a DISC command with the P bit set to 1.

An LLE receiving a DISC command while in ABM state shall transmit a UA response with the F bit set to the same binary value as the P bit in the received DISC command.

Reference

GSM 4.64, clause 4.4., and clause 8.5.2.

46.1.2.2.1.2.2 Test purpose

To test the establishment and release of acknowledged mode data transfer from the SS to the MS.

46.1.2.2.1.2.3 Method of test

Initial conditions

-

Related PICS/PIXIT Statement

-

Test procedure

Initiate PDP context activation from the MS . Do a PDP context modification from the SS, which will make the SS initiate a link establishment.

Initiate acknowledged data transfer from the SS on SAPI 9. Verify that the MS responds with a UA.

Initiate data transfer from the SS and ensure that the data sent from the SS is received at the MS.

Terminate data transfer from the SS.

Maximum duration of the test

3 minutes.

Expected sequence

Step	Direction	Message	Comments
1		{PDP Context Activation}	Macro. Initiate PDP context activation from the MS using PDP Context 10.
2		{PDP Context Modification}	Macro. Initiate PDP context modification from the SS using PDP Context 12.
3	SS -> MS	SABM	Send SABM with P/F = 1.
4	MS -> SS	UA	Verify that UA is received before the T200 timer at the SS expires.
5			Initiate data transfer of 2000 octets from the SS.
6	SS -> MS	I + S	Set the A bit to 1 in each I+S frame.
A7(optional step)	MS -> SS	RNR	The MS can send an RNR. Stop data transmission until the MS sends an RR.
7	MS -> SS	RR	Verify that the MS sends an RR for each frame.
8			Repeat steps 6 and 7 until 2000 octets are sent.
9	SS -> MS	DISC	Send DISC from the SS.
10	MS -> SS	UA	

46.1.2.2.1.3 Loss of UA frame

46.1.2.2.1.3.1 Conformance requirement

If timer T200 expires before the UA or DM response with the F bit set to 1 is received, the LLE shall:

- retransmit the SABM command
- set timer T200
- increment the retransmission counter

Reference

GSM 4.64, clause 8.5.1.3

46.1.2.2.1.3.2 Test purpose

To test the MS response to the loss of a UA frame during link establishment.

46.1.2.2.1.3.3 Method of test

Initial conditions

.

Related PICS/PIXIT Statement

-

Test procedure

Initiate link establishment for acknowledged data transfer from the MS, for SAPI 9. When the SS receives the SABM frame, do not send a response.

After the MS sends another SABM, respond with a UA from the SS and send some frames from the SS to ensure that the link is established.

Maximum duration of the test

3 minutes.

Expected sequence

Step	Direction	Message	Comments
1		{PDP Context Activation}	Macro. Initiate PDP context activation from the MS using PDP context 12.
2	MS -> SS	SABM	Initiate data transfer from the MS. Verify that P/F = 1.
3	MS -> SS	SABM	Do not send UA from the SS. Verify that MS sends another SABM with P/F = 1 after T200 seconds, with the same SAPI that it sent in the first SABM .
4	SS -> MS	UA	Send UA from the SS before T200 for that SAPI expires at the MS.
5			Initiate sending 5 I+S frames from the SS.
6	SS -> MS	I+S	Set the A bit to 1 in all the I+S frames.
A7 (optional step)	MS -> SS	RNR	The MS may send an RNR. If it does, stop transmitting from the SS until the MS sends an RR.
7	MS -> SS	RR	Verify that the MS receives and acknowledges all the frames by sending an RR for each I+S frame received.
8			Repeat steps 6 and 7 until 5 I+S frames are sent from the SS.

46.1.2.2.1.4 Total loss of UA frame

46.1.2.2.1.4.1 Conformance requirement

If timer T200 expires before the UA or DM response with the F bit set to 1 is received, the LLE shall:

- retransmit the SABM command
- set timer T200
- increment the retransmission counter

Reference

GSM 4.64, clause 8.5.1.3

46.1.2.2.1.4.2 Test purpose

To verify that

- The MS attempts to establish a link N200 times after sending the first SABM.

46.1.2.2.1.4.3 Method of test

Initial conditions

-

Related PICS/PIXIT Statement

-

Test procedure

Initiate link establishment from the MS by sending a SABM frame, for SAPI 11. At the SS, ignore the SABM from the MS.

The MS shall wait for time-out of timer T200 and then send a new SABM frame.

At the SS, ignore the SABM frame sent by the MS. Wait until the MS sends $N200 + 1$ SABM frames in all.

Maximum duration of the test

5 minutes.

Expected sequence

Step	Direction	Message	Comments
1		{PDP Context Activation}	Macro. Initiate PDP context activation from the MS, using PDP Context 13.
2	MS -> SS	SABM	Initiate data transfer from the MS. Verify that P/F = 1, SAPI = 11.
3	MS -> SS	SABM	Do not send UA from the SS. Verify that MS sends another SABM with P/F = 1 after T200 seconds, with the same SAPI that it sent in the first SABM .
4			Repeat step 3 N200 times. Ensure that the MS sends at least $N200 + 1$ SABM frames.

46.1.2.2.1.5 DM response

46.1.2.2.1.5.1 Conformance requirement

The DM unnumbered response shall be used by an LLE to report to its peer that the LLE is in such a state that ABM operation cannot be performed.

Upon reception of the DM response with the F bit set to 1, the originator of the SABM command shall enter the ADM state.

Reference

GSM 4.64, clause 6.4.1.4, clause 8.5.1.2

46.1.2.2.1.5.2 Test purpose

To verify that a link is not established with the MS when a DM response is sent in response to a SABM command.

46.1.2.2.1.5.3 Method of test

Initial conditions

-

Related PICS/PIXIT Statement

-

Test procedure

Initiate acknowledged data transfer from the MS on SAPI 3. From the SS, send a DM with the F bit set to 1.

Initiate data transfer from the SS and ensure that MS does not acknowledge the data received.

Maximum duration of the test

3 minutes.

Expected sequence

Step	Direction	Message	Comments
1		{PDP Context Activation}	Macro. Initiate PDP context activation using PDP Context 11.
2	MS -> SS	SABM	Initiate data transfer from the MS. Verify that P/F =1 in the SABM sent from the MS.
3	SS -> MS	DM	Send DM with F=1 from the SS before T200 can expire at the MS. Wait for 2 * T200 seconds after the transmission of DM and verify that the MS does not resend SABM in this period.
4	SS -> MS	I + S	Initiate data transfer from the SS for 1 octet with the A bit set to 1. Verify that the MS does not acknowledge the data transferred.
5	MS -> SS	DM response	Verify that the MS sends a DM response.
6			Wait for 2*T201 seconds at the SS after sending the I+S frame and verify that the MS does not send an RR in response to the I+S frame

46.1.2.2.2 MS sends I+S frames

46.1.2.2.2.1 Checking N(S)

46.1.2.2.2.1.1 Conformance requirement

Having either transmitted the UA response to a received SABM command or received the UA response to a transmitted SABM command, I frames and supervisory frames may be transmitted and received. I frames shall be transmitted in ascending N(S) order.

When there is an opportunity to transmit a frame, then the LLE shall do one of the following in the order of priority:

- If there are any I frames marked for retransmission and if the LLE is not in the peer receive busy condition, then the LLE shall increment by 1 the retransmission count variable for the I frame with lowest send sequence number N(S). If the retransmission count variable does not exceed the value of N200, then the LLE shall retransmit the frame.
- If the LLE has a new frame to retransmit, if $V(S) < V(A) + k$ and if the LLE is not in the peer receiver busy condition, then the new I frame shall be transmitted.
- If the LLE has an acknowledgement to transmit, then the LLE shall transmit an S frame.

Reference

GSM 4.64, clause 8.6, clause 8.6.1.

46.1.2.2.2.1.2 Test purpose

To verify that the MS handles the send sequence number N(S) correctly.

46.1.2.2.2.1.3 Method of test

Initial conditions

Related PICS/PIXIT Statement

-

Test procedure

Initiate data transfer from the MS on SAPI 3. Send 3000 K octets continuously. The value of N(S) shall begin from 0 and increment by 1 mod (512) for each frame.

Acknowledge each I frame by sending an RR frame to the MS, in sequence.

Maximum duration of the test

30 minutes.

Expected sequence

Step	Direction	Message	Comments
1		{PDP Context Activation}	Macro. Initiate a PDP context activation using PDP Context 11, from the MS.
2			Initiate data transfer of 3000K octets, from the MS.
3	MS -> SS	I+S frame	N(S) = 0 for the first frame.
4	SS -> MS	S frame with RR	Respond whenever acknowledgement is requested.
5			Repeat steps 3 and 4 until all 3000K octets have been transmitted from the MS. Verify that : the MS does not retransmit any frame. N(S) begins with 0 and is incremented by 1 mod (512).

Note: The application will resend data until all data have been sent.

46.1.2.2.2.2 Busy condition at the peer, with RR sent for resumption of transmission

46.1.2.2.2.2.1 Conformance requirement

The receive not ready (RNR) command shall be used by an LLE to indicate a busy condition. The value of N(R) in the RNR frame acknowledges I frames numbered up to and including N(R) - 1 . Subsequent frames, if any, shall not be considered confirmed.

After receiving a valid RNR frame, the LLE shall:

- set a peer receiver busy condition
- not transmit or retransmit any frames to the peer LLE
- treat the N(R) contained in the received RNR as an acknowledgement for all the I frames that have been (re-)transmitted, up to and including N(R)- 1 and set its V(A) to the value of N(R) contained in the RNR frame
- set T201 to initiate the inquiry process and
- reset the retransmission count variable

If timer T201 expires, the LLE shall:

- if the value of the retransmission count variable is less than N200:
- transmit an appropriate supervisory frame with an A bit set to 1;
- set timer T201; and
- add one to its retransmission count variable;

The LLE receiving the supervisory frame with the A bit set to 1 shall respond, at the earliest opportunity, with an appropriate supervisory frame (see subclause 8.6.4.1) to indicate whether or not its own receiver busy condition still exists.

Upon receipt of the supervisory frame, the LLE shall reset timer T201, and:

- if the frame is an RR, ACK or SACK frame:
- the peer receiver busy condition shall be cleared;
- if timer T201 was active before the peer receiver busy condition was set, and if the associated I frame is still not acknowledged, then timer T201 shall be set and associated with the same I frame; and
- the LLE may transmit new I frames or retransmit I frames as defined in subclauses 8.6.1 or 8.6.3, respectively;

The busy peer shall respond at the earliest opportunity, with an appropriate supervisory frame.

- If the highest numbered I frame was received with $N(S)=V(R)$, the appropriate supervisory frame is the RR frame.

Reference

GSM 4.64, clause 6.4.3.4, clause 8.6.4.

46.1.2.2.2.2 Test purpose

To verify that the MS

- Handles busy condition when an RNR is sent from the SS
- Resumes transmission upon reception of an RR.

46.1.2.2.2.3 Method of test

Initial conditions

-

Related PICS/PIXIT Statement

-

Test procedure

The MS is made to send 1 I+S frame on SAPI 9. The SS acknowledges the received I+S frame with a supervisory RNR frame.

Immediately after the first RNR frame, the MS shall stop sending I+S frames and start the retransmission timer T201.

After T201 seconds, send an RR frame from the SS.

Immediately after the first RR frame, the MS shall restart the transmission of I+S frames from the point at which it ceased to receive acknowledgement.

Maximum duration of the test

5 minutes.

Expected sequence

Step	Direction	Message	Comments
1		{PDP Context Activation}	Macro. Initiate PDP context activation from the MS using PDP Context 12. Negotiate a value of at least 1 minute for T201 and a value of 15 for N200.
2			Initiate data transfer of 1 octet of data in acknowledged mode from the MS.
3	MS -> SS	I+S frame	Send 1 octet of data. N(S) = 0 for the first frame
4	SS -> MS	RNR frame	Acknowledge the I+S frame by sending an RNR frame. After sending an RNR frame with N(R) = 1 verify that the MS does not send any I + S frames during the next T201 seconds .
5	MS -> SS	RR frame	MS sends an RR frame after T201 times out.
6	SS -> MS	RNR frame	
7			Initiate data transmission from the MS within 1 minute. Verify that the MS does not send this data to the SS.
8	MS -> SS	RR frame	MS sends an RR frame after T201 times out.
9	SS -> MS	RNR frame	
10	SS -> MS	RR	Send an RR from the SS with N(R) = 1
11	MS -> SS	I + S	Verify that the MS starts sending I+S frames from the point at which it had stopped sending, that is, from N(S) = 1
12	SS -> MS	RR	Acknowledge all the frames transmitted by the MS so far, if acknowledgement is requested by the MS.
13			Repeat steps 11 and 12 until 1000 octets of data are transmitted from the MS.

46.1.2.2.2.3 Busy condition at the peer, with ACK sent for resumption of transmission

46.1.2.2.2.3.1 Conformance requirement

The receive not ready (RNR) command shall be used by an LLE to indicate a busy condition. The value of N(R) in the RNR frame acknowledges I frames numbered up to and including N(R) - 1 . Subsequent frames, if any, shall not be considered confirmed.

After receiving a valid RNR frame, the LLE shall:

- set a peer receiver busy condition
- not transmit or retransmit any frames to the peer LLE
- treat the N(R) contained in the received RNR as an acknowledgement for all the I frames that have been (re-)transmitted, up to and including N(R)- 1 and set its V(A) to the value of N(R) contained in the RNR frame
- set T201 to initiate the inquiry process and
- reset the retransmission count variable

If timer T201 expires, the LLE shall:

- if the value of the retransmission count variable is less than N200:
- transmit an appropriate supervisory frame with an A bit set to 1;
- set timer T201; and
- add one to its retransmission count variable;

The LLE receiving the supervisory frame with the A bit set to 1 shall respond, at the earliest opportunity, with an appropriate supervisory frame (see subclause 8.6.4.1) to indicate whether or not its own receiver busy condition still exists.

Upon receipt of the supervisory frame, the LLE shall reset timer T201, and:

- if the frame is an RR, ACK or SACK frame:

- the peer receiver busy condition shall be cleared;
 - if timer T201 was active before the peer receiver busy condition was set, and if the associated I frame is still not acknowledged, then timer T201 shall be set and associated with the same I frame; and
 - the LLE may transmit new I frames or retransmit I frames as defined in subclauses 8.6.1 or 8.6.3, respectively;
- The busy peer shall respond at the earliest opportunity, with an appropriate supervisory frame.

- If the highest numbered frame was received with $N(S) = V(R) + 1$, the appropriate frame is the ACK frame.

Reference

GSM 4.64, clause 6.4.3.4, clause 8.6.4.

46.1.2.2.2.3.2 Test purpose

To verify that the MS

- Handles busy condition when an RNR is sent from the SS
- Resumes transmission upon reception of an ACK.

46.1.2.2.2.3.3 Method of test

Initial conditions

-

Related PICS/PIXIT Statement

-

Test procedure

The MS is made to send I+S frames continuously on SAPI 11. The SS acknowledges the received I+S frames with supervisory RR frames. After 1 second, it acknowledges the received I+S frames with a supervisory RNR frame.

Immediately after the first RNR frame, the MS shall stop sending I+S frames and start the retransmission timer T201. The RNR frame will indicate that all frames except the one before the last one has been received.

After T201 seconds, send an ACK frame from the SS.

Immediately after the first ACK frame, the MS shall restart the transmission of I+S frames from the point at which it ceased to receive acknowledgement. The frame before the last one shall be transmitted first from the MS.

Maximum duration of the test

5 minutes.

Expected sequence

Step	Direction	Message	Comments
1		{PDP Context Activation}	Macro. PDP context activation from the MS with PDP Context 13.
2			Initiate acknowledged mode data transmission from the MS.
3	MS -> SS	I+S frame	N(S)=0 for the first frame
4	SS -> MS	RR frame	Acknowledge when requested
5			Repeat steps 3 and 4. The N(S) of the frames shall range from N(S) = 0 until N(S) = $N_{MS} \bmod 512$. The last RR frame sent from the SS shall have its N(R) = $N_{MS} - 2 \bmod 512$
6	SS -> MS	RNR frame	After sending RNR frame with N(R) = $N_{MS} - 2 \bmod 512$, wait for T201 seconds at the SS. The SS may receive some I+S frames that the MS had sent before it received the RNR.
7	MS -> SS	RR frame	MS sends an RR frame after T201 times out.
8	SS -> MS	RNR frame	
9	SS -> MS	ACK	Send an ACK from the SS with N(R) = $N_{MS} - 1 \bmod 512$.
10	MS -> SS	I + S	Verify that the MS starts sending I+S frames with N(S) = $N_{MS} - 1 \bmod 512$, N(S) = $N_{MS} + 1 \bmod 512$, $N_{MS} + 2 \bmod 512$...
11	SS -> MS	RR	Acknowledge all the frames transmitted by the MS so far.
12	MS -> SS	I + S	Verify that the MS sends the remaining I frames with the correct sequence numbers.
13	SS -> MS	RR	Acknowledge all the frames transmitted by the MS.

46.1.2.2.2.4 SACK frame

46.1.2.2.2.4.1 Conformance requirement

On receipt of a valid SACK frame, the LLE shall consider all I frames with the corresponding bit set to 1 in the SACK bitmap as acknowledged.

Reference

GSM 04.64, clause 8.6.3.2

46.1.2.2.2.4.2 Test purpose

To verify that the MS considers only the frames as indicated by the SACK bitmap have been received correctly and that it retransmits the frames that have not been acknowledged.

46.1.2.2.2.4.3 Method of test

Initial conditions

-

Related PICS/PIXIT Statement

-

Test procedure

Initiate data transfer from the MS and send frames from N(S) = 0 to N(S) = N_{MS} , where N_{MS} is less than kU. Acknowledge all frames until $N_{MS} - 6$. Do not acknowledge the frames $N_{MS} - 6$, $N_{MS} - 3$, $N_{MS} - 2$ and $N_{MS} - 1$. Acknowledge the other frames ($N_{MS} - 5$, $N_{MS} - 4$, N_{MS}) by using SACK. Verify that the MS retransmits the frames $N_{MS} - 6$, $N_{MS} - 3$, $N_{MS} - 2$ and $N_{MS} - 1$. Acknowledge the retransmitted frames.

Maximum duration of the test

3 minutes.

Expected sequence

Step	Direction	Message	Comments
1		{PDP Context Activation}	Macro. PDP context activation from the MS with PDP Context 11.
2			Initiate acknowledged mode data transfer from the MS. If the mobile negotiates a window size less than 6, this test shall end at this step.
3	MS -> SS	I+S frame	$N(S) = 0$ for the first frame
4			Repeat steps 3, with the $N(S)$ incremented by 1 for each step. These must be repeated until an I+S frame with the A bit set to 1 is received at the SS.
5	SS -> MS	RR frame	The $N(S)$ for the last frame sent from the MS shall be N_{MS} . The last RR frame sent from the SS shall have its $N(R) = N_{MS} - 6$.
6	SS -> MS	SACK	Do not acknowledge the frames $N_{MS} - 6$, $N_{MS} - 3$, $N_{MS} - 2$ and $N_{MS} - 1$. Acknowledge the other frames ($N_{MS} - 5$, $N_{MS} - 4$, N_{MS}) by using SACK.
7	MS -> SS	I+S frame	Verify that the MS retransmits the frames $N_{MS} - 6$, $N_{MS} - 3$, $N_{MS} - 2$ and $N_{MS} - 1$.
8	SS -> MS	RR	Acknowledge all the frames.

46.1.2.2.3 Reception of I + S frames at the MS

46.1.2.2.3.1 Checking $N(R)$

46.1.2.2.3.1.1 Conformance requirement

Whenever an LLE receives a frame with the A bit set to 1, it shall transmit an I+S or S frame.

In ABM mode, all I frames and Supervisory frames contain $N(R)$, the expected send sequence number of the next in-sequence received I frame. At the time that a frame of the above type is designated for transmission, the value of $N(R)$ is equal to the value of the receive state variable $V(R)$. $N(R)$ indicates that the LLE transmitting the $N(R)$ has correctly received all I frames numbered up to and including $N(R) - 1$.

Reference

GSM 4.64, clause 6.3.5.4.5, clause 8.6.3.1

46.1.2.2.3.1.2 Test purpose

To verify that the MS transmits acknowledgements with the correct $N(R)$.

46.1.2.2.3.1.3 Method of test

Initial conditions

-

Related PICS/PIXIT Statement

-

Test procedure

Send I+S frames continuously from the SS. Send more than 512 frames. The delay between two I+S frames should be less than T201.

Do not send any data from the MS.

When the MS sends RR frames, check the value of N(R) to verify that it indicates that all frames sent from the SS has been acknowledged.

Maximum duration of the test

30 minutes.

Expected sequence

Step	Direction	Message	Comments
1		{PDP Context Activation}	Macro. Initiate PDP context activation from the MS using PDP Context 11.
2			Initiate acknowledged mode data transfer from the SS.
3	SS -> MS	I+S frame	
4	SS -> MS	I+S frame	The last I+S frame shall have its $N(S) = N_{SS} + i \text{ mod } 512$. Set the A bit to 1 in the last frame of each window and the last frame sent from the SS.
A5 (optional step)	MS -> SS	RR	Verify whether the RR frames received from the MS have the correct N(R) values. Verify whether all the I+S frames sent from the SS have been acknowledged.
B5 (optional step)	MS -> SS	RNR	The SS shall wait for an ACK, SACK or RR frame before it sends the next I+S frame.
C5 (optional step)	MS -> SS	SACK	The SS shall retransmit the unacknowledged frames.
D5 (optional step)	MS -> SS	ACK	The SS shall retransmit the unacknowledged frame.
			The MS may not send an RR if the A bit is not set in step 4.
6			Repeat from step 4 515 times.
7			At the end of the test, all the frames sent shall have been acknowledged.

46.1.2.2.3.2 MS handling busy condition during bi-directional data transfer

46.1.2.2.3.2.1 Conformance requirement

The receive not ready (RNR) command shall be used by an LLE to indicate a busy condition. The value of N(R) in the RNR frame acknowledges I frames numbered up to and including $N(R) - 1$. Subsequent frames, if any, shall not be considered confirmed.

After receiving a valid RNR frame, the LLE shall:

- set a peer receiver busy condition
- not transmit or retransmit any frames to the peer LLE
- treat the N(R) contained in the received RNR as an acknowledgement for all the I frames that have been (re-)transmitted, up to and including $N(R) - 1$ and set its V(A) to the value of N(R) contained in the RNR frame
- set T201 to initiate the inquiry process and
- reset the retransmission count variable

The busy peer shall respond at the earliest opportunity, with an appropriate supervisory frame.

- If the highest numbered frame was received with $N(S) = V(R) + 1$, the appropriate frame is the ACK frame.

Reference

GSM 4.64, clause 6.4.3.4, clause 8.6.4.

46.1.2.2.3.2.2 Test purpose

To verify that the MS handles peer receiver busy condition when it is transmitting to the SS and receiving data from the SS.

46.1.2.2.3.2.3 Method of test

Initial conditions

-

Related PICS/PIXIT Statement

-

Test procedure

Send 1 I+S frame from the SS. Verify that the MS acknowledges this frame.

Send 1 octet of data from the MS. Acknowledge this from the SS.

Send an RNR from the SS to indicate receiver busy condition, after 1 frame ($N(S) = 0$) has been received at the SS. The $N(R)$ value that is sent in the RNR frame is 0.

Verify that the MS stops transmission of I+S frames.

T201 seconds after sending the RNR frame, send an RR frame from the SS with $N(R) = 0$ to request the MS to resume transmission.

Initiate data transmission from the MS and verify that the MS resumes transmission. The first frame sent from the MS should have its $N(S) = 0$.

Verify that the MS sends acknowledgements for all the I+S frames transmitted from the SS.

Maximum duration of the test

10 minutes.

Expected sequence

Step	Direction	Message	Comments
1		{PDP Context Activation}	Macro.Initiate PDP context activation from the MS using PDP Context 12.
2			Initiate acknowledged mode data transfer of 1 octet from the MS and the SS.
3	MS -> SS	I+S frame	N(S) =0 for the first frame
4	SS -> MS	I+S frame	A bit set to 1.
5	SS -> MS	RNR frame	Do not acknowledge the first I+S frame received at the SS. N(R) = 0.
A6 (optional step)	MS -> SS	RNR frame	The MS may repeat this step In this case, the MS shall send an RR frame for resumption of transmission.
6	MS -> SS	RR	Acknowledgement to the I+S frame sent in step 4.
7	MS -> SS	RR	Verify that the MS sends this after T201 seconds after step 5. The MS shall not resend the I+S frame sent in step 3.
8	SS -> MS	RR	N(R) = 0. Send this to resume transmission from the MS.
9	MS -> SS	I+S	Verify that the MS - resends the I+S frame sent in step 3.
10	SS -> MS	RR	Acknowledge the frame transmitted by the MS.

46.1.2.2.3.3 SACK frame

46.1.2.2.3.3.1 Conformance requirement

The SACK supervisory frame shall be used by an LLE to acknowledge single or multiple frames. Frames up to and including $N(R) - 1$, and frames indicated by the SACK bitmap, have been received correctly.

If the LLE is in the own receiver busy condition, the appropriate supervisory frame is the RNR frame. Otherwise, if the highest numbered frame was received with $N(S) = V(R)$, the appropriate supervisory frame is the RR frame. Otherwise, if the highest numbered I frame was received with $N(S) = V(R) + 1$, the appropriate supervisory frame is the ACK frame. Otherwise, the appropriate supervisory frame is the SACK frame.

Reference

GSM 4.64, clause 6.4.3.3 and clause 8.6.4.1

46.1.2.2.3.3.2 Test purpose

To verify whether the MS sends a SACK frame when it is required and that the SACK frame has the correct bits set.

46.1.2.2.3.3.3 Method of test

Initial conditions

-

Related PICS/PIXIT Statement

-

Test procedure

$N_{MS} = 20$, for this test case.

Initiate data transfer from the SS and send frames from $N(S) = 0$ to $N(S) = N_{MS} - 3$. The A bit shall be set to 1 for all frames sent. Wait till all the frames are acknowledged. Send the frame with $N(S) = N_{MS}$ with the A bit set to 1. Verify that the MS acknowledges all the frames until $N_{MS} - 3$ using RR and negatively acknowledges the other frames ($N_{MS} - 2$

and $N_{MS}-1$) by using SACK. Retransmit the frames $N_{MS}-2$ and $N_{MS}-1$ with A bit set to 1. Verify that the MS acknowledges the retransmitted frames.

Maximum duration of the test

3 minutes.

Expected sequence

Step	Direction	Message	Comments
1		{PDP Context Activation}	Macro. Initiate PDP context activation with PDP Context 13. If the negotiated window size is less than 3, the test shall end at this step.
2			Initiate acknowledged mode data transfer from the SS.
3	SS -> MS	I+S frame	$N(S) = 0$ for the first frame, A bit = 1.
-	-	-	
A4 (Optional step)	MS -> SS	RNR frame	The MS can optionally send an RNR frame. If it does, do not send data until the MS sends an RR.
4	MS -> SS	RR frame	$N(R) = 1$ for the first frame
5			Repeat steps 3 and 4 with the $N(S)$ and $N(R)$ values incremented by 1 for each step and with A = 1 for the I+S frame. The last RR frame shall have its $N(R) = N_{MS} - 2$.
6	SS -> MS	I+S frame	Send with $N(S) = N_{MS}$, A bit = 1.
A7 (Optional step)	MS -> SS	RNR	$N(R) = N_{MS} - 2$. In this case the SS shall not transmit anything until the MS sends a SACK.
7	MS -> SS	SACK	Verify that the MS does not acknowledge the frames $N_{MS} - 2$ and $N_{MS} - 1$ and acknowledges the other frames (N_{MS}) using SACK.
8	SS -> MS	I+S frame	Retransmit the frame $N_{MS} - 2$ with A bit = 1.
A9 (Optional step)	MS -> SS	RNR	In this case, the SS shall not transmit anything until the MS sends an ACK.
9	MS -> SS	ACK	
10	SS -> MS	I+S	$N(S) = N_{MS} - 1$, A bit = 1.
A11	MS -> SS	RR	
B11	MS -> SS	RNR	The RNR shall indicate that the MS has received all the frames sent from the SS.

46.1.2.2.3.4 ACK frame

46.1.2.2.3.4.1 Conformance requirement

Whenever an LLE receives a frame with the A bit set to 1, it shall transmit an I+S or S frame.

The ACK supervisory frame shall be used by an LLE to acknowledge a single or multiple I frames. Frames up to and including $N(R) - 1$, and frame $N(R) + 1$, have been received correctly.

Reference

GSM 4.64, clause 6.4.3.2, clause 8.6.3.1

46.1.2.2.3.4.2 Test purpose

To verify that the MS transmits an ACK frame when frames up to and including $N(R) - 1$ and frame $N(R) + 1$ have been received correctly.

46.1.2.2.3.4.3 Method of test

Initial conditions

-

Related PICS/PIXIT Statement

-

Test procedure

For this test case, $N_{SS} = 20$.

Send I+S frames with $N(S) = 0$ to $N(S) = N_{SS} - 2$ from the SS. The delay between two I+S frames should be less than T201. Set the A bit to 1 in frames 0 to $N_{SS} - 2$. Verify that the MS sends an RR frame as acknowledgement for these frames. Send the frame with A=1. Do not send frame $N_{SS} - 1$. Verify that the MS sends an ACK frame, indicating that N_{SS} and $N_{SS} - 2$ have been received and that $N_{SS} - 1$ has not been received. Now send a frame from the SS with $N(S) = N_{SS} - 1$, with A=1. Verify that the MS acknowledges all the frames received so far, including this frame, with an RR.

Maximum duration of the test

5 minutes.

Expected sequence

Step	Direction	Message	Comments
1		{PDP Context Activation}	Macro. Initiate PDP context activation with PDP Context 13.
2			Initiate acknowledged mode data transmission from the SS.
3	SS -> MS	I+S frame	A = 1
A4 (Optional step)	MS -> SS	RNR	If the MS sends an RNR, do not transmit data until it has sent an RR.
4	MS -> SS	RR	
5			Repeat steps 3 to 5 until frames 0 to $N_{SS} - 2$ have been sent. Verify that RR frames are sent to acknowledge frames from $N(S) = 0$ until $N(S) = N_{SS} - 2$.
6	SS -> MS	I+S frame	Send the frame N_{SS} with A=1. Do not send the frame with $N(S) = N_{SS} - 1$.
A7 (Optional step)	MS -> SS	RNR	$N(R) = N_{SS} - 2$. If the MS sends an RNR, do not transmit data until it sends an ACK.
7	MS -> SS	ACK	Verify that an ACK frame is sent to acknowledge the frames $N_{SS} - 2$ and N_{SS} , with $N(R) = N_{SS} - 1$
8	SS -> MS	I+S frame	$N(S) = N_{SS} - 1$, with A=1.
A9 (Optional step)	MS -> SS	RNR	Verify that $N(R) = N_{SS} + 1$
9	MS -> SS	RR	Verify that an RR frame is received to acknowledge frame $N_{SS} - 1$ with $N(R) = N_{SS} + 1$

46.1.2.2.4 Link Reestablishment

46.1.2.2.4.1 Reestablishment due to reception of SABM

46.1.2.2.4.1.1 Conformance requirement

The criteria for re-establishing the ABM mode of operation are defined in this clause by the following conditions:

- the receipt, while in the ABM state, of a SABM;

- the receipt of an LL-ESTABLISH-REQ primitive from layer3
- the occurrence of N200 retransmission failures
- the occurrence of a frame rejection condition; and
- the receipt of an unsolicited DM response with F bit set to 0 while in ABM state.

In Asynchronous Balanced Mode, only I frames contain N(S), the send sequence number of transmitted I frames. At the time that an in-sequence I frame is designated for transmission, the value of N(S) is set equal to the value of the send state variable V(S).

An LLE receiving a SABM command, if it is able to enter the ABM state, shall:

- inform layer 3 using the LL-ESTABLISH-IND primitive;
- if the received SABM command contains a Layer-3 Parameters XID parameter, wait for the receipt of an LL-ESTABLISH-RES primitive from layer 3;
- respond with a UA response with the F bit set to the same binary value as the P bit in the received SABM command (i.e., F=1);
- reset timer T200 if active;
- set V(S), V(R), V(A), and B to 0;
- enter the ABM state;
- clear all existing exception conditions; and
- clear any existing peer receiver busy condition.

Reference

GSM 04.64, clause 8.7.1, clause 6.3.5.4.3, clause 8.5.1.2.

46.1.2.2.4.1.2 Test purpose

To verify whether the MS initiates reestablishment of the link if it receives a SABM while in ABM state.

46.1.2.2.4.1.3 Method of test

Initial conditions

-

Related PICS/PIXIT Statement

-

Test procedure

After establishing a link, initiate data transfer from the MS. After receiving 1 frame from the MS, send a SABM from the SS and verify whether the MS responds with a UA. After the link is re-established, verify that the MS resumes data transmission.

Maximum duration of the test

5 minutes.

Expected sequence

Step	Direction	Message	Comments
1		{PDP Context Activation}	Macro. Initiate PDP context establishment from the MS, using PDP Context 12.
2			Initiate acknowledged mode data transfer from the MS.
3	MS -> SS	I + S	Initiate data transfer of 2000 octets from the MS.
4	SS -> MS	RR	Acknowledge one frame.
5	SS -> MS	SABM	After receiving 1 frame from the MS, send a SABM from the SS to re-establish the link.
			Discard all the I+S frames received.
6	MS -> SS	UA	Verify that the MS responds with a UA.
7	MS -> SS	I+S	Verify that that N(S) begins from 0.
8	SS -> MS	RR	Acknowledge the frame sent from the MS.
9			Repeat steps 7 and 8 until all the frames from the MS are transmitted.

46.1.2.2.4.2 Reestablishment due to N200 failures

46.1.2.2.4.2.1 Conformance requirement

The criteria for re-establishing the ABM mode of operation are defined in this clause by the following conditions:

- the receipt, while in the ABM state, of a SABM;
- the receipt of an LL-ESTABLISH-REQ primitive from layer3
- the occurrence of N200 retransmission failures
- the occurrence of a frame rejection condition; and
- the receipt of an unsolicited DM response with F bit set to 0 while in ABM state.

In case of a re-establishment, all NSAPIs mapped to the affected SAPI shall enter the recovery state and all buffered N-PDUs (i.e. the ones whose complete reception has not been acknowledged and the ones that have not been transmitted yet) shall be transmitted starting with the oldest N-PDU when the link is re-established

Reference

GSM 04.64, clause 8.7.1

GSM 04.65, clauses 5.1.2.3, 5.1.2.5, 6.2.1.2

46.1.2.2.4.2.2 Test purpose

To verify whether the MS initiates reestablishment of the link when there is an N200 retransmission failure.

46.1.2.2.4.2.3 Method of test

Initial conditions

-

Related PICS/PIXIT Statement

-

Test procedure

After establishing a link, initiate data transfer from the MS, to send 1 octet of data. Do not acknowledge the data frame sent from the SS. The MS shall retransmit the frame N200 times. Wait for (N200 * T201) seconds and see if the MS

initiates link reestablishment by sending a SABM. After the link is re-established verify that the MS resumes data transmission.

Maximum duration of the test

5 minutes.

Expected sequence

Step	Direction	Message	Comments
1		{PDP Context Activation}	Macro.Initiate PDP context activation from the MS using PDP context 11.
2			Initiate acknowledged mode data transfer from the MS.
3	MS -> SS	I + S	Send 1 octet of data. Do not acknowledge this frame from the SS.
4	MS -> SS	I + S	Verify that the MS retransmits the I+S frame N200 times and that it does not send any SABM frames during retransmission. SS does not acknowledge any of these frames.
5	MS -> SS	SABM	Verify that the MS sends a SABM and that it stops sending anymore data to the SS. Verify that this occurs after T201 seconds after the last I+S frame in step 4.
6	SS -> MS	UA	
7	MS -> SS	I+S	Verify that the MS resumes transmission of data from step 2.
8	SS -> MS	RR	Acknowledge the frame transmitted from the MS.

46.1.2.2.4.3 Reestablishment due to reception of DM

46.1.2.2.4.3.1 Conformance requirement

The criteria for re-establishing the ABM mode of operation are defined in this clause by the following conditions:

- the receipt, while in the ABM state, of a SABM;
- the receipt of an LL-ESTABLISH-REQ primitive from layer3
- the occurrence of N200 retransmission failures
- the occurrence of a frame rejection condition; and
- the receipt of an unsolicited DM response with F bit set to 0 while in ABM state.

In case of a re-establishment, all NSAPIs mapped to the affected SAPI shall enter the recovery state and all buffered N-PDUs (i.e. the ones whose complete reception has not been acknowledged and the ones that have not been transmitted yet) shall be transmitted starting with the oldest N-PDU when the link is re-established.

Reference

GSM 04.64, clause 8.7.1

GSM 04.65, clauses 5.1.2.3, 5.1.2.5, 6.2.1.2

46.1.2.2.4.3.2 Test purpose

To verify whether the MS initiates reestablishment of the link if it receives a DM while in ABM state.

46.1.2.2.4.3.3 Method of test

Initial conditions

Related PICS/PIXIT Statement

-

Test procedure

After establishing a link, initiate data transfer from the MS . After receiving 1 frame from the MS, send a DM with F=0 from the SS and verify whether the MS responds with a SABM. After the link is re-established, verify that the MS resumes data transmission.

Maximum duration of the test

5 minutes.

Expected sequence

Step	Direction	Message	Comments
1		{PDP Context Activation}	Macro. Initiate PDP context activation from the MS, using PDP context 12.
2			Initiate acknowledged mode data transfer of 8000 octets from the MS.
3	MS -> SS	I + S	
4	SS -> MS	RR	Send RR frames as acknowledgements from the SS.
5			Repeat steps 3 and 4 once.
6	MS -> SS	I+S	
7	SS -> MS	DM	Send a DM with the F bit set to 0 from the SS.
			Discard all the I+S frames received at the SS.
8	MS -> SS	SABM	Verify that the MS re-establishes the link with a SABM
9	SS -> MS	UA	Respond with a UA
10	MS -> SS	I+S	Verify that the MS resumes data transmission , with N(S) set to 0, only for the first frame sent after resumption of transmission.
11	SS -> MS	RR	Acknowledge all frames sent from the MS.
12			Repeat steps 10 and 11 until all the frames from the MS are transmitted.

46.1.2.3 Collision of commands and responses

46.1.2.3.1 Collision of SABM

46.1.2.3.2 Conformance requirement

If the transmitted and received unnumbered commands are SABM commands and a Layer-3 Parameters XID parameter is present in both or in neither, then the SABM command transmitted by the SGSN shall be ignored and treated as not transmitted. The LLE in the SGSN shall send the UA response at the earliest possible opportunity if it is able to enter ABM.

Reference

GSM 04.64 clause 8.5.5.1

46.1.2.3.3 Test purpose

To verify that the MS ignores a SABM command received from the SS when it (the MS) is waiting for a UA response, when a Layer-3 Parameters XID parameter is present in both.

46.1.2.3.3 Method of test

Initial conditions

-

Related PICS/PIXIT Statement

-

Test procedure

Initiate link establishment from the MS by sending a SABM with Layer-3 Parameters XID parameter present. Upon reception of the SABM at the SS, send a SABM with Layer-3 Parameters XID parameter present. Verify that the MS ignores the SABM sent by the SS. Wait for T200 seconds at the SS after receiving the SABM from the MS see if the MS resends the SABM. After reception of the SABM, respond with a UA. Initiate data transmission from the MS. Acknowledge all the frames sent from the MS.

Maximum duration of the test

3 minutes.

Expected sequence

Step	Direction	Message	Comments
1		{PDP Context Activation}	Macro. Initiate PDP context activation from the MS with PDP Context 11.
2	MS -> SS	SABM	Verify that P/F = 1. A layer-3 XID parameter shall be present in the SABM received from the MS.
3	SS -> MS	SABM	Send a SABM with P/F =1 to simulate collision. Send the SABM from the SS with a layer 3 XID parameter.
4	MS -> SS	SABM	Wait for T200 seconds after the reception of SABM at the SS to ensure that the MS resends the SABM.
5	SS -> MS	UA	Send UA from the SS before T200 can expire at the MS.
6	MS -> SS	I + S	Initiate data transfer from the MS.
7	SS -> MS	RR	Send a supervisory frame as acknowledgement. Wait for T201 seconds to ensure that the MS does not retransmit the data.

46.1.2.3.2 Collision of SABM and DISC

46.1.2.3.2.1 Conformance requirement

If the transmitted and received unnumbered commands are a SABM and DISC command, the LLEs shall issue a DM response at the earliest possible opportunity. Upon receipt of a DM response with the F bit set to 1, the LLE shall enter the ADM state and notify layer3 by means of the appropriate primitive.

Reference

GSM 04.64, clause 8.5.5.2

46.1.2.3.2.2 Test purpose

To verify that when the MS receives a DISC after sending a SABM, it shall send a DM response to the SS. Upon reception of a DM response, it shall enter the ADM state.

46.1.2.3.2.3 Method of test

Initial conditions

-

Related PICS/PIXIT Statement

-

Test procedure

Initiate link establishment from the MS by sending a SABM command. Send a DISC command in response to this from the SS. Verify that the MS sends a DM and upon reception of a DM from the SS, it enters the ADM state. Send numbered frames from the SS and verify that the MS does not acknowledge them.

Maximum duration of the test

3 minutes

Expected sequence

Step	Direction	Message	Comments
1		{PDP Context Activation}	Macro. Initiate PDP context activation from the MS using PDP Context 12.
2	MS -> SS	SABM	Verify that P/F = 1.
3	SS -> MS	DISC	Send DISC from the SS before T200 can expire at the MS.
4	MS -> SS	DM	
5	SS -> MS	DM	Send DM with F=1
6	SS -> MS	I+S	Send an I+S frame from the SS.
7	MS -> SS	DM	Verify that the MS does not send an acknowledgement for the I+S frame transmitted and that it sends a DM response

46.1.2.3.3 Collision of SABM and XID commands

46.1.2.3.3.1 Conformance requirement

If the transmitted unnumbered command is a SABM command and the received unnumbered command is an XID command, then the LLE shall ignore the received XID command.

Reference

GSM 04.64 clause 8.5.5.2

46.1.2.3.3.2 Test purpose

To verify that the MS ignores the XID command if it collides with a SABM command.

46.1.2.3.3.3 Method of test

Initial conditions

-

Related PICS/PIXIT Statement

-

Test procedure

When the MS initiates link establishment using a SABM, send an XID command. Verify that the XID command is ignored.

Maximum duration of the test

3 minutes.

Expected sequence

Step	Direction	Message	Comments
1		{PDP Context Activation}	Macro. Initiate PDP context activation from the MS using PDP Context 12.
2	MS -> SS	SABM	Verify that P/F = 1.
3	SS -> MS	XID	Send an XID command without layer3 parameters.
4	MS -> SS	SABM	Wait for T200 seconds at the SS to ensure that the MS does not send an XID response and resends the SABM.
5	SS -> MS	UA	Send UA from the SS before T200 can expire at the MS. Wait for T200 seconds after the transmission of UA to ensure that the MS does not send an XID response.

46.1.2.4 Unsolicited response frames

46.1.2.4.1 Unsolicited DM

46.1.2.4.1.1 Conformance requirement

When a DM response with the F bit set to 0 is received by an LLE, a collision between a transmitted SABM or DISC command and the unsolicited DM response may have occurred.

A DM response with the F bit set to 0 colliding with a SABM or DISC shall be ignored.

An LLE shall ignore a DM response received with F=0 when it is in the Local Establishment state.

Reference

GSM 04.64 clauses 8.5.6 and 8.8.4.

46.1.2.4.1.2 Test purpose

To verify that the MS ignores a DM response sent with F=0 when LLC is in the Local Establishment state.

46.1.2.4.1.3 Method of test

Initial conditions

-

Related PICS/PIXIT Statement

-

Test procedure

Send SABM with P/F=1 from the MS to establish a link. Send a DM response with F=0 from the SS, in response to this. Verify that the MS ignores this DM response and sends SABM after expiry of T200. Respond with UA from the SS after receiving SABM. Send 1 I+S frame from the SS and verify that the MS acknowledges it.

Maximum duration of the test

3 minutes.

Expected sequence

Step	Direction	Message	Comments
1		{PDP Context Activation}	Macro. Initiate PDP context activation from the MS with PDP Context 11.
2	MS -> SS	SABM	Initiate data transfer from the MS. Verify that P/F = 1.
3	SS -> MS	DM	Send a DM response with F=0
4	MS -> SS	SABM	Ensure that the second SABM is sent after T200 seconds.
5	SS -> MS	UA	Send UA from the SS before T200 expires at the MS.
6	SS -> MS	I+S frame	Send one I+S frame from the SS.
A7 (Optional step)	MS -> SS	RNR	Verify that the RNR acknowledges the frame transmitted in step 6.
7	MS -> SS	RR frame	Verify that the MS acknowledges the I+S frame transmitted from the SS.

46.1.2.5 FRMR frames

46.1.2.5.1 Sending FRMR due to undefined command control field

46.1.2.5.1.1 Conformance requirement

The FRMR unnumbered response may be received by an LLE as a report of a frame rejection condition not recoverable by retransmission of the identical frame:

- receipt of a command or response control field that is undefined or not implemented
- receipt of a supervisory or unnumbered frame with incorrect length; or
- receipt of an I frame with an information field that exceeds the maximum established length.

Upon occurrence of a frame rejection condition, the LLME shall issue an LLGMM-STATUS-IND primitive; and the LLE shall:

- discard the frame causing the frame rejection condition;
- transmit a FRMR response frame; and
- if the LLE is in ABM operation, initiate re-establishment

Reference

GSM 04.64, clause 6.4.1.5 and clause 8.8.2

46.1.2.5.1.2 Test purpose

To verify that if the MS receives a frame with a command control field that is not implemented, it sends an FRMR frame and re-establishes the link.

46.1.2.5.1.3 Method of test

Initial conditions

-

Related PICS/PIXIT Statement

-

Test procedure

After establishing a link, initiate data transfer from the MS . After receiving the first frame, send a supervisory frame from the SS to acknowledge the last I+S frame received. In this set the first byte of the S frame control field to 1110 0000. Verify whether the MS sends an FRMR. After the link is re-established, verify that the MS resumes data transmission.

Maximum duration of the test

5 minutes.

Expected sequence

Step	Direction	Message	Comments
1		{PDP Context Activation}	Macro. Initiate PDP context activation from the MS with PDP context 11.
2			Initiate acknowledged mode data transfer of 1 octet from the MS.
3	MS -> SS	I + S	
4	SS -> MS		After receiving the first I+S frame, send a frame, with the contents of the control field as 1110 0000.
5	MS -> SS	FRMR	Verify that the control field of the frame sent in step 4 is sent back in the FRMR response. Verify that the value of V(S) received is 1. W3 and C/R field shall be set to 1 . W1 and W2 shall be set to 0. W4 shall be set to 1.
6	MS -> SS	SABM	Verify that the MS re-establishes the link with a SABM and that it stops sending anymore data to the SS.
7	SS -> MS	UA	Respond with a UA
8	MS -> SS	I+S	Verify that the MS resumes data transmission, with N(S)=0, for the first frame transmitted
9	SS -> MS	RR	Acknowledge all frames sent from the MS.

46.1.2.5.2 Sending FRMR due to reception of an S frame with incorrect length

46.1.2.5.2.1 Conformance requirement

The FRMR unnumbered response may be received by an LLE as a report of a frame rejection condition not recoverable by retransmission of the identical frame:

- receipt of a command or response control field that is undefined or not implemented
- receipt of a supervisory or unnumbered frame with incorrect length; or
- receipt of an I frame with an information field that exceeds the maximum established length.

Upon occurrence of a frame rejection condition whilst in ABM operation, the LLME shall issue an LLGMM-STATUS-IND primitive; and the LLE shall initiate re-establishment.

Reference

GSM 04.64, clause 6.4.1.5 and clause 8.8.2

46.1.2.5.2.2 Test purpose

To verify that if the MS receives an S frame with incorrect length, it sends an FRMR frame and re-establishes the link.

46.1.2.5.2.3 Method of test

Initial conditions

Related PICS/PIXIT Statement

-

Test procedure

After establishing a link, initiate data transfer from the MS . After receiving 2 frames at the SS, send an RR with incorrect length, from the SS, when an I+S frame with the A bit set is received. Verify whether the MS sends an FRMR. After the link is re-established, verify that the MS resumes data transmission.

Maximum duration of the test

5 minutes.

Expected sequence

Step	Direction	Message	Comments
1		{PDP Context Activation}	Macro. Initiate PDP context activation from the MS with PDP context 12.
2			Initiate acknowledged mode data transfer from the MS.
3	MS -> SS	I + S	Initiate data transfer of 5000 octets from the MS.
4	SS -> MS	RR	Send RR frames as acknowledgements from the SS.
5			Repeat steps 3 and 4 until 2 frames are transmitted.
6	SS -> MS	RR	For one of the I+S frames with an A bit set received at the SS, send an RR from the SS. There shall be an extra octet in this RR frame, before the FCS. The RR frame shall appear as follows: Address field (1 octet) Control field (2 octets) Extra field (1 octet) FCS (3 octets)
7	MS -> SS	FRMR	Verify that the control field of the RR message is sent back in the FRMR response. C/R field shall be set to 0 . W1, W3 and W4 shall be set to 1. The content of W2 shall not be checked.
8	MS -> SS	SABM	Verify that the MS re-establishes the link with a SABM and that it stops sending anymore data to the SS.
9	SS -> MS	UA	Respond with a UA
10	MS -> SS	I+S	Verify that the MS resumes transmission of data.
11	SS -> MS	RR	Acknowledge all frames sent from the MS.
12			Repeat 10 and 11 until all the frames from the MS are transmitted and acknowledged.

46.1.2.5.3 Sending FRMR due to reception of an I frame information field exceeding the maximum length

46.1.2.5.3.1 Conformance requirement

The FRMR unnumbered response may be received by an LLE as a report of a frame rejection condition not recoverable by retransmission of the identical frame:

- receipt of a command or response control field that is undefined or not implemented
- receipt of a supervisory or unnumbered frame with incorrect length; or
- receipt of an I frame with an information field that exceeds the maximum established length.

Upon occurrence of a frame rejection condition whilst in ABM operation, the LLME shall issue an LLGMM-STATUS-IND primitive; and the LLE shall initiate re-establishment.

Reference

GSM 04.64, clause 6.4.15 and clause 8.8.2

46.1.2.5.3.2 Test purpose

To verify that if the MS receives an I frame with an information field that exceeds the maximum established length, it sends an FRMR frame and re-establishes the link.

46.1.2.5.3.3 Method of test

Initial conditions

-

Related PICS/PIXIT Statement

-

Test procedure

After establishing a link, initiate data transfer from the SS. After sending 10 frames from the SS, send an I+S frame with length greater than N201-I, from the SS. Verify whether the MS sends an FRMR. After the link is re-established, send frames from the SS with N(S) = 0 until N(S) = 100. Verify that the MS acknowledges all the data sent.

Maximum duration of the test

5 minutes.

Expected sequence

Step	Direction	Message	Comments
1		{PDP Context Activation}	Macro. Initiate PDP context activation from the MS using PDP context 11,
2			Initiate acknowledged mode data transfer from the SS.
3	SS -> MS	I + S	A = 1
A4 (Optional step)	MS -> SS	RNR	If the MS sends an RNR, do not transmit data until it sends an RR.
4	MS -> SS	RR	Send RR frames as acknowledgements from the MS.
5			Repeat steps 3 and 4 until 10 frames are sent from the SS.
6	SS -> MS	I + S	Send an I+S frame with the information field length greater than N201-I, from the SS .
7	MS -> SS	FRMR	Verify that the control field of the I+S message is sent back in the FRMR response. Also verify that the value of V(R) indicates all the frames sent so far except the erroneous I+S frame have been received. W2 and W4 shall be set to 1. W1, W3 and the C/R field shall be set to 0.
8	MS -> SS	SABM	Verify that the MS re-establishes the link with a SABM .
9	SS -> MS	UA	Respond with a UA
10	SS -> MS	I+S	Send data from the SS.
A11 (Optional step)	MS -> SS	RNR	If the MS sends an RNR , do not transmit data until it has sent an RR.
B11 (Optional step)	MS -> SS	RR	Verify that all the frames sent from the SS are acknowledged.
12			Repeat 10 and 11 until all the frames from the SS are transmitted and acknowledged.

46.1.2.5.4 Frame reject condition during establishment of ABM

46.1.2.5.4.1 Conformance requirement

The FRMR unnumbered response may be received by an LLE as a report of a frame rejection condition not recoverable by retransmission of the identical frame:

- receipt of a command or response control field that is undefined or not implemented
- receipt of a supervisory or unnumbered frame with incorrect length; or
- receipt of an I frame with an information field that exceeds the maximum established length.

Upon occurrence of a frame rejection condition whilst in ABM operation, the LLME shall issue an LLGMM-STATUS-IND primitive; and the LLE shall initiate re-establishment.

Upon occurrence of a frame rejection condition during establishment of or release from ABM operation, or whilst in ADM state, the LLE shall discard the frame.

Reference

GSM 04.64, clause 6.4.15 and clause 8.8.2

46.1.2.5.4.2 Test purpose

To verify that if the MS receives a U frame with its frame type not implemented during ABM establishment, it shall ignore the message.

46.1.2.5.4.3 Method of test

Initial conditions

-

Related PICS/PIXIT Statement

-

Test procedure

Initiate link establishment from the MS by sending a SABM. Send an invalid U frame as response. Wait for T200 seconds and check if the MS resends the SABM. Respond with a UA. Initiate data transfer from the MS and acknowledge all the frames sent from the MS.

Maximum duration of the test

5 minutes.

Expected sequence

Step	Direction	Message	Comments
1		{PDP Context Activation}	Macro. Initiate PDP context activation from the MS using PDP Context 13.
2	MS -> SS	SABM	Initiate acknowledged mode data transfer from the MS. Verify that P/F = 1.
3	SS -> MS	Invalid U frame	Send a U frame with its control field M4 M3 M2 M1 = 0010
4	MS -> SS	FRMR	
5	MS -> SS	SABM	Wait for T200 seconds after the reception of the first SABM, to ensure that the MS resends SABM
6	SS -> MS	UA	
7	MS -> SS	I + S	Initiate data transfer from the MS.
8	SS -> MS	RR	Acknowledge all frames sent from the MS.

46.1.2.6 Multiple Connections

46.1.2.6.1 Simultaneous acknowledged and unacknowledged data transfer on the same SAPI

Applicability

This test is applicable to mobiles which support more than one PDP context simultaneously on the same SAPI.

46.1.2.6.1.1 Conformance requirement

The purpose of LLC is to convey information between layer-3 entities in the MS and SGSN. Specifically, LLC shall support:

- multiple MSs, at the Um interface,
- multiple layer-3 entities within the MS.

Reference

GSM 4.64, clause 4.2.

46.1.2.6.1.2 Test purpose

To verify that LLC supports simultaneous acknowledged and unacknowledged data transfer in the same direction on the same SAPI.

46.1.2.6.1.3 Method of test

Initial conditions

-

Related PICS/PIXIT Statement

-

Test procedure

Initiate acknowledged data transfer from the MS on SAPI 3. Send 1500 K octets continuously. The value of N(S) shall begin from 0 and increment by 1 mod (512) for each frame. Initiate unacknowledged data transfer from the MS on the same SAPI within 1 minute from initiation of the acknowledged data transfer.

Acknowledge all the I frames sent from the SS by sending RR frames to the MS.

Maximum duration of the test

20 minutes.

Expected sequence

Step	Direction	Message	Comments
1		{PDP Context Activation}	Macro. Initiate the first PDP context using PDP context 11.
2			Initiate acknowledged mode data transfer from the MS.
3	MS -> SS	I+S frame	N(S) = 0 for the first frame
A4	SS -> MS	S frame with RR	Send RR only when A bit = 1.
5		{PDP Context Activation}	Macro. Initiate the second PDP context using PDP context 1
6			Initiate unacknowledged mode data transfer of 1000 K octets (using PDP context 1) from the MS within 1 minute from step2.
A7	MS -> SS	I+S frame	
A8	SS -> MS	RR	Send RR only when A bit = 1.
B7	MS -> SS	UI	
9			Repeat from step 7 until 1500 K octets of acknowledged data and 1000 K octets of unacknowledged data are transmitted. I Verify that : The MS does not retransmit any frame. N(S) begins with 0 and is incremented by 1 mod (512) for each transmission N(U) begins with 0 and is incremented by 1 mod (512) for each transmission

46.1.2.6.2 Simultaneous acknowledged and unacknowledged data transfer on different SAPIs

Applicability

This test is applicable to mobiles which support more than one PDP context simultaneously.

46.1.2.6.2.1 Conformance requirement

The purpose of LLC is to convey information between layer-3 entities in the MS and SGSN. Specifically, LLC shall support:

- multiple MSs, at the Um interface,
- multiple layer-3 entities within the MS.

Reference

GSM 4.64, clause 4.2.

46.1.2.6.2.2 Test purpose

To verify that LLC supports simultaneous acknowledged and unacknowledged data transfer on different SAPIs in different directions.

46.1.2.6.2.3 Method of test

Initial conditions

-

Related PICS/PIXIT Statement

-

Test procedure

Initiate unacknowledged data transfer from the MS on SAPI 5. Initiate acknowledged data transfer from the SS on SAPI 3 after the first *i* frames have been received from the MS. Send 1500K octets continuously from the SS. The value of *N(S)* shall begin from 0 and increment by 1 mod (512) for each frame.

Verify that the MS acknowledges all the I frames sent from the SS. Verify that the UI frames are received at the SS in sequence.

Maximum duration of the test

15 minutes.

Expected sequence

Step	Direction	Message	Comments
1		{PDP Context Activation}	Macro. Initiate PDP context activation on PDP Contexts 8 and 11 from the MS.
2			Initiate unacknowledged mode data transfer of 1000 K octets from the MS.
3	MS -> SS	UI frame	
4			Initiate acknowledged mode data transfer of 1500 K octets from the SS.
5	SS -> MS	I+S frame	Start sending I+S frames after i UI frames have been received. Set the A bit to 1 when the window is full and for the last I+S frame.
A6	MS -> SS	UI frame	
B6	MS -> SS	RNR	If the MS sends an RNR, the SS shall resume transmission only after it transmits a SACK, RR or an ACK.
C6	MS -> SS	SACK	The SS shall retransmit the unacknowledged frames.
D6	MS -> SS	ACK	The SS shall retransmit the unacknowledged frames.
E6	MS -> SS	S frame with RR	Verify that the MS acknowledges all the frames sent from the SS.
			The MS may not send any frame if the A bit was not set in step 5.
7			Repeat steps 5 and 6 until all 1500K octets have been transmitted for the acknowledged mode from the SS and 1000 K octets for the unacknowledged mode to the SS. Verify that : The MS acknowledges all I+S frames sent. -The MS sends all UI frames in the correct sequence.

46.1.2.7 XID Negotiation

46.1.2.7.1 Negotiation initiated by the SS during ABM, for T200 and N200

46.1.2.7.1.1 Conformance requirement

The negotiation procedure is one-step, i.e., one side shall start the process by sending an XID command, offering a certain set of parameters from the applicable parameter repertoire the sending entity wants to negotiate, proposing values within the allowed range. In return, the other side shall send an XID response, either confirming these requested values, or offering higher or lower ones in their place.

XID frames shall always be used with the P/F bit set to 1.

T200, N200 and N201-U can be negotiated in ADM and ABM.

Reference

GSM 4.64, clause 6.4.1.6

46.1.2.7.1.2 Test purpose

To verify that when the SS initiates XID negotiations with a certain value of T200 and N200, the MS complies with the final negotiated values

46.1.2.7.1.3 Method of test

Initial conditions

-

Related PICS/PIXIT Statement

-

Test procedure

Initiate XID negotiation from the SS, with N200 = 4 and T200 = 10 seconds. The MS will send an XID response. Initiate data transfer from the MS. Send an XID command with layer3 parameters and verify that the MS complies with the values of T200 and N200 that were agreed upon.

Maximum duration of the test

5 minutes.

Expected sequence

Step	Direction	Message	Comments
1		{PDP Context Activation}	Macro. Initiate PDP context activation from the MS for PDP Context 11
2	SS -> MS	XID	XID command with N200 = 4, T200 = 10 seconds. Check if the P/F bit is set to 1.
3	MS -> SS	XID	XID response Check if the P/F bit is set to 1. The values received in this message shall be the negotiated values.
4			Initiate acknowledged mode data transfer of 1 octet from the MS.
5	MS -> SS	I + S	
6			Do not respond with an RR.
7	MS -> SS	I+S	Verify that the MS resends the I+S frame every T200 seconds N200 times.
8	MS -> SS	SABM	Verify that the MS sends a SABM to re-establish the link
9	SS -> MS	UA	Respond with a UA within T200 seconds.

46.1.2.7.2 Negotiation initiated by the SS during ADM, for N201-I

46.1.2.7.2.1 Conformance requirement

The negotiation procedure is one-step, i.e., one side shall start the process by sending an XID command, offering a certain set of parameters from the applicable parameter repertoire the sending entity wants to negotiate, proposing values within the allowed range. In return, the other side shall send an XID response, either confirming these requested values, or offering higher or lower ones in their place.

XID frames shall always be used with the P/F bit set to 1.

N201-I, mD, mU, kD and kU can be negotiated to any value in Range in ADM. In ABM, N201-I, mD, mU, kD and kU can only be negotiated to the same or higher value as previously used.

Reference

GSM 4.64, clause 6.4.1.6

46.1.2.7.2.2 Test purpose

To verify that when the SS initiates XID negotiations with a certain value of N201-I during ADM, the MS complies with the final negotiated values.

46.1.2.7.2.3 Method of test

Initial conditions

-

Related PICS/PIXIT Statement

-

Test procedure

Initiate PDP context activation from the MS and in the UA response from the SS send a value of 140 for N201-I .. If the MS responds with an XID command, in the XID response, give N201-I = 140.

Initiate data transfer from the SS. Send an I+S frame of length N201-I with the A bit set to 1. Verify that the MS acknowledges this I+S frame.

The next I+S frame sent from the SS shall be of length N201-I + 1. Verify that the MS sends FRMR and re-establishes the link.

Maximum duration of the test

5 minutes.

Expected sequence

Step	Direction	Message	Comments
1		{PDP Context Activation}	Macro. Initiate PDP context activation from the MS using PDP Context 11.
2	MS -> SS	SABM	
3	SS -> MS	UA	Set N201-I = 140 in the UA sent. If the MS sends an XID command with a different value of N201-I, send back a response with N201-I = 140. If the MS sends an XID command, respond with a value of N201-I = 140.
4	SS -> MS	I+S	Send an I+S frame from the SS with length N201-I with the A bit set to 1.
A5 (optional step)	MS -> SS	RNR	If the MS sends an RNR, verify that the RNR acknowledges the frame sent in step 3. Do not transmit the next I+S frame to the SS until the MS sends an RR.
5	MS -> SS	RR	Verify that the MS responds with an RR.
6	SS -> MS	I+S	The length of this I+S frame shall be N201-I + 1. Set the A bit to 1.
7	MS -> SS	FRMR	Verify that the control field of the I+S message is sent back in the FRMR response. Also verify that the value of V(R) indicates all the frames sent so far except the erroneous I+S frame have been received. W2 and W4 shall be set to 1. W1, W3 and the C/R field shall be set to 0.
8	MS -> SS	SABM	Verify that the MS re-establishes the link with a SABM.
9	SS -> MS	UA	Respond with a UA within T200 seconds.

46.1.2.7.3 Negotiation initiated by the SS (using SABM, for IOV-I)

46.1.2.7.3.1 Conformance requirement

The negotiation procedure is one-step, i.e., one side shall start the process by sending an XID command, offering a certain set of parameters from the applicable parameter repertoire the sending entity wants to negotiate, proposing values within the allowed range. In return, the other side shall send an XID response, either confirming these requested values, or offering higher or lower ones in their place.

XID frames shall always be used with the P/F bit set to 1.

LLC layer and layer-3 parameters may be negotiated with the exchange of XID frames or with the exchange of SABM and UA frames. After successful negotiations of SABM and UA frames, the LLE shall be in ABM mode of operation

IOV-I shall only be negotiated with SABM and UA frames. IOV-UI and IOV-I shall only be transmitted in the downlink direction.

Reference

GSM 4.64, clause 6.4.1.6, 8.5.3

46.1.2.7.3.2 Test purpose

To verify that when the SS sends IOV-I to the MS in a SABM, the MS shall cipher its output using this value of IOV-I.

46.1.2.7.3.3 Method of test

Initial conditions

The MS shall be GPRS attached with ciphering enabled.

Related PICS/PIXIT Statement

-

Test procedure

Initiate link establishment from the SS. In the SABM command, send a new value of IOV-I, different from the default used. Send 1000 octets from the MS and verify that the frames have been ciphered as per the new value of IOV-I.

Maximum duration of the test

5 minutes.

Expected sequence

Step	Direction	Message	Comments
1		{PDP Context Activation}	Macro. Initiate PDP context activation from the SS using PDP Context 11.
2		{PDP Context Modification}	Macro. Initiate PDP context modification to PDP Context 13 from the SS.
3	SS -> MS	SABM	With IOV-I = $2^{27} * 10$.
4	MS -> SS	UA	
5	MS -> SS	I+S	Initiate data transfer from the MS. Send 1000 octets.
6	SS -> MS	RR	Verify that ciphering is as per the new value of IOV-I. The SS shall check this by analyzing the FCS. Acknowledge all the I+S frames.
7	SS -> MS	I + S	Initiate data transfer from the SS. Send 1 I+S frame with A=1
A8	MS -> SS	RNR	Verify that the MS acknowledges the frame sent in step 7.
B8	MS -> SS	RR	Verify that the MS acknowledges the frames.

46.1.2.7.4 Negotiation initiated by the SS (during ADM, for N201-U)

46.1.2.7.4.1 Conformance requirement

The negotiation procedure is one-step, i.e., one side shall start the process by sending an XID command, offering a certain set of parameters from the applicable parameter repertoire the sending entity wants to negotiate, proposing values within the allowed range. In return, the other side shall send an XID response, either confirming these requested values, or offering higher or lower ones in their place.

XID frames shall always be used with the P/F bit set to 1.

T200, N200 and N201-U can be negotiated in ADM and ABM.

N201-U is used for U and UI frames.

Reference

GSM 4.64, clause 6.4.1.6, clause 8.9.5

46.1.2.7.4.2 Test purpose

To verify that when the SS initiates XID negotiations with a certain value of N201-U during ADM, the MS complies with the final negotiated values.

46.1.2.7.4.3 Method of test

Initial conditions

-

Related PICS/PIXIT Statement

-

Test procedure

Initiate XID negotiation from the SS, with N201-U = 140. The MS shall send an XID response. The value of N201-U in the XID response shall be regarded as the final negotiated value.

Initiate data transfer from the MS. Verify that the length of the UI frames sent from the MS never exceeds the negotiated value of N201-U.

Maximum duration of the test

5 minutes.

Expected sequence

Step	Direction	Message	Comments
1		{PDP Context Activation}	Macro. Initiate PDP context activation from the MS using PDP Context 9.
2	SS -> MS	XID	XID command with N201-U = 140
3	MS -> SS	XID	XID response. The value of N201-U shall be regarded as the negotiated value.
4			Initiate unacknowledged data transfer of 1000 octets from the MS.
5	MS -> SS	UI	Verify that the frame length does not exceed the negotiated value of N201-U.
6			Repeat step 5 until 1000 octets have been sent from the MS.

46.1.2.7.5 Negotiation initiated by the SS (during ADM, for IOV-UI)

46.1.2.7.5.1 Conformance requirement

The negotiation procedure is one-step, i.e., one side shall start the process by sending an XID command, offering a certain set of parameters from the applicable parameter repertoire the sending entity wants to negotiate, proposing values within the allowed range. In return, the other side shall send an XID response, either confirming these requested values, or offering higher or lower ones in their place.

XID frames shall always be used with the P/F bit set to 1.

IOV-UI shall only be negotiated in ADM, and only before ciphering is enabled. IOV-UI and IOV-I shall only be transmitted in the downlink direction.

IOV-UI is associated with a TLLI.

Reference

GSM 4.64, clauses 6.4.1.6, 8.5.3, 8.9

GSM 4.08 clause 4.7.12

46.1.2.7.5.2 Test purpose

To verify that when the SS sends IOV-UI to the MS in an XID command, before ciphering is enabled,

- The MS shall cipher its output using this value of IOV-UI.
- This value of IOV-UI shall be applicable for all SAPIs using this TLLI.
- Identity Response sent from the MS shall not be ciphered.

46.1.2.7.5.3 Method of test

Initial conditions

-

Related PICS/PIXIT Statement

-

Test procedure

Send a value of IOV-UI from the SS, different from the default used. Send 1000 octets from the MS and verify that the frames have been ciphered as per the new value of IOV-UI.

Send 1000 octets from the MS on SAPI 11. Verify that the frames have been ciphered as per the new value of IOV-UI.

Maximum duration of the test

3 minutes.

Expected sequence

Step	Direction	Message	Comments
1		{PDP Context Activation}	Macro. Initiate a PDP context activation from the MS using PDP Context 10.
2	SS -> MS	XID	XID command with IOV-UI = 5000.
3	MS -> SS	XID	Verify that the MS accepts this value of IOV-UI by sending an XID response. Verify the XID response received. If the MS has requested for a new set of XID parameters, verify that the values requested are within range.
4	SS -> MS	UI [Authentication and Ciphering Request]	Send the Authentication and Ciphering Request from the SS to start ciphering.
5	MS -> SS	UI [Authentication and Ciphering Response]	
6			Initiate unacknowledged data transfer of 1000 octets from the MS.
7	MS -> SS	UI	Verify that these frames have been ciphered as per the new value of IOV-UI.
8	SS -> MS	UI [Identity Request]	This UI frame must not be sent ciphered.
9	MS -> SS	UI [Identity Response]	This UI frame shall not be ciphered. The E bit shall not be set to 1.
10		{PDP Context Deactivation}	Macro. Deactivate PDP Context 10.
11		{PDP Context Activation}	Macro. Activate PDP Context 9.
12			Initiate a data transfer of 50 octets from the MS on SAPI 11 for the same value of TLLI as before.
13	MS -> SS	UI	Verify that ciphering is as per the new value of IOV-UI.

46.1.2.7.6 Negotiation initiated by the SS (during ABM, for Reset)

Send Reset during unacknowledged mode data transfer and check if N(S) begins from 0.

Applicability

This test is applicable to only those mobiles which can support more than one PDP context simultaneously.

46.1.2.7.6.1 Conformance requirement

The negotiation procedure is one-step, i.e., one side shall start the process by sending an XID command, offering a certain set of parameters from the applicable parameter repertoire the sending entity wants to negotiate, proposing values within the allowed range. In return, the other side shall send an XID response, either confirming these requested values, or offering higher or lower ones in their place.

XID frames shall always be used with the P/F bit set to 1.

Reset shall only be negotiated with an XID frame, and only transmitted in the downlink direction. If Reset is present in an XID frame, it shall be the first parameter in the XID information field.

The Reset parameter shall be used, in the SGSN originating Reset and the MS receiving Reset, to:

- set all LLC layer parameters to the default values given in Table 9;
- change any LLEs in ABM state to ADM state;
- set the unconfirmed state variable V(U) to value 0;
- set the unconfirmed receive state variable V(UR) to 0;
- set the OCs for unacknowledged information transfer to 0.

The Reset parameter shall be treated before any additional XID parameters present in the same XID frame.

Reference

GSM 4.64, clause 6.4.1.6, 8.5.3.1

46.1.2.7.6.2 Test purpose

To verify that when the SS sends the Reset parameter to the MS in an XID,

- It sets all LLC layer parameters to the default values
- change any LLEs in ABM state to ADM state;
- set the unconfirmed state variable V(U) to value 0;
- set the unconfirmed receive state variable V(UR) to 0;
- set the OCs for unacknowledged information transfer to 0.

46.1.2.7.6.3 Method of test

Initial conditions

The System Simulator shall support two cells, each in a different SGSN Routing Area.

Related PICS/PIXIT Statement

-

Test procedure

For this test case, $N_{MS} = N_{SS} = 200$.

Initiate unacknowledged data transfer from the MS. Send N_{MS} UI frames.

Initiate unacknowledged data transfer from the SS. Send N_{SS} UI frames.

During PDP context activation for Context 11, initiate XID negotiation from the SS, with $N200 = 4$ and $T200 = 10$. Initiate data transfer from the MS. Do not acknowledge the first frame sent from the MS and verify that the MS complies with the values of $T200$ and $N200$ that were agreed upon.

Initiate inter-SGSN Routing Area Update from the MS, which will make the SS send an XID command with the Reset parameter. Send I+S frames from the MS, with the A bit set to 1. Do not acknowledge the first I+S frame. Verify that the MS sends the I+S frame $N200$ times, every $T201$ seconds. Verify that the values of $N200$ and $T201$ are the default values.

Initiate unacknowledged data transfer from the MS for the same SAPI and for the same TLLI used before sending Reset from the SS. Verify that the frames are numbered from 0 and not from $N_{MS} + 1$. Verify that the frames can be decrypted using $OC = 0$.

Initiate unacknowledged data transfer from the SS for the same SAPI and for the same TLLI used before sending Reset from the SS. The first frame shall have its sequence number set to N_{SS} . Verify that the MS does not discard these frames.

Maximum duration of the test

3 minutes.

Expected sequence

Step	Direction	Message	Comments
1		{PDP Context Activation}	Macro. Initiate PDP context activation from the MS using PDP Context 9.
2	MS -> SS	UI frame	
3			Repeat step 2 until N _{MS} frames are sent.
4	SS -> MS	UI frame	
5			Repeat step 4 until N _{SS} frames are sent.
6		{PDP Context Activation}	Macro. Initiate PDP context activation from the MS for PDP Context 11.
7	MS -> SS	SABM	
8	SS -> MS	UA	Send N200 = 4, T200 = 10 seconds in the UA response. If the MS sends an XID command, respond accepting the proposed values.
9			Initiate acknowledged mode data transfer of 1 octet from the MS.
10	MS -> SS	I + S	
11			Do not respond with an RR..Verify that the MS retransmits the I+S frame N200 times every T200 seconds.
12	MS -> SS	SABM	Verify that the MS sends a SABM to re-establish the link
13	SS -> MS	UA	Respond with a UA within T200 seconds.
14		{Inter-SGSN Routing Area Update}	Macro. Initiate Inter-SGSN Routing Area Update from the MS. (This procedure sends XID reset). The MS shall reselect the new cell and do a Routing Area Update with the new SGSN.
15	SS->MS	SABM	
16	MS-> SS	UA	
17	MS -> SS	I + S	Resume data transfer from the MS.
18			Do not respond with an RR from the SS. Check that the MS retransmits the frame after T201 seconds, N200 times. T201 and N200 shall be as per the values negotiated, if any, after link re-establishment and not as per the values of N200 and T200 negotiated before sending a Reset, in step 8.
19	MS -> SS	SABM	Verify that the MS sends a SABM to re-establish the link
20	SS -> MS	UA	Respond with a UA within T200 seconds.
21	MS -> SS	UI	Initiate unacknowledged data transfer from the MS and send 50 octets for the same SAPI and for the same TLLI used before sending Reset from the SS. Verify that These frames have been ciphered with OC = 0. These frames are numbered from 0 and not from N _{MS} .

46.1.2.7.7 XID command with unrecognised type field

46.1.2.7.7.1 Conformance requirement

If a SABM or XID command with an invalid XID information field is received, then the SABM or XID command, respectively, shall be ignored.

If a SABM or XID command with unrecognised type field is received, then this parameter shall be ignored.

Reference

GSM 4.64, clause 8.5.3.3

46.1.2.7.7.2 Test purpose

To test the MS response to an XID command with an unrecognised type field.

46.1.2.7.7.3 Method of test

Initial conditions

-

Related PICS/PIXIT Statement

-

Test procedure

Send an XID frame from the SS with N200 = 5 and another parameter with type = 15. Verify that the MS responds with an XID response. Send an I+S frame from the MS with the A bit set to 1. Do not respond with an RR. Verify that the MS retransmits the I+S frame N200 times, every T201 seconds, with N200 taking the negotiated value.

Maximum duration of the test

3 minutes.

Expected sequence

Step	Direction	Message	Comments
1		{PDP Context Activation}	Macro. Initiate a PDP context from the MS using PDP Context 11.
2	SS -> MS	XID	Send an XID command with N200 = 5 and an XID parameter with its type = 15, length =4 and value = 1500.
3	MS -> SS	XID	Verify the XID response received. If the MS has requested for a new XID value, verify that the new values are within range the sense of negotiation is correct The values received in the XID response shall be regarded as the final negotiated values.
4			Initiate acknowledged mode data transfer of 1 octet from the MS.
5	MS -> SS	I+S	Initiate data transfer from the MS. Send an I+S frame from the MS with the A bit set to 1. Do not acknowledge the frame from the SS. Verify that The MS sends an I+S frame every T201 seconds, N200 times.
6	MS -> SS	SABM	Verify that the MS re-establishes the link by sending a SABM, after all retransmissions are complete.
7	SS -> MS	UA	Respond with a UA

46.1.2.7.8 XID Response with out of range values

46.1.2.7.8.1 Conformance requirement

If UA or XID response with an invalid XID information field is received, then the UA or XID response shall be ignored, the SABM or XID command shall be retransmitted, and the retransmission counter shall be incremented.

Reference

GSM 4.64, clause 8.5.3.3

46.1.2.7.8.2 Test purpose

To test the MS response to an XID response with the N201-I value out of range.

46.1.2.7.8.3 Method of test

Initial conditions

-

Related PICS/PIXIT Statement

-

Test procedure

Send an XID frame within SABM, from the MS with layer3 parameters. Respond from the SS with an XID, with N201-I = 1600. Verify that the MS ignores this response and resends the SABM with the XID command. Now accept the XID values received at the SS. Send an I+S frame with length less than N201-I and the A bit set to 1 and verify that the MS responds with an RR. Send an I+S frame from the SS with its length larger than the maximum negotiated value of N201-I and verify that the MS sends an FRMR and re-establishes the link.

Maximum duration of the test

3 minutes.

Expected sequence

Step	Direction	Message	Comments
1		{PDP Context Activation}	Macro. Initiate PDP context activation from the MS, using PDP context 11.
2	MS -> SS	SABM[XID]	XID command with layer3 parameters, sent with SABM.
3	SS -> MS	UA[XID]	Send an XID response in UA, with N201-I = 1600
4	MS -> SS	SABM[XID]	Verify that the MS resends the SABM command.
5	SS -> MS	UA[XID]	Send UA accepting all the XID values.
6	SS -> MS	I+S	Send an I+S frame with the maximum negotiated value of N201-I, with the A bit set to 1.
7	MS -> SS	RR	Verify that the MS responds with an RR
8	SS -> MS	I+S	Send an I+S frame with length = N201 - I + 1, with the A bit set to 1.
9	MS -> SS	FRMR	Verify that the MS responds with an FRMR
10	MS -> SS	SABM	Verify that the MS initiates link re-establishment
11	SS -> MS	UA	Respond with a UA.

46.2 SNDCP Tests

This clause contains the test case requirements for Subnetwork Dependent Convergence Protocol(SNDCP) procedures in the General Packet Radio Service (GPRS).

46.2.1 Default Conditions

- The MS default initial condition is that it is GPRS attached.
- Data and header compression are off .

The N-PDU size shall be more than the negotiated values of N201-U and N201-I so that segmentation at SNDCP is ensured. Unless stated otherwise, the default conditions shall apply.

If the MS sends an XID command with XID parameters any time before a data transfer, the SS shall send an XID response, accepting the values proposed by the MS.

46.2.2 Test cases

46.2.2.1 Data transfer

46.2.2.1.1 Mobile originated normal data transfer with LLC in acknowledged mode

46.2.2.1.1.1 Conformance requirement

The SNDCP entity shall initiate acknowledged data transmission only if the PDP context for the NSAPI identified in the SN-DATA.request has been activated and if acknowledged LLC operation has been established.

The N-PDU number in acknowledged mode is a number assigned to each N-PDU received by SNDCP through an SN-DATA.request. N-PDU numbers for different NSAPIs shall be assigned independently. The N-PDU number shall be included in the SNDCP header of the first segment of an N-PDU.

Upon reception of an SN-DATA.request, the SNDCP entity shall assign to the N-PDU received the current value of the Send N-PDU number as the N-PDU number, increment the Send N-PDU number by 1, perform the compression and segmentation functions, then forward the SN-PDU(s) in LL-DATA.request to the LLC layer. The N-PDU shall be stored into a buffer in the SNDCP entity. The buffered N-PDU shall be deleted when the SN-DATA PDU carrying the last segment of the N-PDU is confirmed by an LL-DATA.confirm primitive.

A (possibly compressed) N-PDU shall be segmented into one or more SN-PDUs. The length of each SN-PDU shall not be greater than N201-I (for acknowledged mode) or N201-U (for unacknowledged mode).

Reference

GSM 04.65, section 6.9.1, 6.7.1.1.

46.2.2.1.1.2 Test purpose

To verify that

- The MS sends the N-PDU number in the first segment of every N-PDU.
- The MS increments the N-PDU number properly.
- The size of a segment must not be greater than N201-I.

46.2.2.1.1.3 Method of test

Initial conditions

-

Related PICS/PIXIT Statement

-

Test procedure

Activation of PDP context 13 is initiated from MS.

Verify that the first segment of the first N-PDU received has N-PDU number 0. Acknowledge all the segments received from the MS. For the subsequent N-PDUs received, verify that the N-PDU number is incremented properly.

Repeat the test case for PDP contexts 11 and 12.

Maximum duration of the test

3 minutes.

Expected sequence

Step	Direction	Message	Comments
1		{PDP Context Activation}	Macro. Initiate PDP context activation from the MS. The PDP context used here is PDP context 13.
2			Initiate data transfer of 5000 octets from the MS .
3	MS -> SS	SN-DATA PDU	Verify that the number of octets in the SN-DATA PDU does not exceed N201-I. Verify that the first SN-DATA PDU received has M=1, T=0, F=1, X = 0, DCOMP = PCOMP = 0, N-PDU number = 0.
4			Verify that the last segment of every N-PDU received has M=0, T=0, and F=0.
5			Verify that for the subsequent N-PDUs, the N-PDU number is incremented properly
6			Repeat step 3 to 5 until 5000 octets are sent.
7			Repeat the test case for SAPIs 3 and 9. The PDP context used for SAPI 3 is PDP Context 11 and the one for SAPI 9 is PDP Context 12.

46.2.2.1.2 Mobile originated normal data transfer with LLC in unacknowledged mode

46.2.2.1.2.1 Conformance requirement

The SNDSCP entity shall initiate unacknowledged data transmission only if the PDP context for the NSAPI identified in the SN-DATA.request has been activated. The SNDSCP entity may initiate unacknowledged data transmission even if the acknowledged peer-to-peer operation is not established for that NSAPI. The N-PDU number in unacknowledged mode is a number assigned to each N-PDU received by SNDSCP through an SN-UNITDATA.request. N-PDU numbers for different NSAPIs shall be assigned independently. The N-PDU number shall be included in the SNDSCP header of every SN-UNITDATA PDU.

A variable, the Send N-PDU number (unacknowledged), shall be maintained for each NSAPI using unacknowledged peer-to-peer LLC operation. When an NSAPI using unacknowledged peer-to-peer LLC operation is activated, the Send N-PDU number (unacknowledged) shall be set to 0. The Send N-PDU number (unacknowledged) shall also be set as described in subclauses 5.1.2.1 and 5.1.2.22. Modulo 4096 operation shall be applied to the Send N-PDU number (unacknowledged).

Upon reception of an SN-UNITDATA request, the SNDSCP entity shall assign the current value of the Send N-PDU number (unacknowledged) as the N-PDU number of the N-PDU received, increment Send N-PDU number (unacknowledged) by 1, compress and segment the information, then forward the SN-PDU(s) in LL-UNITDATA.request to the LLC layer. The N-PDU shall be deleted immediately after the data has been delivered to the LLC layer.

A (possibly compressed) N-PDU shall be segmented into one or more SN-PDUs. The length of each SN-PDU shall not be greater than N201-I (for acknowledged mode) or N201-U (for unacknowledged mode).

The segment number is a sequence number assigned to each SN-UNITDATA PDU. The sequence number shall set to 0 in the first SN-UNITDATA PDU of an N-PDU, and incremented by 1 for each subsequent SN-UNITDATA PDU. Modulo 16 operation is applied. N-PDU number is included in every SN-UNITDATA PDU.

The SNDSCP entity shall perform the mapping function of SN_UNITDATA primitives onto LL_UNITDATA primitives

Reference

GSM 04.65, Section 6.9.2, 6.7.1.1, 6.7.3, 5.2

46.2.2.1.2.2 Test purpose

To verify that

- The MS sends the N-PDU number in every segment of every N-PDU.

- The MS increments the N-PDU number and segment number properly and modulo 16 operation is applied.
- The size of a segment shall not be greater than N201-U.
- The MS maps the SN_UNITDATA PDUs onto SAPs allocated by Network.

46.2.2.1.2.3 Method of test

Initial conditions

-

Related PICS/PIXIT Statement

-

Test procedure

PDP context 10 is initiated from MS.

Initiate unacknowledged data transfer from MS

Verify that the first segment of the first N-PDU received has N-PDU number 0. For the subsequent N-PDUs received, verify that the N-PDU number is incremented properly.

Verify that the SN-UNITDATA PDUs are numbered correctly.

Verify the SAPI number on which the data PDU is received.

Verify that Modulo 16 operation is applied.

Maximum duration of the test

2 minutes.

Expected sequence

Step	Direction	Message	Comments
1		{PDP Context Activation}	Macro. Initiate PDP context activation from the MS. The PDP context used here is PDP context 10.
2			Initiate data transfer of 5000 octets from the MS.
3	MS -> SS	SN-UNITDATA PDU	Verify that the number of octets in the SN-UNITDATA PDU does not exceed N201-U. Verify that the first SN-UNITDATA PDU received has M=1, T=1, F=1, X = 0, DCOMP = PCOMP = 0, N-PDU number = 0, segment = 0.
4	SS		Verify that the segment number is incremented properly for every SN-PDU. Verify that the last segment of every N-PDU received has M=0, T=1, and F=0.
5	SS		Verify that for the subsequent N-PDUs, the N-PDU number is incremented properly and N-PDU number is present in every SN-UNITDATA PDU
6	SS		Verify the SAPI number in the received LLC frame header
7			Repeat steps 3 to 5 until 5000 octets are sent. 3 to 6 for all SN PDUs received. Verify modulo 16 operation is applied for the 17th segment of SN-UNITDATA PDU

46.2.2.1.3 Usage of acknowledged mode for data transmission before and after PDP Context modification, on different SAPIs

46.2.2.1.3.1 Conformance Requirement

Upon reception of the SNSM-MODIFY.indication from the SM sublayer:

- the SNDCP entity shall, if necessary, establish the acknowledged peer-to-peer LLC operation for the indicated SAPI (the establishment criteria and procedure are described in subclause 6.2.1);

the SNDCP entity shall also, if necessary, release the acknowledged peer-to-peer LLC operation for the originally-assigned SAPI (the release criteria and procedure are described in subclause 6.2.2); In addition, if the newly-assigned SAPI is different from the original SAPI:

- LL-DATA.indication, LL-DATA.confirm and LL-UNITDATA.indication received on the old SAPI shall be ignored;
- LL-DATA.request and LL-UNITDATA.request shall be sent on the new SAPI; and
- if acknowledged peer-to-peer LLC operation is used both before and after the receipt of the SNSM-MODIFY.indication, then all buffered N-PDUs (i.e., the ones whose complete reception has not been acknowledged and the ones that have not been transmitted yet) shall be transmitted starting from the oldest N-PDU.

Reference

GSM 04.65, section 5.1.2.23.

46.2.2.1.3.2 Test purpose

To verify that after the PDP context modification,

- the MS resumes acknowledged data transfer correctly with the oldest N-PDU which is buffered after a PDP context modification.

46.2.2.1.3.3 Method of test

Initial conditions

-

Related PICS/PIXIT Statement

-

Test procedure

PDP Context 11 is initiated from MS.

After the first N-PDU is correctly received in acknowledged mode, the last segment of the second N-PDU (N-PDU number=1) is not acked and a PDP context modification is initiated from SS to PDP context 12, ie: using SAPI 9 in acknowledged mode.

After the modification procedure is complete, the first SN-DATA PDU received shall have the N-PDU number 1. The N-PDU received shall be the same as the last one before the modification procedure was triggered.

Maximum duration of the test

2 minutes.

Expected sequence

Step	Direction	Message	Comments
1		{PDP Context Activation}	Macro. Initiate PDP context activation from the MS. Use PDP context 11.
2			Initiate acknowledged data transfer for 5000 octets, from the MS.
3	MS -> SS	SN-DATA PDU	Verify that the number of octets in the SN-DATA PDU does not exceed N201-I. Verify that the first SN-DATA PDU received has M=1, T=0, F=1, X = 0, DCOMP = PCOMP = 0, N-PDU number = 0.
4			Verify that the last segment of the first N-PDU received has M=0, T=0, and F=0.
5			Receive the next N-PDU, N-PDU = 1 by following steps 3 and 4. Do not acknowledge the last segment of the N-PDU.
6		{PDP Context Modification}	Macro. Initiate PDP context modification procedure from the SS. Use PDP context 12 (ie: using SAPI 9 in acknowledged mode)
7	SS->MS	DISC	Initiate the release of LLC link by sending DISC on SAPI 3 and receive UA from MS.
8	MS->SS	UA	
9	SS->MS	SABM	Initiate the establishment of LLC link by sending SABM on SAPI 9 and receive UA from MS.
10	MS->SS	UA	
11	MS -> SS	SN-DATA PDU	Verify that the number of octets in the SN-DATA PDU does not exceed N201-I. Verify that the first SN-DATA PDU received has M=1, T=1, F=1, X = 0, DCOMP = PCOMP = 0, N-PDU number = 0. Verify that the N-PDU received has N-PDU number = 1.
12			Verify that the last segment of every N-PDU received has M=0, T=0, and F=0.
13			Verify that for the subsequent N-PDUs, the N-PDU number is incremented properly
14			Repeat steps 11 to 13 until 5000 octets are sent.

46.2.2.1.4 Reset indication during unacknowledged mode

46.2.2.1.4.1 Conformance Requirement

Upon receipt of the LL-RESET.indication, the SNDSCP layer shall:

- reset all SNDSCP XID parameters to their default values;
- in the MS, for every NSAPI using unacknowledged peer-to-peer LLC operation, set the Send N-PDU number (unacknowledged) to 0

Reference

GSM 04.65, section 5.1.2.1.

46.2.2.1.4.2 Test purpose

To verify that the MS resets the Send N-PDU number to 0 on link reset during an unacknowledged mode data transfer.

46.2.2.1.4.3 Method of test

Initial conditions

-

Related PICS/PIXIT Statement

-

Test procedure

PDP Context 10 is initiated from MS.

An XID command is sent with reset from SS during unacknowledged data transfer, after receiving N-PDU number 5 from MS. The next N-PDU number from MS shall be 0.

Maximum duration of the test

2 minutes.

Expected sequence

Step	Direction	Message	Comments
1		{PDP Context Activation}	Macro. Initiate PDP context activation from the MS. Use PDP context 10.
2			Initiate unacknowledged data transfer for 5000 octets, from the MS.
3	MS -> SS	SN-UNITDATA PDU	Verify that the number of octets in the SN-UNITDATA PDU does not exceed N201-U. Verify that the first SN-UNITDATA PDU received has M=1, T=1, F=1, X = 0, DCOMP = PCOMP = 0, N-PDU number = 0, sequence number = 0.
4			Verify that the last segment of the first N-PDU received has M=0, T=1, and F=0.
5			Receive the N-PDUs from the MS until N-PDU number becomes 5
6	SS->MS	XID	Initiate the XID command from SS with reset
7	MS->SS	XID	XID response
8	MS -> SS	SN-UNITDATA PDU	Verify that the number of octets in the SN-UNITDATA PDU does not exceed N201-U. Verify that the first SN-UNITDATA PDU received after link reset has M=1, T=1, F=1, X = 0, DCOMP = PCOMP = 0, N-PDU number = 0, segment number = 0. Verify that the last segment of every N-PDU received has M=0, T=1, F=0
9			Repeat step 8 until 5000 octets are sent.

46.2.2.1.5 Reset indication during acknowledged mode

46.2.2.1.5.1 Conformance Requirement

Upon receipt of the LL-RESET.indication, the SNDTCP layer shall:

- reset all SNDTCP XID parameters to their default values;
- for every NSAPI using acknowledged peer-to-peer LLC operation, enter the recovery state and suspend the transmission of SN-PDUs until an SNSM-SEQUENCE.indication primitive is received for the NSAPI.

Reference

GSM 04.65, section 5.1.2.1.

46.2.2.1.5.2 Test purpose

To verify that the MS suspends the data transfer in acknowledged mode on link reset and resume when indicated by the SS.

46.2.2.1.5.3 Method of test

Initial conditions

Two cells , cell A and B need to be supported. B is in a routing area (in a new SGSN) and location area different from that of A. The power level of cell A shall be higher than that of cell B so that the MS selects cell A.

Related PICS/PIXIT Statement

-

Test procedure

PDP Context 13 is initiated from MS.

Acknowledge the first 3 N-PDUs received from MS during the data transfer.

Initiate an inter SGSN Routing Area Update procedure from MS.. An XID command is sent with reset from SS, after receiving N-PDU number N from MS. Specify the Receive N-PDU number to be 5 in the Routing Area Update Accept message. Verify that the data transfer is resumed and the MS sends the next N-PDU with N-PDU number 5. The MS shall not send the buffered N-PDU with N-PDU number 4.

Maximum duration of the test

2 minutes.

Expected sequence

Step	Direction	Message	Comments
1		{PDP Context Activation}	Macro. Initiate PDP context activation from the MS. Use PDP context 13.
2			Initiate acknowledged data transfer for 5000 octets, from the MS.
3	MS -> SS	SN-DATA PDU	Verify that the number of octets in the SN-DATA PDU does not exceed N201-I. Verify that the first SN-DATA PDU received has M=1, T=0, F=1, X = 0, DCOMP = PCOMP = 0, N-PDU number = 0.
4			Verify that the last segment of the first N-PDU received has M=0, T=0, and F=0.
5			Receive the N-PDUs from the MS until N-PDU number becomes 3 and acknowledge all the segments completely.
6			Receive the N-PDUs 4 and 5 from the MS and do not acknowledge.
7		{Inter-SGSN Routing Area Update}	Macro. Initiate a cell change requesting the MS to move to cell B. Initiate an inter SGSN Routing Area Update procedure from SS. Send the Receive N-PDU number as 5 in the Routing Area Update Accept message.
8	SS->MS	SABM	
9	MS->SS	UA	
10	MS -> SS	SN-DATA PDU	Verify that the number of octets in the SN-DATA PDU does not exceed N201-I. Verify that the first segment of the SN-DATA PDU received has M=1, T=0, F=1, X = 0, DCOMP = PCOMP = 0, N-PDU number = 5
11			Repeat steps 3 to 5 until 5000 octets are sent.

Note: This test assumes that the LLC layer in the MS has sufficient window size to support two outstanding N-PDUs.

46.2.2.2 Segmentation

46.2.2.2.1 LLC link re-establishment on reception of SN-DATA PDU with F=0 in ack mode in the Receive First Segment state

46.2.2.2.1.1 Conformance Requirement

Receive First Segment state

- If an SN-DATA PDU is received with the F bit set to 0, the SN-DATA PDU shall be discarded, and the acknowledged LLC operation shall be re-established for the SAPI used.

Reference

GSM 04.65, section 6.7.4.1.

46.2.2.2.1.2 Test purpose

To verify that the MS re-establishes the LLC SAPI on reception of an SN-DATA PDU with F=0 as the first segment in the acknowledged mode data transfer

46.2.2.2.1.3 Method of test

Initial conditions

-

Related PICS/PIXIT Statement

-

Test procedure

PDP Context 13 is initiated from MS.

An acknowledged mode data transfer is started from SS with the first SN_DATA PDU with F=0.

Verify that the MS shall re-establish the LLC SAPI 11.

Maximum duration of the test

2 minutes.

Expected sequence

Step	Direction	Message	Comments
1		{PDP Context Activation}	Macro. Initiate PDP context activation from the MS. Use PDP context 13.
2			Initiate acknowledged data transfer for 5000 octets, from the SS.
3	SS -> MS	SN-DATA PDU	Send the first SN-DATA PDU with M=1, T=0, F=0, X = 0, DCOMP = PCOMP = 0, N-PDU number = 0 .
4	MS->SS	SABM	MS re-establishes the LLC SAPI 11
5	SS->MS	UA	
6	SS -> MS	SN-DATA PDU	Send the first SN-DATA PDU with M=1, T=0, F=1, X = 0, DCOMP = PCOMP = 0, N-PDU number = 0
7			Repeat step 6 until 5000 octets are sent. Verify that all SN-DATA PDUs are acknowledged.

46.2.2.2.2 LLC link re-establishment on receiving second segment with F=1 and with different PCOMP and DCOMP values in the acknowledged mode data transfer

46.2.2.2.2.1 Conformance Requirement

Receive Subsequent Segment state

- If an SN-DATA PDU is received with the F bit set to 1, and if DCOMP, PCOMP or N-PDU number is different from those in the first segment, then the SN-DATA PDU and all previous segments belonging to the same N-PDU shall be discarded, and the acknowledged LLC operation shall be re-established for the SAPI used..

Reference

GSM 04.65, section 6.7.4.2.

46.2.2.2.2.2 Test purpose

To verify that the MS re-establishes the LLC SAPI on reception of the second SN-DATA PDU with F=1 and with PCOMP and DCOMP values different from those of the previous segment, in the second segment in acknowledged mode data transfer.

46.2.2.2.2.3 Method of test

Initial conditions

-

Related PICS/PIXIT Statement

Test procedure

PDP Context 13 is initiated from MS.

AN acknowledged mode data transfer is started from SS with the first SN_DATA PDU with F=1. Send the second SN-DATA PDU from SS with F=1 and with PCOMP and DCOMP values different from those in the first segment.

Verify that the MS shall re-establish the LLC SAPI 11.

Maximum duration of the test

2 minutes.

Expected sequence

Step	Direction	Message	Comments
1		{PDP Context Activation}	Macro. Initiate PDP context activation from the MS. Use PDP context 13.
2			Initiate acknowledged data transfer for 5000 octets, from the SS.
3	SS -> MS	SN-DATA PDU	Send the first SN-DATA PDU with M=1, T=0, F=1, X = 0, DCOMP = PCOMP = 0, N-PDU number = 0.
4	SS->MS	SN-DATA PDU	Send the second SN-DATA PDU with M=1, T=0, F=1, X = 0, DCOMP = PCOMP = 1, N-PDU number = 0.
5	MS->SS	SABM	Re-establishment of LLC link on SAPI 11.
6	SS->MS	UA	
7	SS -> MS	SN-DATA PDU	Send the first SN-DATA PDU with M=1, T=0, F=1, X = 0, DCOMP = PCOMP = 0, N-PDU number = 0
8			Repeat step 7 until 5000 octets are sent. Verify that all SN-DATA PDUs are acknowledged.

46.2.2.2.3 Single segment N-PDU from MS

46.2.2.2.3.1 Conformance Requirement

- The F bit in the SNDCP header shall be set to 1 for the first segment, and 0 for all subsequent segments. For unacknowledged peer-to-peer LLC operation, DCOMP and PCOMP shall be included in the header when the F bit is set to 1, and shall not be included when the F bit is set to 0. For acknowledged peer-to-peer LLC operation, DCOMP, PCOMP and N-PDU number shall be included in the header when the F bit is set to 1, and shall not be included when the F bit is set to 0.
- The M bit in the SNDCP header shall be set to 0 for the last segment, and 1 for all previous segments. If only one SN-PDU is generated for an N-PDU, the F bit shall be set to 1 and the M bit set to 0.

Reference

GSM 04.65, section 6.7.1.1.

46.2.2.2.3.2 Test purpose

To verify that for a single segment N-PDU, the MS shall send the SN_UNITDATA PDU with F=1 and M=0 during unacknowledged data transfer

46.2.2.2.3.3 Method of test

Initial conditions

-

Related PICS/PIXIT Statement

-

Test procedure

PDP Context 10 is initiated from MS.

An unacknowledged mode data transfer is started from MS for a data size less than N201-U. Verify that the MS sends the SN-UNITDATA PDU with M=0 and F=1.

Maximum duration of the test

2 minutes.

Expected sequence

Step	Direction	Message	Comments
1		{PDP Context Activation}	Macro. Initiate PDP context activation from the MS. Use PDP context 10.
2			Initiate unacknowledged data transfer for 1 octet, from the MS.
3	MS -> SS	SN-UNITDATA PDU	Verify that the single SN-UNITDATA PDU is received with M=0 and F=1.

46.2.2.3 Link Release

46.2.2.3.1 LLC link release on receiving DM from the SS during link establishment

46.2.2.3.1.1 Conformance Requirement

If the originator of the establishment procedure receives an LL-RELEASE.indication with Cause "DM received", it shall inform the SM sub-layer using the SNSM-STATUS.request primitive with Cause "DM received". SM shall then deactivate all PDP contexts for that SAPI requiring acknowledged peer-to-peer LLC operation.

Reference

GSM 04.65, section 6.2.1.4.

46.2.2.3.1.2 Test purpose

To verify that in MS, the LLC SAPI is released and the PDP context is deactivated on reception of DM response from SS during link establishment.

46.2.2.3.1.3 Method of test

Initial conditions

-

Related PICS/PIXIT Statement

-

Test procedure

PDP Context 13 is initiated from MS.

A DM response is sent from SS, after receiving a SABM from the MS for link establishment. The MS shall release the LLC SAPI 11 and the PDP context for the NSAPI shall be deactivated.

Maximum duration of the test

2 minutes.

Expected sequence

Step	Direction	Message	Comments
1		{PDP Context Activation}	Macro. Initiate PDP context activation from the MS. Use PDP context 13.
2	MS -> SS	SABM	SABM sent for link establishment during PDP context activation
3	SS->MS	DM	Initiate a DM response with F=1 from the SS.
4			Verify that the MS initiates PDP Context Deactivation.

46.2.2.4 XID negotiation

46.2.2.4.1 Response from MS on receiving XID request from the SS

46.2.2.4.1.1 Conformance Requirement

The XID negotiation is a one-step procedure; i.e., the initiating end proposes parameter values, and the responding end either accepts these or offers different values in their place according to the XID negotiation rules described in the

present document; the rules limit the range of parameter values as well as the sense of negotiation. The initiating end accepts (or rejects) the values in the response; this concludes the negotiation.

A bit set to 0 means that the compression entity is not applicable to the corresponding NSAPI. A bit set to 1 means that the compression entity is applicable to the corresponding NSAPI.

Reference

GSM 04.65, section 6.8.1

46.2.2.4.1.2 Test purpose

To verify that

- the MS which does not support compression, responds with applicable NSAPI field with 0 for an XID request from the SS with some compression entity.
- The MS which supports compression responds with the applicable NSAPI field set to 1 for an XID request from the SS with some compression entity.

46.2.2.4.1.3 Method of test

Initial conditions

-

Related PICS/PIXIT Statement

MS supporting compression has compression turned on.

Test procedure

PDP Context 9 is initiated from MS. The MS supporting compression will also trigger an XID negotiation. Modify the PDP Context to PDP Context 14 from the SS.

After PDP context modification, trigger compression by sending an XID Request from SS including a L3-parameter with some compression entity for the NSAPI assigned for the PDP context.

The MS which does not support compression or has a lack of resources shall respond with XID response setting the applicable NSAPI field set to 0, indicating that compression is not supported/wanted.

The MS which support compression and has compression turned on shall respond with XID response setting the applicable NSAPI field set to 1, indicating that compression is supported.

Maximum duration of the test

2 minutes.

Expected sequence

Step	Direction	Message	Comments
1		{PDP Context Activation}	Macro. Initiate PDP context activation from the MS. Use PDP context 9. The MS supporting compression will also trigger an XID negotiation.
2		{PDP Context Modification}	Macro. Initiate PDP Context Modification from the SS. The new context is PDP Context 14.
3	SS -> MS	XID Request	In the layer3 XID parameters, send a PCOMP entity with parameter type = 1 and algorithm type = 0. In the applicable NSAPI field, set the bit for the NSAPI assigned for the PDP context.
A4	MS -> SS	XID Response	Verify that the MS which does not support compression, has compression turned off or has a lack of resources responds with the assigned NSAPI field set to 0.
B4	MS -> SS	XID Response	Verify that the MS which supports compression and has compression turned on responds with the assigned NSAPI field set to 1.
5			Initiate acknowledged data transfer for 5000 octets, from the MS.
6	MS -> SS	SN-DATA PDU	Verify that the number of octets in the SN-DATA PDU does not exceed N201-I.
A7			For mobiles which do not support compression, verify that the first SN-DATA PDU received has M=1, T=0, F=1, X = 0, DCOMP = PCOMP = 0, N-PDU number = 0.
B7			For mobiles which support compression, verify that the first SN-DATA PDU received has M=1, T=0, F=1, X = 0, DCOMP = the negotiated value, PCOMP = the negotiated value, N-PDU number = 0.
8			Verify that the last segment of the first N-PDU received has M=0, T=0, and F=0.
9			Verify that for the subsequent N-PDUs, the N-PDU number is incremented properly
10			Repeat step 6 to 9 until 5000 octets are sent.

46.2.2.4.2 Response from MS on receiving an XID request from the SS with an unassigned entity number

46.2.2.4.2.1 Conformance Requirement

In the originating SNDCP XID block, if an unassigned entity number is included with the P bit set to 0, then the Applicable NSAPIs field in the response shall be set to 0.

Reference

GSM 04.65, section 6.8.3

46.2.2.4.2.2 Test purpose

To verify that in the originating SNDCP XID block, if an unassigned entity number is included with the P bit set to 0, the Applicable NSAPIs field in the response shall be set to 0.

46.2.2.4.2.3 Method of test

Initial conditions

-

Related PICS/PIXIT Statement

-

Test procedure

PDP Context 11 is initiated from MS.

Send an XID command from the SS with P bit set to 0, with an unassigned entity number.

The MS shall respond with XID response setting the applicable NSAPI field set to 0, indicating that compression is not supported.

Maximum duration of the test

2 minutes.

Expected sequence

Step	Direction	Message	Comments
1		{PDP Context Activation}	Macro. Initiate PDP context activation from the MS. Use PDP context 11.
2	SS -> MS	XID	In the layer3 XID parameters, send a PCOMP entity with parameter type = 1 and algorithm type = 0. Set the P bit to 0 and the entity number to a number not assigned.
3	MS -> SS	XID	Verify that the MS responds with the assigned NSAPI field set to 0.

46.2.2.4.3 Response from MS on receiving an XID response from the SS with unrecognised type field

46.2.2.4.2.1 Conformance Requirement

If the responding SNDCP XID block includes a parameter with unrecognised Type field, unsupported length, an out-of-range value or a value violating the sense of negotiation, a parameter type 1 or 2 which violates the rules in subclause 6.8.1, a parameter with duplicated instances, contains prohibited changes (see subclauses 6.5.1.2 and 6.6.1.2) to the parameters of compression entities used with acknowledged peer-to-peer LLC operation when the SNDCP XID block is sent on LL-XID primitives, or a compression field with the P bit set to 1, then the originator shall ignore the block and reinitiate the negotiation.

Reference

GSM 04.65, section 6.8.3

46.2.2.4.1.2 Test purpose

To verify that in the XID response, if an unrecognised type field is specified, the originator shall ignore the block and reinitiate XID negotiation.

46.2.2.4.1.3 Method of test

Initial conditions

-

Related PICS/PIXIT Statement

-

Test procedure

PDP Context 11 is initiated from MS.

In the response to SABM, in the UA, send parameter type = 30.

The MS shall resend the SABM command.

Maximum duration of the test

2 minutes.

Expected sequence

Step	Direction	Message	Comments
1		{PDP Context Activation}	Macro. Initiate PDP context activation from the MS. Use PDP context 11.
2	MS -> SS	SABM	
3	SS -> MS	UA	Include a layer3 XID parameter with parameter type = 30.
4	MS -> SS	SABM	Verify that the MS resends SABM.

46.2.2.5 LLC link release on receiving "Invalid XID response" from the network during link establishment procedure

46.2.2.5.1 Conformance Requirement

If the originator of the establishment procedure receives an LL-RELEASE.indication with Cause "Invalid XID response", it shall inform the SM sub-layer using the SNSM-STATUS.request primitive with Cause "Invalid XID response". SM shall then deactivate all PDP contexts for that SAPI.

Reference

GSM 04.65, section 6.2.1.4.

GSM 04.64, section 8.5.5.3

46.2.2.5.2 Test purpose

To verify that in the MS, the PDP context is deactivated on reception of "Invalid XID response" from network during link establishment.

46.2.2.5.3 Method of test

Initial conditions

-

Related PICS/PIXIT Statement

-

Test procedure

Activation of PDP Context 13 is initiated from MS.

The MS sends a SABM from the MS for link establishment.

The SS responds to the SABM with a UA with Invalid XID information field.

The MS shall ignore this response and re-transmit the SABM N200 times.

The SS shall respond with the UA with Invalid XID information, N200 times.

Verify that the MS releases the LLC SAPI and the PDP context for the SAPI is deactivated.

Maximum duration of the test

3 minutes.

Expected sequence

Step	Direction	Message	Comments
1		{PDP Context Activation}	Macro. Initiate PDP context activation from the MS. Use PDP context 13.
2	MS -> SS	SABM	SABM sent for link establishment during PDP context activation
3	SS->MS	UA	In response to the SABM , SS sends UA with an Invalid XID information field . MS shall ignore this response and Re-transmit the SABM N200 times.
4			Repeat steps 2 and 3 N200 times . (Send UA with Invalid XID parameters in response to SABM received every T200 seconds N200 times.)
5		{PDP Context De-Activation}	Verify that the MS initiates PDP Context Deactivation.

50 EGPRS Default Conditions

51 EGPRS Paging, TBF establishment/release and DCCH related procedures

52 EGPRS Test of Medium Access Control (MAC) protocol

53 EGPRS RLC Test Cases

60. Inter-system hard handover from GSM to UTRAN

Clause 60 contains test procedures to be used for executing Inter-system Handover from GSM to UTRAN tests. Table 60-1 contains a summary of the different combinations of parameters being tested, together with a reference to the appropriate generic test procedure. If a test uses a parameter which the MS under test does not support, the test shall be skipped. Test cases in this clause are applicable only to the MS supporting both UTRAN and GSM. The test USIM shall support service 27 to carry out these test cases.

Table 60-1

From	To	State of call	Ref. clause	Exec counter	Remark
GSM FR	UTRAN AMR (conversational/speech/ UL:12.2 DL:12.2 kbps/CS RAB + UL:3.4 DL3.4 kbps SRBS)	U10	60.1	1	call active state
GSM EFR	UTRAN AMR (conversational/speech/ UL:12.2 DL:12.2 kbps/CS RAB + UL:3.4 DL3.4 kbps SRBS)	U10	60.1	2	call active state
GSM AMR	UTRAN AMR (conversational/speech/ UL:12.2 DL:12.2 kbps/CS RAB + UL:3.4 DL3.4 kbps SRBS)	U10	60.1	3	call active state
GSM HR	UTRAN AMR (conversational/speech/ UL:12.2 DL:12.2 kbps/CS RAB + UL:3.4 DL3.4 kbps SRBS)	U10	60.1	4	call active state
GSM 14.4 kbps CS data	UTRAN (Streaming/unknown/ UL:14.4 DL:14.4 kbps/CS RAB + UL:3.4 DL:3.4 kbps SRBS)	U10	60.2	1	same data rate
GSM 28.8 kbps CS data	UTRAN (Streaming/unknown/ UL:28.8 DL:28.8 kbps/CS RAB + UL:3.4 DL:3.4 kbps SRBS)	U10	60.2	2	same data rate
GSM 57.6 kbps CS data	UTRAN (Streaming/unknown/ UL:57.6 DL:57.6 kbps/CS RAB + UL:3.4 DL:3.4 kbps SRBS)	U10	60.2	3	same data rate
GSM 14.4 kbps CS data	UTRAN (Streaming/unknown/ UL:28.8 DL:28.8 kbps/CS RAB + UL:3.4 DL:3.4 kbps SRBS)	U10	60.3	1	data rate upgrading
GSM 14.4 kbps CS data	UTRAN (Streaming/unknown/ UL:57.6 DL:57.6 kbps/CS RAB + UL:3.4 DL:3.4 kbps SRBS)	U10	60.3	2	data rate upgrading
GSM 28.8 kbps CS data	UTRAN (Streaming/unknown/ UL:57.6 DL:57.6 kbps/CS RAB + UL:3.4 DL:3.4 kbps SRBS)	U10	60.3	3	data rate upgrading
GSM FR	UTRAN AMR (conversational/speech/ UL:12.2 DL:12.2 kbps/CS RAB + UL:3.4 DL3.4 kbps SRBS)	U1	60.4	1	during call establishment
GSM FR	UTRAN AMR (conversational/speech/ UL:12.2 DL:12.2 kbps/CS RAB + UL:3.4 DL3.4 kbps SRBS)	U10	60.5	1	blind handover
GSM FR	UTRAN AMR (conversational/speech/ UL:12.2 DL:12.2 kbps/CS RAB + UL:3.4 DL3.4 kbps SRBS)	U10	60.6	1	failure case

60.1 Inter system handover to UTRAN/From GSM/Speech/Success

60.1.1 Definition

60.1.2 Conformance requirement

The MS shall be able to receive a HANOVER TO UTRAN COMMAND message from GSM and perform an inter-system handover, even if no prior MS measurements have been performed on the target UTRAN cell and/or frequency.

If the MS succeeds to establish the connection to UTRAN, it shall transmit a HANOVER TO UTRAN COMPLETE message on the uplink DCCH.

Reference(s)

TS 25.331 Clause 8.3.6.

TS 04.18 Clause 3.4.4a.

60.1.3 Test purpose

To test that MS supporting both GSM and UTRAN handovers to the indicated channel in the UTRAN target cell when it is in the speech call active state in the GSM serving cell and receives a HANOVER TO UTRAN COMMAND.

60.1.4 Method of test

Initial conditions

System Simulator: 2 cells - Cell 1 is GSM, Cell 2 is UTRAN. GSM 11.10-1 section 26.6.5.1 shall be referenced for the default parameters of cell 1.

MS: CC State U10 in cell 1

Related ICS/IXIT statement(s)

MS supports both GSM and UTRAN Radio Access Technologies,

MS supports UTRAN AMR,

MS supports GSM ARM,

MS supports GSM EFR,

MS supports GSM HR,

MS supports GSM-P, GSM-E, GSM-DCS, GSM-450, GSM-480.

Foreseen final state of the MS

The MS is in CC state U10 on cell 2.

Test Procedure

The SS starts the GSM cell and UTRAN cell with cell selection conditions in favour of GSM cell, the MS selects the GSM cell for camping on. In UTRAN cell SIB16 is broadcast and contains the pre-configuration for conversational/speech/UL:12.2 DL:12.2 kbps/CS RAB + UL:3.4 DL3.4 kbps SRBS. After MS received and stored the SIB16, the SS brings the MS into the call active state (CC state U10) with FR speech call (for execution counter M = 1). The SS configures the dedicated channel corresponding to the pre-configuration in UTRAN cell, then sends HANOVER TO UTRAN COMMAND indicating the dedicated channel of the target cell to the MS through the GSM serving cell. After the MS receives the command it shall configure itself accordingly and switch to the dedicated

channel of UTRAN cell. The SS checks whether the handover is performed by checking that the MS transmits **HANDOVER TO UTRAN COMPLETE** to the SS through DCCH of the UTRAN cell.

Depending on the PIXIT parameters, the above procedure is executed maximum four times, each time for different initial conditions:

- If the MS supports GSM FR, the procedure is executed for execution counter $M = 1$;
- If the MS supports GSM EFR, the procedure is executed for execution counter $M = 2$;
- If the MS supports GSM AMR, the procedure is executed for execution counter $M = 3$;
- If the MS supports GSM HR, the procedure is executed for execution counter $M = 4$.

Expected sequence

This sequence is performed for a maximum execution counter $M = 1, 2, 3, 4$, depending on the PIXIT parameters.

Step	Direction		Message	Comments
	MS	SS		
1		SS		The SS configures GSM and UTRAN cells, MS camps on GSM cell and received SIB16 from UTRAN cell.
2		MS		The SS bring the MS into GSM U10 state in cell 1 and for $M = 1$: the MS is in GSM FR speech call; for $M = 2$: the MS is in GSM EFR speech call; for $M = 3$: the MS is in GSM AMR speech call; for $M = 4$: the MS is in GSM HR speech call.
3		SS		The SS configures the dedicated channel with the configuration: conversational/speech/UL:12.2 DL:12.2 kbps/CS RAB + UL:3.4 DL3.4 kbps SRBs in UTRAN cell.
4		←	HANDOVER TO UTRAN COMMAND	Send on cell 1 (GSM cell)
5		MS		The MS accepts the handover command and configures its lower layers using the parameters contained in the HANDOVER TO UTRAN COMMAND
6		SS		The SS waits for uplink physical channel in synchronization
7		→	HANDOVER TO UTRAN COMPLETE	The SS receives this message on DCCH of cell 2 (UTRAN cell). It implies that the down link physical channel has synchronised with UTRAN.

Specific message contents

Content of "SysInfoType16"

Information Element	Value/remark
re-EstablishmentTimer T315	30 s
PredefinedRB_Configuration	
- SRB information list	
- RB identity	1
- CHOICE RLC info choice	RLC info
- CHOICE UL RLC mode	UM RLC mode
- Transmission RLC discard	MaxDAT retransmissions
- Max_DAT	4
- Timer_MRW	100
- MaxMRW	4
- CHOICE DL RLC mode	UM RLC mode
- RB mapping info	
- CHOICE UL logical channel mappings	One logical channel
- UL transport channel type	DCH
- Transport channel identity	1
- Logical channel identity	1
- MAC logical channel priority	1
- Logical channel max loss	0
- DL logical channel mapping	
- DL transport channel type	DCH
- Transport channel identity	1
- Logical channel identity	1
- RB identity	2
- CHOICE RLC info choice	RLC info
- CHOICE UL RLC mode	AM RLC mode
- Transmission RLC discard	MaxDAT retransmissions
- Max_DAT	4
- Timer_MRW	100
- MaxMRW	4
- transmission window size	8
- Timer_RST	500
- MAX_RST	4
- Polling info	
- Timer_poll_prohibit	200
- Timer_poll	200
- Poll_SDU	1
- Last transmission PU poll	TRUE
- Last retransmission PU poll	TRUE
- Poll windows	99
- CHOICE DL RLC mode	AM RLC mode
- In-sequence delivery	TRUE
- Receiving window size	8
- Downlink RLC status info	
- Timer_status_prohibit	200
- Timer_EPC	200
- Missing PU indicator	TRUE
- RB mapping info	
- CHOICE UL logical channel mappings	One logical channel
- UL transport channel type	DCH
- Transport channel identity	1
- Logical channel identity	2
- MAC logical channel priority	2
- Logical channel max loss	0
- DL logical channel mapping	
- DL transport channel type	DCH
- Transport channel identity	1
- Logical channel identity	2
- RB identity	3
- CHOICE RLC info choice	RLC info
- CHOICE UL RLC mode	AM RLC mode
- Transmission RLC discard	MaxDAT retransmissions
- Max_DAT	4
- Timer_MRW	100

- MaxMRW	4
- transmission window size	8
- Timer_RST	500
- MAX_RST	4
- Polling info	
- Timer_poll_prohibit	200
- Timer_poll	200
- Poll_SDU	1
- Last transmission PU poll	TRUE
- Last retransmission PU poll	TRUE
- Poll windows	99
- CHOICE DL RLC mode	AM RLC mode
- In-sequence delivery	TRUE
- Receiving window size	8
- Downlink RLC status info	
- Timer_status_prohibit	200
- Timer_EPC	200
- Missing PU indicator	TRUE
- RB mapping info	
- CHOICE UL logical channel mappings	One logical channel
- UL transport channel type	DCH
- Transport channel identity	1
- Logical channel identity	3
- MAC logical channel priority	3
- Logical channel max loss	0
- DL logical channel mapping	
- DL transport channel type	DCH
- Transport channel identity	1
- Logical channel identity	3
- RB identity	4
- CHOICE RLC info choice	RLC info
- CHOICE UL RLC mode	AM RLC mode
- Transmission RLC discard	MaxDAT retransmissions
- Max_DAT	4
- Timer_MRW	100
- MaxMRW	4
- transmission window size	8
- Timer_RST	500
- MAX_RST	4
- Polling info	
- Timer_poll_prohibit	200
- Timer_poll	200
- Poll_SDU	1
- Last transmission PU poll	TRUE
- Last retransmission PU poll	TRUE
- Poll windows	99
- CHOICE DL RLC mode	AM RLC mode
- In-sequence delivery	TRUE
- Receiving window size	8
- Downlink RLC status info	
- Timer_status_prohibit	200
- Timer_EPC	200
- Missing PU indicator	TRUE
- RB mapping info	
- CHOICE UL logical channel mappings	One logical channel
- UL transport channel type	DCH
- Transport channel identity	1
- Logical channel identity	4
- MAC logical channel priority	4
- Logical channel max loss	0
- DL logical channel mapping	
- DL transport channel type	DCH
- Transport channel identity	1
- Logical channel identity	4
- RB information list	
- RB information to setup	
- RB identity	10
- PDCP info	Not Present
- RLC info	

- CHOICE Uplink RLC mode	TM RLC mode
- Transmission RLC discard	Not Present
- Segmentation indication	TRUE
- CHOICE Downlink RLC mode	TM RLC mode
- Segmentation indication	TRUE
- RB mapping info	
- CHOICE UL logical channel mappings	One logical channel
- Uplink transport channel type	DCH
- Transport channel identity	2
- Logical channel identity	1
- MAC logical channel priority	1
- Logical channel max loss	0
- DL logical channel mapping	1
- Downlink transport channel type	DCH
- Transport channel identity	2
- Logical channel identity	1
- RB information to setup	
- RB identity	11
- PDCP info	Not Present
- RLC info	
- CHOICE Uplink RLC mode	TM RLC mode
- Transmission RLC discard	Not Present
- Segmentation indication	TRUE
- CHOICE Downlink RLC mode	TM RLC mode
- Segmentation indication	TRUE
- RB mapping info	
- CHOICE UL logical channel mappings	One logical channel
- Uplink transport channel type	DCH
- Transport channel identity	3
- Logical channel identity	1
- MAC logical channel priority	1
- Logical channel max loss	0
- DL logical channel mapping	1
- Downlink transport channel type	DCH
- Transport channel identity	3
- Logical channel identity	1
- RB information to setup	
- RB identity	12
- PDCP info	Not Present
- RLC info	
- CHOICE Uplink RLC mode	TM RLC mode
- Transmission RLC discard	Not Present
- Segmentation indication	TRUE
- CHOICE Downlink RLC mode	TM RLC mode
- Segmentation indication	TRUE
- RB mapping info	
- CHOICE UL logical channel mappings	One logical channel
- Uplink transport channel type	DCH
- Transport channel identity	4
- Logical channel identity	1
- MAC logical channel priority	1
- Logical channel max loss	0
- DL logical channel mapping	1
- Downlink transport channel type	DCH
- Transport channel identity	4
- Logical channel identity	1
preDefTransChConfiguration	
- UL Common Transport channel Info	
- TFC subset	
- Allowed Transport Format combination	0, 1, 2, 3, 4, 5
- CHOICE Mode specific info	FDD
- CHOICE UL DCH TFCS	Normal signalling
- CHOICE Normal signalling	Addition
- CHOICE CTFC Size	6 bits
- CTFC information	0
- Power offset information	
- CHOICE Gain Factors	Signalled Gain Factor
- Gain factor β_c	0

- Gain factor β_d	0
- Reference TFC ID	Not Present
- Power offset Pp-m	0dB
- CTFC information	1
- Power offset information	
- CHOICE Gain Factors	Signalled Gain Factor
- Gain factor β_c	0
- Gain factor β_d	0
- Reference TFC ID	Not Present
- Power offset Pp-m	0dB
- CTFC information	11
- Power offset information	
- CHOICE Gain Factors	Signalled Gain Factor
- Gain factor β_c	0
- Gain factor β_d	0
- Reference TFC ID	Not Present
- Power offset Pp-m	0dB
- CTFC information	12
- Power offset information	
- CHOICE Gain Factors	Signalled Gain Factor
- Gain factor β_c	0
- Gain factor β_d	0
- Reference TFC ID	Not Present
- Power offset Pp-m	0dB
- CTFC information	13
- Power offset information	
- CHOICE Gain Factors	Signalled Gain Factor
- Gain factor β_c	0
- Gain factor β_d	0
- Reference TFC ID	Not Present
- Power offset Pp-m	0dB
- CTFC information	23
- Power offset information	
- CHOICE Gain Factors	Signalled Gain Factor
- Gain factor β_c	0
- Gain factor β_d	0
- Reference TFC ID	Not Present
- Power offset Pp-m	0dB
- UL Add or reconfigured transport channel info list	
- Transport channel identity	2
- TFS	
- Dynamic Transport format information	
- Number of Transport blocks	0
- RLC size	81
- Dynamic Transport format information	
- Number of Transport blocks	1
- RLC size	39
- Dynamic Transport format information	
- Number of Transport blocks	1
- RLC size	81
- Semi-static Transport Format information	
- Transmission time interval	20 ms
- Type of channel coding	convolutional
- Coding Rate	1/3
- Rate matching attribute	180-220
- CRC size	12 bits
- Transport channel identity	3
- TFS	
- Dynamic Transport format information	
- Number of Transport blocks	0
- RLC size	103
- Dynamic Transport format information	
- Number of Transport blocks	1
- RLC size	103
- Semi-static Transport Format information	
- Transmission time interval	20 ms
- Type of channel coding	convolutional
- Coding Rate	1/3

- Rate matching attribute	170-210
- CRC size	N/A
- Transport channel identity	4
- TFS	
- Dynamic Transport format information	
- Number of Transport blocks	0
- RLC size	60
- Dynamic Transport format information	
- Number of Transport blocks	1
- RLC size	60
- Semi-static Transport Format information	
- Transmission time interval	20 ms
- Type of channel coding	convolutional
- Coding Rate	1/2
- Rate matching attribute	215-256
- CRC size	N/A
- Transport channel identity	1
- TFS	
- Dynamic Transport format information	
- Number of Transport blocks	0
- RLC size	148
- Dynamic Transport format information	
- Number of Transport blocks	1
- RLC size	148
- Semi-static Transport Format information	
- Transmission time interval	40 ms
- Type of channel coding	convolutional
- Coding Rate	1/3
- Rate matching attribute	155-165
- CRC size	16 bits
- DL Common transport channel info	
- SCCPCH TFCS	Not Present
- CHOICE Mode specific info	FDD
- CHOICE TFCS Signalling mode	Same as UL
- Added or reconfigured DL TrCH info list	
- Transport channel identity	2
- CHOICE TFS signalling mode	SameAsUL
- UL TrCH Identity	2
- DCH quality target	
- BLER Quality value	0
- Transparent mode signalling info	Not Present
- Added or reconfigured DL TrCH info list	
- Transport channel identity	3
- CHOICE TFS signalling mode	SameAsUL
- UL TrCH Identity	3
- DCH quality target	
- BLER Quality value	0
- Transparent mode signalling info	Not Present
- Added or reconfigured DL TrCH info list	
- Transport channel identity	4
- CHOICE TFS signalling mode	SameAsUL
- UL TrCH Identity	4
- DCH quality target	
- BLER Quality value	0
- Transparent mode signalling info	Not Present
PreDefPhyChConfiguration	
-UL_DPCH_InfoPredef	
- UL DPCH Info	
- Uplink DPCH power control info	
- DPCCH power offset	-6dB
- PC Preamble	15 slots
- CHOICE Mode specific info	FDD
- TFCI existence	TRUE
- Puncturing Limit	0.88
- DL_ CommonInformationPredef	
- DL_DPCH_InfoCommon	
- Timing indication	initialize
- CHOICE Mode specific info	FDD
- Spreading factor and pilot	128

- Number of bits for Pilot bits	4 bits
- Fixed or Flexible Position	Fixed
- TFCI existence	FALSE
- Downlink DPCH Offset Value	0

HANDOVER TO UTRAN COMMAND

Information Element	Value/remark
RR management Protocol Discriminator	'0110'B
Skip Indicator	'0000'B
Inter System to UTRAN Handover Command Message Type	'01100011'B
Handover to UTRAN Command IEI	TBD
Length of Handover to UTRAN Command contents	Octet length of the "Handover to UTRAN Command value part"
Handover to UTRAN Command value part	PER encoded ASN.1 value of type "HandoverToUTRANCommand-v1-IEs", the content is presented in the next table.

Content of "HandoverToUTRANCommand-v1-IEs"

Information Element	Value/remark
New U-RNTI	'000000000001'B
- SRNC Identiy	1
- S-RNTI-2	now
Activation time	Standard UMTS Encryption Algorithm UEA1
Ciphering algorithm	
RAB Info	
- RAB identity	'00000001'B
- GSM-MAP RAB identity	CS domain
- CN domain identity	Preconfiguration
CHOICE Specification mode	1
- Predefined configuration identity	FDD
- CHOICE Mode specific info	
- UL DPCH info	
- UL DPCH power control info	1
- Power control algorithm1	long
- Scrambling code type	0
- Reduced scrambling code number	128
- Spreading factor	
- DL common information post	
- DL DPCH info common	initialize
- Timing indication	Not present
- CFN target SFN frame offset	
- DL DPCH power control info	FDD
- CHOICE Mode specific info	Single TPC
- DPC mode	
- DL information perRL list	
- Primary CPICH info	
- Primary scrambling code	100
- DL DPCH info perRL	
- pCPICH usage for channelEst	May be used
- DL channelisation code	
- Secondary scrambling code	1
- SF and code number	SF = 128, code number = 127
- Scrambling code change	No code change
- TPC combination index	0
- Frequency info	
- UARFCN uplink(Nu)	See PIXIT
- UARFCN downlink(Nd)	See PIXIT
Maximum allowed UL TX power	33dBm

60.1.5 Test requirement

After step 7 the ongoing call shall be continued on UTRAN cell.

60.2 Inter system handover to UTRAN/From GSM/Data/Same data rate/Success

60.2.1 Definition

60.2.2 Conformance requirement

The MS shall be able to receive a HANOVER TO UTRAN COMMAND message from GSM and perform an inter-system handover, even if no prior MS measurements have been performed on the target UTRAN cell and/or frequency.

If the MS succeeds to establish the connection to UTRAN, it shall transmit a HANOVER TO UTRAN COMPLETE message on the uplink DCCH.

Reference(s)

TS 25.331 Clause 8.3.6.

TS 04.18 Clause 3.4.4a.

60.2.3 Test purpose

To test that the MS handovers to the indicated UTRAN target cell and the data rate of the target channel is the same as the old channel when it is in the data call active state in the GSM serving cell and receives a HANOVER TO UTRAN COMMAND.

60.2.4 Method of test

Initial conditions

System Simulator: 2 cells - Cell 1 is GSM, Cell 2 is UTRAN. GSM 11.10-1 section 26.6.5.1 or section 26.13.1.3 (for HSCSD) shall be referenced for the default parameters of cell 1.

MS: CC State U10 in cell 1

Related ICS/IXIT statement(s)

MS supports both GSM and UTRAN Radio Access Technologies,

MS supports UTRAN Streaming/unknown/UL:14.4 DL:14.4 kbps/CS RAB + UL:3.4 DL:3.4 kbps SRBs,

MS supports UTRAN Streaming/unknown/UL:28.8 DL:28.8 kbps/CS RAB + UL:3.4 DL:3.4 kbps SRBs,

MS supports UTRAN Streaming/unknown/UL:57.6 DL:57.6 kbps/CS RAB + UL:3.4 DL:3.4 kbps SRBs,

MS supports GSM 14.4 kbps data (HSCSD or full rate traffic channel for 14.4 kbit/s user data (TCH/F14.4)),

MS supports GSM 28.8 kbps data (HSCSD or full rate traffic channel for 28.8 kbit/s user data (E-TCH/F28.8)),

MS supports GSM 57.6 kbps data,

MS supports GSM-P, GSM-E, GSM-DCS, GSM-450, GSM-480.

Foreseen final state of the MS

The MS is in CC state U10 on cell 2.

Test Procedure

The SS starts the GSM cell and the UTRAN cell, the cell selection conditions of these two cells are in favour of GSM cell. The MS selects the GSM cell for camping on. After the MS receives and stores pre-configuration information from SIB16 broadcast in the UTRAN cell, the SS brings the MS into the call active state (CC state U10) with 14.4 kbps CS data call (for execution counter M = 1). The SS configures a dedicated channel corresponding to the pre-configuration (streaming/unknown/UL:14.4 DL:14.4 kbps/CS RAB + UL:3.4 DL3.4 kbps SRBs for M = 1) in UTRAN cell, then sends HANDOVER TO UTRAN COMMAND indicating the dedicated channel of the target cell to the MS through the GSM serving cell. After the MS receives the command it shall configure itself accordingly and switch to the dedicated channel of the UTRAN cell. The SS checks whether the handover is performed by checking that the MS transmits HANDOVER TO UTRAN COMPLETE to the SS through DCCH of the UTRAN cell.

Depending on the PIXIT parameters, the above procedure is executed maximum three times, each time for different initial conditions:

- If the MS supports GSM 14.4 kbps CS data and UTRAN streaming/unknown/UL:14.4 DL:14.4 kbps/CS RAB + UL:3.4 DL3.4 kbps SRBs, the procedure is executed for execution counter M = 1;
- If the MS supports GSM 28.8 kbps CS data and UTRAN streaming/unknown/UL:28.8 DL:28.8 kbps/CS RAB + UL:3.4 DL3.4 kbps SRBs, the procedure is executed for execution counter M = 2;
- If the MS supports GSM 57.6 kbps CS data and UTRAN streaming/unknown/UL:57.6 DL:57.6 kbps/CS RAB + UL:3.4 DL3.4 kbps SRBs, the procedure is executed for execution counter M = 3;

Expected sequence

This sequence is performed for a maximum execution counter M = 1, 2, 3, depending on the PIXIT parameters.

Step	Direction		Message	Comments
	MS	SS		
1		SS		The SS configures GSM and UTRAN cells, the UTRAN cell broadcasts SIB16 containing pre-configuration information: For M = 1: (streaming/unknown/UL:14.4 DL:14.4 kbps/CS RAB + UL:3.4 DL3.4 kbps SRBs); For M = 2: (streaming/unknown/UL:28.8 DL:28.8 kbps/CS RAB + UL:3.4 DL3.4 kbps SRBs); For M = 3: (streaming/unknown/UL:57.6 DL:57.6 kbps/CS RAB + UL:3.4 DL3.4 kbps SRBs). MS camps on GSM cell and received SIB16 from UTRAN cell.
2		MS		The SS bring the MS into GSM U10 state in cell 1 and for M = 1: the MS is in GSM 14.4 kbps CS data call; for M = 2: the MS is in GSM 28.8 kbps CS data call; for M = 3: the MS is in GSM 57.6 kbps CS data call;
3		SS		The SS configures a dedicated channel in the UTRAN cell with the configuration: For M = 1: (streaming/unknown/UL:14.4 DL:14.4 kbps/CS RAB + UL:3.4 DL3.4 kbps SRBs); For M = 2: (streaming/unknown/UL:28.8 DL:28.8 kbps/CS RAB + UL:3.4 DL3.4 kbps SRBs); For M = 3: (streaming/unknown/UL:57.6 DL:57.6 kbps/CS RAB + UL:3.4 DL3.4 kbps SRBs)
4		←	HANDOVER TO UTRAN COMMAND	Send on cell 1 (GSM cell)
5		MS		The MS accepts the handover command and configures its lower layers using the parameters contained in the HANDOVER TO UTRAN COMMAND
6		SS		The SS waits for uplink physical channel in synchronization
7		→	HANDOVER TO UTRAN COMPLETE	The SS receives this message on DCCH of cell 2 (UTRAN cell). It implies that the down link physical channel has synchronised with UTRAN.

Specific message contents

For execution1 (M = 1):

Content of "SysInfoType16"

Information Element	Value/remark
re-EstablishmentTimer T315	30 s
PredefinedRB_Configuration	
- SRB information list	
- RB identity	1
- CHOICE RLC info choice	RLC info
- CHOICE UL RLC mode	UM RLC mode
- Transmission RLC discard	MaxDAT retransmissions
- Max_DAT	4
- Timer_MRW	100
- MaxMRW	4
- CHOICE DL RLC mode	UM RLC mode
- RB mapping info	
- CHOICE UL logical channel mappings	One logical channel
- UL transport channel type	DCH
- Transport channel identity	1
- Logical channel identity	1
- MAC logical channel priority	1
- Logical channel max loss	0
- DL logical channel mapping	
- DL transport channel type	DCH
- Transport channel identity	1
- Logical channel identity	1
- RB identity	2
- CHOICE RLC info choice	RLC info
- CHOICE UL RLC mode	AM RLC mode
- Transmission RLC discard	MaxDAT retransmissions
- Max_DAT	4
- Timer_MRW	100
- MaxMRW	4
- transmission window size	8
- Timer_RST	500
- MAX_RST	4
- Polling info	
- Timer_poll_prohibit	200
- Timer_poll	200
- Poll_SDU	1
- Last transmission PU poll	TRUE
- Last retransmission PU poll	TRUE
- Poll windows	99
- CHOICE DL RLC mode	AM RLC mode
- In-sequence delivery	TRUE
- Receiving window size	8
- Downlink RLC status info	
- Timer_status_prohibit	200
- Timer_EPC	200
- Missing PU indicator	TRUE
- RB mapping info	
- CHOICE UL logical channel mappings	One logical channel
- UL transport channel type	DCH
- Transport channel identity	1
- Logical channel identity	2
- MAC logical channel priority	2
- Logical channel max loss	0
- DL logical channel mapping	
- DL transport channel type	DCH
- Transport channel identity	1
- Logical channel identity	2
- RB identity	3
- CHOICE RLC info choice	RLC info
- CHOICE UL RLC mode	AM RLC mode
- Transmission RLC discard	MaxDAT retransmissions
- Max_DAT	4
- Timer_MRW	100
- MaxMRW	4
- transmission window size	8

- Timer_RST	500
- MAX_RST	4
- Polling info	
- Timer_poll_prohibit	200
- Timer_poll	200
- Poll_SDU	1
- Last transmission PU poll	TRUE
- Last retransmission PU poll	TRUE
- Poll windows	99
- CHOICE DL RLC mode	AM RLC mode
- In-sequence delivery	TRUE
- Receiving window size	8
- Downlink RLC status info	
- Timer_status_prohibit	200
- Timer_EPC	200
- Missing PU indicator	TRUE
- RB mapping info	
- CHOICE UL logical channel mappings	One logical channel
- UL transport channel type	DCH
- Transport channel identity	1
- Logical channel identity	3
- MAC logical channel priority	3
- Logical channel max loss	0
- DL logical channel mapping	
- DL transport channel type	DCH
- Transport channel identity	1
- Logical channel identity	3
- RB identity	4
- CHOICE RLC info choice	RLC info
- CHOICE UL RLC mode	AM RLC mode
- Transmission RLC discard	MaxDAT retransmissions
- Max_DAT	4
- Timer_MRW	100
- MaxMRW	4
- transmission window size	8
- Timer_RST	500
- MAX_RST	4
- Polling info	
- Timer_poll_prohibit	200
- Timer_poll	200
- Poll_SDU	1
- Last transmission PU poll	TRUE
- Last retransmission PU poll	TRUE
- Poll windows	99
- CHOICE DL RLC mode	AM RLC mode
- In-sequence delivery	TRUE
- Receiving window size	8
- Downlink RLC status info	
- Timer_status_prohibit	200
- Timer_EPC	200
- Missing PU indicator	TRUE
- RB mapping info	
- CHOICE UL logical channel mappings	One logical channel
- UL transport channel type	DCH
- Transport channel identity	1
- Logical channel identity	4
- MAC logical channel priority	4
- Logical channel max loss	0
- DL logical channel mapping	
- DL transport channel type	DCH
- Transport channel identity	1
- Logical channel identity	4
- RB information list	
- RB information to setup	
- RB identity	10
- PDCP info	Not Present
- RLC info	
- CHOICE Uplink RLC mode	TM RLC mode
- Transmission RLC discard	Not Present

- Segmentation indication	TRUE
- CHOICE Downlink RLC mode	TM RLC mode
- Segmentation indication	TRUE
- RB mapping info	
- CHOICE UL logical channel mappings	One logical channel
- Uplink transport channel type	DCH
- Transport channel identity	2
- Logical channel identity	1
- MAC logical channel priority	1
- Logical channel max loss	0
- DL logical channel mapping	1
- Downlink transport channel type	DCH
- Transport channel identity	2
- Logical channel identity	1
preDefTransChConfiguration	
- UL Common Transport channel Info	
- TFC subset	
- Allowed Transport Format combination	0, 1, 2, 3
- CHOICE Mode specific info	FDD
- CHOICE UL DCH TFCS	Normal signalling
- CHOICE Normal signalling	Addition
- CHOICE CTFC Size	2 bits
- CTFC information	0
- Power offset information	
- CHOICE Gain Factors	Signalled Gain Factor
- Gain factor β_c	0
- Gain factor β_d	0
- Reference TFC ID	Not Present
- Power offset Pp-m	0dB
- CTFC information	1
- Power offset information	
- CHOICE Gain Factors	Signalled Gain Factor
- Gain factor β_c	0
- Gain factor β_d	0
- Reference TFC ID	Not Present
- Power offset Pp-m	0dB
- CTFC information	2
- Power offset information	
- CHOICE Gain Factors	Signalled Gain Factor
- Gain factor β_c	0
- Gain factor β_d	0
- Reference TFC ID	Not Present
- Power offset Pp-m	0dB
- CTFC information	3
- Power offset information	
- CHOICE Gain Factors	Signalled Gain Factor
- Gain factor β_c	0
- Gain factor β_d	0
- Reference TFC ID	Not Present
- Power offset Pp-m	0dB
- UL Add or reconfigured transport channel info list	
- Transport channel identity	2
- TFS	
- Dynamic Transport format information	
- Number of Transport blocks	0
- RLC size	576
- Dynamic Transport format information	
- Number of Transport blocks	1
- RLC size	576
- Semi-static Transport Format information	
- Transmission time interval	40 ms
- Type of channel coding	Turbo coding
- Rate matching attribute	145-185
- CRC size	16 bits
- Transport channel identity	1
- TFS	
- Dynamic Transport format information	
- Number of Transport blocks	0

- RLC size	148
- Dynamic Transport format information	
- Number of Transport blocks	1
- RLC size	148
- Semi-static Transport Format information	
- Transmission time interval	40 ms
- Type of channel coding	convolutional
- Coding Rate	1/3
- Rate matching attribute	155-165
- CRC size	16 bits
- DL Common transport channel info	
- SCCPCH TFCS	Not Present
- CHOICE Mode specific info	FDD
- CHOICE TFCS Signalling mode	Same as UL
- Added or reconfigured DL TrCH info list	
- Transport channel identity	2
- CHOICE TFS signalling mode	SameAsUL
- UL TrCH Identity	2
- DCH quality target	
- BLER Quality value	0
- Transparent mode signalling info	Not Present
PreDefPhyChConfiguration	
-UL_DPCH_InfoPredef	
- UL DPCH Info	
- Uplink DPCH power control info	
- DPCH power offset	-6dB
- PC Preamble	15 slots
- CHOICE Mode specific info	FDD
- TFCI existence	TRUE
- Puncturing Limit	1
- DL_ CommonInformationPredef	
- DL_DPCH_InfoCommon	
- Timing indication	initialize
- CHOICE Mode specific info	FDD
- Spreading factor and pilot	128
- Number of bits for Pilot bits	8 bits
- Fixed or Flexible Position	Fixed
- TFCI existence	FALSE
- Downlink DPCH Offset Value	0

HANDOVER TO UTRAN COMMAND

Information Element	Value/remark
RR management Protocol Discriminator	'0110'B
Skip Indicator	'0000'B
Inter System to UTRAN Handover Command Message Type	'01100011'B
Handover to UTRAN Command IEI	TBD
Length of Handover to UTRAN Command contents	Octet length of the "Handover to UTRAN Command value part"
Handover to UTRAN Command value part	PER encoded ASN.1 value of type "HandoverToUTRANCommand-v1-IEs", the content is presented in the next table.

Content of "HandoverToUTRANCommand-v1-IEs"

Information Element	Value/remark
New U-RNTI	
- SRNC Identiy	'000000000001'B
- S-RNTI-2	1
Activation time	now
Ciphering algorithm	Standard UMTS Encryption Algorithm UEA1
RAB Info	
- RAB identity	
- GSM-MAP RAB identity	'00000001'B
- CN domain identity	CS domain
CHOICE Specification mode	Preconfiguration
- Predefined configuration identity	1
- CHOICE Mode specific info	FDD
- UL DPCH info	
- UL DPCH power control info	
- Power control algorithm1	1
- Scrambling code type	long
- Reduced scrambling code number	0
- Spreading factor	64
- DL common information post	
- DL DPCH info common	
- Timing indication	initialize
- CFN target SFN frame offset	Not present
- DL DPCH power control info	
- CHOICE Mode specific info	FDD
- DPC mode	Single TPC
- DL information perRL list	
- Primary CPICH info	
- Primary scrambling code	100
- DL DPCH info perRL	
- pCPICH usage for channelEst	May be used
- DL channelisation code	
- Secondary scrambling code	1
- SF and code number	SF = 128, code number = 127
- Scrambling code change	No code change
- TPC combination index	0
- Frequency info	
- UARFCN uplink(Nu)	See PIXIT
- UARFCN downlink(Nd)	See PIXIT
Maximum allowed UL TX power	33dBm

For execution2 (M = 2):

Content of "SysInfoType16" same as for M=1 except:

Information Element	Value/remark
preDefTransChConfiguration	
- UL Common Transport channel Info	
- TFC subset	0, 1, 2, 3, 4, 5
- Allowed Transport Format combination	FDD
- CHOICE Mode specific info	Normal signalling
- CHOICE UL DCH TFCS	Addition
- CHOICE Normal signalling	4 bits
- CHOICE CTFC Size	0
- CTFC information	0
- Power offset information	Signalled Gain Factor
- CHOICE Gain Factors	0
- Gain factor β_c	0
- Gain factor β_d	Not Present
- Reference TFC ID	0dB
- Power offset Pp-m	1
- CTFC information	1
- Power offset information	Signalled Gain Factor
- CHOICE Gain Factors	0
- Gain factor β_c	0
- Gain factor β_d	Not Present
- Reference TFC ID	0dB
- Power offset Pp-m	2
- CTFC information	2
- Power offset information	Signalled Gain Factor
- CHOICE Gain Factors	0
- Gain factor β_c	0
- Gain factor β_d	Not Present
- Reference TFC ID	0dB
- Power offset Pp-m	3
- CTFC information	3
- Power offset information	Signalled Gain Factor
- CHOICE Gain Factors	0
- Gain factor β_c	0
- Gain factor β_d	Not Present
- Reference TFC ID	0dB
- Power offset Pp-m	4
- CTFC information	4
- Power offset information	Signalled Gain Factor
- CHOICE Gain Factors	0
- Gain factor β_c	0
- Gain factor β_d	Not Present
- Reference TFC ID	0dB
- Power offset Pp-m	5
- CTFC information	5
- Power offset information	Signalled Gain Factor
- CHOICE Gain Factors	0
- Gain factor β_c	0
- Gain factor β_d	Not Present
- Reference TFC ID	0dB
- Power offset Pp-m	0dB
- UL Add or reconfigured transport channel info list	
- Transport channel identity	2
- TFS	
- Dynamic Transport format information	
- Number of Transport blocks	0
- RLC size	576
- Dynamic Transport format information	
- Number of Transport blocks	1
- RLC size	576
- Dynamic Transport format information	
- Number of Transport blocks	2
- RLC size	576
- Semi-static Transport Format information	
- Transmission time interval	40 ms

- Type of channel coding	Turbo coding
- Rate matching attribute	135-175
- CRC size	16 bits
PreDefPhyChConfiguration	
-UL_DPCH_InfoPredef	
- UL DPCH Info	
- Uplink DPCH power control info	
- DPCCH power offset	-6dB
- PC Preamble	15 slots
- CHOICE Mode specific info	FDD
- TFCI existence	TRUE
- Puncturing Limit	1
- DL_CommonInformationPredef	
- DL_DPCH_InfoCommon	
- Timing indication	initialize
- CHOICE Mode specific info	FDD
- Spreading factor and pilot	64
- Number of bits for Pilot bits	8 bits
- Fixed or Flexible Position	Fixed
- TFCI existence	FALSE
- Downlink DPCH Offset Value	0

HANDOVER TO UTRAN COMMAND

Information Element	Value/remark
RR management Protocol Discriminator	'0110'B
Skip Indicator	'0000'B
Inter System to UTRAN Handover Command Message Type	'01100011'B
Handover to UTRAN Command IEI	TBD
Length of Handover to UTRAN Command contents	Octet length of the "Handover to UTRAN Command value part"
Handover to UTRAN Command value part	PER encoded ASN.1 value of type "HandoverToUTRANCommand-v1-IEs", the content is presented in the next table.

Content of "HandoverToUtranCommand-v1-IEs"

Information Element	Value/remark
New U-RNTI	
- SRNC Identiy	'000000000001'B
- S-RNTI-2	1
Activation time	now
Ciphering algorithm	Standard UMTS Encryption Algorithm UEA1
RAB Info	
- RAB identity	
- GSM-MAP RAB identity	'00000001'B
- CN domain identity	CS domain
CHOICE Specification mode	Preconfiguration
- Predefined configuration identity	1
- CHOICE Mode specific info	FDD
- UL DPCH info	
- UL DPCH power control info	
- Power control algorithm1	1
- Scrambling code type	long
- Reduced scrambling code number	0
- Spreading factor	32
- DL common information post	
- DL DPCH info common	
- Timing indication	initialize
- CFN target SFN frame offset	Not present
- DL DPCH power control info	
- CHOICE Mode specific info	FDD
- DPC mode	Single TPC
- DL information perRL list	
- Premary CPICH info	
- Primary scrambling code	100
- DL DPCH info perRL	
- pCPICH usage for channelEst	May be used
- DL channelisation code	
- Secondary scrambling code	1
- SF and code number	SF = 64, code number = 63
- Scrambling code change	No code change
- TPC combination index	0
- Frequency info	
- UARFCN uplink(Nu)	See PIXIT
- UARFCN downlink(Nd)	See PIXIT
Maximum allowed UL TX power	33dBm

For execution3 (M = 3):

- Power offset information	
- CHOICE Gain Factors	Signalled Gain Factor
- Gain factor β_c	0
- Gain factor β_d	0
- Reference TFC ID	Not Present
- Power offset Pp-m	0dB
- CTFC information	9
- Power offset information	
- CHOICE Gain Factors	Signalled Gain Factor
- Gain factor β_c	0
- Gain factor β_d	0
- Reference TFC ID	Not Present
- Power offset Pp-m	0dB
- UL Add or reconfigured transport channel info list	
- Transport channel identity	2
- TFS	
- Dynamic Transport format information	
- Number of Transport blocks	0
- RLC size	576
- Dynamic Transport format information	
- Number of Transport blocks	1
- RLC size	576
- Dynamic Transport format information	
- Number of Transport blocks	2
- RLC size	576
- Dynamic Transport format information	
- Number of Transport blocks	3
- RLC size	576
- Dynamic Transport format information	
- Number of Transport blocks	4
- RLC size	576
- Semi-static Transport Format information	
- Transmission time interval	40 ms
- Type of channel coding	Turbo coding
- Rate matching attribute	125-165
- CRC size	16 bits
PreDefPhyChConfiguration	
-UL_DPCH_InfoPredef	
- UL DPCH Info	
- Uplink DPCH power control info	
- DPCCH power offset	-6dB
- PC Preamble	15 slots
- CHOICE Mode specific info	FDD
- TFCI existence	TRUE
- Puncturing Limit	1
- DL_CommonInformationPredef	
- DL_DPCH_InfoCommon	
- Timing indication	initialize
- CHOICE Mode specific info	FDD
- Spreading factor and pilot	32
- Number of bits for Pilot bits	8 bits
- Fixed or Flexible Position	Fixed
- TFCI existence	FALSE
- Downlink DPCH Offset Value	0

HANDOVER TO UTRAN COMMAND

Information Element	Value/remark
RR management Protocol Discriminator	'0110'B
Skip Indicator	'0000'B
Inter System to UTRAN Handover Command Message Type	'01100011'B
Handover to UTRAN Command IEI	TBD
Length of Handover to UTRAN Command contents	Octet length of the "Handover to UTRAN Command value part"
Handover to UTRAN Command value part	PER encoded ASN.1 value of type "HandoverToUTRANCommand-v1-IEs", the content is presented in the next table.

Content of "HandoverToUTRANCommand-v1-IEs"

Information Element	Value/remark
New U-RNTI	'000000000001'B
- SRNC Identity	1
- S-RNTI-2	now
Activation time	Standard UMTS Encryption Algorithm UEA1
Ciphering algorithm	
RAB Info	
- RAB identity	
- GSM-MAP RAB identity	'00000001'B
- CN domain identity	CS domain
CHOICE Specification mode	Preconfiguration
- Predefined configuration identity	1
- CHOICE Mode specific info	FDD
- UL DPCH info	
- UL DPCH power control info	
- Power control algorithm1	1
- Scrambling code type	long
- Reduced scrambling code number	0
- Spreading factor	16
- DL common information post	
- DL DPCH info common	
- Timing indication	initialize
- CFN target SFN frame offset	Not present
- DL DPCH power control info	
- CHOICE Mode specific info	FDD
- DPC mode	Single TPC
- DL information perRL list	
- Primary CPICH info	
- Primary scrambling code	100
- DL DPCH info perRL	
- pCPICH usage for channelEst	May be used
- DL channelisation code	
- Secondary scrambling code	1
- SF and code number	SF = 32, code number = 31
- Scrambling code change	No code change
- TPC combination index	0
- Frequency info	
- UARFCN uplink(Nu)	See PIXIT
- UARFCN downlink(Nd)	See PIXIT
Maximum allowed UL TX power	33dBm

60.2.5 Test requirement

After step 7 the ongoing call shall be continued on UTRAN cell.

60.3 Inter system handover to UTRAN/From GSM/Data/Data rate upgrading/Success

60.3.1 Definition

60.3.2 Conformance requirement

The MS shall be able to receive a HANOVER TO UTRAN COMMAND message from GSM and perform an inter-system handover, even if no prior MS measurements have been performed on the target UTRAN cell and/or frequency.

If the MS succeeds to establish the connection to UTRAN, it shall transmit a HANOVER TO UTRAN COMPLETE message on the uplink DCCH.

Reference(s)

TS 25.331 Clause 8.3.6.

TS 04.18 Clause 3.4.4a.

60.3.3 Test purpose

To test that the MS being in the data call active state handovers from the GSM serving cell to the indicated channel of a higher data rate in the UTRAN target cell after it receives a HANOVER TO UTRAN COMMAND.

60.3.4 Method of test

Initial conditions

System Simulator: 2 cells - Cell 1 is GSM, Cell 2 is UTRAN. GSM 11.10-1 section 26.6.5.1 or section 26.13.1.3(for HSCSD) shall be referenced for the default parameters of cell 1.

MS: CC State U10 in cell 1

Related ICS/IXIT statement(s)

MS supports both GSM and UTRAN Radio Access Technologies,

MS supports UTRAN Streaming/unknown/UL:28.8 DL:28.8 kbps/CS RAB + UL:3.4 DL:3.4 kbps SRBs,

MS supports UTRAN Streaming/unknown/UL:57.6 DL:57.6 kbps/CS RAB + UL:3.4 DL:3.4 kbps SRBs,

MS supports GSM 14.4 kbps data (HSCSD or full rate traffic channel for 14.4 kbit/s user data (TCH/F14.4)),

MS supports GSM 28.8 kbps data (HSCSD or full rate traffic channel for 28.8 kbit/s user data (E-TCH/F28.8)),

MS supports GSM-P, GSM-E, GSM-DCS, GSM-450, GSM-480.

Foreseen final state of the MS

The MS is in CC state U10 on cell 2.

Test Procedure

The SS starts the GSM cell and the UTRAN cell with cell selection conditions in favour of GSM cell. In UTRAN cell SIB16 is broadcast. The MS selects the GSM cell and received the pre-configuration information from SIB16. Then the SS brings the MS into the call active state (CC state U10) with 14.4 kbps CS data call (for execution counter M = 1). The SS configures a dedicated channel corresponding to the pre-configuration (streaming/unknown/UL:28.8 DL:28.8 kbps/CS RAB + UL:3.4 DL:3.4 kbps SRBS for M = 1), then sends HANOVER TO UTRAN COMMAND indicating the dedicated channel of the target cell to the MS through the GSM serving cell. After the MS receives the command it shall configure itself accordingly and switch to the new channel of the UTRAN cell. The SS checks whether the

handover is performed by checking that the MS transmits HANDOVER TO UTRAN COMPLETE to the SS through DCCH of the UTRAN cell.

Depending on the PIXIT parameters, the above procedure is executed maximum three times, each time for different conditions:

- If the MS supports GSM 14.4 kbps CS data and UTRAN streaming/unknown/UL:28.8 DL:28.8 kbps/CS RAB + UL:3.4 DL3.4 kbps SRBs, the procedure is executed for execution counter M = 1;
- If the MS supports GSM 14.4 kbps CS data and UTRAN streaming/unknown/UL:57.6 DL:57.6 kbps/CS RAB + UL:3.4 DL3.4 kbps SRBs, the procedure is executed for execution counter M = 2;
- If the MS supports GSM 28.8 kbps CS data and UTRAN streaming/unknown/UL:57.6 DL:57.6 kbps/CS RAB + UL:3.4 DL3.4 kbps SRBs, the procedure is executed for execution counter M = 3;

Expected sequence

This sequence is performed for a maximum execution counter M = 1, 2, 3, depending on the PIXIT parameters.

Step	Direction		Message	Comments
	MS	SS		
1		SS		The SS configures GSM and UTRAN cells, the UTRAN cell broadcasts SIB16 containing pre-configuration information: For M = 1: (streaming/unknown/UL:28.8 DL:28.8 kbps/CS RAB + UL:3.4 DL3.4 kbps SRBs); For M = 2: (streaming/unknown/UL:57.6 DL:57.6 kbps/CS RAB + UL:3.4 DL3.4 kbps SRBs); For M = 3: (streaming/unknown/UL:57.6 DL:57.6 kbps/CS RAB + UL:3.4 DL3.4 kbps SRBs). MS camps on GSM cell and received SIB16 from UTRAN cell.
2		MS		The SS bring the MS into GSM U10 state in cell 1 and for M = 1: the MS is in GSM 14.4 kbps CS data call; for M = 2: the MS is in GSM 14.4 kbps CS data call; for M = 3: the MS is in GSM 28.8 kbps CS data call;
3		SS		The SS configures a dedicated channel in the UTRAN cell with the configuration: For M = 1: (streaming/unknown/UL:28.8 DL:28.8 kbps/CS RAB + UL:3.4 DL3.4 kbps SRBs); For M = 2: (streaming/unknown/UL:57.6 DL:57.6 kbps/CS RAB + UL:3.4 DL3.4 kbps SRBs); For M = 3: (streaming/unknown/UL:57.6 DL:57.6 kbps/CS RAB + UL:3.4 DL3.4 kbps SRBs)
4		←	HANDOVER TO UTRAN COMMAND	Send on cell 1 (GSM cell)
5		MS		The MS accepts the handover command and configures its lower layers using the parameters contained in the HANDOVER TO UTRAN COMMAND
6		SS		The SS waits for uplink physical channel in synchronization
7		→	HANDOVER TO UTRAN COMPLETE	The SS receives this message on DCCH of cell 2 (UTRAN cell). It implies that the down link physical channel has synchronised with UTRAN.

Specific message contents

For execution1 (M = 1):

Same as the default message contents in clause 60.2 for M = 2.

For execution2 (M = 2):

Same as the default message contents in clause 60.2 for $M = 3$.

For execution3 ($M = 3$):

Same as the default message contents in clause 60.2 for $M = 3$.

60.3.5 Test requirement

After step 7 the ongoing call shall be continued on UTRAN cell.

60.4 Inter system handover to UTRAN/From GSM/Speech/Establishment/Success

60.4.1 Definition

60.4.2 Conformance requirement

The MS shall be able to receive a HANOVER TO UTRAN COMMAND message from GSM and perform an inter-system handover, even if no prior MS measurements have been performed on the target UTRAN cell and/or frequency.

If the MS succeeds to establish the connection to UTRAN, it shall transmit a HANOVER TO UTRAN COMPLETE message on the uplink DCCH.

Reference(s)

TS 25.331 Clause 8.3.6.

TS 04.18 Clause 3.4.4a.

60.4.3 Test purpose

To test that the MS supporting both GSM and UTRAN handovers from the GSM serving cell to the indicated channel in UTRAN target cell when the MS is in the call establishment phase and receives a HANOVER TO UTRAN COMMAND.

60.4.4 Method of test

Initial conditions

System Simulator: 2 cells - Cell 1 is GSM, Cell 2 is UTRAN. GSM 11.10-1 section 26.6.5.1 shall be referenced for the default parameters of cell 1.

MS: CC State U1 in cell 1

Related ICS/IXIT statement(s)

MS supports both GSM and UTRAN Radio Access Technologies,

MS supports UTRAN AMR,

MS supports GSM FR,

MS supports GSM-P, GSM-E, GSM-DCS, GSM-450, GSM-480.

Foreseen final state of the MS

The MS is in CC state U1 on cell 2.

Test Procedure

The SS starts GSM cell and UTRAN cell with the cell selection conditions in favour of GSM cell. The MS selects the GSM cell. After the MS camps on the GSM cell and received SIB16 broadcast in the UTRAN cell, the MS is triggered to make an MO speech call. After the SS received SETUP message it configures a dedicated channel corresponding to the predefined configuration (conversational/speech/UL:12.2 DL:12.2 kbps/CS RAB + UL:3.4 DL3.4 kbps SRBS) described by SIB16, then the SS sends HANDOVER TO UTRAN COMMAND indicating the dedicated channel to the MS through the GSM serving cell. After the MS receives the command and it shall configure itself accordingly and switch to the new channel of UTRAN cell. The SS checks whether the handover is performed by checking that the MS transmits HANDOVER TO UTRAN COMPLETE to the SS through DCCH of the UTRAN cell.

Expected sequence

Step	Direction		Message	Comments
	MS	SS		
1		SS		The SS configures GSM and UTRAN cells, MS camps on GSM cell and received SIB16 from UTRAN cell.
2		MS		To trigger MS to make an MO call
3		→	CHANNEL REQUEST	initiate outgoing call
4		←	IMMEDIATE ASSIGNMENT	SDCCH, U0
5		→	CM SERVICE REQUEST	U0.1
6		→	SETUP	U1
7		SS		The SS configures a dedicated channel with the configuration: conversational/speech/UL:12.2 DL:12.2 kbps/CS RAB + UL:3.4 DL3.4 kbps SRBs in UTRAN cell.
8		←	HANDOVER TO UTRAN COMMAND	Send on cell 1 (GSM cell)
9		MS		The MS accepts the handover command and configures its lower layers using the parameters contained in the HANDOVER TO UTRAN COMMAND
10		SS		The SS waits for uplink physical channel in synchronization
11		→	HANDOVER TO UTRAN COMPLETE	The SS receives this message on DCCH of cell 2 (UTRAN cell). It implies that the down link physical channel has synchronised with UTRAN.

Specific message contents

Same as the default message contents in clause 60.1 for M = 1.

60.4.5 Test requirement

After step 11 the ongoing call shall be continued on UTRAN cell.

60.5 Inter system handover to UTRAN/From GSM/Speech/Blind HO/Success

60.5.1 Definition

60.5.2 Conformance requirement

The MS shall be able to receive a HANOVER TO UTRAN COMMAND message from GSM and perform an inter-system handover, even if no prior MS measurements have been performed on the target UTRAN cell and/or frequency.

If the MS succeeds to establish the connection to UTRAN, it shall transmit a HANOVER TO UTRAN COMPLETE message on the uplink DCCH.

Reference(s)

TS 25.331 Clause 8.3.6.

TS 04.18 Clause 3.4.4a.

60.5.3 Test purpose

To test that the MS handovers from the GSM serving cell to the indicated channel of UTRAN target cell when it is in the speech call active state without any knowledge of the target system (blind handover) and receives a HANOVER TO UTRAN COMMAND.

60.5.4 Method of test

Initial conditions

System Simulator: 2 cells - Cell 1 is GSM, Cell 2 is UTRAN. GSM 11.10-1 section 26.6.5.1 shall be referenced for the default parameters of cell 1.

MS: CC State U10 in cell 1

Related ICS/IXIT statement(s)

MS supports both GSM and UTRAN Radio Access Technologies,

MS supports UTRAN AMR,

MS supports GSM FR,

MS supports GSM-P, GSM-E, GSM-DCS, GSM-450, GSM-480.

Foreseen final state of the MS

The MS is in CC state U10 on cell 2.

Test Procedure

The SS starts the GSM cell and the UTRAN cell with cell selection conditions in favour of GSM cell, SIB16 is not broadcast in the UTRAN cell and the MS has no any predefined configuration stored. The MS selects the GSM cell. Then the SS brings the MS into the call active state (CC state U10) with FR speech. The SS configures a dedicated channel (conversational/speech/UL:12.2 DL:12.2 kbps/CS RAB + UL:3.4 DL:3.4 kbps SRBS), then sends HANOVER TO UTRAN COMMAND indicating the dedicated channel of the target cell to the MS through the GSM serving cell. After the MS receives the command it shall configure itself accordingly and switch to the dedicated channel of UTRAN cell. The SS checks whether the handover is performed by checking that the MS transmits HANOVER TO UTRAN COMPLETE to the SS through DCCH of the UTRAN cell.

Expected sequence

Step	Direction		Message	Comments
	MS	SS		
1	MS			The SS bring the MS into GSM U10 state in cell 1 and the MS has no any pre-configuration information stored
2	SS			The SS configures dedicated channel with the configuration: conversational/speech/UL:12.2 DL:12.2 kbps/CS RAB + UL:3.4 DL3.4 kbps SRBs in UTRAN cell.
3	←		HANDOVER TO UTRAN COMMAND	Send on cell 1 (GSM cell)
4	MS			The MS accepts the handover command and configures its lower layers using the parameters contained in the HANDOVER TO UTRAN COMMAND
5	SS			The SS waits for uplink physical channel in synchronization
6	→		HANDOVER TO UTRAN COMPLETE	The SS receives this message on DCCH of cell 2 (UTRAN cell). It implies that the down link physical channel has synchronised with UTRAN.

Specific message contents

HANDOVER TO UTRAN COMMAND

Information Element	Value/remark
RR management Protocol Discriminator	'0110'B
Skip Indicator	'0000'B
Inter System to UTRAN Handover Command Message Type	'01100011'B
Handover to UTRAN Command IEI	TBD
Length of Handover to UTRAN Command contents	Octet length of the "Handover to UTRAN Command value part"
Handover to UTRAN Command value part	PER encoded ASN.1 value of type "HandoverToUTRANCommand-v1-IEs", content is presented in the next table.

Content of "HandoverToUTRANCommand-v1-IEs"

Information Element	Value/remark
New U-RNTI	
- SRNC Identiy	'000000000001'B
- S-RNTI-2	1
Activation time	now
Ciphering algorithm	Standard UMTS Encryption Algorithm UEA1
RAB Info	
- RAB identity	
- GSM-MAP RAB identity	'00000001'B
- CN domain identity	CS domain
CHOICE Specification mode	complete
- re-Establishment timer	1800 seconds
- SRB information setup list	
- RB identity	1
- CHOICE RLC info choice	RLC info
- CHOICE UL RLC mode	UM RLC mode
- Transmission RLC discard	MaxDAT retransmissions
- Max_DAT	4
- Timer_MRW	100
- MaxMRW	4
- CHOICE DL RLC mode	UM RLC mode
- RB mapping info	
- CHOICE UL logical channel mappings	One logical channel
- UL transport channel type	DCH
- Transport channel identity	1
- Logical channel identity	1
- MAC logical channel priority	1
- Logical channel max loss	0
- DL logical channel mapping	
- DL transport channel type	DCH
- Transport channel identity	1
- Logical channel identity	1
- RB identity	2
- CHOICE RLC info choice	RLC info
- CHOICE UL RLC mode	AM RLC mode
- Transmission RLC discard	MaxDAT retransmissions
- Max_DAT	4
- Timer_MRW	100
- MaxMRW	4
- transmission window size	8
- Timer_RST	500
- MAX_RST	4
- Polling info	
- Timer_poll_prohibit	200
- Timer_poll	200
- Poll_SDU	1
- Last transmission PU poll	TRUE
- Last retransmission PU poll	TRUE
- Poll windows	99
- CHOICE DL RLC mode	AM RLC mode
- In-sequence delivery	TRUE
- Receiving window size	8
- Downlink RLC status info	
- Timer_status_prohibit	200
- Timer_EPC	200
- Missing PU indicator	TRUE
- RB mapping info	
- CHOICE UL logical channel mappings	One logical channel
- UL transport channel type	DCH
- Transport channel identity	1
- Logical channel identity	2
- MAC logical channel priority	2
- Logical channel max loss	0
- DL logical channel mapping	
- DL transport channel type	DCH
- Transport channel identity	1

- Logical channel identity	2
- RB identity	3
- CHOICE RLC info choice	RLC info
- CHOICE UL RLC mode	AM RLC mode
- Transmission RLC discard	MaxDAT retransmissions
- Max_DAT	4
- Timer_MRW	100
- MaxMRW	4
- transmission window size	8
- Timer_RST	500
- MAX_RST	4
- Polling info	
- Timer_poll_prohibit	200
- Timer_poll	200
- Poll_SDU	1
- Last transmission PU poll	TRUE
- Last retransmission PU poll	TRUE
- Poll windows	99
- CHOICE DL RLC mode	AM RLC mode
- In-sequence delivery	TRUE
- Receiving window size	8
- Downlink RLC status info	
- Timer_status_prohibit	200
- Timer_EPC	200
- Missing PU indicator	TRUE
- RB mapping info	
- CHOICE UL logical channel mappings	One logical channel
- UL transport channel type	DCH
- Transport channel identity	1
- Logical channel identity	3
- MAC logical channel priority	3
- Logical channel max loss	0
- DL logical channel mapping	
- DL transport channel type	DCH
- Transport channel identity	1
- Logical channel identity	3
- RB identity	4
- CHOICE RLC info choice	RLC info
- CHOICE UL RLC mode	AM RLC mode
- Transmission RLC discard	MaxDAT retransmissions
- Max_DAT	4
- Timer_MRW	100
- MaxMRW	4
- transmission window size	8
- Timer_RST	500
- MAX_RST	4
- Polling info	
- Timer_poll_prohibit	200
- Timer_poll	200
- Poll_SDU	1
- Last transmission PU poll	TRUE
- Last retransmission PU poll	TRUE
- Poll windows	99
- CHOICE DL RLC mode	AM RLC mode
- In-sequence delivery	TRUE
- Receiving window size	8
- Downlink RLC status info	
- Timer_status_prohibit	200
- Timer_EPC	200
- Missing PU indicator	TRUE
- RB mapping info	
- CHOICE UL logical channel mappings	One logical channel
- UL transport channel type	DCH
- Transport channel identity	1
- Logical channel identity	4
- MAC logical channel priority	4
- Logical channel max loss	0
- DL logical channel mapping	
- DL transport channel type	DCH

- Transport channel identity	1
- Logical channel identity	4
- RB information setup list	
- RB information to setup	
- RB identity	10
- PDCP info	Not Present
- RLC info	
- CHOICE Uplink RLC mode	TM RLC mode
- Transmission RLC discard	Not Present
- Segmentation indication	TRUE
- CHOICE Downlink RLC mode	TM RLC mode
- Segmentation indication	TRUE
- RB mapping info	
- CHOICE UL logical channel mappings	One logical channel
- Uplink transport channel type	DCH
- Transport channel identity	2
- Logical channel identity	1
- MAC logical channel priority	1
- Logical channel max loss	0
- DL logical channel mapping	1
- Downlink transport channel type	DCH
- Transport channel identity	2
- Logical channel identity	1
- RB information to setup	
- RB identity	11
- PDCP info	Not Present
- RLC info	
- CHOICE Uplink RLC mode	TM RLC mode
- Transmission RLC discard	Not Present
- Segmentation indication	TRUE
- CHOICE Downlink RLC mode	TM RLC mode
- Segmentation indication	TRUE
- RB mapping info	
- CHOICE UL logical channel mappings	One logical channel
- Uplink transport channel type	DCH
- Transport channel identity	3
- Logical channel identity	1
- MAC logical channel priority	1
- Logical channel max loss	0
- DL logical channel mapping	1
- Downlink transport channel type	DCH
- Transport channel identity	3
- Logical channel identity	1
- RB information to setup	
- RB identity	12
- PDCP info	Not Present
- RLC info	
- CHOICE Uplink RLC mode	TM RLC mode
- Transmission RLC discard	Not Present
- Segmentation indication	TRUE
- CHOICE Downlink RLC mode	TM RLC mode
- Segmentation indication	TRUE
- RB mapping info	
- CHOICE UL logical channel mappings	One logical channel
- Uplink transport channel type	DCH
- Transport channel identity	4
- Logical channel identity	1
- MAC logical channel priority	1
- Logical channel max loss	0
- DL logical channel mapping	1
- Downlink transport channel type	DCH
- Transport channel identity	4
- Logical channel identity	1
- UL Common Transport channel Info	
- TFC subset	
- Allowed Transport Format combination	0, 1, 2, 3, 4, 5
- CHOICE Mode specific info	FDD
- CHOICE UL DCH TFCS	Normal signalling
- CHOICE Normal signalling	Addition

- CHOICE CTFC Size	6 bits
- CTFC information	0
- Power offset information	
- CHOICE Gain Factors	Signalled Gain Factor
- Gain factor β_c	0
- Gain factor β_d	0
- Reference TFC ID	Not Present
- Power offset Pp-m	0dB
- CTFC information	1
- Power offset information	
- CHOICE Gain Factors	Signalled Gain Factor
- Gain factor β_c	0
- Gain factor β_d	0
- Reference TFC ID	Not Present
- Power offset Pp-m	0dB
- CTFC information	11
- Power offset information	
- CHOICE Gain Factors	Signalled Gain Factor
- Gain factor β_c	0
- Gain factor β_d	0
- Reference TFC ID	Not Present
- Power offset Pp-m	0dB
- CTFC information	12
- Power offset information	
- CHOICE Gain Factors	Signalled Gain Factor
- Gain factor β_c	0
- Gain factor β_d	0
- Reference TFC ID	Not Present
- Power offset Pp-m	0dB
- CTFC information	13
- Power offset information	
- CHOICE Gain Factors	Signalled Gain Factor
- Gain factor β_c	0
- Gain factor β_d	0
- Reference TFC ID	Not Present
- Power offset Pp-m	0dB
- CTFC information	23
- Power offset information	
- CHOICE Gain Factors	Signalled Gain Factor
- Gain factor β_c	0
- Gain factor β_d	0
- Reference TFC ID	Not Present
- Power offset Pp-m	0dB
- UL Add or reconfigured transport channel info list	
- Transport channel identity	2
- TFS	
- Dynamic Transport format information	
- Number of Transport blocks	0
- RLC size	81
- Dynamic Transport format information	
- Number of Transport blocks	1
- RLC size	39
- Dynamic Transport format information	
- Number of Transport blocks	1
- RLC size	81
- Semi-static Transport Format information	
- Transmission time interval	20 ms
- Type of channel coding	convolutional
- Coding Rate	1/3
- Rate matching attribute	180-220
- CRC size	12 bits
- Transport channel identity	3
- TFS	
- Dynamic Transport format information	
- Number of Transport blocks	0
- RLC size	103
- Dynamic Transport format information	
- Number of Transport blocks	1

- RLC size	103
- Semi-static Transport Format information	
- Transmission time interval	20 ms
- Type of channel coding	convolutional
- Coding Rate	1/3
- Rate matching attribute	170-210
- CRC size	N/A
- Transport channel identity	4
- TFS	
- Dynamic Transport format information	
- Number of Transport blocks	0
- RLC size	60
- Dynamic Transport format information	
- Number of Transport blocks	1
- RLC size	60
- Semi-static Transport Format information	
- Transmission time interval	20 ms
- Type of channel coding	convolutional
- Coding Rate	1/2
- Rate matching attribute	215-256
- CRC size	N/A
- Transport channel identity	1
- TFS	
- Dynamic Transport format information	
- Number of Transport blocks	0
- RLC size	148
- Dynamic Transport format information	
- Number of Transport blocks	1
- RLC size	148
- Semi-static Transport Format information	
- Transmission time interval	40 ms
- Type of channel coding	convolutional
- Coding Rate	1/3
- Rate matching attribute	155-165
- CRC size	16 bits
- DL Common transport channel info	
- SCCPCH TFCS	Not Present
- CHOICE Mode specific info	FDD
- CHOICE TFCS Signalling mode	Same as UL
- Added or reconfigured DL TrCH info list	
- Transport channel identity	2
- CHOICE TFS signalling mode	SameAsUL
- UL TrCH Identity	2
- DCH quality target	
- BLER Quality value	0
- Transparent mode signalling info	Not Present
- Added or reconfigured DL TrCH info list	
- Transport channel identity	3
- CHOICE TFS signalling mode	SameAsUL
- UL TrCH Identity	3
- DCH quality target	
- BLER Quality value	0
- Transparent mode signalling info	Not Present
- Added or reconfigured DL TrCH info list	
- Transport channel identity	4
- CHOICE TFS signalling mode	SameAsUL
- UL TrCH Identity	4
- DCH quality target	
- BLER Quality value	0
- Transparent mode signalling info	Not Present
- UL DPCH Info	
- Uplink DPCH power control info	
- DPCCH power offset	-6dB
- PC Preamble	15 slots
- Power Control Algorithm	Algorithm1
- TPC step size	1dB
- CHOICE Mode specific info	FDD
- Scrambling code type	Long
- Scrambling code number	0

- Number of DPDCH	Not Present(1)
- spreading factor	64
- TFCI existence	TRUE
- Number of FBI bit	Not Present(0)
- Puncturing Limit	0.88
- CHOICE Mode specific info	FDD
- DL PDSCH information	Not present
- CPCH SET info	Not present
- Downlink information common for all radio links	
- Downlink DPCH info common for all RL	
- Timing indication	initialize
- CFN target SFN frame offset	Not present
- CHOICE Mode specific info	FDD
- Downlink DPCH power control information	
- DPC mode	0 (single)
- Spreading factor and pilot	128
- Number of bits for Pilot bits	4 bits
- Fixed or Flexible Position	Fixed
- TFCI existence	FALSE
- Downlink DPCH Offset Value	0
- DPCH compressed mode info	
-TGPSI	1
-TGPS Status Flag	Inactive
- Transmission gap pattern sequence configuration parameters	
- TGMP	FDD Measurement
- TGPRC	62
- TGCFN	(Current CFN + (256 – TTI/10msec)) mod 256
- TGSN	8
- TGL1	10
- TGL2	5
- TGD	15
- TGPL1	35
- TGPL2	35
- RPP	Mode 1
- ITP	Mode 1
- UL/DL Mode	DL
- Downlink frame type	A
- DeltaSIR1	2.0
- DeltaSIRafter1	1.0
- DeltaSIR2	Not Present
- DeltaSIRafter2	Not Present
- TX Diversity mode	None
- SSDT information	Not Present
- S field	
- DL information perRL list	
- Primary CPICH info	
- Primary scrambling code	100
- DL DPCH info perRL	
- pCPICH usage for channelEst	May be used
- DL channelisation code	
- Secondary scrambling code	1
- SF and code number	SF = 128, code number = 127
- Scrambling code change	No code change
- TPC combination index	0
- Frequency info	
- UARFCN uplink	See PIXIT
- UARFCN downlink	See PIXIT
- Maximum allowed UL transmission power	33 dbm

60.5.5 Test requirement

At step 6 the HANDOVER TO UTRAN COMPLETE shall be received on UTRAN cell.

60.6 Inter system handover to UTRAN/From GSM/Speech/Failure

60.6.1 Definition

60.6.2 Conformance requirement

The MS shall be able to receive a HANOVER TO UTRAN COMMAND message from GSM and perform an inter-system handover, even if no prior MS measurements have been performed on the target UTRAN cell and/or frequency.

If the MS can not establish the connection to UTRAN, it shall reactivate the old channel and transmit a HANOVER FAILURE message on the old channel.

Reference(s)

TS 25.331 Clause 8.3.6.

TS 04.18 Clause 3.4.4a.

60.6.3 Test purpose

To test that the MS reactivates the old channel and transmits HANOVER FAILURE message to the network on the old channel in the GSM cell when it received HANOVER TO UTRAN COMMAND and the handover to UTRAN failed.

60.6.4 Method of test

Initial conditions

System Simulator: 2 cells - Cell 1 is GSM, Cell 2 is UTRAN. GSM 11.10-1 section 26.6.5.1 shall be referenced for the default parameters of cell 1.

MS: CC State U10 in cell 1

Related ICS/IXIT statement(s)

MS supports both GSM and UTRAN Radio Access Technologies,

MS supports UTRAN AMR,

MS supports GSM RF,

MS supports GSM-P, GSM-E, GSM-DCS, GSM-450, GSM-480.

Foreseen final state of the MS

The MS is in CC state U10 on cell 1.

Test Procedure

The SS starts the GSM cell and the UTRAN cell with cell selection conditions in favour of GSM cell. SIB16 is broadcast in UTRAN cell. The MS selects the GSM cell, and received the SIB16. Then the SS brings the MS into the call active state (CC state U10) with FR speech call. The SS does not configure the dedicated channel corresponding to the predefined configuration described in SIB16 (conversationa/speech/UL:12.2 DL:12.2 kbps/CS RAB + UL:3.4 DL3.4 kbps SRBS), then sends HANOVER TO UTRAN COMMAND indicating the dedicated channel of the target cell to the MS through the GSM serving cell. The MS will not be able to establish the connection to UTRAN. The SS checks that the handover is failed by checking that the MS returns to the old channel and transmits HANOVER FAILURE to the SS through the old channel.

Expected sequence

Step	Direction		Message	Comments
	MS	SS		
1		SS		The SS starts GSM and UTRAN cells, SIB16 is broadcast in the UTRAN cell. The MS camps on GSM cell and received SIB16.
2		MS		The SS bring the MS into GSM U10 state in cell 1
3		SS		There is no dedicated channel with the configuration: conversational/speech/UL:12.2 DL:12.2 kbps/CS RAB + UL:3.4 DL3.4 kbps SRBs in UTRAN cell.
4		←	HANDOVER TO UTRAN COMMAND	Send on cell 1 (GSM cell)
5		MS		The MS accepts the handover command and configures its lower layers using the parameters contained in the HANDOVER TO UTRAN COMMAND
6		MS		The MS fails to establish a connection to UTRAN cell
7		→	HANDOVER FAILURE	The SS receives this message on DCCH of cell 1 (old channel in GSM cell)

Specific message contents

Same as the specific message contents in clause 60.1 for M = 1.

60.6.5 Test requirement

At step 7 the HANDOVER FAILURE shall be received on GSM cell.

Annex 1 (Normative): Reference test methods

A1.1 General Conditions (GC)

A1.1.1 Outdoor test site and general arrangements for measurements involving the use of radiated fields (GC4)

The outdoor test site shall be on a reasonably level surface or ground. At one point on the site a ground plane of at least 5 metres diameter shall be provided. In the middle of this ground plane a non-conducting support capable of rotation through 360 degrees in the horizontal plane shall be used to support the test sample at 1,5 metres above the ground plane.

The test site shall be large enough to allow the erection of a measuring or transmitting antenna at a distance of half a wavelength or at least 3 metres whichever is the greater. Sufficient precautions shall be taken to ensure that reflections from extraneous objects adjacent to the site and ground reflections do not degrade the measurement results.

The test antenna is used to detect the radiation from both the test sample and the substitution antenna, when the site is used for radiation measurements. Where necessary the substitution antenna is used as a transmitting antenna, when the site is used for the measurement of receiver characteristics. This antenna is mounted on a support such as to allow the antenna to be used in either the horizontal or vertical polarization and for the height of its centre above ground to be varied over the range 1 to 4 metres. Preferably test antennas with pronounced directivity should be used. The size of the test antenna along the measurement axis shall not exceed 20 % of the measuring distance.

For radiation measurements the test antenna is connected to a test receiver capable of being tuned to any frequency under investigation and of measuring accurately the relative levels of signals at its input. When necessary (for receiver measurements) the test receiver is replaced by a signal source.

The substitution antenna shall be a half wave dipole, resonant at the frequency under consideration, or a shortened dipole, or (in the range 1 to 4 GHz) a horn radiator. Antennas other than a half wave dipole shall have been calibrated to the half wave dipole. The centre of this antenna shall coincide with the reference point of the test sample it has replaced. This reference point shall be the volume centre of the sample when its antenna is mounted inside the cabinet, or the point where an external antenna is connected to the cabinet. The distance between the lower extremity of the dipole and the ground shall be at least 30 cm.

The substitution antenna shall be connected to a calibrated signal generator when the site is used for radiation measurements and to a calibrated measuring receiver when the site is used for measurements of receiver characteristics. The signal generator and the receiver shall be operating at the frequencies under investigation and shall be connected to the antenna through suitable matching and balancing network.

A1.1.2 Anechoic shielded chamber (GC5)

As an alternative to the above mentioned outdoor test site an indoor test site, being a well shielded anechoic chamber simulating free space environment may be used. If such a chamber is used, this shall be recorded in the test report.

NOTE: The anechoic shielded chamber is the preferred test site for testing to this specification.

The measurement site may be an electrically shielded anechoic chamber being 10 m long, 5 m broad and 5 m high. Walls and ceiling should be coated with RF absorbers of 1 m height. The ground should be covered with absorbing material 1 m thick able to carry test equipment and operators. A measuring distance of 3 to 5 m in the long middle axis of the chamber can be used for measurements up to at least 10 GHz.

The test antenna, test receiver, substitution antenna and calibrated signal generator are used in a way similar to that of the outdoor test site method with the exception that, because the floor absorbers reject floor reflections, the antenna height need not be changed and shall be at the same height as the test sample. In the range between 30 MHz and 100 MHz some additional calibration may be necessary.

A1.1.3 Temporary antenna connector (GC7)

If the MS to be tested does not normally have a permanent external 50 ohm connector then for test purposes only it may be modified to fit a temporary 50 ohm antenna connector.

The permanent integral antenna shall be used for measurement of:

- Transmitter effective radiated power (section 13.3).
- Radiated spurious emissions (section 12).

For tests in the relevant MS Receive band:

- The temporary antenna coupling factor is determined using the procedure defined in annex 1, 1.1.5. When using the temporary antenna connector, the temporary antenna coupling factor needs to be taken into consideration when determining a stimulus or measured level in the receive band.

For tests in the relevant MS Transmit band:

- The temporary antenna coupling factor is determined using the procedure defined in 13.3.4.2. When using the temporary antenna connector, the temporary antenna coupling factor needs to be taken into consideration when determining a stimulus or measured level in the transmit band.

For frequencies outside the above mentioned relevant bands the temporary antenna coupling factor is assumed to be 0 dB.

NOTE 1: The uncertainty in the determined value of the temporary antenna coupling factor is directly related to the uncertainty of the field strength value measured in 13.3.4.2 step n) and annex 1, 1.1.5.2 (approximately +/- [3dB]). By mutual agreement, between the MS manufacturer and the testing authority, a value of 0 dB for the temporary antenna coupling factor could be used.

NOTE 2: The accommodation of the uncertainty in the temporary antenna coupling factor in the relevant MS receive band for the tests in section 14 is for further study.

NOTE 3: The uncertainty in the temporary antenna coupling factor in the relevant MS transmit band can be accommodated with appropriate adjustment of the measured levels by the uncertainty.

Testing must be performed in the following order to ensure that all the free field measurements are performed before the MS is modified.

- Section 12.1.2.
- Sections annex 1, 1.1.5.1 and annex 1, 1.1.5.2.
- Section 13.3.4.2 (during this step the MS is modified).
- Section annex 1, 1.1.5.3.
- All remaining tests of sections 12, 13, 14, 15, 16, 17, 18, 19, 20, 21 and 22.

A1.1.4 Temporary antenna connector characteristics

The method of connection of the temporary connector shall allow secure and repeatable connections to be made to the device under test.

The antenna connector shall present a nominal 50 ohm impedance over the GSM receive and transmit frequency ranges. The maximum loss within the frequency range 100 kHz to 12,75 GHz shall be less than 1 dB.

The connection circuitry shall be maximally broadband and shall contain no non-linear or active devices.

The characteristics of the connector shall not be significantly affected by temperatures in the range -25 to +60 degrees Celsius.

A1.1.5 Calibration of the temporary antenna connector

For equipments fitted with an integral antenna and not provided with a permanent means for connection to an external antenna a calibration procedure is required to allow subsequent measurements to be performed on the temporary antenna connector.

Once calibrated this temporary antenna connector enables all receiver test procedures to be identical for equipments with an integral antenna and for equipments with an antenna connector.

The calibration procedure shall be carried out at three frequencies, namely an ARFCN in the low mid and high ARFCN ranges. The procedure consists of three distinct stages as follows:

- 1) Establish the MS antenna radiation pattern for the three selected frequencies.
- 2) Calibrate the test range (or anechoic shielded chamber) for the conditions needed in 1).
- 3) Determine the temporary antenna connector coupling factor.

A1.1.5.1 Antenna radiation pattern

- a) The MS shall be in the anechoic shielded chamber, or on an outdoor test site, on an isolated support in a vertical position at an orientation specified by the manufacturer. This position is the 0 degree position.

A test antenna, connected to the SS shall be in the anechoic shielded chamber, or on the outdoor test site, at a distance of at least 3 metres from the MS.
- b) A call shall be originated by the SS to the MS on a frequency in the low ARFCN range. The MS shall be made to answer the call. The SS shall command the MS to maximum transmit power.
- c) The SS shall, using estimated parameters for the outdoor test site or anechoic shielded chamber, set its output level "E" [see figure A1-1 to give an MS receiver input level of approximately 32 dB μ V_{emf}. This corresponds to a field strength of 55,5 dB μ V/m at the MS position. The signal shall be the Standard Test Signal C1.

NOTE 1: The absolute value of the received signal level is not critical. The value suggested however will ensure that the MS receiver is operating essentially error free, yet is low enough to avoid any non linear effects in the receiver.

- d) The SS shall use the RXLEV message from the MS to determine a measure of the received field strength. The procedure detailed in the flow chart of figure A1-1 shall now be followed.

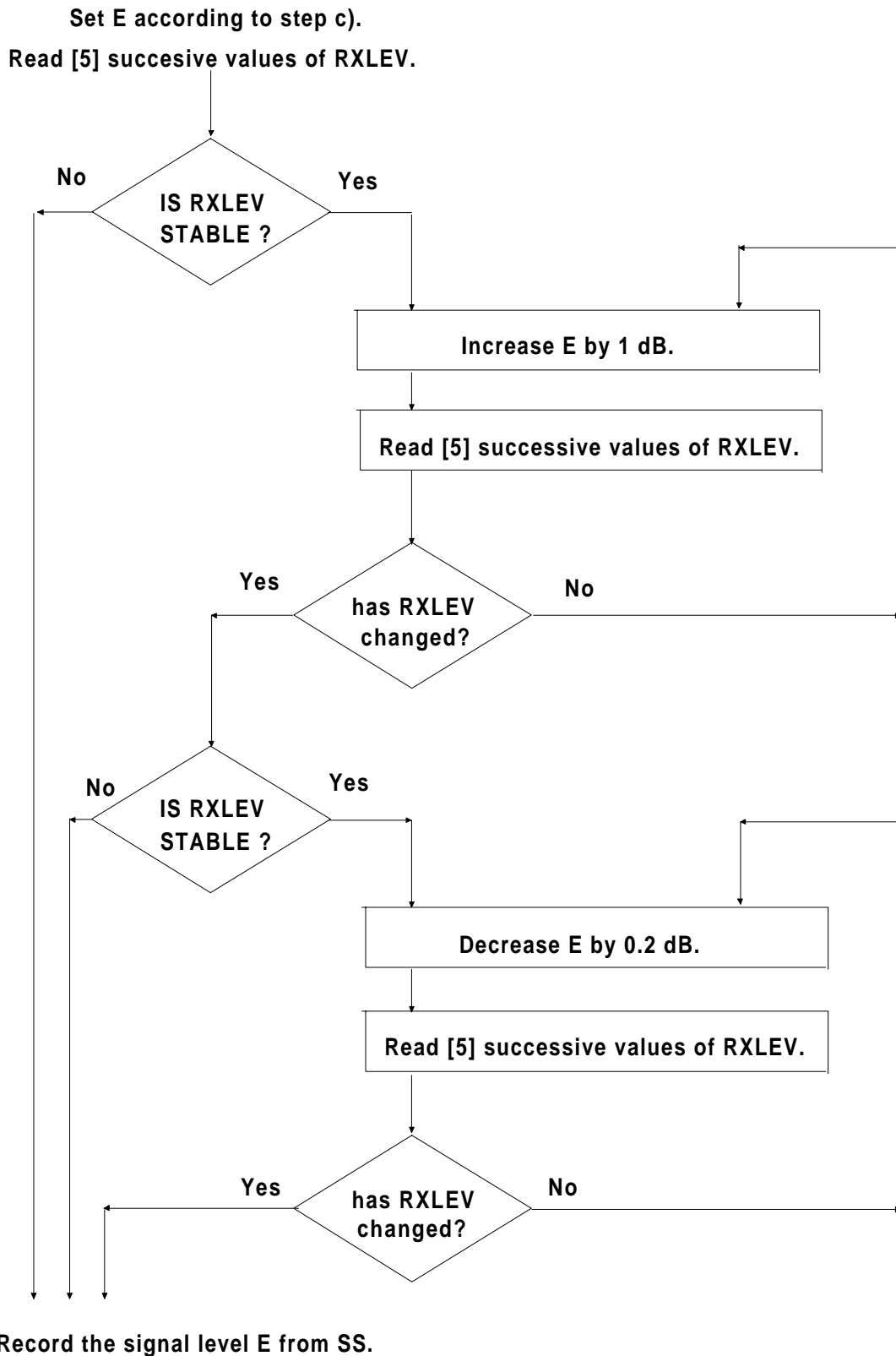

Figure A1-1

The signal level from the SS that just results in the transition from $RXLEV_a$ to $RXLEV_b$ shall be recorded as E_i .

NOTE 2: The actual values of $RXLEV_a$ and $RXLEV_b$ will need to be recorded, because this transition will be used as the reference point for all further stages of the calibration procedure.

e) Step d) shall be repeated after the MS has been rotated by $n * 45$ degrees in the horizontal plane. Ensuring that the same RXLEV transition is used, the signal levels from the SS shall be recorded as E_{in} .

- f) Calculate the effective mean signal level from the RMS value of the eight signal levels obtained in d) and e) above by using the following formula:

$$E_1 = \left[\frac{8}{\sum_{n=0}^{n=7} \frac{1}{E_{in}}} \right]^{\frac{1}{2}}$$

- g) Repeat steps b) to f), except in step b) use an ARFCN in the mid ARFCN range to obtain a mean signal level E_2 . Ensure the same RXLEV transition is used.
- h) Repeat steps b) to f), except in step b) use an ARFCN in the high ARFCN range to obtain a mean signal level E_3 .

Ensure the same RXLEV transition is used.

A1.1.5.2 Test range calibration

The objective of this step is to determine the actual field strength at the MS corresponding to the three signal levels E_1 , E_2 and E_3 established in annex 1, 1.1.5.1. The following procedure shall be used:

- a) Replace the MS by a calibrated reception antenna connected to a measuring receiver.
- b) For each frequency used in annex 1, 1.1.5.1 measure the field strength E_{fr} corresponding to the respective signal levels E_r determined in steps f), g) and h) of annex 1, 1.1.5.1 record these values as E_{f1} , E_{f2} , E_{f3} .

A1.1.5.3 Temporary antenna connector coupling factor

The coupling factor of the temporary antenna connector is the relationship expressed in dB, between the output signal of the SS and the effective receiver input signal for the MS.

The test sample MS is modified to fit a temporary antenna connector in accordance with annex 1, 1.1.3. Or alternatively a second MS shall be provided, fitted with such a temporary antenna connector.

- NOTE: If only one MS is supplied for testing, the tests of radiated spurious emissions (transmit and receive) and receiver sensitivity shall be performed before the MS is modified to accept a temporary antenna connector.

The calibration procedure shall be as follows:

- a) The MS temporary connector is connected to the output of the SS.
- b) A call shall be originated by the SS to the MS using a frequency in the low ARFCN range. The MS shall be made to answer the call. The SS shall command the MS to maximum transmit power, non hopping encrypted mode.
- c) The SS shall, using the procedures of annex 1, 1.1.5.1, adjust its output signal level to determine the $RXLEV_a$ to $RXLEV_b$ transition. This signal level shall be recorded as E_{c1} .
- d) Repeat steps b) and c) for frequencies in the mid ARFCN range and the high ARFCN range. Record the $RXLEV$ transitions as E_{c2} and E_{c3} respectively.
- e) The temporary antenna connector coupling factor F is then calculated from:

$$F_n = 20 \log_{10} \left[\frac{E_{cn}}{E_{fn} * K_n} \right]$$

where K_n = conversion factor of an isotropic antenna expressed as μV at the frequency $\mu V/m$ corresponding to the ARFCN used.

- f) The mean antenna coupling factor F_m to be used for measurements requiring hopping shall be calculated from the RMS value of all parameters in e) as follows:

$$E_{cm} = \left[\frac{3}{1/E_{c1} + 1/E_{c2} + 1/E_{c3}} \right]^{1/2}$$

$$E_{fm} = \left[\frac{3}{1/E_{f1} + 1/E_{f2} + 1/E_{f3}} \right]^{1/2}$$

$$k_m = \left[\frac{k_1 + k_2 + k_3}{3} \right]^{1/2}$$

$$F_m = 20 \log_{10} \left[\frac{E_{cm}}{E_{fm} + k_m} \right]$$

- g) In all tests in which a MS with integral antenna is the unit under test, the signal level at the temporary antenna connector is determined from:

$$E_{in} = E_{req} + F$$

where: E_{in} = signal level at coupling device (dB μ Vemf)

E_{req} = signal level required by the test (dB μ Vemf)

F = coupling factor at the respective ARFCN (dB)

This is indicated in the test procedures as E_{req} , dB μ Vemf(), where the empty parenthesis is to be read as E_{in} .

For frequencies not in the receive band or the transmit band, 0dBi antenna gain shall be assumed.]

A1.2 Normal and extreme Test Conditions (TC)

A1.2.1 Power sources and ambient temperatures (TC2)

During type approval tests the power source of the equipment shall be replaced by a test power source, capable of producing normal and extreme test voltages as specified in sections 1.2.2 and 1.2.3. The internal impedance of the test power source shall be low enough for its effect on the test results to be negligible. For the purpose of tests, the voltage of the power source shall be measured at the input terminals of the equipment. If the equipment is provided with a permanently connected power cable, the test voltage shall be that measured at the point of connection of the power cable to the equipment. In equipment with incorporated batteries the test power source shall be applied as close to the battery terminals as practicable.

During tests the power source voltages shall be maintained within a tolerance of +/-3 % relative to the voltage at the beginning of each test.

A1.2.2 Normal test conditions (TC2.1)

The normal temperature and humidity conditions for tests shall be any convenient combination of temperature and humidity within the following ranges:

Temperature: +15 °C to +35 °C (degrees Celsius)

Relative humidity: 20 % to 75 %

NOTE: When it is impracticable to carry out the tests under the conditions stated above, the actual temperature and relative humidity during the tests shall be recorded in the test report.

The normal test voltage for equipment to be connected to the mains shall be the nominal mains voltage. For the purpose of these specifications, the nominal voltage shall be the declared voltage or any of the declared voltages for which the equipment was designed. The frequency of the test power source corresponding to the mains shall be within 1 Hz of the nominal mains frequency.

When the radio equipment is intended for operation from the usual types of regulated lead-acid battery power source of vehicles, the normal test voltage shall be 1,1 times the nominal voltage of the battery (6 volts, 12 volts etc.).

For operation from other power sources or types of battery (primary or secondary) the normal test voltage shall be that declared by the equipment manufacturer.

A1.2.3 Extreme test conditions (TC2.2)

For tests under extreme test conditions the 4 combinations of extreme voltages and extreme temperatures in table A1.1 shall be applied.

Table A1.1

	1	2	3	4
Temperature	High	High	Low	Low
Voltage	High	Low	High	Low

For tests at extreme ambient temperatures measurements shall be made at the temperatures given in table A1.2, following the testing procedures given in IEC publications 68-2-1 and 68-2-2 for the low and high temperature tests.

For tests at the high temperature, after thermal balance has been achieved, the MS is switched on in the transmit condition (non DTX) for a period of one minute followed by 4 minutes in the idle mode (non DRX) after which the MS shall meet the specified requirements.

For tests at the low temperature, after thermal balance has been achieved, the MS is switched to the idle mode (non DRX) for a period of one minute after which the MS shall meet the specified requirements.

Table A1.2

	Temperature (degrees Celsius)	
	Low	High
Handheld	-10	+55
Vehicular or Portable	-20	+55

For tests at extreme voltages measurements shall be made at the lower and higher extreme voltages as declared by the MS manufacturer. For MS that can be operated from one or more of the power sources listed below, the lower extreme voltage shall not be higher, and the higher extreme voltage shall not be lower than that specified in table A1.3.

Table A1.3

	Voltage (relative to nominal)		
	Lower extreme	Higher extreme	Normal cond.
Power source: AC mains	0,9	1,1	1,0
Regulated lead acid battery	0,9	1,3	1,1
Non regulated batteries:			
Leclanché/ lithium	0,85	1,0	1,0
mercury/ nickel cadmium	0,9	1,0	1,0

A1.2.4 Vibration requirements (TC4)

When the MS is to be tested under vibration, then random vibration is used, where the acceleration spectral densities (ASD) and the frequency ranges of GSM 05.05 [annex D.2.3] apply. These are given in table A1.4.

Table A1.4

frequency in Hz	ASD in m^2/s^3
5- 20	0,96
20 - 500	0,96 at 20 Hz, thereafter -3 dB / octave

The test shall be performed as described in IEC publication 68-2-36.

Annex 2: Not used

Text deleted.

Annex 3: Protocol implementation information

General

The list of PICS and PIXIT gives all the information needed to perform the tests described in GSM 11.10.

A3.1 Protocol Implementation Conformance Statement (PICS)

For the points listed the manufacturer has the choice between different solutions in implementation. The manufacturer has to describe his choice if there is any consequence for the tests.

A3.1.1 LAPDm protocol (GSM 04.05 and 04.06)

A3.1.1.1 Simplified protocol - GSM 04.06 section 6

Statement about the choice made by the manufacturer.

A3.1.1.2 Management of SAPI = 3 - GSM 04.11 section 2.3

Statement about the handling of SAPI = 3 on the data link layer chosen by the manufacturer.

A3.1.2 Mobility management

A3.1.2.1 IMSI detach initiation by the MS - GSM 04.08 section 4.3.4.1

During a location updating, if an IMSI detach has to be performed (SIM or power off), the IMSI detach can be delayed until the location updating is finished, or can be omitted.

A3.1.2.2 IMSI detach completion by the MS - GSM 04.08 section 4.3.4.3

The MS should delay the local release of the channel to allow a normal release from the network after a detach by power off command, if possible.

If not possible the RR sub-layer on the MS side should be aborted without waiting for something from the network.

A3.1.2.3 MM specific procedures - GSM 04.08 section 4.4 and 4.5.1.1

During the lifetime of an MM specific procedure, if an MM connection establishment is required by a CM-entity, this request will either be rejected or delayed until the running MM specific procedure is terminated and, provided that the network has not sent a "follow-on proceed" indication, the RR connection is released.

If the LOCATION UPDATING REQUEST message has not been sent, the mobile station may include a "follow-on request" indicator in the message. The mobile station shall then delay the request until the MM specific procedure is completed, when it may be given the opportunity by the network to use the RR connection.

A3.1.2.4 Receiving an MM STATUS message - GSM 04.08 section 4.6

If the MM-entity of the Mobile Station receives a MM-STATUS message no state transition and no specific action shall be taken as seen from the radio interface, i.e. local actions are possible.

A3.1.3 Call control

A3.1.3.1 Status enquiry procedures - GSM 04.08 section 5.5.3.1

The MS may send a STATUS ENQUIRY and take the appropriate actions based on the answer (STATUS) of the network.

A3.1.3.2 Receiving a STATUS message by a CC entity - GSM 04.08 section 5.5.3.2

The determination of which CC states are incompatible between the MS and the network is left as an implementation decision except in some particular cases.

A3.1.3.3 Called side compatibility checking - GSM 04.08 annex B.3

Compatibility checking can be performed in various ways from the viewpoint of execution order and information to be checked, e.g. first DDI number, sub-address and then compatibility or vice versa.

A3.1.3.4 Disconnect on incoming call

The mobile equipment may or may not offer the possibility to disconnect an incoming call:

- a) after having confirmed an incoming call, but before alerting.
- b) after alerting, but before connecting.

GSM 02.30 (5.2.3) allows the combination of SEND and END function in one key.

A3.1.4 Layer 1

A3.1.4.1 Optional storage of BCCH carrier information - GSM 05.08 section 6.3

The MS may include optional storage of BCCH carrier information. For instance, the MS may store the BCCH carriers in use by the PLMN accessed when it was last active in the GSM network, or it may store BCCH carriers for more than one PLMN.

A3.1.5 Autocalling - (ref.: GSM 02.07, annex 1)

Cause number 27 implemented in:

- category 2 (preferred);
- category 3.

A3.1.6 Transient states

The following call control states may be transient in the mobile station:

State U6

State U6 may be transient if the mobile station is not configured to support explicit refusal of an incoming call by the (human or non-human) user (e.g. via a terminal interface) before call confirmation.

If U6 is transient, there is an internal transition

```

                CALL CONFIRMED
U6 -----> U9
  
```

or an internal transition

```

                RELEASE COMPLETE
U6 -----> U0.
  
```

State U7

State U7 is transient if the implementation allows for automatic connect after an implementation specific time T.

If U7 is transient, there is an internal transition:

after T, CONNECT

U7 ----- > U8.

State U9

State U9 is not transient if:

- the implementation does not support immediate connect
- an appropriate TCH is not yet assigned
- the signalling element has not been present in the SETUP

If the implementation supports immediate connect, there is an internal transition:

CONNECT

U9 ----- > U8.

If the appropriate TCH is available or the signalling element was present in SETUP, there is an internal transition:

ALERTING

U9 ----- > U7.

State U12

U12 is a stable state, if an appropriate speech traffic channel is connected and progress indicator #8 was present in the DISCONNECT message. Otherwise U12 is transient, and there is an internal transition:

A3.2 Protocol Implementation Extra Information for Testing (PIXIT)

A3.2.0 Introduction

Some of the features listed below are mandatory, others are not ; but in any case for each feature implemented the manufacturer must provide information to enable regulatory testing to be conducted.

A3.2.1 Basic characteristics

A3.2.1.1 Type of antenna

- Integrated without a connector.
- Position for normal use (if integrated without a connector).
- With a connector allowing the connection of an external antenna.

If with a connector, declare in band impedance.

A3.2.1.2 Power supply

- Type of battery (if any).

- Type of power supply.
- Nominal voltage(s).
- End-point voltage(s) of battery(s) (if any).
- Details of MS shut-down voltage.

A3.2.1.3 Power class of the MS

- Different class declared.
- Class mark change: description of the means to change the RF power capabilities.

A3.2.1.4 Channel modes supported

Speech full rate

Speech half rate

Data 14.5 kbit/s T/NT

Data 12 kbit/s full rate T/NT

Data 6 kbit/s full rate T/NT

Data 6 kbit/s half rate T/NT

Data 3,6 kbit/s full rate T

Data 3,6 kbit/s half rate T

A3.2.1.5 Teleservices supported

- 1) Telephony
- 12) Emergency calls
- 21) Short message MT/PP
- 22) Short message MO/PP
- 23) Short message transmission cell broadcast
- 61) Alternate speech and facsimile group 3 T/NT
- 62) Automatic facsimile group 3 T/NT

A3.2.1.6 Supplementary services supported

Call forwarding.

Call restriction.

Handling of undefined GSM Supplementary Services.

A3.2.1.7 Bearer services supported

- | | | |
|-----|-------------------------------------|------------------------|
| 20) | Asynchronous General Bearer Service | see GSM 02.02 sect.3.1 |
| 21) | Data circuit Duplex asynchronous | 300 bit/s T/NT |
| 22) | Data circuit Duplex asynchronous | 1200 bit/s T/NT |
| 23) | Data circuit Duplex asynchronous | 1200/75 bit/s T/NT |
| 24) | Data circuit Duplex asynchronous | 2400 bit/s T/NT |

25)	Data circuit Duplex asynchronous	4800 bit/s	T/NT
26)	Data circuit Duplex asynchronous	9600 bit/s	T/NT
30)	Synchronous General Bearer Service	see GSM 02.02 sect.3.1	
31)	Data circuit Duplex synchronous	1200 bit/s	T
32)	Data circuit Duplex synchronous	2400 bit/s	T/NT
33)	Data circuit Duplex synchronous	4800 bit/s	T/NT
34)	Data circuit Duplex synchronous	9600 bit/s	T/NT
40)	General PAD Access Bearer Service	see GSM 02.02 sect.3.1	
41)	PAD Access circuit asynchronous	300 bit/s	T/NT
42)	PAD Access circuit asynchronous	1200 bit/s	T/NT
43)	PAD Access circuit asynchronous	1200/75 bit/s	T/NT
44)	PAD Access circuit asynchronous	2400 bit/s	T/NT
45)	PAD Access circuit asynchronous	4800 bit/s	T/NT
46)	PAD Access circuit asynchronous	9600 bit/s	T/NT
50)	General Packet Access Bearer Service	see GSM 02.02 sect.3.1	
51)	Data Packet Duplex synchronous	2400 bit/s	NT
52)	Data Packet Duplex synchronous	4800 bit/s	NT
53)	Data Packet Duplex synchronous	9600 bit/s	NT
61)	Alternate Speech/Data (here Data offers the same service as bearer services 21-34 with "3,1kHz" information transfer capability)		
81)	Speech followed by Data (here Data offers the same service as bearer services 21-34 with "3,1kHz" information transfer capability)		

A3.2.1.8 SIM removal

- Removal of the SIM is possible without disconnection of the power supply (Y/N).

A3.2.1.9 Classmark

The coding of Mobile station classmark 1, 2, and 3 and the fact whether and under which conditions the classmark 3 information element is included in a CLASSMARK CHANGE message, has to be declared by the manufacturer. The declaration has to fulfil the following requirements:

- Mobile station classmark 1: Bits 4, 5, and 8 of the first (and only) octet of the value part of the information element shall be coded as "0". The "Revision level" and "RF power capability" field shall specify the value that is correct for the MS.
- Mobile station classmark 2: Bits 4, 5, and 8 of the first octet, bits 2, 3, and 8 of the second octet, bits 3 to 7 of the third octet of the value part of the information element shall be coded as "0". The "Revision level" field, "RF power capability" field, "PS capability" field, "SS Screening indicator" field, "SM capability" field, "Frequency capability" field, "Classmark 3" field, "A5/2 algorithm supported" field, and "A5/3 algorithm supported" field shall specify the value that is correct for the MS.
- Mobile station classmark 3: Bits 5 to 8 of the first octet of the value part of the information element shall be coded as "0". If the value part contains more octets, they shall be coded as "0000 0000". The "A5/4 algorithm supported" field, "A5/5 algorithm supported" field "A5/6 algorithm supported" field, and "A5/7 algorithm supported" field shall specify the value that is correct for the MS (that is, they shall be set to "0").

NOTE: The requirements to the classmark may be subject to changes. That is why test cases are expected to verify the manufacturer's declaration, whereas the correctness of the manufacturer's declaration is to be verified "off line".

A3.2.1.10 Type of SIM/ME interface (ref. GSM 11.11 and GSM 11.12)

- 5V SIM/ME interface (5V only ME)
- 3V SIM/ME interface (3V only ME)

- 5V/3V SIM/ME interface (3V technology ME)

A3.2.1.11 Multislot class

- Multislot class as defined in annex B.1 of GSM 05.02

A3.2.2 Man machine interface

A3.2.2.1 Mobile station features

- Description of manual entry and display of a called number.
- Description of the basic way to send a call manually.
- Description of the basic way to take a call manually.
- Description of the basic way to end a call manually.
- Description of the basic way to send an emergency call manually.
- Description of the basic way to send DTMF manually.
- Description of the manual PLMN selector.
- Description of the automatic PLMN selector.
- Description of the indication of the country.
- Description of the indication of the available PLMN.
- Description of the indication of the automatic registration to a PLMN.
- Description of the service indicator.
- Description of the management of the SIM by the user:
 - . keying PIN and changing PIN,
 - . indication of acceptance or rejection of keyed PIN,
 - . indication of blocked SIM,
 - . indication of successful unblocking of the SIM,
 - . storing an abbreviated number,
 - . displaying an abbreviated number.
- Description of the selection of the hands free.
- Description of the volume control.
- Description of local barring of outgoing calls.
- Description of prevention of unauthorized calls.
- Description of the auto calling management:
 - . selection of the auto calling,
 - . indication that the call failed and a re-try is attempted,
 - . indication that the call finally failed,
 - . number of B-party numbers that can be stored in the list of blacklisted numbers.

- Description of the way in which the MS generates an MS originated NOTIFY, if possible. This feature may or may not be supported by the MS.
- Description of the way the MS indicates the identity of the current LSA to the human user (only applicable if the SoLSA MS has an interface to the human user)
- Description of the way the MS indicates the change of the current LSA to the human user (only applicable if the SoLSA MS has an interface to the human user)

NOTE: All the above description could be extracted from the user's manual.

A3.2.2.2 Short message service

- Description of the basic procedures to send a mobile originated short message.
- Description of the basic procedures to display a mobile terminated short message.
- Description of the basic procedures to display a cell broadcasted short message.
- The value of the timer TC1M.
- Whether SMS messages are stored in the SIM and/or the ME.
- Maximum length (characters) of a mobile originated short message.

A3.2.2.3 Supplementary services

A3.2.2.3.1 Call forwarding

- Description of the user's commands and of the display of the answers from the network for:
 - registration,
 - erasure,
 - activation,
 - deactivation,
 - interrogation,
 - specific data request.
- Description of the display of:
 - . notification of an incoming call to the "served" mobile or the "forwarded to" mobile,
 - . notification during out-going call,
 - . information to the calling mobile.

A3.2.2.3.2 Call restriction

- Description of the user's commands and the display of the answers from the network for:
 - registration,
 - change of the password,
 - activation,
 - deactivation,

interrogation.

- Description of the display of the indication of call barring.

A3.2.2.3.3 Handling of (undefined) GSM supplementary services

- Description of the user's commands and the display of the answer from the network.

A3.2.3 Electrical Man Machine Interface (EMMI)

A3.2.3.1 Methods supported for activation/deactivation of EMMI

- all possibilities specified in GSM 11.10, section 36.2.2 ;
- all possibilities specified in GSM 11.10, section 36.2.2 , except activation by inserting a test SIM (when the ME is already switched on);
- activation/deactivation only via layer 3 messages on the radio interface according to GSM 11.10, section 36.2.2

A3.2.3.2 Transmission rate supported by the ME on the EMMI

A3.2.3.3 Layer 3 messages supported on the EMMI

- Layer 3 messages as specified in GSM 11.10, section 36.3.5.3.2, except: (followed by the list of messages not supported);
- others than defined in GSM 11.10 section 36.3.5.3.1 table 9.

A3.2.3.4 Keystroke sequence messages

Non standard keystroke sequences to be used on the EMMI (in line with GSM 11.10, 36.3.5.3.2):

- related to tests of the mobile station features (GSM 11.10, section 33);
- related to testing of the ME/SIM interface (GSM 11.10, section 27);
- related to tests of autocalling restrictions (GSM 11.10, section 28);
- related to tests of supplementary services (GSM 11.10, section 31);
- related to tests of data services (GSM 11.10, section 29);
- related to tests of short message service (GSM 11.10, section 34);
- related to other tests.

A3.2.3.5 Internal malfunction detected messages

List of the error indicators provided.

A3.2.4 Digital Audio Interface (DAI)

Description of the speech data routing:

- via the control lines;
- or via the test interface message.

A3.2.5 Characteristics related to bearer services or teleservices

A3.2.5.1 Access interface

Description of the access interface to connect the DTE (e.g. V series (V.24, V.28), X series, two wire analogue interface for use with fax group 3, I.420 (S-reference point).

In case of a proprietary interface to a DTE (non standard), description of this interface (hardware and software).

In case of a non standard connector provide a mechanical adapter.

A3.2.5.2 Configuration of the MT

Description of the configuration information to be selected in the MT to connect a terminal equipment to the mobile termination.

Description of the (different) configuration(s) of the MT for each bearer service and each teleservice supported, with the range or value for the parameters and the configuration procedure.

For the purpose of test of MOC, the manufacturer shall describe precisely how it is possible to put the MT in the different configurations to generate the capability information of the Mobile according to section 3.2.5.3, and described as supported by the MS.

For the purpose of test of MTC, the manufacturer shall describe how to verify the correct selection by the MT of the required function with regard to the capability information as described below, especially using the messages at the Um interface if there is no R or S interface available (case MTO). The description shall be made for every combination of the parameter value valid for the MT.

A3.2.5.3 Capability information

Description of the capability information, related to supported bearer services:

- bearer capabilities,
- higher layer capabilities,
- lower layer capabilities,

The manufacturer shall describe for every capability the associated terminal functions and their characteristics.

A3.2.5.4 Subaddress or DDI number

Subaddress or a DDI number of the MT.

Procedure to allocate or change DDI number or subaddress, if possible.

A3.2.5.5 User to user signalling

Description of the function and the user's access to it.

A3.2.5.6 Data call set-up and data call clearing

For each implemented transparent and non-transparent data service:

- Description of the data call establishment mechanism:
 - Terminal initiated (CT108) (if possible),
 - MT (MMI/EMMI) initiated.
- Description of DCE provided information (MT to TE), if any.

- Declaration of optimal function and procedure, services supported by the MT.
- Description of the data call clearing mechanism:
 - Terminal initiated (CT109) (if possible),
 - MT (MMI/EMMI) initiated.
- Description of DCE provided information (MT to TE) related to a mobile or network initiated call clearing, if any.

A3.2.5.7 Characteristics of non-transparent data services

Description of Radio Link Protocol (RLP) features supported.

Description of supported RLP parameters and how to modify these values (if possible)

<iws> IWF to MS window size

<mws> MS to IWF window size

<T1> acknowledgement timer T1

<N2> retransmission attempts N2

Ability to configure the MS to use non-default RLP parameters.

Description of flow control mechanism:

- INBAND (XON/XOFF);
- OUTBAND COP_{noFICt} (CT105 and CT106).

A3.2.5.8 Possible ways of setting-up a call from either an external interface or internally

Describe in detail all possible ways a call can be initiated from the MS or a connected terminal.

A3.2.5.9 Application layer causing automatic call termination

State whether the call termination facility can be disabled and if so, describe in detail how.

A3.2.5.10 Call re-establishment for MS not supporting speech

Applicability of call re-establishment.

A3.2.6 International mobile station equipment identity

IMEI of the MS.

A3.2.7 Receiver intermediate frequencies

F_{lo} - Local Oscillator frequency applied to first receiver mixer.

$IF_1 \dots IF_n$ - intermediate frequencies.

A3.2.8 Artificial ear

The manufacturer shall declare which type of artificial ear (type 1 or type 3.2 or type 3.4) is used for teleservices speech testing.

The following illustrate the results of both artificial ears when specified for acoustic receiving measurement.

Type 3.2 results are currently referred to ERP (as specified), but measured at DRP. When introducing DRP to ERP correction, a special frequency response is used which is obtained with the artificial ear in a free sound field. The overall result actually differs substantially from the transfer function under the IEC 318 test conditions. Referring the results to DRP instead avoids misleading interpretations.

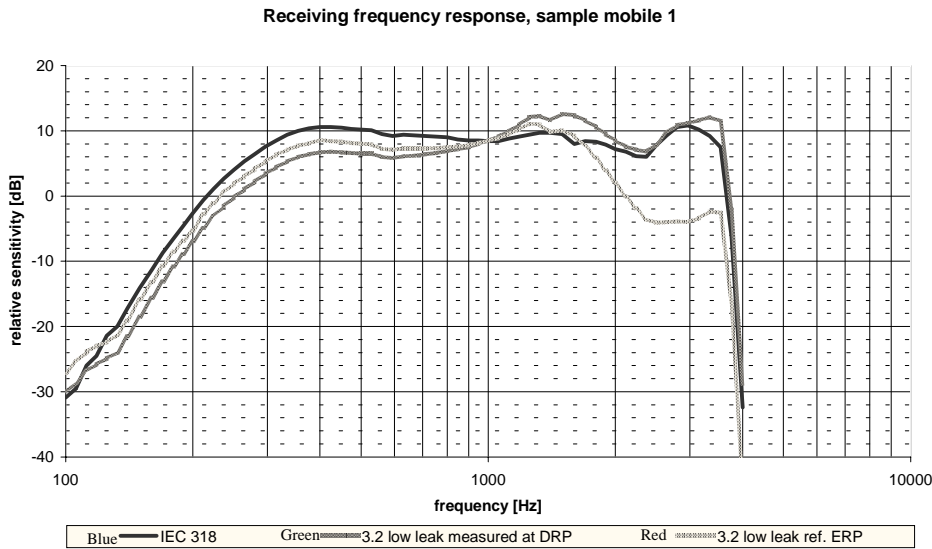

This slide as well as the following two shows results of three measurement and evaluation methods per each mobile sample. The blue curve is as measured sealed to IEC 318 closed coupler. The green curve is as measured with type 3.2 low leak coupler at DRP. The red curve shows the same measurement data corrected to ERP using the correction function provided by the manufacturer.

Receiving frequency response, sample mobile 2

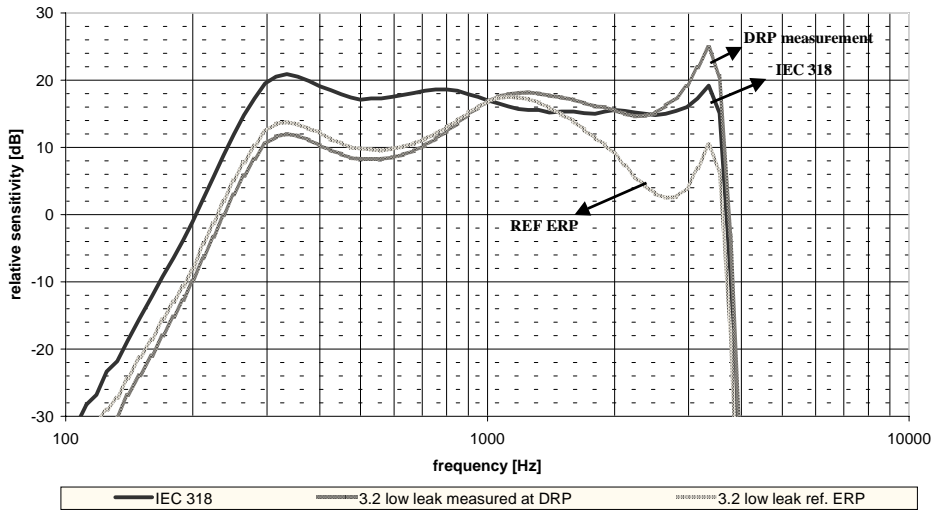

Receiving frequency response, sample mobile 3

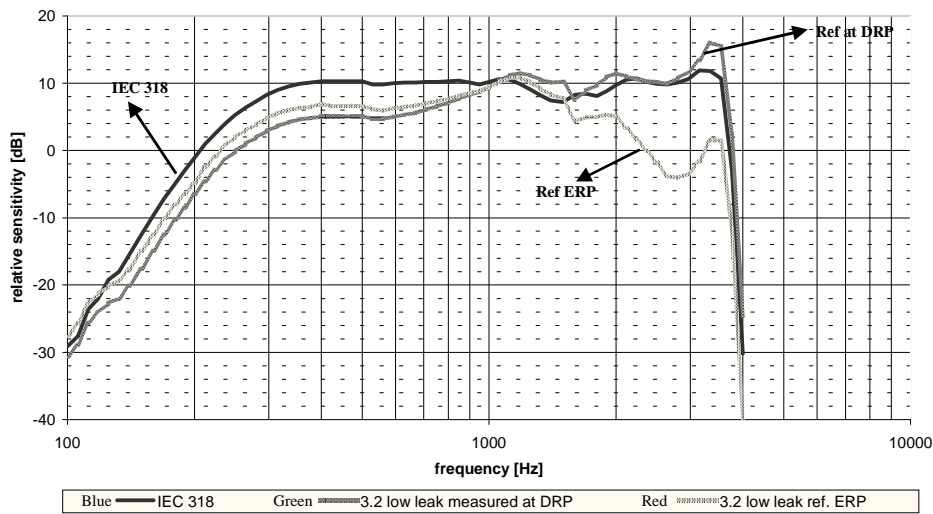

Below 1 KHz both type 3.2 curves are similar. The level decreases from IEC 318 to the type 3.2 results is due to the leak. At high frequencies the measured type 3.2 curve without DRP to ERP correction (green) clearly illustrates better compatibility towards IEC 318 results than the curve referred to ERP (red).

DRP to ERP transfer function of type 3.2 artificial ear

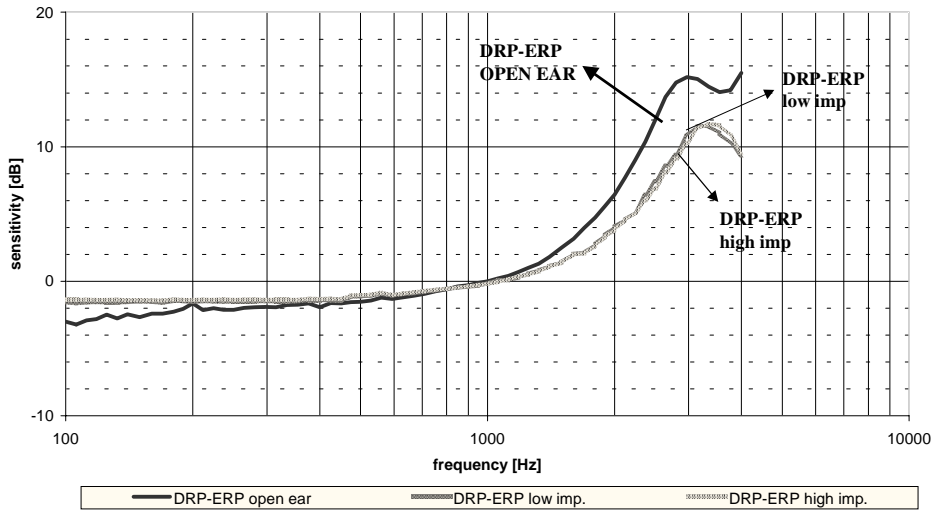

The three curves show the DRP to ERP transfer function for different source conditions. The blue line is obtained mounted in a baffle. The other two functions are measured with a probe microphone at ERP on two mobiles with different acoustic source impedance.

The difference between the results of type 3.2 low leak artificial ear referred to DRP and ERP respectively is due to the acoustic input impedance of the artificial ear. The high acoustic impedance at DRP is transferred to a relatively low impedance at ERP for high frequencies according to the quarter wavelength distance between both points. This means that acoustic energy at ERP is more in terms of sound velocity, which is not measured with the used pressure microphone. The human ear is known to have its highest sensitivity around 5 KHz. Type 3.2 low leak measurement referred to ERP has particularly low sensitivity at this frequency. In order to account for compatibility between IEC 318 results and type 3.2 low leak results as well as for the sensitivity of the human ear, it is up to the choice of the terminal manufacturer, whether acoustic test results from the type 3.2 low leak artificial ear should be referred to ERP or to DRP.

Annex 4: Test SIM Parameters

A4.1 Introduction

This section defines default parameters for programming the elementary files of the test SIM. The requirements of this annex do not apply to the SIM/ME tests of section 27.

A4.1.1 Definitions

"Test SIM card":

A SIM card supporting the test algorithm for authentication, programmed with the parameters defined in this section. The electrical, mechanical and environmental requirements of the test SIM card are specified in GSM 11.11.

"Test SIM":

Either a test SIM card or the SIM simulator programmed with the parameters defined in this section.

A4.1.2 Definition of the test algorithm for authentication

The following procedure employs bit wise modulo 2 addition ("XOR")

The following convention applies:

In all data transfer the most significant byte is the first byte to be sent; data is represented so that the left most bit is the most significant bit of the most significant byte.

Step 1:

XOR to the challenge RAND, a predefined number K_i , having the same bit length (128 bits) as RAND. The result RES1 of this is

$$RES1 = RAND \text{ XOR } K_i$$

Step 2:

The most significant 32 bits of RES1 form SRES. The next 64 bits of RES1 form Kc. The remaining 32 bits are not used.

A4.2 Default Parameters for the test SIM

Ki:

The authentication key "Ki" will be chosen by the test house and will be non zero. The "Ki" value used by the SS will align with this value.

PIN Disabling

The PIN enabled / disabled flag will be set to "PIN Disabled". This ensures that when the Test SIM is inserted into a MS the user will not be prompted for PIN entry. This requires a specific card capability defined by the SIM service table (see section 2.9).

A4.3 Default settings for the Elementary Files (EFs)

The format and coding of elementary files of the SIM are defined in GSM 11.11. The following sections define the default parameters to be programmed into each elementary file. Some files may be updated by the MS based on information received from the SS. These are identified in the following sections.

A4.3.1 EF_{ICCID} (ICC Identification)

The programming of this EF is a test house option.

A4.3.2 EF_{LP} (Language preference)

The programming of this EF is a test house option.

A4.3.3 EF_{IMSI} (IMSI)

The IMSI value will be chosen by the test house. The IMSI used by the SS will align this value.

File size:	9 bytes	
Default values:	Byte 1 (DEC): 8	
	Bytes 2-9 (HEX): 09 10 10 ** ** ** **	for GSM 400, GSM 900 and DCS 1 800
	Bytes 2-9 (HEX): 09 10 10 *1 ** ** **	for GSM 1 900

"*" indicates any number between 0 and 9 subject to the restriction that IMSI mod 1000 (i.e. bytes 7, 8 and 9) lies in one of the following ranges:

063-125, 189-251, 315-377, 441-503, 567-629, 693-755, 819-881 or 945-999

NOTE: This ensures that the MS can listen to the second CCCH when more than one basic physical channel is configured for the CCCH. This is necessary for the test of "paging re-organization".

A4.3.4 EF_{Kc} (Cipherring key Kc)

File size:	9 Bytes
Default values (HEX):	Bytes 1-8: Align with Kc used by SS
	Byte 9: 07

Byte 9 is set to 07 to indicate that there is no key available at the start of a test.

The bytes within this elementary file may be updated by the MS as a result of a successful authentication attempt.

A4.3.5 EF_{PLMNsel} (PLMN selector)

GSM 400, GSM 900 and DCS 1 800 begin

File size:	102 bytes
Default values (HEX):	Bytes 1-3: 32 F4 10 (MCC, MNC) - Translates to 234, 01
	Bytes 4-6: 32 F4 20 (MCC, MNC)
	Bytes 7-9: 32 F4 30 (MCC, MNC)

Bytes 94-96: 32 F4 23 (MCC, MNC)
 Bytes 97-99: 32 F4 33 (MCC, MNC)
 Bytes 100-102: 32 F4 43 (MCC, MNC)

GSM 400, GSM 900 and DCS 1 800 end

PCS 1900 begin

File size: 102 bytes
 Default values (HEX): Bytes 1-3: 32 24 10 (MCC, MNC) - Translates to 234, 012
 Bytes 4-6: 32 34 20 (MCC, MNC)
 Bytes 7-9: 32 44 30 (MCC, MNC)

 Bytes 94-96: 32 34 23 (MCC, MNC)
 Bytes 97-99: 32 44 33 (MCC, MNC)
 Bytes 100-102: 32 54 43 (MCC, MNC)

PCS 1900 end

34 PLMNs are shown coded above since this is the largest number required for a test - see section 27.9.4.1. It is necessary to take this into account since the SIM cards must be dimensioned to cope with this number of records.

A4.3.6 EF_{HPLMN} (HPLMN search period)

File size: 1 byte
 Default value (HEX): 00 (no HPLMN search attempts)

A4.3.7 EF_{ACMmax} (ACM maximum value)

File size: 3 bytes
 Default: Byte 1: 00
 Byte 2: 00
 Byte 3: 00

The above translates to: "Not valid".

A4.3.8 EF_{SST} (SIM service table)

Services will be allocated and activated as follows:

Service	Allocated	Activated
No. 1: CHV1 disable function	Yes	Yes
No. 2: Abbreviated Dialling numbers (ADN)	Yes	Yes
No. 3: Fixed dialling numbers (FDN)	Yes	Optional
No. 4: Short Message Storage (SMS)	Yes	Yes
No. 5: Advice of Charge (AoC)	Yes	Yes
No. 6: Capability Configuration Parameters (CCP)	Yes	Yes
No. 7: PLMN Selector	Yes	Yes
No. 8: Reserved for future use	No	No
No. 9: MSISDN	Optional	Optional
No. 10: Extension 1	Yes	Optional
No. 11: Extension 2	Yes	Optional
No. 12: SMS Parameters	Yes	Yes

No. 13: Last Dialed Number (LND)	Yes	Yes
No. 14: Cell Broadcast Message Identifier	Yes	Yes
No. 15: Group identifier Level 1	Yes	Optional
No. 16: Group identifier Level 2	Yes	Optional
No. 21: VGCS Group Identifier List (EF _{VGCS} , EF _{VGCS})	Yes	Yes
No. 22: VBS Group Identifier List (EF _{VBS} , EF _{VBS})	Yes	Yes
No. 23: eMLPP service	Yes	Yes
No. 24: Automatic answer for eMLPP	Yes	Yes

A4.3.9 EF_{ACM} (Accumulated call meter)

File size:	3 bytes
Default:	Byte 1: 00
	Byte 2: 00
	Byte 3: 00

The above translates to: "Not yet implemented".

A4.3.10 EF_{PUCT} (Price per unit and currency table)

File size:	5 bytes
Default:	Byte 1-3: FF
	Byte 4-5: 00

A4.3.11 EF_{CBMI} (Cell broadcast Message Identifier Selection)

The programming of this EF is a test house option.

The file size is 2n bytes, where n is the number of Cell broadcast message identifier records - each record defining a type of Cell Broadcast message which may be accessed by the MS. Care should be taken when dimensioning the SIM to take into account the number of Cell Broadcast message identifier records required.

A4.3.12 EF_{BCCH} (Broadcast control channels)

File size:	16 Bytes
Default values (BIN):	Bytes 1-2: 11111111 11111111
	Bytes 3-4: 11111111 11111111
	Bytes 5-6: 11111111 11111111
	Bytes 7-8: 11111111 11111111
	Bytes 9-10: 11111111 11111111
	Bytes 11-12: 11111111 11111111
	Bytes 13-14: 11111111 11111111
	Bytes 15-16: 11111111 11111111

This field may be updated dependent on the MS implementation.

A4.3.13 EF_{ACC} (Access control class)

File size:	2 Bytes
Default values (BIN):	Byte 1: 00000000
	Byte 2: *****

The test house may set any single bit of byte 2 to "1". All remaining bits of byte 2 will be set to "0". This determines the access control class of the SIM.

A4.3.14 EF_{FPLMN} (Forbidden PLMNs)

Length: 12 Bytes
 Format (HEX): Bytes 1-3: FF FF FF
 Bytes 4-6: FF FF FF
 Bytes 7-9: FF FF FF
 Bytes 10-12: FF FF FF

This coding corresponds to an empty "forbidden PLMN list". The bytes within this file may be updated if a LOCATION UPDATE REJECT message is received by the MS with cause, "PLMN not allowed".

A4.3.15 EF_{LOCI} (Location information)

GSM 400, GSM 900 and DCS 1 800 begin

File size: 11 Bytes
 Default values: Bytes 1-4 (HEX): FF FF FF FF (TMSI)
 Bytes 5-9 (HEX): 42 F6 18 FF FE (LAI)
 Byte 10 (HEX): FF (Periodic LU Time = "the timer is not running")
 Byte 11 (BIN): 00000001 (Location Update Status = "not updated")

Bytes 5-9: LAI-MCC = 246 (bytes 5-6) and LAI-MNC = 81 (byte 7) are frequently used in section 27. The LAC (bytes 8-9) is set to "FF FE" since this, in conjunction with byte 11 setting of "01", is used to ensure that the MS performs a location update at the beginning of a test.

Bytes in this file (e.g. TMSI in bytes 1-4) may be updated as a result of a location update attempt by the MS.

GSM 400, GSM 900 and DCS 1 800 end

PCS 1900 begin

File size: 11 Bytes
 Default values: Bytes 1-4 (HEX): FF FF FF FF (TMSI)
 Bytes 5-9 (HEX): 42 36 18 FF FE (LAI)
 Byte 10 (HEX): FF (Periodic LU Time = "the timer is not running")
 Byte 11 (BIN): 00000001 (Location Update Status = "not updated")

Bytes 5-9: LAI-MCC = 246 (bytes 5-6) and LAI-MNC = 813 (bytes 6-7) are frequently used in section 27. The LAC (bytes 8-9) is set to "FF FE" since this, in conjunction with byte 11 setting of "01", is used to ensure that the MS performs a location update at the beginning of a test.

Bytes in this file (e.g. TMSI in bytes 1-4) may be updated as a result of a location update attempt by the MS.

PCS 1900 end

A4.3.16 EF_{AD} (Administrative data)

File size: 3 bytes
 Default values: Byte 1: 10000000 - (type approval operations)
 Byte 2: 11111111
 Byte 3: 11111111

A4.3.17 EF_{Phase} (Phase identification)

File size: 1 byte
 Default value (HEX): 02 Phase 2

A4.3.18 EF_{ADN} (Abbreviated dialling numbers)

The programming of this EF is a test house option. It should be noted that sufficient space should be provided on the SIM card for 101 records - see section 27.15.4.1.

A4.3.19 EF_{FDN} (Fixed dialling numbers)

Optional.

A4.3.20 EF_{SMS} (Short messages)

Default: Records 1-5	Byte 1:	00
	Byte 2:	FF
	Bytes 3-14:	FF FF FF FF FF FF FF FF FF FF FF FF
	Bytes 15-26:	FF FF FF FF FF FF FF FF FF FF FF FF
	Byte 27:	FF
	Byte 28:	FF
	Bytes 29-35:	FF FF FF FF FF FF FF
	Byte 36:	FF
	Bytes 37-176:	All Bytes set to FF

A4.3.21 EF_{CCP} (Capability configuration parameters)

File size:	14 bytes
Default values	Byte 1: 04
	Byte 2: 01
	Byte 3: A0
	Bytes 4-14: FF

The above translates to: "Full rate, GSM Standardized coding, circuit mode and speech".

A4.3.22 EF_{MSISDN} (MSISDN)

Optional.

A4.3.23 EF_{SMSP} (Short message service parameters)

The programming of this EF is a test house option.

Each record size is 28+Y bytes, where Y is the number of bytes in the Alpha Identifier. Care should be taken when dimensioning the SIM to take into account the number of Short message service parameter records required.

A4.3.24 EF_{SMSS} (SMS status)

File size: 2 bytes

Byte 1: 00
Byte 2 (BIN): 11111111

The above translates to:

- (a) Last Mobile Originated Short Message had a TP Message Reference parameter of “00”.
- (b) SMS Memory Capacity Exceeded, Notification Flag unset: memory capacity available.

A4.3.25 EF_{EXT1} (Extension 1)

Optional.

A4.3.26 EF_{EXT2} (Extension 2)

Optional.

A4.3.27 EF_{VGCS} (Voice Group Call Service)

This EF contains a list of the default VGCS group identifiers.

File size: Bytes 200

Default values:

Bytes	Group ID	Value	BCD encoding in the SIM card
1-4	1	12	21 FF FF FF
5-8	2	123	21 F3 FF FF
9-12	3	1234	21 43 FF FF
13-16	4	12348	21 43 F8 FF
17-20	5	123491	21 43 19 FF
21-24	6	1235029	21 53 20 F9
25-28	7	12351	21 53 F1 FF
29-32	8	12352	21 53 F2 FF
33-36	9	12353	21 53 F3 FF
37-40	10	12354	21 53 F4 FF
41-44	11	12355	21 53 F5 FF
45-48	12	12356	21 53 F6 FF
49-52	13	12357	21 53 F7 FF
53-56	14	12358	21 53 F8 FF
57-60	15	12359	21 53 F9 FF
61-64	16	20000	02 00 F0 FF
65-68	17	20001	02 00 F1 FF
69-72	18	20002	02 00 F2 FF
73-76	19	20003	02 00 F3 FF
77-80	20	20004	02 00 F4 FF
81-84	21	20005	02 00 F5 FF
85-88	22	20006	02 00 F6 FF
89-92	23	20007	02 00 F7 FF
93-96	24	20008	02 00 F8 FF
97-100	25	20009	02 00 F9 FF
101-104	26	20010	02 10 F0 FF
105-108	27	66660	66 66 F0 FF
109-112	28	66661	66 66 F1 FF
113-116	29	66662	66 66 F2 FF
117-120	30	666638	66 66 83 FF
121-124	31	66664	66 66 F4 FF
125-128	32	66665	66 66 F5 FF
129-132	33	66666	66 66 F6 FF
133-136	34	66667	66 66 F7 FF
137-140	35	66668	66 66 F8 FF
141-144	36	66669	66 66 F9 FF
145-148	37	66670	66 76 F0 FF
149-152	38	80120	08 21 F0 FF
153-156	39	80121	08 21 F1 FF
157-160	40	80122	08 21 F2 FF
161-164	41	80123	08 21 F3 FF
165-168	42	80124	08 21 F4 FF
169-172	43	80125	08 21 F5 FF
173-176	44	80126	08 21 F6 FF
177-180	45	80127	08 21 F7 FF
181-184	46	80128	08 21 F8 FF
185-188	47	80129	08 21 F9 FF
189-192	48	80130	08 31 F0 FF
193-196	49	99999	99 99 F9 FF
197-200	50	1111119	11 11 11 F9

A4.3.28 EF_{VGCS} (Voice Group Call Service Status)

This EF contains the default activation of the VGCS group identifiers. The following list of group ID are activated: 1, 4, 20, 30, 50.

File size: Bytes 7

Default values (HEX): Bytes 1-7: '09 00 08 20 00 00 FE'

A4.3.29 EF_{VBS} (Voice Broadcast Service)

This EF contains a list of the default VBS group identifiers.

File size: Bytes 200

Default values:

Bytes	Group ID	Value	BCD encoding in the SIM card
1-4	1	12	21 FF FF FF
5-8	2	123	21 F3 FF FF
9-12	3	1234	21 43 FF FF
13-16	4	12348	21 43 F8 FF
17-20	5	123491	21 43 19 FF
21-24	6	1235029	21 53 20 F9
25-28	7	12351	21 53 F1 FF
29-32	8	12352	21 53 F2 FF
33-36	9	12353	21 53 F3 FF
37-40	10	12354	21 53 F4 FF
41-44	11	12355	21 53 F5 FF
45-48	12	12356	21 53 F6 FF
49-52	13	12357	21 53 F7 FF
53-56	14	12358	21 53 F8 FF
57-60	15	12359	21 53 F9 FF
61-64	16	20000	02 00 F0 FF
65-68	17	20001	02 00 F1 FF
69-72	18	20002	02 00 F2 FF
73-76	19	20003	02 00 F3 FF
77-80	20	20004	02 00 F4 FF
81-84	21	20005	02 00 F5 FF
85-88	22	20006	02 00 F6 FF
89-92	23	20007	02 00 F7 FF
93-96	24	20008	02 00 F8 FF
97-100	25	20009	02 00 F9 FF
101-104	26	20010	02 10 F0 FF
105-108	27	66660	66 66 F0 FF
109-112	28	66661	66 66 F1 FF
113-116	29	66662	66 66 F2 FF
117-120	30	666638	66 66 83 FF
121-124	31	66664	66 66 F4 FF
125-128	32	66665	66 66 F5 FF
129-132	33	66666	66 66 F6 FF
133-136	34	66667	66 66 F7 FF
137-140	35	66668	66 66 F8 FF
141-144	36	66669	66 66 F9 FF
145-148	37	66670	66 76 F0 FF
149-152	38	80120	08 21 F0 FF
153-156	39	80121	08 21 F1 FF
157-160	40	80122	08 21 F2 FF
161-164	41	80123	08 21 F3 FF
165-168	42	80124	08 21 F4 FF
169-172	43	80125	08 21 F5 FF
173-176	44	80126	08 21 F6 FF
177-180	45	80127	08 21 F7 FF
181-184	46	80128	08 21 F8 FF
185-188	47	80129	08 21 F9 FF
189-192	48	80130	08 31 F0 FF
193-196	49	99999	99 99 F9 FF
197-200	50	1111119	11 11 11 F9

A4.3.30 EF_{VBS} (Voice Broadcast Service Status)

This EF contains the default activation of the VBS group identifiers. The following list of group ID are activated: 1, 4, 20, 30, 50.

File size: Bytes 7

Default values (HEX): Bytes 1-7: '09 00 08 20 00 00 FE'

A4.3.31 EF_{eMLPP} (enhanced Multi Level Pre-emption and Priority)

This EF contains default information about priority levels and fast call set-up conditions for the enhanced Multi Level Pre-emption and Priority service.

Length: 2 Bytes

Format (HEX): Byte 1 (Priority levels): '74'

Byte 2 (Fast call set-up conditions): '04'

The coding corresponds to available priority levels 2, 3, 4 and 0. For fast call setup, the coding corresponds to available priority level 0.

A4.3.32 EF_{AAeM} (Automatic Answer for eMLPP Service)

This EF contains the default priority levels (of the Multi Level Pre-emption and Priority service) for which the mobile station shall answer automatically to incoming calls.

Length: 1 Byte

Format (HEX): Byte 1 : '0F'

The coding corresponds to the default capability of the MS to answer automatically to incoming calls that have a priority level higher than 2.

Annex 5: Test equipment

A5.1 Introduction

A5.1.1 General

The test equipment is either an equipment or assembly of equipments which enables the tests described in this specification to be conducted.

This annex describes requirements for the test equipment which cannot be derived from and which are assumed in, the conformance test descriptions described in this specification.

Specifically stimulus setting and measurement uncertainties are defined.

A5.1.2 Test equipment terms

The term "System Simulator" (SS) is used to describe the complete suite of test equipment required to perform the tests in this specification when interacting with the following MS interfaces:

- Antenna (Connector or radiated);

- Acoustic;
- Data Port(s);
- Power supply;
- DAI.

NOTE: To perform a sub-set of tests, the SS may be simplified accordingly.

The term "SIM simulator" is used to describe the test equipment required to interact with the SIM/ME interface.

A "test SIM" has the physical characteristics of a standard SIM card, (see GSM 11.11) with specific parameters defined in annex 3.

A5.1.3 Confidence level

All uncertainty values stated in this annex are quoted for a Confidence Level of 95 %.

A5.2 Standard test signals

The Cx signals represent the wanted signals and the Ix signals represent the unwanted signals.

Signal C0	Unmodulated continuous carrier;
Signal C1	A standard GSM signal with GMSK modulation derived by applying a data reversals signal to the input of a channel coder. The channel coder will depend on the test and the cipher mode shall be selectable by the test method. When using this signal in the non hopping mode, the unused seven time slots shall also contain dummy bursts, with power levels variable with respect to the used timeslot, see also 2.3.1.3.
Signal I0	Unmodulated continuous carrier;
Signal I1	A GMSK modulated carrier following the structure of the GSM signals, but with all modulating bits (including the midamble period) derived directly from a random or pseudo random data stream.
Signal I2	A standard GMSK modulated signal with valid midamble, different from C1. The data bits (including bits 58 and 59) shall be derived from a random or pseudo random data stream.

A5.3 SS functional requirements

A5.3.1 Level setting range

It is assumed that the SS is capable of setting stimulus levels, at the MS interface, to those required in the test specification extended by the measurement uncertainty defined in this annex.

NOTE: This ensures that the SS is able adequately to stimulate the MS performance at and just beyond the limit requirement under all conditions.

A5.3.2 Level Measurement / operation range

It is assumed that the SS is capable of performing measurements, within the uncertainty defined in this annex, over a level range, at the MS interface, as required in the test specification extended by the SS measurement uncertainty defined in this annex and extended by a further 3dB on the MS conformity requirement.

NOTE: This ensures that the SS is able adequately to measure the MS performance at and just beyond the limit requirement under all conditions.

A5.3.3 MS power supply interface

Test DC power supply for MS:

Voltage setting uncertainty < 1 %.

Ripple < 10 mV RMS, 50 mV peak to peak.

Test AC power supply for MS:

Voltage setting uncertainty: < 1 %.

A5.3.4 MS antenna interface

The SS is assumed to offer a nominal 50 ohm impedance to the MS.

	GSM/DCS/PCS bands	< 4 GHz	< 10 GHz	< 12,75 GHz
VSWR	<= 1,3	<= 2,0	<= 3,0	<= 3,5

A5.3.4.1 Uplink receiver error

The SS receiver should be capable of performing the tests as specified in GSM 11.10 without the addition of bit errors in excess of 1 in 10E7 due to the receiver performance when operated with a MS which meets the transmitter requirements of GSM 05.05. This requirement shall apply for GMSK and 8PSK modulation.

NOTE: This requirement is based on a minimum BER measurement of 1 in 10E5.

A5.3.4.2 Power and Power versus time measurements

Measurement uncertainty of transmitter output power for GMSK and 8PSK signals: +/- 1 dB.

In the case of 8PSK, provision is made for power measurement by averaging over multiple bursts or by using an estimation method, see GSM 05.05, section 4. The estimation method may be based on measurements of one or more bursts, or part of a burst.

If 8PSK power is measured by averaging over multiple bursts, allowance must be made for variations in burst power as a function of the data. This allowance must be included within the +/-1dB measurement limit. The allowance is related to the number of bursts taken in the average and shall be defined as follows:

$$\text{Allowance for burst power variation} = 2\sigma/\text{SQRT}(N)$$

Where σ = the standard deviation of burst power variation for random data (0.2dB).

(two standard deviations yield a 95% confidence interval)

N = number of averages

EXAMPLE: An average is calculated from 4 bursts. The allowance for burst power variation is 0.2dB. The accuracy for the power meter should then be better than +/-0.8dB.

If 8PSK power is measured using an estimation method, it shall be demonstrated, using the method described below, that the accuracy of the estimation technique is also +/-1dB.

A test signal is established consisting of properly formatted bursts with midambles and random data in the payload. The long-term average power of this signal is determined by measuring the power over 200 bursts and taking the average (P_{avg}). The measurement uncertainty of the equipment used to determine the long-term average shall be noted (ΔP).

The same test signal is then measured using the estimation technique. The difference between the estimated value of long-term average power and the measured long-term average power is noted (P_{est}). The following inequality shall hold:

$$|\Delta P| + |(P_{\text{avg}} - P_{\text{est}})| \leq 1\text{dB}$$

For GMSK, measurement uncertainty of power level (relative to peak transmitter carrier power):

Power level	Measurement uncertainty
+ 6 dB to - 7 dB	+/-0,25 dB
- 7 dB to -20 dB	+/-1,0 dB
-20 dB to -32 dB	+/-2,0 dB
-32 dB to -45 dB	+/-5,0 dB
-45 dB to -71 dB	+/-1,0 dB
<-71 dB	+/-2,0 dB

For 8PSK, measurement uncertainty of power level (relative to output power):

Power level	Measurement uncertainty
+6 dB to -7dB	+/-0,25 dB
-7dB to -16dB	+/-1,0 dB
-16dB to -32dB	+/-2,0 dB
-32 dB to -45 dB	+/-5,0 dB
-45 dB to -71 dB	+/-1,0 dB
<-71 dB	+/-2,0 dB

NOTE: Due to the method of measurement (downconversion to I/Q baseband / filtering / A/D conversion / postprocessing) several uncertainties occur. The sources are:

- a) absolute level uncertainty;
- b) filter ripple,
I/Q gain imbalance,
I/Q imperfect quadrature;
- c) A/D conversion (resolution),
I/Q offset.

Items under b) and c) affect the individual samples and can be observed as a "ripple" in the horizontal part of the power time mask.

Items under b) are uncertainties which are proportional to the signal measured.

Items under c) are constant amounts of uncertainty, independent of the signal measured.

The item a) moves the entire power time template up or down.

The uncertainties b) and c) are added to the measured signal as an uncorrelated interferer.

The above mentioned absolute measurement uncertainty refers to a). The table covers uncertainties b) and c).

Uncertainty of time measurement

The relative timing uncertainty of the transition point:

- symbol 13 to 14 in the midamble (normal burst);
- end of the sync sequence (access burst);

is +/- 1/8 symbol.

Timing uncertainty of the measurement samples in the vertical part of the power time mask are displayed as marked fields in the figure A5.3-1

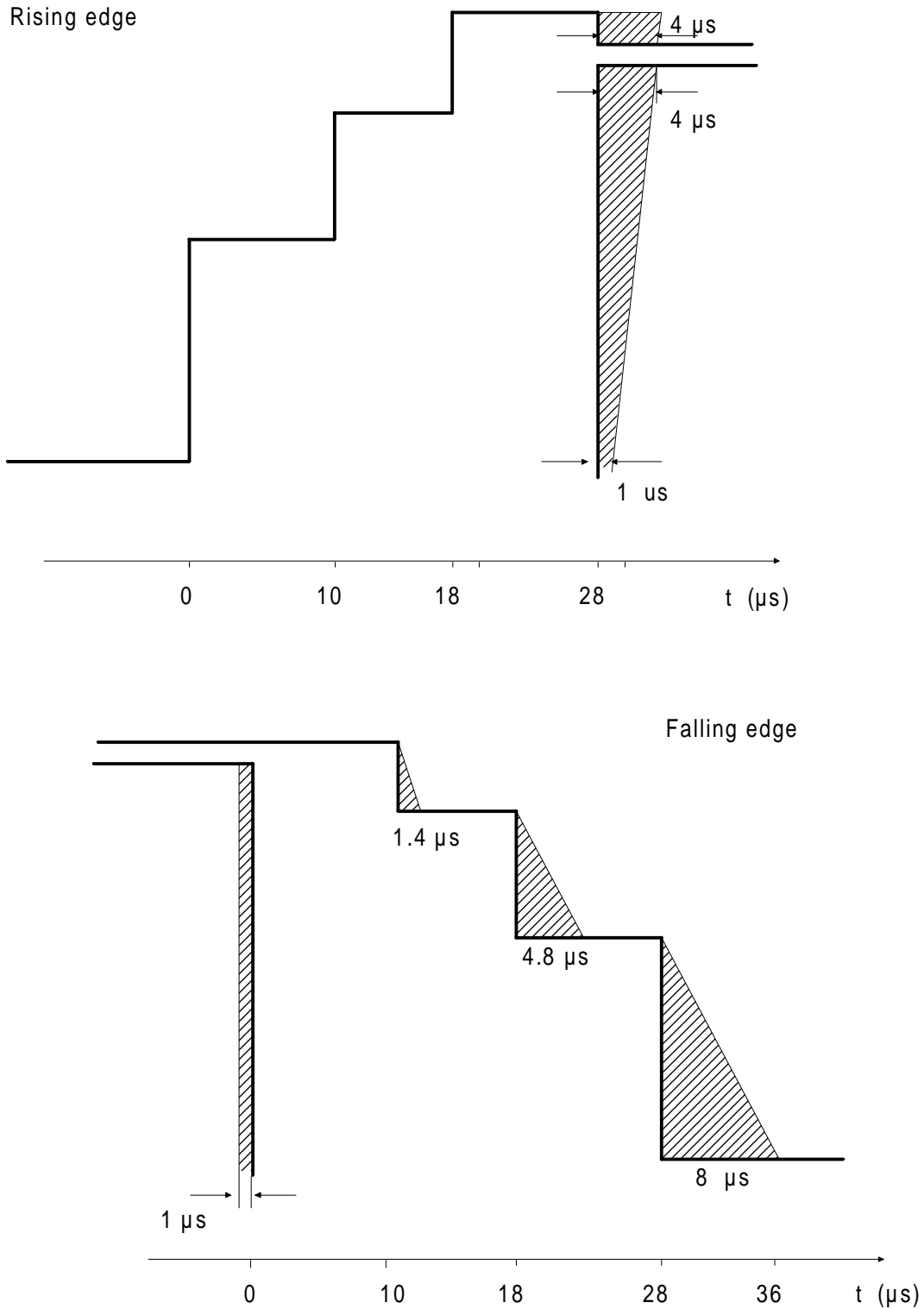

Figure A5.3-1 Time Measurement Uncertainty for the Power Time Mask

NOTE: With a real method of measurement one has to reckon on systematic measurement uncertainties in the vertical part of the power time template (figures 13-2 & 13-3). The reason for this is that the measurement is conducted through a filter which has to fulfil different requirements simultaneously, requirements in the frequency domain and in the time domain as well. The time behaviour of the filter causes the above mentioned measurement uncertainty. It occurs clearly when measuring the falling edge of the power burst. The measurement uncertainty, which in principle delays the actual performance, depends on the filter characteristics and on the signal shape. At favourable signal shapes the uncertainty is negligible, however, at unfavourable signal shapes it consumes the marked area in figure A5.3-1 (falling edge).

The underlying filter is:

type	inverse Chebycheff
passband	$\leq \pm 200$ kHz
stopband (40 dB stop att.)	$\geq \pm 541,67$ kHz.

To avoid aliasing with this filter the RF output spectrum must meet the requirements of section 13.4.

If the lowest limit line in the power time template is replaced by a -54 dBm line, measuring lower carrier powers, the area of measurement uncertainty is reduced equivalently.

The marked area in figure A5.3-1 describes the systematic measurement uncertainty of the test equipment and does not widen the design requirements.

Uncertainties associated with 13.3.5 requirement b) (power control levels, adjacent steps):

Repeatability	$\pm 0,3$ dB
Linearity	$\pm 0,03$ dB/dB
Combined uncertainty is:	$\pm (0,3 + 0,03)$ dB

E.g. where the indicated value of the step size is 2,0 dB, the uncertainty is:

$$\pm (0,3 + 0,06) \text{ dB} = \pm 0,36 \text{ dB.}$$

A5.3.4.3 Wideband selective power measurement

Power is to be measured selectively for spurious emissions without frequency hopping (ref.: section 12).

Uncertainty conducted	100 kHz to 1GHz	$\pm 1,5$ dB
	1 GHz to 12,75 GHz	$\pm 3,0$ dB

Uncertainty radiated	30 MHz to 4 GHz	± 6 dB
----------------------	-----------------	------------

NOTE: The uncertainties include the effect of a worst case reflection from the MS of 0,7 for out of band signals.

It is acceptable to use a band stop filter in spurious emission measurements of the transceiver in order to fulfil the above requirements.

A5.3.4.4 Inband selective power measurements

Power is to be measured selectively for output RF spectrum.

The measurement is performed on a single frequency while the MS is frequency hopping (ref.: section 13.3)

Uncertainty	$< \pm 1,6$ dB
-------------	----------------

NOTE: The video signal of the spectrum analyser is "gated" such that the spectrum generated by at least 40 of the bits 87 to 132 of the burst is the only spectrum measured. This gating may be analogue or numerical, dependent upon the design of the spectrum analyser.

A5.3.4.5 Modulation accuracy and frequency error measurements

GMSK modulation

Ref.: Sections 13.1 & 13.2 for definitions and methods of measurement.

Phase measurement uncertainty

+/- 1 degree RMS

+/- 4 degrees for individual phase measurement samples

The phase measurement uncertainties above apply during the useful bits.

Frequency measurement uncertainty: +/- 5 Hz.

8PSK modulation

Ref.: Sections 13.17.1 for definitions and methods of measurement.

EVM measurement uncertainty

$+(0.75 - 0.025\text{RMS_EVM}), - (0.75 + 0.025\text{RMS_EVM}) \% \text{ RMS}$

4% for individual EVM measurement samples

Note 1: The value of the RMS EVM specification is a function of the value of RMS_EVM being measured. The asymmetric specification results from the RMS EVM minimisation method used for parameter estimation (see GSM 05.05, Annex G). This method of measurement for RMS EVM always produces a result that is lower than the actual value of RMS EVM.

Note 2: The value for individual EVM samples assumes a Rayleigh distribution of measurement errors. It represents the maximum 95th percentile value test equipment should return when measuring a signal without error.

Note 3: If the test equipment demodulates the transmitted signal to derive the reference signal for the EVM measurement, the symbol error rate of the demodulation process must be less than $4.4 \cdot 10^{-4}$ for 95% confidence that no detection errors occur in a burst.

Origin Offset uncertainty <+/-1.5 dB for origin offset $\geq -35\text{dBc}$

Frequency measurement uncertainty <+/-20 Hz

A5.3.4.6 RF delay measurements relative to nominal times

Range -140 to +140 symbol periods

Resolution 1/4 symbol period

Uncertainty +/- 1/8 symbol period

A5.3.4.7 The wanted signal or traffic channel of serving cell

The Wanted signal is used in most of the specified RF measurements. The traffic channel of the serving cell is used in most of the signalling tests.

FREQUENCY:

GMSK

Uncertainty: < +/- $5 \cdot 10^{-9}$

8PSK

Uncertainty: $< +/- 20 * 10E-9$

MODULATION (see GSM 05.04):

GMSK

Phase uncertainty: $< +/- 1$ degree RMS and
 $< +/- 4$ degrees peak(as defined in GSM 05.05)

8PSK

EVM uncertainty < 4 % RMS

Origin offset suppression < -35 dBc

LEVEL:

Uncertainty: $< +/- 1$ dB in section 13, 14 except:-
 $< +/- 3$ dB for test 14.2 radiated
 $< +/- 1,2$ dB for test 14.6
 $< +/- 2,5$ dB for all other tests.

Settling time: < 10 us

DYNAMIC LEVEL SETTING:

The SS shall be able to switch from any power level to any other power level within the range of 30 dB on a timeslot per timeslot basis. This dynamic switching requirement only applicable for a single channel for a limited number of tests.

SPURIOUS:

inchannel: Covered by phase error

outchannel:

Noise Power, 1 Hz bandwidth:

< -100 dBc for > 100 kHz carrier offset,
 < -110 dBc for > 300 kHz carrier offset,
 < -121 dBc for > 1500 kHz carrier offset.

Non harmonics: < -55 dBc for > 100 kHz carrier offset,
 < -68 dBc for > 1500 kHz carrier offset

FREQUENCY HOPPING:

The signal shall be capable of hopping according to the criteria of GSM 05.02. The timing of the frequency change shall be such that frequency transitions do not occur during the active timeslot of the MS.

A5.3.4.8 The first interfering signal or traffic channel of the first adjacent cell

The First interfering signal is used in measurements of co-channel rejection, adjacent channel rejection and intermodulation rejection. The Traffic channel of the first adjacent cell is used in handover tests.

FREQUENCY:

Uncertainty: $< +/- 5 * 10E-9$

PHASE:

Uncertainty: < +/- 1 degree RMS and
< +/- 4 degrees peak(as defined in GSM 05.05)

LEVEL:

Uncertainty < +/- 1 dB relative to the wanted signal for
test 13.2 and 14.5
< +/- 0,3 dB relative to the wanted signal for
test 14.4
< +/- 1 dB for test 14.6
< +/- 2,5 dB for all other tests

MODULATION: GMSK (as specified in GSM 05.04)

The total relative single sideband power (noise + harmonics) in the frequency range 1,5 to 1,7 MHz offset from the nominal carrier frequency shall be less than -72 dBc.

SPURIOUS:

Inchannel: Covered by phase error

Outchannel:

Noise Power, 1 Hz bandwidth:

<-100 dBc for > 100kHz carrier offset

<-110 dBc for > 300kHz carrier offset

<-127 dBc for >1500kHz carrier offset

non harmonics < -55 dBc for > 100kHz carrier offset

< -68 dBc for >1500kHz carrier offset

FREQUENCY HOPPING:

The signal shall be capable of hopping according to the criteria of GSM 05.02. The timing of the frequency change shall be such that frequency transitions do not occur during the active timeslot of the MS.

A5.3.4.9 The second interfering signal

The second interfering signal is used in the measurements of intermodulation rejection and blocking.

FREQUENCY:

Uncertainty: < +/- 5*10E-9

LEVEL:

Uncertainty: < +/- 1 dB for test 14.6
< +/- 1,5 dB relative to the wanted signal
for all other tests.

MODULATION: Unmodulated

SPURIOUS:

Inchannel: No requirements

Outchannel:

Noise Power, 1 Hz bandwidth:

- <-135 dBc for > 500kHz carrier offset,
- <-140 dBc for > 700kHz carrier offset,
- <-150 dBc for >1500kHz carrier offset.

Non harmonics < -79 dBc for > 500kHz carrier offset,
 < -84 dBc for > 700kHz carrier offset,
 < -94 dBc for >1500kHz carrier offset

Harmonically related spuri <-40 dBc

A5.3.4.10 BCCH carriers of serving and adjacent cells

The BCCH of the serving cell is used for synchronizing the MS and to send network information to the MS under test. The BCCH signals of the adjacent cells are used in the handover tests. The MS measures the RF-levels of the BCCHs of adjacent cells.

FREQUENCY:

Uncertainty: < +/- 5*10E-9

PHASE:

Uncertainty: < +/- 1 degree RMS and
 < +/- 4 degrees peak(as defined in GSM 05.05)

LEVEL:

Uncertainty: < 1 dB for test 13.2 and 20
 < 2,5 dB for all other tests
 < 0,6 dB relative to each other and to TCH
 for test 21 over the range 65 dBmicroVoltemf
 to 3 dBmicroVoltemf
 < 1,2 dB relative to each other and to TCH for test 26.3

MODULATION: GMSK (as specified in GSM 05.04)

SPURIOUS:

Inchannel: Covered by phase error

Outchannel:

Noise Power, 1Hz bandwidth:

- <-100 dBc for > 100kHz carrier offset
- <-125 dBc for >1500kHz carrier offset

Non harmonics < -55 dBc for > 100kHz carrier offset
 < -72 dBc for >1500kHz carrier offset

A5.3.4.11 The wide frequency range signal

The wide frequency range signal is used in the measurements of spurious response.

FREQUENCY

Uncertainty: $< +/- 5 \cdot 10^{-9}$

LEVEL

Uncertainty: $< +/- 1,5$ dB relative to the wanted signal for test 14.7

$< +/- 1$ dB error of substituted "wanted signal"

MODULATION: unmodulated

SPURIOUS in the MS receiving range

non harmonics: < -94 dBc

Harmonically related spuri: < -40 dBc

Noise: < -4 dBuVemf equivalent at the MS receiver input
when measured in a 200 kHz bandwidth.

A5.3.4.12 The multipath fading function

The multipath fading function simulates the fading effects of a broadband radio channel in mobile radio communication

The propagation conditions are specified in GSM 05.05, annex 3.

The multipath fading function shall be performed only within a 5 MHz bandwidth during one test case.

A5.3.5 MS audio interface and DAI

A5.3.5.1 General uncertainties

Unless otherwise specified, the following uncertainties apply to the audio interface:--

Signal level measurement uncertainty: $+/- 0,2$ dB

Sound pressure measurement uncertainty: $+/- 0,6$ dB

Frequency Measurement uncertainty: $+/- 0,1$ %

Stimulus frequency setting uncertainty:

Frequency settings are taken from ISO 3, R10 series or R40 series or from table 2 of Rec. CCITT P.79. A departure from the nominal frequencies of $+/- 5$ % below 240 Hz and $+/- 2$ % at 240 Hz and above is accepted.

In the case of 4 kHz the departure is restricted to -2 %.

A5.3.5.2 Analogue single test tone

Total distortion: $< 0,5$ %

A5.3.5.3 Delay measurement between Um and DAI

The delay measurement between the Um interface of the MS and its DAI in both directions is described in section 32.5.

Uncertainty: $< +/- 0,1$ ms

A5.4 SIM simulator functional requirements

A5.4.1 General

The SIM simulator shall implement the functions of a SIM as described in GSM 02.17 and 11.11.

The Test Algorithm for authentication incorporated in the SIM Simulator shall operate as described in annex 3

A5.4.2 Contacts C1, C2, C6, C7

A5.4.2.1 Default measurement / setting uncertainties

Unless stated otherwise below, the following uncertainties apply:

Voltage measurement uncertainty: < +/- 50 mV

Voltage setting uncertainty: < +/- 20 mV

Time measurement uncertainty: < +/- 100 ns

A5.4.2.2 Contact C1

Continuous Spikes

Voltage measurement uncertainty: < +/- 100 mV

Current Load Amplitude 0 mA - 20 mA

Adjustable Step Size 1 mA

Uncertainty < +/- 1 mA

Additional Current Offset 0 mA - 5 mA

Adjustable Step Size 1 mA

Uncertainty < +/- 1 mA

Pulse Width 100 ns - 500 ns

Adjustable Step Size 50 ns

Uncertainty < +/- 25 ns

Rise and Fall Time <= 50 ns

Pause Width 100 ns - 500 ns

Adjustable Step Size 50 ns

Uncertainty < +/- 25 ns

Random Spikes

Voltage measurement uncertainty: < +/- 100 mV

Current Load Amplitude 50 mA - 200 mA

Adjustable Step Size 1 mA

Uncertainty < +/- 1 mA

Additional Current Offset	0 mA - 5 mA
Adjustable Step Size	1 mA
Uncertainty	< +/- 0,1 mA
Pulse Width	100 ns - 500 ns
Adjustable Step Size	50 ns
Uncertainty	< +/- 25 ns
Rise and Fall Time	<= 50 ns
Pause Width	0,1 ms - 500 ms, randomly varied
Adjustable Step Size	0,1 ms
Uncertainty	< +/- 0,1 ms

A5.4.2.3 Contact C7

The Elementary Time Unit (etu) used in the sections below refer to the nominal bit duration on the I/O line, as defined in ISO 7816-3.

Rise & fall Time setting uncertainty:	< +/- 100 ns
Jitter measurement uncertainty:	< +/- 5*10E-3 etu
Jitter setting uncertainty:	< +/- 5*10E-3 etu

A5.4.3 Contact C3

Frequency measurement uncertainty:	< +/- 0,5 %
Voltage Measurement uncertainty:	< +/- 50 mV
Rise & fall time measurement uncertainty:	< +/- 5 ns
Duty cycle measurement uncertainty:	< +/- 2,5 %

A5.4.4 Definition of timing

It shall be possible to define all timings relative to the clock. The SIM simulator shall be able to calculate and to use the absolute values automatically, even if the ME changes the frequency during the communication.

Annex B (informative): Change history

Change history									
TSG #	TSG Doc	CR	Rev	Subject/Comment	Cat	Old	New	WG Doc	Work item
08/2000				Conversion to 3GPP layout and number		11.10-1 v 9.0.1	51.010-1 v 4.0.1		
G-02	GP-000489	001		Applicability of 2 new GPRS tests 20.22.8 and 20.22.9	F	4.0.1	4.1.0	G4-000003	GPRS
G-02	GP-000491	002		PIXIT information for SoLSA	B	4.0.1	4.1.0	G4-000021	SoLS A
G-02	GP-000492	003		Test case 31.3.1.4 – Additions to test procedure	F	4.0.1	4.1.0	G4-000039	TEI
G-02	GP-000492	004		Test case 31.3.1.5 – Additions to test procedure.	F	4.0.1	4.1.0	G4-000040	TEI
G-02	GP-000492	005		TC 31.4.3.1.2 - Alignment of Expected Sequence with the Test Procedure description	F	4.0.1	4.1.0	G4-000050	TEI
G-02	GP-000492	006		TC 31.4.3.5 –Corrections of the Method of test according to the core specification GSM 04.84	F	4.0.1	4.1.0	G4-000051	TEI
G-02	GP-000490	007		Introduction of PCS 1900 into section 23	B	4.0.1	4.1.0	G4-000053	PCS1 900
G-02	GP-000490	008		Introduction of PCS 1900 into section 26.3	B	4.0.1	4.1.0	G4-000054	PCS1 900
G-02	GP-000490	009		Introduction of PCS 1900 into section 26.5	B	4.0.1	4.1.0	G4-000055	PCS1 900
G-02	GP-000490	010		Introduction of PCS 1900 into section 26.6	B	4.0.1	4.1.0	G4-000056	PCS1 900
G-02	GP-000490	011		Introduction of PCS 1900 into section 26.7	B	4.0.1	4.1.0	G4-000057	PCS1 900
G-02	GP-000490	012		Introduction of PCS 1900 into section 26.8	B	4.0.1	4.1.0	G4-000058	PCS1 900
G-02	GP-000490	013		Introduction of PCS 1900 into section 30	B	4.0.1	4.1.0	G4-000059	PCS1 900
G-02	GP-000490	014		Introduction of PCS 1900 into section 34	B	4.0.1	4.1.0	G4-000060	PCS1 900
G-02	GP-000492	015		Correction for testcase 31.4.3.1.1	D	4.0.1	4.1.0	G4-000070	TEI
G-02	GP-000492	016		Correction for testcase 31.4.3.1.2	D	4.0.1	4.1.0	G4-000071	TEI
G-02	GP-000492	017		Correction for testcase 31.4.3.1.3	D	4.0.1	4.1.0	G4-000072	TEI
G-02	GP-000492	018		Correction for testcase 31.4.3.2	D	4.0.1	4.1.0	G4-000073	TEI
G-02	GP-000488	019		Addition of EDGE test cases to the applicability table	B	4.0.1	4.1.0	G4-000099	EDGE
G-02	GP-000488	020		Introduction of 8PSK test equipment measurement uncertainties in Annex 5	B	4.0.1	4.1.0	G4-000100	EDGE
G-02	GP-000488	021		COMPACT Signal Strength test case	B	4.0.1	4.1.0	G4-000103	EDGE
G-02	GP-000488	022		COMPACT Cell Selection and Re-selection	B	4.0.1	4.1.0	G4-000104	EDGE
G-02	GP-000488	023		EDGE Timing advance and absolute delay	B	4.0.1	4.1.0	G4-000105	EDGE
G-02	GP-000492	024		Clause 31.4. Problem with test for call state U0	F	4.0.1	4.1.0	G4-000108	TEI
G-02	GP-000492	025		Test case 31.4.3.1.3 – Incorrect name for timer T in Test Purpose statement	F	4.0.1	4.1.0	G4-000109	TEI
G-02	GP-000487	026		Correction to the numbering of sections and procedures of AMR tests in section 26.16	D	4.0.1	4.1.0	G4-000111	AMR
G-02	GP-000490	027		Inclusion of PCS1900 in clauses 12, 13 and 14	B	4.0.1	4.1.0	G4-000116	PCS1 900
G-02	GP-000492	028		Clause 31.4.2.1.2.1. Correction to MPTY Auxiliary states.	F	4.0.1	4.1.0	G4-000119	TEI
G-02	GP-000492	029		Alignment of the AoC test case with the specification	F	4.0.1	4.1.0	G4-000120	TEI
G-02	GP-000492	030		26.10.2.1: mismatching value and use of the Extension Indication about the BCCH channel list, and inconsistencies in the measurement report list of ARFCNs	F	4.0.1	4.1.0	G4-000121	TEI
G-02	GP-000490	031		Introduction of PCS 1900 into section 40	B	4.0.1	4.1.0	G4-000122	PCS1 900
G-02	GP-000490	032		Introduction of PCS 1900 into sections 1 to 10	B	4.0.1	4.1.0	G4-000123	PCS1 900
G-02	GP-000490	033		Introduction of PCS 1900 into section 41	B	4.0.1	4.1.0	G4-000124	PCS1 900
G-02	GP-000490	034		Introduction of PCS 1900 into section 42	B	4.0.1	4.1.0	G4-000125	PCS1 900
G-02	GP-000491	035		Introduction of new cell selection and reselection test cases for SoLSA	B	4.0.1	4.1.0	G4-000126	SoLS A
G-02	GP-000491	036		Replacement of current chapter 26.15	B	4.0.1	4.1.0	G4-000127	SoLS A
G-02	GP-000491	037		Addition of SoLSA test cases to the applicability table	B	4.0.1	4.1.0	G4-000128	SoLS

Change history									
TSG #	TSG Doc	CR	Rev	Subject/Comment	Cat	Old	New	WG Doc	Work item
									A
G-02	GP-000489	038		Clarification of GPRS Receive Initial Conditions	F	4.0.1	4.1.0	G4-000129	GPRS
G-02	GP-000489	039		Clarification of GPRS Transmitter Initial Conditions	F	4.0.1	4.1.0	G4-000130	GPRS
G-02	GP-000489	040		Clarification of GPRS Timing advance and absolute delay Conditions	F	4.0.1	4.1.0	G4-000131	GPRS
G-02	GP-000492	041		Correction for testcase 31.4.3.4	F	4.0.1	4.1.0	G4-000134	TEI
G-02	GP-000492	042		Correction for testcase 31.4.3.5	F	4.0.1	4.1.0	G4-000135	TEI
G-02	GP-000489	043		Medium Access Control (MAC) Medium Access Control (MAC) Procedures on PCCCH in idle mode	F	4.0.1	4.1.0	G4-000144	GPRS
G-02	GP-000489	044		Dynamic Allocation in Packet Transfer Mode	F	4.0.1	4.1.0	G4-000145	GPRS
G-02	GP-000489	045		TC's section 41 – Channel combination v) instead of iv) and vii)	D	4.0.1	4.1.0	G4-000146	GPRS
G-02	GP-000489	046		The ARFCN list encoding for DCS in 42.1.2.2.3 cannot use Bit Map 0 format.	F	4.0.1	4.1.0	G4-000147	GPRS
G-02	GP-000489	047		Incorrect References in Specific Message Contents of 41.1.3	F	4.0.1	4.1.0	G4-000148	GPRS
G-02	GP-000489	048		Mis-alignment between the "Test Procedure" and "Expected Sequence" of test case 42.3.1.1.7.	F	4.0.1	4.1.0	G4-000149	GPRS
G-02	GP-000489	049		Test case 42.3.1.1.4 - inconsistencies between "Test Procedure" and "Expected Sequence" along with chronologically errors in "Expected Sequence"	F	4.0.1	4.1.0	G4-000150	GPRS
G-02	GP-000489	050		GPRS Paging tests on CCCH for GPRS service	F	4.0.1	4.1.0	G4-000151	GPRS
G-02	GP-000489	051		TC 41.2.2.4 – Correction of Expected sequence numbering	F	4.0.1	4.1.0	G4-000152	GPRS
G-02	GP-000489	052		TC 41.2.3.1 – Correction of Specific message contents	F	4.0.1	4.1.0	G4-000153	GPRS
G-02	GP-000489	053		TC 41.2.3.2 – Correction of Specific message contents	F	4.0.1	4.1.0	G4-000154	GPRS
G-02	GP-000489	054		TC 41.2.6.1 – Editorial modification of Section numbering	D	4.0.1	4.1.0	G4-000155	GPRS
G-02	GP-000489	055		TBF release	F	4.0.1	4.1.0	G4-000156	GPRS
G-02	GP-000489	056		GPRS Paging tests on PACCH for circuit-switched services	F	4.0.1	4.1.0	G4-000157	GPRS
G-02	GP-000489	057		SS Initial Conditions of 41.1	F	4.0.1	4.1.0	G4-000158	GPRS
G-02	GP-000489	058		Incorrect quotations from 0408 leading to unnecessary requirements in 41.1.5.	F	4.0.1	4.1.0	G4-000159	GPRS
G-02	GP-000489	059		41.1.2 Applicability, SS Broadcast Information and Pack Paging Request 1A MI Types	F	4.0.1	4.1.0	G4-000160	GPRS
G-02	GP-000489	060		Incorrect "timeslot allocation" value in 42.1.2.1.6 PSI type 2 message contents	F	4.0.1	4.1.0	G4-000161	GPRS
G-02	GP-000489	061		Correction of GPRS Mobility Management	F	4.0.1	4.1.0	G4-000162	GPRS
G-02	GP-000489	062		Measurement Reports and Cell Change Order Procedures	F	4.0.1	4.1.0	G4-000163	GPRS
G-02	GP-000489	063		TC 41.4.2.1 – Not tested Conformance requirements removed. Corrections in Test purpose, Expected sequence.	F	4.0.1	4.1.0	G4-000164	GPRS
G-02	GP-000489	064		Various Errors and Updates in Section 40	F	4.0.1	4.1.0	G4-000165	GPRS
G-02	GP-000489	065		GPRS SNDP Tests	F	4.0.1	4.1.0	G4-000166	GPRS
G-02	GP-000489	066		GPRS Receive Tests	F	4.0.1	4.1.0	G4-000087	GPRS
				Editorial modification to the title in the cover page		4.1.0	4.1.1		
				Addition of missing record in the history box		4.1.1	4.1.2		
GP-03	GP-010088	067		Clause 31.4.2.1.1.3. Correction to testcase expected sequence.	F	4.1.1	4.2.0	G4-000169	TEI
GP-03	GP-010088	068		Clause 31.4.3.3. Correction to testcase procedure.	F	4.1.1	4.2.0	G4-000170	TEI
GP-03	GP-010085	069		Clauses 41.2.3.1 and 41.2.3.2 on IA Rest Octets discrepancy.	F	4.1.1	4.2.0	G4-000173	GPRS
GP-03	GP-010088	070		Clause 31.4.4.1.1 – Auto-Retrieval of held calls	F	4.1.1	4.2.0	G4-000179	TEI
GP-03	GP-010088	071		Series 31.4.4.3 - Incorrect call states in the Test Procedure and Expected Message Sequence	F	4.1.1	4.2.0	G4-000180r	TEI
GP-03	GP-010088	072		Test case 31.3.1.2.2.2 – Modifications to Test Procedure and Expected message sequence	F	4.1.1	4.2.0	G4-000183	TEI
GP-03	GP-010088	073		Test Case 28.4 – Missing Expected Message Sequence	F	4.1.1	4.2.0	G4-000185	TEI
GP-03	GP-010088	074		Addition of new PIXIT Statement to annex A for section 28 tests	F	4.1.1	4.2.0	G4-000187	TEI
GP-03	GP-010087	075		Introduction of PCS 1900 into section 26.14	B	4.1.1	4.2.0	G4-000190	PCS1900
GP-03	GP-010087	076		Introduction of PCS 1900 into section 27	B	4.1.1	4.2.0	G4-000193	PCS1900
GP-03	GP-010087	077		Introduction of PCS 1900 into section 35	B	4.1.1	4.2.0	G4-000195	PCS1900
GP-03	GP-010087	078		Corrections for PCS 1900 in sections 26.6.3.x and 26.6.18	F	4.1.1	4.2.0	G4-000197	PCS1900

Change history										
TSG #	TSG Doc	CR	Rev	Subject/Comment	Cat	Old	New	WG Doc	Work item	
GP-03	GP-010088	079		Test case 31.4.5 - Incorrect TI for Return Result Component.	F	4.1.1	4.2.0	G4-000202	TEI	
GP-03	GP-010088	080		Incorrect numbering of sequence of TC31.4.4.1.1.1	F	4.1.1	4.2.0	G4-000203	TEI	
GP-03	GP-010088	081		Incorrect call auxillary state in TC31.4.4.3.2	F	4.1.1	4.2.0	G4-000205	TEI	
GP-03	GP-010087	082		Inclusion of PCS 1900 in HSCSD tests section 13 and 14	B	4.1.1	4.2.0	G4-000206	PCS1900	
GP-03	GP-010087	083		Inclusion of PCS 1900 in GPRS tests section 13 and 14	B	4.1.1	4.2.0	G4-000207	PCS1900	
GP-03	GP-010085	084		SS Needs To Send GMM INFORMATION In-Order That MS Deletes Old P-TMSI In 44.2.3.1.1.	F	4.1.1	4.2.0	G4-000208	GPRS	
GP-03	GP-010085	085		41.2.8.1.2 Uplink Data Transfer Should Be Terminated by PACKET UPLINK ACK/NAK With FAI Set.	F	4.1.1	4.2.0	G4-000211	GPRS	
GP-03	GP-010085	086		44.2.5.2.1 Test Method (Expected Sequence) Correction	F	4.1.1	4.2.0	G4-000213	GPRS	
GP-03	GP-010088	087		Incorrect transaction identifier TI used at step 9 + 10 in TC31.4.4.2	F	4.1.1	4.2.0	G4-000220	TEI	
GP-03	GP-010085	088		Updates to the Applicability table	F	4.1.1	4.2.0	G4-000222	GPRS	
GP-03	GP-010085	089		Heading numbering error in one LLC test	D	4.1.1	4.2.0	G4-000224	GPRS	
GP-03	GP-010085	090		Paging on PCCCH for GPRS service with IMSI	F	4.1.1	4.2.0	G4-000226	GPRS	
GP-03	GP-010085	100		Wrong specific message content deleted.	F	4.1.1	4.2.0	G4-000227	GPRS	
GP-03	GP-010085	101		Steps added in the Expected sequence	F	4.1.1	4.2.0	G4-000229	GPRS	
GP-03	GP-010085	102		44.2.3.2.5.3.2 Test Method (Expected Sequence) Corrections.	F	4.1.1	4.2.0	G4-000230	GPRS	
GP-03	GP-010086	103		GSM 700 and GSM 850 to 51.010 section 12	B	4.1.1	4.2.0	G4-000243	GSM700	
GP-03	GP-010086	104		GSM 700 and GSM 850 additions into 51.010 section 15	B	4.1.1	4.2.0	G4-000246	GSM700	
GP-03	GP-010086	105		GSM 700 and GSM 850 additions into 51.010 section 16	B	4.1.1	4.2.0	G4-000247	GSM700	
GP-03	GP-010086	106		GSM 700 and GSM 850 additions into 51.010 section 17	B	4.1.1	4.2.0	G4-000248	GSM700	
GP-03	GP-010086	107		GSM 700 and GSM 850 additions into 51.010 section 18	B	4.1.1	4.2.0	G4-000249	GSM700	
GP-03	GP-010086	108		GSM 700 and GSM 850 additions into 51.010 section 19	B	4.1.1	4.2.0	G4-000250	GSM700	
GP-03	GP-010086	109		GSM 700 and GSM 850 additions into 51.010 section 20	B	4.1.1	4.2.0	G4-000251	GSM700	
GP-03	GP-010086	110		GSM 700 and GSM 850 additions into 51.010 section 21	B	4.1.1	4.2.0	G4-000252	GSM700	
GP-03	GP-010086	111		GSM 700 and GSM 850 additions into 51.010 sections 22-24	B	4.1.1	4.2.0	G4-000253	GSM700	
GP-03	GP-010084	112		Addition of EGPRS Usable receiver input range test to the applicability table	F	4.1.1	4.2.0	G4-000258	EDGE	
GP-03	GP-010084	113		EGPRS Usable receiver user input range test	B	4.1.1	4.2.0	G4-000261	EDGE	
GP-03	GP-010085	114		LLC testcases 46.1.2.2.2.3, 46.1.2.6.2, 46.1.2.7.6 corrections	D	4.1.1	4.2.0	G4-000275	GPRS	
GP-03	GP-010085	115		Macro for downlink TBF establishment (PBCCH not present)	F	4.1.1	4.2.0	G4-000280	GPRS	
GP-03	GP-010085	116		Section 43 numbering correction	D	4.1.1	4.2.0	G4-000281	GPRS	
GP-03	GP-010085	117		Checking only the number of SABM retransmissions	F	4.1.1	4.2.0	G4-000282	GPRS	
GP-03	GP-010085	118		GPRS RLC Test Cases section 43	F	4.1.1	4.2.0	G4-000283	GPRS	
GP-03	GP-010085	119		Wrong reference to table 42.2.1.1	D	4.1.1	4.2.0	G4-000284	GPRS	
GP-03	GP-010087	120		Corrections for PCS 1900 in sections 15 to 24	B	4.1.1	4.2.0	G4-000290	PCS1900	
GP-03	GP-010086	121		GSM 700 and GSM 850 additions into 51.010, sections 00 –10	B	4.1.1	4.2.0	G4-000291	GSM700	
GP-03	GP-010086	122		GSM 700 and GSM 850 additions into 51.010 section 13	B	4.1.1	4.2.0	G4-000292	GSM700	
GP-03	GP-010088	123		TC 31.2.1.7.1.1 - Forwarded-to mobile subscriber side. Corrections of Conformance Requirements, Test Purpose and Method of test (incl. Expected Sequence)	F	4.1.1	4.2.0	G4-000294r	TEI	
GP-03	GP-010087	124		Introduction of PCS 1900 into section 26.12	B	4.1.1	4.2.0	G4-000295	PCS1900	
GP-03	GP-010087	125		Introduction of PCS 1900 into section 26.15	B	4.1.1	4.2.0	G4-000296	PCS1900	
GP-03	GP-010087	126		Introduction of PCS 1900 into section 26.16	B	4.1.1	4.2.0	G4-000297	PCS1900	
GP-03	GP-010088	127		Test Case 28.2 – Missing Test Procedure	F	4.1.1	4.2.0	G4-000298	TEI	
GP-03	GP-010086	128		GSM 700 and GSM 850 additions into 51.010 section 14	B	4.1.1	4.2.0	G4-000300	GSM700	
GP-03	GP-010087	129		Introduction of PCS 1900 into section 31	B	4.1.1	4.2.0	G4-000305	PCS1	

Change history										
TSG #	TSG Doc	CR	Rev	Subject/Comment	Cat	Old	New	WG Doc	Work item	
										900
GP-03	GP-010087	130		Introduction of PCS 1900 into section Annex	B	4.1.1	4.2.0	G4-000306	PCS1	900
GP-03	GP-010087	131		Clause 26.9. Corrections for PCS 1900 emergency calls	F	4.1.1	4.2.0	G4-000307	PCS1	900
GP-03	GP-010088	132		Clause 28.1. Removal of references to section 29.	F	4.1.1	4.2.0	G4-000308	TEI	
GP-03	GP-010088	133		Test case 31.4.2.1.4, 31.4.2.2.1 and 31.4.4.1.2.2 and 31.4.3.5 - Incorrect auxiliary call states in the Test Procedure and Expected Message Sequence.	F	4.1.1	4.2.0	G4-000313	TEI	
GP-03	GP-010088	134		Section 30 - Audio Testing Specification	F	4.1.1	4.2.0	G4-000176	TEI	
				Addition of missing references		4.1.1	4.2.0			
GP-04	GP-010466	135		clause 40 – GPRS default conditions, message contents and macros	F	4.2.0	4.3.0	G4-010030	GPRS	
GP-04	GP-010466	136		clause 44.2.5.2.3 - Ciphering mode / IMEISV request	F	4.2.0	4.3.0	G4-010031	GPRS	
GP-04	GP-010466	137		clause 44.2.3.2.9 - Combined routing area updating / abnormal cases / change of cell during routing area updating procedure	F	4.2.0	4.3.0	G4-010032	GPRS	
GP-04	GP-010466	138		clause 44.2.5.2.1 - Ciphering mode / start ciphering	F	4.2.0	4.3.0	G4-010033	GPRS	
GP-04	GP-010466	139		SNDCP test "Response from MS on receiving XID request from the SS"	F	4.2.0	4.3.0	G4-010047	GPRS	
GP-04	GP-010466	140		Corrections and clarification of the GPRS defaults section 40.	F	4.2.0	4.3.0	G4-010050	GPRS	
GP-04	GP-010466	141		41.2 RR procedures on CCCH related to temporary block flow establishment	F	4.2.0	4.3.0	G4-010051	GPRS	
GP-04	GP-010466	142		clause 41.3.4.2 TBF Release / Downlink / Normal / Network initiated / Unacknowledged mode	F	4.2.0	4.3.0	G4-010052	GPRS	
GP-04	GP-010466	143		Correction of reaction time check in section 42.2.2.11	F	4.2.0	4.3.0	G4-010053	GPRS	
GP-04	GP-010466	144		GPRS MAC Dynamic Allocation Test Case 42.3.1.2.1	F	4.2.0	4.3.0	G4-010054	GPRS	
GP-04	GP-010466	145		Additional GPRS Conformance Tests for Network Controlled Reselection	F	4.2.0	4.3.0	G4-010055	GPRS	
GP-04	GP-010466	146		42.5.1.1 Downlink Transfer / Normal operation / Relative encoding TBF starting time	F	4.2.0	4.3.0	G4-010056	GPRS	
GP-04	GP-010466	147		Stall Indicator usage clarification	F	4.2.0	4.3.0	G4-010057	GPRS	
GP-04	GP-010466	148		GMM Procedure timeout during GPRS Detach or Combined routing area updating	F	4.2.0	4.3.0	G4-010058	GPRS	
GP-04	GP-010466	149		44.2.1.2.7 TMSI Status Check Not Required In ATTACH REQUEST and MS Will Always Respond To Paging With IMSI.	F	4.2.0	4.3.0	G4-010059	GPRS	
GP-04	GP-010466	150		Use of the Allocation bitmap in accordance with the value of T3168	F	4.2.0	4.3.0	G4-010060	GPRS	
GP-04	GP-010466	151		Permission to access the network – setting of priority for data transfer	F	4.2.0	4.3.0	G4-010089	GPRS	
GP-04	GP-010466	152		SS Needs To Send Packet Paging Request or a Paging Request Type 1 In 44.2.1.1.1.	F	4.2.0	4.3.0	G4-010144	GPRS	
GP-04	GP-010466	153		Corrections To The Test Method Of 44.2.1.2.1	F	4.2.0	4.3.0	G4-010145	GPRS	
GP-04	GP-010466	154		Test Duration of 44.2.3.3.1 Calls Periodic Location Update Timer To Be Disabled	F	4.2.0	4.3.0	G4-010146	GPRS	
GP-04	GP-010466	155		Cells Used In The Testing Of Reject Cause 'PLMN not allowed' Should Not Have The Home PLMN and the Location Update Procedure Is Not Initiated By A Mobile in Mode C "GPRS"(44.2.1.1.4)	F	4.2.0	4.3.0	G4-010147	GPRS	
GP-04	GP-010466	156		Various Corrections To The Procedures Of Test Case 44.2.1.1.5	F	4.2.0	4.3.0	G4-010148	GPRS	
GP-04	GP-010466	157		44.2.3.3.2 Periodic routing area updating / accepted / T3312 default value	F	4.2.0	4.3.0	G4-010149	GPRS	
GP-04	GP-010466	158		44.2.3.3.3 Periodic routing area updating / no cell available / Network mode I and 44.2.3.3.4 Combined routing area updating / no cell available	F	4.2.0	4.3.0	G4-010150	GPRS	
GP-04	GP-010466	159		44.2.1.2.3 Combined GPRS attach / GPRS attach while IMSI attach	F	4.2.0	4.3.0	G4-010151	GPRS	
GP-04	GP-010466	160		44.2.2.1.2 GPRS detach / accepted	F	4.2.0	4.3.0	G4-010152	GPRS	
GP-04	GP-010466	161		Corrections To The Test Method Of 45_2_1_1	F	4.2.0	4.3.0	G4-010153	GPRS	
GP-04	GP-010466	162		Procedure, Expected Sequence and Default Message Corrections To 45.2.2	F	4.2.0	4.3.0	G4-010154	GPRS	
GP-04	GP-010466	163		clause 44.2.5.1.1 - Authentication accepted	F	4.2.0	4.3.0	G4-010155	GPRS	
GP-04	GP-010466	164		clause 44.2.5.2.2- Ciphering mode / stop ciphering	F	4.2.0	4.3.0	G4-010156	GPRS	
GP-04	GP-010466	165		clause 44.2.3.1.2- Routing area updating / rejected / IMSI invalid / illegal ME	F	4.2.0	4.3.0	G4-010157	GPRS	
GP-04	GP-010466	166		clause 44.2.6 - Identification procedure	F	4.2.0	4.3.0	G4-010158	GPRS	
GP-04	GP-010466	167		clause 44.2.3.1.6- Routing area updating / abnormal cases / change of cell into new routing area	F	4.2.0	4.3.0	G4-010159	GPRS	

Change history										
TSG #	TSG Doc	CR	Rev	Subject/Comment	Cat	Old	New	WG Doc	Work item	
GP-04	GP-010466	168		clause 44.2.3.2.8- Combined routing area updating / abnormal cases / change of cell into new routing area	F	4.2.0	4.3.0	G4-010160	GPRS	
GP-04	GP-010466	169		clause 44.2.3.1.4- Routing area updating / rejected / location area not allowed	F	4.2.0	4.3.0	G4-010161	GPRS	
GP-04	GP-010466	170		clause 44.2.1.1.1- GPRS attach / accepted	F	4.2.0	4.3.0	G4-010162	GPRS	
GP-04	GP-010466	171		41.3.2.1 TBF Release / Uplink / Normal / Network initiated / Acknowledged mode and 41.3.2.2 TBF Release / Uplink / Normal / Network initiated / Unacknowledged mode	F	4.2.0	4.3.0	G4-010163	GPRS	
GP-04	GP-010467	172		EVM test equipment measurement uncertainties	F	4.2.0	4.3.0	G4-010091	EDGE	
GP-04	GP-010467	173		Introduction of the EGPRS Radio Signalling Test Cases numbering.	B	4.2.0	4.3.0	G4-010122	EDGE	
GP-04	GP-010467	174		EGPRS Power Versus Time Template for 8PSK modulation	F	4.2.0	4.3.0	G4-010138	EDGE	
GP-04	GP-010468	175		Artificial Ear - A3.2.8 - acoustic measurements illustrated	F	4.2.0	4.3.0	G4-010013	TEI	
GP-04	GP-010468	176		Correction of the Testcases 13.16.1-3 of " in 51.010-1 "GPRS Transmitter Tests" in section 13.16	F	4.2.0	4.3.0	G4-010168	TEI	
GP-04	GP-010468	177		Correction of the applicability table in 51.010-1 section 3.2.2	F	4.2.0	4.3.0	G4-010169	TEI	
GP-04	GP-010468	178		Correction of Measurement Range for 13.5	F	4.2.0	4.3.0	G4-010170	TEI	
GP-04	GP-010469	179		Alignment of TS 51.010-1 clause 31.1.3.1 COLP / Normal operation	C	4.2.0	4.3.0	G4-010067	TEI	
GP-04	GP-010469	180		Alignment of TS 51.010-1 clause 31.4.4.3.2 Add the single call to the MPTY, maximum number of participants exceeded	C	4.2.0	4.3.0	G4-010068	TEI	
GP-04	GP-010469	181		Test Case 28.2 – Incorrect Comments in Test Procedure	F	4.2.0	4.3.0	G4-010071	TEI	
GP-04	GP-010469	182		Test Case 28.3 – Missing Test Steps in Test Procedure	F	4.2.0	4.3.0	G4-010072	TEI	
GP-04	GP-010469	183		Test Case 28.4 – Incorrect timer value in Test Procedure	F	4.2.0	4.3.0	G4-010073	TEI	
GP-04	GP-010469	184		test case 31.4.3.4- Incorrect Forseen Final State.	F	4.2.0	4.3.0	G4-010074	TEI	
GP-04	GP-010469	185		Clause 31.11 – Modifications to Specific Message Contents	F	4.2.0	4.3.0	G4-010075	TEI	
GP-04	GP-010469	186		clauses 31.2.1.1.1 and 31.2.1.2.2– Modifications to Specific Message Contents.	F	4.2.0	4.3.0	G4-010076	TEI	
GP-04	GP-010469	187		Test case 31.9.1.2 – Corrections to Expected Message Sequence and Specific Message Contents	F	4.2.0	4.3.0	G4-010077	TEI	
GP-04	GP-010469	188		Test case 31.9.1.1 – Modifications to Specific Message Contents	F	4.2.0	4.3.0	G4-010078	TEI	
GP-04	GP-010469	189		clause 31.4.4.1.2.4. Auto-retrieval of held calls	F	4.2.0	4.3.0	G4-010079	TEI	
GP-04	GP-010469	190		Test Case 31.1.3.1. Error in Test Procedure	F	4.2.0	4.3.0	G4-010082	TEI	
GP-04	GP-010469	191		Alignment of TS 51.010-1 clause 31.3.1.2.2.2 Waiting call accepted; existing call on hold, held call cleared.	C	4.2.0	4.3.0	G4-010112	TEI	
GP-04	GP-010469	192		Alignment of TS 51.010-1 clause 31.9.1.1 Mobile station initiated Unstructured supplementary service data operation / ProcessUnstructuredSS-request/accepted.	F	4.2.0	4.3.0	G4-010113	TEI	
GP-04	GP-010469	193		Editorial Correction for Advice of Charge Charging in section 31.6 and addition of tests for Advice of Charge Information in section 31.6.3.1	B	4.2.0	4.3.0	G4-010115	AoC	
GP-04	GP-010469	194		New test cases for CS intersystem handover	B	4.2.0	4.3.0	G4-010177		
GP-04	GP-010469	195		Introduction of tests for COLR – Normal Operation in section 31.1.4.2	B	4.2.0	4.3.0	G4-010181	TEI	
GP-04	GP-010469	196		Removal of TS51.010-1 test cases 31.4.3.5; 31.4.4.1.2.1 and 31.4.4.1.2.2	F	4.2.0	4.3.0	G4-010182	TEI	
GP-04	GP-010470	197		Removal of the Applicability Table in clause 3.2.2	D	4.2.0	4.3.0	G4-010176	TEI	
GP-04	GP-010469	198		clause 31.8.6.1 : correction of the call barring test	F	4.2.0	4.3.0	G4-010185	TEI	

History

Document history		
V4.3.0	April 2001	Publication