

Final draft **ETSI EN 301 893** V2.2.1 (2024-09)



**5 GHz WAS/RLAN;
Harmonised Standard for access to radio spectrum**



Reference

REN/BRAN-230016

Keywordsaccess, broadband, LAN, layer 1, radio, regulation,
testing**ETSI**650 Route des Lucioles
F-06921 Sophia Antipolis Cedex - FRANCE

Tel.: +33 4 92 94 42 00 Fax: +33 4 93 65 47 16

Siret N° 348 623 562 00017 - APE 7112B
Association à but non lucratif enregistrée à la
Sous-Préfecture de Grasse (06) N° w061004871

Important notice

The present document can be downloaded from the
ETSI [Search & Browse Standards](#) application.

The present document may be made available in electronic versions and/or in print. The content of any electronic and/or print versions of the present document shall not be modified without the prior written authorization of ETSI. In case of any existing or perceived difference in contents between such versions and/or in print, the prevailing version of an ETSI deliverable is the one made publicly available in PDF format on [ETSI deliver](#).

Users should be aware that the present document may be revised or have its status changed,
this information is available in the [Milestones listing](#).

If you find errors in the present document, please send your comments to
the relevant service listed under [Committee Support Staff](#).

If you find a security vulnerability in the present document, please report it through our
[Coordinated Vulnerability Disclosure \(CVD\)](#) program.

Notice of disclaimer & limitation of liability

The information provided in the present deliverable is directed solely to professionals who have the appropriate degree of experience to understand and interpret its content in accordance with generally accepted engineering or other professional standard and applicable regulations.

No recommendation as to products and services or vendors is made or should be implied.
In no event shall ETSI be held liable for loss of profits or any other incidental or consequential damages.

Any software contained in this deliverable is provided "AS IS" with no warranties, express or implied, including but not limited to, the warranties of merchantability, fitness for a particular purpose and non-infringement of intellectual property rights and ETSI shall not be held liable in any event for any damages whatsoever (including, without limitation, damages for loss of profits, business interruption, loss of information, or any other pecuniary loss) arising out of or related to the use of or inability to use the software.

Copyright Notification

No part may be reproduced or utilized in any form or by any means, electronic or mechanical, including photocopying and microfilm except as authorized by written permission of ETSI.

The content of the PDF version shall not be modified without the written authorization of ETSI.

The copyright and the foregoing restriction extend to reproduction in all media.

© ETSI 2024.
All rights reserved.

Contents

Intellectual Property Rights	10
Foreword.....	10
Modal verbs terminology.....	11
Introduction	11
1 Scope	12
2 References	12
2.1 Normative references	12
2.2 Informative references.....	13
3 Definition of terms, symbols and abbreviations.....	14
3.1 Terms.....	14
3.2 Symbols.....	16
3.3 Abbreviations	17
4 Technical requirements for equipment operating in sub-band 1, sub-band 2 or sub-band 3.....	18
4.1 Environmental profile.....	18
4.2 Conformance requirements	18
4.2.1 Nominal centre frequency.....	18
4.2.1.1 General	18
4.2.1.2 Definition	18
4.2.1.3 Limits	19
4.2.1.4 Conformance.....	19
4.2.2 Nominal channel bandwidth and occupied bandwidth	19
4.2.2.1 Definition	19
4.2.2.2 Limits	19
4.2.2.3 Conformance.....	19
4.2.3 RF output power, Transmit Power Control (TPC) and Power Spectral Density (PSD).....	20
4.2.3.1 Definition	20
4.2.3.1.1 RF output power	20
4.2.3.1.2 Transmit Power Control (TPC)	20
4.2.3.1.3 Power Spectral Density (PSD)	20
4.2.3.2 Limits	20
4.2.3.2.1 General requirements.....	20
4.2.3.2.2 Limits for RF output power and PSD.....	20
4.2.3.3 Conformance.....	21
4.2.4 Transmitter unwanted emissions.....	21
4.2.4.1 Transmitter unwanted emissions outside the transmitter's operating bands.....	21
4.2.4.1.1 Definition.....	21
4.2.4.1.2 Limits	21
4.2.4.1.3 Conformance	21
4.2.4.2 Transmitter unwanted emissions within the transmitter's operating bands	21
4.2.4.2.1 Definition.....	21
4.2.4.2.2 Limits	22
4.2.4.2.3 Conformance	24
4.2.5 Receiver spurious emissions	24
4.2.5.1 Definition	24
4.2.5.2 Limits	24
4.2.5.3 Conformance.....	25
4.2.6 Dynamic Frequency Selection (DFS)	25
4.2.6.1 DFS general requirements.....	25
4.2.6.1.1 DFS function	25
4.2.6.1.2 DFS applicable frequency range.....	25
4.2.6.1.3 DFS operational modes	25
4.2.6.1.4 DFS operation.....	25
4.2.6.2 DFS technical requirements	27
4.2.6.2.1 Applicability.....	27

4.2.6.2.2	Channel Availability Check (CAC).....	27
4.2.6.2.3	Off-channel CAC.....	28
4.2.6.2.4	In-service monitoring	28
4.2.6.2.5	Channel shutdown	28
4.2.6.2.6	Non-occupancy period.....	29
4.2.6.2.7	Uniform spreading.....	29
4.2.7	Adaptivity (channel access mechanism).....	30
4.2.7.1	Applicability.....	30
4.2.7.2	Definition	30
4.2.7.3	Limits	30
4.2.7.3.1	Frame Based Equipment (FBE).....	30
4.2.7.3.2	Load Based Equipment (LBE)	33
4.2.7.3.3	Short Control Signalling (SCS) transmissions (FBE and LBE)	38
4.2.7.4	Conformance.....	38
4.2.8	Receiver blocking	38
4.2.8.1	Applicability.....	38
4.2.8.2	Definition	38
4.2.8.3	Performance criteria	39
4.2.8.4	Limits	39
4.2.8.5	Conformance.....	39
4.2.9	Adjacent channel selectivity	39
4.2.9.1	Applicability.....	39
4.2.9.2	Definition	39
4.2.9.3	Performance criteria	39
4.2.9.4	Limits	39
4.2.9.5	Conformance.....	40
4.2.10	User Access Restrictions (UAR)	40
4.2.10.1	Definition	40
4.2.10.2	Requirements	40
4.2.10.3	Conformance.....	40
5	Testing for compliance with technical requirements.....	41
5.1	Environmental conditions for testing	41
5.1.1	General conditions	41
5.1.2	Normal test conditions	41
5.1.2.1	Normal temperature and humidity	41
5.1.2.2	Normal power source	41
5.1.3	Extreme test conditions.....	41
5.2	Interpretation of the measurement results	41
5.3	Definition of other test conditions.....	42
5.3.1	Test sequences and traffic load.....	42
5.3.1.1	General test transmission sequences	42
5.3.1.2	Test transmission sequences for DFS tests.....	42
5.3.2	Test channels	42
5.3.3	Antennas	43
5.3.3.1	Integrated and dedicated antennas.....	43
5.3.3.2	Transmit operating modes.....	44
5.3.3.2.1	Operating mode 1 (single antenna).....	44
5.3.3.2.2	Operating mode 2 (multiple antennas, no beamforming)	44
5.3.3.2.3	Operating mode 3 (multiple antennas, with beamforming)	44
5.3.4	Presentation of equipment	44
5.3.5	Measurement methods	44
5.4	Essential radio test suites.....	45
5.4.1	Product information	45
5.4.2	Nominal centre frequency.....	47
5.4.2.1	Test conditions	47
5.4.2.2	Test methods	48
5.4.2.2.1	Conducted measurement.....	48
5.4.2.2.2	Radiated measurement.....	48
5.4.2.2.3	Test fixture measurement	48
5.4.3	Occupied bandwidth	48
5.4.3.1	Test conditions	48

5.4.3.2	Test methods	49
5.4.3.2.1	Conducted measurement.....	49
5.4.3.2.2	Radiated measurement.....	49
5.4.3.2.3	Test fixture measurement	49
5.4.4	RF output power, Transmit Power Control (TPC) and Power Spectral Density (PSD).....	50
5.4.4.1	Test conditions	50
5.4.4.2	Test methods	50
5.4.4.2.1	Conducted measurement.....	50
5.4.4.2.2	Radiated measurement.....	59
5.4.4.2.3	Test fixture measurement	59
5.4.5	Transmitter unwanted emissions outside the transmitter's operating bands.....	59
5.4.5.1	Test conditions	59
5.4.5.2	Test methods	60
5.4.5.2.1	Conducted measurement.....	60
5.4.5.2.2	Radiated measurement.....	62
5.4.5.2.3	Test fixture measurement	62
5.4.6	Transmitter unwanted emissions within the transmitter's operating bands.....	62
5.4.6.1	Test conditions	62
5.4.6.2	Test methods	62
5.4.6.2.1	Conducted measurement.....	62
5.4.6.2.2	Radiated measurement.....	64
5.4.6.2.3	Test fixture measurement	64
5.4.7	Receiver spurious emissions	64
5.4.7.1	Test conditions	64
5.4.7.2	Test methods	65
5.4.7.2.1	Conducted measurement.....	65
5.4.7.2.2	Radiated measurement.....	67
5.4.7.2.3	Test fixture measurement	67
5.4.8	Dynamic Frequency Selection (DFS)	67
5.4.8.1	Test conditions	67
5.4.8.1.1	General test conditions	67
5.4.8.1.2	Selection of radar test signals	67
5.4.8.1.3	Test setups	68
5.4.8.2	Test methods	69
5.4.8.2.1	Conducted measurement.....	69
5.4.8.2.2	Radiated measurement.....	76
5.4.8.2.3	Test fixture measurement	76
5.4.9	Adaptivity (channel access mechanism).....	77
5.4.9.1	Test conditions	77
5.4.9.2	Test methods for Frame Based Equipment (FBE)	77
5.4.9.2.1	Additional test conditions	77
5.4.9.2.2	Conducted measurements	77
5.4.9.2.3	Generic test procedure for measuring channel/frequency usage	81
5.4.9.2.4	Radiated measurements	82
5.4.9.2.5	Test fixture measurement	82
5.4.9.3	Test methods for Load Based Equipment (LBE)	82
5.4.9.3.1	Additional test conditions	82
5.4.9.3.2	Conducted measurements	82
5.4.9.3.3	Generic test procedure for measuring channel/frequency usage	90
5.4.9.3.4	Radiated measurements	91
5.4.9.3.5	Test fixture measurement	91
5.4.10	Receiver blocking	91
5.4.10.1	Test conditions	91
5.4.10.2	Test methods	91
5.4.10.2.1	Conducted measurements	91
5.4.10.2.2	Radiated measurements	93
5.4.10.2.3	Test fixture measurement	93
5.4.11	Adjacent channel selectivity	93
5.4.11.1	Test conditions	93
5.4.11.2	Test methods	93
5.4.11.2.1	Conducted measurements	93
5.4.11.2.2	Radiated measurements	95

5.4.11.2.3	Test fixture measurement	95
5.4.12	User Access Restrictions (UAR)	95
5.4.12.1	Introduction	95
5.4.12.2	Assessment conditions	95
5.4.12.3	Assessment procedure	95
Annex A (informative):	Relationship between the present document and the essential requirements of Directive 2014/53/EU	96
Annex B (normative):	Equipment operating within the band 5 725 MHz to 5 850 MHz (sub-band 4)	99
B.1	Scope	99
B.2	Technical requirements for equipment operating in sub-band 4	99
B.2.1	Environmental profile	99
B.2.2	Conformance requirements	99
B.2.2.1	Nominal centre frequency	99
B.2.2.1.1	General	99
B.2.2.1.2	Definition	99
B.2.2.1.3	Limits	99
B.2.2.1.4	Conformance	100
B.2.2.2	Nominal channel bandwidth and occupied bandwidth	100
B.2.2.2.1	Definition	100
B.2.2.2.2	Limits	100
B.2.2.2.3	Conformance	100
B.2.2.3	RF output power, Transmit Power Control (TPC) and Power Spectral Density (PSD)	100
B.2.2.3.1	Definition	100
B.2.2.3.2	Limits	100
B.2.2.3.2.1	General requirements	100
B.2.2.3.2.2	Limits for RF output power and PSD	101
B.2.2.3.3	Conformance	101
B.2.2.4	Transmitter unwanted emissions	101
B.2.2.4.1	Transmitter unwanted emissions outside the transmitter's operating bands	101
B.2.2.4.1.1	Definition	101
B.2.2.4.1.2	Limits	101
B.2.2.4.1.3	Conformance	101
B.2.2.4.2	Transmitter unwanted emissions within the transmitter's operating bands	101
B.2.2.4.2.1	Definition	101
B.2.2.4.2.2	Limits	101
B.2.2.4.2.3	Conformance	101
B.2.2.5	Receiver spurious emissions	101
B.2.2.5.1	Definition	101
B.2.2.5.2	Limits	102
B.2.2.5.3	Conformance	102
B.2.2.6	Void	102
B.2.2.7	Adaptivity (channel access mechanism)	102
B.2.2.7.1	Applicability	102
B.2.2.7.2	Definition	102
B.2.2.7.3	Limits	102
B.2.2.7.3.1	Frame Based Equipment (FBE)	102
B.2.2.7.3.2	Load Based Equipment (LBE)	103
B.2.2.7.3.3	Short Control Signalling (SCS) transmissions (FBE and LBE)	104
B.2.2.7.4	Conformance	104
B.2.2.8	Receiver blocking	104
B.2.2.8.1	Applicability	104
B.2.2.8.2	Definition	104
B.2.2.8.3	Performance criteria	104
B.2.2.8.4	Limits	105
B.2.2.8.5	Conformance	105
B.2.2.9	Adjacent channel selectivity	105
B.2.2.9.1	Applicability	105

B.2.2.9.2	Definition	105
B.2.2.9.3	Performance criteria	105
B.2.2.9.4	Limits	105
B.2.2.9.5	Conformance.....	105
B.2.2.10	User Access Restrictions (UAR)	105
B.2.2.10.1	Definition	105
B.2.2.10.2	Requirements	105
B.2.2.10.3	Conformance.....	105
B.2.2.11	Country determination capability	106
B.2.2.11.1	Definition	106
B.2.2.11.2	Applicability.....	106
B.2.2.11.3	Requirements	106
B.2.2.11.4	Conformance.....	106
B.3	Testing for compliance with technical requirements.....	106
B.3.1	Environmental conditions for testing	106
B.3.2	Interpretation of the measurement results	106
B.3.3	Definition of other test conditions.....	106
B.3.3.1	Test sequences and traffic load.....	106
B.3.3.2	Test channels	107
B.3.3.3	Antennas	107
B.3.3.4	Presentation of equipment	108
B.3.3.5	Measurement methods	108
B.3.4	Essential radio test suites.....	108
B.3.4.1	Product information	108
B.3.4.2	Nominal centre frequency.....	109
B.3.4.3	Occupied bandwidth	109
B.3.4.4	RF output power, Transmit Power Control (TPC) and Power Spectral Density (PSD).....	109
B.3.4.4.1	Test conditions	109
B.3.4.4.2	Test methods	110
B.3.4.4.2.1	Conducted measurement.....	110
B.3.4.4.2.2	Radiated measurement.....	114
B.3.4.4.2.3	Test fixture measurement	115
B.3.4.5	Transmitter unwanted emissions outside the transmitter's operating bands.....	115
B.3.4.6	Transmitter unwanted emissions within the transmitter's operating bands.....	115
B.3.4.7	Receiver spurious emissions	115
B.3.4.8	Void	115
B.3.4.9	Adaptivity (channel access mechanism).....	115
B.3.4.10	Receiver blocking	115
B.3.4.11	Adjacent channel selectivity	115
B.3.4.12	User Access Restrictions (UAR)	116
B.3.4.13	Country determination capability	116
B.3.4.13.1	Test conditions	116
B.3.4.13.2	Test method.....	116
Annex C (informative):	Maximum measurement uncertainties	118
Annex D (normative):	DFS parameters	119
Annex E (normative):	Test sites and arrangements for radiated measurements.....	122
E.1	Introduction	122
E.2	Radiated test sites	122
E.2.1	Open Area Test Site (OATS)	122
E.2.2	Semi Anechoic Room (SAR)	123
E.2.3	Fully Anechoic Room (FAR)	124
E.2.4	Measurement distance	125
E.3	Antennas.....	126
E.3.1	Introduction	126
E.3.2	Measurement antenna.....	126
E.3.3	Substitution antenna	126

E.4	Test fixture	126
E.4.1	Introduction	126
E.4.2	Description of the test fixture	127
E.4.3	Using the test fixture for relative measurements at the lower and upper extreme temperatures	127
E.4.4	Using the test fixture for normalized measurements	127
E.4.5	Using the test fixture for level independent measurements	128
E.5	Arrangement of the radiated test sites	128
E.5.1	Introduction	128
E.5.2	Power supplies for the battery powered UUT	128
E.5.3	Site preparation	128
E.6	Coupling of signals.....	129
E.6.1	General	129
E.6.2	Data signals	129
E.7	Interference signals used for adaptivity tests.....	129
E.7.1	Additive White Gaussian Noise (AWGN) test signal	129
E.7.2	OFDM test signal based on IEEE 802.11 PHY	129
E.7.3	OFDM test signal based on LTE PHY	129
E.7.4	Interference signal characteristics	129
E.7.4.1	Verification of flatness and bandwidth	129
E.7.4.2	Measurement of PSD	130
E.7.5	Waveforms for test signals	131
Annex F (normative): Procedures for radiated measurements		132
F.1	Introduction	132
F.2	Radiated measurements in an OATS or SAR.....	132
F.3	Radiated measurements in a FAR	133
F.4	Substitution measurement	133
F.5	Testing technical requirements on equipment with an integral antenna	133
F.5.1	Radio test suites and corresponding test sites.....	133
F.5.2	Testing adaptivity (channel access mechanism).....	134
F.5.2.1	Introduction.....	134
F.5.2.2	Measurement setup	134
F.5.2.3	Calibration of the measurement setup.....	134
F.5.2.4	Test method	135
F.5.3	Testing receiver blocking	135
F.5.3.1	Introduction.....	135
F.5.3.2	Measurement setup	135
F.5.3.3	Calibration of the measurement setup.....	135
F.5.3.4	Test method	136
F.5.4	Testing adjacent channel selectivity	136
F.5.4.1	Introduction.....	136
F.5.4.2	Measurement setup	136
F.5.4.3	Calibration of the measurement setup.....	137
F.5.4.4	Test method	137
Annex G (informative): Adaptivity flowchart.....		138
Annex H (informative): Application form for testing.....		139
H.1	The right to copy	139
H.2	Introduction	139
H.3	Information as required by ETSI EN 301 893 (V2.2.1), clause 5.4.1	139
H.4	Additional information provided by the manufacturer.....	150
H.4.1	Modulation	150
H.4.2	Duty cycle	150

H.4.3	About the UUT	150
H.4.4	List of ancillary and/or support equipment provided by the manufacturer.....	151
Annex I (informative): Examples of spectrum masks.....		152
I.1	Introduction	152
I.2	Equipment configured for multi-channel operation in groups of four adjacent channels	152
I.2.1	Example 1.....	152
I.2.2	Example 2.....	152
I.2.3	Example 3.....	153
I.2.4	Example 4.....	154
I.3	Equipment configured for multi-channel operation in groups of eight adjacent channels.....	154
I.3.1	Example 5.....	154
I.3.2	Example 6.....	155
I.3.3	Example 7.....	155
I.3.4	Example 8.....	156
I.3.5	Example 9.....	156
Annex J (informative): Bibliography.....		158
Annex K (informative): Change history		159
History		160

Intellectual Property Rights

Essential patents

IPRs essential or potentially essential to normative deliverables may have been declared to ETSI. The declarations pertaining to these essential IPRs, if any, are publicly available for **ETSI members and non-members**, and can be found in ETSI SR 000 314: "*Intellectual Property Rights (IPRs); Essential, or potentially Essential, IPRs notified to ETSI in respect of ETSI standards*", which is available from the ETSI Secretariat. Latest updates are available on the ETSI Web server (<https://ipr.etsi.org/>).

Pursuant to the ETSI Directives including the ETSI IPR Policy, no investigation regarding the essentiality of IPRs, including IPR searches, has been carried out by ETSI. No guarantee can be given as to the existence of other IPRs not referenced in ETSI SR 000 314 (or the updates on the ETSI Web server) which are, or may be, or may become, essential to the present document.

Trademarks

The present document may include trademarks and/or tradenames which are asserted and/or registered by their owners. ETSI claims no ownership of these except for any which are indicated as being the property of ETSI, and conveys no right to use or reproduce any trademark and/or tradename. Mention of those trademarks in the present document does not constitute an endorsement by ETSI of products, services or organizations associated with those trademarks.

DECT™, **PLUGTESTS™**, **UMTS™** and the ETSI logo are trademarks of ETSI registered for the benefit of its Members. **3GPP™** and **LTE™** are trademarks of ETSI registered for the benefit of its Members and of the 3GPP Organizational Partners. **oneM2M™** logo is a trademark of ETSI registered for the benefit of its Members and of the oneM2M Partners. **GSM®** and the GSM logo are trademarks registered and owned by the GSM Association.

Foreword

This final draft Harmonised European Standard (EN) has been produced by ETSI Technical Committee Broadband Radio Access Networks (BRAN), and is now submitted for the Vote phase of the ETSI Standardisation Request deliverable Approval Procedure.

The present document has been prepared under the Commission's standardisation request C(2015) 5376 final [i.2] to provide one voluntary means of conforming to the essential requirements of Directive 2014/53/EU on the harmonisation of the laws of the Member States relating to the making available on the market of radio equipment and repealing Directive 1999/5/EC [i.1].

Once the present document is cited in the Official Journal of the European Union under that Directive, compliance with the normative clauses of the present document given in table A.1 confers, within the limits of the scope of the present document, a presumption of conformity with the corresponding essential requirements of that Directive and associated EFTA regulations.

Proposed national transposition dates	
Date of latest announcement of this EN (doa):	3 months after ETSI publication
Date of latest publication of new National Standard or endorsement of this EN (dop/e):	6 months after doa
Date of withdrawal of any conflicting National Standard (dow):	36 months after doa

Modal verbs terminology

In the present document "**shall**", "**shall not**", "**should**", "**should not**", "**may**", "**need not**", "**will**", "**will not**", "**can**" and "**cannot**" are to be interpreted as described in clause 3.2 of the [ETSI Drafting Rules](#) (Verbal forms for the expression of provisions).

"**must**" and "**must not**" are **NOT** allowed in ETSI deliverables except when used in direct citation.

Introduction

5 GHz Wireless Access Systems (WAS) including RLAN equipment are used in wireless local area networks which provide high speed data communications in between devices connected to the wireless infrastructure. The present document also addresses ad-hoc networking where devices communicate directly with each other, without the use of a wireless infrastructure.

The spectrum usage conditions for equipment within the scope of the present document are set out as follows:

- ECC Decision (04)08 [i.6], Commission Implementing Decision (EU) 2022/179 [i.7] amended by Commission Implementing Decision (EU) 2022/2307 [i.8] for sub-band 1, sub-band 2 and sub-band 3 as shown in table 1.
- The operation in sub-band 4 as shown in table B.1 is subject to national frequency usage conditions. Hence, it should be verified whether national frequency usage conditions permit operations in this sub-band in accordance with the present document.

NOTE: An example for national frequency usage conditions is given in UK Interface Requirements IR 2030 [i.12].

1 Scope

The present document specifies technical characteristics and methods of measurement for Wireless Access Systems (WAS) including Radio Local Area Network (RLAN) equipment operating in the 5 GHz RLAN band.

The present document specifies spectrum access requirements to facilitate spectrum sharing with other equipment.

Radio equipment capable of operating in all or parts of the service frequency bands given in table 1 is within the scope of the present document.

Table 1: Service frequency bands

	Sub-band 1	Sub-band 2	Sub-band 3
Transmit	5 150 MHz to 5 250 MHz	5 250 MHz to 5 350 MHz	5 470 MHz to 5 725 MHz
Receive	5 150 MHz to 5 250 MHz	5 250 MHz to 5 350 MHz	5 470 MHz to 5 725 MHz

Provisions for radio equipment capable of operating in all or parts of the 5 725 MHz to 5 850 MHz frequency band (sub-band 4 as given in table B.1) are contained in annex B. However, operation in sub-band 4 is subject to national frequency usage conditions. The present document also contains provisions for equipment operating on channels whose nominal channel bandwidth falls partly in sub-band 3 and partly in sub-band 4.

NOTE 1: The technical requirements for equipment operating in the service frequency bands identified in table 1 are contained in the main part of the present document (see clause 4) while the technical requirements for equipment operating in the service frequency band identified in table B.1 are contained in annex B.

NOTE 2: The relationship between the present document and essential requirements of article 3.2 of Directive 2014/53/EU [i.1] is given in annex A.

2 References

2.1 Normative references

References are either specific (identified by date of publication and/or edition number or version number) or non-specific. For specific references, only the cited version applies. For non-specific references, the latest version of the referenced document (including any amendments) applies.

Referenced documents which are not found to be publicly available in the expected location might be found at <https://docbox.etsi.org/Reference/>.

NOTE: While any hyperlinks included in this clause were valid at the time of publication, ETSI cannot guarantee their long term validity.

The following referenced documents are necessary for the application of the present document.

- [1] [ETSI TS 136 141 \(V18.4.0\) \(05-2024\)](#): "LTE; Evolved Universal Terrestrial Radio Access (E-UTRA); Base Station (BS) conformance testing (3GPP TS 36.141 version 18.4.0 Release 18)".
- [2] [ISO/IEC/IEEE 8802-11:2022](#): "Telecommunications and information exchange between systems - Specific requirements for local and metropolitan area networks - Part 11: Wireless LAN medium access control (MAC) and physical layer (PHY) specifications".

2.2 Informative references

References are either specific (identified by date of publication and/or edition number or version number) or non-specific. For specific references, only the cited version applies. For non-specific references, the latest version of the referenced document (including any amendments) applies.

NOTE: While any hyperlinks included in this clause were valid at the time of publication, ETSI cannot guarantee their long term validity.

The following referenced documents are not necessary for the application of the present document but they assist the user with regard to a particular subject area.

- [i.1] [Directive 2014/53/EU of the European Parliament and of the Council of 16 April 2014](#) on the harmonisation of the laws of the Member States relating to the making available on the market of radio equipment and repealing Directive 1999/5/EC.
- [i.2] [Commission Implementing Decision C\(2015\) 5376 final of 4.8.2015](#) on a standardisation request to the European Committee for Electrotechnical Standardisation and to the European Telecommunications Standards Institute as regards radio equipment in support of Directive 2014/53/EU of the European Parliament and of the Council.
- [i.3] [ETSI EG 203 367 \(V1.1.1\) \(06-2016\)](#): "Guide to the application of harmonised standards covering articles 3.1b and 3.2 of the Directive 2014/53/EU (RED) to multi-radio and combined radio and non-radio equipment".
- [i.4] [ETSI TR 100 028-1 \(V1.4.1\) \(12-2001\)](#): "Electromagnetic compatibility and Radio spectrum Matters (ERM); Uncertainties in the measurement of mobile radio equipment characteristics; Part 1".
- [i.5] [ETSI TR 100 028-2 \(V1.4.1\) \(12-2001\)](#): "Electromagnetic compatibility and Radio spectrum Matters (ERM); Uncertainties in the measurement of mobile radio equipment characteristics; Part 2".
- [i.6] [ECC/DEC/\(04\)08](#): "On the harmonised use of the 5 GHz frequency bands for Wireless Access Systems including Radio Local Area Networks (WAS/RLAN)" (approved 9 July 2004, latest amended 1 July 2022).
- [i.7] [Commission Implementing Decision \(EU\) 2022/179 of 8 February 2022](#) on the harmonised use of radio spectrum in the 5 GHz frequency band for the implementation of Wireless Access Systems including Radio Local Area Networks and repealing Decision 2005/513/EC.
- [i.8] [Commission Implementing Decision \(EU\) 2022/2307 of 23 November 2022](#) amending Implementing Decision (EU) 2022/179 as regards designating and making available the 5 150–5 250 MHz, 5 250–5 350 MHz and 5 470–5 725 MHz frequency bands in accordance with the technical conditions set out in the Annex.
- [i.9] [ETSI TR 102 273-2 \(V1.2.1\) \(12-2001\)](#): "Electromagnetic compatibility and Radio spectrum Matters (ERM); Improvement on Radiated Methods of Measurement (using test site) and evaluation of the corresponding measurement uncertainties; Part 2: Anechoic chamber".
- [i.10] [ETSI TR 102 273-3 \(V1.2.1\) \(12-2001\)](#): "Electromagnetic compatibility and Radio spectrum Matters (ERM); Improvement on Radiated Methods of Measurement (using test site) and evaluation of the corresponding measurement uncertainties; Part 3: Anechoic chamber with a ground plane".
- [i.11] [ETSI TR 102 273-4 \(V1.2.1\) \(12-2001\)](#): "Electromagnetic compatibility and Radio spectrum Matters (ERM); Improvement on Radiated Methods of Measurement (using test site) and evaluation of the corresponding measurement uncertainties; Part 4: Open area test site".
- [i.12] IR 2030: "UK Interface Requirements 2030; Licence Exempt Short Range Devices".
- [i.13] [ERC Recommendation 74-01](#): "Unwanted emissions in the spurious domain" (approved 1998, corrected 23 May 2022).

- [i.14] [ECC Report 330](#): "To enable WAS/RLAN use on a national basis in the band 5725-5850 MHz but also ensure the protection of RTTT/Smart Tachograph and radars (including Fast Frequency Hopping) taking into account free circulation of WAS/RLAN" (approved 8 October 2021).
- [i.15] [ECO Report 06](#): "Country Determination Capability; National use of the 5725-5850 MHz frequency band by WAS/RLAN devices with maximum power higher than 25 mW and up to 200 mW e.i.r.p. in CEPT countries" (approved 9 June 2022).

3 Definition of terms, symbols and abbreviations

3.1 Terms

For the purposes of the present document, the terms given in Directive 2014/53/EU [i.1] and the following apply:

5 GHz DFS band: total frequency range within the 5 GHz RLAN band in which DFS is required

NOTE: The 5 GHz DFS band is defined in clause 4.2.6.1.2.

5 GHz RLAN band: service frequency bands for WAS/RLAN equipment within the scope of the present document

ad-hoc mode: operating mode in which an RLAN device establishes a temporary wireless connection with other RLAN devices without a controlling network infrastructure

antenna array: two or more antennas connected to a single device and operating simultaneously

antenna assembly: combination of the antenna (integral or dedicated), its coaxial cable and if applicable, its antenna connector and associated switching components

NOTE: This term (antenna assembly) refers to an antenna connected to one transmit chain.

available channel: usable channel where the radar detection mechanism did not detect radar signals or where radar detection is not required

backoff procedure: procedure that facilitates the sharing of the medium by randomizing the transmission attempts from multiple devices competing for access to an operating channel

beamforming gain: additional (antenna) gain realized by using beamforming techniques in smart antenna systems

burst: period during which radio waves are intentionally transmitted, preceded and succeeded by periods during which no intentional transmission is made

channel: continuous part of the radio-frequency spectrum used for transmission and reception by RLAN devices and identified by a nominal centre frequency and a nominal channel bandwidth

NOTE: An RLAN device is permitted to operate (transmit/receive) in one or more adjacent or non-adjacent channels simultaneously.

EXAMPLE: For the purpose of the present document, a device operating in 40 MHz according to ISO/IEC/IEEE 8802-11:2022 [2] may be considered as operating in two adjacent channels simultaneously.

channel access engine: mechanism that determines when a transmission attempt is permitted

channel plan: list of channels with their nominal centre frequencies and, for each of the centre frequencies, the nominal channel bandwidth(s)

Clear Channel Assessment (CCA): mechanism used by an equipment to identify other transmissions in the channel

configuration interface: Graphical User Interface (GUI) or Command Line Interface (CLI) accessible to the user for configuration and/or programming operational parameters of the equipment

Contention Window (CW): main parameter that determines the duration of the backoff procedure

dedicated antenna: antenna external to the equipment using an antenna connector with a cable or a wave-guide and which has been designed or developed for one or more specific types of equipment

Energy Detection (ED): mechanism used to determine the presence of transmissions in the operating channel based on detecting the signal energy of the transmission

environmental profile: conditions under which equipment within the scope of the present document is required to comply with the provisions of the present document

Frame Based Equipment (FBE): equipment where the transmit/receive structure has a periodic timing with a periodicity equal to the Fixed Frame Period (FFP)

Fixed Frame Period (FFP): periodic timing of the transmit/receive structure for FBE

initiating device: device that initiates a sequence of one or more transmissions

integral antenna: antenna designed as a fixed part of the equipment (without the use of an external connector) which cannot be disconnected from the equipment by a user with the intent to connect another antenna

NOTE: An integral antenna may be fitted internally or externally. In the case where the antenna is external, a non-detachable cable or wave-guide can be used.

Listen Before Talk (LBT): mechanism by which an equipment applies CCA before using the channel

Load Based Equipment (LBE): equipment where the transmit/receive structure is not fixed in time but demand-driven

nominal channel bandwidth: widest band of frequencies, inclusive of guard bands, assigned to a channel

non-occupancy period: period of time in which a usable channel is an unavailable channel due to the detection of a radar signal

observation slot: period during which the operating channel is checked for the presence of other transmissions

occupied channel: operating channel on which the adaptivity mechanism detected transmissions

operating channel: available channel on which the RLAN device has started the channel access mechanism

post backoff procedure: backoff procedure that is applied after every successful transmission

primary device: RLAN device operating in a mode which relates to the DFS functionality where the RLAN device uses radar detection and controls the transmissions of RLAN devices operating as secondary devices

NOTE: This corresponds to the WAS/RLAN devices defined in the Explanatory Memorandum of ECC Decision (04)08 [i.6], with regard to DFS, as operating in the mode in which they are obliged to use the Radar Interference Detection function and implement a channel selection mechanism to ensure a near uniform spread of the loading of available spectrum, and in which they may control other WAS/RLAN devices.

prioritization period: period consisting of an initial deferral period followed by an observation period during which the operating channel is checked for the presence of other transmissions

receive chain: receiver circuit with an associated antenna

responding device: device that transmits in response to the actions of an initiating device

RLAN device: components or sub-assemblies which intentionally emit and/or receive radio waves for the purpose of radio communication and are intended for incorporation into RLAN equipment

secondary device: RLAN device operating in a mode which relates to the DFS functionality where the transmissions are under control of an RLAN device operating as primary device

NOTE: This corresponds to the WAS/RLAN devices defined in the Explanatory Memorandum of ECC Decision (04)08 [i.6], with regard to DFS, as operating in the mode where they can only operate in a network controlled by another WAS/RLAN device.

simulated radar burst: series of periodic radio wave pulses for test purposes

smart antenna system: equipment that combines multiple transmit and/or receive chains with a signal processing function to increase the throughput and/or to optimize its radiation and/or reception capabilities

NOTE: These are techniques such as spatial multiplexing, beamforming, cyclic delay diversity, MIMO, etc.

stand-alone radio equipment: equipment that is intended primarily as radio communications equipment and that is normally used on a stand-alone basis

sub-band: portion of the 5 GHz RLAN band

transmit chain: transmitter circuit with an associated antenna

Transmit Power Control (TPC): technique in which the transmitter RF output power is controlled resulting in reduced interference to other systems

unavailable channel: usable channel where the radar detection mechanism detected a radar signal and which, therefore, cannot be used by the RLAN device for a certain period of time (non-occupancy period)

unusable channel: channel from the channel plan which is not considered for use by the RLAN device

unoccupied channel: operating channel on which the adaptivity mechanism did not detect transmissions

usable channel: channel from the channel plan, which is considered for use by the RLAN device

Wireless Access System including Radio Local Area Network (WAS/RLAN): broadband radio system that allows wireless access for public and private applications regardless of the underlying network topology

3.2 Symbols

For the purposes of the present document, the following symbols apply:

A	measured power output
B	radar burst period
Ch_r	channel in which radar test signals are inserted to simulate the presence of a radar
CW_{min}	minimum CW size
CW_{max}	maximum CW size
D	measured PSD
dB	decibel
dBc	dB relative to the RF output power
dB _i	dB relative to the gain of an isotropic antenna
dB _m	dB relative to 1 mW
dB _r	dB relative to the reference level
E	field strength
E_0	reference field strength
f_c	nominal centre frequency
f_{c_offset}	offset in the nominal centre frequency
f_g	indexed frequency
g	running index
G	antenna assembly gain
GHz	gigahertz
h	running index
Hz	hertz
kHz	kilohertz
L	radar burst length
M	frequency separation between the lower edge of the lowest channel used for transmission and the higher edge of the highest channel used for transmission in case of multi-channel operation where from a group of adjacent channels the lowest channel(s) and/or the highest channel(s) is/are not used for transmission
MHz	megahertz
ms	millisecond
mW	milliwatt
n	number of channels
N	total bandwidth of a group of adjacent channels

p	prioritization period related counter
P_{burst}	RMS (mean) power over the transmission burst
P_d	detection probability
$P_{H, sb}$	maximum RF output power in sub-band sb

NOTE: If TPC is used, $P_{H, sb}$ is the RF output power in sub-band sb at the highest power level of the TPC range in sub-band sb.

$P_{L, sb}$	RF output power in sub-band sb at the lowest power level of the TPC range in sub-band sb
P_{max}	maximum configured RF output power (per channel, in dBm)
q	backoff procedure related counter
R	distance
R_0	reference distance
R_{ch}	number of active receive chains
sb	sub-band index
S_0	signal power
samples/s	samples per second
T_0	time instant
T_1	time instant
T_2	time instant
T_3	time instant
T_{ch}	number of active transmit chains
U	total bandwidth of adjacent channels used for transmission in case of multi-channel operation where in a group of adjacent channels two or more channels not used for transmission are in between channels used for transmission
W	radar pulse width
x	observed duty cycle
Y	beamforming (antenna) gain

3.3 Abbreviations

For the purposes of the present document, the following abbreviations apply:

3GPP	3 rd Generation Partnership Project
AC	Alternating Current
ACK	Acknowledgement
ATT	Attenuator
AWGN	Additive White Gaussian Noise
BIT	Burst Interval Time
CAC	Channel Availability Check
CAE	Channel Access Engine
CCA	Clear Channel Assessment
CLI	Command Line Interface
COT	Channel Occupancy Time
CW	Contention Window
DC	Direct Current
DFS	Dynamic Frequency Selection
ED	Energy Detection
EDT	Energy Detection Threshold
EFTA	European Free Trade Association
EIRP	Equivalent Isotropically Radiated Power
ERP	Effective Radiated Power
FAR	Fully Anechoic Room
FBE	Frame Based Equipment
FER	Frame Error Rate
FFP	Fixed Frame Period
GUI	Graphical User Interface
IEEE	Institute of Electrical and Electronic Engineers
IF	Intermediate Frequency
LBE	Load Based Equipment
LBT	Listen Before Talk

LO	Local Oscillator
LPDA	Logarithmic Periodic Dipole Antenna
LTE	3GPP Long Term Evolution
MIMO	Multiple Input, Multiple Output
OATS	Open Area Test Site
OFDM	Orthogonal Frequency Division Multiplexing
PER	Packet Error Rate
PFD	Power Flux Density
PHY	Physical Layer
PPB	Pulses Per Burst
PPS	Pulses Per Second
PRF	Pulse Repetition Frequency
PSD	Power Spectral Density
RBW	Resolution Bandwidth
RF	Radio Frequency
RLAN	Radio Local Area Network
RMS	Root Mean Square
SAR	Semi Anechoic Room
SCS	Short Control Signalling
TPC	Transmit Power Control
Tx	Transmitter
UAR	User Access Restrictions
UDP	User Datagram Protocol
UUT	Unit Under Test
VBW	Video Bandwidth
VSWR	Voltage Standing Wave Ratio
WAS	Wireless Access System

4 Technical requirements for equipment operating in sub-band 1, sub-band 2 or sub-band 3

4.1 Environmental profile

The technical requirements of the present document apply under the environmental profile for operation of the equipment, which shall be in accordance with its intended use. The equipment shall comply with all the technical requirements of the present document at all times when operating within the boundary limits of the operational environmental profile defined by its intended use. Conformance tests shall be carried out under environmental conditions as defined in clause 5.1.

Where multiple combinations of radio equipment and antenna (antenna assemblies) are intended, each combination shall comply with all the technical requirements of the present document.

4.2 Conformance requirements

4.2.1 Nominal centre frequency

4.2.1.1 General

RLAN devices typically operate on one or more fixed frequencies. The equipment is allowed to change its normal operating frequency when interference is detected, to prevent causing interference to other equipment, or for frequency planning purposes.

4.2.1.2 Definition

The nominal centre frequency is the centre of the channel.

4.2.1.3 Limits

The nominal centre frequencies (f_c) for channels whose nominal channel bandwidth falls partly or completely within sub-band 1, sub-band 2 or sub-band 3 shall be defined by equation (1).

$$f_c = 5\,160 \text{ MHz} + (g \times 20 \text{ MHz}) \pm f_{c_offset}, \text{ with } g \text{ integer and } 0 \leq g \leq 9 \text{ or } 16 \leq g \leq 28 \quad (1)$$

Operation on the channel with $g = 28$ is only permitted where operation in sub-band 4 by RLAN devices is allowed by national frequency usage conditions.

An offset (f_{c_offset}) is permitted for each nominal centre frequency. The offset may be different for each nominal centre frequency, but it shall not be greater than 200 kHz. Where an offset is applied, the nominal centre frequencies used by the equipment shall be noted in the test report (see clause 5.4.1, item a)).

The nominal centre frequency for any given channel shall be maintained within the range of $f_c \pm 0,002 \%$.

Equipment may have simultaneous transmissions on more than one channel.

4.2.1.4 Conformance

Conformance tests as defined in clause 5.4.2 shall be carried out.

4.2.2 Nominal channel bandwidth and occupied bandwidth

4.2.2.1 Definition

The nominal channel bandwidth is the widest band of frequencies, inclusive of guard bands, assigned to a channel.

The occupied bandwidth is the bandwidth within the nominal channel bandwidth containing 99 % of the power of the signal.

When RLAN devices have simultaneous transmissions in adjacent channels, these transmissions are considered as one signal with a total bandwidth (N) of n times the nominal channel bandwidth of an individual channel where n is the number of adjacent channels. When equipment has simultaneous transmissions in non-adjacent channels, each power envelope is considered separately.

4.2.2.2 Limits

The nominal channel bandwidth for a single channel shall be 20 MHz.

Alternatively, equipment may implement a lower nominal channel bandwidth with a minimum of 5 MHz, providing it still conforms to the limits defined for nominal centre frequencies (20 MHz raster).

For channels whose nominal channel bandwidth falls partly or completely within sub-band 2 or sub-band 3, the occupied bandwidth shall not be less than 80 % of the nominal channel bandwidth. During a Channel Occupancy Time (COT), equipment may operate temporarily with an occupied bandwidth of less than 80 % of its nominal channel bandwidth. The occupied bandwidth shall not be less than 2 MHz.

For channels whose nominal channel bandwidth falls completely outside sub-band 2 and sub-band 3, the occupied bandwidth shall be equal or less than the nominal channel bandwidth.

In case of smart antenna systems (devices with multiple transmit chains) each of the transmit chains shall meet the requirements specified in this clause.

The occupied bandwidth might change with time/payload.

4.2.2.3 Conformance

Conformance tests as defined in clause 5.4.3 shall be carried out to determine the occupied bandwidth.

4.2.3 RF output power, Transmit Power Control (TPC) and Power Spectral Density (PSD)

4.2.3.1 Definition

4.2.3.1.1 RF output power

The RF output power is the mean equivalent isotropically radiated power (EIRP) during a transmission burst.

4.2.3.1.2 Transmit Power Control (TPC)

Transmit Power Control (TPC) is a mechanism to ensure a mitigation factor of at least 3 dB on the aggregate power from a large number of devices, which implies a TPC range of at least 6 dB. The RF output power limit and the PSD limit might depend on whether an RLAN device operates with or without TPC.

4.2.3.1.3 Power Spectral Density (PSD)

The Power Spectral Density (PSD) is the mean EIRP density during a transmission burst.

4.2.3.2 Limits

4.2.3.2.1 General requirements

The limits in clause 4.2.3.2.2 are applicable to the device as a whole and in any possible configuration. This means that the antenna gain of the integral or dedicated antenna shall be taken into account as well as the additional (beamforming) gain in case of smart antenna systems (devices with multiple transmit chains).

4.2.3.2.2 Limits for RF output power and PSD

The maximum RF output power $P_{H, sb}$ and the PSD in sub-band *sb* shall not exceed the limits given in table 2 for that sub-band. If the device uses TPC, $P_{H, sb}$ is the RF output power in sub-band *sb* at the highest power level of the TPC range in sub-band *sb*. In case of multiple (adjacent or non-adjacent) channels, the limits for the maximum RF output power and the PSD apply per sub-band.

NOTE: According to ECC/DEC/(04)08 [i.6] as well as Commission Implementing Decision (EU) 2022/179 [i.7] amended by Commission Implementing Decision (EU) 2022/2307 [i.8], for certain installations, the RF output power limit and the PSD limit might be lower than given in table 2.

Table 2: RF output power and PSD limits

Sub-band	RF output power limit (dBm)		PSD limit (dBm/MHz)	
	with TPC (see note 3)	without TPC	with TPC	without TPC
Sub-band 1	23	23	10	10
Sub-band 2	23	20	10	7
Sub-band 3 (see note 2)	30 (see note 1)	27 (see note 1)	17 (see note 1)	14 (see note 1)
NOTE 1: Secondary devices without radar detection operating in sub-band 3 shall conform to the limits for sub-band 2.				
NOTE 2: National frequency usage conditions may allow devices to operate in sub-band 3 on a channel with a nominal channel bandwidth that extends into sub-band 4.				
NOTE 3: If TPC is used, the RF output power in sub-band <i>sb</i> at the lowest power level of the TPC range in sub-band <i>sb</i> ($P_{L, sb}$) shall be at least 6 dB less than the applicable RF output power limit with TPC.				

4.2.3.3 Conformance

Conformance tests as defined in clause 5.4.4 shall be carried out.

For equipment also capable of operating in sub-band 4, conformance tests in clause 5.4.4 shall be replaced by conformance tests in clause B.3.4.4.

4.2.4 Transmitter unwanted emissions

4.2.4.1 Transmitter unwanted emissions outside the transmitter's operating bands

4.2.4.1.1 Definition

Transmitter unwanted emissions outside the transmitter's operating bands are radio frequency emissions outside the sub-bands of the 5 GHz RLAN band.

4.2.4.1.2 Limits

The level of transmitter unwanted emissions outside the transmitter's operating bands shall not exceed the limits given in table 3.

In case of equipment with antenna connectors, these limits apply to emissions at the antenna port (conducted). For emissions radiated by the cabinet or emissions radiated by integral antenna equipment (without antenna connectors), these limits are ERP for emissions up to 1 GHz and EIRP for emissions above 1 GHz.

Table 3: Transmitter unwanted emission limits outside the transmitter's operating bands

Frequency range	Maximum power	Measurement bandwidth
$30 \text{ MHz} \leq f < 87,5 \text{ MHz}$	-36 dBm	100 kHz
$87,5 \text{ MHz} \leq f \leq 118 \text{ MHz}$	-54 dBm	100 kHz
$118 \text{ MHz} < f < 174 \text{ MHz}$	-36 dBm	100 kHz
$174 \text{ MHz} \leq f \leq 230 \text{ MHz}$	-54 dBm	100 kHz
$230 \text{ MHz} < f < 470 \text{ MHz}$	-36 dBm	100 kHz
$470 \text{ MHz} \leq f \leq 694 \text{ MHz}$	-54 dBm	100 kHz
$694 \text{ MHz} < f \leq 1 \text{ GHz}$	-36 dBm	100 kHz
$1 \text{ GHz} < f \leq 26 \text{ GHz}$	-30 dBm	1 MHz
NOTE: Information in this table is based on ERC Recommendation 74-01 [i.13], Annex 2, Table 6.		

4.2.4.1.3 Conformance

Conformance tests as defined in clause 5.4.5 shall be carried out.

4.2.4.2 Transmitter unwanted emissions within the transmitter's operating bands

4.2.4.2.1 Definition

Transmitter unwanted emissions within the transmitter's operating bands are radio frequency emissions within the sub-bands of the 5 GHz RLAN band, excluding emissions within the nominal channel bandwidth of channels used for transmission.

4.2.4.2.2 Limits

4.2.4.2.2.1 Transmit spectral power mask

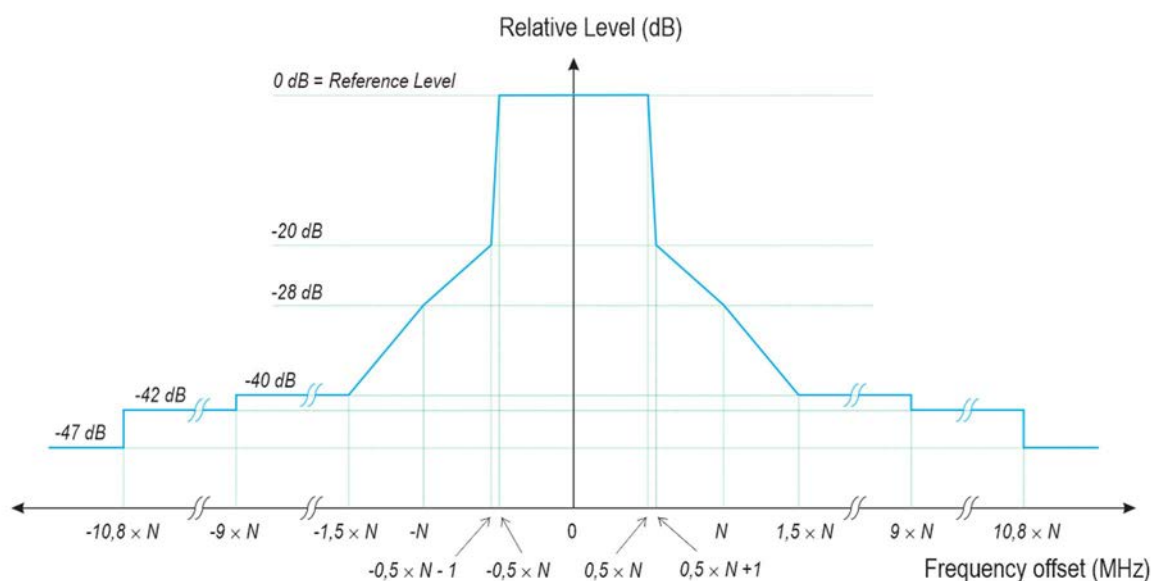

Figure 1: Transmit spectral power mask

The mean PSD of the transmitter unwanted emissions within the transmitter's operating bands shall not exceed the limits of the mask provided in figure 1 or an absolute level of -30 dBm/MHz, whichever is greater. The limits in figure 1 are relative to the maximum PSD transmitted by the RLAN device when measured with a reference bandwidth of 1 MHz.

The mask is only applicable within the band(s) of operation. Beyond the band edges, the requirements for transmitter unwanted emissions outside the transmitter's operating bands (see clause 4.2.4.1) apply.

In case of smart antenna systems (devices with multiple transmit chains) each of the transmit chains shall meet the limits for transmitter unwanted emissions within the transmitter's operating bands.

In case of multi-channel operation in adjacent or non-adjacent channels, clause 4.2.4.2.2.2 and clause 4.2.4.2.2.3 describe how the overall transmit spectral power mask to be applied shall be constructed. The transmitter unwanted emissions within the transmitter's operating bands shall not exceed the limits of this overall transmit spectral power mask or an absolute level of -30 dBm/MHz based on ERC Recommendation 74-01 [i.13], whichever is greater.

The channel edge masks for multi-channel operation in adjacent and/or non-adjacent channels which are supported by the equipment shall be noted in the test report (see clause 5.4.1).

4.2.4.2.2.2 Channel edge mask for multi-channel operation in adjacent channels

For equipment configured for multi-channel operation (see clause 4.2.7.3.1.3 or clause 4.2.7.3.2.3) on a group of adjacent channels where all these adjacent channels are used for transmissions, these transmissions may be considered as one signal with a total bandwidth (N) of n times the nominal channel bandwidth of an individual channel where n is the number of adjacent channels used simultaneously. This signal shall be subject to the limits provided by the mask in figure 1.

In case of a multi-channel configuration on a group of adjacent channels where not all the adjacent channels are used for transmissions, the overall transmit spectral power mask is constructed from the mask provided in figure 1 together with additional restrictions for the channels in the group of adjacent channels that are not used for transmission as described in the following:

- When the lowest channel(s) and/or the highest channel(s) of a group of adjacent channels is/are not used for transmission, an additional channel edge mask as in figure 2 shall be applied at the lower edge of the lowest channel used for transmission and at the higher edge of the highest channel used for transmission. M is the separation in MHz between these edges.

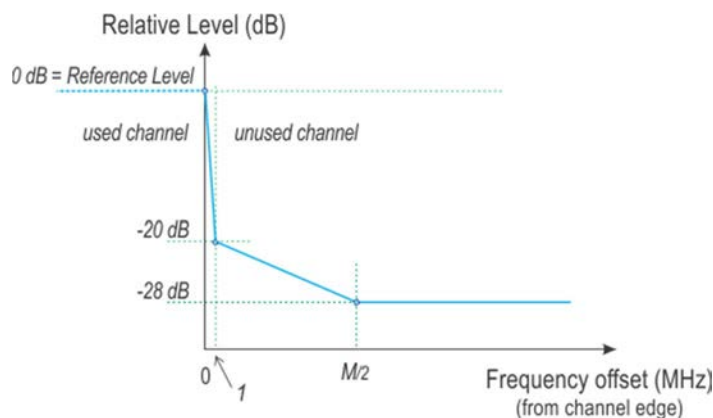

Figure 2: Channel edge mask - case 1

- When there are two or more channels not used for transmission in between channels used for transmission (all belonging to the same group of adjacent channels configured for multi-channel operation) and these channels not used for transmission are adjacent to each other, an additional channel edge mask as in figure 3 shall be applied at the higher edge of the channel adjacent to the lowest channel of the group of adjacent channels not used for transmission and at the lower edge of the channel adjacent to the highest channel of the group of adjacent channels not used for transmission. U is the total bandwidth of channels used for transmission adjacent to the channels not used for transmission.

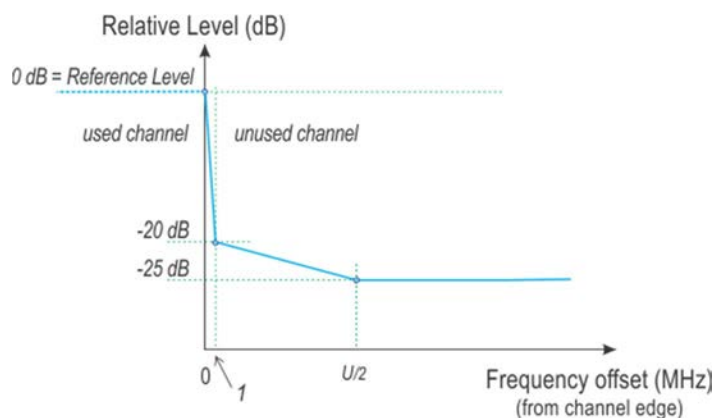

Figure 3: Channel edge mask - case 2

- When there is only one channel not used for transmission in between channels used for transmission (all belonging to the group of adjacent channels configured for multi-channel operation), an additional channel edge mask as in figure 4 shall be applied at the higher edge of the channel below the channel not used for transmission and at the lower edge of the channel above the channel not used for transmission.

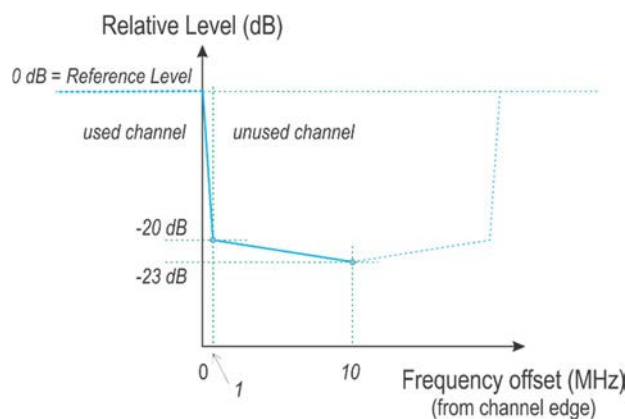

Figure 4: Channel edge mask - case 3

Any Local Oscillator (LO) power in a 2 MHz band may exceed the limits provided by the overall transmit spectral power mask (constructed from the masks in figure 1 to figure 4) but shall be less than -28 dBc (relative to the RF output power), or less than -20 dBm/MHz, whichever is greater. A 2 MHz band per LO can be located anywhere within the group of adjacent channels configured for multi-channel operation. The LO exceedance shall occur not more than once per 20 MHz of the total bandwidth (N) of the group of adjacent channels. For the specific case of a 40 MHz band configured for multi-channel operation and only one channel is being used for transmission, the LO exceedance shall be not more than 0 dBc if occurring.

Annex I contains a number of examples of how the overall transmit spectral power mask is constructed.

4.2.4.2.2.3 Channel edge mask for multi-channel operation in non-adjacent channels

For simultaneous transmissions in multiple non-adjacent channels (or non-adjacent groups of adjacent channels), the overall transmit spectral power mask is constructed in the following manner. First, the procedure as described in clause 4.2.4.2.2.2 shall be applied to each of the channels (or to each group of adjacent channels). Then, for each frequency point, the greatest value from the applicable transmit spectral power masks for each of the channels or the group of adjacent channels assessed shall be taken as the overall spectral power mask requirement at that frequency.

4.2.4.2.3 Conformance

Conformance tests as defined in clause 5.4.6 shall be carried out.

4.2.5 Receiver spurious emissions

4.2.5.1 Definition

Receiver spurious emissions are emissions at any frequency when the equipment is in receive mode.

4.2.5.2 Limits

The receiver spurious emissions shall not exceed the limits given in table 4.

In case of equipment with antenna connectors, these limits apply to emissions at the antenna port (conducted). For emissions radiated by the cabinet or emissions radiated by integral antenna equipment (without antenna connectors), these limits are ERP for emissions up to 1 GHz and EIRP for emissions above 1 GHz.

Table 4: Spurious radiated emission limits

Frequency range	Maximum power	Measurement bandwidth
30 MHz \leq f \leq 1 GHz	-57 dBm	100 kHz
1 GHz < f \leq 26 GHz	-47 dBm	1 MHz

NOTE: Information in this table is based on ERC Recommendation 74-01 [i.13], Annex 2, Table 6.

4.2.5.3 Conformance

Conformance tests as defined in clause 5.4.7 shall be carried out.

4.2.6 Dynamic Frequency Selection (DFS)

4.2.6.1 DFS general requirements

4.2.6.1.1 DFS function

An RLAN device shall employ a Dynamic Frequency Selection (DFS) function to:

- detect radar systems (radar detection) and to avoid co-channel operation with these systems;
- provide on aggregate a near-uniform loading of the spectrum (uniform spreading).

Whilst the DFS function described in this clause defines conditions under which the equipment may transmit, transmissions are allowed providing they are not prohibited by the adaptivity requirement.

4.2.6.1.2 DFS applicable frequency range

Radar detection shall be used when operating on channels whose nominal channel bandwidth falls partly or completely within the 5 GHz DFS band. The 5 GHz DFS band covers sub-band 2 and sub-band 3. This requirement applies to all types of RLAN devices within the scope of the present document regardless of the type of communication between these devices.

Uniform spreading is only required in sub-band 2 and in sub-band 3.

4.2.6.1.3 DFS operational modes

Within the context of the operation of the DFS function, an RLAN device shall operate as either a primary device or a secondary device. RLAN devices operating as a secondary device shall only operate in a network controlled by an RLAN device operating as a primary device. A device which is capable of operating as either a primary device or a secondary device shall conform to the requirements applicable to the mode in which it operates (see table 5).

Some RLAN devices are capable of communicating in ad-hoc manner without being attached to a network. RLAN devices operating in this manner on channels whose nominal channel bandwidth falls partly or completely within the 5 GHz DFS band shall employ DFS and shall be tested against the requirements applicable to a primary device.

Secondary devices used in fixed outdoor point-to-point or fixed outdoor point-to-multipoint applications shall behave as a secondary device with radar detection independent of their output power.

4.2.6.1.4 DFS operation

4.2.6.1.4.1 Primary devices

The operational behaviour and individual DFS requirements that are applicable to primary devices are as follows:

- a) The primary device shall use radar detection in order to detect radar signals.

The primary device may rely on another device to implement radar detection. In such a case, the combination of devices shall conform to the requirements applicable to a primary device.

An RLAN network always has at least one RLAN device operating as primary device when operating in the 5 GHz DFS band.

- b) A primary device shall only start operations on available channels. At installation (or reinstallation) of the equipment, the RLAN device is assumed to have no available channels within the 5 GHz DFS band. In such a case, before starting operations on one or more of these channels, the primary device shall perform either a Channel Availability Check (CAC) or an off-channel CAC to ensure that there are no radars operating on any selected channel. If no radar has been detected, the channel(s) become(s) available channel(s) and remain(s) as such until a radar signal is detected during the in-service monitoring after the channel became an operating channel. The CAC or the off-channel CAC may be performed over a wider bandwidth than the nominal channel bandwidth.

The initial CAC may be activated manually at installation or reinstallation of the equipment.

- c) A primary device may initiate a network by sending enabling signals to other RLAN devices which then become secondary devices. Once the RLAN device has started operations on an available channel, then that channel becomes an operating channel. During normal operation, the primary device shall monitor all operating channels (in-service monitoring) to ensure that there is no radar operating within these channel(s). If no radar was detected on an operating channel by the in-service monitoring but the RLAN stops operating on that channel, then the channel becomes again an available channel.

An RLAN device is allowed to start operations on multiple (adjacent or non-adjacent) available channels. In this case all these channels become operating channels.

- d) If the primary device has detected a radar signal on an operating channel during in-service monitoring, the primary device shall instruct all its associated secondary devices to stop transmitting on this channel which becomes an unavailable channel. When operating on multiple (adjacent or non-adjacent) operating channels simultaneously, only the operating channel containing the frequency on which radar was detected shall become an unavailable channel.
- e) An unavailable channel can become an available channel again after the non-occupancy period. A new CAC or an off-channel CAC is required to verify there is no radar operating on this channel before it becomes an available channel again. A CAC may be performed at the end of the non-occupancy period such that the CAC time as given in table D.1 shall complete later than or concurrently with the non-occupancy period.
- f) In all cases, if radar detection has occurred, then the channel containing the frequency on which radar was detected becomes an unavailable channel. Alternatively, the channel may be marked as an unusable channel.

4.2.6.1.4.2 Secondary devices

The operational behaviour and individual DFS requirements that are applicable to secondary devices are as follows:

- a) A secondary device shall not transmit before receiving an appropriate enabling signal from the primary device to which it is associated. Some secondary devices also have to perform their own radar detection (see table D.2, note 2).
- b) A secondary device shall stop its transmissions on a channel whenever instructed by its primary device. The secondary device shall not resume any transmissions on this channel until it has received an appropriate enabling signal from its primary device.
- c) If a secondary device that is required to perform radar detection (see table D.2, note 2) detects a radar on its operating channel(s), it shall inform its primary device. This may involve Short Control Signalling (SCS) transmissions in accordance with clause 4.2.7.3.3.3 on the channel the secondary device with radar detection has been instructed to operate on. This is equivalent to the primary device detecting a radar (see clause 4.2.6.1.4.1, point d)). The secondary device that detected the radar as well as the primary device with all other associated secondary devices shall stop their transmissions on that operating channel(s). The operating channel(s) become(s) unavailable channel(s) for the primary device and all associated secondary devices. There shall be no transmissions on unavailable channels for a period of time equal to the non-occupancy period. A CAC or an off-channel CAC is required by the secondary device that detected the radar to verify there is no radar operating on this channel before the secondary device may use it again.

4.2.6.2 DFS technical requirements

4.2.6.2.1 Applicability

Table 5 lists the DFS related technical requirements and their applicability for every operational mode. If the RLAN device is capable of operating in more than one operational mode then every operating mode shall be assessed separately.

Table 5: Applicability of DFS requirements

Requirement	DFS operational mode		
	Primary device	Secondary device without radar detection (see table D.2, note 2)	Secondary device with radar detection (see table D.2, note 2)
CAC	Required	Not required	Required (see note 2)
Off-channel CAC (see note 1)	Required	Not required	Required (see note 2)
In-service monitoring	Required	Not required	Required
Channel shutdown	Required	Required	Required
Non-occupancy period	Required	Not required	Required
Uniform spreading	Required	Not required	Not required
NOTE 1: If implemented.			
NOTE 2: A secondary device with radar detection is not required to perform a CAC or off-channel CAC at initial use of a channel but only before returning to the use of a channel where it has detected a radar signal by in-service monitoring. Where the secondary device with radar detection is under the control of its primary device and does not start transmissions on the channel until connected to that primary device, then the secondary device with radar detection does not have to perform a CAC or off-channel CAC and may rely on the CAC performed by the primary device to enable in-service monitoring.			

The radar detection requirements specified in the present document assume that the centre frequencies of the radar signals fall within the central 80 % of the occupied bandwidth of the RLAN device.

4.2.6.2.2 Channel Availability Check (CAC)

4.2.6.2.2.1 Definition

Channel Availability Check (CAC) is the process by which an RLAN device checks channels for the presence of radar signals. This process is used for identifying available and unavailable channels.

4.2.6.2.2.2 Limits

A CAC shall be performed during a continuous period in time (CAC time) which shall not be less than the value given in table D.1.

A CAC may be performed over a wider bandwidth than the nominal channel bandwidth. In this case, any channel whose nominal channel bandwidth falls completely within the bandwidth over which the CAC was performed becomes an available channel providing no radar was detected on that channel.

There shall be no transmissions by the RLAN device on the channels being checked during this process except by a secondary device in order to conform to the requirements specified in clause 4.2.6.1.4.2, point c).

During a CAC, the RLAN device shall be capable of detecting any of the radar test signals that fall within the ranges given by table D.4 with a level above the radar detection threshold defined in table D.2.

The RLAN device shall conform to the minimum detection probability as defined in table D.5.

4.2.6.2.2.3 Conformance

Conformance tests as defined in clause 5.4.8 shall be carried out.

4.2.6.2.3 Off-channel CAC

4.2.6.2.3.1 Definition

Off-channel CAC is an optional process by which an RLAN device operating within sub-band 1, sub-band 2, or sub-band 3 monitors channel(s), different from the operating channel(s), for the presence of radar signals.

4.2.6.2.3.2 Limits

Off-channel CAC may be used in addition to CAC as specified in clause 4.2.6.2.2 for identifying available channels.

An off-channel CAC may be performed by a number of non-continuous checks spread over a period in time. This period, which is required to determine the presence of radar signals, is the off-channel CAC time.

If implemented, the off-channel CAC time shall be noted in the test report. However, the off-channel CAC time shall be within the range specified in table D.1.

During an off-channel CAC, the RLAN device shall be capable of detecting any of the radar test signals that fall within the ranges given by table D.4 with a level above the radar detection threshold defined in table D.2.

The RLAN device shall conform to the minimum detection probability as defined in table D.5.

4.2.6.2.3.3 Conformance

Conformance tests as defined in clause 5.4.8 shall be carried out.

4.2.6.2.4 In-service monitoring

4.2.6.2.4.1 Definition

In-service monitoring is the process by which an RLAN device monitors each operating channel for the presence of radar signals.

4.2.6.2.4.2 Limits

In-service monitoring shall be used to monitor each operating channel.

In-service monitoring shall start immediately after the RLAN device has started transmissions on a channel.

During in-service monitoring, the RLAN device shall be capable of detecting any of the radar test signals that fall within the ranges given by table D.4 with a level above the radar detection threshold defined in table D.2.

The RLAN device shall conform to the minimum detection probability associated with a given radar test signal as defined in table D.5.

4.2.6.2.4.3 Conformance

Conformance tests as defined in clause 5.4.8 shall be carried out.

4.2.6.2.5 Channel shutdown

4.2.6.2.5.1 Definition

Channel shutdown is the process initiated by the RLAN device on an operating channel after a radar signal has been detected during in-service monitoring.

4.2.6.2.5.2 Limits

Radar signals can be detected by a primary device or by a secondary device with radar detection. If a radar signal was detected by a secondary device with radar detection, this secondary device shall inform its primary device that it has detected a radar.

The primary device shall instruct all associated secondary devices to stop transmitting on this operating channel, which they shall do within the channel move time. The primary device shall also stop its own transmissions on that operating channel within the channel move time.

The aggregate duration of all transmissions of the RLAN device on this channel during the channel move time shall be limited to the channel closing transmission time. The aggregate duration of all transmissions shall not include quiet periods in between transmissions.

For equipment having simultaneous transmissions on multiple (adjacent or non-adjacent) operating channels, only the channel(s) containing the frequency on which radar was detected is subject to the channel shutdown requirement. The equipment is allowed to continue transmissions on other operating channels.

The channel move time shall not exceed the limit given in table D.1.

The channel closing transmission time shall not exceed the limit given in table D.1.

4.2.6.2.5.3 Conformance

Conformance tests as defined in clause 5.4.8 shall be carried out.

4.2.6.2.6 Non-occupancy period

4.2.6.2.6.1 Definition

The non-occupancy period is the time during which the RLAN device does not transmit on a channel after a radar signal was detected on that channel.

4.2.6.2.6.2 Limits

During the non-occupancy period the RLAN device shall not make any transmissions on a channel once radar has been detected.

For equipment having simultaneous transmissions on multiple (adjacent or non-adjacent) operating channels, only the channel(s) containing the frequency on which radar was detected is (are) subject to the non-occupancy period requirement. The equipment is allowed to continue transmissions on other operating channels.

Before the RLAN device may transmit on a channel after the non-occupancy period ended, the channel shall be again identified as an available channel.

The non-occupancy period shall not be less than the value defined in table D.1.

4.2.6.2.6.3 Conformance

Conformance tests as defined in clause 5.4.8 shall be carried out.

4.2.6.2.7 Uniform spreading

4.2.6.2.7.1 Definition

Uniform spreading is a mechanism used to provide, on aggregate, a uniform loading of the spectrum across all devices.

The spreading can be achieved by various means. These means include network management functions controlling large numbers of RLAN devices as well as the channel selection function in an individual RLAN device.

4.2.6.2.7.2 Limits

Uniform spreading is only required in sub-band 2 and in sub-band 3. It is further limited to the usable channels within these frequency bands as specified as part of the channel plan.

Each of the channel plans shall make use of at least 60 % of the spectrum available in sub-band 2 and in sub-band 3.

Usable channels shall not be included in uniform spreading if they are precluded by either:

- 1) the intended outdoor usage of the RLAN device; or
- 2) previous detection of a radar on the channel (unavailable channel); or
- 3) national frequency usage conditions.

Each of the usable channels as defined above shall be used with approximately equal probability. Equipment for which the channel plan includes channels whose nominal channel bandwidth falls completely or partly within the band 5 600 MHz to 5 650 MHz may omit these channels from the list of usable channels at initial power up or at initial installation. Channels being used by other equipment may be omitted from the list of usable channels.

4.2.7 Adaptivity (channel access mechanism)

4.2.7.1 Applicability

The present requirement applies to all equipment within the scope of the present document.

The present document defines two types of equipment:

- Frame Based Equipment (FBE); and
- Load Based Equipment (LBE).

Whilst the mechanisms described in this clause define conditions under which the equipment may transmit, transmissions are only allowed providing they are not prohibited by any of the DFS requirements in the present document.

4.2.7.2 Definition

Adaptivity (channel access mechanism) is an automatic mechanism by which a device limits its transmissions and gains access to a channel.

Adaptivity is not intended to be used as an alternative to DFS to detect radar transmissions, but to detect transmissions from other RLAN devices operating on a channel.

4.2.7.3 Limits

4.2.7.3.1 Frame Based Equipment (FBE)

4.2.7.3.1.1 Introduction (FBE)

FBE is equipment where the transmit/receive structure has a periodic timing with a periodicity equal to the Fixed Frame Period (FFP).

FBE implements a Listen Before Talk (LBT) based channel access mechanism to detect the presence of other transmissions on an operating channel.

4.2.7.3.1.2 Device types (FBE)

With regard to adaptivity for FBE, a device that initiates a sequence of one or more transmissions is denoted as the initiating device. Otherwise, the device is denoted as a responding device. FBE may be an initiating device, a responding device, or both.

The initiating device shall implement a channel access mechanism as further described in clause 4.2.7.3.1.5.

A responding device shall implement a channel access mechanism as further described in clause 4.2.7.3.1.6.

4.2.7.3.1.3 Multi-channel operation (FBE)

FBE being capable of simultaneous transmissions in adjacent or non-adjacent operating channels (see clause 4.2.1) may use any combination/grouping of channels out of the list of channels identified by the nominal centre frequencies provided in clause 4.2.1, if it satisfies the channel access requirements (channel access mechanism) for an initiating device as described in clause 4.2.7.3.1.5 on each such operating channel.

For equipment also capable of operating in sub-band 4, the combination/grouping of channels may include channels identified by the nominal centre frequencies provided in clause B.2.2.1. The same channel access requirements apply.

4.2.7.3.1.4 Energy Detection Threshold (EDT) (FBE)

An operating channel is an occupied channel as long as transmissions in that channel are present at a power level greater than the Energy Detection Threshold (EDT). The power level is determined by integrating the received power over the channel and then normalized to per MHz power. The received power shall be determined at the interface between the equipment and the antenna assembly. If no transmissions are present at a power level greater than the EDT, the operating channel is an unoccupied channel. Equipment may consist of one or more devices.

The EDT is proportional to the equipment's maximum configured RF output power and shall be:

$$\text{EDT} = \begin{cases} -75 \text{ dBm/MHz} & \text{for } P_{\max} \leq 18 \text{ dBm} \\ -80 \text{ dBm/MHz} + (23 \text{ dBm} - P_{\max}) & \text{for } 18 \text{ dBm} < P_{\max} < 23 \text{ dBm} \\ -80 \text{ dBm/MHz} & \text{for } P_{\max} \geq 23 \text{ dBm} \end{cases} \quad (2)$$

The EDT is an absolute level that applies at all times independent of background noise of other signals being present in the channel.

4.2.7.3.1.5 Initiating device channel access mechanism (FBE)

An observation slot shall have a duration of not less than 9 μ s.

The initiating device shall implement a channel access mechanism that conforms to the following requirements:

- 1) The FFPs supported by the equipment shall be noted in the test report (see clause 5.4.1, item r)). These shall be within the range of 1 ms to 10 ms. Transmissions can start only at the beginning of a FFP (see figure 5). An equipment may change its FFP but it shall not do so more than once every 200 ms.
- 2) Immediately before starting transmissions on an operating channel or a combination of operating channels at the start of a FFP, the initiating device shall perform a Clear Channel Assessment (CCA) check during a single observation slot. An operating channel is an occupied channel as long as transmissions in that channel are present at a power level greater than the Energy Detection Threshold (EDT) as described in clause 4.2.7.3.1.4. If no transmissions are present at a power level greater than the EDT, the operating channel is an unoccupied channel. Transmissions may start on an unoccupied channel (see figure 5).

If the operating channel is an occupied channel, the initiating device shall not transmit on the channel during the FFP (see figure 5). The FBE is allowed to continue Short Control Signalling (SCS) transmissions on the channel providing it conforms to the requirements given in clause 4.2.7.3.3.

For equipment having simultaneous transmissions on multiple (adjacent or non-adjacent) operating channels, the equipment is allowed to continue transmissions on other operating channels that are unoccupied channels.

The total time during which FBE can have transmissions on a given channel for a given FFP is defined as the Channel Occupancy Time (COT).

The equipment can have multiple transmissions within a COT without performing an additional CCA on this operating channel providing the gap between such transmissions does not exceed 18 μ s.

If the gap exceeds 18 μ s, the equipment may continue transmissions provided that an additional CCA detects no transmissions with a level above the EDT defined in clause 4.2.7.3.1.4. The additional CCA shall be performed within the gap and within the observation slot immediately before transmission. All gaps are counted as part of the COT.

- 3) An initiating device is allowed to grant an authorization to one or more associated responding devices to transmit on the current operating channel within the current COT. A responding device that receives such a grant shall follow the procedure described in clause 4.2.7.3.1.6.
- 4) The COT shall not be greater than 95 % of the FFP defined in point 1) and shall be followed by an idle period until the start of the next FFP such that the total idle period is at least equal to the minimum idle period, i.e. 5 % of the COT, with a minimum of 100 μ s.
- 5) The equipment, upon correct reception of a packet which was intended for this equipment, can skip CCA and immediately proceed with management and control signalling. A consecutive sequence of such transmissions by the equipment, without it performing a new CCA, shall not exceed the maximum COT as defined in point 4).

For the purpose of multicast, the ACK transmissions (associated with the same data packet) of the individual devices are allowed to take place in a sequence.

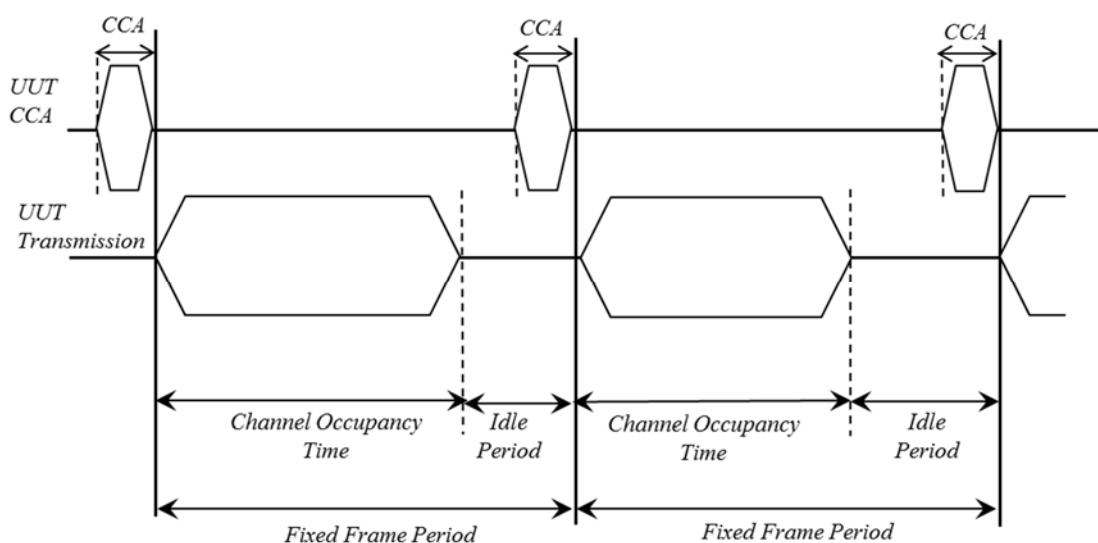

Figure 5: Example of timing for FBE

4.2.7.3.1.6 Responding device channel access mechanism (FBE)

Clause 4.2.7.3.1.5, point 3) describes the possibility whereby an initiating device grants an authorization to one or more associated responding devices to transmit on the current operating channel within the current FFP. A responding device that receives such a grant shall follow the procedure described in step 1) to step 3):

- 1) A responding device that received a transmission grant from an associated initiating device may proceed with transmissions on the current operating channel:
 - a) The responding device may proceed with such transmissions without performing a CCA if these transmissions are initiated at most 18 μ s after the last transmission by the initiating device that issued the grant.
 - b) The responding device that does not proceed with such transmissions within 18 μ s after the last transmission from the initiating device that issued the grant shall perform a CCA on the operating channel during a single observation slot within a 27 μ s period ending immediately before the granted transmission time. If energy was detected with a level above the EDT defined in clause 4.2.7.3.1.4, the responding device shall proceed with step 3). Otherwise, the responding device shall proceed with step 2).
- 2) The responding device may perform transmissions on the current operating channel for the remaining COT of the current FFP. The responding device may have multiple transmissions on this operating channel provided that the gap in between such transmissions does not exceed 18 μ s. When the transmissions by the responding device are completed, the responding device shall proceed with step 3).
- 3) The transmission grant for the responding device is withdrawn.

4.2.7.3.2 Load Based Equipment (LBE)

4.2.7.3.2.1 Introduction (LBE)

LBE implements a Listen Before Talk (LBT) based channel access mechanism to detect the presence of other transmissions on an operating channel.

4.2.7.3.2.2 Device types (LBE)

With regard to adaptivity for LBE, a device that initiates a sequence of one or more transmissions is denoted as the initiating device. Otherwise, the device is denoted as a responding device. LBE may be an initiating device, a responding device, or both.

The initiating device shall implement a channel access mechanism with a prioritized, truncated exponential backoff procedure as further described in clause 4.2.7.3.2.6.

A responding device shall implement a channel access mechanism as further described in clause 4.2.7.3.2.7.

Each transmission belongs to a single Channel Occupancy Time (COT). A COT consists of one or more transmissions of an initiating device and zero or more transmissions of one or more responding devices.

An equipment that controls (non-DFS related) operating parameters of one or more other equipment is denoted as a supervising device. Otherwise, the equipment is denoted as a supervised device. The roles of a supervising device and a supervised device have only to be seen in relation to adaptivity and are different from the roles of a primary device and a secondary device in the context of DFS.

EXAMPLE: Examples of supervising devices are an RLAN access point or a mobile phone operating as an RLAN hotspot.

4.2.7.3.2.3 Multi-channel operation (LBE)

LBE being capable of simultaneous transmissions in adjacent or non-adjacent operating channels (see clause 4.2.1) shall implement either of the following options:

Option 1: LBE may use any combination/grouping of channels out of the list of channels identified by the nominal centre frequencies provided in clause 4.2.1, if it satisfies the channel access requirements (channel access mechanism) for an initiating device as described in clause 4.2.7.3.2.6 on each such operating channel.

For equipment also capable of operating in sub-band 4, the combination/grouping of channels may include channels identified by the nominal centre frequencies provided in clause B.2.2.1. The same channel access requirements apply.

Option 2: Figure 6 defines groups of adjacent channels with a total bandwidth of 40 MHz, 80 MHz or 160 MHz (see also clause 4.2.1.3 for the channel number). LBE that uses a combination/grouping of adjacent channels that is a subset of the 40 MHz, 80 MHz or 160 MHz groups of adjacent channels in figure 6 may transmit on any of the operating channels, if:

- the equipment satisfies the channel access requirements (channel access mechanism) for an initiating device as defined in clause 4.2.7.3.2.6 on one of the operating channels (primary operating channel) and
- the equipment performs a Clear Channel Assessment (CCA) of at least 23 μ s immediately before the intended transmissions on each of the other operating channels on which transmissions are intended, and no energy was detected with a level above the Energy Detection Threshold (EDT) defined in clause 4.2.7.3.2.5.

The choice of the primary operating channel shall follow one of the following procedures:

- The primary operating channel is chosen uniformly randomly whenever the Contention Window (CW) corresponding to a completed transmission on the current primary operating channel is set to its minimum value (CW_{min}). For this procedure, a CW is maintained for each priority class (see clause 4.2.7.3.2.4) within each operating channel from the group of adjacent channels.
- The primary operating channel is arbitrarily determined and not changed more than once per second.

For equipment also capable of operating in sub-band 4, the combination/grouping of channels may include groups of adjacent channels of 40 MHz or 80 MHz defined in figure B.1 in clause B.2.2.7.3.2.3. The same channel access requirements apply.

The group of adjacent channels of 40 MHz, 80 MHz or 160 MHz that the combination/grouping of channels is a subset of shall not be changed more than once per second.

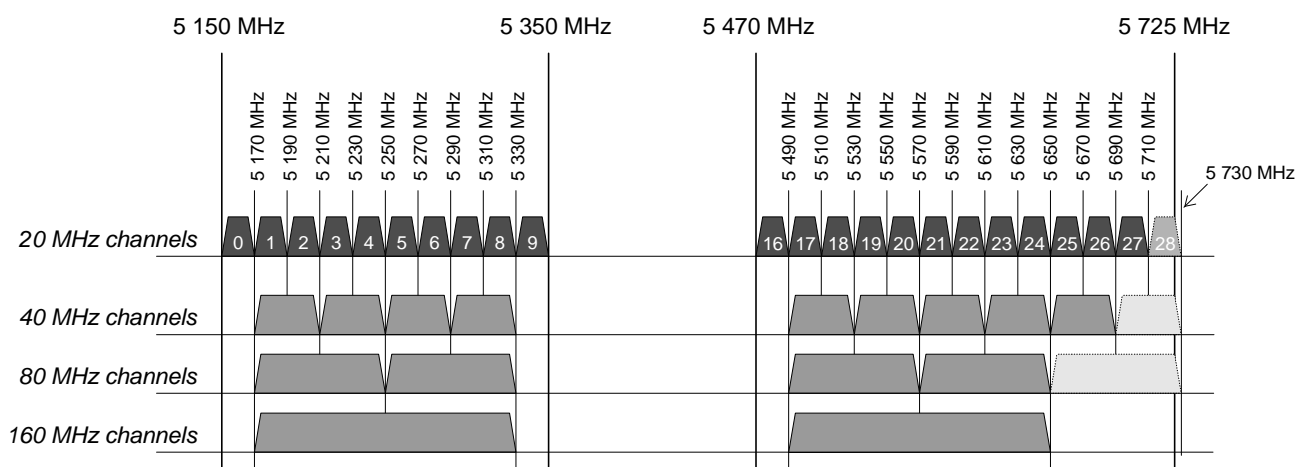

Figure 6: Groups of adjacent channels for option 2

4.2.7.3.2.4 Priority classes (LBE)

Table 6 and table 7 each contain four different sets of channel access parameters for supervising devices and supervised devices respectively resulting in different priority classes and different maximum COTs. These parameters are used by the channel access mechanism for the initiating device described in clause 4.2.7.3.2.6 to gain access to an operating channel.

If a channel occupancy consists of more than one transmission, the transmissions may be separated by gaps. The COT is the total duration that an initiating device and any responding devices occupy one or more operating channels and includes all gaps of 27 μ s duration or less. The total duration of a channel occupancy shall not exceed the maximum COT in table 6 and table 7. If a channel occupancy has gaps exceeding 27 μ s, the duration from the start of the first transmission of a channel occupancy until the end of the last transmission of the same channel occupancy shall not exceed 20 ms.

The initiating device may have data to be transmitted in different priority classes and therefore the channel access mechanism is allowed to operate different Channel Access Engines (CAE) as described in clause 4.2.7.3.2.6 simultaneously (one for each implemented priority class).

Table 6: Priority class dependent channel access parameters for supervising devices

Class	p_0	CW_{min}	CW_{max}	Maximum COT
4	1	3	7	2 ms
3	1	7	15	4 ms
2	3	15	63	6 ms (see note 1 and note 2)
1	7	15	1 023	6 ms (see note 1)

NOTE 1: The maximum COT of 6 ms may be increased to 8 ms by inserting one or more pauses. The minimum duration of a pause shall be 100 μ s. The maximum duration (channel occupancy) before including any such pause shall be 6 ms. Pause duration is not included in the COT.

NOTE 2: The maximum COT of 6 ms may be increased to 10 ms by extending CW to $CW \times 2 + 1$ when selecting the random number q for any backoff(s) that precede the channel occupancy that may exceed 6 ms or which follow the channel occupancy that exceeded 6 ms. The choice between preceding or following a channel occupancy shall remain unchanged during the operation time of the device.

NOTE 3: The values for p_0 , CW_{min} , CW_{max} are minimum values. Greater values are allowed.

Table 7: Priority class dependent channel access parameters for supervised devices

Class	p_0	CW_{min}	CW_{max}	Maximum COT
4	2	3	7	2 ms
3	2	7	15	4 ms
2	3	15	1 023	6 ms (see note 1)
1	7	15	1 023	6 ms (see note 1)

NOTE 1: The maximum COT of 6 ms may be increased to 8 ms by inserting one or more pauses. The minimum duration of a pause shall be 100 μ s. The maximum duration (channel occupancy) before including any such pause shall be 6 ms. Pause duration is not included in the COT.

NOTE 2: The values for p_0 , CW_{min} , CW_{max} are minimum values. Greater values are allowed.

4.2.7.3.2.5 Energy Detection Threshold (EDT) (LBE)

An operating channel is an occupied channel as long as transmissions in that channel are present at a power level greater than the Energy Detection Threshold (EDT). The power level is determined by integrating the received power over the channel and then normalized to per MHz power. The received power shall be determined at the interface between the equipment and the antenna assembly. If no transmissions are present at a power level greater than the EDT, the operating channel is an unoccupied channel. Equipment may consist of one or more devices.

The EDT is proportional to the equipment's maximum configured RF output power and shall be:

$$EDT = \begin{cases} -75 \text{ dBm/MHz} & \text{for } P_{max} \leq 18 \text{ dBm} \\ -80 \text{ dBm/MHz} + (23 \text{ dBm} - P_{max}) & \text{for } 18 \text{ dBm} < P_{max} < 23 \text{ dBm} \\ -80 \text{ dBm/MHz} & \text{for } P_{max} \geq 23 \text{ dBm} \end{cases} \quad (3)$$

The EDT is an absolute level that applies at all times independent of background noise of other signals being present in the channel.

4.2.7.3.2.6 Initiating device channel access mechanism (LBE)

Before a transmission or a burst of transmissions on an operating channel or combination of operating channels, the initiating device shall operate at least one Channel Access Engine (CAE) that executes the procedure described in step 1) to step 7). This CAE makes use of the parameters defined in table 6 or table 7 in clause 4.2.7.3.2.4.

An observation slot shall have a duration of not less than 9 μ s.

An initiating device shall operate at least one and no more than four different CAEs each with a different priority class as defined in clause 4.2.7.3.2.4:

- 1) The CAE shall set CW to CW_{\min} .
- 2) The CAE shall select a random number q from a uniform distribution over the range 0 to CW . Note 2 in table 6 defines an alternative range for q when the previous or next COT is greater than the maximum COT specified in table 6.
- 3) The CAE shall initiate a prioritization period as described in step 3) a) to step 3) c):
 - a) The CAE shall set p equal to p_0 according to the priority class associated with this CAE (see clause 4.2.7.3.2.4).
 - b) The CAE shall wait for a period of 14 μ s.
 - c) The CAE shall perform a Clear Channel Assessment (CCA) on the operating channel. During a single observation slot the CAE shall determine if the operating channel or combination of operating channels are occupied channel(s):
 - i) For the operating channel(s) that have been detected as occupied, the CAE shall initiate a new prioritization period starting with step 3) a) after the energy within the channel(s) has dropped below the EDT defined in clause 4.2.7.3.2.5.
 - ii) For the operating channels that have been determined as unoccupied channels, p may be decremented by not more than 1. If p is equal to 0, the CAE shall proceed with step 4), otherwise the CAE shall proceed with step 3) c).
- 4) The CAE shall perform a backoff procedure as described in step 4) a) to step 4) d):
 - a) This step verifies if the CAE satisfies the post backoff condition. If $q < 0$ and the CAE is ready for a transmission, the CAE shall set CW equal to CW_{\min} and shall select a random number q from a uniform distribution over the range 0 to CW before proceeding with step 4) b). Note 2 in table 6 defines an alternative range for q when the previous or next COT is greater than the maximum COT specified in table 6.
 - b) If $q < 1$ the CAE shall proceed with step 4) d). Otherwise, the CAE may decrement the value q by not more than 1 and the CAE shall proceed with step 4) c).
 - c) The CAE shall perform a CCA on the operating channel. During a single observation slot the CAE shall determine if the operating channel or combination of operating channels are occupied channel(s) or unoccupied channel(s):
 - i) For the operating channel(s) that have been determined as occupied channel(s), the CAE shall continue with step 3).
 - ii) For the operating channel(s) that have been detected as unoccupied channel(s) the CAE shall continue with step 4) b).
 - d) If the CAE is ready for a transmission the CAE shall continue with step 5). Otherwise, the CAE shall decrement the value q by 1 and the CAE shall proceed with step 4) c). It should be understood that q can become negative and keep decrementing as long as the CAE is not ready for a transmission.
- 5) If only one CAE of the initiating device is in this stage (see note 1) the CAE shall proceed with step 6). If the initiating device has a multitude of CAEs in this stage (see note 2), the CAE with highest priority class in this multitude shall proceed with step 6) and all other CAE in the current stage shall proceed with step 7).

NOTE 1: This is equivalent to the equipment having no internal collision.

NOTE 2: This is equivalent to the equipment having one or more internal collisions.

- 6) The CAE may start transmissions belonging to the corresponding or higher priority classes on one or more operating channels. If the initiating device transmits in more than one operating channel, it shall conform to the requirements defined for multi-channel operation:
- a) The initiating device and its responding devices can have multiple transmissions without performing an additional CCA on the operating channel or combination of operating channels providing the gap in between such transmissions does not exceed 18 μ s. Otherwise, if this gap exceeds 18 μ s and does not exceed 27 μ s, the initiating device may continue transmissions provided that for a duration of one observation slot the initiating device found the operating channel(s) to be unoccupied channel(s).
 - b) The CAE may grant up to ten authorizations to transmit on the current operating channel to each of one or more responding devices. If the initiating device issues such a transmission grant to a responding device, the responding device shall operate according to the procedure described in clause 4.2.7.3.2.7.
 - c) The initiating device may have simultaneous transmissions of priority classes lower than the priority class of the CAE, provided that the corresponding transmission duration (COT) is not extended beyond the time that is needed for the transmission(s) corresponding to the priority class of the CAE.
- 7) When the channel occupancy has completed, CW shall be updated as specified in the present clause, and the initiating device proceeds with step 2).

According to clause 4.2.7.3.2.4 where four different priority classes are defined, an initiating device shall operate only one CAE for each priority class implemented.

CW may take values that are greater than the values of CW in step 1) to step 7).

Updating CW is based on feedback about the success or failure of channel occupancies.

Success and failure of a channel occupancy are defined as follows:

- A channel occupancy is a success when at least one transmission that started at the beginning of the channel occupancy was successful or when there is no intention to retransmit any part of the information transmitted during the channel occupancy.
- Otherwise, the channel occupancy is a failure.

When CW is updated:

- If new feedback is available relative to the prior CW update, the feedback for the latest COT, for which new feedback is received, shall be used as follows:
 - If the feedback indicates success, CW shall be set to CW_{\min} .
 - If the feedback indicates failure, CW shall be set to $\min(CW \times 2 + 1, CW_{\max})$.
- Otherwise, CW shall remain the same.

During normal operation, there is no bias towards success in the selection of the feedback used to update CW.

4.2.7.3.2.7 Responding device channel access mechanism (LBE)

Clause 4.2.7.3.2.6 step 6) b) describes the possibility whereby an initiating device grants an authorization to one or more associated responding devices to transmit on the current operating channel. A responding device that receives such a grant shall follow the procedure described in step 1) to step 3):

- 1) A responding device that received a transmission grant from an associated initiating device may proceed with transmissions on the current operating channel. The responding device shall set h equal to the number of transmission times that the initiating device granted to the responding device:
 - a) The responding device may proceed with such transmissions without performing a CCA if these transmissions are initiated at most 18 μ s after the last transmission by the initiating device that issued the grant.

- b) The responding device that does not proceed with such transmissions within 18 μ s after the last transmission within the channel occupancy, shall perform a CCA on the operating channel during a single observation slot within a 27 μ s period ending immediately before the h-th granted transmission time. The CAE shall determine whether the operating channel is an occupied channel or an unoccupied channel. If the operating channel is an occupied channel, the responding device shall proceed with step 1) c). If the operating channel is an unoccupied channel, the responding device shall proceed with step 2).
 - c) The responding device shall decrement h by 1. If $h \leq 0$, the responding device shall proceed with step 3). Otherwise, the responding device shall proceed with step 1) b).
- 2) The responding device may perform transmissions on the current operating channel for the remaining COT. The responding device may have multiple transmissions on this operating channel provided that the gap in between such transmissions does not exceed 18 μ s. When the transmissions by the responding device are completed the responding device shall proceed with step 3).
 - 3) The transmission grant for the responding device is withdrawn.

4.2.7.3.3 Short Control Signalling (SCS) transmissions (FBE and LBE)

4.2.7.3.3.1 General

FBE and LBE are allowed to have Short Control Signalling (SCS) transmissions on the operating channel providing these transmissions conform to the limits defined in clause 4.2.7.3.3.3. It is not required for equipment to implement SCS transmissions.

4.2.7.3.3.2 Definition

SCS transmissions are transmissions used by the equipment to send management and control signals without sensing the channel for the presence of other signals.

4.2.7.3.3.3 Limits

The use of SCS transmissions is constrained as follows:

- within an observation period of 50 ms, the number of SCS transmissions by the equipment shall be equal to or less than 50; and
- the total duration of the equipment's SCS transmissions shall be less than 2 500 μ s within said observation period.

4.2.7.4 Conformance

Conformance tests as defined in clause 5.4.9 shall be carried out.

4.2.8 Receiver blocking

4.2.8.1 Applicability

The present requirement applies to all equipment within the scope of the present document.

4.2.8.2 Definition

Receiver blocking is a measure of the capability of the equipment to receive a wanted signal on its usable channels without exceeding a given degradation due to the presence of an unwanted input signal (blocking signal) on frequencies other than those of the operating bands.

4.2.8.3 Performance criteria

For equipment that supports a PER or FER test to be performed, the minimum performance criterion shall be a PER or FER less than or equal to 10 %.

For equipment that does not support a PER or a FER test to be performed, the minimum performance criterion shall be no loss of the wireless transmission function needed for the intended use of the equipment.

4.2.8.4 Limits

While maintaining the minimum performance criteria as defined in clause 4.2.8.3, the blocking levels at specified frequency offsets shall be equal to or greater than the limits given in table 8.

Table 8: Receiver blocking parameters

Wanted signal mean power from companion device (dBm)	Blocking signal frequency (MHz)	Blocking signal power		Type of blocking signal
		Primary device or secondary device with radar detection (see note 2 in table D.2) (dBm)	Secondary device without radar detection (see note 2 in table D.2) (dBm)	
$P_{\min} + 6$ dB	5 100	-53	-59	Continuous wave
$P_{\min} + 6$ dB	4 900	-47	-53	Continuous wave
	5 000			
	5 975			
NOTE: P_{\min} is the minimum level of the wanted signal (in dBm) required to meet the minimum performance criteria as defined clause 4.2.8.3 in the absence of any blocking signal.				

4.2.8.5 Conformance

Conformance tests as defined in clause 5.4.10 shall be carried out.

4.2.9 Adjacent channel selectivity

4.2.9.1 Applicability

The present requirement applies to all equipment within the scope of the present document.

4.2.9.2 Definition

Adjacent channel selectivity is a measure of the capability of the equipment to receive a wanted signal on its usable channels without exceeding a given degradation due to the presence of an interfering signal in an adjacent channel.

4.2.9.3 Performance criteria

For equipment that supports a PER or FER test to be performed, the minimum performance criterion shall be a PER or FER less than or equal to 10 %.

For equipment that does not support a PER or a FER test to be performed, the minimum performance criterion shall be no loss of the wireless transmission function needed for the intended use of the equipment.

4.2.9.4 Limits

The limits defined in this clause apply when the equipment receives the wanted signal on a single channel and the occupied bandwidth of the interfering signal falls completely within a channel adjacent to this channel. Both channels have a nominal channel bandwidth as defined in clause 4.2.2.

While maintaining the minimum performance criteria as defined in clause 4.2.9.3, the adjacent channel interferer level shall be equal to or greater than the limit given in table 9 corresponding to a frequency offset within the range specified in table 9.

Table 9: Adjacent channel selectivity parameters

Wanted signal mean power from companion device (dBm)	Interferer signal frequency offset range (MHz)	Interferer signal power (dBm) (see note 2)	Type of interferer signal
$P_{\min} + 10$ dB	$20 \pm 0,2$	$P_{\min} + 26$ dB	Same as the wanted signal with an equivalent occupied bandwidth
NOTE 1: P_{\min} is the minimum level of the wanted signal (in dBm) required to meet the minimum performance criteria as defined clause 4.2.9.3 in the absence of any interfering signal.			
NOTE 2: The level specified for the interferer signal applies at the lowest data rate.			

4.2.9.5 Conformance

Conformance tests as defined in clause 5.4.11 shall be carried out.

4.2.10 User Access Restrictions (UAR)

4.2.10.1 Definition

As certain parameters are deemed to be critical in the mitigation of interference to other radio services, these parameters are subject to User Access Restrictions (UAR).

UAR are intended to ensure that the defined value or range of values, settings and functions for the identified parameters cannot be altered by any software or hardware element in the field by the user to any value that falls outside the range of values detailed in the appropriate clauses within the present document.

NOTE: The user should be understood as to include the end user, the operator or any person not responsible for the conformity of the equipment against the requirements in the present document.

In addition, any hardware element that can be activated by the user to change the identified parameters is also subject to the requirements of the clause.

4.2.10.2 Requirements

The equipment shall be so constructed that settings (hardware and/or software) are not accessible to the user if changing those settings result in the equipment no longer being conformant to the following:

- The DFS requirements as specified in clause 4.2.6.
- The adaptivity requirements as specified in clause 4.2.7, in particular the thresholds as defined or referred to in clause 4.2.7.3.1.4 and in clause 4.2.7.3.2.5.

EXAMPLE: The equipment does not allow the user to change the country of operation and/or the operating frequency band if that results in the equipment no longer being conformant to the DFS and/or the adaptivity requirements.

4.2.10.3 Conformance

The UUT shall be deemed to conform to the UAR requirements if the UUT does not provide options that allow automatic or manual adjustment of limits and/or requirements for those parameters identified in clause 4.2.10.2.

The conformance assessment procedure as defined in clause 5.4.12 shall be carried out.

5 Testing for compliance with technical requirements

5.1 Environmental conditions for testing

5.1.1 General conditions

Tests defined in the present document shall be carried out at representative points within the boundary limits of the operational environmental profile defined by its intended use (see clause 5.4.1, item n)).

Where technical performance varies subject to environmental conditions, tests shall be carried out under a sufficient variety of environmental conditions (within the boundary limits of the operational environmental profile defined by its intended use) to give confidence of compliance for the affected technical requirements.

For each test defined in the present document, the environmental condition(s) at which the test has to be performed is specified in the clause on test conditions for that particular test.

5.1.2 Normal test conditions

5.1.2.1 Normal temperature and humidity

The normal temperature and humidity conditions for tests shall be within the following ranges:

- temperature: +15 °C to +35 °C;
- relative humidity: 20 % to 75 %.

The actual values during the tests shall be recorded.

5.1.2.2 Normal power source

The power source for testing the equipment under normal conditions shall supply a voltage within the voltage range for which the equipment was designed.

5.1.3 Extreme test conditions

Where testing under extreme test conditions is required in the present document, measurements shall be performed at both the lower extreme temperature and the upper extreme temperature.

Unless otherwise specified by the intended use of the equipment (see clause 5.4.1, item n)), the lower extreme temperature shall be -20 °C and the upper extreme temperature shall be +55 °C.

The lower extreme temperature and the upper extreme temperature may be specified by the operating temperature range as required by the intended use of the equipment (see clause 5.4.1, item n)). The lower extreme temperature shall not be higher than +15 °C and the upper extreme temperature shall not be lower than +35 °C.

The extreme temperatures used in measurements shall be recorded in the test report.

The power source for testing the equipment under extreme conditions shall supply a voltage within the voltage range for which the equipment was designed.

5.2 Interpretation of the measurement results

The information provided in annex C can be used for the interpretation of the results recorded in a test report for the measurements described in the present document.

5.3 Definition of other test conditions

5.3.1 Test sequences and traffic load

5.3.1.1 General test transmission sequences

Except for the DFS tests or if mentioned otherwise, all the tests in the present document shall be performed by using a test transmission sequence that shall consist of regularly transmitted packets (e.g. with an interval of 2 ms). The test transmissions shall be fixed in length in a sequence and shall exceed the transmitter minimum activity ratio of 10 %.

The general structure of the test transmission sequence is shown in figure 7.

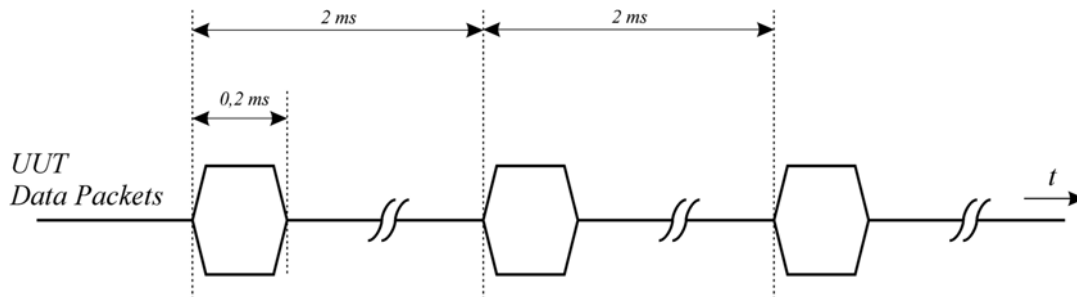

Figure 7: General structure of the test transmission sequences

5.3.1.2 Test transmission sequences for DFS tests

The DFS tests related to the off-channel CAC (clause 5.4.8.2.1.4) and the in-service monitoring (clause 5.4.8.2.1.5) shall be performed by using a test transmission sequence on the operating channel that shall consist of packet transmissions that together exceed the transmitter minimum activity ratio of 30 % measured over an interval of 100 ms.

There shall be no transmissions on channels being checked during a CAC or during an off-channel CAC.

5.3.2 Test channels

Unless otherwise stated in the test procedures for essential radio test suites, the channels (and nominal channel bandwidths) on which the essential radio test suites contained in the present document shall be performed are given in table 10. The channel identifiers have the format $C_{sb}f$ in which context C denotes 'channel', sb denotes the sub-band that the test channel is applicable to (where 'gen' denotes that the test channel is not sub-band dependent), and f is an index.

When testing devices that support simultaneous transmissions in adjacent or non-adjacent channels, DFS testing does not need to be performed simultaneously in these different channels.

Table 10: Test channels for sub-band 1, sub-band 2 and sub-band 3

Test	Clause	Test channel		
		Sub-band 1	Sub-band 2	Sub-band 3
Nominal centre frequency (see note 1)	5.4.2	C ₁₁	C ₂₁	C ₃₁
Occupied bandwidth	5.4.3	C ₁₁	C ₂₁	C ₃₁
RF output power, Power Spectral Density (PSD)	5.4.4	C ₁₂ , C ₁₃	C ₂₂ , C ₂₃	C ₃₂ , C ₃₃
Transmit Power Control (TPC) (see note 1)	5.4.4	n.a.	C ₂₂ , C ₂₃	C ₃₂ , C ₃₃
Transmitter unwanted emissions outside the transmitter's operating bands (see note 1)	5.4.5	C ₁₁	C ₂₁	C ₃₁
Transmitter unwanted emissions within the transmitter's operating bands (for single-channel operation)	5.4.6	C ₁₂ , C ₁₃	C ₂₂ , C ₂₃	C ₃₂ , C ₃₃

Test	Clause	Test channel		
		Sub-band 1	Sub-band 2	Sub-band 3
Transmitter unwanted emissions within the transmitter's operating bands (for multi-channel operation in adjacent channels) (see note 3 for multi-channel operation in non-adjacent channels)	5.4.6	C_{gen1}, C_{gen2} (see note 4 for channels in the group of adjacent channels not used for transmission)		
Receiver spurious emissions (see note 1)	5.4.7	C_{11}	C_{21}	C_{31}
Dynamic Frequency Selection (DFS)	5.4.8	n.a.	C_{24}	C_{34} (see note 2)
Adaptivity (channel access mechanism)	5.4.9	C_{gen3}		
Receiver blocking	5.4.10	C_{11}	C_{21}	C_{31}
Adjacent channel selectivity	5.4.11	C_{11}	C_{21}	C_{31}
Test channel definitions:				
C_{11}, C_{21}, C_{31} :	One channel from the channel plan for the sub-band. For occupied bandwidth, testing shall be repeated for every nominal channel bandwidth within the sub-band. For receiver blocking and adjacent channel selectivity, it is sufficient to only perform this test using the lowest nominal channel bandwidth.			
C_{12}, C_{22}, C_{32} :	The lowest channel for every channel plan within this sub-band. For PSD testing, it is sufficient to only perform this test using the lowest nominal channel bandwidth. For unwanted emissions testing, it is sufficient to only perform this test using a nominal channel bandwidth of 20 MHz.			
C_{13}, C_{23}, C_{33} :	The highest channel for every channel plan within this sub-band. For PSD testing, it is sufficient to only perform this test using the lowest nominal channel bandwidth. For unwanted emissions testing, it is sufficient to only perform this test using a nominal channel bandwidth of 20 MHz.			
C_{14}, C_{24}, C_{34} :	One channel from the channel plan for this sub-band. If more than one nominal channel bandwidth is specified for this sub-band, testing shall be performed using the lowest and highest nominal channel bandwidth.			
C_{gen1} :	The lowest channel in the group of adjacent channels for all supported total bandwidths (N).			
C_{gen2} :	The highest channel in the group of adjacent channels for all supported total bandwidths (N).			
C_{gen3} :	One channel (in case of single-channel testing) or a group of adjacent channels (in case of multi-channel testing) from the channel plan.			
NOTE 1: In case of more than one channel plan, testing of these specific requirements needs only to be performed using one of the channel plans.				
NOTE 2: Where the channel plan includes channels whose nominal channel bandwidth falls completely or partly within the 5 600 MHz to 5 650 MHz band, the tests for the Channel Availability Check (CAC) (and, where implemented, for the off-channel CAC) shall be performed on one of these channels in addition to a channel within the band 5 470 MHz to 5 600 MHz or within the band 5 650 MHz to 5 725 MHz.				
NOTE 3: For multi-channel operation in non-adjacent channels, each group of adjacent channels shall be tested individually with the specified test channels.				
NOTE 4: If one or more of the channels in the group of adjacent channels might not be used for transmission, channel configurations suitable to verify each of the supported channel edge masks as shown in figure 2, figure 3 and figure 4 shall be tested in addition.				

5.3.3 Antennas

5.3.3.1 Integrated and dedicated antennas

The equipment can have either integral antennas or dedicated antennas. Dedicated antennas, further referred to as dedicated external antennas, are antennas that are physically external to the equipment and are assessed in combination with the equipment against the requirements in the present document.

An antenna assembly referred to in the present document is understood as the combination of the antenna (integral or dedicated), its coaxial cable and, if applicable, its antenna connector and associated switching components. The gain of an antenna assembly G in dBi does not include the additional gain that may result out of beamforming.

Smart antenna systems may use beamforming techniques which may result in additional (antenna) gain. This beamforming gain Y is specified in dB. Beamforming gain does not include the gain of the antenna assembly G .

Although the measurement methods in the present document allow conducted measurements to be performed, it should be noted that the equipment together with all its intended antenna assemblies shall conform to the applicable technical requirements defined in the present document.

5.3.3.2 Transmit operating modes

5.3.3.2.1 Operating mode 1 (single antenna)

The equipment uses only one antenna when operating in this mode.

The following types of equipment and/or operating modes are examples covered by this category:

- Equipment with only one antenna.
- Equipment with two diversity antennas but at any moment in time only one antenna is used.
- Smart antenna system with two or more antennas, but operating in a mode where only one antenna is used.

5.3.3.2.2 Operating mode 2 (multiple antennas, no beamforming)

The equipment that can operate in this mode contains a smart antenna system using two or more transmit chains simultaneously but without beamforming.

5.3.3.2.3 Operating mode 3 (multiple antennas, with beamforming)

The equipment that can operate in this mode contains a smart antenna system using two or more transmit chains simultaneously with beamforming.

In addition to the antenna assembly gain G , the beamforming gain Y may have to be taken into account when performing the measurements described in the present document.

5.3.4 Presentation of equipment

Stand-alone equipment shall be tested against all requirements of the present document.

For testing combined or multi-radio equipment against the requirements of the present document, specific guidance is given by ETSI EG 203 367 [i.3], clause 6.

Whether the equipment is stand-alone equipment, combined equipment or multi-radio equipment shall be noted in the test report (see clause 5.4.1, item p)).

5.3.5 Measurement methods

Either conducted or radiated measurements may be used.

For integral antenna equipment, connectors may be provided to allow conducted measurements to be performed.

In the case of integral antenna equipment that has no antenna connector(s), the manufacturer may be required to supply a test fixture to allow relative, normalized and level independent measurements to be made. The measurement methods allowed are specific to the test case and are given in table 11.

The test fixture and its use are further described in clause E.4.

Table 11 : Measurement methods allowed

Test case	Conducted with connector on UUT	Radiated	Test fixture relative	Test fixture normalized	Test fixture level independent
Nominal centre frequency	Yes	Yes	Yes	Yes	Yes
Occupied bandwidth	Yes	Yes	No	Yes	Yes
RF output power, Transmit Power Control (TPC) and Power Spectral Density (PSD)	Yes	Yes	Yes	Yes	No
Transmitter unwanted emissions outside the transmitter's operating bands	Yes	Yes	No	No	No
Transmitter unwanted emissions within the transmitter's operating bands	Yes	Yes	No	Yes	No
Receiver spurious emissions	Yes	Yes	No	No	No
Dynamic Frequency Selection (DFS)	Yes	Yes	No	Yes	No
Adaptivity (channel access mechanism)	Yes	Yes	No	Yes	No
Receiver blocking	Yes	Yes	No	Yes	No
Adjacent channel selectivity	Yes	Yes	No	Yes	No

5.4 Essential radio test suites

5.4.1 Product information

The information requested in this clause shall be included in the test report. The form included in clause H.3 can be used for this purpose. This information is required in order to carry out the test suites and/or to declare compliance to technical requirements (e.g. technical requirements for which no compliance test is included in the present document):

- a) The channel plan(s), being the nominal centre frequencies and the associated nominal channel bandwidth(s).
- b) If the equipment supports multi-channel operation (see clause 4.2.7.3.1.3 and clause 4.2.7.3.2.3):
 - the maximum number of channels that are supported for multi-channel operation;
 - whether or not it is possible that these channels are in different sub-bands;
 - whether the equipment supports a multi-channel configuration as specified in clause 4.2.4.2.2.2 and which channel configurations are supported;
 - whether the equipment supports a multi-channel configuration as specified in clause 4.2.4.2.2.3 and which combinations of channels are supported;
 - where there may be channels not used for transmission in multi-channel operation within a group of adjacent channels, a list of channel edge masks (i.e. figure 2, figure 3 and figure 4 from clause 4.2.4.2.2.2) supported by the equipment;
 - for LBE, whether it supports option 1 and/or option 2 for multi-channel operation (see clause 4.2.7.3.2.3);
 - for LBE implementing option 1, the number of channels used for multi-channel operation when performing the test described in clause 5.4.9.3.2.3.1.
- c) The different transmit operating modes in which the equipment can operate (see clause 5.3.3.2).
- d) For each of the modes under c):
 - the number of receive chains;
 - the number of transmit chains;

- if more than one transmit chain is active, whether the power is distributed equally or not;
 - whether or not antenna beamforming is implemented, and if so, the maximum beamforming gain Y for this transmit operating mode.
- e) Whether the device has a TPC feature, and if so, a list of the supported TPC ranges.
- NOTE 1: The equipment can have more than one TPC range to accommodate different antennas and/or different applicable power limits.
- NOTE 2: The equipment can operate both with and without a TPC feature depending on the configuration in which case details can be provided in both item f) and item g).
- f) For devices with a TPC feature, for each TPC range:
- the applicable operating frequency range(s);
 - the lowest and highest transmitter output power level (or lowest and highest EIRP level in case of integrated antenna equipment);
 - if the equipment supports simultaneous transmissions in multiple sub-bands or supports different transmitter operating modes (e.g. in case of smart antenna systems) (see clause 5.3.3.2), the lowest and highest transmitter output power or EIRP level for each of the sub-bands, and each of the transmitter operating modes;
 - the intended antenna assembly or antenna assemblies, the corresponding maximum gain(s) G, the resulting RF output power values (taking also into account the beamforming gain Y if applicable), and the corresponding DFS threshold(s).
- g) For devices without a TPC feature:
- the applicable operating frequency range(s);
 - the maximum transmitter output power level (or maximum EIRP level in case of integrated antenna equipment);
 - if the equipment supports simultaneous transmissions in multiple sub-bands or supports different transmitter operating modes (e.g. in case of smart antenna systems) (see clause 5.3.3.2), the maximum transmitter output power or EIRP level for each of the sub-bands, and each of the transmitter operating modes;
 - the intended antenna assembly or antenna assemblies, the corresponding maximum gain(s) G, the resulting RF output power values (taking also into account the beamforming gain Y if applicable), and the corresponding DFS threshold(s).
- h) The DFS operational modes which the equipment supports (primary device, secondary device with radar detection, secondary device without radar detection) and how uniform spreading as specified in clause 4.2.6.2.7 is achieved.
- i) With regards to DFS, whether the equipment has implemented the off-channel CAC function for operation in sub-band 2 or sub-band 3 as given in clause 4.2.6.2.3.
- j) For devices with an off-channel CAC function, for each sub-band:
- the off-channel CAC time required to determine the presence of a radar on a channel whose nominal channel bandwidth falls completely outside the band 5 600 MHz to 5 650 MHz (equivalent to the 60 s CAC);
 - the off-channel CAC time for channels whose nominal channel bandwidth falls partly or completely within the band 5 600 MHz to 5 650 MHz (equivalent to the 10 minutes CAC).
- k) With regards to UAR, a confirmation that the equipment is constructed to conform to the requirements contained in clause 4.2.10.
- l) Whether the device can operate in ad-hoc mode, and if so, the operating frequency range when operating in ad-hoc mode.

- m) The sub-bands and corresponding operating frequency range(s) implemented by the equipment.
- n) The operating temperature range that applies to the intended use of the equipment, if different from -20 °C to +55 °C.
- o) The test sequence/test software used by the equipment.
- p) The type of equipment: stand-alone equipment, combined equipment or multi-radio equipment.
- q) With regards to adaptivity, whether the equipment is Frame Based Equipment (FBE) and/or Load Based Equipment (LBE).
- r) With regards to adaptivity for FBE:
 - whether the equipment supports operating as an initiating device and/or as a responding device (see clause 4.2.7.3.1.2);
 - the Fixed Frame Period(s) (FFPs) implemented by the equipment.
- s) With regards to adaptivity for LBE:
 - whether the equipment supports operating as a supervising device and/or as a supervised device (see clause 4.2.7.3.2.2);
 - the priority classes that the equipment supports (see clause 4.2.7.3.2.4);
 - whether the equipment supports using note 1 in table 6 and/or note 1 in table 7;
 - for supervising devices, whether the equipment supports using note 2 in table 6;
 - whether the equipment supports operating as an initiating device and/or as a responding device (see clause 4.2.7.3.2.6 and clause 4.2.7.3.2.7).
- t) Where applicable, the minimum performance criteria (see clause 4.2.8.3 and clause 4.2.9.3) that correspond to the intended use of the equipment.
- u) The theoretical maximum radio performance of the equipment (e.g. maximum throughput).

5.4.2 Nominal centre frequency

5.4.2.1 Test conditions

These measurements shall be performed under both normal and extreme test conditions (see clause 5.1.2 and clause 5.1.3).

The UUT shall be configured to operate at normal RF output power. In addition, the UUT shall be configured to operate on a single channel.

For a UUT with antenna connector(s) and using dedicated external antenna(s), or for a UUT with integral antenna(s) but with one or more temporary antenna connectors provided, conducted measurements shall be used.

In case of conducted measurements on smart antenna systems (devices with multiple transmit chains) the measurements shall be performed on only one of the active transmit chains.

For a UUT with integral antenna(s) and without temporary antenna connectors, radiated measurements shall be used.

In the case of equipment intended for use with an integral antenna and where no external (temporary) antenna connectors are provided, a test fixture as described in clause E.4 may be used to perform relative measurements at the lower and upper extreme temperatures.

5.4.2.2 Test methods

5.4.2.2.1 Conducted measurement

5.4.2.2.1.1 Equipment operating without modulation

This test method requires that the UUT can be operated in an unmodulated test mode.

The UUT shall be connected to a suitable frequency measuring device (e.g. a frequency counter or a spectrum analyser) and operated in an unmodulated mode.

The result shall be recorded.

5.4.2.2.1.2 Equipment operating with modulation

This method is an alternative to the method in clause 5.4.2.2.1.1 in case the UUT cannot be operated in an unmodulated mode.

The UUT shall be connected to a spectrum analyser.

The trace mode Max Hold shall be selected and the centre frequency shall be adjusted to that of the channel at which the transmission to be investigated occurs.

The peak value of the power envelope shall be measured and noted. The frequency span shall be reduced and the marker moved in a positive frequency increment until the upper, (relative to the centre frequency), -10 dBc point is reached. This value shall be noted as f1.

The marker shall then be moved in a negative frequency increment until the lower, (relative to the centre frequency), -10 dBc point is reached. This value shall be noted as f2.

The nominal centre frequency is calculated as $(f1 + f2) / 2$.

5.4.2.2.2 Radiated measurement

The test setup as described in annex E shall be used with a spectrum analyser attached to the test antenna.

The test procedure is as described under clause 5.4.2.2.1.

5.4.2.2.3 Test fixture measurement

The test setup and the procedure as described in clause E.4.5 shall be used with the spectrum analyser attached to the test fixture.

The test procedure is further as described under clause 5.4.2.2.1.

5.4.3 Occupied bandwidth

5.4.3.1 Test conditions

These measurements shall be performed only under normal operating conditions (see clause 5.1.2).

The measurements shall be performed using normal operation of the equipment with the test signal applied (see clause 5.3.1.1).

The UUT shall be configured to operate at a typical RF power output level used for normal operation.

For equipment capable of multi-channel operation (see clause 4.2.7.3.1.3 or clause 4.2.7.3.2.3) using adjacent channels, the equipment shall be configured to have transmissions in all the channels. These transmissions may be considered as one signal with a total bandwidth of n times the nominal channel bandwidth of an individual channel where n is the number of adjacent channels.

When equipment has simultaneous transmissions in non-adjacent channels, each power envelope shall be considered separately.

For a UUT with antenna connector(s) and using dedicated external antenna(s), or for a UUT with integral antenna(s) but with one or more temporary antenna connectors provided, conducted measurements shall be used.

In case of conducted measurements on smart antenna systems (devices with multiple transmit chains) measurements need only to be performed on one of the active transmit chains (antenna outputs).

For a UUT with integral antenna(s) and without temporary antenna connectors, radiated measurements shall be used.

5.4.3.2 Test methods

5.4.3.2.1 Conducted measurement

The measurement procedure shall be as follows:

Step 1:

- Connect the UUT to the spectrum analyser and use the following settings:
 - Centre frequency: nominal centre frequency of the channel being investigated
 - RBW: 100 kHz
 - VBW: 300 kHz
 - Frequency span: $2 \times$ nominal channel bandwidth (e.g. 40 MHz for a nominal channel bandwidth of 20 MHz)
 - Sweep time: > 1 s; in case of multi-channel operation, the sweep time may be increased to a value where the sweep time has no impact on the RMS value of the signal
 - Detector mode: RMS
 - Trace mode: Max Hold

Step 2:

- Wait for the trace to stabilize.

Step 3:

- Ensure that the power envelope is sufficiently above the noise floor of the analyser to avoid the noise signals left and right from the power envelope being taken into account by this measurement.
- Use the 99 % bandwidth function of the spectrum analyser to measure the occupied bandwidth of the UUT. This value shall be recorded.

The measurement described in step 1 to step 3 shall be repeated in case of simultaneous transmissions in non-adjacent channels.

5.4.3.2.2 Radiated measurement

The test setup as described in annex E and the applicable measurement procedures described in annex F shall be used.

The test procedure is as described under clause 5.4.3.2.1.

5.4.3.2.3 Test fixture measurement

The test setup and the procedure as described in clause E.4.5 shall be used with the spectrum analyser attached to the test fixture.

The test procedure is further as described under clause 5.4.3.2.1.

5.4.4 RF output power, Transmit Power Control (TPC) and Power Spectral Density (PSD)

5.4.4.1 Test conditions

The measurements described in the present clause may need to be repeated to cover:

- each of the TPC ranges (or transmitter output power levels for equipment without TPC) and corresponding antenna assemblies (see clause 5.4.1, item e), item f) and item g));
- each of the transmit operating modes (see clause 5.3.3.2 and clause 5.4.1, item c)).

The measurements shall be performed with test signal specified in clause 5.3.1.1 applied. Alternatively, if special test functions are available, the equipment may also be configured in a continuous transmit mode or with a constant duty cycle (e.g. FBE) which is at least 10 %.

For a UUT with antenna connector(s) and using dedicated external antenna(s), or for a UUT with integral antenna(s) but with one or more temporary antenna connectors provided, conducted measurements may be used in conjunction with the antenna assembly gain(s).

For a UUT with integral antenna(s) and without temporary antenna connectors, radiated measurements shall be used.

In the case of equipment intended for use with an integral antenna and where no external (temporary) antenna connectors are provided, a test fixture as described in clause E.4 may be used to perform relative measurements at the lower and upper extreme temperatures.

5.4.4.2 Test methods

5.4.4.2.1 Conducted measurement

5.4.4.2.1.1 RF output power at the highest power level

5.4.4.2.1.1.1 Additional test conditions

These measurements shall be performed under both normal and extreme test conditions (see clause 5.1.2 and clause 5.1.3).

The UUT shall be configured to operate at:

- the highest transmitter output power level of the TPC range; or
- the maximum transmitter output power level in case the equipment has no TPC feature.

Procedure 1 (see clause 5.4.4.2.1.1.2) shall be performed for equipment that operates only in one sub-band or which is capable of operating in multiple sub-bands simultaneously but, for the purpose of the testing, can be configured to:

- operate in a continuous transmit mode or with a constant duty cycle (x) (e.g. FBE); and
- operate only within one sub-band.

Procedure 2 (see clause 5.4.4.2.1.1.3) shall be performed for equipment that is either:

- capable of operating in more than one sub-band but not simultaneously; or
- capable of operating in multiple sub-bands simultaneously but which, for the purpose of the testing, can be configured to transmit only in one sub-band.

Procedure 3 (see clause 5.4.4.2.1.1.4) shall be performed for equipment capable of operating in multiple sub-bands simultaneously but which cannot be configured to transmit only in one sub-band.

5.4.4.2.1.1.2 Procedure 1

The test procedure shall be as follows and shall be performed for each of the supported sub-bands:

Step 1:

- For equipment configured into a continuous transmit mode ($x = 1$), proceed immediately with step 2.
- Couple the output power of the transmitter to a matched diode detector or equivalent thereof. Connect the output of the diode detector to the vertical channel of an oscilloscope.

The combination of the diode detector and the oscilloscope shall be capable of faithfully reproducing the duty cycle of the transmitter output signal.

- Note the observed duty cycle of the transmitter (Tx on / (Tx on + Tx off)) as x ($0 < x \leq 1$) and record it in the test report.

Step 2:

- Determine the RF output power using a wideband RF power meter with a thermocouple detector or an equivalent thereof and with an integration period that exceeds the repetition period of the transmitter by a factor 5 or more. Note the observed value as A (in dBm).
- In case of conducted measurements on smart antenna systems operating in a mode with multiple transmit chains active simultaneously, measure the output power of each transmit chain separately to calculate the total power (value A in dBm) for the UUT.

Step 3:

- Calculate the RF output power at the highest power level $P_{H, sb}$ from the RF output power A (in dBm) measured in step 2, the observed duty cycle x , the antenna assembly gain G in dBi and if applicable the beamforming gain Y in dB, according to equation (4). If more than one antenna assembly is intended for this power setting or TPC range, use the gain of the antenna assembly with the highest gain.

$$P_{H, sb} = A + G + Y + 10 \times \log_{10} (1 / x) \text{ (dBm)} \quad (4)$$

- Compare the value $P_{H, sb}$ to the applicable limit and record it in the test report.

5.4.4.2.1.1.3 Procedure 2

The test procedure shall be as follows and shall be performed for each of the supported sub-bands:

Step 1:

- Sample the transmit signal from the UUT using a fast power sensor suitable for 6 GHz. Save the raw samples, representing the RMS power of the signal. Use the following settings:
 - Sample speed: $\geq 10^6$ samples/s
 - Measurement duration: sufficient to capture a minimum of 10 transmitter bursts (see clause 5.3.1.1)

Step 2:

- For conducted measurements on devices with one transmit chain:
 - Connect the power sensor to the transmit port, sample the transmit signal and store the raw data. Use these stored samples in all following steps.
- For conducted measurements on devices with multiple transmit chains:
 - Connect a power sensor to each transmit port for a synchronous measurement on all transmit ports.
 - Trigger the power sensors so that they start sampling at the same time. Ensure that the time difference between the samples of all sensors is less than 500 ns.

- For each individual sampling point (time domain), sum the coincident power samples of all ports and store them. Use these summed samples in the following steps.

Step 3:

- Find the start and stop times of each burst in the stored measurement samples.

The start and stop times are defined as the points where the power is at least 30 dB below the highest value of the stored samples from step 2. In case of insufficient dynamic range, the value of 30 dB may need to be reduced appropriately.

Step 4:

- Between the start and stop times of each individual burst, calculate the RMS (mean) power over the burst (P_{burst}) using equation (5):

$$P_{burst} = \frac{1}{k} \sum_{n=1}^k P_{sample}(n) \quad (5)$$

with k the total number of samples and n the actual sample number.

- Note the highest of all P_{burst} values as the value A in dBm.

Step 5:

- Calculate the RF output power at the highest power level $P_{H, sb}$ from the RF output power A (in dBm) determined in step 4, the antenna assembly gain G in dBi and if applicable the beamforming gain Y in dB, according to equation (6). If more than one antenna assembly is intended for this power setting or TPC range, use the gain of the antenna assembly with the highest gain.

$$P_{H, sb} = A + G + Y \text{ (dBm)} \quad (6)$$

- Compare the value $P_{H, sb}$ to the applicable limit and record it in the test report.

5.4.4.2.1.1.4 Procedure 3

This procedure first measures the peak power in each sub-band separately, then measures the peak-to-mean power ratio for the overall transmission and uses this to calculate the RF output power in each sub-band separately using the measured values for peak power.

The test procedure shall be as follows:

Step 1: Measuring the total peak power within sub-band 1

- Connect the UUT to the spectrum analyser and use the following settings:
 - Start frequency: 5 100 MHz
 - Stop frequency: 5 300 MHz
 - RBW: 1 MHz
 - VBW: 3 MHz
 - Detector mode: Peak
 - Trace mode: Max Hold
 - Sweep time: Auto
- Ensure that the noise floor of the spectrum analyser is at least 30 dB below the peak of the power envelope. If this is not possible (e.g. radiated measurements), reduce the bandwidth of the channel power measurement function to avoid the noise floor influencing the measurement result.
- When the trace is complete, use the channel power measurement function to measure the total peak power of the transmissions within sub-band 1.

- For conducted measurements on devices with multiple transmit chains, repeat the procedure in step 1 for each of the active transmit chains. Sum the results to provide the total peak power of the transmissions within sub-band 1.

Step 2: Measuring the total peak power within sub-band 2

- Change the start frequency to 5 200 MHz and the stop frequency to 5 400 MHz.
- Ensure that the noise floor of the spectrum analyser is at least 30 dB below the peak of the power envelope. If this is not possible (e.g. radiated measurements), reduce the bandwidth of the channel power measurement function to avoid the noise floor influencing the measurement result.
- When the trace is complete, use the channel power measurement function to measure the total peak power of the transmissions within sub-band 2.
- For conducted measurements on devices with multiple transmit chains, repeat the procedure in step 2 for each of the active transmit chains. Sum the results to provide the total peak power of the transmissions within sub-band 2.

Step 3: Measuring the total peak power within sub-band 3 (if applicable including transmissions between 5 725 MHz and 5 730 MHz)

- Change the start frequency to 5 420 MHz and the stop frequency to 5 775 MHz.

If the channel plan includes a channel with a nominal centre frequency within sub-band 3 whose nominal channel bandwidth extends into sub-band 4, adjust the stop frequency accordingly.
- Ensure that the noise floor of the spectrum analyser is at least 30 dB below the peak of the power envelope. If this is not possible (e.g. radiated measurements), reduce the bandwidth of the channel power measurement function to avoid the noise floor influencing the measurement result.
- When the trace is complete, use the channel power measurement function to measure the total peak power of all transmissions within sub-band 3.
- For conducted measurements on devices with multiple transmit chains, repeat the procedure in step 3 for each of the active transmit chains. Sum the results to calculate the total peak power of the transmissions within sub-band 3.

NOTE: If the channel plan includes a channel with a nominal centre frequency within sub-band 3 whose nominal channel bandwidth extends into sub-band 4, the total peak power may include transmissions within the band 5 725 MHz to 5 730 MHz.

Step 4: Calculating the total peak power

- Calculate the total peak power by summing the measured values in step 1, step 2 and step 3.

Modern spectrum analysers may be able to measure the peak power in all sub-bands in one measurement in which case step 1, step 2 and step 3 can be combined.

Step 5: Measuring the total mean output power

- Sample the transmit signal from the device using a fast power sensor suitable for 6 GHz. Save the raw samples, representing the RMS power of the signal. Use the following settings:
 - Sample speed: $\geq 10^6$ samples/s
 - Measurement duration: sufficient to capture a minimum of 10 transmitter bursts (see clause 5.3.1.1)
- For conducted measurements on devices with one transmit chain:
 - Connect the power sensor to the transmit port, sample the transmit signal and store the raw data. Use these stored samples in all following steps.
- For conducted measurements on devices with multiple transmit chains:
 - Connect one power sensor to each transmit port for a synchronous measurement on all transmit ports.

- Trigger the power sensors so that they start sampling at the same time. Ensure that the time difference between the samples of all sensors is less than 500 ns.
- For each individual sampling point (time domain), sum the coincident power samples of all ports and store them. Use these summed samples in all following steps.

- Find the start and stop times of each burst in the stored measurement samples.

The start and stop times are defined as the points where the power is at least 30 dB below the highest value of the stored samples. In case of insufficient dynamic range, the value of 30 dB may need to be reduced appropriately.

- Between the start and stop times of each individual burst, calculate the RMS (mean) power over the burst (P_{burst}) using equation (7):

$$P_{burst} = \frac{1}{k} \sum_{n=1}^k P_{sample}(n) \quad (7)$$

with k the total number of samples and n the actual sample number.

- The highest of all P_{burst} values is the total mean output power, and this value will be used for further calculations.

Step 6: Calculating the peak-to-mean power ratio

- Using the value for total peak power calculated in step 4 and the highest value for total mean output power measured in step 5, calculate the peak-to-mean power ratio in dB.

Step 7: Calculating the RF output power at the highest power level $P_{H, sb}$ for sub-band 1, sub-band 2 and sub-band 3

- Calculate the RF output power at the highest power level $P_{H, sb}$ for each of the sub-bands defined in table 1 from the peak-to-mean power ratio obtained in step 6 and the measured values for peak power in each of the sub-bands (see step 1, step 2 and step 3). These values (values A in dBm) will be used for RF output power calculations:
 - Add the antenna assembly gain G in dBi of the individual antenna element.
 - If applicable, add the additional beamforming gain Y in dB.
 - If more than one antenna assembly is intended for this power setting or TPC range, use the maximum overall antenna gain (G or G + Y).
- For each sub-band, calculate $P_{H, sb}$ using equation (8):

$$P_{H, sb} = A + G + Y \text{ (dBm)} \quad (8)$$

- Compare the values for $P_{H, sb}$ to the applicable limits and record them in the test report.

5.4.4.2.1.2 RF output power at the lowest power level of the TPC range

5.4.4.2.1.2.1 Additional test conditions

This test is only required for equipment with a TPC feature.

These measurements shall be performed under both normal and extreme test conditions (see clause 5.1.2 and clause 5.1.3).

The UUT shall be configured to operate at the lowest transmitter output power level of the TPC range.

Procedure 1 (see clause 5.4.4.2.1.2.2) shall be performed for equipment that operates only in one sub-band or which is capable of operating in multiple sub-bands simultaneously but, for the purpose of the testing, can be configured to:

- operate in a continuous transmit mode or with a constant duty cycle (x) (e.g. FBE); and
- operate only within one sub-band.

Procedure 2 (see clause 5.4.4.2.1.2.3) shall be performed for equipment that is either:

- capable of operating in more than one sub-band but not simultaneously; or
- capable of operating in multiple sub-bands simultaneously but which, for the purpose of the testing, can be configured to transmit only in one sub-band.

Procedure 3 (see clause 5.4.4.2.1.2.4) shall be performed for equipment capable of operating in multiple sub-bands simultaneously but which cannot be configured to transmit only in one sub-band.

5.4.4.2.1.2.2 Procedure 1

The test procedure shall be as follows and shall be performed for each of the supported sub-bands:

Step 1:

- See step 1 in clause 5.4.4.2.1.1.2.

The duty cycle measurement may not need to be repeated.

Step 2:

- See step 2 in clause 5.4.4.2.1.1.2.

Step 3:

- Calculate the RF output power at the lowest power level of the TPC range $P_{L, sb}$ from the RF output power A (in dBm) measured in step 2, the observed duty cycle x , the antenna assembly gain G in dBi and, if applicable, the beamforming gain Y in dB according to equation (9). If more than one antenna assembly is intended for this TPC range, use the gain of the antenna assembly with the highest gain.

$$P_{L, sb} = A + G + Y + 10 \times \log_{10} (1 / x) \text{ (dBm)} \quad (9)$$

- Compare the value $P_{L, sb}$ to the applicable limit and record it in the test report.

5.4.4.2.1.2.3 Procedure 2

The test procedure shall be as follows:

Step 1 to step 4:

- See step 1 to step 4 in clause 5.4.4.2.1.1.3.

Step 5:

- Calculate the RF output power at the lowest power level of the TPC range $P_{L, sb}$ from the RF output power A (in dBm) determined in step 4, the antenna assembly gain G in dBi and, if applicable, the beamforming gain Y in dB according to equation (10). If more than one antenna assembly is intended for this TPC range, use the gain of the antenna assembly with the highest gain.

$$P_{L, sb} = A + G + Y \text{ (dBm)} \quad (10)$$

- Compare the value $P_{L, sb}$ to the applicable limit and record it in the test report.

5.4.4.2.1.2.4 Procedure 3

This procedure first measures the peak power in each sub-band separately, then measures the peak-to-mean power ratio for the overall transmission and uses this to calculate the RF output power in each sub-band separately using the measured values for peak power.

The test procedure shall be as follows:

Step 1 to step 6:

- See step 1 to step 6 in clause 5.4.4.2.1.1.4.

Step 7: Calculating the RF output power at the lowest power level of the TPC range $P_{L, sb}$ for sub-band 1, sub-band 2 and sub-band 3

- Calculate the RF output power at the lowest power level of the TPC range $P_{L, sb}$ for each of the sub-bands defined in table 1 from the peak-to-mean power ratio obtained in step 6 and the measured values for peak power in each of the sub-bands (see step 1, step 2 and step 3). These values (values A in dBm) will be used for RF output power calculations:
 - Add the antenna assembly gain G in dBi of the individual antenna element.
 - If applicable, add the additional beamforming gain Y in dB.
 - If more than one antenna assembly is intended for this TPC range, use the maximum overall antenna gain (G or G + Y).
- For each sub-band, calculate $P_{L, sb}$ using equation (11):

$$P_{L, sb} = A + G + Y \text{ (dBm)} \quad (11)$$

- Compare the values for $P_{L, sb}$ to the applicable limit and record them in the test report.

5.4.4.2.1.3 Power Spectral Density (PSD)

5.4.4.2.1.3.1 Additional test conditions

These measurements shall only be performed at normal test conditions (see clause 5.1.2).

The UUT shall be configured to operate at the lowest nominal channel bandwidth with:

- the highest transmitter output power level of its TPC range; or
- the maximum transmitter output power level in case the equipment has no TPC feature.

Procedure 1 (see clause 5.4.4.2.1.3.2) shall be performed for equipment that can be configured to operate in a continuous transmit mode or with a constant duty cycle (x) (e.g. FBE).

Procedure 2 (see clause 5.4.4.2.1.3.3) shall be performed for equipment that has non-continuous transmissions and cannot be configured to transmit continuously or with a constant duty cycle.

5.4.4.2.1.3.2 Procedure 1

The test procedure shall be as follows:

Step 1:

- Connect the UUT to the spectrum analyser and use the following settings:
 - Centre frequency: nominal centre frequency of the channel being investigated
 - RBW: 1 MHz
 - VBW: 3 MHz
 - Frequency span: $2 \times$ nominal channel bandwidth (e.g. 40 MHz for a nominal channel bandwidth of 20 MHz)
 - Detector mode: Peak
 - Trace mode: Max Hold

Step 2:

- When the trace is complete, find the peak value of the power envelope and record the frequency.

Step 3:

- Make the following changes to the settings of the spectrum analyser:
 - Centre frequency: frequency recorded in step 2
 - Frequency span: 3 MHz
 - RBW: 1 MHz
 - VBW: 3 MHz
 - Sweep time: 1 minute
 - Detector mode: RMS
 - Trace mode: Max Hold

Step 4:

- When the trace is complete, capture the trace using the Hold or View mode on the spectrum analyser.
Find the peak value of the trace and place the analyser marker on this peak. This level is the highest measured PSD in a 1 MHz band. Record it as D.
Where a spectrum analyser is equipped with a function to measure PSD, this function may be used to determine the peak PSD value D in dBm/MHz.
- In case of conducted measurements on smart antenna systems operating in a mode with multiple transmit chains active simultaneously, measure the PSD of each transmit chain separately to calculate the total peak PSD value D in dBm/MHz for the UUT.

Step 5:

- Calculate the maximum PSD from the peak PSD value D measured in step 4, the observed duty cycle x (see clause 5.4.4.2.1.1.2, step 1), the applicable antenna assembly gain G in dBi and, if applicable, the beamforming gain Y in dB according to equation (12). If more than one antenna assembly is intended for this power setting or TPC range, use the gain of the antenna assembly with the highest gain.

$$\text{PSD}_{\text{total}} = D + G + Y + 10 \times \log_{10} (1 / x) \text{ (dBm/MHz)} \quad (12)$$

Step 6:

- Compare the value of $\text{PSD}_{\text{total}}$ obtained in step 5 with the applicable limit and record it in the test report.

5.4.4.2.1.3.3 Procedure 2

For devices capable of operating in multiple sub-bands simultaneously, the PSD in each of the sub-bands shall be measured separately and compared with the applicable limits.

The test procedure for measuring the PSD in a given sub-band shall be as follows:

Step 1:

- Connect the UUT to the spectrum analyser and use the following settings:
 - Start frequency: lower band edge of applicable sub-band (i.e. 5 150 MHz, 5 250 MHz or 5 470 MHz)
 - Stop frequency: upper band edge of applicable sub-band (i.e. 5 250 MHz, 5 350 MHz or 5 725 MHz)
 - RBW: 10 kHz
 - VBW: 30 kHz

- Sweep points: > 10 000 (for sub-band 1)
> 10 000 (for sub-band 2)
> 25 500 (for sub-band 3)

For spectrum analysers not supporting this number of sweep points, the frequency band may be segmented.
- Detector mode: RMS
- Trace mode: Max Hold
- Sweep time: 30 s

- For non-continuous signals, wait for the trace to be stabilized. Save the (trace) data set to a file.

Step 2:

- For conducted measurements on smart antenna systems using either operating mode 2 or operating mode 3 (see clause 5.3.3.2), repeat the measurement for each of the transmit ports. For each sampling point (frequency domain), add up the coincident power values (in mW) for the different transmit chains and use this as the new data set.

Step 3:

- Add up the values of power for all the samples in the file using equation (13):

$$P_{\text{sum}} = \sum_{n=1}^k P_{\text{sample}}(n) \quad (13)$$

with k the total number of samples and n the actual sample number.

Step 4:

- Normalize the individual values for power (in dBm) so that the sum is equal to the RF output power at the highest power level $P_{\text{H, sb}}$ measured in clause 5.4.4.2.1.1 for this sub-band. Equations (14) and (15) may be used:

$$C_{\text{corr}} = P_{\text{sum}} - P_{\text{H, sb}} \quad (14)$$

$$P_{\text{samplecorr}}(n) = P_{\text{sample}}(n) - C_{\text{corr}} \quad (15)$$

with n the actual sample number.

Step 5:

- Starting from the first sample $P_{\text{samplecorr}}(n)$ in the file (lowest frequency), add up the power (in mW) of the following samples representing a 1 MHz segment and record the results for power and position (i.e. sample 1 to sample 100). This is the PSD for the first 1 MHz segment. Save this value.

Step 6:

- Shift the start point of the samples added up in step 5 by one sample and repeat the procedure in step 5 (i.e. sample 2 to sample 101).

Step 7:

- Repeat step 6 until the end of the data set and save the radiated PSD values for each of the 1 MHz segments.
From all the saved results, the highest value is the maximum PSD for the UUT.

Step 8:

- Compare the values for the maximum PSD obtained in step 7 with the applicable limits and record them in the test report.

5.4.4.2.2 Radiated measurement

When performing radiated measurements on a UUT with a directional antenna (including smart antenna systems and systems capable of beamforming), the UUT shall be configured/positioned for maximum RF output power towards the measurement antenna and in the horizontal plane. This configuration/position shall be recorded for future use (see clause 5.4.10.2.2, clause 5.4.11.2.2, clause F.5.2.4, clause F.5.3.4, clause F.5.4.4).

A test site as described in annex E and using the applicable measurement procedures as described in annex F shall be used.

The test procedure is further as described under clause 5.4.4.2.1. However, the following shall be taken into account when performing radiated measurements.

For measuring RF output power:

- When using procedure 1 as in clause 5.4.4.2.1.1.2 and clause 5.4.4.2.1.2.2, the values G and Y used in step 3 shall be ignored.
- When using procedure 2 as in clause 5.4.4.2.1.1.3 and clause 5.4.4.2.1.2.3, the values G and Y used in step 5 shall be ignored.
- When using procedure 3 as in clause 5.4.4.2.1.1.4 and clause 5.4.4.2.1.2.4, the values G and Y used in step 7 shall be ignored.

For measuring PSD:

- When using procedure 1 as in clause 5.4.4.2.1.3.2, the values G and Y used in step 5 shall be ignored.

For measuring the RF output power at the highest and lowest power level, it is likely that a radiated measurement would be performed using a spectrum analyser or measurement receiver rather than a wide band power sensor. If this is the case and if the resolution bandwidth capability of the measurement device is narrower than the occupied bandwidth of the UUT signal measured, then the method of measurement shall be documented in the test report.

5.4.4.2.3 Test fixture measurement

The test setup and the normalization procedure as described in clause E.4.4 shall be used with the measuring device attached to the fixture.

The test procedure is further as described under clause 5.4.4.2.1.

5.4.5 Transmitter unwanted emissions outside the transmitter's operating bands

5.4.5.1 Test conditions

These measurements shall be performed only under normal test conditions (see clause 5.1.2).

The equipment shall be configured to operate under conditions aligned with its intended use so that unwanted emissions outside the transmitter's operating bands are maximized.

If possible, the UUT shall be set to continuous transmit (duty cycle = 1) for the duration of this test.

If continuous transmit is not possible, the UUT should be configured to operate at its maximum duty cycle.

The level of transmitter unwanted emissions shall be measured as, either:

- a) their power in a specified load (conducted emissions) and their radiated power (ERP for emissions up to 1 GHz and EIRP for emissions above 1 GHz) when radiated by the cabinet or structure of the equipment (cabinet radiation); or
- b) their radiated power (ERP for emissions up to 1 GHz and EIRP for emissions above 1 GHz) when radiated by cabinet and antenna.

5.4.5.2 Test methods

5.4.5.2.1 Conducted measurement

5.4.5.2.1.1 Pre-scan

The UUT shall be connected to a spectrum analyser capable of RF power measurements.

This pre-scan test procedure shall be used to identify potential unwanted emissions of the UUT.

The sensitivity of the spectrum analyser should be such that the noise floor is at least 12 dB below the applicable limits.

The test procedure shall be as follows:

Step 1:

- Identify the unwanted emissions over the range 30 MHz to 1 000 MHz using the following spectrum analyser settings:
 - RBW: 100 kHz
 - VBW: 300 kHz
 - Detector mode: Peak
 - Trace mode: Max Hold
 - Sweep points: $\geq 9\,700$
For spectrum analysers not supporting this number of sweep points, the frequency band may be segmented. For spectrum analysers capable of supporting twice this number of sweep points, the frequency adjustment in clause 5.4.5.2.1.2, step 1, last bullet may be omitted.
 - Sweep time: For non-continuous transmissions (duty cycle less than 100 %), the sweep time shall be sufficiently long, such that for each 100 kHz frequency step, the measurement time is greater than two transmissions of the UUT.

EXAMPLE 1: For non-continuous transmissions, if the UUT is using a test sequence as described in clause 5.3.1.1 with a transmitter on + off time of 2 ms, then the sweep time has to be greater than 4 ms per 100 kHz.

- Allow the trace to stabilize. Measure any emissions identified that have a margin of less than 6 dB with respect to the applicable limit individually using the procedure in clause 5.4.5.2.1.2 and compare it to the applicable limit.

Step 2:

- Identify the unwanted emissions over the range 1 GHz to 26 GHz using the following spectrum analyser settings:
 - RBW: 1 MHz
 - VBW: 3 MHz
 - Detector mode: Peak
 - Trace mode: Max Hold
 - Sweep points: $\geq 25\,000$
For spectrum analysers not supporting this number of sweep points, the frequency band may be segmented. For spectrum analysers capable of supporting twice this number of sweep points, the frequency adjustment in clause 5.4.5.2.1.2, step 1, last bullet may be omitted.

- Sweep time: For non-continuous transmissions (duty cycle less than 100 %), the sweep time shall be sufficiently long, such that for each 1 MHz frequency step, the measurement time is greater than two transmissions of the UUT.

EXAMPLE 2: For non-continuous transmissions, if the UUT is using a test sequence as described in clause 5.3.1.1 with a transmitter on + off time of 2 ms, then the sweep time has to be greater than 4 ms per 1 MHz.

- Allow the trace to stabilize. Measure any emissions identified that have a margin of less than 6 dB with respect to the applicable limits individually using the procedure in clause 5.4.5.2.1.2 and compare it to the applicable limits.

5.4.5.2.1.2 Measurement of the emissions identified during the pre-scan

The limits for transmitter unwanted emissions refer to average power levels.

The steps in the present clause shall be used to accurately measure the individual unwanted emissions identified during the pre-scan measurements in clause 5.4.5.2.1.1.

Continuous transmit signals:

For continuous transmit signals, a simple measurement using the RMS detector of the spectrum analyser is permitted. Record the measured values and compare them with the applicable limits.

Non-continuous transmit signals:

For non-continuous transmit signals, the measurement shall be made using the RMS detector of the spectrum analyser only over the "on" part of the burst.

Step 1:

- Measure the level of the emissions in the time domain using the following spectrum analyser settings:
 - Centre frequency: frequency of emission identified during the pre-scan
 - RBW: 100 kHz (≤ 1 GHz) / 1 MHz (> 1 GHz)
 - VBW: 300 kHz (≤ 1 GHz) / 3 MHz (> 1 GHz)
 - Frequency span: 0 Hz
 - Sweep mode: Single Sweep
 - Sweep time: suitable to capture one transmission burst. Additional measurements may be needed to identify the length of the transmission burst. In case of continuous signals, the sweep time shall be set to 30 ms.
 - Sweep points: sweep time (μ s) / 1 μ s with a maximum of 30 000
 - Trigger mode: Video (burst signals) or Manual (continuous signals)
 - Detector mode: RMS
 - Trace mode: Clear/Write
- Adjust the centre frequency (fine tune) to capture the highest level of one burst of the emission to be measured. This fine tuning may be omitted for spectrum analysers capable of supporting twice this number of sweep points required in step 2 and step 3 from the pre-scan procedure in clause 5.4.5.2.1.1.

Step 2:

- Adjust the trigger level to select the transmissions with the highest power level.

- Set a window (start and stop lines) to match with the start and end of the burst. Measure the RMS power in the set window using the time domain power function. If the spurious emission to be measured is a continuous signal, set the measurement window to match the start and stop times of the sweep.
- Select RMS power to be measured within the selected window and note the result which is the RMS power of this particular spurious emission. Compare this value with the applicable limit.

This procedure shall be repeated for every emission identified during the pre-scan. The values and corresponding frequencies shall be recorded.

In case of conducted measurements on smart antenna systems (equipment with multiple transmit chains), the measurements shall be repeated for each of the active transmit chains. Comparison with the applicable limits shall be done using either of the following options:

- Option 1: the results for each of the transmit chains for the corresponding 1 MHz segments are added and compared with the applicable limits.
- Option 2: the results for each of the transmit chains are individually compared with the applicable limits after these limits have been reduced by $10 \times \log_{10}(T_{ch})$ (number of active transmit chains).

5.4.5.2.2 Radiated measurement

The test setup as described in annex E shall be used with a spectrum analyser attached to the test antenna.

The test procedure is as described under clause 5.4.5.2.1.

5.4.5.2.3 Test fixture measurement

The use of a test fixture is not allowed for testing transmitter unwanted emissions outside the transmitter's operating bands.

5.4.6 Transmitter unwanted emissions within the transmitter's operating bands

5.4.6.1 Test conditions

These measurements shall be performed only under normal test conditions (see clause 5.1.2).

The equipment shall be configured to operate under conditions aligned with its intended use so that unwanted emissions within the transmitter's operating bands are maximized.

For UUT without an integral antenna and for a UUT with an integral antenna but with one or more temporary antenna connectors, conducted measurements should be performed. Alternatively, if UUT has one or more integral antennas, but no temporary antenna connector(s), radiated measurements may be used.

In case of conducted measurements on smart antenna systems (devices with multiple transmit chains) operating in a mode with more than one transmit chain being active simultaneously, measurements shall only be performed on one of the transmit chains (antenna outputs).

5.4.6.2 Test methods

5.4.6.2.1 Conducted measurement

5.4.6.2.1.0 Applicability of procedures

For equipment with continuous transmission capability (duty cycle equal to 100 %), the procedure specified in clause 5.4.6.2.1.1 shall be used.

For equipment without continuous transmission capability (duty cycle less than 100 %), the procedure specified in clause 5.4.6.2.1.2 shall be used.

If the relative power envelope of the UUT (from measurements using either the procedure specified in clause 5.4.6.2.1.1 or the procedure specified in clause 5.4.6.2.1.2) does not meet the limit defined for a 1 MHz measurement bandwidth:

- i) in the 0 dB (i.e. reference level of the mask) to -20 dB slope of the applied mask; or
- ii) within 500 kHz of the -20 dB point(s) of the applied mask; or
- iii) for LO exceedance defined in clause 4.2.4.2.2.2,

the procedure specified in clause 5.4.6.2.1.3 may be used in addition. This procedure may be applied to determine conformance in regions i), ii) and iii) when applying the transmit spectral power mask in figure 1 and any overall transmit spectral power mask constructed from figure 2, figure 3 and figure 4. This procedure may also be applied for multi-channel operation in non-adjacent channels as defined in clause 4.2.4.2.2.3.

5.4.6.2.1.1 Equipment with continuous transmission capability

The UUT shall be configured for continuous transmit mode (duty cycle equal to 100 %).

The test procedure shall be as follows:

Step 1: Determination of the reference average power level

- Adjust the spectrum analyser to the following settings:
 - RBW: 1 MHz
 - VBW: 30 kHz
 - Detector mode: RMS
 - Trace mode: Video Average
 - Sweep time: coupled
 - Centre frequency: nominal centre frequency of the channel being investigated
 - Frequency span: $2 \times$ nominal channel bandwidth
- Use the marker to find the highest average power level of the power envelope of the UUT. Use this level as the reference level for the relative measurements.

Step 2: Determination of the relative average power levels

- Adjust the frequency range of the spectrum analyser to allow the measurement to be performed within the sub-band of operation. No other parameter of the spectrum analyser should be changed.
- Compare the relative power envelope of the UUT with the limits defined in clause 4.2.4.2.2.

Step 3: Allowance for a 100 kHz RBW measurement procedure

- As applicable, run additional measurements per clause 5.4.6.2.1.3.

5.4.6.2.1.2 Equipment without continuous transmission capability

The test procedure shall be as follows:

Step 1: Determination of the reference average power level

- Adjust the spectrum analyser to the following settings:
 - RBW: 1 MHz
 - VBW: 30 kHz
 - Detector mode: RMS
 - Trace mode: Max Hold

- Sweep time: ≥ 1 min
- Centre frequency: nominal centre frequency of the channel being investigated
- Frequency span: $2 \times$ nominal channel bandwidth
- Use the marker to find the highest average power level of the power envelope of the UUT. Use this level as the reference level for the relative measurements.

Step 2: Determination of the relative average power levels

- Adjust the frequency range of the spectrum analyser to allow the measurement to be performed within the sub-band of operation. No other parameter of the spectrum analyser should be changed.
- Compare the relative power envelope of the UUT with the limits defined in clause 4.2.4.2.2.

Step 3: Allowance for a 100 kHz RBW measurement procedure

- As applicable, run additional measurements per clause 5.4.6.2.1.3.

5.4.6.2.1.3 Additional measurements using a 100 kHz RBW

The test procedure shall be as follows:

Step 1: Determination of the reference average power level

- Adjust the spectrum analyser to the following settings:
 - RBW: 100 kHz
 - VBW: 300 kHz

Otherwise, use the relevant settings from either clause 5.4.6.2.1.1 or clause 5.4.6.2.1.2.

- Use the marker to find the highest average power level of the power envelope of the UUT. Use this level as the reference level for the relative measurements.

Step 2: Determination of the relative average power levels

- Adjust the frequency range of the spectrum analyser to allow the measurement to be performed within the sub-band of operation. No other parameter of the spectrum analyser should be changed.
- Compare the relative power envelope of the UUT with the limits defined in clause 4.2.4.2.2.

5.4.6.2.2 Radiated measurement

The test setup as described in annex E shall be used with a spectrum analyser attached to the test antenna.

The test procedure is as described under clause 5.4.6.2.1.

5.4.6.2.3 Test fixture measurement

The test setup and the procedure as described in clause E.4.4 shall be used with the spectrum analyser attached to the test fixture.

The test procedure is further as described under clause 5.4.6.2.1.

5.4.7 Receiver spurious emissions

5.4.7.1 Test conditions

These measurements shall be performed only under normal test conditions (see clause 5.1.2).

For equipment having different operating modes (see clause 5.3.3.2) the measurements described in the present clause may not need to be repeated for all the operating modes.

The level of receiver spurious emissions shall be measured as, either:

- a) their power in a specified load (conducted emissions) and their radiated power (ERP for emissions up to 1 GHz and EIRP for emissions above 1 GHz) when radiated by the cabinet or structure of the equipment (cabinet radiation); or
- b) their radiated power (ERP for emissions up to 1 GHz and EIRP for emissions above 1 GHz) when radiated by cabinet and antenna.

The test method in clause 5.4.7.2 assumes that, for the duration of the test, the UUT is configured into a continuous receive mode, or is operated in a mode where no transmissions occur.

5.4.7.2 Test methods

5.4.7.2.1 Conducted measurement

5.4.7.2.1.1 Pre-scan

The test procedure in the present clause shall be used to identify potential receiver spurious emissions of the UUT.

The sensitivity of the spectrum analyser should be such that the noise floor is at least 12 dB below the limits given in clause 4.2.5.2, table 4.

The test procedure shall be as follows:

Step 1:

- Measure the emissions over the range 30 MHz to 1 000 MHz using the following spectrum analyser settings:
 - RBW: 100 kHz
 - VBW: 300 kHz
 - Detector mode: Peak
 - Trace mode: Max Hold
 - Sweep points: $\geq 9\,700$
For spectrum analysers not supporting this number of sweep points, the frequency band may be segmented. For spectrum analysers capable of supporting twice this number of sweep points, the frequency adjustment in clause 5.4.7.2.1.2, step 1, last bullet may be omitted.
 - Sweep time: Auto
- Wait for the trace to stabilize. Measure any emissions identified that have a margin of less than 6 dB with respect to the applicable limit individually using the procedure in clause 5.4.7.2.1.2 and compare it to the applicable limit.

Step 2:

- Measure the emissions over the range 1 GHz to 26 GHz using the following spectrum analyser settings:
 - RBW: 1 MHz
 - VBW: 3 MHz
 - Detector mode: Peak
 - Trace mode: Max Hold

- Sweep points: $\geq 25\ 000$
For spectrum analysers not supporting this high number of sweep points, the frequency band may need to be segmented. For spectrum analysers capable of supporting twice this number of sweep points, the frequency adjustment in clause 5.4.7.2.1.2, step 1, last bullet may be omitted.
- Sweep time: Auto
- Wait for the trace to stabilize. Measure any emissions identified that have a margin of less than 6 dB with respect to the applicable limit given in clause 4.2.5.2, table 4 individually using the procedure in clause 5.4.7.2.1.2 and compare it to the applicable limit.

5.4.7.2.1.2 Measurement of the emissions identified during the pre-scan

The limits for receiver spurious emissions refer to average power levels.

The steps in the present clause shall be used to accurately measure the individual unwanted emissions identified during the pre-scan measurements in clause 5.4.7.2.1.1. This method assumes the spectrum analyser has a Time Domain Power function.

The test procedure shall be as follows:

Step 1:

- Measure the level of the emissions using the following spectrum analyser settings:
 - Measurement mode: Time Domain Power
 - Centre frequency: frequency of the emission identified during the pre-scan
 - RBW: 100 kHz (emissions ≤ 1 GHz) / 1 MHz (emissions > 1 GHz)
 - VBW: 300 kHz (emissions ≤ 1 GHz) / 3 MHz (emissions > 1 GHz)
 - Frequency span: 0 Hz
 - Sweep mode: Single Sweep
 - Sweep time: 30 ms
 - Sweep points: $\geq 30\ 000$
 - Trigger mode: Video (for burst signals) or Manual (for continuous signals)
 - Detector mode: RMS
- Adjust the centre frequency (fine tune) to capture the highest level of one burst of the emission to be measured.
This fine tuning may be omitted for spectrum analysers capable of supporting twice the number of sweep points required in step 2 and step 3 from the pre-scan procedure in clause 5.4.7.2.1.1.

Step 2:

- Set a window where the start and stop indicators match the start and end of the burst with the highest level and record the value of the power measured within this window.
- If the spurious emission to be measured is a continuous transmission, set the measurement window to the start and stop times of the sweep.

Step 3:

- In case of conducted measurements on smart antenna systems (equipment with multiple receive chains), repeat step 2 for each of the active receive chains.
- Sum the measured power (within the observed window) for each of the active receive chains.

Step 4:

- Compare the value obtained in step 3 to the applicable limit.

5.4.7.2.2 Radiated measurement

The test setup as described in annex E shall be used with a spectrum analyser attached to the test antenna.

The test procedure is as described under clause 5.4.7.2.1.

5.4.7.2.3 Test fixture measurement

The use of a test fixture is not allowed for testing receiver spurious emissions.

5.4.8 Dynamic Frequency Selection (DFS)**5.4.8.1 Test conditions****5.4.8.1.1 General test conditions**

These measurements shall be performed only under normal test conditions (see clause 5.1.2).

Some of the tests may be facilitated by disabling certain operational features of the UUT for the duration of the test.

It should be noted that once a UUT is powered on, it will not start its normal operating functions immediately, as it will have to finish its power-up cycle first ($T_{\text{power_up}}$). As such, the UUT, as well as any other device used in the setup, may be equipped with a feature that will indicate its status during the testing, e.g. power-up mode, normal operation mode, channel check status, radar detection event, etc.

The UUT shall be capable of transmitting a test transmission sequence resulting in a transmitter minimum activity ratio as further described in clause 5.3.1.2. The UUT shall be configured so that during the transmitter on-time it operates at its maximum Channel Occupancy Time (COT) without the use of any pauses in between transmissions. This is defined in clause 4.2.7.3.1 for Frame Based Equipment (FBE) and in clause 4.2.7.3.2 for Load Based Equipment (LBE).

The signal generator is capable of generating any of the radar test signals defined in table D.3 and table D.4.

A spectrum analyser shall be used to measure the aggregate transmission time of the UUT.

Clause 5.4.8.1.3.1 to clause 5.4.8.1.3.3 describe the different setups to be used during the measurements.

5.4.8.1.2 Selection of radar test signals

The radar test signals to be used during the DFS testing are defined in table D.3 and table D.4.

The radar test signals given in table D.4 take into account the combined effect of antenna rotation speed, antenna beam width and pulse repetition frequency for a particular type of radar.

For each of the variable radar test signals in table D.4, an arbitrary combination of pulse width, Pulse Repetition Frequency (PRF) and, if applicable, the number of different PRFs shall be chosen from the ranges given in table D.4 and recorded in the test report. When using the test signals, the tests related to Channel Availability Check (CAC), in-service monitoring, channel shutdown and non-occupancy period (see clause 5.4.8.2.1.2, clause 5.4.8.2.1.3, clause 5.4.8.2.1.5 and clause 5.4.8.2.1.6) are performed with a single-burst radar test signal while the tests related to off-channel CAC (see clause 5.4.8.2.1.4) are performed with a repetitive-burst radar test signal (see note 4 in table D.4).

Table D.5 provides for each radar test signal the required detection probability (P_d).

NOTE: P_d represents a minimum level of detection performance under defined conditions. Therefore, P_d does not represent the overall detection probability for any particular radar under real life conditions.

The pulse widths given in table D.3 and table D.4 shall have an accuracy of $\pm 5\%$.

5.4.8.1.3 Test setups

5.4.8.1.3.1 Setup A

Setup A is a setup in which the UUT is an RLAN device operating as primary device. Radar test signals are injected into the UUT. This setup also contains an RLAN device operating as secondary device without radar detection and which is associated with the UUT.

Figure 8 shows an example for setup A. The setup used shall be documented in the test report.

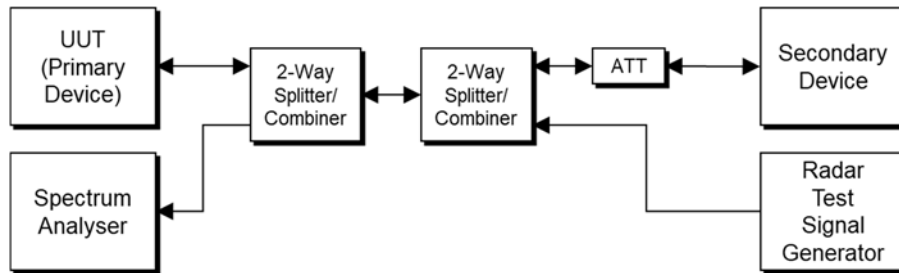

Figure 8: Setup A

5.4.8.1.3.2 Setup B

Setup B is a setup in which the UUT is an RLAN device operating as secondary device with or without radar detection. This setup also contains an RLAN device operating as primary device. The radar test signals are injected into the primary device. The UUT (secondary device) is associated with the primary device.

Figure 9 shows an example for setup B. When the UUT is a secondary device with radar detection, the value of the attenuator shall be sufficient to prevent radar detection by the secondary device. The setup used shall be documented in the test report.

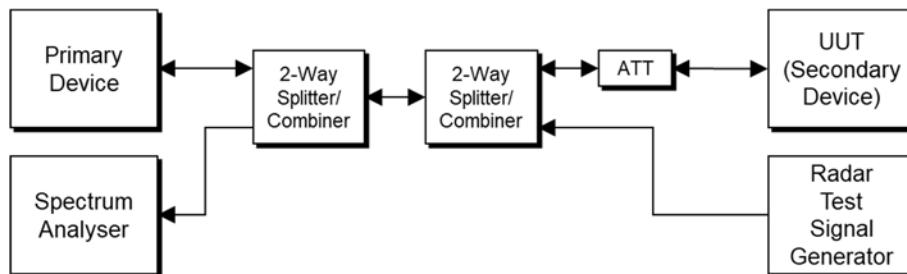

Figure 9: Setup B

5.4.8.1.3.3 Setup C

The UUT is an RLAN device operating as secondary device with radar detection. Radar test signals are injected into the secondary device. This setup also contains an RLAN device operating as primary device. The UUT (secondary device) is associated with the primary device.

Figure 10 shows an example for setup C. The value of the attenuator shall be sufficient to prevent radar detection by the primary device. The setup used shall be documented in the test report.

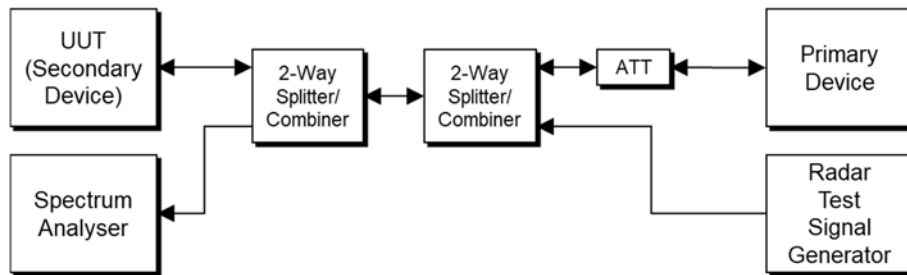

Figure 10: Setup C

5.4.8.2 Test methods

5.4.8.2.1 Conducted measurement

5.4.8.2.1.1 Additional test conditions

For a UUT with antenna connector(s) and using one or more dedicated external antennas, or for a UUT with integral antenna(s) but with one or more temporary antenna connectors provided, conducted measurements shall be used.

When performing DFS testing on smart antenna systems, a power splitter/combiner shall be used to combine all the receive chains (antenna inputs) into a single test point. The insertion loss of the splitter/combiner shall be taken into account.

The UUT shall be configured to operate at

- the highest transmitter output power level of the TPC range; or
- the maximum transmitter output power level in case the equipment has no TPC feature.

The radar test signal generator shall (unless otherwise specified) provide a signal power such that the power level at the antenna connector of the UUT is equal to the applicable radar detection threshold defined in table D.2. Parameter G (dBi) in table D.2 corresponds to the gain of the antenna assembly. If more than one antenna assembly is intended for this power setting or TPC range, the gain of the antenna assembly with the lowest gain shall be used.

Beamforming gain Y of smart antenna systems, operating in a mode where beamforming is active, is ignored in order to test the worst case.

The centre frequencies of the radar test signals used in the test procedures of clause 5.4.8.2.1 shall fall within the central 80 % of the occupied bandwidth of the RLAN channel under test.

5.4.8.2.1.2 Channel Availability Check (CAC)

5.4.8.2.1.2.1 Additional test conditions

Clause 5.4.8.2.1.2.2 and clause 5.4.8.2.1.2.3 define the procedures to verify the CAC and the CAC time ($T_{ch_avail_check}$) on the selected channel Ch_r by ensuring that the UUT is capable of detecting radar pulses at the beginning and at the end of the CAC time. This is illustrated in figure 11. There shall be no transmissions by the UUT on Ch_r during this time.

The channel on which the CAC test needs to be performed is designated as Ch_r . For the purpose of the test, the UUT shall be configured to ensure that the CAC is performed on Ch_r .

5.4.8.2.1.2.2 Tests with a radar burst at the beginning of the CAC time

The steps in the present clause define the procedure to verify the radar detection capability on the selected channel Ch_r when a radar burst occurs at the beginning of the CAC time:

- a) The radar test signal generator and UUT shall be connected using setup A as described in clause 5.4.8.1.3.1. The power of the UUT shall be switched off.

- b) The UUT shall be powered on at T_0 . T_1 denotes the instant when the UUT has completed its power-up sequence ($T_{\text{power_up}}$) and is ready to start the radar detection. The CAC is expected to commence on Ch_r at instant T_1 and is expected to end no sooner than $T_1 + T_{\text{ch_avail_check}}$ unless the radar test signal is detected sooner.

Additional verification may be needed to define T_1 in case it is not exactly known or indicated by the UUT.

- c) A single radar burst shall be generated on Ch_r using the reference test signal defined in table D.3 at a level of up to 10 dB above the level defined in clause 5.4.8.2.1.1. This single-burst radar test signal shall commence within 2 s after time T_1 .
- d) It shall be recorded if the radar test signal was detected.
- e) A timing trace or description of the observed timing and behaviour of the UUT shall be recorded.

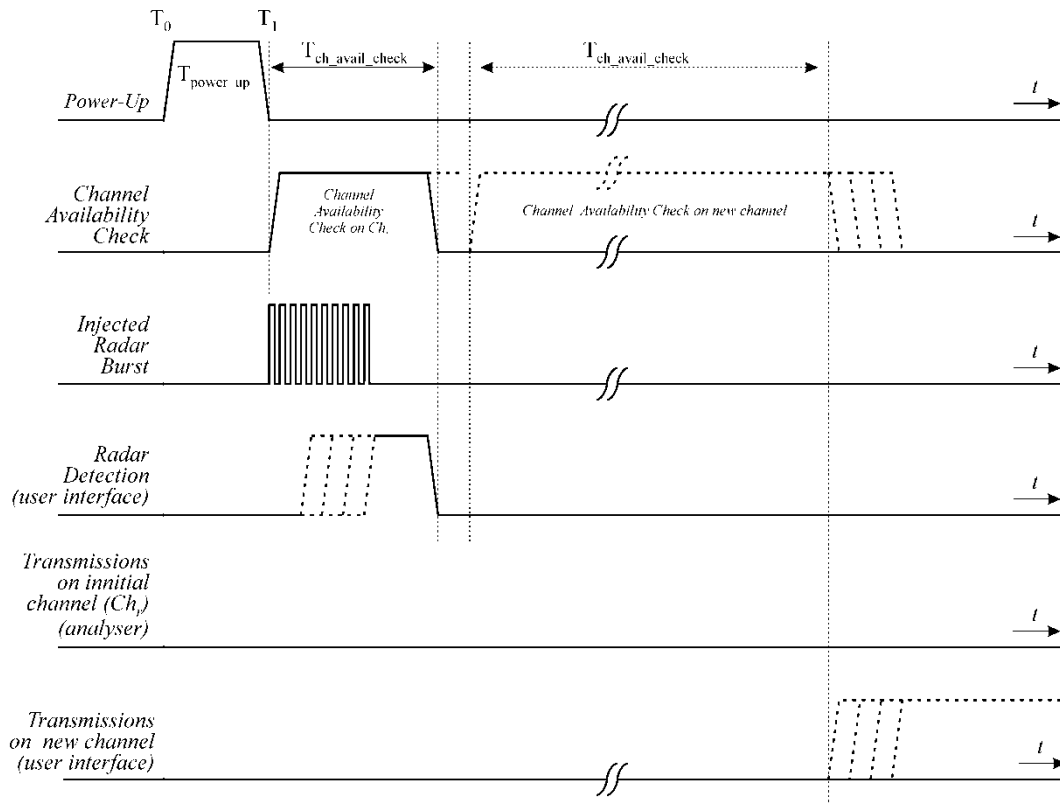

Figure 11: Example of timing for radar testing at the beginning of the CAC time

5.4.8.2.1.2.3 Tests with radar burst at the end of the CAC time

The steps in the present clause define the procedure to verify the radar detection capability on the selected channel Ch_r when a radar burst occurs at the end of the CAC time (see note). This is illustrated in figure 12.

NOTE: The applicable CAC times are given by table D.1.

- a) The radar test signal generator and UUT shall be connected using setup A described in clause 5.4.8.1.3.1. The power of the UUT shall be switched off.
- b) The UUT shall be powered up at T_0 . T_1 denotes the instant when the UUT has completed its power-up sequence ($T_{\text{power_up}}$) and is ready to start the radar detection. The CAC is expected to commence on Ch_r at instant T_1 and is expected to end no sooner than $T_1 + T_{\text{ch_avail_check}}$ unless the radar test signal is detected sooner.

Additional verification may be needed to define T_1 in case it is not exactly known or indicated by the UUT.

- c) A single radar burst shall be generated on Ch_r using the reference test signal defined in table D.3 at a level of up to 10 dB above the level defined in clause 5.4.8.2.1.1. This single-burst radar test signal shall commence towards the end of the minimum required CAC time but not before time $T_1 + T_{\text{ch_avail_check}} - 2$ s.
- d) It shall be recorded if the radar test signal was detected.

- e) A timing trace or description of the observed timing and behaviour of the UUT shall be recorded.

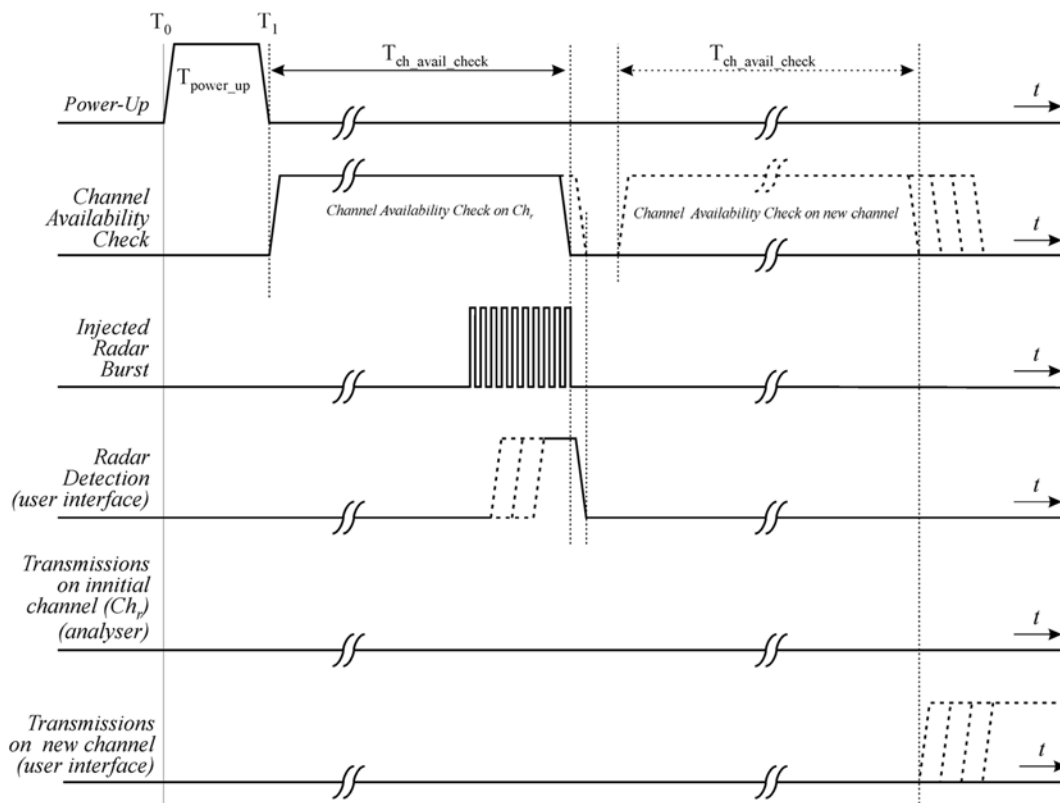

Figure 12: Example of timing for radar testing towards the end of the CAC time

5.4.8.2.1.3 Radar detection threshold (during CAC)

The steps in the present clause define the procedure to verify the radar detection threshold during the CAC time for channels outside the 5 600 MHz to 5 650 MHz band. This is illustrated in figure 13.

- The radar test signal generator and UUT shall be connected using setup A described in clause 5.4.8.1.3.1. The power of the UUT shall be switched off.
- The UUT shall be powered on at T_0 . T_1 denotes the instant when the UUT has completed its power-up sequence ($T_{\text{power_up}}$) and is ready to start the radar detection. The CAC on Ch_r is expected to commence at instant T_1 and is expected to end no sooner than $T_1 + T_{\text{ch_avail_check}}$ unless the radar test signal is detected sooner.

Additional verification may be needed to define T_1 in case it is not exactly known or indicated by the UUT.

- A single burst radar test signal shall be generated on Ch_r using any of the radar test signals defined in table D.4 at a level defined in clause 5.4.8.2.1.1. This single-burst radar test signal may commence at any time within the applicable CAC time.

For the purpose of reducing test time, it is recommended that the single-burst radar test signal starts approximately 10 s after T_1 .

- It shall be recorded if the radar test signal was detected.
- Step c) to step d) shall be performed 20 times, and each time a unique radar test signal shall be generated from options provided in table D.4. When selecting these 20 unique radar test signals, the radar test signals 1 to 6 from table D.4 shall be included as well as variations of pulse width, PRF and number of different PRFs (if applicable) within the ranges given. The radar test signals used shall be recorded in the report. The radar test signal shall be detected at least 12 times out of the 20 trials in order to conform to the detection probability specified for this frequency range in table D.5.

Where the channel plan includes channels whose nominal channel bandwidth falls completely or partly within the 5 600 MHz to 5 650 MHz band, additional testing as described in step f) and step g) shall be performed on such a channel.

- f) A single-burst radar test signal shall be generated on Ch_r using any of the radar test signals defined in table D.4 (except test signal 3 and test signal 4) at a level of 10 dB above the level defined in clause 5.4.8.2.1.1. This single-burst radar test signal may commence at any time within the applicable CAC time.

For the purpose of reducing test time, it is recommended that the single-burst radar test signal starts approximately 10 s after T_1 .

- g) Step f) shall be performed 20 times, each time a different radar test signal shall be generated from options provided in table D.4 (except test signal 3 and test signal 4). The radar test signals used shall be recorded in the report. The radar test signal shall be detected during each of these tests and this shall be recorded.

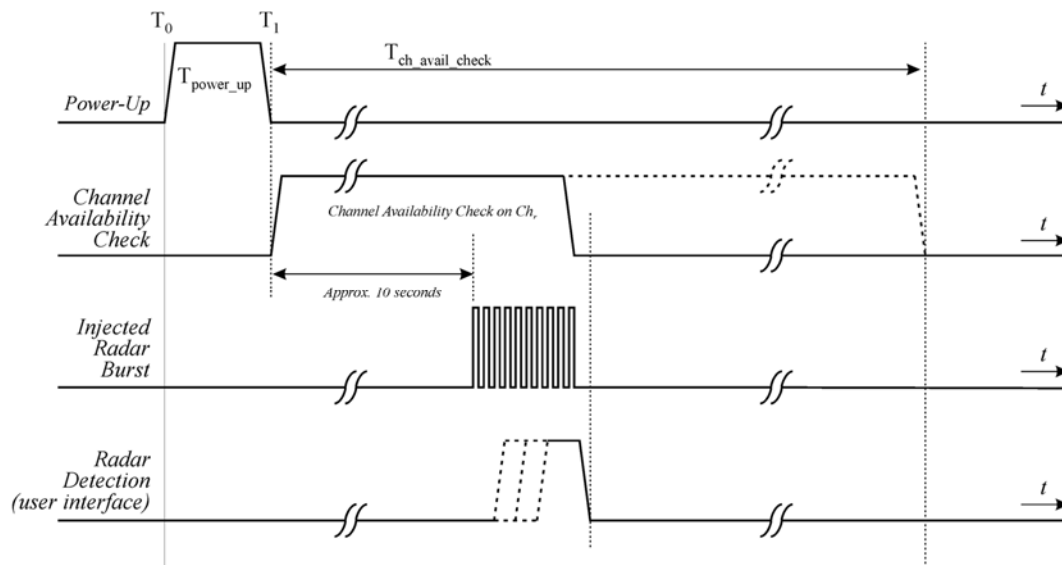

Figure 13: Example of timing for radar testing during the CAC time

5.4.8.2.1.4 Off-channel CAC

5.4.8.2.1.4.1 Additional test conditions

The channel, on which the off-channel CAC test will be performed, shall be selected in accordance with clause 5.3.2. This channel is designated as Ch_r .

For the purpose of the test, the UUT shall be configured to select the operating channel(s) different from Ch_r . There shall be no transmissions by the UUT on Ch_r during the off-channel CAC time.

5.4.8.2.1.4.2 Radar detection threshold (during off-channel CAC)

The steps in the present clause define the procedure to verify the radar detection threshold during the off-channel CAC.

Where the channel plan includes channels whose nominal channel bandwidth falls completely or partly within the 5 600 MHz to 5 650 MHz band, the test shall be performed on one of these channels in addition to a channel outside this band (see clause 5.3.2).

- The radar test signal generator, the UUT (primary device), and a secondary device associated with the UUT shall be connected using setup A described in clause 5.4.8.1.3.1.
- The UUT shall transmit a test transmission sequence in accordance with clause 5.3.1.2 on (all) the operating channel(s).

- c) A multi-burst radar test signal shall be generated on Ch_r using any of the radar test signals defined in table D.4 at a level defined in clause 5.4.8.2.1.1. The radar test signal used shall be recorded in the report. This multi-burst radar test signal shall commence at T_3 and shall continue for the total duration of the off-channel CAC time ($T_{\text{off-channel_CAC}}$) in accordance with table D.1. For channels within the 5 600 MHz to 5 650 MHz band, test signal 3 and test signal 4 shall not be used and the Burst Interval Time (BIT) during the test shall be varied between 8 minutes and 10 minutes. For channels outside this band, the BIT during the test shall be varied between 45 s and 60 s.
- d) The UUT shall detect the radar test signal before the end of the off-channel CAC time and this shall be recorded.

For the purpose of reducing test time, the test may be terminated immediately once the UUT has reported detection of the radar test signal.

5.4.8.2.1.4.3 Detection probability (P_d)

This test may be facilitated by disabling the channel shutdown feature for the duration of the test.

For channels outside the 5 600 MHz to 5 650 MHz band, the test in clause 5.4.8.2.1.4.2 is sufficient to demonstrate that the UUT meets the detection probability (P_d) defined in table D.5.

Where the channel plan includes channels whose nominal channel bandwidth falls completely or partly within the 5 600 MHz to 5 650 MHz band, the procedure shall be performed on one of these channels (see clause 5.3.2).

- a) A multi-burst radar test signal shall be generated on Ch_r using any of the radar test signals defined in table D.4 (except test signal 3 and test signal 4) at a level of 10 dB above the level defined in clause 5.4.8.2.1.1. The radar test signal used shall be recorded in the report. This multi-burst radar test signal shall commence at T_3 and shall continue for the total duration of the off-channel CAC time ($T_{\text{off-channel_CAC}}$) in accordance with table D.1. The BIT during the test shall be varied between 8 minutes and 10 minutes.
- b) It shall be recorded how many bursts have been detected by the UUT at the end of the off-channel CAC time. The minimum number of bursts that the UUT shall detect in order to conform to the detection probability defined for this frequency range in table D.5 is given by table 12.

Table 12: Minimum number of burst detections for channels within the 5 600 MHz to 5 650 MHz band

Off-channel CAC time (minutes)	Number of bursts generated assuming a BIT of 10 minutes	Minimum number of burst detections
60	6	5
90	9	6
160	16	7
320	32	8
1 440	144	9

For the purpose of reducing test time, the test may be terminated immediately once the UUT has reported the minimum number of burst detections required.

Figure 14 provides an example of the timing of a UUT when radar signals are detected during the off-channel CAC testing.

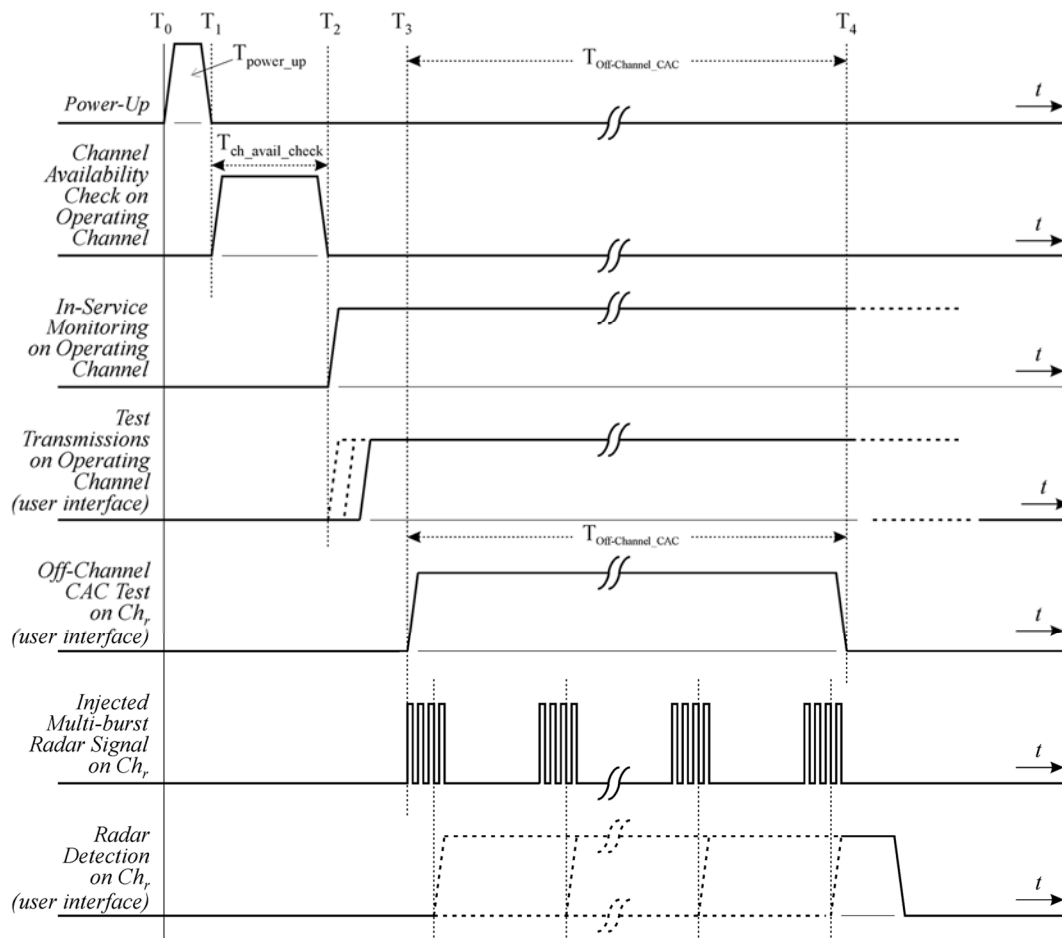

Figure 14: Example of timing for radar testing during the off-channel CAC

5.4.8.2.1.5 In-service monitoring

The steps in the present clause define the procedure to verify the in-service monitoring and the radar detection threshold during the in-service monitoring.

The operating channel on which the in-service monitoring test is performed is designated as Ch_r .

- a) When the UUT is a primary device, a secondary device shall be used that associates with the UUT. The radar test signal generator and the UUT shall be connected using setup A described in clause 5.4.8.1.3.1.
When the UUT is a secondary device with radar detection, the UUT shall associate with a primary device. The radar test signal generator and the UUT shall be connected using setup C described in clause 5.4.8.1.3.3.
- b) The UUT shall transmit a test transmission sequence in accordance with clause 5.3.1.2 on the selected channel Ch_r . While the testing is performed on Ch_r , the equipment is allowed to have simultaneous transmissions on other adjacent or non-adjacent operating channels.
- c) At a time T_0 , a single-burst radar test signal shall be generated on Ch_r using radar test signal 1 defined in table D.4 and at a level defined in clause 5.4.8.2.1.1. T_1 denotes the end of the radar burst.
- d) It shall be recorded if the radar test signal was detected.
- e) Step b) to step d) shall be performed 20 times, each time a random value shall be chosen for pulse width and PRF from the corresponding ranges provided in table D.4. For radar test signal 5 and radar test signal 6 provided in table D.4 the number of PRF values shall vary between 2 and 3. The radar test signal shall be detected at least 12 times out of the 20 trials in order to conform to the detection probability specified in table D.5.
- f) Step b) to step e) shall be repeated for each of the radar test signals defined in table D.4 and as described in clause 5.4.8.1.2.

Figure 15 provides an example of the timing of a UUT when radar signals are detected during the in-service monitoring.

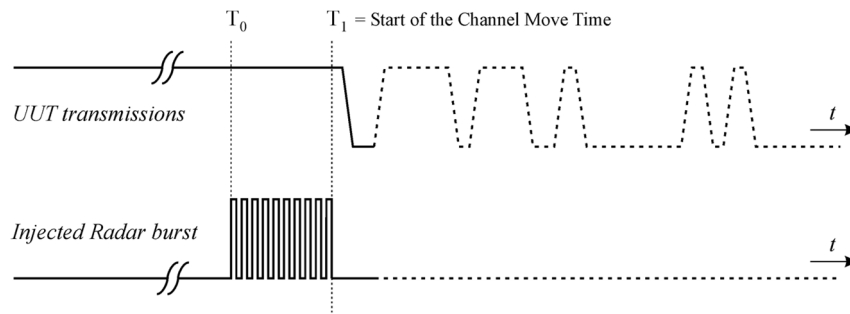

Figure 15: Example of timing for radar testing during in-service monitoring

5.4.8.2.1.6 Channel shutdown and non-occupancy period

The steps in the present clause define the procedure to verify the channel shutdown process and to determine the channel closing transmission time, the channel move time and the non-occupancy period. This is illustrated in figure 16.

The operating channel on which these tests are performed is designated as Ch_r .

- a) When the UUT is a primary device, a secondary device shall be used that associates with the UUT. The radar test signal generator and the UUT shall be connected using setup A described in clause 5.4.8.1.3.1.

When the UUT is a secondary device (with or without radar detection), the UUT shall associate with a primary device. The radar test signal generator and the UUT shall be connected using setup B described in clause 5.4.8.1.3.2.

In both cases, it is assumed that the channel selection mechanism for the uniform spreading requirement is disabled in the primary device.
- b) The UUT shall transmit a test transmission sequence in accordance with clause 5.3.1.2 on the selected channel Ch_r . While the testing is performed on Ch_r , the equipment is allowed to have simultaneous transmissions on other adjacent or non-adjacent operating channels.
- c) At a time T_0 , a single-burst test signal shall be generated on Ch_r using the reference DFS test signal defined in table D.3 and at a level of up to 10 dB above the level defined in clause 5.4.8.2.1.1 on the selected channel. T_1 denotes the end of the radar burst.
- d) The transmissions of the UUT following instant T_1 on the selected channel Ch_r shall be observed for a period greater than or equal to the channel move time defined in table D.1. The aggregate duration (channel closing transmission time) of all transmissions from the UUT on Ch_r during the channel move time shall be compared to the limit given in table D.1. For equipment capable of having simultaneous transmissions on multiple (adjacent or non-adjacent) operating channels, the equipment is allowed to continue transmissions on other operating channels (different from Ch_r).

The aggregate duration of all transmissions of the UUT does not include quiet periods in between transmissions of the UUT.
- e) T_2 denotes the instant when the UUT has ceased all transmissions on channel Ch_r . The time difference between T_1 and T_2 shall be measured. This value (channel move time) shall be noted and compared with the limit given in table D.1.
- f) Following instant T_2 , the selected channel Ch_r shall be observed for a period equal to the non-occupancy period ($T_3 - T_2$) to verify that the UUT does not resume any transmissions on this channel.
- g) When the UUT is a secondary device with radar detection, step b) to step f) shall be repeated with the generator connected to the UUT using setup C as described in clause 5.4.8.1.3.3 (see also table D.2, note 2).

For a secondary device with radar detection, the following additional steps are performed to verify the capability of the secondary device to report the detection of a radar to its primary device.

- h) The radar test signal generator, the UUT and the primary device shall be connected using setup C as described in clause 5.4.8.1.3.3.
- i) The primary device shall transmit a test transmission sequence in accordance with clause 5.3.1.2 on the selected channel Ch_r . While the testing is performed on Ch_r , the equipment is allowed to have simultaneous transmissions on other adjacent or non-adjacent operating channels.
- j) At a time T_0 , a single-burst test signal shall be generated on Ch_r using the reference DFS test signal defined in table D.3 and at a level of up to 10 dB above the level defined in clause 5.4.8.2.1.1 on the selected channel. T_1 denotes the end of the radar burst.
- k) The transmissions of the primary device following instant T_1 on the selected channel Ch_r shall be observed for a period greater than or equal to the channel move time given in table D.1. The aggregate duration (channel closing transmission time) of all transmissions from the primary device on Ch_r during the channel move time shall be compared to the limit given in table D.1. For equipment capable of having simultaneous transmissions on multiple (adjacent or non-adjacent) operating channels, the equipment is allowed to continue transmissions on other operating channels (different from Ch_r).

The aggregate duration of all transmissions of the primary device does not include quiet periods in between transmissions of the primary device.

- l) T_2 denotes the instant when the primary device has ceased all transmissions on the channel Ch_r . The time difference between T_1 and T_2 shall be measured. This value (channel move time) shall be noted and compared with the limit given in table D.1.
- m) Following instant T_2 , the selected channel Ch_r shall be observed for a period equal to the non-occupancy period ($T_3 - T_2$) to verify that neither the secondary device nor the primary device do resume any transmissions on this channel.

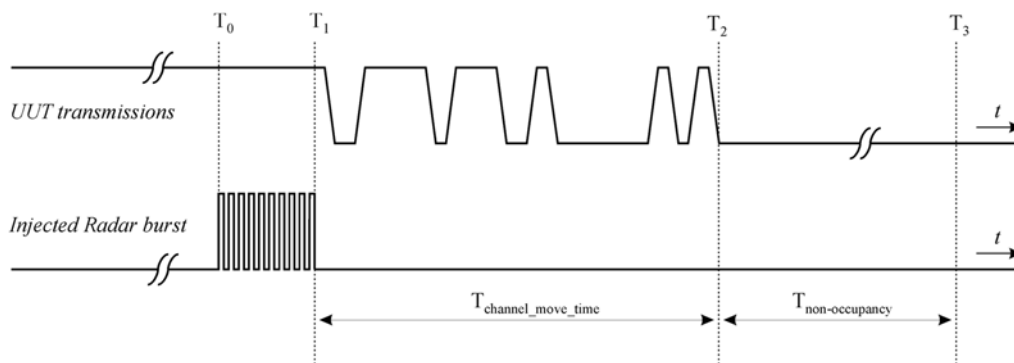

Figure 16: Channel closing transmission time, channel move time and non-occupancy period

5.4.8.2.2 Radiated measurement

For a UUT with integral antenna(s) and without temporary antenna connector(s), radiated measurements shall be used.

The radar test signal generator shall (unless otherwise specified) provide a signal power such that the power level at the antenna of the UUT is equal to the radar detection threshold given in table D.2.

When performing radiated DFS testing on a UUT with a directional antenna (including smart antenna systems and systems capable of beamforming), the wanted communications link (between the UUT and the associated device) and the DFS radar test signals shall be aligned to the direction corresponding to the UUT's maximum antenna gain.

The test setup as described in annex E and applicable measurement procedures as described in annex F shall be used to test the different DFS features of the UUT. The test procedure is further as described under clause 5.4.8.2.1.

5.4.8.2.3 Test fixture measurement

The test setup and the normalization procedure as described in clause E.4.4 shall be used with the measuring devices attached to the fixture.

The test procedure is further as described under clause 5.4.8.2.1.

5.4.9 Adaptivity (channel access mechanism)

5.4.9.1 Test conditions

These measurements shall only be performed at normal test conditions (see clause 5.1.2).

The device shall be configured to operate at its maximum output power level.

NOTE: Capabilities of the equipment that are relevant for the test method in the present clause have been noted in the test report per clause 5.4.1.

5.4.9.2 Test methods for Frame Based Equipment (FBE)

5.4.9.2.1 Additional test conditions

All measurements shall have temporal resolution of less than or equal to 1 μ s.

The measurement equipment shall be able to observe the UUT behaviour for a duration of at least 250 ms at the aforementioned temporal resolution. This data may be recorded in segments. In that case, the FFPs shall be extracted from each data segment. The combined set of all FFPs shall be analysed as described in clause 5.4.9.2.2.4.

5.4.9.2.2 Conducted measurements

5.4.9.2.2.1 Initialization of the test

Figure 17 shows an example of the test setup.

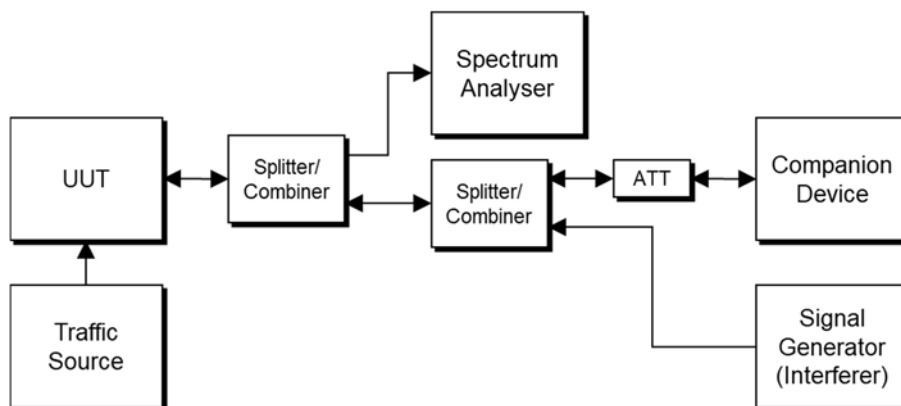

Figure 17: Example test setup for verifying the adaptivity of FBE

The steps in the present clause define the procedure to initialize the test to verify the conformance of the adaptivity mechanism of the equipment.

Step 1:

- The UUT shall connect to a companion device during the test. The signal generator, the spectrum analyser, the UUT, the traffic source and the companion device shall be connected using a setup equivalent to the example given by figure 17 although the interference source shall be switched off at this point in time. The spectrum analyser is used to monitor the transmissions of the UUT in response to the interference signal. The traffic source might be part of the UUT itself.
- The received signal level (wanted signal from the companion device) at the UUT shall be sufficient to maintain a reliable link for the duration of the test. A typical value for the received signal level which can be used in most cases is -50 dBm/MHz.

- The spectrum analyser shall be set as follows:
 - RBW: \geq occupied bandwidth (if the analyser does not support this setting, the highest available setting shall be used)
 - VBW: $3 \times$ RBW (if the analyser does not support this setting, the closest higher available setting shall be used)
 - Detector mode: RMS
 - Centre frequency: nominal centre frequency of the channel being investigated
 - Frequency span: 0 Hz
 - Sweep time: $> 2 \times$ Channel Occupancy Time (COT)
 - Trace mode: Clear/Write
 - Trigger mode: Video or RF/IF Power

Step 2:

- The traffic source shall be configured so that it exceeds the UUT's theoretical radio performance. The traffic source shall fill the UUT's buffers to a level causing the UUT to always have transmissions queued (full buffer condition) towards the companion device. Where this is not possible, the UUT shall be configured to occupy the COT of the FFP to the highest extent possible.
- To avoid adverse effects on the measurement results, a unidirectional traffic source should be used. An example of such a unidirectional traffic source not triggering reverse traffic on higher layer protocols is UDP.

5.4.9.2.2.2 Procedure to verify the capability to detect other transmissions when operating on a single channel

Step 1: Initialization

- See clause 5.4.9.2.2.1, step 1.

Step 2: Setting up the traffic source

- See clause 5.4.9.2.2.1, step 2.

Step 3: Setting up the communications link

- The UUT shall be configured to operate on a single operating channel.

Step 4: Adding the interference signal

- One of the three interference signals as defined in clause E.7 shall be injected on the current operating channel of the UUT. The bandwidth of this signal shall be such that it covers the current operating channel. The level of this interference signal measured at the interface between the UUT and its antenna assembly shall be equal to the applicable Energy Detection Threshold (EDT) defined in clause 4.2.7.3.1.4.

Step 5: Verification of reaction to the interference signal

- The spectrum analyser shall be used to monitor the transmissions of the UUT on the selected operating channel after the interference signal was injected. This may require the spectrum analyser sweep to be triggered by the start of the interfering signal.
- Using the procedure defined in clause 5.4.9.2.3, it shall be verified that:
 - i) The UUT does not have transmissions on the current operating channel during the FFP following the first Clear Channel Assessment (CCA) after the interference signal was injected. The UUT is allowed to have Short Control Signalling (SCS) transmissions on the current operating channel (see ii) and iii)).
 - ii) Apart from SCS transmissions, there are no subsequent transmissions while the interfering signal is present.

iii) The SCS transmissions conform to the limits defined in clause 4.2.7.3.3.

The verification of the SCS transmissions may require the analyser settings to be changed (e.g. sweep time).

- To verify that the UUT is not resuming normal transmissions as long as the interference signal is present, the monitoring time may need to be 60 s or more, in which case a segmented measurement may need to be performed in order to achieve the required resolution.
- Once the test is completed and the interference signal is removed, the UUT may start transmissions again on this operating channel; however, this is not a requirement and therefore does not require testing.

Step 6:

- Step 4 and step 5 shall be repeated for each of the interference signals defined in clause E.7.

5.4.9.2.2.3 Procedure to verify the capability to detect other transmissions in case of multi-channel operation

Step 1: Initialization

- See clause 5.4.9.2.2.1, step 1.

Step 2: Setting up the traffic source

- See clause 5.4.9.2.2.1, step 2.

Step 3: Setting up the communications link

- The UUT shall be configured to operate on a group of at least two and at most six adjacent operating channels. The number of channels used for the multi-channel operation during this test shall be noted in the test report (see clause 5.4.1, item b)).
- It shall be verified that the UUT started transmissions on all these channels.

Step 4: Adding the interference signal

- The interference signal as defined in clause E.7.1 shall be switched on.
- The centre frequency and the bandwidth of this signal shall be such that it covers all operating channels used for the multi-channel operation during this test. Alternatively, this test may be performed sequentially by which each of the operating channels is tested separately using an interference signal that only covers a single operating channel.
- The level of this interference signal measured at the interface between the UUT and its antenna assembly shall be equal to the applicable EDT defined in clause 4.2.7.3.1.4.

Step 5: Verification of reaction to the interference signal

- The spectrum analyser shall be used to monitor the transmissions of the UUT after the interference signal was injected. This may require the spectrum analyser sweep to be triggered by the start of the interfering signal.
- Using the procedure defined in clause 5.4.9.2.3, it shall be verified that:
 - i) The UUT does not have transmissions on any of the operating channels configured in step 1 and on which the interference signal was inserted during the FFP following the first CCA after the interference signal was detected. The UUT is allowed to have SCS transmissions on any of the current operating channels (see ii) and iii)).
 - ii) Apart from SCS transmissions, there are no subsequent transmissions of the UUT on any of the operating channels configured in step 3 and on which the interference signal was inserted, while the interfering signal is present in those channels.

iii) The SCS transmissions conform to the limits defined in clause 4.2.7.3.3.

The verification of the SCS transmissions may require the analyser settings to be changed (e.g. sweep time).

- To verify that the UUT is not resuming normal transmissions on any of the operating channels configured in step 3 as long as the interference signal is present in that channel, the monitoring time may need to be 60 s or more, in which case a segmented measurement may need to be performed in order to achieve the required resolution.
- Once the test is completed and the interference signal is removed, the UUT may start transmissions again on any of the operating channels used for the multi-channel operation configured in step 3; however, this is not a requirement and therefore does not require testing.

5.4.9.2.2.4 Procedure to verify the channel access mechanism

The steps in the present clause define the test procedure to verify the COT and idle period as part of the channel access mechanism.

Step 1: Initialization

- See clause 5.4.9.2.2.1, step 1.

Step 2: Setting up the traffic source

- See clause 5.4.9.2.2.1, step 2.

Step 3: Recording transmissions

- Start time and duration of every transmission on the operating channel as well as start time and duration of every gap in between transmissions on the operating channel shall be recorded.
- t_x shall denote a point in time the operating channel becomes occupied and d_x shall denote the duration of the transmission where the operating channel is subsequently occupied. i_y shall denote a point in time the operating channel becomes unoccupied and g_y shall denote the duration of the gap where the operating channel is subsequently unoccupied. Figure 18 presents an example.

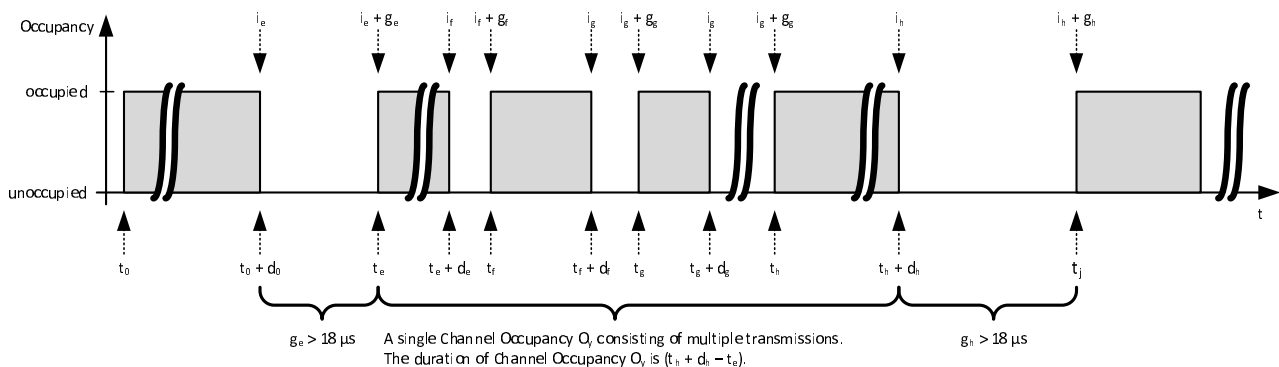

Figure 18: Example of UUT transmissions of FBE

Step 4: Measurement of idle periods and COTs

- Any COT O_x is defined as $(t_h + d_h - t_e)$ with $t_e < t_h$, if within the interval $[t_e, t_h + d_h]$ all periods g_y that the operating channel is unoccupied have duration of less than or equal to $18 \mu\text{s}$. As defined in clause 4.2.7.3.1.5, any COT may consist of one or more transmissions of the UUT. If the companion device acts as a responding device (see clause 4.2.7.3.1.6), any COT may consist of one or more transmissions of the UUT and zero or more transmissions of the companion device.
- Using the values recorded in step 3, the duration of any of the COTs shall be determined and the duration of any of the idle periods between such COTs shall be determined. An idle period is defined as any period g_y that has a duration greater than $18 \mu\text{s}$. All other gaps in between transmissions are considered as part of the COT.

- Where the source of a COT can be identified as being from the companion device, only COTs from the UUT need to be assessed for COT conformance.

Step 5: Identification of the FFP

- Based on the measurement results of step 4 and the specified FFP(s) of the UUT, the start point and duration of each FFP shall be identified.
- The contiguous idle period immediately before the start of an FFP shall be classified as idle period that belongs to the preceding FFP as defined in clause 4.2.7.3.1.5.

Step 6: Verification of requirements

- Using the results of step 5, it shall be verified that the UUT conforms to the maximum COT and the minimum idle period for each of the FFPs implemented and as defined in clause 4.2.7.3.1.5.

5.4.9.2.3 Generic test procedure for measuring channel/frequency usage

This is a generic test method to evaluate transmissions on the operating channel being investigated. This test is only performed as part of the procedure described in clause 5.4.9.2.2.2 and clause 5.4.9.2.2.3.

The test procedure shall be as follows:

Step 1:

- Set the spectrum analyser as follows:
 - Centre frequency: nominal centre frequency of the channel being investigated
 - Frequency span: 0 Hz
 - RBW: approximately 50 % of the occupied bandwidth (if the analyser does not support this setting, the highest available setting shall be used)
 - VBW: \geq RBW (if the analyser does not support this setting, the highest available setting shall be used)
 - Detector mode: RMS
 - Sweep time: $> 2 \times$ COT
 - Sweep points: at least one sweep point per μ s
 - Trace mode: Clear/Write
 - Trigger mode: Video or RF/IF Power

Step 2:

- Save the trace data to a file for further analysis by a computing device using an appropriate software application or program.

Step 3:

- Identify the data points related to the channel being investigated by applying a threshold.
- Count the number of consecutive data points identified as resulting from a single transmission on the channel being investigated and multiply this number by the time difference between two consecutive data points. Repeat this for all the transmissions within the measurement window.
- For measuring idle or silent periods, count the number of consecutive data points identified as resulting from a single transmitter off period on the channel being investigated and multiply this number by the time difference between two consecutive data points. Repeat this for all the transmitter off periods within the measurement window.

5.4.9.2.4 Radiated measurements

The signal generator simulating the interference signal shall provide a signal power such that the power level at the interface between the UUT and its antenna assembly corresponds to the applicable EDT defined in clause 4.2.7.3.1.4.

When performing radiated testing on a UUT with a directional antenna (including smart antenna systems and systems capable of beamforming), the wanted communications link (between the UUT and the companion device) and the interference test signals shall be aligned to the direction corresponding to the UUT's maximum antenna gain.

The test setup as described in annex E and applicable measurement procedures as described in annex F shall be used to test the adaptivity of the UUT. The test procedure is further as described under clause 5.4.9.2.2.

5.4.9.2.5 Test fixture measurement

The test setup and the normalization procedure as described in clause E.4.4 shall be used with the measuring devices attached to the fixture.

The test procedure is further as described under clause 5.4.9.2.2.

5.4.9.3 Test methods for Load Based Equipment (LBE)

5.4.9.3.1 Additional test conditions

A UUT that can operate as a supervising device and as a supervised device (see clause 4.2.7.3.2.2) shall be tested for both functionalities.

NOTE: Capabilities of the equipment that are relevant for the test method in the present clause have been noted in the test report per clause 5.4.1.

All measurements shall have temporal resolution of less than or equal to 1 μ s.

The measurement equipment shall be able to observe UUT behaviour of at least 10 000 Channel Occupancy Times (COTs) at the aforementioned temporal resolution. This data may be recorded in segments. In that case, the COTs shall be extracted from each data segment. The combined set of all COTs shall be analysed as described in clause 5.4.9.3.2.4.

The priority class used for testing is selected as follows:

- If the UUT implements priority class 2 (and potentially other priority classes), the UUT shall be tested against the requirements of priority class 2 as outlined in table 6 or table 7 in clause 4.2.7.3.2.4.
- If the UUT does not implement priority class 2 but the UUT implements priority class 1 (and potentially other priority classes), the UUT shall be tested against the requirements of priority class 1 as outlined in table 6 or table 7 in clause 4.2.7.3.2.4.
- If the UUT implements neither priority class 2 nor priority class 1 but the UUT implements priority class 3 (and optionally priority class 4), the UUT shall be tested against the requirements of priority class 3 as outlined in table 6 or table 7 in clause 4.2.7.3.2.4.
- If the UUT implements no priority classes other than priority class 4, the UUT shall be tested against the requirements of priority class 4 as outlined in table 6 or table 7 in clause 4.2.7.3.2.4.

5.4.9.3.2 Conducted measurements

5.4.9.3.2.1 Initialization of the test

Figure 19 shows an example of the test setup.

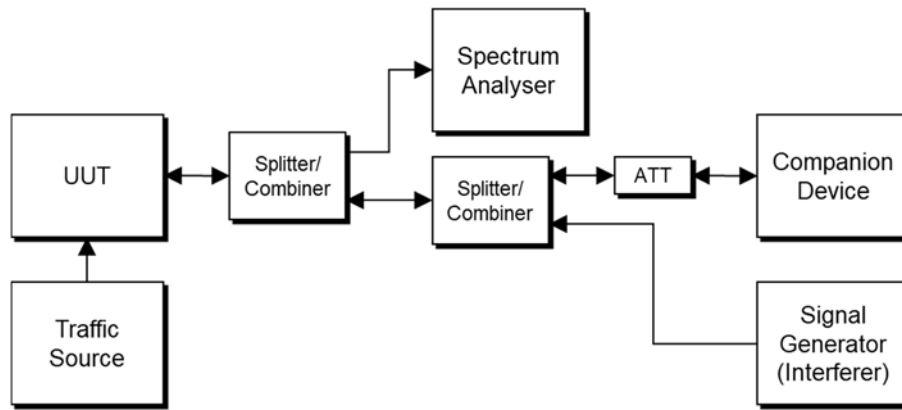

Figure 19: Example test setup for verifying the adaptivity of LBE

The steps in the present clause define the procedure to initialize the test to verify the conformance of the adaptivity mechanism of the equipment.

Step 1:

- The UUT shall connect to a companion device during the test. The signal generator, the spectrum analyser, the UUT, the traffic source and the companion device shall be connected using a setup equivalent to the example given by figure 19 although the interference source shall be switched off at this point in time. The spectrum analyser is used to monitor the transmissions of the UUT in response to the interference signal. The traffic source might be part of the UUT itself.
- The received signal level (wanted signal from the companion device) at the UUT shall be sufficient to maintain a reliable link for the duration of the test. A typical value for the received signal level which can be used in most cases is -50 dBm/MHz.
- The spectrum analyser shall be set as follows:
 - RBW: \geq occupied bandwidth (if the analyser does not support this setting, the highest available setting shall be used)
 - VBW: $3 \times$ RBW (if the analyser does not support this setting, the closest higher available setting shall be used)
 - Detector mode: RMS
 - Centre frequency: nominal centre frequency of the channel being investigated
 - Frequency span: 0 Hz
 - Sweep time: $> 2 \times$ COT
 - Trace mode: Clear/Write
 - Trigger mode: Video or RF/IF power

Step 2:

- The traffic source shall be configured so that it exceeds the UUT's theoretical radio performance. The traffic source shall fill the UUT's buffers to a level causing the UUT to always have transmissions queued (full buffer condition) towards the companion device.
- To avoid adverse effects on the measurement results, a unidirectional traffic source should be used. An example of such a unidirectional traffic source not triggering reverse traffic on higher layer protocols is UDP.

5.4.9.3.2.2 Procedure to verify the capability to detect other transmissions when operating on a single channel

It shall be noted in the test report whether the equipment contains one or more devices.

Step 1: Initialization

- See clause 5.4.9.3.2.1, step 1.

Step 2: Setting up the traffic source

- See clause 5.4.9.3.2.1, step 2.

Step 3: Setting up the communications link

- The UUT shall be configured to operate on a single operating channel.

Step 4: Adding the interference signal

- One of the three interference signals as defined in clause E.7 shall be injected on the current operating channel of the UUT. The bandwidth of this signal shall be such that it covers the current operating channel. The level of this interference signal measured at the interface between the UUT and its antenna assembly shall be equal to the applicable Energy Detection Threshold (EDT) defined in clause 4.2.7.3.2.5.

Step 5: Verification of reaction to the interference signal

- The spectrum analyser shall be used to monitor the transmissions of the UUT on the selected operating channel after the interference signal was injected. This may require the spectrum analyser sweep to be triggered by the start of the interfering signal.
- Using the procedure defined in clause 5.4.9.3.3, it shall be verified that:

- i) The UUT stops transmissions on the current operating channel.

The UUT is expected to stop transmissions within a period equal to the maximum COT that corresponds to the priority class being tested (see table 6 and table 7). The UUT is allowed to have Short Control Signalling (SCS) transmissions on the current operating channel (see ii) and iii)).

- ii) Apart from SCS transmissions, there are no subsequent transmissions while the interfering signal is present.
- iii) The SCS transmissions conform to the limits defined in clause 4.2.7.3.3.

The verification of the SCS transmissions may require the analyser settings to be changed (e.g. sweep time).

- To verify that the UUT is not resuming normal transmissions as long as the interference signal is present, the monitoring time may need to be 60 s or more, in which case a segmented measurement may need to be performed in order to achieve the required resolution.
- Once the test is completed and the interference signal is removed, the UUT may start transmissions again on this channel; however this is not a requirement and therefore does not require testing.

Step 6:

- Step 4 and step 5 shall be repeated for each of the interference signals defined in clause E.7.

5.4.9.3.2.3 Procedure to verify the capability to detect other transmissions in case of multi-channel operation

5.4.9.3.2.3.1 Equipment implementing option 1 for multi-channel operation

Step 1: Initialization

- See clause 5.4.9.3.2.1, step 1.

Step 2: Setting up the traffic source

- See clause 5.4.9.3.2.1, step 2.

Step 3: Setting up the communications link

- The UUT shall be configured to operate on a group of at least two and at most six adjacent operating channels. The number of channels used for the multi-channel operation during this test shall be noted in the test report (see clause 5.4.1, item b)).
- It shall be verified that the UUT started transmissions on all these channels.

Step 4: Adding the interference signal

- The interference signal as defined in clause E.7.1 shall be switched on.
- The centre frequency and the bandwidth of this signal shall be such that it covers all operating channels used for the multi-channel operation during this test. Alternatively, this test may be performed sequentially by which each of the operating channels is tested separately using an interference signal that only covers a single operating channel.
- The level of this interference signal measured at the interface between the UUT and its antenna assembly shall be equal to the applicable EDT defined in clause 4.2.7.3.2.5.

Step 5: Verification of reaction to the interference signal

- The spectrum analyser shall be used to monitor the transmissions of the UUT after the interference signal was injected. This may require the spectrum analyser sweep to be triggered by the start of the interfering signal.
- Using the procedure defined in clause 5.4.9.3.3, it shall be verified that:

- i) The UUT stops transmissions on any of the operating channels configured in step 1 and on which the interference signal was inserted.

The UUT is expected to stop transmissions on any of the operating channels used for the multi-channel operation (see step 1) during this test and on which the interference signal was inserted within a period equal to the maximum COT that corresponds to the priority class being tested (see table 6 and table 7). The UUT is allowed to have SCS transmissions on any of the operating channels configured in step 1 (see also ii) and iii)).

- ii) Apart from SCS transmissions, there are no subsequent transmissions of the UUT on any of the operating channels configured in step 3 and on which the interference signal was inserted, while the interfering signal is present in those channels.
- iii) The SCS transmissions conform to the limits defined in clause 4.2.7.3.3.

The verification of the SCS transmissions may require the analyser settings to be changed (e.g. sweep time).

- To verify that the UUT is not resuming normal transmissions on any of the operating channels configured in step 3 as long as the interference signal is present in that channel, the monitoring time may need to be 60 s or more, in which case a segmented measurement may need to be performed in order to achieve the required resolution.
- Once the test is completed and the interference signal is removed, the UUT may start transmissions again on any of the operating channels used for the multi-channel operation configured in step 3; however, this is not a requirement and, therefore, does not require testing.

5.4.9.3.2.3.2 Equipment implementing option 2 for multi-channel operation**Step 1: Initialization**

- See clause 5.4.9.3.2.1, step 1.

Step 2: Setting up the traffic source

- See clause 5.4.9.3.2.1, step 2.

Step 3: Setting up the communications link

- The UUT shall be configured to operate on a group of adjacent channels with a total bandwidth of 40 MHz. One of the two adjacent channels within this group shall be configured as the primary operating channel (see clause 4.2.7.3.2.3, option 2).
- It shall be verified that the UUT started transmissions within the 40 MHz group of adjacent channels.

Step 4: Adding the interference signal

- The interference signal as defined in clause E.7.1 shall be switched on.
- The centre frequency and the bandwidth of the interference signal shall be as such that it covers only the adjacent (non-primary) operating channel, it shall not cover the primary operating channel.
- The level of this interference signal measured at the interface between the UUT and its antenna assembly shall be equal to the applicable EDT defined in clause 4.2.7.3.2.5.

Step 5: Verification of reaction to the interference signal

- The spectrum analyser shall be used to monitor the transmissions of the UUT after the interference signal was injected. This may require the spectrum analyser sweep to be triggered by the start of the interfering signal.
- Using the procedure defined in clause 5.4.9.3.3, it shall be verified that:
 - i) The UUT stops transmissions on the adjacent (non-primary) operating channel.
The UUT is expected to stop transmissions on the adjacent (non-primary) operating channel within a period equal to the maximum COT that corresponds to the priority class being tested (see table 6 and table 7). The UUT is allowed to have SCS transmissions on the adjacent (non-primary) operating channel (see ii) and iii)).
 - ii) Apart from SCS transmissions, there are no subsequent transmissions on the adjacent (non-primary) operating channel while the interfering signal is present.
 - iii) The SCS transmissions conform to the limits defined in clause 4.2.7.3.3.
The verification of the SCS transmissions may require the analyser settings to be changed (e.g. sweep time).
- To verify that the UUT is not resuming normal transmissions on the adjacent (non-primary) operating channel as long as the interference signal is present in that channel, the monitoring time may need to be 60 s or more, in which case a segmented measurement may need to be performed in order to achieve the required resolution.
- Once the test is completed and the interference signal is removed, the UUT may start transmissions again on the adjacent (non-primary) operating channel. However, this is not a requirement and, therefore, does not require testing.

5.4.9.3.2.4 Procedure to verify the channel access mechanism

The steps in the present clause define the test procedure to verify the channel access mechanism implemented by the UUT.

Step 1: Initialization

- See clause 5.4.9.3.2.1, step 1.

Step 2: Setting up the traffic source

- See clause 5.4.9.3.2.1, step 2.
- If the UUT is making use of note 1 in table 6 in clause 4.2.7.3.2.4, the following additionally applies:
 - A second traffic source shall be configured so that it exceeds the companion device's theoretical radio performance. The second traffic source shall fill the companion device's buffers causing the companion device to always have transmissions queued (full buffer condition) towards the UUT.

- In this test, the supervising device shall issue one or more grants with each COT. Per COT, one and not more than one grant shall foresee inserting a single pause of at least 100 μs (see clause 4.2.7.3.2.4, table 6, note 1).

Step 3: Recording transmissions

- Start time and duration of every transmission on the operating channel as well as start time and duration of every gap in between transmissions on the operating channel shall be recorded.
- t_x shall denote a point in time the operating channel becomes occupied and d_x shall denote the duration of the transmission where the operating channel is subsequently occupied. i_y shall denote a point in time the operating channel becomes unoccupied and g_y shall denote the duration of the gap where the operating channel is subsequently unoccupied. Figure 20 presents an example.

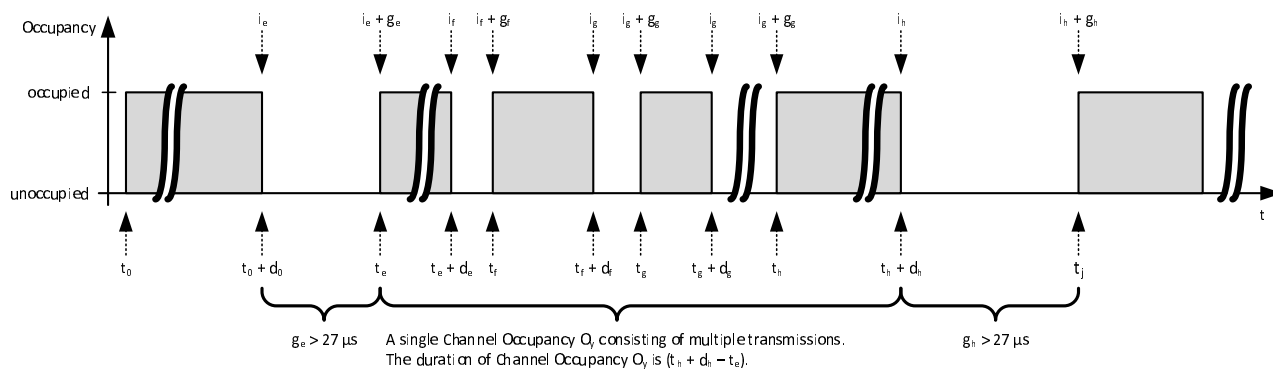

Figure 20: Example of UUT transmissions of LBE

Step 4: Measurement of idle periods and COTs

- Any COT O_x is defined as $(t_h + d_h - t_e)$ with $t_e < t_h$, if within the interval $[t_e, t_h + d_h]$ all periods g_y that the operating channel is unoccupied have duration of less than or equal to 27 μs . As defined in clause 4.2.7.3.2.2, any COT may consist of one or more transmissions of the UUT and zero or more transmissions of the companion device.
- Using the values recorded in step 3, the duration of any of the COTs shall be determined and the duration of any of the idle periods between such COTs shall be determined. An idle period is defined as any period g_y that has a duration greater than 27 μs . All other gaps in between transmissions are considered as part of the COT.
- Where the source of a COT can be identified as being from the companion device, only COTs from the UUT need to be assessed for COT conformance.

Step 5: Classification of idle periods

- k shall be an integer greater than or equal to zero.
- All idle periods shall be assigned to one of $k + 1$ different bins. The value of k depends on the priority class used for the test. A bin shall be denoted as B_n with $0 \leq n \leq k$.
 - If the priority class used for the test is 1, then $k = 16$ and the bins are denoted $B_0 \dots B_{16}$.
 - If the priority class used for the test is 2, the following applies:
 - i) If the UUT makes use of note 2 in table 6 in clause 4.2.7.3.2.4, then $k = 32$ and the bins are denoted $B_0 \dots B_{32}$.
 - ii) If the UUT does not make use of note 2 in table 6 in clause 4.2.7.3.2.4, then $k = 16$ and the bins are denoted $B_0 \dots B_{16}$.
 - If the priority class used for the test is 3, then $k = 8$ and the bins are denoted $B_0 \dots B_8$.
 - If the priority class used for the test is 4, then $k = 4$ and the bins are denoted $B_0 \dots B_4$.

- If the priority class used for the test is 1, bin B_n shall be defined as:

$$B_n = \begin{cases} [0, 77[\mu\text{s}, & n = 0 \\ [77 + 9 \times (n - 1), 77 + 9 \times n[\mu\text{s}, & 1 \leq n \leq 15 \\ [212, \infty[\mu\text{s}, & n = 16 \end{cases} \quad (16)$$

- If the priority class used for the test is 2, bin B_n shall be defined as:

- If the UUT is a supervising device making use of note 2 in table 6 in clause 4.2.7.3.2.4, bin B_n is:

$$B_n = \begin{cases} [0, 41[\mu\text{s}, & n = 0 \\ [41 + 9 \times (n - 1), 41 + 9 \times n[\mu\text{s}, & 1 \leq n \leq 31 \\ [320, \infty[\mu\text{s}, & n = 32 \end{cases} \quad (17)$$

- If the UUT is a supervised device or if the UUT is a supervising device not making use of note 2 in table 6 in clause 4.2.7.3.2.4, bin B_n is:

$$B_n = \begin{cases} [0, 41[\mu\text{s}, & n = 0 \\ [41 + 9 \times (n - 1), 41 + 9 \times n[\mu\text{s}, & 1 \leq n \leq 15 \\ [176, \infty[\mu\text{s}, & n = 16 \end{cases} \quad (18)$$

- If the priority class used for the test is 3, bin B_n shall be defined as:

- If the UUT is a supervised device, bin B_n is:

$$B_n = \begin{cases} [0, 32[\mu\text{s}, & n = 0 \\ [32 + 9 \times (n - 1), 32 + 9 \times n[\mu\text{s}, & 1 \leq n \leq 7 \\ [95, \infty[\mu\text{s}, & n = 8 \end{cases} \quad (19)$$

- If the UUT is a supervising device, bin B_n is:

$$B_n = \begin{cases} [0, 23[\mu\text{s}, & n = 0 \\ [23 + 9 \times (n - 1), 23 + 9 \times n[\mu\text{s}, & 1 \leq n \leq 7 \\ [86, \infty[\mu\text{s}, & n = 8 \end{cases} \quad (20)$$

- If the priority class used for the test is 4, bin B_n shall be defined as:

- If the UUT is a supervised device, bin B_n is:

$$B_n = \begin{cases} [0, 32[\mu\text{s}, & n = 0 \\ [32 + 9 \times (n - 1), 32 + 9 \times n[\mu\text{s}, & 1 \leq n \leq 3 \\ [59, \infty[\mu\text{s}, & n = 4 \end{cases} \quad (21)$$

- If the UUT is a supervising device, bin B_n is:

$$B_n = \begin{cases} [0, 23[\mu\text{s}, & n = 0 \\ [23 + 9 \times (n - 1), 23 + 9 \times n[\mu\text{s}, & 1 \leq n \leq 3 \\ [50, \infty[\mu\text{s}, & n = 4 \end{cases} \quad (22)$$

Step 6: Idle period probability evaluation

- $H(B_n)$ shall define the number of idle periods assigned to bin B_n .
- E shall define the total number of idle periods observed. Then E shall be the sum of events in all bins:

$$E = \sum_{n=0}^k H(B_n) \quad (23)$$

- The observed cumulative probabilities shall be calculated as follows:
 - Let $p(n)$ define the probability that idle periods of duration less than the upper limit specified for bin B_n occurred $p(n) = p(\text{idle period} < \text{upper limit of bin } B_n)$.
 - Then, for each n , $0 \leq n \leq k$, $p(n)$ is:

$$p(n) = \frac{\sum_{i=0}^n H(B_i)}{E} \quad (24)$$

- It shall be verified that the UUT's channel access mechanism complies with the limits defined in table 6 and table 7 in clause 4.2.7.3.2.4 using the following test methodology:
 - If the priority class used for the test is 1, each cumulative probability $p(n)$ of all idle periods recorded in bins $[B_0 \dots B_n]$ does not exceed the following maximum probability:

$$p(n) \leq \begin{cases} 0,05, & n = 0 \\ 0,12, & n = 1 \\ 0,12 + (n - 1) \times 0,0625, & 2 \leq n \leq 15 \\ 1, & n > 15 \end{cases} \quad (25)$$

- If the priority class used for the test is 2, each cumulative probability $p(n)$ of all idle periods recorded in bins $[B_0 \dots B_n]$ does not exceed the following maximum probability:

- If the UUT makes use of note 2 in table 6 in clause 4.2.7.3.2.4:

$$p(n) \leq \begin{cases} 0,05, & n = 0 \\ 0,12, & n = 1 \\ 0,12 + (n - 1) \times 0,03125, & 2 \leq n \leq 29 \\ 1, & n > 29 \end{cases} \quad (26)$$

- If the UUT does not make use of note 2 in table 6 in clause 4.2.7.3.2.4:

$$p(n) \leq \begin{cases} 0,05, & n = 0 \\ 0,12, & n = 1 \\ 0,12 + (n - 1) \times 0,0625, & 2 \leq n \leq 15 \\ 1, & n > 15 \end{cases} \quad (27)$$

- If the UUT makes use of note 1 in table 6 in clause 4.2.7.3.2.4:

$$p(n) \leq \begin{cases} 0,05, & n = 0 \\ 0,09 + (n - 1) \times 0,03125, & 1 \leq n \leq 7 \\ 0,59 + (n - 1) \times 0,03125, & 8 \leq n \leq 14 \\ 1, & n > 14 \end{cases} \quad (28)$$

- If the priority class used for the test is 3, each cumulative probability $p(n)$ of all idle periods recorded in bins $[B_0 \dots B_n]$ does not exceed the following maximum probability:

$$p(n) \leq \begin{cases} 0,05, & n = 0 \\ 0,18, & n = 1 \\ 0,18 + (n - 1) \times 0,125, & 2 \leq n \leq 6 \\ 1, & n > 6 \end{cases} \quad (29)$$

- If the priority class used for the test is 4, each cumulative probability $p(n)$ of all idle periods recorded in bins $[B_0 \dots B_n]$ does not exceed the following maximum probability:

$$p(n) \leq \begin{cases} 0,05, & n = 0 \\ 0,05 + n \times 0,25, & 1 \leq n \leq 3 \\ 1, & n > 3 \end{cases} \quad (30)$$

5.4.9.3.2.5 Procedure to verify the maximum Channel Occupancy Time(s) (COT)

The steps in the present clause define the test procedure to verify the maximum COT(s) implemented by the UUT.

A channel occupancy consists of transmissions from the UUT and may contain transmissions of the companion device (see clause 4.2.7.3.2.2).

The COTs shall be determined using the results of step 4 in clause 5.4.9.3.2.4. These COTs shall be noted in the test report.

The configuration in step 2 of clause 5.4.9.3.2.1 is assumed to result in an operational mode that enables the longest COT for the UUT to occur.

The UUT conforms to the limit for the maximum COT under the following conditions:

- If the priority class used for the test is 1, none of the COTs shall exceed 6 ms.
- If the priority class used for the test is 2, none of the COTs shall exceed the following limits:
 - 6 ms if the UUT makes use of note 1 in table 6 in clause 4.2.7.3.2.4.
 - 10 ms if the UUT makes use of note 2 in table 6 in clause 4.2.7.3.2.4.
 - 6 ms if the UUT does not make use of note 2 in table 6 in clause 4.2.7.3.2.4.
- If the priority class used for the test is 3, none of the COTs shall exceed 4 ms.
- If the priority class used for the test is 4, none of the COTs shall exceed 2 ms.

5.4.9.3.3 Generic test procedure for measuring channel/frequency usage

This is a generic test method to evaluate transmissions on the operating channel being investigated. This test is only performed as part of the procedure described in clause 5.4.9.3.2.2, clause 5.4.9.3.2.3.1 and clause 5.4.9.3.2.3.2.

The test procedure shall be as follows:

Step 1:

- Set the spectrum analyser as follows:
 - Centre frequency: nominal centre frequency of the channel being investigated
 - Frequency span: 0 Hz
 - RBW: approximately 50 % of the occupied bandwidth (if the analyser does not support this setting, the highest available setting shall be used)
 - VBW: \geq RBW (if the analyser does not support this setting, the highest available setting shall be used)
 - Detector mode: RMS
 - Sweep time: $> 2 \times$ COT
 - Sweep points: at least one sweep point per μ s
 - Trace mode: Clear/Write
 - Trigger mode: Video or RF/IF Power

Step 2:

- Save the trace data to a file for further analysis by a computing device using an appropriate software application or program.

Step 3:

- Identify the data points related to the channel being investigated by applying a threshold.
- Count the number of consecutive data points identified as resulting from a single transmission on the channel being investigated and multiply this number by the time difference between two consecutive data points. Repeat this for all the transmissions within the measurement window.

- For measuring idle or silent periods, count the number of consecutive data points identified as resulting from a single transmitter off period on the channel being investigated and multiply this number by the time difference between two consecutive data points. Repeat this for all the transmitter off periods within the measurement window.

5.4.9.3.4 Radiated measurements

The signal generator simulating the interference signal shall provide a signal power such that the power level at the interface between the UUT and its antenna assembly corresponds to the applicable EDT defined in clause 4.2.7.3.2.5.

When performing radiated testing on a UUT with a directional antenna (including smart antenna systems and systems capable of beamforming), the wanted communications link (between the UUT and the companion device) and the interference test signals shall be aligned to the direction corresponding to the UUT's maximum antenna gain.

The test setup as described in annex E and applicable measurement procedures as described in annex F shall be used to test the adaptivity of the UUT. The test procedure is further as described under clause 5.4.9.3.2.

5.4.9.3.5 Test fixture measurement

The test setup and the normalization procedure as described in clause E.4.4 shall be used with the measuring devices attached to the fixture.

The test procedure is further as described under clause 5.4.9.3.2.

5.4.10 Receiver blocking

5.4.10.1 Test conditions

These measurements shall only be performed at normal test conditions (see clause 5.1.2).

The UUT shall operate in its normal operational mode.

For devices which can change their operating frequency automatically (adaptive channel allocation), this function shall be disabled.

If the equipment can be configured to operate with different nominal channel bandwidths and different data rates, then the combination of the smallest channel bandwidth and the lowest data rate for this channel bandwidth which still allows the equipment to operate as intended shall be used. This mode of operation shall be aligned with the performance criteria defined in clause 4.2.8.3 and shall be described in the test report.

It shall be verified that these performance criteria are achieved during the blocking test.

5.4.10.2 Test methods

5.4.10.2.1 Conducted measurements

For systems using multiple receive chains, only one chain needs to be tested. All other receiver inputs shall be terminated.

Figure 21 shows the test setup which can be used for performing the receiver blocking test. The companion device may require appropriate shielding or may need to be put in a shielded room to prevent a negative impact on the measurement.

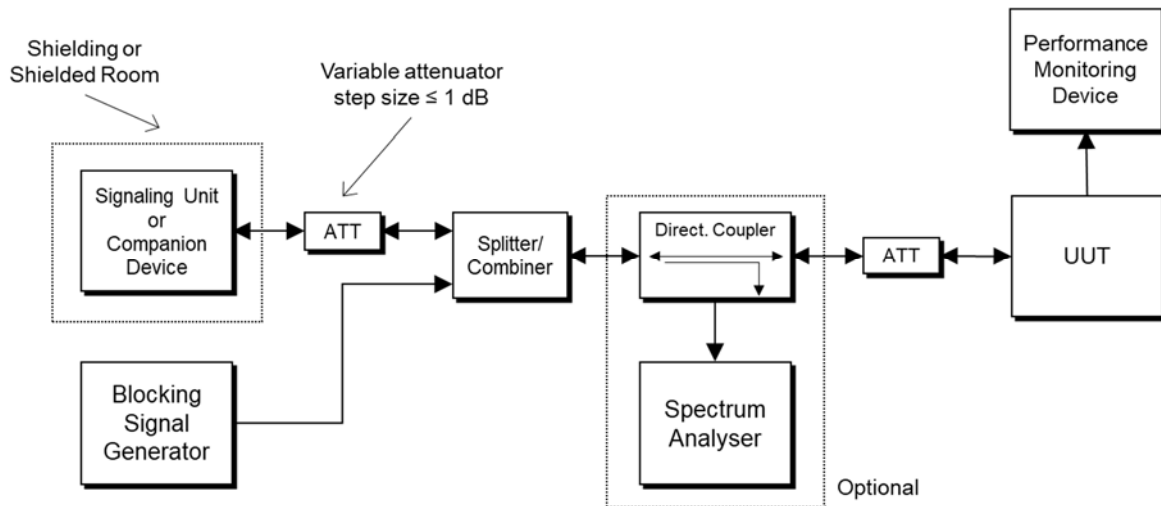

Figure 21: Test setup for receiver blocking

The steps in the present clause define the procedure to verify the receiver blocking requirement as described in clause 4.2.8.

Step 1:

- The UUT shall be set to the first channel to be tested.

Step 2:

- The blocking signal generator shall be set to the first frequency as defined in table 8.

Step 3:

- With the blocking signal generator switched off, a communication link shall be set up between the UUT and the associated companion device using the test setup shown in figure 21. The attenuation of the variable attenuator shall be increased in 1 dB steps to a value at which the minimum performance criteria as specified in clause 4.2.8.3 is still met. The resulting level for the wanted signal measured at the interface between the UUT and its antenna assembly is P_{\min} .
- This signal level (P_{\min}) shall be increased by 6 dB resulting in a new level ($P_{\min} + 6$ dB) of the wanted signal at the UUT receiver input.

Step 4:

- The level of the blocking signal measured at the interface between the UUT and its antenna assembly shall be set to the level provided in table 8. It shall be verified and recorded in the test report that the performance criteria as specified in clause 4.2.8.3 are met.
- If the performance criteria as specified in clause 4.2.8.3 are met, the level of the blocking signal at the UUT may be further increased (e.g. in steps of 1 dB) until the level whereby the performance criteria as specified in clause 4.2.8.3 are no longer met. The highest level at which the performance criteria are met shall be recorded in the test report.

Step 5:

- Step 4 shall be repeated for each remaining combination of frequency and level as specified in table 8.

Step 6:

- If applicable, step 2 to step 5 shall be repeated with the UUT operating at the other channels at which the blocking test has to be performed.

5.4.10.2.2 Radiated measurements

When performing radiated measurements on equipment with dedicated antennas, measurements shall be repeated for each alternative dedicated antenna.

A test site as described in annex E and applicable measurement procedures as described in annex F shall be used.

The test procedure is further as described under clause 5.4.10.2.1.

The level of the blocking signal at the UUT referred to in step 4 is assumed to be the level at the interface between the UUT and its antenna assembly. In case of radiated measurements on a UUT with an integral antenna equipment without external (temporary) antenna connector(s) provided, the equivalent Power Flux Density (PFD) at the UUT is the ratio of the level of the blocking signal and the antenna area of the UUT antenna. In case of radiated measurements with a substitution antenna, the equivalent PFD at the said antenna is the ratio of the level of the blocking signal and the antenna area of the substitution antenna.

The UUT shall be configured/positioned with its main beam pointing towards the antenna radiating the blocking signal. The position recorded in clause 5.4.4.2.2 can be used.

5.4.10.2.3 Test fixture measurement

The test setup and the normalization procedure as described in clause E.4.4 shall be used with the measuring devices attached to the fixture.

The test procedure is further as described under clause 5.4.10.2.1.

5.4.11 Adjacent channel selectivity

5.4.11.1 Test conditions

These measurements shall only be performed at normal test conditions (see clause 5.1.2).

For devices which can change their operating frequency automatically (adaptive channel allocation), this function shall be disabled.

The UUT shall operate in its normal operational mode, except that it shall be configured to operate with a nominal channel bandwidth of 20 MHz and at the lowest data rate for this channel bandwidth.

It shall be verified that the performance criteria as defined in clause 4.2.9.3 are achieved during the adjacent channel selectivity test.

5.4.11.2 Test methods

5.4.11.2.1 Conducted measurements

For systems using multiple receive chains, only one chain needs to be tested. All other receiver inputs shall be terminated.

Figure 22 shows the test setup which can be used for performing the receiver adjacent channel selectivity test. The companion device may require appropriate shielding or may need to be put in a shielded room to prevent a negative impact on the measurement.

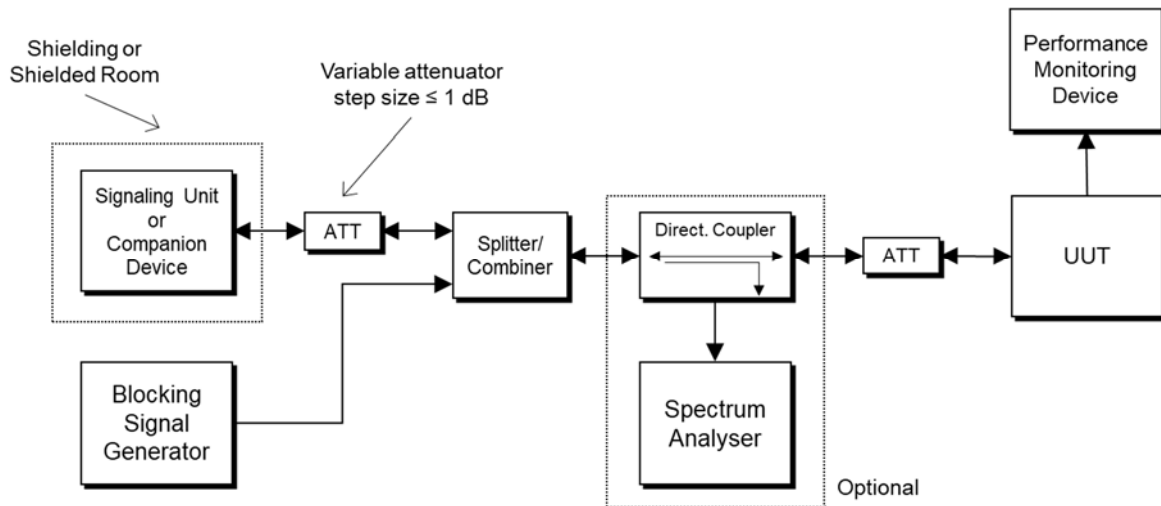

Figure 22: Test setup for receiver adjacent channel selectivity

The steps in the present clause define the procedure to verify the adjacent channel selectivity requirement as described in clause 4.2.9.

Step 1:

- The UUT shall be set to the first channel to be tested.

Step 2:

- The interference source shall be set to operate in the upper adjacent channel using the frequency offset as defined in table 9.

Step 3:

- With the interference source switched off, a communication link shall be set up between the UUT and the associated companion device using the test setup shown in figure 22. The attenuation of the variable attenuator shall be increased in 1 dB steps to a value at which the minimum performance criteria as specified in clause 4.2.9.3 is still met. The resulting level for the wanted signal measured at the interface between the UUT and its antenna assembly is P_{\min} .
- This signal level (P_{\min}) shall be increased by 10 dB resulting in a new level ($P_{\min} + 10$ dB) of the wanted signal at the UUT receiver input.

Step 4:

- The interference signal source shall be switched on. It shall transmit continuously unsynchronized with a duty cycle of at least 50 %. The level of the interference source measured at the interface of the UUT and its antenna assembly shall be set to the level provided in table 9. It shall be verified and recorded in the test report that the performance criteria as specified in clause 4.2.9.3 are met.
- If the performance criteria as specified in clause 4.2.9.3 are met, the level of the interference source at the UUT may be further increased (e.g. in steps of 1 dB) until the level whereby the performance criteria as specified in clause 4.2.9.3 are no longer met. The highest level at which the performance criteria are met shall be recorded in the test report.

Step 5:

- Step 4 shall be repeated after the interference source is set to operate in the lower adjacent channel using the frequency offset as defined in table 9.

Step 6:

- If applicable, step 2 to step 5 shall be repeated with the UUT operating at the other channels at which the receiver adjacent channel selectivity test has to be performed.

5.4.11.2.2 Radiated measurements

When performing radiated measurements on equipment with dedicated antennas, measurements shall be repeated for each alternative dedicated antenna.

A test site as described in annex E and applicable measurement procedures as described in annex F shall be used.

The test procedure is further as described under clause 5.4.11.2.1.

The level of the interference source at the UUT referred to in step 4 is assumed to be the level at the interface between the UUT and its antenna assembly. In case of radiated measurements on a UUT with an integral antenna equipment without external (temporary) antenna connector(s) provided, the equivalent Power Flux Density (PFD) at the UUT is the ratio of the level of the interference source and the antenna area of the UUT antenna. In case of radiated measurements with a substitution antenna, the equivalent PFD at the said antenna is the ratio of the level of the interference source and the antenna area of the substitution antenna.

The UUT shall be configured/positioned with its main beam pointing towards the antenna radiating the interference source. The position recorded in clause 5.4.4.2.2 can be used.

5.4.11.2.3 Test fixture measurement

The test setup and the normalization procedure as described in clause E.4.4 shall be used with the measuring devices attached to the fixture.

The test procedure is further as described under clause 5.4.11.2.1.

5.4.12 User Access Restrictions (UAR)

5.4.12.1 Introduction

The aim of this assessment procedure is to verify that it is not possible to change the parameters identified in clause 4.2.10.2 by means of any configuration interface available either on the UUT or on an external controller that may be used for networked devices.

5.4.12.2 Assessment conditions

This assessment shall be performed at normal test conditions (see clause 5.1.2).

The UUT shall operate in its normal operational mode.

For a UUT which requires connection (wired or wireless) to an external device for its configuration, this external device shall be made available to allow the assessment to be performed. The details of this external device shall be described in the test report.

5.4.12.3 Assessment procedure

The UUT's configuration options shall be inspected on all interfaces that the equipment offers for its configuration.

All interfaces in this context includes those provided by any external controller (e.g. hardware-based, cloud-based, or centralized solutions). In these cases, all equipment required to inspect these interfaces shall be included in this assessment.

It shall be verified by visual inspection of all configuration interfaces whether there are any commands or settings available to the user which would allow the user to (re-)configure the equipment parameters listed in clause 4.2.10.2 so it is no longer conforming to the requirements of the present document.

The outcome of this assessment shall be recorded in the test report.

Annex A (informative): Relationship between the present document and the essential requirements of Directive 2014/53/EU

The present document has been prepared under the Commission's standardisation request C(2015) 5376 final [i.2] to provide one voluntary means of conforming to the essential requirements of Directive 2014/53/EU on the harmonisation of the laws of the Member States relating to the making available on the market of radio equipment and repealing Directive 1999/5/EC [i.1].

Once the present document is cited in the Official Journal of the European Union under that Directive, compliance with the normative clauses of the present document given in table A.1 confers, within the limits of the scope of the present document, a presumption of conformity with the corresponding essential requirements of that Directive and associated EFTA regulations.

Table A.1: Relationship between the present document and the essential requirements of Directive 2014/53/EU [i.1]

Harmonised Standard ETSI EN 301 893					
Requirement				Requirement Conditionality	
No	Description	Essential requirements of Directive	Clause(s) of the present document	U/C	Condition
1	Nominal centre frequency	3.2	4.2.1	U	
			B.2.2.1	U	
2	Nominal channel bandwidth and occupied bandwidth	3.2	4.2.2	U	
			B.2.2.2	U	
3	RF output power	3.2	4.2.3	U	
			B.2.2.3	U	
4	Power Spectral Density (PSD)	3.2	4.2.3	U	
			B.2.2.3	U	
5	Transmitter unwanted emissions outside the transmitter's operating bands	3.2	4.2.4.1	U	
			B.2.2.4.1	U	
6	Transmitter unwanted emissions within the transmitter's operating bands	3.2	4.2.4.2	U	
			B.2.2.4.2	U	
7	Receiver spurious emissions	3.2	4.2.5	U	
			B.2.2.5	U	
8	DFS: Channel Availability Check (CAC)	3.2	4.2.6.2.2	C	1) Not required for channels whose nominal channel bandwidth falls completely within sub-band 1 (see clause 4.2.6.1.2). 2) Not required for secondary devices with a maximum RF output power of less than or equal to 23 dBm EIRP unless these devices are used in fixed outdoor point-to-point or in fixed outdoor point-to-multipoint applications (see table D.2, note 2).
9	DFS: off-channel CAC	3.2	4.2.6.2.3	C	1) Not required for channels whose nominal channel bandwidth falls completely within sub-band 1 (see clause 4.2.6.1.2). 2) Not required for secondary devices with a maximum RF output power of less than or equal to 23 dBm EIRP unless these devices are used in fixed outdoor point-to-point or in fixed outdoor point-to-multipoint applications (see table D.2, note 2).

Harmonised Standard ETSI EN 301 893					
Requirement				Requirement Conditionality	
No	Description	Essential requirements of Directive	Clause(s) of the present document	U/C	Condition
10	DFS: in-service monitoring	3.2	4.2.6.2.4	C	1) Not required for channels whose nominal channel bandwidth falls completely within sub-band 1 (see clause 4.2.6.1.2). 2) Not required for secondary devices with a maximum RF output power of less than or equal to 23 dBm EIRP unless these devices are used in fixed outdoor point-to-point or in fixed outdoor point-to-multipoint applications (see table D.2, note 2).
11	DFS: channel shutdown	3.2	4.2.6.2.5	C	Not required for channels whose nominal channel bandwidth falls completely within sub-band 1 (see clause 4.2.6.1.2).
12	DFS: non-occupancy period	3.2	4.2.6.2.6	C	1) Not required for channels whose nominal channel bandwidth falls completely within sub-band 1 (see clause 4.2.6.1.2). 2) Not required for secondary devices with a maximum RF output power of less than or equal to 23 dBm EIRP unless these devices are used in fixed outdoor point-to-point or in fixed outdoor point-to-multipoint applications (see table D.2, note 2).
13	DFS: uniform spreading	3.2	4.2.6.2.7	C	1) Not required for channels whose nominal channel bandwidth falls completely within sub-band 1 (see clause 4.2.6.1.2). 2) Not required for secondary devices.
14	Adaptivity (channel access mechanism)	3.2	4.2.7.3.1	C	Applicable to FBE
			4.2.7.3.2	C	Applicable to LBE
			B.2.2.7.3.1	C	Applicable to FBE
			B.2.2.7.3.2	C	Applicable to LBE
15	Receiver blocking	3.2	4.2.8	U	
			B.2.2.8	U	
16	Adjacent channel selectivity	3.2	4.2.9	U	
			B.2.2.9	U	
17	User Access Restrictions (UAR)	3.2	4.2.10	U	
			B.2.2.10	U	
18	Country determination capability	3.2	B.2.2.11	C	Required for RLAN devices that are capable of applying an RF output power of greater than 25 mW EIRP in sub-band 4.

Key to columns:**Requirement:**

No A unique identifier for one row of the table which may be used to identify a requirement.

Description A textual reference to the requirement.

Essential requirements of Directive

Identification of article(s) defining the requirement in the Directive.

Clause(s) of the present document

Identification of clause(s) defining the requirement in the present document unless another document is referenced explicitly.

Requirement conditionality:

U/C	Indicates whether the requirement is unconditionally applicable (U) or is conditional upon the manufacturer's claimed functionality of the equipment (C).
Condition	Explains the conditions when the requirement is or is not applicable for a requirement which is classified "conditional".

Presumption of conformity stays valid only as long as a reference to the present document is maintained in the list published in the Official Journal of the European Union. Users of the present document should consult frequently the latest list published in the Official Journal of the European Union.

Other Union legislation may be applicable to the product(s) falling within the scope of the present document.

Annex B (normative): Equipment operating within the band 5 725 MHz to 5 850 MHz (sub-band 4)

B.1 Scope

This annex specifies technical characteristics and methods of measurement for Wireless Access Systems (WAS) including Radio Local Area Network (RLAN) equipment which are capable of operating in all or parts of the service frequency band given in table B.1.

Table B.1: Service frequency band

Sub-band 4	
Transmit	5 725 MHz to 5 850 MHz
Receive	5 725 MHz to 5 850 MHz

Operation in sub-band 4 or parts thereof is subject to national frequency usage conditions as discussed in ECC Report 330 [i.14]. It should be verified whether national frequency usage conditions permit operations in this sub-band.

This annex does not cover equipment used for fixed outdoor installations or installations in vehicles for devices operating in sub-band 4 above 25 mW EIRP, in accordance with the conclusions of ECC Report 330 [i.14] that recommends that such installations should not be allowed by countries introducing national frequency usage conditions.

B.2 Technical requirements for equipment operating in sub-band 4

B.2.1 Environmental profile

See clause 4.1.

B.2.2 Conformance requirements

B.2.2.1 Nominal centre frequency

B.2.2.1.1 General

See clause 4.2.1.1.

B.2.2.1.2 Definition

See clause 4.2.1.2.

B.2.2.1.3 Limits

The nominal centre frequencies (f_c) for channels whose nominal channel bandwidth falls partly or completely within sub-band 4 shall be defined by equation (B.1).

$$f_c = f_g \pm f_{c_offset}, \text{ with } g \text{ an integer index and } 28 \leq g \leq 33 \quad (\text{B.1})$$

Frequency values for f_g are given in table B.2.

Table B.2: Centre frequencies in sub-band 4

Channel index g	Centre frequency f_g (MHz)
28 (see note)	5 720
29	5 745
30	5 765
31	5 785
32	5 805
33	5 825
NOTE: Channel 28 is a channel defined in clause 4.2.1 for sub-band 3	

Operation on the channel with $g = 28$ is only permitted where operation in both sub-band 3 and sub-band 4 by RLAN devices is allowed by national frequency usage conditions.

An offset (f_{c_offset}) is permitted for each nominal centre frequency. The offset may be different for each nominal centre frequency, but it shall not be greater than 200 kHz. Where an offset is applied, the nominal centre frequencies used by the equipment shall be noted in the test report (see clause B.3.4.1, item a)).

The nominal centre frequency for any given channel shall be maintained within the range of $f_c \pm 0,002\%$.

Equipment may have simultaneous transmissions on more than one channel.

B.2.2.1.4 Conformance

Conformance tests as defined in clause B.3.4.2 shall be carried out.

B.2.2.2 Nominal channel bandwidth and occupied bandwidth

B.2.2.2.1 Definition

See clause 4.2.2.1.

B.2.2.2.2 Limits

See clause 4.2.2.2.

B.2.2.2.3 Conformance

Conformance tests as defined in clause B.3.4.3 shall be carried out to determine the occupied bandwidth.

B.2.2.3 RF output power, Transmit Power Control (TPC) and Power Spectral Density (PSD)

B.2.2.3.1 Definition

See clause 4.2.3.1.

B.2.2.3.2 Limits

B.2.2.3.2.1 General requirements

The limits in clause B.2.2.3.2.2 are applicable to the device as a whole and in any possible configuration. This means that the antenna gain of the integral or dedicated antenna shall be taken into account as well as the additional (beamforming) gain in case of smart antenna systems (devices with multiple transmit chains).

B.2.2.3.2.2 Limits for RF output power and PSD

The maximum RF output power $P_{H,4}$ and the PSD in sub-band 4 shall not exceed the limits given in table B.3 for that sub-band. If the device uses TPC, $P_{H,4}$ is the RF output power in sub-band 4 at the highest power level of the TPC range in sub-band 4. In case of multiple (adjacent or non-adjacent) channels, the limits for the maximum RF output power and the PSD apply per sub-band.

Table B.3: RF output power and PSD limits

Sub-band	RF output power limit (dBm)		PSD limit (dBm/MHz)	
	with TPC (see note)	without TPC	with TPC	without TPC
Sub-band 4	23	20	10	7
NOTE: If TPC is used, the RF output power in sub-band 4 at the lowest power level of the TPC range in sub-band 4 ($P_{L,4}$) shall be at least 6 dB less than the applicable RF output power limit with TPC.				

B.2.2.3.3 Conformance

Conformance tests as defined in clause B.3.4.4 shall be carried out.

B.2.2.4 Transmitter unwanted emissions

B.2.2.4.1 Transmitter unwanted emissions outside the transmitter's operating bands

B.2.2.4.1.1 Definition

See clause 4.2.4.1.1.

B.2.2.4.1.2 Limits

See clause 4.2.4.1.2.

B.2.2.4.1.3 Conformance

Conformance tests as defined in clause B.3.4.5 shall be carried out.

B.2.2.4.2 Transmitter unwanted emissions within the transmitter's operating bands

B.2.2.4.2.1 Definition

See clause 4.2.4.2.1.

B.2.2.4.2.2 Limits

See clause 4.2.4.2.2.

B.2.2.4.2.3 Conformance

Conformance tests as defined in clause B.3.4.6 shall be carried out.

B.2.2.5 Receiver spurious emissions

B.2.2.5.1 Definition

See clause 4.2.5.1.

B.2.2.5.2 Limits

See clause 4.2.5.2.

B.2.2.5.3 Conformance

Conformance tests as defined in clause B.3.4.7 shall be carried out.

B.2.2.6 Void

B.2.2.7 Adaptivity (channel access mechanism)

B.2.2.7.1 Applicability

See clause 4.2.7.1.

B.2.2.7.2 Definition

See clause 4.2.7.2.

B.2.2.7.3 Limits

B.2.2.7.3.1 Frame Based Equipment (FBE)

B.2.2.7.3.1.1 Introduction (FBE)

See clause 4.2.7.3.1.1.

B.2.2.7.3.1.2 Device types (FBE)

See clause 4.2.7.3.1.2.

B.2.2.7.3.1.3 Multi-channel operation (FBE)

Frame Based Equipment (FBE) being capable of simultaneous transmissions in adjacent or non-adjacent operating channels (see clause B.2.2.1) may use any combination/grouping of channels out of the list of channels identified by the nominal centre frequencies provided in clause B.2.2.1, if it satisfies the channel access requirements (channel access mechanism) for an initiating device as described in clause B.2.2.7.3.1.5 on each such operating channel.

For equipment also capable of operating in sub-band 1, sub-band 2 or sub-band 3, the combination/grouping of channels may include channels identified by the nominal centre frequencies provided in clause 4.2.1. The same channel access requirements apply.

B.2.2.7.3.1.4 Energy Detection Threshold (EDT) (FBE)

See clause 4.2.7.3.1.4.

B.2.2.7.3.1.5 Initiating device channel access mechanism (FBE)

See clause 4.2.7.3.1.5.

B.2.2.7.3.1.6 Responding device channel access mechanism (FBE)

See clause 4.2.7.3.1.6.

B.2.2.7.3.2 Load Based Equipment (LBE)

B.2.2.7.3.2.1 Introduction (LBE)

See clause 4.2.7.3.2.1.

B.2.2.7.3.2.2 Device types (LBE)

See clause 4.2.7.3.2.2.

B.2.2.7.3.2.3 Multi-channel operation (LBE)

Load Based Equipment (LBE) being capable of simultaneous transmissions in adjacent or non-adjacent channels (see clause B.2.2.1) shall implement either of the following options:

Option 1: LBE may use any combination/grouping of channels out of the list of channels identified by the nominal centre frequencies provided in clause B.2.2.1, if it satisfies the channel access requirements (channel access mechanism) for an initiating device as described in clause B.2.2.7.3.2.6 on each such operating channel.

For equipment also capable of operating in sub-band 1, sub-band 2 or sub-band 3, the combination/grouping of channels may include channels identified by the nominal centre frequencies provided in clause 4.2.1. The same channel access requirements apply.

Option 2: Figure B.1 defines groups of adjacent channels with a total bandwidth of 40 MHz or 80 MHz (see also clause B.2.2.1.3 for the channel number). LBE that uses a combination/grouping of adjacent channels that is a subset of the 40 MHz or 80 MHz groups of adjacent channels in figure B.1 may transmit on any of the operating channels, if:

- the equipment satisfies the channel access requirements (channel access mechanism) for an initiating device as defined in clause B.2.2.7.3.2.6 on one of the operating channels (primary operating channel); and
- the equipment performs a Clear Channel Assessment (CCA) of at least 23 μ s immediately before the intended transmissions on each of the other operating channels on which transmissions are intended, and no energy was detected with a level above the Energy Detection Threshold (EDT) defined in clause B.2.2.7.3.2.5.

The choice of the primary operating channel shall follow one of the following procedures:

- The primary channel is chosen uniformly randomly whenever the Contention Window (CW) corresponding to a completed transmission on the current primary operating channel is set to its minimum value (CW_{min}). For this procedure, a CW is maintained for each priority class (see clause B.2.2.7.3.2.4) within each operating channel from the group of adjacent channels.
- The primary operating channel is arbitrarily determined and not changed more than once per second.

For equipment also capable of operating in sub-band 1, sub-band 2 or sub-band 3, the combination/grouping of channels may include groups of adjacent channels of 40 MHz, 80 MHz or 160 MHz defined in figure 6 in clause 4.2.7.3.2.3. The same channel access requirements apply.

The group of adjacent channels of 40 MHz or 80 MHz or, if applicable, 160 MHz that the combination/grouping of channels is a subset of shall not be changed more than once per second.

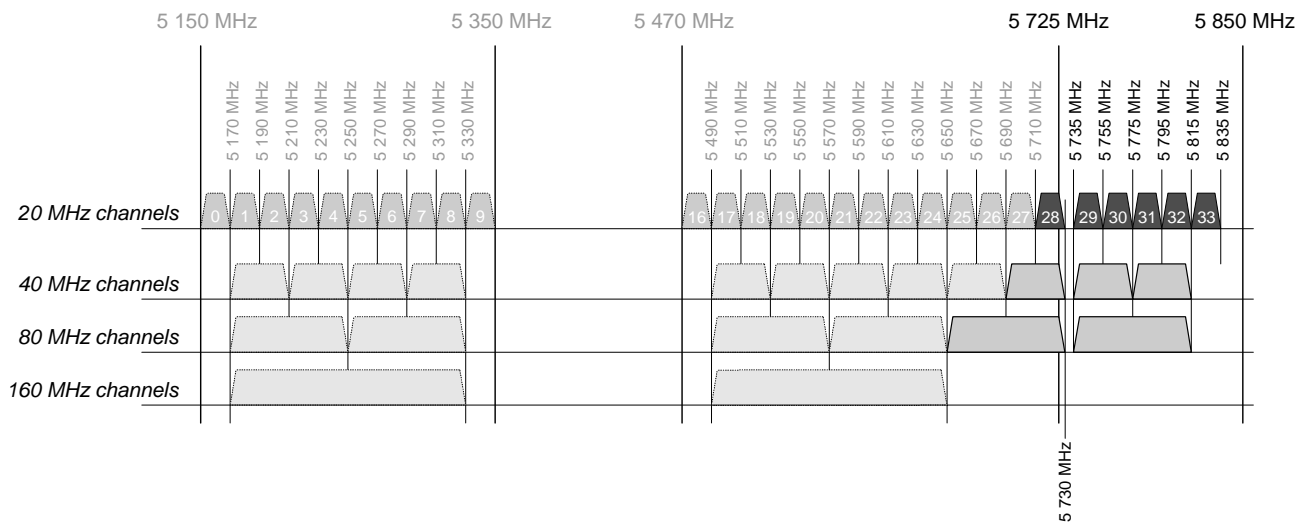

Figure B.1: Groups of adjacent channels for option 2

B.2.2.7.3.2.4 Priority classes (LBE)

See clause 4.2.7.3.2.4.

B.2.2.7.3.2.5 Energy Detection Threshold (EDT) (LBE)

See clause 4.2.7.3.2.5.

B.2.2.7.3.2.6 Initiating device channel access mechanism (LBE)

See clause 4.2.7.3.2.6.

B.2.2.7.3.2.7 Responding device channel access mechanism (LBE)

See clause 4.2.7.3.2.7.

B.2.2.7.3.3 Short Control Signalling (SCS) transmissions (FBE and LBE)

See clause 4.2.7.3.3.

B.2.2.7.4 Conformance

Conformance tests as defined in clause B.3.4.9 shall be carried out.

B.2.2.8 Receiver blocking

B.2.2.8.1 Applicability

See clause 4.2.8.1.

B.2.2.8.2 Definition

See clause 4.2.8.2.

B.2.2.8.3 Performance criteria

See clause 4.2.8.3.

B.2.2.8.4 Limits

See clause 4.2.8.4.

B.2.2.8.5 Conformance

Conformance tests as defined in clause B.3.4.10 shall be carried out.

B.2.2.9 Adjacent channel selectivity

B.2.2.9.1 Applicability

See clause 4.2.9.1.

B.2.2.9.2 Definition

See clause 4.2.9.2.

B.2.2.9.3 Performance criteria

See clause 4.2.9.3.

B.2.2.9.4 Limits

See clause 4.2.9.4.

B.2.2.9.5 Conformance

Conformance test as defined in clause B.3.4.11 shall be carried out.

B.2.2.10 User Access Restrictions (UAR)

B.2.2.10.1 Definition

See clause 4.2.10.1.

B.2.2.10.2 Requirements

The equipment shall be so constructed that settings (hardware and/or software) are not accessible to the user if changing those settings results in the equipment no longer being conformant to the following:

- the adaptivity requirements as specified in clause B.2.2.7, in particular the thresholds as defined or referred to in clause B.2.2.7.3.1.4 and in clause B.2.2.7.3.2.5.
- the country determination capability requirements as specified in clause B.2.2.11.

B.2.2.10.3 Conformance

The UUT shall be deemed to conform to the UAR requirements if the UUT does not provide options that allow automatic or manual adjustment of limits and/or requirements for those parameters identified in clause B.2.2.10.2.

The conformance assessment procedure as defined in clause B.3.4.12 shall be carried out.

B.2.2.11 Country determination capability

B.2.2.11.1 Definition

Country determination capability is a feature of an RLAN device which enables the device to be configured automatically according to the regulatory requirements applicable at the location where the device operates.

This includes implementations where the country determination capability is present in the RLAN device itself or in external equipment associated with the device.

Details of which CEPT countries permit use of WAS/RLAN in sub-band 4 or parts thereof are found in ECO Report 06 [i.15].

B.2.2.11.2 Applicability

Requirements in clause B.2.2.11 shall apply to RLAN devices that are capable of applying an RF output power of greater than 25 mW EIRP in sub-band 4.

B.2.2.11.3 Requirements

Before the RLAN device starts transmitting in sub-band 4 with an RF output power of greater than 25 mW EIRP, the RLAN device shall use the country determination capability to identify the country where it is located. The RLAN device shall not transmit in sub-band 4 with an RF output power of greater than 25 mW EIRP, if any of the following applies:

- The RLAN device is in a country where regulatory requirements prohibit transmitting in sub-band 4 with an RF output power of greater than 25 mW EIRP.
- The RLAN device cannot identify the country where the RLAN device is located.

B.2.2.11.4 Conformance

Conformance tests as defined in clause B.3.4.13 shall be carried out.

B.3 Testing for compliance with technical requirements

B.3.1 Environmental conditions for testing

See clause 5.1.

B.3.2 Interpretation of the measurement results

See clause 5.2.

B.3.3 Definition of other test conditions

B.3.3.1 Test sequences and traffic load

See clause 5.3.1.

B.3.3.2 Test channels

Unless otherwise stated in the test procedures for essential radio test suites, the channels (and nominal channel bandwidths) on which the essential radio test suites contained in this annex shall be performed are given in table B.4. The channel identifiers have the format $C_{sb}f$ in which context C denotes 'channel', sb denotes the sub-band that the test channel is applicable to (where 'gen' denotes that the test channel is not sub-band dependent), and f is an index.

Table B.4: Test channels for sub-band 4

Test	Clause	Test channel
Nominal centre frequency (see note 1)	B.3.4.2	C ₄₁
Occupied bandwidth	B.3.4.3	C ₄₁
RF output power, Power Spectral Density (PSD)	B.3.4.4	C ₄₂ , C ₄₃
Transmit Power Control (TPC) (see note 1)	B.3.4.4	C ₄₂ , C ₄₃
Transmitter unwanted emissions outside the transmitter's operating bands (see note 1)	B.3.4.5	C ₄₁
Transmitter unwanted emissions within the transmitter's operating bands (for single-channel operation)	B.3.4.6	C ₄₂ , C ₄₃
Transmitter unwanted emissions within the transmitter's operating bands (for multi-channel operation in adjacent channels) (see note 2 for multi-channel operation in non-adjacent channels)	B.3.4.6	C _{gen1} , C _{gen2} (see note 3 for channels in the group of adjacent channels not used for transmission)
Receiver spurious emissions (see note 1)	B.3.4.7	C ₄₁
Adaptivity (channel access mechanism)	B.3.4.9	C _{gen3}
Receiver blocking	B.3.4.10	C ₄₁
Adjacent channel selectivity	B.3.4.11	C ₄₁
Test channel definitions:		
C ₄₁ :	One channel from the channel plan in sub-band 4. For occupied bandwidth, testing shall be repeated for every nominal channel bandwidth within sub-band 4. For receiver blocking and adjacent channel selectivity, it is sufficient to only perform this test using the lowest nominal channel bandwidth.	
C ₄₂ :	The lowest channel for every channel plan in sub-band 4. For PSD testing, it is sufficient to only perform this test using the lowest nominal channel bandwidth. For unwanted emissions testing, it is sufficient to only perform this test using a nominal channel bandwidth of 20 MHz.	
C ₄₃ :	The highest channel for every channel plan in sub-band 4. For PSD testing, it is sufficient to only perform this test using the lowest nominal channel bandwidth. For unwanted emissions testing, it is sufficient to only perform this test using a nominal channel bandwidth of 20 MHz.	
C _{gen1} :	See definition in table 10.	
C _{gen2} :	See definition in table 10.	
C _{gen3} :	See definition in table 10.	
NOTE 1:	In case of more than one channel plan, testing of these specific requirements needs only to be performed using one of the channel plans.	
NOTE 2:	For multi-channel operation in non-adjacent channels, each group of adjacent channels shall be tested individually with the specified test channels.	
NOTE 3:	If one or more of the channels in the group of adjacent channels might not be used for transmission, channel configurations suitable to verify each of the supported channel edge masks as shown in figure 2, figure 3 and figure 4 shall be tested in addition.	

B.3.3.3 Antennas

See clause 5.3.3.

B.3.3.4 Presentation of equipment

See clause 5.3.4.

B.3.3.5 Measurement methods

See clause 5.3.5.

B.3.4 Essential radio test suites

B.3.4.1 Product information

The information requested in this clause shall be included in the test report. The form included in clause H.3 can be used for this purpose. This information is required in order to carry out the test suites and/or to declare compliance to technical requirements (e.g. technical requirements for which no compliance test is included in the present document):

- a) See clause 5.4.1, item a).
- b) If the equipment supports multi-channel operation (see clause B.2.2.7.3.1.3 and clause B.2.2.7.3.2.3):
 - the maximum number of channels that are supported for multi-channel operation;
 - whether or not it is possible that these channels are in different sub-bands;
 - whether the equipment supports a multi-channel configuration as specified in clause 4.2.4.2.2.2 and which channel configurations are supported;
 - whether the equipment supports a multi-channel configuration as specified in clause 4.2.4.2.2.3 and which combination of channels are supported;
 - where there may be channels not used for transmission in multi-channel operation within a group of adjacent channels, a list of channel edge masks (i.e. figure 2, figure 3 and figure 4 from clause 4.2.4.2.2.2) supported by the equipment;
 - for LBE, whether it supports option 1 and/or option 2 for multi-channel operation (see clause B.2.2.7.3.2.3);
 - for LBE implementing option 1, the number of channels used for multi-channel operation when performing the test described in clause 5.4.9.3.2.3.1.
- c) See clause 5.4.1, item c).
- d) See clause 5.4.1, item d).
- e) See clause 5.4.1, item e).
- f) For devices with a TPC feature, for each TPC range:
 - the applicable operating frequency range(s);
 - the lowest and highest transmitter output power level (or lowest and highest EIRP level in case of integrated antenna equipment);
 - if the equipment supports simultaneous transmissions in multiple sub-bands or supports different transmitter operating modes (e.g. in case of smart antenna systems) (see clause 5.3.3.2), the lowest and highest transmitter output power or EIRP level for each of the sub-bands, and each of the transmitter operating modes;
 - the intended antenna assembly or antenna assemblies, the corresponding maximum gain(s) G , the resulting RF output power values (taking also into account the beamforming gain Y if applicable).

- g) For devices without a TPC feature:
- the applicable operating frequency range(s);
 - the maximum transmitter output power level (or maximum EIRP level in case of integrated antenna equipment);
 - if the equipment supports simultaneous transmissions in multiple sub-bands or supports different transmitter operating modes (e.g. in case of smart antenna systems) (see clause 5.3.3.2), the maximum transmitter output power or EIRP level for each of the sub-bands, and each of the transmitter operating modes;
 - the intended antenna assembly or antenna assemblies, the corresponding maximum gain(s) G , the resulting RF output power values (taking also into account the beamforming gain Y if applicable).
- h) Void.
- i) Void.
- j) Void.
- k) With regards to UAR, a confirmation that the equipment is constructed to conform to the requirements contained in clause B.2.2.10.
- l) See clause 5.4.1, item l).
- m) See clause 5.4.1, item m).
- n) See clause 5.4.1, item n).
- o) See clause 5.4.1, item o).
- p) See clause 5.4.1, item p).
- q) See clause 5.4.1, item q).
- r) See clause 5.4.1, item r).
- s) See clause 5.4.1, item s).
- t) See clause 5.4.1, item t).
- u) See clause 5.4.1, item u).
- v) Whether the equipment supports a country determination capability as defined in clause B.2.2.11.

B.3.4.2 Nominal centre frequency

See clause 5.4.2.

B.3.4.3 Occupied bandwidth

See clause 5.4.3.

B.3.4.4 RF output power, Transmit Power Control (TPC) and Power Spectral Density (PSD)

B.3.4.4.1 Test conditions

See clause 5.4.4.1.

B.3.4.4.2 Test methods

B.3.4.4.2.1 Conducted measurement

B.3.4.4.2.1.1 RF output power at the highest power level

B.3.4.4.2.1.1.1 Additional test conditions

These measurements shall be performed under both normal and extreme test conditions (see clause 5.1.2 and clause 5.1.3).

The UUT shall be configured to operate at:

- the highest transmitter output power level of the TPC range; or
- the maximum transmitter output power level in case the equipment has no TPC feature.

Procedure 1 (see clause B.3.4.4.2.1.1.2) shall be performed for equipment that operates only in one sub-band or which is capable of operating in multiple sub-bands simultaneously but, for the purpose of the testing, can be configured to:

- operate in a continuous transmit mode or with a constant duty cycle (x) (e.g. FBE); and
- operate only within one sub-band.

Procedure 2 (see clause B.3.4.4.2.1.1.3) shall be performed for equipment that is either:

- capable of operating in more than one sub-band but not simultaneously; or
- capable of operating in multiple sub-bands simultaneously but which, for the purpose of the testing, can be configured to transmit only in one sub-band.

Procedure 3 (see clause B.3.4.4.2.1.1.4) shall be performed for equipment capable of operating in multiple sub-bands simultaneously (including sub-band 4) but which cannot be configured to transmit only in one sub-band.

B.3.4.4.2.1.1.2 Procedure 1

See clause 5.4.4.2.1.1.2.

B.3.4.4.2.1.1.3 Procedure 2

See clause 5.4.4.2.1.1.3.

B.3.4.4.2.1.1.4 Procedure 3

This procedure first measures the peak power in each sub-band separately, then measures the peak-to-mean power ratio for the overall transmission and uses this to calculate the RF output power in each sub-band separately using the measured values for peak power.

The test procedure shall be as follows:

Step 1: Measuring the total peak power within sub-band 1

See step 1 in clause 5.4.4.2.1.1.4.

Step 2: Measuring the total peak power within sub-band 2

See step 2 in clause 5.4.4.2.1.1.4.

Step 3: Measuring the total peak power within sub-band 3 (if applicable including transmissions between 5 725 MHz and 5 730 MHz)

See step 3 in clause 5.4.4.2.1.1.4.

Step 4: Measuring the total peak power within sub-band 4 (if applicable excluding transmissions between 5 725 MHz and 5 730 MHz)

- Change the start frequency to 5 675 MHz and the stop frequency to 5 900 MHz.
If the channel plan includes a channel with a nominal centre frequency within sub-band 3 whose nominal channel bandwidth extends into sub-band 4, adjust the start frequency accordingly.
- Ensure that the noise floor of the spectrum analyser is at least 30 dB below the peak of the power envelope. If this is not possible (e.g. radiated measurements), reduce the bandwidth of the channel power measurement function to avoid the noise floor influencing the measurement result.
- When the trace is complete, use the channel power measurement function to measure the total peak power of all transmissions within sub-band 4.
- For conducted measurements on devices with multiple transmit chains, repeat the procedure in step 4 for each of the active transmit chains. Sum the results to calculate the total peak power of the transmissions within sub-band 4.

NOTE: If the channel plan includes a channel with a nominal centre frequency within sub-band 3 whose nominal channel bandwidth extends into sub-band 4, the total peak power may exclude transmissions within the band 5 725 MHz to 5 730 MHz as they were measured in step 3.

Step 5: Calculating the total peak power

- Calculate the total peak power by summing the measured values in step 1, step 2, step 3 and step 4.

Modern spectrum analysers may be able to measure the peak power in multiple sub-bands in one measurement in which case step 1 to step 4 can be performed in any combination.

Step 6: Measuring the total mean output power

See step 5 in clause 5.4.4.2.1.1.4.

Step 7: Calculating the peak-to-mean power ratio

- Using the value for total peak power calculated in step 5 and the highest value for total mean output power measured in step 6, calculate the peak-to-mean power ratio in dB.

Step 8: Calculating the RF output power at the highest power level $P_{H, sb}$ for each sub-band

- Calculate the RF output power at the highest power level $P_{H, sb}$ for each of the sub-bands from the peak-to-mean power ratio obtained in step 7 and the measured values for peak power in each of the sub-bands (see step 1 to step 4). These values (values A in dBm) will be used for RF output power calculations:
 - Add the antenna assembly gain G in dBi of the individual antenna element.
 - If applicable, add the additional beamforming gain Y in dB.
 - If more than one antenna assembly is intended for this power setting or TPC range, use the maximum overall antenna gain (G or G + Y).

- For each sub-band, calculate $P_{H, sb}$ using equation (B.2):

$$P_{H, sb} = A + G + Y \text{ (dBm)}. \quad (\text{B.2})$$

- Compare the values for $P_{H, sb}$ to the applicable limits and record them in the test report.

B.3.4.4.2.1.2 RF output power at the lowest power level of the TPC range

B.3.4.4.2.1.2.1 Additional test conditions

This test is only required for equipment with a TPC feature.

These measurements shall be performed under both normal and extreme test conditions (see clause 5.1.2 and clause 5.1.3).

The UUT shall be configured to operate at the lowest transmitter output power level of the TPC range.

Procedure 1 (see clause B.3.4.4.2.1.2.2) shall be performed for equipment that operates only in one sub-band or which is capable of operating in multiple sub-bands simultaneously but, for the purpose of the testing, can be configured to:

- operate in a continuous transmit mode or with a constant duty cycle (x) (e.g. FBE); and
- operate only within one sub-band.

Procedure 2 (see clause B.3.4.4.2.1.2.3) shall be performed for equipment that is either:

- capable of operating in more than one sub-band but not simultaneously; or
- capable of operating in multiple sub-bands simultaneously but which, for the purpose of the testing, can be configured to transmit only in one sub-band.

Procedure 3 (see clause B.3.4.4.2.1.2.4) shall be performed for equipment capable of operating in multiple sub-bands simultaneously (including sub-band 4) but which cannot be configured to transmit only in one sub-band.

B.3.4.4.2.1.2.2 Procedure 1

See clause 5.4.4.2.1.2.2.

B.3.4.4.2.1.2.3 Procedure 2

See clause 5.4.4.2.1.2.3.

B.3.4.4.2.1.2.4 Procedure 3

This procedure first measures the peak power in each sub-band separately, then measures the peak-to-mean power ratio for the overall transmission and uses this to calculate the RF output power in each sub-band separately using the measured values for peak power.

The test procedure shall be as follows:

Step 1 to step 7:

- See step 1 to step 7 in clause B.3.4.4.2.1.1.4.

Step 8: Calculating the RF output power at the lowest power level of the TPC range $P_{L, sb}$ for each sub-band

- Calculate the RF output power at the lowest power level of the TPC range $P_{L, sb}$ for each of the sub-bands from the peak-to-mean power ratio obtained in step 7 and the measured values for peak power in each of the sub-bands (see step 1 to step 4). These values (values A in dBm) will be used for RF output power calculations:
 - Add the antenna assembly gain G in dBi of the individual antenna element.
 - If applicable, add the additional beamforming gain Y in dB.
 - If more than one antenna assembly is intended for this TPC range, use the maximum overall antenna gain (G or G + Y).
- For each sub-band, calculate $P_{L, sb}$ using equation (B.3):

$$P_{L, sb} = A + G + Y \text{ (dBm)} \quad (\text{B.3})$$

- Compare the values for $P_{L, sb}$ to the applicable limit and record them in the test report.

B.3.4.4.2.1.3 Power Spectral Density (PSD)

B.3.4.4.2.1.3.1 Additional test conditions

These measurements shall only be performed at normal test conditions (see clause 5.1.2).

The UUT shall be configured to operate at the lowest nominal channel bandwidth with:

- the highest transmitter output power level of its TPC range; or
- the maximum transmitter output power level in case the equipment has no TPC feature.

Procedure 1 (see clause B.3.4.4.2.1.3.2) shall be performed for equipment that can be configured to operate in a continuous transmit mode or with a constant duty cycle (x) (e.g. FBE).

Procedure 2 (see clause B.3.4.4.2.1.3.3) shall be performed for equipment that has non-continuous transmissions and cannot be configured to transmit continuously or with a constant duty cycle.

B.3.4.4.2.1.3.2 Procedure 1

See clause 5.4.4.2.1.3.2.

B.3.4.4.2.1.3.3 Procedure 2

For devices capable of operating in multiple sub-bands simultaneously (including sub-band 4), the PSD in each of the sub-bands shall be measured separately and compared with the applicable limits.

The test procedure for measuring the PSD in a given sub-band shall be as follows:

Step 1:

- Connect the UUT to the spectrum analyser and use the following settings:
 - Start frequency: lower band edge of applicable sub-band (i.e. 5 150 MHz, 5 250 MHz, 5 470 MHz or 5 725 MHz)
 - Stop frequency: upper band edge of applicable sub-band (i.e. 5 250 MHz, 5 350 MHz, 5 725 MHz or 5 850 MHz)
 - RBW: 10 kHz
 - VBW: 30 kHz
 - Sweep points:
 - > 10 000 (for sub-band 1)
 - > 10 000 (for sub-band 2)
 - > 25 500 (for sub-band 3)
 - > 12 500 (for sub-band 4)

For spectrum analysers not supporting this number of sweep points, the frequency band may be segmented.
 - Detector mode: RMS
 - Trace mode: Max Hold
 - Sweep time: 30 s
- When measuring the PSD within sub-band 3 and the channel plan includes a channel with a nominal centre frequency within sub-band 3 whose nominal channel bandwidth extends into sub-band 4, adjust the stop frequency accordingly. Adjust the sweep points to cover at least 100 points per MHz of measurement bandwidth.

- When measuring the PSD within sub-band 4 and the channel plan includes a channel with a nominal centre frequency within sub-band 3 whose nominal channel bandwidth extends into sub-band 4, adjust the start frequency accordingly. Adjust the sweep points to cover at least 100 points per MHz of measurement bandwidth.
- For non-continuous signals, wait for the trace to be stabilized. Save the (trace) data set to a file.

Step 2:

- For conducted measurements on smart antenna systems using either operating mode 2 or operating mode 3 (see clause 5.3.3.2), repeat the measurement for each of the transmit ports. For each sampling point (frequency domain), add up the coincident power values (in mW) for the different transmit chains and use this as the new data set.

Step 3:

- Add up the values of power for all the samples in the file using equation (B.4):

$$P_{\text{sum}} = \sum_{n=1}^k P_{\text{sample}}(n) \quad (\text{B.4})$$

with k the total number of samples and n the actual sample number.

Step 4:

- Normalize the individual values for power (in dBm) so that the sum is equal to the RF output power at the highest power level $P_{\text{H,sb}}$ measured in clause B.3.4.4.2.1.1 for this sub-band. Equations (B.5) and (B.6) may be used:

$$C_{\text{corr}} = P_{\text{sum}} - P_{\text{H,sb}} \quad (\text{B.5})$$

$$P_{\text{samplecorr}}(n) = P_{\text{sample}}(n) - C_{\text{corr}} \quad (\text{B.6})$$

with n the actual sample number.

Step 5:

- Starting from the first sample $P_{\text{samplecorr}}(n)$ in the file (lowest frequency), add up the power (in mW) of the following samples representing a 1 MHz segment and record the results for power and position (i.e. sample 1 to sample 100). This is the PSD for the first 1 MHz segment. Save this value.

Step 6:

- Shift the start point of the samples added up in step 5 by one sample and repeat the procedure in step 5 (i.e. sample 2 to sample 101).

Step 7:

- Repeat step 6 until the end of the data set and save the radiated PSD values for each of the 1 MHz segments.

From all the saved results, the highest value is the maximum PSD for the UUT.

Step 8:

- Compare the values for the maximum PSD obtained in step 7 with the applicable limits and record them in the test report.

B.3.4.4.2.2 Radiated measurement

When performing radiated measurements on a UUT with a directional antenna (including smart antenna systems and systems capable of beamforming), the UUT shall be configured/positioned for maximum RF output power towards the measurement antenna and in the horizontal plane. This configuration/position shall be recorded for future use (see clause B.3.4.10, clause B.3.4.11, clause F.5.2.4, clause F.5.3.4, clause F.5.4.4).

A test site as described in annex E and using the applicable measurement procedures as described in annex F shall be used.

The test procedure is further as described under clause B.3.4.4.2.1. However, the following shall be taken into account when performing radiated measurements.

For measuring RF output power:

- When using procedure 1 as in clause B.3.4.4.2.1.1.2 and clause B.3.4.4.2.1.2.2, the values G and Y used in step 3 shall be ignored.
- When using procedure 2 as in clause B.3.4.4.2.1.1.3 and clause B.3.4.4.2.1.2.3, the values G and Y used in step 5 shall be ignored.
- When using procedure 3 as in clause B.3.4.4.2.1.1.4 and clause B.3.4.4.2.1.2.4, the values G and Y used in step 8 shall be ignored.

For measuring PSD:

- When using procedure 1 as in clause B.3.4.4.2.1.3.2, the values G and Y used in step 5 shall be ignored.

For measuring the RF output power at the highest and lowest power level, it is likely that a radiated measurement would be performed using a spectrum analyser or measurement receiver rather than a wide band power sensor. If this is the case and if the resolution bandwidth capability of the measurement device is narrower than the occupied bandwidth of the UUT signal measured, then the method of measurement shall be documented in the test report.

B.3.4.4.2.3 Test fixture measurement

The test setup and the normalization procedure as described in clause E.4.4 shall be used with the measuring device attached to the fixture.

The test procedure is further as described under clause B.3.4.4.2.1.

B.3.4.5 Transmitter unwanted emissions outside the transmitter's operating bands

See clause 5.4.5.

B.3.4.6 Transmitter unwanted emissions within the transmitter's operating bands

See clause 5.4.6.

B.3.4.7 Receiver spurious emissions

See clause 5.4.7.

B.3.4.8 Void

B.3.4.9 Adaptivity (channel access mechanism)

See clause 5.4.9.

B.3.4.10 Receiver blocking

See clause 5.4.10.

B.3.4.11 Adjacent channel selectivity

See clause 5.4.11.

B.3.4.12 User Access Restrictions (UAR)

See clause 5.4.12.

B.3.4.13 Country determination capability

B.3.4.13.1 Test conditions

The measurements shall be performed under normal test conditions (see clause 5.1.2). During the test, the UUT shall connect to a companion device. A traffic source shall be attached to the UUT. The traffic source shall be configured so that it exceeds the UUT's theoretical radio performance. The traffic source shall fill the UUT's buffers causing the UUT to always have transmissions queued (full buffer condition) towards the companion device.

B.3.4.13.2 Test method

These measurements require a method of generating location information which shall be provided for all the geographical areas covered by the regulatory domains supported by the UUT and covered by the present document.

NOTE: This might include provisions of wireless internet access, or physical connection, or access to a cellular network, or any other means.

The following test method shall be applied:

Step 1:

- Position the UUT in a Fully Anechoic Room (FAR), a Semi Anechoic Room (SAR) or in an environment which is free from radio frequency signals that are not specified in the test procedure.

Step 2:

- Randomly select a channel C in sub-band 4.
- Present the UUT with location information associated with a location at which operation on channel C is not permitted with an RF output power of greater than 25 mW EIRP.
- Configure the UUT to operate on channel C.
- Verify that the UUT does not operate in sub-band 4 with an RF output power of greater than 25 mW EIRP.

Step 3:

- Power-off the UUT.

Step 4:

- Change the location information presented to the UUT to a location at which operation on channel C is permitted with an RF output power of greater than 25 mW EIRP.

Step 5:

- Power-on the UUT.

Step 6:

- Verify that the UUT starts transmissions on channel C.

Step 7:

- Power-off the UUT.

Step 8:

- Stop the presentation of location information.

Step 9:

- Power-on the UUT.

Step 10:

- Verify that the UUT does not operate in sub-band 4 with an RF output power of greater than 25 mW EIRP.

The test shall be passed if the UUT conducts step 1 to step 10 without error.

Annex C (informative): Maximum measurement uncertainties

The measurements described in the present document are based on the following assumptions:

- the measured value related to the corresponding limit is used to decide whether an equipment meets the requirements of the present document;
- the value of the measurement uncertainty for the measurement of each parameter is included in the test report.

Table C.1 shows the recommended values for the maximum measurement uncertainty figures.

Table C.1: Maximum measurement uncertainty figures

Parameter	Uncertainty
Radio frequency	$\pm 0,001$ % (see note)
RF power, conducted	$\pm 1,5$ dB
RF power, radiated	± 6 dB
Generated signal levels, conducted	± 3 dB
Generated signal levels, radiated	± 6 dB
Spurious emissions, conducted	± 3 dB
Spurious emissions, radiated	± 6 dB
Humidity	± 5 %
Temperature	± 2 °C
Time	± 10 %
NOTE: 0,001 % is equal to 10 parts-per-million.	

Annex D (normative): DFS parameters

Table D.1 to table D.5 contain the values and limits for the DFS specific parameters referred to in clause 4.2.6 and clause 5.4.8.

Figure D.1 shows a single burst for a radar test signal using a constant Pulse Repetition Frequency (PRF) which is representative for radar test signal 1 to radar test signal 4 from table D.4. Figure D.2 shows multiple bursts of these same test signals.

Figure D.3 shows a single burst of a pulse-based staggered PRF radar test signal. Figure D.4 shows a single burst of a packet-based staggered PRF radar test signal which is representative for radar test signal 5 and radar test signal 6 from table D.4. Figure D.5 shows multiple bursts of these same test signals.

Table D.1: DFS requirement values

Parameter	Value
Channel Availability Check (CAC) time	60 s (see note 1)
Minimum off-channel CAC time	6 minutes (see note 2)
Maximum off-channel CAC time	4 hours (see note 2)
Channel move time	10 s
Channel closing transmission time	1 s
Non-occupancy period	30 minutes
NOTE 1: For channels whose nominal channel bandwidth falls completely or partly within the band 5 600 MHz to 5 650 MHz, the CAC time shall be 10 minutes.	
NOTE 2: For channels whose nominal channel bandwidth falls completely or partly within the band 5 600 MHz to 5 650 MHz, the off-channel CAC time shall be within the range 1 hour to 24 hours.	

Table D.2: Radar detection threshold

Power Spectral Density (PSD) (dBm/MHz)	Radar detection threshold (dBm) (see note 1 and note 2)
10	-62
NOTE 1: This is the level at the input of the receiver of an RLAN device with a maximum PSD of 10 dBm/MHz and assuming a 0 dBi receive antenna. For devices employing a different PSD and/or a different receive antenna assembly gain G (dBi), the radar detection threshold at the receiver input follows the following relationship: $\text{radar detection threshold (dBm)} = -62 + 10 \cdot \text{PSD (dBm/MHz)} + G \text{ (dBi)}$ However, the radar detection threshold shall not be less than -64 dBm assuming a 0 dBi receive antenna gain.	
NOTE 2: Secondary devices with a maximum RF output power of less than or equal to 23 dBm EIRP do not have to implement radar detection unless these devices are used in fixed outdoor point-to-point or fixed outdoor point-to-multipoint applications (see clause 4.2.6.1.3).	

Table D.3: Parameters of the reference DFS test signal

Pulse width W (μ s)	PRF (PPS)	Pulses Per Burst (PPB)
1	700	18

Table D.4: Parameters of radar test signals

Radar test signal (see note 1 to note 3)	Pulse width W (μ s)		PRF (PPS)		Number of different PRFs	PPB for each PRF (see note 5)
	Min	Max	Min	Max		
1	0,5	5	200	1 000	1	10 (see note 6)
2	0,5	15	200	1 600	1	15 (see note 6)
3	0,5	15	2 300	4 000	1	25
4	20	30	2 000	4 000	1	20
5	0,5	2	300	400	2/3	10 (see note 6)
6	0,5	2	400	1 200	2/3	15 (see note 6)

NOTE 1: Radar test signal 1 to signal 4 are signals with constant PRF (see figure D.1). These radar test signals are intended to simulate also radars using a packet-based staggered PRF (see figure D.2).

NOTE 2: Radar test signal 4 is a modulated radar test signal. The modulation is a chirp modulation with a $\pm 2,5$ MHz frequency deviation as shown in the following graph.

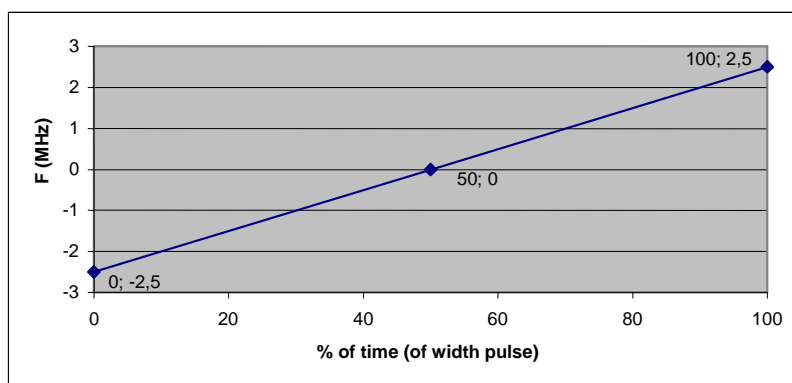

NOTE 3: Radar test signal 5 and radar test signal 6 are signals with single pulse-based staggered PRF using 2 or 3 different PRF values. For radar test signal 5, the difference between the PRF values chosen shall be between 20 PPS and 50 PPS. For radar test signal 6, the difference between the PRF values chosen shall be between 80 PPS and 400 PPS (see figure D.3).

NOTE 4: Apart from off-channel CAC testing, the radar test signals shall only contain a single burst of pulses (see figure D.1, figure D.3 and figure D.4). For off-channel CAC testing, repetitive bursts shall be used for the total duration of the test (see figure D.2 and figure D.5 (see also clause 4.2.6.2.3, clause 5.4.8.2.1.4.2 and clause 5.4.8.2.1.4.3)).

NOTE 5: The total number of pulses in a burst is equal to the number of pulses for a single PRF multiplied by the number of different PRFs used.

NOTE 6: For the CAC and off-channel CAC requirements, the minimum number of pulses (for each PRF) for any of the radar test signals to be detected in the band 5 600 MHz to 5 650 MHz shall be 18.

Table D.5: Detection probability

Parameter	Detection probability (P_d) (see note)	
	Channels whose nominal channel bandwidth falls partly or completely within the 5 600 MHz to 5 650 MHz band	Other channels
CAC, off-channel CAC	99,99 %	60 %
In-service monitoring	60 %	60 %

NOTE: P_d gives the probability of detection per radar test signal and represents a minimum level of detection performance under defined conditions.

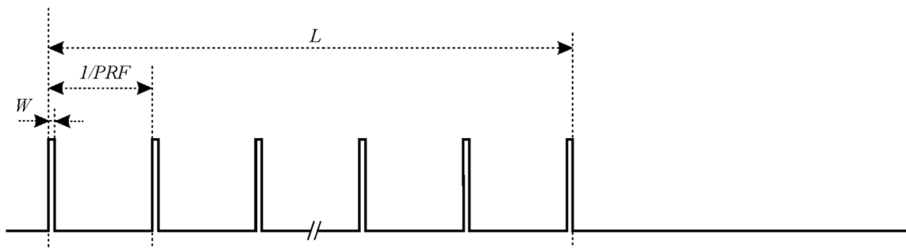

Figure D.1: General structure of a single-burst radar test signal with constant PRF

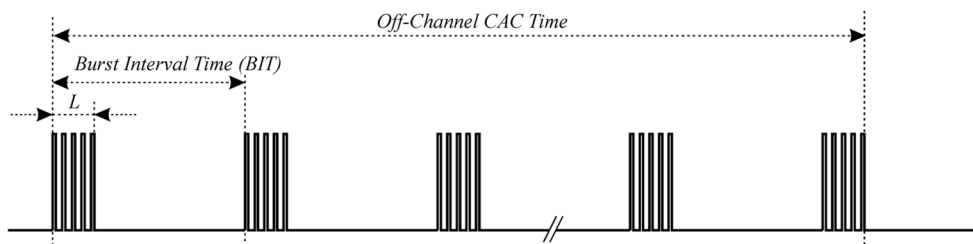

Figure D.2: General structure of a multi-burst radar test signal with constant PRF

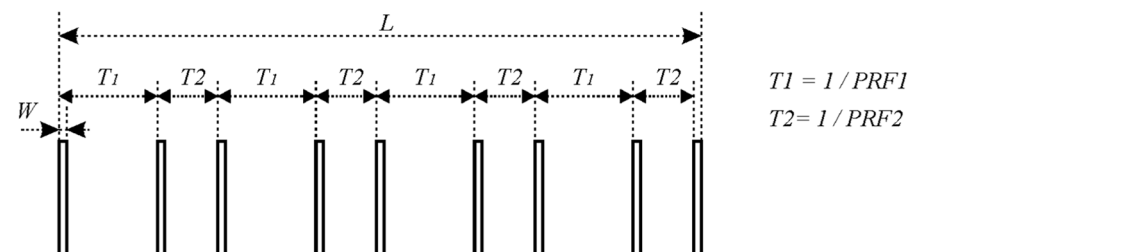

Figure D.3: General structure of a single-burst radar test signal with single pulse-based staggered PRF

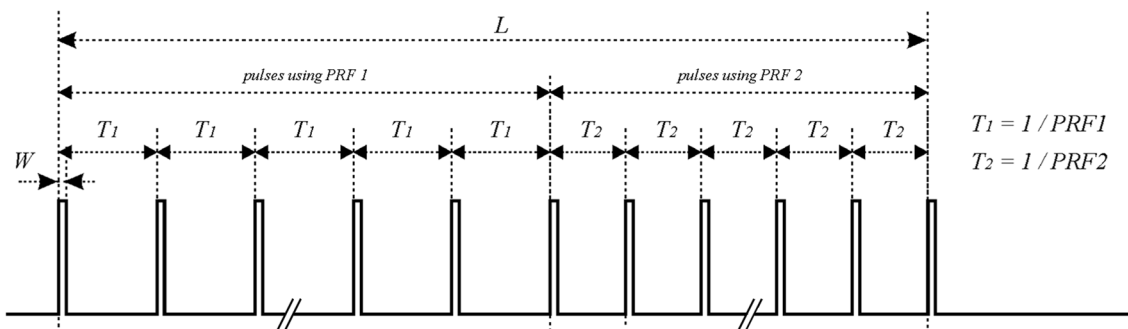

Figure D.4: General structure of a single-burst radar test signal with packet-based staggered PRF

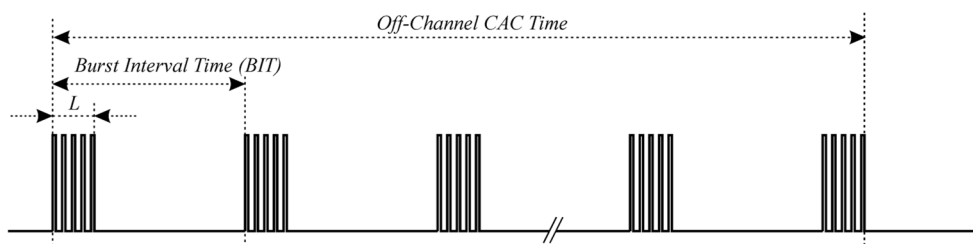

Figure D.5: General structure of a multi-burst radar test signal with packet-based staggered PRF

Annex E (normative): Test sites and arrangements for radiated measurements

E.1 Introduction

This annex describes the use of test sites (including antennas) to perform radiated measurements in accordance with the present document. All test sites and measurement arrangements described in this annex, when considered with their associated measurement uncertainty (see annex C), provide equivalent test results for the purpose of demonstrating compliance with the present document.

The information provided in annex C can be used for the interpretation of the results recorded in a test report for the radiated measurements described in this annex.

In addition this annex specifies the use of a test fixture to perform conducted (relative) measurements on equipment with integral antennas. It also defines the interference signal to be used in the adaptivity tests.

Subsequently the following items will be described:

- Open Area Test Site (OATS).
- Semi Anechoic Room (SAR).
- Fully Anechoic Room (FAR).
- Test fixture for relative measurements.
- Interference signal used for adaptivity tests.

The first three are generally referred to as free field test sites. Both absolute and relative measurements can be performed on these sites. They are described in clause E.2. Clause E.3 describes the antennas used in these test sites.

Where absolute measurements are to be carried out, the chamber should be verified. A detailed verification procedure is described in clause 6 of ETSI TR 102 273-4 [i.11] for the OATS, in clause 6 of ETSI TR 102 273-3 [i.10] for the SAR and in clause 6 of ETSI TR 102 273-2 [i.9] for the FAR.

Information for calculating the measurement uncertainty of measurements on one of these test sites can be found in ETSI TR 100 028-1 [i.4] and ETSI TR 100 028-2 [i.5], ETSI TR 102 273-2 [i.9], ETSI TR 102 273-3 [i.10] and ETSI TR 102 273-4 [i.11].

E.2 Radiated test sites

E.2.1 Open Area Test Site (OATS)

An OATS comprises a turntable at one end and an antenna mast of variable height at the other end above a ground plane which, in the ideal case, is perfectly conducting and of infinite extent. In practice, while good conductivity can be achieved, the ground plane size has to be limited. A typical OATS is shown in figure E.1.

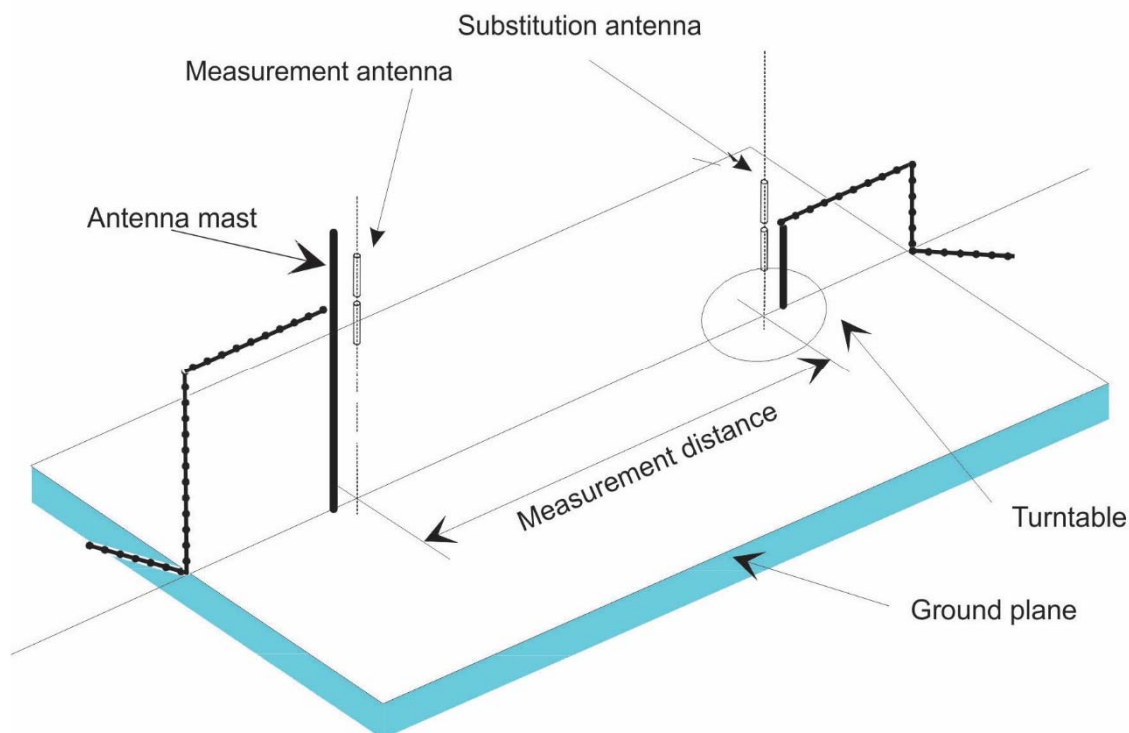

Figure E.1: A typical OATS

The ground plane creates a wanted reflection path, such that the signal received by the receiving antenna is the sum of the signals received from the direct and reflected transmission paths. The phasing of these two signals creates a unique receive level for each height of the transmitting antenna (or UUT) and the receiving antenna above the ground plane.

The antenna mast provides a variable height facility (from 1 m to 4 m) so that the position of the measurement antenna can be optimized for maximum coupled signal between antennas or between a UUT and the measurement antenna.

A turntable is capable of rotation through 360° in the horizontal plane and it is used to support the test sample (UUT) at a height of usually 1,5 m above the ground plane.

The measurement distance and minimum test site dimensions can be found in clause E.2.4. The distance used in actual measurements shall be recorded with the test results.

Further information on OATSs can be found in ETSI TR 102 273-4 [i.11].

E.2.2 Semi Anechoic Room (SAR)

A SAR - or anechoic chamber with a conductive ground plane - is an enclosure, usually shielded, whose internal walls and ceiling are covered with radio absorbing material. The floor, which is metallic, is not covered by absorbing material and forms the ground plane. The chamber usually contains an antenna mast at one end and a turntable at the other end. A typical anechoic chamber with a conductive ground plane is shown in figure E.2.

This type of test chamber attempts to simulate an ideal OATS, whose primary characteristic is a perfectly conducting ground plane of infinite extent.

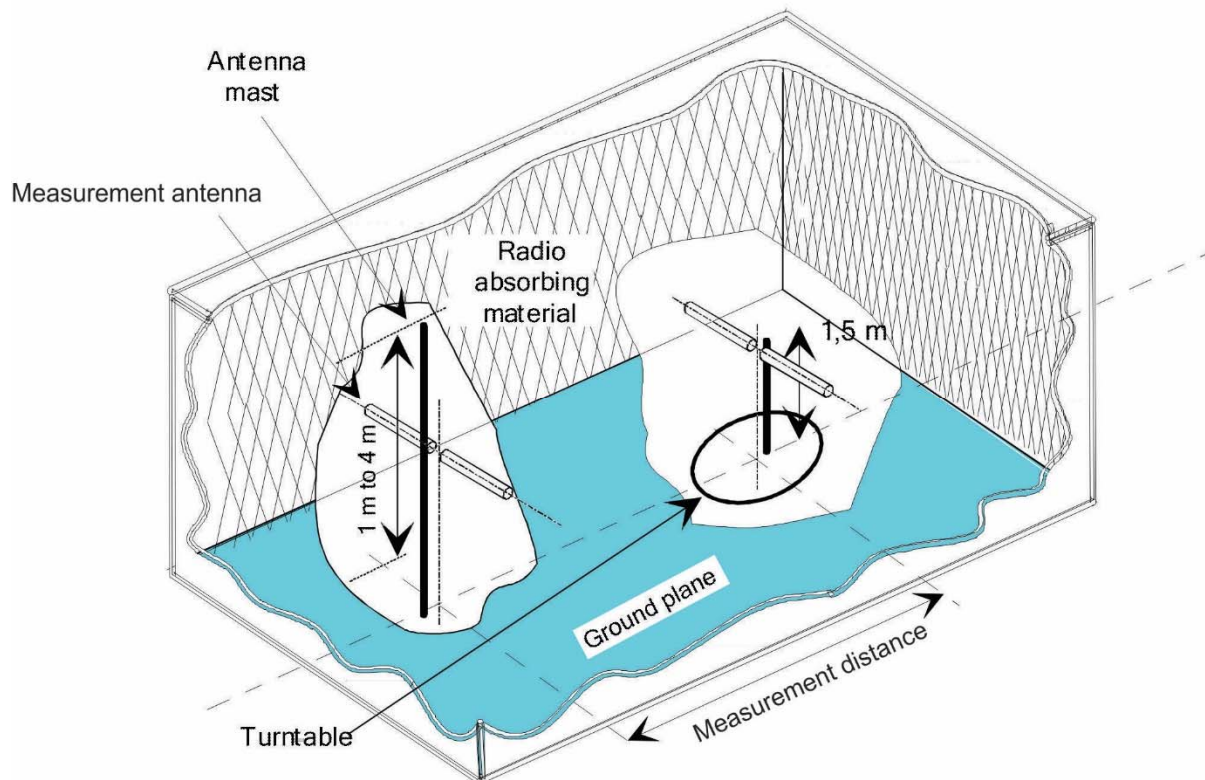

Figure E.2: A typical SAR

In this facility the ground plane creates a wanted reflection path, such that the signal received by the receiving antenna is the sum of the signals received from the direct and reflected transmission paths. The phasing of these two signals creates a unique receive level for each height of the transmitting antenna (or UUT) and the receiving antenna above the ground plane.

The antenna mast provides a variable height facility (from 1 m to 4 m) so that the position of the measurement antenna can be optimized for maximum coupled signal between antennas or between a UUT and the measurement antenna.

A turntable is capable of rotation through 360° in the horizontal plane and it is used to support the test sample (UUT) at a height of usually 1,5 m above the ground plane.

The measurement distance and minimum chamber dimensions can be found in clause E.2.4. The distance used in actual measurements shall be recorded with the test results.

Further information on SARs can be found in ETSI TR 102 273-3 [i.10].

E.2.3 Fully Anechoic Room (FAR)

A FAR is an enclosure, usually shielded, whose internal walls, floor and ceiling are covered with radio absorbing material. The chamber usually contains an antenna support at one end and a turntable at the other end. A typical FAR is shown in figure E.3.

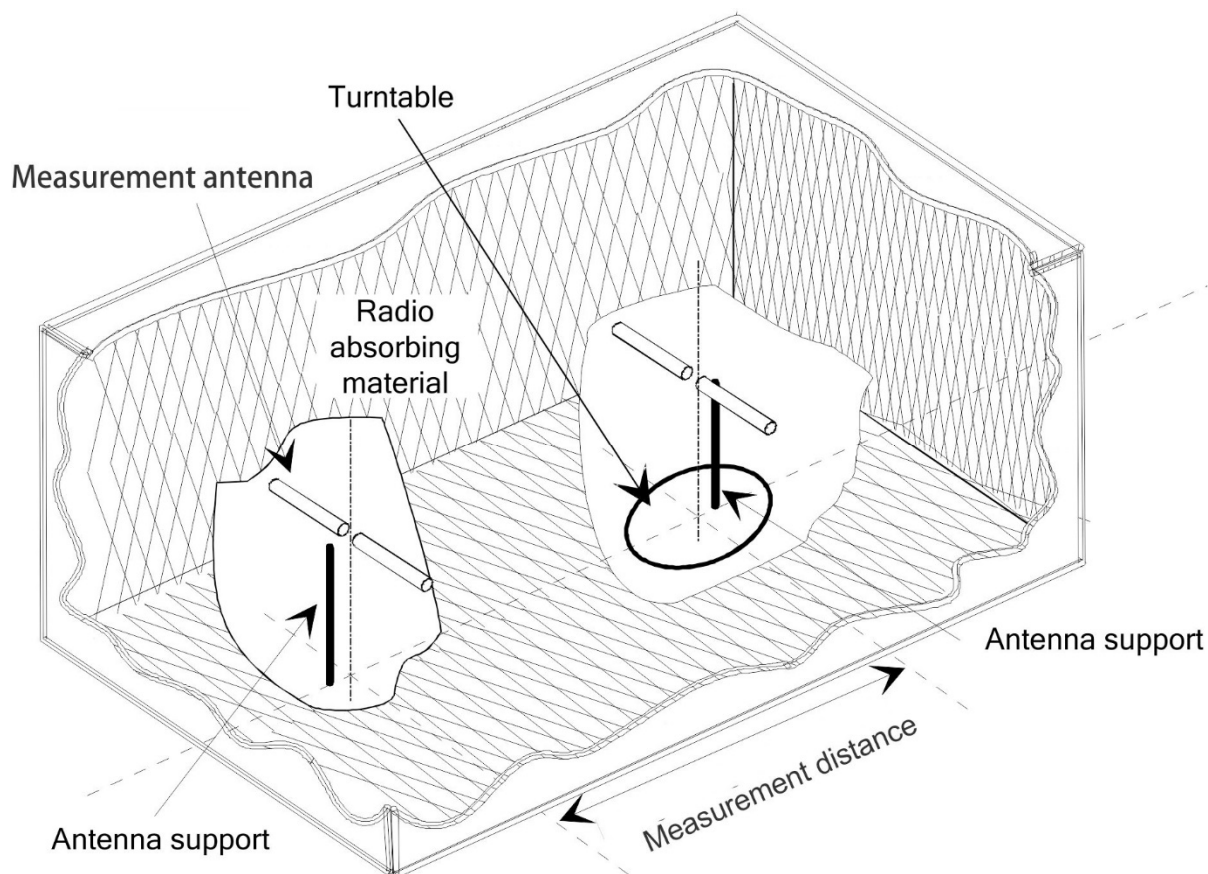

Figure E.3: A typical FAR

The chamber shielding and radio absorbing material provide a controlled environment for testing purposes. This type of test chamber attempts to simulate free space conditions.

The shielding provides a test space with reduced levels of interference from ambient signals and other outside effects, whilst the radio absorbing material minimizes unwanted reflections from the walls and ceiling which can influence the measurements. The shielding should be sufficient to eliminate interference from the external environment that would mask any signals that have to be measured.

A turntable is capable of rotation through 360° in the horizontal plane and it is used to support the UUT at a height of usually 1 m above the absorbing material.

The measurement distance and minimum chamber dimensions can be found in clause E.2.4. The distance used in actual measurements shall be recorded with the test results.

Further information on FAR can be found in ETSI TR 102 273-2 [i.9].

E.2.4 Measurement distance

The measurement distance should be chosen in order to measure the UUT at far-field conditions. The minimum measurement distance between the equipment and the measurement antenna should be λ or $r_m \gg \frac{D^2}{\lambda}$, whichever is greater.

λ = wavelength in m

r_m = minimum measurement distance between UUT and measurement antenna in m

D = largest dimension of physical aperture of the largest antenna in the measurement setup in m

$\frac{D^2}{\lambda}$ = distance between outer boundary of radiated near field (Fresnel region) and inner boundary of the radiated far-field (Fraunhofer region) in m, also known as Rayleigh distance

For those measurements, where these conditions cannot be fulfilled and where the measurement distance would result in measurements in the near field (e.g. while measuring spurious emissions), this should be noted in the test report and the additional measurement uncertainty should be incorporated into the results.

E.3 Antennas

E.3.1 Introduction

Antennas are needed for the radiated measurements on the three test sites described in clause E.2. Depending on its use, the antenna will be designated as measurement antenna or substitution antenna.

E.3.2 Measurement antenna

The measurement antenna is used to determine the field from the UUT and from the substitution antenna. When the test site is used for the measurement of receiver characteristics, the antenna is used as the transmitting device.

The measurement antenna should be mounted on a support capable of allowing the antenna to be used in either horizontal or vertical polarization. Additionally, on an OATS or SAR the height of the centre of the antenna above the ground should be variable over the specified range (usually 1 m to 4 m).

In the frequency band 30 MHz to 1 000 MHz, biconical or Logarithmic Periodic Dipole Antennas (LPDA) are recommended. Above 1 GHz, horn antennas or LPDAs are recommended.

The measurement antenna does not require an absolute calibration.

E.3.3 Substitution antenna

The substitution antenna shall be used to replace the equipment under test in substitution measurements.

The substitution antenna shall be suitable for the frequency range, and the return loss of the antenna shall be taken into account when calculating the measurement uncertainty.

The reference point of the substitution antenna shall coincide with the volume centre of the UUT when its antenna is internal or with the point where an external antenna is connected to the UUT.

The distance between the lower extremity of the antenna and the ground shall be at least 30 cm.

The substitution antenna shall be calibrated. For below 1 GHz, the calibration is relative to a half-wave dipole, while above 1 GHz, an isotropic radiator is the reference.

E.4 Test fixture

E.4.1 Introduction

Equipment provided with a (temporary) antenna connector can use conducted measurements, e.g. by means of a spectrum analyser.

In the case of integral antenna equipment with no external (temporary) antenna connector(s) provided, a test fixture can be used to allow relative measurements to be performed according to the procedure in clause E.4.3 as well as normalized measurements according to the procedure in E.4.4 as well as level independent measurements according to the procedure in clause E.4.5.

E.4.2 Description of the test fixture

The test fixture shall provide a means of coupling to the radio frequency output(s) of the UUT.

The impedance of the external connection to the test fixture shall be 50 Ω in the operating bands of the equipment.

The performance characteristics of the test fixture under normal and extreme test conditions shall be such that:

- a) the coupling loss shall be limited to ensure a sufficient dynamic range of the setup;
- b) the variation of coupling loss with frequency shall not cause errors exceeding ± 2 dB;
- c) the coupling device shall not include any non-linear elements.

E.4.3 Using the test fixture for relative measurements at the lower and upper extreme temperatures

For relative measurements related to requirements where testing needs to be repeated at the lower and upper extreme temperatures the following steps shall be performed:

Step 1:

Perform the measurement under normal conditions on a test site for radiated measurements as described in clause E.2. This will result in an absolute value for the requirement being tested. Record this value.

Step 2:

Put the equipment with the test fixture in the temperature chamber. Perform the same measurement at normal conditions in this environment and normalize the measuring equipment to get the same reading as before in step 1.

Step 3:

Ensure that the RF coupling accuracy remains within the range specified in clause E.4.2, item b).

Step 4:

Change the temperature in the temperature chamber and perform the measurement again. Due to the normalization done in step 2, the result will be the value for this requirement at the extreme condition.

E.4.4 Using the test fixture for normalized measurements

For normalized measurements the following steps shall be performed:

Step 1:

Perform a reference measurement for the RF output power of the UUT (without test fixture) on a test site for radiated measurements as described in clause E.2. This will result in a reference value to be used for the normalization.

Step 2:

Place the UUT in the test fixture. Do not change the position of the UUT in the test fixture for the total duration of the test procedure including the normalization and the measurement.

Step 3:

Perform the RF output power measurement without correction factors for coupling.

Step 4:

Calculate the coupling loss of the test fixture by comparing the measurements from step 1 and step 3. Use the resulting coupling loss only for in-band measurements and for the measurement of receiver blocking. Ensure that the RF coupling accuracy remains within the range specified in clause E.4.2, item b).

E.4.5 Using the test fixture for level independent measurements

For level independent measurements the following steps shall be performed:

Step 1:

Place the UUT in the test fixture.

Step 2:

Perform the applicable measurement as further described in the relevant part of clause 5 without correction factors for coupling loss.

E.5 Arrangement of the radiated test sites

E.5.1 Introduction

This clause details procedures, test equipment arrangements and verification that should be carried out before any of the radiated tests are undertaken. These schemes are common to all types of test sites described in clause E.2.

Where necessary, a mounting bracket of minimal size should be available for mounting the UUT on the turntable. This bracket should be made from low conductivity, low relative permittivity (i.e. $\frac{\epsilon}{\epsilon_0} < 1,5$) material(s) such as expanded polystyrene, balsawood, etc.

E.5.2 Power supplies for the battery powered UUT

All tests should be performed using power supplies wherever possible, including tests on UUT designed for battery-only use. For battery powered equipment, power leads should be connected to the UUT's supply terminals (and monitored with a digital voltmeter) but the battery should remain present, electrically isolated from the rest of the equipment, possibly by putting tape over its contacts.

The presence of these power cables can, however, affect the measured performance of the UUT. For this reason, they should be made to be "transparent" as far as the testing is concerned. This can be achieved by routing them away from the UUT and down to either the screen, ground plane or facility wall (as appropriate) by the shortest possible paths. Precautions should be taken to minimize pick-up on these leads (e.g. the leads could be twisted together, loaded with ferrite beads at 0,15 m spacing or otherwise loaded).

E.5.3 Site preparation

The cables to the measuring and substitution antenna should be routed horizontally away from the testing area for a minimum of 2 m (unless, in the case both types of anechoic chamber, a back wall is reached) and then allowed to drop vertically and out through either the ground plane or screen (as appropriate) to the test equipment. Precautions should be taken to minimize pick-up on these leads (e.g. dressing with ferrite beads or other loading). The cables, their routing and dressing should be identical to the verification setup.

NOTE: For ground reflection test sites (i.e. anechoic chambers with ground planes and OATS) which incorporate a cable drum with the antenna mast, the 2 m requirement may be impossible to conform to.

Calibration data for all items of test equipment should be available and valid. For test, substitution and measuring antennas, the data should include gain relative to an isotropic radiator (or antenna factor) for the frequencies of the test. Also, the VSWR of the substitution and measuring antennas should be known.

The calibration data on all cables and attenuators should include insertion loss and VSWR throughout the entire frequency range of the tests. All VSWR and insertion loss figures should be recorded in the log book results sheet for the specific test.

Where correction factors/tables are required, these should be immediately available.

For all items of test equipment, the maximum errors they exhibit should be known along with the distribution of the error, e.g.:

- cable loss: $\pm 0,5$ dB with a rectangular distribution;
- measuring receiver: 1,0 dB (standard deviation) signal level accuracy with a Gaussian error distribution.

At the start of measurements, system checks should be made on the items of test equipment used on the test site.

E.6 Coupling of signals

E.6.1 General

The presence of leads in the radiated field may cause a disturbance of that field and lead to additional measurement uncertainty. These disturbances can be minimized by using suitable coupling methods, offering signal isolation and minimum field disturbance (e.g. optical coupling).

E.6.2 Data signals

Isolation can be provided by the use of optical, ultrasonic or infra-red means. Field disturbance can be minimized by using a suitable fibre optic connection. Ultrasonic or infra-red radiated connections require suitable measures for the minimization of ambient noise.

E.7 Interference signals used for adaptivity tests

E.7.1 Additive White Gaussian Noise (AWGN) test signal

This test signal shall be a continuous (100 % duty cycle) Gaussian noise signal with a minimum of 20 MHz bandwidth.

E.7.2 OFDM test signal based on IEEE 802.11 PHY

This test signal shall consist of a continuous (100 % duty cycle) sequence of OFDM data symbols as defined in ISO/IEC/IEEE 8802-11:2022 [2], clause 17. This implies that the OFDM test signal does not contain any OFDM PHY preambles as defined in ISO/IEC/IEEE 8802-11:2022 [2], clause 17.3.3.

E.7.3 OFDM test signal based on LTE PHY

This test signal shall be a continuous (100 % duty cycle) LTE-type signal of 20 MHz channel bandwidth as described in ETSI TS 136 141 [1], clause 6.1.1.1.

E.7.4 Interference signal characteristics

E.7.4.1 Verification of flatness and bandwidth

The flatness and the bandwidth of an interference signal can be verified with the procedure in the present clause.

When the interference signal is used in the context of testing the capability to detect other transmissions in case of single channel operation (see clause 5.4.9.3.2.2), flatness and bandwidth of the interference signal are verified for the single channel.

When the interference signal is used in the context of testing the capability to detect other transmissions in case of multi-channel operation using option 1 (see clause 5.4.9.3.2.3.1), flatness and bandwidth of the interference signal are verified for each channel used for multi-channel operation.

When the interference signal is used in the context of testing the capability to detect other transmissions in case of multi-channel operation using option 2 (see clause 5.4.9.3.2.3.2), flatness and bandwidth of the interference signal are verified for an operating channel that is adjacent to the primary operating channel.

Step 1:

- Connect the signal generator for generating the interference signal to a spectrum analyser using the following settings:
 - Centre frequency: centre frequency of the interference signal
 - Frequency span: $2 \times$ bandwidth of the interference signal
 - RBW: $\sim 1 \%$ of the bandwidth of the interference signal
 - VBW: $3 \times$ RBW
 - Sweep points: $2 \times$ frequency span divided by RBW
For spectrum analysers not supporting this number of sweep points, the frequency band may be segmented.
 - Detector mode: Peak
 - Trace mode: Trace Averaging
 - Number of sweeps: sufficient to let the signal stabilize
 - Sweep time: Auto

Step 2:

- Verify that the occupied bandwidth (the bandwidth containing 99 % of the signal power) of the interference signal is within a range from 80 % to 100 % of the nominal channel bandwidth of the UUT.

Step 3:

- To ensure the flatness of the interference signal, verify that the 4 dB bandwidth of the signal (ignoring the DC notch at the centre frequency) covers at least 80 % of the occupied bandwidth of the signal.

E.7.4.2 Measurement of PSD

The Power Spectral Density (PSD) of the interference signal can be measured with the procedure in the present clause.

When combining multiple interference signals for verifying multi-channel operation, the procedure applies separately for each of the individual interference signals within the combination.

Step 1:

- Connect the signal generator for generating the interference signal to a spectrum analyser using the following settings:
 - Centre frequency: centre frequency of the interference signal
 - Frequency span: bandwidth of the interference signal
 - RBW: 1 MHz
 - VBW: $3 \times$ RBW
 - Filter mode: Channel
 - Detector mode: RMS

- Trace mode: Clear Write
- Number of sweeps: Single
- Sweep time: 1 s; the sweep time may be increased until a value where the sweep time has no impact on the RMS value of the signal

The peak value within the trace is the PSD of the interference signal.

E.7.5 Waveforms for test signals

The test signals described in clause E.7.1, clause E.7.2 and clause E.7.3 may be generated by a vector signal generator. Example waveform files are contained in archive en_301893v020201va0.zip which accompanies the present document.

In case the test signal needs to cover multiple channels, multiple (adjacent) 20 MHz signals shall be combined into a single test signal covering the channels under test.

Annex F (normative): Procedures for radiated measurements

F.1 Introduction

This annex gives the general procedures for radiated measurements using the test sites and arrangements described in annex E.

Preferably, radiated measurements are performed in an FAR (see clause F.3). Radiated measurements in an OATS or SAR are described in clause F.2.

F.2 Radiated measurements in an OATS or SAR

Radiated measurements shall be performed with the aid of a measurement antenna and a substitution antenna in test sites described in annex E. The measurement setup shall be calibrated according to the procedure defined in the present clause. The UUT and the measurement antenna shall be oriented such as to obtain the maximum emitted power level. This position shall be recorded in the measurement report.

- a) The measurement antenna (device 2 in figure F.1) shall be oriented initially for vertical polarization unless otherwise stated and the UUT (device 1 in figure F.1) shall be placed on the support in its standard position and switched on.
- b) The measurement equipment (device 3 in figure F.1) shall be connected to the measurement antenna and set up as specified in the test.

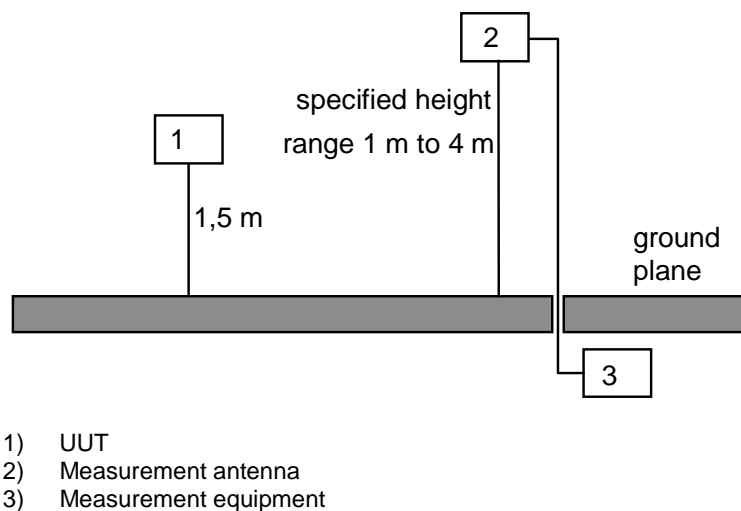

Figure F.1: Measurement arrangement for radiated measurements

- c) The UUT shall be rotated through 360° in a horizontal plane until the maximum signal strength is received at the measurement antenna.
- d) The measurement antenna shall be raised or lowered through the specified height range until a maximum is obtained. This level shall be recorded. This maximum may be a lower value than the value obtainable at heights outside the specified limits.
- e) The measurement procedure in step c) and step d) shall be repeated for horizontal polarization.

F.3 Radiated measurements in a FAR

For radiated measurements using a FAR, the procedure is identical to the one described in clause F.2, except that the height scan in step d) is omitted.

F.4 Substitution measurement

To determine the absolute measurement value, a substitution measurement is performed. The following steps shall be performed:

- 1) Replace the UUT (depicted as device 1 in figure F.1) with the substitution antenna configured for vertical polarization.
- 2) Connect a signal generator to the substitution antenna and adjust it to the measurement frequency.
- 3) If an OATS or a SAR is used, vary the measurement antenna height within the range provided in figure F.1 to ensure that the maximum signal level is received.
- 4) Adjust the power of the signal generator until the same level is obtained as recorded from the UUT (see clause F.2).
- 5) The radiated power is equal to the power supplied by the signal generator (plus the substitution antenna gain and minus the cable losses (values in dB)).
- 6) Repeat the measurement procedure described in step 2) to step 5) with horizontal polarization for the substitution antenna.

For test sites with a fixed setup of the measurement antenna(s) and a reproducible positioning of the UUT, correction values from a verified site calibration may be used alternatively.

F.5 Testing technical requirements on equipment with an integral antenna

F.5.1 Radio test suites and corresponding test sites

Table F.1 details the test site to be used for each of the radio test suites when performing radiated measurements on integral antenna equipment.

Table F.1: Radio test suites and corresponding test sites

Radio test suite	Test procedure	Corresponding test site
Nominal centre frequency	5.4.2	E.2.1, E.2.2, E.2.3
Occupied bandwidth	5.4.3	E.4.3
RF output power, Transmit Power Control (TPC) and Power Spectral Density (PSD)	5.4.4, B.3.4.4	E.2.1, E.2.2, E.2.3
Transmitter unwanted emissions outside the transmitter's operating bands	5.4.5	E.2.1, E.2.2, E.2.3
Transmitter unwanted emissions within the transmitter's operating bands	5.4.6	E.2.1, E.2.2, E.2.3
Receiver spurious emissions	5.4.7	E.2.1, E.2.2, E.2.3
Dynamic Frequency Selection (DFS)	5.4.8	E.2.1, E.2.2, E.2.3
Adaptivity (channel access mechanism)	5.4.9	F.5.2
Receiver blocking	5.4.10	F.5.3
Adjacent channel selectivity	5.4.11	F.5.4

F.5.2 Testing adaptivity (channel access mechanism)

F.5.2.1 Introduction

This clause describes how the adaptivity requirement can be verified on integral antenna equipment using radiated measurements.

F.5.2.2 Measurement setup

Figure F.2 describes an example of a setup that can be used to perform radiated adaptivity tests. This setup may need to be made inside a SAR (see clause E.2.2) or inside a FAR (see clause E.2.3) to avoid impact from any external signal on the measurement.

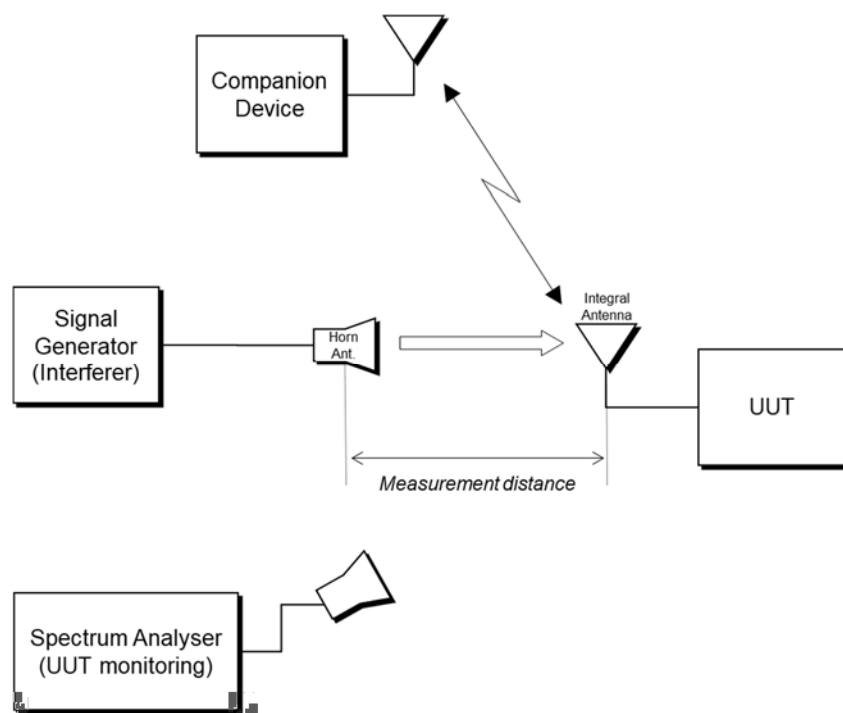

Figure F.2: Measurement setup

F.5.2.3 Calibration of the measurement setup

Before starting the actual measurement, the setup shall be calibrated. Figure F.3 shows an example of a setup that can be used for calibrating the setup given in figure F.2 using a substitution antenna and a spectrum analyser. The signal generator simulating the interference signal shall provide a signal power at the input of the substitution antenna such that the power level at the interface between the UUT and its antenna assembly corresponds to the applicable EDT defined in clause 4.2.7.3.1.4 for FBE and clause 4.2.7.3.2.5 for LBE.

For test sites with a fixed setup of the measurement antenna(s) and a reproducible positioning of the UUT, correction values from a verified site calibration may be used alternatively.

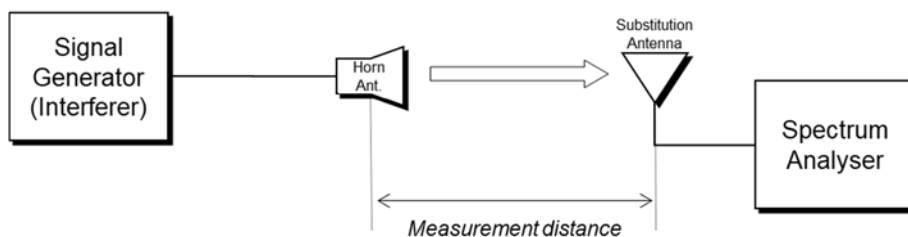

Figure F.3: Measurement setup for calibration

F.5.2.4 Test method

The test procedure shall be as follows:

- Replace the substitution antenna with the UUT once the calibration is performed.
- Configure/position the UUT for maximum RF output power towards the measurement antenna and in the horizontal plane.

NOTE: This configuration/position was recorded as part of the procedure in clause 5.4.4.2.2.

The test method is further as described in clause 5.4.9.2.2 for FBE and in clause 5.4.9.3.2 for LBE.

F.5.3 Testing receiver blocking

F.5.3.1 Introduction

This clause describes how the receiver blocking requirement can be verified on integral antenna equipment using radiated measurements.

F.5.3.2 Measurement setup

Figure F.4 describes an example of a setup that can be used to perform radiated receiver blocking tests. This setup may need to be made inside a SAR (see clause E.2.2) or inside a FAR (see clause E.2.3) to avoid impact from any external signal on the measurement.

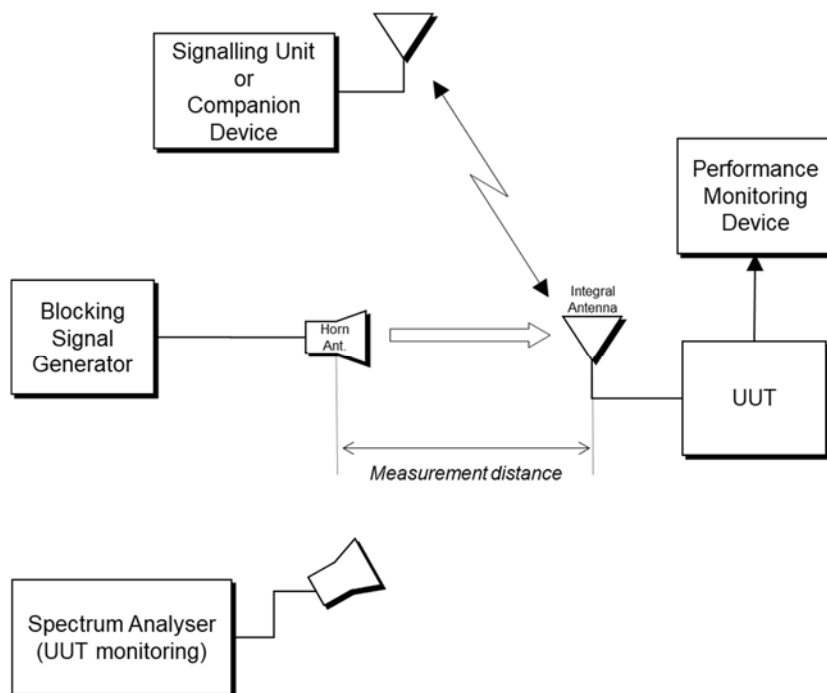

Figure F.4: Measurement setup

F.5.3.3 Calibration of the measurement setup

Before starting the actual measurement, the setup shall be calibrated. Figure F.5 shows an example of a setup that can be used for calibrating the setup given in figure F.4 using a substitution antenna and a spectrum analyser. The signal generator generating the blocking signal shall provide a signal power at the input of the substitution antenna such that the power level at the interface between the UUT and its antenna assembly corresponds to the applicable level used for conducted measurements (see clause 5.4.10).

For test sites with a fixed setup of the measurement antenna(s) and a reproducible positioning of the UUT, correction values from a verified site calibration may be used alternatively.

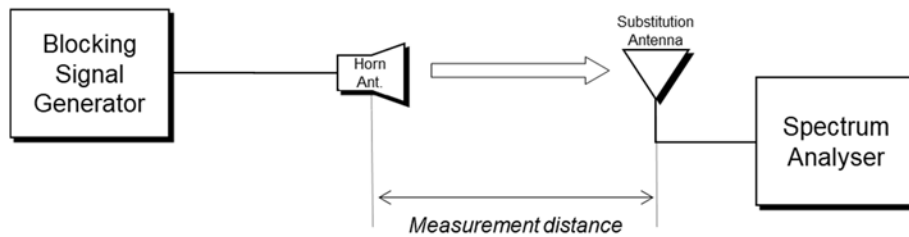

Figure F.5: Measurement setup for calibration

F.5.3.4 Test method

The test procedure shall be as follows:

- Replace the substitution antenna with the UUT once the calibration is performed.
- Configure/position the UUT for maximum RF output power towards the measurement antenna and in the horizontal plane.

NOTE: This configuration/position was recorded as part of the procedure in clause 5.4.4.2.2.

The test method is further as described under clause 5.4.10.2.1.

F.5.4 Testing adjacent channel selectivity

F.5.4.1 Introduction

This clause describes how the adjacent channel selectivity requirement can be verified on integral antenna equipment, using radiated measurements.

F.5.4.2 Measurement setup

Figure F.6 describes an example of a setup that can be used to perform radiated adjacent channel selectivity tests. This setup may need to be made inside a SAR (see clause E.2.2) or inside a FAR (see clause E.2.3) to avoid impact from any external signal on the measurement.

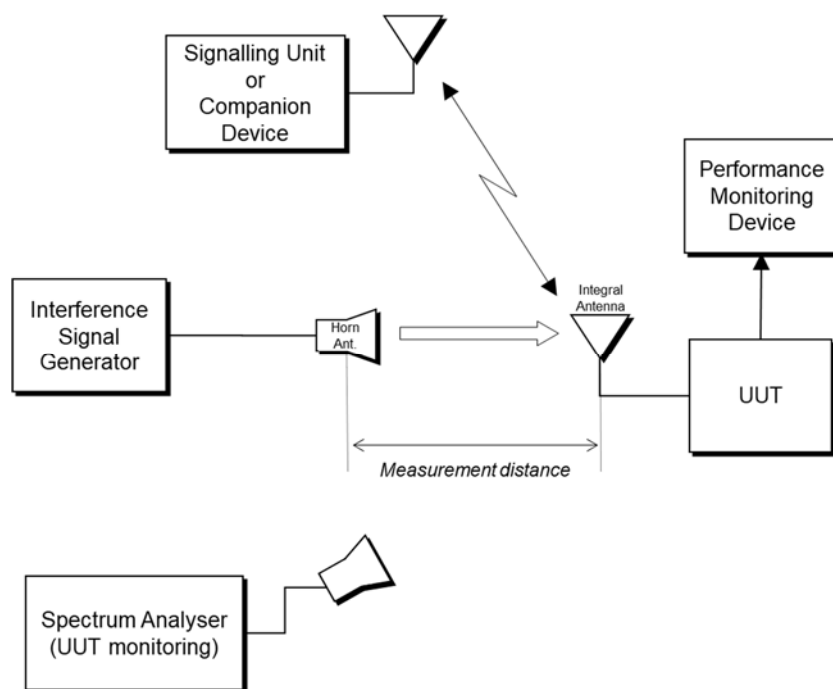

Figure F.6: Measurement setup

F.5.4.3 Calibration of the measurement setup

Before starting the actual measurement, the setup shall be calibrated. Figure F.7 shows an example of a setup that can be used for calibrating the setup given in figure F.6 using a substitution antenna and a spectrum analyser. The signal generator simulating the interference signal shall provide a signal power at the input of the substitution antenna such that the power level at the interface between the UUT and its antenna assembly corresponds to the applicable level used for conducted measurements (see clause 5.4.11).

For test sites with a fixed setup of the measurement antenna(s) and a reproducible positioning of the UUT, correction values from a verified site calibration may be used alternatively.

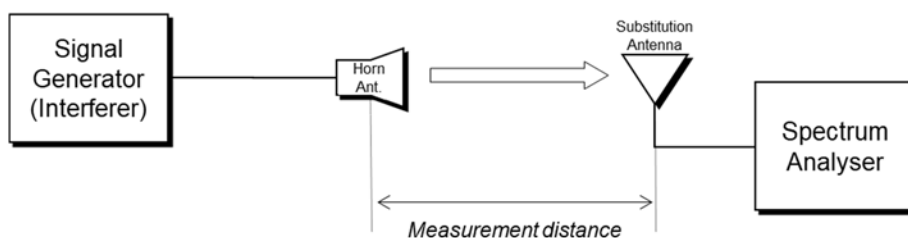

Figure F.7: Measurement setup for calibration

F.5.4.4 Test method

The test procedure shall be as follows:

- Replace the substitution antenna with the UUT once the calibration is performed.
- Configure/position the UUT for maximum RF output power towards the measurement antenna and in the horizontal plane.

NOTE: This configuration/position was recorded as part of the procedure in clause 5.4.4.2.2.

The test method is further as described under clause 5.4.11.2.1.

Annex G (informative): Adaptivity flowchart

The flowchart contained in figure G.1 illustrates the adaptivity (channel access mechanism) for Load Based Equipment (LBE) as defined in clause 4.2.7.3.2, and more in particular the channel access mechanism for an initiating device defined in clause 4.2.7.3.2.6.

Figure G.1 does not consider note 2 in table 6 in clause 4.2.7.3.2.4.

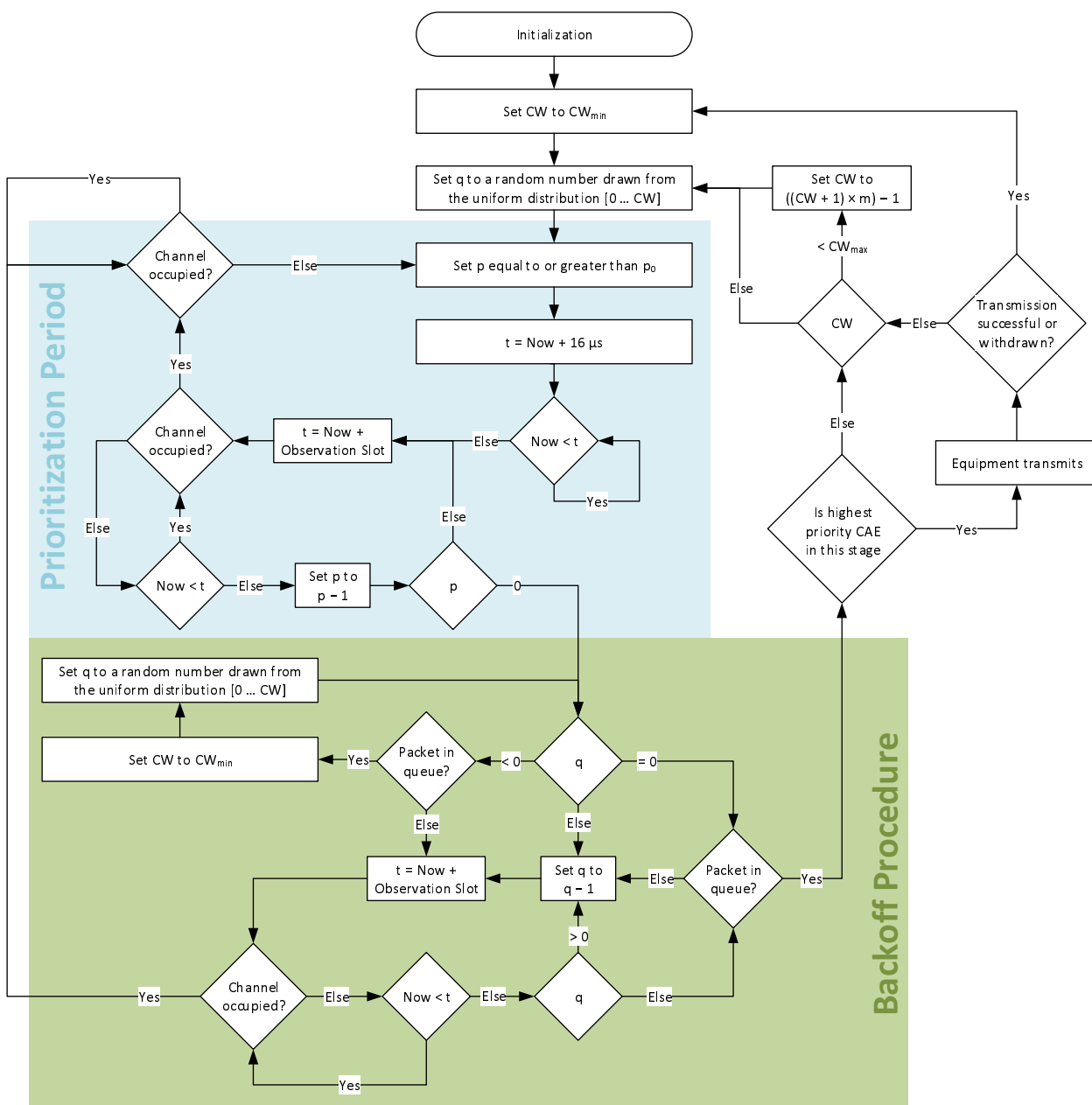

Figure G.1: Flowchart for adaptivity of LBE (initiating device)

Annex H (informative): Application form for testing

H.1 The right to copy

Notwithstanding the provisions of the copyright clause related to the text of the present document, ETSI grants that users of the present document may freely reproduce the application form for testing so that it can be used for its intended purposes and may further publish the completed application form.

H.2 Introduction

The form contained in this annex might be used by the manufacturer to conform to the requirements contained in clause 5.4.1 to provide the necessary information about the equipment to the test laboratory prior to the testing. It contains product information as well as other information which might be required to define which configurations are expected to be tested, which tests are expected to be performed as well as the test conditions.

If used, this application form becomes an integral part of the test report.

H.3 Information as required by ETSI EN 301 893 (V2.2.1), clause 5.4.1

With reference to the requirements in ETSI EN 301 893 V2.2.1, the following information is provided by the manufacturer. In case that multiple options are available, check all that apply.

a) Nominal channel bandwidth(s):

Nominal channel bandwidth 1: MHz

Nominal channel bandwidth 2: MHz

Nominal channel bandwidth 3: MHz

Associated nominal centre frequencies:

For nominal channel bandwidth 1:

for the band 5 150 MHz to 5 250 MHz (sub-band 1): MHz; MHz; MHz; MHz;

for the band 5 250 MHz to 5 350 MHz (sub-band 2): MHz; MHz; MHz; MHz;

for the band 5 470 MHz to 5 725 MHz (sub-band 3): MHz; MHz; MHz; MHz;

for the band 5 725 MHz to 5 850 MHz (sub-band 4): MHz; MHz; MHz; MHz;

For nominal channel bandwidth 2:

for the band 5 150 MHz to 5 250 MHz (sub-band 1): MHz; MHz; MHz; MHz;

for the band 5 250 MHz to 5 350 MHz (sub-band 2): MHz; MHz; MHz; MHz;

for the band 5 470 MHz to 5 725 MHz (sub-band 3): MHz; MHz; MHz; MHz;

for the band 5 725 MHz to 5 850 MHz (sub-band 4): MHz; MHz; MHz; MHz;

For nominal channel bandwidth 3:

for the band 5 150 MHz to 5 250 MHz (sub-band 1): MHz; MHz; MHz; MHz;

for the band 5 250 MHz to 5 350 MHz (sub-band 2): MHz; MHz; MHz; MHz;

for the band 5 470 MHz to 5 725 MHz (sub-band 3): MHz; MHz; MHz; MHz;

for the band 5 725 MHz to 5 850 MHz (sub-band 4): MHz; MHz; MHz; MHz;

b) For equipment that supports multi-channel operation:

- The (maximum) number of channels that are supported for multi-channel operation:
- It is possible that these channels are in different sub-bands: yes no

equipment supports a multi-channel configuration with adjacent channels as described in clause 4.2.4.2.2.2

Supported channel configurations for groups of adjacent channels for multi-channel operation:

.....

equipment supports a multi-channel configuration with non-adjacent channels as described in clause 4.2.4.2.2.3

Supported combinations of channels and configurations for groups of adjacent channels for multi-channel operation:

.....

- In case of channels not used for transmission in multi-channel operation within a group of adjacent channels

equipment supports channel edge mask given in figure 2 in clause 4.2.4.2.2.2

equipment supports channel edge mask given in figure 3 in clause 4.2.4.2.2.2

equipment supports channel edge mask given in figure 4 in clause 4.2.4.2.2.2

- In case of Load Based Equipment (LBE)

equipment supports option 1 as described in clause 4.2.7.3.2.3 or in clause B.2.2.7.3.2.3

equipment supports option 2 as described in clause 4.2.7.3.2.3 or in clause B.2.2.7.3.2.3

For equipment implementing option 1 (see clause 4.2.7.3.2.3 or clause B.2.2.7.3.2.3), the number of channels used for multi-channel operation when performing the test described in clause 5.4.9.3.2.3.1:

.....

c) Transmit operating modes (see clause 5.3.3.2):

operating mode 1: single antenna equipment

equipment with only 1 antenna

equipment with diversity antennas but only 1 antenna active at any moment in time

smart antenna systems with 2 or more antennas but operating in a (legacy) mode where only 1 antenna is used

operating mode 2: smart antenna systems - multiple antennas without beamforming

single spatial stream / standard throughput

high throughput (> 1 spatial stream) using nominal channel bandwidth 1

high throughput (> 1 spatial stream) using nominal channel bandwidth 2

high throughput (> 1 spatial stream) using nominal channel bandwidth 3

operating mode 3: smart antenna systems - multiple antennas with beamforming

single spatial stream / standard throughput

- high throughput (> 1 spatial stream) using nominal channel bandwidth 1
- high throughput (> 1 spatial stream) using nominal channel bandwidth 2
- high throughput (> 1 spatial stream) using nominal channel bandwidth 3

d) For equipment with smart antenna systems or multiple antenna systems:

- For operating mode 2
 - Number of receive chains:
 - Number of transmit chains:
 - Equal power distribution among the transmit chains: yes no
- For operating mode 3
 - Number of receive chains:
 - Number of transmit chains:
 - Equal power distribution among the transmit chains: yes no
 - Maximum (additional) beamforming gain: dB

NOTE: Beamforming gain does not include the basic gain of a single antenna (assembly).

e) Transmit Power Control (TPC):

- Does the equipment implement TPC: yes no

f) For equipment with TPC:

The lowest and highest power level (or lowest and highest EIRP level in case of integrated antenna equipment), intended antenna assemblies and corresponding operating frequency range for TPC (or for each of the TPC ranges if more than one is implemented).

TPC range 1:

- Applicable frequency range (check all that apply):
 - sub-band 1
 - sub-band 2
 - sub-band 3
 - sub-band 4
- Simultaneous transmissions in multiple sub-bands: yes no
- Power level reference:

Indicate whether the power levels specified are transmitter output power (Tx out) levels or EIRP levels in case of integrated antenna equipment.

Power levels specified for: Tx out EIRP
- For more than one transmit chain:

If more than one transmit chain is present (e.g. in the case of smart antenna systems), the power levels in table H.1 represent the TPC range per active transmit chain (and per sub-band in case of multi-channel operation).

Table H.1: Power levels for TPC range 1

	Sub-band	Operating mode 1 (dBm)	Operating mode 2 (dBm)	Operating mode 3 (dBm)
Highest power level	1
	2
	3
	4
Lowest power level	1
	2
	3
	4

- Beamforming:

Beamforming possible:

yes no

- Intended antenna assemblies:

Table H.2: Intended antenna assemblies for TPC range 1

Antenna assembly name	Antenna gain (dBi)	Operating mode	Sub-band	Beam-forming gain (dB)	Highest power level (dBm)	Lowest power level (dBm)	
<Antenna 1>	Mode 1	1	
			2	
			3	
			4	
		Mode 2	1
			2
			3
			4
		Mode 3	1
			2
			3
			4
<Antenna 2>	Mode 1	1	
			2	
			3	
			4	
		Mode 2	1
			2
			3
			4
		Mode 3	1
			2
			3
			4
<Antenna 3>	Mode 1	1	
			2	
			3	
			4	
		Mode 2	1
			2
			3
			4
		Mode 3	1
			2
			3
			4

- DFS threshold: dBm at the antenna connector
 in front of the antenna

TPC range 2:

- Applicable frequency range (check all that apply):

- sub-band 1
- sub-band 2
- sub-band 3
- sub-band 4

Simultaneous transmissions in multiple sub-bands: yes no

- Power level reference:

Indicate whether the power levels specified are transmitter output power (Tx out) levels or EIRP levels in case of integrated antenna equipment.

Power levels specified for: Tx out EIRP

- For more than one transmit chain:

If more than one transmit chain is present (e.g. in the case of smart antenna systems), the power levels in table H.3 represent the TPC range per active transmit chain (and per sub-band in case of multi-channel operation).

Table H.3: Power levels for TPC range 2

	Sub-band	Operating mode 1 (dBm)	Operating Mode 2 (dBm)	Operating mode 3 (dBm)
Highest power level	1
	2
	3
	4
Lowest power level	1
	2
	3
	4

- Beamforming:

Beamforming possible: yes no

- Intended antenna assemblies:

Table H.4: Intended antenna assemblies for TPC range 2

Antenna assembly name	Antenna gain (dBi)	Operating mode	Sub-band	Beam forming gain (dB)	Highest power level (dBm)	Lowest power level (dBm)	
<Antenna 1>	Mode 1	1	
			2	
			3	
			4	
		Mode 2	1
			2
			3
			4
		Mode 3	1
			2
			3
			4
<Antenna 2>	Mode 1	1	
			2	
			3	
			4	
		Mode 2	1
			2
			3
			4
		Mode 3	1
			2
			3
			4
<Antenna 3>	Mode 1	1	
			2	
			3	
			4	
		Mode 2	1
			2
			3
			4
		Mode 3	1
			2
			3
			4

- DFS threshold: dBm at the antenna connector
 in front of the antenna

g) For equipment without TPC:

Power setting 1:

- Applicable frequency range (check all that apply):

- sub-band 1
- sub-band 2
- sub-band 3
- sub-band 4

Simultaneous transmissions in multiple sub-bands: yes no

- Power level reference:

Indicate whether the power levels specified are transmitter output power (Tx out) levels or EIRP levels in case of integrated antenna equipment.

Power levels specified for: Tx out EIRP

- For more than one transmit chain:

If more than one transmit chain is present (e.g. in the case of smart antenna systems), the power levels in table H.5 represent the power settings per active transmit chain (and per sub-band in case of multi-channel operation).

Table H.5: Maximum RF output power for power setting 1

Sub-band	Operating mode 1 (dBm)	Operating mode 2 (dBm)	Operating mode 3 (dBm)
1
2
3
4

- Beamforming:

Beamforming possible: yes no

- Intended antenna assemblies:

Table H.6: Intended antenna assemblies for power setting 1

Antenna assembly name	Antenna gain (dBi)	Operating mode	Sub-band	Beamforming gain (dB)	Max RF output power (dBm)
<Antenna 1>	Mode 1	1
			2
			3
			4
		Mode 2	1
			2
			3
			4
		Mode 3	1
			2
			3
			4
<Antenna 2>	Mode 1	1
			2
			3
			4
		Mode 2	1
			2
			3
			4
		Mode 3	1
			2
			3
			4

Antenna assembly name	Antenna gain (dBi)	Operating mode	Sub-band	Beamforming gain (dB)	Max RF output power (dBm)
<Antenna 3>	Mode 1	1
			2
			3
			4
		Mode 2	1
			2
			3
			4
		Mode 3	1
			2
			3
			4

- DFS threshold: dBm at the antenna connector
 in front of the antenna

Power setting 2:

- Applicable frequency range (check all that apply):

- sub-band 1
 sub-band 2
 sub-band 3
 sub-band 4

Simultaneous transmissions in multiple sub-bands: yes no

- Power level reference:

Indicate whether the power levels specified are transmitter output power (Tx out) levels or EIRP levels in case of integrated antenna equipment.

Power levels specified for: Tx out EIRP

- For more than one transmit chain:

If more than one transmit chain is present (e.g. in the case of smart antenna systems), the power levels in table H.7 represent the power settings per active transmit chain (and per sub-band in case of multi-channel operation).

Table H.7: Maximum RF output power for power setting 2

Sub-band	Operating mode 1 (dBm)	Operating mode 2 (dBm)	Operating mode 3 (dBm)
1
2
3
4

- Beamforming:

Beamforming possible: yes no

- Intended antenna assemblies:

Table H.8: Intended antenna assemblies for power setting 2

Antenna assembly name	Antenna gain (dBi)	Operating mode	Sub-band	Beamforming gain (dB)	Max RF output power (dBm)
<Antenna 1>	Mode 1	1
			2
			3
			4
		Mode 2	1
			2
			3
			4
		Mode 3	1
			2
			3
			4
<Antenna 2>	Mode 1	1
			2
			3
			4
		Mode 2	1
			2
			3
			4
		Mode 3	1
			2
			3
			4
<Antenna 3>	Mode 1	1
			2
			3
			4
		Mode 2	1
			2
			3
			4
		Mode 3	1
			2
			3
			4

- DFS threshold: dBm at the antenna connector
 in front of the antenna

h) DFS operating mode(s):

- primary device
- secondary device with radar detection
- secondary device without radar detection

i) With regard to DFS:

The equipment has an off-channel CAC function when operating in sub-band 2 or in sub-band 3:

- yes no

j) For equipment with off-channel CAC function:

Off-channel CAC time:

- For channels in sub-band 2: hours
- For channels in sub-band 3 outside the 5 600 MHz to 5 650 MHz range: hours
- For channels in sub-band 3 (partially) within the 5 600 MHz to 5 650 MHz range: hours

k) User Access Restrictions (UAR):

- equipment is constructed to conform to the requirements contained in clause 4.2.10
- equipment is constructed to conform to the requirements contained in clause B.2.2.10

l) Ad-hoc mode:

- no ad-hoc operation
- ad-hoc operation in sub-band 1 without DFS
- ad-hoc operation with DFS

m) Operating frequency range(s):

- Range 1: sub-band 1
- Range 2: sub-band 2
- Range 3: sub-band 3
- Range 4: sub-band 4
- Range 5: other, please specify:

n) Operating temperature and supply voltage range:

- 20 °C to +55 °C (outdoor & indoor usage)
- 0 °C to +35 °C (indoor usage only)
- other:

Supply voltage details provided for: stand-alone equipment

combined (or host) equipment

test jig

Supply voltage AC mains AC voltage: minimum: ... nominal: ... maximum: ...

DC DC voltage: minimum: ... nominal: ... maximum: ...

In case of DC, indicate the type of power source:

- internal power supply
- external power supply or AC/DC adapter
- battery nickel cadmium
- alkaline
- nickel-metal hydride
- lithium-ion
- lead acid (vehicle regulated)

other

o) Test sequence / test software used (see also clause 5.3.1.2):

.....

p) Type of equipment:

- stand-alone
- combined equipment (equipment where the radio part is fully integrated within another type of equipment)
- plug-in radio device (equipment intended for a variety of host systems)
- other

q) Adaptivity (channel access mechanism):

- Frame Based Equipment (FBE)
- Load Based Equipment (LBE)

r) With regards to adaptivity for FBE:

- FBE supports operating as an initiating device
- FBE supports operating as a responding device

FBE implements the following Fixed Frame Period(s) (FFPs):

..... ms
 ms
 ms

s) With regards to adaptivity for LBE:

- LBE supports operating as a supervising device
- LBE supports operating as a supervised device

Priority classes supported by the equipment (see clause 4.2.7.3.2.4):

- When operating as a supervising device
 - priority class 4 (highest priority)
 - priority class 3
 - priority class 2
 - priority class 1 (lowest priority)
- When operating as a supervised device
 - priority class 4 (highest priority)
 - priority class 3
 - priority class 2
 - priority class 1 (lowest priority)

- LBE supports using note 1 in table 6 in clause 4.2.7.3.2.4
- LBE supports using note 1 in table 7 in clause 4.2.7.3.2.4
- LBE, when operating as a supervising device, supports using note 2 in table 6 in clause 4.2.7.3.2.4
- LBE supports operating as an initiating device
- LBE supports operating as a responding device

t) **Minimum performance criteria (see clause 4.2.8.3 and clause 4.2.9.3) that correspond to the intended use of the equipment:**

.....

u) **Theoretical maximum radio performance of the equipment (e.g. maximum throughput) (see clause 5.4.9.3.2):**

.....

v) **Equipment supports a country determination capability as defined in clause B.2.2.11:**

yes no

H.4 Additional information provided by the manufacturer

H.4.1 Modulation

Can the transmitter operate unmodulated? yes no

H.4.2 Duty cycle

The transmitter is intended for : continuous duty
 intermittent duty
 continuous operation possible for testing purposes

H.4.3 About the UUT

- The equipment submitted are representative production models.
- If not, the equipment submitted are pre-production models.
- If pre-production equipment is submitted, the final production equipment will be identical in all respects with the equipment tested.
- If not, supply full details:

.....

Annex I (informative): Examples of spectrum masks

I.1 Introduction

This annex contains a number of examples of spectrum masks resulting from the application of clause 4.2.4.2.2.2 on equipment configured for multi-channel operation in adjacent channels.

These masks are relative masks (relative to the Power Spectral Density (PSD) of the equipment) but they can never impose a limit below the absolute value of -30 dBm/MHz (see clause 4.2.4.2.2.1). The examples do not show this -30 dBm/MHz overall lowest limit as the exact position of the line representing this level depends on the PSD of the equipment.

The Local Oscillator (LO) exceedance referred to in clause 4.2.4.2.2.2 is not included in these examples.

I.2 Equipment configured for multi-channel operation in groups of four adjacent channels

I.2.1 Example 1

The channels in the group of adjacent channels used for multi-channel operation are numbered 1 to 4. In this example, transmissions take place simultaneously in all channels.

For this example, the mask in figure 1 is applied to the group of adjacent channels with a total bandwidth (N) of 80 MHz (see figure I.1).

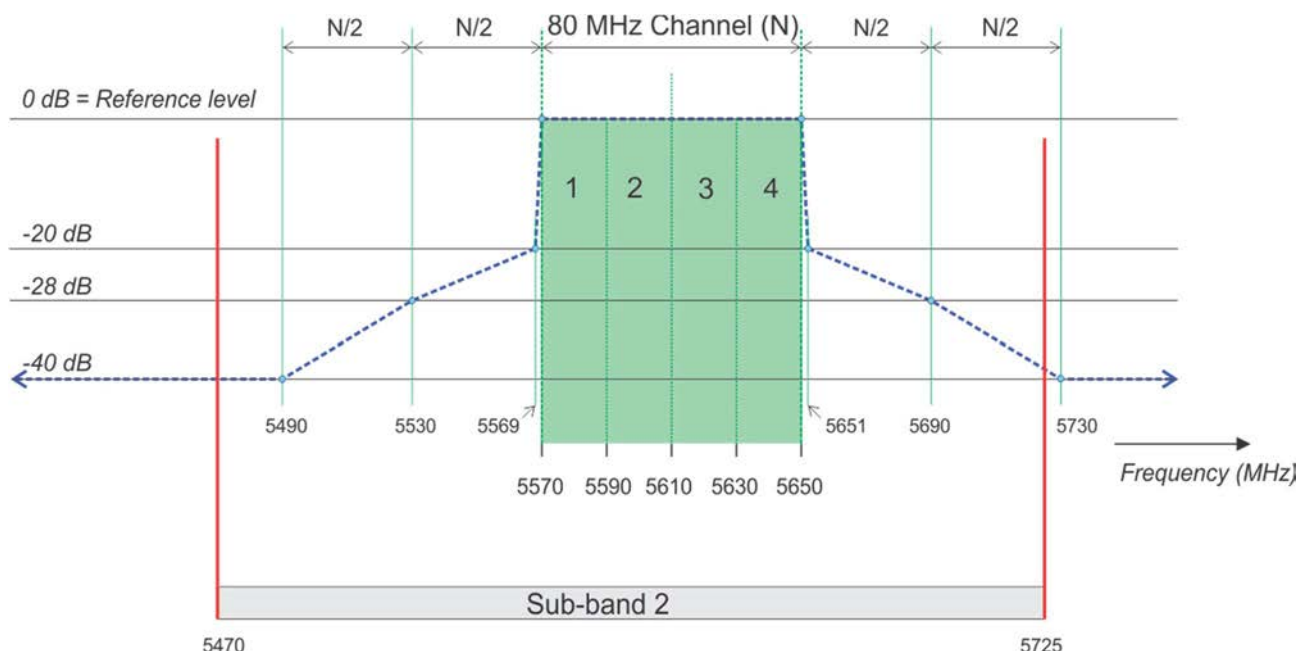

Figure I.1: Example 1

I.2.2 Example 2

The channels in the group of adjacent channels used for multi-channel operation are numbered 1 to 4. In this example, transmissions take place simultaneously in channels 2, 3 and 4.

The overall transmit spectral power mask as provided in figure I.2 is constructed from (1) the mask provided in figure 1 applied on the entire group of adjacent channels that is configured for multi-channel operation with a total bandwidth (N) of 80 MHz and (2) the channel edge mask provided in figure 2 applied at 5 590 MHz and at 5 650 MHz.

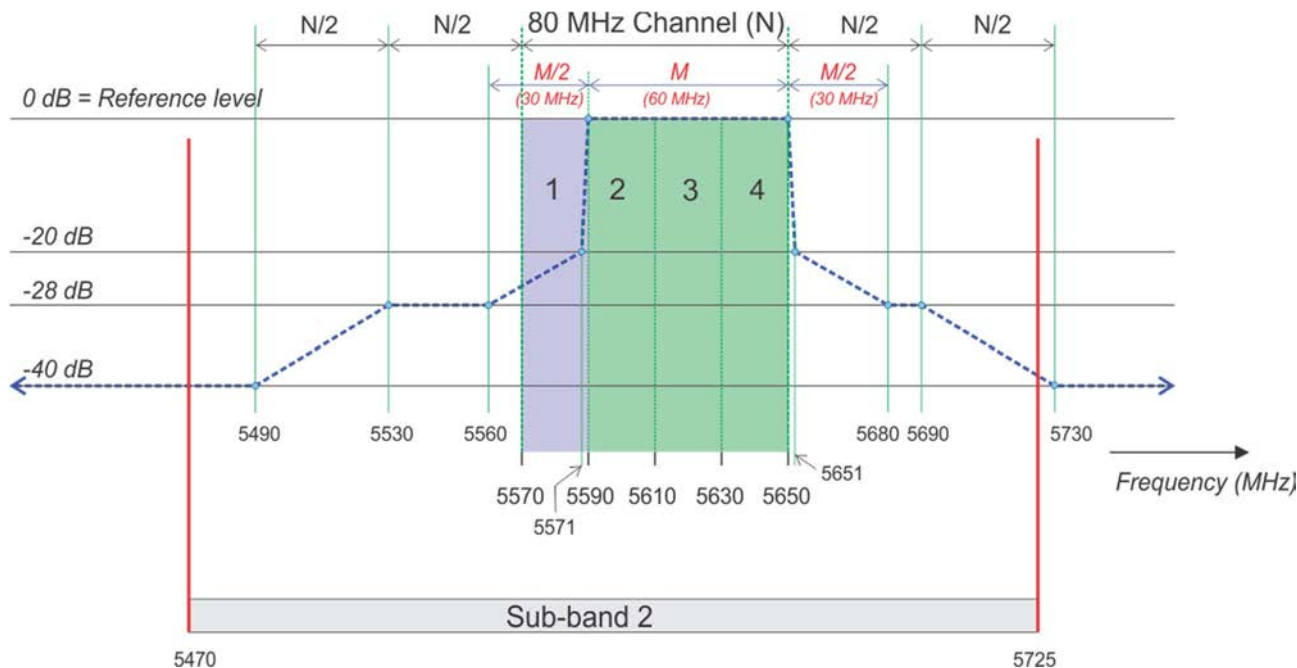

Figure I.2: Example 2

I.2.3 Example 3

The channels in the group of adjacent channels used for multi-channel operation are numbered 1 to 4. In this example, transmissions take place simultaneously in channels 1, 2 and 4.

The overall transmit spectral power mask as provided in figure I.3 is constructed from (1) the mask provided in figure 1 applied on the entire group of adjacent channels that is configured for multi-channel operation with a total bandwidth (N) of 80 MHz and (2) the channel edge mask provided in figure 4 (as there is only one channel not used for transmission) applied at both edges of this single channel (5 610 MHz and 5 630 MHz).

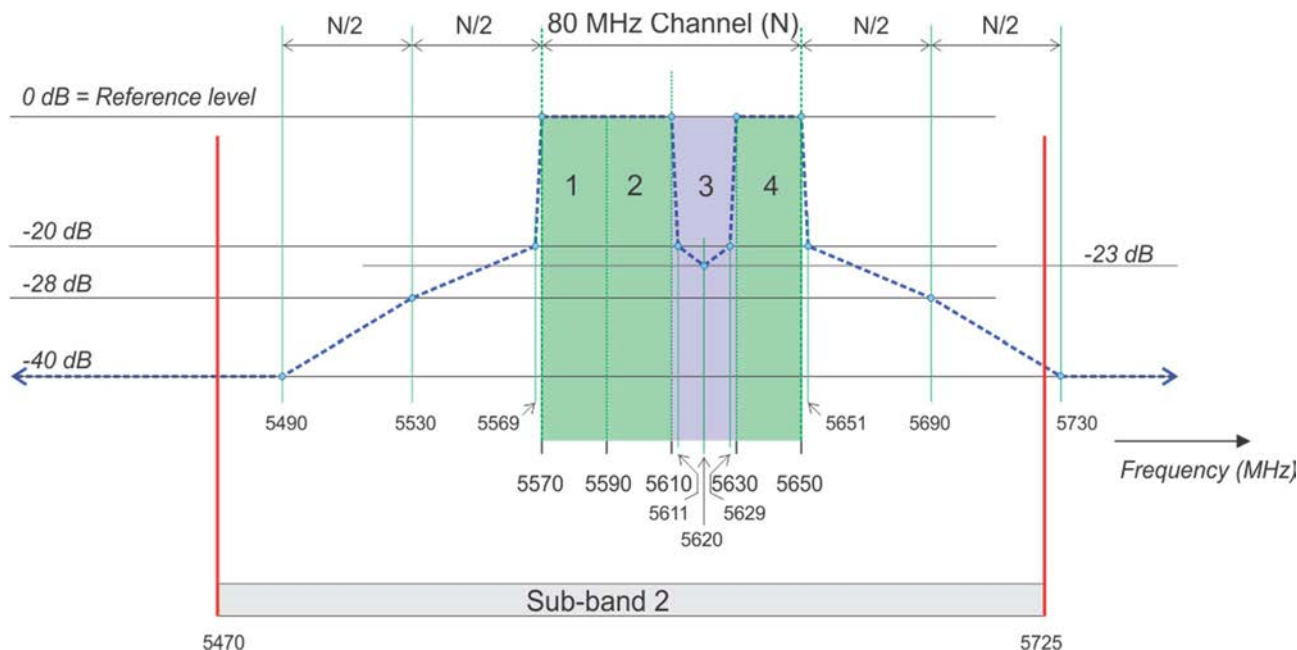

Figure I.3: Example 3

I.2.4 Example 4

The channels in the group of adjacent channels used for multi-channel operation are numbered 1 to 4. In this example, transmissions take place simultaneously in channels 1 and 4.

The overall transmit spectral power mask as provided in figure I.4 is constructed from (1) the mask provided in figure 1 applied on the entire group of adjacent channels that is configured for multi-channel operation with a total bandwidth (N) of 80 MHz and (2) the channel edge mask provided in figure 3 applied at 5 590 MHz and at 5 630 MHz.

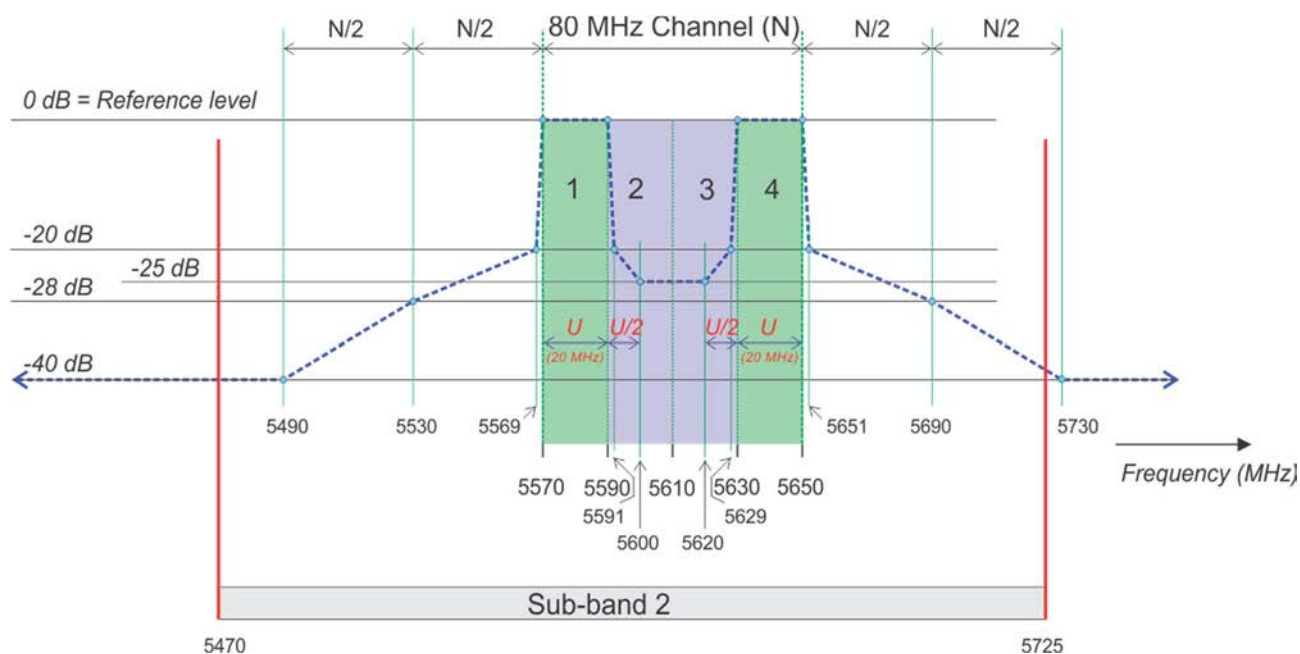

Figure I.4: Example 4

I.3 Equipment configured for multi-channel operation in groups of eight adjacent channels

I.3.1 Example 5

The channels in the group of adjacent channels used for multi-channel operation are numbered 1 to 8. In this example, transmissions take place simultaneously in channels 1, 2, 5, 6, 7 and 8.

The overall transmit spectral power mask as provided in figure I.5 is constructed from (1) the mask provided in figure 1 applied on the entire group of adjacent channels that is configured for multi-channel operation with a total bandwidth (N) of 160 MHz and (2) the channel edge mask provided in figure 3 applied at 5 530 MHz and at 5 570 MHz. The resulting mask within the channels 3 and 4 which are not used for transmission is not symmetrical as the total bandwidth of the adjacent channels used for transmission on either side of the gap is different (U_1 versus U_2).

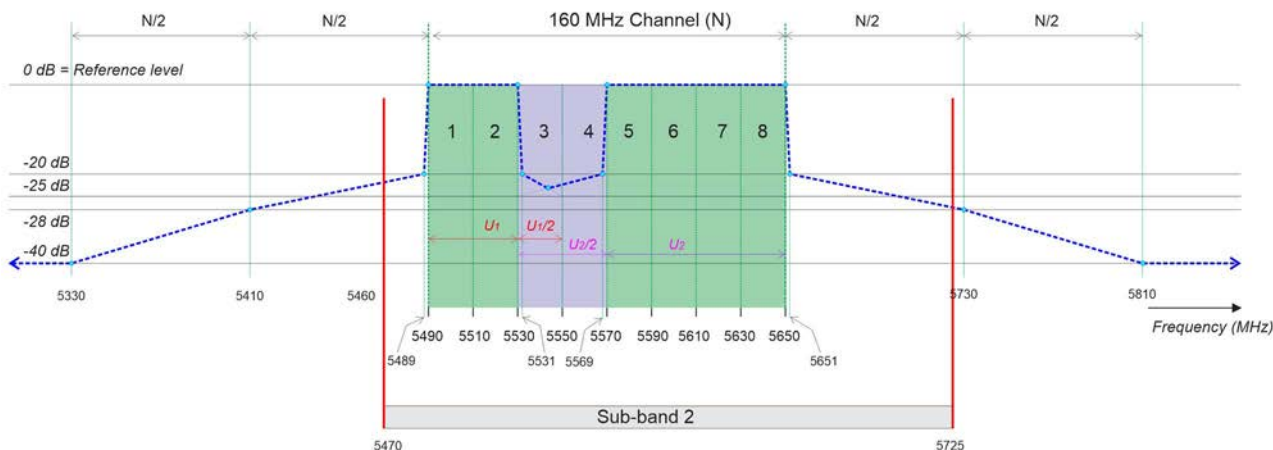

Figure I.5: Example 5

1.3.2 Example 6

The channels in the group of adjacent channels used for multi-channel operation are numbered 1 to 8. In this example, transmissions take place simultaneously in channels 1, 2, 6, 7 and 8.

The overall transmit spectral power mask as provided in figure I.6 is constructed from (1) the mask provided in figure 1 applied on the entire group of adjacent channels that is configured for multi-channel operation with a total bandwidth (N) of 160 MHz and (2) the channel edge mask provided in figure 3 applied at 5 530 MHz and at 5 590 MHz. The resulting mask within the channels 3, 4 and 5 which are not used for transmission is not symmetrical as the total bandwidth of the adjacent channels used for transmission on either side of the gap is different (U_1 versus U_2).

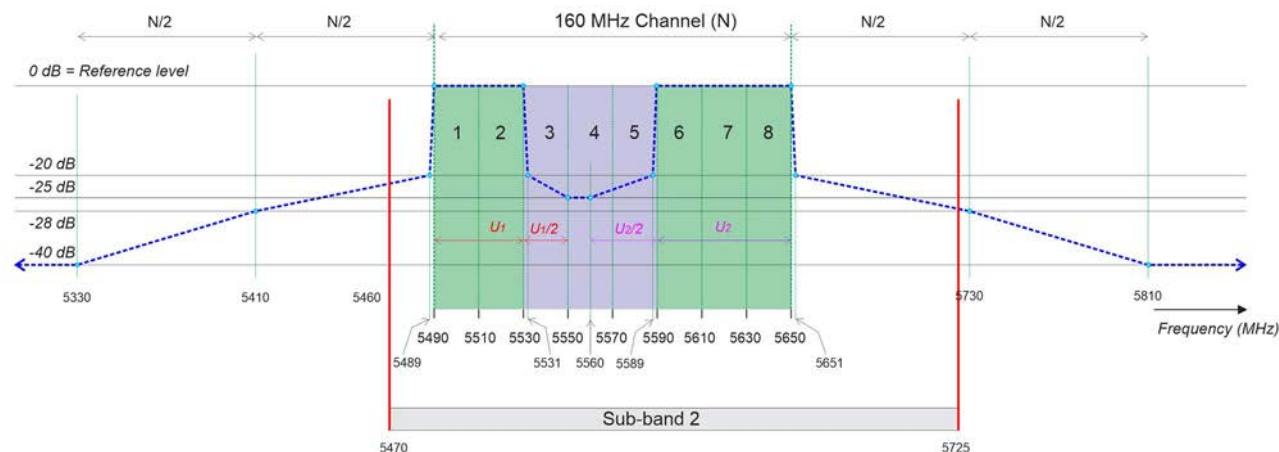

Figure I.6: Example 6

1.3.3 Example 7

The channels in the group of adjacent channels used for multi-channel operation are numbered 1 to 8. In this example, transmissions take place simultaneously in channels 1, 2, 5, 7 and 8.

The overall transmit spectral power mask as provided in figure I.7 is constructed from (1) the mask provided in figure 1 applied on the entire group of adjacent channels that is configured for multi-channel operation with a total bandwidth of 160 MHz, (2) the channel edge mask provided in figure 3 applied at 5 530 MHz and at 5 570 MHz and (3) the channel edge mask provided in figure 4 applied at 5 590 MHz and at 5 610 MHz.

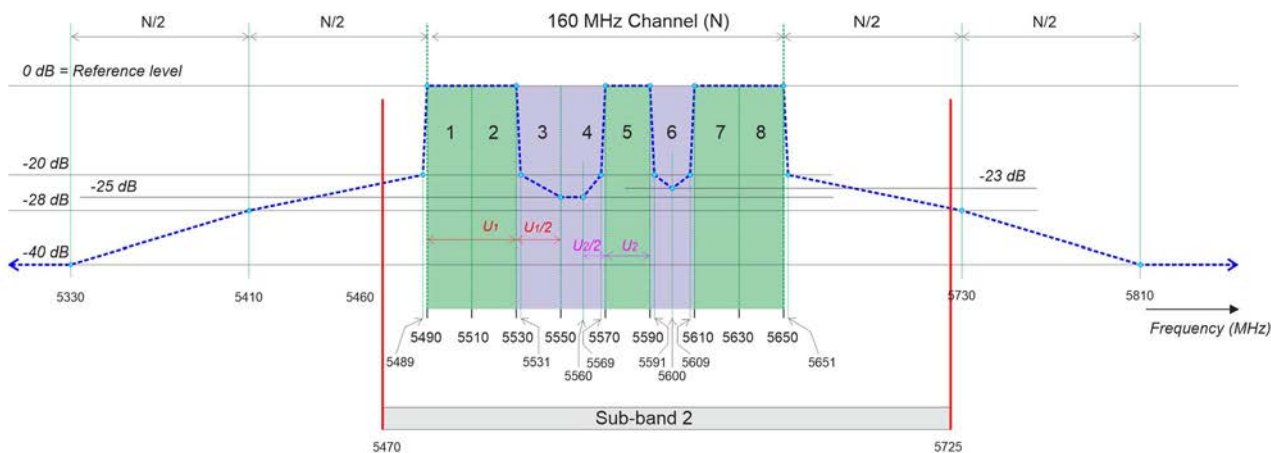

Figure I.7: Example 7

I.3.4 Example 8

The channels in the group of adjacent channels used for multi-channel operation are numbered 1 to 8. In this example, transmissions take place simultaneously in channels 2, 3, 4, 5 and 6.

The overall transmit spectral power mask as provided in figure I.8 is constructed from (1) the mask provided in figure 1 applied on the entire group of adjacent channels that is configured for multi-channel operation with a total bandwidth (N) of 160 MHz and (2) the channel edge mask provided in figure 2 applied at 5 510 MHz and at 5 610 MHz.

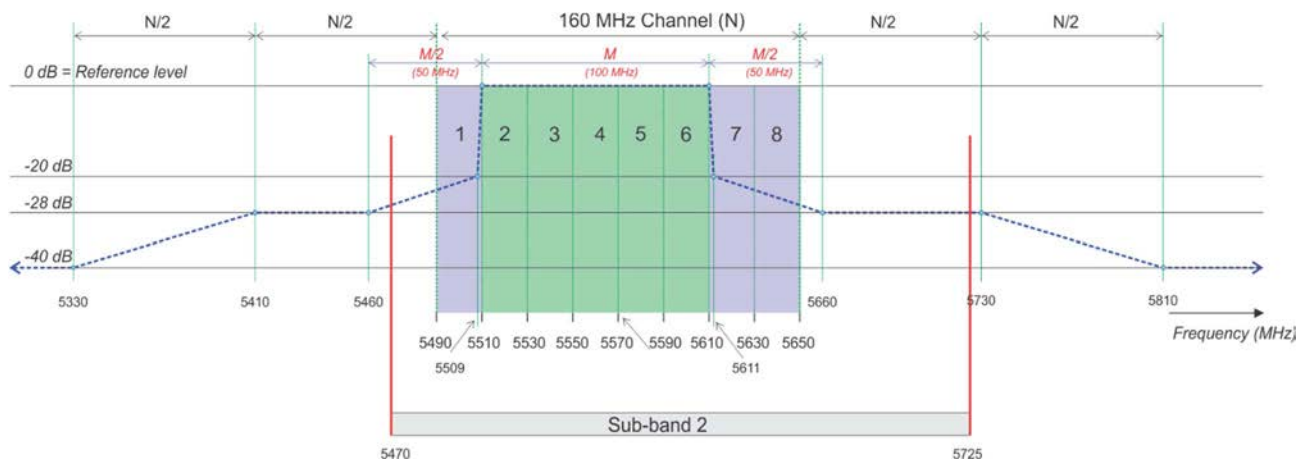

Figure I.8: Example 8

I.3.5 Example 9

The channels in the group of adjacent channels used for multi-channel operation are numbered 1 to 8. In this example, transmissions take place simultaneously in channels 1, 2, 6 and 7.

The overall transmit spectral power mask as provided in figure I.9 is constructed from (1) the mask provided in figure 1 applied on the entire group of adjacent channels that is configured for multi-channel operation with a total bandwidth (N) of 160 MHz, (2) the channel edge mask provided in figure 2 applied at 5 490 MHz and at 5 630 MHz and (3) the channel edge mask provided in figure 3 applied at 5 530 MHz and at 5 590 MHz.

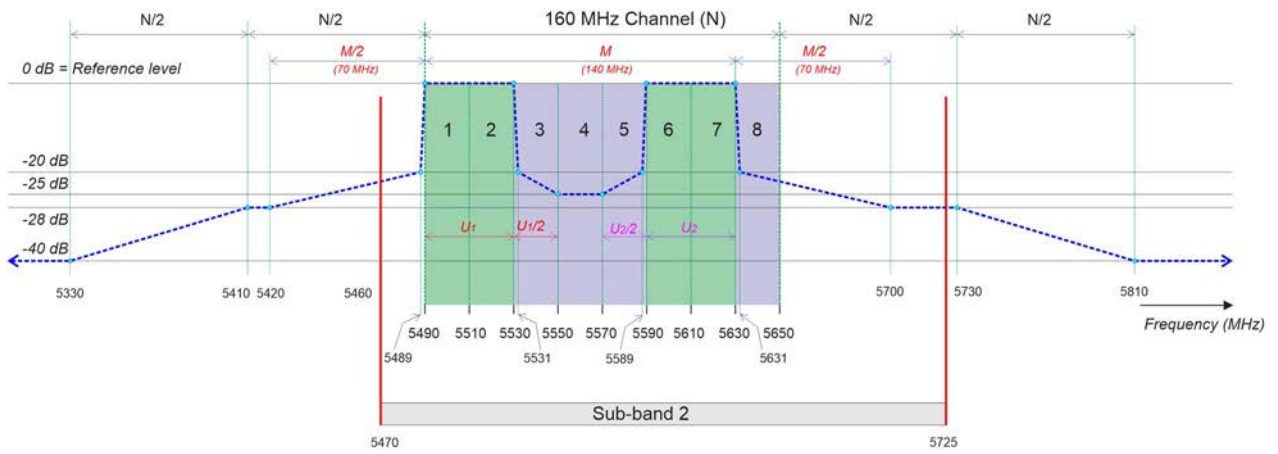

Figure I.9: Example 9

Annex J (informative): Bibliography

- Recommendation ITU-R M.1652: "Dynamic frequency selection (DFS) in wireless access systems including radio local area networks for the purpose of protecting the radio determination service in the 5 GHz band".

Annex K (informative): Change history

Version	Information about changes
2.1.1	First published version covering Directive 2014/53/EU. Major changes are: <ul style="list-style-type: none"> • Inclusion of Receiver Blocking as a new requirement. • Revision of the <i>Adaptivity</i> Requirement to accommodate multiple technologies. • Revised test method for <i>Adaptivity</i>. • Modifications required for alignment with Directive 2014/53/EU.
2.2.1	Second published version covering Directive 2014/53/EU Major changes are: <ul style="list-style-type: none"> • Revision of clause 4.2.4.2 on transmitter unwanted emissions to accommodate flexible use of spectrum for multi-channel operation and minimize interference • Revision of clause 4.2.7.3.1.4 and clause 4.2.7.3.2.5 regarding EDT requirements for FBE and LBE • Addition of clause 4.2.9 on adjacent channel selectivity including the related conformance test in clause 5.4.11 • Revision of clause 5.4.9.3.2.4 and clause 5.4.9.3.2.5 on conformance test for adaptivity (channel access mechanism) • Addition of clause 5.4.12 regarding a conformance assessment procedure for User Access Restrictions • Addition of a new normative annex to cover technical requirements and methods of measurement for the band 5 725 MHz to 5 850 MHz including Country Determination Capability (Annex B) • Replacement of non-inclusive terms for DFS operation • Clarification of measurement uncertainty in Annex C • Addition of a new informative annex on examples for various configurations of transmission channels to demonstrate the construction of the transmit spectral power mask (Annex I)

History

Document history		
V1.2.3	August 2003	Publication
V1.3.1	August 2005	Publication
V1.4.1	July 2007	Publication
V1.5.1	December 2008	Publication
V1.6.1	November 2011	Publication
V1.7.1	June 2012	Publication
V1.8.1	March 2015	Publication
V2.1.1	May 2017	Publication
V2.2.0	November 2023	SRdAP EV 20240215: 2023-11-17 to 2024-02-15
V2.2.1	September 2024	SRdAP VA 20241124: 2024-09-25 to 2024-11-25