



**Short Range Devices (SRD)  
using Ultra Wide Band technology (UWB);  
Harmonised standard for access to radio spectrum;  
Part 1: Level Probing Radar (LPR) equipment operating in the  
frequency ranges 6 GHz to 8,5 GHz, 24,05 GHz to 26,5 GHz,  
57 GHz to 64 GHz, 75 GHz to 85 GHz for strictly vertical  
downward installation**

---

**Reference**REN/ERM-TGUWB-152

---

**Keywords**harmonised standard, radar, short range, SRD,  
testing, UWB

---

**ETSI**650 Route des Lucioles  
F-06921 Sophia Antipolis Cedex - FRANCE

---

Tel.: +33 4 92 94 42 00 Fax: +33 4 93 65 47 16

Siret N° 348 623 562 00017 - APE 7112B  
Association à but non lucratif enregistrée à la  
Sous-Préfecture de Grasse (06) N° w061004871

---

**Important notice**

---

The present document can be downloaded from the  
[ETSI Search & Browse Standards](#) application.

The present document may be made available in electronic versions and/or in print. The content of any electronic and/or print versions of the present document shall not be modified without the prior written authorization of ETSI. In case of any existing or perceived difference in contents between such versions and/or in print, the prevailing version of an ETSI deliverable is the one made publicly available in PDF format on [ETSI deliver](#) repository.

Users should be aware that the present document may be revised or have its status changed,  
this information is available in the [Milestones listing](#).

If you find errors in the present document, please send your comments to  
the relevant service listed under [Committee Support Staff](#).

If you find a security vulnerability in the present document, please report it through our  
[Coordinated Vulnerability Disclosure \(CVD\)](#) program.

---

**Notice of disclaimer & limitation of liability**

---

The information provided in the present deliverable is directed solely to professionals who have the appropriate degree of experience to understand and interpret its content in accordance with generally accepted engineering or other professional standard and applicable regulations.

No recommendation as to products and services or vendors is made or should be implied.  
In no event shall ETSI be held liable for loss of profits or any other incidental or consequential damages.

Any software contained in this deliverable is provided "AS IS" with no warranties, express or implied, including but not limited to, the warranties of merchantability, fitness for a particular purpose and non-infringement of intellectual property rights and ETSI shall not be held liable in any event for any damages whatsoever (including, without limitation, damages for loss of profits, business interruption, loss of information, or any other pecuniary loss) arising out of or related to the use of or inability to use the software.

---

**Copyright Notification**

---

No part may be reproduced or utilized in any form or by any means, electronic or mechanical, including photocopying and microfilm except as authorized by written permission of ETSI.

The content of the PDF version shall not be modified without the written authorization of ETSI.

The copyright and the foregoing restriction extend to reproduction in all media.

© ETSI 2025.  
All rights reserved.

# Contents

Intellectual Property Rights .....	6
Foreword.....	6
Modal verbs terminology.....	7
Introduction .....	7
1 Scope .....	8
2 References .....	8
2.1 Normative references .....	8
2.2 Informative references.....	8
3 Definition of terms, symbols and abbreviations.....	9
3.1 Terms.....	9
3.2 Symbols.....	10
3.3 Abbreviations .....	10
4 Technical requirements specifications .....	11
4.1 Environmental profile.....	11
4.2 EUT categories.....	11
4.2.1 General.....	11
4.2.2 Categorization by output power.....	11
4.2.3 Categorization by Operating Frequency Range (OFR).....	11
4.2.4 Categorization by antenna connection .....	12
4.2.5 Summary of LPR sub-categories .....	12
4.3 Transmitter Requirements .....	13
4.3.1 General.....	13
4.3.2 Operating Frequency Range (OFR).....	13
4.3.2.1 Applicability.....	13
4.3.2.2 Description .....	13
4.3.2.3 Limits .....	13
4.3.2.4 Conformance .....	13
4.3.3 Mean e.i.r.p. spectral density .....	14
4.3.3.1 Applicability.....	14
4.3.3.2 Description.....	14
4.3.3.3 Limits .....	14
4.3.3.4 Conformance.....	14
4.3.4 Peak e.i.r.p. spectral density.....	14
4.3.4.1 Applicability.....	14
4.3.4.2 Description .....	14
4.3.4.3 Limits .....	14
4.3.4.4 Conformance.....	15
4.3.5 Transmitter unwanted emissions (TXUE) .....	15
4.3.5.1 Applicability.....	15
4.3.5.2 Description .....	15
4.3.5.3 Limits .....	15
4.3.5.4 Conformance.....	16
4.3.6 Antenna requirements .....	16
4.3.6.1 Applicability.....	16
4.3.6.2 Description .....	16
4.3.6.3 Limits .....	17
4.3.6.4 Conformance.....	17
4.3.7 Mitigation techniques .....	17
4.3.7.1 General .....	17
4.3.7.2 Adaptive power control (APC) .....	18
4.3.7.2.1 Applicability .....	18
4.3.7.2.2 Description .....	18
4.3.7.2.3 Limits .....	18
4.3.7.2.4 Conformance .....	18

4.3.7.3	Duty cycle over signal repetition period (DC_Trep).....	18
4.3.7.3.1	Applicability.....	18
4.3.7.3.2	Description.....	18
4.3.7.3.3	Limits.....	19
4.3.7.3.4	Conformance.....	19
4.3.7.4	Frequency Domain Mitigation (FDM).....	19
4.3.7.4.1	Applicability.....	19
4.3.7.4.2	Description.....	19
4.3.7.4.3	Limits.....	20
4.3.7.4.4	Conformance.....	20
4.3.8	TX-behaviour under the complete environmental profile.....	20
4.3.8.1	Applicability.....	20
4.3.8.2	Description.....	20
4.3.8.3	Limits.....	21
4.3.8.3.1	Limits for radiated assessment of the TX behaviour.....	21
4.3.8.3.2	Limits for conducted assessment of the TX behaviour.....	21
4.3.8.4	Conformance.....	21
4.4	Receiver Requirements.....	21
4.4.1	General.....	21
4.4.2	Wanted performance criteria.....	21
4.4.3	Receiver Baseline Sensitivity (RBS).....	21
4.4.3.1	Applicability.....	21
4.4.3.2	Description.....	21
4.4.3.3	Limits.....	22
4.4.3.4	Conformance.....	22
4.4.4	Receiver Baseline Resilience (RBR).....	22
4.4.4.1	Applicability.....	22
4.4.4.2	Description.....	22
4.4.4.3	Limits.....	23
4.4.4.4	Conformance.....	23
5	Testing for compliance with technical requirements.....	23
5.1	Environmental conditions for testing.....	23
5.1.1	General.....	23
5.1.2	Normal test conditions.....	23
5.1.3	Complete environmental profile test conditions.....	24
5.2	General conditions for testing.....	24
5.3	Conformance test suites.....	24
5.4	Conformance test methods of measurement for transmitter.....	24
5.4.1	Operating Frequency Range (OFR).....	24
5.4.2	Mean e.i.r.p. spectral density.....	24
5.4.3	Peak e.i.r.p. spectral density.....	25
5.4.4	Transmitter Unwanted Emissions (TXUE).....	25
5.4.4.1	General.....	25
5.4.4.2	Transmitter Unwanted Emissions in the Out-Of-Band (OOB) domain.....	25
5.4.4.3	Transmitter Unwanted Emissions in the spurious domain.....	26
5.4.5	Antenna parameters.....	27
5.4.5.1	General.....	27
5.4.5.2	Conformance test for AUTs with antenna connector.....	27
5.4.5.3	Conformance test for integral AUTs without antenna connector.....	27
5.4.5.4	Antenna gain for integral AUTs without antenna connector.....	27
5.4.6	Adaptive Power Control (APC).....	28
5.4.6.1	General.....	28
5.4.6.2	Radiated test setup for EUTs without antenna connector.....	28
5.4.6.3	Conducted test setup for EUTs with antenna connector.....	29
5.4.7	Duty cycle over signal repetition period.....	30
5.4.8	Frequency domain mitigation.....	30
5.4.9	TX behaviour under the complete environmental profile.....	30
5.4.9.1	General.....	30
5.4.9.2	EUT without antenna connector.....	31
5.4.9.3	EUT with antenna connector.....	31
5.5	Conformance test methods of measurement for receiver.....	31

5.5.1	General.....	31
5.5.2	Receiver Baseline Sensitivity (RBS) .....	31
5.5.2.1	Radiated test setup for EUTs without antenna connector.....	31
5.5.2.2	Conducted test setup for EUTs with antenna connector.....	32
5.5.2.3	Test procedure.....	33
5.5.3	Receiver Baseline Resilience (RBR) .....	33
5.5.3.1	Test setups for EUTs providing no access to the receiver noise level.....	33
5.5.3.1.1	Radiated test setup for EUTs without antenna connector.....	33
5.5.3.1.2	Conducted test setup for EUTs with antenna connector .....	35
5.5.3.1.3	Test procedure .....	36
5.5.3.2	Test setups for EUTs providing access to the receiver noise level.....	37
5.5.3.2.1	General .....	37
5.5.3.2.2	Test procedure .....	37
<b>Annex A (informative):</b>	<b>Relationship between the present document and the essential requirements of Directive 2014/53/EU .....</b>	<b>39</b>
<b>Annex B (informative):</b>	<b>Selection of technical parameters .....</b>	<b>41</b>
<b>Annex C (normative):</b>	<b>Test scenarios for receiver parameters measurements .....</b>	<b>43</b>
C.1	Introduction .....	43
C.2	Definition of the real scenario .....	43
C.3	Derivation of the radiated equivalent scenario .....	44
C.4	Evaluation of the Radar Cross Section (RCS) of standard radar targets .....	44
<b>Annex D (normative):</b>	<b>Interferer signals for receiver baseline resilience .....</b>	<b>45</b>
D.1	General .....	45
D.2	Interferer within the OFR .....	45
D.3	Interferer outside of the OFR .....	45
<b>Annex E (informative):</b>	<b>Installation requirements.....</b>	<b>46</b>
<b>Annex F (informative):</b>	<b>Range of modulation schemes.....</b>	<b>48</b>
F.1	Pulse modulation schemes.....	48
F.2	FMCW modulation schemes .....	48
<b>Annex G (informative):</b>	<b>Bibliography.....</b>	<b>49</b>
<b>Annex H (informative):</b>	<b>Change history .....</b>	<b>50</b>
History .....		51

---

# Intellectual Property Rights

## Essential patents

IPRs essential or potentially essential to normative deliverables may have been declared to ETSI. The declarations pertaining to these essential IPRs, if any, are publicly available for **ETSI members and non-members**, and can be found in ETSI SR 000 314: "*Intellectual Property Rights (IPRs); Essential, or potentially Essential, IPRs notified to ETSI in respect of ETSI standards*", which is available from the ETSI Secretariat. Latest updates are available on the [ETSI IPR online database](#).

Pursuant to the ETSI Directives including the ETSI IPR Policy, no investigation regarding the essentiality of IPRs, including IPR searches, has been carried out by ETSI. No guarantee can be given as to the existence of other IPRs not referenced in ETSI SR 000 314 (or the updates on the ETSI Web server) which are, or may be, or may become, essential to the present document.

## Trademarks

The present document may include trademarks and/or tradenames which are asserted and/or registered by their owners. ETSI claims no ownership of these except for any which are indicated as being the property of ETSI, and conveys no right to use or reproduce any trademark and/or tradename. Mention of those trademarks in the present document does not constitute an endorsement by ETSI of products, services or organizations associated with those trademarks.

**DECT™**, **PLUGTESTS™**, **UMTS™** and the ETSI logo are trademarks of ETSI registered for the benefit of its Members. **3GPP™**, **LTE™** and **5G™** logo are trademarks of ETSI registered for the benefit of its Members and of the 3GPP Organizational Partners. **oneM2M™** logo is a trademark of ETSI registered for the benefit of its Members and of the oneM2M Partners. **GSM®** and the GSM logo are trademarks registered and owned by the GSM Association.

---

# Foreword

This final draft Harmonised European Standard (EN) has been produced by ETSI Technical Committee Electromagnetic compatibility and Radio spectrum Matters (ERM), and is now submitted for the Vote phase of the ETSI Standardisation Request deliverable Approval Procedure (SRdAP).

The present document has been prepared under the Commission's standardisation request C(2015) 5376 final [i.2] to provide one voluntary means of conforming to the essential requirements of Directive 2014/53/EU] on the harmonisation of the laws of the Member States relating to the making available on the market of radio equipment and repealing Directive 1999/5/EC [i.1].

Once the present document is cited in the Official Journal of the European Union under that Directive, compliance with the normative clauses of the present document given in Table A.1 confers, within the limits of the scope of the present document, a presumption of conformity with the corresponding essential requirements of that Directive and associated EFTA regulations.

The present document is part 1 of a multi-part deliverable covering Short Range Devices (SRD) using Ultra Wide Band technology (UWB); Harmonised standard for access to radio spectrum, as identified below:

- Part 1: "Level Probing Radar (LPR) equipment operating in the frequency ranges 6 GHz to 8,5 GHz, 24,05 GHz to 26,5 GHz, 57 GHz to 64 GHz, 75 GHz to 85 GHz for strictly vertical downward installation";**
- Part 2: "Level Probing Radar (LPR) equipment operating in the frequency range 75 GHz to 85 GHz for tilted downward installation".

<b>Proposed national transposition dates</b>	
Date of latest announcement of this EN (doa):	3 months after ETSI publication
Date of latest publication of new National Standard or endorsement of this EN (dop/e):	6 months after doa
Date of withdrawal of any conflicting National Standard (dow):	18 months after doa

---

## Modal verbs terminology

In the present document "**shall**", "**shall not**", "**should**", "**should not**", "**may**", "**need not**", "**will**", "**will not**", "**can**" and "**cannot**" are to be interpreted as described in clause 3.2 of the [ETSI Drafting Rules](#) (Verbal forms for the expression of provisions).

"**must**" and "**must not**" are **NOT** allowed in ETSI deliverables except when used in direct citation.

---

## Introduction

ETSI ERM TGUWB decided to develop more specific standards; this means instead of one generic ETSI EN 302 729 [i.13] for all Level Probing Radar (LPR) devices, a multi-part deliverable was initiated in order to reflect the intended use in relation to different aspects of the corresponding regulation ECC Decision (11)02 [i.3].

Part 1 of the multi-part deliverable covers the original provisions made in ECC Decision (11)02 [i.3] of 11 March 2011 for LPR equipment with strictly vertical downward installation (see ECC Decision (11)02 [i.3], first four lines of Table 1 for strictly vertical antenna orientation).

Part 2 of the multi-part deliverable covers the amendments made in ECC Decision (11)02 [i.3] on 5 July 2019 for LPR equipment with tilted downward installation (see ECC Decision (11)02 [i.3], last three lines of Table 1 for tilted antenna orientation).

Due to the amendment of ECC Decision (11)02 [i.3] on 5 July 2019, ETSI ERM TGUWB decided to follow henceforth a two part structure and to only reflect the amendments made in 2019 in part 2 of the series.

More information on the conducted changes in previous versions of the present document can be found in the change history in Annex H.

---

# 1 Scope

The present document specifies technical requirements, limits and test methods for Level Probing Radar (LPR) equipment operating in the frequency ranges 6 GHz to 8,5 GHz, 24,05 GHz to 26,5 GHz, 57 GHz to 64 GHz, 75 GHz to 85 GHz for strictly vertical downward installation in outdoor as well as indoor environments.

Level Probing Radars in the scope of the present document consist of a combined transmitter and receiver and are equipped with an integral or dedicated antenna provided also by the EUT manufacturer. EUTs intended to be equipped with antennas from third-party manufacturers are not covered by the scope of the present document.

LPR equipment and the related categorization is further specified in clause 4.2.

NOTE: The relationship between the present document and essential requirements of article 3.2 of Directive 2014/53/EU [i.1] is given in Annex A.

---

## 2 References

### 2.1 Normative references

References are either specific (identified by date of publication and/or edition number or version number) or non-specific. For specific references, only the cited version applies. For non-specific references, the latest version of the referenced document (including any amendments) applies.

Referenced documents which are not found to be publicly available in the expected location might be found at [ETSI docbox](#).

NOTE: While any hyperlinks included in this clause were valid at the time of publication, ETSI cannot guarantee their long term validity.

The following referenced documents are necessary for the application of the present document.

- [1] [ETSI EN 303 883-1 \(V2.1.1\) \(08-2024\)](#): "Short Range Devices (SRD) and Ultra Wide Band (UWB); Part 1: Measurement techniques for transmitter requirements".
- [2] [ETSI EN 303 883-2 \(V2.1.1\) \(08-2024\)](#): "Short Range Devices (SRD) and Ultra Wide Band (UWB); Part 2: Measurement techniques for receiver requirements".
- [3] [ETSI TS 103 789 \(V1.1.1\) \(05-2023\)](#): "Short Range Devices (SRD) and Ultra Wide Band (UWB); Radar related parameters and physical test setup for object detection, identification and RCS measurement".
- [4] [ETSI TS 103 941 \(V1.1.1\) \(01-2024\)](#): "Short Range Devices (SRD) and Ultra Wide Band (UWB); Measurement setups and specifications for testing under full environmental profile (normal and extreme environmental conditions)".

### 2.2 Informative references

References are either specific (identified by date of publication and/or edition number or version number) or non-specific. For specific references, only the cited version applies. For non-specific references, the latest version of the referenced document (including any amendments) applies.

NOTE: While any hyperlinks included in this clause were valid at the time of publication, ETSI cannot guarantee their long term validity.

The following referenced documents are not necessary for the application of the present document but they assist the user with regard to a particular subject area.

- [i.1] [Directive 2014/53/EU](#) of the European Parliament and of the Council of 16 April 2014 on the harmonisation of the laws of the Member States relating to the making available on the market of radio equipment and repealing Directive 1999/5/EC (RE-Directive).



- [i.2] [Commission implementing Decision C\(2015\) 5376](#) final of 4.8.2015 on a standardisation request to the European Committee for Electrotechnical Standardisation and to the European Telecommunications Standards Institute as regards radio equipment in support of Directive 2014/53/EU of the European Parliament and of the Council.
- [i.3] [ECC Decision \(11\)02](#): "ECC Decision of 11 March 2011 and amended on 5 July 2019 on industrial Level Probing Radars (LPR) operating in frequency bands 6-8.5 GHz, 24.05-26.5 GHz, 57-64 GHz and 75-85 GHz".
- [i.4] [ECC Report 139](#): "Impact of Level Probing Radars Using Ultra-Wideband Technology on Radiocommunications Services", Rottach-Egern, February 2010.
- [i.5] [CEPT ERC Recommendation 74-01 \(May 2022\)](#): "Unwanted emissions in the spurious domain".
- [i.6] ETSI TR 102 601 V1.1.1 (12-2007): "Electromagnetic compatibility and Radio spectrum Matters (ERM); System reference document; Short Range Devices (SRD); Equipment for Detecting Movement using Ultra Wide Band (UWB) radar sensing technology; Level Probing Radar (LPR)-sensor equipment operating in the frequency bands 6 GHz to 8,5 GHz; 24,05 GHz to 26,5 GHz; 57 GHz to 64 GHz and 75 GHz to 85 GHz".
- [i.7] [Commission Implementing Decision \(EU\) 2022/180 of 8 February 2022](#) amending Decision 2006/771/EC as regards the update of harmonised technical conditions in the area of radio spectrum use for short-range devices (notified under document C(2022) 644) (Text with EEA relevance).
- [i.8] [Committee on Radio Astronomy Frequencies, European Science Foundation](#).
- [i.9] [IEC 61298-2:2008](#): "Process measurement and control devices - General methods and procedures for evaluating performance - Part 2: Tests under reference conditions".
- [i.10] ETSI EG 203 336 (V1.2.1) (05-2020): "Guide for the selection of technical parameters for the production of Harmonised Standards covering article 3.1(b) and article 3.2 of Directive 2014/53/EU".
- [i.11] ETSI TS 103 567 (V1.1.1) (09-2019): "Requirements on signal interferer handling".
- [i.12] ETSI TS 103 361 (V1.1.1) (03-2016): "Short Range Devices (SRD) using Ultra Wide Band technology (UWB); Receiver technical requirements, parameters and measurement procedures to fulfil the requirements of the Directive 2014/53/EU".
- [i.13] ETSI EN 302 729 (all parts): "Short Range Devices (SRD) using Ultra Wide Band technology (UWB); Harmonised standard for access to radio spectrum".

---

## 3 Definition of terms, symbols and abbreviations

### 3.1 Terms

For the purposes of the present document, the terms given in ETSI EN 303 883-1 [1], ETSI EN 303 883-2 [2] and the following apply:

**Adaptive Power Control (APC):** automatic mechanism to reduce interference to other radio services and applications

NOTE 1: APC basically regulates the transmitter power based on the available signal-to-noise ratio of the current Rx-signal in order to reduce the emissions.

NOTE 2: The Adaptive Power Control (APC) is sometimes also called transmit power control.

**Duty Cycle over measurement period (DC\_T<sub>on</sub>):** ratio of the sum of all the pulse durations  $t_{\text{pulse}}$  within the active measurement period  $T_{\text{on}}$

**Duty Cycle over signal repetition period (DC\_T<sub>rep</sub>):** ratio of the sum of all active measurement periods  $T_{\text{on}}$  (bursts, sweeps, scans) within the signal repetition period  $T_{\text{rep}}$

**Equipment Under Test (EUT):** Level Probing Radar (LPR) under test

**Frequency Modulated Continuous Wave (FMCW) radar:** modulation scheme based on a periodically linear frequency sweep of the transmit signal

NOTE: See ETSI EN 303 883-1 [1], clause C.2.2.

**pulsed radar (or here simply "pulsed LPR"):** modulation scheme based on a periodically transmission of short RF pulses

NOTE: See ETSI EN 303 883-1 [1], clause C.2.1.

**radiation:** signals emitted intentionally for level measurements

**step response time (of an LPR):** time span after a sudden distance change until the output value (distance value) reaches 90 % of the final value for the first time

## 3.2 Symbols

For the purposes of the present document, the following symbols apply:

$t_{\text{pulse}}$  pulse duration time in pulsed radar modulation schemes and dwell time or sweep time for FMCW modulation schemes

## 3.3 Abbreviations

For the purposes of the present document, the abbreviations given in ETSI EN 303 883-1 [1], ETSI EN 303 883-2 [2] and the following apply:

APC	Adaptive Power Control
AUT	Antenna Under Test
DC	Duty Cycle
e.i.r.p.	equivalent isotropically radiated power
EC	European Commission
ECC	Electronic Communication Committee
EFTA	European Free Trade Union
ERC	European Radiocommunication Committee
EU	European Union
EUT	Equipment Under Test
FMCW	Frequency Modulated Continuous Wave
HPBW	Half Power BeamWidth
HPLPR	High Power Level Probing Radar
IEC	International Electrotechnical Commission
ITU-R	International Telecommunication Union - Radio sector
LPR	Level Probing Radar
LPLPR	Low Power Level Probing Radar
OFR	Operating Frequency Range
OOB	Out-Of-Band
RB	Reference Bandwidth
RBW	Resolution Bandwidth
RCS	Radar Cross Section
RF	Radio Frequency
RX	Receiver
SFCW	Stepped Frequency Continuous Wave
SNR	Signal to Noise Ratio
SRD	Short Range Device
TX	Transmitter
UK	United Kingdom
UWB	Ultra-Wideband
VBW	Video Bandwidth

---

## 4 Technical requirements specifications

### 4.1 Environmental profile

The technical requirements of the present document apply under the environmental profile for operation of the equipment, which shall be in accordance with its intended use, but as a minimum, shall be that specified in the test conditions contained in the present document. The equipment shall comply with all the technical requirements of the present document at all times when operating within the boundary limits of the operational environmental profile defined by its intended use.

### 4.2 EUT categories

#### 4.2.1 General

Technical and regulatory requirements for Level Probing Radars are provided in general in European Commission Implementing Decision (EU) 2022/180 [i.7] and ECC Decision (11)02 [i.3], which are based on ECC Report 139 [i.4]. The present document covers only the essential technical requirements set out in the first four rows in Table 1 of ECC Decision (11)02 [i.3] for LPR equipment using a strictly vertical downward orientation of the EUT antenna.

In addition, the manufacturer needs to consider further installation requirements as specified in Annex E and will have to provide this information to the user/installer. These installation requirements, however, are not subject to Annex A of the present document.

Receive-only devices, EUTs exhibiting a receive only mode or a standby mode are not covered by the scope of the present document.

A further sub-categorization of this LPR device category has been conducted based on:

- the output power, see clause 4.2.2;
- the used Operating Frequency Range (OFR), see clause 4.2.3;
- the used antenna connection, see clause 4.2.4.

The environmental conditions for testing are specified in clause 5.1.

#### 4.2.2 Categorization by output power

The following sub-categorization of LPR EUTs by the output power is used:

- LP1: EUT is a low power LPR (LPLPR) device;
- LP2: EUT is a high power LPR (HPLPR) device.

More information on LP1 and LP2 devices can be found in clause 4.3.7.1.

**NOTE:** The LP1 category considers a reduced mean and peak power limit by 20 dB compared to ECC Decision (11)02 [i.3]. This reduction of transmit power is equivalent to the use of a mitigation technique as described in clause 4.3.7 and therefore no additional mitigation measures are necessary for the LP1 category.

#### 4.2.3 Categorization by Operating Frequency Range (OFR)

The following sub-categorization of LPR EUTs by the operating frequency range is used:

- OFR1: OFR of the EUT is contained in the frequency range 6 GHz to 8,5 GHz;
- OFR2: OFR of the EUT is contained in the frequency range 24,05 GHz to 26,5 GHz;

- OFR3: OFR of the EUT is contained in the frequency range 57 GHz to 64 GHz;
- OFR4: OFR of the EUT is contained in the frequency range 75 GHz to 85 GHz.

This categorization has been conducted, reflecting the different permitted frequency ranges which can be used for Level Probing Radars in accordance with European Commission Implementing Decision (EU) 2022/180 [i.7] and ECC Decision (11)02 [i.3].

#### 4.2.4 Categorization by antenna connection

The following sub-categorization of LPR EUTs by the antenna connection is used:

- ANT1: EUT features an antenna connector, e.g. the EUT is equipped with a dedicated antenna;
- ANT2: EUT has no antenna connector, e.g. the EUT is equipped with an integral antenna.

#### 4.2.5 Summary of LPR sub-categories

An overview of the applicability of transmitter requirements and receiver requirements for the different LPR sub-categories is shown in Table 1 and Table 2, respectively.

**Table 1: Applicability of transmitter requirements for the different LPR sub-categories**

TX requirements	Clause	Categorization by sub-category		
		output power	operating frequency range	antenna connection
		LP1 and LP2	OFR1 to OFR4	ANT1 and ANT2
Operating frequency range	4.3.2	applicable to any category (LP1 and LP2)	applicable to any category (OFR1 to OFR4)	applicable to any category (ANT1 and ANT2)
Mean e.i.r.p. spectral density	4.3.3			
Peak e.i.r.p. spectral density	4.3.4			
Transmitter Unwanted Emissions (TXUE)	4.3.5			
Antenna requirements	4.3.6			
Mitigation techniques	4.3.7.1	only applicable to category LP2 (HPLPR)	applicable to any category (OFR1 to OFR4) only if the EUT is categorized as LP2 (HPLPR)	applicable to any category (ANT1 and ANT2) only if the EUT is categorized as LP2 (HPLPR)

**Table 2: Applicability of receiver requirements for the different LPR sub-categories**

RX requirements	Clause	Categorization by sub-category		
		output power	operating frequency range	antenna connection
		LP1 and LP2	OFR1 to OFR4	ANT1 and ANT2
Receiver Baseline Sensitivity (RBS)	4.4.3	applicable to any category (LP1 and LP2)	applicable to any category (OFR1 to OFR4)	applicable to any category (ANT1 and ANT2)
Receiver Baseline Resilience (RBR)	4.4.4			

The manufacturer shall indicate which LPR category (LPR1 to LPR16) applies to the available EUT (see Table 3). Only one category shall apply for each EUT.

**Table 3: LPR categories based on the sub-categories listed in clause 4.2.1**

LPR category	Categorization by sub-category		
	output power	operating frequency range	antenna connection
LPR1	LP1	OFR1	ANT1
LPR2	LP1	OFR1	ANT2
LPR3	LP1	OFR2	ANT1
LPR4	LP1	OFR2	ANT2
LPR5	LP1	OFR3	ANT1
LPR6	LP1	OFR3	ANT2
LPR7	LP1	OFR4	ANT1
LPR8	LP1	OFR4	ANT2
LPR9	LP2	OFR1	ANT1
LPR10	LP2	OFR1	ANT2
LPR11	LP2	OFR2	ANT1
LPR12	LP2	OFR2	ANT2
LPR13	LP2	OFR3	ANT1
LPR14	LP2	OFR3	ANT2
LPR15	LP2	OFR4	ANT1
LPR16	LP2	OFR4	ANT2

## 4.3 Transmitter Requirements

### 4.3.1 General

The transmitter requirements for EUT covered by the scope of the present document are justified in Table B.1.

### 4.3.2 Operating Frequency Range (OFR)

#### 4.3.2.1 Applicability

The Operating Frequency Range (OFR) requirement applies to all LPR categories as specified in Table 3.

#### 4.3.2.2 Description

The operating frequency range is described in ETSI EN 303 883-1 [1], clause 5.2. According to this description, a value of 20 dB shall be used for the parameter X.

#### 4.3.2.3 Limits

The OFR (all frequencies between  $f_L$  and  $f_H$ ) shall be within one of the permitted frequency ranges (see Table 4).

**Table 4: Permitted frequency ranges for the different level probing radar (LPR) categories**

Mode of operation	LPR category	Frequency range
Transmit and receive	LPR1, LPR2, LPR9, LPR10	6 GHz $\leq$ f $\leq$ 8,5 GHz
Transmit and receive	LPR3, LPR4, LPR11, LPR12	24,05 GHz $\leq$ f $\leq$ 26,5 GHz
Transmit and receive	LPR5, LPR6, LPR13, LPR14	57 GHz $\leq$ f $\leq$ 64 GHz
Transmit and receive	LPR7, LPR8, LPR15, LPR16	75 GHz $\leq$ f $\leq$ 85 GHz

NOTE: The permitted frequency ranges are based on ECC Decision (11)02 [i.3], Annex 1, Table 1.

#### 4.3.2.4 Conformance

The conformance test for the OFR shall be as defined in clause 5.4.1 and shall be done under normal conditions as defined in clause 5.1.2.

### 4.3.3 Mean e.i.r.p. spectral density

#### 4.3.3.1 Applicability

The mean e.i.r.p. spectral density requirement applies to all LPR categories as specified in Table 3.

#### 4.3.3.2 Description

The mean e.i.r.p. spectral density is described in ETSI EN 303 883-1 [1], clause 5.3.2.

#### 4.3.3.3 Limits

Within the OFR, the mean e.i.r.p. spectral density shall not exceed the limits in Table 5.

**Table 5: Mean e.i.r.p. spectral density limits**

LPR category	Maximum mean e.i.r.p. spectral density (within the antenna main beam)
LPR1, LPR2	-53 dBm/MHz
LPR9, LPR10	-33 dBm/MHz
LPR3, LPR4	-34 dBm/MHz
LPR11, LPR12	-14 dBm/MHz
LPR5, LPR6	-22 dBm/MHz
LPR13, LPR14	-2 dBm/MHz
LPR7, LPR8	-23 dBm/MHz
LPR15, LPR16	-3 dBm/MHz

#### 4.3.3.4 Conformance

The conformance test for mean e.i.r.p. spectral density shall be as defined in clause 5.4.2 and shall be done under normal conditions as defined in clause 5.1.2.

### 4.3.4 Peak e.i.r.p. spectral density

#### 4.3.4.1 Applicability

The peak e.i.r.p. spectral density requirement applies to all LPR categories as specified in Table 3.

#### 4.3.4.2 Description

The peak e.i.r.p. spectral density is described in ETSI EN 303 883-1 [1], clause 5.3.4.1.

#### 4.3.4.3 Limits

Within the OFR, the peak e.i.r.p. spectral density shall not exceed the limits in Table 6.

**Table 6: Peak e.i.r.p. spectral density limits**

LPR category	Maximum peak e.i.r.p. (measured in 50 MHz within the antenna main beam)
LPR1, LPR2	-13 dBm
LPR9, LPR10	7 dBm
LPR3, LPR4	6 dBm
LPR11, LPR12	26 dBm
LPR5, LPR6	15 dBm
LPR13, LPR14	35 dBm
LPR7, LPR8	14 dBm
LPR15, LPR16	34 dBm

#### 4.3.4.4 Conformance

The conformance test for peak e.i.r.p. spectral density shall be as defined in clause 5.4.3 and shall be done under normal conditions as defined in clause 5.1.2.

### 4.3.5 Transmitter unwanted emissions (TXUE)

#### 4.3.5.1 Applicability

The transmitter unwanted emissions (TXUE) requirement applies to all LPR categories as specified in Table 3.

#### 4.3.5.2 Description

The transmitter unwanted emissions are described in ETSI EN 303 883-1 [1], clause 5.5.1. According to this description, a value of 250 % shall be used for the parameter  $X_{TXUE}$  in order to define the boundaries  $f_{LS}$  and  $f_{HS}$  between the Out-Of-Band (OOB) domain and the spurious domain.

#### 4.3.5.3 Limits

The transmitter unwanted emissions (TXUE) for LPR equipment operating in the frequency range 6 to 8,5 GHz (EUT sub-category OFR1) shall not exceed the limits in Table 7. LPR equipment operating in the remaining frequency ranges 24,05 to 26,5 GHz, 57 to 64 GHz and 75 to 85 GHz (EUT sub-categories OFR2, OFR3 and OFR4), shall not exceed the limits indicated in Table 8 for the out-of-band domain and in Table 9 for the spurious domain.

NOTE: For LPR operating in the frequency range 6 GHz to 8,5 GHz (EUT sub-category OFR1) no distinction between the out-of-band domain and spurious domain is made since ECC Decision (11)02 [i.3] provides a complete limit mask for the OOB and spurious domain (see Table 7 and ECC/DEC(11)02 Table 2). For the other equipment categories, there is a clear distinction between the OOB and spurious domain. The limits are provided in Table 8 for the OOB domain (based on ECC/DEC(11)02, Annex 1, Note 5) and in Table 9 for the spurious domain (based on CEPT ERC Recommendation 74-01 [i.5], Annex 2).

**Table 7: Transmitter unwanted emissions limits for LPR categories LPR1, LPR2, LPR9, LPR10 according to ECC Decision (11)02 [i.3]**

Frequency range	Maximum mean e.i.r.p. spectral density
$30 \text{ MHz} \leq f \leq 1,73 \text{ GHz}$	-63 dBm/MHz
$1,73 \text{ GHz} < f \leq 2,7 \text{ GHz}$	-58 dBm/MHz
$2,7 \text{ GHz} < f \leq 5 \text{ GHz}$	-48 dBm/MHz
$5 \text{ GHz} < f < 6 \text{ GHz}$	-43 dBm/MHz
$8,5 \text{ GHz} < f \leq 10,6 \text{ GHz}$	-43 dBm/MHz
$10,6 \text{ GHz} < f \leq 26 \text{ GHz}$	-63 dBm/MHz

**Table 8: Transmitter unwanted emissions limits in the Out-Of-Band (OOB) domain for LPR categories LPR3, LPR4, LPR5, LPR6, LPR7, LPR8, LPR11, LPR12, LPR13, LPR14, LPR15, LPR16 according to ECC Decision (11)02 [i.3]**

LPR category	Maximum mean e.i.r.p. spectral density
LPR3, LPR4, LPR11, LPR12	-34 dBm/MHz Inside the "passive band" $23,6 \text{ GHz} \leq f \leq 24,0 \text{ GHz}$ : -44 dBm/MHz
LPR5, LPR6, LPR13, LPR14	-22 dBm/MHz
LPR7, LPR8, LPR15, LPR16	-23 dBm/MHz

**Table 9: Transmitter unwanted emissions limits in the spurious domain for LPR categories LPR3, LPR4, LPR5, LPR6, LPR7, LPR8, LPR11, LPR12, LPR13, LPR14, LPR15, LPR16 according to CEPT ERC Recommendation 74-01 [i.5]**

LPR category	Frequency range	Limit values for TXUE/RB (note)
LPR3, LPR4, LPR5, LPR6, LPR7, LPR8, LPR11, LPR12, LPR13, LPR14, LPR15, LPR16	$87,5 \text{ MHz} \leq f \leq 118 \text{ MHz}$	-54 dBm/100 kHz
	$174 \text{ MHz} \leq f \leq 230 \text{ MHz}$	-54 dBm/100 kHz
	$470 \text{ MHz} \leq f \leq 694 \text{ MHz}$	-54 dBm/100 kHz
	otherwise in band $30 \text{ MHz} \leq f \leq 1\,000 \text{ MHz}$	-36 dBm/100 kHz
	$1\,000 \text{ MHz} < f \leq F_{\text{UPPER}}$ (see Table 10)	-30 dBm/1 MHz
NOTE: Only applicable in the spurious domain (see clause 4.3.5.2).		

**Table 10: Upper frequency boundary for the spurious domain based on the EUT Operating Frequency Range (OFR) according to CEPT ERC Recommendation 74-01 [i.5]**

LPR category	Frequency range which contains the OFR of the EUT (defined by $f_L$ and $f_H$ ) (note)	Upper frequency ( $F_{\text{UPPER}}$ )
LPR1, LPR2, LPR9, LPR10	$5,2 \text{ GHz} \leq f < 13 \text{ GHz}$	26 GHz
LPR3, LPR4, LPR5, LPR6, LPR7, LPR8, LPR11, LPR12, LPR13, LPR14, LPR15, LPR16	$13 \text{ GHz} \leq f < 150 \text{ GHz}$	2 <sup>nd</sup> harmonic (note)
NOTE: For $F_{\text{UPPER}}$ the value of $f_H$ shall be used ( $f_H$ is the upper edge of the Operating Frequency Range (OFR), which is assessed in clause 4.3.2).		

#### 4.3.5.4 Conformance

The conformance test for Transmitter Unwanted Emissions (TXUE) shall be as defined in clause 5.4.4.2 for the out-of-band domain and clause 5.4.4.3 for the spurious domain and shall be done under normal conditions as defined in clause 5.1.2.

#### 4.3.6 Antenna requirements

##### 4.3.6.1 Applicability

The antenna requirements apply to all LPR categories as specified in Table 3.

##### 4.3.6.2 Description

ECC Decision (11)02 [i.3], Table 1 includes requirements for the following antenna parameters:

- Maximum antenna beamwidth in degrees, which is defined as the half power beamwidth (HPBW, i.e. -3 dB beamwidth) relative to the maximum antenna gain in the main beam direction. The antenna beamwidth is sometimes also referred to as the total opening angle.
- Sidelobe suppression in elevation angles above 60° relative to the maximum antenna gain in main beam direction.

NOTE 1: The maximum antenna beamwidth and the sidelobe suppression in elevation angles above 60° (see Table 11) are limited to ensure compliance with the maximum mean e.i.r.p. spectral density requirements in horizontal directions of the LPR installation as studied in ECC Report 139 [i.4] (also refer to the note in Table 11 of the present document).

NOTE 2: According to ECC Decision (11)02 [i.3] the equipment in the scope of the present document is limited to a strictly vertical downward orientation of the EUT antenna main beam. This requirement of the use and installation of the equipment is not in the scope of the present document. However, the manufacturer should provide a clear guidance in the user manual on how the equipment is properly operated and installed.



### 4.3.6.3 Limits

The Half Power Beamwidth (HPBW) and side lobe suppression of LPR antennas shall not exceed the limits in Table 11.

**Table 11: Maximum half power beamwidth (HPBW) and side lobe suppression**

LPR category	Maximum half power beamwidth -3 dB beamwidth) (in degree)	Antenna sidelobe suppression relative to the main beam gain in elevation angles above 60° (note)
LPR1, LPR2, LPR9, LPR10	12°	25 dB
LPR3, LPR4, LPR11, LPR12	12°	30 dB
LPR5, LPR6, LPR13, LPR14	8°	35 dB
LPR7, LPR8, LPR15, LPR16	8°	39 dB

NOTE: These sidelobe suppression limits are equivalent to a maximum antenna gain of -10 dBi in angles above 60° relative to the main beam direction using the typical antenna gains for the different frequency bands which have been defined in ECC Report 139 [i.4], Table 2.5.

### 4.3.6.4 Conformance

The conformance tests for antenna requirements shall be as defined in clause 5.4.5 and shall be done under normal conditions as defined in clause 5.1.2.

## 4.3.7 Mitigation techniques

### 4.3.7.1 General

Level probing radars sub-categorized as LP2 (see clause 4.2.2 and Table 3), which exhibit higher transmit power levels for the mean e.i.r.p. spectral density as well as for the peak e.i.r.p. spectral density, are denoted as High Power Level Probing Radars (HPLPR). The corresponding limits for these devices are depicted in Table 5 and Table 6. These potential emission levels require high power level probing radars to implement at least one of the mitigation techniques listed below and outlined in the following clauses 4.3.7.2 to 4.3.7.4 in order to reduce the interference potential towards other spectrum users by decreasing the mean e.i.r.p. spectral density of the level probing radar under test by at least 20 dB.

The following mitigation techniques are distinguished for LPRs:

- Adaptive Power Control (APC), see clause 4.3.7.2;
- Duty Cycle over signal repetition period ( $DC_{T_{rep}}$ ), see clause 4.3.7.3;
- Frequency Domain Mitigation (FDM), see clause 4.3.7.4.

NOTE 1: According to ECC Decision (11)02 [i.3], Annex 2 it is required that "*LPR devices to be operated under license-exempt conditions shall include technical provisions to limit the radiation in all directions regardless of the installation heights and reflecting material below the LPR. A practical technical solution to achieve this is to have Adaptive Power Control (APC) implemented with a dynamic range of at least about 20 dB or an equivalent mitigation technique. The APC function for tilted operation shall provide the same mitigation control of sideways and vertical reflections as for LPR devices, which point directly downward. APC as well as equivalent techniques for LPR devices, are described in the Harmonised European Standard ETSI EN 302 729*".

The mitigation techniques APC,  $DC_{T_{rep}}$ , and FDM, when implemented in the EUT, may be combined in order to obtain an overall reduction of the mean e.i.r.p. spectral density by at least 20 dB. For all the sub-categories of LPRs covered by the present document except for LP1, the combination of the mitigation techniques shall be calculated as the sum of the individual mitigation factors in positive dB-values and shall be equal or more than 20 dB:

$$Mitigation^{dB} = APC^{dB} + DC_{T_{rep}}^{dB} + FDM^{dB} \geq 20dB \quad (1)$$

where:

- Mitigation<sup>dB</sup> is the overall mitigation factor (in dB) of the EUT.
- APC<sup>dB</sup> is the mitigation factor (in dB) provided by the adaptive power control function of the EUT.
- DC\_T<sub>rep</sub><sup>dB</sup> is the mitigation factor (in dB) provided by the duty cycle over signal repetition period (DC\_T<sub>rep</sub>) of the EUT.
- FDM<sup>dB</sup> is the mitigation factor (in dB) provided by frequency domain mitigation of the EUT.

NOTE 2: If the assessment for an individual mitigation technique shows that this technique is not implemented in the EUT the corresponding mitigation factor is considered with 0 dB in equation (1) above.

## 4.3.7.2 Adaptive power control (APC)

### 4.3.7.2.1 Applicability

The Adaptive Power Control (APC) requirement applies to LPR categories LPR9, LPR10, LPR11, LPR12, LPR13, LPR14, LPR15, LPR16 only (see clause 4.2.2 and Table 3).

### 4.3.7.2.2 Description

The Adaptive Power Control (APC), sometimes also called transmit power control, is an automatic mechanism to reduce interference to other radio services and applications. The APC basically regulates the transmitter power to reduce emissions. It is controlled by the received power within the total LPR receiver bandwidth. If the signal-to-noise ratio of the currently conducted measurement is sufficiently good, the transmitter power is reduced, and a reliable measurement can be ensured anyway. If the signal-to-noise ratio drops below a certain value, the transmitter power is again increased back to the previous value.

### 4.3.7.2.3 Limits

If APC is the only implemented mitigation technique in the EUT, its dynamic range shall be at least 20 dB.

If there are several mitigation techniques implemented, the combination of mitigation shall be equal or more than 20 dB (see clause 4.3.7.1 equation (1)).

### 4.3.7.2.4 Conformance

The conformance test for Adaptive Power Control (APC) shall be as defined in clause 5.4.6 and shall be done under normal conditions as defined in clause 5.1.2.

## 4.3.7.3 Duty cycle over signal repetition period (DC\_T<sub>rep</sub>)

### 4.3.7.3.1 Applicability

The duty cycle over signal repetition period (DC\_T<sub>rep</sub>) requirement applies to LPR categories LPR9, LPR10, LPR11, LPR12, LPR13, LPR14, LPR15, LPR16 only (see clause 4.2.2 and Table 3).

NOTE: This mitigation technique is an equivalent mitigation technique as mentioned in European Commission Implementing Decision (EU) 2022/180 [i.7], footnote [10] and ECC Decision (11)02 [i.3], Annex 2.

### 4.3.7.3.2 Description

Duty cycle over signal repetition period (DC\_T<sub>rep</sub>) is defined as the ratio of the sum of all active measurement periods T<sub>on</sub> (bursts, sweeps, scans) to the signal repetition period T<sub>rep</sub>, i.e.:

$$DC_{T_{rep}}^{dB} = 10 \times \log_{10} \left( DC_{T_{rep}} \right) = 10 \times \log_{10} \left( \frac{\sum T_{on}}{T_{rep}} \right) \quad (2)$$

where:

- $T_{on}$  is a measurement period when the transmitter of the EUT is active;
- $T_{rep}$  is the overall measurement cycle of the EUT including any off-times of the transmitter.

Duty cycle over signal repetition period is also sometimes referred to as "duty cycle resulting from user" in some sources dealing with UWB devices. This duty cycle usually applies to both, FMCW modulation as well as pulse modulation. Further information on LPR modulation schemes can be found by following the references given in Annex F. A duty cycle of e.g. 1 % represents an interference mitigation of 20 dB.

**EXAMPLE:** A frequency modulated continuous wave Radar (FMCW) transmits two measurement periods  $T_{on} = 20$  ms within an overall repetition period of  $T_{rep} = 100$  ms. The equivalent duty cycle over signal repetition period is  $2 \times 20$  ms/100 ms = 40 %. This is equivalent to a mitigation factor of -3,98 dB (see also Annex F).

#### 4.3.7.3.3 Limits

The duty cycle over signal repetition period ( $DC_{T_{rep}}$ ) when implemented in the EUT as an exclusive mitigation technique, shall be equivalent to at least 20 dB.

If there are several mitigation techniques implemented, the combination of mitigation shall be equal or more than 20 dB (see clause 4.3.7.1 equation (1)).

#### 4.3.7.3.4 Conformance

The conformance test for duty cycle over signal repetition period ( $DC_{T_{rep}}$ ) shall be as defined in clause 5.4.7 and shall be done under normal conditions as defined in clause 5.1.2.

### 4.3.7.4 Frequency Domain Mitigation (FDM)

#### 4.3.7.4.1 Applicability

The Frequency Domain Mitigation (FDM) requirement applies to LPR categories LPR9, LPR10, LPR11, LPR12, LPR13, LPR14, LPR15, LPR16 only (see clause 4.2.2 and Table 3).

**NOTE:** This mitigation technique is an equivalent mitigation technique as mentioned in European Commission Implementing Decision (EU) 2022/180 [i.7], footnote [10] and ECC Decision (11)02 [i.3], Annex 2.

#### 4.3.7.4.2 Description

For virtually all swept modulation schemes, the instantaneous bandwidth of the radar signal is very small, which results in an intrinsic mitigation. The swept band is, therefore, not able to generate simultaneous interferences to victim receivers over the whole OFR over a longer time period.

**EXAMPLE:** A Stepped Frequency Continuous Wave Radar (SFCW) sweeps 1 000 steps within a period of 100 ms. At each step the radar transmits a different frequency with a dwell time of 100  $\mu$ s within a narrow bandwidth of just 1 MHz. For a 10 MHz victim receiver bandwidth, the equivalent frequency domain mitigation is  $10 \times 100$   $\mu$ s/100 ms = 1 %. This is equivalent to a mitigation factor of -20 dB.

The Frequency Domain Mitigation (FDM) shall be assessed using a 10 MHz bandwidth, which represents the virtual victim receiver bandwidth.

The FDM factor is therefore defined as the ratio of the sum of all time periods  $t_{10MHz}$  when the Tx signal falls into the 10 MHz bandwidth of the virtual victim receiver to the sum of all dwell times  $t_{pulse}$  in the active measurement period  $T_{on}$ :

$$FDM^{dB} = 10 \times \log_{10}(FDM) = -10 \times \log_{10} \left( \frac{\sum t_{10MHz}}{\sum t_{pulse}} \right) \quad (3)$$

where:

- $t_{10\text{MHz}}$  is the time duration of the instantaneous Tx signal frequency falling into the virtual victim receiver bandwidth of 10 MHz during the dwell time  $t_{\text{pulse}}$ .

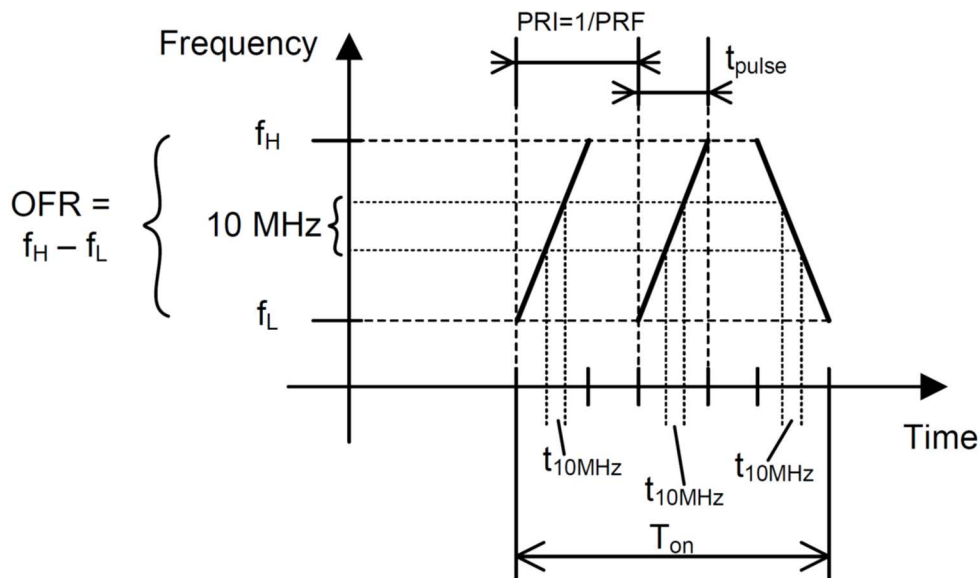

**Figure 1: Definition of FDM in a typical FMCW modulation scheme**

#### 4.3.7.4.3 Limits

If the Frequency Domain Mitigation (FDM) is the only implemented mitigation technique in the EUT, its value calculated according to equation (3) shall be at least 20 dB.

If there are several mitigation techniques implemented, the combination of mitigation shall be equal or more than 20 dB (see clause 4.3.7.1, equation (1)).

#### 4.3.7.4.4 Conformance

The conformance test for frequency domain mitigation shall be as defined in clause 5.4.8 and shall be done under normal conditions as defined in clause 5.1.2.

### 4.3.8 TX-behaviour under the complete environmental profile

#### 4.3.8.1 Applicability

The TX-behaviour under the complete environmental profile requirement applies to all LPR categories as specified in Table 3.

For LPR categories LPR2, LPR4, LPR6, LPR8, LPR10, LPR12, LPR14, LPR16 (radiated assessment as EUT features no antenna connector), the limits in clause 4.3.8.3.1 apply.

For LPR categories LPR1, LPR3, LPR5, LPR7, LPR9, LPR11, LPR13, LPR15 (conducted assessment as EUT features an antenna connector), the limits in clause 4.3.8.3.2 apply.

#### 4.3.8.2 Description

For the description of the TX behaviour under the complete environmental profile, see ETSI TS 103 941 [4], clause 4.3.1.

### 4.3.8.3 Limits

#### 4.3.8.3.1 Limits for radiated assessment of the TX behaviour

The TX behaviour is obtained by measuring the peak e.i.r.p. spectral density ( $P_{\text{step}}$ ) across the complete environmental profile (as specified in clause 5.1.3) and assessing the variation with respect to a peak e.i.r.p. spectral density adjusted reference value ( $\text{Adjusted\_RL}$ ).

If for each environmental measurement point ( $T_{\text{step}}$ ) over the complete environmental profile the measured values for  $P_{\text{step}}$  shall be below the adjusted reference values the TX behaviour assessment is passed.

#### 4.3.8.3.2 Limits for conducted assessment of the TX behaviour

The TX behaviour is obtained by measuring the peak e.i.r.p. spectral density ( $P_{\text{step}}$ ) across the complete environmental profile (as specified in clause 5.1.3) and assessing the variation with respect to the peak e.i.r.p. spectral density regulated value (RL).

If for each environmental measurement point ( $T_{\text{step}}$ ) over the complete environmental profile the measured values for  $P_{\text{step}}$  shall be below the reference values the TX behaviour assessment is passed.

### 4.3.8.4 Conformance

The conformance test shall be done under the complete environmental profile (see clause 5.1.3); the parameters shall be measured as described in clause 5.4.9.

## 4.4 Receiver Requirements

### 4.4.1 General

The following receiver requirements apply for the EUT covered by the present document:

- Receiver baseline sensitivity (RBS), see clause 4.4.3.
- Receiver baseline resilience (RBR), see clause 4.4.4.

The receiver requirements for EUTs covered by the scope of the present document are justified in Table B.1.

### 4.4.2 Wanted performance criteria

The wanted performance criterion for receiver baseline sensitivity (RBS) is defined as the detection probability of a specified static radar target during a distance measurement over a defined period of time (see clauses 4.4.3.2 and 4.4.3.3).

The wanted performance criterion for Receiver Baseline Resilience (RBR) is defined as the detection probability of a specified static radar target during a distance measurement over a defined period of time under the influence of an interfering signal (see clauses 4.4.4.2 and 4.4.4.3).

### 4.4.3 Receiver Baseline Sensitivity (RBS)

#### 4.4.3.1 Applicability

The Receiver Baseline Sensitivity (RBS) requirement applies to all LPR categories as specified in Table 3.

#### 4.4.3.2 Description

Receiver baseline sensitivity is the capability of the EUT to receive a wanted signal at application related defined input signal levels while maintaining a minimum level of performance.

This quality of the EUT enables the reduction interference as it allows the corresponding transmitter power to be decreased for a particular link budget and thus demonstrates the efficient use of radio spectrum by way of a reduced generation of interference against other spectrum users.

The use of a static radar target is adequate as LPR devices are used to measure the distance to a liquid or solid material, in order to determine its filling level. The level changes in these environments occur very slowly by nature, so that quasi-static conditions can be assumed.

#### 4.4.3.3 Limits

For the RBS test, a static radar target shall be detected with at least 99 % detection probability. In this case, a sufficient receiver sensitivity of the EUT can be ensured. The static radar target shall produce a maximum echo signal power at the LPR receiver of -53,8 dBm (see derivation of the test scenario in Annex C).

The radar target is deemed to be detected if the EUT measures and displays the correct distance value to the target. This means, in the present case, that the measured distance value to the Radar target shall stay within the maximum allowed measurement value variation of  $\Delta d = \pm 50$  mm for at least 99 % of the conducted measurements in a measurement period of at least 120 seconds or 40 times the step response time of the EUT, whichever is longer. This applies to all EUT categories.

**EXAMPLE:** A sub-category OFR2 EUT operating in the frequency range 24,05 GHz to 26,5 GHz with 0 dBm conducted peak output power and 23 dBi antenna gain requires a radar target with a maximum RCS of -9,3 dBm<sup>2</sup> for example, in 3 m distance (see clause C.3) in order to evaluate the receiver baseline sensitivity in the radiated test setup outlined in clause 5.5.2.1. A detection probability of this radar target of 99 % is demanded. The test is conducted for at least 120 seconds, provided that the LPR sensor exhibits a step response time of < 3 s.

#### 4.4.3.4 Conformance

The conformance test for Receiver Baseline Sensitivity (RBS) shall be as defined in clause 5.5.2 and shall be done under normal conditions as defined in clause 5.1.2.

### 4.4.4 Receiver Baseline Resilience (RBR)

#### 4.4.4.1 Applicability

The Receiver Baseline Resilience (RBS) requirement applies to all LPR categories as specified in Table 3.

#### 4.4.4.2 Description

Receiver Baseline Resilience (RBR) is the capability of the EUT to maintain a minimum level of performance in the presence of interfering signals in the Operating Frequency Range (OFR), in adjacent bands and in remote frequency bands.

This quality of the EUT ensures a proper operation in an environment where other spectrum users are present and demonstrates the efficient use of radio spectrum by way of an increased resilience against interference.

The wanted performance criterion for receiver baseline resilience is defined as the detection probability of a specified static radar target during a distance measurement over a defined period of time under the influence of an interfering signal.

The use of a static radar target is adequate as LPR devices are used to measure the distance to a liquid or solid material (see clause 1), in order to determine its filling level. The level changes in these environments occur very slowly by nature, so that quasi-static conditions can be assumed.

#### 4.4.4.3 Limits

For the RBR test, the static radar target shall be detected with a defined minimum detection probability under the influence of an interfering signal. In this case a sufficient receiver resilience of the EUT against interference from other spectrum users can be ensured. The static radar target shall produce a maximum echo signal power at the LPR receiver of -53,8 dBm (see derivation of the test scenario in Annex C).

The radar target is deemed to be detected if the EUT measures and displays the correct distance value to the target. This means in the present case, that the measured distance value to the radar target shall stay within the maximum allowed measurement value variation of  $\Delta d = \pm 50$  mm for (see ETSI EN 303 883-2 [2], clause 5.3.2 for radiodetermination applications):

- at least 50 % of the conducted measurements (detection probability at least 50 %) if the interferer is located inside the OFR (co-channel interference);
- at least 85 % of the conducted measurements (detection probability at least 85 %) if the interferer is located at  $f_c \pm \text{OFR}$  (adjacent channel interference);
- at least 95 % of the conducted measurements (detection probability at least 95 %) if the interferer is located at  $f_c \pm 2 \times \text{OFR}$  (blocking);

in a measurement period of at least 120 seconds or 40 times the step response time of the EUT, whichever is longer. This applies to all EUT categories.

**EXAMPLE:** A sub-category OFR4 EUT operating in the frequency range 75 GHz to 85 GHz with 2 dBm conducted peak output power and 32 dBi antenna gain requires a radar target with a maximum RCS of -20,4 dBm<sup>2</sup> for example in 5 m distance (see clause C.3) in order to evaluate the receiver baseline resilience in the radiated test setup outlined in clause 5.5.3.1.1. A detection probability of this radar target of 85 % is demanded under interference conditions, when the interferer is located at  $f_c \pm \text{OFR}$ . The test is conducted for at least 120 seconds provided that the LPR sensor exhibits a step response time of  $< 3$  s.

#### 4.4.4.4 Conformance

The conformance test for receiver baseline sensitivity shall be as defined in clause 5.5.3 and shall be done under normal conditions as defined in clause 5.1.2.

---

## 5 Testing for compliance with technical requirements

### 5.1 Environmental conditions for testing

#### 5.1.1 General

Tests defined in the present document shall be carried out at representative points within the boundary limits of the operational environmental profile defined by its intended use, which, as a minimum, shall be that specified in the test conditions contained in the present document.

Where technical performance varies subject to environmental conditions, tests shall be carried out under a sufficient variety of environmental conditions (within the boundary limits of the operational environmental profile defined by its intended use) to give confidence of compliance for the affected technical requirements.

#### 5.1.2 Normal test conditions

Normal test conditions shall be as defined in ETSI TS 103 941 [4], clause 4.5.3.1.

Hence, the temperature for testing under normal temperature conditions shall be within +15 °C to +35 °C as specified in ETSI TS 103 941 [4], clause 4.5.3.1.1.

### 5.1.3 Complete environmental profile test conditions

The complete environmental profile test conditions cover both, the normal (see clause 5.1.2) and extreme test conditions.

According ETSI EN 303 883-1 [1], clause A5.3 normal test conditions shall be as defined in ETSI TS 103 941 [4], clause 4.5.3.1 and extreme test conditions shall be as defined in ETSI TS 103 941 [4], in clause 4.5.3.2. Hence, the specified temperature range shall vary from -20 °C to +60 °C in steps of 20 °C; the primary supply voltage varies from 90 % to 110 % of its nominal value.

NOTE: The nominal supply voltage is provided in the user manual or technical specification file of the EUT.

## 5.2 General conditions for testing

General conditions for testing for the TX measurements shall be as defined in ETSI EN 303 883-1 [1], clauses A.3, A.5 and A.8 of Annex A.

General conditions for testing for the RX measurements shall be as defined in ETSI EN 303 883-2 [2], clauses A.5 and A.8 of Annex A and Annex B.

ETSI EN 303 883-1 [1], Annex A provides additional information on general conditions for testing, e.g. test environment and test conditions, measurement uncertainty and interpretation of the measurement results. An overview is provided in ETSI EN 303 883-1 [1], clause A.1.

## 5.3 Conformance test suites

Unless otherwise noted, the radiated conformance tests described in clause 5.4 for the transmitter and clause 5.5 for the receiver shall be done on the test site according to ETSI EN 303 883-1 [1], clause B.2.2.2 under far field conditions according to ETSI EN 303 883-1 [1], clause B.2.3.5. Radiated emission measurements, unless otherwise specified, shall in addition use the test method from ETSI EN 303 883-1 [1], clause B.2.5.

Unless otherwise noted, the conducted conformance tests described in clause 5.4 for the transmitter and clause 5.5 for the receiver shall be performed according to the provisions in ETSI EN 303 883-1 [1], clause B.3.

ETSI EN 303 883-1 [1], clause B.2 provides additional information on test sites for radiated measurements and clause B.3 for conducted measurements.

## 5.4 Conformance test methods of measurement for transmitter

### 5.4.1 Operating Frequency Range (OFR)

For all LPR categories the OFR conformance test shall use the procedure described in ETSI EN 303 883-1 [1], clause 5.2.2 using the peak e.i.r.p. spectral density measurement as defined in clause 5.4.3 in the present document. The procedure shall be used with an RBW set to 3 MHz.

Additionally, for LPR categories LPR1, LPR3, LPR5, LPR7, LPR9, LPR11, LPR13, LPR15 (see clause 4.2.2 and Table 3) the provisions for conducted measurements in ETSI EN 303 883-1 [1], clause B.3 shall be considered.

### 5.4.2 Mean e.i.r.p. spectral density

For all LPR categories the mean e.i.r.p. spectral density conformance test shall use the procedure described in ETSI EN 303 883-1 [1], clause 5.3.2.4.

The needed signal repetition time of the EUT shall be assessed according to ETSI EN 303 883-1 [1], Annex C and clause 5.4.7 in the present document.

Additionally, for LPR categories LPR1, LPR3, LPR5, LPR7, LPR9, LPR11, LPR13, LPR15 (see clause 4.2.2 and Table 3) the provisions for conducted measurements in ETSI EN 303 883-1 [1], clause B.3 shall be considered.



The gain of the LPR antenna, which is required to calculate the mean e.i.r.p. spectral density when performing conducted measurements (without the antenna), shall be determined according to the described procedure in clause 5.4.5.2.

### 5.4.3 Peak e.i.r.p. spectral density

For all LPR categories the peak e.i.r.p. spectral density conformance test shall use the procedure described in ETSI EN 303 883-1 [1], clause 5.3.4.1.3 for EUTs using pulse modulation techniques and ETSI EN 303 883-1 [1], clause 5.3.4.1.4 for EUTs using FMCW or other swept frequency modulation techniques. These swept frequency signals are instantaneously narrowband signals with full power within the resolution bandwidth of the spectrum analyser.

Additionally, for LPR categories LPR1, LPR3, LPR5, LPR7, LPR9, LPR11, LPR13, LPR15 (see clause 4.2.2 and Table 3) the provisions for conducted measurements in ETSI EN 303 883-1 [1], clause B.3 shall be considered.

The gain of the LPR antenna, which is required to calculate the peak e.i.r.p. spectral density when performing conducted measurements (without the antenna), shall be determined according to the described procedure in clause 5.4.5.2.

### 5.4.4 Transmitter Unwanted Emissions (TXUE)

#### 5.4.4.1 General

For the Transmitter Unwanted Emissions (TXUE) (see ETSI EN 303 883-1 [1], clause 5.5) two different test procedures are used based on the domain where these emissions are located in frequency. For the transmitter unwanted emissions in the out-of-band domain the procedure in clause 5.4.4.2 shall be used whereas for the transmitter unwanted emissions in the spurious domain the procedure in clause 5.4.4.3 shall be used.

#### 5.4.4.2 Transmitter Unwanted Emissions in the Out-Of-Band (OOB) domain

The transmitter unwanted emissions in the Out-Of-Band (OOB) shall be determined in a two-step approach according to the setup described in ETSI EN 303 883-1 [1], Figure B.12 in clause B.4.2.

In the first step a spherical fast scan is conducted in order to determine the spatial direction in which the EUT produces the highest emissions. This is achieved by applying a fast scan technique in the spectrum analyser.

The measurement antenna shall initially be oriented for vertical polarization and the EUT shall be rotated horizontally through 360° in at least 15° angular steps until a maximum signal level is detected in the test receiver (see ETSI EN 303 883-1 [1], clause B.4.1.4).

In this position of the EUT the measurement antenna shall be raised and lowered through the specified height range applicable to the used test site until the maximum signal level is detected in the test receiver.

The procedure described above shall be repeated with horizontal polarization of the measurement antenna.

For the fast scan the following spectrum analyser settings shall be used.

For measurement below the OFR:

Start frequency:	$f_{LS}$
Stop frequency:	$f_L$

For measurement above the OFR:

Start frequency:	$f_H$
Stop frequency:	$f_{HS}$

NOTE: There could be a need to split the measurement into different frequency ranges depending on the measurement setup (e.g. due to external mixers, bandwidth of antennas and waveguides, RBW).

Resolution Bandwidth (RBW):	$\geq 100$ kHz between 30 MHz and 1 GHz $\geq 1$ MHz above 1 GHz
Video Bandwidth (VBW):	Equal or greater than RBW
Detector mode:	Peak
Trace mode:	Max hold
Sweep time:	AUTO; wait for each position of the EUT until the reading in the display is stable

The orientation and configuration of the EUT and the measurement antenna determined in step 1, producing the highest emission towards the measurement antenna, shall be used to conduct the second step where the TX unwanted emissions are determined using the procedure described in ETSI EN 303 883-1 [1], clause 5.5.3. The assessment shall be done using the procedure 2b of ETSI EN 303 883-1 [1], clause 5.5.3.1.4.

#### 5.4.4.3 Transmitter Unwanted Emissions in the spurious domain

The transmitter unwanted emissions in the spurious domain shall be determined in a two-step approach according to the setup described in ETSI EN 303 883-1 [1], Figure B.12 in clause B.4.2.

In the first step a spherical fast scan is conducted in order to determine the spatial direction in which the EUT produces the highest emissions. This is achieved by applying a fast scan technique in the spectrum analyser.

The measurement antenna shall initially be oriented for vertical polarization and the EUT shall be rotated horizontally through  $360^\circ$  in at least  $15^\circ$  angular steps until a maximum signal level is detected in the test receiver. (see ETSI EN 303 883-1 [1], clause B.4.1.4).

In this position of the EUT the measurement antenna shall be raised and lowered through the specified height range applicable to the used test site until the maximum signal level is detected in the test receiver.

The procedure described above shall be repeated with horizontal polarization of the measurement antenna.

For the fast scan the following spectrum analyser settings shall be used.

For measurement below the OFR:

Start frequency:	$F_{\text{LOWER}}$
Stop frequency:	$f_{\text{LS}}$

For measurement above the OFR:

Start frequency:	$f_{\text{HS}}$
Stop frequency:	$F_{\text{UPPER}}$

NOTE: There could be a need to split the measurement into different frequency ranges depending on the measurement setup (e.g. due to external mixers, bandwidth of antennas and waveguides, RBW).

Resolution Bandwidth (RBW):	$\geq 100$ kHz between 30 MHz and 1 GHz $\geq 1$ MHz above 1 GHz
Video Bandwidth (VBW):	Equal or greater than RBW
Detector mode:	Peak
Trace mode:	Max hold
Sweep time:	AUTO; wait for each position of the EUT until the reading in the display is stable

The orientation and configuration of the EUT and the measurement antenna determined in step 1, producing the highest emissions towards the measurement antenna, shall be used to conduct the second step where the TX unwanted emissions are determined using the procedure described in ETSI EN 303 883-1 [1], clause 5.5.3. The assessment shall be done using the procedure 2a of ETSI EN 303 883-1 [1], clause 5.5.3.1.3.

For procedure 2a as specified in ETSI EN 303 883-1 [1], clause 5.5.3.1.3 the burst duration (Ton time) of the EUT (see ETSI EN 303 883-1 [1], clause C.3) needs to be known.

For the assessment of the burst duration of the EUT, the same  $T_{dis}$  and  $P_{thresh}$  limits as for the duty cycle over signal repetition period assessment (see clause 5.4.7) shall be used.  $P_{thresh}$  is related to the measured power level at the frequency  $f_M$  (frequency with the maximum emission within the OFR (see ETSI EN 303 883-1 [1], clause 5.2.2)).

## 5.4.5 Antenna parameters

### 5.4.5.1 General

Generally, LPR devices can be equipped either with integral antennas or dedicated antennas. Integral antennas often do not exhibit an antenna connector and can, therefore, not be accessed from the outside for measurement purposes. Dedicated antennas, on the contrary, are always equipped with a connector which can also be used for measurement purposes. LPR Antennas Under Test (AUTs) with an antenna connector (EUT sub-category ANT1) shall use the procedure described in clause 5.4.5.2. For integral AUTs without antenna connector (EUT sub-category ANT2) the procedure described in clause 5.4.5.3 shall be used.

The measurement of the radiation pattern shall be conducted at the centre frequency  $f_c$  of the Operating Frequency Range (OFR) as defined in ETSI EN 303 883-1 [1], clause 5.2.2. For all measurement procedures the recorded antenna patterns shall have the following characteristics:

- Angular resolution of beam pattern:  $\leq 1^\circ$ , within the HPBW of the AUT at least 5 measurement points shall be recorded.
- Angular measurement range:  $-180^\circ$  to  $+180^\circ$  (with main lobe at  $0^\circ$ ).

### 5.4.5.2 Conformance test for AUTs with antenna connector

For LPR categories LPR1, LPR3, LPR5, LPR7, LPR9, LPR11, LPR13, LPR15 (see clause 4.2.2 and Table 3) the conformance test for antenna parameters shall use the procedure described in ETSI EN 303 883-1 [1], clause 5.12.2.2.

The Half-Power Beamwidth (HPBW) and side lobe suppression of the LPR Antenna Under Test (AUT) can be extracted from the radiation pattern, which shall be determined in both E-plane and H-plane. Examples of typical radiation patterns of high directive LPR antennas are given in ETSI EN 303 883-1 [1], clause 5.12.1.

### 5.4.5.3 Conformance test for integral AUTs without antenna connector

For LPR categories LPR2, LPR4, LPR6, LPR8, LPR10, LPR12, LPR14, LPR16 (see clause 4.2.2 and Table 3) the conformance test for antenna parameters shall use the procedure described in ETSI EN 303 883-1 [1], clause 5.12.3.

### 5.4.5.4 Antenna gain for integral AUTs without antenna connector

This conformance test is only applicable to LPR categories LPR2, LPR4, LPR6, LPR8, LPR10, LPR12, LPR14, LPR16 only (see clause 4.2.2 and Table 3).

The method for determining the radiation pattern described above in clause 5.4.5.3 for integral antennas does not readily provide the possibility to deduce the antenna gain. The antenna gain, however, is needed in order to e.g. calculate the received echo power  $P_{r\_equivalent}$  in the equivalent measurement scenario for assessing the Receiver Baseline Resilience (RBR) (see clause 5.5.3 and clause C.3, respectively).

The antenna gain in boresight direction, however, shall be calculated as the difference between the radiated peak power in the direction of the highest emission and the calculated Total Radiated Power (TRP) of the EUT as described in the procedure in ETSI EN 303 883-1 [1], clause 5.12.3. For assessing the required Total Radiated Power (TRP) the procedure in ETSI EN 303 883-1 [1], clause 5.6.4.3 shall be used by conducting a spherical scan with rotating the EUT according to ETSI EN 303 883-1 [1], clause B.4.2. Additional information on standard test methods can be found in ETSI EN 303 883-1 [1], clause B.4.

## 5.4.6 Adaptive Power Control (APC)

### 5.4.6.1 General

For EUTs with an antenna connector (EUT sub-category ANT1) the conformance test for APC shall be performed conducted as described in clause 5.4.6.3. For EUTs without antenna connector (EUT sub-category ANT2) the conformance test for APC shall be performed radiated as described in clause 5.4.6.2.

The test procedure for APC is targeted on evaluating two extreme scenarios. In the first scenario nearly perfect reflection conditions are established so that a large echo is produced and received by the LPR which consequently produces a large Signal-to-Noise Ratio (SNR) in the receiver. In the second scenario poor reflection conditions are established. The produced received echo is consequently small and this leads also to a small signal-to-noise ratio in the LPR receiver.

The two extreme scenarios shall activate two APC conditions in which the sensor transmits with full transmit power (poor reflection conditions with weak echo signal and small SNR) and with reduced transmit power (good reflection conditions with strong echo signal and large SNR).

The dynamic range of the APC is the difference between these EUT transmit powers produced in both extreme scenarios, i.e. with metal plate reflector and with microwave absorbing material reflector (see clause 5.4.6.2) for the radiated test and with short circuit reflection and termination (see clause 5.4.6.3) connected to the end of a transmission line for the conducted test. Due to the fact that in both cases only the difference of the EUT transmit powers is relevant, relative power measurements are sufficient. Therefore, the absolute value of the EUT transmit power needs not to be known nor to be determined for this test.

In both APC conformance tests, the procedure used for measuring the peak e.i.r.p. spectral density shall be applied, which is described in ETSI EN 303 883-1 [1], clause 5.3.4.1.3 for EUTs using pulse modulation and in ETSI EN 303 883-1 [1], clause 5.3.4.1.4 for EUTs using FMCW or other swept frequency modulations. See also ETSI EN 303 883-1 [1], clause 5.1.1 for general guidance on measurements with a permanent or temporary antenna connector.

More information on APC can be found in ECC Report 139 [i.4] and ETSI TR 102 601 [i.6].

### 5.4.6.2 Radiated test setup for EUTs without antenna connector

This conformance test is only applicable to LPR categories LPR2, LPR4, LPR6, LPR8, LPR10, LPR12, LPR14, LPR16 only (see clause 4.2.2 and Table 3). The reflector in the first extreme scenario shall be a metal plate (e.g. steel, aluminium, copper) with a smooth and flat surface of 0,6 m × 0,6 m in size. The metal plate shall be placed at 1 m distance from the EUT and shall be equipped with a horn antenna protruding in the centre for transmit power testing. This scenario represents maximum reflection conditions and, therefore, requires the lowest transmit power of the EUT.

The second extreme scenario uses a microwave absorbing surface, also 0,6 m × 0,6 m in size, at the same distance of 1 m that incorporates the same horn antenna. This second scenario represents minimum reflection conditions and, therefore, allows the EUT to switch to the highest transmit power. The microwave absorbers (e.g. pyramidal absorbers consisting of an absorbing foam) shall feature a reflection loss of at least 20 dB at the OFR centre frequency of the EUT. This value can be extracted from the absorbers' datasheet.

The dynamic range of the APC is the difference of the measured peak e.i.r.p. levels with metal plate and absorber:

$$\text{Dynamic Range APC} = \text{Peak e.i.r.p.}_{\text{metal plate}} - \text{Peak e.i.r.p.}_{\text{absorber}} \quad (4)$$

The radiated measurement setup of the APC conformance test is shown in Figure 2. In order to set up the first extreme scenario, just the microwave-absorbing material in front of the metal plate is removed. Thus, the metal plate acts as a nearly perfect reflector. Details of the horn antenna protruding the microwave absorbers and the metal plate are shown in Figure 3.

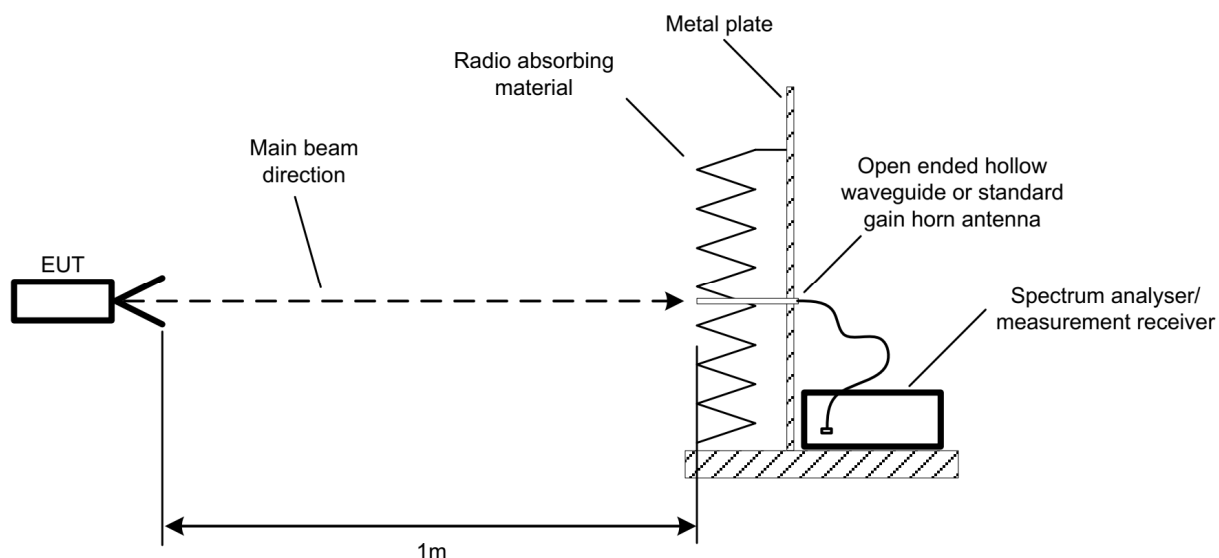

**Figure 2: Radiated measurement setup for the APC conformance test**



**Figure 3: Left: Horn antenna fitted in pyramidal absorbers; Right: Horn antenna protruding the centre of the metal plate**

The radiated test procedure for the APC test will work properly for the required 20 dB APC dynamic range when the peak e.i.r.p. spectral density is within 15 dB of the limits specified in clause 4.3.4.3.

#### 5.4.6.3 Conducted test setup for EUTs with antenna connector

This conformance test is only applicable to LPR categories LPR1, LPR3, LPR5, LPR7, LPR9, LPR11, LPR13, LPR15 only (see clause 4.2.2 and Table 3). In the conducted test method, the two extreme radiated scenarios described in clause 5.4.6.2 above are reproduced with the help of a transmission line connected to the antenna connector of the EUT via a directional coupler. At the other end of the transmission line, a short circuit is used in order to represent the nearly perfect reflection conditions and a termination is used to simulate the poor reflection conditions. The termination shall feature a reflection loss of at least 20 dB at the OFR centre frequency of the EUT. This value can be extracted from the termination's datasheet. A directional coupler is needed to measure the EUT's transmit power.

The dynamic range of the APC is the difference between the measured peak power levels with short circuit and termination:

$$\text{Dynamic Range APC} = \text{Peak power}_{\text{short}} - \text{Peak power}_{\text{termination}} \quad (5)$$

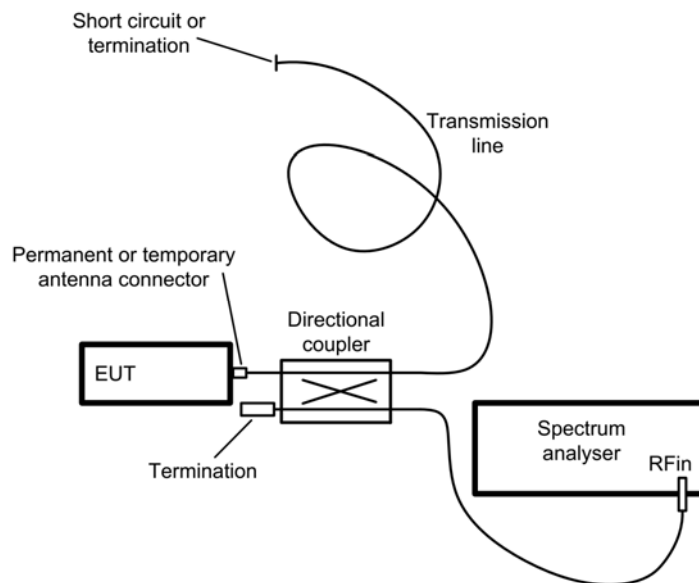

**Figure 4: Measurement setup for the equivalent conducted APC conformance test method**

### 5.4.7 Duty cycle over signal repetition period

For all LPR categories the duty cycle over measurement period ( $DC_{T_{rep}}$ ) conformance test shall use the procedure described in ETSI EN 303 883-1 [1], clause 5.11.2.3.3.

The required parameters  $T_{obs}$ ,  $T_{dis}$  and  $P_{thresh}$  are specified as follows:

- $T_{obs} \geq T_{rep}$
- $T_{dis} = 1 \mu s$
- $P_{thresh} = 20 \text{ dB}$  below the maximum peak e.i.r.p. spectral density.

NOTE: The maximum peak e.i.r.p. spectral density is measured during the evaluation of the Operating Frequency Range (OFR) of the EUT (see clause 4.3.2).

Additionally, for LPR categories LPR1, LPR3, LPR5, LPR7, LPR9, LPR11, LPR13, LPR15 (see clause 4.2.2 and Table 3) the provisions for conducted measurements in ETSI EN 303 883-1 [1], clause 5.1.1 shall be considered.

### 5.4.8 Frequency domain mitigation

For all LPR categories, the Frequency Domain Mitigation (FDM) conformance test shall use the procedure described in ETSI EN 303 883-1 [1], clause 5.11.2.3.3 using the time  $T_{on}$ , when the transmitter is switched on, as observation period and a Resolution Bandwidth (RBW) of the spectrum analyser of 10 MHz which equals the virtual receiver bandwidth as specified in clause 4.3.7.4.2.

Additionally, for LPR categories LPR1, LPR3, LPR5, LPR7, LPR9, LPR11, LPR13, LPR15 (see clause 4.2.2 and Table 3) the provisions for conducted measurements in ETSI EN 303 883-1 [1], clause 5.1.1 shall be considered.

### 5.4.9 TX behaviour under the complete environmental profile

#### 5.4.9.1 General

The best test set-up shall be chosen based on ETSI TS 103 941 [4], clause 4.3.1 and Figure 1.

For LPR categories LPR2, LPR4, LPR6, LPR8, LPR10, LPR12, LPR14, LPR16 (radiated assessment as EUT features no antenna connector), the conformance test procedure in clause 5.4.9.2 shall be used.

For LPR categories LPR1, LPR3, LPR5, LPR7, LPR9, LPR11, LPR13, LPR15 (conducted assessment as EUT features an antenna connector), the conformance test procedure in clause 5.4.9.3 shall be used.

The environmental profile test conditions and the general test procedure are shown in ETSI TS 103 941 [4], clause 4.5.4. The parameters for the assessment procedure are specified in clause 5.1.3.

#### 5.4.9.2 EUT without antenna connector

Conformance shall be assessed based on the test setup assessment in clause 5.4.9.1. The assessment procedure shall be conducted according to ETSI TS 103 941 [4], clause 6.2.

#### 5.4.9.3 EUT with antenna connector

Conformance shall be assessed based on the test-set assessment in clause 5.4.9.1. The assessment procedure shall be conducted according to ETSI TS 103 941 [4], clause 7.

## 5.5 Conformance test methods of measurement for receiver

### 5.5.1 General

ETSI EN 303 883-2 [2] clause 5.1 gives general guidance on RX measurements applicable to all LPR categories. For LPR categories LPR1, LPR3, LPR5, LPR7, LPR9, LPR11, LPR13, LPR15 (see clause 4.2.2 and Table 3) the conformance tests for receiver baseline sensitivity (see clause 5.5.2) and receiver baseline resilience (see clause 5.5.3) shall be performed conducted as described in clauses 5.5.2.2 and 5.5.3.1.2 and as indicated in ETSI EN 303 883-1 [1], clause 5.1.1.

### 5.5.2 Receiver Baseline Sensitivity (RBS)

#### 5.5.2.1 Radiated test setup for EUTs without antenna connector

This conformance test is only applicable to LPR categories LPR2, LPR4, LPR6, LPR8, LPR10, LPR12, LPR14, LPR16 only (see clause 4.2.2 and Table 3). Figure 5 shows the radiated test setup for the equivalent scenario for the Receiver Baseline Sensitivity (RBS) test. The test setup for the equivalent scenario includes a specific radar target and features the generation of a defined echo signal power. The equivalent scenario is derived from the defined real scenario in Annex C.

The echo signal produced by the reflection at the radar target with specific Radar Cross Section (RCS)  $\sigma$  in a distance  $R_T$  shall deliver the power  $P_{r\_equivalent} \leq P_{r\_real}$  to the LPR receiver (see Annex C and particularly clause C.3). The RCS can be calculated by following the procedure outlined in clause C.3.

In the radiated test setup according to Figure 5 the EUT antenna and the radar target shall be ideally aligned facing towards each other. The conditions in ETSI TS 103 789 [3], clause B.2 and clause B.3 shall be considered in order to ensure far field conditions and to fulfil the point target condition.

The EUT has to be adjusted to measure the distance to the radar target.

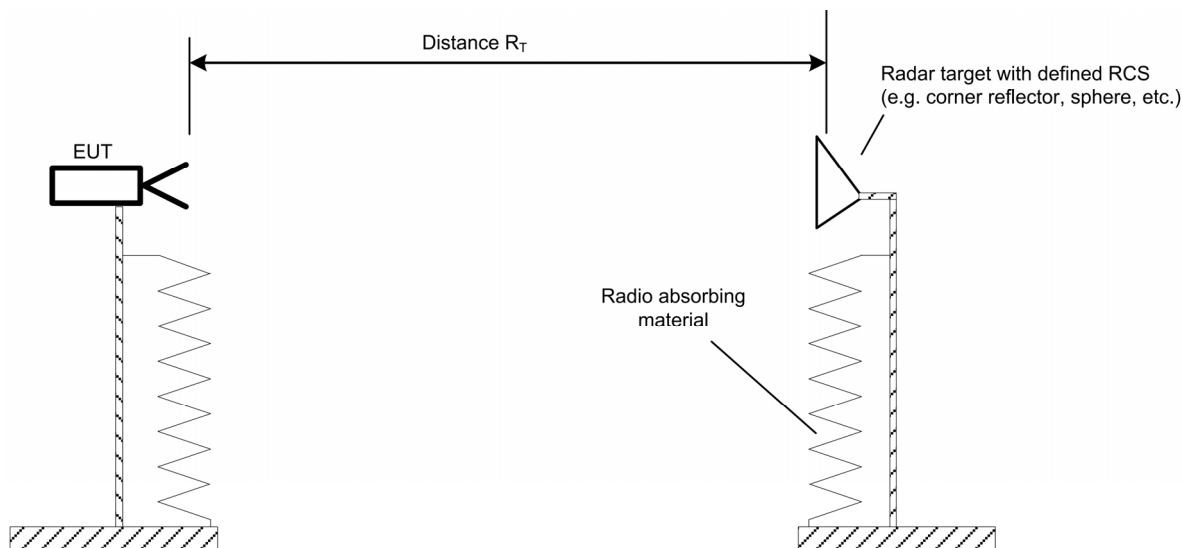

**Figure 5: Radiated test setup providing a defined echo signal to the EUT**

It should be mentioned that LPR devices often can be equipped with antennas of different size and gain. However, the radiated sensitivity test is independent of the LPR antenna as its gain is compensated in the radar target RCS (see clause C.3 and clause C.4 for the reference device defined in Table C.1). Thus, all available LPR antennas can be used to conduct the radiated RBS test.

The attenuation in the signal path from the EUT antenna to the radar target and back again to the EUT receiver can be influenced by adjusting the RCS of the radar target and/or varying the distance  $R_T$  (see clause C.3). Thus, the desired echo signal power  $P_{r\_equivalent} \leq P_{r\_real}$  can be provided to the receiver of the EUT.

### 5.5.2.2 Conducted test setup for EUTs with antenna connector

This conformance test is only applicable to LPR categories LPR1, LPR3, LPR5, LPR7, LPR9, LPR11, LPR13, LPR15 only (see clause 4.2.2 and Table 3). Figure 6 shows the conducted test setup for the equivalent scenario for the Receiver Baseline Sensitivity (RBS) test using coaxial or hollow waveguide components.

The test setup features the generation of a defined echo signal power which is provided to the LPR receiver.

The echo signal produced by the reflection at the short-circuited transmission line shall deliver the power  $P_{r\_equivalent} \leq P_{r\_real}$  to the LPR receiver (see Annex C and particularly clause C.3).

The EUT has to be adjusted to measure the distance to the short circuit.

**NOTE:** In general, there are built in functions and techniques which enable LPR devices to suppress echoes from unwanted reflections, like the unwanted reflection originating from the transition of the antenna connector to the attenuator for example.

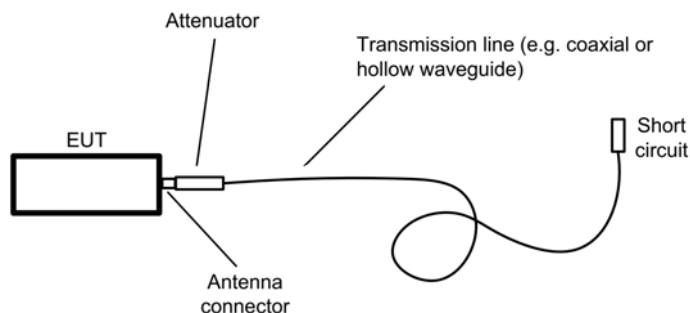

**Figure 6: Conducted test setup providing a defined echo signal to the EUT**



The desired attenuation in the signal path from the antenna connector over the transmission line to the short circuit and back again to the antenna connector can be further adjusted by selecting a suitable attenuation in the employed attenuator (see Figure 6). Thus, the desired echo signal power  $P_{r\_equivalent} \leq P_{r\_real}$  can be provided to the receiver of the EUT.

### 5.5.2.3 Test procedure

The test procedure for receiver baseline sensitivity shall be conducted as follows:

- The measurement setup for the radiated equivalent scenario is arranged according to Figure 5. If the equipment under test provides an antenna connector (EUT sub-category ANT1) the test shall be carried out in the conducted equivalent scenario according to Figure 6.
- The corresponding Radar Cross Section (RCS)  $\sigma$  of the radar target with the corresponding distance  $R_T$  can be determined according to clause C.3 for the radiated setup in clause 5.5.2.1 delivering the desired echo power to the EUT receiver.
- For the conducted setup in clause 5.5.2.2 the desired echo power delivered to the EUT receiver can be adjusted by selecting a suitable attenuation in the employed attenuator (see Figure 6).
- The resulting received echo power  $P_{r\_equivalent}$  provided to the EUT receiver shall be equal or less than the received echo power  $P_{r\_real} = -53,8$  dBm in the real scenario (see clause C.2).
- The distance measurement is carried out against the radar target in the radiated setup (Figure 5) or against the short circuit in the conducted setup (Figure 6).

The test is passed if the radar target/short circuit can be detected with the required detection probability as specified in clause 4.4.3.3. In this case a sufficient receiver sensitivity of the EUT can be ensured.

- During the test, the EUT shall be configured for the fastest possible step response time. The configuration of the device under test in this regard shall be noted in the test report.

The step response time of an LPR sensor is defined according to IEC 61298-2 [i.9], clause 5.4 and can often be extracted from the manufacturer's datasheet or product manual. However, if the step response of the EUT is not known, it shall be determined by introducing a sudden change of the measurement distance of maximum 2 m. This shall be achieved by changing the distance to the radar target in the radiated equivalent scenario or changing the length of the transmission line to the short circuit in the conducted equivalent scenario. The step response time is the time span until the new distance value reaches 90 % of the final value for the first time.

## 5.5.3 Receiver Baseline Resilience (RBR)

### 5.5.3.1 Test setups for EUTs providing no access to the receiver noise level

#### 5.5.3.1.1 Radiated test setup for EUTs without antenna connector

This conformance test is only applicable to LPR categories LPR2, LPR4, LPR6, LPR8, LPR10, LPR12, LPR14, LPR16 only (see clause 4.2.2 and Table 3). Figure 7 and Figure 8 show the radiated test setup for the equivalent scenario for the receiver baseline resilience (RBR) test. The equivalent scenario is derived from the defined real scenario in Annex C. For the RBR test, there are two signals which have to be provided to the LPR receiver simultaneously:

- 1) The echo signal of the radar target with specific RCS  $\sigma$  which produces the power  $P_{r\_equivalent} \leq P_{r\_real}$  to the LPR receiver (see Annex C and particularly clause C.3).
- 2) The interferer signals which shall be determined according to the procedure outlined in Annex D.

The interferer signals (see Annex D) are generated by means of a microwave signal generator which is connected to a test antenna with gain  $G_T$ . The test antenna is placed in a certain distance  $R$  from the LPR device and shall also be positioned within the LPR antenna main lobe.

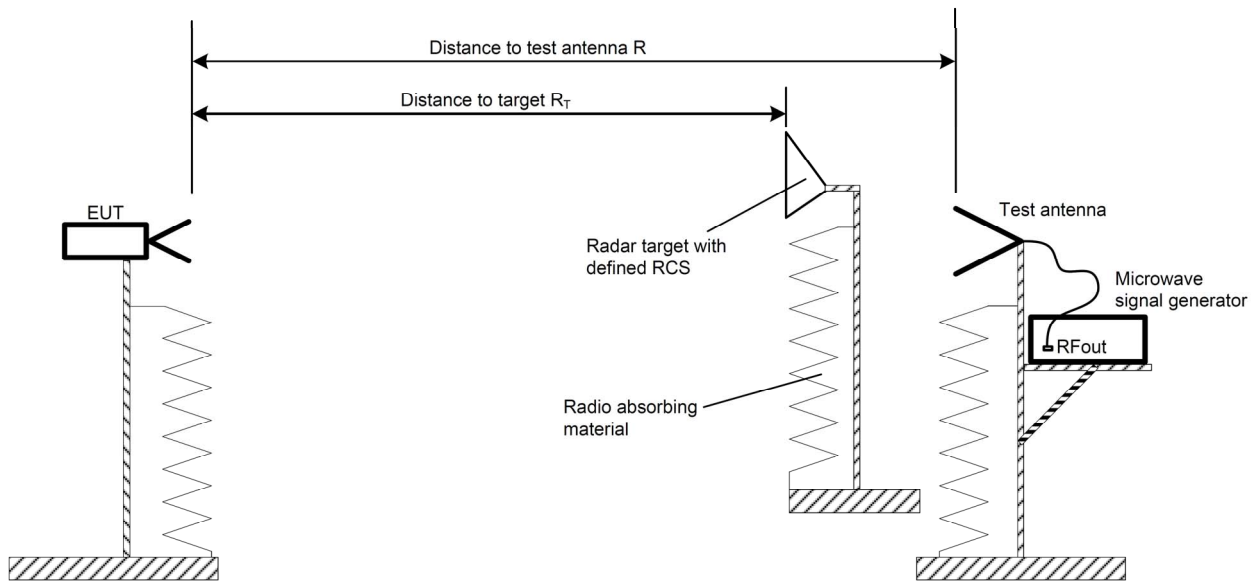

**Figure 7: Radiated test setup providing a defined echo signal and an interferer signal to the EUT**

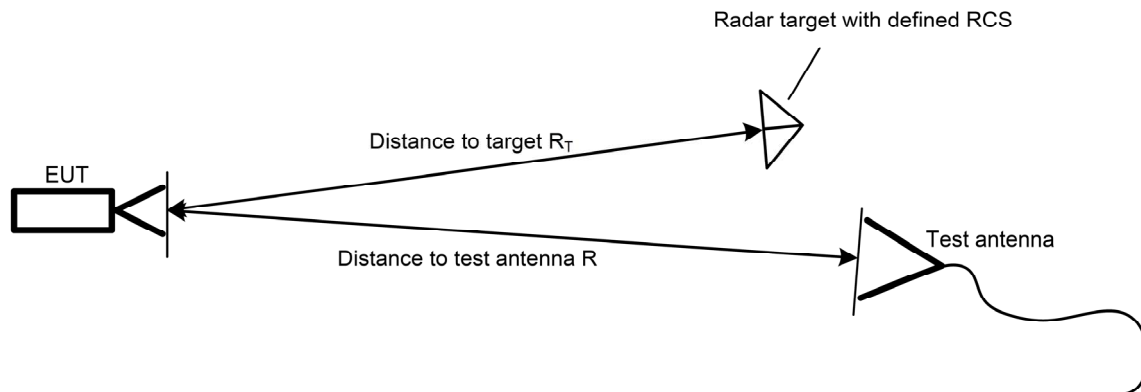

**Figure 8: Radiated test setup providing a defined echo signal and an interferer signal to the EUT (top view of Figure 7 drawn without measurement instrumentation)**

The EUT has to be adjusted to measure the distance to the radar target. Therefore, the radar target and the test antenna shall not provide the same distance to the EUT (see also ETSI EN 303 883-2 [2], clause 5.5.3.5 Figure 21).

Instead, the test antenna shall be placed at a minimum distance  $R$  behind the radar target ( $R > R_T + 1 \text{ m}$ ). Hence, the test antenna setup does not disturb the target echo signal and the EUT can resolve and separate the desired radar target from the unwanted echo signal generated by the test antenna setup.

In the radiated test setup, according to Figure 7 and Figure 8, it is necessary to place both the test antenna and the radar target within the half-power beamwidth (HPBW) of the main lobe of the LPR antenna. In this case, the interferer signal from the microwave generator and the echo signal from the Radar target reach the LPR receiver over the main lobe of the LPR antenna. Therefore, it is valid to use the LPR antenna gain  $G$  in the direction of main radiation (main lobe axis) for further evaluation.

The conditions in ETSI TS 103 789 [3], clause B.2 and clause B.3 shall be considered in order to ensure far field conditions and to fulfil the point target condition for the radar target.

It should be mentioned that LPR devices often can be equipped with antennas of different size and gain. However, the radiated resilience test is independent of the LPR antenna as its gain is compensated in the radar target RCS (see clause C.3 and clause C.4 for the reference device defined in Table C.1. In addition, the EUT antenna gain is considered when determining the interferer power level at the EUT (see equation (C.1) in ETSI TS 103 789 [3], Annex C). Thus, all available LPR antennas can be used to conduct the radiated RBR test.

The attenuation in the signal path from the EUT antenna to the radar target and back again to the EUT receiver can be influenced by adjusting the RCS of the radar target and/or varying the distance  $R_T$  (see clause C.3). Thus, the desired echo signal power  $P_{r\_equivalent} \leq P_{r\_real}$  can be provided to the receiver of the EUT.

The employed power level at the microwave signal generator (see Figure 7 and Figure 8) has to be aligned with the EUT antenna gain and the test antenna gain in order to result in the correct interferer power level  $P_{r\_interferer}$  at the receiver of the EUT.

The interferer power level  $P_{r\_interferer}$  which shall be applied to the receiver of the LPR device shall be determined by following the procedure outlined in Annex D.

The transmitted power level of the interfering signal  $P_{t\_interferer}$  which shall be fed into the test antenna in order to generate the wanted interferer power level  $P_{r\_interferer}$  at the LPR receiver shall be determined using the well-known Friis transmission equation. A description of this equation related to the case under consideration can be found in ETSI TS 103 789 [3], Annex C. Thus, the correct interferer power of  $P_{r\_interferer}$  and the desired echo power  $P_{r\_equivalent}$  can simultaneously be provided to the receiver of the EUT.

### 5.5.3.1.2 Conducted test setup for EUTs with antenna connector

This conformance test is only applicable to LPR categories LPR1, LPR3, LPR5, LPR7, LPR9, LPR11, LPR13, LPR15 only (see clause 4.2.2 and Table 3). Figure 9 shows the conducted test setup for the equivalent scenario of the Receiver Baseline Resilience (RBR) test using coaxial or hollow waveguide components. There are two signals which have to be provided to the LPR receiver simultaneously:

- 1) The echo signal from a short-circuited transmission line which produces the power  $P_{r\_equivalent} \leq P_{r\_real}$  to the LPR receiver (see Annex C and particularly clause C.3).
- 2) The interferer signals which shall be determined according to the procedure outlined in Annex D.

The interferer signals (see Annex D) are generated by means of a microwave signal generator which is connected to the EUT via the transmission line B and the directional coupler.

Similarly to the previous clause 5.5.3.1.1, the electric length to the interferer source (transmission line B) shall be 1 m longer than the electric length to the short circuit (transmission line A) (see Figure 9). Hence, the EUT can separate between the desired echo of the short-circuited line and the unwanted reflection of the RF output stage of the microwave signal generator. The EUT has to be adjusted to measure the distance to the short circuit.

**NOTE:** In general, there are built in functions and techniques which enable LPR devices to suppress echoes from unwanted reflections, like the unwanted reflections of the RF output stage of the microwave signal generator.

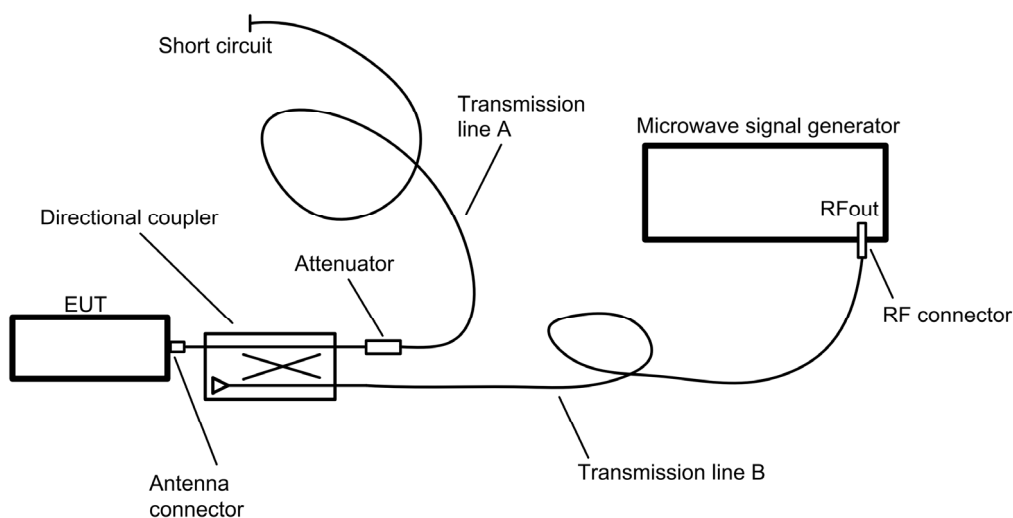

**Figure 9: Conducted test setup providing a defined echo signal and an interferer signal to the EUT**

The attenuation in the signal path from the LPR antenna connector to the short circuit and back again to the antenna connector can be adjusted by selecting a suitable attenuation in the employed attenuator. Thus, the desired echo signal power  $P_{r\_equivalent} \leq P_{r\_real}$  can be provided to the receiver of the EUT.

The exact interferer power level  $P_{r\_interferer}$  which shall be applied to the receiver of the LPR device shall be determined according to the procedure outlined in Annex D.

The transmitted power level of the interfering signal  $P_{t\_interferer}$  which shall be fed into coaxial cable B at the RF-connector of the signal generator in order to generate the wanted interferer power level  $P_{r\_interferer}$  at the LPR receiver shall be calculated by considering the attenuation of transmission line B and the coupling factor of the used directional coupler. Thus, the correct interferer power of  $P_{r\_interferer}$  and the desired echo power of  $P_{r\_equivalent}$  will simultaneously be provided to the EUT.

### 5.5.3.1.3 Test procedure

The test procedure for receiver baseline resilience shall be conducted as follows:

- The measurement setup for the radiated approach is arranged according to Figure 7 and Figure 8. If the equipment under test provides an antenna connector (EUT sub-category ANT1) the test shall be carried out in a conducted arrangement according to Figure 9.
- The interferer frequencies  $f_{interferer}$  and power levels  $P_{r\_interferer}$  shall be determined by following the procedure outlined in Annex D. The respective test shall be repeated for all applicable interferer signals.
- The transmitted interferer power levels (microwave signal generator output power)  $P_{t\_interferer}$  shall be determined by means of the approaches outlined in clause 5.5.3.1.1 or the radiated test setup or clause 5.5.3.1.2 for the conducted test setup.
- The corresponding Radar Cross Section (RCS)  $\sigma$  of the radar target with the corresponding distance  $R_T$  shall be determined according to clause C.3 for the radiated setup in clause 5.5.3.1.1 delivering the desired echo power to the EUT receiver.
- For the conducted setup in clause 5.5.3.1.2 the desired echo power delivered to the EUT receiver can be adjusted by selecting a suitable attenuation in the employed attenuator (see Figure 9).
- The resulting received echo power  $P_{r\_equivalent}$  provided to the EUT receiver shall be equal or less than the received echo power  $P_{r\_real} = -53,8$  dBm in the real scenario (see clause C.2).
- The distance measurement is carried out against the radar target in the radiated setup (Figure 7 and Figure 8) or against the short circuit in the conducted setup (Figure 9) with the interferer signal turned on.

The test is passed if the radar target/short circuit can be detected with the required detection probability as specified in clause 4.4.4.3. In this case a sufficient resilience of the EUT receiver against interferer signals can be ensured.

- During the test, the EUT shall be configured for the fastest possible step response time. The configuration of the device under test in this regard shall be noted in the test report.

The step response time of an LPR sensor is defined according to IEC 61298-2 [i.9], clause 5.4 and can often be extracted from the manufacturer's datasheet or product manual. However, if the step response of the EUT is not known, it shall be determined by introducing a sudden change of the measurement distance of maximum 2 m. This shall be achieved by changing the distance to the radar target in the radiated equivalent scenario or changing the length of the transmission line to the short circuit in the conducted equivalent scenario. The step response time is the time span until the new distance value reaches 90 % of the final value for the first time.

### 5.5.3.2 Test setups for EUTs providing access to the receiver noise level

#### 5.5.3.2.1 General

If the EUT provides information about the noise level of the implemented receiver and the possibility to monitor changes in the noise level over time, for example, in an echo curve graph, the test for RBR shall be carried out without a simultaneous distance measurement against a radar target. If the EUT does not provide this feature, the procedure in clause 5.5.3.1 shall be applied for testing.

The interfering signal is directly coupled into the receiver of the EUT and the response of the noise floor is being monitored. An interfering signal will cause a rise of the noise floor in the receiver of the LPR sensor, no matter what frequency or type of modulation is used.

The LPR signal processing algorithms, however, need a stable echo, and a minimum echo signal-to-noise ratio  $SNR_{min}$  shall be maintained in order to ensure a measurement value variation  $\Delta d \leq \pm 50$  mm over time during a distance measurement. Echoes with smaller signal to noise ratios than  $SNR_{min}$  cannot be processed by the LPR with the predefined accuracy. This correlation is used to define the following test procedure.

The received echo power  $P_{r\_real} = -53,8$  dBm is determined according to see clause C.2 assuming a reference device in a real environment measuring against an oil surface. The maximum allowed noise level, which still ensures a measurement value variation  $\Delta d \leq \pm 50$  mm of the device, is then determined by subtracting the minimum allowed echo signal-to-noise ratio  $SNR_{min}$  from the echo power  $P_{r\_real} = -53,8$  dBm.

$$\text{max. allowed noise level (in dBm)} = P_{r\_real} - SNR_{min} \text{ (in dB)} \quad (6)$$

The relation between the measurement value variation  $\Delta d$  and the signal-to-noise-ratio SNR of the corresponding echo signal, and thus the minimum signal-to-noise-ratio  $SNR_{min}$ , shall be determined by providing different echo signal power levels to the EUT and recording the measured distance value over a period of 120 seconds or 40 times the step response time of the EUT, whichever is longer. If the step response time of the EUT is not known, it can be determined according to the procedure described in clause 5.5.3.1.3.

The measurement for  $SNR_{min}$  shall be carried out in a radiated setup according to Figure 5 if the EUT provides no antenna connector (EUT sub-category ANT2). The different echo power levels used to determine  $SNR_{min}$  can be realized by varying the RCS of the used radar target and/or the distance  $R_T$  to this artificial target. If the EUT provides an antenna connector (EUT sub-category ANT1) this measurement shall be carried out in a conducted setup according to Figure 6. The different echo power levels used to determine  $SNR_{min}$  can be realized by varying the attenuation in the attenuator employed in the signal path from the EUT to the short circuit and back into the receiver of the EUT.

The minimum required signal-to-noise-ratio  $SNR_{min}$  and the maximum allowed noise level shall be noted in the test report.

The RBR test is passed if the noise floor of the LPR under test stays permanently below the maximum allowed noise level under interference conditions.

#### 5.5.3.2.2 Test procedure

The test procedure for receiver baseline resilience shall be conducted as follows:

- The measurement setup for the radiated approach is arranged according to Figure 7 and Figure 8 but without the radar target. The test antenna and EUT antenna shall be placed in the distance  $R$  and shall be ideally aligned for main beam direction and polarization.

If the equipment under test provides an antenna connector (EUT sub-category ANT1) the test shall be carried out in a conducted arrangement according to Figure 9 where the signal generator is directly connected to the antenna connector of the EUT by means of the transmission line B, i.e. the directional coupler, the attenuator and the transmission line A are not used in this test setup.

- The interferer frequencies  $f_{interferer}$  and power levels  $P_{r\_interferer}$  shall be determined by following the procedure outlined in Annex D. The respective test shall be repeated for all applicable interferer signals (see Annex D).

- The transmitted interferer power levels (microwave signal generator output power)  $P_{t\_interferer}$  shall be determined by means of the approaches outlined in clause 5.5.3.1.1 for the radiated test setup or clause 5.5.3.1.2 for the conducted test setup.
- The minimum echo signal-to-noise ratio  $SNR_{min}$  which ensures a measurement value variation  $\Delta d \leq \pm 50$  mm shall be determined according to the procedure described in clause 5.5.3.2.1 and recorded in the test report.
- The maximum allowed noise level is calculated by means of Equation (6) in clause 5.5.3.2.1.
- The interfering signal is activated and the noise level of the EUT is continuously monitored for example in an echo curve graph.
- The test is passed if the noise floor of the EUT stays below the maximum allowed noise level for a fraction of:
  - 50 % of the measurement period if the interferer is located inside the OFR (co-channel interference);
  - 85 % of the measurement period if the interferer is located at  $f_c \pm$  OFR (adjacent channel interference);
  - 95 % of the measurement period if the interferer is located at  $f_c \pm 2 \times$  OFR (blocking);

as specified in clause 4.4.4.3. In this case a sufficient resilience of the EUT receiver against interferer signals can be ensured.

## Annex A (informative): Relationship between the present document and the essential requirements of Directive 2014/53/EU

The present document has been prepared under the Commission's standardisation request C(2015) 5376 final [i.2] to provide one voluntary means of conforming to the essential requirements of Directive 2014/53/EU on the harmonisation of the laws of the Member States relating to the making available on the market of radio equipment and repealing Directive 1999/5/EC [i.1].

Once the present document is cited in the Official Journal of the European Union under that Directive, compliance with the normative clauses of the present document given in Table A.1 confers, within the limits of the scope of the present document, a presumption of conformity with the corresponding essential requirements of that Directive and associated EFTA regulations.

**Table A.1: Relationship between the present document and the essential requirements of Directive 2014/53/EU [i.1]**

Harmonised Standard ETSI EN 302 729-1					
Requirement				Requirement Conditionality	
No	Description	Essential requirements of Directive	Clause(s) of the present document	U/C	Condition
1	Operating Frequency Range (OFR)	3.2	4.3.2	U	
2	Mean e.i.r.p. spectral density	3.2	4.3.3	U	
3	Peak e.i.r.p. spectral density	3.2	4.3.4	U	
4	TX Unwanted Emissions (TXUE)	3.2	4.3.5	U	
5	Antenna requirements	3.2	4.3.6	U	
6	Mitigation techniques	3.2	4.3.7	C	Applies only to LPR categories LPR9, LPR10, LPR11, LPR12, LPR13, LPR14, LPR15, LPR16.
7	TX-behaviour under the complete environmental profile	3.2	4.3.8	U	
8	Receiver Baseline Sensitivity (RBS)	3.2	4.4.3	U	
9	Receiver Baseline Resilience (RBR)	3.2	4.4.4	U	

### Key to columns:

#### Requirement:

**No** A unique identifier for one row of the table which may be used to identify a requirement.

**Description** A textual reference to the requirement.

#### Essential requirements of Directive

Identification of article(s) defining the requirement in the Directive.

#### Clause(s) of the present document

Identification of clause(s) defining the requirement in the present document unless another document is referenced explicitly.

#### Requirement Conditionality:

**U/C** Indicates whether the requirement is unconditionally applicable (U) or is conditional upon the manufacturer's claimed functionality of the equipment (C).

**Condition** Explains the conditions when the requirement is or is not applicable for a requirement which is classified "conditional".

Presumption of conformity stays valid only as long as a reference to the present document is maintained in the list published in the Official Journal of the European Union. Users of the present document should consult frequently the latest list published in the Official Journal of the European Union.

Other Union legislation may be applicable to the product(s) falling within the scope of the present document.



## Annex B (informative): Selection of technical parameters

ETSI EG 203 336 [i.10], clause 5 lists the technical parameters applicable to transmitters and receivers that should be considered when producing Harmonised Standards and that are intended to cover the essential requirements in article 3.2 of Directive 2014/53/EU [i.1]. Essential requirements are high level objectives described in European Directives. The purpose of the Harmonised Standard is to translate those high-level objectives into detailed technical specifications. Table B.1 contains the parameters listed in ETSI EG 203 336 [i.10], clause 5 for transmitter and receiver, and cross references these to the clauses within the present document in which the requirements for measurement of such parameters are satisfied or justified.

**Table B.1: Cross reference of clauses in the present document to technical parameters for transmitter and receiver listed in ETSI EG 203 336 [i.10]**

ETSI EG 203 336 [i.10]		Present document		Justification
Clause	Parameter	Clause	Parameter	
5.2.2	Transmitter power limits	4.3.3	Mean e.i.r.p. spectral density	As specified in European Commission Implementing Decision (EU) 2022/180 [i.7] and ECC Decision (11)02 [i.3].
		4.3.4	Peak e.i.r.p. spectral density	
		4.3.6	Antenna requirements, i.e. HPBW and sidelobe suppression	
5.2.3	Transmitter power accuracy	-	-	From the latest version of ETSI EG 203 336 [i.10]: "When regulatory limits imply only a maximum emission limit (e.g. products that operate under a general licence regime), this parameter need not to be considered for inclusion in an HS."
5.2.4	Transmitter spectrum mask	4.3.2	Operating Frequency Range (OFR)	
5.2.5	Transmitter frequency stability	-	-	See note.
5.2.6	Transmitter intermodulation attenuation	-	-	From latest version of ETSI EG 203 336 [i.10]. This parameter is only applicable "where high levels of quality services are required". This is not the case for generic short-range devices which are operating on the "no interference, no protection" principle under a licence exempt regime without any kind of regulatory protection. SRDs have to accept interferences.
5.2.7.2	Transmitter unwanted emissions in the out of band domain	4.3.5	TX Unwanted emissions	
5.2.7.3	Transmitter unwanted emissions in the spurious domain	4.3.5	TX Unwanted emissions	
5.2.8	Transmitter time domain characteristics	4.3.7.3	Duty cycle over signal repetition period (DC <sub>Trep</sub> )	
5.2.9	Transmitter transients	4.3.5	TX Unwanted emissions	
	Other mitigation, spectrum access requirements not specified in the ETSI Guide but specified in related ECC/EC framework	4.3.7.2 4.3.7.4	Adaptive power control Frequency Domain Mitigation (FDM)	

ETSI EG 203 336 [i.10]		Present document		Justification
Clause	Parameter	Clause	Parameter	
5.3.2	Receiver sensitivity	-	-	Covered by RBS. See justification in ETSI EN 303 883-2 [2], Annex C.
5.3.2.3	Desensitization	-	-	
5.3.3	Receiver co-channel rejection	-	-	
5.3.4.2.1	Receiver adjacent channel selectivity	-	-	
5.3.4.2.2	Receiver adjacent band selectivity	-	-	
5.3.4.3	Receiver blocking	-	-	
5.3.4.4	Receiver spurious response rejection	-	-	
5.3.4.5	Receiver radio-frequency intermodulation	-	-	
5.3.5	Receiver unwanted emissions in the spurious domain	-	-	Not applicable as the present document does not cover receive-only devices or transceivers with receive-only mode (see clause 4.2.1).
5.3.6.1	Receiver dynamic range	4.4.3	partly by Receiver Baseline Resilience (RBR)	See ETSI EN 303 883-2 [2], Table C.1 for more information.
5.3.6.2	Reciprocal mixing	-	-	Covered by RBR See justification in ETSI EN 303 883-2 [2], Annex C.
5.3.1	Signal interferer handling	4.4.3 4.4.4	Receiver Baseline Sensitivity (RBS) Receiver Baseline Resilience (RBR)	Signal interferer handling (ETSI EG 203 336 [i.10], clause 5.3.1) is an alternative method for specifying receiver parameters intended for receivers such as UWB and certain types of radar equipment. The present document is following this concept, see ETSI TS 103 567 [i.11] and ETSI EN 303 883-2 [2].
NOTE: Not applicable for UWB/wideband devices based on the nature of the used modulation.				

# Annex C (normative): Test scenarios for receiver parameters measurements

## C.1 Introduction

An equivalent test scenario (see Figure C.1) is applied, which accurately reflects the conditions set out in the typical real scenario (see clause C.2) for the EUT setup at much shorter measurement distances. The radiated test can then conveniently be conducted in the limited space provided in an anechoic chamber described, for example, in ETSI EN 303 883-1 [1], clause B.2.2.2 under the boundary conditions specified in ETSI TS 103 789 [3], Annex B.

A detailed description of how to transfer a real measurement scenario against a material surface in distance  $D_{meas}$  into a radiated equivalent scenario using an artificial radar target (e.g. sphere, corner reflector, etc.) located in an arbitrary distance  $D_T$  which produces exactly the same Rx power at the EUT's receiver can be found in ETSI TS 103 789 [3], clause A.2.4.

## C.2 Definition of the real scenario

In the typical real scenario, the received echo power is derived from the reflection of the transmit signal generated by a sub-category OFR2 reference LPR device operating at a centre frequency  $f_c = 25,275$  GHz at a reference material surface with permittivity  $\epsilon_r = 2,0$  (e.g. oil) in a distance of  $R_{meas} = 20$  m.

Table C.1 lists the technical parameters of the reference LPR device in detail.

**Table C.1: Technical parameters of the reference LPR device**

EUT sub-category	Frequency range which contains the OFR of the EUT	Centre frequency $f_c$	Peak power (conducted)	Antenna gain	Peak e.i.r.p.
OFR2	24,05 to 26,5 GHz	25,275 GHz	-2 dBm (0,631 mW)	28 dBi (631)	26 dBm

NOTE: The conducted peak power and the antenna gain of the reference device are defined in a way, that, in this example, the resulting peak e.i.r.p. value hits the regulated limit of 26 dBm.

The received power  $P_{r\_real}$  fed back into the EUT receiver can be calculated according to the following equation (see ETSI TS 103 789 [3], clause A.2.4), assuming a specular reflection at the above defined flat oil surface.

$$P_{r\_real} = \frac{P_{t\_ref} G_{ref}^2 \lambda^2 |r|^2}{(8\pi R_{meas})^2} \quad (C.1)$$

- $P_{r\_real}$ : received echo power in the real measurement scenario (in Watt)
- $P_{t\_ref}$ : maximum conducted peak power of the reference LPR device (0,631 mW)
- $G_{ref}$ : antenna gain of the reference LPR device in main lobe direction (631)
- $\lambda$ : wavelength of the transmit signal at centre frequency  $f_c$
- $R_{meas}$ : measurement distance in the real scenario ( $R_{meas} = 20$  m)
- $r$ : reflection coefficient of the reference surface ( $r = -0,172$  with  $\epsilon_r = 2,0$ ).

The reflection coefficient of the transition from air to the surface material with relative permittivity  $\epsilon_r$  can be approximated by:

$$r \approx \frac{1 - \sqrt{\epsilon_r}}{1 + \sqrt{\epsilon_r}} \quad (C.2)$$

- $\epsilon_r$ : relative permittivity of the considered surface material

Consequently, for the typical real scenario the power  $P_{r\_real} = -53,8$  dBm is returned back into the receiver of the EUT.

### C.3 Derivation of the radiated equivalent scenario

The real scenario, outlined in clause C.2, can be translated into a radiated equivalent scenario using an artificial radar target (e.g. sphere, corner reflector etc.) located in an arbitrary distance  $R_T$  which produces the same Rx power at the EUT's receiver as the above defined reference surface obtained with the respective reference device.

The aim of the equivalent scenario is to enable the possibility to carry out the radiated measurements in the limited space provided in an anechoic chamber (described for example in ETSI EN 303 883-1 [1], clause B.2.2.2) at a much shorter measurement distance  $R_T$  ( $R_T < R_{meas}$ ) and thus to facilitate testing.

In order to ensure the same echo signal power at the LPR receiver as in the defined real scenario (i.e.  $P_{r\_real} = -53,8$  dBm), a radar target with a certain Radar Cross Section (RCS)  $\sigma$  is used (see clause C.4) which is placed at a convenient distance  $R_T$  (often at standard distances of 3 m, 5 m or 10 m depending on the used anechoic chamber) from the EUT (Figure C.1).

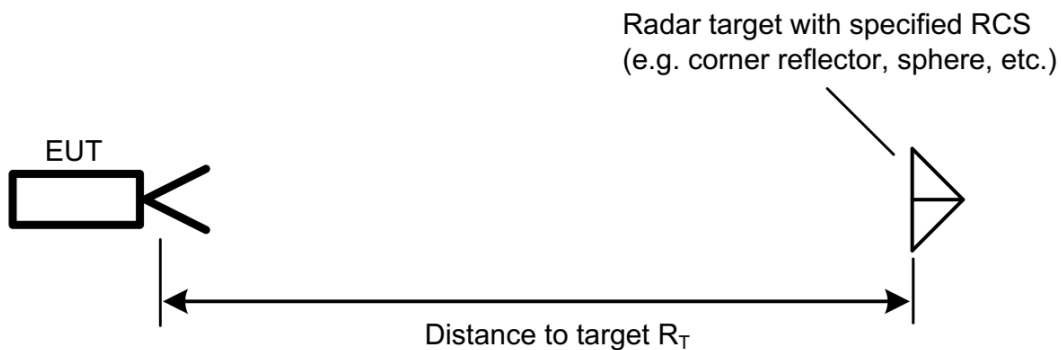

**Figure C.1: Radiated measurement setup of the equivalent scenario**

The measurement at this shorter distance  $R_T$  is valid as the variation of the measured distance value and thus also the detection probability (performance criterion) of the LPR sensor solely depends on the signal-to-noise ratio of the echo signal and not on the distance to the radar target itself.

The power level of the echo signal in the equivalent scenario  $P_{r\_equivalent}$  at the receiver during the measurement against the radar target with RCS  $\sigma$  shall be determined by following the provisions in ETSI TS 103 789 [3], clause A.2.4.

The shape and size of a radar target depends on the desired Radar Cross Section (RCS)  $\sigma$ . The equations for the radar cross sections of different reflectors in boresight direction can be found in ETSI TS 103 789 [3], clause A.1.

### C.4 Evaluation of the Radar Cross Section (RCS) of standard radar targets

In order to evaluate the Radar Cross Section (RCS) of standard radar targets the approach described in ETSI TS 103 789 [3], clause 7 shall be followed.

---

## Annex D (normative): Interferer signals for receiver baseline resilience

### D.1 General

The approach defined in ETSI EN 303 883-2 [2], clause A.2.1.0 option 2 shall be used.

---

### D.2 Interferer within the OFR

To determine the interferer test signals within the OFR, the provisions in ETSI EN 303 883-2 [2], clause A.2.1 shall be followed. For the purpose of the present document, option 2 shall be used (see ETSI EN 303 883-2 [2], clause A.2.1.2) using the following parameters in order to determine the interferer power level at the EUT receiver:

- 100 mW e.i.r.p. interferer power;
- 10 m distance under line-of-sight conditions;
- 10 dB additional loss.

NOTE: The deviation from the distance value of 2 m in ETSI EN 303 883-2 [2], clause A.2.1.2 is sensible as level probing radar equipment is usually operated in remote industrial areas. The 10 m minimum distance is thus also reflected in ETSI TS 103 361 [i.12], clause 7.7.

---

### D.3 Interferer outside of the OFR

To determine the interferer test signals outside of the OFR, the provisions in ETSI EN 303 883-2 [2], clause A.2.2 shall be followed. For the purpose of the present document, the power level of the interfering signals shall be determined following also the procedure in ETSI EN 303 883-2 [2], clause A.2.1.2 using the same parameters listed in clause D.2.

---

## Annex E (informative): Installation requirements

The following installation requirements apply to LPR equipment and are direct citations from ECC Decision (11)02 [i.3]. These installation requirements, however, are not subject to Annex A of the present document:

- *"LPR devices shall always be installed at permanent fixed positions.*
- *A strict (stable) orientation of LPR antennas under any operating conditions shall be ensured by appropriate installation.*
- *LPR devices are intended to be installed in industrial environments by professionally trained personnel.*

*In addition, radio astronomy stations shall be protected as follows:*

- *From 0 km up to 4 km radius around any radio astronomy station, installation of LPR devices operating in 6 GHz to 8,5 GHz, 24,05 GHz to 26,5 GHz and 75 GHz to 85 GHz bands shall be prohibited unless a special authorization has been provided by the responsible national administration.*
- *From 4 to 40 km around any radio astronomy station, the antenna height of an LPR installation of devices operating in 6 GHz to 8,5 GHz, 24,05 GHz to 26,5 GHz and 75 GHz to 85 GHz bands shall not exceed 15 m".*

A list of presently known radio astronomy sites is provided in Table E.1 and in ECC Decision (11)02 [i.3]. The manufacturer is required to inform the users and installers of LPR equipment about the restrictions listed above.

Table E.1: List of radio astronomy sites exclusion zones according to ECC Decision (11)02 [i.3]

Country	Name of station	Geographic Latitude	Geographic Longitude	Frequency Band (see note below)
Finland	Metsähovi	60°13'04" N	24°23'37" E	A, B and C
	Tuorla	60°24'56" N	22°26'31" E	A and B
France	Plateau de Bure	44°38'01" N	05°54'26" E	B and C
Germany	Effelsberg	50°31'32" N	06°53'00" E	A, B and C
Hungary	Penc	47°47'22" N	19°16'53" E	B
Italy	Medicina	44°31'14" N	11°38'49" E	B
	Noto	36°52'34" N	14°59'21" E	B
	Sardinia	39°29'50" N	09°14'40" E	A, B and C
Latvia	Ventspils	57°33'12" N	21°51'17" E	A and B
Poland	Kraków – Fort Skala	50°03'18" N	19°49'36" E	B
	Toruń - Pivnice	52°54'48" N	18°33'30" E	A
Russia	Badari	51° 45'27" N	102° 13'16" E	A
	Dmitrov	56°26'00" N	37°27'00" E	B
	Kalyazin	57°13'22" N	37°54'01" E	B
	Pushchino	54°49'00" N	37°40'00" E	B
	Svetloe	61° 05' N	29° 46'54" E	A
	Zelenchukskaya	43°49'53" N	41°35'32" E	A and B
Spain	Yebes	40°31'27" N	03°05'22" W	A, B and C
	Robledo	40°25'38" N	04°14'57" W	B
	Pico Veleta	37°03'58" N	03°23'34" W	C
Switzerland	Bleien	47°20'26" N	08°06'44" E	B
Sweden	Onsala	57°23'45" N	11°55'35" E	A, B and C
The Netherlands	Westerbork	52°55'01" N	06°36'15" E	A
Turkey	Kayseri	38°59'45" N	36°17'58" E	A
UK	Cambridge	52°09'59" N	00°02'20" E	B
	Darnhall	53°09'22" N	02°32'03" W	B
	Jodrell Bank	53°14'10" N	02°18'26" W	A and B
	Knockin	52°47'24" N	02°59'45" W	B
	Pickmere	53°17'18" N	02°26'38" W	B
NOTE:	Band A: 6 GHz to 8,5 GHz. Band B: 24,05 GHz to 26,5 GHz. Band C: 75 GHz to 85 GHz.			

Table E.1 is based on available information at the time of creation of the present document. The possible omission of stations for certain frequency ranges does not mean that future use of these frequency ranges is excluded. Additional information on the list of radio astronomy stations may be available under [www.craf.eu](http://www.craf.eu) [i.8].

---

## Annex F (informative): Range of modulation schemes

### F.1 Pulse modulation schemes

In pulse modulation schemes, the transmitter periodically transmits a pulse train containing of pulses with individual pulse durations. Typical examples of pulse modulation schemes are shown in ETSI EN 303 883-1 [1], clause C.2.1.

---

### F.2 FMCW modulation schemes

In FMCW modulation schemes, the transmitter periodically transmits a pulse train containing of frequency modulated sweeps or ramps with individual sweep durations. Typical examples of FMCW modulation schemes are shown in ETSI EN 303 883-1 [1], clause C.2.2.



---

## Annex G (informative): Bibliography

- CEPT [ERC Recommendation 70-03](#): "ERC Recommendation on relating to the use of Short Range Devices (SRD)", Tromsø 1997 and subsequent amendments.
- Commission Decision 2013/752/EU on harmonisation of the radio spectrum for use by short-range devices as amended by subsequent Commission Decisions.
- Recommendation ITU-R SM.329-12 (2012): "Unwanted emissions in the spurious domain".
- ETSI TS 103 060 (V1.1.1): "Electromagnetic compatibility and Radio spectrum Matters (ERM); Short Range Devices (SRD); Method for a harmonized definition of Duty Cycle Template (DCT) transmission as a passive mitigation technique used by short range devices and related conformance test methods".
- Recommendation ITU-R SM.1755: "Characteristics of ultra-wideband technology".

## Annex H (informative): Change history

Date	Version	Information about changes
May 2011	1.1.2	Last publication of ETSI EN 302 729 -1 and -2 as a two-part HS under R&TTE-Directive.
December 2016	2.1.1	<p>Revision of ETSI EN 302 729 for Level Probing Radar (LPR) equipment for compliance under the Radio Equipment Directive 2014/53/EU; cited in OJEU at 10 March 2017.</p> <p>Main changes to previous version:</p> <ul style="list-style-type: none"> <li>• Merge of ETSI EN 302 729-1/-2 into a single EN covering the essential requirement of the Directive 2014/53/EU</li> <li>• Out-sourcing of some standard measurement procedures into a separate ETSI EN 303 883 (V1.1.1)</li> <li>• New requirement on receiver interferer signal handling</li> <li>• New Annex B "Application form for testing"</li> <li>• Annex I "Atmospheric absorptions and material dependent attenuations" deleted</li> <li>• New Annex K "Radar targets for radiated measurements"</li> <li>• New Annex L "Boundary conditions for the radar equation"</li> </ul>
	3.1.1	<p>Revision of ETSI EN 302 729 on request of the EC to improve the standard, especially regarding receiver requirements (more information is given in the introduction of this document).</p> <p>In order to achieve soundness and clarity, TGUWB decided to develop more specific standards. For the present document this means that it is a subpart 1 of a series of standards. Subpart 2 is dedicated to "Level Probing Radar (LPR) equipment operating in the frequency range 75 GHz to 85 GHz for tilted downward installation". Other sub-parts may follow.</p> <p>The main changes compared to the previous version are:</p> <ul style="list-style-type: none"> <li>• Clear categorization of EUTs covered by the present document based on regulation, technical implementations and intended use-case requirements.</li> <li>• Change in the EN structure to allow other use-cases with different requirements related to the intended use.</li> <li>• Receive-only devices, EUTs exhibiting a receive only mode or a standby mode have been removed from the scope of the present document.</li> <li>• Addition of a TX-requirement over the complete environmental profile.</li> <li>• Introduction of the new UWB emission concept as described in ETSI EN 303 883-1 V2.1.1 (2024-06) clause 5.1.2.</li> <li>• All manufacturer declarations have been removed.</li> <li>• Clarification to assess the mean e.i.r.p. spectral density according to ETSI EN 303 883-1, clause 5.3.2.4 over 1 ms.</li> </ul>

# History

<b>Document history</b>		
V1.1.2	May 2011	Publication
V2.1.1	December 2016	Publication as ETSI EN 302 729
V3.0.0	October 2024	SRdAP process EV 20250106: 2024-10-08 to 2025-01-06
V3.1.0	March 2025	SRdAP process VA 20250511: 2025-03-12 to 2025-05-12