



Harmonized European Standard

**Advanced Surface Movement Guidance
and Control System (A-SMGCS);
Part 6: Harmonized EN covering the essential requirements
of article 3.2 of the R&TTE Directive for
deployed surface movement radar sensors;
Sub-part 1: X-band sensors using pulsed signals and
transmitting power up to 100 kW**

Reference

DEN/ERM-JTFEA-005-6

Keywords

aeronautical, ATM, interoperability, regulation

ETSI

650 Route des Lucioles
F-06921 Sophia Antipolis Cedex - FRANCE

Tel.: +33 4 92 94 42 00 Fax: +33 4 93 65 47 16

Siret N° 348 623 562 00017 - NAF 742 C
Association à but non lucratif enregistrée à la
Sous-Préfecture de Grasse (06) N° 7803/88

Important notice

Individual copies of the present document can be downloaded from:

<http://www.etsi.org>

The present document may be made available in more than one electronic version or in print. In any case of existing or perceived difference in contents between such versions, the reference version is the Portable Document Format (PDF). In case of dispute, the reference shall be the printing on ETSI printers of the PDF version kept on a specific network drive within ETSI Secretariat.

Users of the present document should be aware that the document may be subject to revision or change of status. Information on the current status of this and other ETSI documents is available at

<http://portal.etsi.org/tb/status/status.asp>

If you find errors in the present document, please send your comment to one of the following services:

http://portal.etsi.org/chaicor/ETSI_support.asp

Copyright Notification

No part may be reproduced except as authorized by written permission.
The copyright and the foregoing restriction extend to reproduction in all media.

© European Telecommunications Standards Institute 2011.
All rights reserved.

DECT™, **PLUGTESTS™**, **UMTS™** and the ETSI logo are Trade Marks of ETSI registered for the benefit of its Members.
3GPP™ and **LTE™** are Trade Marks of ETSI registered for the benefit of its Members and of the 3GPP Organizational Partners.
GSM® and the GSM logo are Trade Marks registered and owned by the GSM Association.

Contents

Intellectual Property Rights	5
Foreword.....	5
Introduction	6
1 Scope	7
2 References	7
2.1 Normative references	7
2.2 Informative references.....	7
3 Definitions, symbols and abbreviations	8
3.1 Definitions	8
3.2 Symbols.....	8
3.3 Abbreviations	9
4 Technical requirements	9
4.1 Environmental profile.....	9
4.2 Conformance requirements	9
4.2.1 Operating frequency	9
4.2.1.1 Definition	9
4.2.1.2 Limits	10
4.2.1.3 Conformance.....	10
4.2.2 Transmitter power.....	10
4.2.2.1 Definition	10
4.2.2.2 Limits	10
4.2.2.3 Conformance.....	10
4.2.3 Out-of-band emissions.....	10
4.2.3.1 Definition	10
4.2.3.2 Limits	11
4.2.3.3 Conformance.....	12
4.2.4 Spurious emissions	12
4.2.4.1 Definition	12
4.2.4.2 Limits	13
4.2.4.3 Conformance.....	14
4.3 Receiver requirements.....	14
4.3.1 Receiver Noise Figure	14
4.3.1.1 Limit.....	14
4.3.1.2 Conformance.....	14
4.3.2 Receiver Selectivity	14
4.3.2.1 Limit.....	14
4.3.2.2 Conformance.....	14
5 Testing for compliance with technical requirements.....	14
5.1 Test conditions, power supply and ambient temperatures	14
5.1.1 Standard operating mode of the radar equipment	14
5.2 Normal test conditions.....	15
5.2.1 Introduction.....	15
5.2.2 Normal temperature and humidity	15
5.2.3 Normal test power supply	15
5.3 Essential radio test suites.....	15
5.3.1 Operating frequency	15
5.3.2 Transmitter power.....	16
5.3.3 Out-of-Band-emissions	16
5.3.4 Spurious emissions	18
5.3.5 System Noise Figure	18
5.3.6 Receiver Selectivity	18
5.3.6.1 Receiver Out-of-Band selectivity.....	19
5.3.6.2 Receiver spurious response rejection	19

Annex A (normative):	HS Requirements and conformance Test specifications Table (HS-RTT).....	21
Annex B (normative):	Transmission power and unwanted emissions of radar systems with indirect methods.....	23
Annex C (informative):	The EN title in the official languages	24
Annex D (informative):	Bibliography.....	25
History		26

Intellectual Property Rights

IPRs essential or potentially essential to the present document may have been declared to ETSI. The information pertaining to these essential IPRs, if any, is publicly available for **ETSI members and non-members**, and can be found in ETSI SR 000 314: "*Intellectual Property Rights (IPRs); Essential, or potentially Essential, IPRs notified to ETSI in respect of ETSI standards*", which is available from the ETSI Secretariat. Latest updates are available on the ETSI Web server (<http://ipr.etsi.org>).

Pursuant to the ETSI IPR Policy, no investigation, including IPR searches, has been carried out by ETSI. No guarantee can be given as to the existence of other IPRs not referenced in ETSI SR 000 314 (or the updates on the ETSI Web server) which are, or may be, or may become, essential to the present document.

Foreword

This Harmonized European Standard (EN) has been produced by ETSI Technical Committee Electromagnetic compatibility and Radio spectrum Matters (ERM).

The present document has been produced by ETSI in response to a mandate from the European Commission issued under Directive 98/34/EC [i.9] as amended, laying down a procedure for the provision of information in the field of technical standards and regulations.

The title and reference to the present document are intended to be included in the publication in the Official Journal of the European Union of titles and references of Harmonized Standard under the Directive 1999/5/EC [i.1].

See article 5.1 of Directive 1999/5/EC [i.1] for information on presumption of conformity and Harmonised Standards or parts thereof the references of which have been published in the Official Journal of the European Union.

The requirements relevant to Directive 1999/5/EC [i.1] are summarised in annex A.

The present document is part 6, sub-part 1 of a multi-part deliverable covering Advanced Surface Movement Guidance and Control System (A-SMGCS), as identified below:

- Part 1: "Community Specification for application under the Single European Sky Interoperability Regulation EC 552/2004 for A-SMGCS Level 1 including external interfaces";
- Part 2: "Community Specification for application under the Single European Sky Interoperability Regulation EC 552/2004 for A-SMGCS Level 2 including external interfaces";
- Part 3: "Community Specification for application under the Single European Sky Interoperability Regulation EC 552/2004 for a deployed cooperative sensor including its interfaces";
- Part 4: "Community Specification for application under the Single European Sky Interoperability Regulation EC 552/2004 for a deployed non-cooperative sensor including its interfaces";
- Part 5: "Harmonized EN covering the essential requirements of article 3.2 of the R&TTE Directive for transmitter used in multilateration equipment";
- Part 6: "Harmonized EN covering the essential requirements of article 3.2 of the R&TTE Directive for deployed surface movement radar sensors";**

Sub-part 1: "X-Band sensors using pulsed signals and transmitting power up to 100 kW".

NOTE: SMR systems using FM-CW signals may be covered by future sub-parts of this multi-part deliverable.

National transposition dates	
Date of adoption of this EN:	19 September 2011
Date of latest announcement of this EN (doa):	31 December 2011
Date of latest publication of new National Standard or endorsement of this EN (dop/e):	30 June 2012
Date of withdrawal of any conflicting National Standard (dow):	30 June 2012

Introduction

The present document is part of a set of standards developed by ETSI and is designed to fit in a modular structure to cover all radio and telecommunications terminal equipment within the scope of the R&TTE Directive [i.1]. The modular structure is shown in EG 201 399 [i.10].

1 Scope

The present document applies to X-band radar sensors intended for the surveillance of airport surface movement traffic with the following characteristics:

- Utilizing modulated or unmodulated pulses.
- Transmitter Peak Envelope Power up to 100 kW.
- The transceiver-antenna connection is using a hollow metallic rectangular waveguide.
- The antenna is rotating, waveguide- based and passive.
- At the transceiver output an RF-circulator is used.

The present document covers only the essential requirements of article 3.2 of the R&TTE Directive [i.1].

NOTE 1: Since transceiver and antenna are hollow metallic rectangular waveguide based the frequency range for measurements that needs to be addressed covers 6,56 GHz to 26 GHz The lower limit of this frequency range is obtained as cut-off frequency of the combination of WR112/R84 taper section and a WR90/R100 Waveguide IEC 60153-2 [i.3]. The upper limit corresponds to the upper limit stated in ERC/Recommendation 74-01 [i.5].

NOTE 2: Since at the transceiver output an RF circulator is used, it is assumed that the transceiver characteristics remain independent from the antenna.

NOTE 3: According Article 5 of the ITU Radio Regulations [i.6] the band 9 000 MHz to 9 200 MHz is allocated to the Aeronautical Radionavigation Service on a primary basis and the band 9 300 MHz to 9 500 MHz is allocated to the Aeronautical Radionavigation Service on a secondary basis.

2 References

References are either specific (identified by date of publication and/or edition number or version number) or non-specific. For specific references, only the cited version applies. For non-specific references, the latest version of the reference document (including any amendments) applies.

Referenced documents which are not found to be publicly available in the expected location might be found at <http://docbox.etsi.org/Reference>.

NOTE: While any hyperlinks included in this clause were valid at the time of publication ETSI cannot guarantee their long term validity.

2.1 Normative references

The following referenced documents are necessary for the application of the present document.

Not applicable.

2.2 Informative references

The following referenced documents are not necessary for the application of the present document but they assist the user with regard to a particular subject area.

- [i.1] Directive 1999/5/EC of The European Parliament and of the Council of 9 March 1999 on radio equipment and telecommunications terminal equipment and the mutual recognition of their conformity (R&TTE Directive).
- [i.2] Merrill I. Skolnik: "Radar Handbook", 2nd Edition, McGraw Hill publications.

- [i.3] IEC 60153-2 (Edition 2.0, 1974): "Hollow metallic waveguides. Part 2: Relevant specifications for ordinary rectangular waveguides".
- [i.4] ECC/Recommendation (02)05 (2004): "Unwanted emissions".
- [i.5] ERC/Recommendation 74-01 (2011): "Unwanted emissions in the spurious domain".
- [i.6] International Telecommunication Union (ITU) Geneva 2008: "Radio Regulations".
- [i.7] ITU-R Recommendation M.1177-4 (2011): "Techniques for measurement of unwanted emissions of radar systems".
- [i.8] ITU-R Recommendation SM.1541-3 (2011): "Unwanted emissions in the out-of-band domain".
- NOTE: More stringent requirements envisioned for future versions of ITU-R Recommendation SM.1541-3, ECC/Recommendation (02)05 and ERC/Recommendation 74-01 may need to be considered in a future version of the present document.
- [i.9] Directive 98/34/EC of the European Parliament and of the Council laying down a procedure for the provision of information in the field of technical standards and regulations and of rules on information society services.
- [i.10] ETSI EG 201 399: "Electromagnetic compatibility and Radio spectrum Matters (ERM); A guide to the production of Harmonized Standards for application under the R&TTE Directive".

3 Definitions, symbols and abbreviations

3.1 Definitions

For the purposes of the present document, the following terms and definitions apply:

necessary bandwidth: for a given class of emission, the width of the frequency band which is just sufficient to ensure the transmission of information at the rate and with the quality required under specified conditions

NOTE: This definition is taken from ITU Radio Regulation No. 1.152 [i.6].

occupied bandwidth: Width of a frequency band such that, below the lower and above the upper frequency limits, the mean powers emitted are each equal to a specified percentage $\beta/2$ of the total mean power of a given emission. Unless otherwise specified in an ITU-R Recommendation for the appropriate class of emission, the value of $\beta/2$ should be taken as 0,5%.

NOTE: This definition is taken from ITU Radio Regulation No. 1.153 [i.6].

peak envelope power: average power supplied to the antenna transmission line by a transmitter during one radio frequency cycle at the crest of the modulation envelope taken under normal operating conditions

NOTE: This definition is taken from ITU Radio Regulation No. 1.157 [i.6]).

pulse duration: time between the 50 % amplitude (voltage) points

pulse rise time: time taken for the leading edge of the pulse to increase from 10 % to 90 % of the maximum amplitude (voltage)

3.2 Symbols

For the purposes of the present document, the following symbols apply:

B_{-40}	-40 dB bandwidth
B_C	Chirp bandwidth
B_N	Necessary bandwidth
B_{res}	3 dB resolution bandwidth of transceiver

dB_{pp}	dB with respect to peak power
$D_{no\ spur}$	Detectability Factor (function of PD & Pfa)
k	Boltzmann's constant
MDS	Minimum Detectable Signal
NF_{sys}	Noise Figure of the system
PD	Probability of detection
PEP	Peak Envelope Power
Pfa	Probability of false detection
P_t	Pulse power of transmission
t	Time
t_p	Pulse duration
t_r	Pulse rise time
T_0	Temperature in Kelvin
T_C	Chirp length in sec.
λ	Wavelength

3.3 Abbreviations

For the purposes of the present document, the following abbreviations apply:

AC	Alternating Current
FM-CW	Frequency Modulated Continuous Wave
LNA	Low Noise Amplifier
OoB	Out-of-Band
R&TTE	Radio and Telecommunication Terminal Equipment
SMR	Surface Movement Radar

4 Technical requirements

4.1 Environmental profile

Tests defined in the present document shall be carried out at representative points within the boundary limits of the declared operational environmental profile which, as a minimum, shall be that specified in the test conditions contained in the present document.

As technical performance varies subject to environmental conditions, tests shall be carried out under a sufficient variety of environmental conditions as specified in the present document to give confidence of compliance for the affected technical requirements (which shall also be within the boundary limits of the declared operational environmental profile).

4.2 Conformance requirements

4.2.1 Operating frequency

4.2.1.1 Definition

The transmitter of a pulsed radar produces microwave pulses, which cause a broad frequency spectrum, depending on the pulse duration.

The operating frequency is to be understood as the frequency of the microwave emission during the transmitting pulse and is represented by the spectral line of highest amplitude.

NOTE: It is only practicable to indicate an operating frequency for radars with unmodulated pulses. In this case a limit for the frequency tolerance is specified. For radars with modulated pulses such a limit is not applicable. In any case the occupied bandwidth is completely contained in the allocated frequency band(s).

4.2.1.2 Limits

The limit for the frequency tolerance for SMR applying unmodulated pulses is ± 30 MHz.

For all radar types covered by the present documents the occupied bandwidth of the signal shall be contained completely within the frequency ranges 9 000 MHz to 9 200 MHz or 9 300 MHz to 9 500 MHz in all operating modes.

4.2.1.3 Conformance

Conformance tests as defined in clause 5.3.1 shall be carried out.

4.2.2 Transmitter power

4.2.2.1 Definition

The transmitter power shall be referenced with respect to the output port of the radar transmitter.

The transmitter power of a pulse radar is understood as the peak value of the transmitter pulse power during the transmission pulse (PEP).

If the transmitter power varies over the azimuth, the highest PEP over at least one rotation period has to be used.

4.2.2.2 Limits

The transmitter power shall be as specified by the manufacturer with an accuracy of at least ± 1 dB. The peak power value shall not exceed 100 kW (50 dBW).

4.2.2.3 Conformance

Conformance tests as defined in clause 5.3.2 shall be carried out.

4.2.3 Out-of-band emissions

4.2.3.1 Definition

An important parameter of the Out-of-Band (OoB) emissions mask of the radar is the -40 dB bandwidth. Annex 8 of ITU-R Recommendation SM.1541-3 [i.8] specifies the -40 dB bandwidth specified for various types of waveforms (e.g. pulsed radar signals). With the following assumptions which apply to most airport surface movement radars these specifications can be further simplified:

- the radar is operating in the bands 9 000 MHz to 9 200 MHz or 9 300 MHz to 9 500 MHz
- the pulse power is below 100 kW
- the pulse rise time t_r is greater than $0,0094 \cdot t$, where t is the pulse duration

With the aforementioned assumptions the -40 dB bandwidth (B_{-40}) for primary non-FM pulse radars can be determined as follows:

$$B_{-40} = \frac{7.6}{\sqrt{t \times t_r}}$$

Where:

t is the pulse duration

t_r is the rise time in the case of a trapezoidal pulse

NOTE: For typical values of a pulse duration of $t = 50$ ns and a rise time of $t_r = 10$ ns the formula above yields a -40 dB bandwidth value of 340 MHz.

For radars with multiple pulse waveforms, the B_{-40} bandwidth should be calculated for each individual pulse type and the maximum B_{-40} bandwidth obtained shall be used to establish the shape of the emission mask.

For radars with a highly asymmetrical spectrum, the B_{-40} dB bandwidth can be offset from the frequency of maximum emission level, but the necessary bandwidth, B_N and preferably the overall occupied bandwidth should be contained completely within the allocated band as stipulated in section 4 of Annex 8 of ITU-R Recommendation SM.1541-3 [i.8].

The application of this rule is illustrated in Figure 1.

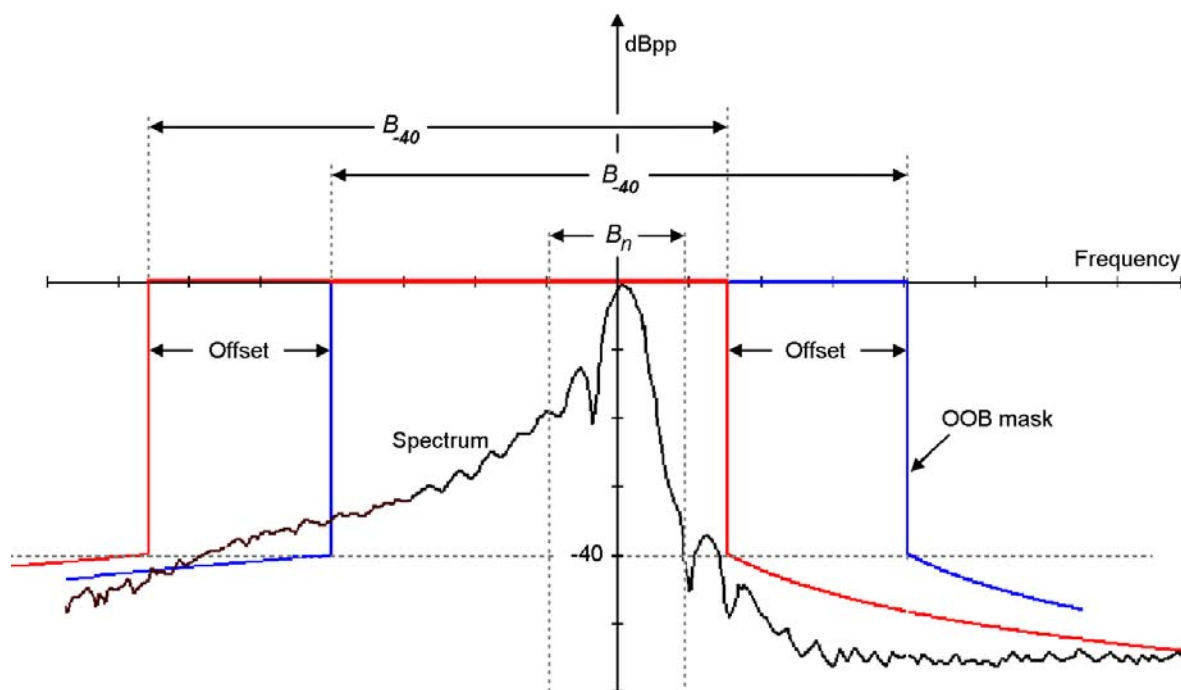

Figure 1: Application of the offset-rule for the Out-of-Band emission limit mask

The Out-of-Band emission limits and the spurious emission limits are defined based on the -40 dB bandwidth.

4.2.3.2 Limits

NOTE 1: In a future version of the present document more stringent requirements for OoB Emissions due to revisions to Annex 8 of ITU-R Recommendation SM.1541-3 [i.8] and ERC/Recommendation 74-01 [i.5] may need to be considered.

The maximum radiated Out-of-Band emission power level shall not exceed the limits stated in Table 1 and the corresponding mask depicted in Figure 2. The roll-off of the OoB-mask beyond the -40 dB bandwidth, B_{-40} in relation to B_{-40} is specified as follows:

- The mask has a roll-off at 20 dB/dec from the calculated (identified) B_{-40} bandwidth to a level of -60 dBpp. The mask then continues to roll-off at 60 dB/dec to a spurious emission limit level of -100 dBpp.

NOTE 2: This mask corresponds to the specification in Annex 2 of i.e. Figure A2.1 of ECC/Recommendation (02)05 [i.4].

- If an absolute limit of -30 dBm can be more easily achieved this limit applies in lieu of -100 dBpp.

NOTE 3: ERC/Recommendation 74-01 [i.5] stipulates in its Table 5.1 for fixed radars a spurious emission limit in the reference bandwidth of "-30 dBm or 100 dB, whichever is less stringent".

Table 1: Limits for unwanted emissions

Frequency offset relative to B ₋₄₀	Limit dBpp	Slope dB/decade
0 to 0,5	0	0
0,5	-40	-∞
0,5 to 5	-40 to -60	-20
5 to 23,2	-60 to -100 / -30 dBm	-60
23,2 to ∞	-100 / -30 dBm	0

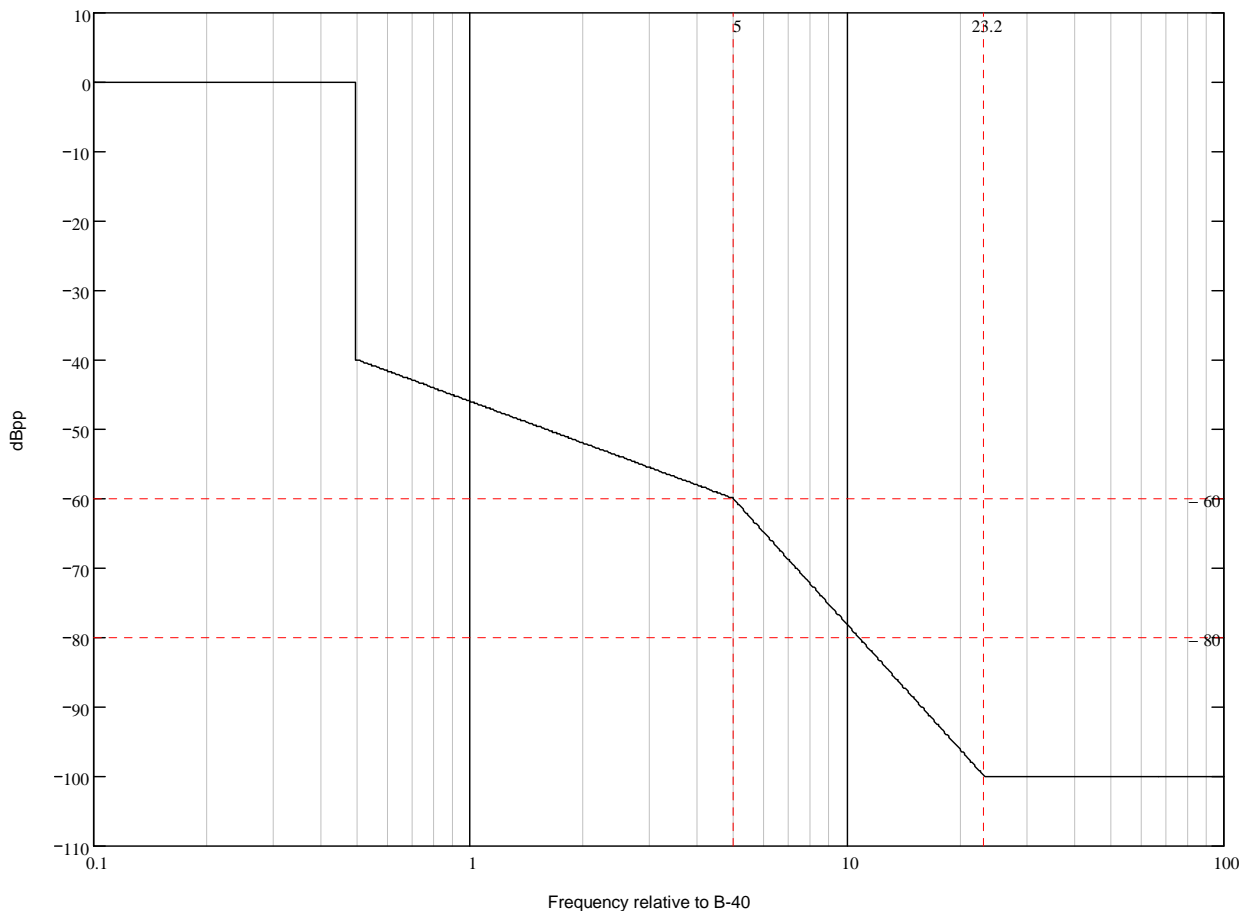

Figure 2: Out-of-Band emission limit masks

4.2.3.3 Conformance

Conformance tests as defined in clause 5.3.3 shall be carried out.

4.2.4 Spurious emissions

4.2.4.1 Definition

Spurious emissions are defined as the entity of all emissions in the frequency range of the cut-off frequency 6,56 GHz of the waveguide section to 26 GHz, but outside the OoB-boundaries.

NOTE: The lower limit of this frequency range of 6,56 GHz is obtained as cut-off frequency of the combination of WR112/R84 taper section and a WR90/R100 Waveguide as defined in IEC 60153-2 [i.3]. The upper limit corresponds to the upper limit stated in ERC/Recommendation 74-01 [i.5].

They include:

- harmonic emissions (whole multiples of the operating frequency);
- parasitic emissions (independent, accidentally);
- intermodulation (between oscillator- and operation frequency or between oscillator and harmonics);
- emissions caused by frequency conversions.

The boundaries between OoB domain and the spurious domain are where the OoB limit mask according to ECC/Recommendation (02)05 [i.4] reach the spurious emission limit according to ERC/Recommendation 74-01 [i.5].

This is illustrated in Figure 3.

The first mask limit ECC/Recommendation (02)05 [i.4] will result in the out-of-band emission domain width of 46,4 times B_{-40} . The design objective mask limits will reduce the out-of-band emission domain to the width of 21,5 times B_{-40} .

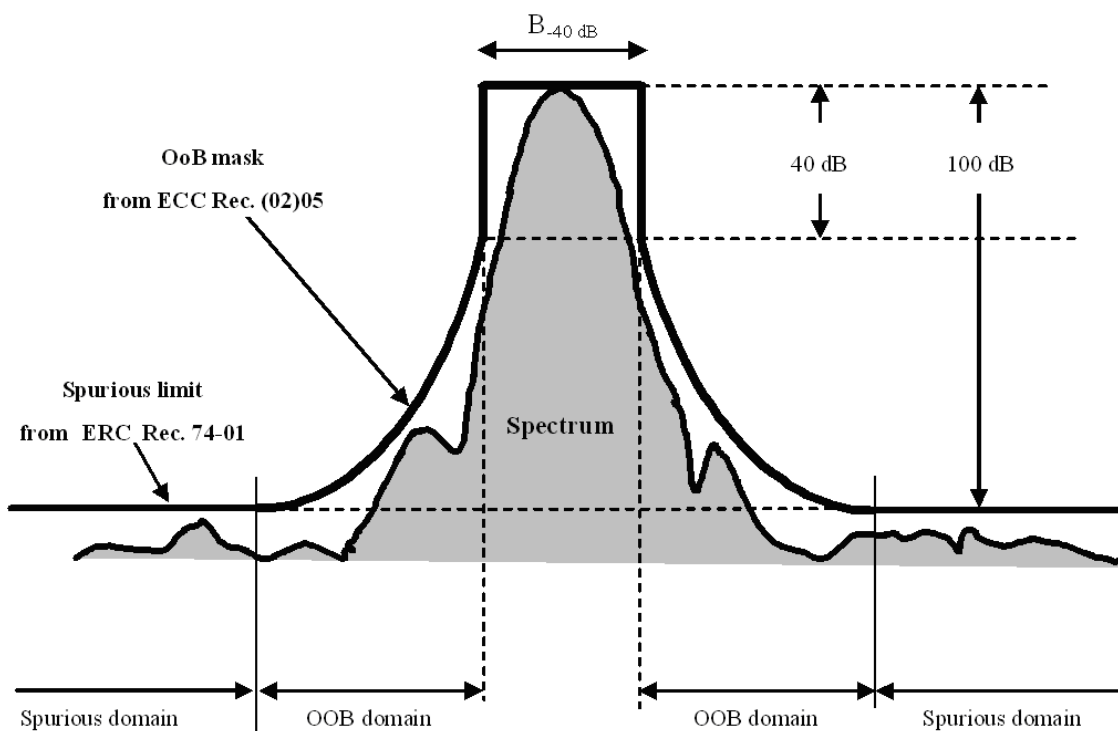

Figure 3: Definition of OoB and spurious emission domains
(Not to scale)

4.2.4.2 Limits

NOTE 1: In a future version of the present document, more stringent requirements for Spurious Emissions due to revisions of Annex 8 of ITU-R Recommendation SM.1541-3 [i.8] and ERC/Recommendation 74-01 [i.5] need to be considered.

For the spurious emissions the following requirement is based on Table 5.1 in Annex 5 for the case of fixed stations in ERC/Recommendation 74-01 [i.5] apply:

- All spurious emission levels radar equipment shall have:
 - a minimum attenuation of 100 dB or a maximum power -30 dBm, whichever is less stringent
 - measured as PEP in the reference bandwidth of 1 MHz

NOTE 2: A reference bandwidth of 1 MHz is recommended for frequencies above 1 GHz as in ERC/Recommendation 74-01 [i.5].

NOTE 3: In the case of occurrence of interferences caused by unwanted emissions of the radar system much higher suppression of Out-of-Band or spurious emissions may be required! Therefore it is desirable that it is possible to possible to attenuate or to suppress parts of the emitted signal in the feeder line.

4.2.4.3 Conformance

Conformance tests as defined in clause 5.3.4 shall be carried out.

4.3 Receiver requirements

4.3.1 Receiver Noise Figure

4.3.1.1 Limit

The maximum system Noise Figures shall be 6 dB.

4.3.1.2 Conformance

The conformance tests as defined in clause 5.3.5 shall be carried out.

4.3.2 Receiver Selectivity

4.3.2.1 Limit

The input selectivity characteristic of the SMR receiver shall be commensurate with the requirements for the spectrum of the emitted signal.

4.3.2.2 Conformance

The conformance tests as defined in clause 5.3.6 shall be carried out.

5 Testing for compliance with technical requirements

5.1 Test conditions, power supply and ambient temperatures

5.1.1 Standard operating mode of the radar equipment

For the purpose of the compliance tests described in the present document, the radar under test shall be set up in a realistic operation mode. This means that the transceiver shall be operating and set-up with parameters which produce the worst-case spectrum (e.g. shortest pulse length, highest peak frequency deviation). Furthermore, the radar must be supplied with the necessary signals (e.g. antenna azimuth encoder signal, safety loop signals) to simulate normal operation.

NOTE: The standard operating parameters depend very much on the type of the radar.

In the test-report the mode of operation applied for the tests shall be documented, in conjunction with a rationale, why this mode has been chosen.

5.2 Normal test conditions

5.2.1 Introduction

Unless otherwise stated, all tests shall take place under the following normal test conditions. During the tests the radar equipment shall be operated in the standard operation mode as described in clause 5.1.1.

5.2.2 Normal temperature and humidity

The temperature and humidity conditions for tests shall be a combination of temperature and humidity within the following ranges:

- a) temperature: +15 °C to +35 °C;
- b) relative humidity: 20 % to 75 %.

When the relative humidity is lower than 20 %, it shall be stated in the test report.

5.2.3 Normal test power supply

The test voltage for equipment to be connected to an AC supply shall be the nominal mains voltage declared by the manufacturer -10 % to +10 %. For the purpose of the present document, the nominal voltage shall be the declared voltage or each of the declared voltages for which the equipment is indicated as having been designed. The frequency of the test voltage shall be 50 Hz \pm 1 Hz.

5.3 Essential radio test suites

5.3.1 Operating frequency

The antenna shall be replaced by a suitable adapter to adapt the rotary joint to a waveguide with a plane flange. On that flange a high-power directional coupler will be mounted with its main port terminated by a matching high-power dummy load. The coupled port shall have an adequate attenuation within the whole frequency band 8 600 MHz to 9 900 MHz (400 MHz outside edges of allocated bands) to protect the measurement equipment.

To measure and display the spectrum of the transmitted signal a suitable spectrum analyser shall be used. The acquisition time for the spectrum shall be at least 60 seconds. The spectrum shall be measured in the maximum hold mode of the spectrum analyzer.

The results obtained shall be compared to the limits in clause 4.2.1.2 in order to prove compliance with the requirement.

To measure the frequency stability a spectrum analyzer with a frequency stability of equal or better 10 ppm is connected to the SMR transmitter via suitable couplers. In this way the deviation of the emission peak frequency from the specified frequency is measured.

5.3.2 Transmitter power

The antenna shall be replaced by a suitable adapter to adapt the rotary joint to a waveguide with a plane flange. On that flange a high-power directional coupler will be mounted with its main port terminated by a matching high-power dummy load. The coupled port shall have a sufficient attenuation within the whole frequency band 8 600 MHz to 9 900 MHz to avoid saturation of the measurement equipment. The coupling factor shall be known in the allocated band with an accuracy of 0,5 dB.

To determine the Peak Envelope Power of the pulse a suitable pulse power meter with direct reading of the transmitter pulse power shall be used.

To reference the indicated transmitter power to the transmitter output flange the coupling factor has to be taken into account.

NOTE: Either the power meter allows already for compensation of the coupling loss, or the coupling loss has to be added to the meter reading.

The results obtained shall be compared to the limits in clause 4.2.2.2 in order to prove compliance with the requirement.

5.3.3 Out-of-Band-emissions

The so-called indirect method shall be applied for the measurement of unwanted emissions of radar systems. At first the transmitter output spectrum is measured with removed antenna at the output port of the transmitter as illustrated in Figure B.1.

NOTE 1: To obtain a sufficient dynamic range the radar signal need to be suppressed by an additional notch-filter.

Further information how to perform the measurement can be found in ITU-R Recommendation M.1177-4 [7]. The Out-of-Band power emission shall be measured in the frequency bands given in Table 2. The results obtained shall be compared to the limits in clause 4.2.3.2 and depicted is given in Figure 2 in order to prove compliance with the requirement.

NOTE 2: These OoB-boundaries are taken from ECC/Recommendation (02)05 [i.4].

Table 2: Out-of-Band emissions boundaries

Lower OoB boundary	Upper OoB boundary
Carrier frequency - 23,2 B_{-40}	Carrier frequency + 23,2 B_{-40}

NOTE 3: Typical SMR parameters are e.g. a centre frequency of 9,1 GHz, a pulse duration of $t = 50$ ns and a rise time of $t_r = 10$ ns, the 40 dB bandwidth calculated applying the equation from clause 4.2.1.1 is 340 MHz. This leads to OoB boundaries at $23,2 \times 340$ MHz = 7,9 GHz away from the centre frequency (Figure 4). For this example the absolute boundaries between out-of-band emission and spurious emission are: 9,1 GHz - 7,9 GHz = 1,2 GHz and 9,1 GHz + 7,9 GHz = 17 GHz (Figure 5).

Figures 4 and 5 depict the calculated emission masks for the aforementioned parameters of a typical SMR applying the mask specification in clause 4.2.3.2 which is corresponding to the standard mask in Figure A2.1 of ECC/Recommendation (02)05 [i.4].

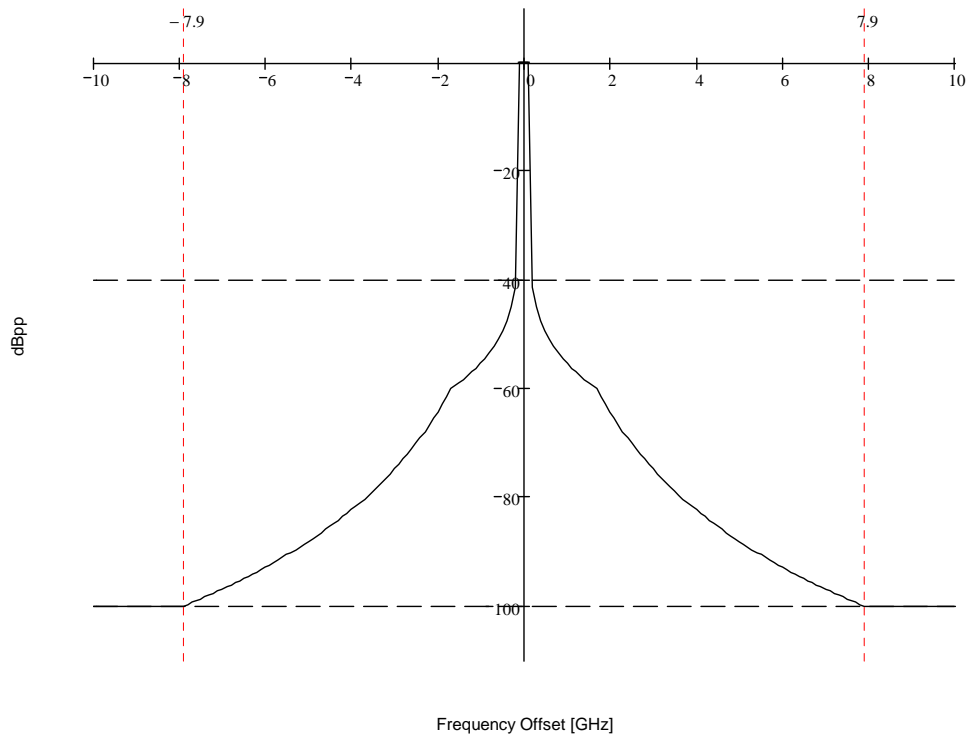

Figure 4: Theoretical emissions mask for typical pulse duration of $t = 50$ ns and rise time of $t_r = 10$ ns

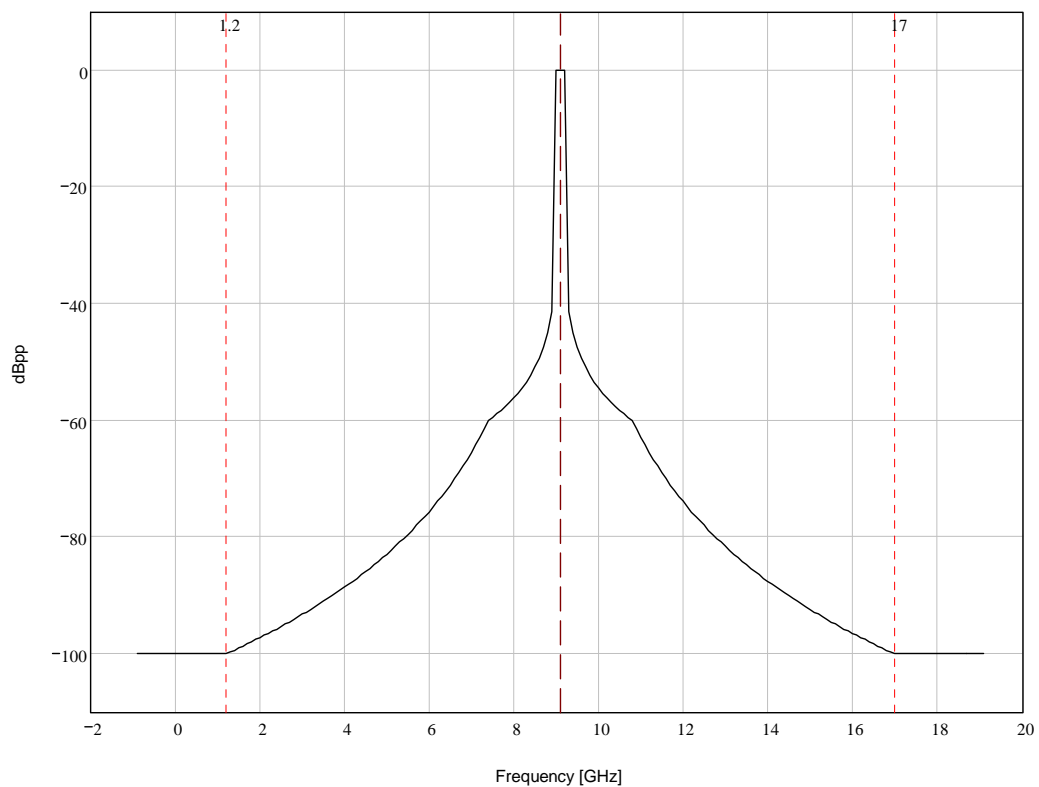

Figure 5: Calculated emissions mask for pulse duration of $t = 50$ ns and rise time of $t_r = 10$ ns at centre frequency of 9,1 GHz

5.3.4 Spurious emissions

For the spurious emission measurements the aforementioned indirect method shall be used. To perform the measurement the radar and the measuring equipment shall be installed as displayed in Figure B.1. The spurious power emission shall be measured in frequency ranges outside the Out-of-Band emissions boundaries

If required to reach a dynamic amplitude measuring range of 110 dB minimum, a Low Noise Amplifier (LNA), and a notch filter for the operating frequency should be used.

The results obtained shall be compared to the limits in clause 4.2.4.2 in order to prove compliance with the requirement.

Table 3: Spurious emissions measurement bands

Lower measurement band	Upper measurement band
From 6,56 GHz to the lower OoB boundary	From the upper OoB boundary to 26 GHz

5.3.5 System Noise Figure

The system noise figure is measured along the complete receiving signal chain (as close as possible, but excluding antenna & waveguide, and noise processing). It shall be measured using a noise source (which may be built into the system) and a detector (may be built in as well).

One recommended measurement method for the System Noise Figure is the Y-factor method. A noise source is connected in lieu of the antenna to the radar receiver input port. The System Noise Figure is then determined from the ratio between the noise power values at output of the intermediate frequency stage (or its digitized equivalent) with noise source on and noise source off.

Other equivalent methods to establish the System Noise Figure are also acceptable.

NOTE: According to clause 4.3.1.1, the NF_{sys} shall be maximum 6 dB.

5.3.6 Receiver Selectivity

Compliance is tested by calculating the minimum detectable signal (MDS) level of the receiver at the transmission frequency:

$$MDS = kT_0 B_{res} NF_{sys} D_{no spur} \frac{1}{T_C B_C} M$$

Where:

MDS	Minimum Detectable Signal
k	Boltzmann constant
T_0	Temperature in Kelvin
B_{res}	3 dB resolution bandwidth of transceiver
NF_{sys}	Noise Figure of the system
$D_{no spur}$	Detectability Factor (function of P_D & P_{fa}) = 0,1

NOTE: The value of 0,1 for $D_{no spur}$ is taken from Figure 2.3 of "Radar Handbook" [i.2].

P_D Probability of detection = 10^{-3} (selected value)

P_{fa} Probability of false detection = 10^{-3} (selected value)

T_C	Chirp length in sec
B_C	Chirp bandwidth
M	Test margin = 0,1 (Without this margin the receiver should give a detectable signal)

The factor $1/(T_C B_C) = 1$ is applicable for a simple pulse radar.

5.3.6.1 Receiver Out-of-Band selectivity

In order to determine if the receiver selectivity follows the required emission mask, a disturbance signal level at MDS level plus the required attenuation shall be applied at the antenna flange.

EXAMPLE: A typical MDS is + 40 dB, which is to be applied at the end points of $B_{.40}$. In such a case a maximum disturbance signal strength of -30 dBm is used in order to simulate another transmitter's spurious level transmissions.

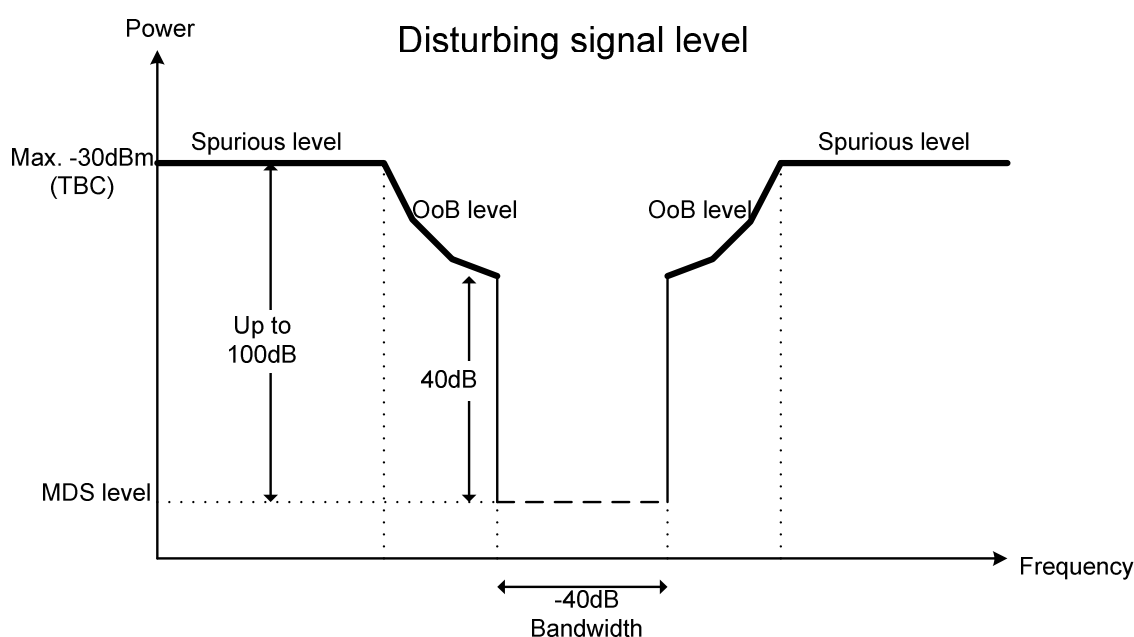

Figure 6: Receiver selectivity mask

The disturbance signal shall be a sinusoidal pulsed signal with pulse duration of 100 ns and a pulse repetition frequency of 1 kHz. The receiver selectivity curve shall be then checked beginning from the borders of $B_{.40}$ at a number of test points over the Out-of-Band frequency span - each with a disturbance signal level of MDS plus the Out-of-Band level of the emission mask. This is illustrated in Figure 6.

The radar video must not show any "targets" at any of the measurement points. The radar transceiver is setup in normal operating mode during the test.

5.3.6.2 Receiver spurious response rejection

The frequency band which in which the spurious response shall be checked is the part of the transmission band of the waveguide which is outside the Out-of-Band frequency range.

A test signal with the following characteristics shall be applied:

Sinusoidal pulsed signal with a pulse duration of 100 ns and a pulse repetition frequency of 1 kHz, no modulation, signal amplitude MDS + spurious level of emission mask.

The radar transceiver is setup in normal operating mode during the test.

Due to the spurious signals, the radar video must not show any "targets" at any of the measurement points.

In the test setup a WR112/R84 Waveguide taper section shall be connected to the regular WR90/R100 Waveguide.

NOTE: In this way the measurement setup is able to cover the cut-off frequency, otherwise the measurement setup will itself be "blind" near the cut-off frequency. With the taper section the cut-off is lowered to 6,56 GHz.

Annex A (normative): HS Requirements and conformance Test specifications Table (HS-RTT)

The HS Requirements and conformance Test specifications Table (HS-RTT) in table A.1 serves a number of purposes, as follows:

- it provides a statement of all the requirements in words and by cross reference to (a) specific clause(s) in the present document or to (a) specific clause(s) in (a) specific referenced document(s);
- it provides a statement of all the test procedures corresponding to those requirements by cross reference to (a) specific clause(s) in the present document or to (a) specific clause(s) in (a) specific referenced document(s);
- it qualifies each requirement to be either:
 - Unconditional: meaning that the requirement applies in all circumstances; or
 - Conditional: meaning that the requirement is dependent on the manufacturer having chosen to support optional functionality defined within the schedule.
- in the case of Conditional requirements, it associates the requirement with the particular optional service or functionality;
- it qualifies each test procedure to be either:
 - Essential: meaning that it is included with the Essential Radio Test Suite and therefore the requirement shall be demonstrated to be met in accordance with the referenced procedures;
 - Other: meaning that the test procedure is illustrative but other means of demonstrating compliance with the requirement are permitted.

Table A.1: HS Requirements and conformance Test specifications Table (HS-RTT)

Harmonized Standard EN 303 213-6-1						
The following requirements and test specifications are relevant to the presumption of conformity under the article 3.2 of the R&TTE Directive [i.1]						
Requirement			Requirement Conditionality		Test Specification	
No	Description	Reference: Clause No	U/C	Condition	E/O	Reference: Clause No
1	Operating frequency	4.2.1	U		E	5.3.1
2	Transmitter pulse power	4.2.2	U		E	5.3.2
3	Radiated Out-of-Band emissions	4.2.3	U		E	5.3.3
4	Radiated spurious emissions	4.2.4	U		E	5.3.4
5	Receiver Noise Figure	4.3.1	U		E	5.3.5
6	Receiver Selectivity	4.3.2	U		E	5.3.6

Key to columns:

Requirement:

No A unique identifier for one row of the table which may be used to identify a requirement or its test specification.

Description A textual reference to the requirement.

Clause Number Identification of clause(s) defining the requirement in the present document unless another document is referenced explicitly.

Requirement Conditionality:

U/C Indicates whether the requirement is to be *unconditionally* applicable (U) or is *conditional* upon the manufacturers claimed functionality of the equipment (C).

Condition Explains the conditions when the requirement shall or shall not be applicable for a technical requirement which is classified "conditional".

Test Specification:

E/O Indicates whether the test specification forms part of the Essential Radio Test Suite (E) or whether it is one of the Other Test Suite (O).

NOTE: All tests whether "E" or "O" are relevant to the requirements. Rows designated "E" collectively make up the Essential Radio Test Suite; those designated "O" make up the Other Test Suite; for those designated "X" there is no test specified corresponding to the requirement. The completion of all tests classified "E" as specified with satisfactory outcomes is a necessary condition for a presumption of conformity. Compliance with requirements associated with tests classified "O" or "X" is a necessary condition for presumption of conformity, although conformance with the requirement may be claimed by an equivalent test or by manufacturer's assertion supported by appropriate entries in the technical construction file.

Clause Number Identification of clause(s) defining the test specification in the present document unless another document is referenced explicitly. Where no test is specified (that is, where the previous field is "X") this field remains blank.

Annex B (normative): Transmission power and unwanted emissions of radar systems with indirect methods

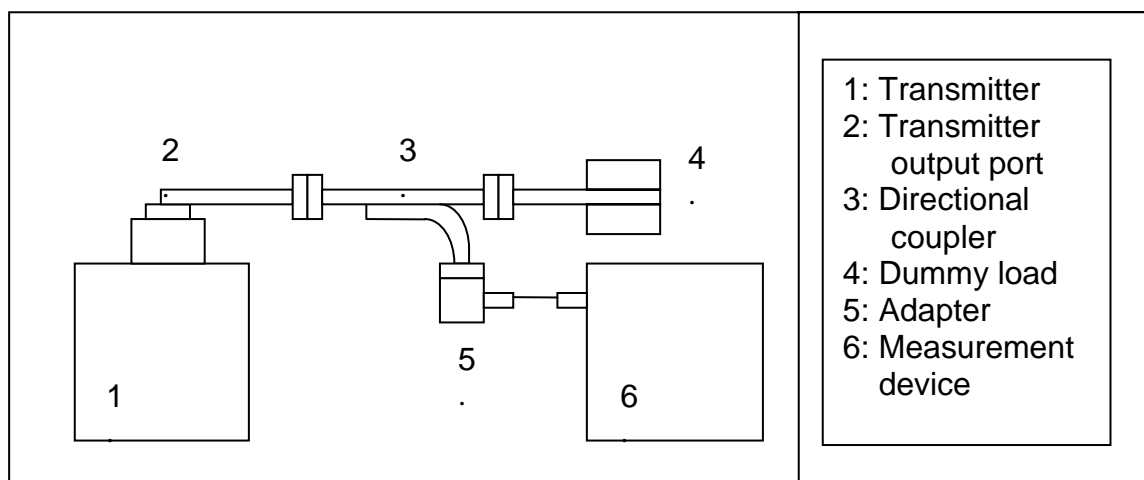

Figure B.1: Indirect method for radio frequency measurements with dismantled antenna

This method is applied for measurement of the operation frequency; transmit power, as well as out-of-band and spurious emission measurements.

Annex C (informative): The EN title in the official languages

The enlargement of the European Union (EU) resulted in a requirement from the EU for a larger number of languages for the translation of the titles of Harmonized Standards and mandated ENs that are to be listed in the Official Journal to support the implementation of this legislation.

For this reason the title translation concerning the present document can be consulted via the [e-approval](#) application.

Annex D (informative): Bibliography

ITU-R Recommendation SM.328-11: "Spectra and bandwidth of emissions".

ITU-R Recommendation SM.329-10: "Unwanted emissions in the spurious domain".

ETSI TR 102 273 (2001): "Electromagnetic compatibility and Radio spectrum Matters (ERM); Improvement on Radiated Methods of Measurement (using test site) and evaluation of the corresponding measurement uncertainties".

ANSI C63.5 (2006): "American National Standard for Calibration of Antennas Used for Radiated Emission Measurements in Electro Magnetic Interference".

Directive 2004/108/EC of the European Parliament and of the Council of 15 December 2004 on the approximation of the laws of the Member States relating to electromagnetic compatibility and repealing Directive 89/336/EEC (EMC Directive).

Directive 2006/95/EC of the European Parliament and of the Council of 12 December 2006 on the harmonisation of the laws of Member States relating to electrical equipment designed for use within certain voltage limits (LV Directive).

History

Document history		
V0.0.20	December 2010	Public Enquiry PE 20110416: 2010-12-17 to 2011-04-18
V1.1.1	July 2011	Vote V 20110918: 2011-07-20 to 2011-09-19
V1.1.1	September 2011	Publication