



**Satellite Earth Stations and Systems (SES);
Earth Stations on Mobile Platforms (ESOMP)
communicating with satellites in geostationary orbit,
operating in the 27,5 GHz to 30,0 GHz and
17,3 GHz to 20,2 GHz frequency bands;
Harmonised Standard for access to radio spectrum**

Reference

REN/SES-00468

Keywordsantenna, earth station, GSO, mobile, regulation,
satellite**ETSI**650 Route des Lucioles
F-06921 Sophia Antipolis Cedex - FRANCE

Tel.: +33 4 92 94 42 00 Fax: +33 4 93 65 47 16

Siret N° 348 623 562 00017 - APE 7112B
Association à but non lucratif enregistrée à la
Sous-Préfecture de Grasse (06) N° w061004871

Important notice

The present document can be downloaded from the
ETSI [Search & Browse Standards](#) application.

The present document may be made available in electronic versions and/or in print. The content of any electronic and/or print versions of the present document shall not be modified without the prior written authorization of ETSI. In case of any existing or perceived difference in contents between such versions and/or in print, the prevailing version of an ETSI deliverable is the one made publicly available in PDF format on [ETSI deliver](#).

Users should be aware that the present document may be revised or have its status changed,
this information is available in the [Milestones listing](#).

If you find errors in the present document, please send your comments to
the relevant service listed under [Committee Support Staff](#).

If you find a security vulnerability in the present document, please report it through our
[Coordinated Vulnerability Disclosure \(CVD\)](#) program.

Notice of disclaimer & limitation of liability

The information provided in the present deliverable is directed solely to professionals who have the appropriate degree of experience to understand and interpret its content in accordance with generally accepted engineering or other professional standard and applicable regulations.

No recommendation as to products and services or vendors is made or should be implied.
In no event shall ETSI be held liable for loss of profits or any other incidental or consequential damages.

Any software contained in this deliverable is provided "AS IS" with no warranties, express or implied, including but not limited to, the warranties of merchantability, fitness for a particular purpose and non-infringement of intellectual property rights and ETSI shall not be held liable in any event for any damages whatsoever (including, without limitation, damages for loss of profits, business interruption, loss of information, or any other pecuniary loss) arising out of or related to the use of or inability to use the software.

Copyright Notification

No part may be reproduced or utilized in any form or by any means, electronic or mechanical, including photocopying and microfilm except as authorized by written permission of ETSI.

The content of the PDF version shall not be modified without the written authorization of ETSI.

The copyright and the foregoing restriction extend to reproduction in all media.

© ETSI 2024.
All rights reserved.

Contents

Intellectual Property Rights	8
Foreword.....	8
Modal verbs terminology.....	9
Introduction	9
1 Scope	11
2 References	11
2.1 Normative references	11
2.2 Informative references.....	12
3 Definitions of terms, symbols and abbreviations	13
3.1 Terms.....	13
3.2 Symbols.....	14
3.3 Abbreviations	15
4 Technical requirements specifications	16
4.1 General	16
4.1.1 Environmental profile	16
4.1.2 Operational configurations	16
4.1.3 Determination of geographical location of the ESOMP	16
4.1.4 EIRP _{Aggregate} for networks of ESOMPs.....	16
4.1.5 Presentation of equipment for testing purposes	16
4.1.6 Choice of model for testing	17
4.2 Conformance requirements	17
4.2.1 Off-axis spurious radiation	17
4.2.1.1 Justification	17
4.2.1.2 Specification.....	17
4.2.1.3 Conformance tests.....	18
4.2.2 On-axis spurious radiation.....	18
4.2.2.1 Justification	18
4.2.2.2 Specification.....	18
4.2.2.2.1 "Carrier-on" radio state.....	18
4.2.2.2.2 "Carrier-off" and "Emissions disabled" radio states	19
4.2.2.3 Conformance tests.....	19
4.2.3 Off-axis EIRP emission density within the band	19
4.2.3.0 General	19
4.2.3.1 Justification	19
4.2.3.2 Total EIRP density specification.....	19
4.2.3.3 Void.....	20
4.2.3.4 Void.....	20
4.2.3.5 Burst Transmission Specification.....	20
4.2.3.6 Off-axis Geometry Specification	20
4.2.3.7 Conformance tests.....	21
4.2.4 Uplink Power Control Specification.....	21
4.2.5 Carrier suppression	21
4.2.5.1 Justification	21
4.2.5.2 Specification.....	21
4.2.5.3 Conformance tests.....	21
4.2.6 Antenna pointing and polarization alignment	21
4.2.6.1 Antenna pointing accuracy.....	21
4.2.6.1.1 Justification	21
4.2.6.1.2 Pointing accuracy specification	21
4.2.6.1.3 On-axis cross polarization isolation specification	22
4.2.6.1.4 Conformance tests	22
4.2.6.2 Antenna Pointing Error Detection.....	22
4.2.6.2.0 General	22

4.2.6.2.1	Pointing error detection specification	22
4.2.6.2.2	Polarization angle alignment specification	22
4.2.6.2.3	Conformance tests	23
4.2.7	Cessation of emissions	23
4.2.7.1	Justification	23
4.2.7.2	Specification.....	23
4.2.7.2.1	Specification 1: Mode of cessation of emissions	23
4.2.7.2.2	Specification 2: Conditions under which the ESOMP shall cease emissions	23
4.2.7.2.3	Specification 3: Cessation of emissions	24
4.2.7.2.4	Specification 4: Fault conditions	24
4.2.7.3	Conformance tests	24
4.2.8	Identification of the ESOMP	24
4.2.8.1	Justification	24
4.2.8.2	Specification.....	24
4.2.8.3	Conformance tests	24
4.2.9	Control and Monitoring Functions (CMFs).....	25
4.2.9.1	ESOMP States.....	25
4.2.9.1.0	General	25
4.2.9.1.1	CMF state diagram	26
4.2.9.2	Processor monitoring	27
4.2.9.2.1	Justification	27
4.2.9.2.2	Specification	27
4.2.9.2.3	Conformance tests	28
4.2.9.3	Transmit subsystem monitoring.....	28
4.2.9.3.1	Justification	28
4.2.9.3.2	Specification.....	28
4.2.9.3.3	Conformance tests	28
4.2.9.4	Power-on/Reset	28
4.2.9.4.1	Justification	28
4.2.9.4.2	Specification.....	28
4.2.9.4.3	Conformance tests	28
4.2.9.5	Control Channel (CC) and Response Channel (RC).....	28
4.2.9.5.1	Justification	28
4.2.9.5.2	Specification.....	29
4.2.9.5.3	Conformance tests	29
4.2.9.6	Network control commands	29
4.2.9.6.1	Justification	29
4.2.9.6.2	Specification.....	29
4.2.9.6.3	Conformance tests	30
4.2.9.7	Initial burst transmission	30
4.2.9.7.1	Justification	30
4.2.9.7.2	Specification.....	30
4.2.9.7.3	Conformance tests	30
4.2.9.8	Inhibition of transmissions	30
4.2.9.8.1	Justification	30
4.2.9.8.2	Specification.....	31
4.2.9.8.3	Conformance tests	31
4.2.10	Receive antenna off-axis gain pattern.....	31
4.2.10.1	Justification	31
4.2.10.2	Specification.....	31
4.2.10.3	Conformance tests	31
4.2.11	Blocking performance.....	31
4.2.11.1	Justification	31
4.2.11.2	Specification.....	32
4.2.11.3	Conformance tests	32
4.2.12	Adjacent Signal Selectivity.....	32
4.2.12.1	Justification	32
4.2.12.2	Specification.....	32
4.2.12.3	Conformance tests	32
5	Testing for compliance with technical requirements.....	33
5.1	Environmental conditions for testing	33

5.2	Radio test suites.....	33
6	Test methods for all aspects of the ESOMP.....	33
6.1	General.....	33
6.1.0	Introduction.....	33
6.1.1	Uplink power control.....	33
6.1.1.1	General.....	33
6.1.1.2	Test method.....	34
6.1.2	Measuring receiver.....	34
6.2	Off-axis spurious radiation.....	35
6.2.0	Introduction.....	35
6.2.1	Test method.....	35
6.2.1.0	Void.....	35
6.2.1.1	General.....	35
6.2.1.2	Multi-carrier operation.....	35
6.2.2	Measurements up to 1 000 MHz.....	36
6.2.2.1	Test site.....	36
6.2.2.2	Measuring receivers.....	36
6.2.2.3	Procedure.....	36
6.2.3	Measurements above 1 000 MHz.....	36
6.2.3.0	General.....	36
6.2.3.1	Identification of the significant frequencies of spurious radiation.....	37
6.2.3.1.1	Test site.....	37
6.2.3.1.2	Procedure.....	37
6.2.3.2	Measurement of radiated power levels of identified spurious radiation.....	37
6.2.3.2.1	Test site.....	37
6.2.3.2.2	Procedure.....	37
6.2.3.3	Measurement of conducted spurious radiation at the antenna flange.....	38
6.2.3.3.1	Test site.....	38
6.2.3.3.2	Procedure.....	39
6.3	On-axis spurious radiation.....	39
6.3.1	Test method.....	39
6.3.1.0	General.....	39
6.3.1.1	Test site.....	39
6.3.1.2	Method of measurement.....	39
6.3.1.2.1	General.....	39
6.3.1.2.2	Method of measurement at the antenna flange.....	39
6.3.1.2.3	Method of measurement for an EUT with antenna.....	40
6.4	Off-axis EIRP emission density within the band.....	41
6.4.1	Test method.....	41
6.4.1.0	Introduction.....	41
6.4.1.1	Transmit output power density.....	42
6.4.1.1.1	General.....	42
6.4.1.1.2	Test site.....	42
6.4.1.1.3	Method of measurement.....	42
6.4.1.2	Antenna transmit gain.....	43
6.4.1.2.1	General.....	43
6.4.1.2.2	Test site.....	43
6.4.1.2.3	Method of measurement.....	43
6.4.1.3	Antenna transmit radiation patterns.....	44
6.4.1.3.1	General.....	44
6.4.1.3.2	Test site.....	44
6.4.1.3.3	Test arrangement.....	45
6.4.1.3.4	Co-polar radiation pattern - azimuth.....	45
6.4.1.3.5	Co-polar radiation pattern - elevation.....	45
6.4.1.3.6	Cross-polar radiation pattern - azimuth.....	46
6.4.1.3.7	Cross-polar radiation pattern - elevation.....	46
6.4.2	Computation of results.....	47
6.5	Carrier suppression.....	47
6.5.1	Test method.....	47
6.6	Antenna pointing.....	47
6.6.1	General.....	47

6.6.2	Test method	48
6.7	Polarization angle alignment capability	48
6.7.1	General.....	48
6.7.2	Test site.....	48
6.7.3	Test method	48
6.8	Cessation of emissions of the ESOMP	49
6.8.0	General.....	49
6.8.1	Test Method.....	49
6.8.1.1	Required documentation	49
6.8.1.2	Cessation of emissions from the "Transmission enabled" state	49
6.8.1.3	Cessation of emission from the "Transmission disabled" state	49
6.8.1.4	Cessation of emission from the "Initial Phase" state.....	50
6.8.1.4.1	EUTs transmitting initial bursts.....	50
6.8.1.4.2	EUTs not transmitting initial bursts.....	50
6.8.1.5	"Single action" means of cessation of emissions.....	51
6.8.1.6	Fault conditions.....	51
6.9	Identification of ESOMP.....	52
6.9.1	Test arrangement	52
6.9.2	Test method	52
6.10	Control and monitoring functions	52
6.10.0	General.....	52
6.10.1	Test arrangement	52
6.10.2	Processor monitoring- Test method	52
6.10.3	Transmit subsystem monitoring-Test method.....	53
6.10.4	Power-on/Reset-Test method.....	53
6.10.5	Control Channel (CC) and Response Channel (RC) - Test method.....	53
6.10.6	Network Control commands-Test method.....	54
6.10.7	Initial burst transmission-Test method.....	55
6.10.8	Inhibition of transmission-Test method	55
6.11	Receive antenna off-axis gain pattern	56
6.11.1	Test method	56
6.11.1.1	Test site	56
6.11.1.2	Method of measurement.....	56
6.11.1.3	Computation.....	57
6.12	Blocking performance	57
6.12.1	Test method	57
6.13	Adjacent Signal Selectivity	58
6.13.1	Test method	58
6.14	Test for determination of geographical location of the ESOMP	58
6.14.1	Test arrangement	58
6.14.2	Test method	58
Annex A (informative): Relationship between the present document and the essential requirements of Directive 2014/53/EU		59
Annex B: Void.....		61
Annex C (normative): Radiated measurement.....		62
C.1	Test sites and general arrangements for measurements involving the use of radiated fields	62
C.1.0	General	62
C.1.1	Anechoic Chamber	62
C.1.2	Anechoic Chamber with a conductive ground plane	63
C.1.3	Open Area Test Site (OATS)	64
C.1.4	Minimum requirements for test sites for measurements above 18 GHz.....	65
C.1.5	Test antenna.....	65
C.1.6	Substitution antenna	66
C.1.7	Measuring antenna	66
C.2	Guidance on the use of radiation test sites	66
C.2.0	General	66
C.2.1	Verification of the test site	66
C.2.2	Preparation of the EUT.....	66

C.2.3	Power supplies to the EUT	66
C.2.4	Range length.....	67
C.2.5	Site preparation	67
C.3	Coupling of signals.....	68
C.3.1	General	68
C.4	Standard test methods.....	68
C.4.0	General	68
C.4.1	Calibrated setup.....	68
C.4.2	Substitution method.....	69
Annex D (normative):	Conducted measurements	70
Annex E (informative):	General Requirements for RF Cables.....	71
Annex F (informative):	RF Waveguides	72
Annex G (informative):	Applicability of parameters given in ETSI EG 203 336	74
Annex H (informative):	Maximum measurement uncertainty.....	76
Annex I (informative):	Bibliography.....	77
Annex J (informative):	Change history	78
History		79

Intellectual Property Rights

Essential patents

IPRs essential or potentially essential to normative deliverables may have been declared to ETSI. The declarations pertaining to these essential IPRs, if any, are publicly available for **ETSI members and non-members**, and can be found in ETSI SR 000 314: "*Intellectual Property Rights (IPRs); Essential, or potentially Essential, IPRs notified to ETSI in respect of ETSI standards*", which is available from the ETSI Secretariat. Latest updates are available on the ETSI Web server (<https://ipr.etsi.org/>).

Pursuant to the ETSI Directives including the ETSI IPR Policy, no investigation regarding the essentiality of IPRs, including IPR searches, has been carried out by ETSI. No guarantee can be given as to the existence of other IPRs not referenced in ETSI SR 000 314 (or the updates on the ETSI Web server) which are, or may be, or may become, essential to the present document.

Trademarks

The present document may include trademarks and/or tradenames which are asserted and/or registered by their owners. ETSI claims no ownership of these except for any which are indicated as being the property of ETSI, and conveys no right to use or reproduce any trademark and/or tradename. Mention of those trademarks in the present document does not constitute an endorsement by ETSI of products, services or organizations associated with those trademarks.

DECT™, **PLUGTESTS™**, **UMTS™** and the ETSI logo are trademarks of ETSI registered for the benefit of its Members. **3GPP™** and **LTE™** are trademarks of ETSI registered for the benefit of its Members and of the 3GPP Organizational Partners. **oneM2M™** logo is a trademark of ETSI registered for the benefit of its Members and of the oneM2M Partners. **GSM®** and the GSM logo are trademarks registered and owned by the GSM Association.

Foreword

This draft Harmonised European Standard (EN) has been produced by ETSI Technical Committee Satellite Earth Stations and Systems (SES), and is now submitted for the combined Public Enquiry and Vote phase of the ETSI Standardisation Request deliverable Approval Procedure.

The present document is a revision of ETSI EN 303 978 (V2.1.2). Major changes concern the off-axis eirp density. Editorial clarifications have also been introduced.

The present document has been prepared under the Commission's standardisation request C(2015) 5376 final [i.9] to provide one voluntary means of conforming to the essential requirements of Directive 2014/53/EU on the harmonisation of the laws of the Member States relating to the making available on the market of radio equipment and repealing Directive 1999/5/EC [i.11].

Once the present document is cited in the Official Journal of the European Union under that Directive, compliance with the normative clauses of the present document given in table A.1 confers, within the limits of the scope of the present document, a presumption of conformity with the corresponding essential requirements of that Directive, and associated EFTA regulations.

Proposed national transposition dates	
Date of latest announcement of this EN (doa):	3 months after ETSI publication
Date of latest publication of new National Standard or endorsement of this EN (dop/e):	6 months after doa
Date of withdrawal of any conflicting National Standard (dow):	18 months after doa

Modal verbs terminology

In the present document "shall", "shall not", "should", "should not", "may", "need not", "will", "will not", "can" and "cannot" are to be interpreted as described in clause 3.2 of the [ETSI Drafting Rules](#) (Verbal forms for the expression of provisions).

"must" and "must not" are **NOT** allowed in ETSI deliverables except when used in direct citation.

Introduction

The Earth Stations on Mobile Platforms (ESOMPs) system overview is given in figure 1 and has the following characteristics:

- The ESOMP operates as part of a satellite network (e.g. star, mesh or point-to-point) used for the distribution and/or exchange of information.
- The ESOMP is comprised of all the equipment, electrical and mechanical, from the antenna itself to the interface with other communications equipment on a mobile platform (usually referred to as the terrestrial interface).
- The ESOMP transmits in the frequency range from 27,50 GHz to 30,00 GHz, and receives in one or more frequencies within the range from 17,30 GHz to 20,20 GHz (FSS) which are bands allocated to the Fixed Satellite Services (FSS) (Earth-to-space) among other services.
- The ESOMP uses linear or circular polarization.
- The ESOMP is designed for unattended operation.
- The ESOMP is controlled and monitored by a Network Control Facility (NCF). This function may be performed centrally (e.g. for a network of ESOMPs with a central hub) or it could be performed within the ESOMP for autonomous control. The NCF is outside the scope of the present document.
- The ESOMP operates through a geostationary satellite (or a cluster of co-located geostationary satellites) that is at least 2° away from any other geostationary satellite operating in the same frequencies and over the same coverage area.
- The geostationary satellite network with which the ESOMP communicates is assumed to have completed coordination per ITU requirements with the neighbouring geostationary satellite networks.
- The coordination agreement or agreements above would allow the ESOMP to operate with the coordinated parameters, such as off-axis EIRP density and other parameters.

NOTE: ESOMPs may operate with satellites that are more closely spaced than 2° with additional operational constraints that are beyond the scope of the present document.

Enclosure / Radome

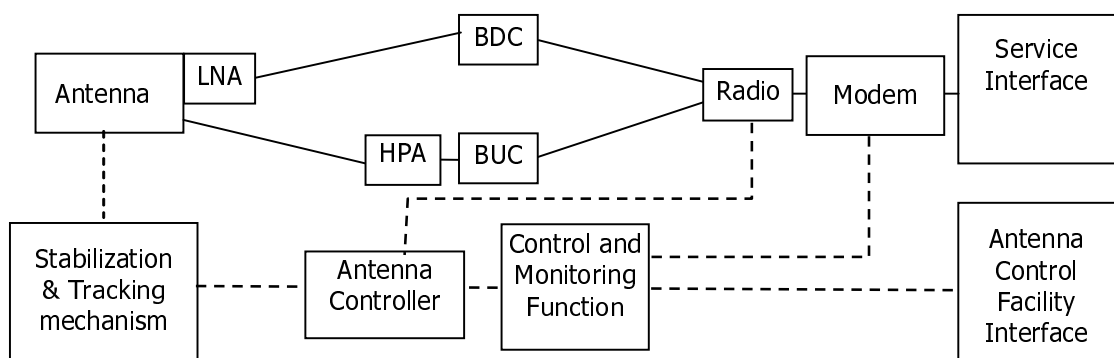

Figure 1: ESOMP System Overview

The present document may also be applicable to the frequency bands 30,0 GHz to 31,0 GHz (Earth-to-space) and 20,2 GHz to 21,2 GHz (space-to-Earth) subject to national regulation.

Annex A (informative) provides HS Requirements specifications.

Annex B is void.

Annex C (normative) provides specifications concerning radiated measurements.

Annex D (normative) provides specifications concerning conducted measurements.

Annex E (informative) provides general information concerning RF cables.

Annex F (informative) provides information concerning RF waveguides.

Annex G (informative) covers selection of receiver conformance parameters.

Annex H (informative) covers maximum measurement uncertainty.

Annex I (informative) provides bibliographical references.

Annex J (informative) change history.

1 Scope

The present document specifies technical characteristics and methods of measurements for Earth Stations on Mobile Platforms (ESOMP) equipment with the following characteristics:

- The ESOMP is designed for both mobile and stationary operation.
- The ESOMP operates on various mobile platforms such as trains, maritime vessels, aircraft and other vehicles.
- The ESOMP is controlled and monitored by a Network Control Facility (NCF). This function may be performed centrally (e.g. for a network of ESOMPs with a central hub) or it could be performed within the ESOMP for autonomous control. The NCF is outside the scope of the present document.
- The ESOMP transmit and receive frequencies are shown in table 1.

Table 1: Frequency bands

	Frequency Bands/frequencies (GHz)
Transmit (Earth-to-space)	27,50 to 30,00
Receive (space-to-Earth)	17,30 to 20,20

NOTE: The relationship between the present document and essential requirements of article 3.2 of Directive 2014/53/EU [i.11] is given in annex A.

2 References

2.1 Normative references

References are either specific (identified by date of publication and/or edition number or version number) or non-specific. For specific references, only the cited version applies. For non-specific references, the latest version of the referenced document (including any amendments) applies.

Referenced documents which are not found to be publicly available in the expected location might be found at <https://docbox.etsi.org/Reference/>.

NOTE: While any hyperlinks included in this clause were valid at the time of publication, ETSI cannot guarantee their long term validity.

The following referenced documents are necessary for the application of the present document.

- [1] Void.
- [2] Void.
- [3] Void.
- [4] [CISPR 16-1-1 \(2019\)](#): "Specification for radio disturbance and immunity measuring apparatus and methods - Part 1-1: Radio disturbance and immunity measuring apparatus - Measuring apparatus".
- [5] [CISPR 16-1-4:2019+AMD1:2020+AMD2:2023 CSV Consolidated version](#): "Specification for radio disturbance and immunity measuring apparatus and methods - Part 1-4: Radio disturbance and immunity measuring apparatus - Antennas and test sites for radiated disturbance measurements".
- [6] [ANSI C63.5-2006](#): "American National Standard for Calibration of Antennas Used for Radiated Emission Measurements in Electro Magnetic Interference".

2.2 Informative references

References are either specific (identified by date of publication and/or edition number or version number) or non-specific. For specific references, only the cited version applies. For non-specific references, the latest version of the referenced document (including any amendments) applies.

NOTE: While any hyperlinks included in this clause were valid at the time of publication, ETSI cannot guarantee their long term validity.

The following referenced documents are not necessary for the application of the present document but they assist the user with regard to a particular subject area.

- [i.1] Void.
- [i.2] Void.
- [i.3] Void.
- [i.4] ETSI TR 102 375: "Satellite Earth Stations and Systems (SES); Guidelines for determining the parts of satellite earth station antenna radiation patterns concerned by the geostationary satellite orbit protection".
- [i.5] Void.
- [i.6] Void.
- [i.7] Void.
- [i.8] Void.
- [i.9] [Commission Implementing Decision C\(2015\) 5376 final of 4.8.2015](#) on a standardisation request to the European Committee for Electrotechnical Standardisation and to the European Telecommunications Standards Institute as regards radio equipment in support of Directive 2014/53/EU of the European Parliament and of the Council.
- [i.10] IEC 153 (all parts): "Hollow metallic waveguides".
- [i.11] [Directive 2014/53/EU](#) of the European Parliament and of the Council of 16 April 2014 on the harmonisation of the laws of the Member States relating to the making available on the market of radio equipment and repealing Directive 1999/5/EC (RE Directive).
- [i.12] ETSI TR 103 896: "Satellite Earth Stations and Systems (SES); Considerations on off-axis EIRP density mask applicability for Ka band GSO ESOMPs in relation to potential revision to ETSI EN 303 978 (V2.1.2)".
- [i.13] ETSI EG 203 336 (V1.2.1) (05-2020): "Guide for the selection of technical parameters for the production of Harmonised Standards covering article 3.1(b) and article 3.2 of Directive 2014/53/EU".
- [i.14] ETSI TR 103 581 (V1.1.1) (11-2019): "Use of measurement detectors in radio measurement methods".
- [i.15] ETSI TR 102 273 (all parts) (V1.2.1) (12-2001): "Electromagnetic compatibility and Radio spectrum Matters (ERM); Improvement on Radiated Methods of Measurement (using test site) and evaluation of the corresponding measurement uncertainties".
- [i.16] ETSI TR 100 028: "Electromagnetic compatibility and Radio spectrum Matters (ERM); Uncertainties in the measurement of mobile radio equipment characteristics".

3 Definitions of terms, symbols and abbreviations

3.1 Terms

For the purposes of the present document, the terms given in Directive 2014/53/EU [i.11] and the following apply:

ancillary equipment: equipment used in connection with an ESOMP, where:

- the equipment is intended for use in conjunction with the ESOMP to provide additional operational and/or control features (e.g. to extend control to another position or location); and
- the equipment cannot be used on a stand alone basis, to provide user functions independently of the ESOMP; and
- the absence of the equipment does not inhibit the operation of the ESOMP.

antenna controller: equipment used to maintain antenna stabilization and tracking accuracy based on inputs from the Control and Monitoring Functions (CMF)

applicant: manufacturer or his authorized representative within the European Community or the person responsible for placing the apparatus on the market

carrier-off radio state: radio state in which the ESOMP may transmit and does not transmit any carrier

NOTE 1: The phrase "the ESOMP may transmit" means that all the conditions for transmission are satisfied (e.g. in a state where transmissions are permitted, no failure detected, and the ESOMP is correctly pointed towards the satellite).

NOTE 2: The existence of a "Carrier-off" radio state depends on the system of transmission used. For ESOMPs designed for continuous transmission mode there may be no "Carrier-off" state.

carrier-on radio state: radio state in which the ESOMP may transmit and transmits a carrier

Control Channel (CC): channel or channels by which ESOMPs receive control information from the NCF

EIRP_{Aggregate}: sum of the EIRP (watts) within the nominated bandwidth of the ESOMP network

EIRP_{cs}: clear sky EIRP of the ESOMP

EIRP_{max}: maximum EIRP capability of the ESOMP provided with the equipment for the intended use

emissions disabled radio state: radio state in which the ESOMP is not emitting

NOTE: Examples of cases where the ESOMP is in this radio state: before system monitoring pass, before the control channel is received, when a failure is detected, when an ESOMP is commanded to disable, and when the ESOMP is in a location requiring cessation of emissions.

external control channel: control channel which is either:

- i) carried by the ESOMP network via the same or another satellite, but not within the internal protocol of the ESOMP system; or
- ii) carried by any other radio communication system.

external response channel: response channel which is either:

- i) carried by the ESOMP network via the same or another satellite, but not within the internal protocol of the ESOMP system; or
- ii) carried by any other radio communication system.

integral antenna: antenna which may not be removed during the tests

internal control channel: control channel which is carried by the ESOMP network via the same satellite as used for transmission of user data and within the internal protocol structure of the ESOMP system

internal response channel: response channel which is carried by the ESOMP network via the same satellite as used for transmission of user data and within the internal protocol structure of the ESOMP system

mobile platform: any platform such as a train, a vessel, an aircraft or other vehicles capable of moving.

Network Control Facility (NCF): set of functional entities that, at system level, monitor and control the correct operation of the ESOMP and, if appropriate, all of the ESOMPs in a network

nominal antenna diameter: antenna diameter in meters for the intended use. For non circular antennas the nominal diameter is that of the widest dimension

NOTE : Network operators might request antennas of a certain diameter. Then an antenna that is compliant with the requirement for nominal antenna diameter equal to the requested antenna diameter can be used. Equipment can be marked with antenna diameters used in the requirements during compliance test.

nominated bandwidth: bandwidth of the ESOMP radio frequency transmission provided with the equipment for the intended use

NOTE 1: The nominated bandwidth is centred on the transmit frequency and does not exceed 5 times the occupied bandwidth.

NOTE 2: The nominated bandwidth is wide enough to encompass all spectral elements of the transmission which have a level greater than the specified spurious radiation limits. The nominated bandwidth is wide enough to take account of the transmit carrier frequency stability. The nominated bandwidth allows identification of adjacent channel interference levels which will be taken into account by operational procedures depending on the exact transponder carrier assignment situation.

occupied bandwidth: for a digital modulation scheme the width of the signal spectrum 10 dB below the maximum in-band density

off-axis angle: angle between the direction of the axis of the antenna main beam and the considered direction

removable antenna: antenna which may be removed during the tests according to the intended use

Response Channel (RC): channel by which ESOMP transmit monitoring information to the ACF

Special Test Equipment (STE): specific equipment needed for a test

EXAMPLE: NCF, downlink beacon frequencies, etc.

spurious radiation: any radiation outside the nominated bandwidth

transmission disabled state: ESOMP is in this state when it is not authorized by the NCF to transmit

transmission enabled state: ESOMP is in this state when it is authorized by the NCF to transmit

wanted signal occupied Bandwidth (BW):

- for a digital modulation scheme: the width of the signal spectrum 10 dB below the maximum in-band density;
- for an analogue modulation scheme: the width of a frequency band such that, below the lower and above the upper frequency limits, the mean power emitted is equal to 0,5 % of the total mean power of the emission.

3.2 Symbols

For the purposes of the present document, the following symbols apply:

dBc	ratio expressed in decibels relative to the EIRP of the unmodulated carrier
dB _i	ratio of an antenna gain to the gain of an isotropic antenna, expressed in decibels
dB _m	ratio of a power to 1 milliwatt, expressed in decibels
dB _{pW}	ratio of a power to 1 picowatt, expressed in decibels
dB _{sd}	ratio expressed in decibels relative to the spectral density
dB _W	ratio of a power to 1 watt, expressed in decibels
dB _{μV/m}	ratio of an electric field to 1 μV/m, expressed in decibels (20 log(electric field / 1 μV/m))

3.3 Abbreviations

For the purposes of the present document, the following abbreviations apply:

ACF	Antenna Control Facility
BDC	Block Down Converter
BUC	Block Up Converter
BW	BandWidth
CC	Control Channel
CCF	Control Channel reception Failure
CCR	Control Channel correctly Received
CENR	Cessation of Emissions Not Required
CEPT	Conférence Européenne des Postes et Télécommunications (European Conference of Postal and Telecommunications Administrations)
CER	Cessation of Emissions Required
CISPR	Comité International Spécial des Perturbations Radioélectriques (International Special Committee on Radio Interference)
CMF	Control and Monitoring Functions
DC	Direct Current
EIA	Electronic Industries Alliance
EIRP	Equivalent Isotropically Radiated Power
EMC	Electro-Magnetic Compatibility
ESOMP	Earth Station On Mobile Platform
EUT	Equipment Under Test
FEC	Forward Error Correction
FSS	Fixed Satellite Service
G_{EUT}	Gain of EUT
GSO	Geostationary Satellite Orbit
HPA	High Power Amplifier
IDU	In Door Unit
IEC	International Electrotechnical Commission
IPR	Intellectual Property Rights
LNA	Low noise amplifier
LNB	Low Noise Block
LO	Local Oscillator
LV	Low Voltage
NCF	Network Control Facility
OATS	Open Area Test Site
OFDM	Orthogonal Frequency Division Multiplexing
RC	Response Channel
RCSC	Radio Components Standardization Committee
RF	Radio Frequency
RMS	Root Mean Square
SMA	SubMiniature version A
SMF	System Monitoring Fail
SMP	System Monitoring Pass
STE	Special Test Equipment
TDMA	Time Division Multiple Access
TxD	Transmission Disable command
TxE	Transmission Enable command
VSWR	Voltage Standing Wave Ratio
WG	Wave Guide
WR	Waveguide Rectangular

4 Technical requirements specifications

4.1 General

4.1.1 Environmental profile

The technical requirements of the present document apply under the environmental profile for operation of the equipment, which shall be in accordance with its intended use. The equipment shall comply with all the technical requirements of the present document at all times when operating within the boundary limits of the operational environmental profile defined by its intended use.

The ESOMP shall not show any sign of permanent distortion that could affect the radiation subsystem after the application of the load under the maximum values provided with the equipment for its intended use.

4.1.2 Operational configurations

Under operational conditions an ESOMP may dynamically change the occupied bandwidth and other transmission parameters (e.g. FEC, modulation, symbol rate) of the transmitted signal. For each occupied bandwidth an $EIRP_{max}$ and a nominated bandwidth shall be provided with the equipment for the intended use. For the purposes of verifying that the ESOMP complies with these specifications, the ESOMP shall include the necessary information on the worst case combination of transmission parameters. The following specifications apply to the ESOMP for each occupied bandwidth and other transmission parameters.

In the present document, ESOMPs that use OFDM modulation shall be considered as transmitting a single carrier.

All operational parameters including the EIRP, modulation and occupied bandwidth shall be provided together with the equipment.

4.1.3 Determination of geographical location of the ESOMP

Internal to the network, the ESOMP shall have a means of determining its geographical location within the accuracy specified for the intended use and sufficient to maintain operation within all of the parameters provided with the equipment.

Conformance tests are carried out in accordance with clause 6.14.

4.1.4 $EIRP_{Aggregate}$ for networks of ESOMPs

For the case where several ESOMPs are transmitting simultaneously on the same carrier frequency, the $EIRP_{Aggregate}$ is the sum of the EIRP (= watts) within the nominated bandwidth of the ESOMP network.

For ESOMPs designed to operate in an FSS network where the EIRP of each ESOMP is determined by the NCF, the NCF shall ensure compliance with the EIRP density requirements in the present document. The following sections define the methods to be used to ensure compliance.

4.1.5 Presentation of equipment for testing purposes

ESOMP equipment submitted for testing, where applicable, shall fulfil the requirements of the present document on all frequencies over which it is intended to operate.

One or more samples of the equipment as appropriate for testing shall be submitted.

Additionally, technical documentation and operating manuals, to allow testing to be performed, shall be supplied.

The performance of the ESOMP equipment submitted for testing shall be representative of the performance of the corresponding production model. Equipment complete with any auxiliary equipment needed for testing shall be provided.

The frequency range(s), the range of operation conditions and power requirements, as applicable, in order to establish the appropriate test conditions shall be provided together with the equipment.

4.1.6 Choice of model for testing

If an ESOMP equipment has several optional features, then the tests need only to be performed on one sample of the equipment configured with that combination of features creating the highest unintentional emissions.

In addition, when a device has the capability of using different dedicated antennas or other features that affect the RF parameters, at least the worst combination of features from an emission point of view shall be tested.

Where the transmitter is designed with adjustable output power, then all transmitter parameters shall be measured using the highest maximum mean power spectral density level, as provided with the equipment for the intended use.

The selected model(s) for testing shall be recorded in the test report.

4.2 Conformance requirements

4.2.1 Off-axis spurious radiation

4.2.1.1 Justification

To limit the level of interference to terrestrial and satellite radio services.

4.2.1.2 Specification

The following specifications apply to the ESOMP transmitting at Equivalent isotropically radiated Power (EIRP) values up to and including $EIRP_{max}$:

- 1) The electric field strength level of any radiation from the ESOMP in the frequency range from 30 MHz to 1 GHz shall not exceed the limits specified in table 2.

Table 2: Limits of radiated field strength at a test distance of 10 m in a 120 kHz bandwidth

Frequency range	Quasi-peak limits
$30 \text{ MHz} \leq f \leq 230 \text{ MHz}$	30 dB μ V/m
$230 \text{ MHz} < f \leq 1\,000 \text{ MHz}$	37 dB μ V/m

The Quasi Peak detector shall be in accordance with CISPR 16-1-1 [4].

- 2) When the ESOMP is in the "Emissions disabled" radio state, the off-axis spurious EIRP from the ESOMP shall not exceed the limits in table 3, for all off-axis angles greater than 7° or greater than the minimum elevation angle provided for the intended use, whichever is lower.

Table 3: Limits of spurious EIRP - "Emissions disabled" radio state

Frequency band	EIRP limit	Measurement bandwidth
1,0 GHz to 2,0 GHz	52 dBpW	1 MHz
2,0 GHz to 10,7 GHz	58 dBpW	1 MHz
10,7 GHz to 21,2 GHz	64 dBpW	1 MHz
21,2 GHz to 60,0 GHz	70 dBpW	1 MHz

The lower limits shall apply at the transition frequency (2,0 GHz, 10,7 GHz and 21,2 GHz).

- 3) In the "Carrier-on" and "Carrier-off" radio states, the off-axis spurious EIRP density from the ESOMP, shall not exceed the limits in table 4, for all off-axis angles greater than 7° or greater than the minimum elevation angle provided for the intended use, whichever is lower.

Table 4: Limits of spurious EIRP - "Carrier-on" and "Carrier-off" radio states

Frequency band	EIRP limit	Measurement bandwidth
1,0 GHz to 2,0 GHz	53 dBpW	1 MHz
2,0 GHz to 3,4 GHz	59 dBpW	1 MHz
3,4 GHz to 10,7 GHz	65 dBpW	1 MHz
10,7 GHz to 21,2 GHz	71 dBpW	1 MHz
21,2 GHz to 27,35 GHz	77 dBpW	1 MHz
27,35 GHz to 27,50 GHz	85 dBpW	1 MHz
27,50 GHz to 30,00 GHz	85 dBpW	1 MHz
30,00 GHz to 31,00 GHz	85 dBpW	1 MHz
31,00 GHz to 31,15 GHz	85 dBpW	1 MHz
31,15 GHz to 60,0 GHz	77 dBpW	1 MHz

The lower limits shall apply at the transition frequency.

- 4) These limits are applicable to the complete ESOMP equipment, including cabling between the units.

4.2.1.3 Conformance tests

Conformance tests shall be carried out in accordance with clause 6.2.

4.2.2 On-axis spurious radiation

4.2.2.1 Justification

To limit the level of interference to satellite radio services.

4.2.2.2 Specification

4.2.2.2.1 "Carrier-on" radio state

The following specification applies to the ESOMP transmitting at EIRP values up to $EIRP_{max}$.

In the 27,5 GHz to 30,0 GHz band the EIRP spectral density of the spurious radiation and outside a bandwidth of 5 times the occupied bandwidth centred on the carrier centre frequency shall not exceed 14 - K dBW in any 1 MHz band. At the network level, the limit shall not be exceeded for more than 0,01 % of the time.

The above limit may be exceeded in a bandwidth of 5 times the occupied bandwidth centred on the carrier centre frequency, in which case the EIRP spectral density of the spurious radiation outside the nominated bandwidth, shall not exceed 28 - K dBW in any 1 MHz band. At the network level, the higher limit shall not be exceeded for more than 0,01 % of the time.

Where K is the factor that accounts for a reduction on the on-axis spurious radiation level in case of multiple ESOMPs operating on the same frequency and the value is given by one the following cases:

- 1) For the case where only one ESOMP transmits at any one time on a given carrier frequency, the value of K is 0.
- 2) For the case where several ESOMPs are expected to transmit simultaneously on a given carrier frequency at the same EIRP then $K = 10 \log(N)$ where N is the maximum number of these ESOMPs. The value of N and the operational conditions of the system for the intended use shall be provided.
- 3) For the case where several ESOMPs are expected to transmit simultaneously on a given carrier frequency at different EIRP levels then $K = 10 \log(EIRP_{Aggregate} / EIRP_{term})$, where:
 - $EIRP_{term}$ is the on-axis EIRP (watts) of the ESOMP within the nominated bandwidth.

The value of $EIRP_{Aggregate}$ and the operational conditions of the ESOMP network for the intended use shall be provided.

NOTE 1: The on-axis spurious radiations, outside the 27,5 GHz to 30,0 GHz band, are limited by clause 4.2.1.2.

NOTE 2: Intermodulation limits inside the band of 27,5 GHz to 30,0 GHz are to be determined by system design and are subject to satellite operator specifications.

For ESOMPs designed to transmit several carriers on different frequencies simultaneously (multicarrier operation), the above limits only apply to each individual carrier when transmitted alone.

4.2.2.2.2 "Carrier-off" and "Emissions disabled" radio states

In the 27,5 GHz to 30,0 GHz band the EIRP spectral density of the spurious radiation outside the nominated bandwidth shall not exceed -11 dBW in any 1 MHz band.

4.2.2.3 Conformance tests

Conformance tests shall be carried out in accordance with clause 6.3.

4.2.3 Off-axis EIRP emission density within the band

4.2.3.0 General

The present clause deals with the off-axis EIRP emission density within the band of 27,5 GHz to 30,0 GHz.

4.2.3.1 Justification

Protection of other satellite (uplink) systems.

4.2.3.2 Total EIRP density specification

The concept of total EIRP density specification is based on the analysis conducted in ETSI TR 103 896 [i.12].

The following specifications apply to the ESOMP transmitting at EIRP values up to $EIRP_{max}$.

The total EIRP density (in dBW/Hz) in direction (α, ϕ) (as defined in clause 4.2.3.6 below) is derived from the total antenna gain $G_{TOT}(\alpha, \phi)$ (in dBi) and from the power density P (dBW/Hz) at the antenna flange as:

$$EIRP_{TOT}(\alpha, \phi) = G_{TOT}(\alpha, \phi) + P$$

G_{TOT} (dBi) is derived from the copol G_R (dBi) and cross pol G_L (dBi) antenna gain in direction (α, ϕ) as:

$$G_{TOT}(\alpha, \phi) = 10 \log (10^{G_R(\alpha, \phi) / 10} + 10^{G_L(\alpha, \phi) / 10})$$

The total EIRP in any 40 kHz band within the nominated bandwidth in any direction ϕ degrees along the geostationary satellite arc from the antenna main beam axis shall not exceed the following limits for more than 0,01 % of the time:

19 - 25 log ϕ -K	dBW	for	$2,0^\circ \leq \phi \leq 7,0^\circ$;
-2 - K	dBW	for	$7,0^\circ < \phi \leq 9,2^\circ$;
22 - 25 log ϕ -K	dBW	for	$9,2^\circ < \phi \leq 48^\circ$;
-10 -K	dBW	for	$48 < \phi \leq 180^\circ$;

where:

- ϕ is the angle, in degrees, between the main beam axis and the direction considered; and
- K is as defined in clause 4.2.2.2.1.

ESOMPs with low elevation angles may exceed the levels defined in clause 4.2.3.2 by the following amount:

Elevation angle to Satellite (ϵ)	Increase in EIRP density (dB)
$\epsilon \leq 5^\circ$	2,5
$5^\circ < \epsilon \leq 30^\circ$	3 - 0,1 ϵ

NOTE: ESOMPs at lower elevation angles should be allowed to use higher EIRP levels relative to the same terminals at higher elevation angles to compensate for the combined effect of increased distance and atmospheric absorption. This will ensure same power flux densities (pfd) at the satellite for ESOMPs at lower elevation angles as for ESOMPs at higher elevation.

4.2.3.3 Void

4.2.3.4 Void

4.2.3.5 Burst Transmission Specification

For non-continuous transmission, the limits in clauses 4.2.3.2 shall not apply for a specific portion of each burst as provided for the intended use. This excluded portion shall not exceed 50 μ sec or 10 % of the burst, whichever is the smaller.

The excluded portion shall have characteristics similar to the remaining part of the burst:

- same symbol rate and modulation; and
- same or lower maximum amplitude.

NOTE 1: The specification above is intended to take account of the spectrum of the preamble of bursts in TDMA systems.

NOTE 2: The satellite operator may require lower off-axis EIRP limits in compliance with FSS intersystem coordination agreements or if coordination agreements permit may allow greater off-axis EIRP limits. In all cases, off-axis EIRP emissions are subject to compliance with national regulations and the relevant FSS intersystem coordination agreements.

4.2.3.6 Off-axis Geometry Specification

Any antenna off-axis direction may be defined by a pair of values (α, ϕ) where ϕ is the off-axis angle of that direction with the antenna main beam axis and α is the angle of the plane defined by that direction and the antenna main beam axis with any arbitrary plane containing the antenna main beam axis.

The range of values of ϕ and α is from $\phi_{\min} - \delta\phi$ to 180° for ϕ , and from -180° to $+180^\circ$ for α .

where:

- ϕ_{\min} is the minimum elevation angle provided with the equipment; and
- $\delta\phi$ is antenna pointing accuracy as defined in clause 4.2.6.1.2.

The limits in clauses 4.2.3.2, apply to any off-axis direction (α, ϕ) within $\pm 3^\circ$ of the visible part of the GSO and may be exceeded up to 3 dB in any other direction.

The limits in clauses 4.2.3.2 may also be exceeded by up to 3 dB for ϕ greater than 10° and within $\pm 3^\circ$ of the visible part of the GSO provided that the total angular range over which this occurs does not exceed 20° when measured along both sides of the geostationary orbit.

The determination of the (α, ϕ) subset shall take into account the operational conditions for which the ESOMP is designed, indicated within the user documentation. These conditions shall include:

- the range of latitudes of the ESOMP;
- the minimum elevation pointing angle;
- the type of antenna mount (e.g. with azimuth and elevation axes or equatorial);
- the maximum static and dynamic alignment errors of the antenna mount axes;
- the maximum static and dynamic alignment errors of the antenna major axis with respect to the GSO arc;

- the range of adjustment for the major axis of the antenna for antennas with asymmetric main beam;
- the direction of the electric field radiated by the satellite with respect to the Earth's axis, when the electric field is used for the antenna alignment.

The alignment errors shall not exceed the maximum values provided with the equipment when applying the alignment method indicated within the user documentation.

NOTE: ETSI TR 102 375 [i.4] gives guidance for the determination of the concerned subset within the (α, ϕ) domain.

4.2.3.7 Conformance tests

Conformance tests shall be carried out in accordance with clause 6.4.1 with the results being computed in accordance with clause 6.4.2.

4.2.4 Uplink Power Control Specification

In the case of ESOMPs employing uplink power control, the above limits shall apply under clear-sky conditions and these limits include all additional margins above the minimum clear-sky level necessary for the implementations of uplink power control. For ESOMPs implementing uplink power control, the above limits may be exceeded by up to A dB during fade conditions, where A is the attenuation of the transmit signal relative to clear sky conditions. The above limits shall not be exceeded by more than 20 dB.

The accuracy (B dB) of uplink power control shall be provided with the equipment.

The conformance test is described in clause 6.1.1.

4.2.5 Carrier suppression

4.2.5.1 Justification

To allow for the satisfactory suppression of transmissions of the ESOMP by the NCF, under any fault condition and under any cessation of emissions condition (see clause 4.2.7 for definition).

4.2.5.2 Specification

In the "Carrier-off" and in the "Emissions disabled" radio states the on-axis EIRP density shall not exceed 14 dBW in any 1 MHz band within the nominated bandwidth.

4.2.5.3 Conformance tests

Conformance tests shall be carried out in accordance with clause 6.5.

4.2.6 Antenna pointing and polarization alignment

4.2.6.1 Antenna pointing accuracy

4.2.6.1.1 Justification

Protection of transmissions to adjacent satellites and cross-polarized transponders on the same satellite.

4.2.6.1.2 Pointing accuracy specification

The peak pointing accuracy value ($\delta\phi$) and the associated statistical basis shall be provided with the equipment.

The antenna shall maintain the provided peak pointing accuracy ($\delta\phi$), such that the off-axis EIRP emission density pattern projected onto the geostationary arc remains within the mask specified in clause 4.2.3.2 when shifted by an angle of $\pm(\delta\phi^\circ)$, taking into account the following factors:

- the environmental conditions for the intended use;
- the range of latitude, longitude and altitude relative to the satellite orbital position.

4.2.6.1.3 On-axis cross polarization isolation specification

For linearly polarized ESOMPs the on-axis cross polarization isolation of the ESOMP shall be provided with the equipment and:

- The polarization angle shall be continuously adjustable within the operational range provided with the equipment. It shall be possible to fix the transmit antenna polarization angle with an accuracy of at least 1° .
- When linear polarization is used for both transmission and reception, the angle between the receive and corresponding transmit polarization planes shall not deviate by more than 1° from the nominal value as provided with the equipment.

For circularly polarized ESOMPs, the voltage axial ratio shall be provided with the equipment.

4.2.6.1.4 Conformance tests

Conformance tests shall be carried out in accordance with clause 6.6 for pointing accuracy and clause 6.7 for polarization alignment.

4.2.6.2 Antenna Pointing Error Detection

4.2.6.2.0 General

Protection of transmissions to adjacent satellites and cross-polarized transponders on the same satellite.

4.2.6.2.1 Pointing error detection specification

Pointing error detection:

- Ranges of values for $\delta\phi$ as functions of on-axis EIRP spectral density such that the EIRP density limits in clause 4.2.3.2 are not exceeded shall be provided with the equipment.
- The ESOMP shall be able to detect the pointing error. The ESOMP, when in the "Carrier-on" radio state, shall enter the "Carrier-off" radio state when the instantaneous pointing error exceeds the pointing error threshold, $\delta\phi_{\max}$, relative to the direction of the wanted satellite at its actual position, within T seconds. The values of $\delta\phi_{\max}$ and T shall be provided with the equipment and the value of T shall not exceed 2 seconds. The ESOMP shall not re-enter the "Carrier-on" radio state until the instantaneous pointing error is within $\delta\phi_{\max}$ for a period of $2 \times T$ seconds.
- The maximum inhibit time (IT_{\max}) that the ESOMP can remain in "Transmission enabled" state and "Carrier off" radio state (see also clause 4.2.9.8) shall be provided with the equipment. If the pointing error threshold is exceeded for more than IT_{\max} then the ESOMP shall enter the "Initial phase" state.

4.2.6.2.2 Polarization angle alignment specification

For linearly polarized ESOMPs, the following applies:

- The polarization angle shall be adjustable over the range provided with the equipment. For a range lower than 90° , the geographical region (latitude and longitude) relative to the satellite orbital position for which the ESOMP is designed to operate, taking into account the inclination of the electric field radiated by the satellite, shall also be provided with the equipment.

- The alignment error, α , of the transmit antenna polarization is the sum of the alignment errors due to the tracking process plus, for ESOMPs that set the transmit polarization by tracking the receive polarization, the alignment error of the transmit polarization plane relative to the receive polarization plane. The alignment error, α , shall not exceed the maximum polarization alignment error, α_{\max} , provided with the equipment.

For circularly polarized ESOMPs, the voltage axial ratio shall be provided with the equipment.

4.2.6.2.3 Conformance tests

Conformance tests shall be carried out in accordance with clauses 6.7.

4.2.7 Cessation of emissions

4.2.7.1 Justification

Cessation of emissions of the ESOMP where the ESOMP is not allowed to transmit.

4.2.7.2 Specification

4.2.7.2.1 Specification 1: Mode of cessation of emissions

The following three modes of cessation of emissions shall be implemented:

- a) the NCF determines that the ESOMP shall cease emissions;
- b) the ESOMP autonomously determines that it shall cease emissions;
- c) a "single-action" means (e.g. operating a switch) by which a local operator may disable the ESOMP and thereby cease emissions.

The ESOMP interfaces involved in the cessation of emissions shall be provided with the equipment:

- the list of relevant parameters which are collected by the ESOMP or the NCF for determination as to whether the ESOMP should cease emissions;
- the list of these relevant parameters which are used by the ESOMP;
- the list of these relevant parameters which are transmitted by the ESOMP to the NCF;
- the list of the relevant parameters which are received by the ESOMP from the NCF;
- for the collected relevant parameters, the ESOMP interface (s), including the protocols, the timing, the ranges of the values, the speed of the variations and the required accuracies;
- for the relevant parameters transmitted to the NCF, the ESOMP interface with the NCF, including the protocols and the timing;
- for the transmission parameter received from the NCF, the ESOMP interface with the NCF, including the protocols and the timing.

These ESOMP interfaces shall be in accordance with the user documentation.

4.2.7.2.2 Specification 2: Conditions under which the ESOMP shall cease emissions

The relevant parameters and the exchange of information between the ESOMP and the NCF shall allow ceasing emissions within the accuracy provided with the equipment.

The conditions for cessation of emissions shall take into account at least the following parameters:

- the location of the ESOMP and the boundaries of the authorized operating area so that cessation of emissions occurs prior to entering any exclusionary zone including any inaccuracy in determination of the geographic location of the ESOMP;

- the operating parameters specified in clauses 4.2.1 through 4.2.6;
- the carrier frequency and the authorized frequency bands.

4.2.7.2.3 Specification 3: Cessation of emissions

A condition requiring cessation of emissions occurs either when the ESOMP receives the command from the NCF at its input or when the ESOMP determines autonomously on the need to cease emissions.

When in the "Transmission enabled" state a condition requiring cessation of emissions occurs, the ESOMP shall cease transmissions and enter the "Initial Phase" state.

When in the "Transmission disabled" state, the ESOMP shall not leave that state for the "Transmission enable" state as long as a condition requiring cessation of emissions exists or the last CC command received from the NCF is a transmission disable command.

When in the "Initial phase-BurstOn" or "Initial phase-BurstOff" substate a condition requiring cessation of emissions occurs, the ESOMP shall cease transmissions and enter the "Initial phase-Standby" substate.

When in the "Initial phase-Standby" substate, the ESOMP shall not leave that state for the "Initial phase-BurstOn" or the "Transmission enabled" states as long as a condition requiring cessation of emissions exists.

The time for transition in any state from the occurrence of a condition requiring cessation of emissions to the "Emissions disabled" radio state shall not exceed 1 second.

4.2.7.2.4 Specification 4: Fault conditions

Any collection of the relevant parameters by the ESOMP or transmission of these parameters to the NCF, which have not been completed correctly within the required delay(s) as provided with the equipment, shall be considered as a fault condition.

Any transmission parameter not received or not correctly received from the NCF within the required delay provided with the equipment shall be considered as a fault condition.

These fault conditions shall be processed as conditions requiring cessation of emissions.

4.2.7.3 Conformance tests

Conformance tests are carried out in accordance with clause 6.8.

4.2.8 Identification of the ESOMP

4.2.8.1 Justification

To fulfil the requirements for identification of individual ESOMP units whether operated in a point-to-point fashion or in a network and for potential use by duly authorized entities.

4.2.8.2 Specification

The ESOMP shall be designed such that it is possible for the NCF to identify which ESOMPs are transmitting in a given geographic area. The ESOMP shall report location with at least 100 m resolution. The means by which identification of ESOMPs is accomplished and the location reporting interval shall be provided with the equipment. In the case where an external system is required, the additional means necessary for identification of the ESOMP shall be provided with the equipment.

4.2.8.3 Conformance tests

Conformance tests shall be carried out in accordance with clause 6.9.

4.2.9 Control and Monitoring Functions (CMFs)

4.2.9.1 ESOMP States

4.2.9.1.0 General

For the purpose of the present document the following four ESOMP states are defined, without presuming the effective implementation of the ESOMP state machine:

- "Non valid";
- "Initial phase";
- "Transmission disabled"; and
- "Transmission enabled".

The four ESOMP states are represented on figure 2, State Transition Diagram of the Control and Monitoring Functions (CMFs).

In the "Non-valid" state and in the "Transmission disabled" state the ESOMP is not allowed to transmit. In the "Transmission-enabled" state the ESOMP is allowed to transmit. In the "Initial phase" state the ESOMP is only allowed to transmit initial bursts or is waiting for a transmit enable/disable command.

The "Initial phase" is divided into three substates:

- "Initial phase-Standby" prior to the transmission of the first initial burst or when no initial bursts are transmitted;
- "Initial phase-BurstOn" during the transmission of the initial bursts;
- "Initial phase-BurstOff" between initial bursts.

NOTE: ESOMPs which do not transmit initial bursts have no "Initial phase-BurstOn" state and no "Initial phase-BurstOff" state.

The ESOMP is allowed to transmit when the following conditions for transmission are satisfied:

- in a state where transmissions are permitted;
- no failure detected;
- correctly pointed towards the satellite; and
- there is no requirement for cessation of emissions.

The following radio states of the ESOMP are defined:

- "Emissions disabled" when the ESOMP shall not transmit any carrier;
- "Carrier-off" when the ESOMP may transmit and does not transmit any carrier;
- "Carrier-on" when the ESOMP may transmit and transmits a carrier.

Table 5 gives the only possible combinations of the ESOMP states and radio states which shall apply, with some examples of associated events.

Table 5: ESOMP states and radio states of the ESOMP

ESOMP states and substates	Radio states	Examples of events
"Non valid"	"Emissions disabled"	After-power on; or After any fault; or During the checking phase.
"Initial phase"		When waiting for a transmission enable or disable command from the NCF.
"Initial phase-Standby"	"Emissions disabled"	Before the first initial burst transmissions; or In locations where no transmission is allowed.
"Initial phase-BurstOn"	"Carrier-on"	During the transmission of each initial burst, and the pointing is correct.
"Initial phase-BurstOff"	"Carrier-off"	Between initial bursts; or When the pointing threshold is exceeded.
"Transmission enabled"	"Carrier-off"	When no carrier is transmitted; or When receive synchronization is lost; or When the pointing threshold is exceeded.
	"Carrier-on"	During transmission of carrier(s), and the pointing is correct.
"Transmission disabled"	"Emissions disabled"	When a disable command from the NCF has been received and waiting for a transmission enable command from the NCF; or In locations where no transmission is allowed.

4.2.9.1.1 CMF state diagram

The following minimum set of CMFs shall be implemented in ESOMPs in order to minimize the probability that they originate unwanted transmissions that may give rise to harmful interference to other systems.

In the "Non-valid" state and in the "Transmission disabled" state the ESOMP shall not transmit. In the "Transmission-enabled" state the ESOMP is allowed to transmit. In the "Initial phase" state the ESOMP is only allowed to transmit initial bursts.

NOTE 1: The restrictions in the "Initial phase" state are for the protection of other systems when the ESOMP is entering the system after a power-on or a reset. These initial burst restrictions do not apply to the ESOMP transmissions in the "Transmission-enabled" state and once a transmission enable command has been received by the ESOMP the ESOMP may transmit or not transmit as required.

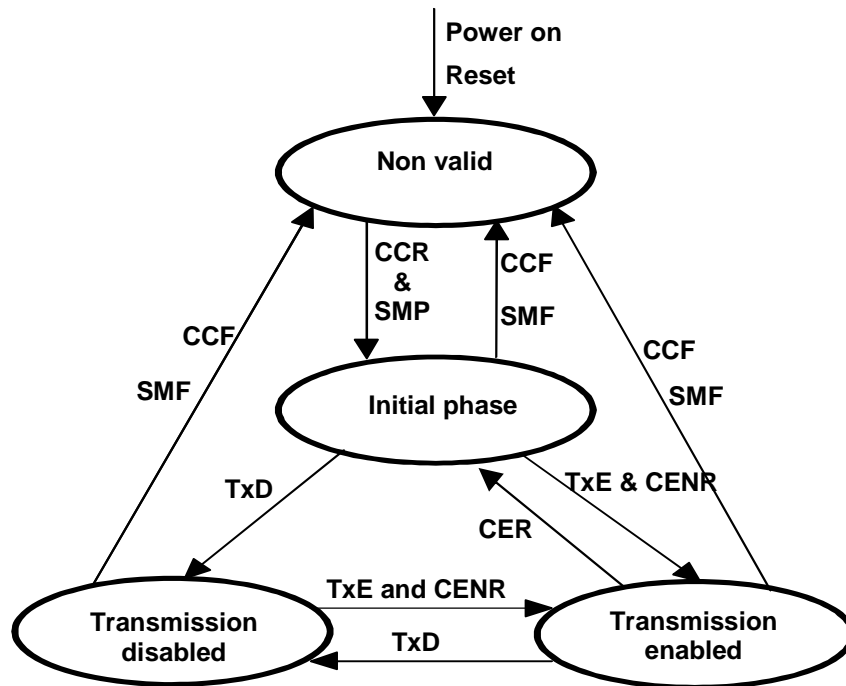

CER: Cessation of Emissions Required;
 CENR: Cessation of Emissions Not Required;
 SMP: System Monitoring Pass;
 SMF: System Monitoring Fail;
 TxE: Transmission Enable command;
 TxD: Transmission Disable command;
 CCR: Control Channel correctly Received;
 CCF: Control Channel reception Failure.

Figure 2: State transition diagram of the control and monitoring function of an ESOMP

NOTE 2: From "Transmission disabled" state a TxE command may also result in a transition towards the "Initial phase" state.

When the ESOMP transmits several carriers having different frequencies, an ESOMP state machine as described above may be associated with each carrier or each set of carriers. The events then apply to the subsystem associated with the specific carrier or the specific set of carriers, rather than the whole ESOMP.

4.2.9.2 Processor monitoring

4.2.9.2.1 Justification

To ensure that the ESOMP can suppress its transmissions in the event of a processor sub-system failure.

4.2.9.2.2 Specification

The ESOMP shall incorporate a processor monitoring function for each of its processors involved in maintaining the performance requirements of the present document and in Control and Monitoring Functions (CMF).

The processor monitoring function shall detect failures of these processors' hardware and software.

In the "Transmission enabled" state, the ESOMP shall enter the "Non valid" state or the "Carrier-off" radio state no later than 1 second after any fault condition occurs. In all states, the ESOMP shall enter the "Non valid" state within a maximum of 30 seconds after the occurrence of any persistent fault condition. Once in the "Non Valid" state, the ESOMP shall remain in the "Non Valid" state until the processor monitoring function has determined that all fault conditions have been cleared.

4.2.9.2.3 Conformance tests

Conformance tests shall be carried out in accordance with clause 6.10.2.

4.2.9.3 Transmit subsystem monitoring

4.2.9.3.1 Justification

To ensure the inhibition of transmissions that are potentially harmful to other systems in the event of incorrect operation of the transmit frequency generation sub-system.

4.2.9.3.2 Specification

The ESOMP shall monitor the operation of its transmit frequency generation sub-system and shall be able to detect:

- a) loss of frequency lock; or
- b) absence of Local Oscillator (LO) output signal.

No later than 1 second after any of these fault conditions of the transmit frequency generation sub-system occurs, the ESOMP shall enter the "Non-valid" state or the "Carrier-off" radio state until the transmit sub-system monitoring function has determined that all fault conditions have been cleared (see clause 4.2.9.2.2 for detailed specification).

4.2.9.3.3 Conformance tests

Conformance tests shall be carried out in accordance with clause 6.10.3.

4.2.9.4 Power-on/Reset

4.2.9.4.1 Justification

To demonstrate that the ESOMP achieves a controlled non-transmitting state following the powering of the unit, or the occurrence of a reset made by a local operator.

4.2.9.4.2 Specification

During and following a reset the ESOMP shall remain in the "Non-valid" state until all the conditions for entering "Initial phase" have been satisfied.

4.2.9.4.3 Conformance tests

Conformance tests shall be carried out in accordance with clause 6.10.4.

4.2.9.5 Control Channel (CC) and Response Channel (RC)

4.2.9.5.1 Justification

To ensure that the ESOMP cannot transmit unless it correctly receives the CC messages from the NCF.

Control Channels (CC) are used by ESOMPs to receive control information from the NCF and Response Channels (RCs) to respond to the NCF. For an ESOMP designed to operate within networks where the NCF determines that the ESOMP will have to cease emissions, then the CCs and RCs are also used for the dialogue with the NCF.

4.2.9.5.2 Specification

4.2.9.5.2.1 Specification 1: types of CCs and RCs

- a) The ESOMP shall have at least one CC from the NCF. If exchange of information with the NCF is necessary for operation according to the intended use of the ESOMP then the ESOMP shall have at least one RC to the NCF (see clause 4.2.7). Each CC and each RC may be internal or external.

The types (internal or external) of each CC and each RC shall be provided with the equipment.

NOTE 1: The availability of the network carrying the external CC(s) and RC(s) and the numbers of external CC(s) and RC(s) are not within the scope of the present document.

NOTE 2: Some satellite operators may require that internal CC(s) and or RC(s) are available.

- b) The connection between the NCF and the ESOMP via the CCs and RCs shall be either permanent or set up on a call by call basis through a switched network. In case of connection through a switched network the ESOMP shall be able to receive calls from the NCF and to initiate calls towards the NCF in order to set up the CCs and RCs.
- c) The ESOMP with an external CC shall not transmit without receiving an appropriate signal from the NCF indicating to the ESOMP that the NCF is alive and insuring that the ESOMP is pointing to the target satellite.

4.2.9.5.2.2 Specification 2: CC Reception

- a) The ESOMP shall enter the "Non-valid" state if it does not correctly receive the CC from the NCF within a period not to exceed 30 seconds. This event is called a "CC disruption":
- In the case of external CCs and RCs without permanent connection of the NCF with the ESOMP, the ability to receive CC messages from the NCF is the ability at any time to receive calls and messages within a period not to exceed 30 seconds from the network through which is connected the NCF.
 - The inability to receive CC messages from the NCF may be due to the following various causes but not limited to them: no received signal from the NCF or from the network, a too low level received signal, no network accessible, the inability to lock onto the received carrier frequency, to demodulate, to decode, to receive calls and/or messages, a hardware failure or power off.
- b) The ESOMP shall remain in the "Non-valid" state as long as the ESOMP is unable to receive CC messages from the NCF.
- c) From the "Non-valid" state the ESOMP may enter the "Initial phase" state if the following conditions are met:
- the ESOMP is able to receive CC messages from the NCF; and
 - no fault conditions are present.

4.2.9.5.3 Conformance tests

Conformance tests shall be carried out in accordance with clause 6.10.5.

4.2.9.6 Network control commands

4.2.9.6.1 Justification

These requirements ensure that the ESOMP is capable of:

- a) retaining a unique identification in the network;
- b) receiving commands from the NCF through its CC(s) and executing those commands.

4.2.9.6.2 Specification

The ESOMP shall hold, in non-volatile memory, its unique identification code in the network.

The ESOMP shall be capable of receiving through its CCs dedicated messages (addressed to the ESOMP) from the NCF, and which contain:

- Transmission Enable commands (TxE);
- Transmission Disable commands (TxD).

When in the "Initial phase" or "Transmission enabled" states, once a transmission disable command is received, within 1 second the ESOMP shall enter into, and shall remain in the "Transmission disabled" state until the transmission disable command is superseded by a subsequent transmission enable command (see also clause 4.2.7).

When in the "Initial phase" or "Transmission disabled" states, once a transmission enable command is received, the ESOMP may enter into the "Transmission enabled" state.

When entering the "Initial phase" from the "Non-valid" state, the last TxE or TxD command received from the NCF may be used by the ESOMP to enter the "Transmission enabled" state or the "Transmission disabled" state, respectively, if since the time of reception of that command no "CC disruption" has occurred.

NOTE: The physical unit in charge of the reception of the CCs, of the transmissions of the RCs and of the CC commands reception may be a separate and independent unit from the other units of the ESOMP or it may be common to several ESOMPs.

4.2.9.6.3 Conformance tests

Conformance tests shall be carried out in accordance with clause 6.10.6.

4.2.9.7 Initial burst transmission

4.2.9.7.1 Justification

Restrictions on the initial burst transmissions are necessary to limit disturbance to other services.

4.2.9.7.2 Specification

For systems where no transmission enable command is foreseen without request from the ESOMP, in the "Initial phase" state the ESOMP may transmit initial bursts:

- a) The ESOMP shall only transmit initial bursts after confirming that no cessation of emission applies where the ESOMP is located. This confirmation shall be obtained either by local means (see clause 4.2.7) or from the NCF via an external control channel.
- b) The duty cycle of the initial burst transmission shall not exceed 0,2 %, where the duty cycle is defined as the ratio of burst duration to the duration between two successive bursts.
- c) The initial burst shall be transmitted at an EIRP no greater than $EIRP_{max}$.
- d) The duration between two successive bursts shall not be less than the required NCF response time as provided with the equipment. This response time is defined as the duration, measured at the ESOMP, between an initial burst transmission and the reception and processing of a transmission enable or disable command from the NCF which is never exceeded during 99 % of the cases under normal conditions in the system for which the ESOMP is designed, as provided with the equipment.

4.2.9.7.3 Conformance tests

Conformance tests shall be carried out in accordance with clause 6.10.7.

4.2.9.8 Inhibition of transmissions

4.2.9.8.1 Justification

To ensure the correct inhibition of transmissions that are potentially harmful to other systems and persons in the event of signal blockage.

4.2.9.8.2 Specification

ESOMP shall enter the "Carrier-off" radio state within a period not exceeding 1 second, whenever there is a loss of receive carrier (e.g. synchronization or signal level), and shall remain in this radio state until the receiver carrier has been restored.

If the receive carrier is not restored within IT_{\max} (see clause 4.2.6.2), then the ESOMP shall transition to the "Initial phase" state.

The time to transition from "Carrier off" to "Carrier on" radio state (T_{trans}) when in "Transmission enabled" state after the receive carrier is restored within It_{\max} shall be provided with the equipment.

4.2.9.8.3 Conformance tests

Conformance tests shall be carried out in accordance with clause 6.10.8.

4.2.10 Receive antenna off-axis gain pattern

4.2.10.1 Justification

To protect the wanted signals from interference from terrestrial services and from other satellite services.

4.2.10.2 Specification

The maximum antenna gain of each of the co-polarized components in any direction ϕ degrees from the antenna main beam axis shall not exceed the following limits:

$$G = 32 - 25 \log \phi \text{ dBi} \quad \text{for} \quad \phi_{\min} \leq \phi < 48^\circ$$

$$G = -10 \text{ dBi} \quad \text{for} \quad 48^\circ \leq \phi \leq 85^\circ$$

$$G = 0 \text{ dBi} \quad \text{for} \quad 85^\circ \leq \phi \leq 180^\circ$$

where:

- $\phi_{\min} = 1^\circ$ or $100 \lambda/D$ degrees, whichever is the greater, for $D/\lambda \geq 50$.
- $\phi_{\min} = 2^\circ$ or $114 (D/\lambda)^{-1.09}$ degrees, whichever is the greater, for $D/\lambda < 50$.
- D is the nominal diameter of the antenna.

In addition the maximum antenna gain of each of the cross-polarized components in any direction ϕ degrees from the antenna main beam axis shall not exceed the following limits:

$$G_x(\phi) = 23 - 20 \log \phi \text{ dBi} \quad \text{for} \quad \phi_r \leq \phi \leq 7^\circ$$

where:

- $\phi_r = 1^\circ$ or $100 \lambda/D$, whichever is greater.

4.2.10.3 Conformance tests

Conformance tests shall be carried out in accordance with clause 6.11.

4.2.11 Blocking performance

4.2.11.1 Justification

To prevent high power signals outside the receive frequency band from blocking the reception of signals inside the receive frequency band.

4.2.11.2 Specification

Receiver blocking is characterized here through gain compression for a signal inside the receive frequency band that is caused by another signal outside the receive frequency band at high power. The level of the other signal is compared to the level of a signal inside the receive frequency band that would cause the same gain compression.

Receiver blocking rejection at a particular frequency is defined as the level of a second signal at this frequency that causes a certain gain compression to a first signal inside the receive frequency band, minus the level of a second signal at a frequency inside the receive frequency band that causes the same gain compression.

The first signal shall be at the centre frequency of the receive frequency band and have a level in the operational range. The second signal shall cause a gain compression for the first signal of 1 dB.

The rejection shall comply with table 6.

Table 6: Receiver blocking rejection

Frequency	Minimum rejection
$f \leq 14$ GHz	20 dB
14 GHz to 16 GHz	10 dB
16 GHz to 17.3 GHz	Linear from 10 dB to 0 dB
21,2 GHz to 24 GHz	Linear from 0 dB to 10 dB
24 GHz to 27,5 GHz	10 dB
$f > 27,5$ GHz	20 dB

4.2.11.3 Conformance tests

Conformance tests shall be carried out in accordance with clause 6.12.

4.2.12 Adjacent Signal Selectivity

4.2.12.1 Justification

To enable reception of a wanted signal in presence of other signals on adjacent frequencies which are transmitted with high EIRP density from target satellite orbital positions.

NOTE: The power level of signals transmitted from the same orbital position are under control of the satellite operator. Signals transmitted from an adjacent orbital position that is not near-by are suppressed by the antenna gain pattern.

4.2.12.2 Specification

Adjacent Signal Selectivity is a measure of a receiver's ability to receive a signal at its assigned channel frequency in the presence of an adjacent signal at a given frequency offset from the centre frequency of the assigned channel. The adjacent signal shall occupy the same bandwidth as the wanted signal. Frequency offset and relative power level of the adjacent signal compared to the wanted signal shall take the value given in table 7. BW is the wanted signal occupied bandwidth.

Table 7: Adjacent signal frequency and Power level

Signal	Centre frequency offset from wanted signal	Power level relative to wanted signal
Adjacent Carrier	BW	7 dBsd

The decrease in the required signal to noise ratio in the presence of an adjacent signal shall be no more than 0,5 dB.

4.2.12.3 Conformance tests

Conformance tests shall be carried out in accordance with clause 6.13.

5 Testing for compliance with technical requirements

5.1 Environmental conditions for testing

Tests defined in the present document shall be carried out at representative points within the boundary limits of the operational environmental profile defined by its intended use.

Where technical performance varies subject to environmental conditions, tests shall be carried out under a sufficient variety of environmental conditions (within the boundary limits of the operational environmental profile defined by its intended use) to give confidence of compliance for the affected technical requirements.

5.2 Radio test suites

The radio test suites for a complete ESOMP are given in clause 6 as part of the test methods.

6 Test methods for all aspects of the ESOMP

6.1 General

6.1.0 Introduction

The present clause describes the general requirements for verifying that the performance of the EUT complies with the specifications. The applicant shall maintain documentary evidence of the results obtained in performing the essential radio tests. At a minimum, the documentary evidence shall include:

- test setup (configurations, test equipment and calibration status);
- test conditions (environmental and operational parameters);
- results of measurements, measurement resolution and uncertainty; and
- statement of compliance with technical specifications of the present document.

The test conditions for each test shall be representative of the intended operational environment and be noted in the test report where it has a significant effect on the measurement results.

The type, termination and length of each cable used shall be representative of the intended installation and recorded in the test report. For maximum cable lengths longer than 10 m, as provided with the equipment, the tests shall be performed with cables no shorter than 10 m.

6.1.1 Uplink power control

6.1.1.1 General

Uplink power control refers to the capability of an ESOMP to increase its output power from the nominal clear sky value to compensate for changes in atmospheric attenuation. The adjustment range (A dB) and measurement uncertainty (B dB) from clause 4.2.4 are evaluated using STE to confirm that:

- The adjustment may range from 0 to A dB where A dB is the value provided with the equipment for its intended use as upper limit of the adjustment value, not to exceed 20 dB over the clear sky limit.
- The target adjustment value shall be met with a measurement uncertainty of $\pm B$ dB as provided with the equipment, which shall be less than $\pm 1,5$ dB from the target adjustment value.

6.1.1.2 Test method

The tests for the specification in clause 4.2.4 shall be limited to the "Carrier-on" radio state. The tests shall be undertaken by using an STE, with a transmitter initially operating at EIRPcs, where EIRPcs is the value provided by the applicant which represents the nominal Clear Sky operating output power of the EUT for the condition when atmospheric attenuation (rain) is not present. The test methodology is as follows:

- a) Output power of EUT is verified to be at EIRPcs within $\pm B$ dB.
- b) Using the applicant provided STE the EUT is directed to increase output power by 1 dB in response to a simulated increase in atmospheric attenuation.
- c) EUT output power is verified to have increased by 1 dB $\pm B$ dB.
- d) Steps b) and c) are repeated until either one of the EIRP level below is reached first:
 - EIRPcs + A dB, or
 - EIRPcs + 20 dB, or
 - EIRPmax, the upper limit of the power output of the EUT.

If the measured output value of each step c) was within $\pm B$ dB of the target adjustment value and, neither the adjustment range A dB nor the 20 dB upper limit on uplink power increases were exceeded, the EUT has met the specification in clause 4.2.4.

6.1.2 Measuring receiver

The term "measuring receiver" refers to a spectrum analyser. The bandwidth of the measuring receiver and the deployed detectors shall be as given in table 8.

Table 8: Measurement receiver parameters

Frequency range: (f)	Measuring receiver bandwidth	Detector
$30 \text{ MHz} \leq f \leq 1\,000 \text{ MHz}$	100 kHz or 120 kHz	peak/RMS (see note 1)
$1\,000 \text{ MHz} < f \leq 40 \text{ GHz}$	1 MHz	peak/RMS
$f > 40 \text{ GHz}$	1 MHz (see note 2)	peak/RMS
NOTE 1: With the values from the peak and the RMS detector the quasi peak value can be calculated for particular measurement applications [i.14].		
NOTE 2: The actual frequency accuracy shall be taken into account to determine the minimum measurement bandwidth possible.		

In case a narrower measurement bandwidth was used, the following conversion formula has to be applied:

$$B = A + 10 \log \frac{BW_{ref}}{BW_{MEASURED}}$$

Where:

- A is the value at the narrower measurement bandwidth;
- B is the value referred to the reference bandwidth; or
- use the measured value, A, directly if the measured spectrum is a discrete spectral line. (A discrete spectrum line is defined as a narrow peak with a level of at least 6 dB above the average level inside the measurement bandwidth.)

6.2 Off-axis spurious radiation

6.2.0 Introduction

The tests for the ESOMP specification in clause 4.2.1.2 shall be conducted in "Carrier on", "Carrier off" and "Emissions disabled" radio states as required. The tests in "Carrier on" radio state shall be undertaken with the transmitter operating at $EIRP_{max}$.

6.2.1 Test method

6.2.1.0 Void

6.2.1.1 General

The tests for the specification in clause 4.2.1.2 shall be limited to the "Carrier-on" radio state. The tests shall be undertaken with the transmitter operating at $EIRP_{max}$.

The ESOMP may be tested with or without antenna. An "EUT with antenna" is an ESOMP with integral antenna. An "EUT without antenna" is an ESOMP with the removable antenna removed.

In the case where the ESOMP antenna is remotely mounted from the associated electronics, the connecting cable shall be of the same type and length as specified by the applicant in the installation manual. If the cable is normally longer than 10 m, a cable of 10 m in length may be used for the test. The type and length of cable used shall be entered in the test report.

The EUT shall be terminated with matched impedance at the terrestrial ports if recommended by the applicant in the user documentation and if there is no associated equipment connected to each port.

For frequencies up to 80 MHz the measuring antenna shall be a balanced dipole with a length equal to the 80 MHz resonant length and shall be matched to the feeder by a suitable balanced transforming device.

For frequencies between 80 MHz and 1 000 MHz the measuring antenna shall be a balanced dipole which shall be resonant in length.

For frequencies above 1 000 MHz the antenna shall be a horn radiator of known gain/frequency characteristics. The antenna is mounted on a support capable of allowing the antenna to be used in either horizontal or vertical polarization and at the specified height.

6.2.1.2 Multi-carrier operation

For ESOMPs designed to transmit simultaneously several carriers the verification up to 1 000 MHz shall be performed with one or more carriers and the verification above 1 000 MHz shall be repeated for each combination of carriers provided with the equipment.

For each combination of carriers, the carriers' centre frequencies and characteristics, the maximum value of the total on-axis EIRP of the carriers and the relative levels of the carriers (in dBs) at the input or output of the HPA or antenna need to be provided.

In the case of combinations of carriers with identical characteristics and when the power at the input of the HPA does not exceed the maximum input power with two carriers, the verification may be limited to the case with two carriers and with the maximum frequency separation between them.

In any other case, the number of configurations to be verified above may be limited to the cases which can be proven by the applicant to generate the maximum EIRP density level of the out-of-band emissions due to inter-modulation products.

6.2.2 Measurements up to 1 000 MHz

6.2.2.1 Test site

The test shall be performed either in an open area test site, a semi-anechoic chamber or an anechoic chamber, however the anechoic chamber is preferred. Ambient noise levels shall be at least 6 dB below the applicable unwanted emissions limit.

The open area test site shall be flat, free of overhead wires and nearby reflecting structures, sufficiently large to permit aerial placement at the specified measuring distance and provide adequate separation between aerial, test unit and reflecting structures, according to CISPR 16-1-4 [5].

For both the open area test site and the semi-anechoic chamber a metal ground plane shall be inserted on the natural ground plane and it shall extend at least 1 m beyond the perimeter of the EUT at one end and at least 1 m beyond the measurement antenna at the other end.

The distance between the EUT and the measuring antenna should be 10 m. For measurements at a different distance an inverse proportionality factor of 20 dB per decade shall be used to normalize the measured data to the specified distance for determining compliance. Care should be taken in measurement of large test units at 3 m at frequencies near 30 MHz due to near field effects.

6.2.2.2 Measuring receivers

Measuring receivers shall conform to the following characteristics:

- the response to a constant amplitude sine wave signal shall remain within ± 1 dB across the frequency range of interest;
- quasi-peak detection shall be used in a -6 dB bandwidth of 120 kHz;
- the receiver shall be operated below the 1 dB compression point.

6.2.2.3 Procedure

- a) The EUT shall be an EUT with antenna or, preferably, without antenna but with the antenna flange terminated by a dummy load.
- b) The EUT shall be in the "Carrier-on" radio state.
- c) The EUT shall be rotated through 360° and, except in an anechoic chamber, the measuring antenna shall be rotated and height varied from 1 m to 4 m above the ground plane to determine the maximum emission.
- d) All identified spurious radiation shall be measured and noted in frequency and level.

6.2.3 Measurements above 1 000 MHz

6.2.3.0 General

The spectrum analyser resolution bandwidth shall be set to the specified measuring bandwidth or as close as possible. If the resolution bandwidth is different from the specified measuring bandwidth, bandwidth correction shall be performed for the noise-like wideband spurious.

For an EUT with antenna the tests shall be performed in two stages for both the "Carrier-on" and "Carrier-off" radio states:

- Procedure a): Identification of the significant frequencies of spurious radiation.
- Procedure b): Measurement of radiated power levels of identified spurious radiation.

For an EUT without antenna the tests shall be performed in three stages for both the "Carrier-on" and "Carrier-off" radio states:

- Procedure a): Identification of the significant frequencies of spurious radiation.
- Procedure b): Measurement of radiated power levels of identified spurious radiation.
- Procedure c): Measurement of conducted spurious radiation radiated through the antenna flange.

6.2.3.1 Identification of the significant frequencies of spurious radiation

6.2.3.1.1 Test site

The identification of frequencies emitting from the EUT shall be performed either in an anechoic chamber, an open area test site or a semi-anechoic chamber with the test antenna close to the EUT and at the same height as the volume centre of the EUT.

6.2.3.1.2 Procedure

- a) The EUT shall be in the "Carrier-off" radio state.
- b) For an EUT with antenna the main beam of the antenna shall have an angle of elevation corresponding to 8 dBi antenna gain, and, for an EUT without antenna the antenna flange shall be terminated by a dummy load.
- c) The receivers shall scan the frequency band while the EUT revolves.
- d) The EUT shall be rotated through 360° and the frequency of any spurious signals noted for further investigation.
- e) For an EUT with antenna the test shall be repeated with the test antenna being in the opposite polarization.
- f) The test shall be repeated in the "Carrier-on" radio state while transmitting one modulated carrier at maximum power.

6.2.3.2 Measurement of radiated power levels of identified spurious radiation

6.2.3.2.1 Test site

The measurement of each spurious radiation noted during procedure a) of the test shall be performed on a test site that is free from reflecting objects, i.e. either an open-area test site, a semi-anechoic chamber or an anechoic chamber.

6.2.3.2.2 Procedure

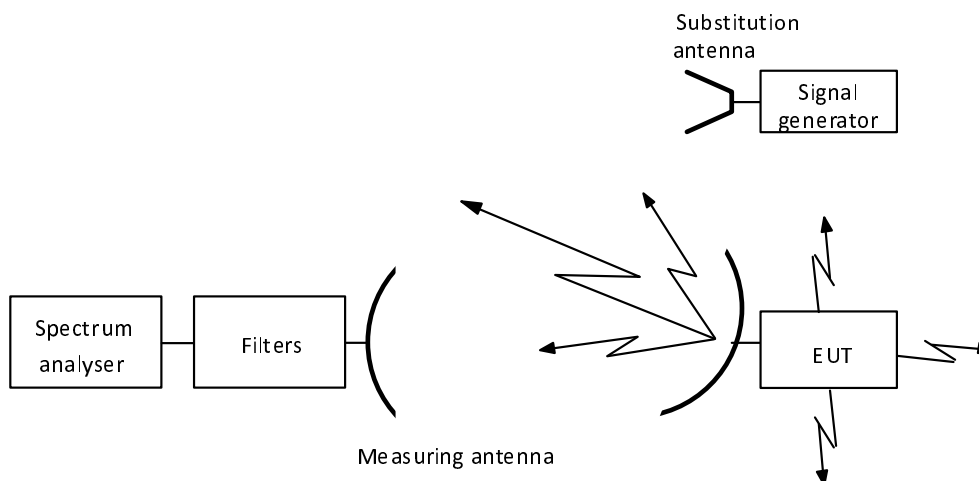

Figure 3: Test arrangement - Spurious radiation measurement above 1 000 MHz for an EUT with antenna

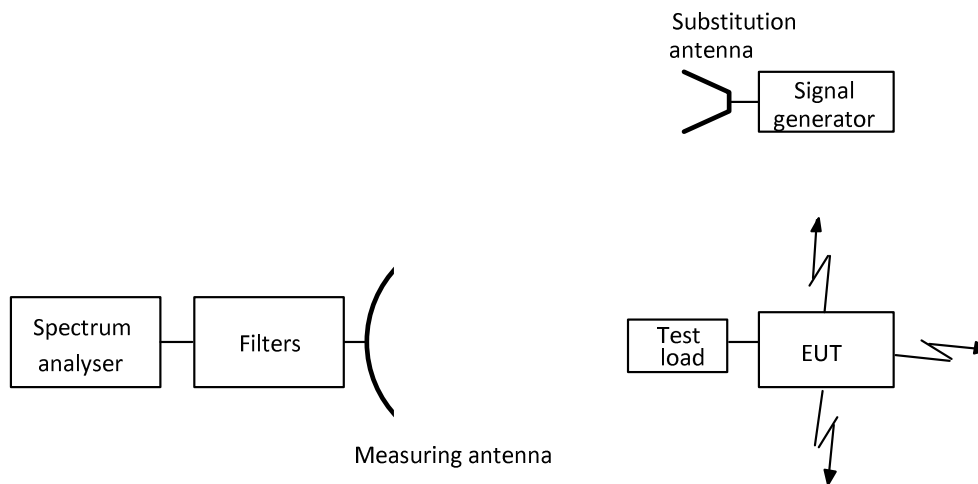

Figure 4: Test arrangement - spurious radiation measurements above 1 000 MHz for an EUT without antenna

- a) The test arrangement shall be as shown in figure 3 or 4.
- b) The EUT shall be installed at a height between 0,5 m and 1,0 m on a non-metallic turntable. For an EUT with separable components, the components shall be separated by 1 m to 2 m. For the test arrangement shown in figure 3 the main beam of the antenna shall have an angle of elevation sufficient to achieve a peak gain of 8 dBi in the direction the test receiver. The Geostationary Satellite Orbit (GSO) shall be protected from EUT emissions during the test procedure.
- c) The measuring antenna shall be positioned at a distance from the EUT (e.g. 3 m, 5 m, 10 m) relevant to the applied test site. The measuring antenna shall be adjusted in height and the EUT rotated, while the EUT is in the appropriate carrier condition, for a maximum response on the associated spectrum analyser at each spurious frequency previously identified, this response level shall be noted. The adjustment in height of the measuring antenna does not apply when an anechoic chamber is being used. The measuring antenna shall never enter the 8 dBi off-axis cone around the main beam direction.
- d) The investigation shall be repeated with the measuring antenna in the opposite polarization and the response level similarly noted.
- e) The EUT shall be replaced by the substitution antenna to which is connected a signal generator. The main beam axes of the measuring and substitution antennas shall be aligned. The distance between these antennas shall be the distance determined under test c).
- f) The substitution and measuring antennas shall be aligned in the polarization which produced the larger response between the EUT and the test antenna in steps c) and d).
- g) The output of the generator shall be adjusted so that the received level is identical to that of the previously noted largest spurious radiation.
- h) The output level of the signal generator shall be noted. The EIRP of the spurious radiation is the sum, in dB, of the signal generator output plus the substitution antenna isotropic gain minus the interconnection cable loss.

6.2.3.3 Measurement of conducted spurious radiation at the antenna flange

6.2.3.3.1 Test site

There are no requirements for the test site to be used for this test.

6.2.3.3.2 Procedure

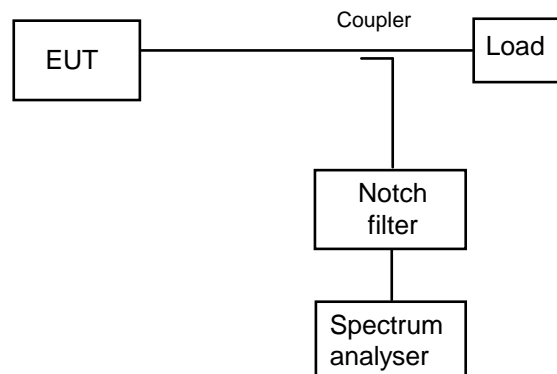

Figure 5: Test arrangement - conducted spurious radiation above the cut-off frequency

- a) The test arrangement shall be as shown in figure 5 with the notch filter being optional. In order to protect the spectrum analyser while ensuring the necessary measurement accuracy, particularly close to the carrier, if a notch filter is used it shall be tuned to the transmit carrier frequency.
- b) The frequency range from the cut-off frequency of the waveguide of the EUT to 60 GHz shall be investigated for spurious radiation while in the "Carrier-on" radio state with the carrier being at maximum power and normally modulated.
- c) To obtain the off-axis spurious EIRP the maximum measured antenna transmit gain, measured at the frequency of the identified unwanted emission, for off-axis angles greater than 7°, shall be added to the measured power density and any correction or calibration factors summated with the result.
- d) The test shall be repeated in the "Carrier-off" radio state.

6.3 On-axis spurious radiation

6.3.1 Test method

6.3.1.0 General

The tests shall be undertaken with the transmitter operating at $EIRP_{max}$.

6.3.1.1 Test site

The tests shall be carried out using radiated measurements.

6.3.1.2 Method of measurement

6.3.1.2.1 General

For ESOMP equipment for which measurements at the antenna flange are possible, the measurements shall be performed at the antenna flange.

For ESOMP equipment for which measurements at the antenna flange are not possible, the measurements shall be performed with a test antenna.

6.3.1.2.2 Method of measurement at the antenna flange

- a) The test arrangement shall be as shown in figure 5 with the notch filter being optional. In order to protect the spectrum analyser while ensuring the necessary measurement accuracy, particularly close to the carrier, if a notch filter is used it shall be tuned to the transmit carrier frequency.

- b) The EUT shall transmit one modulated carrier continuously, or at its maximum burst rate where applicable, centred on a frequency as close to the lower limit of the operating frequency band of the EUT as possible. The EUT shall be operated at $EIRP_{max}$. The frequency range 27,50 GHz to 30,00 GHz shall be investigated.
- c) Due to the proximity of the carrier the spectrum analyser resolution bandwidth shall be set to a measurement bandwidth of 3 kHz, or as close as possible. If the measurement bandwidth is different from the specified measurement bandwidth, bandwidth correction shall be performed for noise-like wideband spurious radiation.
- d) To obtain the on-axis spurious EIRP, the antenna transmit gain shall be added to any figure obtained in the above measurement and any correction or calibration factor summated with the result. The antenna gain shall be as measured in clause 6.4.1.2 at the closest frequency to the spurious frequency.
- e) The tests in b) to e) shall be repeated with a transmit frequency in the centre of the operating frequency band.
- f) The tests in b) to e) shall be repeated with a transmit frequency as close to the upper limit of the operating frequency band of the EUT as possible.
- g) The tests in b) to f) shall be repeated in the "Carrier-off" radio state.

6.3.1.2.3 Method of measurement for an EUT with antenna

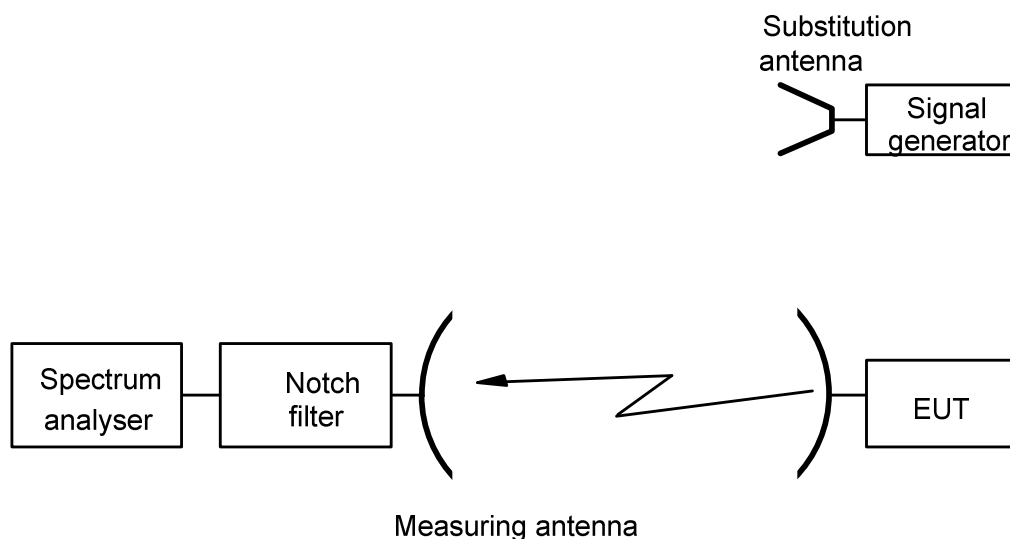

Figure 6: Test arrangement - on-axis spurious radiation measurements for an EUT with antenna

- a) The test arrangement shall be as shown in figure 6 with the notch filter being optional.
- b) The EUT shall be installed such that the units are separated by 1 m to 2 m with the indoor unit at a height between 0,5 m and 1,0 m on a non-metallic turntable.
- c) The spectrum analyser resolution bandwidth shall be set to the specified measuring bandwidth or as close as possible. If the resolution bandwidth is different from the specified measuring bandwidth, bandwidth correction shall be performed for noise-like wideband spurious radiation.
- d) The EUT shall transmit one modulated carrier continuously, or at its maximum burst rate where applicable, centred on a frequency as close to the lower limit of the operating frequency band of the EUT as possible. The EUT shall be operated at $EIRP_{max}$. The frequency range 27,50 GHz to 30,00 GHz shall be investigated and each spurious frequency shall be noted.
- e) Due to the proximity of the carrier the spectrum analyser resolution bandwidth shall be set to a measurement bandwidth of 3 kHz, or lower. If the measurement bandwidth is different from the specified measurement bandwidth, bandwidth correction shall be performed for noise-like wideband spurious radiation.

- f) The measuring antenna shall be positioned at a distance from the EUT (e.g. 3 m, 5 m, 10 m, etc.) relevant to the applied test site and shall be aligned with the EUT antenna for the transmit frequency. The measuring antenna shall be adjusted in height, while the EUT is in the appropriate carrier condition, for a maximum response on the associated spectrum analyser at each spurious frequency previously identified, this response level shall be noted. The adjustment in height of the measuring antenna does not apply when an anechoic chamber is being used.
- g) The EUT shall be replaced by a representative substitution antenna to which a signal generator is connected. The main beam axes of the measuring and substitution antennas shall be aligned. The distance between these antennas shall be the distance determined under test f).
- h) The substitution and measuring antennas shall be aligned to that polarization which produced the largest response between the EUT and the test antenna.
- i) The output of the generator shall be adjusted so that the received level is identical to that of the previously noted largest spurious radiation.
- j) The output level of the signal generator shall be noted. The EIRP of the on-axis spurious radiation is the sum, in dB, of the signal generator output plus the substitution antenna isotropic gain minus the interconnection cable loss.
- k) The tests in d) to j) shall be repeated with a transmit frequency in the centre of the operating frequency band.
- l) The tests in d) to j) shall be repeated with a transmit frequency as close to the upper limit of the operating frequency band of the EUT as possible.
- m) The tests in b) to l) shall be repeated in the "Carrier-off" radio state.

6.4 Off-axis EIRP emission density within the band

6.4.1 Test method

6.4.1.0 Introduction

The measurement shall be made at the occupied bandwidth and $EIRP_{max}$ that produces the highest operational emission density in the frequency band. The selected configuration(s) shall be recorded in the test report.

If the test is to be carried out with an STE the STE shall provide all the signals needed by the ESOMPs under normal operation (e.g. a radio beacon if it is expected to be received by the satellite).

For ESOMPs with uplink power density control capability the compliance of the ESOMP with the specification of clause 4.2.4 during fading conditions shall be demonstrated by documentary evidence from the applicant.

The total EIRP density $EIRP_{TOT}$ (in dBW/Hz) is determined from the calculation of the total gain $G_{TOT}(\alpha, \phi)$ (in dBi) from the measurements of the antenna copolar G_R (in dBi) and crosspolar G_L (in dBi) gain patterns, and from the power density P (in dBW/Hz) at the antenna flange as:

$$EIRP_{TOT}(\alpha, \phi) = G_{TOT}(\alpha, \phi) + P$$

Where: $G_{TOT}(\alpha, \phi) = 10\log(10^{G_R(\alpha, \phi)/10} + 10^{G_L(\alpha, \phi)/10})$

The total EIRP density shall be compared to the specified mask in clause 4.2.3.2, taking into account the declared pointing accuracy $\delta\phi$ provided with the equipment defined in clause 4.2.6.1.2, if applicable.

To ascertain the off-axis EIRP density it is necessary to know the transmit power density and antenna transmit radiation pattern. To ascertain the radiation pattern it is necessary to know the antenna transmit gain.

The following three measurement procedures shall be performed:

- a) transmit output power density (dBW/40 kHz);
- b) antenna transmit gain (dBi);

- c) antenna transmit radiation patterns (dBi).

6.4.1.1 Transmit output power density

6.4.1.1.1 General

For the purpose of this test the EUT is defined as the ESOMP up to the antenna flange.

The EUT output power shall be set to the power corresponding to $EIRP_{max}$.

6.4.1.1.2 Test site

There are no requirements for the test site to be used for this test.

6.4.1.1.3 Method of measurement

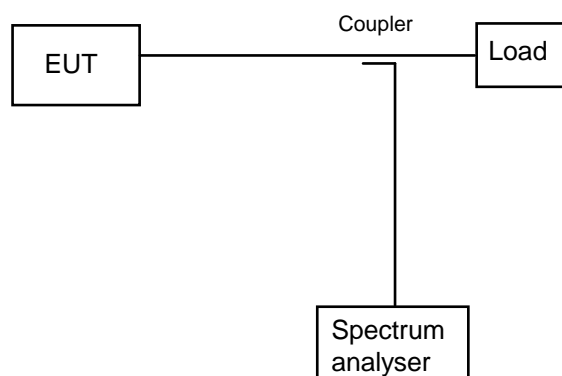

Figure 7: Test arrangement - transmit output power density measurement

- a) The test arrangement shall be as shown in figure 7.
- b) The EUT shall transmit one carrier modulated with data. For burst mode transmission the EUT shall transmit at its maximum burst rate. The power density supplied to the antenna flange shall be measured in dBW/40 kHz. The coupling factor of the test coupler at the test frequency and the attenuation of any necessary waveguide adapter shall be taken into account.

The spectrum analyser shall be operated under the following conditions:

frequency span:	as required for the complete nominated bandwidth;
resolution bandwidth:	the resolution bandwidth of the spectrum analyser shall be set as close as possible to the specified measuring bandwidth of 40 kHz. If the resolution bandwidth is different from the specified bandwidth then bandwidth correction shall be performed;
display/video bandwidth:	equal to the resolution bandwidth;
averaging:	yes;
max hold:	yes.

For an ESOMP operating in a continuous carrier mode, the measurement time shall be sufficient to ensure that at any frequency the difference between any two measurement results is less than 1 dB.

For an ESOMP operating in a non-continuous carrier mode, the average measurement shall be performed over the transmitted burst and the measurements from a series of bursts shall be combined as follows:

- each measurement may exclude a specific portion of each burst. The excluded portion shall not exceed 50 μ s or 10 % of the burst, whichever is the smaller. The excluded portion for the intended use shall be provided with the equipment;

- the measurements from several bursts shall be averaged to give a final measurement result. The number of bursts that are averaged shall be sufficient to ensure that the difference between any two final measurement results is less than 1 dB.
- c) The measurement shall be made at the occupied bandwidth and $EIRP_{max}$ that produces the highest emission density in the frequency band. The selected configuration(s) shall be recorded in the test report.

6.4.1.2 Antenna transmit gain

6.4.1.2.1 General

For the purpose of the present document, the antenna transmit gain is defined as the ratio, expressed in decibels (dBi), of the power that would have to be supplied to the reference antenna, i.e. an isotropic radiator isolated in space, to the power supplied to the antenna being considered, so that they produce the same field strength at the same distance in the same direction. Unless otherwise specified the gain is for the direction of maximum radiation.

For the purpose of this test the EUT is defined as the antenna and its flange. The antenna may include the reflector(s), feed, support struts and an enclosure of equal weight/distribution to any electrical equipment normally housed with the feed at the antenna focal point.

The operating frequency range of the EUT for the intended use shall be provided with the equipment. For the tests in this clause the following test frequencies shall be defined:

- Test Frequency A - the low test frequency shall be the middle of the lowest carrier in operating frequency range;
- Test Frequency B - the mid-range test frequency shall be the middle of the carrier that includes (or is adjacent to) the middle of the operating range; and
- Test Frequency C - the high test frequency shall be the middle of the highest carrier in the operating range.

6.4.1.2.2 Test site

This test shall be performed on either an outdoor far-field test site, compact test range or near-field scanner, however the compact test range is preferred.

6.4.1.2.3 Method of measurement

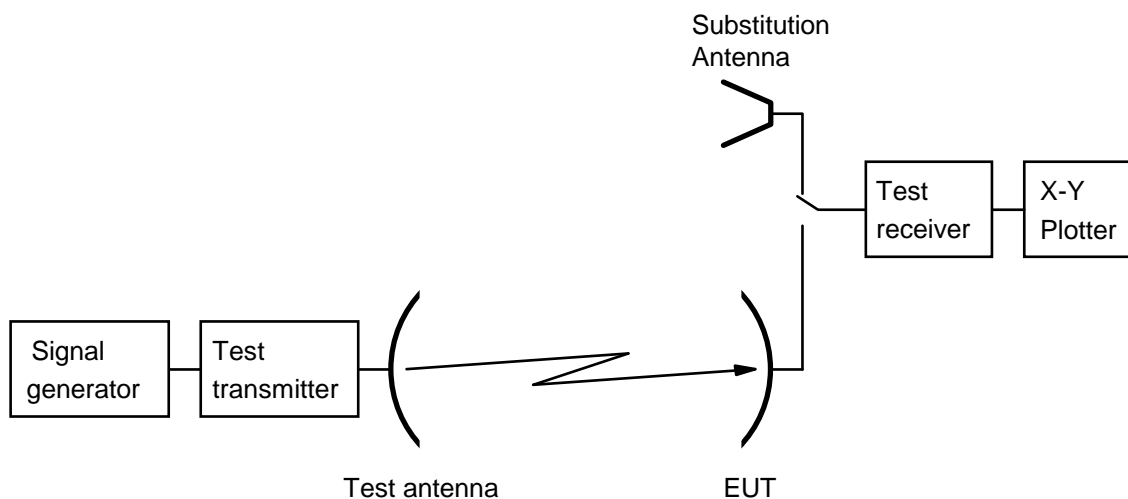

Figure 8: Test arrangement - antenna transmit gain measurement

- a) The test arrangement shall be as shown in figure 8 with the EUT connected to the test receiver. A signal proportional to the angular position from the servo mechanism shall be applied to the X-axis and the signal level from the test receiver shall be applied to the Y-axis of the plotter.

- b) A test signal at Test Frequency B shall be transmitted by the test transmitter through the test antenna. The E-plane shall be vertical. The EUT antenna main beam axis shall be aligned with the main beam axis of the test transmitter. The polarizer of the EUT antenna shall be rotated and adjusted such that the E-plane coincides with the E-plane of the test transmitter.
- c) The EUT shall be aligned to maximize the received signal and the X-Y plotter adjusted to give the maximum reading on the chart.
- d) The EUT shall be driven in azimuth in one direction through 10°.
- e) The pattern measurement is then obtained by driving the EUT in azimuth back through boresight to 10° the other side with the plotter recording the results.
- f) The EUT shall be replaced by the substitution antenna and the received signal level maximized.
- g) This level shall be recorded on the X-Y plotter.
- h) The substitution antenna shall be driven in azimuth as in d) and e).
- i) The gain of the EUT shall be calculated from:

$$G_{EUT} = L_1 - L_2 + C$$

where:

G_{EUT} is the gain of the EUT (dBi);

L_1 is the peak level obtained with the EUT (dB);

L_2 is the peak level obtained with the substitution antenna (dB);

C is the calibrated gain of the substituted antenna at the test frequency (dBi).

- j) The tests in c) to i) shall be repeated with the frequency changed to Test Frequency A.
- k) The tests in c) to i) shall be repeated with the frequency changed to Test Frequency C.
- l) The tests in b) to k) may be performed simultaneously.

6.4.1.3 Antenna transmit radiation patterns

6.4.1.3.1 General

For the purposes of the present document, the antenna transmit radiation patterns are diagrams relating field strength to the angle of the direction pointed by the antenna at a constant large distance from the antenna.

For the purpose of this test, the EUT is defined as the antenna and its flange. The antenna includes the reflector(s), feed, support struts and an enclosure of equal weight/distribution to any electrical equipment normally housed with the feed at the antenna focal point.

6.4.1.3.2 Test site

This test shall be performed on either an outdoor far-field test site, compact test range or near-field scanner, however the compact test range is preferred.

6.4.1.3.3 Test arrangement

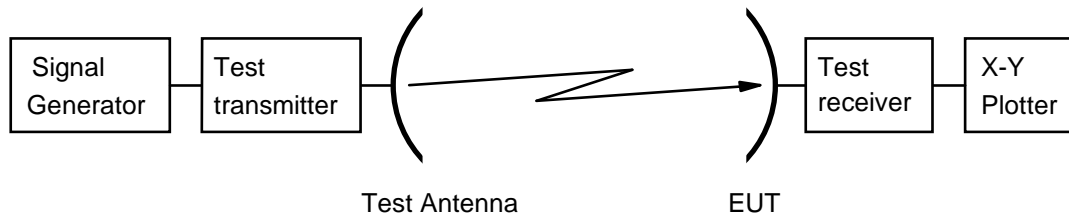

Figure 9: Test arrangement - antenna transmit radiation pattern measurement

6.4.1.3.4 Co-polar radiation pattern - azimuth

- a) The test arrangement shall be as shown in figure 9 with the EUT connected to the test receiver. A signal proportional to the angular position from the servo mechanism shall be applied to the X-axis and the signal level from the test receiver shall be applied to the Y-axis of the plotter.
- b) The frequency of the test signal shall be set to Test Frequency B.
- c) The initial E-plane of the test signal radiated by the test transmitter through its antenna shall be vertical for linear polarization or left hand for circular polarization antennas. The EUT antenna main beam axis shall be aligned with the main beam axis of the test transmitter. For linear polarization the polarizer of the EUT antenna shall be rotated and adjusted such that its E-plane coincides with the E-plane of the test transmitter. Precise co-polar peaking of the polarization shall be done by observing the cross-polar minimum (fine adjustment).
- d) The EUT shall be aligned to maximize the received signal and the X-Y plotter adjusted to give the maximum reading on the chart.
- e) The EUT shall be driven in azimuth to -180° .
- f) The transmit pattern measurement is then obtained by driving the EUT in azimuth from -180° to $+180^\circ$ with the plotter recording the results.
- g) The tests in d) to f) shall be repeated with the frequency changed to Test Frequency A.
- h) The tests in d) to f) shall be repeated with the frequency changed to Test Frequency C.
- i) The tests in b) to h) may be performed simultaneously.
- j) The tests in d) to i) shall be repeated with the E-plane of the test signal being horizontal or right hand circular as applicable. The frequency of the test signal shall be set to Test Frequency B. For linear polarization the polarizer of the EUT antenna shall be rotated and adjusted such that its E-plane coincides with the E-plane of the test transmitter (giving the minimum cross-polar receive signal). Precise co-polar peaking of the polarization shall be done by observing the cross-polar minimum.

6.4.1.3.5 Co-polar radiation pattern - elevation

- a) The test arrangement shall be as shown in figure 9 with the EUT connected to the test receiver. A signal proportional to the angular position from the servo mechanism shall be applied to the X-axis and the signal level from the test receiver shall be applied to the Y-axis of the plotter.
- b) The frequency of the test signal shall be set to Test Frequency B.
- c) The initial E-plane of the test signal radiated by the test transmitter through its antenna shall be vertical for linear polarization or left-hand for circular polarization antennas. The EUT antenna main beam axis shall be aligned with the main beam axis of the test transmitter. For linear polarization the polarizer of the EUT antenna shall be rotated and adjusted such that its E-plane coincides with the E-plane of the test transmitter. Precise co-polar peaking of the polarization shall be done by observing the cross-polar minimum (fine adjustment).

- d) The EUT shall be aligned to maximize the received signal and the X-Y plotter adjusted to give the maximum reading on the chart.
- e) The EUT shall be driven in elevation to -1° .
- f) The transmit pattern measurement is then obtained by driving the EUT in elevation from -1° to a maximum elevation angle which is equal or less than 70° as provided with the equipment for the intended use with the plotter recording the results.
- g) The tests in d) to f) shall be repeated with the frequency changed to Test Frequency A.
- h) The tests in d) to f) shall be repeated with the frequency changed to Test Frequency C.
- i) The tests in b) to h) may be performed simultaneously.
- j) The tests in d) to i) shall be repeated with the E-plane of the test signal being horizontal. The frequency of the test signal shall be set to Test Frequency B. For linear polarization the polarizer of the EUT antenna shall be rotated and adjusted such that its E-plane coincides with the E-plane of the test transmitter. The EUT antenna main beam axis shall be aligned with the main beam axis of the test transmitter. Precise co-polar peaking of the polarization plane shall be done by observing the cross-polar minimum.

6.4.1.3.6 Cross-polar radiation pattern - azimuth

- a) The test arrangement shall be as shown in figure 9 with the EUT connected to the test receiver. A signal proportional to the angular position from the servo mechanism shall be applied to the X-axis and the signal level from the test receiver shall be applied to the Y-axis of the plotter.
- b) The frequency of the test signal shall be set to Test Frequency B.
- c) The initial E-plane of the test signal radiated by the test transmitter through its antenna shall be vertical for linear polarization or left-hand for circular polarization antennas. The EUT antenna main beam axis shall be aligned with the main beam axis of the test transmitter. For linear polarization the polarizer of the EUT antenna shall be rotated and adjusted such that its E-plane is orthogonal to the E-plane of the test transmitter. Precise fine adjustment of the polarization plane shall be done by observing the cross-polar minimum.
- d) In order to adjust the X-Y plotter giving the maximum reading on the chart the boresight co-polar receive signal shall be used.
- e) The EUT shall be driven in azimuth to -10° .
- f) The transmit pattern measurement is then obtained by driving the EUT in azimuth from -10° to $+10^\circ$ with the plotter recording the results.
- g) The tests in d) to f) shall be repeated with the frequency changed to Test Frequency A.
- h) The tests in d) to f) shall be repeated with the frequency changed to Test Frequency C.
- i) The tests in b) to h) may be performed simultaneously.
- j) The tests in d) to i) shall be repeated with the E-plane of the test signal being horizontal or right hand circular as appropriate. The frequency of the test signal shall be set to Test Frequency B. The EUT antenna main beam axis shall be aligned with the main beam axis of the test transmitter. For linear polarization the polarizer of the EUT antenna shall be rotated and adjusted such that its E-plane is orthogonal with the E-plane of the test transmitter. Precise fine adjustment of the polarization plane shall be done by observing the cross-polar minimum.

6.4.1.3.7 Cross-polar radiation pattern - elevation

- a) The test arrangement shall be as shown in figure 9 with the EUT connected to the test receiver. A signal proportional to the angular position from the servo mechanism shall be applied to the X-axis and the signal level from the test receiver shall be applied to the Y-axis of the plotter.
- b) The frequency of the test signal shall be set to Test Frequency B.

- c) The initial E-plane of the test signal radiated by the test transmitter through its antenna shall be vertical for linear polarization or left hand for circular polarization antennas. The EUT antenna main beam axis shall be aligned with the main beam axis of the test transmitter. For linear polarization the polarizer of the EUT antenna shall be rotated and adjusted such that its E-plane is orthogonal to the E-plane of the test transmitter. Precise fine adjustment of the polarization plane shall be done by observing the cross-polar minimum.
- d) In order to adjust the X-Y plotter giving the maximum reading on the chart the boresight co-polar receive signal shall be used.
- e) The EUT shall be driven in elevation to -1° .
- f) The transmit pattern measurement is then obtained by driving the EUT in elevation from -1° to $+10^\circ$ with the plotter recording the results.
- g) The tests in d) to f) shall be repeated with the frequency changed to Test Frequency A.
- h) The tests in d) to f) shall be repeated with the frequency changed to Test Frequency C.
- i) The tests in b) to h) may be performed simultaneously.
- j) The tests in d) to i) shall be repeated with the E-plane of the test signal being horizontal or right hand circular as appropriate. The frequency of the test signal shall be set to Test Frequency B. The EUT antenna main beam axis shall be aligned with the main beam axis of the test transmitter. The polarizer of the EUT antenna shall be rotated and adjusted such that its E-plane is orthogonal with the E-plane of the test transmitter. Precise fine adjustment of the polarization plane shall be done by observing the cross-polar minimum.

6.4.2 Computation of results

The results shall be computed by producing a "mask" to the specified limits with the reference level being equal to the sum of the transmitter output power density and the total gain of the antenna $G_{TOT}(\alpha, \phi)$.

$$\text{With } G_{TOT}(\alpha, \phi) = 10 \log (10^{GR(\alpha, \phi) / 10} + 10^{GL(\alpha, \phi) / 10}).$$

This reference shall then be placed on the maximum point of the plots obtained from the transmit radiation pattern measurements, so as to ascertain that the off-axis total EIRP density is within the mask, and thus conforming to the present document.

6.5 Carrier suppression

6.5.1 Test method

For the purposes of this test, the EUT shall transmit one carrier modulated continuously, or at its maximum burst rate where applicable, centred on the middle frequency of the operating frequency band as provided with the equipment for the intended use. The "transmission disabled state" shall be obtained by use of the NCF or an STE, if required. For conducted measurements the maximum residual carrier power density within the nominated bandwidth shall be measured and added to the antenna on-axis gain. For radiated measurements the maximum residual EIRP density within the nominated bandwidth shall be measured and recorded. If the results obtained are within the limit given in clause 4.2.5.2, then the EUT will be compliant with the requirement.

6.6 Antenna pointing

6.6.1 General

The antenna pointing test method is designed to verify the ability of the EUT to detect and correctly respond to pointing errors that exceed the threshold, $\delta\phi_{\max}$, provided with the equipment for the intended use as required in clauses 4.2.6.1 and 4.2.6.2.

For the purpose of these tests the EUT is the ESOMP with its antenna.

6.6.2 Test method

There shall be a means for measuring and analysing true pointing error values provided with the equipment for the intended use. The means of measuring and analysing pointing errors shall be included in the test report.

There shall be a means of inducing pointing errors that exceed the threshold provided with the equipment for the intended use. Pointing errors shall be induced in at least two orthogonal directions; but not necessarily during the same test sequence. The means of inducing pointing errors shall be included in the test report.

It shall be verified that the EUT correctly detects that the induced pointing error has exceeded the pointing error threshold and enters the "Carrier-off" radio state no later than T seconds after the pointing error threshold is exceeded, where T is the response time provided with the equipment for the intended use.

After the pointing error has been decreased below the pointing error threshold, it shall be verified that the EUT does not re-enter the "Carrier-on" radio state for at least $2 \times T$ seconds.

The tests shall be repeated a sufficient number of times to ensure the statistical reliability of pointing error detection and response time measurements.

6.7 Polarization angle alignment capability

6.7.1 General

The polarization angle alignment test method is designed to verify the ability of the EUT to detect and correct polarization alignment errors as required in clauses 4.2.6.1 and 4.2.6.2.

For the purpose of these tests the EUT is the ESOMP with its antenna.

6.7.2 Test site

This test shall be performed either on an outdoor far field test site, on a compact test range, or by the near field scanner technology. The compact test range is the preferred method.

The servo mechanism shall be capable of driving the EUT in polarization. It may be capable of driving the EUT in azimuth and elevation.

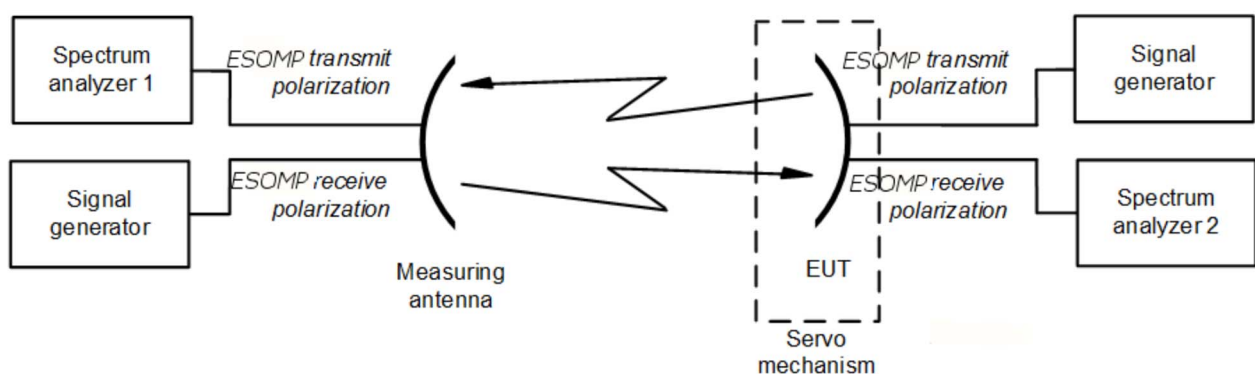

Figure 10: Test arrangement - polarization angle alignment measurement

6.7.3 Test method

- The test arrangement shall be as shown in figure 10.
- The test frequencies shall be the centre frequency of each applicable frequency range.
- The EUT shall be aligned in azimuth, elevation and polarization to maximize the signal level measured by spectrum analyser 2. The polarization position shall be memorized.

- d) The EUT shall be aligned in polarization to maximize the signal level measured by spectrum analyser 1. The polarization position shall be memorized.
- e) The polarization error is the difference of polarization positions obtained in steps c) and d).
- f) Steps c) to e) shall be repeated for all combinations of transmit and receive test frequencies in accordance with the intended use of the ESOMP.
- g) If the ESOMP allows changing the transmit and receive polarization, then steps c) to f) shall be repeated for all combinations of transmit and receive polarization in accordance with the intended use of the ESOMP.
- h) The maximum of polarization errors obtained in steps c) to g) shall be determined. If the maximum does not exceed the limit given in the requirement, then the EUT passed the test.

6.8 Cessation of emissions of the ESOMP

6.8.0 General

There shall be a means of simulating a condition where cessation of emissions is required. The spectrum analyser or the oscilloscope may be used to measure the time difference between the occurrence of the condition and the cessation of emissions. In all test methods, it shall be verified that the time difference does not exceed 1 second as specified in clause 4.2.7.2.3.

Where the EUT adds an operational margin around areas where cessation of emissions is required to account for the position determination accuracy and latency, the test procedure may simulate the actual behaviour of an EUT as it enters into an area where cessation of emissions is required. For example, if the EUT adds a margin of X metres around areas where cessation of emissions is required, then the test may begin with the EUT being simulated at a position more than X metres outside of an area where cessation of emissions is required. The test may then simulate the motion of the EUT towards the area where cessation of emissions is required. In any event, the EUT shall enter the "emission disabled" radio state within 1 second of entering the actual area where cessation of emissions is required.

For the purpose of these tests the EUT is the ESOMP either with, or without its antenna.

6.8.1 Test Method

6.8.1.1 Required documentation

The mode(s) of cessation of emissions implemented in the EUT and the ESOMP interfaces involved in the cessation of emissions as specified in clause 4.2.7.2.1 shall be provided with the equipment for the intended use.

The applicant shall demonstrate by documentary evidence compliance with specification 2 in clause 4.2.7.2.2 for the determination of the conditions under which the ESOMP shall cease emissions.

6.8.1.2 Cessation of emissions from the "Transmission enabled" state

- a) The EUT shall be set in the "Transmission enabled" ESOMP state.
- b) The EUT shall be set in the "Carrier on" radio state.
- c) A condition requiring the cessation of emission shall be initiated either by the STE or the EUT.
- d) It shall be verified that the EUT enters the "Emissions disabled" radio state.
- e) In order to verify that the EUT is in the "Transmission disabled" ESOMP state, it shall be verified that the EUT remains in the "Emissions disabled" radio state when the EUT is requested to transmit data.

6.8.1.3 Cessation of emission from the "Transmission disabled" state

- a) The EUT shall be set in the "Transmission disabled" state.
- b) A condition requiring the cessation of emission shall be initiated either by the STE or the EUT.

- c) In order to verify that the EUT remains in the "Transmission disabled" ESOMP state, it shall be verified that the EUT remains in the "Emissions disabled" radio state when the EUT is requested to transmit data.
- d) The STE shall send a TxE command to the EUT.
- e) In order to verify that the EUT remains in the "Transmission disabled" ESOMP state, it shall be verified that the EUT remains in the "Emissions disabled" radio state when the EUT is requested to transmit data.
- f) The STE shall send a TxD command to the EUT.
- g) The condition requiring the cessation of emissions shall be removed.
- h) In order to verify that the EUT remains in the "Transmission disabled" ESOMP state, it shall be verified that the EUT remains in the "Emissions disabled" radio state when the EUT is requested to transmit data.

6.8.1.4 Cessation of emission from the "Initial Phase" state

6.8.1.4.1 EUTs transmitting initial bursts

This applies only to EUTs transmitting initial bursts (i.e. where "Initial phase-BurstOn" and "Initial phase-BurstOff" are implemented):

- a) The EUT shall be set in "Initial phase-BurstOn" state.
- b) The STE shall not send the TxE command and the EUT shall be allowed to cycle between "Initial phase-BurstOn" and "Initial phase-BurstOff" as it would under normal operations.
- c) A condition requiring the cessation of emission shall be initiated either by the STE or the EUT.
- d) It shall be verified that the EUT enters the "Emissions disabled" radio state.
- e) In order to verify that the EUT is in the "Initial phase-Standby" ESOMP state, it shall be verified that the EUT remains in the "Emissions disabled" radio state when the EUT is requested to transmit data.
- f) The STE shall send a TxE command to the EUT.
- g) In order to verify that the EUT remains in the "Initial phase-Standby" ESOMP state or enters the "Transmission disabled" ESOMP state, it shall be verified that the EUT remains in the "Emissions disabled" radio state when the EUT is requested to transmit data.
- h) Repeat the test steps a) through g) using a TxD command in step f) instead of the TxE command.

6.8.1.4.2 EUTs not transmitting initial bursts

This applies only to EUTs that do not transmit initial bursts (i.e. where only "Initial phase-Standby" is implemented):

- a) The EUT shall be set in "Initial phase-Standby" ESOMP state.
- b) The STE shall not send the TxE command to maintain the EUT in "Initial phase-Standby" ESOMP state.
- c) A condition requiring the cessation of emission shall be initiated either by the STE or the EUT.
- d) In order to verify that the EUT remains in the "Initial phase-Standby" ESOMP state, it shall be verified that the EUT remains in the "Emissions disabled" radio state when the EUT is requested to transmit data.
- e) The STE shall send a TxE command to the EUT.
- f) In order to verify that the EUT remains in the "Initial phase-Standby" ESOMP state or enters the "Transmission disabled" ESOMP state, it shall be verified that the EUT remains in the "Emissions disabled" radio state when the EUT is requested to transmit data.
- g) Repeat the test steps a) through f) using a TxD command in step e) instead of the TxE command.

6.8.1.5 "Single action" means of cessation of emissions

- a) It shall be verified that there is a "single action" means of ceasing emissions of the EUT (e.g. the switch thrown):
- b) The EUT shall be set in the "Transmission enabled" ESOMP state.
- c) The EUT shall be set in the "Carrier on" radio state.
- d) The "single action" means of cessation of emissions shall be activated.
- e) It shall be verified that the EUT enters the "Emissions disabled" radio state.
- f) In order to verify that the EUT is in the "Transmission disabled" ESOMP state, it shall be verified that the EUT remains in the "Emissions disabled" radio state when the EUT is requested to transmit data.
- g) The STE shall send a TxE command to the EUT.
- h) In order to verify that the EUT remains in the "Transmission disabled" ESOMP state, it shall be verified that the EUT remains in the "Emissions disabled" radio state when the EUT is requested to transmit data.
- i) The EUT shall be switched off and then switched on and the EUT shall enter the "Initial phase" ESOMP state without receiving a TxE from the STE.
- j) The "single action" means of cessation of emissions shall be activated.
- k) The STE shall send a TxE command to the EUT.
- l) In order to verify that the EUT remains in the "Initial phase" ESOMP state or enters the "Transmission disabled" ESOMP state, it shall be verified that the EUT remains in the "Emissions disabled" radio state when the EUT is requested to transmit data.
- m) The EUT shall be switched off and then switched on and the EUT shall enter the "Initial phase" ESOMP state without receiving a TxE from the STE.
- n) The STE shall send a TxD command to the EUT so that it enters the "Transmission disabled" ESOMP state.
- o) The "single action" means of cessation of emissions shall be activated.
- p) The STE shall send a TxE command to the EUT.
- q) In order to verify that the EUT remains in the "Transmission disabled" ESOMP state, it shall be verified that the EUT remains in the "Emissions disabled" radio state when the EUT is requested to transmit data.

6.8.1.6 Fault conditions

The applicant shall declare the means of generating fault conditions:

- a) The EUT shall be set in the "Transmission enabled" ESOMP state.
- b) The EUT shall be set in the "Carrier on" radio state.
- c) A fault condition requiring the cessation of emission shall be generated either by the STE or directly on the EUT.
- d) It shall be verified that the EUT enters the "Emissions disabled" radio state as long as the fault condition persists.
- e) Steps a) through d) shall be repeated for each fault condition provided with the equipment for the intended use.

6.9 Identification of ESOMP

6.9.1 Test arrangement

The test shall be arranged such that EUT can determine its own location, or if external means are employed, the test shall be arranged so that the EUT can be located by the means provided with the equipment for the intended use. The STE shall be arranged to simulate the NCF. The actual location of the EUT shall be known within the resolution provided with the equipment for the intended use as required in clause 4.1.3.

6.9.2 Test method

- a) The EUT shall be in the "Transmission enabled" state.
- b) The EUT shall report its location to the STE.
- c) The difference between the reported EUT location and actual location of the EUT (as simulated in the test) shall be within twice the resolution provided with the equipment for the intended use as required in clause 4.1.3.

6.10 Control and monitoring functions

6.10.0 General

The applicant may modify an ESOMP for the purpose of these tests provided that full documentation is given to prove that the modifications accurately simulate the required test conditions.

The EUT shall transmit at $EIRP_{max}$.

For the purpose of these tests the EUT is the ESOMP either with, or without its antenna connected.

The measurement of the EIRP spectral density shall be limited within either the nominated bandwidth or to a 10 MHz bandwidth centred on the carrier frequency, whichever is the greater.

6.10.1 Test arrangement

The EUT shall be authorized to transmit and shall be in the "Transmission enabled" state at the commencement of each test, unless otherwise stated. The time difference between the command, or failure, and the occurrence of the expected event (e.g. the transmission suppression) shall be measured and recorded.

6.10.2 Processor monitoring- Test method

- a) Each of the processors within the EUT shall, in turn, be caused to fail.
- b) Within 1 second of such failure the EUT shall cease to transmit.
- c) It shall be confirmed that the transmissions have been suppressed within the limits of the "Carrier-off" radio state emission levels.
- d) Within 30 seconds of such failure it shall be confirmed that the transmissions have been suppressed within the limits of the "Emissions disabled" radio state emission levels.
- e) The failed processor shall be restored to normal working condition and the EUT shall restore automatically to normal working before the next processor shall be induced to fail.

6.10.3 Transmit subsystem monitoring-Test method

- a) The frequency generation subsystem within the EUT shall be caused to fail in respect of:
 - loss of frequency lock (if applicable);
 - absence of Local Oscillator (LO) output signal.
- b) Recognition of each failure in turn by the subsystem monitor shall constitute an SMF event.
- c) Within 1 second of such failure the EUT shall cease to transmit.
- d) It shall be observed that the transmissions have been suppressed within the limits of the "Emissions disabled" radio state emission levels.
- e) The failed elements shall be restored to normal working state and the EUT shall be restored to normal working condition before the next induced failure.

6.10.4 Power-on/Reset-Test method

- a) The EUT shall be switched off and the STE shall not transmit the CC.
- b) The EUT shall be switched on.
- c) The EUT shall not transmit during and after switching-on, and shall enter the "Non valid" state.

If a manual reset function is implemented the following test shall be performed:

- d) The EUT shall be restored to the "Initial phase" state and the STE shall transmit the CC.
- e) The EUT shall remain in the "Initial phase" state.
- f) The reset function shall be initiated.
- g) The EUT shall enter the "Non valid" state.
- h) The EUT shall be restored to the "Initial phase" state and the STE shall transmit the CC as well as a TxE.
- i) The EUT shall enter the "Transmission enabled" state.
- j) The reset function shall be initiated.
- k) The EUT shall enter the "Non valid" state.

6.10.5 Control Channel (CC) and Response Channel (RC) - Test method

For the purposes of these test, the period without correct reception of the CC (T1) shall be as specified in clause 4.2.9.5.2.2.

These test procedures require simulation of the following events:

- The CC has never been received by the EUT after power-on.
 - The CC is lost by the EUT after reception of a Transmission Enable command.
 - The CC is lost by the EUT without reception of a Transmission Enable command.
 - The CC is being lost by the EUT and a call is initiated within the period T1.
- a) Case where the CC has never been received by the EUT after power-on:
 - a1) the EUT shall be switched off and the STE shall not transmit the CC;
 - a2) the EUT shall be switched on;
 - a3) the EUT shall remain in the "Non valid" state.

- b) Case where the CC is lost by the EUT after reception of a Transmission Enable command:
- b1) the EUT shall be switched-on and the STE shall transmit the CC and a Transmission Enable command;
 - b2) the EUT shall enter the "Initial phase" state and go, if applicable, to the "Transmission enabled" state;
 - b3) a transmission request shall be initiated from the EUT;
 - b4) the STE shall stop transmitting the CC;
 - b5) within the period T1 from event b4), the EUT shall enter the "Non valid" state.
- c) Case where the CC is lost by the EUT without reception of a Transmission Enable command:
- c1) the EUT shall be switched on and the STE shall transmit the CC;
 - c2) the EUT shall enter the "Initial phase" state;
 - c3) the STE shall stop transmitting the CC;
 - c4) the EUT shall enter in the "Non valid" state not later than T1;
 - c5) a transmission request shall be initiated and the EUT shall remain in the "Non valid" state.
- d) Case where the CC is being lost by the EUT and a call is initiated within the T1 period:
- d1) the EUT shall be switched on and the STE shall transmit the CC;
 - d2) the STE shall stop transmitting the CC;
 - d3) within the period T1 from d2), a transmission request shall be initiated from the EUT;
 - d4) the EUT may transmit but within the T1 period the EUT shall enter the "Non valid" state.

6.10.6 Network Control commands-Test method

The tests shall be performed in the following sequence:

- Transmission Enable command.
 - Transmission Disable command received in the "Transmission enabled" state.
 - Transmission Disable command received in the "Initial phase" state.
- a) Transmission Enable command:
- a1) the EUT shall be switched-on and the STE shall transmit the CC;
 - a2) the EUT shall enter the "Initial phase" state;
 - a3) a transmission request shall be initiated from the EUT, the EUT shall remain in the "Initial phase" state;
 - a4) the STE shall transmit a transmit enable command to the EUT;
 - a5) a transmission request shall be initiated from the EUT;
 - a6) the EUT shall enter the "Transmission enabled" state and shall transmit.
- b) Transmission Disable command received in the "Transmission enabled" state:
- b1) continue from a6);
 - b2) the STE shall transmit a disable command to the EUT;
 - b3) the EUT shall enter the "Transmission disabled" state within 1 second;
 - b4) a transmission request shall be initiated from the EUT;

- b5) the EUT shall remain in the "Transmission disabled" state;
 - b6) the STE shall transmit an enable command;
 - b7) the EUT shall enter either the "Transmission enabled" state or the "Initial phase" state;
 - b8) if the EUT is in the "Transmission enable" state then the test continues with b11);
 - b9) the STE shall transmit a TxE command;
 - b10) the EUT shall enter the "Transmission enable" state;
 - b11) if a transmission request is not active any more than a new transmission request shall be initiated;
 - b12) the EUT shall transmit;
 - b13) the EUT transmission shall be terminated.
- c) Transmission disable command received in the "Initial phase" state:
- c1) the EUT shall be switched-on and the STE shall transmit the CC;
 - c2) the EUT shall enter the "Initial phase" state;
 - c3) the STE shall transmit a Transmission Disable command to the EUT;
 - c4) the EUT shall enter the "Transmission disabled" state within 1 second;
 - c5) a transmission request shall be initiated from the EUT;
 - c6) the EUT shall remain in the "Transmission disabled" state;
 - c7) the STE shall transmit a Transmission Enable command;
 - c8) the EUT shall enter either the "Transmission enabled" state or the "Initial phase" state;
 - c9) if the EUT is in the "Transmission enable" state then the test continues with c12);
 - c10) the STE shall transmit a TxE command;
 - c11) the EUT shall enter the "Transmission enable" state;
 - c12) if a transmission request is not active any more than a new transmission request shall be initiated;
 - c13) the EUT shall transmit;
 - c14) the EUT transmission shall be terminated.

6.10.7 Initial burst transmission-Test method

The initial burst duration for the intended use shall be provided with the equipment.

The following test shall be performed in sequence:

- a) the EUT shall be switched-off and the STE shall transmit the CC;
- b) the EUT shall be switched-on;
- c) the EUT shall not transmit, except the initial bursts;
- d) it shall be verified that the specifications given in clause 4.2.9.7.2 are fulfilled.

6.10.8 Inhibition of transmission-Test method

The values for IT_{\max} and IT_{trans} , for the intended use as specified in clauses 4.2.6.2.1 and 4.2.9.8 shall be provided with the equipment.

The receive carrier to the EUT shall be removed:

- a) Within 1 second of such failure the EUT shall cease to transmit.
- b) It shall be observed that the EUT remains in the "Transmission enabled" state and that transmissions have been suppressed within the limits of the "Carrier off" radio state emission levels given in clause 4.2.1.2, table 3.
- c) The receive carrier to the EUT shall be restored within IT_{max} .
- d) It shall be observed that the EUT enters the "Carrier on" radio state and begins transmission within IT_{trans} .
- e) The receive carrier to the EUT shall be removed.
- f) It shall be observed that after IT_{max} the EUT enters the "Initial phase" state.

6.11 Receive antenna off-axis gain pattern

6.11.1 Test method

6.11.1.1 Test site

This test shall be performed on either an outdoor far field test site or compact test range. However if the near field scanner technology to convert near field measurements to far field results is proven and sufficiently accurate by reference to tests taken in both regions then antenna measurements may be taken in the near field. Fully automated systems can be used for these tests providing that the results can be proven to be as accurate as if they were done according to the specified method. The compact test range is the preferred test site.

6.11.1.2 Method of measurement

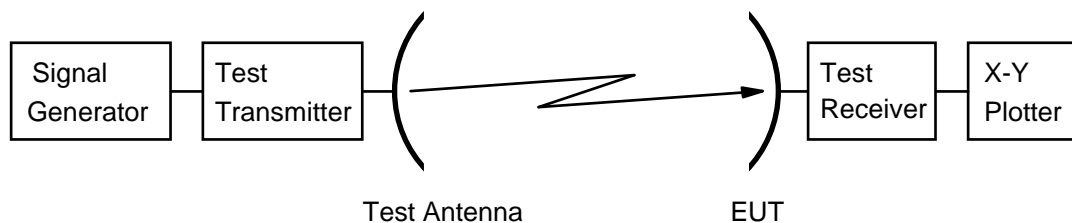

Figure 11: Test arrangement - antenna receive pattern measurement

- a) The test arrangement shall be as shown in figure 10 with the EUT connected to the test receiver.
- b) A signal proportional to the angular position from the servo mechanism shall be applied to the X-axis and the signal level from the test receiver shall be applied to the Y-axis of the plotter.
- c) The test frequencies shall be the centre frequency of each applicable frequency range. The E-plane shall be vertical.
- d) The EUT shall be aligned to maximize the received signal level and the X-Y plotter shall be adjusted to give the maximum reading on the chart.
- e) The EUT shall be driven in azimuth through 180°.
- f) The pattern measurement is then obtained by driving the EUT in azimuth through 360° with the plotter recording the results.
- g) The tests in b) to e) shall be repeated with the frequency changed to the lower limit of the applicable band provided with the equipment for the intended use.
- h) The tests in b) to e) shall be repeated with the frequency changed to the upper limit of the applicable band provided with the equipment for the intended use.

- i) The tests in b) to h) shall be repeated with the frequencies changed to the others specified if the design of the equipment is such that operation is possible, but not necessarily simultaneously, in all bands.
- j) The tests in b) to h) shall be repeated with the test signal being transmitted in the H-plane instead of the E-plane.
- k) The tests in b) to h) shall be repeated with the test signal being transmitted in a plane at 45° to the H-plane.
- l) The tests in b) to h) shall be repeated with the test signal being transmitted in a plane at 90° to that in k).
- m) The tests in b) to l) shall be repeated between the angles of φ , and 7° with the EUT rotated through 90°, or the test antenna or the polarization subsystem of the EUT rotated by 90°, to give the cross-polar measurement.

6.11.1.3 Computation

The computation of results shall be carried out by producing a "mask" to the specified limits with the reference level being equal to the gain of the antenna. This reference shall then be placed on the maximum point of the plot obtained from the pattern measurements.

6.12 Blocking performance

6.12.1 Test method

- a) The output signals of two signal generators shall be combined with equal weight. The combined signal shall be coupled to the LNB input.
- b) A spectrum analyser shall be connected to the LNB output in a way that allows to supply the LNB with power.
- c) f_c is the center frequency of the receive frequency band.
- d) The first signal generator frequency shall be set to f_c .
- e) The first signal generator level shall be set to a level in the LNB operational input level range.
- f) The spectrum analyser shall be set for measuring the level of the converted first signal at the LNB output.
- g) The second signal generator frequency shall be set to $f_c - 20$ MHz.
- h) The second signal generator level shall be adjusted so that the measured level is 1 dB less than in absence of the second signal.
- i) The second signal generator level shall be noted down as reference level.
- j) The second signal generator frequency shall be set to the frequency of interest.
- k) The second signal generator level shall be adjusted so that the measured level is 1 dB less than in absence of the second signal.
- l) The rejection at the frequency of interest is equal to the second signal generator level minus the reference level determined in step i).
- m) Steps j) to l) shall be repeated for frequencies in the ranges of table 6.

NOTE: The worst case rejection in a particular frequency range can be determined after step i) by sweeping the second signal generator frequency over the frequency range and observe the gain compression, then perform steps j) to l) with the frequency where gain compression is highest.

6.13 Adjacent Signal Selectivity

6.13.1 Test method

- a) Two test signal generators shall be used. Each signal generator shall generate a modulated signal in the IDU input frequency range and thermal noise.
- b) The signal generators shall be connected to the IDU input through a splitter (combiner).
- c) The test signal generators shall be set to the frequencies and levels according to table 7.
- d) The IDU shall be set to receive the signal of the first test signal generator.
- e) The second test signal generator shall be set to signal off.
- f) The noise level (or signal to noise ratio) of the first test signal generator shall be varied in order to determine the threshold reference sensitivity level.
- g) The second signal generator shall be set to signal on.
- h) The noise level (or signal to noise ratio) of the first test signal generator shall be varied in order to determine the threshold reference sensitivity level.
- i) The degradation is equal to the noise level (or signal to noise ratio) determined in step d minus that determined in step b).
- j) The result is the highest degradation found.

6.14 Test for determination of geographical location of the ESOMP

6.14.1 Test arrangement

The test shall be arranged such that EUT can determine its own location, or if external means are employed, the test shall be arranged so that the EUT can be located by the means provided to the test house with the EUT, consistent with the intended use in association with the satellite network. The STE shall be arranged to simulate the NCF.

The position accuracy, precision, resolution and update rates shall be specified for the intended use in association with the satellite network for the EUT type and its intended application.

6.14.2 Test method

- a) The EUT shall be in the "Transmission enabled" state.
- b) The EUT shall report its location to the STE.
- c) The difference between the reported EUT location and actual location of the EUT (as simulated in the test) shall meet the specifications provided with the EUT for its intended use.

Annex A (informative): Relationship between the present document and the essential requirements of Directive 2014/53/EU

The present document has been prepared under the Commission's standardisation request C(2015) 5376 final [i.9] to provide one voluntary means of conforming to the essential requirements of Directive 2014/53/EU on the harmonisation of the laws of the Member States relating to the making available on the market of radio equipment and repealing Directive 1999/5/EC [i.11].

Once the present document is cited in the Official Journal of the European Union under that Directive, compliance with the normative clauses of the present document given in table A.1 confers, within the limits of the scope of the present document, a presumption of conformity with the corresponding essential requirements of that Directive, and associated EFTA regulations.

**Table A.1: Relationship between the present document and
the essential requirements of Directive 2014/53/EU**

Harmonised Standard ETSI EN 303 978					
Requirement				Requirement Conditionality	
No	Description	Essential requirements of Directive	Clause(s) of the present document	U/C	Condition
1	Off-axis spurious radiation	3.2	4.2.1	U	
2	On-axis spurious radiation	3.2	4.2.2	U	
3	Off-axis EIRP emission density within the band	3.2	4.2.3	U	Compliance with off-axis EIRP density mask or limits of inter-satellite coordination agreements.
4	Uplink power control	3.2	4.2.4	U	
5	Carrier suppression	3.2	4.2.5	U	
6	Antenna pointing	3.2	4.2.6	U	
7	Antenna polarization alignment	3.2	4.2.6	U	
8	Cessation of emissions	3.2	4.2.7	U	
9	Identification of ESOMP	3.2	4.2.8	U	
10	Control and Monitoring Functions (CMF)	3.2	4.2.9	U	
11	Receive antenna off-axis gain pattern	3.2	4.2.10	C	Satellite communications networks may contain a central control unit that keeps received interference low by taking into account the actual antenna gain pattern of earth stations. The requirement is not relevant for earth stations that are always operated as part of such a network. The requirement is relevant in all other cases. If the receive antenna performance does not meet the requirement in clause 4.2.10, then the earth station will have to accept an additional co-frequency interference caused by its off-axis gain which is not compliant to the mask.
12	Blocking performance	3.2	4.2.11	U	
13	Adjacent Signal Selectivity	3.2	4.2.12	U	

NOTE: See annex G for non applying parameters and the reason why they do not apply.

Key to columns:

Requirement:

No A unique identifier for one row of the table which may be used to identify a requirement.

Description A textual reference to the requirement.

Essential requirements of Directive

Identification of article(s) defining the requirement in the Directive.

Clause(s) of the present document

Identification of clause(s) defining the requirement in the present document unless another document is referenced explicitly.

Requirement Conditionality:

U/C Indicates whether the requirement shall be unconditionally applicable (U) or is conditional upon the manufacturers claimed functionality of the equipment (C).

Condition Explains the conditions when the requirement shall or shall not be applicable for a requirement which is classified "conditional".

Presumption of conformity stays valid only as long as a reference to the present document is maintained in the list published in the Official Journal of the European Union. Users of the present document should consult frequently the latest list published in the Official Journal of the European Union.

Other Union legislation may be applicable to the product(s) falling within the scope of the present document.

Annex B:
Void

Annex C (normative): Radiated measurement

C.1 Test sites and general arrangements for measurements involving the use of radiated fields

C.1.0 General

This annex introduces three most commonly available test sites, an anechoic chamber, an anechoic chamber with a ground plane and an Open Area Test Site (OATS), which may be used for radiated tests. These test sites are generally referred to as free field test sites. Both absolute and relative measurements can be performed in these sites. Where absolute measurements are to be carried out, the chamber shall be verified. A detailed verification procedure is described in the relevant parts of ETSI TR 102 273 [i.15] or equivalent.

C.1.1 Anechoic Chamber

An anechoic chamber is an enclosure, usually shielded, whose internal walls, floor and ceiling are covered with radio absorbing material, normally of the pyramidal urethane foam type. The chamber usually contains an antenna support at one end and a turntable at the other. A typical anechoic chamber is shown in figure C.1.

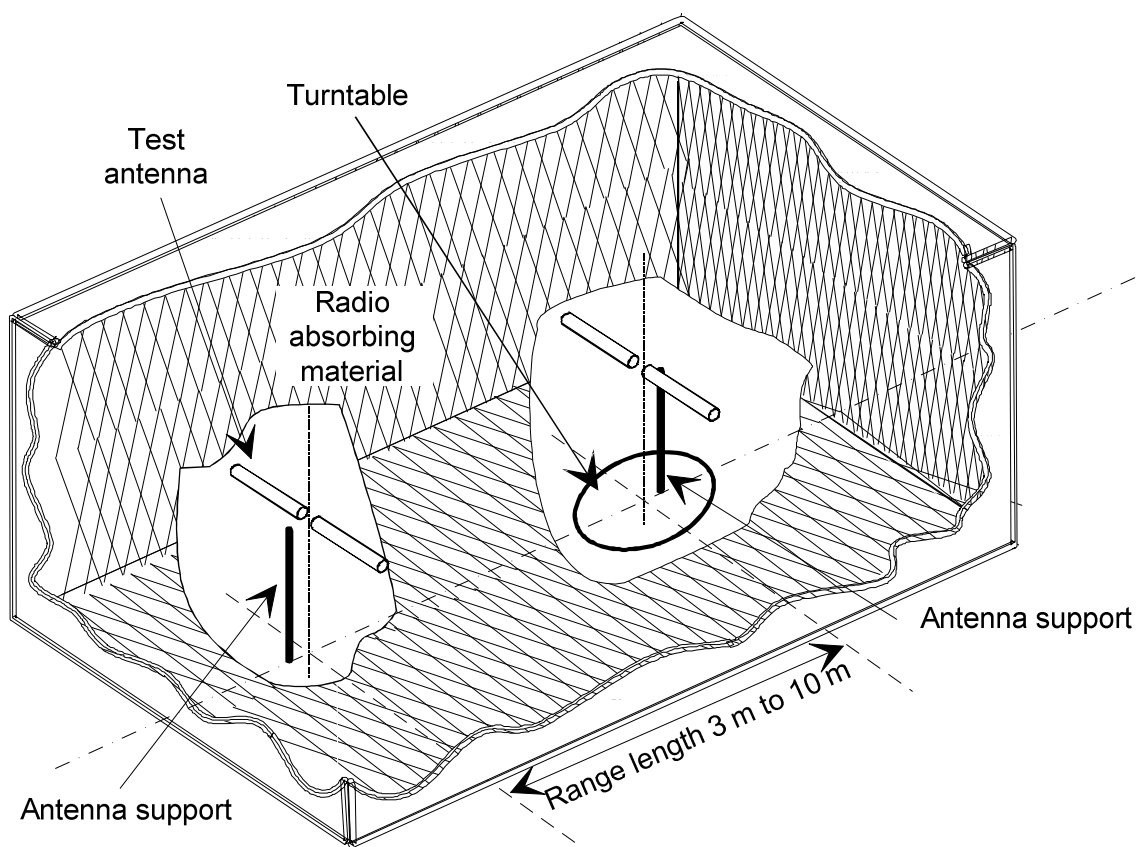

Figure C.1: A typical Anechoic Chamber

The chamber shielding and radio absorbing material work together to provide a controlled environment for testing purposes. This type of test chamber attempts to simulate free space conditions.

The shielding provides a test space, with reduced levels of interference from ambient signals and other outside effects, whilst the radio absorbing material minimizes unwanted reflections from the walls and ceiling which can influence the measurements. In practice it is relatively easy for shielding to provide high levels (80 dB to 140 dB) of ambient interference rejection, normally making ambient interference negligible.

A turntable is capable of rotation through 360° in the horizontal plane and it is used to support the test sample (EUT) at a suitable height (e.g. 1 m) above the ground plane. The chamber shall be large enough to allow the measuring distance of at least 3 m or $2(d_1 + d_2)^2/\lambda$ (m), whichever is greater (see clause C.2.4). For further information on measurements at shorter distances see annex E. The distance used in actual measurements shall be recorded with the test results.

The anechoic chamber generally has several advantages over other test facilities. There is minimal ambient interference, minimal floor, ceiling and wall reflections and it is independent of the weather. It does however have some disadvantages which include limited measuring distance and limited lower frequency usage due to the size of the pyramidal absorbers. To improve low frequency performance, a combination structure of ferrite tiles and urethane foam absorbers is commonly used.

All types of emission, sensitivity and immunity testing can be carried out within an anechoic chamber without limitation.

C.1.2 Anechoic Chamber with a conductive ground plane

An anechoic chamber with a conductive ground plane is an enclosure, usually shielded, whose internal walls and ceiling are covered with radio absorbing material, normally of the pyramidal urethane foam type. The floor, which is metallic, is not covered and forms the ground plane. The chamber usually contains an antenna mast at one end and a turntable at the other. A typical anechoic chamber with a conductive ground plane is shown in figure C.2.

This type of test chamber attempts to simulate an ideal Open Area Test Site whose primary characteristic is a perfectly conducting ground plane of infinite extent.

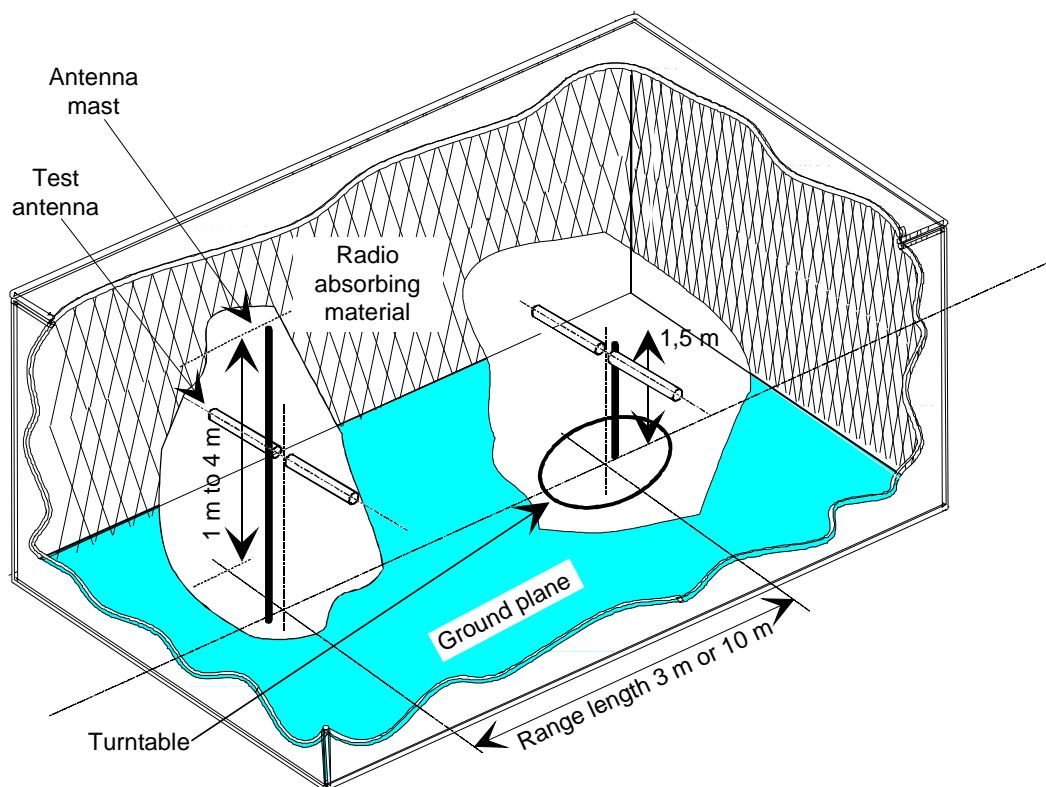

Figure C.2: A typical Anechoic Chamber with a conductive ground plane

In this facility the ground plane creates the wanted reflection path, such that the signal received by the receiving antenna is the sum of the signals from both the direct and reflected transmission paths. This creates a unique received signal level for each height of the transmitting antenna (or EUT) and the receiving antenna above the ground plane.

The antenna mast provides a variable height facility (from 1 m to 4 m) so that the position of the test antenna can be optimized for maximum coupled signal between antennas or between an EUT and the test antenna.

A turntable is capable of rotation through 360° in the horizontal plane and it is used to support the test sample (EUT) at a specified height, usually 1,5 m above the ground plane. The chamber shall be large enough to allow the measuring distance of at least 3 m or $2(d_1 + d_2)^2/\lambda$ (m), whichever is greater (see clause C.2.4). For further information on measurements at shorter distances see annex E. The distance used in actual measurements shall be recorded with the test results.

Emission testing involves firstly "peaking" the field strength from the EUT by raising and lowering the receiving antenna on the mast (to obtain the maximum constructive interference of the direct and reflected signals from the EUT) and then rotating the turntable for a "peak" in the azimuth plane. At this height of the test antenna on the mast, the amplitude of the received signal is noted. Secondly the EUT is replaced by a substitution antenna (positioned at the EUT's phase or volume centre) which is connected to a signal generator. The signal is again "peaked" and the signal generator output adjusted until the level, noted in stage one, is again measured on the receiving device.

Receiver sensitivity tests over a ground plane also involve "peaking" the field strength by raising and lowering the test antenna on the mast to obtain the maximum constructive interference of the direct and reflected signals, this time using a measuring antenna which has been positioned where the phase or volume centre of the EUT will be during testing. A transform factor is derived. The test antenna remains at the same height for stage two, during which the measuring antenna is replaced by the EUT. The amplitude of the transmitted signal is reduced to determine the field strength level at which a specified response is obtained from the EUT.

C.1.3 Open Area Test Site (OATS)

An Open Area Test Site comprises a turntable at one end and an antenna mast of variable height at the other end above a ground plane, which in the ideal case, is perfectly conducting and of infinite extent. In practice, whilst good conductivity can be achieved, the ground plane size has to be limited. A typical OATS is shown in figure C.3.

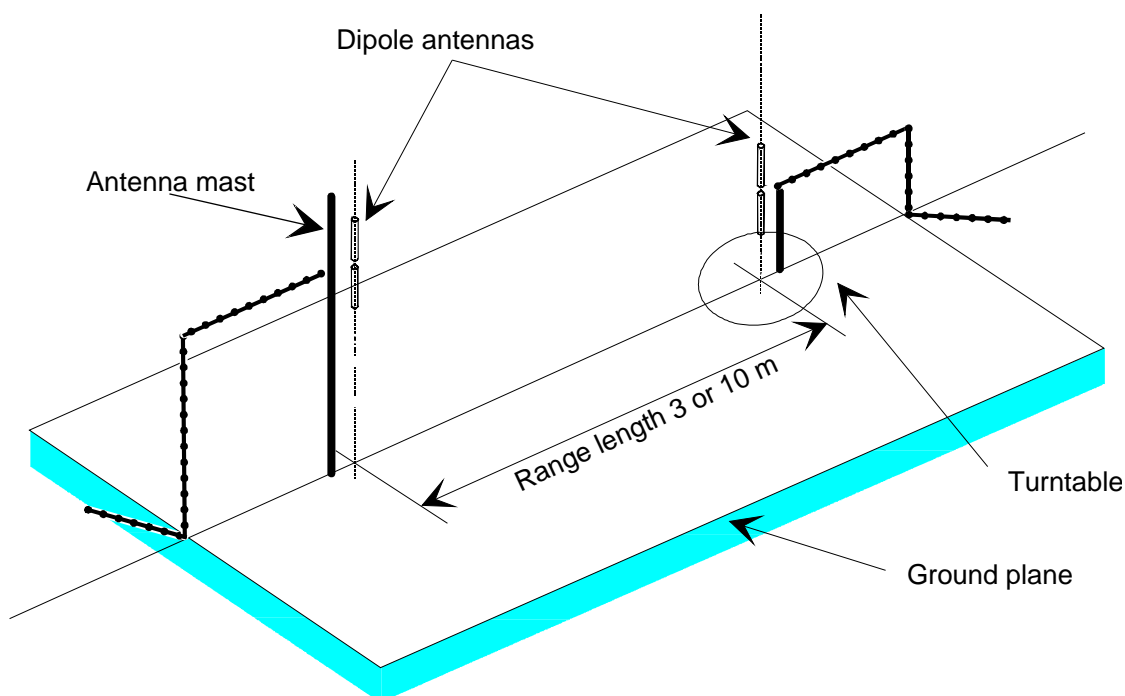

Figure C.3: A typical Open Area Test Site

The ground plane creates a wanted reflection path, such that the signal received by the receiving antenna is the sum of the signals received from the direct and reflected transmission paths. The phasing of these two signals creates a unique received level for each height of the transmitting antenna (or EUT) and the receiving antenna above the ground plane.

Site qualification concerning antenna positions, turntable, measurement distance and other arrangements are same as for anechoic chamber with a ground plane. In radiated measurements an OATS is also used by the same way as anechoic chamber with a ground plane.

Typical measuring arrangement common for ground plane test sites is presented in figure C.4.

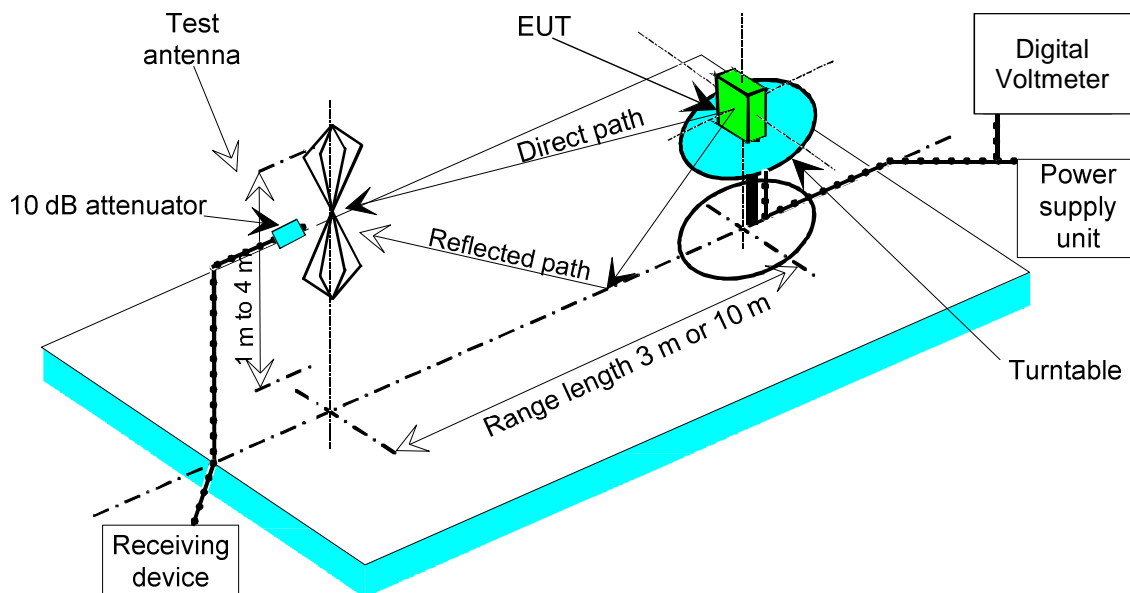

Figure C.4: Measuring arrangement on ground plane test site (OATS set-up for spurious emission testing)

C.1.4 Minimum requirements for test sites for measurements above 18 GHz

Generally the test site shall be adequate to allow for testing in the far field of the EUT. The test site should therefore consist of an electromagnetic anechoic room where either at least the ground surface is covered with radio absorbing material or up to six surrounding surfaces are covered with radio absorbing material. The absorbing material shall have a minimum attenuation of 30 dB. It shall be verified that reflections are sufficiently reduced.

C.1.5 Test antenna

A test antenna is always used in radiated test methods. In emission tests (i.e. frequency error, effective radiated power, spurious emissions and adjacent channel power) the test antenna is used to detect the field from the EUT in one stage of the measurement and from the substitution antenna in the other stage. When the test site is used for the measurement of receiver characteristics (i.e. sensitivity and various immunity parameters) the antenna is used as the transmitting device.

The test antenna should be mounted on a support capable of allowing the antenna to be used in either horizontal or vertical polarization which, on ground plane sites (i.e. anechoic chambers with ground planes and Open Area Test Sites), should additionally allow the height of its centre above the ground to be varied over the specified range (usually 1 metre to 4 metres).

In the frequency band 30 MHz to 1 000 MHz, dipole antennas are generally recommended. For frequencies of 80 MHz and above, the dipoles should have their arm lengths set for resonance at the frequency of test. Below 80 MHz, shortened arm lengths are recommended. A combination of bicones and log periodic dipole array antennas (commonly termed "log periodics") could be used to cover the entire 30 MHz to 1 000 MHz band. Above 1 000 MHz, waveguide horns are recommended although, again, log periodics could be used.

NOTE: The gain of a horn antenna is generally expressed relative to an isotropic radiator.

C.1.6 Substitution antenna

The substitution antenna is used to replace the EUT for tests in which a transmitting parameter (i.e. frequency error, effective radiated power, spurious emissions and adjacent channel power) is being measured. For measurements in the frequency band 30 MHz to 1 000 MHz, the substitution antenna shall be a dipole antenna (constructed in accordance with ANSI C63.5 [6]). For frequencies of 80 MHz and above, the dipoles should have their arm lengths set for resonance at the frequency of test. Below 80 MHz, shortened arm lengths are recommended. For measurements above 1 000 MHz, a waveguide horn is recommended. The centre of this antenna should coincide with either the phase centre or volume centre.

C.1.7 Measuring antenna

The measuring antenna is used in tests on an EUT in which a receiving parameter (i.e. sensitivity and various immunity tests) is being measured. Its purpose is to enable a measurement of the electric field strength in the vicinity of the EUT. For measurements in the frequency band 30 MHz to 1 000 MHz, the measuring antenna shall be a dipole antenna. For frequencies of 80 MHz and above, the dipoles should have their arm lengths set for resonance at the frequency of test. Below 80 MHz, shortened arm lengths are recommended. The centre of this antenna should coincide with either the phase centre or volume centre (as specified in the test method) of the EUT.

C.2 Guidance on the use of radiation test sites

C.2.0 General

This clause details procedures, test equipment arrangements and verification that should be carried out before any of the radiated test are undertaken. These schemes are common to all types of test sites described in annex C.

C.2.1 Verification of the test site

No test should be carried out on a test site, which does not possess a valid certificate of verification. The verification procedures for the different types of test sites described in annex A (i.e. anechoic chamber, anechoic chamber with a ground plane and Open Area Test Site) are given in the relevant parts of ETSI TR 102 273 [i.15] or equivalent.

C.2.2 Preparation of the EUT

The manufacturer should supply information about the EUT covering the operating frequency, polarization, supply voltage(s) and the reference face. Additional information, specific to the type of EUT should include, where relevant, output power, whether different operating modes are available (e.g. high and low power modes) and if operation is continuous or is subject to a maximum test duty cycle (e.g. 1 minute on, 4 minutes off).

Where necessary, a mounting bracket of minimal size should be available for mounting the EUT on the turntable. This bracket should be made from low conductivity, low relative dielectric constant (i.e. less than 1,5) material(s) such as expanded polystyrene, balsa wood, etc.

C.2.3 Power supplies to the EUT

All tests should be performed using power supplies wherever possible, including tests on EUT designed for battery-only use. In all cases, power leads should be connected to the EUT's supply terminals (and monitored with a digital voltmeter) but the battery should remain present, electrically isolated from the rest of the equipment, possibly by putting tape over its contacts.

The presence of these power cables can, however, affect the measured performance of the EUT. For this reason, they should be made to be "transparent" as far as the testing is concerned. This can be achieved by routing them away from the EUT and down to either the screen, ground plane or facility wall (as appropriate) by the shortest possible paths. Precautions should be taken to minimize pick-up on these leads (e.g. the leads could be twisted together, loaded with ferrite beads at 0,15 m spacing or otherwise loaded).

C.2.4 Range length

The range length for all these types of test facility should be adequate to allow for testing in the far-field of the EUT i.e. it should be equal to or exceed:

$$\frac{2(d_1 + d_2)^2}{\lambda}$$

where:

d_1 is the largest dimension of the EUT/dipole after substitution (m);

d_2 is the largest dimension of the test antenna (m);

λ is the test frequency wavelength (m).

It should be noted that in the substitution part of this measurement, where both test and substitution antennas are half wavelength dipoles, this minimum range length for far-field testing would be:

$$2\lambda$$

It should be noted in the test report when either of these conditions is not met so that the additional measurement uncertainty can be incorporated into the results.

For further information on measurements at shorter distances see annex E.

NOTE 1: For the fully anechoic chamber, no part of the volume of the EUT should, at any angle of rotation of the turntable, fall outside the "quiet zone" of the chamber at the nominal frequency of the test.

NOTE 2: The "quiet zone" is a volume within the anechoic chamber (without a ground plane) in which a specified performance has either been proven by test, or is guaranteed by the designer/manufacture. The specified performance is usually the reflectivity of the absorbing panels or a directly related parameter (e.g. signal uniformity in amplitude and phase). It should be noted however that the defining levels of the quiet zone tend to vary.

NOTE 3: For the anechoic chamber with a ground plane, a full height scanning capability, i.e. 1 m to 4 m, should be available for which no part of the test antenna should come within 1 m of the absorbing panels. For both types of Anechoic Chamber, the reflectivity of the absorbing panels should not be worse than -5 dB.

NOTE 4: For both the anechoic chamber with a ground plane and the Open Area Test Site, no part of any antenna should come within 0,25 m of the ground plane at any time throughout the tests. Where any of these conditions cannot be met, measurements should not be carried out.

C.2.5 Site preparation

The cables for both ends of the test site should be routed horizontally away from the testing area for a minimum of 2 m (unless, in the case either type of anechoic chamber, a back wall is reached) and then allowed to drop vertically and out through either the ground plane or screen (as appropriate) to the test equipment. Precautions should be taken to minimize pick up on these leads (e.g. dressing with ferrite beads or other loading). The cables, their routing and dressing should be identical to the verification set-up.

NOTE: For ground reflection test sites (i.e. anechoic chambers with ground planes and Open Area Test Sites) which incorporate a cable drum with the antenna mast, the 2 m requirement may be impossible to comply with.

Calibration data for all items of test equipment should be available and valid. For test, substitution and measuring antennas, the data should include gain relative to an isotropic radiator (or antenna factor) for the frequency of test. Also, the VSWR of the substitution and measuring antennas should be known.

The calibration data on all cables and attenuators should include insertion loss and VSWR throughout the entire frequency range of the tests. All VSWR and insertion loss figures should be recorded in the log book results sheet for the specific test.

Where correction factors/tables are required, these should be immediately available.

For all items of test equipment, the maximum errors they exhibit should be known along with the distribution of the error e.g.:

- cable loss: $\pm 0,5$ dB with a rectangular distribution;
- measuring receiver: 1,0 dB (standard deviation) signal level accuracy with a Gaussian error distribution.

At the start of measurements, system checks should be made on the items of test equipment used on the test site.

C.3 Coupling of signals

C.3.1 General

The presence of leads in the radiated field may cause a disturbance of that field and lead to additional measurement uncertainty. These disturbances can be minimized by using suitable coupling methods, offering signal isolation and minimum field disturbance (e.g. optical and acoustic coupling).

C.4 Standard test methods

C.4.0 General

Two methods of determining the radiated power of a device are described in clauses C.4.1 and C.4.2.

C.4.1 Calibrated setup

The measurement receiver, test antenna and all associated equipment (e.g. cables, filters, amplifiers, etc.) shall have been recently calibrated against known standards at all the frequencies on which measurements of the equipment are to be made.

On a test site according to clause C.1, the equipment shall be placed at the specified height on a support, and in the position closest to normal use.

The test antenna shall be oriented initially for vertical polarization and shall be chosen to correspond to the frequency of the transmitter.

The output of the test antenna shall be connected to the spectrum analyser via whatever (fully characterized) equipment is required to render the signal measurable (e.g. amplifiers).

The transmitter shall be switched on, if possible without modulation, and the spectrum analyser shall be tuned to the frequency of the transmitter under test.

The test antenna shall be raised and lowered through the specified range of height until a maximum signal level is detected by the spectrum analyser.

The transmitter shall then be rotated through 360° in the horizontal plane, until the maximum signal level is detected by the spectrum analyser.

The test antenna shall be raised and lowered again through the specified range of height until a maximum signal level is detected by the spectrum analyser.

The maximum signal level detected by the spectrum analyser shall be noted and converted into the radiated power by application of the pre-determined calibration coefficients for the equipment configuration used.

C.4.2 Substitution method

On a test site, selected from clause C.1, the equipment shall be placed at the specified height on a support, as specified in clause C.1, and in the position closest to normal use.

The test antenna shall be oriented initially for vertical polarization and shall be chosen to correspond to the frequency of the transmitter.

The output of the test antenna shall be connected to the spectrum analyser.

The transmitter shall be switched on, if possible without modulation, and the measuring receiver shall be tuned to the frequency of the transmitter under test.

The test antenna shall be raised and lowered through the specified range of height until a maximum signal level is detected by the spectrum analyser.

The transmitter shall then be rotated through 360° in the horizontal plane, until the maximum signal level is detected by the spectrum analyser.

The test antenna shall be raised and lowered again through the specified range of height until a maximum signal level is detected by the spectrum analyser.

The maximum signal level detected by the spectrum analyser shall be noted.

The transmitter shall be replaced by a substitution antenna as defined in clause C.1.5.

The substitution antenna shall be orientated for vertical polarization and the length of the substitution antenna shall be adjusted to correspond to the frequency of the transmitter.

The substitution antenna shall be connected to a calibrated signal generator.

If necessary, the input attenuator setting of the spectrum analyser shall be adjusted in order to increase the sensitivity of the spectrum analyser.

The test antenna shall be raised and lowered through the specified range of height to ensure that the maximum signal is received. When a test site according clause C.1.1 is used, the height of the antenna shall not be varied.

The input signal to the substitution antenna shall be adjusted to the level that produces a level detected by the spectrum analyser, that is equal to the level noted while the transmitter radiated power was measured, corrected for the change of input attenuator setting of the spectrum analyser.

The input level to the substitution antenna shall be recorded as power level, corrected for any change of input attenuator setting of the spectrum analyser.

The measurement shall be repeated with the test antenna and the substitution antenna orientated for horizontal polarization.

The measure of the radiated power of the device is the larger of the two levels recorded at the input to the substitution antenna, corrected for gain of the substitution antenna if necessary.

Annex D (normative): Conducted measurements

In view of the low power levels of the equipment to be tested under the present document, conducted measurements may be applied to equipment provided with an antenna connector. Where the equipment to be tested does not provide a suitable termination, a coupler or attenuator that does provide the correct termination value shall be used.

The equivalent isotropically radiated power is then calculated from the measured value, the known antenna gain, relative to an isotropic antenna, and if applicable, any losses due to cables and connectors in the measurement system.

The Voltage Standing Wave Ratio (VSWR) shall not be greater than 1,5:1 over the frequency range of the measurement.

Annex E (informative): General Requirements for RF Cables

All RF cables including their connectors at both ends used within the measurement arrangements and set-ups should be of coaxial or waveguide type featuring within the frequency range they are used:

- a VSWR of less than 1,2 at either end;
- a shielding loss in excess of 60 dB.

When using coaxial cables for frequencies above 40 GHz attenuation features increase significantly and decrease of return loss due to mismatching caused by joints at RF connectors and impedance errors should be considered.

All RF cables and waveguide interconnects should be routed suitably in order to reduce impacts on antenna radiation pattern, antenna gain, antenna impedance. Table E.1 provides some information about connector systems that can be used in connection with the cables.

Table E.1: Connector systems

Connector System	Frequency	Recommended coupling torque
N	18 GHz	0,68 Nm to 1,13 Nm
SMA	18 GHz (some up to 26 GHz)	~ 0,56 Nm
3,50 mm	26,5 GHz	0,8 Nm to 1,1 Nm
2,92 mm	40 GHz (some up to 46 GHz)	0,8 Nm to 1,1 Nm
2,40 mm	50 GHz (some up to 60 GHz)	0,8 Nm to 1,1 Nm
1,85 mm	65 GHz (some up to 75 GHz)	0,8 Nm to 1,1 Nm

Annex F (informative): RF Waveguides

Wired signal transmission in the millimetre range is preferably realized by means of waveguides because they offer low attenuation and high reproducibility. Unlike coaxial cables, the frequency range in which waveguides can be used is limited also towards lower frequencies (highpass filter characteristics). Wave propagation in the waveguide is not possible below a certain cutoff frequency where attenuation of the waveguide is very high. Beyond a certain upper frequency limit, several wave propagation modes are possible so that the behaviour of the waveguide is no longer unambiguous. In the unambiguous range of a rectangular waveguide, only H₁₀ waves are capable of propagation.

The dimensions of rectangular and circular waveguides are defined by international standards such as IEC 153 [i.10] for various frequency ranges. These frequency ranges are also referred to as waveguide bands. They are designated using different capital letters depending on the standard. Table F.1 provides an overview of the different waveguide bands together with the designations of the associated waveguides and flanges.

For rectangular waveguides, which are mostly used in measurements, harmonic mixers with matching flanges are available for extending the frequency coverage of measuring receivers. Table F.1 provides some information on waveguides.

Table F.1: Waveguide bands and associated waveguides

Band	Frequency in GHz	Designations	Internal dimensions of waveguide	Designations of frequently used flanges						
		MIL-W-85	EIA	153-IEC	RCSC (British)	in mm	in inches	MIL-F-3922	UG-XXX/U equivalent (reference)	Remarks
Ka	26,5 to 40,0	3-006	WR-28	R320	WG-22	7,11 × 3,56	0,280 × 0,140	54-006 68-002 67B-005	UG-559/U - UG-381/U	Rectangular Rectangular Round
Q	33,0 to 55,0	3-010	WR-22	R400	WG-23	5,69 × 2,84	0,224 × 0,112	67B-006	UG-383/U	Round
U	40,0 to 60,0	3-014	WR-19	R500	WG-24	4,78 × 2,388	0,188 × 0,094	67B-007	UG-383/U-M	Round
V	50,0 to 75,0	3-017	WR-15	R620	WG-25	3,759 × 1,879	0,148 × 0,074	67B-008	UG-385/U	Round
E	60,0 to 90,0	3-020	WR-12	R740	WG-26	3,099 × 1,549	0,122 × 0,061	67B-009	UG-387/U	Round

As waveguides are rigid, it is impractical to set up connections between antenna and measuring receiver with waveguides. Either a waveguide transition to coaxial cable is used or - at higher frequencies - the harmonic mixer is used for frequency extension of the measuring receiver and is directly mounted at the antenna.

Annex G (informative): Applicability of parameters given in ETSI EG 203 336

ETSI EG 203 336 [i.13] gives guidance on the selection of technical parameters for the production of Harmonised Standards covering articles 3.1(b) and 3.2 of the Radio Equipment Directive [i.11]. Clause 5.3 of ETSI EG 203 336 [i.13] gives receiver parameters under article 3.2 that should be contained in a Harmonised Standard.

Table G.1 explains how these parameters are considered in the present document.

Table G.1: Parameters given in ETSI EG 203 336 [i.13]

ETSI EG 203 336 [i.13]		Present document		Explanation												
Clause	Parameter	Clause	Parameter													
5.3.2	Receiver sensitivity	-	-	There is no causal relationship between receiver sensitivity and interference in the case of satellite communications. Therefore, a quantitative calculation is not possible.												
5.3.3	Receiver co-channel rejection	4.2.10	Receive antenna off-axis gain pattern	Co-channel signals transmitted by other satellite networks are rejected by means of low off-axis antenna gain. In the case of phased array antennas, co-channel rejection is obtained by digital beam forming or interference mitigation techniques.												
5.3.4.2.1	Single signal selectivity - receiver adjacent signal selectivity	4.2.12	Adjacent signal selectivity													
5.3.4.2.2	Receiver spurious response rejection		Image frequency rejection	Frequencies other than the image frequency are not relevant because this is covered by receiver blocking and adjacent channel requirements which are already included in the receiver parameters.												
5.3.4.3.1	Receiver blocking	4.2.11	Blocking performance													
5.3.4.3.2	Receiver radio-frequency intermodulation	-	-	<p>In an FSS network, receiver radio-frequency intermodulation is not relevant, because possibly inter-modulating signals originating from other networks are rejected thanks to requirements on receive antenna off-axis gain pattern and adjacent signal selectivity. Interfering signals up to 28 dB above the wanted carrier can be tolerated with minimal impact on performance. See calculation below:</p> <table border="1" style="width: 100%; border-collapse: collapse;"> <tr> <td style="padding: 2px;">Co-polar antenna discrimination: at 3°</td> <td style="text-align: right; padding: 2px;">-7,5 dB</td> </tr> <tr> <td style="text-align: right; padding: 2px;">at 5°</td> <td style="text-align: right; padding: 2px;">-21,0 dB</td> </tr> <tr> <td colspan="2" style="padding: 2px;">Adjacent channel selectivity:</td> </tr> <tr> <td style="padding: 2px;">Relative power tolerated in adjacent channel for 0,4 dB degradation in signal to noise ratio threshold.</td> <td style="text-align: right; padding: 2px;">+7,0 dB</td> </tr> <tr> <td style="padding: 2px;">Relative power (arriving at antenna from 3° off-axis)</td> <td style="text-align: right; padding: 2px;">+14,5 dB</td> </tr> <tr> <td style="padding: 2px;">Relative power (arriving at antenna from 5° off-axis)</td> <td style="text-align: right; padding: 2px;">+28,0 dB</td> </tr> </table> <p>Concerning signals originating from the own network, the network operator has control over levels and can prevent intermodulation.</p>	Co-polar antenna discrimination: at 3°	-7,5 dB	at 5°	-21,0 dB	Adjacent channel selectivity:		Relative power tolerated in adjacent channel for 0,4 dB degradation in signal to noise ratio threshold.	+7,0 dB	Relative power (arriving at antenna from 3° off-axis)	+14,5 dB	Relative power (arriving at antenna from 5° off-axis)	+28,0 dB
Co-polar antenna discrimination: at 3°	-7,5 dB															
at 5°	-21,0 dB															
Adjacent channel selectivity:																
Relative power tolerated in adjacent channel for 0,4 dB degradation in signal to noise ratio threshold.	+7,0 dB															
Relative power (arriving at antenna from 3° off-axis)	+14,5 dB															
Relative power (arriving at antenna from 5° off-axis)	+28,0 dB															

ETSI EG 203 336 [i.13]		Present document		Explanation
Clause	Parameter	Clause	Parameter	
5.3.4.3.3	Receiver multiple signal selectivity - receiver adjacent signal selectivity	4.2.12	Adjacent signal selectivity	
5.3.4.4.1	Receiver dynamic range	-	-	In an FSS network, receiver dynamic range has no influence on harmful interference. The satellite earth stations are deployed in a manner that results in a situation where it is impossible to receive a wanted signal that is high enough to produce any overloading effect (satellite systems are power limited). So that it is not necessary to specify receiver dynamic range. See clause 5.3.6.1 of ETSI EG 203 336 [i.13].
5.3.4.4.2	Reciprocal mixing	-	-	For FSS equipment, the parameter is excluded for the following reason. It is considered that the reciprocal mixing effects are implicitly covered in HSs where comprehensive interference characteristics are specified in terms of selectivity and/or blocking requirements, thus removing the need for this parameter to be included in HSs as the effects of receiver selectivity and reciprocal mixing cannot be separated. See clause 5.3.6.2 of ETSI EG 203 336 [i.13].
5.3.4.4.3	Desensitization	-	-	As desensitization is a receiver effect addressed by other parameters (including receiver blocking), its inclusion as a separate parameter in a HS is not required. See clause 5.3.2.3 of ETSI EG 203 336 [i.13].
5.3.5	Receiver unwanted emissions in the spurious domain	4.2.1	Off-axis spurious radiation	

Annex H (informative): Maximum measurement uncertainty

The measurements described in the present document are based on the following assumptions:

- the measured value related to the corresponding limit is used to decide whether an equipment meets the requirements of the present document;
- the value of the measurement uncertainty for the measurement of each parameter is included in the test report.

Table H.1 shows the recommended values for the maximum measurement uncertainty figures (computed on the basis of ETSI TR 100 028 [i.16]).

Table H.1: Maximum measurement uncertainties

Parameter	Uncertainty
Radio frequency	$\pm 1 \times 10^{-7}$
Radiated RF power (up to 40 GHz)	± 6 dB
Radiated RF power (above 40 GHz)	± 8 dB
Conducted Measurements (up to 18 GHz)	$\pm 1,5$ dB
Conducted Measurements (from 18 GHz up to 40 GHz)	$\pm 2,5$ dB
Conducted Measurements (above 40 GHz)	± 4 dB
Temperature	± 1 °C
Humidity	± 5 %
DC and low frequency voltages	± 3 %

Annex I (informative): Bibliography

- [Council Directive 73/23/EEC](#) of 19 February 1973 on the harmonisation of the laws of Member States relating to Electrical Equipment designed for use within certain voltage limits (LV Directive).
- [Council Directive 89/336/EEC](#) of 3 May 1989 on the approximation of the laws of the Member States relating to electromagnetic compatibility (EMC Directive).
- [Directive 2004/40/EC](#) of the European Parliament and of the Council of 29 April 2004 on the minimum health and safety requirements regarding the exposure of workers to the risks arising from physical agents (electromagnetic fields) (18th individual Directive within the meaning of Article 16(1) of Directive 89/391/EEC).
- ETSI ETR 169 (1995): "Satellite Earth Stations and Systems (SES); Common Technical Regulations (CTRs) in the satellite earth station equipment field".
- EN 60068: "Environmental testing. Test methods for vibration and shock", produced by CENELEC.
- EN 55022: "Limits and methods of measurement of radio disturbance characteristics of information technology equipment", produced by CENELEC.
- SAE J1211: "Recommended Environmental Practices for Electronic Equipment Design, Recommended Practice".
- CEPT/ERC/Recommendation 74-01: "Unwanted emissions in the spurious domain".
- EN 60529 (1991): "Degrees of protection provided by enclosures (IP code)", produced by CENELEC.
- EN 60068-2-6 (2008): "Environmental testing - Part 2-6: Test - Test Fc: Vibration (sinusoidal)", produced by CENELEC.
- EN 60068-2-11 (1999): "Environmental testing - Part 2-11: Tests - Test KA: Salt mist", produced by CENELEC.
- EN 60068-2-27 (2007): "Environmental testing - Part 2-27: Tests - Test Ea and guidance: Shock", produced by CENELEC.
- [Directive 98/34/EC](#) of the European Parliament and of the Council of 22 June 1998 laying down a procedure for the provision of information in the field of technical standards and regulations.
- [Directive 98/48/EC](#) of the European Parliament and of the Council of 20 July 1998 amending Directive 98/34/EC laying down a procedure for the provision of information in the field of technical standards and regulations.
- ETSI EG 201 399: "Electromagnetic compatibility and Radio spectrum Matters (ERM); A guide to the production of Harmonized Standards for application under the Radio & Telecommunication Terminal Equipment Directive 1999/5/EC (R&TTE) and a first guide on the impact of the Radio Equipment Directive 2014/53/EU (RED) on Harmonized Standards".
- ETSI TS 103 052: "Electromagnetic compatibility and Radio spectrum Matters (ERM); Radiated measurement methods and general arrangements for test sites up to 100 GHz".

Annex J (informative): Change history

Version	Information about changes
2.2.1	Changes in clause 4.2.3 with the introduction of "total EIRP density" and corresponding test clause 6.4

History

Document history		
V1.1.2	February 2013	Publication
V2.1.1	May 2016	Publication
V2.1.2	October 2016	Publication
V2.2.0	September 2024	SRdAP process EV 20241219: 2024-09-20 to 2024-12-19