

ETSI ES 201 873-6 V4.13.1 (2022-04)



**Methods for Testing and Specification (MTS);  
The Testing and Test Control Notation version 3;  
Part 6: TTCN-3 Control Interface (TCI)**

---

**Reference**

RES/MTS-201873-6v4.13.1

---

**Keywords**control, interface, methodology, TCI, testing,  
TTCN-3**ETSI**650 Route des Lucioles  
F-06921 Sophia Antipolis Cedex - FRANCE

Tel.: +33 4 92 94 42 00 Fax: +33 4 93 65 47 16

Siret N° 348 623 562 00017 - APE 7112B  
Association à but non lucratif enregistrée à la  
Sous-Préfecture de Grasse (06) N° w061004871

---

**Important notice**

The present document can be downloaded from:

<http://www.etsi.org/standards-search>

The present document may be made available in electronic versions and/or in print. The content of any electronic and/or print versions of the present document shall not be modified without the prior written authorization of ETSI. In case of any existing or perceived difference in contents between such versions and/or in print, the prevailing version of an ETSI deliverable is the one made publicly available in PDF format at [www.etsi.org/deliver](http://www.etsi.org/deliver).

Users of the present document should be aware that the document may be subject to revision or change of status.

Information on the current status of this and other ETSI documents is available at

<https://portal.etsi.org/TB/ETSIDeliverableStatus.aspx>

If you find errors in the present document, please send your comment to one of the following services:

<https://portal.etsi.org/People/CommitteeSupportStaff.aspx>

If you find a security vulnerability in the present document, please report it through our  
Coordinated Vulnerability Disclosure Program:

<https://www.etsi.org/standards/coordinated-vulnerability-disclosure>

---

**Notice of disclaimer & limitation of liability**

The information provided in the present deliverable is directed solely to professionals who have the appropriate degree of experience to understand and interpret its content in accordance with generally accepted engineering or other professional standard and applicable regulations.

No recommendation as to products and services or vendors is made or should be implied.

No representation or warranty is made that this deliverable is technically accurate or sufficient or conforms to any law and/or governmental rule and/or regulation and further, no representation or warranty is made of merchantability or fitness for any particular purpose or against infringement of intellectual property rights.

In no event shall ETSI be held liable for loss of profits or any other incidental or consequential damages.

Any software contained in this deliverable is provided "AS IS" with no warranties, express or implied, including but not limited to, the warranties of merchantability, fitness for a particular purpose and non-infringement of intellectual property rights and ETSI shall not be held liable in any event for any damages whatsoever (including, without limitation, damages for loss of profits, business interruption, loss of information, or any other pecuniary loss) arising out of or related to the use of or inability to use the software.

---

**Copyright Notification**

No part may be reproduced or utilized in any form or by any means, electronic or mechanical, including photocopying and microfilm except as authorized by written permission of ETSI.

The content of the PDF version shall not be modified without the written authorization of ETSI.

The copyright and the foregoing restriction extend to reproduction in all media.

© ETSI 2022.  
All rights reserved.

# Contents

|   |    |
|---|----|
| Intellectual Property Rights .....                                      | 16 |
| Foreword.....   | 16 |
| Modal verbs terminology.....  | 16 |
| 1 Scope .....   | 17 |
| 2 References .....  | 17 |
| 2.1 Normative references .....  | 17 |
| 2.2 Informative references.....   | 18 |
| 3 Definition of terms, symbols and abbreviations.....                   | 18 |
| 3.1 Terms.....  | 18 |
| 3.2 Symbols.....  | 19 |
| 3.3 Abbreviations .....   | 19 |
| 4 Introduction .....  | 20 |
| 5 Compliance.....   | 20 |
| 6 General structure of a TTCN-3 test system.....                        | 21 |
| 6.1 Entities in a TTCN-3 test system.....                               | 21 |
| 6.1.0 Types of entities.....  | 21 |
| 6.1.1 Test Management and Control (TMC).....                            | 22 |
| 6.1.1.0 Test Management and Control Entities .....                      | 22 |
| 6.1.1.1 Test Management (TM) .....                                      | 22 |
| 6.1.1.2 Coding and Decoding (CD) .....                                  | 23 |
| 6.1.1.3 Component Handling (CH).....                                    | 23 |
| 6.1.1.4 Test Logging (TL).....  | 24 |
| 6.1.2 TTCN-3 Executable (TE) .....                                      | 24 |
| 6.1.3 SUT Adaptor (SA).....   | 24 |
| 6.1.4 Platform Adaptor (PA).....  | 24 |
| 6.2 Execution requirements for a TTCN-3 test system .....               | 24 |
| 7 TTCN-3 control interface and operations.....                          | 25 |
| 7.1 Overview of the TCI.....  | 25 |
| 7.1.0 TCI role in a TTCN-3 test system.....                             | 25 |
| 7.1.1 Correlation between TTCN-3 and TCI operation invocations .....    | 25 |
| 7.1.1.0 Mapping of TTCN-3 operations to TCI operations.....             | 25 |
| 7.1.1.1 TTCN-3 operations with TCI operation equivalent .....           | 26 |
| 7.1.1.2 TTCN-3 operations with TCI operation pair equivalent .....      | 26 |
| 7.1.1.3 TTCN-3 operations without direct TCI operation equivalent ..... | 27 |
| 7.1.1.3.0 Mapping of TTCN-3 operations to series of TCI operations..... | 27 |
| 7.1.1.3.1 Test case stop operation.....                                 | 27 |
| 7.2 TCI data.....   | 27 |
| 7.2.0 Abstract data types.....  | 27 |
| 7.2.1 General abstract data types .....                                 | 28 |
| 7.2.1.0 Use of general abstract data types .....                        | 28 |
| 7.2.1.1 Management.....   | 28 |
| 7.2.1.2 Communication .....   | 29 |
| 7.2.2 Abstract TTCN-3 data types and values .....                       | 29 |
| 7.2.2.0 Definition and scope of use.....                                | 29 |
| 7.2.2.1 Abstract TTCN-3 data types .....                                | 29 |
| 7.2.2.2 Abstract TTCN-3 values .....                                    | 31 |
| 7.2.2.2.0 Basic rules .....   | 31 |
| 7.2.2.2.1 The abstract data type Value .....                            | 32 |
| 7.2.2.2.2 The abstract data type IntegerValue .....                     | 35 |
| 7.2.2.2.3 The abstract data type FloatValue .....                       | 35 |
| 7.2.2.2.4 The abstract data type BooleanValue .....                     | 35 |
| 7.2.2.2.5 The abstract data type CharstringValue .....                  | 35 |

|            |  |    |
|------------|--|----|
| 7.2.2.2.6  | The abstract data type UniversalCharstringValue..... | 36 |
| 7.2.2.2.7  | The abstract data type BitstringValue.....           | 36 |
| 7.2.2.2.8  | The abstract data type OctetstringValue.....         | 37 |
| 7.2.2.2.9  | The abstract data type HexstringValue.....           | 38 |
| 7.2.2.2.10 | The abstract data type RecordValue.....              | 39 |
| 7.2.2.2.11 | The abstract data type RecordOfValue.....            | 39 |
| 7.2.2.2.12 | The abstract data type UnionValue.....               | 41 |
| 7.2.2.2.13 | The abstract data type EnumeratedValue.....          | 41 |
| 7.2.2.2.14 | The abstract data type VerdictValue.....             | 41 |
| 7.2.2.2.15 | The abstract data type AddressValue.....             | 42 |
| 7.2.2.3    | Abstract TTCN-3 matching mechanisms.....             | 42 |
| 7.2.2.3.1  | The abstract data type MatchingMechanism.....        | 42 |
| 7.2.2.3.2  | The abstract data type MatchingList.....             | 42 |
| 7.2.2.3.3  | The abstract data type ValueRange.....               | 43 |
| 7.2.2.3.4  | The abstract data type CharacterPattern.....         | 43 |
| 7.2.2.3.5  | The abstract data type MatchDecodedContent.....      | 44 |
| 7.2.2.4    | Data types for complex TTCN-3 properties.....        | 44 |
| 7.2.2.4.0  | Scope of use of TTCN-3 properties.....               | 44 |
| 7.2.2.4.1  | The abstract data type LengthRestriction.....        | 44 |
| 7.2.2.4.2  | The abstract data type Permutation.....              | 44 |
| 7.2.2.4.3  | The abstract data type RangeBoundary.....            | 45 |
| 7.2.3      | Abstract logging types.....                          | 45 |
| 7.2.3.1    | The abstract data type TciValueTemplate.....         | 45 |
| 7.2.3.2    | The abstract data type TciNonValueTemplate.....      | 45 |
| 7.2.3.3    | The Value List and Mismatch Types.....               | 46 |
| 7.2.3.4    | The Status Types.....                                | 46 |
| 7.3        | TCI operations.....                                  | 47 |
| 7.3.0      | The TCI interfaces.....                              | 47 |
| 7.3.1      | The TCI-TM interface.....                            | 48 |
| 7.3.1.0    | Scope of use.....                                    | 48 |
| 7.3.1.1    | TCI-TM required.....                                 | 48 |
| 7.3.1.1.0  | Scope of use.....                                    | 48 |
| 7.3.1.1.1  | tciRootModule.....                                   | 48 |
| 7.3.1.1.2  | tciGetImportedModules.....                           | 49 |
| 7.3.1.1.3  | tciGetModuleParameters.....                          | 49 |
| 7.3.1.1.4  | tciGetTestCases.....                                 | 49 |
| 7.3.1.1.5  | tciGetTestCaseParameters.....                        | 49 |
| 7.3.1.1.6  | tciGetTestCaseTSI.....                               | 49 |
| 7.3.1.1.7  | tciStartTestCase.....                                | 50 |
| 7.3.1.1.8  | tciStopTestCase.....                                 | 50 |
| 7.3.1.1.9  | tciStartControl.....                                 | 50 |
| 7.3.1.1.10 | tciStopControl.....                                  | 50 |
| 7.3.1.1.11 | tciGetControlParameters.....                         | 51 |
| 7.3.1.1.12 | tciStartControlWithParameters.....                   | 51 |
| 7.3.1.2    | TCI-TM provided.....                                 | 51 |
| 7.3.1.2.0  | Scope of use.....                                    | 51 |
| 7.3.1.2.1  | tciTestCaseStarted.....                              | 51 |
| 7.3.1.2.2  | tciTestCaseTerminated.....                           | 52 |
| 7.3.1.2.3  | tciControlTerminated.....                            | 52 |
| 7.3.1.2.4  | tciGetModulePar.....                                 | 52 |
| 7.3.1.2.5  | tciLog.....  | 52 |
| 7.3.1.2.6  | tciError.....  | 53 |
| 7.3.1.2.7  | tciControlTerminatedWithResult.....                  | 53 |
| 7.3.2      | The TCI-CD interface.....                            | 53 |
| 7.3.2.0    | Scope of use.....                                    | 53 |
| 7.3.2.1    | TCI-CD required.....                                 | 54 |
| 7.3.2.1.0  | Scope of use.....                                    | 54 |
| 7.3.2.1.1  | getTypeForName.....                                  | 54 |
| 7.3.2.1.2  | getInteger.....                                      | 54 |
| 7.3.2.1.3  | getFloat.....  | 54 |

|            |                                     |    |
|------------|-------------------------------------|----|
| 7.3.2.1.4  | getBoolean.....                     | 54 |
| 7.3.2.1.5  | Void.....                           | 55 |
| 7.3.2.1.6  | getCharstring.....                  | 55 |
| 7.3.2.1.7  | getUniversalCharstring.....         | 55 |
| 7.3.2.1.8  | getHexstring.....                   | 55 |
| 7.3.2.1.9  | getBitstring.....                   | 55 |
| 7.3.2.1.10 | getOctetstring.....                 | 55 |
| 7.3.2.1.11 | getVerdict.....                     | 55 |
| 7.3.2.1.12 | tciErrorReq.....                    | 55 |
| 7.3.2.2    | TCI-CD provided.....                | 55 |
| 7.3.2.2.0  | Scope of use.....                   | 55 |
| 7.3.2.2.1  | decode.....                         | 56 |
| 7.3.2.2.2  | encode.....                         | 56 |
| 7.3.2.2.3  | decodeValue.....                    | 56 |
| 7.3.2.2.4  | encodeValue.....                    | 57 |
| 7.3.3      | The TCI-CH interface.....           | 57 |
| 7.3.3.0    | Scope of use.....                   | 57 |
| 7.3.3.1    | TCI-CH required.....                | 58 |
| 7.3.3.1.0  | Scope of use.....                   | 58 |
| 7.3.3.1.1  | tciEnqueueMsgConnected.....         | 58 |
| 7.3.3.1.2  | tciEnqueueCallConnected.....        | 58 |
| 7.3.3.1.3  | tciEnqueueReplyConnected.....       | 59 |
| 7.3.3.1.4  | tciEnqueueRaiseConnected.....       | 59 |
| 7.3.3.1.5  | tciCreateTestComponent.....         | 59 |
| 7.3.3.1.6  | tciStartTestComponent.....          | 60 |
| 7.3.3.1.7  | tciStopTestComponent.....           | 60 |
| 7.3.3.1.8  | tciConnect.....                     | 60 |
| 7.3.3.1.9  | tciDisconnect.....                  | 60 |
| 7.3.3.1.10 | tciMap.....                         | 61 |
| 7.3.3.1.11 | tciMapParam.....                    | 61 |
| 7.3.3.1.12 | tciUnmap.....                       | 61 |
| 7.3.3.1.13 | tciUnmapParam.....                  | 61 |
| 7.3.3.1.14 | tciTestComponentTerminated.....     | 62 |
| 7.3.3.1.15 | tciTestComponentRunning.....        | 62 |
| 7.3.3.1.16 | tciTestComponentDone.....           | 62 |
| 7.3.3.1.17 | tciGetMTC.....                      | 62 |
| 7.3.3.1.18 | tciExecuteTestCase.....             | 63 |
| 7.3.3.1.19 | tciReset.....                       | 63 |
| 7.3.3.1.20 | tciKillTestComponent.....           | 63 |
| 7.3.3.1.21 | tciTestComponentAlive.....          | 63 |
| 7.3.3.1.22 | tciTestComponentKilled.....         | 64 |
| 7.3.3.1.23 | tciCallTestComponent.....           | 64 |
| 7.3.3.1.24 | tciTestComponentCallTerminated..... | 64 |
| 7.3.3.2    | TCI-CH provided.....                | 65 |
| 7.3.3.2.0  | Scope of use.....                   | 65 |
| 7.3.3.2.1  | tciSendConnected.....               | 65 |
| 7.3.3.2.2  | tciSendConnectedBC.....             | 65 |
| 7.3.3.2.3  | tciSendConnectedMC.....             | 65 |
| 7.3.3.2.4  | tciCallConnected.....               | 66 |
| 7.3.3.2.5  | tciCallConnectedBC.....             | 66 |
| 7.3.3.2.6  | tciCallConnectedMC.....             | 67 |
| 7.3.3.2.7  | tciReplyConnected.....              | 67 |
| 7.3.3.2.8  | tciReplyConnectedBC.....            | 68 |
| 7.3.3.2.9  | tciReplyConnectedMC.....            | 68 |
| 7.3.3.2.10 | tciRaiseConnected.....              | 69 |
| 7.3.3.2.11 | tciRaiseConnectedBC.....            | 69 |
| 7.3.3.2.12 | tciRaiseConnectedMC.....            | 69 |
| 7.3.3.2.13 | tciCreateTestComponentReq.....      | 70 |
| 7.3.3.2.14 | tciStartTestComponentReq.....       | 70 |
| 7.3.3.2.15 | tciStopTestComponentReq.....        | 70 |
| 7.3.3.2.16 | tciConnectReq.....                  | 70 |
| 7.3.3.2.17 | tciDisconnectReq.....               | 71 |

|            |   |    |
|------------|---|----|
| 7.3.3.2.18 | tciMapReq .....                         | 71 |
| 7.3.3.2.19 | tciMapParamReq .....                    | 71 |
| 7.3.3.2.20 | tciUnmapReq .....                       | 71 |
| 7.3.3.2.21 | tciUnmapParamReq .....                  | 72 |
| 7.3.3.2.22 | tciTestComponentTerminatedReq .....     | 72 |
| 7.3.3.2.23 | tciTestComponentRunningReq .....        | 72 |
| 7.3.3.2.24 | tciTestComponentDoneReq .....           | 72 |
| 7.3.3.2.25 | tciGetMTCReq .....                      | 72 |
| 7.3.3.2.26 | tciExecuteTestCaseReq .....             | 73 |
| 7.3.3.2.27 | tciResetReq .....                       | 73 |
| 7.3.3.2.28 | tciKillTestComponentReq .....           | 73 |
| 7.3.3.2.29 | tciTestComponentAliveReq .....          | 73 |
| 7.3.3.2.30 | tciTestComponentKilledReq .....         | 73 |
| 7.3.3.2.31 | tciCallTestComponentReq .....           | 74 |
| 7.3.3.2.32 | tciTestComponentCallTerminatedReq ..... | 74 |
| 7.3.4      | The TCI-TL interface.....               | 75 |
| 7.3.4.0    | Scope of use .....                      | 75 |
| 7.3.4.1    | TCI-TL provided.....                    | 75 |
| 7.3.4.1.0  | Scope of use.....                       | 75 |
| 7.3.4.1.1  | tliTcExecute.....                       | 75 |
| 7.3.4.1.2  | tliTcStart .....                        | 76 |
| 7.3.4.1.3  | tliTcStop .....                         | 76 |
| 7.3.4.1.4  | tliTcStarted .....                      | 76 |
| 7.3.4.1.5  | tliTcTerminated .....                   | 77 |
| 7.3.4.1.6  | tliCtrlStart .....                      | 77 |
| 7.3.4.1.7  | tliCtrlStop .....                       | 77 |
| 7.3.4.1.8  | tliCtrlTerminated .....                 | 78 |
| 7.3.4.1.9  | tliMSend_m.....                         | 78 |
| 7.3.4.1.10 | tliMSend_m_BC.....                      | 79 |
| 7.3.4.1.11 | tliMSend_m_MC.....                      | 79 |
| 7.3.4.1.12 | tliMSend_c .....                        | 80 |
| 7.3.4.1.13 | tliMSend_c_BC .....                     | 80 |
| 7.3.4.1.14 | tliMSend_c_MC .....                     | 80 |
| 7.3.4.1.15 | tliMDetected_m.....                     | 81 |
| 7.3.4.1.16 | tliMDetected_c .....                    | 81 |
| 7.3.4.1.17 | tliMMismatch_m.....                     | 81 |
| 7.3.4.1.18 | tliMMismatch_c .....                    | 82 |
| 7.3.4.1.19 | tliMReceive_m .....                     | 82 |
| 7.3.4.1.20 | tliMReceive_c .....                     | 83 |
| 7.3.4.1.21 | tliPrCall_m .....                       | 83 |
| 7.3.4.1.22 | tliPrCall_m_BC .....                    | 84 |
| 7.3.4.1.23 | tliPrCall_m_MC .....                    | 84 |
| 7.3.4.1.24 | tliPrCall_c.....                        | 85 |
| 7.3.4.1.25 | tliPrCall_c_BC .....                    | 85 |
| 7.3.4.1.26 | tliPrCall_c_MC.....                     | 86 |
| 7.3.4.1.27 | tliPrGetCallDetected_m.....             | 86 |
| 7.3.4.1.28 | tliPrGetCallDetected_c.....             | 87 |
| 7.3.4.1.29 | tliPrGetCallMismatch_m.....             | 87 |
| 7.3.4.1.30 | tliPrGetCallMismatch_c .....            | 88 |
| 7.3.4.1.31 | tliPrGetCall_m.....                     | 88 |
| 7.3.4.1.32 | tliPrGetCall_c .....                    | 89 |
| 7.3.4.1.33 | tliPrReply_m .....                      | 89 |
| 7.3.4.1.34 | tliPrReply_m_BC .....                   | 90 |
| 7.3.4.1.35 | tliPrReply_m_MC .....                   | 90 |
| 7.3.4.1.36 | tliPrReply_c.....                       | 91 |
| 7.3.4.1.37 | tliPrReply_c_BC.....                    | 91 |
| 7.3.4.1.38 | tliPrReply_c_MC.....                    | 92 |
| 7.3.4.1.39 | tliPrGetReplyDetected_m.....            | 92 |
| 7.3.4.1.40 | tliPrGetReplyDetected_c .....           | 93 |
| 7.3.4.1.41 | tliPrGetReplyMismatch_m.....            | 93 |
| 7.3.4.1.42 | tliPrGetReplyMismatch_c .....           | 94 |
| 7.3.4.1.43 | tliPrGetReply_m.....                    | 94 |

|             |                                 |     |
|-------------|---------------------------------|-----|
| 7.3.4.1.44  | tliPrGetReply_c .....           | 95  |
| 7.3.4.1.45  | tliPrRaise_m .....              | 95  |
| 7.3.4.1.46  | tliPrRaise_m_BC .....           | 96  |
| 7.3.4.1.47  | tliPrRaise_m_MC .....           | 96  |
| 7.3.4.1.48  | tliPrRaise_c .....              | 97  |
| 7.3.4.1.49  | tliPrRaise_c_BC .....           | 97  |
| 7.3.4.1.50  | tliPrRaise_c_MC .....           | 98  |
| 7.3.4.1.51  | tliPrCatchDetected_m .....      | 98  |
| 7.3.4.1.52  | tliPrCatchDetected_c .....      | 99  |
| 7.3.4.1.53  | tliPrCatchMismatch_m .....      | 99  |
| 7.3.4.1.54  | tliPrCatchMismatch_c .....      | 100 |
| 7.3.4.1.55  | tliPrCatch_m .....              | 100 |
| 7.3.4.1.56  | tliPrCatch_c .....              | 101 |
| 7.3.4.1.57  | tliPrCatchTimeoutDetected ..... | 101 |
| 7.3.4.1.58  | tliPrCatchTimeout .....         | 101 |
| 7.3.4.1.59  | tliCCreate .....                | 102 |
| 7.3.4.1.60  | tliCStart .....                 | 102 |
| 7.3.4.1.61  | tliCRunning .....               | 102 |
| 7.3.4.1.62  | tliCAlive .....                 | 103 |
| 7.3.4.1.63  | tliCStop .....                  | 103 |
| 7.3.4.1.64  | tliCKill .....                  | 103 |
| 7.3.4.1.65  | tliCDoneMismatch .....          | 104 |
| 7.3.4.1.66  | tliCDone .....                  | 104 |
| 7.3.4.1.67  | tliCKilledMismatch .....        | 104 |
| 7.3.4.1.68  | tliCKilled .....                | 105 |
| 7.3.4.1.69  | tliCTerminated .....            | 105 |
| 7.3.4.1.70  | tliPConnect .....               | 105 |
| 7.3.4.1.71  | tliPDisconnect .....            | 106 |
| 7.3.4.1.72  | tliPMap .....                   | 106 |
| 7.3.4.1.73  | tliPMapParam .....              | 106 |
| 7.3.4.1.74  | tliPUnmap .....                 | 107 |
| 7.3.4.1.75  | tliPUnmapParam .....            | 107 |
| 7.3.4.1.76  | tliPClear .....                 | 107 |
| 7.3.4.1.77  | tliPStart .....                 | 108 |
| 7.3.4.1.78  | tliPStop .....                  | 108 |
| 7.3.4.1.79  | tliPHalt .....                  | 108 |
| 7.3.4.1.80  | tliEncode .....                 | 109 |
| 7.3.4.1.81  | tliDecode .....                 | 109 |
| 7.3.4.1.82  | tliTTimeoutDetected .....       | 109 |
| 7.3.4.1.83  | tliTTimeoutMismatch .....       | 110 |
| 7.3.4.1.84  | tliTTimeout .....               | 110 |
| 7.3.4.1.85  | tliTStart .....                 | 110 |
| 7.3.4.1.86  | tliTStop .....                  | 111 |
| 7.3.4.1.87  | tliTRead .....                  | 111 |
| 7.3.4.1.88  | tliTRunning .....               | 111 |
| 7.3.4.1.89  | tliSEnter .....                 | 112 |
| 7.3.4.1.90  | tliSLeave .....                 | 112 |
| 7.3.4.1.91  | tliVar .....                    | 112 |
| 7.3.4.1.92  | tliModulePar .....              | 113 |
| 7.3.4.1.93  | tliGetVerdict .....             | 113 |
| 7.3.4.1.94  | tliSetVerdict .....             | 113 |
| 7.3.4.1.95  | tliLog .....                    | 114 |
| 7.3.4.1.96  | tliAEnter .....                 | 114 |
| 7.3.4.1.97  | tliALeave .....                 | 114 |
| 7.3.4.1.98  | tliANomatch .....               | 114 |
| 7.3.4.1.99  | tliARepeat .....                | 115 |
| 7.3.4.1.100 | tliADefaults .....              | 115 |
| 7.3.4.1.101 | tliAActivate .....              | 115 |
| 7.3.4.1.102 | tliADeactivate .....            | 116 |
| 7.3.4.1.103 | tliAWait .....                  | 116 |
| 7.3.4.1.104 | tliAction .....                 | 116 |
| 7.3.4.1.105 | tliMatch .....                  | 116 |

|             |                                   |     |
|-------------|-----------------------------------|-----|
| 7.3.4.1.106 | tliMatchMismatch.....             | 117 |
| 7.3.4.1.107 | tliInfo .....                     | 117 |
| 7.3.4.1.108 | tliMChecked_m .....               | 117 |
| 7.3.4.1.109 | tliMChecked_c .....               | 118 |
| 7.3.4.1.110 | tliPrGetCallChecked_m.....        | 118 |
| 7.3.4.1.111 | tliPrGetCallChecked_c .....       | 119 |
| 7.3.4.1.112 | tliPrGetReplyChecked_m.....       | 119 |
| 7.3.4.1.113 | tliPrGetReplyChecked_c .....      | 120 |
| 7.3.4.1.114 | tliPrCatchChecked_m.....          | 120 |
| 7.3.4.1.115 | tliPrCatchChecked_c .....         | 121 |
| 7.3.4.1.116 | tliCheckedAny_m.....              | 121 |
| 7.3.4.1.117 | tliCheckedAny_c .....             | 122 |
| 7.3.4.1.118 | tliCheckAnyMismatch_m.....        | 122 |
| 7.3.4.1.119 | tliCheckAnyMismatch_c .....       | 122 |
| 7.3.4.1.120 | tliRnd .....                      | 123 |
| 7.3.4.1.121 | tliEvaluate.....                  | 123 |
| 7.3.4.1.122 | tliCCall .....                    | 123 |
| 7.3.4.1.123 | tliCCallTerminated .....          | 124 |
| 7.3.4.1.124 | tliCtrlStartWithParameters .....  | 124 |
| 7.3.4.1.125 | tliCtrlTerminatedWithResult ..... | 124 |
| 8           | Java™ language mapping.....       | 125 |
| 8.1         | Introduction .....                | 125 |
| 8.2         | Names and scopes .....            | 125 |
| 8.2.1       | Names .....                       | 125 |
| 8.2.2       | Scopes .....                      | 125 |
| 8.3         | Type mapping.....                 | 125 |
| 8.3.1       | Basic type mapping.....           | 125 |
| 8.3.2       | Structured type mapping .....     | 126 |
| 8.3.2.0     | General principles .....          | 126 |
| 8.3.2.1     | TciParameterType .....            | 126 |
| 8.3.2.2     | TciParameterPassingModeType.....  | 127 |
| 8.3.2.3     | TciParameterListType.....         | 127 |
| 8.3.2.4     | TciTypeClassType .....            | 127 |
| 8.3.2.5     | TciTestComponentKindType.....     | 128 |
| 8.3.2.6     | TciBehaviourIdType .....          | 128 |
| 8.3.2.7     | TciTestCaseIdType .....           | 128 |
| 8.3.2.8     | TciModuleIdType .....             | 128 |
| 8.3.2.9     | TciModuleParameterIdType .....    | 128 |
| 8.3.2.10    | TciModuleParameterListType .....  | 129 |
| 8.3.2.11    | TciModuleParameterType.....       | 129 |
| 8.3.2.12    | TciParameterTypeListType.....     | 129 |
| 8.3.2.13    | TciParameterTypeType.....         | 130 |
| 8.3.2.14    | TciModuleIdListType .....         | 130 |
| 8.3.2.15    | TciTestCaseIdListType .....       | 130 |
| 8.3.2.16    | TciDecodingResult.....            | 131 |
| 8.3.2.17    | TciMatchingTypeType.....          | 131 |
| 8.3.2.18    | LengthRestriction.....            | 131 |
| 8.3.2.19    | Permutation .....                 | 132 |
| 8.3.2.20    | RangeBoundary.....                | 132 |
| 8.3.3       | Abstract type mapping.....        | 133 |
| 8.3.3.0     | General principles .....          | 133 |
| 8.3.3.1     | Type .....                        | 133 |
| 8.3.4       | Abstract value mapping .....      | 134 |
| 8.3.4.0     | General principles .....          | 134 |
| 8.3.4.1     | Value .....                       | 134 |
| 8.3.4.2     | IntegerValue.....                 | 135 |
| 8.3.4.3     | FloatValue.....                   | 136 |
| 8.3.4.4     | BooleanValue.....                 | 136 |
| 8.3.4.5     | CharstringValue .....             | 136 |
| 8.3.4.6     | BitstringValue .....              | 137 |
| 8.3.4.7     | OctetstringValue .....            | 138 |



|          |                                      |     |
|----------|--------------------------------------|-----|
| 8.3.4.8  | UniversalCharstringValue .....       | 139 |
| 8.3.4.9  | HexstringValue .....                 | 140 |
| 8.3.4.10 | RecordValue .....                    | 141 |
| 8.3.4.11 | RecordOfValue .....                  | 141 |
| 8.3.4.12 | UnionValue .....                     | 142 |
| 8.3.4.13 | EnumeratedValue .....                | 143 |
| 8.3.4.14 | VerdictValue .....                   | 143 |
| 8.3.4.15 | AddressValue .....                   | 144 |
| 8.3.5    | Abstract template mapping .....      | 144 |
| 8.3.5.0  | General principles .....             | 144 |
| 8.3.5.1  | MatchingMechanism .....              | 144 |
| 8.3.5.2  | MatchingList .....                   | 144 |
| 8.3.5.3  | ValueRange .....                     | 145 |
| 8.3.5.4  | CharacterPattern .....               | 145 |
| 8.3.5.5  | MatchDecodedContent .....            | 145 |
| 8.3.6    | Abstract logging types mapping ..... | 146 |
| 8.3.6.0  | General principles .....             | 146 |
| 8.3.6.1  | TciValueTemplate .....               | 146 |
| 8.3.6.2  | TciNonValueTemplate .....            | 146 |
| 8.3.6.3  | TciValueList .....                   | 147 |
| 8.3.6.4  | TciValueDifference .....             | 147 |
| 8.3.6.5  | TciValueDifferenceList .....         | 147 |
| 8.3.6.6  | ComponentStatus .....                | 148 |
| 8.3.6.7  | TimerStatus .....                    | 148 |
| 8.3.6.8  | TciStatus .....                      | 148 |
| 8.4      | Constants .....                      | 148 |
| 8.5      | Mapping of interfaces .....          | 150 |
| 8.5.0    | Calling rules .....                  | 150 |
| 8.5.1    | The TCI-TM interface .....           | 150 |
| 8.5.1.1  | TCI-TM provided .....                | 150 |
| 8.5.1.2  | TCI-TM required .....                | 150 |
| 8.5.2    | The TCI-CD interface .....           | 151 |
| 8.5.2.1  | TCI-CD provided .....                | 151 |
| 8.5.2.2  | TCI-CD required .....                | 151 |
| 8.5.3    | The TCI-CH interface .....           | 151 |
| 8.5.3.1  | TCI-CH provided .....                | 151 |
| 8.5.3.2  | TCI-CH required .....                | 153 |
| 8.5.4    | The TCI-TL interface .....           | 154 |
| 8.5.4.1  | TCI-TL provided .....                | 154 |
| 8.6      | Optional parameters .....            | 158 |
| 8.7      | TCI initialization .....             | 158 |
| 8.8      | Error handling .....                 | 158 |
| 9        | ANSI C language mapping .....        | 159 |
| 9.1      | Introduction .....                   | 159 |
| 9.2      | Value interfaces .....               | 159 |
| 9.3      | Logging interface .....              | 164 |
| 9.4      | Operation interfaces .....           | 165 |
| 9.4.1    | The TCI-TM interface .....           | 165 |
| 9.4.1.1  | TCI-TM provided .....                | 165 |
| 9.4.1.2  | TCI-TM required .....                | 165 |
| 9.4.2    | The TCI-CD interface .....           | 166 |
| 9.4.2.1  | TCI-CD provided .....                | 166 |
| 9.4.2.2  | TCI-CD required .....                | 166 |
| 9.4.3    | The TCI-CH interface .....           | 166 |
| 9.4.3.1  | TCI-CH provided .....                | 166 |
| 9.4.3.2  | TCI-CH required .....                | 167 |
| 9.4.4    | The TCI-TL interface .....           | 167 |
| 9.4.4.1  | TCI-TL provided .....                | 167 |
| 9.5      | Data .....                           | 173 |
| 9.6      | Miscellaneous .....                  | 174 |
| 9.7      | Optional parameters .....            | 175 |

|           |   |     |
|-----------|---|-----|
| 10        | C++ language mapping .....                  | 175 |
| 10.1      | Introduction .....                          | 175 |
| 10.2      | Names and scopes .....                      | 175 |
| 10.3      | Memory management.....                      | 176 |
| 10.4      | Error handling .....                        | 176 |
| 10.5      | Type mapping.....                           | 176 |
| 10.5.0    | Basic concepts .....                        | 176 |
| 10.5.1    | Encapsulated C++ types.....                 | 176 |
| 10.5.2    | General abstract data types .....           | 176 |
| 10.5.2.1  | TciBehaviourId .....                        | 176 |
| 10.5.2.2  | TciModuleId.....                            | 177 |
| 10.5.2.3  | TciModuleParameterId .....                  | 177 |
| 10.5.2.4  | TciTestCaseId .....                         | 177 |
| 10.5.2.5  | TciModuleIdList .....                       | 178 |
| 10.5.2.6  | TciModuleParameter .....                    | 178 |
| 10.5.2.7  | TciModuleParameterList.....                 | 179 |
| 10.5.2.8  | TciParameterPassingMode.....                | 179 |
| 10.5.2.9  | TciParameter .....                          | 180 |
| 10.5.2.10 | TciParameterList .....                      | 180 |
| 10.5.2.11 | TciParameterType .....                      | 181 |
| 10.5.2.12 | TciParameterTypeList.....                   | 181 |
| 10.5.2.13 | TciTestComponentKind .....                  | 182 |
| 10.5.2.14 | TciTypeClass .....                          | 182 |
| 10.5.2.15 | TciTestCaseIdList .....                     | 182 |
| 10.5.2.16 | TciMatchingTypeType.....                    | 183 |
| 10.5.2.17 | LengthRestriction.....                      | 183 |
| 10.5.2.18 | Permutation .....                           | 184 |
| 10.5.2.19 | RangeBoundary.....                          | 184 |
| 10.5.3    | Abstract TTCN-3 data types and values ..... | 185 |
| 10.5.3.1  | TciType .....                               | 185 |
| 10.5.3.2  | TciValue.....                               | 186 |
| 10.5.3.3  | IntegerValue.....                           | 187 |
| 10.5.3.4  | FloatValue .....                            | 188 |
| 10.5.3.5  | BooleanValue.....                           | 188 |
| 10.5.3.6  | CharstringValue .....                       | 189 |
| 10.5.3.7  | UniversalCharstringValue.....               | 189 |
| 10.5.3.8  | BitstringValue .....                        | 190 |
| 10.5.3.9  | OctetstringValue .....                      | 191 |
| 10.5.3.10 | HexstringValue .....                        | 191 |
| 10.5.3.11 | RecordValue.....                            | 192 |
| 10.5.3.12 | RecordOfValue .....                         | 193 |
| 10.5.3.13 | UnionValue .....                            | 194 |
| 10.5.3.14 | EnumeratedValue.....                        | 194 |
| 10.5.3.15 | VerdictValue .....                          | 195 |
| 10.5.3.16 | VerdictValueEnum.....                       | 195 |
| 10.5.3.17 | AddressValue .....                          | 195 |
| 10.5.3.18 | MatchingMechanism.....                      | 196 |
| 10.5.3.19 | MatchingList .....                          | 196 |
| 10.5.3.20 | ValueRange .....                            | 197 |
| 10.5.3.21 | CharacterPattern.....                       | 197 |
| 10.5.3.22 | MatchDecodedContent.....                    | 198 |
| 10.5.4    | Abstract logging types .....                | 198 |
| 10.5.4.1  | TciValueTemplate.....                       | 198 |
| 10.5.4.2  | TciNonValueTemplate .....                   | 199 |
| 10.5.4.3  | TciValueList.....                           | 199 |
| 10.5.4.4  | TciValueDifference.....                     | 200 |
| 10.5.4.5  | TciValueDifferenceList.....                 | 200 |
| 10.5.4.6  | ComponentStatus .....                       | 201 |
| 10.5.4.7  | TimerStatus .....                           | 201 |
| 10.5.4.8  | TciStatus .....                             | 201 |
| 10.6      | Operations mapping .....                    | 201 |
| 10.6.1    | TCI-TM .....                                | 201 |

|           |                                   |     |
|-----------|-----------------------------------|-----|
| 10.6.1.1  | TciTmRequired .....               | 201 |
| 10.6.1.2  | TciTmProvided .....               | 202 |
| 10.6.2    | TCI-CD .....                      | 202 |
| 10.6.2.1  | TciCdRequired .....               | 202 |
| 10.6.2.2  | TciCdProvided .....               | 203 |
| 10.6.3    | TCI-CH .....                      | 203 |
| 10.6.3.1  | TciChRequired .....               | 203 |
| 10.6.3.2  | TciChProvided .....               | 205 |
| 10.6.4    | TCI-TL .....                      | 207 |
| 10.6.4.1  | TciTlProvided .....               | 207 |
| 11        | W3C XML mapping .....             | 215 |
| 11.1      | Introduction .....                | 215 |
| 11.2      | Scopes .....                      | 215 |
| 11.3      | Type mapping .....                | 216 |
| 11.3.1    | Mapping of simple types .....     | 216 |
| 11.3.1.1  | TBoolean .....                    | 216 |
| 11.3.1.2  | TString .....                     | 216 |
| 11.3.1.3  | TInteger .....                    | 216 |
| 11.3.1.4  | TriTimerDurationType .....        | 216 |
| 11.3.1.5  | TciParameterPassingModeType ..... | 216 |
| 11.3.1.6  | TriStatusType .....               | 216 |
| 11.3.1.7  | TciStatusType .....               | 216 |
| 11.3.1.8  | ComponentStatusType .....         | 216 |
| 11.3.1.9  | TimerStatusType .....             | 216 |
| 11.3.1.10 | PortStatusType .....              | 216 |
| 11.3.2    | Complex type mapping .....        | 217 |
| 11.3.2.1  | TriPortIdType .....               | 217 |
| 11.3.2.2  | TriComponentIdType .....          | 217 |
| 11.3.2.3  | TriComponentIdListType .....      | 217 |
| 11.3.2.4  | Port .....                        | 218 |
| 11.3.2.5  | Id .....                          | 218 |
| 11.3.2.6  | TriMessageType .....              | 218 |
| 11.3.2.7  | TriParameterType .....            | 219 |
| 11.3.2.8  | TriParameterListType .....        | 219 |
| 11.3.2.9  | TriAddressType .....              | 219 |
| 11.3.2.10 | TriAddressListType .....          | 220 |
| 11.3.2.11 | TriExceptionType .....            | 220 |
| 11.3.2.12 | TriSignatureIdType .....          | 220 |
| 11.3.2.13 | TriTimerIdType .....              | 221 |
| 11.3.2.14 | TriTimerDurationType .....        | 221 |
| 11.3.2.15 | QualifiedName .....               | 221 |
| 11.3.2.16 | TciBehaviourIdType .....          | 221 |
| 11.3.2.17 | TciTestCaseIdType .....           | 222 |
| 11.3.2.18 | TciParameterType .....            | 222 |
| 11.3.2.19 | TciParameterListType .....        | 222 |
| 11.3.2.20 | TriPortIdListType .....           | 222 |
| 11.3.3    | Abstract value mapping .....      | 223 |
| 11.3.3.1  | Value .....                       | 223 |
| 11.3.3.2  | IntegerValue .....                | 225 |
| 11.3.3.3  | FloatValue .....                  | 225 |
| 11.3.3.4  | BooleanValue .....                | 225 |
| 11.3.3.5  | Void .....                        | 226 |
| 11.3.3.6  | VerdictValue .....                | 226 |
| 11.3.3.7  | BitstringValue .....              | 226 |
| 11.3.3.8  | HexstringValue .....              | 226 |
| 11.3.3.9  | OctetstringValue .....            | 226 |
| 11.3.3.10 | CharstringValue .....             | 227 |
| 11.3.3.11 | UniversalCharstringValue .....    | 227 |
| 11.3.3.12 | RecordValue .....                 | 227 |
| 11.3.3.13 | RecordOfValue .....               | 228 |
| 11.3.3.14 | ArrayValue .....                  | 229 |

|           |  |     |
|-----------|--|-----|
| 11.3.3.15 | SetValue .....   | 230 |
| 11.3.3.16 | SetOfValue .....   | 230 |
| 11.3.3.17 | EnumeratedValue .....                                    | 230 |
| 11.3.3.18 | UnionValue .....   | 231 |
| 11.3.3.19 | AnytypeValue .....                                       | 231 |
| 11.3.3.20 | AddressValue .....                                       | 232 |
| 11.3.3.21 | ComponentValue .....                                     | 232 |
| 11.3.3.22 | PortValue .....  | 232 |
| 11.3.3.23 | DefaultValue .....                                       | 233 |
| 11.3.3.24 | TimerValue .....   | 233 |
| 11.3.3.25 | MatchingMechanism .....                                  | 233 |
| 11.3.3.26 | MatchingList .....                                       | 234 |
| 11.3.3.27 | ValueRange .....   | 234 |
| 11.3.3.28 | CharacterPattern .....                                   | 235 |
| 11.3.3.29 | MatchDecodedContent .....                                | 235 |
| 11.3.4    | Abstract logging types mapping .....                     | 235 |
| 11.3.4.1  | TciValueTemplate .....                                   | 235 |
| 11.3.4.2  | TciNonValueTemplate .....                                | 237 |
| 11.3.4.3  | TciValueList .....                                       | 237 |
| 11.3.4.4  | TciValueDifference .....                                 | 238 |
| 11.3.4.5  | TciValueDifferenceList .....                             | 238 |
| 11.4      | Mapping of the operations on the logging interface ..... | 238 |
| 11.4.0    | Mapping rules .....                                      | 238 |
| 11.4.1    | Event .....  | 238 |
| 11.4.2    | The TCI-TL interface .....                               | 239 |
| 11.4.2.1  | TCI-TL provided .....                                    | 239 |
| 12        | C# mapping .....   | 261 |
| 12.1      | Introduction .....                                       | 261 |
| 12.2      | Names and scopes .....                                   | 261 |
| 12.2.1    | Names .....  | 261 |
| 12.2.2    | Scopes .....   | 262 |
| 12.3      | Null value mapping .....                                 | 262 |
| 12.4      | Type mapping .....                                       | 262 |
| 12.4.1    | Basic type mapping .....                                 | 262 |
| 12.4.1.0  | Mapped types .....                                       | 262 |
| 12.4.1.1  | TciVerdict .....   | 263 |
| 12.4.2    | Structured type mapping .....                            | 263 |
| 12.4.2.0  | Mapping rules .....                                      | 263 |
| 12.4.2.1  | TciParameterPassingModeType .....                        | 263 |
| 12.4.2.2  | TciParameterType .....                                   | 263 |
| 12.4.2.3  | TciParameterListType .....                               | 263 |
| 12.4.2.4  | TciTypeClassType .....                                   | 264 |
| 12.4.2.5  | TciTestComponentKindType .....                           | 264 |
| 12.4.2.6  | TciBehaviourIdType .....                                 | 264 |
| 12.4.2.7  | TciTestCaseIdType .....                                  | 265 |
| 12.4.2.8  | TciTestCaseIdListType .....                              | 265 |
| 12.4.2.9  | TciModuleIdType .....                                    | 265 |
| 12.4.2.10 | TciModuleIdListType .....                                | 265 |
| 12.4.2.11 | TciModuleParameterIdType .....                           | 266 |
| 12.4.2.12 | TciModuleParameterType .....                             | 266 |
| 12.4.2.13 | TciModuleParameterListType .....                         | 266 |
| 12.4.2.14 | TciParameterTypeType .....                               | 266 |
| 12.4.2.15 | TciParameterTypeListType .....                           | 267 |
| 12.4.2.16 | TciMatchingTypeType .....                                | 267 |
| 12.4.2.17 | LengthRestriction .....                                  | 267 |
| 12.4.2.18 | Permutation .....  | 268 |
| 12.4.2.19 | RangeBoundary .....                                      | 268 |
| 12.4.3    | Abstract type mapping .....                              | 268 |
| 12.4.3.0  | Mapping rules .....                                      | 268 |
| 12.4.3.1  | Type .....   | 268 |
| 12.4.4    | Abstract value mapping .....                             | 270 |

|                             |  |            |
|-----------------------------|--|------------|
| 12.4.4.0                    | Mapping rules .....                          | 270        |
| 12.4.4.1                    | Value .....                                  | 270        |
| 12.4.4.2                    | IntegerValue .....                           | 271        |
| 12.4.4.3                    | FloatValue .....                             | 272        |
| 12.4.4.4                    | BooleanValue .....                           | 272        |
| 12.4.4.5                    | CharstringValue .....                        | 272        |
| 12.4.4.6                    | BitstringValue .....                         | 273        |
| 12.4.4.7                    | OctetstringValue .....                       | 274        |
| 12.4.4.8                    | UniversalCharstringValue .....               | 274        |
| 12.4.4.9                    | HexstringValue .....                         | 275        |
| 12.4.4.10                   | RecordValue .....                            | 276        |
| 12.4.4.11                   | RecordOfValue .....                          | 276        |
| 12.4.4.12                   | UnionValue .....                             | 278        |
| 12.4.4.13                   | EnumeratedValue .....                        | 278        |
| 12.4.4.14                   | VerdictValue .....                           | 278        |
| 12.4.4.15                   | AddressValue .....                           | 279        |
| 12.4.5                      | Abstract template mapping .....              | 279        |
| 12.4.5.0                    | Mapping rules .....                          | 279        |
| 12.4.5.1                    | MatchingMechanism .....                      | 279        |
| 12.4.5.2                    | MatchingList .....                           | 279        |
| 12.4.5.3                    | ValueRange .....                             | 280        |
| 12.4.5.4                    | CharacterPattern .....                       | 280        |
| 12.4.5.5                    | MatchDecodedContent .....                    | 280        |
| 12.4.6                      | Abstract logging types mapping .....         | 280        |
| 12.4.6.0                    | Mapping rules .....                          | 280        |
| 12.4.6.1                    | TciValueTemplate .....                       | 281        |
| 12.4.6.2                    | TciNonValueTemplate .....                    | 281        |
| 12.4.6.3                    | TciValueList .....                           | 281        |
| 12.4.6.4                    | TciValueDifference .....                     | 282        |
| 12.4.6.5                    | TciValueDifferenceList .....                 | 282        |
| 12.4.6.6                    | TciStatusType .....                          | 282        |
| 12.4.6.7                    | ComponentStatusType .....                    | 283        |
| 12.4.6.8                    | TimerStatusType .....                        | 283        |
| 12.5                        | Mapping of interfaces .....                  | 283        |
| 12.5.0                      | Calling rules .....                          | 283        |
| 12.5.1                      | TCI-TM interface .....                       | 283        |
| 12.5.1.1                    | TCI-TM provided .....                        | 283        |
| 12.5.1.2                    | TCI-TM required .....                        | 284        |
| 12.5.2                      | TCI-CD interface .....                       | 284        |
| 12.5.2.1                    | TCI-CD provided .....                        | 284        |
| 12.5.2.2                    | TCI-CD required .....                        | 284        |
| 12.5.3                      | TCI-CH interface .....                       | 285        |
| 12.5.3.1                    | TCI-CH provided .....                        | 285        |
| 12.5.3.2                    | TCI-CH required .....                        | 286        |
| 12.5.4                      | TCI-TL interface .....                       | 286        |
| 12.5.4.1                    | TCI-TL provided .....                        | 286        |
| 12.6                        | Optional parameters .....                    | 293        |
| 12.7                        | Error Handling .....                         | 293        |
| <b>Annex A (normative):</b> | <b>IDL Specification of TCI .....</b>        | <b>294</b> |
| <b>Annex B (normative):</b> | <b>XML Mapping for TCI TL Provided .....</b> | <b>312</b> |
| B.0                         | Introduction .....                           | 312        |
| B.1                         | TCI-TL XML Schema for Simple Types .....     | 312        |
| B.2                         | TCI-TL XML Schema for Types .....            | 313        |
| B.3                         | TCI-TL XML Schema for Values .....           | 315        |
| B.4                         | TCI-TL XML Schema for Templates .....        | 319        |
| B.5                         | TCI-TL XML Schema for Events .....           | 322        |

|                               |   |            |
|-------------------------------|---|------------|
| B.6                           | TCI-TL XML Schema for a Log.....  | 345        |
| <b>Annex C (informative):</b> | <b>Use scenarios .....</b>  | <b>349</b> |
| C.0                           | Introduction .....  | 349        |
| C.1                           | Initialization, collecting information, logging.....                          | 349        |
| C.1.1                         | Use scenario: initialization .....  | 349        |
| C.1.1.0                       | Scenario description.....   | 349        |
| C.1.1.1                       | Sequence diagram .....  | 350        |
| C.1.1.2                       | TTCN-3 fragment .....   | 350        |
| C.1.2                         | Use scenario: requesting module parameters .....                              | 350        |
| C.1.2.0                       | Scenario description.....   | 350        |
| C.1.2.1                       | Sequence diagram .....  | 351        |
| C.1.2.2                       | TTCN-3 fragment .....   | 351        |
| C.1.3                         | Use scenario: logging .....   | 351        |
| C.1.3.0                       | Scenario description.....   | 351        |
| C.1.3.1                       | Sequence diagram .....  | 352        |
| C.1.3.2                       | TTCN-3 fragment .....   | 352        |
| C.2                           | Execution of test cases and control .....                                     | 352        |
| C.2.1                         | Use scenario: execution of control .....                                      | 352        |
| C.2.1.0                       | Scenario description.....   | 352        |
| C.2.1.1                       | Sequence diagram .....  | 353        |
| C.2.1.2                       | TTCN-3 fragment .....   | 353        |
| C.2.2                         | Use scenario: test case execution within control .....                        | 353        |
| C.2.2.0                       | Scenario description.....   | 353        |
| C.2.2.1                       | Sequence diagram .....  | 354        |
| C.2.2.2                       | TTCN-3 fragment .....   | 354        |
| C.2.3                         | Use scenario: direct test case execution .....                                | 354        |
| C.2.3.0                       | Scenario description.....   | 354        |
| C.2.3.1                       | Sequence diagram .....  | 355        |
| C.2.3.2                       | TTCN-3 fragment .....   | 355        |
| C.2.4                         | Use scenario: execute test case to TRI .....                                  | 355        |
| C.2.4.0                       | Scenario description.....   | 355        |
| C.2.4.1                       | Sequence diagram .....  | 356        |
| C.2.4.2                       | TTCN-3 fragment .....   | 356        |
| C.3                           | Component handling .....  | 356        |
| C.3.1                         | Use scenario: local control component creation .....                          | 356        |
| C.3.1.0                       | Scenario description.....   | 356        |
| C.3.1.1                       | Sequence diagram .....  | 357        |
| C.3.1.2                       | TTCN-3 fragment .....   | 357        |
| C.3.2                         | Use scenario: remote control component creation.....                          | 357        |
| C.3.2.0                       | Scenario description.....   | 357        |
| C.3.2.1                       | Sequence diagram .....  | 358        |
| C.3.2.2                       | TTCN-3 fragment .....   | 358        |
| C.3.3                         | Use scenario: local MTC creation .....  | 358        |
| C.3.3.0                       | Scenario description.....   | 358        |
| C.3.3.1                       | Sequence diagram .....  | 359        |
| C.3.3.2                       | TTCN-3 fragment .....   | 359        |
| C.3.4                         | Use scenario: remote MTC creation .....                                       | 359        |
| C.3.4.0                       | Scenario description.....   | 359        |
| C.3.4.1                       | Sequence diagram .....  | 360        |
| C.3.4.2                       | TTCN-3 fragment .....   | 360        |
| C.3.5                         | Use scenario: component handling for test case execution within control ..... | 360        |
| C.3.5.0                       | Scenario description.....   | 360        |
| C.3.5.1                       | Sequence diagram .....  | 361        |
| C.3.5.2                       | TTCN-3 fragment .....   | 361        |
| C.3.6                         | Use scenario: component handling for direct test case execution .....         | 362        |
| C.3.6.0                       | Scenario description.....   | 362        |
| C.3.6.1                       | Sequence diagram .....  | 362        |
| C.3.6.2                       | TTCN-3 fragment .....   | 363        |

|                               |  |            |
|-------------------------------|--|------------|
| C.3.7                         | Use scenario: propagation of map/connect.....                      | 363        |
| C.3.7.0                       | Scenario description.....  | 363        |
| C.3.7.1                       | Sequence diagram.....  | 363        |
| C.3.7.2                       | TTCN-3 fragment.....   | 363        |
| C.3.8                         | Use scenario: propagation of unmap/disconnect.....                 | 364        |
| C.3.8.0                       | Scenario description.....  | 364        |
| C.3.8.1                       | Sequence diagram.....  | 364        |
| C.3.8.2                       | TTCN-3 fragment.....   | 364        |
| C.4                           | Termination of test cases and control.....                         | 364        |
| C.4.1                         | Use scenario: stop a test case.....                                | 364        |
| C.4.1.0                       | Scenario description.....  | 364        |
| C.4.1.1                       | Sequence diagram.....  | 365        |
| C.4.1.2                       | TTCN-3 fragment.....   | 365        |
| C.4.2                         | Use scenario: stop control.....                                    | 365        |
| C.4.2.0                       | Scenario description.....  | 365        |
| C.4.2.1                       | Sequence diagram.....  | 366        |
| C.4.2.2                       | TTCN-3 fragment.....   | 366        |
| C.4.3                         | Use scenario: termination of control after error.....              | 366        |
| C.4.3.0                       | Scenario description.....  | 366        |
| C.4.3.1                       | Sequence diagram.....  | 367        |
| C.4.3.2                       | TTCN-3 fragment.....   | 367        |
| C.4.4                         | Use scenario: termination of a test case after error.....          | 367        |
| C.4.4.0                       | Scenario description.....  | 367        |
| C.4.4.1                       | Sequence diagram.....  | 368        |
| C.4.4.2                       | TTCN-3 fragment.....   | 369        |
| C.4.5                         | Use scenario: reset.....   | 369        |
| C.4.5.0                       | Scenario description.....  | 369        |
| C.4.5.1                       | Sequence diagram.....  | 369        |
| C.4.5.2                       | TTCN-3 fragment.....   | 369        |
| C.5                           | Communication.....   | 369        |
| C.5.1                         | Use scenario: local intercomponent communication.....              | 369        |
| C.5.1.0                       | Scenario description.....  | 369        |
| C.5.1.1                       | Sequence diagram.....  | 370        |
| C.5.1.2                       | TTCN-3 fragment.....   | 370        |
| C.5.2                         | Use scenario: internode communication between test components..... | 371        |
| C.5.2.0                       | Scenario description.....  | 371        |
| C.5.2.1                       | Sequence diagram.....  | 371        |
| C.5.2.2                       | TTCN-3 fragment.....   | 371        |
| C.5.3                         | Use scenario: encoding.....  | 372        |
| C.5.3.0                       | Scenario description.....  | 372        |
| C.5.3.1                       | Sequence diagram.....  | 372        |
| C.5.3.2                       | TTCN-3 fragment.....   | 372        |
| C.5.4                         | Use scenario: decoding.....  | 372        |
| C.5.4.0                       | Scenario description.....  | 372        |
| C.5.4.1                       | Sequence diagram.....  | 373        |
| C.5.4.2                       | TTCN-3 fragment.....   | 373        |
| <b>Annex D (informative):</b> | <b>Bibliography.....</b>   | <b>374</b> |
| History.....                  |  | 375        |

---

## Intellectual Property Rights

### Essential patents

IPRs essential or potentially essential to normative deliverables may have been declared to ETSI. The declarations pertaining to these essential IPRs, if any, are publicly available for **ETSI members and non-members**, and can be found in ETSI SR 000 314: "*Intellectual Property Rights (IPRs); Essential, or potentially Essential, IPRs notified to ETSI in respect of ETSI standards*", which is available from the ETSI Secretariat. Latest updates are available on the ETSI Web server (<https://ipr.etsi.org/>).

Pursuant to the ETSI Directives including the ETSI IPR Policy, no investigation regarding the essentiality of IPRs, including IPR searches, has been carried out by ETSI. No guarantee can be given as to the existence of other IPRs not referenced in ETSI SR 000 314 (or the updates on the ETSI Web server) which are, or may be, or may become, essential to the present document.

### Trademarks

The present document may include trademarks and/or tradenames which are asserted and/or registered by their owners. ETSI claims no ownership of these except for any which are indicated as being the property of ETSI, and conveys no right to use or reproduce any trademark and/or tradename. Mention of those trademarks in the present document does not constitute an endorsement by ETSI of products, services or organizations associated with those trademarks.

**DECT™**, **PLUGTESTS™**, **UMTS™** and the ETSI logo are trademarks of ETSI registered for the benefit of its Members. **3GPP™** and **LTE™** are trademarks of ETSI registered for the benefit of its Members and of the 3GPP Organizational Partners. **oneM2M™** logo is a trademark of ETSI registered for the benefit of its Members and of the oneM2M Partners. **GSM®** and the GSM logo are trademarks registered and owned by the GSM Association.

---

## Foreword

This ETSI Standard (ES) has been produced by ETSI Technical Committee Methods for Testing and Specification (MTS).

The present document is part 6 of a multi-part deliverable. Full details of the entire series can be found in part 1 [1].

---

## Modal verbs terminology

In the present document "**shall**", "**shall not**", "**should**", "**should not**", "**may**", "**need not**", "**will**", "**will not**", "**can**" and "**cannot**" are to be interpreted as described in clause 3.2 of the [ETSI Drafting Rules](#) (Verbal forms for the expression of provisions).

"**must**" and "**must not**" are **NOT** allowed in ETSI deliverables except when used in direct citation.



---

# 1 Scope

The present document specifies the control interfaces for TTCN-3 test system implementations. The TTCN-3 Control Interfaces provide a standardized adaptation for management, test component handling and encoding/decoding of a test system to a particular test platform. The present document defines the interfaces as a set of operations independent of a target language.

The interfaces are defined to be compatible with the TTCN-3 standard (see clause 2). The interface definition uses the CORBA Interface Definition Language (IDL) to specify the TCI completely. Clauses 8, 9, 10, 11 and 12 present language mappings for this abstract specification to the target languages Java™, ANSI C, C++, XML and C#. A summary of the IDL-based interface specification is provided in annex A.

NOTE: Java™ is the trade name of a programming language developed by Oracle Corporation. This information is given for the convenience of users of the present document and does not constitute an endorsement by ETSI of the programming language named. Equivalent programming languages may be used if they can be shown to lead to the same results.

---

## 2 References

### 2.1 Normative references

References are either specific (identified by date of publication and/or edition number or version number) or non-specific. For specific references, only the cited version applies. For non-specific references, the latest version of the referenced document (including any amendments) applies.

Referenced documents which are not found to be publicly available in the expected location might be found at <https://docbox.etsi.org/Reference/>.

NOTE: While any hyperlinks included in this clause were valid at the time of publication ETSI cannot guarantee their long term validity.

The following referenced documents are necessary for the application of the present document.

- [1] ETSI ES 201 873-1: "Methods for Testing and Specification (MTS); The Testing and Test Control Notation version 3; Part 1: TTCN-3 Core Language".
- [2] ETSI ES 201 873-4: "Methods for Testing and Specification (MTS); The Testing and Test Control Notation version 3; Part 4: TTCN-3 Operational Semantics".
- [3] ETSI ES 201 873-5: "Methods for Testing and Specification (MTS); The Testing and Test Control Notation version 3; Part 5: TTCN-3 Runtime Interface (TRI)".
- [4] Recommendation ITU-T X.290: "OSI conformance testing methodology and framework for protocol Recommendations for ITU-T applications - General concepts".

NOTE: The corresponding ISO/IEC standard is ISO/IEC 9646-1: "Information technology -- Open Systems Interconnection -- Conformance testing methodology and framework; Part 1: General concepts".

- [5] ISO/IEC 10646: "Information technology -- Universal Coded Character Set (UCS)".
- [6] CORBA 3.0: "Common Object Request Broker Architecture: Core Specification", OMG Formal Document (specifies IDL).
- [7] Sun Microsystems: "The Java™ Language Specification".

NOTE: See at <https://docs.oracle.com/javase/specs/>.

- [8] ISO/IEC 9899: "Information technology -- Programming languages -- C".
- [9] ISO/IEC 14882:2017: " Programming languages -- C++".

[10] W3C® Recommendation: "XML Schema Part 0: Primer".

NOTE: See at <http://www.w3.org/TR/xmlschema-0/>.

[11] W3C® Recommendation: "XML Schema Part 1: Structures".

NOTE: See at <http://www.w3.org/TR/xmlschema-1/>.

[12] W3C® Recommendation: "XML Schema Part 2: Datatypes".

NOTE: See at <http://www.w3.org/TR/xmlschema-2/>.

[13] ECMA-334: "C# Language Specification".

NOTE: See at <http://www.ecma-international.org/publications/standards/Ecma-334.htm>.

## 2.2 Informative references

References are either specific (identified by date of publication and/or edition number or version number) or non-specific. For specific references, only the cited version applies. For non-specific references, the latest version of the referenced document (including any amendments) applies.

NOTE: While any hyperlinks included in this clause were valid at the time of publication ETSI cannot guarantee their long term validity.

The following referenced documents are not necessary for the application of the present document but they assist the user with regard to a particular subject area.

Not applicable.

---

# 3 Definition of terms, symbols and abbreviations

## 3.1 Terms

For the purposes of the present document, the terms given in Recommendation ITU-T X.290 [4] and the following apply:

**Abstract Test Suite (ATS):** test suite composed of abstract test cases, which are specified by TTCN-3 module(s)

**codec:** encoder/decoder entity used for encoding and decoding data to be transmitted and received, respectively

**Coding/Decoding (CD):** entity that administers the value and type handling including encoding and decoding in the TTCN-3 test system

**communication port:** abstract mechanism facilitating communication between test components

NOTE: A communication port is modelled as a FIFO queue in the receiving direction. Ports can be message-based, procedure-based or a mixture of the two.

**Component Handling (CH):** entity that administers the handling of test components in the TTCN-3 test system

**control component:** component that executes the behaviour of the control part of a TTCN-3 module

**Executable Test Suite (ETS):** Refer to Recommendation ITU-T X.290 [4].

**Implementation eXtra Information for Testing (IXIT):** Refer to Recommendation ITU-T X.290 [4].

**Platform Adaptor (PA):** entity that adapts the TTCN-3 Executable to a particular execution platform

NOTE: The Platform Adaptor creates a single notion of time for a TTCN-3 test system, and implements both, explicit and implicit, timers as well as external functions.

**real test system interface:** Refer to Recommendation ITU-T X.290 [4].

**SUT Adaptor (SA):** entity that adapts the TTCN-3 communication operations with the SUT based on an abstract test system interface

NOTE: It implements the real test system interface.

**System Under Test (SUT):** Refer to Recommendation ITU-T X.290 [4].

**test case:** Refer to Recommendation ITU-T X.290 [4].

**test event:** either sent or received test data (message or procedure call) on a communication port that is part of the test system interface as well as timeout events of timers

**Test Logging (TL):** entity which provides logging information about test execution (including also the information provided by the TTCN-3 log statement)

**Test Management (TM):** entity which provides a user interface to as well as the administration of the TTCN-3 test system

**Test Management and Control (TMC):** set of entities providing test management and control; consists of the Test Management (TM), the Component Handling (CH), the Test Logging (TL) and the Coding/Decoding (CD)

NOTE: The TMC is an implementation of TCI.

**test system:** Refer to Recommendation ITU-T X.290 [4].

**Test System Interface (TSI):** test component that provides a mapping of the ports available in the (abstract) TTCN-3 test system to those offered by a real test system

**Testing and Test Control Notation (TTCN-3):** Refer to Recommendation ITU-T X.290 [4].

**TTCN-3 Control Interfaces (TCI):** four interfaces that define the interaction of the TTCN-3 Executable with the test management, the coding and decoding, the test component handling and the logging in a test system

**TTCN-3 Executable (TE):** part of a test system that deals with interpretation or execution of a TTCN-3 ETS

**TTCN-3 Runtime Interface (TRI):** two interfaces that define the interaction of the TTCN-3 Executable between the SUT and the Platform Adapter (PA) and the System Adapter (SA) in a test system

## 3.2 Symbols

Void.

## 3.3 Abbreviations

For the purposes of the present document, the following abbreviations apply:

|       |  |
|-------|--|
| ADT   | Abstract Data Type                                 |
| ANSI  | American National Standards Institute              |
| ASCII | American Standard Code for Information Interchange |
| ATS   | Abstract Test Suite                                |
| CD    | (External) Coding/Decoding                         |
| CH    | Component Handler                                  |
| CORBA | Common Object Request Broker Architecture          |
| CR    | Carriage Return                                    |
| ETS   | Executable Test Suite                              |
| FIFO  | First In First Out                                 |
| IDL   | Interface Definition Language                      |
| IXIT  | Implementation eXtra Information for Testing       |
| LF    | Line Feed  |
| MTC   | Main Test Component                                |
| OMG   | Object Management Group                            |

|        |   |
|--------|---|
| PA     | Platform Adaptor                            |
| PTC    | Parallel Test Component                     |
| SA     | SUT Adaptor                                 |
| SUT    | System Under Test                           |
| TCI    | TTCN-3 Control Interfaces                   |
| TE     | TTCN-3 Executable                           |
| TL     | Test Logging                                |
| TLI    | Test Logging Interface                      |
| TM     | Test Management                             |
| TMC    | Test Management and Control                 |
| TRI    | TTCN-3 Runtime Interface                    |
| TSI    | Test System Interface                       |
| TTCN-3 | Testing and Test Control Notation Version 3 |
| UML    | Unified Modelling Language                  |
| W3C    | World Wide Web Consortium                   |
| XML    | eXtensible Markup Language                  |

---

## 4 Introduction

The present document consists of two distinct parts, the first part describing the structure of a TTCN-3 test system implementation and the second part presenting the TTCN-3 Control Interfaces specification.

The first part introduces the decomposition of a TTCN-3 test system into four main entities:

- Test Management and Control (TMC).
- TTCN-3 Executable (TE).
- SUT Adaptor (SA).
- Platform Adaptor (PA).

The TMC consists itself of three entities: Test Management (TM), Coder/Decoder (CD), and Test Component Handler (CH). In addition, the interaction between these entities, i.e. the corresponding interfaces, is defined.

The second part of the present document specifies the TTCN-3 Control Interfaces (TCI). The interfaces are defined in terms of operations implemented as part of one entity and called by other test system entities. For each operation, the interface specification defines associated data structures, the intended effect on the test system and any constraints on the usage of the operation. Note that these interface specifications only define interactions between the TE and TM, TE and CD, and TE and CH. For interactions between the TE and SA and the TE and PA please refer to the TTCN-3 Runtime Interface specification (ETSI ES 201 873-5 [3]).

---

## 5 Compliance

The minimum required for a TCI compliant TTCN-3 test system is to adhere to the interface specification stated in the present document. The TTCN-3 semantics in the test system shall adhere to the operational semantics defined in ETSI ES 201 873-4 [2]. In addition, one language mapping shall be supported. For example, if a vendor supports Java™, the TCI operation calls and implementations, which are part of the TTCN-3 executable, shall comply with the IDL to Java™ mapping specified in the present document. For the logging interface, the XML mapping can be used instead of the Java™ or the C mapping.

## 6 General structure of a TTCN-3 test system

### 6.1 Entities in a TTCN-3 test system

#### 6.1.0 Types of entities

A TTCN-3 test system can be thought of conceptually as a set of interacting entities. Each entity implements specific test system functionality. These entities:

- manage test execution;
- interpret or execute compiled TTCN-3 code;
- realize proper communication with the SUT;
- administer types, values and test components;
- implement external functions; and
- handle timer operations.

The structure of a TTCN-3 test system implementation is illustrated in figure 1.

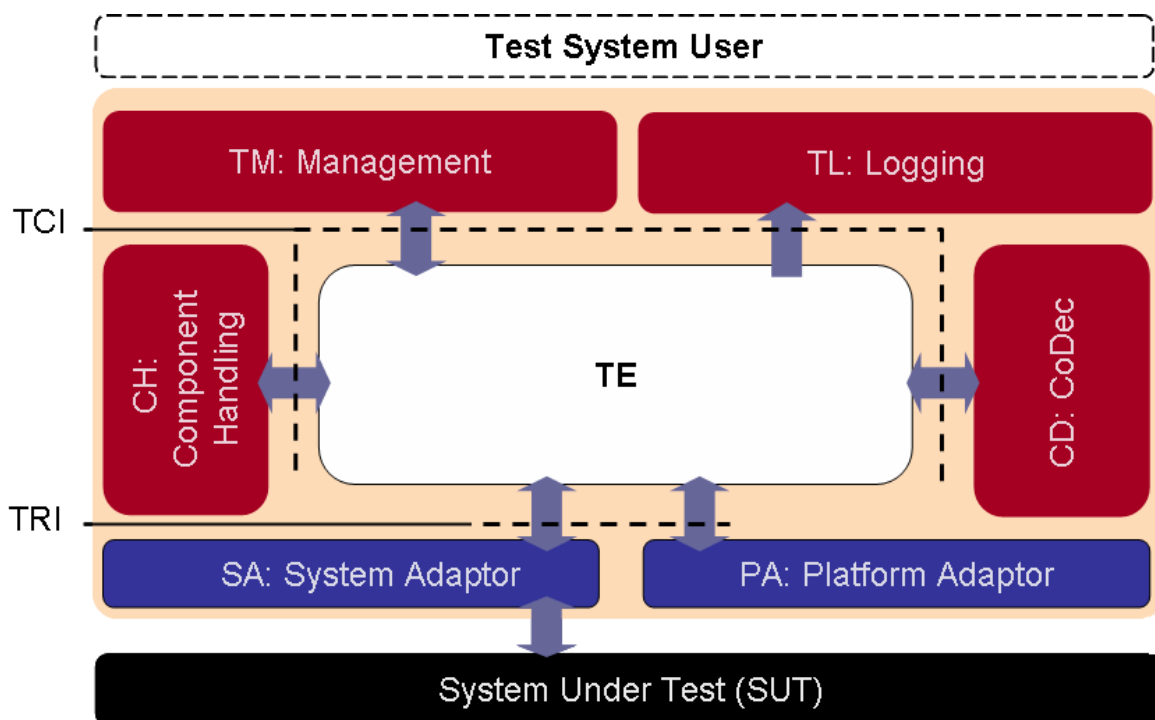

**Figure 1: General structure of a TTCN-3 test system**

As shown in figure 1, the TTCN-3 Executable (TE), also referred to as the Executable Test Suite (ETS), interprets and executes TTCN-3 modules. Various TE structural elements can be identified: control, behaviour, components, types, values and queues. The structural elements within the TE represent functionality that is defined within a TTCN-3 module or by the TTCN-3 standard (ETSI ES 201 873-1 [1]) itself. For example, the structural element "Control" represents the control part within a TTCN-3 module, while the structural element "Queues" represents the requirement on a TTCN-3 Executable that each port of a test component maintains its own port queue. While the first is specified within a TTCN-3 module, the latter is required by the TTCN-3 specification.

Refinement of the TE, as shown in figure 1, is provided as an aid in defining the TTCN-3 Control Interfaces. The TE would typically correspond in a test system implementation either to the executable code produced by a TTCN-3 compiler or by a TTCN-3 interpreter.

The TE may be executed in a centralized or in a distributed manner. That is, on a single test device or across several test devices respectively. Although the structural entities of the TE implement a complete TTCN-3 module, single structural entities might be distributed over several test devices.

The TE implements a TTCN-3 module on an abstract level. The other entities of a TTCN-3 test system make these abstract concepts concrete. For example, the abstract concept of sending a message or receiving a timeout cannot be implemented within the TE. The remaining part of the test system implements the encoding of the message and its sending over concrete physical means or measuring the time and determining when a timer has expired, respectively.

The SA and PA and their interaction with the TE are defined in ETSI ES 201 873-5 [3]. The TCI specification defines the interaction between the TE and the TMC.

The logging interface provides logging capabilities to all elements of the test system architecture, i.e. the TE, the TM, the CH, the CD, the SA and the PA are able to log information on the test execution via TL. Figure 2 represents a more detailed view on TL.

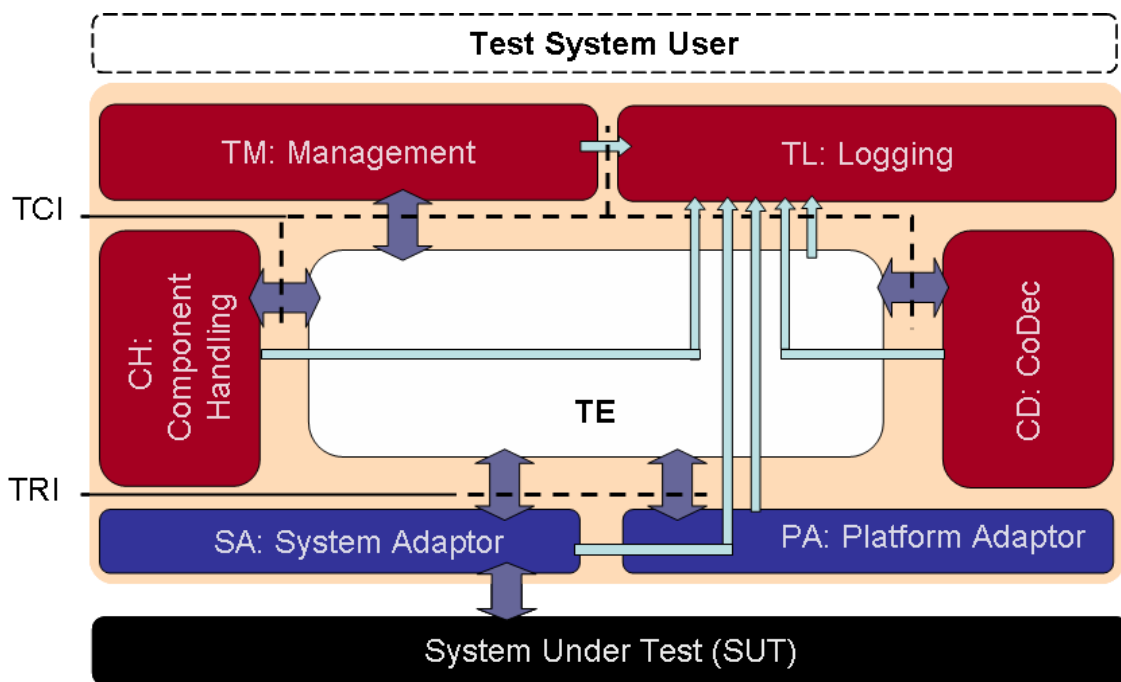

Figure 2: Detailed View on TL

## 6.1.1 Test Management and Control (TMC)

### 6.1.1.0 Test Management and Control Entities

The TMC entity includes functionality related to management of:

- test execution;
- components;
- encoding and decoding; and
- logging.

#### 6.1.1.1 Test Management (TM)

The TM entity is responsible for the overall management of a test system. After the test system has been initialized, test execution starts within the TM entity. The entity is responsible for the proper invocation of TTCN-3 modules, i.e. propagating module parameters such as IXIT information to the TE if necessary. Typically, this entity would also implement a test system user interface.

### 6.1.1.2 Coding and Decoding (CD)

The CD entity is responsible for the external encoding and decoding of TTCN-3 values into bitstrings suitable to be sent to the System Under Tests (SUT). Whenever external codecs are used, the TE determines which codecs shall be used. It passes the TTCN-3 data to the appropriate encoder to obtain the encoded data. Received data is decoded in the CD entity by using the appropriate decoder, which translates the received data into TTCN-3 values.

### 6.1.1.3 Component Handling (CH)

The TE can be distributed among several test devices. The CH implements communication between distributed test system entities. The CH entity provides the means to synchronize test system entities which might be distributed onto several nodes.

NOTE 1: Nodes and test devices are used as synonyms.

The general structure of a test system distributed among several nodes is depicted in figure 3.

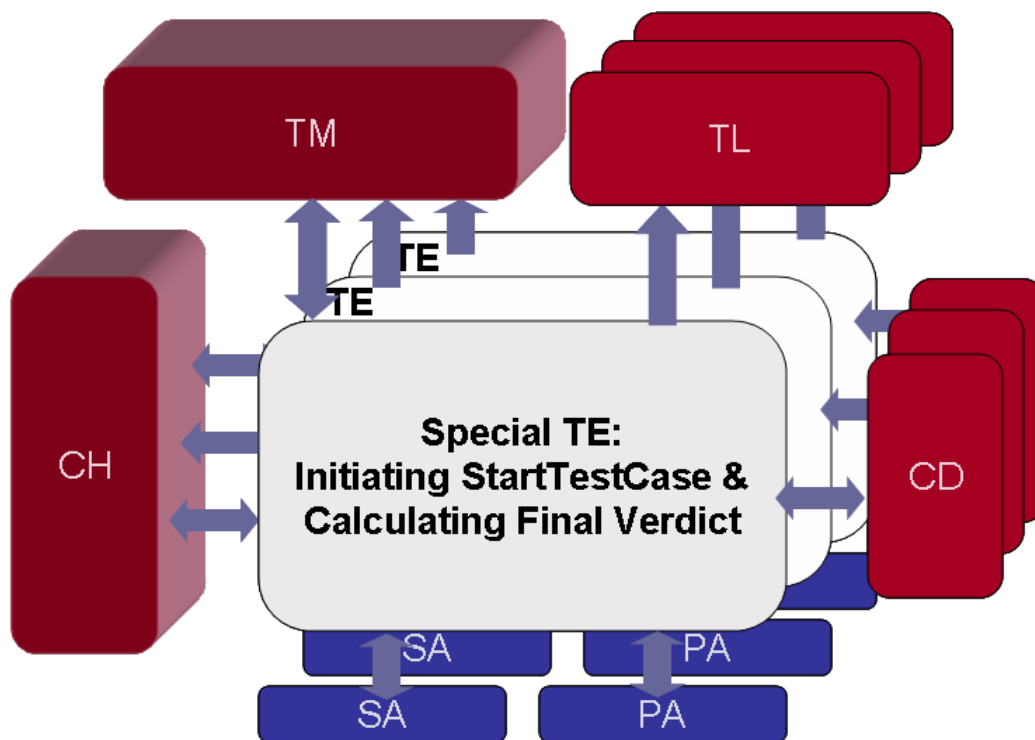

**Figure 3: General structure of a distributed TTCN-3 test system**

Each node within a test system includes the TE, SA, PA, CD and TL entities. The entities CH and TM mediate the test management and test component handling between the TEs on each node. The TE which starts a test case is a special TE. It shall calculate the final test case verdict. Besides this, all TEs are handled the same.

NOTE 2: As stated in ETSI ES 201 873-4 [2], a test system executes at most one test case at a given point in time, i.e. a TTCN-3 module cannot execute multiple test cases at the same time.

The creation of the MTC, PTCs and the control component in TEs is controlled by CH. Please note the special role of the system component, which exists only conceptually and not as a running test component in a TE. System ports, i.e. the ports of the system component, may be distributed among several nodes. Further, test components on different nodes may have access to the same physical port of the SUT, i.e. they may be mapped to the same port of the test system interface.

EXAMPLE: Access to remote real SUT ports can be realized by TEs via local proxies.

Communication between TTCN-3 components is either message or procedure based. Therefore, the CH adapts message and procedure based communication of TTCN-3 components to the particular execution platform of the test system. It is aware of connections between TTCN-3 test component communication ports. It propagates send request operations from one TTCN-3 component to another TTCN-3 component. The receiving component may reside in a different instance of the same TE located on a different node. It then notifies the TE of any received test events by enqueueing them in the port queues of the TE.

Procedure based communication operations between TTCN-3 components are also visible at the CH. The CH shall distinguish between the different kinds of procedure-based communication, i.e. call, reply, and exception, and shall propagate them in the appropriate manner to the TE where the target component resides. TTCN-3 procedure based communication semantics, i.e. the effect of such operation on TTCN-3 test component execution, are to be handled in the TE.

Additional communication is needed to implement the distribution of test components onto several nodes. Component management communication includes the indication of the creation of test components, the starting of execution of a test component, verdict distribution, as well as component termination indication. The CH does not implement the TTCN-3 component behaviour. Rather, it implements the communication between several components implemented by a TE.

#### 6.1.1.4 Test Logging (TL)

The TL entity performs test event logging and presentation to the test system user. It provides the logging of information about the test execution such as which test components have been created, started and terminated, which data is sent to the SUT, received from the SUT and matched to TTCN-3 templates, which timers have been started, stopped or timed out, etc.

#### 6.1.2 TTCN-3 Executable (TE)

The TE entity executes or interprets a TTCN-3 module. Conceptually, the TE can be decomposed into six interacting entities: a Control, Behaviour, Component, Type, Value and Queue entity. This structural decomposition of the TE is defined in ETSI ES 201 873-5 [3]. The terminology for TE defined in ETSI ES 201 873-5 [3] is used within the present document.

#### 6.1.3 SUT Adaptor (SA)

The SA is the implementation of the System under Test Adaptor (SA) as defined in ETSI ES 201 873-5 [3]. The terminology for SA defined in ETSI ES 201 873-5 [3] is used within the present document.

#### 6.1.4 Platform Adaptor (PA)

The PA is the implementation of the Platform Adaptor (PA) as defined in ETSI ES 201 873-5 [3]. The terminology for PA defined in ETSI ES 201 873-5 [3] is used within the present document.

### 6.2 Execution requirements for a TTCN-3 test system

Each TCI operation call shall be treated as an atomic operation in the calling entity. The called entity, which implements a TCI operation, shall return control to the calling entity as soon as its intended effect has been accomplished or if the operation cannot be completed successfully. The called entity shall not block in the implementation of procedure-based communication.

As stated before, no assumption is made as to whether the TTCN-3 test system or individual entities are implemented in a single executable or process or whether they are distributed among different processes or even test devices.

A TCI implementation shall fulfil the above mentioned requirements.



## 7 TTCN-3 control interface and operations

### 7.1 Overview of the TCI

#### 7.1.0 TCI role in a TTCN-3 test system

The clause 7 defines a set of abstract data types used to represent data communicated between the TE and the TMC. In addition, it defines TCI operations in terms of their signatures, when they are to be used and what their effects on the TTCN-3 test system are.

This definition also includes a more detailed description of the input parameters required for each TCI operation call and its return value.

The TCI defines the interaction between the TTCN-3 Executable (TE), Component Handling (CH), the Test Management (TM), the Coding/Decoding (CD), the Test Logging (TL) entities within a TTCN-3 test system. It provides means for the TE to:

- manage test execution;
- distribute execution of test components among different test devices;
- encode and decode test data; and
- logging of information about test execution.

The TCI consists of four sub-interfaces:

- **TCI Test Management Interface (TCI-TM):** This interface includes all operations needed to manage test execution, provide module parameters and external constants and provide test event logging.
- **TCI Component Handling Interface (TCI-CH):** This interface consists of operations needed to implement the management of, and communication between TTCN-3 test components in a centralized or distributed test system. It includes operations to create, start and stop test components, establish connection between TTCN-3 components, manage test components and their verdicts, and handle message and procedure based communication between TTCN-3 components.
- **TCI Coding/Decoding Interface (TCI-CD):** This interface includes all operations needed to retrieve and access codecs, i.e. encoders or decoders, for encoding data to be sent, defined using the TTCN-3 encode attribute, and to decode received data.
- **TCI Test Logging Interface (TCI-TL):** This interface includes all operations needed to retrieve information about test execution and to control the level of detail of this information.

All interfaces are bi-directional so that calling and called parts reside in the TE and in the TMC of the test system. The provided interfaces (those operations which an interface offers to the TE) and the required operations (those operation which an interface needs to use from the TE) are combined into the respective provided and required subinterface for each interface, i.e. TCI-TM Provided/ TCI-TM Required, TCI-CH Provided/ TCI-CH Required, TCI-CD Provided/ TCI-CD Required, and TCI-TL Provided/TCI-TL Required.

#### 7.1.1 Correlation between TTCN-3 and TCI operation invocations

##### 7.1.1.0 Mapping of TTCN-3 operations to TCI operations

For some TTCN-3 operation invocations, there is a direct correlation to a TCI operation invocation, which is shown in table 1. Some of the TTCN-3 operations correlate to a pair of TCI operation request and TCI operation to implement the propagation of TTCN-3 operations through the test system. For the other TCI operation invocations there is an indirect correlation - they are needed to implement the TTCN-3 semantics of underlying concepts.

### 7.1.1.1 TTCN-3 operations with TCI operation equivalent

The correlation shown for TTCN-3 communication operations (i.e. send, call, reply, and raise) only holds if these operations are invoked on a test component port connected to another test component port. The correlation for communication operations that are invoked on test component ports that are mapped to test system interface ports is defined in ETSI ES 201 873-5 [3].

**Table 1: Correlation between TTCN-3 communication operations and TCI operation invocations**

| TTCN-3 Operation Name                | TCI Operation Name               | TCI Interface Name |
|--------------------------------------|----------------------------------|--------------------|
| send                                 | tciSendConnected (see note 1)    | TCI-CH Provided    |
|                                      | tciSendConnectedBC (see note 2)  |                    |
|                                      | tciSendConnectedMC (see note 3)  |                    |
|                                      | tciEnqueueMsgConnected           | TCI-CH Required    |
| call                                 | tciCallConnected (see note 1)    | TCI-CH Provided    |
|                                      | tciCallConnectedBC (see note 2)  |                    |
|                                      | tciCallConnectedMC (see note 3)  |                    |
|                                      | tciEnqueueCallConnected          | TCI-CH Required    |
| reply                                | tciReplyConnected (see note 1)   | TCI-CH Provided    |
|                                      | tciReplyConnectedBC (see note 2) |                    |
|                                      | tciReplyConnectedMC (see note 3) |                    |
|                                      | tciEnqueueReplyConnected         | TCI-CH Required    |
| raise                                | tciRaiseConnected (see note 1)   | TCI-CH Provided    |
|                                      | tciRaiseConnectedBC (see note 2) |                    |
|                                      | tciRaiseConnectedMC (see note 3) |                    |
|                                      | tciEnqueueRaiseConnected         | TCI-CH Required    |
| log                                  | tliLog                           | TCI-TL Provided    |
| NOTE 1: For unicast communication.   |                                  |                    |
| NOTE 2: For broadcast communication. |                                  |                    |
| NOTE 3: For multicast communication. |                                  |                    |

### 7.1.1.2 TTCN-3 operations with TCI operation pair equivalent

The correlation for TTCN-3 test case, test component and port operations is shown below. The initiating TE issues a TCI request operation to the TCI-CH, which propagates the respective TCI operation on the TE(s) which has (have) to perform it.

**Table 2: Correlation between TTCN-3 test case, test component and port operations and TCI operation invocations**

| TTCN-3 Operation Name | TCI Operation Name            | TCI Interface Name |
|-----------------------|-------------------------------|--------------------|
| create                | tciCreateTestComponentReq     | TCI-CH Provided    |
|                       | tciCreateTestComponent        | TCI-CH Required    |
| start (a component)   | tciStartTestComponentReq      | TCI-CH Provided    |
|                       | tciStartTestComponent         | TCI-CH Required    |
| stop (a component)    | tciStopTestComponentReq       | TCI-CH Provided    |
|                       | tciStopTestComponent          | TCI-CH Required    |
| kill                  | tciKillTestComponentReq       | TCI-CH Provided    |
|                       | tciKillTestComponent          | TCI-CH Required    |
| connect               | tciConnectReq                 | TCI-CH Provided    |
|                       | tciConnect                    | TCI-CH Required    |
| disconnect            | tciDisconnectReq              | TCI-CH Provided    |
|                       | tciDisconnect                 | TCI-CH Required    |
| map                   | tciMapReq (see note 1)        | TCI-CH Provided    |
|                       | tciMapParamReq (see note 2)   |                    |
|                       | tciMap (see note 1)           | TCI-CH Required    |
|                       | tciMapParam (see note 2)      |                    |
| unmap                 | tciUnmapReq (see note 1)      | TCI-CH Provided    |
|                       | tciUnmapParamReq (see note 2) |                    |
|                       | tciUnmap (see note 1)         | TCI-CH Required    |
|                       | tciUnmapParam (see note 2)    |                    |

| TTCN-3 Operation Name                                  | TCI Operation Name         | TCI Interface Name |
|--|----------------------------|--------------------|
| running  | tciTestComponentRunningReq | TCI-CH Provided    |
|  | tciTestComponentRunning    | TCI-CH Required    |
| alive  | tciTestComponentAliveReq   | TCI-CH Provided    |
|  | tciTestComponentAlive      | TCI-CH Required    |
| done   | tciTestComponentDoneReq    | TCI-CH Provided    |
|  | tciTestComponentDone       | TCI-CH Required    |
| killed   | tciTestComponentKilledReq  | TCI-CH Provided    |
|  | tciTestComponentKilled     | TCI-CH Required    |
| mtc  | tciGetMTCReq               | TCI-CH Provided    |
|  | tciGetMTC                  | TCI-CH Required    |
| execute  | tciTestCaseExecuteReq      | TCI-CH Provided    |
|  | tciTestCaseExecute         | TCI-CH Required    |
| NOTE 1: For statement without configuration parameter. |                            |                    |
| NOTE 2: For statement with configuration parameter.    |                            |                    |

### 7.1.1.3 TTCN-3 operations without direct TCI operation equivalent

#### 7.1.1.3.0 Mapping of TTCN-3 operations to series of TCI operations

For some TTCN-3 operation invocations, there is no direct correlation to TCI operation invocations as the ones shown in table 1. These TTCN-3 operation invocations are realized by a series of TCI operation invocations as described in this clause.

#### 7.1.1.3.1 Test case stop operation

When the testcase.stop operation is invoked from the TE, the following actions need to be taken by the TE:

- the overall verdict should be set to `USER_ERROR` with the message given to the invocation of the testcase.stop operation as the verdict reason by invoking `tciSetVerdict()`;
- a reference to the mtc should be obtained by invoking `triGetMtcReq()` in the CH interface; and
- via TLI, testcase.stop shall be logged with `tliTcTerminated()` with verdict `USER_ERROR`;
- the mtc should be stopped by invoking `triStopTestComponentReq()` in the CH with the obtained reference to the mtc.

## 7.2 TCI data

### 7.2.0 Abstract data types

The TCI specification defines a set of abstract data types. These describe, at a very high level, which kind of data shall be passed from a calling to a called entity. The abstract data types are used to determine:

- how TTCN-3 data is passed from a TE to an encoder, to encode TTCN-3 value representations into a bitstring; and in the reverse case;
- how data passed from a decoder to the TE shall be decoded from a bitstring into its TTCN-3 value representation.

For these abstract data types a set of operations is defined to process the data by the coder/decoder.

The concrete representation of these abstract data types as well as the definition of basic data types like `string` and `boolean` are defined in the respective language mappings in clauses 8, 9, 10, 11 and 12.

Notice that the values for any identifier data type shall be unique in the test system implementation where uniqueness is defined as being globally distinct at any point in time. This guarantees that different objects, e.g. two timers, are identified by different identifiers and identifiers are not reused.

## 7.2.1 General abstract data types

### 7.2.1.0 Use of general abstract data types

The following abstract data types are defined and used for the definition of TCI operations.

#### 7.2.1.1 Management

|  |   |
|--|---|
| <code>TciModuleIdType</code>             | A value of <code>TciModuleIdType</code> is the name of a TTCN-3 module as specified in the TTCN-3 ATS. This abstract type is used for module handling.  |
| <code>TciModuleParameterIdType</code>    | A value of <code>TciModuleParameterIdType</code> is the qualified name of a TTCN-3 module parameter as specified in the TTCN-3 ATS. This abstract type is used for module parameter handling.   |
| <code>TciTestCaseIdType</code>           | A value of <code>TciTestCaseIdType</code> is the qualified name of a TTCN-3 testcase as specified in the TTCN-3 ATS. This abstract type is used for testcase handling.  |
| <code>TciTestCaseIdListType</code>       | A value of <code>TciTestCaseIdListType</code> is a list of <code>TciTestCaseIdListType</code> . This abstract type is used when retrieving the list of test cases in a TTCN-3 module.   |
| <code>TciModuleIdListType</code>         | A value of type <code>TciModuleIdListType</code> is a list of <code>TciModuleIdType</code> . This abstract type is used when retrieving the list of modules which are imported by a TTCN-3 module.  |
| <code>TciModuleParameterType</code>      | A value of type <code>TciModuleParameterType</code> is a structure of <code>TciModuleParameterIdType</code> and <code>Value</code> . This abstract type is used to represent the parameter name and the default value of a module parameter.  |
| <code>TciModuleParameterListType</code>  | A value of type <code>TciModuleParameterListType</code> is a list of <code>TciModuleParameterType</code> . This abstract type is used when retrieving the module parameters of a TTCN-3 module.   |
| <code>TciParameterType</code>            | A value of type <code>TciParameterType</code> includes a TTCN-3 <code>Value</code> , which can be absent, and a value of <code>TciParameterPassingModeType</code> to represent the name, the value and parameter passing mode specified for the parameter in the TTCN-3 ATS.              |
| <code>TciParameterPassingModeType</code> | A value of type <code>TciParameterPassingModeType</code> is either <code>IN</code> , <code>INOUT</code> , or <code>OUT</code> . This abstract type is used when starting a test case or when the termination of a test case is indicated.   |
| <code>TciParameterListType</code>        | A value of type <code>TciParameterListType</code> is a list of <code>TciParameterType</code> . This abstract type is used when starting a test case or when the termination of a test case is indicated.  |
| <code>TciParameterTypeType</code>        | A value of type <code>TciParameterTypeType</code> is a structure of <code>Type</code> and <code>TciParameterPassingModeType</code> . This abstract type is used to represent the type, the name and the parameter passing mode of a test case parameter.                                  |
| <code>TciParameterTypeListType</code>    | A value of type <code>TciParameterTypeListType</code> is a list of <code>TciParameterTypeType</code> . This abstract type is used to represent the list of parameters of a test case.   |
| <code>TciTestComponentKindType</code>    | A value of type <code>TciTestComponentKindType</code> is a literal of the set of kinds of TTCN-3 test components, i.e. <code>CONTROL</code> , <code>MTC</code> , <code>PTC</code> , <code>SYSTEM</code> , and <code>PTC_ALIVE</code> . This abstract type is used for component handling. |
| <code>TciTypeClassType</code>            | A value of type <code>TciTypeClassType</code> is a literal of the set of type classes in TTCN-3 such as <code>boolean</code> , <code>float</code> , <code>record</code> , etc. This abstract type is used for value handling.   |

`TciMatchingTypeType` A value of type `TciMatchingTypeType` is a literal of the set of matching mechanism types in TTCN-3 such as template list, range, `AnyValue` etc. This abstract type is used for template handling.

### 7.2.1.2 Communication

`TciBehaviourIdType` A value of type `TciBehaviourIdType` identifies a TTCN-3 behaviour functions.

Additional abstract data types with the prefix `Tri` are taken from ETSI ES 201 873-5 [3]: `TriPortIdType`, `TriPortIdListType`, `TriComponentIdType`, `TriComponentIdListType`, `TriAddressType`, `TriAddressListType`, `TriTimerIdType` and `TriMessageType`.

## 7.2.2 Abstract TTCN-3 data types and values

### 7.2.2.0 Definition and scope of use

The clause 7.2.2 defines the set of abstract data types that build up the TTCN-3 type, value and template representation. Functionality of each data type is defined by an accompanying set of operations. Operations on or using this abstract data type return either a value of this abstract type or a basic type like `boolean`.

All operations have been defined using the Interface Description Language (IDL). Concrete language mappings for the operations on the abstract data types are given in clauses 8, 9, 10, 11 and 12. In certain languages, the application of an operation on an abstract data type is represented by passing (either by-value or by-reference, depending on the mapping) the concrete value as a parameter to the operation. Other languages might choose other referencing method to the concrete value, e.g. by considering the value as an object on which a method corresponding to the operation is invoked. To indicate the inability to perform a certain task or to indicate the absence of an optional parameter in the following, the distinct value `null` is used. It can be considered as being a reserved value indicating a special value. The language mappings will define a concrete representation of this distinct value `null`.

The abstract TTCN-3 type, value and template representation consists of the following parts:

- an abstract data type `Type` that represents all TTCN-3 types in a TTCN-3 module;
- different abstract data types that represent TTCN-3 values, i.e. TTCN-3 values of a given TTCN-3 type. This can be either values of TTCN-3 predefined types or of TTCN-3 user-defined types;
- different abstract data types that represent matching mechanisms that can occur in TTCN-3 templates;
- other abstract data types that represent complex value properties such as permutations or length restrictions.

For accessing, evaluating, and coding the TTCN-3 data the test system uses the abstract data type `Type` and the different abstract value data types. Therefore, these abstract data types define the abstraction level between the TTCN-3 Executable (TE) and the remaining test system using the TCI interfaces.

### 7.2.2.1 Abstract TTCN-3 data types

According to the present document TTCN-3 types, either predefined or user-defined, will be represented at the TCI interfaces using the abstract data type `Type`.

For the abstract data type `Type` a set of operations is defined to:

- reference predefined and user-defined TTCN-3 data types; and
- create and maintain TTCN-3 values and templates.

The following operations are defined for the abstract data type `Type`:

`TciModuleIdType` `getDefiningModule()` Returns the module identifier of the module in which type is defined. Returns the distinct value `null` if type is a TTCN-3 base type, e.g. `boolean`, `integer`, etc.).

`TString getName()` Returns the name of the type as defined in the TTCN-3 module. If the type is a nested type without explicit name, the TE has to create an additional unique identifier for this type which is consistently used in TRI/TCI.

NOTE 1: The creation of identifiers for nested types is tool dependent.

NOTE 2: The naming for a nested type without explicit name can follow the rules defined in clauses 6.2.1.1 and 6.2.3.2 of ETSI ES 201 873-1 [1], e.g. `TypeIdOrExpression.ElementId` and `TypeId[-]`, respectively.

NOTE 3: There might be several instances of the abstract data type `Type` representing the same TTCN-3 type, e.g. in a situation when the type has different attributes in different context.

`TciTypeClassType getTypeClass()` Returns the type class of the respective type. A value of `TciTypeClassType` can have one of the following constants: `ADDRESS`, `ANYTYPE`, `ARRAY`, `BITSTRING`, `BOOLEAN`, `CHARSTRING`, `COMPONENT`, `ENUMERATED`, `FLOAT`, `HEXSTRING`, `INTEGER`, `OCTETSTRING`, `RECORD`, `RECORD_OF`, `SET`, `SET_OF`, `UNION`, `UNIVERSAL_CHARSTRING`, `VERDICT`, `DEFAULT`, `PORT`, `TIMER`.

`Value newInstance()` Returns a freshly created value of the given type. This initial value of the created value is undefined.

NOTE 4: Newly created instances of empty record types are considered to be initialized.

`TString getTypeEncoding()` Returns the current type encode attribute as defined in the TTCN-3 module and possibly dynamically restricted by the `setencode` operation or `dynamic_encoding` parameter of codec operations. If no encode attribute is defined, the distinct value `null` is returned. If the type has more than one encode attributes associated with it, all encode attributes are concatenated to a single string using LF (line feed char(0, 0, 0, 10)), CR (carriage return char(0, 0, 0, 13)) or their combination as a separator.

`TString getTypeEncodingVariant()` This operation returns the current value encoding variant attribute as defined in the TTCN-3 module and possibly dynamically restricted by the `setencode` operation or `dynamic_encoding` parameter of codec operations, if any. If no encoding variant attribute is defined, the distinct value `null` is returned. If the type has more than one variant attributes associated with it, all variant attributes are concatenated to a single string using LF (line feed char(0, 0, 0, 10)), CR (carriage return char(0, 0, 0, 13)) or their combination as a separator. In case the type supports multiple encodings, the function returns variants for all encodings. Each variant is prefixed with the associated encode attribute and followed by a full stop character in this case.

`TStringSeq getEncodingAttributes()` Returns all current encode attributes of the type as defined in the TTCN-3 module. If no encode attribute is defined the distinct value `null` is returned.

`TStringSeq getVariantAttributes(in TString encoding)` This operation returns all variant attributes of the type as defined in the TTCN-3 module and possibly dynamically restricted by the `setencode` operation or `dynamic_encoding` parameter of codec operations. If no variant attribute is defined, the distinct value `null` is returned. The parameter is used to specify encoding the variant attributes are related to. It is required when the type has multiple encodings associated with it. If the type uses a single encoding, the parameter can be set to the special value `null`. The operation returns the special value `null`, if the parameter specifies a non-existent encoding or if it contains `null` and the type contains multiple encodings.

`TStringSeq getTypeExtension()` Returns the type extension attribute as defined in the TTCN-3 module.

`Value parseValue(in TString val)` This operation creates a new value of the given type from a string provided in the parameter. The input string shall use valid TTCN-3 syntax for values or templates of this type. The only references allowed in the input string are type references. If the input string contains an error, the distinct value `null` is returned. The operation is an optional part of the TCI and tool vendors are not required to support value parsing. If not supported, `parseValue` will always return the distinct value `null`.

NOTE 5: The `parseValue` operation can be used for defining matching symbols to enable the representation of templates in TCI.

`MatchingMechanism newTemplate(TciMatchingType matchingType)`  
Returns a freshly created matching mechanism of this type. The `matchingType` parameter determines what kind of matching mechanism will be created (see clause 7.2.2.3.1 for more details). If the created matching mechanism contains additional data properties, these properties are uninitialized in the created matching mechanism.

`RangeBoundary getLowerTypeBoundary()`  
Returns the lower range boundary of the type if it has a range-restriction attached to it. Otherwise, the distinct value `null` is returned.

`RangeBoundary getUpperTypeBoundary()`  
Returns the lower range boundary of the type if it has a range-restriction attached to it. Otherwise, the distinct value `null` is returned.

`LengthRestriction getTypeLengthRestriction()`  
Returns the length restriction of the type if it has a length restriction attached to it. Otherwise, the distinct value `null` is returned.

`MatchingMechanism getTypeMatchingMechanism()`  
Returns the matching mechanism of the type if it is restricted by a matching mechanism. Otherwise, the distinct value `null` is returned.

## 7.2.2.2 Abstract TTCN-3 values

### 7.2.2.2.0 Basic rules

According to the present document, TTCN-3 values are represented at the TCI interfaces via numerous abstract data types.

Figure 4 presents the hierarchy between the abstract data types for TTCN-3 values (short: abstract values).

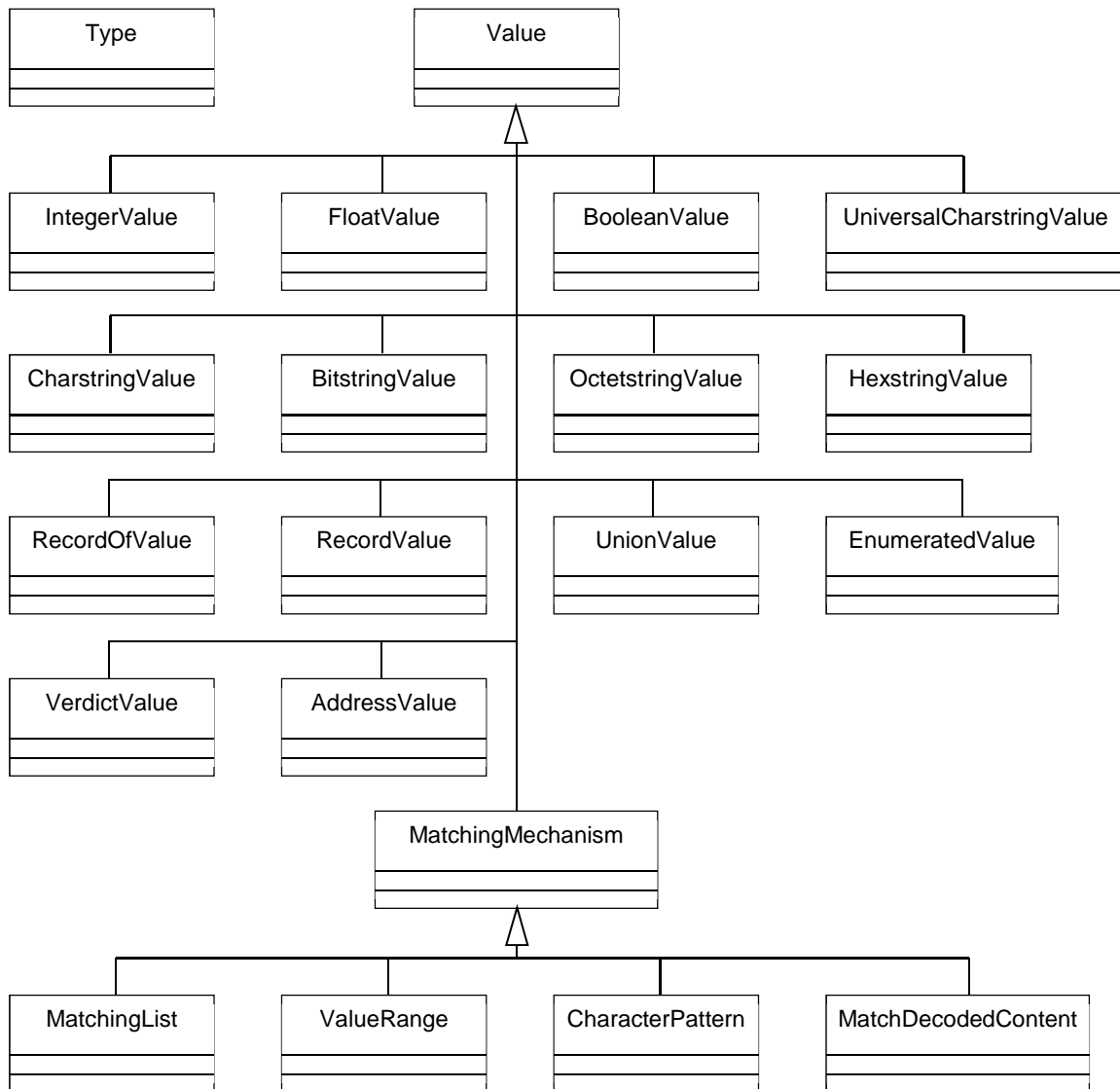

**Figure 4: Hierarchy of abstract values**

As shown in figure 4, all TTCN-3 abstract values share the same base abstract data type `Value`. All operations defined on this common base data type are implicitly defined also for the abstract value types derived from it.

In addition, `Value` can be used to represent matching mechanisms, which are used instead or inside values e.g. in template parameters or for template variables. Two additional operations: `isMatchingSymbol` (returns true for matching symbols) and `valueToString` (for printing value content in the same way as the `any2unistr` predefined function; can be used for displaying value content) are defined. These operations are not mandatory - it is up to a tool vendor to support them or not.

Values using `@lazy` and `@fuzzy` modifiers are represented by the `Value` data type too. However, it is not possible to use the `Value` data type to perform evaluation of these values; evaluation can be performed by the TE only. If a `@lazy` or `@fuzzy` value has been assigned, but it does not contain result of the evaluation, any data access operations shall result in an error.

#### 7.2.2.2.1 The abstract data type `Value`

The following operations are defined on the base abstract data type `Value`. The concrete representations of these operations are defined in the respective language mapping sections:

`Type getType()` Returns the type of the specified value.

`TBoolean notPresent()` Returns `true` if the specified value is omit, `false` otherwise.



|   |   |
|---|---|
| <code>TString getValueEncoding()</code>                           | Returns the current value encode attribute as defined in the TTCN-3 module and possibly dynamically restricted by the <code>setencode</code> operation or <code>dynamic_encoding</code> parameter of codec operations, if any. If no encoding attribute is defined, the distinct value <code>null</code> is returned. If the value has more than one encode attributes associated with it, all encode attributes are concatenated to a single string using LF (line feed char(0, 0, 0, 10)), CR (carriage return char(0, 0, 0, 13)) or their combination as a separator.  |
| <code>TString getValueEncodingVariant()</code>                    | Returns the current value encoding variant attribute as defined in the TTCN-3 module and possibly dynamically restricted by the <code>setencode</code> operation or <code>dynamic_encoding</code> parameter of codec operations, if any. If no encoding variant attribute is defined, the distinct value <code>null</code> is returned. If the value has more than one variant attributes associated with it, all variant attributes are concatenated to a single string using LF (line feed char(0, 0, 0, 10)), CR (carriage return char(0, 0, 0, 13)) or their combination as a separator. In case the value supports multiple encodings, the function returns variants for all encodings. Each variant will be prefixed with the associated encode attribute and followed by a full stop character in this case. |
| <code>TStringSeq getEncodingAttributes()</code>                   | Returns all current encode attributes of the value as defined in the TTCN-3 module and possibly dynamically restricted by the <code>setencode</code> operation or <code>dynamic_encoding</code> parameter of codec operations. If no encode attribute is defined, the distinct value <code>null</code> is returned.   |
| <code>TStringSeq getVariantAttributes(in TString encoding)</code> | This operation returns all current variant attributes of the value as defined in the TTCN-3 module and possibly dynamically restricted by the <code>setencode</code> operation or <code>dynamic_encoding</code> parameter of codec operations. If no variant attribute is defined, the distinct value <code>null</code> is returned. The parameter is used to specify encoding the variant attributes are related to. It is required when the value has multiple encodings associated with it. If the type uses a single encoding, the parameter can be set to the special value <code>null</code> . The operation returns the distinct value <code>null</code> , if the parameter specifies a non-existent encoding or if it contains <code>null</code> and the value contains multiple encodings.                 |
| <code>TBoolean isMatchingSymbol()</code>                          | Returns <code>true</code> if the instance is of the <code>MatchingMechanism</code> abstract data type (or any other abstract data type derived from the <code>MatchingMechanism</code> data type) and <code>false</code> in all other cases.  |
|   | <b>NOTE:</b> This method can be used for detecting the exact abstract data type of the instance. If the method returns <code>false</code> , it is safe to assume that the instance is one of the abstract value data types defined in clause 7.2.2.2. If the method returns <code>true</code> , the instance is one of the matching mechanism defined in clause 7.2.2.3.  |
| <code>TString valueToString()</code>                              | Returns the same string as produced by the <code>any2unistr</code> predefined function (specified in clause C.1.33 of ETSI ES 201 873-1 [1]) with the specified value as the <code>invalue</code> parameter and the <code>format</code> parameter equal to "canonical".   |
| <code>TBoolean isFuzzy ()</code>                                  | Returns <code>true</code> if the specified value has the <code>@fuzzy</code> modifier, <code>false</code> otherwise.  |
| <code>TBoolean isLazy ()</code>                                   | Returns <code>true</code> if the specified value has the <code>@lazy</code> modifier, <code>false</code> otherwise.   |

|   |   |
|---|---|
| <code>TBoolean isEvaluated ()</code>                                  | Returns <code>true</code> if the value has been evaluated and its data content is available, <code>false</code> otherwise. In case of uninitialized values, <code>false</code> is always returned. The method is typically used for <code>@lazy</code> values, and it returns <code>false</code> for values that have been assigned, but not evaluated yet and <code>true</code> if the value contains the evaluation result. The method returns <code>false</code> for <code>@fuzzy</code> values, as the result of evaluation is never stored by the TE. For all other values, the method returns <code>true</code> . |
| <code>LengthRestriction getLengthRestriction()</code>                 | Returns a length restriction matching attribute (specified in clause B.1.4.1 of ETSI ES 201 873-1 [1]) in case it is attached to the value or the distinct value <code>null</code> if no such matching attribute is present.  |
| <code>void setLengthRestriction(LengthRestriction restriction)</code> | Adds a length restriction matching attribute (specified in clause B.1.4.1 of ETSI ES 201 873-1 [1]) to the value or modifies an existing one. The distinct value <code>null</code> can be used as a parameter to disable an existing length restriction.  |
| <code>TBoolean isIfPresentEnabled()</code>                            | Returns <code>true</code> if the <code>ifpresent</code> indicator (specified in clause B.1.4.2 of ETSI ES 201 873-1 [1]) is attached to the value and <code>false</code> otherwise.   |
| <code>void setIfPresentEnabled(TBoolean enabled)</code>               | Sets the whether the <code>ifpresent</code> indicator (specified in clause B.1.4.2 of ETSI ES 201 873-1 [1]) is attached to the value or not.   |
| <code>RangeBoundary getLowerTypeBoundary()</code>                     | Returns the lower range boundary of the value's type if it has a range-restriction attached to it. Otherwise, the distinct value <code>null</code> is returned. This is only applicable for values with types of typeclass <code>INTEGER</code> and <code>FLOAT</code> .  |
| <code>RangeBoundary getUpperTypeBoundary()</code>                     | Returns the lower range boundary of the value's type if it has a range-restriction attached to it. Otherwise, the distinct value <code>null</code> is returned. This is only applicable for values with types of typeclass <code>INTEGER</code> or <code>FLOAT</code> .   |
| <code>LengthRestriction getTypeLengthRestriction()</code>             | Returns a length restriction matching attribute (specified in clause B.1.4.1 of ETSI ES 201 873-1 [1]) in case it is attached to the value's type or the distinct value <code>null</code> if no such matching attribute is present.<br>This is only applicable for values with types of typeclass <code>CHARSTRING</code> , <code>UNIVERSAL_CHARSTRING</code> , <code>BITSTRING</code> , <code>HEXSTRING</code> , <code>OCTETSTRING</code> , <code>RECORD_OF</code> , <code>SET_OF</code> or <code>ARRAY</code> .   |
| <code>MatchingMechanism getTypeMatchingMechanism()</code>             | Returns the matching mechanism (see clause 7.2.2.3.1) of the value's type if it is restricted by a subtype specification attribute (specified in clauses 6.1.2 and 6.2.13 of ETSI ES 201 873-1 [1]). Otherwise, the distinct value <code>null</code> is returned.   |
| <code>TBoolean isOptional()</code>                                    | Returns <code>true</code> if and only if the value is either an optional field or a template without value or present template restriction.   |

When working with length restriction data using the `getLengthRestriction` and `setLengthRestriction`, methods, no assumption shall be made on how the data are stored in a value. An internal implementation might choose to use a reference to the data or copy the data. It is safe to assume that the data are copied. Therefore, it should be assumed that subsequent modifications of the length restriction data will not be considered in the value object.

### 7.2.2.2.2 The abstract data type IntegerValue

The abstract data type `IntegerValue` is based on the abstract data type `Value`. It represents TTCN-3 integer values.

The following operations are defined on the abstract data type `IntegerValue`:

`TInteger getInt()` Returns the integer value of this TTCN-3 integer.  
`void setInt(in TInteger value)` Sets this `IntegerValue` to value.

### 7.2.2.2.3 The abstract data type FloatValue

The abstract data type `FloatValue` is based on the abstract data type `Value`. It represents TTCN-3 float values.

The following operations are defined on the abstract data type `FloatValue`:

`TFloat getFloat()` Returns the float value of this TTCN-3 float.  
`void setFloat(in TFloat value)` Sets this `FloatValue` to value.

### 7.2.2.2.4 The abstract data type BooleanValue

The abstract data type `BooleanValue` is based on the abstract data type `Value`. It represents TTCN-3 boolean values.

The following operations are defined on the abstract data type `BooleanValue`:

`TBoolean getBoolean ()` Returns the boolean value of the TTCN-3 boolean.  
`void setBoolean(in TBoolean value)` Sets this boolean value to value.

### 7.2.2.2.5 The abstract data type CharstringValue

The abstract data type `CharstringValue` is based on the abstract data type `Value`. It represents TTCN-3 `charstring` values. `TChar` is a character within a `charstring` value.

The following operations are defined on the abstract data type `CharstringValue`:

`TString getString()` Returns the string value of the TTCN-3 `charstring`. The textual representation of the empty TTCN-3 `charstring` is "", while its length is zero.  
`void setString(in TString value)` Sets this `CharstringValue` to value.  
`TChar getChar(in TInteger position)` Returns the char value of the TTCN-3 `charstring` at `position`. Position 0 denotes the first char of the TTCN-3 `charstring`. Valid values for `position` are from 0 to `length - 1`.  
`void setChar(in TInteger position, in TChar value)` Set the character at `position` to `value`. Valid values for `position` are from 0 to `length - 1`.  
`TInteger getLength()` Returns the length of this `CharstringValue` in chars, zero if the value of this `CharstringValue` is omit.  
`void setLength(in TInteger len)` `setLength` first resets this `CharstringValue` to its initial value and afterwards sets the length of this `CharstringValue` in chars to `len`.

### 7.2.2.2.6 The abstract data type `UniversalCharstringValue`

The abstract data type `UniversalCharstringValue` is based on the abstract data type `Value`. It represents TTCN-3 universal charstring values. `TUniversalChar` is a character within a universal charstring value.

The following operations are defined on the abstract data type `UniversalCharstringValue`:

|  |  |
|--|--|
| <code>TString getString()</code>   | Returns the textual representation of this <code>UniversalCharstringValue</code> , as defined in TTCN-3.   |
| <code>void setString(in TString value)</code>                            | Sets the value of this <code>UniversalCharstringValue</code> according to the textual representation as defined by <code>value</code> .  |
| <code>TUniversalChar getChar(in TInteger position)</code>                | Returns the universal char value of the TTCN-3 universal charstring at position. Position 0 denotes the first <code>TUniversalChar</code> of the TTCN-3 universal charstring. Valid values for <code>position</code> are from 0 to <code>length - 1</code> . |
| <code>void setChar(in TInteger position, in TUniversalChar value)</code> | Sets the universal char at position to <code>value</code> . Valid values for <code>position</code> are from 0 to <code>length - 1</code> .   |
| <code>TInteger getLength()</code>  | Returns the length of this universal charstring value in universal chars, zero if the value of this universal charstring value is omit.  |
| <code>void setLength(in TInteger len)</code>                             | <code>setLength</code> first resets this <code>UniversalCharstringValue</code> to its initial value and afterwards sets the length of this <code>UniversalCharstringValue</code> in universal chars to <code>len</code> .                                    |

### 7.2.2.2.7 The abstract data type `BitstringValue`

The abstract data type `BitstringValue` is based on the abstract data type `Value`. It represents TTCN-3 bitstring values. This abstract data type uses a parameter `position` in some of its operations for addressing individual bits or embedded matching mechanisms. The following rules are valid in this case:

- Position 0 denotes the first bit or matching mechanism of the TTCN-3 bitstring
- Valid values for `position` are from 0 to `length - 1`, where `length` is the total number of bits and individual matching mechanisms in the value

Each individual matching mechanism takes exactly one position regardless of how many bits it can match.

The following operations are defined on the abstract data type `BitstringValue`.

|   |   |
|---|---|
| <code>TString getString()</code>                                  | Returns the textual representation of this <code>BitstringValue</code> , as defined in TTCN-3. E.g. the textual representation of 0101 is '0101'B. The textual representation of the empty TTCN-3 bitstring is ''B, while its length is zero.   |
| <code>void setString(in TString value)</code>                     | Sets the value of this <code>BitstringValue</code> according to the textual representation as defined by <code>value</code> . E.g. the value of this <code>BitstringValue</code> is 0101 if the textual representation in <code>value</code> is '0101'B. The parameter may contain allowed matching symbols such as <code>AnyElement</code> or <code>AnyElementsOrNone</code> . |
| <code>TChar getBit(in TInteger position)</code>                   | Returns the value (0   1) at position of this TTCN-3 bitstring as a character. An error will occur when the specified position contains a matching mechanism.   |
| <code>void setBit(in TInteger position, in TInteger value)</code> | Sets the bit at position to the value (0   1).  |

|   |  |
|---|--|
| <code>TInteger</code> <code>getLength()</code>  | Returns the length of this <code>BitstringValue</code> . The length is equal to the total number of bits and individual matching mechanisms in the value. If the value of this <code>BitstringValue</code> is <code>omit</code> , the length is equal to 0. Each individual matching mechanism is considered to have the length of one bit regardless of how many bits it can match. |
| <code>void</code> <code>setLength(in TInteger len)</code>                                       | <code>setLength</code> first resets this <code>BitstringValue</code> to its initial value and afterwards sets the length of this <code>BitstringValue</code> in bits to <code>len</code> .   |
| <code>TBoolean</code> <code>isMatchingAt(in TInteger position)</code>                           | Returns <code>true</code> if the item at <code>position</code> of this TTCN-3 bitstring is a matching mechanism inside a value ( <code>AnyElement</code> , <code>AnyElementsOrNone</code> ) and <code>false</code> otherwise.  |
| <code>MatchingMechanism</code> <code>getMatchingAt(in TInteger position)</code>                 | If the <code>position</code> of this TTCN-3 bitstring contains a matching mechanism inside a value ( <code>AnyElement</code> , <code>AnyElementsOrNone</code> ), the method returns it. Otherwise the distinct value <code>null</code> is returned.  |
| <code>void</code> <code>setMatching(in TInteger position, in MatchingMechanism template)</code> | Sets a matching mechanism at <code>position</code> . Only two matching mechanisms are allowed: <code>AnyElement</code> and <code>AnyElementsOrNone</code> .  |

#### 7.2.2.2.8 The abstract data type `OctetstringValue`

The abstract data type `OctetstringValue` is based on the abstract data type `Value`. It represents TTCN-3 `octetstring` values. This abstract data type uses a parameter `position` in some of its operations for addressing individual octets or embedded matching mechanisms. The following rules are valid in this case:

- Position 0 denotes the first octet or matching mechanism of the TTCN-3 `octetstring`
- Valid values for `position` are from 0 to `length - 1`, where `length` is the total number of octets and individual matching mechanisms in the value
- Each individual matching mechanism takes exactly one position regardless of how many octets it can match

The following operations are defined on the abstract data type `OctetstringValue`:

|  |   |
|--|---|
| <code>TString</code> <code>getString()</code>                                    | Returns the textual representation of this <code>OctetstringValue</code> , as defined in TTCN-3. E.g. the textual representation of <code>0xCAFFEE</code> is <code>'CAFFEE'</code> . The textual representation of the empty TTCN-3 <code>octetstring</code> is <code>' '</code> , while its length is zero.  |
| <code>void</code> <code>setString(in TString value)</code>                       | Sets the value of this <code>OctetstringValue</code> according to the textual representation as defined by <code>value</code> . E.g. The value of this <code>OctetstringValue</code> is <code>0xCAFFEE</code> if the textual representation in <code>value</code> is <code>'CAFFEE'</code> . The parameter may contain allowed matching symbols such as <code>AnyElement</code> or <code>AnyElementsOrNone</code> . |
| <code>TChar</code> <code>getOctet(in TInteger position)</code>                   | Returns the value (0..255) at <code>position</code> of this TTCN-3 <code>octetstring</code> . An error will occur when the specified position contains a matching mechanism.  |
| <code>void</code> <code>setOctet(in TInteger position, in TInteger value)</code> | Sets the octet at <code>position</code> to value (0..255).  |
| <code>TInteger</code> <code>getLength()</code>                                   | Returns the length of this <code>OctetstringValue</code> . The length is equal to the total number of octets and individual matching mechanisms in the value. If the value of this <code>OctetstringValue</code> is <code>omit</code> , the length is equal to 0. Each individual matching mechanism is considered to have the length of one octet regardless of how many octets it can match.                      |

|  |   |
|--|---|
| <code>void setLength(in TInteger len)</code>                                       | <code>setLength</code> first resets this <code>OctetstringValue</code> to its initial value and afterwards sets the length of this <code>OctetstringValue</code> in octets to <code>len</code> .  |
| <code>TBoolean isMatchingAt(in TInteger position)</code>                           | Returns <code>true</code> if the item at <code>position</code> of this TTCN-3 octetstring is a matching mechanism inside a value ( <code>AnyElement</code> , <code>AnyElementsOrNone</code> ) and <code>false</code> otherwise.                       |
| <code>MatchingMechanism getMatchingAt(in TInteger position)</code>                 | If the <code>position</code> of this TTCN-3 octetstring contains a matching mechanism inside a value ( <code>AnyElement</code> , <code>AnyElementsOrNone</code> ), the method returns it. Otherwise the distinct value <code>null</code> is returned. |
| <code>void setMatching(in TInteger position, in MatchingMechanism template)</code> | Sets a matching mechanism at <code>position</code> . Only two matching mechanisms are allowed: <code>AnyElement</code> and <code>AnyElementsOrNone</code> .   |

### 7.2.2.2.9 The abstract data type `HexstringValue`

The abstract data type `HexstringValue` is based on the abstract data type `Value`. It represents TTCN-3 `hexstring` values. This abstract data type uses a parameter `position` in some of its operations for addressing individual hex digits or embedded matching mechanisms. The following rules are valid in this case:

- Position 0 denotes the first hex digit or matching mechanism of the TTCN-3 `hexstring`
- Valid values for `position` are from 0 to `length - 1`, where `length` is the total number of hex digits and individual matching mechanisms in the value

Each individual matching mechanism takes exactly one position regardless of how many hex digits it can match.

The following operations are defined on the abstract data type `HexstringValue`:

|   |  |
|---|--|
| <code>TString getString()</code>                                  | Returns the textual representation of this <code>HexstringValue</code> , as defined in TTCN-3. E.g. the textual representation of <code>0xAFFEE</code> is <code>'AFFEE'H</code> . The textual representation of the empty TTCN-3 <code>hexstring</code> is <code>''H</code> , while its length is zero.  |
| <code>void setString(in TString value)</code>                     | Sets the value of this <code>HexstringValue</code> according to the textual representation as defined by <code>value</code> . E.g. The value of this <code>HexstringValue</code> is <code>0xAFFEE</code> if the textual representation in <code>value</code> is <code>'AFFEE'H</code> . The parameter may contain allowed matching symbols such as <code>AnyElement</code> or <code>AnyElementsOrNone</code> . |
| <code>TChar getHex(in TInteger position)</code>                   | Returns the value (0..15) at <code>position</code> of this TTCN-3 <code>hexstring</code> . An error will occur when the specified position contains a matching mechanism.  |
| <code>void setHex(in TInteger position, in TInteger value)</code> | Sets the hex digit at <code>position</code> to value (0..15).  |
| <code>TInteger getLength()</code>                                 | Returns the length of this <code>HexstringValue</code> . The length is equal to the total number of hex digits and individual matching mechanisms in the value. If the value of this <code>HexstringValue</code> is <code>omit</code> , the length is equal to 0. Each individual matching mechanism is considered to have the length of one hex digit regardless of how many hex digits it can match.         |
| <code>void setLength(in TInteger len)</code>                      | <code>setLength</code> first resets this <code>HexstringValue</code> to its initial value and afterwards sets the length of this <code>HexstringValue</code> in hex digits to <code>len</code> .   |
| <code>TBoolean isMatchingAt(in TInteger position)</code>          | Returns <code>true</code> if the item at <code>position</code> of this TTCN-3 <code>hexstring</code> is a matching mechanism inside a value ( <code>AnyElement</code> , <code>AnyElementsOrNone</code> ) and <code>false</code> otherwise.   |

MatchingMechanism getMatchingAt(in TInteger position)

If the `position` of this TTCN-3 hexstring contains a matching mechanism inside a value (AnyElement, AnyElementsOrNone) the method returns it. Otherwise the distinct value `null` is returned.

void setMatching(in TInteger position, in MatchingMechanism template)

Sets a matching mechanism at `position`. Only two matching mechanisms are allowed: AnyElement and AnyElementsOrNone.

#### 7.2.2.2.10 The abstract data type RecordValue

The abstract data type `RecordValue` is based on the abstract data type `Value`. It specifies how to get and set the TTCN-3 record type.

NOTE: Newly created instances of empty record types are considered to be initialized.

The same abstract data type applies for values whose type class is `SET`. The distinction between `record` and `set` is only relevant at matching time.

The following operations are defined on the abstract data type `RecordValue`:

Value getField(in TString fieldName)

Returns the value of the field named `fieldName`. The return value is the common abstract base type `Value`, as a record field can have any type defined in TTCN-3. If the field cannot be obtained from the record the distinct value `null` is returned.

void setField(in TString fieldName, in Value value)

Sets the field named `fieldName` of the record to `value`. No assumption shall be made on how a field is stored in a record. An internal implementation might choose to store a reference to this value or to copy the value. It is safe to assume that the value is copied. Therefore it should be assumed that subsequent modifications of `value` will not be considered in the record. Using a `MatchingMechanism` of the `OMIT_TEMPLATE` type as the `value` parameter has the same effect as calling the `setFieldOmitted` with the `fieldName` as a parameter.

TStringSeq getFieldNames()

Returns a sequence of string of field names, the empty sequence, if the record has no fields.

void setFieldOmitted(in TString fieldName)

Mark the referenced field of the record as being omitted.

#### 7.2.2.2.11 The abstract data type RecordOfValue

The abstract data type `RecordOfValue` is based on the abstract data type `Value`. It specifies how to get and set elements in TTCN-3 `record of` types. The same abstract data type applies for value whose type class is `ARRAY` or `SET_OF`. The distinction between `record of`, `set of`, and `array` is only relevant at matching time.

This abstract data type uses a parameter `position` in some of its operations for addressing individual elements or embedded matching mechanisms. The following rules are valid in this case:

- Position 0 denotes the first element or matching mechanism of the record of, set of or array value.
- Valid values for position are from 0 to `length - 1`, where `length` is the total number of elements and individual matching mechanisms in the record of, set of and or array value.
- In case of array, element indices start from 0, independent of the lower index bound.
- Each individual matching mechanism with exception permutations takes exactly one position regardless of how many elements it can match.

- Permutation takes exactly as many positions as many items it contains: each value or matching mechanism inside it takes exactly one position.

When working with instances received from the get methods (`getField`, `getPermutation`), and passed to the set methods (`setField`, `appendField`, `setPermutation`), no assumption shall be made on how the data are stored in a `record of`. An internal implementation might choose to use a reference to the data or to copy the data. It is safe to assume that the data are copied. Therefore, it should be assumed that subsequent modifications of the field or permutation data will not be considered in the `record of`.

The following operations are defined on the abstract data type `RecordOfValue`:

|  |  |
|--|--|
| <code>Value getField(in TInteger position)</code>                | Returns the value of the <code>record of</code> at <code>position</code> if <code>position</code> is between zero and <code>length - 1</code> , the distinct value <code>null</code> otherwise. The return value is the common abstract base type <code>Value</code> , as a <code>record of</code> can have fields of any type defined in TTCN-3.  |
| <code>void setField(in TInteger position, in Value value)</code> | Sets the field at <code>position</code> to <code>value</code> . If <code>position</code> is greater than <code>(length - 1)</code> the <code>record of</code> is extended to have the length <code>(position + 1)</code> . The <code>record of</code> elements between the original position at <code>length</code> and <code>position - 1</code> is set to <code>omit</code> .  |
| <code>void appendField(in Value value)</code>                    | Appends the value at the end of the <code>record of</code> , i.e. at position <code>length</code> .  |
| <code>Type getElementType()</code>                               | Returns the <code>Type</code> of the elements of this <code>record of</code> .   |
| <code>TInteger getLength()</code>                                | Returns the actual length of the <code>record of value</code> , zero if the <code>record of value</code> is <code>omit</code> .  |
| <code>void setLength(in TInteger len)</code>                     | Sets the length of the <code>record of</code> to <code>len</code> . If <code>len</code> is greater than the original length, newly created elements have the value <code>omit</code> . If <code>len</code> is less or equal than the original length this operation is ignored.  |
| <code>TInteger getOffset()</code>                                | Returns the lowest possible index. For a <code>record of</code> or <code>set of value</code> this is always 0. For an array value, this is the lower index bound used in the type definition.  |
| <code>TInteger getPermutationCount()</code>                      | Returns the number of permutations in the <code>record of</code> or array value.   |
| <code>Permutation getPermutation(TInteger index)</code>          | Returns the permutation at the specified index. The allowed index range is from 0 to <code>(getPermutationCount() - 1)</code> .  |
| <code>void definePermutation(Permutation permutation)</code>     | Creates permutation from existing elements of a <code>record of value</code> . The <code>permutation</code> parameter shall not include a direct or indirect reference to elements that are already a part of other existing permutations attached to the same <code>record of</code> . In particular, no element with an index greater or equal to <code>permutation.getStartPosition()</code> and less than <code>permutation.getStartPosition() + permutation.getLength()</code> may be a part of a different permutation. No elements are added to the <code>record of</code> by this operation. |
| <code>void removePermutation(TInteger index)</code>              | Removes the permutation at the specified index. The allowed index range is from 0 to <code>(getPermutationCount() - 1)</code> . No elements are removed from the <code>record of</code> by this operation. When the operation completes, the existing elements at positions specified by the removed permutation do not belong to any permutation.   |
| <code>void clearPermutations()</code>                            | Removes all permutations from the value. The elements that belonged to the removed permutation are not removed.  |



### 7.2.2.2.12 The abstract data type UnionValue

The abstract data type `UnionValue` is based on the abstract data type `Value`. It specifies how to get and set variants in a TTCN-3 union type. The TTCN-3 anytype is represented by a `UnionValue` where the type class of the type obtained by `getType()` is `ANYTYPE`. For details on type classes see clause 7.2.2.1.

The following operations are defined on the abstract data type `UnionValue`:

|  |  |
|--|--|
| <code>Value getVariant(in TString variantName)</code>                | Returns the value of the TTCN-3 union <code>variantName</code> , if <code>variantName</code> equals the result of <code>getPresentVariantName</code> , the distinct value <code>null</code> otherwise. <code>variantName</code> denotes the name of the union variant as defined in the TTCN-3 module.                                 |
| <code>void setVariant(in TString variantName, in Value value)</code> | Sets <code>variantName</code> of the union to <code>value</code> . If <code>variantName</code> is not defined for this union this operation is ignored. If another variant was selected the new variant is selected instead.   |
| <code>TString getPresentVariantName()</code>                         | Returns a <code>String</code> representing the currently selected variant name in the given TTCN-3 union. The distinct value <code>null</code> is returned if no variant is selected.  |
| <code>TStringSeq getVariantNames()</code>                            | Returns a sequence of string of variant names, the distinct value <code>null</code> , if the union has no fields. If the <code>UnionValue</code> represents the TTCN-3 anytype, i.e. the type class of the type obtained by <code>getType()</code> is <code>ANYTYPE</code> , all predefined and user-defined TTCN-3 types is returned. |

### 7.2.2.2.13 The abstract data type EnumeratedValue

The abstract data type `EnumeratedValue` is based on the abstract data type `Value`. It specifies how TTCN-3 `enumerated` can be set and get.

The following operations are defined on the abstract data type `EnumeratedValue`:

|   |  |
|---|--|
| <code>TString getEnum()</code>                  | Returns the string identifier of this <code>EnumeratedValue</code> . This identifier equals the identifier in the TTCN-3 specification.  |
| <code>void setEnum(in TString enumValue)</code> | Sets the enum to <code>enumValue</code> . If <code>enumValue</code> is not an allowed value for this enumeration the operation is ignored.   |
| <code>TInteger getInt()</code>                  | Returns the integer value of this <code>EnumeratedValue</code> . This integer equals the user-assigned integer value in the TTCN-3 specification or the automatically assigned integer value.  |
| <code>setInt(in TInteger intValue)</code>       | Sets the integer value of this <code>EnumeratedValue</code> . This integer should equal the user-assigned integer value in the TTCN-3 specification or the automatically assigned integer value. If <code>intValue</code> is not an allowed value for this enumeration the operation is ignored. |

### 7.2.2.2.14 The abstract data type VerdictValue

The abstract data type `VerdictValue` is based on the abstract data type `Value`. It specifies how TTCN-3 `verdict` can be set and get.

The following operations are defined on the abstract data type `VerdictValue`:

|                                    |  |
|------------------------------------|--|
| <code>TInteger getVerdict()</code> | Returns the integer value for this <code>VerdictValue</code> . The integer is one of the following constants: <code>ERROR</code> , <code>FAIL</code> , <code>INCONC</code> , <code>NONE</code> , <code>PASS</code> , <code>USER_ERROR</code> . |
|------------------------------------|--|

```
void setVerdict(in TInteger verdict)
```

Sets this `VerdictValue` to `verdict`. Note that a `VerdictValue` can be set to any of the above mentioned verdicts at any time. The `VerdictValue` does not perform any verdict calculations as defined in TTCN-3. For example, it is legal to set the `VerdictValue` first to `INCONC` and then to `PASS`.

### 7.2.2.2.15 The abstract data type `AddressValue`

The following operations are defined on the base abstract data type `AddressValue`. The concrete representations of these operations are defined in the respective language mapping sections:

```
Value getAddress()
```

Returns the address value, which will no longer be of type class `ADDRESS` but rather of the actual type used for address.

```
void setAddress(in Value value)
```

Sets this address value to `value`.

## 7.2.2.3 Abstract TTCN-3 matching mechanisms

### 7.2.2.3.1 The abstract data type `MatchingMechanism`

In case a template can occur in a TCI operation in the same place as a value (e.g. in a function call).

TTCN-3 matching mechanisms are represented at the TCI interfaces via numerous abstract data types. All matching mechanisms share the same abstract data type `MatchingMechanism`. This data type is based on the abstract data type `Value` and inherits all its operations. While simpler matching mechanisms that do not have any additional properties are represented by the `MatchingMechanism` data type, more complex ones have their own dedicated data types. These data types are derived from the `MatchingMechanism` data type implicitly inherit all its operations.

The abstract data type `MatchingMechanism` defines operations that are common for all TCI matching mechanisms. It is also used to represent simple matching mechanisms with no additional properties, in particular: `AnyValue`, `AnyValueOrNone`, `AnyElement`, `AnyElementsOrNone`, `omit`.

The following operations are defined on the base abstract data type `MatchingMechanism`. The concrete representations of these operations are defined in the respective language mapping sections:

```
TciMatchingTypeType getMatchingType()
```

Returns the matching mechanism type. A value of `TciMatchingTypeType` can have one of the following constants: `TEMPLATE_LIST`, `COMPLEMENTED_LIST`, `ANY_VALUE`, `ANY_VALUE_OR_NONE`, `VALUE_RANGE`, `SUBSET`, `SUPERSET`, `ANY_ELEMENT`, `ANY_ELEMENTS_OR_NONE`, `PATTERN`, `MATCH_DECODED_CONTENT`, `OMIT_TEMPLATE`.

NOTE: `OMIT_TEMPLATE` is used to represent an omit matching symbol assigned to a top-level template. Omitted fields of record templates are represented in a different way (see clause 7.2.2.2.10 for more details).

### 7.2.2.3.2 The abstract data type `MatchingList`

The abstract data type `MatchingList` is used to represent matching mechanisms that contain a list of items of the same type: template list, complemented template list, `SubSet` and `SuperSet`.

This abstract data type uses a parameter `position` in some of its operations for addressing individual values or templates inside this matching mechanism. The following rules are valid in this case:

- Position 0 denotes the first value or template in the TTCN-3 matching mechanism
- Valid values for position are from 0 to  $(\text{size}() - 1)$

When working with instances received from the `get` method and passed to the set methods (`add`, `insert`), no assumption shall be made on how the data are stored in a matching mechanism. An internal implementation might choose to use a reference to the data or to copy the data. It is safe to assume that the data are copied. Therefore, it should be assumed that subsequent modifications of the data will not be considered in the matching mechanism.

The following operations are defined on the base abstract data type `MatchingList`:

|   |   |
|---|---|
| <code>TInteger size()</code>                | Returns the number of items in the matching mechanism.  |
| <code>Value get(TInteger position)</code>   | Returns the value or template at the specified <code>position</code> inside the matching mechanism. |
| <code>void add(Value item)</code>           | Adds a new <code>item</code> to the end of the matching list, increasing its size.                  |
| <code>void remove(TInteger position)</code> | Removes the value or template at the specified <code>position</code> inside the matching mechanism. |
| <code>void clear()</code>                   | Removes all values and templates from the matching mechanism.                                       |

### 7.2.2.3.3 The abstract data type `ValueRange`

The abstract data type `ValueRange` is used to represent the value range matching mechanism.

When working with instances received from the get methods (`getLowerBoundary`, `getUpperBoundary`) and passed to the set methods (`setLowerBoundary`, `setUpperBoundary`), no assumption shall be made on how the data are stored in a matching mechanism. An internal implementation might choose to use a reference to the data or to copy the data. It is safe to assume that the data are copied. Therefore, it should be assumed that subsequent modifications of the data will not be considered in the `ValueRange` instance.

The following operations are defined on the base abstract data type `ValueRange`:

|   |  |
|---|--|
| <code>RangeBoundary getLowerBoundary()</code>                   | Returns the lower boundary of the range. |
| <code>RangeBoundary getUpperBoundary()</code>                   | Returns the upper boundary of the range. |
| <code>void setLowerBoundary(RangeBoundary lowerBoundary)</code> | Sets the lower boundary of the range.    |
| <code>void setUpperBoundary(RangeBoundary upperBoundary)</code> | Sets the upper boundary of the range.    |

### 7.2.2.3.4 The abstract data type `CharacterPattern`

The abstract data type `CharacterPattern` is used to represent the character pattern matching mechanism.

When working with instances received from the `getPatternString` method and passed to the `setPatternString` method, no assumption shall be made on how the data are stored in a matching mechanism. An internal implementation might choose to use a reference to the data or to copy the data. It is safe to assume that the data are copied. Therefore, it should be assumed that subsequent modifications of the data will not be considered in the `CharacterPattern` instance.

The following operations are defined on the base abstract data type `CharacterPattern`:

|  |   |
|--|---|
| <code>Value getPatternString ()</code>                     | Returns the character pattern definition of this pattern (either a <code>CharstringValue</code> or <code>UniversalCharstringValue</code> ).   |
| <code>void setPatternString(Value characterPattern)</code> | Sets the character pattern definition of this pattern. The <code>characterPattern</code> parameter shall contain either a <code>CharstringValue</code> or <code>UniversalCharstringValue</code> . |

### 7.2.2.3.5 The abstract data type `MatchDecodedContent`

The abstract data type `MatchDecodedContent` is used to represent the `decmatch` matching mechanism.

When working with instances received from the `getContent` method and passed to the `setContent` method, no assumption shall be made on how the data are stored in a matching mechanism. An internal implementation might choose to use a reference to the data or to copy the data. It is safe to assume that the data are copied. Therefore, it should be assumed that subsequent modifications of the data will not be considered in the `DecodedMatch` instance.

The following operations are defined on the base abstract data type `DecodedMatch`:

|   |   |
|---|---|
| <code>Value getContent()</code>             | Returns the value or matching mechanism used as an argument of the <code>decmatch</code> matching mechanism.      |
| <code>void setContent(Value content)</code> | Sets the value or matching mechanism that is used as an argument of the <code>decmatch</code> matching mechanism. |

## 7.2.2.4 Data types for complex TTCN-3 properties

### 7.2.2.4.0 Scope of use of TTCN-3 properties

The abstract data types described in the clause 7.2.2.4 are used to describe complex properties of TTCN-3 values and matching mechanisms.

#### 7.2.2.4.1 The abstract data type `LengthRestriction`

The abstract data type `LengthRestriction` is used to represent the length restriction matching attribute.

The following operations are defined on the base abstract data type `LengthRestriction`:

|   |   |
|---|---|
| <code>TInteger getLowerBoundary()</code>              | Returns the lower boundary of the length restriction.   |
| <code>TInteger getUpperBoundary()</code>              | Returns the upper boundary of the length restriction.   |
| <code>void setLowerBoundary(TInteger boundary)</code> | Sets the lower boundary value.  |
| <code>void setUpperBoundary(TInteger boundary)</code> | Sets the upper boundary value.  |
| <code>TBoolean isUpperBoundaryInfinity()</code>       | Returns <code>true</code> if the upper boundary contains infinity and <code>false</code> otherwise. |
| <code>void setInfiniteUpperBoundary()</code>          | Sets the upper boundary to infinity.  |

#### 7.2.2.4.2 The abstract data type `Permutation`

The abstract data type `Permutation` is used to describe properties of a permutation matching mechanism embedded in a `RecordOfValue` instance.

The following operations are defined on the base abstract data type `Permutation`:

|  |   |
|--|---|
| <code>TInteger getStartPosition()</code>         | Returns the position of the first item of the permutation in the <code>RecordOfValue</code> .                                 |
| <code>setStartPosition(TInteger position)</code> | Sets the position of the first item of the permutation in the <code>RecordOfValue</code> .                                    |
| <code>TInteger getLength()</code>                | Returns the number of elements or matching mechanisms of the <code>RecordOfValue</code> that are included in the permutation. |

`void setLength(TInteger length)` Sets the number of elements or matching mechanisms of the `RecordOfValue` that are included in the permutation.

### 7.2.2.4.3 The abstract data type `RangeBoundary`

The abstract data type `RangeBoundary` is used to describe properties of lower and upper bound of `ValueRange` instances.

The following operations are defined on the base abstract data type `RangeBoundary`:

`Value getBoundary()` Returns the boundary value. Dependent on the type of the value range, the return value can be either an `IntegerValue`, `FloatValue`, `CharstringValue` or `UniversalCharstringValue`. If the boundary is undefined or it cannot be represented by a `Value` instance (infinity in case of integer values), the distinct value `null` is returned.

`TBoolean isInclusive()` Returns `true` if the boundary value is a part of the allowed range and `false` otherwise.

`void setBoundary(Value boundary, TBoolean inclusive)` Sets the boundary value. Dependent on the type of the value range, the boundary parameter can contain either an `IntegerValue`, `FloatValue`, `UniversalCharstringValue` or `CharstringValue`. The inclusive parameter determines whether the boundary value is a part of the range (`true`) or not (`false`).

`TBoolean isInfinity()` Returns `true` if the boundary is equal to infinity or -infinity and `false` otherwise. The infinity setting is context-dependent. If the `RangeBoundary` instance is used as a lower boundary, it will be interpreted as -infinity and if it is used as an upper boundary, it will be interpreted as infinity.

`void setToInfinity()` Sets the boundary to infinity.

## 7.2.3 Abstract logging types

### 7.2.3.1 The abstract data type `TciValueTemplate`

The following operations are defined on the abstract data type `TciValueTemplate`. The concrete representations of these operations are defined in the respective language mapping sections:

`TBoolean isOmit()` Returns `true` if the template is an omit template.

`TBoolean isAny()` Returns `true` if the template is an any template.

`TBoolean isAnyOrOmit()` Returns `true` if the template is an any or omit template.

`TString getTemplateDef()` Returns the definition of that template.

### 7.2.3.2 The abstract data type `TciNonValueTemplate`

The following operations are defined on the abstract data type `TciNonValueTemplate`. The concrete representations of these operations are defined in the respective language mapping sections:

`TBoolean isAny()` Returns `true` if the template is an any template.

`TBoolean isAll()` Returns `true` if the template is an all template.

`TString getTemplateDef()` Returns the definition of that template.

### 7.2.3.3 The Value List and Mismatch Types

The following abstract data types are defined and used for the logging of differences between values and templates:

|                                     |  |
|-------------------------------------|--|
| <code>TciValueList</code>           | A value of <code>TciValueList</code> is a list of values.  |
| <code>TciValueDifference</code>     | A value of <code>TciValueDifference</code> is a structure containing a value, a template, and a description for the reason of this difference. |
| <code>TciValueDifferenceList</code> | A value of <code>TciValueDifferenceList</code> is a sequence of value differences.   |

The following operations are defined on the abstract data type `TciValueList`. The concrete representations of these operations are defined in the respective language mapping sections:

|   |  |
|---|--|
| <code>TInteger size()</code>              | Returns the number of values in this list.                 |
| <code>TBoolean isEmpty()</code>           | Returns <code>true</code> if this list contains no values. |
| <code>Value get(in TInteger index)</code> | Returns the value at the specified position.               |

The following operations are defined on the abstract data type `TciValueDifference`. The concrete representations of these operations are defined in the respective language mapping sections:

|   |   |
|---|---|
| <code>Value getValue()</code>                       | Returns the value of the <code>TciValueDifference</code> .    |
| <code>TciValueTemplate getTciValueTemplate()</code> | Returns the template of the <code>TciValueDifference</code> . |
| <code>String getDescription()</code>                | Returns the description of the mismatch.                      |

The following operations are defined on the abstract data type `TciValueDifferenceList`. The concrete representations of these operations are defined in the respective language mapping sections:

|  |  |
|--|--|
| <code>TInteger size()</code>                           | Returns the number of values in the list.                              |
| <code>TBoolean isEmpty()</code>                        | Returns <code>true</code> if the list contains no values.              |
| <code>TciValueDifference get(in TInteger index)</code> | Returns the <code>TciValueDifference</code> at the specified position. |

### 7.2.3.4 The Status Types

The following abstract data types are defined and used for the logging of component and timer status:

|                                  |   |
|----------------------------------|---|
| <code>ComponentStatusType</code> | A value of <code>ComponentStatusType</code> is either "inactiveC", "runningC", "stoppedC", "killedC", or "nullC". |
| <code>TimerStatusType</code>     | A value of <code>TimerStatusType</code> is either "runningT", "inactiveT", "expiredT", or "nullC".                |
| <code>PortStatusType</code>      | A value of <code>PortStatusType</code> is either "startedP", "haltedP", or "stoppedP".                            |

## 7.3 TCI operations

### 7.3.0 The TCI interfaces

The clause 7.3 specifies the operations that a TTCN-3 Executable shall provide to a test system (*required operations*) and which functionality shall be provided by the test system to the TTCN-3 Executable (*provided operations*).

The terms "required" and "provided" reflect the fact that the present document defines the requirements on a TTCN-3 Executable from a user's point of view. The user "requires" from a TTCN-3 Executable certain functionality to build a complete TTCN-3-based test system. To fulfil its task the TTCN-3 Executable has to inform the user on certain events where the user has to "provide" this possibility to the TTCN-3 Executable.

All operation definitions in this clause are defined using the Interface Definition Language (IDL). Concrete language mappings are defined in clauses 8, 9, 10, 11 and 12. Annex B provides for the logging interface an alternative mapping to XML.

For every TCI operation call all *in*, *inout*, and *out* parameters listed in the particular operation definition are mandatory. The value of an *in* parameter is specified by the calling entity. Calling entity refers to the direction of the call. For operations on a *required* interface the calling entity is the test system while the called entity is the TTCN-3 Executable. For operations on a *provided* interface the calling entity is the TTCN-3 Executable while the test system is the called entity.

Similarly, the value of an *out* parameter is specified by the called entity. In the case of an *inout* parameter, a value is first specified by the calling entity but may be replaced with a new value by the called entity. Note that although TTCN-3 also uses *in*, *inout*, and *out* for signature definitions the denotations used in TCI IDL specification are not related to those in a TTCN-3 specification.

Operation calls should use a reserved value to indicate the absence of parameters. The reserved values for these types are defined in each language mapping and will be subsequently referred to as the `null` value.

In addition, the `null` value will also be used to indicate the inability to perform a certain task.

As this clause specifies interfaces only and does not suggest concrete implementations on how to perform the specified functionality the term entity will be used to identify the part of the test system implementation that implements this interface and performs the requested functionality. For example, the calling entity in the `tcISendConnected` operation is the TE, i.e. the part of test system implementation that provides the TE functionality.

All functions in the interface are described using the following template. Descriptions that are not applicable for certain operations are removed.

|                         |   |
|-------------------------|---|
| <b>Signature</b>        | IDL Signature   |
| <b>In Parameters</b>    | Description of data passed as parameters to the operation from the calling entity to the called entity.   |
| <b>Out Parameters</b>   | Description of data passed as parameters to the operation from the called entity to the calling entity.   |
| <b>InOut Parameters</b> | Description of data passed as parameters to the operation from the calling entity to the called entity and from the called entity back to the calling entity. |
| <b>Return Value</b>     | Description of data returned from the operation to the calling entity.  |
| <b>Constraint</b>       | Description of any constraints when the operation can be called.  |
| <b>Effect</b>           | Behaviour required of the called entity before the operation may return.  |

## 7.3.1 The TCI-TM interface

### 7.3.1.0 Scope of use

The TCI Test Management Interface (TCI-TM) describes the operations a TTCN-3 Executable is required to implement and the operations a test management implementation shall provide to the TE (figure 5).

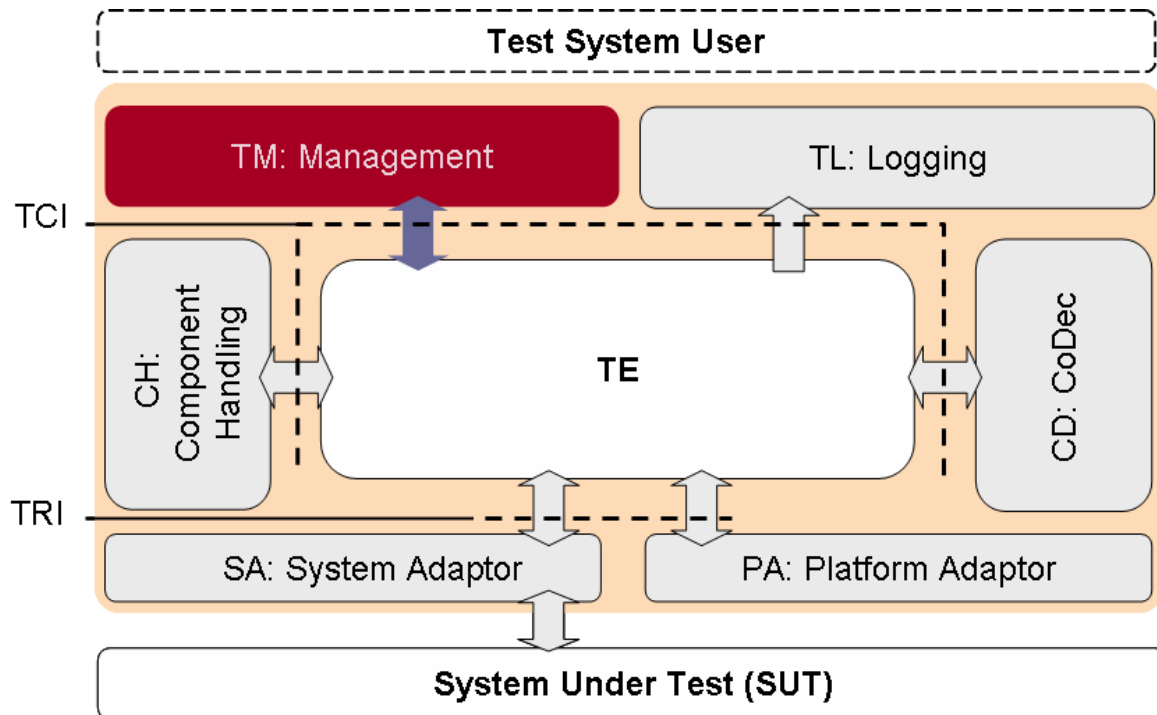

Figure 5: The TCI-TM interface

A test management implementation provides overall test management to the test system user. It requires from the TE the presence of operations to start and stop test execution of a TTCN-3 module or of certain test cases in a TTCN-3 module. In turn it provides operations to the TE for resolving module parameter at runtime and the indication of execution termination.

Annex C illustrates the usage and sequential ordering of operation calls by either the TE or the test management.

### 7.3.1.1 TCI-TM required

#### 7.3.1.1.0 Scope of use

Clause 7.3.1.1 specifies the operations the TM requires from the TE. In addition to the operations specified in this clause, a test management requires the operations as required at the TCI-CD interface.

#### 7.3.1.1.1 tciRootModule

|                      |   |  |
|----------------------|---|--|
| <b>Signature</b>     | void tciRootModule (in TciModuleIdType moduleName)  |  |
| <b>In Parameters</b> | moduleName  | The moduleName denotes the module identifiers as defined in the TTCN-3 module. |
| <b>Return Value</b>  | void  |  |
| <b>Constraint</b>    | Shall be used only if neither the control part nor a test case is currently being executed.   |  |
| <b>Effect</b>        | tciRootModule selects the indicated module for execution through a subsequent call using tciStartTestCase or tciStartControl. A tciError will be issued by the TE if no such module exists. |  |



## 7.3.1.1.2 tciGetImportedModules

|                     |  |
|---------------------|--|
| <b>Signature</b>    | TciModuleIdListType tciGetImportedModules()  |
| <b>Return Value</b> | A list of all imported modules of the root module. The modules are ordered as they appear in the TTCN-3 module. If no imported modules exist, an empty module list is returned.  |
| <b>Constraint</b>   | Shall be used only if a root module has been set before.   |
| <b>Effect</b>       | The TE provides to the management a list of imported modules of the root module. If no imported module exists, an empty module list is returned. If the TE cannot provide a list, the distinct null value shall be returned. |

## 7.3.1.1.3 tciGetModuleParameters

|                      |  |
|----------------------|--|
| <b>Signature</b>     | TciModuleParameterListType tciGetModuleParameters (in TciModuleIdType moduleName)  |
| <b>In Parameters</b> | moduleName<br>The moduleName denotes the module identifiers for which the module parameters should be retrieved.   |
| <b>Return Value</b>  | A list of all module parameters of the identified module. The parameters are ordered as they appear in the TTCN-3 module. If no parameters exist, an empty module parameter list is returned.  |
| <b>Constraint</b>    | Shall be used only if a root module has been set before.   |
| <b>Effect</b>        | The TE provides to the management a list of module parameters of the identified module. If no module parameters exist, an empty module parameter list is returned. If the TE cannot provide a list, the distinct null value shall be returned. |

## 7.3.1.1.4 tciGetTestCases

|                     |  |
|---------------------|--|
| <b>Signature</b>    | TciTestCaseIdListType tciGetTestCases ()   |
| <b>Return Value</b> | A list of all test cases that are either defined in or imported into the root module.  |
| <b>Constraint</b>   | Shall be used only if a root module has been set before.   |
| <b>Effect</b>       | The TE provides to the management a list of test cases. If no test cases exist, an empty test case list is returned. If the TE cannot provide a list, the distinct null value shall be returned. |

## 7.3.1.1.5 tciGetTestCaseParameters

|                      |   |
|----------------------|---|
| <b>Signature</b>     | TciParameterTypeListType tciGetTestCaseParameters (in TciTestCaseIdType testCaseId)   |
| <b>In Parameters</b> | testCaseId<br>A test case identifier as defined in the TTCN-3 module.   |
| <b>Return Value</b>  | A list of all parameter types of the given test case. The parameter types are ordered as they appear in the TTCN-3 signature of the test case. If no parameters exist, an empty parameter type list is returned.                            |
| <b>Constraint</b>    | Shall be used only if a root module has been set before.  |
| <b>Effect</b>        | The TE provides to the management a list of parameter types of the given test case. If no test case parameters exist, an empty parameter type list is returned. If the TE cannot provide a list, the distinct null value shall be returned. |

## 7.3.1.1.6 tciGetTestCaseTSI

|                      |  |
|----------------------|--|
| <b>Signature</b>     | TriPortIdListType tciGetTestCaseTSI (in TciTestCaseIdType testCaseId)  |
| <b>In Parameters</b> | testCaseId<br>A test case identifier as defined in the TTCN-3 module.  |
| <b>Return Value</b>  | A list of all system ports of the given test case that have been declared in the definition of the system component for the test case, i.e. the TSI ports. If a system component has not been explicitly defined for the test case, then the list contains all communication ports of the MTC test component. The ports are ordered as they appear in the respective TTCN-3 component type declaration. If no system ports exist, an empty list, i.e. a list of length zero is returned. |
| <b>Constraint</b>    | Shall be used only if a root module has been set before.   |
| <b>Effect</b>        | The TE provides to the management a list of system ports of the given test case. If no system ports exist, an empty port list is returned. If the TE cannot provide a list, the distinct null value shall be returned.   |

## 7.3.1.1.7 tciStartTestCase

|                      |  |   |
|----------------------|--|---|
| <b>Signature</b>     | void tciStartTestCase(in TciTestCaseIdType testCaseId,<br>in TciParameterListType parameterList)   |   |
| <b>In Parameters</b> | testCaseId   | A test case identifier as defined in the TTCN-3 module.   |
|                      | parameterList  | A list of Values where each value defines a parameter from the parameter list as defined in the TTCN-3 test case definition. The parameters in parameterList are ordered as they appear in the TTCN-3 signature of the test case. If no parameters have to be passed either the null value or an empty parameterList, i.e. a list of length zero shall be passed. |
| <b>Return Value</b>  | void   |   |
| <b>Constraint</b>    | Shall be called only if a module has been selected before. Only testCaseIds for test cases that are declared in the currently selected TTCN-3 module shall be passed. Test cases that are imported in a referenced module cannot be started. To start imported test cases the referenced (imported) module shall be selected first using the tciRootModule operation.                            |   |
| <b>Effect</b>        | tciStartTestCase starts a test case in the currently selected module with the given parameters. A tciError will be issued by the TE if no such test case exists.<br>All in and inout test case parameters in parameterList contain Value. All out test case parameters in parameterList shall contain the distinct value of null since they are only of relevance when the test case terminates. |   |

## 7.3.1.1.8 tciStopTestCase

|                     |  |  |
|---------------------|--|--|
| <b>Signature</b>    | void tciStopTestCase()   |  |
| <b>Return Value</b> | void   |  |
| <b>Constraint</b>   | Shall be called only if a module has been selected before.   |  |
| <b>Effect</b>       | tciStopTestCase stops the test case currently being executed. If the TE is not executing a test case, the operation will be ignored. If the control part is being executed, tciStopTestCase will stop execution of the currently executed test case, i.e. the execution of the test case that has recently been indicated using the provided operation tciTestCaseStarted. A possible executing control part will continue execution as if the test case has stopped normally and returned with verdict ERROR. |  |

## 7.3.1.1.9 tciStartControl

|                     |   |  |
|---------------------|---|--|
| <b>Signature</b>    | TriComponentId tciStartControl()  |  |
| <b>Return Value</b> | A TriComponentId that represents the test component the module control part is executed on. If the TE cannot start control part of the selected module the distinct value null will be returned.  |  |
| <b>Constraint</b>   | Shall be called only if a module has been selected before.  |  |
| <b>Effect</b>       | Starts the module control function of the selected module. The module control function started this way shall not contain any parameters and it shall not return a value. The module control function will start TTCN-3 test cases as described in TTCN-3. While executing the control function the TE will call the provided operation tciTestCaseStarted and tciTestCaseTerminated for every test case that has been started and that has terminated. After termination of the control part the TE will call the provided operation tciControlPartTerminated. |  |

## 7.3.1.1.10 tciStopControl

|                     |   |  |
|---------------------|---|--|
| <b>Signature</b>    | void tciStopControl()   |  |
| <b>Return Value</b> | void  |  |
| <b>Constraint</b>   | Shall only be called if a module has been selected before.  |  |
| <b>Effect</b>       | tciStopControl stops execution of the control part. If no control part is currently being executed the operation will be ignored. If a test case has been started directly this will stop execution of the current test case as if tciStopTestCase has been called. |  |

## 7.3.1.1.11 tciGetControlParameters

|                     |  |
|---------------------|--|
| <b>Signature</b>    | TciParameterTypeListType tciGetControlParameters ()  |
| <b>Return Value</b> | A list of all parameter types of the module control function of the root module. The parameter types are ordered as they appear in the TTCN-3 signature of the module control function.  |
| <b>Constraint</b>   | Shall be used only if a root module has been set before.   |
| <b>Effect</b>       | The TE provides to the management a list of parameter types of the module control function of the root module. If no module control function parameters exist, an empty parameter type list is returned. If the TE cannot provide a list, the distinct null value shall be returned. |

## 7.3.1.1.12 tciStartControlWithParameters

|                      |   |
|----------------------|---|
| <b>Signature</b>     | void tciStartControlWithParameters(in TciParameterListType parameterList)   |
| <b>In Parameters</b> | parameterList<br>A list of Values where each value defines a parameter from the parameter list as defined in the TTCN-3 module control function definition. The parameters in parameterList are ordered as they appear in the TTCN-3 signature of the module control function. If no parameters have to be passed either the null value or an empty parameterList, i.e. a list of length zero shall be passed.                                    |
| <b>Return Value</b>  | void  |
| <b>Constraint</b>    | Shall be called only if a module has been selected before.  |
| <b>Effect</b>        | tciStartControlWithParameters starts the module control function of the currently selected module with the given parameters. A tciError will be issued by the TE if the module control function does not exist.<br>All in and inout parameters in parameterList shall contain a Value. All out parameters in parameterList shall contain the distinct value of null since they are only of relevance when the module control function terminates. |

## 7.3.1.2 TCI-TM provided

## 7.3.1.2.0 Scope of use

Clause 7.3.1.2 specifies the operations the TM has to provide to the TE.

## 7.3.1.2.1 tciTestCaseStarted

|                      |  |
|----------------------|--|
| <b>Signature</b>     | void tciTestCaseStarted(in TciTestCaseIdType testCaseId,<br>in TciParameterListType parameterList,<br>in TFloat timer)   |
| <b>In Parameters</b> | testCaseId<br>A test case identifier as defined in the TTCN-3 module.<br>parameterList<br>A list of values that are part of the test case signature. The parameters in parameterList are ordered as they appear in the TTCN-3 test case declaration.<br>timer<br>A float value representing the duration of the test case timer. |
| <b>Return Value</b>  | void   |
| <b>Constraint</b>    | Shall only be called after either the control part of the module or a test case has been started using the <i>required</i> operations tciStartControl or tciStartTestCase.   |
| <b>Effect</b>        | tciTestCaseStarted indicates to the TM that a test case with testCaseId has been started. It will not be distinguished whether the test case has been started explicitly using the <i>required</i> operation tciStartTestCase or implicitly while executing the control part.  |

## 7.3.1.2.2 tciTestCaseTerminated

|                      |  |  |
|----------------------|--|--|
| <b>Signature</b>     | void tciTestCaseTerminated(in VerdictValue verdict,<br>in TciParameterListType parameterList)  |  |
| <b>In Parameters</b> | verdict  | The final verdict of the test case.  |
|                      | parameterList  | A list of values that are part of the test case signature. The parameters in parameterList are ordered as they appear in the TTCN-3 test case declaration. |
| <b>Return Value</b>  | void   |  |
| <b>Constraint</b>    | Shall only be called after either the control part of the module or a test case has been started using the <i>required</i> operations tciStartControl or tciStartTestCase.   |  |
| <b>Effect</b>        | This operation will be called by the TE to indicate the test management that the test case that has been currently executed on the MTC has terminated and that the final verdict was verdict. On the invocation of a tciTestCaseTerminated operation all <i>out</i> and <i>inout</i> test case parameters contain Values. All in test case parameters contain the distinct value of null because they are only of relevance to the test case start but not in the reply to the call. |  |

## 7.3.1.2.3 tciControlTerminated

|                     |  |  |
|---------------------|--|--|
| <b>Signature</b>    | void tciControlTerminated ()   |  |
| <b>Return Value</b> | void   |  |
| <b>Constraint</b>   | Shall only be called when the module execution has been started using the tciStartControl operation.   |  |
| <b>Effect</b>       | This operation will be called by the TE to indicate the test management that the module control function of the selected module has just terminated execution. |  |

## 7.3.1.2.4 tciGetModulePar

|                      |  |   |
|----------------------|--|---|
| <b>Signature</b>     | Value tciGetModulePar (in TciModuleParameterIdType parameterId)  |   |
| <b>In Parameters</b> | parameterId  | The identifier of the module parameter as defined in the TTCN-3 module. |
| <b>Return Value</b>  | A value.   |   |
| <b>Constraint</b>    | This operation shall be called whenever the TE needs to access the value of a module parameter. Every accessed module parameter will be resolved only once between a tciStartTestCase and tciTestCaseTerminated pair if a test case has been started explicitly or between a tciStartControl and tciControlTerminated pair if the control part of a module has been started. |   |
| <b>Effect</b>        | The management provides to the TE a Value for the indicated parameterId. Every call of tciGetModulePar() will return the same value throughout the execution of an explicitly started test case or throughout the execution of a control part If the management cannot provide a TTCN-3 value, the distinct null value shall be returned.                                    |   |

## 7.3.1.2.5 tciLog

|                      |   |  |
|----------------------|---|--|
| <b>Signature</b>     | void tciLog (in TriComponentIdType testComponentId,<br>in TString message)  |  |
| <b>In Parameters</b> | testComponentId   | Identifier of the component that logs the message. |
|                      | message   | A string value, i.e. the message to be logged.     |
| <b>Return Value</b>  | void  |  |
| <b>Constraint</b>    | Shall be called by the TE when the TTCN-3 statement log will be executed, either in the control part of a module or within the test case. |  |
| <b>Effect</b>        | The TM presents testComponentId and message to the user, how this done is not within the scope of the present document.                   |  |

## 7.3.1.2.6 tciError

|                      |  |   |
|----------------------|--|---|
| <b>Signature</b>     | void tciError(in TString message)  |   |
| <b>In Parameters</b> | message  | A string value, i.e. the error message. |
| <b>Return Value</b>  | void   |   |
| <b>Constraint</b>    | Can be called at any time by the TE to indicate an unrecoverable error situation. This error situation could either be indicated by the CH or the CD or could occur within the TE.   |   |
| <b>Effect</b>        | The TE indicates the occurrence of an unrecoverable error situation. message contains a reason phrase that might be communicated to the test system user. It is up to the test management to terminate execution of test cases or control parts if running. The test management has to take explicit measures to terminate test execution immediately. |   |

## 7.3.1.2.7 tciControlTerminatedWithResult

|                      |   |  |
|----------------------|---|--|
| <b>Signature</b>     | void tciControlTerminatedWithResult (in Value result, in TciParameterListType parameterList)  |  |
| <b>In Parameters</b> | result  | The return value of the module control function or the distinct value null if the function does not return any value.  |
|                      | parameterList   | A list of values that are part of the module control function signature. The parameters in parameterList are ordered as they appear in the TTCN-3 module control function declaration. |
| <b>Return Value</b>  | Void  |  |
| <b>Constraint</b>    | Shall only be called when the module execution has been started using the tciStartControlWithParameters operation.  |  |
| <b>Effect</b>        | This operation will be called by the TE to indicate the test management that the control part of the selected module has just terminated execution. On the invocation of a tciControlTerminatedWithResult operation all <i>out</i> and <i>inout</i> parameters contain Values. All <i>in</i> parameters contain the distinct value of null. |  |

## 7.3.2 The TCI-CD interface

## 7.3.2.0 Scope of use

The TCI Codec Interface (TCI-CD) describes the operations a TTCN-3 Executable is required to implement and the operations a codec implementation for a certain encoding scheme shall provide to the TE (see figure 6).

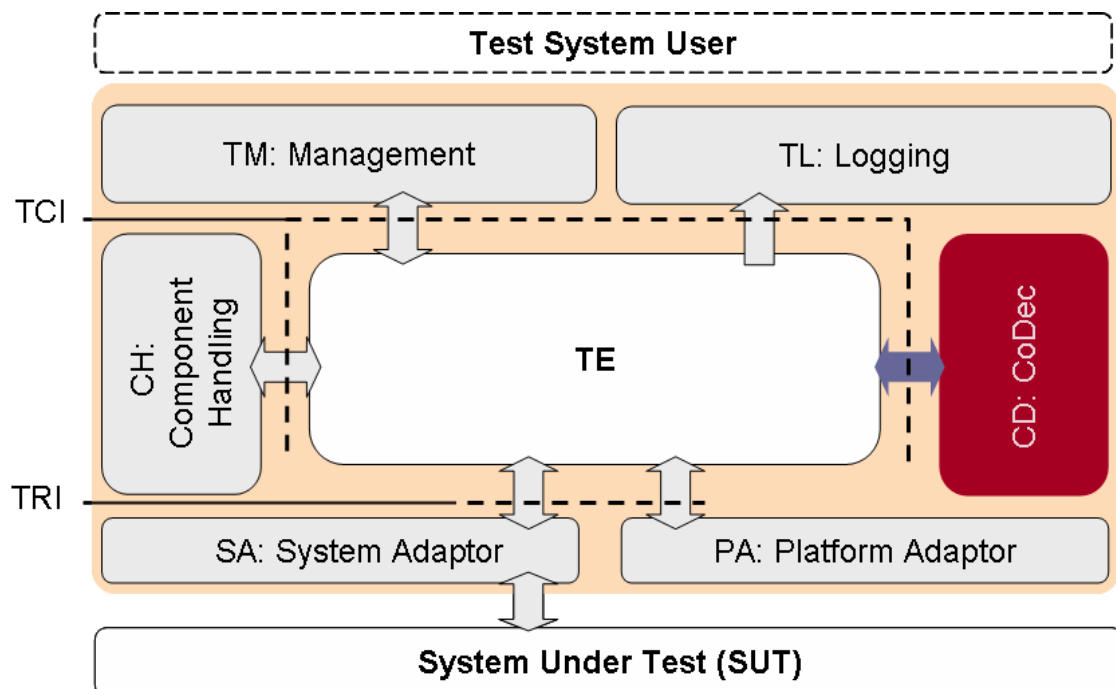

Figure 6: The TCI-CD interface

A codec implementation encodes TTCN-3 values according to the encoding attribute into a bitstring and decodes a bitstring according to decoding hypothesis. To be able to decode a bitstring into a TTCN-3 value the CD requires certain functionality from the TE. In turn the CD provides encoding and decoding functionality to the TTCN-3 Executable.

Annex C illustrates the usage and sequential ordering of operation calls by either the TE or the CD.

### 7.3.2.1 TCI-CD required

#### 7.3.2.1.0 Scope of use

Clause 7.3.2.1 specifies the operations the CD requires from the TE. All operations specified in this clause are also required at the TCI-TM and TCI-CH interfaces.

#### 7.3.2.1.1 getTypeForName

|                      |   |  |
|----------------------|---|--|
| <b>Signature</b>     | Type getTypeForName(in TString typeName)  |  |
| <b>In Parameters</b> | typeName  | The TTCN-3 name of the type as defined in the TTCN-3 module. The following are reserved type names and will return a predefined type:<br>"integer"<br>"float"<br>"bitstring"<br>"hexstring"<br>"octetstring"<br>"charstring"<br>"universal charstring"<br>"boolean"<br>"verdicttype"<br><br>typeName has to be the fully qualified type name, i.e. module.typeName |
| <b>Return Value</b>  | A type representing the requested TTCN-3 type.  |  |
| <b>Constraint</b>    | ---   |  |
| <b>Effect</b>        | Returns a type representing a TTCN-3 type. Predefined TTCN-3 types can be retrieved from the TE by using the TTCN-3 keywords for the predefined types. In this case typeName denotes to the basic TTCN-3 type like "charstring", "bitstring", etc.<br>Returns the distinct value null if the requested type cannot be returned. Note that the anytype and address cannot be obtained with module set to null. Although they are predefined types they might be distinct between modules. For example, address can either be the unmodified predefined type, or a user-defined type in a module. Other predefined types cannot be redefined. |  |

#### 7.3.2.1.2 getInteger

|                     |   |
|---------------------|---|
| <b>Signature</b>    | Type getInteger()                                       |
| <b>Return Value</b> | An instance of Type representing a TTCN-3 integer type. |
| <b>Effect</b>       | Constructs and returns a basic TTCN-3 integer type.     |

#### 7.3.2.1.3 getFloat

|                     |   |
|---------------------|---|
| <b>Signature</b>    | Type getFloat()                                       |
| <b>Return Value</b> | An instance of Type representing a TTCN-3 float type. |
| <b>Effect</b>       | Constructs and returns a basic TTCN-3 float type.     |

#### 7.3.2.1.4 getBoolean

|                     |   |
|---------------------|---|
| <b>Signature</b>    | Type getBoolean()                                       |
| <b>Return Value</b> | An instance of Type representing a TTCN-3 boolean type. |
| <b>Effect</b>       | Constructs and returns a basic TTCN-3 boolean type.     |

7.3.2.1.5 Void

7.3.2.1.6 getCharstring

|                     |  |
|---------------------|--|
| <b>Signature</b>    | Type getCharstring ()                                      |
| <b>Return Value</b> | An instance of Type representing a TTCN-3 charstring type. |
| <b>Effect</b>       | Constructs and returns a basic TTCN-3 charstringtype.      |

7.3.2.1.7 getUniversalCharstring

|                     |  |
|---------------------|--|
| <b>Signature</b>    | Type getUniversalCharstring ()                                       |
| <b>Return Value</b> | An instance of Type representing a TTCN-3 universal charstring type. |
| <b>Effect</b>       | Constructs and returns a basic TTCN-3 universal charstring type.     |

7.3.2.1.8 getHexstring

|                     |   |
|---------------------|---|
| <b>Signature</b>    | Type getHexstring ()                                      |
| <b>Return Value</b> | An instance of Type representing a TTCN-3 hexstring type. |
| <b>Effect</b>       | Constructs and returns a basic TTCN-3 hexstring type.     |

7.3.2.1.9 getBitstring

|                     |   |
|---------------------|---|
| <b>Signature</b>    | Type getBitstring()                                       |
| <b>Return Value</b> | An instance of Type representing a TTCN-3 bitstring type. |
| <b>Effect</b>       | Constructs and returns a basic TTCN-3 bitstring type.     |

7.3.2.1.10 getOctetstring

|                     |   |
|---------------------|---|
| <b>Signature</b>    | Type getOctetstring ()                                      |
| <b>Return Value</b> | An instance of Type representing a TTCN-3 octetstring type. |
| <b>Effect</b>       | Constructs and returns a basic TTCN-3 octetstring type.     |

7.3.2.1.11 getVerdict

|                     |   |
|---------------------|---|
| <b>Signature</b>    | Type getVerdict()                                       |
| <b>Return Value</b> | An instance of Type representing a TTCN-3 verdict type. |
| <b>Effect</b>       | Constructs and returns a basic TTCN-3 verdict type.     |

7.3.2.1.12 tciErrorReq

|                      |   |
|----------------------|---|
| <b>Signature</b>     | void tciErrorReq(in TString message)  |
| <b>In Parameters</b> | Message   A string value, i.e. the error phrase describing the problem.   |
| <b>Return Value</b>  | void  |
| <b>Constraint</b>    | Shall be called whenever an error situation has occurred.   |
| <b>Effect</b>        | The TE will be notified about an unrecoverable error situation within the CD and forward the error indication to the test management. |

7.3.2.2 TCI-CD provided

7.3.2.2.0 Scope of use

Clause 7.3.2.2 specifies the operations the TM shall provide to the TE.

## 7.3.2.2.1 decode

|                      |  |  |
|----------------------|--|--|
| <b>Signature</b>     | Value decode(in TriMessageType message,<br>in Type decodingHypothesis)   |  |
| <b>In Parameters</b> | message  | The encoded message to be decoded.           |
|                      | decodingHypothesis   | The hypothesis the decoding can be based on. |
| <b>Return Value</b>  | Returns the decoded value, if the value is of a compatible type as the decodingHypothesis, else the distinct value null.   |  |
| <b>Constraint</b>    | This operation shall be called whenever the TE has to implicitly decode an encoded value (e.g. when performing a port operation such as receive, trigger, getcall, getreply, catch, check or calling an external function). The TE might decode immediately after reception of an encoded value, or might for performance considerations postpone the decoding until the actual access of the encoded value.   |  |
| <b>Effect</b>        | This operation decodes message according to the encoding rules and returns a TTCN-3 value. The decodingHypothesis shall be used to determine whether the encoded value can be decoded. If an encoding rule is not self-sufficient, i.e. if the encoded message does not inherently contain its type decodingHypothesis shall be used. If the encoded value can be decoded without the decoding hypothesis, the distinct null value shall be returned if the type determined from the encoded message is not compatible with the decoding hypothesis. |  |

## 7.3.2.2.2 encode

|                      |  |                          |
|----------------------|--|--------------------------|
| <b>Signature</b>     | TriMessageType encode(in Value value)  |                          |
| <b>In Parameters</b> | value  | The value to be encoded. |
| <b>Return Value</b>  | Returns an encoded TriMessage for the specified encoding rule.   |                          |
| <b>Constraint</b>    | This operation shall be called whenever the TE has to implicitly encode a value (e.g. when performing a port operation such as send, call, reply and raise or calling an external function). |                          |
| <b>Effect</b>        | Returns an encoded TriMessage according to the encoding rules.   |                          |

## 7.3.2.2.3 decodeValue

|                       |  |  |
|-----------------------|--|--|
| <b>Signature</b>      | TInteger decodeValue(inout TriMessageType encodedValue,<br>in Type decodingHypothesis,<br>in TString encodingInfo,<br>out Value decodedValue)  |  |
| <b>In Parameters</b>  | message  | The encoded message to be decoded.   |
|                       | decodingHypothesis   | The hypothesis the decoding can be based on.   |
|                       | encodingInfo   | Dynamic decoding parameters.   |
| <b>Out Parameters</b> | decodedValue   | The decoded value, if the value is of a compatible type as the decodingHypothesis, else the distinct value null. |
| <b>Return Value</b>   | An integer value indicating success of the operation: 0 in case of success, 1 in case of an unspecified decoding error and 2 if decoding could not be completed because encodedValue did not contain enough bits.  |  |
| <b>Constraint</b>     | This operation shall be called whenever the TE invokes the predefined functions decvalue or decvalue_uniuchar.   |  |
| <b>Effect</b>         | This operation decodes message according to the encoding rules and returns the result of the decoding operation. The decodingHypothesis shall be used to determine whether the encoded value can be decoded. If an encoding rule is not self-sufficient, i.e. if the encoded message does not inherently contain its type decodingHypothesis shall be used. In case of success, the used bits are removed from the encodedValue parameter and the decoded TTCN-3 value is passed to the caller in the decodedValue parameter. In case of a failure, the TE shall ignore the content of the encodedValue and decodedValue parameter and shall act as if the former one were unchanged and the latter one contained the distinct value null. |  |



## 7.3.2.2.4 encodeValue

|                      |   |                              |
|----------------------|---|------------------------------|
| <b>Signature</b>     | TriMessageType encode(in Value value, in TString encodingInfo)  |                              |
| <b>In Parameters</b> | value   | The value to be encoded.     |
|                      | encodingInfo  | Dynamic encoding parameters. |
| <b>Return Value</b>  | Returns an encoded TriMessage for the specified encoding rule.  |                              |
| <b>Constraint</b>    | This operation shall be called whenever the TE invokes the predefined functions encvalue or encvalue_unichar. |                              |
| <b>Effect</b>        | Returns an encoded TriMessage according to the encoding rules.  |                              |

## 7.3.3 The TCI-CH interface

## 7.3.3.0 Scope of use

The TCI Component Handling Interface (TCI-CH) describes the operations a TTCN-3 Executable is required to implement and the operations a component handling implementation shall provide to the TE (figure 7).

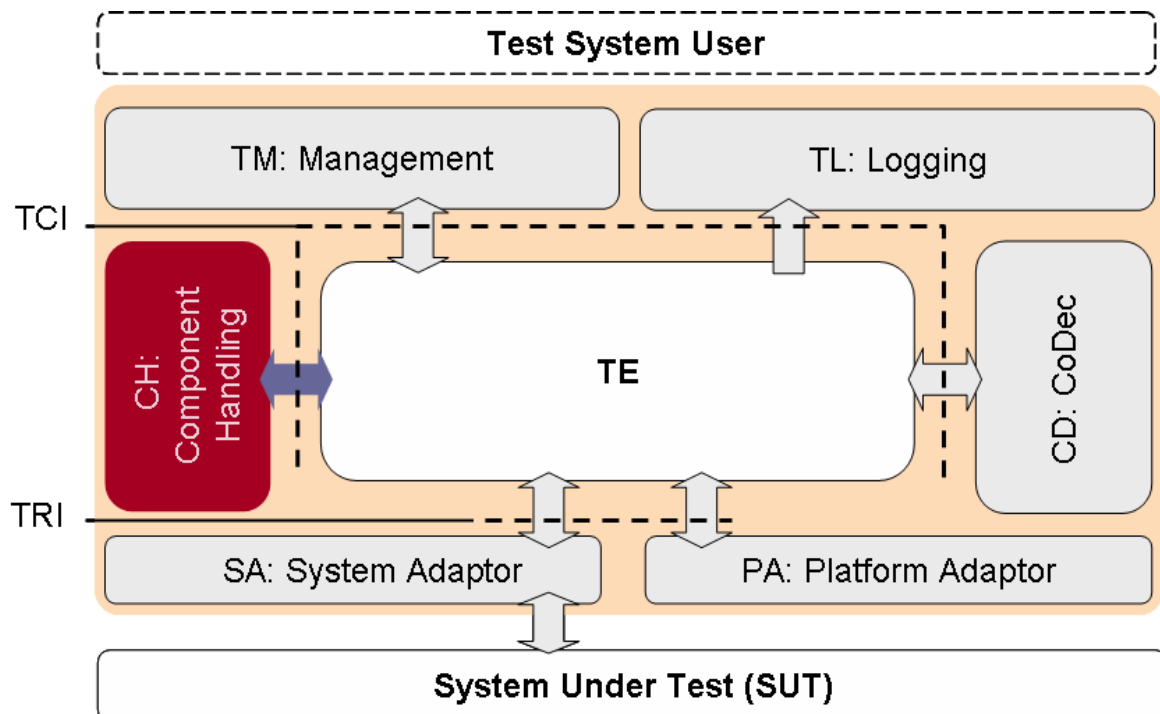

Figure 7: The TCI-CH interface

A component handling implementation distributes TTCN-3 configuration operations like create, connect and start and intercomponent communication like send on a connected port among one or more TTCN-3 Executables participating in a test session. Note that although multiple instances of a TE might participate in a test session this is not mandatory.

The basic principle is that TCI-CH is not *implementing* any kind of TTCN-3 functionality. Instead it will be informed by the TE that for example a test component shall be created. Based on Component Handling (CH) internal knowledge the request for creation of a test component will be transmitted to another (remote) participating TE. This second (remote) participating TE will create the TTCN-3 component and will provide a handle back to the requesting (local) TE. The requesting (local) TE can now operate on the created test component via this component handle.

Within the operation definitions the terms local TE and remote TE is used to highlight the fact that a test system implementation might be distributed over several test devices, each of them hosting a complete TE. The terms "local" and "remote" always refer to the interfaces currently being described. For convenience, the term "local" refers always to the TE being either the callee of an operation (for *required* operations) or the caller of an operation (for *provided* operations). While the TE is conceptually considered as being distributed, the CH is considered to be non-distributed. This can either be achieved using a centralized architecture or by using a middleware-platform that abstracts from distribution aspects. Although the TE might be distributed over different physical devices, there might be configurations where only one, non-distributed TE will participate in a test session. In this case the term "local" and "remote" refer to the same TE instance.

Annex C illustrates the usage and sequential ordering of operation calls by either the TE or the CH.

Although all TTCN-3 Executables participating in a test session are equal, there is a distinct TE\*. This TE\* is the TE where the explicit `tcIStartTestCase()` or `tcIStartControl()` has been processed. The reason for this distinction is, that TE\* shall calculate the global verdict. TE\* will notify the test management upon termination of test execution and shall provide then the global verdict of the test case.

### 7.3.3.1 TCI-CH required

#### 7.3.3.1.0 Scope of use

Clause 7.3.3.1 specifies the operations the CH requires from the TE. In addition to the operations specified in this clause, all *required* operations of the TCI-CD interface are also required.

#### 7.3.3.1.1 `tcIenqueueMsgConnected`

|                      |   |   |
|----------------------|---|---|
| <b>Signature</b>     | void <code>tcIenqueueMsgConnected</code> (in <code>TriPortIdType</code> sender,<br>in <code>TriComponentIdType</code> receiver,<br>in <code>Value</code> rcvdMessage) |   |
| <b>In Parameters</b> | sender  | Port identifier at the sending component via which the message is sent. |
|                      | receiver  | Identifier of the receiving component.                                  |
|                      | rcvdMessage   | The value to be enqueued.   |
| <b>Return Value</b>  | void  |   |
| <b>Constraint</b>    | This operation shall be called by the CH at the local TE when at remote TE a <i>provided</i> <code>tcISendConnected</code> has been called.                           |   |
| <b>Effect</b>        | The TE enqueues the received value into the local port queue of the indicated receiver component.   |   |

#### 7.3.3.1.2 `tcIenqueueCallConnected`

|                      |   |  |
|----------------------|---|--|
| <b>Signature</b>     | void <code>tcIenqueueCallConnected</code> (in <code>TriPortIdType</code> sender,<br>in <code>TriComponentIdType</code> receiver,<br>in <code>TriSignatureIdType</code> signature,<br>in <code>TciParameterListType</code> parameterList)  |  |
| <b>In Parameters</b> | sender  | Port identifier at the sending component via which the message is sent.  |
|                      | receiver  | Identifier of the receiving component.   |
|                      | signature   | Identifier of the signature of the procedure call.   |
|                      | parameterList   | A list of value parameters which are part of the indicated signature. The parameters in <code>parameterList</code> are ordered as they appear in the TTCN-3 signature declaration. |
| <b>Return Value</b>  | void  |  |
| <b>Constraint</b>    | This operation shall be called by the CH at the local TE when at a remote TE a <i>provided</i> <code>tcICallConnected</code> has been called. All <i>in</i> and <i>inout</i> procedure parameters contain values. All <i>out</i> procedure parameters shall contain the distinct value of <code>null</code> because they are only of relevance in a reply to the procedure call but not in the procedure call itself. The procedure parameters are the parameters specified in the TTCN-3 signature template. |  |
| <b>Effect</b>        | The TE enqueues the calls at the local port queue of the indicated receiver component.  |  |

## 7.3.3.1.3 tciEnqueueReplyConnected

|                      |   |   |
|----------------------|---|---|
| <b>Signature</b>     | void tciEnqueueReplyConnected (in TriPortIdType sender,<br>in TriComponentIdType receiver,<br>in TriSignatureIdType signature,<br>in TciParameterListType parameterList,<br>in Value returnValue)   |   |
| <b>In Parameters</b> | sender  | Identifier of the port sending the reply.   |
|                      | receiver  | Identifier of the component receiving the reply.  |
|                      | signature   | Identifier of the signature of the procedure call.  |
|                      | parameterList   | A list of value parameters which are part of the indicated signature. The parameters in parameterList are ordered as they appear in the TTCN-3 signature declaration. |
|                      | returnValue   | (Optional) return value of the procedure call.  |
| <b>Return Value</b>  | void  |   |
| <b>Constraint</b>    | This operation shall be called by the CH at the local TE when at a remote TE a <i>provided</i> tciReplyConnected has been called. All <i>out</i> and <i>inout</i> procedure parameters and the return value contain values. All <i>in</i> procedure parameters shall contain the distinct value of null since they are only of relevance to the procedure call but not in the reply to the call. The parameterList contains procedure call parameters. These parameters are the parameters specified in the TTCN-3 signature template. If no return type has been defined for the procedure signature in the TTCN-3 ATS, the distinct value null shall be passed for the returnValue. |   |
| <b>Effect</b>        | The TE enqueues the reply at the local port queue of the indicated receiver component.  |   |

## 7.3.3.1.4 tciEnqueueRaiseConnected

|                      |   |  |
|----------------------|---|--|
| <b>Signature</b>     | void tciEnqueueRaiseConnected (in TriPortIdType sender,<br>in TriComponentIdType receiver,<br>in TriSignatureIdType signature,<br>in Value exception) |  |
| <b>In Parameters</b> | sender  | Identifier of the port sending the reply.          |
|                      | receiver  | Identifier of the component receiving the reply.   |
|                      | signature   | Identifier of the signature of the procedure call. |
|                      | exception   | The exception.                                     |
| <b>Return Value</b>  | void  |  |
| <b>Constraint</b>    | This operation shall be called by the CH at the local TE when at a remote TE a <i>provided</i> tciRaiseConnected has been called.                     |  |
| <b>Effect</b>        | The TE enqueues the exception at the local port queue of the indicated receiver component.  |  |

## 7.3.3.1.5 tciCreateTestComponent

|                      |   |  |
|----------------------|---|--|
| <b>Signature</b>     | TriComponentIdType tciCreateTestComponent<br>(in TciTestComponentKindType kind,<br>in Type componentType),<br>in TString name)  |  |
| <b>In Parameters</b> | kind  | The kind of component that shall be created (any kind except of SYSTEM). |
|                      | componentType   | Identifier of the TTCN-3 component type that shall be created.           |
|                      | name  | Name of the component that shall be created.                             |
| <b>Return Value</b>  | A TriComponentIdType value for the created component.   |  |
| <b>Constraint</b>    | This operation shall be called by the CH at the local TE when at a remote TE a <i>provided</i> tciCreateTestComponentReq has been called. componentType shall be set to the distinct value null if a test component of kind control shall be created. name shall be set to the distinct value null if no name is given in the TTCN-3 create statement. If a non-null hostId is given, this hostId should be used to identify the remote TE in which to call tciCreateTestComponent. |  |
| <b>Effect</b>        | The TE creates a TTCN-3 test component of the componentType and passes a TriComponentIdType reference back to the CH. The CH communicates the reference back to the remote TE.  |  |

## 7.3.3.1.6 tciStartTestComponent

|                      |   |   |
|----------------------|---|---|
| <b>Signature</b>     | void tciStartTestComponent(in TriComponentIdType component,<br>in TciBehaviourIdType behaviour,<br>in TciParameterListType parameterList) |   |
| <b>In Parameters</b> | component   | Identifier of the component to be started. Refers to an identifier previously created by a call of tciCreateTestComponent.  |
|                      | behaviour   | Identifier of the behaviour to be started on the component.   |
|                      | parameterList   | A list of Values where each value defines a parameter from the parameter list as defined in the TTCN-3 function declaration of the function being started. The parameters in parameterList are ordered as they appear in the TTCN-3 signature of the test case. If no parameters have to be passed either the null value or an empty parameterList, i.e. a list of length zero shall be passed. |
| <b>Return Value</b>  | void  |   |
| <b>Constraint</b>    | This operation shall be called by the CH at the local TE when at a remote TE a <i>provided</i> tciStartTestComponentReq has been called.  |   |
| <b>Effect</b>        | The TE shall start the indicated behaviour on the indicated component.  |   |

## 7.3.3.1.7 tciStopTestComponent

|                      |   |  |
|----------------------|---|--|
| <b>Signature</b>     | void tciStopTestComponent(in TriComponentIdType component)  |  |
| <b>In Parameters</b> | component   | Identifier of the component to be stopped. |
| <b>Return Value</b>  | void  |  |
| <b>Constraint</b>    | This operation shall be called by the CH at the local TE when at a remote TE a <i>provided</i> tciStopTestComponentReq has been called. |  |
| <b>Effect</b>        | The TE shall stop the indicated behaviour on the indicated component.   |  |

## 7.3.3.1.8 tciConnect

|                      |   |   |
|----------------------|---|---|
| <b>Signature</b>     | void tciConnect (in TriPortIdType fromPort,<br>in TriPortIdType toPort)   |   |
| <b>In Parameters</b> | fromPort  | Identifier of the test component port to be connected from. |
|                      | toPort  | Identifier of the test component port to be connected to.   |
| <b>Return Value</b>  | void  |   |
| <b>Constraint</b>    | This operation shall be called by the CH at the local TE when at a remote TE a <i>provided</i> tciConnectReq has been called. |   |
| <b>Effect</b>        | The TE shall connect the indicated ports to one another.  |   |

## 7.3.3.1.9 tciDisconnect

|                      |  |   |
|----------------------|--|---|
| <b>Signature</b>     | void tciDisconnect (in TriPortIdType fromPort,<br>in TriPortIdType toPort)   |   |
| <b>In Parameters</b> | fromPort   | Identifier of the test component port to be disconnected. |
|                      | toPort   | Identifier of the test component port to be disconnected. |
| <b>Return Value</b>  | void   |   |
| <b>Constraint</b>    | This operation shall be called by the CH at the local TE when at a remote TE a <i>provided</i> tciDisconnectReq has been called. |   |
| <b>Effect</b>        | The TE shall disconnect the indicated ports.   |   |

## 7.3.3.1.10 tciMap

|                      |   |  |
|----------------------|---|--|
| <b>Signature</b>     | void tciMap (in TriPortIdType fromPort,<br>in TriPortIdType toPort)   |  |
| <b>In Parameters</b> | fromPort  | Identifier of the test component port to be mapped from. |
|                      | toPort  | Identifier of the test component port to be mapped to.   |
| <b>Return Value</b>  | void  |  |
| <b>Constraint</b>    | This operation shall be called by the CH at the local TE when at a remote TE a <i>provided</i> tciMapReq has been called. |  |
| <b>Effect</b>        | The TE shall map the indicated ports to one another.  |  |

## 7.3.3.1.11 tciMapParam

|                      |  |  |
|----------------------|--|--|
| <b>Signature</b>     | void tciMapParam (in TriPortIdType fromPort,<br>in TriPortIdType toPort<br>in TriParameterListType paramList)                  |  |
| <b>In Parameters</b> | fromPort   | Identifier of the test component port to be mapped from. |
|                      | toPort   | Identifier of the test component port to be mapped to.   |
|                      | paramList  | Configuration parameter list.                            |
| <b>Return Value</b>  | void   |  |
| <b>Constraint</b>    | This operation shall be called by the CH at the local TE when at a remote TE a <i>provided</i> tciMapParamReq has been called. |  |
| <b>Effect</b>        | The TE shall map the indicated ports to one another.   |  |

## 7.3.3.1.12 tciUnmap

|                      |   |   |
|----------------------|---|---|
| <b>Signature</b>     | void tciUnmap (in TriPortIdType fromPort,<br>in TriPortIdType toPort)   |   |
| <b>In Parameters</b> | fromPort  | Identifier of the test component port to be unmapped. |
|                      | toPort  | Identifier of the test component port to be unmapped. |
| <b>Return Value</b>  | void  |   |
| <b>Constraint</b>    | This operation shall be called by the CH at the local TE when at a remote TE a <i>provided</i> tciUnmapReq has been called. |   |
| <b>Effect</b>        | The TE shall unmap the indicated ports.   |   |

## 7.3.3.1.13 tciUnmapParam

|                      |  |   |
|----------------------|--|---|
| <b>Signature</b>     | void tciUnmapParam (in TriPortIdType fromPort,<br>in TriPortIdType toPort<br>in TriParameterListType paramList)                  |   |
| <b>In Parameters</b> | fromPort   | Identifier of the test component port to be unmapped. |
|                      | toPort   | Identifier of the test component port to be unmapped. |
|                      | paramList  | Configuration parameter.                              |
| <b>Return Value</b>  | void   |   |
| <b>Constraint</b>    | This operation shall be called by the CH at the local TE when at a remote TE a <i>provided</i> tciUnmapParamReq has been called. |   |
| <b>Effect</b>        | The TE shall unmap the indicated ports.  |   |

## 7.3.3.1.14 tciTestComponentTerminated

|                      |  |  |
|----------------------|--|--|
| <b>Signature</b>     | void tciTestComponentTerminated (in TriComponentIdType component, in VerdictValue verdict)   |  |
| <b>In Parameters</b> | component  | Identifier of the component that has terminated. |
|                      | verdict  | Verdict after termination of the component.      |
| <b>Return Value</b>  | void   |  |
| <b>Constraint</b>    | This operation shall be called by the CH at the local TE when at a remote TE a <i>provided</i> tciTestComponentTerminatedReq has been called.  |  |
| <b>Effect</b>        | The local TE is notified of the termination of the indicated test component on a remote TE. Because the out values of <i>inout</i> and <i>out</i> parameters of a function being executed on a test component have no effect on that test component (ETSI ES 201 873-1 [1]), the tciTestComponentTerminated operation does not have a parameterList parameter. |  |

## 7.3.3.1.15 tciTestComponentRunning

|                      |   |  |
|----------------------|---|--|
| <b>Signature</b>     | TBoolean tciTestComponentRunning (in TriComponentIdType component)  |  |
| <b>In Parameters</b> | component   | Identifier of the component to be checked for running. |
| <b>Return Value</b>  | true if the indicated component is still executing a behaviour, false otherwise.  |  |
| <b>Constraint</b>    | This operation shall be called by the CH at the local TE when at a remote TE a <i>provided</i> tciTestComponentRunningReq has been called.  |  |
| <b>Effect</b>        | The local TE determines whether the indicated component is executing a test behaviour. If the component is executing a behaviour true will be returned. In any other case, e.g. test component has finished execution, or test component has not been started, etc. false will be returned. After the operation returns, the CH will communicate the value back to the remote TE. |  |

## 7.3.3.1.16 tciTestComponentDone

|                       |  |   |
|-----------------------|--|---|
| <b>Signature</b>      | TBoolean tciTestComponentDone (in TriComponentIdType comp, out TInteger verdict)   |   |
| <b>In Parameters</b>  | comp   | Identifier of the component to be checked for done.   |
| <b>Out Parameters</b> | verdict  | If the component has completed executing its behaviour, the parameter will contain numeric representation of the final component verdict (one of the following constants: ERROR, FAIL, INCONC, NONE, PASS, USER_ERROR). Otherwise, the parameter will contain the ERROR constant. |
| <b>Return Value</b>   | true if the indicated component has completed executing its behaviour, false otherwise.  |   |
| <b>Constraint</b>     | This operation shall be called by the CH at the local TE when at a remote TE a <i>provided</i> tciTestComponentDoneReq has been called.  |   |
| <b>Effect</b>         | The local TE determines whether the indicated component has completed executing its test behaviour. If the component has completed its behaviour true will be returned. In any other case, e.g. test component has not been started, or test component is still executing, false will be returned. After the operation returns, the CH will communicate the value back to the remote TE. |   |

## 7.3.3.1.17 tciGetMTC

|                     |  |  |
|---------------------|--|--|
| <b>Signature</b>    | TriComponentIdType tciGetMTC()   |  |
| <b>Return Value</b> | A TriComponentIdType value of the MTC if the MTC executes on the local TE, the distinct value null otherwise.  |  |
| <b>Constraint</b>   | This operation can be called by the CH at the appropriate local TE when at a remote TE a <i>provided</i> tciGetMTCReq has been called.   |  |
| <b>Effect</b>       | The local TE determines whether the MTC is executing on the local TE. If the MTC executes on the local TE the component id of the MTC is being returned. If the MTC is not executed on the local TE the distinct value null will be returned. The operation will have no effect on the execution of the MTC. After the operation returns, the CH will communicate the value back to the remote TE. |  |

## 7.3.3.1.18 tciExecuteTestCase

|                      |   |  |
|----------------------|---|--|
| <b>Signature</b>     | void tciExecuteTestCase (in TciTestCaseIdType testCaseId,<br>in TriPortIdListType tsiPortList)  |  |
| <b>In Parameters</b> | testCaseId  | A test case identifier as defined in the TTCN-3 module.  |
|                      | tsiPortList   | Contains all ports that have been declared in the definition of the system component for the test case, i.e. the TSI ports. If a system component has not been explicitly defined for the test case, then the tsiPortList contains all communication ports of the MTC. The ports in tsiPortList are ordered as they appear in the respective TTCN-3 component type declaration. If no ports have to be passed either the null value or an empty tsiPortList, i.e. a list of length zero shall be passed. |
| <b>Return Value</b>  | void  |  |
| <b>Constraint</b>    | This operation shall be called by the CH at the appropriate local TE when at a remote TE a <i>provided</i> tciExecuteTestCaseReq has been called. |  |
| <b>Effect</b>        | The local TE determines whether static connections to the SUT and the initialization of communication means for TSI ports should be done.         |  |

## 7.3.3.1.19 tciReset

|                     |  |  |
|---------------------|--|--|
| <b>Signature</b>    | void tciReset ()   |  |
| <b>Return Value</b> | void   |  |
| <b>Constraint</b>   | This operation shall be called by the CH at appropriate local TEs when at a remote TE a <i>provided</i> tciResetReq has been called. |  |
| <b>Effect</b>       | The TE can decide to take any means to reset the test system locally.  |  |

## 7.3.3.1.20 tciKillTestComponent

|                      |   |   |
|----------------------|---|---|
| <b>Signature</b>     | void tciKillTestComponent(in TriComponentIdType comp)   |   |
| <b>In Parameters</b> | comp  | Identifier of the component to be killed. |
| <b>Return Value</b>  | void  |   |
| <b>Constraint</b>    | This operation shall be called by the CH at the local TE when at a remote TE a <i>provided</i> tciKillTestComponentReq has been called. |   |
| <b>Effect</b>        | The TE stops the behaviour on the indicated component if necessary and transfers it into the killed state.                              |   |

## 7.3.3.1.21 tciTestComponentAlive

|                      |   |  |
|----------------------|---|--|
| <b>Signature</b>     | TBoolean tciTestComponentAlive (in TriComponentIdType comp)   |  |
| <b>In Parameters</b> | comp  | Identifier of the component to be checked for being alive. |
| <b>Return Value</b>  | true if the indicated component is alive, false otherwise.  |  |
| <b>Constraint</b>    | This operation shall be called by the CH at the local TE when at a remote TE a <i>provided</i> tciTestComponentAliveReq has been called.                |  |
| <b>Effect</b>        | The local TE determines whether the indicated component is alive. After the operation returns, the CH will communicate the value back to the remote TE. |  |

## 7.3.3.1.22 tciTestComponentKilled

|                       |   |   |
|-----------------------|---|---|
| <b>Signature</b>      | TBoolean tciTestComponentKilled (in TriComponentIdType comp, out TInteger verdict)  |   |
| <b>In Parameters</b>  | comp  | Identifier of the component to be checked for being killed.   |
| <b>Out Parameters</b> | verdict   | If the component has been killed, the parameter will contain numeric representation of the final component verdict (one of the following constants: ERROR, FAIL, INCONC, NONE, PASS, USER_ERROR). Otherwise, the parameter will contain the ERROR constant. |
| <b>Return Value</b>   | true if the indicated component has been killed, false otherwise.   |   |
| <b>Constraint</b>     | This operation shall be called by the CH at the local TE when at a remote TE a <i>provided</i> tciTestComponentKilledReq has been called.   |   |
| <b>Effect</b>         | The local TE determines whether the indicated component is in the killed state. If it is, true will be returned. In any other case, false will be returned. After the operation returns, the CH will communicate the value back to the remote TE. |   |

## 7.3.3.1.23 tciCallTestComponent

|                      |   |  |
|----------------------|---|--|
| <b>Signature</b>     | void tciCallTestComponent (in TriComponentIdType component, in TciBehaviourIdType behaviour, in TciParameterListType parameterList)     |  |
| <b>In Parameters</b> | component   | Identifier of the component to be called. Refers to an identifier previously created by a call of tciCreateTestComponent.  |
|                      | behaviour   | Identifier of the behaviour to be called on the component.   |
|                      | parameterList   | A list of Values where each value defines a parameter from the parameter list as defined in the TTCN-3 function declaration of the function being started. The parameters in parameterList are ordered as they appear in the TTCN-3 definition of the called function. If no parameters have to be passed either the null value or an empty parameterList, i.e. a list of length zero shall be passed. |
| <b>Return Value</b>  | Void  |  |
| <b>Constraint</b>    | This operation shall be called by the CH at the local TE when at a remote TE a <i>provided</i> tciCallTestComponentReq has been called. |  |
| <b>Effect</b>        | The TE shall call the indicated behaviour on the indicated component.   |  |

## 7.3.3.1.24 tciTestComponentCallTerminated

|                      |   |   |
|----------------------|---|---|
| <b>Signature</b>     | void tciTestComponentCallTerminated (in TriComponentIdType component, in VerdictValue verdict, in TciParameterListType parameterList, in Value returnValue) |   |
| <b>In Parameters</b> | component   | Identifier of the called component that has finished execution.   |
|                      | verdict   | Verdict after finishing component call.   |
|                      | parameterList   | A list of Values where each value defines a parameter from the parameter list as defined in the TTCN-3 function declaration of the function being started. The parameters in parameterList are ordered as they appear in the TTCN-3 definition of the called. If no parameters have to be passed either the null value or an empty parameterList, i.e. a list of length zero shall be passed. |
|                      | returnValue   | The return value of the called function or the null value if no return value is defined.  |
| <b>Return Value</b>  | Void  |   |
| <b>Constraint</b>    | This operation shall be called by the CH at the local TE when at a remote TE a <i>provided</i> tciTestComponentCallTerminatedReq has been called.           |   |
| <b>Effect</b>        | The local TE is notified that the call to the indicated test component on a remote TE has been finished and receives the result of the call.                |   |



### 7.3.3.2 TCI-CH provided

#### 7.3.3.2.0 Scope of use

Clause 7.3.3.2 specifies the operations the CH shall provide to the TE.

#### 7.3.3.2.1 tciSendConnected

|                      |  |   |
|----------------------|--|---|
| <b>Signature</b>     | void tciSendConnected (in TriPortIdType sender,<br>in TriComponentIdType receiver,<br>in Value sendMessage)  |   |
| <b>In Parameters</b> | sender   | Port identifier at the sending component via which the message is sent. |
|                      | receiver   | Identifier of the receiving component.                                  |
|                      | sendMessage  | The message to be sent.   |
| <b>Return Value</b>  | void   |   |
| <b>Constraint</b>    | This operation shall be called by the TE when it executes a TTCN-3 unicast send operation on a component port, which has been connected to another component port.                             |   |
| <b>Effect</b>        | Sends an asynchronous transmission only to the given receiver component. CH transmits the message to the remote TE on which receiver is being executed and enqueues the data in the remote TE. |   |

#### 7.3.3.2.2 tciSendConnectedBC

|                      |  |   |
|----------------------|--|---|
| <b>Signature</b>     | void tciSendConnectedBC (in TriPortIdType sender,<br>in Value sendMessage)   |   |
| <b>In Parameters</b> | sender   | Port identifier at the sending component via which the message is sent. |
|                      | sendMessage  | The message to be sent.   |
| <b>Return Value</b>  | void   |   |
| <b>Constraint</b>    | This operation shall be called by the TE when it executes a TTCN-3 broadcast send operation on a component port, which has been connected to other component ports.  |   |
| <b>Effect</b>        | Sends an asynchronous transmission to all components being connected to this port. CH transmits the message to all remote TEs on which receivers are being executed and enqueues the data in the remote TEs. |   |

#### 7.3.3.2.3 tciSendConnectedMC

|                      |  |   |
|----------------------|--|---|
| <b>Signature</b>     | void tciSendConnectedMC (in TriPortIdType sender,<br>in TriComponentIdListType receivers,<br>in Value sendMessage)   |   |
| <b>In Parameters</b> | sender   | Port identifier at the sending component via which the message is sent. |
|                      | receivers  | Identifiers of the receiving components.                                |
|                      | sendMessage  | The message to be sent.   |
| <b>Return Value</b>  | void   |   |
| <b>Constraint</b>    | This operation shall be called by the TE when it executes a TTCN-3 multicast send operation on a component port, which has been connected to other component ports.                            |   |
| <b>Effect</b>        | Sends an asynchronous transmission to all given receiver components. CH transmits the message to all remote TEs on which receivers are being executed and enqueues the data in the remote TEs. |   |

## 7.3.3.2.4 tciCallConnected

|                      |   |   |
|----------------------|---|---|
| <b>Signature</b>     | void tciCallConnected (in TriPortIdType sender,<br>in TriComponentIdType receiver,<br>in TriSignatureIdType signature,<br>in TciParameterListType parameterList)  |   |
| <b>In Parameters</b> | sender  | Port identifier at the sending component via which the message is sent.   |
|                      | receiver  | Identifier of the receiving component.  |
|                      | signature   | Identifier of the signature of the procedure call.  |
|                      | parameterList   | A list of value parameters which are part of the indicated signature. The parameters in parameterList are ordered as they appear in the TTCN-3 signature declaration. |
| <b>Return Value</b>  | void  |   |
| <b>Constraint</b>    | This operation shall be called by the TE when it executes a TTCN-3 unicast call operation on a component port, which has been connected to another component port. All <i>in</i> and <i>inout</i> procedure parameters contain values. All <i>out</i> procedure parameters shall contain the distinct value of <code>null</code> because they are only of relevance in a reply to the procedure call but not in the procedure call itself. The procedure parameters are the parameters specified in the TTCN-3 signature template.  |   |
| <b>Effect</b>        | On invocation of this operation the TE can initiate the procedure call corresponding to the signature identifier <i>signature</i> at the called component receiver. The <code>tciCallConnected</code> operation shall return without waiting for the return of the issued procedure call. Note that an optional timeout value, which can be specified in the TTCN-3 ATS for a call operation, is not included in the <code>tciCallConnected</code> operation signature. The TE is responsible to address this issue by starting a timer for the TTCN-3 call operation in the PA with a separate TRI operation call, i.e. <code>triStartTimer</code> . CH transmits the call to the remote TE on which <i>receiver</i> is being executed and enqueues the call in the remote TE. |   |

## 7.3.3.2.5 tciCallConnectedBC

|                      |   |   |
|----------------------|---|---|
| <b>Signature</b>     | void tciCallConnectedBC (in TriPortIdType sender,<br>in TriSignatureIdType signature,<br>in TciParameterListType parameterList)   |   |
| <b>In Parameters</b> | sender  | Port identifier at the sending component via which the message is sent.   |
|                      | signature   | Identifier of the signature of the procedure call.  |
|                      | parameterList   | A list of value parameters which are part of the indicated signature. The parameters in parameterList are ordered as they appear in the TTCN-3 signature declaration. |
| <b>Return Value</b>  | void  |   |
| <b>Constraint</b>    | This operation shall be called by the TE when it executes a TTCN-3 broadcast call operation on a component port, which has been connected to other component ports. All <i>in</i> and <i>inout</i> procedure parameters contain values. All <i>out</i> procedure parameters shall contain the distinct value of <code>null</code> because they are only of relevance in a reply to the procedure call but not in the procedure call itself. The procedure parameters are the parameters specified in the TTCN-3 signature template.   |   |
| <b>Effect</b>        | On invocation of this operation the TE can initiate the procedure call corresponding to the signature identifier <i>signature</i> at the called component receiver. The <code>tciCallConnected</code> operation shall return without waiting for the return of the issued procedure call. Note that an optional timeout value, which can be specified in the TTCN-3 ATS for a call operation, is not included in the <code>tciCallConnected</code> operation signature. The TE is responsible to address this issue by starting a timer for the TTCN-3 call operation in the PA with a separate TRI operation call, i.e. <code>triStartTimer</code> . CH transmits the call to all remote TEs on which a <i>receiver</i> is being executed and enqueues the call in the remote TEs. |   |

## 7.3.3.2.6 tciCallConnectedMC

|                      |   |   |
|----------------------|---|---|
| <b>Signature</b>     | void tciCallConnectedMC (in TriPortIdType sender,<br>in TriComponentIdListType receivers,<br>in TriSignatureIdType signature,<br>in TciParameterListType parameterList)   |   |
| <b>In Parameters</b> | sender  | Port identifier at the sending component via which the message is sent.   |
|                      | receivers   | Identifier of the receiving components.   |
|                      | signature   | Identifier of the signature of the procedure call.  |
|                      | parameterList   | A list of value parameters which are part of the indicated signature. The parameters in parameterList are ordered as they appear in the TTCN-3 signature declaration. |
| <b>Return Value</b>  | void  |   |
| <b>Constraint</b>    | This operation shall be called by the TE when it executes a TTCN-3 multicast call operation on a component port, which has been connected to other component ports. All <i>in</i> and <i>inout</i> procedure parameters contain values. All <i>out</i> procedure parameters shall contain the distinct value of null because they are only of relevance in a reply to the procedure call but not in the procedure call itself. The procedure parameters are the parameters specified in the TTCN-3 signature template.  |   |
| <b>Effect</b>        | On invocation of this operation the TE can initiate the procedure call corresponding to the signature identifier signature at the called component receiver. The tciCallConnected operation shall return without waiting for the return of the issued procedure call. Note that an optional timeout value, which can be specified in the TTCN-3 ATS for a call operation, is not included in the tciCallConnected operation signature. The TE is responsible to address this issue by starting a timer for the TTCN-3 call operation in the PA with a separate TRI operation call, i.e. triStartTimer. CH transmits the call to all remote TEs on which a receiver is being executed and enqueues the call in the remote TEs. |   |

## 7.3.3.2.7 tciReplyConnected

|                      |   |   |
|----------------------|---|---|
| <b>Signature</b>     | void tciReplyConnected (in TriPortIdType sender,<br>in TriComponentIdType receiver,<br>in TriSignatureIdType signature,<br>in TciParameterListType parameterList,<br>in Value returnValue)  |   |
| <b>In Parameters</b> | sender  | Identifier of the port sending the reply.   |
|                      | receiver  | Identifier of the component receiving the reply.  |
|                      | signature   | Identifier of the signature of the procedure call.  |
|                      | parameterList   | A list of encoded parameters which are part of the indicated signature. The parameters in parameterList are ordered as they appear in the TTCN-3 signature declaration. |
|                      | returnValue   | (Optional) return value of the procedure call.  |
| <b>Return Value</b>  | void  |   |
| <b>Constraint</b>    | This operation shall be called by the TE when it executes a TTCN-3 unicast reply operation on a component port which has been connected to another component port. All <i>out</i> and <i>inout</i> procedure parameters and the return value contain values. All <i>in</i> procedure parameters shall contain the distinct value of null since they are only of relevance to the procedure call but not in the reply to the call. The parameterList contains procedure call parameters. These parameters are the parameters specified in the TTCN-3 signature template. If no return type has been defined for the procedure signature in the TTCN-3 ATS, the distinct value null shall be passed for the return value. |   |
| <b>Effect</b>        | On invocation of this operation the CH can issue the reply to a procedure call corresponding to the signature identifier signature and component identifier receiver. CH transmits the reply to the remote TE on which receiver is being executed and enqueues the reply in the remote TE.  |   |

## 7.3.3.2.8 tciReplyConnectedBC

|                      |  |   |
|----------------------|--|---|
| <b>Signature</b>     | void tciReplyConnectedBC (in TriPortIdType sender,<br>in TriSignatureIdType signature,<br>in TciParameterListType parameterList,<br>in Value returnValue)  |   |
| <b>In Parameters</b> | sender   | Identifier of the port sending the reply.   |
|                      | signature  | Identifier of the signature of the procedure call.  |
|                      | parameterList  | A list of encoded parameters which are part of the indicated signature. The parameters in parameterList are ordered as they appear in the TTCN-3 signature declaration. |
|                      | returnValue  | (Optional) return value of the procedure call.  |
| <b>Return Value</b>  | void   |   |
| <b>Constraint</b>    | This operation shall be called by the TE when it executes a TTCN-3 broadcast reply operation on a component port which has been connected to other component ports.<br>All <i>out</i> and <i>inout</i> procedure parameters and the return value contain values. All <i>in</i> procedure parameters shall contain the distinct value of <code>null</code> since they are only of relevance to the procedure call but not in the reply to the call. The <code>parameterList</code> contains procedure call parameters. These parameters are the parameters specified in the TTCN-3 signature template. If no return type has been defined for the procedure signature in the TTCN-3 ATS, the distinct value <code>null</code> shall be passed for the return value. |   |
| <b>Effect</b>        | On invocation of this operation the CH can issue the reply to a procedure call corresponding to the signature identifier <code>signature</code> and all components connected to <code>sender</code> . CH transmits the exception to all remote TEs on which receivers are being executed and enqueues the exception in the remote TEs.   |   |

## 7.3.3.2.9 tciReplyConnectedMC

|                      |  |   |
|----------------------|--|---|
| <b>Signature</b>     | void tciReplyConnectedMC (in TriPortIdType sender,<br>in TriComponentIdListType receivers,<br>in TriSignatureIdType signature,<br>in TciParameterListType parameterList,<br>in Value returnValue)  |   |
| <b>In Parameters</b> | sender   | Identifier of the port sending the reply.   |
|                      | receivers  | Identifier of the components receiving the reply.   |
|                      | signature  | Identifier of the signature of the procedure call.  |
|                      | parameterList  | A list of encoded parameters which are part of the indicated signature. The parameters in parameterList are ordered as they appear in the TTCN-3 signature declaration. |
|                      | returnValue  | (Optional) return value of the procedure call.  |
| <b>Return Value</b>  | void   |   |
| <b>Constraint</b>    | This operation shall be called by the TE when it executes a TTCN-3 multicast reply operation on a component port which has been connected to other component ports.<br>All <i>out</i> and <i>inout</i> procedure parameters and the return value contain values. All <i>in</i> procedure parameters shall contain the distinct value of <code>null</code> since they are only of relevance to the procedure call but not in the reply to the call. The <code>parameterList</code> contains procedure call parameters. These parameters are the parameters specified in the TTCN-3 signature template. If no return type has been defined for the procedure signature in the TTCN-3 ATS, the distinct value <code>null</code> shall be passed for the return value. |   |
| <b>Effect</b>        | On invocation of this operation the CH can issue the reply to a procedure call corresponding to the signature identifier <code>signature</code> and one of the component identifier in <code>receivers</code> . CH transmits the reply to the remote TEs on which <code>receivers</code> are being executed and enqueues the reply in the remote TEs.  |   |

## 7.3.3.2.10 tciRaiseConnected

|                      |   |  |
|----------------------|---|--|
| <b>Signature</b>     | void tciRaiseConnected (in TriPortIdType sender,<br>in TriComponentIdType receiver,<br>in TriSignatureIdType signature,<br>in Value exception)  |  |
| <b>In Parameters</b> | sender  | Identifier of the port sending the reply.          |
|                      | receiver  | Identifier of the component receiving the reply.   |
|                      | signature   | Identifier of the signature of the procedure call. |
|                      | exception   | The exception value.                               |
| <b>Return Value</b>  | void  |  |
| <b>Constraint</b>    | This operation shall be called by the TE when it executes a TTCN-3 unicast raise operation on a component port which has been connected to another component port.  |  |
| <b>Effect</b>        | On invocation of this operation the CH can raise an exception to a procedure call corresponding to the signature identifier <i>signature</i> and component identifier <i>receiver</i> . CH transmits the exception to the remote TE on which <i>receiver</i> is being executed and enqueues the exception in the remote TE. |  |

## 7.3.3.2.11 tciRaiseConnectedBC

|                      |   |  |
|----------------------|---|--|
| <b>Signature</b>     | void tciRaiseConnectedBC (in TriPortIdType sender,<br>in TriSignatureIdType signature,<br>in Value exception)   |  |
| <b>In Parameters</b> | sender  | Identifier of the port sending the reply.          |
|                      | signature   | Identifier of the signature of the procedure call. |
|                      | exception   | The exception value.                               |
| <b>Return Value</b>  | void  |  |
| <b>Constraint</b>    | This operation shall be called by the TE when it executes a TTCN-3 broadcast raise operation on a component port which has been connected to other component ports.   |  |
| <b>Effect</b>        | On invocation of this operation the CH can raise an exception to a procedure call corresponding to the signature identifier <i>signature</i> and all components connected to <i>sender</i> . CH transmits the exception to all remote TEs on which receivers are being executed and enqueues the exception in the remote TEs. |  |

## 7.3.3.2.12 tciRaiseConnectedMC

|                      |   |  |
|----------------------|---|--|
| <b>Signature</b>     | void tciRaiseConnectedMC (in TriPortIdType sender,<br>in TriComponentIdListType receiver,<br>in TriSignatureIdType signature,<br>in Value exception)  |  |
| <b>In Parameters</b> | sender  | Identifier of the port sending the reply.          |
|                      | receivers   | Identifiers of the component receiving the reply.  |
|                      | signature   | Identifier of the signature of the procedure call. |
|                      | exception   | The exception value.                               |
| <b>Return Value</b>  | void  |  |
| <b>Constraint</b>    | This operation shall be called by the TE when it executes a TTCN-3 multicast raise operation on a component port which has been connected to another component port.  |  |
| <b>Effect</b>        | On invocation of this operation the CH can raise an exception to a procedure call corresponding to the signature identifier <i>signature</i> and one of the component identifier <i>receivers</i> . CH transmits the exception to all remote TEs on which <i>receivers</i> are being executed and enqueues the exception in the remote TEs. |  |

## 7.3.3.2.13 tciCreateTestComponentReq

|                      |   |  |
|----------------------|---|--|
| <b>Signature</b>     | TriComponentIdType tciCreateTestComponentReq<br>(in TciTestComponentKindType kind,<br>in Type componentType,<br>in TString name,<br>in Value hostId)  |  |
| <b>In Parameters</b> | kind  | The kind of component that shall be created (any kind except of SYSTEM). |
|                      | componentType   | Identifier of the TTCN-3 component type that shall be created.           |
|                      | hostId  | Value identifying the remote TE where the component shall be deployed.   |
| <b>Return Value</b>  | A TriComponentIdType value for the created component.   |  |
| <b>Constraint</b>    | This operation shall be called from the TE when a component has to be created, either explicitly when the TTCN-3 create operation is called or implicitly when the master test component (MTC) or a control component has to be created. name shall be set to the distinct value null if no name is given in the TTCN-3 create statement. |  |
| <b>Effect</b>        | CH transmits the component creation request to the remote TE and calls there the tciCreateTestComponent operation to obtain a component identifier for this component.  |  |

## 7.3.3.2.14 tciStartTestComponentReq

|                      |  |   |
|----------------------|--|---|
| <b>Signature</b>     | void tciStartTestComponentReq(in TriComponentIdType component,<br>in TciBehaviourIdType behaviour,<br>in TciParameterListType parameterList) |   |
| <b>In Parameters</b> | component  | Identifier of the component to be started.  |
|                      | behaviour  | Identifier of the behaviour to be started on the component.   |
|                      | parameterList  | A list of Values where each value defines a parameter from the parameter list as defined in the TTCN-3 function declaration of the function being started. The parameters in parameterList are ordered as they appear in the TTCN-3 signature of the test case. If no parameters have to be passed either the null value or an empty parameterList, i.e. a list of length zero shall be passed. |
| <b>Return Value</b>  | void   |   |
| <b>Constraint</b>    | This operation shall be called by the TE when it executes the TTCN-3 start operation.  |   |
| <b>Effect</b>        | CH transmits the start component request to the remote TE and calls there the tciStartTestComponent operation.                               |   |

## 7.3.3.2.15 tciStopTestComponentReq

|                      |  |  |
|----------------------|--|--|
| <b>Signature</b>     | void tciStopTestComponentReq(in TriComponentIdType component)  |  |
| <b>In Parameters</b> | component  | Identifier of the component to be stopped. |
| <b>Return Value</b>  | void   |  |
| <b>Constraint</b>    | This operation shall be called by the TE when it executes the TTCN-3 stop operation.                         |  |
| <b>Effect</b>        | CH transmits the stop component request to the remote TE and calls there the tciStopTestComponent operation. |  |

## 7.3.3.2.16 tciConnectReq

|                      |  |   |
|----------------------|--|---|
| <b>Signature</b>     | void tciConnectReq (in TriPortIdType fromPort,<br>in TriPortIdType toPort)   |   |
| <b>In Parameters</b> | fromPort   | Identifier of the test component port to be connected from. |
|                      | toPort   | Identifier of the test component port to be connected to.   |
| <b>Return Value</b>  | void   |   |
| <b>Constraint</b>    | This operation shall be called by the TE when it executes a TTCN-3 connect operation.  |   |
| <b>Effect</b>        | CH transmits the connection request to the remote TE where it calls the tciConnect operation to establish a logical connection between the two indicated ports. Note that both ports can be on remote TEs. In this case, the operation returns only after calling the tciConnect operation on both remote TEs. |   |

## 7.3.3.2.17 tciDisconnectReq

|                      |  |   |
|----------------------|--|---|
| <b>Signature</b>     | void tciDisconnectReq (in TriPortIdType fromPort,<br>in TriPortIdType toPort)  |   |
| <b>In Parameters</b> | fromPort   | Identifier of the test component port to be disconnected. |
|                      | toPort   | Identifier of the test component port to be disconnected. |
| <b>Return Value</b>  | void   |   |
| <b>Constraint</b>    | This operation shall be called by the TE when it executes a TTCN-3 disconnect operation.   |   |
| <b>Effect</b>        | CH transmits the disconnect request to the remote TE where it calls the tciDisconnect operation to tear down the logical connection between the two indicated ports. Note that both ports can be on remote TEs. In this case, the operation returns only after calling the tciDisconnect operation on both remote TEs. |   |

## 7.3.3.2.18 tciMapReq

|                      |  |  |
|----------------------|--|--|
| <b>Signature</b>     | void tciMapReq (in TriPortIdType fromPort,<br>in TriPortIdType toPort)   |  |
| <b>In Parameters</b> | fromPort   | Identifier of the test component port to be mapped from. |
|                      | toPort   | Identifier of the test component port to be mapped to.   |
| <b>Return Value</b>  | void   |  |
| <b>Constraint</b>    | This operation shall be called by the TE when it executes a TTCN-3 map operation.  |  |
| <b>Effect</b>        | CH transmits the map request to the remote TE where it calls the tciMap operation to establish a logical connection between the two indicated ports. |  |

## 7.3.3.2.19 tciMapParamReq

|                      |   |  |
|----------------------|---|--|
| <b>Signature</b>     | void tciMapParamReq (in TriPortIdType fromPort,<br>in TriPortIdType toPort,<br>in TriParameterListType paramList)   |  |
| <b>In Parameters</b> | fromPort  | Identifier of the test component port to be mapped from. |
|                      | toPort  | Identifier of the test component port to be mapped to.   |
|                      | paramList   | Configuration parameter list.                            |
| <b>Return Value</b>  | void  |  |
| <b>Constraint</b>    | This operation shall be called by the TE when it executes a TTCN-3 map operation including parameters.  |  |
| <b>Effect</b>        | CH transmits the map request to the remote TE where it calls the tciMapParam operation to establish a logical connection between the two indicated ports. |  |

## 7.3.3.2.20 tciUnmapReq

|                      |  |   |
|----------------------|--|---|
| <b>Signature</b>     | void tciUnmapReq (in TriPortIdType fromPort,<br>in TriPortIdType toPort)   |   |
| <b>In Parameters</b> | fromPort   | Identifier of the test component port to be unmapped. |
|                      | toPort   | Identifier of the test component port to be unmapped. |
| <b>Return Value</b>  | void   |   |
| <b>Constraint</b>    | This operation shall be called by the TE when it executes a TTCN-3 unmap operation.  |   |
| <b>Effect</b>        | CH transmits the unmap request to the remote TE where it calls the tciUnmap operation to tear down the logical connection between the two indicated ports. |   |

## 7.3.3.2.21 tciUnmapParamReq

|                      |  |   |
|----------------------|--|---|
| <b>Signature</b>     | void tciUnmapParamReq (in TriPortIdType fromPort,<br>in TriPortIdType toPort,<br>in TriParameterListType paramList)                                    |   |
| <b>In Parameters</b> | fromPort   | Identifier of the test component port to be unmapped. |
|                      | toPort   | Identifier of the test component port to be unmapped. |
|                      | paramList  | Configuration parameter list.                         |
| <b>Return Value</b>  | void   |   |
| <b>Constraint</b>    | This operation shall be called by the TE when it executes a TTCN-3 unmap operation including parameters.   |   |
| <b>Effect</b>        | CH transmits the unmap request to the remote TE where it calls the tciUnmapParam operation to teardown the connection between the two indicated ports. |   |

## 7.3.3.2.22 tciTestComponentTerminatedReq

|                      |   |  |
|----------------------|---|--|
| <b>Signature</b>     | void tciTestComponentTerminatedReq (in TriComponentIdType component,<br>in VerdictValue verdict)  |  |
| <b>In Parameters</b> | component   | Identifier of the component that has terminated. |
|                      | verdict   | Verdict after termination of the component.      |
| <b>Return Value</b>  | void  |  |
| <b>Constraint</b>    | This operation shall be called by the TE when a test component terminates execution, either explicitly with the TTCN-3 stop operation or implicitly, if it has reached the last statement.  |  |
| <b>Effect</b>        | The CH is notified of the termination of the indicated test component. Because the out values of <i>inout</i> and <i>out</i> parameters of a function being executed on a test component have no effect on that test component (ETSI ES 201 873-1 [1]), the tciTestComponentTerminateReq operation does not have a parameterList parameter. CH communicates the termination of the indicated component to all participating TEs and to the special TE*, which keeps track of the overall verdict. |  |

## 7.3.3.2.23 tciTestComponentRunningReq

|                      |  |  |
|----------------------|--|--|
| <b>Signature</b>     | TBoolean tciTestComponentRunningReq (in TriComponentIdType component)  |  |
| <b>In Parameters</b> | component  | Identifier of the component to be checked for running. |
| <b>Return Value</b>  | true if the indicated component is still executing a behaviour, false otherwise.   |  |
| <b>Constraint</b>    | This operation shall be called by the TE when it executes a TTCN-3 running operation.  |  |
| <b>Effect</b>        | CH transmits the running request to the remote TE having the test component to be checked, where it calls the tciTestComponentRunning operation to check the execution status of the indicated test component. |  |

## 7.3.3.2.24 tciTestComponentDoneReq

|                       |  |   |
|-----------------------|--|---|
| <b>Signature</b>      | TBoolean tciTestComponentDoneReq (in TriComponentIdType comp, out TInteger verdict)  |   |
| <b>In Parameters</b>  | comp   | Identifier of the component to be checked for done.   |
| <b>Out Parameters</b> | verdict  | If the component has completed executing its behaviour, the parameter will contain numeric representation of the final component verdict (one of the following constants: ERROR, FAIL, INCONC, NONE, PASS, USER_ERROR). Otherwise, the parameter will contain the ERROR constant. |
| <b>Return Value</b>   | true if the indicated component has completed executing its behaviour, false otherwise.  |   |
| <b>Constraint</b>     | This operation shall be called by the TE when it executes a TTCN-3 done operation.   |   |
| <b>Effect</b>         | CH transmits the done request to the remote TE having the test component to be checked, where it calls the tciTestComponentDone operation to check the status of the indicated test component. |   |

## 7.3.3.2.25 tciGetMTCReq

|                     |   |  |
|---------------------|---|--|
| <b>Signature</b>    | TriComponentIdType tciGetMTCReq()   |  |
| <b>Return Value</b> | A TriComponentIdType value of the MTC.  |  |
| <b>Constraint</b>   | This operation shall be called by the TE when it executes a TTCN-3 mtc operation. |  |
| <b>Effect</b>       | The CH determines the component id of the MTC.                                    |  |



## 7.3.3.2.26 tciExecuteTestCaseReq

|                      |   |   |
|----------------------|---|---|
| <b>Signature</b>     | void tciExecuteTestCaseReq (in TciTestCaseIdType testCaseId,<br>in TriPortIdListType tsiPortList)   |   |
| <b>In Parameters</b> | testCaseId  | A test case identifier as defined in the TTCN-3 module.   |
|                      | tsiPortList   | tsiPortList contains all ports that have been declared in the definition of the system component for the test case, i.e. the TSI ports. If a system component has not been explicitly defined for the test case, then the tsiPortList contains all communication ports of the MTC. The ports in tsiPortList are ordered as they appear in the respective TTCN-3 component type declaration.<br>If no ports have to be passed either the null value or an empty tsiPortList, i.e. a list of length zero shall be passed. |
| <b>Return Value</b>  | void  |   |
| <b>Constraint</b>    | This operation can be called by the TE immediately before it starts the test case behaviour on the MTC (in course of a TTCN-3 execute operation).   |   |
| <b>Effect</b>        | CH transmits the execute test case request to the remote TEs having system ports of the indicated test case. Static connections to the SUT and the initialization of communication means for TSI ports can be set up. |   |

## 7.3.3.2.27 tciResetReq

|                     |  |  |
|---------------------|--|--|
| <b>Signature</b>    | void tciResetReq ()  |  |
| <b>Return Value</b> | void   |  |
| <b>Constraint</b>   | This operation can be called by the TE at any time to reset the test system. |  |
| <b>Effect</b>       | CH transmits the reset request to all involved TEs.                          |  |

## 7.3.3.2.28 tciKillTestComponentReq

|                      |  |   |
|----------------------|--|---|
| <b>Signature</b>     | void tciKillTestComponentReq(in TriComponentIdType comp)   |   |
| <b>In Parameters</b> | comp   | Identifier of the component to be killed. |
| <b>Return Value</b>  | void   |   |
| <b>Constraint</b>    | This operation shall be called by the TE when it executes the TTCN-3 kill operation.                         |   |
| <b>Effect</b>        | CH transmits the kill component request to the remote TE and calls there the tciKillTestComponent operation. |   |

## 7.3.3.2.29 tciTestComponentAliveReq

|                      |  |  |
|----------------------|--|--|
| <b>Signature</b>     | TBoolean tciTestComponentAliveReq (in TriComponentIdType comp)   |  |
| <b>In Parameters</b> | comp   | Identifier of the component to be checked for being alive. |
| <b>Return Value</b>  | true if the indicated component is alive, false otherwise.   |  |
| <b>Constraint</b>    | This operation shall be called by the TE when it executes the TTCN-3 alive operation.  |  |
| <b>Effect</b>        | CH transmits the request to the remote TE that created the test component in question, where it calls the tciTestComponentAlive operation to check the status of the indicated test component. |  |

## 7.3.3.2.30 tciTestComponentKilledReq

|                       |   |   |
|-----------------------|---|---|
| <b>Signature</b>      | TBoolean tciTestComponentKilledReq (in TriComponentIdType comp, out TInteger verdict)   |   |
| <b>In Parameters</b>  | comp  | Identifier of the component to be checked for being killed.   |
| <b>Out Parameters</b> | verdict   | If the component has been killed, the parameter will contain numeric representation of the final component verdict (one of the following constants: ERROR, FAIL, INCONC, NONE, PASS, USER_ERROR). Otherwise, the parameter will contain the ERROR constant. |
| <b>Return Value</b>   | true if the indicated component has been killed, false otherwise.   |   |
| <b>Constraint</b>     | This operation shall be called by the TE when it executes the TTCN-3 killed operation.  |   |
| <b>Effect</b>         | CH transmits the request to the remote TE that created the test component in question, where it calls the tciTestComponentKilled operation to check the status of the indicated test component. |   |

## 7.3.3.2.31 tciCallTestComponentReq

|                      |  |  |
|----------------------|--|--|
| <b>Signature</b>     | void tciCallTestComponentReq (in TriComponentIdType component,<br>in TciBehaviourIdType behaviour,<br>in TciParameterListType parameterList) |  |
| <b>In Parameters</b> | component  | Identifier of the component to be called.  |
|                      | behaviour  | Identifier of the behaviour to be called on the component.   |
|                      | parameterList  | A list of Values where each value defines a parameter from the parameter list as defined in the TTCN-3 function declaration of the function being started. The parameters in parameterList are ordered as they appear in the TTCN-3 definition of the called function. If no parameters have to be passed either the null value or an empty parameterList, i.e. a list of length zero shall be passed. |
| <b>Return Value</b>  | void   |  |
| <b>Constraint</b>    | This operation shall be called by the TE when it executes the TTCN-3 call component operation.   |  |
| <b>Effect</b>        | CH transmits the call component request to the remote TE and calls there the tciCallTestComponent operation.                                 |  |

## 7.3.3.2.32 tciTestComponentCallTerminatedReq

|                      |   |   |
|----------------------|---|---|
| <b>Signature</b>     | void tciTestComponentCallTerminatedReq (in TriComponentIdType component,<br>in VerdictValue verdict,<br>in TciParameterListType parameterList,<br>in Value returnValue)   |   |
| <b>In Parameters</b> | component   | Identifier of the called component that has finished execution.   |
|                      | verdict   | Verdict after finishing component call.   |
|                      | parameterList   | A list of Values where each value defines a parameter from the parameter list as defined in the TTCN-3 function declaration of the function being started. The parameters in parameterList are ordered as they appear in the TTCN-3 definition of the called. If no parameters have to be passed either the null value or an empty parameterList, i.e. a list of length zero shall be passed. |
|                      | returnValue   | The return value of the called function or the null value if no return value is defined.  |
| <b>Return Value</b>  | void  |   |
| <b>Constraint</b>    | This operation shall be called by the TE when a test component terminates execution of a function called on the component implicitly, if it has reached the return statement or executed the last statement of the called function.   |   |
| <b>Effect</b>        | The CH is notified of the termination of the called test component. CH communicates the termination of the indicated component to the component that initiated the call operation and notifies all other participating TEs and the special TE* which keeps track of the overall verdict that the component has been terminated. This notification is done by using the tciTestComponentTerminated function as all other participating TEs and the special TE do not need the return value and values of the out parameters. |   |

## 7.3.4 The TCI-TL interface

### 7.3.4.0 Scope of use

The TCI Test Logging Interface (TCI-TL) describes the operations a TTCN-3 Executable is required to implement and the operations a test logging implementation shall provide to the TE (figure 8).

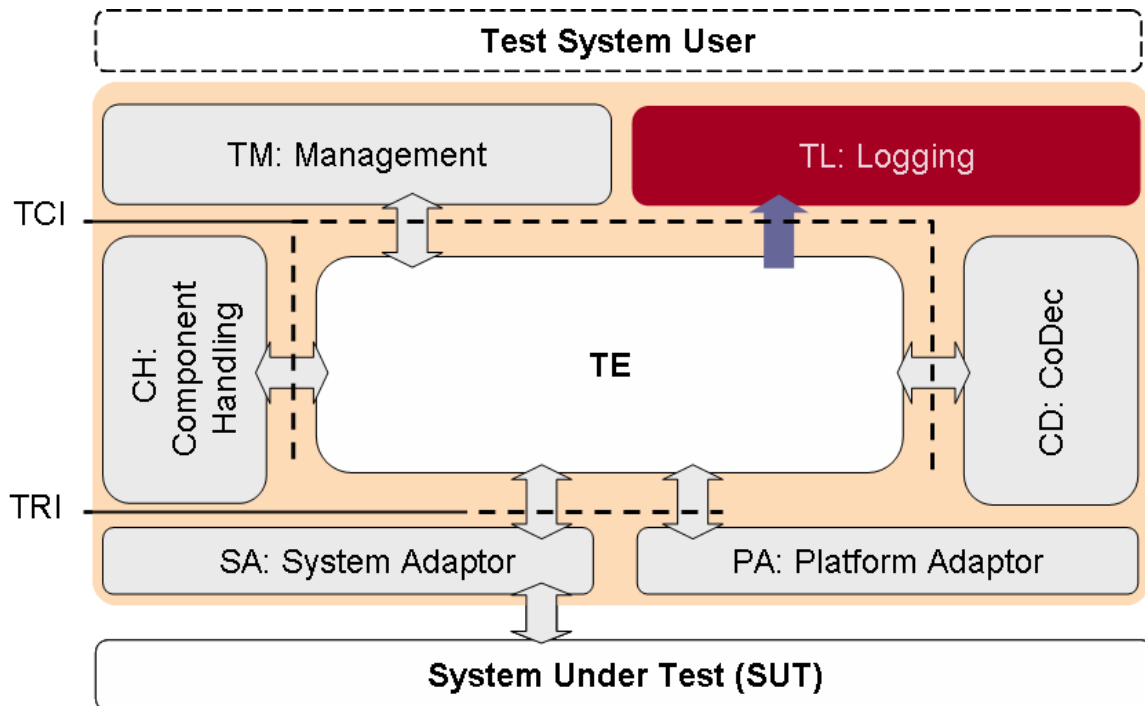

Figure 8: The TCI-TL interface

The logging provides for all TTCN-3 level operations an operation to log the respective event being performed by the TE, the SA, the PA, the CH or the CD to the user.

### 7.3.4.1 TCI-TL provided

#### 7.3.4.1.0 Scope of use

Clause 7.3.4.1.0 specifies the operations the TL shall provide to the TE.

**NOTE:** A logging event is timestamped. The timestamps are specific to the language mapping and to the tool used. For example, C# mapping uses System.DateTime objects and C++ mapping uses the timeval structure. Java™, C and XML use integer instead, so that a tool has to choose its timestamp handling. For example, for Java™ System.currentTimeMillis() could be used or for C time() could be used.

#### 7.3.4.1.1 tliTcExecute

|                      |   |  |
|----------------------|---|--|
| <b>Signature</b>     | void tliTcExecute(in TString am, in TInteger ts,<br>in TString src, in TInteger line, in TriComponentIdType c,<br>in TciTestCaseIdType tcId, in TciParameterListType tciPars,<br>in TriTimerDurationType dur) |  |
| <b>In Parameters</b> | am  | An additional message.                           |
|                      | ts  | The time when the event is produced.             |
|                      | src   | The source file of the test specification.       |
|                      | line  | The line number where the request is performed.  |
|                      | c   | The component which produces this event.         |
|                      | tcId  | The testcase to be executed.                     |
|                      | tciPars   | The list of parameters required by the testcase. |
| <b>Return Value</b>  | void  |  |

|                   |   |
|-------------------|---|
| <b>Constraint</b> | Shall be called by TE to log the execute test case request.   |
| <b>Effect</b>     | The TL presents all the information provided in the parameters of this operation to the user, how this is done is not within the scope of the present document. |

#### 7.3.4.1.2 tliTcStart

|                      |   |  |
|----------------------|---|--|
| <b>Signature</b>     | void tliTcStart(in TString am, in TInteger ts,<br>in TString src, in TInteger line, in TriComponentIdType c,<br>in TciTestCaseIdType tcId, in TciParameterListType tciPars,<br>in TriTimerDurationType dur) |  |
| <b>In Parameters</b> | am  | An additional message.                           |
|                      | ts  | The time when the event is produced.             |
|                      | src   | The source file of the test specification.       |
|                      | line  | The line number where the request is performed.  |
|                      | c   | The component which produces this event.         |
|                      | tcId  | The testcase to be executed.                     |
|                      | tciPars   | The list of parameters required by the testcase. |
|                      | dur   | Duration of the execution.                       |
| <b>Return Value</b>  | void  |  |
| <b>Constraint</b>    | Shall be called by TE to log the start of a testcase. This event occurs before the testcase is started.   |  |
| <b>Effect</b>        | The TL presents all the information provided in the parameters of this operation to the user, how this is done is not within the scope of the present document.   |  |

#### 7.3.4.1.3 tliTcStop

|                      |   |  |
|----------------------|---|--|
| <b>Signature</b>     | void tliTcStop(in TString am, in TInteger ts,<br>in TString src, in TInteger line,<br>in TriComponentIdType c, in TString reason)                               |  |
| <b>In Parameters</b> | Am  | An additional message.                           |
|                      | Ts  | The time when the event is produced.             |
|                      | Src   | The source file of the test specification.       |
|                      | Line  | The line number where the request is performed.  |
|                      | C   | The component which produces this event.         |
|                      | reason  | The optional reason of the setverdict statement. |
| <b>Return Value</b>  | Void  |  |
| <b>Constraint</b>    | Shall be called by TE to log the stop of a testcase.  |  |
| <b>Effect</b>        | The TL presents all the information provided in the parameters of this operation to the user, how this is done is not within the scope of the present document. |  |

#### 7.3.4.1.4 tliTcStarted

|                      |   |  |
|----------------------|---|--|
| <b>Signature</b>     | void tliTcStarted(in TString am, in TInteger ts,<br>in TString src, in TInteger line,<br>in TriComponentIdType c, in TciTestCaseIdType tcId,<br>in TciParameterListType tciPars, in TriTimerDurationType dur) |  |
| <b>In Parameters</b> | am  | An additional message.                           |
|                      | ts  | The time when the event is produced.             |
|                      | src   | The source file of the test specification.       |
|                      | line  | The line number where the request is performed.  |
|                      | c   | The component which produces this event.         |
|                      | tcId  | The testcase to be executed.                     |
|                      | tciPars   | The list of parameters required by the testcase. |
|                      | dur   | Duration of the execution.                       |
| <b>Return Value</b>  | Void  |  |
| <b>Constraint</b>    | Shall be called by TM or TE to log the start of a testcase. This event occurs after the testcase was started.   |  |
| <b>Effect</b>        | The TL presents all the information provided in the parameters of this operation to the user, how this is done is not within the scope of the present document.   |  |

## 7.3.4.1.5 tliTcTerminated

|                      |  |  |
|----------------------|--|--|
| <b>Signature</b>     | void tliTcTerminated(in TString am, in TInteger ts,<br>in TString src, in TInteger line,<br>in TriComponentIdType c, in TciTestCaseIdType tcId,<br>in TciParameterListType tciPars, in VerdictValue verdict,<br>in TString reason) |  |
| <b>In Parameters</b> | am   | An additional message.                           |
|                      | ts   | The time when the event is produced.             |
|                      | src  | The source file of the test specification.       |
|                      | line   | The line number where the request is performed.  |
|                      | c  | The component which produces this event.         |
|                      | tcId   | The testcase to be executed.                     |
|                      | tciPars  | The list of parameters required by the testcase. |
|                      | verdict  | The verdict of the testcase.                     |
|                      | reason   | The optional reason of the setverdict statement. |
| <b>Return Value</b>  | void   |  |
| <b>Constraint</b>    | Shall be called by TM or TE to log the termination of a testcase. This event occurs after the testcase terminated.   |  |
| <b>Effect</b>        | The TL presents all the information provided in the parameters of this operation to the user, how this is done is not within the scope of the present document.  |  |

## 7.3.4.1.6 tliCtrlStart

|                      |  |   |
|----------------------|--|---|
| <b>Signature</b>     | void tliCtrlStart(in TString am, in TInteger ts,<br>in TString src, in TInteger line,<br>in TriComponentIdType c)  |   |
| <b>In Parameters</b> | am   | An additional message.                          |
|                      | ts   | The time when the event is produced.            |
|                      | src  | The source file of the test specification.      |
|                      | line   | The line number where the request is performed. |
|                      | c  | The component which produces this event.        |
| <b>Return Value</b>  | void   |   |
| <b>Constraint</b>    | Shall be called by TE to log the start of the module control function in cases when the module control function does not define any parameters and does not return a value. This event occurs before the control is started. |   |
| <b>Effect</b>        | The TL presents all the information provided in the parameters of this operation to the user, how this is done is not within the scope of the present document.  |   |

## 7.3.4.1.7 tliCtrlStop

|                      |   |   |
|----------------------|---|---|
| <b>Signature</b>     | void tliCtrlStop(in TString am, in TInteger ts,<br>in TString src, in TInteger line,<br>in TriComponentIdType c)  |   |
| <b>In Parameters</b> | am  | An additional message.                          |
|                      | ts  | The time when the event is produced.            |
|                      | src   | The source file of the test specification.      |
|                      | line  | The line number where the request is performed. |
|                      | c   | The component which produces this event.        |
| <b>Return Value</b>  | void  |   |
| <b>Constraint</b>    | Shall be called by TE to log the stop of the control part. This event occurs before the control is stopped.   |   |
| <b>Effect</b>        | The TL presents all the information provided in the parameters of this operation to the user, how this is done is not within the scope of the present document. |   |

## 7.3.4.1.8 tliCtrlTerminated

|                      |   |   |
|----------------------|---|---|
| <b>Signature</b>     | void tliCtrlTerminated (in TString am, in TInteger ts,<br>in TString src, in TInteger line,<br>in TriComponentIdType c)   |   |
| <b>In Parameters</b> | am  | An additional message.                          |
|                      | ts  | The time when the event is produced.            |
|                      | src   | The source file of the test specification.      |
|                      | line  | The line number where the request is performed. |
|                      | c   | The component which produces this event.        |
| <b>Return Value</b>  | void  |   |
| <b>Constraint</b>    | Shall be called by TM or TE to log the termination of the module control function in cases when the module control function does not define any parameters and does not return a value. This event occurs after the control has terminated. |   |
| <b>Effect</b>        | The TL presents all the information provided in the parameters of this operation to the user, how this is done is not within the scope of the present document.   |   |

## 7.3.4.1.9 tliMSend\_m

|                      |   |  |
|----------------------|---|--|
| <b>Signature</b>     | void tliMSend_m(in TString am, in TInteger ts,<br>in TString src, in TInteger line, in TriComponentIdType c,<br>in TriPortIdType at, in TriPortIdType to, in Value msgValue,<br>in Value addrValue,<br>in TciStatusType encoderFailure,<br>in TriMessageType msg, in TriAddressType address,<br>in TriStatusType transmissionFailure) |  |
| <b>In Parameters</b> | am  | An additional message.                                 |
|                      | ts  | The time when the event is produced.                   |
|                      | src   | The source file of the test specification.             |
|                      | line  | The line number where the request is performed.        |
|                      | c   | The component which produces this event.               |
|                      | at  | The port via which the message is sent.                |
|                      | to  | The port to which the message is sent.                 |
|                      | msgValue  | The value to be encoded and sent.                      |
|                      | addrValue   | The address value of the destination within the SUT.   |
|                      | encoderFailure  | The failure message which might occur at encoding.     |
|                      | msg   | The encoded message.                                   |
|                      | address   | The address of the destination within the SUT.         |
|                      | transmissionFailure   | The failure message which might occur at transmission. |
| <b>Return Value</b>  | void  |  |
| <b>Constraint</b>    | Shall be called by SA or TE to log a unicast send operation. This event occurs after sending. This event is used for logging the communication with the SUT.  |  |
| <b>Effect</b>        | The TL presents all the information provided in the parameters of this operation to the user, how this is done is not within the scope of the present document.   |  |

## 7.3.4.1.10 tliMSend\_m\_BC

|                      |  |  |
|----------------------|--|--|
| <b>Signature</b>     | <pre>void tliMSend_m_BC(in TString am, in TInteger ts,                   in TString src, in TInteger line, in TriComponentIdType c,                   in TriPortIdType at, in TriPortIdType to,                   in Value msgValue,                   in TciStatusType encoderFailure,                   in TriMessageType msg,                   in TriStatusType transmissionFailure)</pre> |  |
| <b>In Parameters</b> | am   | An additional message.                             |
|                      | ts   | The time when the event is produced.               |
|                      | src  | The source file of the test specification.         |
|                      | line   | The line number where the request is performed.    |
|                      | c  | The component which produces this event.           |
|                      | at   | The port via which the message is sent.            |
|                      | to   | The port to which the message is sent.             |
|                      | msgValue   | The value to be encoded and sent.                  |
|                      | encoderFailure   | The failure message which might occur at encoding. |
|                      | msg  | The encoded message.                               |
| transmissionFailure  | The failure message which might occur at transmission.   |  |
| <b>Return Value</b>  | void   |  |
| <b>Constraint</b>    | Shall be called by SA or TE to log a broadcast send operation. This event occurs after sending. This event is used for logging the communication with the SUT.   |  |
| <b>Effect</b>        | The TL presents all the information provided in the parameters of this operation to the user, how this is done is not within the scope of the present document.  |  |

## 7.3.4.1.11 tliMSend\_m\_MC

|                      |   |  |
|----------------------|---|--|
| <b>Signature</b>     | <pre>void tliMSend_m_MC(in TString am, in TInteger ts,                   in TString src, in TInteger line, in TriComponentIdType c,                   in TriPortIdType at, in TriPortIdType to,                   in Value msgValue,                   in TciValueList addrValues,                   in TciStatusType encoderFailure,                   in TriMessageType msg, in TriAddressListType addresses,                   in TriStatusType transmissionFailure)</pre> |  |
| <b>In Parameters</b> | am  | An additional message.                                 |
|                      | ts  | The time when the event is produced.                   |
|                      | src   | The source file of the test specification.             |
|                      | line  | The line number where the request is performed.        |
|                      | c   | The component which produces this event.               |
|                      | at  | The port via which the message is sent.                |
|                      | to  | The port to which the message is sent.                 |
|                      | msgValue  | The value to be encoded and sent.                      |
|                      | addrValues  | The address values of the destinations within the SUT. |
|                      | encoderFailure  | The failure message which might occur at encoding.     |
|                      | msg   | The encoded message.                                   |
|                      | addresses   | The addresses of the destinations within the SUT.      |
| transmissionFailure  | The failure message which might occur at transmission.  |  |
| <b>Return Value</b>  | void  |  |
| <b>Constraint</b>    | Shall be called by SA or TE to log a multicast send operation. This event occurs after sending. This event is used for logging the communication with the SUT.  |  |
| <b>Effect</b>        | The TL presents all the information provided in the parameters of this operation to the user, how this is done is not within the scope of the present document.   |  |

## 7.3.4.1.12 tliMSend\_c

|                      |   |  |
|----------------------|---|--|
| <b>Signature</b>     | void tliMSend_c(in TString am, in TInteger ts,<br>in TString src, in TInteger line, in TriComponentIdType c,<br>in TriPortIdType at, in TriPortIdType to, in Value msgValue,<br>in TriStatusType transmissionFailure) |  |
| <b>In Parameters</b> | am  | An additional message.                                 |
|                      | ts  | The time when the event is produced.                   |
|                      | src   | The source file of the test specification.             |
|                      | line  | The line number where the request is performed.        |
|                      | c   | The component which produces this event.               |
|                      | at  | The port via which the message is sent.                |
|                      | msgValue  | The value to be encoded and sent.                      |
|                      | to  | The component which will receive the message.          |
|                      | transmissionFailure   | The failure message which might occur at transmission. |
| <b>Return Value</b>  | void  |  |
| <b>Constraint</b>    | Shall be called by CH or TE to log a unicast send operation. This event occurs after sending. This event is used for logging the intercomponent communication.  |  |
| <b>Effect</b>        | The TL presents all the information provided in the parameters of this operation to the user, how this is done is not within the scope of the present document.   |  |

## 7.3.4.1.13 tliMSend\_c\_BC

|                      |   |  |
|----------------------|---|--|
| <b>Signature</b>     | void tliMSend_c_BC(in TString am, in TInteger ts,<br>in TString src, in TInteger line, in TriComponentIdType c,<br>in TriPortIdType at, in TriPortIdListType to,<br>in Value msgValue,<br>in TriStatusType transmissionFailure) |  |
| <b>In Parameters</b> | am  | An additional message.                                 |
|                      | ts  | The time when the event is produced.                   |
|                      | src   | The source file of the test specification.             |
|                      | line  | The line number where the request is performed.        |
|                      | c   | The component which produces this event.               |
|                      | at  | The port via which the message is sent.                |
|                      | to  | The ports to which the message is sent.                |
|                      | msgValue  | The value to be encoded and sent.                      |
|                      | transmissionFailure   | The failure message which might occur at transmission. |
| <b>Return Value</b>  | void  |  |
| <b>Constraint</b>    | Shall be called by CH or TE to log a broadcast send operation. This event occurs after sending. This event is used for logging the intercomponent communication.  |  |
| <b>Effect</b>        | The TL presents all the information provided in the parameters of this operation to the user, how this is done is not within the scope of the present document.   |  |

## 7.3.4.1.14 tliMSend\_c\_MC

|                      |   |  |
|----------------------|---|--|
| <b>Signature</b>     | void tliMSend_c_MC(in TString am, in TInteger ts,<br>in TString src, in TInteger line, in TriComponentIdType c,<br>in TriPortIdType at, in TriPortIdListType to,<br>in Value msgValue,<br>in TriStatusType transmissionFailure) |  |
| <b>In Parameters</b> | am  | An additional message.                                 |
|                      | ts  | The time when the event is produced.                   |
|                      | src   | The source file of the test specification.             |
|                      | line  | The line number where the request is performed.        |
|                      | c   | The component which produces this event.               |
|                      | at  | The port via which the message is sent.                |
|                      | to  | The port to which the message is sent.                 |
|                      | msgValue  | The value to be encoded and sent.                      |
|                      | transmissionFailure   | The failure message which might occur at transmission. |
| <b>Return Value</b>  | void  |  |
| <b>Constraint</b>    | Shall be called by CH or TE to log a multicast send operation. This event occurs after sending. This event is used for logging the intercomponent communication.  |  |
| <b>Effect</b>        | The TL presents all the information provided in the parameters of this operation to the user, how this is done is not within the scope of the present document.   |  |



## 7.3.4.1.15 tliMDetected\_m

|                      |   |   |
|----------------------|---|---|
| <b>Signature</b>     | void tliMDetected_m(in TString am, in TInteger ts,<br>in TString src, in TInteger line, in TriComponentIdType c,<br>in TriPortIdType at, in TriPortIdType from,<br>in TriMessageType msg,<br>in TriAddressType address) |   |
| <b>In Parameters</b> | am  | An additional message.                          |
|                      | ts  | The time when the event is produced.            |
|                      | src   | The source file of the test specification.      |
|                      | line  | The line number where the request is performed. |
|                      | c   | The component which produces this event.        |
|                      | at  | The port via which the message is received.     |
|                      | from  | The port from which the message has been sent.  |
|                      | msg   | The received encoded message.                   |
| address              | The address of the source within the SUT.   |   |
| <b>Return Value</b>  | Void  |   |
| <b>Constraint</b>    | Shall be called by SA or TE to log the enqueueing of a message. This event occurs after the message is enqueued. This event is used for logging the communication with the SUT.   |   |
| <b>Effect</b>        | The TL presents all the information provided in the parameters of this operation to the user, how this is done is not within the scope of the present document.   |   |

## 7.3.4.1.16 tliMDetected\_c

|                      |  |   |
|----------------------|--|---|
| <b>Signature</b>     | void tliMDetected_c(in TString am, in TInteger ts,<br>in TString src, in TInteger line, in TriComponentIdType c,<br>in TriPortIdType at, in TriPortIdType from, in Value msgValue) |   |
| <b>In Parameters</b> | am   | An additional message.                          |
|                      | ts   | The time when the event is produced.            |
|                      | src  | The source file of the test specification.      |
|                      | line   | The line number where the request is performed. |
|                      | c  | The component which produces this event.        |
|                      | at   | The port via which the message is received.     |
|                      | from   | The port from which the message has been sent.  |
|                      | msgValue   | The received message.                           |
| <b>Return Value</b>  | Void   |   |
| <b>Constraint</b>    | Shall be called by CH or TE to log the enqueueing of a message. This event occurs after the message is enqueued. This event is used for logging the intercomponent communication.  |   |
| <b>Effect</b>        | The TL presents all the information provided in the parameters of this operation to the user, how this is done is not within the scope of the present document.                    |   |

## 7.3.4.1.17 tliMMismatch\_m

|                      |  |   |
|----------------------|--|---|
| <b>Signature</b>     | void tliMMismatch_m(in TString am, in TInteger ts,<br>in TString src, in TInteger line, in TriComponentIdType c,<br>in TriPortIdType at, in Value msgValue,<br>in TciValueTemplate msgTpl,<br>in TciValueDifferenceList diffs,<br>in Value addrValue,<br>in TciValueTemplate addressTpl) |   |
| <b>In Parameters</b> | am   | An additional message.                                    |
|                      | ts   | The time when the event is produced.                      |
|                      | src  | The source file of the test specification.                |
|                      | line   | The line number where the request is performed.           |
|                      | c  | The component which produces this event.                  |
|                      | at   | The port via which the message is received.               |
|                      | msgValue   | The message which is checked against the template.        |
|                      | msgTpl   | The template used to check the message match.             |
|                      | diffs  | The difference/the mismatch between message and template. |
|                      | addrValue  | The address value of the source within the SUT.           |
| addressTpl           | The expected address of the source within the SUT.   |   |
| <b>Return Value</b>  | Void   |   |

|                   |  |
|-------------------|--|
| <b>Constraint</b> | Shall be called by TE to log the mismatch of a template. This event occurs after checking a template match. This event is used for logging the communication with the SUT. |
| <b>Effect</b>     | The TL presents all the information provided in the parameters of this operation to the user, how this is done is not within the scope of the present document.            |

## 7.3.4.1.18 tliMMismatch\_c

|                      |  |   |
|----------------------|--|---|
| <b>Signature</b>     | void tliMMismatch_c(in TString am, in TInteger ts,<br>in TString src, in TInteger line, in TriComponentIdType c,<br>in TriPortIdType at, in Value msgValue,<br>in TciValueTemplate msgTpl,<br>in TciValueDifferenceList diffs,<br>in TriComponentIdType from,<br>in TciNonValueTemplate fromTpl) |   |
| <b>In Parameters</b> | am   | An additional message.                                    |
|                      | ts   | The time when the event is produced.                      |
|                      | src  | The source file of the test specification.                |
|                      | line   | The line number where the request is performed.           |
|                      | c  | The component which produces this event.                  |
|                      | at   | The port via which the message is received.               |
|                      | msgValue   | The message which is checked against the template.        |
|                      | msgTpl   | The template used to check the message match.             |
|                      | diffs  | The difference/the mismatch between message and template. |
|                      | from   | The component which sent the message.                     |
|                      | fromTpl  | The expected sender component.                            |
| <b>Return Value</b>  | Void   |   |
| <b>Constraint</b>    | Shall be called by TE to log the mismatch of a template. This event occurs after checking a template match. This event is used for logging the intercomponent communication.   |   |
| <b>Effect</b>        | The TL presents all the information provided in the parameters of this operation to the user, how this is done is not within the scope of the present document.  |   |

## 7.3.4.1.19 tliMReceive\_m

|                      |   |  |
|----------------------|---|--|
| <b>Signature</b>     | void tliMReceive_m(in TString am, in TInteger ts, in TString src,<br>in TInteger line, in TriComponentIdType c,<br>in TriPortIdType at,<br>in Value msgValue, in TciValueTemplate msgTpl,<br>in Value addrValue,<br>in TciValueTemplate addressTpl) |  |
| <b>In Parameters</b> | am  | An additional message.                             |
|                      | ts  | The time when the event is produced.               |
|                      | src   | The source file of the test specification.         |
|                      | line  | The line number where the request is performed.    |
|                      | c   | The component which produces this event.           |
|                      | at  | The port via which the message is received.        |
|                      | msgValue  | The message which is checked against the template. |
|                      | msgTpl  | The template used to check the message match.      |
|                      | addrValue   | The address value of the source within the SUT.    |
|                      | addressTpl  | The expected address of the source within the SUT. |
| <b>Return Value</b>  | Void  |  |
| <b>Constraint</b>    | Shall be called by TE to log the receiving of a message. This event occurs after checking a template match. This event is used for logging the communication with SUT.  |  |
| <b>Effect</b>        | The TL presents all the information provided in the parameters of this operation to the user, how this is done is not within the scope of the present document.   |  |

## 7.3.4.1.20 tliMReceive\_c

|                      |  |  |
|----------------------|--|--|
| <b>Signature</b>     | void tliMReceive_c(in TString am, in TInteger ts, in TString src, in TInteger line, in TriComponentIdType c, in TriPortIdType at, in Value msgValue, in TciValueTemplate msgTpl, in TriComponentIdType from, in TciNonValueTemplate fromTpl) |  |
| <b>In Parameters</b> | am   | An additional message.                             |
|                      | ts   | The time when the event is produced.               |
|                      | src  | The source file of the test specification.         |
|                      | line   | The line number where the request is performed.    |
|                      | c  | The component which produces this event.           |
|                      | at   | The port via which the message is received.        |
|                      | msgValue   | The message which is checked against the template. |
|                      | msgTpl   | The template used to check the message match.      |
|                      | from   | The component which sent the message.              |
| fromTpl              | The expected sender component.   |  |
| <b>Return Value</b>  | Void   |  |
| <b>Constraint</b>    | Shall be called by TE to log the receiving of a message. This event occurs after checking a template match. This event is used for logging the intercomponent communication.   |  |
| <b>Effect</b>        | The TL presents all the information provided in the parameters of this operation to the user, how this is done is not within the scope of the present document.  |  |

## 7.3.4.1.21 tliPrCall\_m

|                      |   |  |
|----------------------|---|--|
| <b>Signature</b>     | void tliPrCall_m(in TString am, in TInteger ts, in TString src, in TInteger line, in TriComponentIdType c, in TriPortIdType at, in TriPortIdType to, in TriSignatureIdType signature, in TciParameterListType tciPars, in Value addrValue, in TciStatusType encoderFailure, in TriParameterListType triPars, in TriAddressType address, in TriStatusType transmissionFailure) |  |
| <b>In Parameters</b> | am  | An additional message.                               |
|                      | ts  | The time when the event is produced.                 |
|                      | src   | The source file of the test specification.           |
|                      | line  | The line number where the request is performed.      |
|                      | c   | The component which produces this event.             |
|                      | at  | The port via which the call is invoked.              |
|                      | to  | The port to which the call is sent.                  |
|                      | signature   | The signature of the called operation.               |
|                      | tciPars   | The parameters of the called operation.              |
|                      | addrValue   | The address value of the destination within the SUT. |
|                      | encoderFailure  | The failure message which might occur at encoding.   |
|                      | triPars   | The encoded parameters.                              |
|                      | address   | The address of the destination within the SUT.       |
| transmissionFailure  | The failure message which might occur at transmission.  |  |
| <b>Return Value</b>  | Void  |  |
| <b>Constraint</b>    | Shall be called by SA or TE to log a unicast call operation. This event occurs after call execution. This event is used for logging the communication with the SUT.   |  |
| <b>Effect</b>        | The TL presents all the information provided in the parameters of this operation to the user, how this is done is not within the scope of the present document.   |  |

## 7.3.4.1.22 tliPrCall\_m\_BC

|                      |   |  |
|----------------------|---|--|
| <b>Signature</b>     | void tliPrCall_m_BC(in TString am, in TInteger ts, in TString src, in TInteger line, in TriComponentIdType c, in TriPortIdType at, in TriPortIdType to, in TriSignatureIdType signature, in TciParameterListType tciPars, in TciStatusType encoderFailure, in TriParameterListType triPars, in TriStatusType transmissionFailure) |  |
| <b>In Parameters</b> | am  | An additional message.                                 |
|                      | ts  | The time when the event is produced.                   |
|                      | src   | The source file of the test specification.             |
|                      | line  | The line number where the request is performed.        |
|                      | c   | The component which produces this event.               |
|                      | at  | The port via which the call is invoked.                |
|                      | to  | The port to which the call is sent.                    |
|                      | signature   | The signature of the called operation.                 |
|                      | tciPars   | The parameters of the called operation.                |
|                      | encoderFailure  | The failure message which might occur at encoding.     |
|                      | triPars   | The encoded parameters.                                |
|                      | transmissionFailure   | The failure message which might occur at transmission. |
| <b>Return Value</b>  | Void  |  |
| <b>Constraint</b>    | Shall be called by SA or TE to log a broadcast call operation. This event occurs after call execution. This event is used for logging the communication with the SUT.   |  |
| <b>Effect</b>        | The TL presents all the information provided in the parameters of this operation to the user, how this is done is not within the scope of the present document.   |  |

## 7.3.4.1.23 tliPrCall\_m\_MC

|                      |  |  |
|----------------------|--|--|
| <b>Signature</b>     | void tliPrCall_m_MC(in TString am, in TInteger ts, in TString src, in TInteger line, in TriComponentIdType c, in TriPortIdType at, in TriPortIdType to, in TriSignatureIdType signature, in TciParameterListType tciPars, in TciValueList addrValues, in TciStatusType encoderFailure, in TriParameterListType triPars, in TriAddressListType addresses, in TriStatusType transmissionFailure) |  |
| <b>In Parameters</b> | am   | An additional message.                                 |
|                      | ts   | The time when the event is produced.                   |
|                      | src  | The source file of the test specification.             |
|                      | line   | The line number where the request is performed.        |
|                      | c  | The component which produces this event.               |
|                      | at   | The port via which the call is invoked.                |
|                      | to   | The port to which the call is sent.                    |
|                      | signature  | The signature of the called operation.                 |
|                      | tciPars  | The parameters of the called operation.                |
|                      | addrValues   | The address values of the destinations within the SUT. |
|                      | encoderFailure   | The failure message which might occur at encoding.     |
|                      | triPars  | The encoded parameters.                                |
|                      | addresses  | The addresses of the destinations within the SUT.      |
|                      | transmissionFailure  | The failure message which might occur at transmission. |
| <b>Return Value</b>  | Void   |  |
| <b>Constraint</b>    | Shall be called by SA or TE to log a multicast call operation. This event occurs after call execution. This event is used for logging the communication with the SUT.  |  |
| <b>Effect</b>        | The TL presents all the information provided in the parameters of this operation to the user, how this is done is not within the scope of the present document.  |  |

## 7.3.4.1.24 tliPrCall\_c

|                      |  |  |
|----------------------|--|--|
| <b>Signature</b>     | void tliPrCall_c(in TString am, in TInteger ts, in TString src, in TInteger line, in TriComponentIdType c, in TriPortIdType at, in TriPortIdType to, in TriSignatureIdType signature, in TciParameterListType tciPars, in TriStatusType transmissionFailure) |  |
| <b>In Parameters</b> | am   | An additional message.                                 |
|                      | ts   | The time when the event is produced.                   |
|                      | src  | The source file of the test specification.             |
|                      | line   | The line number where the request is performed.        |
|                      | c  | The component which produces this event.               |
|                      | at   | The port via which the call is invoked.                |
|                      | to   | The port to which the call is sent.                    |
|                      | signature  | The signature of the called operation.                 |
|                      | tciPars  | The parameters of the called operation.                |
|                      | transmissionFailure  | The failure message which might occur at transmission. |
| <b>Return Value</b>  | Void   |  |
| <b>Constraint</b>    | Shall be called by CH or TE to log a unicast call operation. This event occurs after call execution. This event is used for logging the intercomponent communication.  |  |
| <b>Effect</b>        | The TL presents all the information provided in the parameters of this operation to the user, how this is done is not within the scope of the present document.  |  |

## 7.3.4.1.25 tliPrCall\_c\_BC

|                      |   |  |
|----------------------|---|--|
| <b>Signature</b>     | void tliPrCall_c_BC(in TString am, in TInteger ts, in TString src, in TInteger line, in TriComponentIdType c, in TriPortIdType at, in TriPortIdListType to, in TriSignatureIdType signature, in TciParameterListType tciPars, in TriStatusType transmissionFailure) |  |
| <b>In Parameters</b> | am  | An additional message.                                 |
|                      | ts  | The time when the event is produced.                   |
|                      | src   | The source file of the test specification.             |
|                      | line  | The line number where the request is performed.        |
|                      | c   | The component which produces this event.               |
|                      | at  | The port via which the call is invoked.                |
|                      | to  | The port list to which the call is sent.               |
|                      | signature   | The signature of the called operation.                 |
|                      | tciPars   | The parameters of the called operation.                |
|                      | transmissionFailure   | The failure message which might occur at transmission. |
| <b>Return Value</b>  | Void  |  |
| <b>Constraint</b>    | Shall be called by CH or TE to log a broadcast call operation. This event occurs after call execution. This event is used for logging the intercomponent communication.   |  |
| <b>Effect</b>        | The TL presents all the information provided in the parameters of this operation to the user, how this is done is not within the scope of the present document.   |  |

## 7.3.4.1.26 tliPrCall\_c\_MC

|                      |   |  |
|----------------------|---|--|
| <b>Signature</b>     | void tliPrCall_c_MC(in TString am, in TInteger ts, in TString src, in TInteger line, in TriComponentIdType c, in TriPortIdType at, in TriPortIdListType to, in TriSignatureIdType signature, in TciParameterListType tciPars, in TriStatusType transmissionFailure) |  |
| <b>In Parameters</b> | am  | An additional message.                                 |
|                      | ts  | The time when the event is produced.                   |
|                      | src   | The source file of the test specification.             |
|                      | line  | The line number where the request is performed.        |
|                      | c   | The component which produces this event.               |
|                      | at  | The port via which the call is invoked.                |
|                      | to  | The port list to which the call is sent.               |
|                      | signature   | The signature of the called operation.                 |
|                      | tciPars   | The parameters of the called operation.                |
|                      | transmissionFailure   | The failure message which might occur at transmission. |
| <b>Return Value</b>  | Void  |  |
| <b>Constraint</b>    | Shall be called by CH or TE to log a multicast call operation. This event occurs after call execution. This event is used for logging the intercomponent communication.   |  |
| <b>Effect</b>        | The TL presents all the information provided in the parameters of this operation to the user, how this is done is not within the scope of the present document.   |  |

## 7.3.4.1.27 tliPrGetCallDetected\_m

|                      |  |   |
|----------------------|--|---|
| <b>Signature</b>     | void tliPrGetCallDetected_m(in TString am, in TInteger ts, in TString src, in TInteger line, in TriComponentIdType c, in TriPortIdType at, in TriPortIdType from, in TriSignatureIdType signature, in TriParameterListType triPars, in TriAddressType address) |   |
| <b>In Parameters</b> | am   | An additional message.                          |
|                      | ts   | The time when the event is produced.            |
|                      | src  | The source file of the test specification.      |
|                      | line   | The line number where the request is performed. |
|                      | c  | The component which produces this event.        |
|                      | at   | The port via which the call is received.        |
|                      | from   | The port from which the call has been sent.     |
|                      | signature  | The signature of the detected call.             |
|                      | triPars  | The encoded parameters of detected call.        |
|                      | address  | The address of the destination within the SUT.  |
| <b>Return Value</b>  | Void   |   |
| <b>Constraint</b>    | Shall be called by SA or TE to log the getcall enqueue operation. This event occurs after call is enqueued. This event is used for logging the communication with the SUT.   |   |
| <b>Effect</b>        | The TL presents all the information provided in the parameters of this operation to the user, how this is done is not within the scope of the present document.  |   |

## 7.3.4.1.28 tliPrGetCallDetected\_c

|                      |  |   |
|----------------------|--|---|
| <b>Signature</b>     | void tliPrGetCallDetected_c(in TString am, in TInteger ts,<br>in TString src,<br>in TInteger line, in TriComponentIdType c,<br>in TriPortIdType at, in TriPortIdType from,<br>in TriSignatureIdType signature,<br>in TciParameterListType tciPars) |   |
| <b>In Parameters</b> | am   | An additional message.                          |
|                      | ts   | The time when the event is produced.            |
|                      | src  | The source file of the test specification.      |
|                      | line   | The line number where the request is performed. |
|                      | c  | The component which produces this event.        |
|                      | at   | The port via which the call is received.        |
|                      | from   | The port from which the call has been sent.     |
|                      | signature  | The signature of the called operation.          |
|                      | tciPars  | The encoded parameters of detected call.        |
| <b>Return Value</b>  | Void   |   |
| <b>Constraint</b>    | Shall be called by CH or TE to log the getcall enqueue operation. This event occurs after call is enqueued. This event is used for logging the intercomponent communication.   |   |
| <b>Effect</b>        | The TL presents all the information provided in the parameters of this operation to the user, how this is done is not within the scope of the present document.  |   |

## 7.3.4.1.29 tliPrGetCallMismatch\_m

|                      |  |  |
|----------------------|--|--|
| <b>Signature</b>     | void tliPrGetCallMismatch_m(in TString am, in TInteger ts,<br>in TString src,<br>in TInteger line, in TriComponentIdType c,<br>in TriPortIdType at, in TriSignatureIdType signature,<br>in TciParameterListType tciPars,<br>in TciValueTemplate parsTpl,<br>in TciValueDifferenceList diffs,<br>in Value addrValue,<br>in TciValueTemplate addressTpl) |  |
| <b>In Parameters</b> | am   | An additional message.                                 |
|                      | ts   | The time when the event is produced.                   |
|                      | src  | The source file of the test specification.             |
|                      | line   | The line number where the request is performed.        |
|                      | c  | The component which produces this event.               |
|                      | at   | The port via which the call is received.               |
|                      | signature  | The signature of the detected call.                    |
|                      | tciPars  | The parameters of detected call.                       |
|                      | parsTpl  | The template used to check the parameter match.        |
|                      | diffs  | The difference/the mismatch between call and template. |
|                      | addrValue  | The address value of the source within the SUT.        |
|                      | addressTpl   | The expected address of the source within the SUT.     |
| <b>Return Value</b>  | Void   |  |
| <b>Constraint</b>    | Shall be called by TE to log the mismatch of a getcall. This event occurs after getcall is checked against a template. This event is used for logging the communication with the SUT.  |  |
| <b>Effect</b>        | The TL presents all the information provided in the parameters of this operation to the user, how this is done is not within the scope of the present document.  |  |

## 7.3.4.1.30 tliPrGetCallMismatch\_c

|                      |  |   |
|----------------------|--|---|
| <b>Signature</b>     | void tliPrGetCallMismatch_c(in TString am, in TInteger ts,<br>in TString src,<br>in TInteger line, in TriComponentIdType c,<br>in TriPortIdType at, in TriSignatureIdType signature,<br>in TciParameterListType tciPars,<br>in TciValueTemplate parsTpl,<br>in TciValueDifferenceList diffs,<br>in TriComponentIdType from,<br>in TciNonValueTemplate fromTpl) |   |
| <b>In Parameters</b> | am   | An additional message.                                    |
|                      | ts   | The time when the event is produced.                      |
|                      | src  | The source file of the test specification.                |
|                      | line   | The line number where the request is performed.           |
|                      | c  | The component which produces this event.                  |
|                      | at   | The port via which the call is received.                  |
|                      | signature  | The signature of the detected call.                       |
|                      | tciPars  | The parameters of detected call.                          |
|                      | parsTpl  | The template used to check the parameter match.           |
|                      | diffs  | The difference/the mismatch between message and template. |
|                      | from   | The component which called the operation.                 |
|                      | fromTpl  | The expected calling component.                           |
| <b>Return Value</b>  | Void   |   |
| <b>Constraint</b>    | Shall be called by TE to log the mismatch of a getcall. This event occurs after getcall is checked against a template. This event is used for logging the intercomponent communication.  |   |
| <b>Effect</b>        | The TL presents all the information provided in the parameters of this operation to the user, how this is done is not within the scope of the present document.  |   |

## 7.3.4.1.31 tliPrGetCall\_m

|                      |   |  |
|----------------------|---|--|
| <b>Signature</b>     | void tliPrGetCall_m(in TString am, in TInteger ts, in TString src,<br>in TInteger line, in TriComponentIdType c,<br>in TriPortIdType at, in TriSignatureIdType signature,<br>in TciParameterListType tciPars,<br>in TciValueTemplate parsTpl,<br>in Value addrValue,<br>in TciValueTemplate addressTpl) |  |
| <b>In Parameters</b> | am  | An additional message.                             |
|                      | ts  | The time when the event is produced.               |
|                      | src   | The source file of the test specification.         |
|                      | line  | The line number where the request is performed.    |
|                      | c   | The component which produces this event.           |
|                      | at  | The port via which the call is received.           |
|                      | signature   | The signature of the detected call.                |
|                      | tciPars   | The parameters of detected call.                   |
|                      | parsTpl   | The template used to check the parameter match.    |
|                      | addrValue   | The address value of the source within the SUT.    |
|                      | addressTpl  | The expected address of the source within the SUT. |
|                      | <b>Return Value</b>   | void   |
| <b>Constraint</b>    | Shall be called by TE to log getting a call. This event occurs after getcall has matched against a template. This event is used for logging the communication with the SUT.   |  |
| <b>Effect</b>        | The TL presents all the information provided in the parameters of this operation to the user, how this is done is not within the scope of the present document.   |  |



## 7.3.4.1.32 tliPrGetCall\_c

|                      |   |   |
|----------------------|---|---|
| <b>Signature</b>     | void tliPrGetCall_c(in TString am, in TInteger ts, in TString src, in TInteger line, in TriComponentIdType c, in TriPortIdType at, in TriSignatureIdType signature, in TciParameterListType tciPars, in TciValueTemplate parsTpl, in TriComponentIdType from, in TciNonValueTemplate fromTpl) |   |
| <b>In Parameters</b> | am  | An additional message.                          |
|                      | ts  | The time when the event is produced.            |
|                      | src   | The source file of the test specification.      |
|                      | line  | The line number where the request is performed. |
|                      | c   | The component which produces this event.        |
|                      | at  | The port via which the call is received.        |
|                      | signature   | The signature of the detected call.             |
|                      | tciPars   | The parameters of detected call.                |
|                      | parsTpl   | The template used to check the parameter match. |
|                      | from  | The component which called the operation.       |
| fromTpl              | The expected calling component.   |   |
| <b>Return Value</b>  | void  |   |
| <b>Constraint</b>    | Shall be called by TE to log getting a call. This event occurs after getcall has matched against a template. This event is used for logging the intercomponent communication.   |   |
| <b>Effect</b>        | The TL presents all the information provided in the parameters of this operation to the user, how this is done is not within the scope of the present document.   |   |

## 7.3.4.1.33 tliPrReply\_m

|                      |  |  |
|----------------------|--|--|
| <b>Signature</b>     | void tliPrReply_m(in TString am, in TInteger ts, in TString src, in TInteger line, in TriComponentIdType c, in TriPortIdType at, in TriPortIdType to, in TriSignatureIdType signature, in TciParameterListType tciPars, in Value replValue, in Value addrValue, in TciStatusType encoderFailure, in TriParameterListType triPars, in TriParameterType repl, in TriAddressType address, in TriStatusType transmissionFailure) |  |
| <b>In Parameters</b> | am   | An additional message.                               |
|                      | ts   | The time when the event is produced.                 |
|                      | src  | The source file of the test specification.           |
|                      | line   | The line number where the request is performed.      |
|                      | c  | The component which produces this event.             |
|                      | at   | The port via which the reply is sent.                |
|                      | to   | The port to which the reply is sent.                 |
|                      | signature  | The signature relating to the reply.                 |
|                      | tciPars  | The signature parameters relating to the reply.      |
|                      | replValue  | The reply to be sent.                                |
|                      | addrValue  | The address value of the destination within the SUT. |
|                      | encoderFailure   | The failure message which might occur at encoding.   |
|                      | triPars  | The encoded parameters.                              |
|                      | repl   | The encoded reply.                                   |
|                      | address  | The address of the destination within the SUT.       |
| transmissionFailure  | The failure message which might occur at transmission.   |  |
| <b>Return Value</b>  | void   |  |
| <b>Constraint</b>    | Shall be called by SA or TE to log a unicast reply operation. This event occurs after reply execution. This event is used for logging the communication with the SUT.  |  |
| <b>Effect</b>        | The TL presents all the information provided in the parameters of this operation to the user, how this is done is not within the scope of the present document.  |  |

## 7.3.4.1.34 tliPrReply\_m\_BC

|                      |  |  |
|----------------------|--|--|
| <b>Signature</b>     | void tliPrReply_m_BC(in TString am, in TInteger ts, in TString src, in TInteger line, in TriComponentIdType c, in TriPortIdType at, in TriPortIdType to, in TriSignatureIdType signature, in TciParameterListType tciPars, in Value replValue, in TciStatusType encoderFailure, in TriParameterListType triPars, in TriParameterType repl, in TriStatusType transmissionFailure) |  |
| <b>In Parameters</b> | am   | An additional message.                             |
|                      | ts   | The time when the event is produced.               |
|                      | src  | The source file of the test specification.         |
|                      | line   | The line number where the request is performed.    |
|                      | c  | The component which produces this event.           |
|                      | at   | The port via which the reply is sent.              |
|                      | to   | The port to which the reply is sent.               |
|                      | signature  | The signature relating to the reply.               |
|                      | tciPars  | The signature parameters relating to the reply.    |
|                      | replValue  | The reply to be sent.                              |
|                      | encoderFailure   | The failure message which might occur at encoding. |
|                      | triPars  | The encoded parameters.                            |
|                      | repl   | The encoded reply.                                 |
| transmissionFailure  | The failure message which might occur at transmission.   |  |
| <b>Return Value</b>  | void   |  |
| <b>Constraint</b>    | Shall be called by SA or TE to log a broadcast reply operation. This event occurs after reply execution. This event is used for logging the communication with the SUT.  |  |
| <b>Effect</b>        | The TL presents all the information provided in the parameters of this operation to the user, how this is done is not within the scope of the present document.  |  |

## 7.3.4.1.35 tliPrReply\_m\_MC

|                      |   |  |
|----------------------|---|--|
| <b>Signature</b>     | void tliPrReply_m_MC(in TString am, in TInteger ts, in TString src, in TInteger line, in TriComponentIdType c, in TriPortIdType at, in TriPortIdType to, in TriSignatureIdType signature, in TciParameterListType tciPars, in Value replValue, in TciValueList addrValues, in TciStatusType encoderFailure, in TriParameterListType triPars, in TriParameterType repl, in TriAddressListType addresses, in TriStatusType transmissionFailure) |  |
| <b>In Parameters</b> | am  | An additional message.                                 |
|                      | ts  | The time when the event is produced.                   |
|                      | src   | The source file of the test specification.             |
|                      | line  | The line number where the request is performed.        |
|                      | c   | The component which produces this event.               |
|                      | at  | The port via which the reply is sent.                  |
|                      | to  | The port to which the reply is sent.                   |
|                      | signature   | The signature relating to the reply.                   |
|                      | tciPars   | The signature parameters relating to the reply.        |
|                      | replValue   | The reply to be sent.                                  |
|                      | addrValues  | The address values of the destinations within the SUT. |
|                      | encoderFailure  | The failure message which might occur at encoding.     |
|                      | triPars   | The encoded parameters.                                |
|                      | repl  | The encoded reply.                                     |
| addresses            | The addresses of the destinations within the SUT.   |  |
| transmissionFailure  | The failure message which might occur at transmission.  |  |
| <b>Return Value</b>  | void  |  |
| <b>Constraint</b>    | Shall be called by SA or TE to log a multicast reply operation. This event occurs after reply execution. This event is used for logging the communication with the SUT.   |  |
| <b>Effect</b>        | The TL presents all the information provided in the parameters of this operation to the user, how this is done is not within the scope of the present document.   |  |

## 7.3.4.1.36 tliPrReply\_c

|                      |  |  |
|----------------------|--|--|
| <b>Signature</b>     | void tliPrReply_c(in TString am, in TInteger ts, in TString src, in TInteger line, in TriComponentIdType c, in TriPortIdType at, in TriPortIdType to, in TriSignatureIdType signature, in Value parsValue, in Value replValue, in TriStatusType transmissionFailure) |  |
| <b>In Parameters</b> | am   | An additional message.                                 |
|                      | ts   | The time when the event is produced.                   |
|                      | src  | The source file of the test specification.             |
|                      | line   | The line number where the request is performed.        |
|                      | c  | The component which produces this event.               |
|                      | at   | The port via which the reply is sent.                  |
|                      | to   | The port to which the reply is sent.                   |
|                      | signature  | The signature relating to the reply.                   |
|                      | parsValue  | The signature parameters relating to the reply.        |
|                      | replValue  | The reply to be sent.                                  |
|                      | transmissionFailure  | The failure message which might occur at transmission. |
| <b>Return Value</b>  | void   |  |
| <b>Constraint</b>    | Shall be called by CH or TE to log a unicast reply operation. This event occurs after reply execution. This event is used for logging the intercomponent communication.  |  |
| <b>Effect</b>        | The TL presents all the information provided in the parameters of this operation to the user, how this is done is not within the scope of the present document.  |  |

## 7.3.4.1.37 tliPrReply\_c\_BC

|                      |   |  |
|----------------------|---|--|
| <b>Signature</b>     | void tliPrReply_c_BC(in TString am, in TInteger ts, in TString src, in TInteger line, in TriComponentIdType c, in TriPortIdType at, in TriPortIdListType to, in TriSignatureIdType signature, in Value parsValue, in Value replValue, in TriStatusType transmissionFailure) |  |
| <b>In Parameters</b> | am  | An additional message.                                 |
|                      | ts  | The time when the event is produced.                   |
|                      | src   | The source file of the test specification.             |
|                      | line  | The line number where the request is performed.        |
|                      | c   | The component which produces this event.               |
|                      | at  | The port via which the reply is sent.                  |
|                      | to  | The port list to which the reply is sent.              |
|                      | signature   | The signature relating to the reply.                   |
|                      | parsValue   | The signature parameters relating to the reply.        |
|                      | replValue   | The reply to be sent.                                  |
|                      | transmissionFailure   | The failure message which might occur at transmission. |
| <b>Return Value</b>  | void  |  |
| <b>Constraint</b>    | Shall be called by CH or TE to log a broadcast reply operation. This event occurs after reply execution. This event is used for logging the intercomponent communication.   |  |
| <b>Effect</b>        | The TL presents all the information provided in the parameters of this operation to the user, how this is done is not within the scope of the present document.   |  |

## 7.3.4.1.38 tliPrReply\_c\_MC

|                      |   |  |
|----------------------|---|--|
| <b>Signature</b>     | void tliPrReply_c_MC(in TString am, in TInteger ts, in TString src, in TInteger line, in TriComponentIdType c, in TriPortIdType at, in TriPortIdListType to, in TriSignatureIdType signature, in Value parsValue, in Value replValue, in TriStatusType transmissionFailure) |  |
| <b>In Parameters</b> | am  | An additional message.                                 |
|                      | ts  | The time when the event is produced.                   |
|                      | src   | The source file of the test specification.             |
|                      | line  | The line number where the request is performed.        |
|                      | c   | The component which produces this event.               |
|                      | at  | The port via which the reply is sent.                  |
|                      | to  | The port list to which the reply is sent.              |
|                      | signature   | The signature relating to the reply.                   |
|                      | parsValue   | The signature parameters relating to the reply.        |
|                      | replValue   | The reply to be sent.                                  |
|                      | transmissionFailure   | The failure message which might occur at transmission. |
| <b>Return Value</b>  | void  |  |
| <b>Constraint</b>    | Shall be called by CH or TE to log a multicast reply operation. This event occurs after reply execution. This event is used for logging the intercomponent communication.   |  |
| <b>Effect</b>        | The TL presents all the information provided in the parameters of this operation to the user, how this is done is not within the scope of the present document.   |  |

## 7.3.4.1.39 tliPrGetReplyDetected\_m

|                      |   |   |
|----------------------|---|---|
| <b>Signature</b>     | void tliPrGetReplyDetected_m(in TString am, in TInteger ts, in TString src, in TInteger line, in TriComponentIdType c, in TriPortIdType at, in TriPortIdType from, in TriSignatureIdType signature, in TriParameterListType triPars, in TriParameterType repl, in TriAddressType address) |   |
| <b>In Parameters</b> | am  | An additional message.                          |
|                      | ts  | The time when the event is produced.            |
|                      | src   | The source file of the test specification.      |
|                      | line  | The line number where the request is performed. |
|                      | c   | The component which produces this event.        |
|                      | at  | The port via which the reply is received.       |
|                      | from  | The port from which the reply has been sent.    |
|                      | signature   | The signature relating to the reply.            |
|                      | triPars   | The encoded parameters of detected reply.       |
|                      | repl  | The received encoded reply.                     |
|                      | address   | The address of the source within the SUT.       |
| <b>Return Value</b>  | void  |   |
| <b>Constraint</b>    | Shall be called by SA or TE to log the getreply enqueue operation. This event occurs after getreply is enqueued. This event is used for logging the communication with the SUT.   |   |
| <b>Effect</b>        | The TL presents all the information provided in the parameters of this operation to the user, how this is done is not within the scope of the present document.   |   |

## 7.3.4.1.40 tliPrGetReplyDetected\_c

|                      |  |   |
|----------------------|--|---|
| <b>Signature</b>     | void tliPrGetReplyDetected_c(in TString am, in TInteger ts,<br>in TString src,<br>in TInteger line, in TriComponentIdType c,<br>in TriPortIdType at, in TriPortIdType from,<br>in TriSignatureIdType signature,<br>in TciParameterListType tciPars,<br>in Value replValue) |   |
| <b>In Parameters</b> | am   | An additional message.                          |
|                      | ts   | The time when the event is produced.            |
|                      | src  | The source file of the test specification.      |
|                      | line   | The line number where the request is performed. |
|                      | c  | The component which produces this event.        |
|                      | at   | The port via which the reply is received.       |
|                      | from   | The port from which the reply has been sent.    |
|                      | signature  | The signature relating to the reply.            |
|                      | tciPars  | The encoded parameters of detected reply.       |
| replValue            | The received reply.  |   |
| <b>Return Value</b>  | void   |   |
| <b>Constraint</b>    | Shall be called by CH or TE to log the getreply enqueue operation. This event occurs after getreply is enqueued. This event is used for logging the intercomponent communication.  |   |
| <b>Effect</b>        | The TL presents all the information provided in the parameters of this operation to the user, how this is done is not within the scope of the present document.  |   |

## 7.3.4.1.41 tliPrGetReplyMismatch\_m

|                      |  |   |
|----------------------|--|---|
| <b>Signature</b>     | void tliPrGetReplyMismatch_m(in TString am, in TInteger ts,<br>in TString src,<br>in TInteger line, in TriComponentIdType c,<br>in TriPortIdType at, in TriSignatureIdType signature,<br>in TciParameterListType tciPars,<br>in TciValueTemplate parsTpl,<br>in Value replValue, in TciValueTemplate replyTpl,<br>in TciValueDifferenceList diffs,<br>in Value addrValue,<br>in TciValueTemplate addressTpl) |   |
| <b>In Parameters</b> | am   | An additional message.                                  |
|                      | ts   | The time when the event is produced.                    |
|                      | src  | The source file of the test specification.              |
|                      | line   | The line number where the request is performed.         |
|                      | c  | The component which produces this event.                |
|                      | at   | The port via which the reply is received.               |
|                      | signature  | The signature relating to the reply.                    |
|                      | tciPars  | The signature parameters relating to the reply.         |
|                      | parsTpl  | The template used to check the parameter match.         |
|                      | replValue  | The received reply.                                     |
|                      | replyTpl   | The template used to check the reply match.             |
|                      | diffs  | The difference/the mismatch between reply and template. |
|                      | addrValue  | The address value of the source within the SUT.         |
| addressTpl           | The expected address of the source within the SUT.   |   |
| <b>Return Value</b>  | void   |   |
| <b>Constraint</b>    | Shall be called by TE to log the mismatch of a getreply operation. This event occurs after getreply is checked against a template. This event is used for logging the communication with SUT.  |   |
| <b>Effect</b>        | The TL presents all the information provided in the parameters of this operation to the user, how this is done is not within the scope of the present document.  |   |

## 7.3.4.1.42 tliPrGetReplyMismatch\_c

|                      |   |   |
|----------------------|---|---|
| <b>Signature</b>     | void tliPrGetReplyMismatch_c(in TString am, in TInteger ts,<br>in TString src,<br>in TInteger line, in TriComponentIdType c,<br>in TriPortIdType at, in TriSignatureIdType signature,<br>in TciParameterListType tciPars,<br>in TciValueTemplate parsTmpl,<br>in Value replValue, in TciValueTemplate replyTmpl,<br>in TciValueDifferenceList diffs,<br>in TriComponentIdType from,<br>in TciNonValueTemplate fromTmpl) |   |
| <b>In Parameters</b> | am  | An additional message.                                  |
|                      | ts  | The time when the event is produced.                    |
|                      | src   | The source file of the test specification.              |
|                      | line  | The line number where the request is performed.         |
|                      | c   | The component which produces this event.                |
|                      | at  | The port via which the reply is received.               |
|                      | signature   | The signature relating to the reply.                    |
|                      | tciPars   | The signature parameters relating to the reply.         |
|                      | parsTmpl  | The template used to check the parameter match.         |
|                      | repl  | The received reply.                                     |
|                      | replyTmpl   | The template used to check the reply match.             |
|                      | diffs   | The difference/the mismatch between reply and template. |
| from                 | The component which sent the reply.   |   |
| fromTmpl             | The expected replying component.  |   |
| <b>Return Value</b>  | void  |   |
| <b>Constraint</b>    | Shall be called by TE to log the mismatch of a getreply operation. This event occurs after getreply is checked against a template. This event is used for logging the intercomponent communication.   |   |
| <b>Effect</b>        | The TL presents all the information provided in the parameters of this operation to the user, how this is done is not within the scope of the present document.   |   |

## 7.3.4.1.43 tliPrGetReply\_m

|                      |  |   |
|----------------------|--|---|
| <b>Signature</b>     | void tliPrGetReply_m(in TString am, in TInteger ts, in TString src,<br>in TInteger line, in TriComponentIdType c,<br>in TriPortIdType at, in TriSignatureIdType signature,<br>in TciParameterListType tciPars,<br>in TciValueTemplate parsTmpl,<br>in Value replValue, in TciValueTemplate replyTmpl,<br>in Value addrValue,<br>in TciValueTemplate addressTmpl) |   |
| <b>In Parameters</b> | am   | An additional message.                          |
|                      | ts   | The time when the event is produced.            |
|                      | src  | The source file of the test specification.      |
|                      | line   | The line number where the request is performed. |
|                      | c  | The component which produces this event.        |
|                      | at   | The port via which the reply is received.       |
|                      | signature  | The signature relating to the reply.            |
|                      | tciPars  | The signature parameters relating to the reply. |
|                      | parsTmpl   | The template used to check the parameter match. |
|                      | replValue  | The received reply.                             |
|                      | replyTmpl  | The template used to check the reply match.     |
|                      | addrValue  | The address value of the source within the SUT. |
| addressTmpl          | The expected address of the source within the SUT.   |   |
| <b>Return Value</b>  | void   |   |
| <b>Constraint</b>    | Shall be called by TE to log getting a reply. This event occurs after getreply is checked against a template. This event is used for logging the communication with SUT.   |   |
| <b>Effect</b>        | The TL presents all the information provided in the parameters of this operation to the user, how this is done is not within the scope of the present document.  |   |

## 7.3.4.1.44 tliPrGetReply\_c

|                      |   |   |
|----------------------|---|---|
| <b>Signature</b>     | void tliPrGetReply_c(in TString am, in TInteger ts, in TString src, in TInteger line, in TriComponentIdType c, in TriPortIdType at, in TriSignatureIdType signature, in TciParameterListType tciPars, in TciValueTemplate parsTmpl, in Value replValue, in TciValueTemplate replyTmpl, in TriComponentIdType from, in TciNonValueTemplate fromTmpl) |   |
| <b>In Parameters</b> | am  | An additional message.                          |
|                      | ts  | The time when the event is produced.            |
|                      | src   | The source file of the test specification.      |
|                      | line  | The line number where the request is performed. |
|                      | c   | The component which produces this event.        |
|                      | at  | The port via which the reply is received.       |
|                      | signature   | The signature relating to the reply.            |
|                      | tciPars   | The signature parameters relating to the reply. |
|                      | parsTmpl  | The template used to check the parameter match. |
|                      | replValue   | The received reply.                             |
|                      | replyTmpl   | The template used to check the reply match.     |
|                      | from  | The component which sent the reply.             |
|                      | fromTmpl  | The expected replying component.                |
| <b>Return Value</b>  | void  |   |
| <b>Constraint</b>    | Shall be called by TE to log getting a reply. This event occurs after getreply is checked against a template. This event is used for logging the intercomponent communication.  |   |
| <b>Effect</b>        | The TL presents all the information provided in the parameters of this operation to the user, how this is done is not within the scope of the present document.   |   |

## 7.3.4.1.45 tliPrRaise\_m

|                      |   |  |
|----------------------|---|--|
| <b>Signature</b>     | void tliPrRaise_m(in TString am, in TInteger ts, in TString src, in TInteger line, in TriComponentIdType c, in TriPortIdType at, in TriPortIdType to, in TriSignatureIdType signature, in TciParameterListType tciPars, in Value excValue, in Value addrValue, in TciStatusType encoderFailure, in TriExceptionType exc, in TriAddressType address, in TriStatusType transmissionFailure) |  |
| <b>In Parameters</b> | am  | An additional message.                               |
|                      | ts  | The time when the event is produced.                 |
|                      | src   | The source file of the test specification.           |
|                      | line  | The line number where the request is performed.      |
|                      | c   | The component which produces this event.             |
|                      | at  | The port via which the exception is sent.            |
|                      | to  | The port to which the exception is sent.             |
|                      | signature   | The signature relating to the exception.             |
|                      | tciPars   | The signature parameters relating to the exception.  |
|                      | excValue  | The exception to be sent.                            |
|                      | addrValue   | The address value of the destination within the SUT. |
|                      | encoderFailure  | The failure message which might occur at encoding.   |
|                      | exc   | The encoded exception.                               |
|                      | address   | The address of the destination within the SUT.       |
| transmissionFailure  | The failure message which might occur at transmission.  |  |
| <b>Return Value</b>  | void  |  |
| <b>Constraint</b>    | Shall be called by SA or TE to log a unicast raise operation. This event occurs after reply execution. This event is used for logging the communication with the SUT.   |  |
| <b>Effect</b>        | The TL presents all the information provided in the parameters of this operation to the user, how this is done is not within the scope of the present document.   |  |

## 7.3.4.1.46 tliPrRaise\_m\_BC

|                      |   |   |
|----------------------|---|---|
| <b>Signature</b>     | void tliPrRaise_m_BC(in TString am, in TInteger ts, in TString src, in TInteger line, in TriComponentIdType c, in TriPortIdType at, in TriPortIdType to, in TriSignatureIdType signature, in TciParameterListType tciPars, in Value excValue, in TciStatusType encoderFailure, in TriExceptionType exc, in TriStatusType transmissionFailure) |   |
| <b>In Parameters</b> | am  | An additional message.                              |
|                      | ts  | The time when the event is produced.                |
|                      | src   | The source file of the test specification.          |
|                      | line  | The line number where the request is performed.     |
|                      | c   | The component which produces this event.            |
|                      | at  | The port via which the exception is sent.           |
|                      | to  | The port to which the exception is sent.            |
|                      | signature   | The signature relating to the exception.            |
|                      | tciPars   | The signature parameters relating to the exception. |
|                      | excValue  | The exception to be sent.                           |
|                      | encoderFailure  | The failure message which might occur at encoding.  |
|                      | exc   | The encoded exception.                              |
| transmissionFailure  | The failure message which might occur at transmission.  |   |
| <b>Return Value</b>  | void  |   |
| <b>Constraint</b>    | Shall be called by SA or TE to log a broadcast raise operation. This event occurs after reply execution. This event is used for logging the communication with the SUT.   |   |
| <b>Effect</b>        | The TL presents all the information provided in the parameters of this operation to the user, how this is done is not within the scope of the present document.   |   |

## 7.3.4.1.47 tliPrRaise\_m\_MC

|                      |  |  |
|----------------------|--|--|
| <b>Signature</b>     | void tliPrRaise_m_MC(in TString am, in TInteger ts, in TString src, in TInteger line, in TriComponentIdType c, in TriPortIdType at, in TriPortIdType to, in TriSignatureIdType signature, in TciParameterListType tciPars, in Value excValue, in TciValueList addrValues, in TciStatusType encoderFailure, in TriExceptionType exc, in TriAddressListType addresses, in TriStatusType transmissionFailure) |  |
| <b>In Parameters</b> | am   | An additional message.                                 |
|                      | ts   | The time when the event is produced.                   |
|                      | src  | The source file of the test specification.             |
|                      | line   | The line number where the request is performed.        |
|                      | c  | The component which produces this event.               |
|                      | at   | The port via which the exception is sent.              |
|                      | to   | The port to which the exception is sent.               |
|                      | signature  | The signature relating to the exception.               |
|                      | tciPars  | The signature parameters relating to the exception.    |
|                      | excValue   | The exception to be sent.                              |
|                      | addrValues   | The address values of the destinations within the SUT. |
|                      | encoderFailure   | The failure message which might occur at encoding.     |
|                      | exc  | The encoded exception.                                 |
|                      | addresses  | The addresses of the destinations within the SUT.      |
| transmissionFailure  | The failure message which might occur at transmission.   |  |
| <b>Return Value</b>  | void   |  |
| <b>Constraint</b>    | Shall be called by SA or TE to log a multicast raise operation. This event occurs after reply execution. This event is used for logging the communication with the SUT.  |  |
| <b>Effect</b>        | The TL presents all the information provided in the parameters of this operation to the user, how this is done is not within the scope of the present document.  |  |



## 7.3.4.1.48 tliPrRaise\_c

|                      |  |  |
|----------------------|--|--|
| <b>Signature</b>     | void tliPrRaise_c(in TString am, in TInteger ts, in TString src, in TInteger line, in TriComponentIdType c, in TriPortIdType at, in TriPortIdType to, in TriSignatureIdType signature, in TciParameterListType tciPars, in Value excValue, in TriStatusType transmissionFailure) |  |
| <b>In Parameters</b> | am   | An additional message.                                 |
|                      | ts   | The time when the event is produced.                   |
|                      | src  | The source file of the test specification.             |
|                      | line   | The line number where the request is performed.        |
|                      | c  | The component which produces this event.               |
|                      | at   | The port via which the exception is sent.              |
|                      | to   | The port to which the exception is sent.               |
|                      | signature  | The signature relating to the exception.               |
|                      | tciPars  | The signature parameters relating to the exception.    |
|                      | excValue   | The exception to be sent.                              |
| <b>Return Value</b>  | transmissionFailure  | The failure message which might occur at transmission. |
| <b>Return Value</b>  | void   |  |
| <b>Constraint</b>    | Shall be called by CH or TE to log a unicast raise operation. This event occurs after reply execution. This event is used for logging the intercomponent communication.  |  |
| <b>Effect</b>        | The TL presents all the information provided in the parameters of this operation to the user, how this is done is not within the scope of the present document.  |  |

## 7.3.4.1.49 tliPrRaise\_c\_BC

|                      |   |  |
|----------------------|---|--|
| <b>Signature</b>     | void tliPrRaise_c_BC(in TString am, in TInteger ts, in TString src, in TInteger line, in TriComponentIdType c, in TriPortIdType at, in TriPortIdListType to, in TriSignatureIdType signature, in TciParameterListType tciPars, in Value excValue, in TriStatusType transmissionFailure) |  |
| <b>In Parameters</b> | am  | An additional message.                                 |
|                      | ts  | The time when the event is produced.                   |
|                      | src   | The source file of the test specification.             |
|                      | line  | The line number where the request is performed.        |
|                      | c   | The component which produces this event.               |
|                      | at  | The port via which the exception is sent.              |
|                      | to  | The port list to which the exception is sent.          |
|                      | signature   | The signature relating to the exception.               |
|                      | tciPars   | The signature parameters relating to the exception.    |
|                      | excValue  | The exception to be sent.                              |
| <b>Return Value</b>  | transmissionFailure   | The failure message which might occur at transmission. |
| <b>Return Value</b>  | void  |  |
| <b>Constraint</b>    | Shall be called by CH or TE to log a broadcast raise operation. This event occurs after reply execution. This event is used for logging the intercomponent communication.   |  |
| <b>Effect</b>        | The TL presents all the information provided in the parameters of this operation to the user, how this is done is not within the scope of the present document.   |  |

## 7.3.4.1.50 tliPrRaise\_c\_MC

|                      |   |   |
|----------------------|---|---|
| <b>Signature</b>     | void tliPrRaise_c_MC(in TString am, in TInteger ts, in TString src, in TInteger line, in TriComponentIdType c, in TriPortIdType at, in TriPortIdListType to, in TriSignatureIdType signature, in TciParameterListType tciPars, in Value excValue, in TriStatusType transmissionFailure) |   |
| <b>In Parameters</b> | am  | An additional message.                              |
|                      | ts  | The time when the event is produced.                |
|                      | src   | The source file of the test specification.          |
|                      | line  | The line number where the request is performed.     |
|                      | c   | The component which produces this event.            |
|                      | at  | The port via which the exception is sent.           |
|                      | to  | The port list to which the exception is sent.       |
|                      | signature   | The signature relating to the exception.            |
|                      | tciPars   | The signature parameters relating to the exception. |
|                      | excValue  | The exception to be sent.                           |
| <b>Return Value</b>  | void  |   |
| <b>Constraint</b>    | Shall be called by CH or TE to log a multicast raise operation. This event occurs after reply execution. This event is used for logging the intercomponent communication.   |   |
| <b>Effect</b>        | The TL presents all the information provided in the parameters of this operation to the user, how this is done is not within the scope of the present document.   |   |

## 7.3.4.1.51 tliPrCatchDetected\_m

|                      |  |  |
|----------------------|--|--|
| <b>Signature</b>     | void tliPrCatchDetected_m(in TString am, in TInteger ts, in TString src, in TInteger line, in TriComponentIdType c, in TriPortIdType at, in TriPortIdType from, in TriSignatureIdType signature, in TriExceptionType exc, in TriAddressType address) |  |
| <b>In Parameters</b> | am   | An additional message.                           |
|                      | ts   | The time when the event is produced.             |
|                      | src  | The source file of the test specification.       |
|                      | line   | The line number where the request is performed.  |
|                      | c  | The component which produces this event.         |
|                      | at   | The port via which the exception is received.    |
|                      | from   | The port from which the exception has been sent. |
|                      | signature  | The signature relating to the exception.         |
|                      | exc  | The exception caught.                            |
|                      | address  | The address of the source within the SUT.        |
| <b>Return Value</b>  | void   |  |
| <b>Constraint</b>    | Shall be called by SA or TE to log the catch enqueue operation. This event occurs after catch is enqueued. This event is used for logging the communication with the SUT.  |  |
| <b>Effect</b>        | The TL presents all the information provided in the parameters of this operation to the user, how this is done is not within the scope of the present document.  |  |

## 7.3.4.1.52 tliPrCatchDetected\_c

|                      |  |  |
|----------------------|--|--|
| <b>Signature</b>     | void tliPrCatchDetected_c(in TString am, in TInteger ts,<br>in TString src,<br>in TInteger line, in TriComponentIdType c,<br>in TriPortIdType at, in TriPortIdType from,<br>in TriSignatureIdType signature,<br>in Value excValue) |  |
| <b>In Parameters</b> | am   | An additional message.                           |
|                      | ts   | The time when the event is produced.             |
|                      | src  | The source file of the test specification.       |
|                      | line   | The line number where the request is performed.  |
|                      | c  | The component which produces this event.         |
|                      | at   | The port via which the exception is received.    |
|                      | from   | The port from which the exception has been sent. |
|                      | signature  | The signature relating to the exception.         |
|                      | excValue   | The caught exception.                            |
| <b>Return Value</b>  | void   |  |
| <b>Constraint</b>    | Shall be called by CH or TE to log the catch enqueue operation. This event occurs after catch is enqueued. This event is used for logging the intercomponent communication.  |  |
| <b>Effect</b>        | The TL presents all the information provided in the parameters of this operation to the user, how this is done is not within the scope of the present document.  |  |

## 7.3.4.1.53 tliPrCatchMismatch\_m

|                      |  |   |
|----------------------|--|---|
| <b>Signature</b>     | void tliPrCatchMismatch_m(in TString am, in TInteger ts,<br>in TString src,<br>in TInteger line, in TriComponentIdType c,<br>in TriPortIdType at, in TriSignatureIdType signature,<br>in Value excValue, in TciValueTemplate excTpl,<br>in TciValueDifferenceList diffs,<br>in Value addrValue,<br>in TciValueTemplate addressTpl) |   |
| <b>In Parameters</b> | am   | An additional message.                                      |
|                      | ts   | The time when the event is produced.                        |
|                      | src  | The source file of the test specification.                  |
|                      | line   | The line number where the request is performed.             |
|                      | c  | The component which produces this event.                    |
|                      | at   | The port via which the exception is received.               |
|                      | signature  | The signature relating to the exception.                    |
|                      | excValue   | The received exception.                                     |
|                      | excTpl   | The template used to check the exception match.             |
|                      | diffs  | The difference/the mismatch between exception and template. |
|                      | addrValue  | The address value of the source within the SUT.             |
|                      |  | addressTpl  |
| <b>Return Value</b>  | void   |   |
| <b>Constraint</b>    | Shall be called by TE to log the mismatch of a catch operation. This event occurs after catch is checked against a template. This event is used for logging the communication with SUT.  |   |
| <b>Effect</b>        | The TL presents all the information provided in the parameters of this operation to the user, how this is done is not within the scope of the present document.  |   |

## 7.3.4.1.54 tliPrCatchMismatch\_c

|                      |  |   |
|----------------------|--|---|
| <b>Signature</b>     | void tliPrCatchMismatch_c(in TString am, in TInteger ts,<br>in TString src,<br>in TInteger line, in TriComponentIdType c,<br>in TriPortIdType at, in TriSignatureIdType signature,<br>in Value excValue, in TciValueTemplate excTmpl,<br>in TciValueDifferenceList diffs,<br>in TriComponentIdType from,<br>in TciNonValueTemplate fromTmpl) |   |
| <b>In Parameters</b> | Am   | An additional message.                                      |
|                      | Ts   | The time when the event is produced.                        |
|                      | Src  | The source file of the test specification.                  |
|                      | Line   | The line number where the request is performed.             |
|                      | C  | The component which produces this event.                    |
|                      | At   | The port via which the exception is received.               |
|                      | Signature  | The signature relating to the exception.                    |
|                      | excValue   | The received exception.                                     |
|                      | excTmpl  | The template used to check the exception match.             |
|                      | Diffs  | The difference/the mismatch between exception and template. |
|                      | From   | The component which sent the reply.                         |
|                      | fromTmpl   | The expected replying component.                            |
| <b>Return Value</b>  | Void   |   |
| <b>Constraint</b>    | Shall be called by TE to log the mismatch of a catch operation. This event occurs after catch is checked against a template. This event is used for logging the intercomponent communication.  |   |
| <b>Effect</b>        | The TL presents all the information provided in the parameters of this operation to the user, how this is done is not within the scope of the present document.  |   |

## 7.3.4.1.55 tliPrCatch\_m

|                      |   |   |
|----------------------|---|---|
| <b>Signature</b>     | void tliPrCatch_m(in TString am, in TInteger ts, in TString src,<br>in TInteger line, in TriComponentIdType c,<br>in TriPortIdType at, in TriSignatureIdType signature,<br>in Value excValue, in TciValueTemplate excTmpl,<br>in Value addrValue,<br>in TciValueTemplate addressTmpl) |   |
| <b>In Parameters</b> | Am  | An additional message.                          |
|                      | Ts  | The time when the event is produced.            |
|                      | Src   | The source file of the test specification.      |
|                      | Line  | The line number where the request is performed. |
|                      | C   | The component which produces this event.        |
|                      | At  | The port via which the exception is received.   |
|                      | Signature   | The signature relating to the exception.        |
|                      | excValue  | The received exception.                         |
|                      | excTmpl   | The template used to check the exception match. |
|                      | addrValue   | The address value of the source within the SUT. |
| addressTmpl          | The expected address of the source within the SUT.  |   |
| <b>Return Value</b>  | Void  |   |
| <b>Constraint</b>    | Shall be called by SA or TE to log catching an exception. This event occurs after catch is checked against a template. This event is used for logging the communication with SUT.   |   |
| <b>Effect</b>        | The TL presents all the information provided in the parameters of this operation to the user, how this is done is not within the scope of the present document.   |   |

## 7.3.4.1.56 tliPrCatch\_c

|                      |  |   |
|----------------------|--|---|
| <b>Signature</b>     | void tliPrCatch_c(in TString am, in TInteger ts, in TString src, in TInteger line, in TriComponentIdType c, in TriPortIdType at, in TriSignatureIdType signature, in Value excValue, in TciValueTemplate excTpl, in TriComponentIdType from, in TciNonValueTemplate fromTpl) |   |
| <b>In Parameters</b> | Am   | An additional message.                          |
|                      | Ts   | The time when the event is produced.            |
|                      | Src  | The source file of the test specification.      |
|                      | Line   | The line number where the request is performed. |
|                      | C  | The component which produces this event.        |
|                      | At   | The port via which the exception is received.   |
|                      | Signature  | The signature relating to the exception.        |
|                      | excValue   | The received exception.                         |
|                      | excTpl   | The template used to check the exception match. |
|                      | From   | The component which sent the reply.             |
| fromTpl              | The expected replying component.   |   |
| <b>Return Value</b>  | Void   |   |
| <b>Constraint</b>    | Shall be called by CH or TE to log catching an exception. This event occurs after catch is checked against a template. This event is used for logging the intercomponent communication.  |   |
| <b>Effect</b>        | The TL presents all the information provided in the parameters of this operation to the user, how this is done is not within the scope of the present document.  |   |

## 7.3.4.1.57 tliPrCatchTimeoutDetected

|                      |  |   |
|----------------------|--|---|
| <b>Signature</b>     | void tliPrCatchTimeoutDetected<br>(in TString am, in TInteger ts, in TString src, in TInteger line, in TriComponentIdType c, in TriPortIdType at, in TriSignatureIdType signature) |   |
| <b>In Parameters</b> | Am   | An additional message.                          |
|                      | Ts   | The time when the event is produced.            |
|                      | Src  | The source file of the test specification.      |
|                      | Line   | The line number where the request is performed. |
|                      | C  | The component which produces this event.        |
|                      | At   | The port via which the exception is received.   |
|                      | Signature  | The signature relating to the exception.        |
| <b>Return Value</b>  | Void   |   |
| <b>Constraint</b>    | Shall be called by PA or TE to log the detection of a catch timeout. This event occurs after the timeout is enqueued.  |   |
| <b>Effect</b>        | The TL presents all the information provided in the parameters of this operation to the user, how this is done is not within the scope of the present document.                    |   |

## 7.3.4.1.58 tliPrCatchTimeout

|                      |   |   |
|----------------------|---|---|
| <b>Signature</b>     | void tliPrCatchTimeout (in TString am, in TInteger ts, in TString src, in TInteger line, in TriComponentIdType c, in TriPortIdType at, in TriSignatureIdType signature) |   |
| <b>In Parameters</b> | am  | An additional message.                          |
|                      | ts  | The time when the event is produced.            |
|                      | src   | The source file of the test specification.      |
|                      | line  | The line number where the request is performed. |
|                      | c   | The component which produces this event.        |
|                      | at  | The port via which the exception is received.   |
|                      | signature   | The signature relating to the exception.        |
| <b>Return Value</b>  | void  |   |
| <b>Constraint</b>    | Shall be called by TE to log catching a timeout. This event occurs after the catch timeout has been performed.  |   |
| <b>Effect</b>        | The TL presents all the information provided in the parameters of this operation to the user, how this is done is not within the scope of the present document.         |   |

## 7.3.4.1.59 tliCCreate

|                      |   |   |
|----------------------|---|---|
| <b>Signature</b>     | void tliCCreate(in TString am, in TInteger ts, in TString src,<br>in TInteger line, in TriComponentIdType c,<br>in TriComponentIdType comp, in TString name, in TBoolean alive) |   |
| <b>In Parameters</b> | am  | An additional message.                          |
|                      | ts  | The time when the event is produced.            |
|                      | src   | The source file of the test specification.      |
|                      | line  | The line number where the request is performed. |
|                      | c   | The component which produces this event.        |
|                      | comp  | The component which is created.                 |
|                      | name  | The name of the component which is created.     |
|                      | alive   | If the component is an alive component.         |
| <b>Return Value</b>  | void  |   |
| <b>Constraint</b>    | Shall be called by TE to log the create component operation. This event occurs after component creation.  |   |
| <b>Effect</b>        | The TL presents all the information provided in the parameters of this operation to the user, how this is done is not within the scope of the present document.                 |   |

## 7.3.4.1.60 tliCStart

|                      |   |   |
|----------------------|---|---|
| <b>Signature</b>     | void tliCStart(in TString am, in TInteger ts, in TString src,<br>in TInteger line, in TriComponentIdType c,<br>in TriComponentIdType comp, in TciBehaviourIdType beh,<br>in TciParameterListType tciPars) |   |
| <b>In Parameters</b> | am  | An additional message.                          |
|                      | ts  | The time when the event is produced.            |
|                      | src   | The source file of the test specification.      |
|                      | line  | The line number where the request is performed. |
|                      | c   | The component which produces this event.        |
|                      | comp  | The component which is started.                 |
|                      | beh   | The behaviour being started on the component.   |
|                      | tciPars   | The parameters of the started behaviour.        |
| <b>Return Value</b>  | void  |   |
| <b>Constraint</b>    | Shall be called by TE to log the start component operation. This event occurs after component start.  |   |
| <b>Effect</b>        | The TL presents all the information provided in the parameters of this operation to the user, how this is done is not within the scope of the present document.   |   |

## 7.3.4.1.61 tliCRunning

|                      |   |   |
|----------------------|---|---|
| <b>Signature</b>     | void tliCRunning(in TString am, in TInteger ts, in TString src,<br>in TInteger line, in TriComponentIdType c,<br>in TriComponentIdType comp, in ComponentStatusType status) |   |
| <b>In Parameters</b> | am  | An additional message.                          |
|                      | ts  | The time when the event is produced.            |
|                      | src   | The source file of the test specification.      |
|                      | line  | The line number where the request is performed. |
|                      | c   | The component which produces this event.        |
|                      | comp  | The component which is checked to be running.   |
|                      | status  | The status of this component.                   |
| <b>Return Value</b>  | void  |   |
| <b>Constraint</b>    | Shall be called by TE to log the running component operation. This event occurs after component running.  |   |
| <b>Effect</b>        | The TL presents all the information provided in the parameters of this operation to the user, how this is done is not within the scope of the present document.             |   |

## 7.3.4.1.62 tliCAlive

|                      |   |   |
|----------------------|---|---|
| <b>Signature</b>     | void tliCAlive(in TString am, in TInteger ts, in TString src, in TInteger line, in TriComponentIdType c, in TriComponentIdType comp, in ComponentStatusType status) |   |
| <b>In Parameters</b> | am  | An additional message.                          |
|                      | ts  | The time when the event is produced.            |
|                      | src   | The source file of the test specification.      |
|                      | line  | The line number where the request is performed. |
|                      | c   | The component which produces this event.        |
|                      | comp  | The component which is checked to be running.   |
|                      | status  | The status of this component.                   |
| <b>Return Value</b>  | void  |   |
| <b>Constraint</b>    | Shall be called by TE to log the alive component operation. This event occurs after component alive.  |   |
| <b>Effect</b>        | The TL presents all the information provided in the parameters of this operation to the user, how this is done is not within the scope of the present document.     |   |

## 7.3.4.1.63 tliCStop

|                      |   |   |
|----------------------|---|---|
| <b>Signature</b>     | void tliCStop(in TString am, in TInteger ts, in TString src, in TInteger line, in TriComponentIdType c, in TriComponentIdType comp)                             |   |
| <b>In Parameters</b> | am  | An additional message.                          |
|                      | ts  | The time when the event is produced.            |
|                      | src   | The source file of the test specification.      |
|                      | line  | The line number where the request is performed. |
|                      | c   | The component which produces this event.        |
|                      | comp  | The component which is stopped.                 |
| <b>Return Value</b>  | void  |   |
| <b>Constraint</b>    | Shall be called by TE to log the stop component operation. This event occurs after component stop.  |   |
| <b>Effect</b>        | The TL presents all the information provided in the parameters of this operation to the user, how this is done is not within the scope of the present document. |   |

## 7.3.4.1.64 tliCKill

|                      |   |   |
|----------------------|---|---|
| <b>Signature</b>     | void tliCKill(in TString am, in TInteger ts, in TString src, in TInteger line, in TriComponentIdType c, in TriComponentIdType comp)                             |   |
| <b>In Parameters</b> | am  | An additional message.                          |
|                      | ts  | The time when the event is produced.            |
|                      | src   | The source file of the test specification.      |
|                      | line  | The line number where the request is performed. |
|                      | c   | The component which produces this event.        |
|                      | comp  | The component which is killed.                  |
| <b>Return Value</b>  | void  |   |
| <b>Constraint</b>    | Shall be called by TE to log the kill component operation. This event occurs after component kill.  |   |
| <b>Effect</b>        | The TL presents all the information provided in the parameters of this operation to the user, how this is done is not within the scope of the present document. |   |

## 7.3.4.1.65 tliCDoneMismatch

|                      |   |   |
|----------------------|---|---|
| <b>Signature</b>     | void tliCDoneMismatch(in TString am, in TInteger ts, in TString src, in TInteger line, in TriComponentIdType c, in TriComponentIdType comp, in TciNonValueTemplate compTpl) |   |
| <b>In Parameters</b> | am  | An additional message.                          |
|                      | ts  | The time when the event is produced.            |
|                      | src   | The source file of the test specification.      |
|                      | line  | The line number where the request is performed. |
|                      | c   | The component which produces this event.        |
|                      | comp  | The first component that did not match.         |
|                      | compTpl   | The template used to check the done match.      |
| <b>Return Value</b>  | void  |   |
| <b>Constraint</b>    | Shall be called by TE to log the mismatch of a done component operation. This event occurs after done is checked against a template.  |   |
| <b>Effect</b>        | The TL presents all the information provided in the parameters of this operation to the user, how this is done is not within the scope of the present document.             |   |

## 7.3.4.1.66 tliCDone

|                      |   |   |
|----------------------|---|---|
| <b>Signature</b>     | void tliCDone (in TString am, in TInteger ts, in TString src, in TInteger line, in TriComponentIdType c, in TciNonValueTemplate compTpl, in VerdictValue verdict) |   |
| <b>In Parameters</b> | am  | An additional message.  |
|                      | ts  | The time when the event is produced.  |
|                      | src   | The source file of the test specification.                                      |
|                      | line  | The line number where the request is performed.                                 |
|                      | c   | The component which produces this event.  |
|                      | compTpl   | The template used to check the done match.                                      |
|                      | verdict   | The final verdict of the component if the component is known or null otherwise. |
| <b>Return Value</b>  | void  |   |
| <b>Constraint</b>    | Shall be called by TE to log the done component operation. This event occurs after the done operation.  |   |
| <b>Effect</b>        | The TL presents all the information provided in the parameters of this operation to the user, how this is done is not within the scope of the present document.   |   |

## 7.3.4.1.67 tliCKilledMismatch

|                      |   |   |
|----------------------|---|---|
| <b>Signature</b>     | void tliCKilledMismatch(in TString am, in TInteger ts, in TString src, in TInteger line, in TriComponentIdType c, in TriComponentIdType comp, in TciNonValueTemplate compTpl) |   |
| <b>In Parameters</b> | am  | An additional message.                          |
|                      | ts  | The time when the event is produced.            |
|                      | src   | The source file of the test specification.      |
|                      | line  | The line number where the request is performed. |
|                      | c   | The component which produces this event.        |
|                      | comp  | The first component that did not match.         |
|                      | compTpl   | The template used to check the killed match.    |
| <b>Return Value</b>  | void  |   |
| <b>Constraint</b>    | Shall be called by TE to log the mismatch of a killed component operation. This event occurs after killed is checked against a template.                                      |   |
| <b>Effect</b>        | The TL presents all the information provided in the parameters of this operation to the user, how this is done is not within the scope of the present document.               |   |



## 7.3.4.1.68 tliCKilled

|                      |   |   |
|----------------------|---|---|
| <b>Signature</b>     | void tliCKilled (in TString am, in TInteger ts, in TString src, in TInteger line, in TriComponentIdType c, in TciNonValueTemplate compTpl, in VerdictValue verdict) |   |
| <b>In Parameters</b> | am  | An additional message.  |
|                      | ts  | The time when the event is produced.  |
|                      | src   | The source file of the test specification.                                      |
|                      | line  | The line number where the request is performed.                                 |
|                      | c   | The component which produces this event.  |
|                      | compTpl   | The template used to check the killed match.                                    |
|                      | verdict   | The final verdict of the component if the component is known or null otherwise. |
| <b>Return Value</b>  | void  |   |
| <b>Constraint</b>    | Shall be called by TE to log the killed component operation. This event occurs after the killed operation.  |   |
| <b>Effect</b>        | The TL presents all the information provided in the parameters of this operation to the user, how this is done is not within the scope of the present document.     |   |

## 7.3.4.1.69 tliCTerminated

|                      |   |  |
|----------------------|---|--|
| <b>Signature</b>     | void tliCTerminated(in TString am, in TInteger ts, in TString src, in TInteger line, in TriComponentIdType c, in VerdictValue verdict, in TString reason)       |  |
| <b>In Parameters</b> | am  | An additional message.                           |
|                      | ts  | The time when the event is produced.             |
|                      | src   | The source file of the test specification.       |
|                      | line  | The line number where the request is performed.  |
|                      | c   | The component which produces this event.         |
|                      | verdict   | The verdict of the component.                    |
|                      | reason  | The optional reason of the setverdict statement. |
| <b>Return Value</b>  | void  |  |
| <b>Constraint</b>    | Shall be called by TE to log the termination of a component. This event occurs after the termination of the component.  |  |
| <b>Effect</b>        | The TL presents all the information provided in the parameters of this operation to the user, how this is done is not within the scope of the present document. |  |

## 7.3.4.1.70 tliPConnect

|                      |   |   |
|----------------------|---|---|
| <b>Signature</b>     | void tliPConnect(in TString am, in TInteger ts, in TString src, in TInteger line, in TriComponentIdType c, in TriPortIdType port1, in TriPortIdType port2)      |   |
| <b>In Parameters</b> | am  | An additional message.                          |
|                      | ts  | The time when the event is produced.            |
|                      | src   | The source file of the test specification.      |
|                      | line  | The line number where the request is performed. |
|                      | c   | The component which produces this event.        |
|                      | port1   | The first port to be connected.                 |
|                      | port2   | The second port to be connected.                |
| <b>Return Value</b>  | void  |   |
| <b>Constraint</b>    | Shall be called by CH or TE to log the connect operation. This event occurs after the connect operation.  |   |
| <b>Effect</b>        | The TL presents all the information provided in the parameters of this operation to the user, how this is done is not within the scope of the present document. |   |

## 7.3.4.1.71 tliPDisconnect

|                      |   |   |
|----------------------|---|---|
| <b>Signature</b>     | void tliPDisconnect(in TString am, in TInteger ts, in TString src, in TInteger line, in TriComponentIdType c, in TriPortIdType port1, in TriPortIdType port2)   |   |
| <b>In Parameters</b> | am  | An additional message.                          |
|                      | ts  | The time when the event is produced.            |
|                      | src   | The source file of the test specification.      |
|                      | line  | The line number where the request is performed. |
|                      | c   | The component which produces this event.        |
|                      | port1   | The first port to be disconnected.              |
|                      | port2   | The second port to be disconnected.             |
| <b>Return Value</b>  | void  |   |
| <b>Constraint</b>    | Shall be called by CH or TE to log the disconnect operation. This event occurs after the disconnect operation.  |   |
| <b>Effect</b>        | The TL presents all the information provided in the parameters of this operation to the user, how this is done is not within the scope of the present document. |   |

## 7.3.4.1.72 tliPMap

|                      |   |   |
|----------------------|---|---|
| <b>Signature</b>     | void tliPMap(in TString am, in TInteger ts, in TString src, in TInteger line, in TriComponentIdType c, in TriPortIdType port1, in TriPortIdType port2)          |   |
| <b>In Parameters</b> | am  | An additional message.                          |
|                      | ts  | The time when the event is produced.            |
|                      | src   | The source file of the test specification.      |
|                      | line  | The line number where the request is performed. |
|                      | c   | The component which produces this event.        |
|                      | port1   | The first port to be mapped.                    |
|                      | port2   | The second port to be mapped.                   |
| <b>Return Value</b>  | void  |   |
| <b>Constraint</b>    | Shall be called by SA or TE to log the map operation. This event occurs after the map operation.  |   |
| <b>Effect</b>        | The TL presents all the information provided in the parameters of this operation to the user, how this is done is not within the scope of the present document. |   |

## 7.3.4.1.73 tliPMapParam

|                      |  |  |
|----------------------|--|--|
| <b>Signature</b>     | void tliPMapParam(in TString am, in TInteger ts, in TString src, in TInteger line, in TriComponentIdType c, in TriPortIdType port1, in TriPortIdType port2, in TciParameterListType tciPars, in TciStatusType encoderFailure, in TriParameterListType triPars) |  |
| <b>In Parameters</b> | am   | An additional message.                             |
|                      | ts   | The time when the event is produced.               |
|                      | src  | The source file of the test specification.         |
|                      | line   | The line number where the request is performed.    |
|                      | c  | The component which produces this event.           |
|                      | port1  | The first port to be mapped.                       |
|                      | port2  | The second port to be mapped.                      |
|                      | tciPars  | The configuration parameter list.                  |
|                      | encoderFailure   | The failure message which might occur at encoding. |
|                      | triPars  | The encoded configuration parameter list.          |
| <b>Return Value</b>  | void   |  |
| <b>Constraint</b>    | Shall be called by SA or TE to log the map operation. This event occurs after the map operation including parameters.  |  |
| <b>Effect</b>        | The TL presents all the information provided in the parameters of this operation to the user, how this is done is not within the scope of the present document.  |  |

## 7.3.4.1.74 tliPUnmap

|                      |   |   |
|----------------------|---|---|
| <b>Signature</b>     | void tliPUnmap(in TString am, in TInteger ts, in TString src, in TInteger line, in TriComponentIdType c, in TriPortIdType port1, in TriPortIdType port2)        |   |
| <b>In Parameters</b> | am  | An additional message.                          |
|                      | ts  | The time when the event is produced.            |
|                      | src   | The source file of the test specification.      |
|                      | line  | The line number where the request is performed. |
|                      | c   | The component which produces this event.        |
|                      | port1   | The first port to be unmapped.                  |
|                      | port2   | The second port to be unmapped.                 |
| <b>Return Value</b>  | void  |   |
| <b>Constraint</b>    | Shall be called by SA or TE to log the unmap operation. This event occurs after the unmap operation.  |   |
| <b>Effect</b>        | The TL presents all the information provided in the parameters of this operation to the user, how this is done is not within the scope of the present document. |   |

## 7.3.4.1.75 tliPUnmapParam

|                      |  |  |
|----------------------|--|--|
| <b>Signature</b>     | void tliPUnmapParam(in TString am, in TInteger ts, in TString src, in TInteger line, in TriComponentIdType c, in TriPortIdType port1, in TriPortIdType port2, in TciParameterListType tciPars, in TciStatusType encoderFailure, in TriParameterListType triPars) |  |
| <b>In Parameters</b> | am   | An additional message.                             |
|                      | ts   | The time when the event is produced.               |
|                      | src  | The source file of the test specification.         |
|                      | line   | The line number where the request is performed.    |
|                      | c  | The component which produces this event.           |
|                      | port1  | The first port to be unmapped.                     |
|                      | port2  | The second port to be unmapped.                    |
|                      | tciPars  | The configuration parameter list.                  |
|                      | encoderFailure   | The failure message which might occur at encoding. |
|                      | triPars  | The encoded configuration parameter list.          |
| <b>Return Value</b>  | void   |  |
| <b>Constraint</b>    | Shall be called by SA or TE to log the unmap operation. This event occurs after the unmap operation including parameters.  |  |
| <b>Effect</b>        | The TL presents all the information provided in the parameters of this operation to the user, how this is done is not within the scope of the present document.  |  |

## 7.3.4.1.76 tliPClear

|                      |   |   |
|----------------------|---|---|
| <b>Signature</b>     | void tliPClear(in TString am, in TInteger ts, in TString src, in TInteger line, in TriComponentIdType c, in TriPortIdType port)                                 |   |
| <b>In Parameters</b> | am  | An additional message.                          |
|                      | ts  | The time when the event is produced.            |
|                      | src   | The source file of the test specification.      |
|                      | line  | The line number where the request is performed. |
|                      | c   | The component which produces this event.        |
|                      | port  | The port to be cleared.                         |
| <b>Return Value</b>  | void  |   |
| <b>Constraint</b>    | Shall be called by TE to log the port clear operation. This event occurs after the port clear operation.  |   |
| <b>Effect</b>        | The TL presents all the information provided in the parameters of this operation to the user, how this is done is not within the scope of the present document. |   |

## 7.3.4.1.77 tliPStart

|                      |   |   |
|----------------------|---|---|
| <b>Signature</b>     | void tliPStart(in TString am, in TInteger ts, in TString src,<br>in TInteger line, in TriComponentIdType c,<br>in TriPortIdType port)                           |   |
| <b>In Parameters</b> | am  | An additional message.                          |
|                      | ts  | The time when the event is produced.            |
|                      | src   | The source file of the test specification.      |
|                      | line  | The line number where the request is performed. |
|                      | c   | The component which produces this event.        |
|                      | port  | The port to be started.                         |
| <b>Return Value</b>  | void  |   |
| <b>Constraint</b>    | Shall be called by TE to log the port start operation. This event occurs after the port start operation.  |   |
| <b>Effect</b>        | The TL presents all the information provided in the parameters of this operation to the user, how this is done is not within the scope of the present document. |   |

## 7.3.4.1.78 tliPStop

|                      |   |   |
|----------------------|---|---|
| <b>Signature</b>     | void tliPStop(in TString am, in TInteger ts, in TString src,<br>in TInteger line, in TriComponentIdType c,<br>in TriPortIdType port)                            |   |
| <b>In Parameters</b> | am  | An additional message.                          |
|                      | ts  | The time when the event is produced.            |
|                      | src   | The source file of the test specification.      |
|                      | line  | The line number where the request is performed. |
|                      | c   | The component which produces this event.        |
|                      | port  | The port to be stopped.                         |
| <b>Return Value</b>  | void  |   |
| <b>Constraint</b>    | Shall be called by TE to log the port stop operation. This event occurs after the port stop operation.  |   |
| <b>Effect</b>        | The TL presents all the information provided in the parameters of this operation to the user, how this is done is not within the scope of the present document. |   |

## 7.3.4.1.79 tliPHalt

|                      |   |   |
|----------------------|---|---|
| <b>Signature</b>     | void tliPHalt(in TString am, in TInteger ts, in TString src,<br>in TInteger line, in TriComponentIdType c,<br>in TriPortIdType port)                            |   |
| <b>In Parameters</b> | am  | An additional message.                          |
|                      | ts  | The time when the event is produced.            |
|                      | src   | The source file of the test specification.      |
|                      | line  | The line number where the request is performed. |
|                      | c   | The component which produces this event.        |
|                      | port  | The port to be stopped.                         |
| <b>Return Value</b>  | void  |   |
| <b>Constraint</b>    | Shall be called by TE to log the port halt operation. This event occurs after the port halt operation.  |   |
| <b>Effect</b>        | The TL presents all the information provided in the parameters of this operation to the user, how this is done is not within the scope of the present document. |   |

## 7.3.4.1.80 tliEncode

|                      |  |  |
|----------------------|--|--|
| <b>Signature</b>     | void tliEncode(in TString am, in TInteger ts, in TString src, in TInteger line, in TriComponentIdType c, in Value val, in TciStatusType encoderFailure, in TriMessageType msg, in TString codec) |  |
| <b>In Parameters</b> | am   | An additional message.                             |
|                      | ts   | The time when the event is produced.               |
|                      | src  | The source file of the test specification.         |
|                      | line   | The line number where the request is performed.    |
|                      | c  | The component which produces this event.           |
|                      | value  | The value to be encoded.                           |
|                      | encoderFailure   | The failure message which might occur at encoding. |
|                      | msg  | The encoded value.                                 |
|                      | codec  | The used encoder.                                  |
| <b>Return Value</b>  | void   |  |
| <b>Constraint</b>    | Shall be called by CD or TE to log the encode operation.   |  |
| <b>Effect</b>        | The TL presents all the information provided in the parameters of this operation to the user, how this is done is not within the scope of the present document.                                  |  |

## 7.3.4.1.81 tliDecode

|                      |  |  |
|----------------------|--|--|
| <b>Signature</b>     | void tliDecode(in TString am, in TInteger ts, in TString src, in TInteger line, in TriComponentIdType c, in TriMessageType msg, in TciStatusType decoderFailure, in Value val, in TString codec) |  |
| <b>In Parameters</b> | am   | An additional message.                             |
|                      | ts   | The time when the event is produced.               |
|                      | src  | The source file of the test specification.         |
|                      | line   | The line number where the request is performed.    |
|                      | c  | The component which produces this event.           |
|                      | msg  | The value to be decoded.                           |
|                      | decoderFailure   | The failure message which might occur at decoding. |
|                      | val  | The decoded value.                                 |
|                      | codec  | The used decoder.                                  |
| <b>Return Value</b>  | void   |  |
| <b>Constraint</b>    | Shall be called by CD or TE to log the decode operation.   |  |
| <b>Effect</b>        | The TL presents all the information provided in the parameters of this operation to the user, how this is done is not within the scope of the present document.                                  |  |

## 7.3.4.1.82 tliTimeoutDetected

|                      |   |   |
|----------------------|---|---|
| <b>Signature</b>     | void tliTimeoutDetected(in TString am, in TInteger ts, in TString src, in TInteger line, in TriComponentIdType c, in TriTimerIdType timer)                      |   |
| <b>In Parameters</b> | am  | An additional message.                          |
|                      | ts  | The time when the event is produced.            |
|                      | src   | The source file of the test specification.      |
|                      | line  | The line number where the request is performed. |
|                      | c   | The component which produces this event.        |
|                      | timer   | The timer that timed out.                       |
| <b>Return Value</b>  | void  |   |
| <b>Constraint</b>    | Shall be called by PA or TE to log the detection of a timeout. This event occurs after timeout is enqueued.   |   |
| <b>Effect</b>        | The TL presents all the information provided in the parameters of this operation to the user, how this is done is not within the scope of the present document. |   |

## 7.3.4.1.83 tliTTimeoutMismatch

|                      |  |   |
|----------------------|--|---|
| <b>Signature</b>     | void tliTTimeoutMismatch(in TString am, in TInteger ts,<br>in TString src,<br>in TInteger line, in TriComponentIdType c,<br>in TriTimerIdType timer,<br>in TciNonValueTemplate timerTpl) |   |
| <b>In Parameters</b> | am   | An additional message.                          |
|                      | ts   | The time when the event is produced.            |
|                      | src  | The source file of the test specification.      |
|                      | line   | The line number where the request is performed. |
|                      | c  | The component which produces this event.        |
|                      | timer  | The first timer that did not match.             |
|                      | timerTpl   | The timer template that did not match.          |
| <b>Return Value</b>  | void   |   |
| <b>Constraint</b>    | Shall be called by TE to log a timeout mismatch. This event occurs after a timeout match failed.   |   |
| <b>Effect</b>        | The TL presents all the information provided in the parameters of this operation to the user, how this is done is not within the scope of the present document.                          |   |

## 7.3.4.1.84 tliTTimeout

|                      |  |   |
|----------------------|--|---|
| <b>Signature</b>     | void tliTTimeout(in TString am, in TInteger ts,<br>in TString src,<br>in TInteger line, in TriComponentIdType c,<br>in TriTimerIdType timer,<br>in TciNonValueTemplate timerTpl) |   |
| <b>In Parameters</b> | am   | An additional message.                          |
|                      | ts   | The time when the event is produced.            |
|                      | src  | The source file of the test specification.      |
|                      | line   | The line number where the request is performed. |
|                      | c  | The component which produces this event.        |
|                      | timer  | The timer that matched.                         |
|                      | timerTpl   | The timer template that matched.                |
| <b>Return Value</b>  | void   |   |
| <b>Constraint</b>    | Shall be called by TE to log a timeout match. This event occurs after a timeout matched.   |   |
| <b>Effect</b>        | The TL presents all the information provided in the parameters of this operation to the user, how this is done is not within the scope of the present document.                  |   |

## 7.3.4.1.85 tliTStart

|                      |  |   |
|----------------------|--|---|
| <b>Signature</b>     | void tliTStart(in TString am, in TInteger ts, in TString src,<br>in TInteger line, in TriComponentIdType c,<br>in TriTimerIdType timer, in TriTimerDurationType dur) |   |
| <b>In Parameters</b> | am   | An additional message.                          |
|                      | ts   | The time when the event is produced.            |
|                      | src  | The source file of the test specification.      |
|                      | line   | The line number where the request is performed. |
|                      | c  | The component which produces this event.        |
|                      | timer  | The timer that is started.                      |
|                      | dur  | The timer duration.                             |
| <b>Return Value</b>  | void   |   |
| <b>Constraint</b>    | Shall be called by PA or TE to log the start of a timer. This event occurs after the start timer operation.  |   |
| <b>Effect</b>        | The TL presents all the information provided in the parameters of this operation to the user, how this is done is not within the scope of the present document.      |   |

## 7.3.4.1.86 tliTStop

|                      |   |   |
|----------------------|---|---|
| <b>Signature</b>     | void tliTStop(in TString am, in TInteger ts, in TString src,<br>in TInteger line, in TriComponentIdType c,<br>in TriTimerIdType timer, in TriTimerDurationType dur) |   |
| <b>In Parameters</b> | am  | An additional message.                          |
|                      | ts  | The time when the event is produced.            |
|                      | src   | The source file of the test specification.      |
|                      | line  | The line number where the request is performed. |
|                      | c   | The component which produces this event.        |
|                      | timer   | The timer that is stopped.                      |
|                      | dur   | The duration of the timer when it was stopped.  |
| <b>Return Value</b>  | void  |   |
| <b>Constraint</b>    | Shall be called by PA or TE to log the stop of a timer. This event occurs after the stop timer operation.   |   |
| <b>Effect</b>        | The TL presents all the information provided in the parameters of this operation to the user, how this is done is not within the scope of the present document.     |   |

## 7.3.4.1.87 tliTRead

|                      |   |   |
|----------------------|---|---|
| <b>Signature</b>     | void tliTRead(in TString am, in TInteger ts, in TString src,<br>in TInteger line, in TriComponentIdType c,<br>in TriTimerIdType timer, in TriTimerDurationType elapsed) |   |
| <b>In Parameters</b> | am  | An additional message.                          |
|                      | ts  | The time when the event is produced.            |
|                      | src   | The source file of the test specification.      |
|                      | line  | The line number where the request is performed. |
|                      | c   | The component which produces this event.        |
|                      | timer   | The timer that is started.                      |
|                      | elapsed   | The elapsed time of the timer.                  |
| <b>Return Value</b>  | void  |   |
| <b>Constraint</b>    | Shall be called by PA or TE to log the reading of a timer. This event occurs after the read timer operation.  |   |
| <b>Effect</b>        | The TL presents all the information provided in the parameters of this operation to the user, how this is done is not within the scope of the present document.         |   |

## 7.3.4.1.88 tliTRunning

|                      |  |   |
|----------------------|--|---|
| <b>Signature</b>     | void tliTRunning(in TString am, in TInteger ts, in TString src,<br>in TInteger line, in TriComponentIdType c,<br>in TriTimerIdType timer, in TimerStatusType status) |   |
| <b>In Parameters</b> | am   | An additional message.                          |
|                      | ts   | The time when the event is produced.            |
|                      | src  | The source file of the test specification.      |
|                      | line   | The line number where the request is performed. |
|                      | c  | The component which produces this event.        |
|                      | timer  | The timer which is checked to be running.       |
|                      | status   | The status of this component.                   |
| <b>Return Value</b>  | void   |   |
| <b>Constraint</b>    | Shall be called by PA or TE to log the running timer operation. This event occurs after the running timer operation.   |   |
| <b>Effect</b>        | The TL presents all the information provided in the parameters of this operation to the user, how this is done is not within the scope of the present document.      |   |

## 7.3.4.1.89 tliSEnter

|                      |   |   |
|----------------------|---|---|
| <b>Signature</b>     | void tliSEnter(in TString am, in TInteger ts, in TString src, in TInteger line, in TriComponentIdType c, in QualifiedName name, in TciParameterListType tciPars, in TString kind) |   |
| <b>In Parameters</b> | am  | An additional message.  |
|                      | ts  | The time when the event is produced.  |
|                      | src   | The source file of the test specification.  |
|                      | line  | The line number where the request is performed.                                       |
|                      | c   | The component which produces this event.  |
|                      | name  | The name of the scope.  |
|                      | tciPars   | The parameters of the scope.  |
|                      | kind  | The kind of the scope. If the scope contains modifiers, they prefix the scope string. |
| <b>Return Value</b>  | void  |   |
| <b>Constraint</b>    | Shall be called by TE to log the entering of a scope. This event occurs after the scoped has been entered.  |   |
| <b>Effect</b>        | The TL presents all the information provided in the parameters of this operation to the user, how this is done is not within the scope of the present document.                   |   |

## 7.3.4.1.90 tliSLeave

|                      |   |   |
|----------------------|---|---|
| <b>Signature</b>     | void tliSLeave(in TString am, in TInteger ts, in TString src, in TInteger line, in TriComponentIdType c, in QualifiedName name, in TciParameterListType tciPars, in Value returnValue, in TString kind) |   |
| <b>In Parameters</b> | am  | An additional message.  |
|                      | ts  | The time when the event is produced.  |
|                      | src   | The source file of the test specification.  |
|                      | line  | The line number where the request is performed.                                       |
|                      | c   | The component which produces this event.  |
|                      | name  | The name of the scope.  |
|                      | tciPars   | The parameters of the scope.  |
|                      | returnValue   | The return value of the scope.  |
|                      | kind  | The kind of the scope. If the scope contains modifiers, they prefix the scope string. |
| <b>Return Value</b>  | void  |   |
| <b>Constraint</b>    | Shall be called by TE to log the leaving of a scope. This event occurs after the scoped has been left.  |   |
| <b>Effect</b>        | The TL presents all the information provided in the parameters of this operation to the user, how this is done is not within the scope of the present document.   |   |

## 7.3.4.1.91 tliVAr

|                      |   |   |
|----------------------|---|---|
| <b>Signature</b>     | void tliVAr(in TString am, in TInteger ts, in TString src, in TInteger line, in TriComponentIdType c, in QualifiedName name, in Value varValue)   |   |
| <b>In Parameters</b> | am  | An additional message.                          |
|                      | ts  | The time when the event is produced.            |
|                      | src   | The source file of the test specification.      |
|                      | line  | The line number where the request is performed. |
|                      | c   | The component which produces this event.        |
|                      | name  | The name of the variable.                       |
|                      | varValue  | The new value of the variable.                  |
| <b>Return Value</b>  | void  |   |
| <b>Constraint</b>    | Shall be called by TE to log the modification of the value of a variable. This event occurs after the value has been changed. In case of @lazy variables, it is called also after performing evaluation as evaluation result is automatically assigned to the variable. |   |
| <b>Effect</b>        | The TL presents all the information provided in the parameters of this operation to the user, how this is done is not within the scope of the present document.   |   |



## 7.3.4.1.92 tliModulePar

|                      |  |   |
|----------------------|--|---|
| <b>Signature</b>     | void tliModulePar(in TString am, in TInteger ts, in TString src, in TInteger line, in TriComponentIdType c, in QualifiedName name, in Value parValue)  |   |
| <b>In Parameters</b> | am   | An additional message.                          |
|                      | ts   | The time when the event is produced.            |
|                      | src  | The source file of the test specification.      |
|                      | line   | The line number where the request is performed. |
|                      | c  | The component which produces this event.        |
|                      | name   | The name of the module parameter.               |
|                      | parValue   | The value of the module parameter.              |
| <b>Return Value</b>  | void   |   |
| <b>Constraint</b>    | Shall be called by TE to log the value of a module parameter. This event occurs after the access to the value of a module parameter and only if the value of the module parameter was accessed for the first time. |   |
| <b>Effect</b>        | The TL presents all the information provided in the parameters of this operation to the user, how this is done is not within the scope of the present document.  |   |

## 7.3.4.1.93 tliGetVerdict

|                      |   |   |
|----------------------|---|---|
| <b>Signature</b>     | void tliGetVerdict(in TString am, in TInteger ts, in TString src, in TInteger line, in TriComponentIdType c, in VerdictValue verdict)                           |   |
| <b>In Parameters</b> | am  | An additional message.                          |
|                      | ts  | The time when the event is produced.            |
|                      | src   | The source file of the test specification.      |
|                      | line  | The line number where the request is performed. |
|                      | c   | The component which produces this event.        |
|                      | verdict   | The current value of the local verdict.         |
|                      | <b>Return Value</b>   | void  |
| <b>Constraint</b>    | Shall be called by TE to log the getverdict operation. This event occurs after the getverdict operation.  |   |
| <b>Effect</b>        | The TL presents all the information provided in the parameters of this operation to the user, how this is done is not within the scope of the present document. |   |

## 7.3.4.1.94 tliSetVerdict

|                      |   |  |
|----------------------|---|--|
| <b>Signature</b>     | void tliSetVerdict(in TString am, in TInteger ts, in TString src, in TInteger line, in TriComponentIdType c, in VerdictValue verdict, in TString reason)                                    |  |
| <b>In Parameters</b> | am  | An additional message.                           |
|                      | ts  | The time when the event is produced.             |
|                      | src   | The source file of the test specification.       |
|                      | line  | The line number where the request is performed.  |
|                      | c   | The component which produces this event.         |
|                      | verdict   | The value to be set to the local verdict.        |
|                      | reason  | The optional reason of the setverdict statement. |
| <b>Return Value</b>  | void  |  |
| <b>Constraint</b>    | Shall be called by TE to log the setverdict operation or the occurrence of a runtime error. If used to log the setverdict operation, then this event occurs after the setverdict operation. |  |
| <b>Effect</b>        | The TL presents all the information provided in the parameters of this operation to the user, how this is done is not within the scope of the present document.                             |  |

## 7.3.4.1.95 tliLog

|                      |   |   |
|----------------------|---|---|
| <b>Signature</b>     | void tliLog (in TString am, in TInteger ts, in TString src, in TInteger line, in TriComponentIdType c, in TString log)  |   |
| <b>In Parameters</b> | am  | An additional message.                          |
|                      | ts  | The time when the event is produced.            |
|                      | src   | The source file of the test specification.      |
|                      | line  | The line number where the request is performed. |
|                      | c   | The component which produces this event.        |
|                      | log   | The string to be logged.                        |
| <b>Return Value</b>  | void  |   |
| <b>Constraint</b>    | Shall be called by TM or TE to log the TTCN-3 statement log. This event occurs after the TTCN-3 log operation.  |   |
| <b>Effect</b>        | The TL presents all the information provided in the parameters of this operation to the user, how this is done is not within the scope of the present document. |   |

## 7.3.4.1.96 tliAEnter

|                      |   |   |
|----------------------|---|---|
| <b>Signature</b>     | void tliAEnter(in TString am, in TInteger ts, in TString src, in TInteger line, in TriComponentIdType c)  |   |
| <b>In Parameters</b> | am  | An additional message.                          |
|                      | ts  | The time when the event is produced.            |
|                      | src   | The source file of the test specification.      |
|                      | line  | The line number where the request is performed. |
|                      | c   | The component which produces this event.        |
|                      | <b>Return Value</b>   | void  |
| <b>Constraint</b>    | Shall be called by TE to log entering an alt. This event occurs after an alt has been entered.  |   |
| <b>Effect</b>        | The TL presents all the information provided in the parameters of this operation to the user, how this is done is not within the scope of the present document. |   |

## 7.3.4.1.97 tliALeave

|                      |   |   |
|----------------------|---|---|
| <b>Signature</b>     | void tliALeave(in TString am, in TInteger ts, in TString src, in TInteger line, in TriComponentIdType c)  |   |
| <b>In Parameters</b> | am  | An additional message.                          |
|                      | ts  | The time when the event is produced.            |
|                      | src   | The source file of the test specification.      |
|                      | line  | The line number where the request is performed. |
|                      | c   | The component which produces this event.        |
|                      | <b>Return Value</b>   | void  |
| <b>Constraint</b>    | Shall be called by TE to log leaving an alt. This event occurs after the alt has been leaved.   |   |
| <b>Effect</b>        | The TL presents all the information provided in the parameters of this operation to the user, how this is done is not within the scope of the present document. |   |

## 7.3.4.1.98 tliANomatch

|                      |   |   |
|----------------------|---|---|
| <b>Signature</b>     | void tliANomatch (in TString am, in TInteger ts, in TString src, in TInteger line, in TriComponentIdType c)   |   |
| <b>In Parameters</b> | am  | An additional message.                          |
|                      | ts  | The time when the event is produced.            |
|                      | src   | The source file of the test specification.      |
|                      | line  | The line number where the request is performed. |
|                      | c   | The component which produces this event.        |
|                      | <b>Return Value</b>   | void  |
| <b>Constraint</b>    | Shall be called by TE to log the nomatch of an alt. This event occurs after the alt has not matched.  |   |
| <b>Effect</b>        | The TL presents all the information provided in the parameters of this operation to the user, how this is done is not within the scope of the present document. |   |

## 7.3.4.1.99 tliARepeat

|                      |   |   |
|----------------------|---|---|
| <b>Signature</b>     | void tliARepeat(in TString am, in TInteger ts, in TString src,<br>in TInteger line, in TriComponentIdType c)  |   |
| <b>In Parameters</b> | am  | An additional message.                          |
|                      | ts  | The time when the event is produced.            |
|                      | src   | The source file of the test specification.      |
|                      | line  | The line number where the request is performed. |
|                      | c   | The component which produces this event.        |
| <b>Return Value</b>  | void  |   |
| <b>Constraint</b>    | Shall be called by TE to log repeating an alt. This event occurs when the alt has been repeated.  |   |
| <b>Effect</b>        | The TL presents all the information provided in the parameters of this operation to the user, how this is done is not within the scope of the present document. |   |

## 7.3.4.1.100 tliADefaults

|                      |   |   |
|----------------------|---|---|
| <b>Signature</b>     | void tliADefaults(in TString am, in TInteger ts, in TString src,<br>in TInteger line, in TriComponentIdType c)  |   |
| <b>In Parameters</b> | am  | An additional message.                          |
|                      | ts  | The time when the event is produced.            |
|                      | src   | The source file of the test specification.      |
|                      | line  | The line number where the request is performed. |
|                      | c   | The component which produces this event.        |
| <b>Return Value</b>  | void  |   |
| <b>Constraint</b>    | Shall be called by TE to log entering the default section. This event occurs after the default section has been entered.  |   |
| <b>Effect</b>        | The TL presents all the information provided in the parameters of this operation to the user, how this is done is not within the scope of the present document. |   |

## 7.3.4.1.101 tliAActivate

|                      |  |   |
|----------------------|--|---|
| <b>Signature</b>     | void tliAActivate(in TString am, in TInteger ts, in TString src,<br>in TInteger line, in TriComponentIdType c,<br>in QualifiedName name, in TciParameterListType tciPars,<br>in Value ref) |   |
| <b>In Parameters</b> | am   | An additional message.                          |
|                      | ts   | The time when the event is produced.            |
|                      | src  | The source file of the test specification.      |
|                      | line   | The line number where the request is performed. |
|                      | c  | The component which produces this event.        |
|                      | name   | The name of the default.                        |
|                      | tciPars  | The parameter of the default.                   |
|                      | ref  | The resulting default reference.                |
| <b>Return Value</b>  | void   |   |
| <b>Constraint</b>    | Shall be called by TE to log the activation of a default. This event occurs after the default activation.  |   |
| <b>Effect</b>        | The TL presents all the information provided in the parameters of this operation to the user, how this is done is not within the scope of the present document.                            |   |

## 7.3.4.1.102 tliADeactivate

|                      |   |   |
|----------------------|---|---|
| <b>Signature</b>     | void tliADeactivate(in TString am, in TInteger ts, in TString src, in TInteger line, in TriComponentIdType c, in Value ref)                                     |   |
| <b>In Parameters</b> | am  | An additional message.                          |
|                      | ts  | The time when the event is produced.            |
|                      | src   | The source file of the test specification.      |
|                      | line  | The line number where the request is performed. |
|                      | c   | The component which produces this event.        |
|                      | ref   | The default reference.                          |
| <b>Return Value</b>  | void  |   |
| <b>Constraint</b>    | Shall be called by TE to log the deactivation of a default. This event occurs after the default deactivation.   |   |
| <b>Effect</b>        | The TL presents all the information provided in the parameters of this operation to the user, how this is done is not within the scope of the present document. |   |

## 7.3.4.1.103 tliAWait

|                      |   |   |
|----------------------|---|---|
| <b>Signature</b>     | void tliAWait(in TString am, in TInteger ts, in TString src, in TInteger line, in TriComponentId c)   |   |
| <b>In Parameters</b> | am  | An additional message.                          |
|                      | ts  | The time when the event is produced.            |
|                      | src   | The source file of the test specification.      |
|                      | line  | The line number where the request is performed. |
|                      | c   | The component which produces this event.        |
| <b>Return Value</b>  | void  |   |
| <b>Constraint</b>    | Shall be called by TE to log that the component awaits events for a new snapshot.   |   |
| <b>Effect</b>        | The TL presents all the information provided in the parameters of this operation to the user, how this is done is not within the scope of the present document. |   |

## 7.3.4.1.104 tliAction

|                      |   |   |
|----------------------|---|---|
| <b>Signature</b>     | void tliAction(in TString am, in TInteger ts, in TString src, in TInteger line, in TriComponentIdType c, in TString action)                                     |   |
| <b>In Parameters</b> | am  | An additional message.                          |
|                      | ts  | The time when the event is produced.            |
|                      | src   | The source file of the test specification.      |
|                      | line  | The line number where the request is performed. |
|                      | c   | The component which produces this event.        |
|                      | action  | The action to be performed.                     |
| <b>Return Value</b>  | void  |   |
| <b>Constraint</b>    | Shall be called by TE to log that the component executed an SUT action.   |   |
| <b>Effect</b>        | The TL presents all the information provided in the parameters of this operation to the user, how this is done is not within the scope of the present document. |   |

## 7.3.4.1.105 tliMatch

|                      |   |   |
|----------------------|---|---|
| <b>Signature</b>     | void tliMatch(in TString am, in TInteger ts, in TString src, in TInteger line, in TriComponentIdType c, in Value expr, in TciValueTemplate tpl)                 |   |
| <b>In Parameters</b> | am  | An additional message.                          |
|                      | ts  | The time when the event is produced.            |
|                      | src   | The source file of the test specification.      |
|                      | line  | The line number where the request is performed. |
|                      | c   | The component which produces this event.        |
|                      | expr  | The expression to be matched with tpl.          |
|                      | tpl   | The template to be matched with expr.           |
| <b>Return Value</b>  | void  |   |
| <b>Constraint</b>    | Shall be called by TE to log that the component successfully executed a match operation.  |   |
| <b>Effect</b>        | The TL presents all the information provided in the parameters of this operation to the user, how this is done is not within the scope of the present document. |   |

## 7.3.4.1.106 tliMatchMismatch

|                      |   |  |
|----------------------|---|--|
| <b>Signature</b>     | void tliMatchMismatch(in TString am, in TInteger ts, in TString src, in TInteger line, in TriComponentIdType c, in Value expr, in TciValueTemplate tmpl, in TciValueDifferenceList diffs) |  |
| <b>In Parameters</b> | am  | An additional message.                             |
|                      | ts  | The time when the event is produced.               |
|                      | src   | The source file of the test specification.         |
|                      | line  | The line number where the request is performed.    |
|                      | c   | The component which produces this event.           |
|                      | expr  | The expression to be matched with tmpl.            |
|                      | tmpl  | The template to be matched with expr.              |
|                      | diffs   | The difference/the mismatch between expr and tmpl. |
| <b>Return Value</b>  | void  |  |
| <b>Constraint</b>    | Shall be called by TE to log that the component unsuccessfully executed a match operation - a mismatch occurred.  |  |
| <b>Effect</b>        | The TL presents all the information provided in the parameters of this operation to the user, how this is done is not within the scope of the present document.                           |  |

## 7.3.4.1.107 tliInfo

|                      |  |   |
|----------------------|--|---|
| <b>Signature</b>     | void tliInfo (in TString am, in TInteger ts, in TString src, in TInteger line, in TriComponentIdType c, in TInteger level, in TString info)                                    |   |
| <b>In Parameters</b> | am   | An additional message.                          |
|                      | ts   | The time when the event is produced.            |
|                      | src  | The source file of the test specification.      |
|                      | line   | The line number where the request is performed. |
|                      | c  | The component which produces this event.        |
|                      | level  | The information level.                          |
|                      | info   | The information.                                |
| <b>Return Value</b>  | void   |   |
| <b>Constraint</b>    | Can be called by TE to log additional information during test execution. The generation of this event is tool dependent as well as the usage of the parameters level and info. |   |
| <b>Effect</b>        | The TL presents all the information provided in the parameters of this operation to the user, how this is done is not within the scope of the present document.                |   |

## 7.3.4.1.108 tliMChecked\_m

|                      |  |  |
|----------------------|--|--|
| <b>Signature</b>     | void tliMChecked_m(in TString am, in TInteger ts, in TString src, in TInteger line, in TriComponentIdType c, in TriPortIdType at, in Value msgValue, in TciValueTemplate msgTmpl, in Value addrValue, in TciValueTemplate addressTmpl) |  |
| <b>In Parameters</b> | am   | An additional message.                             |
|                      | ts   | The time when the event is produced.               |
|                      | src  | The source file of the test specification.         |
|                      | line   | The line number where the request is performed.    |
|                      | c  | The component which produces this event.           |
|                      | at   | The port via which the message is received.        |
|                      | msgValue   | The message which is checked against the template. |
|                      | msgTmpl  | The template used to check the message match.      |
|                      | addrValue  | The address value of the source within the SUT.    |
|                      | addressTmpl  | The expected address of the source within the SUT. |
| <b>Return Value</b>  | Void   |  |
| <b>Constraint</b>    | Shall be called by SA or TE to log the checking of a message. This event occurs after the message is checked successfully. This event is used for logging the communication with the SUT.  |  |
| <b>Effect</b>        | The TL presents all the information provided in the parameters of this operation to the user, how this is done is not within the scope of the present document.  |  |

## 7.3.4.1.109 tliMChecked\_c

|                      |  |   |
|----------------------|--|---|
| <b>Signature</b>     | void tliMChecked_c(in TString am, in TInteger ts,<br>in TString src, in TInteger line, in TriComponentIdType c,<br>in TriPortIdType at,<br>in Value msgValue,<br>in TciValueTemplate msgTpl,<br>in TriComponentIdType from,<br>in TciNonValueTemplate fromTpl) |   |
| <b>In Parameters</b> | am   | An additional message.                          |
|                      | ts   | The time when the event is produced.            |
|                      | src  | The source file of the test specification.      |
|                      | line   | The line number where the request is performed. |
|                      | c  | The component which produces this event.        |
|                      | msgValue   | The received message.                           |
|                      | msgTpl   | The template used to check the message match.   |
|                      | from   | The component which sent the message.           |
|                      | fromTpl  | The expected sender component.                  |
| <b>Return Value</b>  | Void   |   |
| <b>Constraint</b>    | Shall be called by CH or TE to log the checking of a message. This event occurs after the message is checked successfully. This event is used for logging the intercomponent communication.  |   |
| <b>Effect</b>        | The TL presents all the information provided in the parameters of this operation to the user, how this is done is not within the scope of the present document.  |   |

## 7.3.4.1.110 tliPrGetCallChecked\_m

|                      |  |   |
|----------------------|--|---|
| <b>Signature</b>     | void tliPrGetCallChecked_m(in TString am, in TInteger ts,<br>in TString src,<br>in TInteger line, in TriComponentIdType c,<br>in TriPortIdType at,<br>in TriSignatureIdType signature,<br>in TciParameterListType tciPars,<br>in TciValueTemplate parsTpl,<br>in Value addrValue,<br>in TciValueTemplate addressTpl) |   |
| <b>In Parameters</b> | am   | An additional message.                          |
|                      | ts   | The time when the event is produced.            |
|                      | src  | The source file of the test specification.      |
|                      | line   | The line number where the request is performed. |
|                      | c  | The component which produces this event.        |
|                      | at   | The port via which the call is received.        |
|                      | signature  | The signature of the checked call.              |
|                      | tciPars  | The parameters of detected call.                |
|                      | parsTpl  | The template used to check the parameter match. |
|                      | addrValue  | The address value of the source within the SUT. |
|                      |  | addressTpl                                      |
| <b>Return Value</b>  | Void   |   |
| <b>Constraint</b>    | Shall be called by SA or TE to log the getcall check operation. This event occurs after call is checked successfully. This event is used for logging the communication with the SUT.   |   |
| <b>Effect</b>        | The TL presents all the information provided in the parameters of this operation to the user, how this is done is not within the scope of the present document.  |   |

## 7.3.4.1.111 tliPrGetCallChecked\_c

|                      |  |   |
|----------------------|--|---|
| <b>Signature</b>     | void tliPrGetCallChecked_c(in TString am, in TInteger ts,<br>in TString src,<br>in TInteger line, in TriComponentIdType c,<br>in TriPortIdType at,<br>in TriSignatureIdType signature,<br>in TciParameterListType tciPars,<br>in TciValueTemplate parsTpl,<br>in TriComponentIdType from,<br>in TciNonValueTemplate fromTpl) |   |
| <b>In Parameters</b> | am   | An additional message.                          |
|                      | ts   | The time when the event is produced.            |
|                      | src  | The source file of the test specification.      |
|                      | line   | The line number where the request is performed. |
|                      | c  | The component which produces this event.        |
|                      | at   | The port via which the call is received.        |
|                      | signature  | The signature of the called operation.          |
|                      | tciPars  | The encoded parameters of checked call.         |
|                      | parsTpl  | The template used to check the parameter match. |
|                      | from   | The component which called the operation.       |
|                      | fromTpl  | The expected calling component.                 |
| <b>Return Value</b>  | Void   |   |
| <b>Constraint</b>    | Shall be called by CH or TE to log the getcall check operation. This event occurs after call is checked successfully. This event is used for logging the intercomponent communication.   |   |
| <b>Effect</b>        | The TL presents all the information provided in the parameters of this operation to the user, how this is done is not within the scope of the present document.  |   |

## 7.3.4.1.112 tliPrGetReplyChecked\_m

|                      |  |   |
|----------------------|--|---|
| <b>Signature</b>     | void tliPrGetReplyChecked_m(in TString am, in TInteger ts,<br>in TString src,<br>in TInteger line, in TriComponentIdType c,<br>in TriPortIdType at,<br>in TriSignatureIdType signature,<br>in TciParameterListType tciPars,<br>in TciValueTemplate parsTpl,<br>in Value replValue, in TciValueTemplate replyTpl,<br>in Value addrValue,<br>in TciValueTemplate addressTpl) |   |
| <b>In Parameters</b> | am   | An additional message.                          |
|                      | ts   | The time when the event is produced.            |
|                      | src  | The source file of the test specification.      |
|                      | line   | The line number where the request is performed. |
|                      | c  | The component which produces this event.        |
|                      | at   | The port via which the reply is received.       |
|                      | signature  | The signature relating to the reply.            |
|                      | tciPars  | The signature parameters relating to the reply. |
|                      | parsTpl  | The template used to check the parameter match. |
|                      | replValue  | The received reply.                             |
|                      | replyTpl   | The template used to check the reply match.     |
|                      | addrValue  | The address value of the source within the SUT. |
|                      |  | addressTpl                                      |
| <b>Return Value</b>  | Void   |   |
| <b>Constraint</b>    | Shall be called by SA or TE to log the getreply check operation. This event occurs after getreply is checked successfully. This event is used for logging the communication with the SUT.  |   |
| <b>Effect</b>        | The TL presents all the information provided in the parameters of this operation to the user, how this is done is not within the scope of the present document.  |   |

## 7.3.4.1.113 tliPrGetReplyChecked\_c

|                      |  |   |
|----------------------|--|---|
| <b>Signature</b>     | void tliPrGetReplyChecked_c(in TString am, in TInteger ts,<br>in TString src,<br>in TInteger line, in TriComponentIdType c,<br>in TriPortIdType at,<br>in TriSignatureIdType signature,<br>in TciParameterListType tciPars,<br>in TciValueTemplate parsTpl,<br>in Value replValue, in TciValueTemplate replyTpl,<br>in TriComponentIdType from,<br>in TciNonValueTemplate fromTpl) |   |
| <b>In Parameters</b> | am   | An additional message.                          |
|                      | ts   | The time when the event is produced.            |
|                      | src  | The source file of the test specification.      |
|                      | line   | The line number where the request is performed. |
|                      | c  | The component which produces this event.        |
|                      | at   | The port via which the reply is received.       |
|                      | signature  | The signature relating to the reply.            |
|                      | tciPars  | The encoded parameters of checked reply.        |
|                      | parsTpl  | The template used to check the parameter match. |
|                      | replValue  | The received reply.                             |
|                      | replyTpl   | The template used to check the reply match.     |
|                      | from   | The component which sent the reply.             |
| fromTpl              | The expected replying component.   |   |
| <b>Return Value</b>  | Void   |   |
| <b>Constraint</b>    | Shall be called by CH or TE to log the getreply check operation. This event occurs after getreply is checked successfully. This event is used for logging the intercomponent communication.  |   |
| <b>Effect</b>        | The TL presents all the information provided in the parameters of this operation to the user, how this is done is not within the scope of the present document.  |   |

## 7.3.4.1.114 tliPrCatchChecked\_m

|                      |  |  |
|----------------------|--|--|
| <b>Signature</b>     | void tliPrCatchChecked_m(in TString am, in TInteger ts,<br>in TString src,<br>in TInteger line, in TriComponentIdType c,<br>in TriPortIdType at,<br>in TriSignatureIdType signature,<br>in Value excValue, in TciValueTemplate excTpl,<br>in Value addrValue,<br>in TciValueTemplate addressTpl) |  |
| <b>In Parameters</b> | am   | An additional message.                             |
|                      | ts   | The time when the event is produced.               |
|                      | src  | The source file of the test specification.         |
|                      | line   | The line number where the request is performed.    |
|                      | c  | The component which produces this event.           |
|                      | at   | The port via which the exception is received.      |
|                      | signature  | The signature relating to the exception.           |
|                      | excValue   | The received exception.                            |
|                      | excTpl   | The template used to check the exception match.    |
|                      | addrValue  | The address value of the source within the SUT.    |
|                      | addressTpl   | The expected address of the source within the SUT. |
|                      | <b>Return Value</b>  | Void   |
| <b>Constraint</b>    | Shall be called by SA or TE to log the catch check operation. This event occurs after catch is checked successfully. This event is used for logging the communication with the SUT.  |  |
| <b>Effect</b>        | The TL presents all the information provided in the parameters of this operation to the user, how this is done is not within the scope of the present document.  |  |



## 7.3.4.1.115 tliPrCatchChecked\_c

|                      |  |   |
|----------------------|--|---|
| <b>Signature</b>     | void tliPrCatchChecked_c(in TString am, in TInteger ts,<br>in TString src,<br>in TInteger line, in TriComponentIdType c,<br>in TriPortIdType at,<br>in TriSignatureIdType signature,<br>in Value excValue, in TciValueTemplate excTpl,<br>in TriComponentIdType from,<br>in TciNonValueTemplate fromTpl) |   |
| <b>In Parameters</b> | am   | An additional message.                          |
|                      | ts   | The time when the event is produced.            |
|                      | src  | The source file of the test specification.      |
|                      | line   | The line number where the request is performed. |
|                      | c  | The component which produces this event.        |
|                      | at   | The port via which the exception is received.   |
|                      | signature  | The signature relating to the exception.        |
|                      | excValue   | The caught exception.                           |
|                      | excTpl   | The template used to check the exception match. |
|                      | from   | The component which sent the reply.             |
|                      | fromTpl  | The expected replying component.                |
| <b>Return Value</b>  | Void   |   |
| <b>Constraint</b>    | Shall be called by CH or TE to log the catch check operation. This event occurs after catch is checked successfully. This event is used for logging the intercomponent communication.  |   |
| <b>Effect</b>        | The TL presents all the information provided in the parameters of this operation to the user, how this is done is not within the scope of the present document.  |   |

## 7.3.4.1.116 tliCheckedAny\_m

|                      |  |  |
|----------------------|--|--|
| <b>Signature</b>     | void tliCheckedAny_m(in TString am, in TInteger ts,<br>in TString src, in TInteger line, in TriComponentIdType c,<br>in TriPortIdType at, in Value addrValue,<br>in TciValueTemplate addressTpl) |  |
| <b>In Parameters</b> | am   | An additional message.                             |
|                      | ts   | The time when the event is produced.               |
|                      | src  | The source file of the test specification.         |
|                      | line   | The line number where the request is performed.    |
|                      | c  | The component which produces this event.           |
|                      | at   | The port via which the message is received.        |
|                      | addrValue  | The address value of the source within the SUT.    |
|                      | addressTpl   | The expected address of the source within the SUT. |
| <b>Return Value</b>  | Void   |  |
| <b>Constraint</b>    | Shall be called by SA or TE to log a check any operation. This event occurs after the check is successfully performed. This event is used for logging the communication with the SUT.            |  |
| <b>Effect</b>        | The TL presents all the information provided in the parameters of this operation to the user, how this is done is not within the scope of the present document.                                  |  |

## 7.3.4.1.117 tliCheckedAny\_c

|                      |  |   |
|----------------------|--|---|
| <b>Signature</b>     | void tliCheckedAny_c(in TString am, in TInteger ts,<br>in TString src, in TInteger line, in TriComponentIdType c,<br>in TriPortIdType at, in TriComponentIdType from,<br>in TciNonValueTemplate fromTpl) |   |
| <b>In Parameters</b> | am   | An additional message.                          |
|                      | ts   | The time when the event is produced.            |
|                      | src  | The source file of the test specification.      |
|                      | line   | The line number where the request is performed. |
|                      | c  | The component which produces this event.        |
|                      | at   | The port via which the message is received.     |
|                      | from   | The component which sent the message.           |
|                      | fromTpl  | The expected sender component.                  |
| <b>Return Value</b>  | Void   |   |
| <b>Constraint</b>    | Shall be called by CH or TE to log a check any operation. This event occurs after the check is successfully performed. This event is used for logging the intercomponent communication.                  |   |
| <b>Effect</b>        | The TL presents all the information provided in the parameters of this operation to the user, how this is done is not within the scope of the present document.  |   |

## 7.3.4.1.118 tliCheckAnyMismatch\_m

|                      |   |  |
|----------------------|---|--|
| <b>Signature</b>     | void tliCheckAnyMismatch_m(in TString am, in TInteger ts,<br>in TString src, in TInteger line, in TriComponentIdType c,<br>in TriPortIdType at,<br>in Value addrValue,<br>in TciValueTemplate addressTpl) |  |
| <b>In Parameters</b> | am  | An additional message.                             |
|                      | ts  | The time when the event is produced.               |
|                      | src   | The source file of the test specification.         |
|                      | line  | The line number where the request is performed.    |
|                      | c   | The component which produces this event.           |
|                      | at  | The port via which the message is received.        |
|                      | addrValue   | The address value of the source within the SUT.    |
|                      | addressTpl  | The expected address of the source within the SUT. |
| <b>Return Value</b>  | Void  |  |
| <b>Constraint</b>    | Shall be called by TE to log a mismatch that occurred during a check any operation. This event occurs after checking an address match. This event is used for logging the communication with the SUT.     |  |
| <b>Effect</b>        | The TL presents all the information provided in the parameters of this operation to the user, how this is done is not within the scope of the present document.   |  |

## 7.3.4.1.119 tliCheckAnyMismatch\_c

|                      |   |   |
|----------------------|---|---|
| <b>Signature</b>     | void tliCheckAnyMismatch_c(in TString am, in TInteger ts,<br>in TString src, in TInteger line, in TriComponentIdType c,<br>in TriPortIdType at,<br>in TriComponentIdType from,<br>in TciNonValueTemplate fromTpl) |   |
| <b>In Parameters</b> | am  | An additional message.                          |
|                      | ts  | The time when the event is produced.            |
|                      | src   | The source file of the test specification.      |
|                      | line  | The line number where the request is performed. |
|                      | c   | The component which produces this event.        |
|                      | at  | The port via which the message is received.     |
|                      | from  | The component which sent the message.           |
|                      | fromTpl   | The expected sender component.                  |
| <b>Return Value</b>  | Void  |   |
| <b>Constraint</b>    | Shall be called by TE to log a mismatch that occurred during a check any operation. This event occurs after checking a component match. This event is used for logging the intercomponent communication.          |   |
| <b>Effect</b>        | The TL presents all the information provided in the parameters of this operation to the user, how this is done is not within the scope of the present document.   |   |

## 7.3.4.1.120 tliRnd

|                      |   |  |
|----------------------|---|--|
| <b>Signature</b>     | void tliRnd(in TString am, in TInteger ts,<br>in TString src, in TInteger line, in TriComponentIdType c,<br>in FloatValue val,<br>in FloatValue seed)           |  |
| <b>In Parameters</b> | am  | An additional message.                                 |
|                      | ts  | The time when the event is produced.                   |
|                      | src   | The source file of the test specification.             |
|                      | line  | The line number where the request is performed.        |
|                      | c   | The component which produces this event.               |
|                      | val   | The value returned by the random number generator.     |
|                      | seed  | The value used by the random number generator as seed. |
| <b>Return Value</b>  | Void  |  |
| <b>Constraint</b>    | Shall be called by TE to log a call to the random number generator function rnd. This event occurs after the random number has been generated.                  |  |
| <b>Effect</b>        | The TL presents all the information provided in the parameters of this operation to the user, how this is done is not within the scope of the present document. |  |

## 7.3.4.1.121 tliEvaluate

|                      |   |   |
|----------------------|---|---|
| <b>Signature</b>     | void tliEvaluate (in TString am, in TInteger ts, in TString src,<br>in TInteger line, in TriComponentIdType c,<br>in QualifiedName name, in Value evalResult)         |   |
| <b>In Parameters</b> | am  | An additional message.                          |
|                      | ts  | The time when the event is produced.            |
|                      | src   | The source file of the test specification.      |
|                      | line  | The line number where the request is performed. |
|                      | c   | The component which produces this event.        |
|                      | name  | The name of the template or variable.           |
|                      | evalResult  | The result of evaluation.                       |
| <b>Return Value</b>  | void  |   |
| <b>Constraint</b>    | Shall be called by TE to log the result of evaluation of a @lazy or @fuzzy template or variable. This event occurs after the template or variable has been evaluated. |   |
| <b>Effect</b>        | The TL presents all the information provided in the parameters of this operation to the user, how this is done is not within the scope of the present document.       |   |

## 7.3.4.1.122 tliCCall

|                      |  |   |
|----------------------|--|---|
| <b>Signature</b>     | void tliCCall(in TString am, in TInteger ts, in TString src,<br>in TInteger line, in TriComponentIdType c,<br>in TriComponentIdType comp, in TciBehaviourIdType beh,<br>in TciParameterListType tciPars) |   |
| <b>In Parameters</b> | am   | An additional message.                          |
|                      | ts   | The time when the event is produced.            |
|                      | src  | The source file of the test specification.      |
|                      | line   | The line number where the request is performed. |
|                      | c  | The component which produces this event.        |
|                      | comp   | The component which is called.                  |
|                      | beh  | The behaviour being called on the component.    |
|                      | tciPars  | The parameters of the called behaviour.         |
| <b>Return Value</b>  | void   |   |
| <b>Constraint</b>    | Shall be called by TE to log the call component operation. This event occurs before starting the called behaviour on the target component.   |   |
| <b>Effect</b>        | The TL presents all the information provided in the parameters of this operation to the user, how this is done is not within the scope of the present document.  |   |

## 7.3.4.1.123 tliCCallTerminated

|                      |  |  |
|----------------------|--|--|
| <b>Signature</b>     | void tliCCallTerminated(in TString am, in TInteger ts, in TString src, in TInteger line, in TriComponentIdType c, in VerdictValue verdict, in TString reason, in TciParameterListType tciPars, in Value returnValue) |  |
| <b>In Parameters</b> | am   | An additional message.                           |
|                      | ts   | The time when the event is produced.             |
|                      | src  | The source file of the test specification.       |
|                      | line   | The line number where the request is performed.  |
|                      | c  | The component which produces this event.         |
|                      | verdict  | The verdict of the component.                    |
|                      | reason   | The optional reason of the setverdict statement. |
|                      | tciPars  | The parameters of the called behaviour.          |
| <b>Return Value</b>  | void   |  |
| <b>Constraint</b>    | Shall be called by TE to log implicit termination of a called component. This event occurs after the termination of the component.   |  |
| <b>Effect</b>        | The TL presents all the information provided in the parameters of this operation to the user, how this is done is not within the scope of the present document.  |  |

## 7.3.4.1.124 tliCtrlStartWithParameters

|                      |   |   |
|----------------------|---|---|
| <b>Signature</b>     | void tliCtrlStartWithParameters(in TString am, in TInteger ts, in TString src, in TInteger line, in TriComponentIdType c, in TciParameterListType tciPars)  |   |
| <b>In Parameters</b> | am  | An additional message.  |
|                      | ts  | The time when the event is produced.                          |
|                      | src   | The source file of the test specification.                    |
|                      | line  | The line number where the request is performed.               |
|                      | c   | The component which produces this event.                      |
|                      | tciPars   | The list of parameters passed to the module control function. |
| <b>Return Value</b>  | void  |   |
| <b>Constraint</b>    | Shall be called by TE to log the start of the module control function in cases when the module control function defines parameters or returns a value. This event occurs before the control is started. |   |
| <b>Effect</b>        | The TL presents all the information provided in the parameters of this operation to the user, how this is done is not within the scope of the present document.   |   |

## 7.3.4.1.125 tliCtrlTerminatedWithResult

|                      |  |   |
|----------------------|--|---|
| <b>Signature</b>     | void tliCtrlTerminated (in TString am, in TInteger ts, in TString src, in TInteger line, in TriComponentIdType c, in Value returnValue, in TciParameterListType tciPars)   |   |
| <b>In Parameters</b> | am   | An additional message.  |
|                      | ts   | The time when the event is produced.                            |
|                      | src  | The source file of the test specification.                      |
|                      | line   | The line number where the request is performed.                 |
|                      | c  | The component which produces this event.                        |
|                      | returnValue  | The value returned by the module control function.              |
|                      | tciPars  | The list of parameters passed from the module control function. |
| <b>Return Value</b>  | void   |   |
| <b>Constraint</b>    | Shall be called by TM or TE to log the termination of the module control function in cases when the module control function defines parameters or returns a value. This event occurs after the control has terminated. |   |
| <b>Effect</b>        | The TL presents all the information provided in the parameters of this operation to the user, how this is done is not within the scope of the present document.  |   |

## 8 Java™ language mapping

### 8.1 Introduction

This clause introduces the TCI Java™ language mapping. For efficiency reasons a dedicated language mapping is introduced instead of using the OMG IDL [6] to Java™ language [7].

The Java™ language mapping for the TTCN-3 Control Interface defines how the IDL definitions described in clause 7 are mapped to the Java™ language. The language mapping is independent of the used Java™ version as only basic Java™ language constructs are used.

### 8.2 Names and scopes

#### 8.2.1 Names

Although there are no conflicts between identifiers used in the IDL definition and the Java™ language some naming translation rules are applied to the IDL identifiers.

Java™ interfaces or class identifiers are omitting the trailing `Type` used in the IDL definition.

EXAMPLE: The IDL type `TciTestCaseIdType` maps to `TciTestCaseId` in Java™.

The resulting mapping conforms to the standard Java™ coding conventions.

#### 8.2.2 Scopes

The IDL module `tciInterface` is mapped to the Java™ package `org.etsi.ttcn3.tci`. All IDL type declarations within this module are mapped to Java™ classes or interface declarations within this package.

### 8.3 Type mapping

#### 8.3.1 Basic type mapping

Table 3 gives an overview on how the native types `TBoolean`, `TFloat`, `TInteger`, `TString`, and `TStringSeq` are mapped to the Java™ types.

**Table 3: Basic type mappings**

| IDL Type                | Java™ Type                      |
|-------------------------|---------------------------------|
| <code>Tboolean</code>   | <code>boolean</code>            |
| <code>Tfloat</code>     | <code>float</code>              |
| <code>Tinteger</code>   | <code>int</code>                |
| <code>Tstring</code>    | <code>java.lang.String</code>   |
| <code>TstringSeq</code> | <code>java.lang.String[]</code> |

`boolean`

The IDL `TBoolean` type is mapped to the java basic type `boolean`.

`float`

The IDL `TFloat` type is mapped to the java basic type `float`.

`char`

The IDL `TChar` type is mapped to the java basic type `char`.

int

The IDL **TInteger** type is mapped to the java basic type `int`.

String

The IDL **TString** type is mapped to the `java.lang.String` class without range checking or bounds for characters in the string. All possible strings defined in TTCN-3 can be converted to `java.lang.String`.

String[]

The IDL **TStringSeq** type is mapped to an array of the `java.lang.String` class.

Universal Char

The IDL **TUniversalChar** type is mapped to a java basic type `int`. The integer uses the canonical form as defined in ISO/IEC 10646 [5], clause 6.2.

## 8.3.2 Structured type mapping

### 8.3.2.0 General principles

The TCI IDL description defines user defined types as native types. In the Java™ language mapping these types are mapped to Java™ interfaces. The interfaces define methods and attributes being available for objects implementing this interface.

#### 8.3.2.1 TciParameterType

**TciParameterType** is mapped to the following interface:

```
// TCI IDL TciParameterType
package org.etsi.ttcn.tci;
public interface TciParameter {
    public String    getParameterName();
    public void     setParameterName(String name);
    public int      getParameterPassingMode();
    public void     setParameterPassingMode(TciParameterPassingMode mode);
    public Value    getParameter();
    public void     setParameter(Value parameter);
}
```

#### Methods:

- `getParameterName` Returns the parameter name as defined in the TTCN-3 specification.
- `setParameterName` Sets the name of this `TciParameter` parameter to `name`.
- `getParameterPassingMode` Returns the parameter passing mode of this parameter.
- `setParameterPassingMode` Sets the parameter mode of this `TriParameter` parameter to `mode`.
- `getParameter` Returns the `Value` parameter of this `TciParameter`, or the `null` object if the parameter contains the distinct value `null`.
- `setParameter` Sets the `Value` parameter of this `TciParameter` to `parameter`. If the distinct value `null` shall be set to indicate that this parameter holds no value, the Java `null` shall be passed as parameter.

### 8.3.2.2 TciParameterPassingModeType

**TciParameterPassingModeType** is mapped to the following interface:

```
// TCI IDL TciParameterPassingModeType
package org.etsi.ttcn.tci;
public interface TciParameterPassingMode {
    public final static int TCI_IN      = 0;
    public final static int TCI_INOUT   = 1;
    public final static int TCI_OUT     = 2;
}
```

#### Constants:

- TCI\_IN                                Will be used to indicate that a TciParameter is an in parameter.
- TCI\_INOUT                           Will be used to indicate that a TciParameter is an inout parameter.
- TCI\_OUT                              Will be used to indicate that a TciParameter is an out parameter.

### 8.3.2.3 TciParameterListType

**TciParameterListType** is mapped to the following interface:

```
// TCI IDL TciParameterListType
package org.etsi.ttcn.tci;
public interface TciParameterList {
    public int                            size() ;
    public boolean                        isEmpty() ;
    public java.util.Enumeration        getParameters() ;
    public TciParameter                 get(int index) ;
    public void                           clear() ;
    public void                           add(TciParameter parameter) ;
    public void                           setParameters(TciParameter[] parameters) ;
}
```

#### Methods:

- size                                  Returns the number of parameters in this list.
- isEmpty                               Returns true if this list contains no parameters.
- getParameters                        Returns an Enumeration over the parameters in the list. The enumeration provides the parameters in the same order as they appear in the list.
- get                                    Returns the TciParameter at the specified position.
- clear                                  Removes all parameters from this TciParameterList.
- add                                    Adds parameter to the end of this TciParameterList.
- setParameter                         Fills this TciParameterList with parameters.

### 8.3.2.4 TciTypeClassType

**TciTypeClassType** is mapped to the following interface:

```
// TCI IDL TciTypeClassType
package org.etsi.ttcn.tci;
public interface TciTypeClass {
    public final static int ADDRESS       = 0 ;
    public final static int ANYTYPE       = 1 ;
    public final static int BITSTRING     = 2 ;
    public final static int BOOLEAN       = 3 ;
    public final static int CHARSTRING    = 5 ;
    public final static int COMPONENT     = 6 ;
    public final static int ENUMERATED    = 7 ;
    public final static int FLOAT          = 8 ;
    public final static int HEXSTRING     = 9 ;
}
```

```

public final static int INTEGER           = 10 ;
public final static int OCTETSTRING      = 12 ;
public final static int RECORD           = 13 ;
public final static int RECORD_OF        = 14 ;
public final static int ARRAY            = 15 ;
public final static int SET               = 16 ;
public final static int SET_OF           = 17 ;
public final static int UNION             = 18 ;
public final static int UNIVERSAL_CHARSTRING = 20 ;
public final static int VERDICT          = 21 ;
public final static int DEFAULT          = 22 ;
public final static int PORT              = 23 ;
public final static int TIMER            = 24 ;
}

```

### 8.3.2.5 TciTestComponentKindType

**TciTestComponentKindType** is mapped to the following interface:

```

// TCI IDL TciTestComponentKindType
public interface TciTestComponentKind {
    public final static int TCI_CTRL_COMP      = 0;
    public final static int TCI_MTC_COMP      = 1;
    public final static int TCI_PTC_COMP      = 2;
    public final static int TCI_SYSTEM_COMP = 3;
    public final static int TCI_ALIVE_COMP    = 4;
}

```

### 8.3.2.6 TciBehaviourIdType

**TciBehaviourIdType** is mapped to the following interface:

```

// TCI IDL TciBehaviourIdType
package org.etsi.ttcn.tci;
public interface TciBehaviourId extends QualifiedName {
}

```

### 8.3.2.7 TciTestCaseIdType

**TciTestCaseIdType** is mapped to the following interface:

```

// TCI IDL TciTestCaseIdType
package org.etsi.ttcn.tci;
public interface TciTestCaseId extends QualifiedName {
}

```

### 8.3.2.8 TciModuleIdType

**TciModuleIdType** is mapped to the following interface:

```

// TCI IDL TciModuleIdType
package org.etsi.ttcn.tci;
public interface TciModuleId extends QualifiedName {
}

```

### 8.3.2.9 TciModuleParameterIdType

**TciModuleParameterIdType** is mapped to the following interface:

```

// TCI IDL TciModuleParameterIdType
package org.etsi.ttcn.tci;
public interface TciModuleParameterId extends QualifiedName {
}

```



### 8.3.2.10 TciModuleParameterListType

**TciModuleParameterListType** is mapped to the following interface:

```
// TCI IDL TciModuleParameterListType
package org.etsi.ttcn.tci;
public interface TciModuleParameterList {
    public int size() ;
    public boolean isEmpty() ;
    public java.util.Enumeration getModuleParameters() ;
    public TciModuleParameter get(int index) ;
}
```

#### Methods:

- `size` Returns the number of module parameters in this list.
- `isEmpty` Returns `true` if this list contains no module parameters.
- `getModuleParameters` Returns an `Enumeration` over the module parameters in the list. The enumeration provides the module parameters in the same order as they appear in the list.
- `get` Returns the `TciModuleParameter` at the specified position.

### 8.3.2.11 TciModuleParameterType

**TciModuleParameterType** is mapped to the following interface:

```
// TCI IDL TciModuleParameterType
package org.etsi.ttcn.tci;
public interface TciModuleParameter {
    public TciModuleParameterId getModuleParameterName();
    public Value getDefaultValue();
}
```

#### Methods:

- `getModuleParameterName` Returns the module parameter name as defined in the TTCN-3 specification.
- `getDefaultValue` Returns the default `Value` module parameter of this `TciModuleParameter`, or the `null` object if the module parameter contains the distinct value `null`.

### 8.3.2.12 TciParameterTypeListType

**TciParameterTypeListType** is mapped to the following interface:

```
// TCI IDL TciParameterTypeListType
package org.etsi.ttcn.tci;
public interface TciParameterTypeList {
    public int size() ;
    public boolean isEmpty() ;
    public java.util.Enumeration getParameterTypes() ;
    public TciParameterType get(int index) ;
}
```

#### Methods:

- `size` Returns the number of parameter types in this list.
- `isEmpty` Returns `true` if this list contains no parameter types.
- `getParameterTypes` Returns an `Enumeration` over the parameter types in the list. The enumeration provides the parameter types in the same order as they appear in the list.
- `get` Returns the `TciParameterType` at the specified position.

### 8.3.2.13 TciParameterTypeType

**TciParameterTypeType** is mapped to the following interface:

```
// TCI IDL TciParameterTypeType
package org.etsi.ttcn.tci;
public interface TciParameterType {
    public String    getParameterName();
    public Type      getParameterType();
    public int       getParameterPassingMode();
}
```

#### Methods:

- `getParameterName` Returns the parameter name as defined in the TTCN-3 specification.
- `getParameterType` Returns the `Type` of the parameter.
- `getParameterPassingMode` Returns the parameter passing mode of this parameter.

### 8.3.2.14 TciModuleIdListType

**TciModuleIdListType** is mapped to the following interface:

```
// TCI IDL TciModuleIdListType
package org.etsi.ttcn.tci;
public interface TciModuleIdList {
    public int          size();
    public boolean      isEmpty();
    public java.util.Enumeration tciGetImportedModules();
    public TciModuleId  get(int index);
}
```

#### Methods:

- `size` Returns the number of modules in this list.
- `isEmpty` Returns `true` if this list contains no modules.
- `tciGetImportedModules` Returns an `Enumeration` over the modules in the list. The enumeration provides the modules in the same order as they appear in the list.
- `get` Returns the `TciModuleId` at the specified position.

### 8.3.2.15 TciTestCaseIdListType

**TciTestCaseIdType** is mapped to the following interface:

```
// TCI IDL TciTestCaseIdListType
package org.etsi.ttcn.tci;
public interface TciTestCaseIdList {
    public int          size();
    public boolean      isEmpty();
    public java.util.Enumeration tciGetTestCases();
    public TciTestCaseId  get(int index);
}
```

#### Methods:

- `size` Returns the number of test cases in this list.
- `isEmpty` Returns `true` if this list contains no test cases.
- `tciGetTestCases` Returns an `Enumeration` over the test cases in the list. The enumeration provides the test cases in the same order as they appear in the list.
- `get` Returns the `TciTestCaseId` at the specified position.

### 8.3.2.16 TciDecodingResult

**TciDecodingResult** is used as a return type of the `TciCDPprovided.decodeValue` operation and it is defined as follows:

```
package org.etsi.ttcn.tci;
public interface TciDecodingResult {
    public int getResult ();
    public Value getDecodedValue ();
}
```

#### Methods:

- `getResult` Returns the numeric result of the `TciCDPprovided.decodeValue` operation.
- `getDecodedValue` Returns the decoded value or the distinct value `null`.

### 8.3.2.17 TciMatchingTypeType

**TciMatchingTypeType** is mapped to the following interface:

```
// TCI IDL TciTypeClassType
package org.etsi.ttcn.tci;
public interface TciMatchingType {
    public final static int TEMPLATE_LIST = 0 ;
    public final static int COMPLEMENTED_LIST = 1 ;
    public final static int ANY_VALUE = 2 ;
    public final static int ANY_VALUE_OR_NONE = 3 ;
    public final static int VALUE_RANGE = 4 ;
    public final static int SUBSET = 5 ;
    public final static int SUPERSET = 6 ;
    public final static int ANY_ELEMENT = 7 ;
    public final static int ANY_ELEMENTS_OR_NONE = 8 ;
    public final static int PATTERN = 9 ;
    public final static int MATCH_DECODED_CONTENT = 10 ;
    public final static int OMIT_TEMPLATE = 11 ;
}
```

### 8.3.2.18 LengthRestriction

**LengthRestriction** is mapped to the following interface:

```
// TCI IDL LengthRestriction
package org.etsi.ttcn.tci;
public interface LengthRestriction {
    public int getLowerBoundary ();
    public int getUpperBoundary ();
    public void setLowerBoundary (int boundary);
    public void setUpperBoundary (int boundary);
    public boolean isUpperBoundaryInfinity ();
    public void setInfiniteUpperBoundary ();
}
```

#### Methods:

- `getLowerBoundary` Returns the lower boundary of the length restriction.
- `getUpperBoundary` Returns the upper boundary of the length restriction.
- `setLowerBoundary` Sets the lower boundary value.
- `setUpperBoundary` Sets the upper boundary value.
- `isUpperBoundaryInfinity` Returns `true` if the upper boundary contains infinity and `false` otherwise.
- `setInfiniteUpperBoundary` Sets the upper boundary to infinity.

### 8.3.2.19 Permutation

**Permutation** is mapped to the following interface:

```
// TCI IDL Permutation
package org.etsi.ttcn.tci;
public interface Permutation {
    public int getStartPosition ();
    public void setStartPosition (int position);
    public int getLength ();
    public void setLength (int length);
}
```

#### Methods:

- `getStartPosition` Returns the position of the first item of the permutation in the `RecordOfValue`.
- `setStartPosition` Sets the position of the first item of the permutation in the `RecordOfValue`.
- `getLength` Returns the number of elements or matching mechanisms of the `RecordOfValue` that are included in the permutation.
- `setLength` Sets the number of elements or matching mechanisms of the `RecordOfValue` that are included in the permutation.

### 8.3.2.20 RangeBoundary

**RangeBoundary** is mapped to the following interface:

```
// TCI IDL RangeBoundary
package org.etsi.ttcn.tci;
public interface RangeBoundary {
    public Value getBoundary ();
    public boolean isInclusive ();
    public void setBoundary (Value boundary, boolean isInclusive);
    public boolean isInfinity ();
    public void setToInfinity ();
}
```

#### Methods:

- `getBoundary` Returns the boundary value. Dependent on the type of the value range, the return value can be either an `IntegerValue`, `FloatValue`, `CharstringValue` or `UniversalCharstringValue`. If the boundary is undefined or it cannot be represented by a `Value` instance (infinity in case of integer values), the distinct value `null` is returned.
- `isInclusive` Returns `true` if the boundary value is a part of the allowed range and `false` otherwise.
- `setBoundary` Sets the boundary value. Dependent on the type of the value range, the boundary parameter can contain either an `IntegerValue`, `FloatValue`, `UniversalCharstringValue` or `CharstringValue`. The inclusive parameter determines whether the boundary value is a part of the range (`true`) or not (`false`).
- `isInfinity` Returns `true` if the boundary is equal to infinity and `false` otherwise.
- `setToInfinity` Sets the boundary to infinity (if the instance is used for the upper range boundary) or `-infinity` (if the instance is used for the lower range boundary).

## 8.3.3 Abstract type mapping

### 8.3.3.0 General principles

The TTCN-3 data types are modelled in Java™ using the abstract type mapping as defined in the clause 8.3.3. The `Type` interface defines only operations used to retrieve in TTCN-3 defined types. No TTCN-3 types can be constructed using the `Type` interface. Types are modelled using the single interface `Type`, that provides methods to identify types and to retrieve values of a given type.

### 8.3.3.1 Type

**Type** is mapped to the following interface:

```
// TCI IDL Type
package org.etsi.ttcn.tci;
public interface Type {
    public TciModuleId getDefiningModule ();
    public String      getName ();
    public int         getTypeClass ();
    public Value       newInstance ();
    public String      getTypeEncoding ();
    public String      getTypeEncodingVariant();
    public String[]    getEncodeAttributes();
    public String[]    getVariantAttributes(String encoding);
    public String[]    getTypeExtension();
    public Value       parseValue (String val);
    public MatchingMechanism newTemplate (int matchingType);
    public RangeBoundary getLowerTypeBoundary();
    public RangeBoundary getUpperTypeBoundary();
    public LengthRestriction getTypeLengthRestriction();
    public MatchingMechanism getTypeMatchingMechanism();
}
```

#### Methods:

- `getDefiningModule` Returns the module identifier of the module the type has been defined in. If the type represents a TTCN-3 base type the distinct value `null` will be returned.
- `getName` Returns name of the type as defined in the TTCN-3 module.
- `getTypeClass` Returns the type class of the respective type. A value of `TciTypeClassType` can have one of the following constants: `ADDRESS`, `ANYTYPE`, `BITSTRING`, `BOOLEAN`, `CHARSTRING`, `COMPONENT`, `ENUMERATED`, `FLOAT`, `HEXSTRING`, `INTEGER`, `OCTETSTRING`, `RECORD`, `RECORD_OF`, `ARRAY`, `SET`, `SET_OF`, `UNION`, `UNIVERSAL_CHARSTRING`, `VERDICT`, `DEFAULT`, `PORT`, `TIMER`.
- `newInstance` Returns a freshly created value of the given type. This initial value of the created value is undefined.
- `getTypeEncoding` Returns the type encoding attribute as defined in the TTCN-3 module.
- `getTypeEncodingVariant` This operation returns the value encoding variant attribute as defined in the TTCN-3 module, if any. If no encoding variant attribute has been defined the distinct value `null` will be returned.
- `getEncodeAttributes` Returns all encode attributes of the type.
- `getVariantAttributes` Returns all variant attributes of the type for the specified encoding.
- `getTypeExtension` Returns the type extension attribute as defined in the TTCN-3 module.
- `parseValue` Parses the value provided in the parameter and in case of successful parsing returns a `Value` object representing the parsed value. In case of an error or if value parsing is not supported by the tool, the method returns `null`.

- `newTemplate` Returns a freshly created matching mechanism of this type. The `matchingType` parameter determines what kind of matching mechanism will be created and it shall be one of the following constants: `TEMPLATE_LIST`, `COMPLEMENTED_LIST`, `ANY_VALUE`, `ANY_VALUE_OR_NONE`, `VALUE_RANGE`, `SUBSET`, `SUPERSET`, `ANY_ELEMENT`, `ANY_ELEMENTS_OR_NONE`, `PATTERN`, `DECODED_MATCH`. If the created matching mechanism contains additional data properties, these properties are uninitialized in the created matching mechanism.
- `getLowerTypeBoundary` Return the lower boundary of the type restriction or `null`.
- `getUpperTypeBoundary` Return the upper boundary of the type restriction or `null`.
- `getTypeLengthRestriction` Return the length restriction of the type or `null`.
- `getTypeMatchingMechanism` Return the matching mechanism restriction of the type or `null`.

## 8.3.4 Abstract value mapping

### 8.3.4.0 General principles

TTCN-3 values can be retrieved from the TE and constructed using the Value interface. The value mapping interface is constructed hierarchically with Value as the basic interface. Specialized interfaces for different types of values have been defined.

#### 8.3.4.1 Value

**Value** is mapped to the following interface:

```
// TCI IDL Value
package org.etsi.ttcn.tci;
public interface Value {
    public Type      getType();
    public boolean   notPresent();
    public String    getValueEncoding();
    public String    getValueEncodingVariant();
    public String[]  getEncodeAttributes();
    public String[]  getVariantAttributes(String encoding);
    public boolean   isMatchingSymbol();
    public String    valueToString ();
    public boolean   isLazy();
    public boolean   isFuzzy();
    public boolean   isEvaluated();
    public LengthRestriction getLengthRestriction ();
    public LengthRestriction newLengthRestriction ();
    public void      setLengthRestriction (LengthRestriction restriction);
    public boolean   isIfPresentEnabled ();
    public void      setIfPresentEnabled (boolean enabled);
    public RangeBoundary getLowerTypeBoundary();
    public RangeBoundary getUpperTypeBoundary();
    public LengthRestriction getTypeLengthRestriction();
    public MatchingMechanism getTypeMatchingMechanism();
    public boolean   isOptional();
}
public LengthRestriction getTypeLengthRestriction();
```

#### Methods:

- `getType` Returns the type of the specified value.
- `notPresent` Returns `true` if the specified value is omit, `false` otherwise.
- `getValueEncoding` This operation returns the value encoding attribute as defined in the TTCN-3module, if any. If no encoding attribute has been defined the distinct `valuenull` will be returned.

- `getValueEncodingVariant` This operation returns the value encoding variant attribute as defined in TTCN-3, if any. If no encoding variant attribute has been defined the distinct value `null` will be returned.
- `getEncodeAttributes` Returns all encode attributes of the value.
- `getVariantAttributes` Returns all variant attributes of the value for the specified encoding.
- `isMatchingSymbol` Returns `true` if the specified value is a matching symbol (see clause 7.2.2.2.1 for more details), `false` otherwise.
- `valueToString` Returns the same string as produced by the `any2unistr` predefined function with the specified value as its parameter.
- `isLazy` Returns `true` if the specified value is `@lazy`, `false` otherwise.
- `isFuzzy` Returns `true` if the specified value is `@fuzzy`, `false` otherwise.
- `isEvaluated` Returns `true` if the specified value contains an evaluation result, `false` otherwise (see clause 7.2.2.2.1 for more details).
- `getLengthRestriction` Returns a length restriction matching attribute in case it is attached to the value or the distinct value `null` if no such matching attribute is present.
- `newLengthRestriction` Creates a new instance of the `LengthRestriction` interface.
- `setLengthRestriction` Adds a length restriction matching to the value or modifies an existing one. The distinct value `null` can be used as a parameter to disable an existing length restriction.
- `isIfPresentEnabled` Returns `true` if the `ifpresent` is attached to the value and `false` otherwise.
- `setIfPresentEnabled` Sets the whether the `ifpresent` indicator is attached to the value or not.
- `getLowerTypeBoundary` Return the lower boundary of the value's type restriction or `null`.
- `getUpperTypeBoundary` Return the upper boundary of the value's type restriction or `null`.
- `getTypeLengthRestriction` Return the value's type length restriction or `null`.
- `getTypeMatchingMechanism` Return the value's type restriction.
- `isOptional` Returns `true` if and only if the value is either an optional field or a template without value or present template restriction.

### 8.3.4.2 IntegerValue

**IntegerValue** type is mapped to the following interface:

```
// IntegerValue
package org.etsi.ttcn.tci;
public interface IntegerValue {
    public void    setInteger(int value);
    public int     getInteger();
}
```

#### Methods:

- `setInteger` Sets this `IntegerValue` to the `int` value `value`.
- `getInteger` Returns the `int` value represented by this `IntegerValue`.

### 8.3.4.3 FloatValue

**FloatValue** type is mapped to the following interface:

```
// FloatValue
package org.etsi.ttcn.tci;
public interface FloatValue {
    public void    setFloat(float value);
    public float   getFloat();
    public void    setDouble(double value);
    public double  getDouble();
    public void    setBigDecimal(java.math.BigDecimal value);
    public java.math.BigDecimal getBigDecimal();
}
```

#### Methods:

- `setFloat`                      Sets this FloatValue to the float value value.
- `getFloat`                      Returns the float value represented by this FloatValue.
- `setDouble`                     Sets this FloatValue to the float value with double precision.
- `getDouble`                     Returns the float value represented by this FloatValue with double precision.
- `setBigDecimal`                Sets this FloatValue to the float value with user-defined precision. If loss of precision is probable when using float or double, this method should be used.
- `getBigDecimal`                Returns the float value represented by this FloatValue with user-defined precision. If loss of precision is probable when using float or double, this method should be used.

### 8.3.4.4 BooleanValue

**BooleanValue** type is mapped to the following interface:

```
// BooleanValue
package org.etsi.ttcn.tci;
public interface BooleanValue {
    public void    setBoolean(boolean value);
    public boolean getBoolean();
}
```

#### Methods:

- `setBoolean`                    Sets this BooleanValue to the boolean value value.
- `getBoolean`                    Returns the boolean value represented by this BooleanValue.

### 8.3.4.5 CharstringValue

**CharstringValue** is mapped to the following interface:

```
// TCI IDL CharstringValue
package org.etsi.ttcn.tci;
public interface CharstringValue {
    String  getString ();
    void    setString (String value);
    char    getChar (int position);
    void    setChar (int position, char value);
    int     getLength ();
    void    setLength (int len);
}
```



**Methods:**

- `getString` Returns the string of the TTCN-3 charstring. The textual representation of the empty TTCN-3 charstring is "", while its length is zero.
- `setString` Sets this CharstringValue to value.
- `getChar` Returns the char value of the TTCN-3 charstring at position. position 0 denotes the first char of the TTCN-3 charstring. Valid values for position are 0 to length - 1.
- `setChar` Set the char at position to value. Valid values for position are 0 to length - 1.
- `getLength` Returns the length of this CharstringValue in chars, zero if the value of this CharstringValue is omit.
- `setLength` Sets the length of this CharstringValue in chars to len.

**8.3.4.6 BitstringValue**

**BitstringValue** is mapped to the following interface:

```
// TCI IDL BitstringValue
package org.etsi.ttcn.tci;
public interface BitstringValue {
    String getString ();
    void    setString (String value);
    int     getBit (int position);
    void    setBit (int position, int value);
    int     getLength ();
    void    setLength (int len);
    public java.io.InputStream getInputStream();
    public void setInputStream(java.io.InputStream stream, int numberOfBits);
    boolean isMatchingAt (int position);
    MatchingMechanism getMatchingAt (int position);
    void    setMatchingAt (int position, MatchingMechanism template);
}
```

**Methods:**

- `getString` Returns the textual representation of this BitstringValue, as defined in TTCN-3. E.g. the textual representation of 0101 is '0101'B. The textual representation of the empty TTCN-3 bitstring is ''B, while its length is zero. In some cases, the message data are available in the form of a stream and cannot be converted into a string by TCI (e.g. because of memory restrictions). In such cases, this method returns null and the `getInputStream` method shall be used for reading the data.
- `setString` Sets the value of this BitstringValue according to the textual representation as defined by value. E.g. The value of this BitstringValue will be 0101 if the textual representation in value is '0101'B.
- `getBit` Returns the value (0 | 1) at position of this TTCN-3 bitstring. position 0 denotes the first bit of the TTCN-3 bitstring. Valid values for position are 0 to length - 1.
- `setBit` Set the bit at position to value (0 | 1). position 0 denotes the first bit in this BitstringValue. Valid values for position are 0 to length - 1.
- `getLength` Returns the length of this BitstringValue in bits, zero if the value of this BitstringValue is omit.
- `setLength` Sets the length of this BitstringValue in bits to len.

- `getInputStream` Returns the bits in the form of an input stream. Repeated calls to the same method return different stream instances. The method returns `null` if the bitstring contains matching symbols.
- `setInputStream` Sets the value of this `BitstringValue` by providing a source stream that is used by the `BitstringValue` object to read the value content. Values set this way do not contain matching symbols.
- `isMatchingAt` Returns `true` if the item at `position` of this TTCN-3 bitstring is a matching mechanism inside a value (`AnyElement`, `AnyElementsOrNone`) and `false` otherwise.
- `getMatchingAt` If the `position` of this TTCN-3 bitstring contains a matching mechanism inside a value (`AnyElement`, `AnyElementsOrNone`), the method returns it. Otherwise the distinct value `null` is returned.
- `setMatching` Sets a matching mechanism at `position`. Only two matching mechanisms are allowed: `AnyElement` and `AnyElementsOrNone`.

### 8.3.4.7 OctetstringValue

**OctetstringValue** is mapped to the following interface:

```
// TCI IDL OctetstringValue
package org.etsi.ttcn.tci;
public interface OctetstringValue {
    String getString ();
    void setString (String value);
    int getOctet (int position);
    void setOctet (int position, int value);
    int getLength ();
    void setLength (int len);
    public java.io.InputStream getInputStream();
    public void setInputStream(java.io.InputStream stream);
    boolean isMatchingAt (int position);
    MatchingMechanism getMatchingAt (int position);
    void setMatchingAt (int position, MatchingMechanism template);
}
```

#### Methods:

- `getString` Returns the textual representation of this `OctetstringValue`, as defined in TTCN-3. E.g. the textual representation of `0xCAFFEE` is `'CAFFEE'0`. The textual representation of the empty TTCN-3 octetstring is `'0`, while its length is zero. In some cases, the message data are available in the form of a byte stream and cannot be converted into a string by TCI (e.g. because of memory restrictions). In such cases, this method returns `null` and the `getInputStream` method shall be used for reading the data.
- `setString` Sets the value of this `OctetstringValue` according to the textual representation as defined by value. E.g. the value of this `OctetstringValue` will be `0xCAFFEE` if the textual representation in value is `'CAFFEE'0`.
- `getOctet` Returns the value (0..255) at `position` of this TTCN-3 octetstring. `position 0` denotes the first octet of the TTCN-3 octetstring. Valid values for `position` are `0` to `length - 1`.
- `setOctet` Set the octet at `position` to value (0..255). `position 0` denotes the first octet in the octetstring. Valid values for `position` are `0` to `length - 1`.
- `getLength` Returns the length of this `OctetstringValue` in octets, zero if the value of this `OctetstringValue` is `omit`.
- `setLength` Sets the length of this `OctetstringValue` in octets to `len`.

- `getInputStream` Returns the octets in the form of an input stream. Repeated calls to the same method return different stream instances. The method returns `null` if the octetstring contains matching symbols.
- `setInputStream` Sets the value of this `OctetstringValue` by providing a source stream that is used by the `OctetstringValue` object to read the value content. Values set this way do not contain matching symbols.
- `isMatchingAt` Returns `true` if the item at `position` of this TTCN-3 octetstring is a matching mechanism inside a value (`AnyElement`, `AnyElementsOrNone`) and `false` otherwise.
- `getMatchingAt` If the `position` of this TTCN-3 octetstring contains a matching mechanism inside a value (`AnyElement`, `AnyElementsOrNone`), the method returns it. Otherwise the distinct value `null` is returned.
- `setMatching` Sets a matching mechanism at `position`. Only two matching mechanisms are allowed: `AnyElement` and `AnyElementsOrNone`.

### 8.3.4.8 UniversalCharstringValue

**UniversalCharstringValue** is mapped to the following interface:

```
// TCI IDL UniversalCharstringValue
package org.etsi.ttcn.tci;
public interface UniversalCharstringValue {
    String getString ();
    void   setString (String value);
    int    getChar (int position);
    void   setChar (int position, int value);
    int    getLength ();
    void   setLength (int len);
}
```

#### Methods:

- `getString` Returns the textual representation of this `UniversalCharstringValue`, as defined in TTCN-3.
- `setString` Sets the value of this `UniversalCharstringValue` according to the textual representation as defined by value.
- `getChar` Returns the `UniversalChar` value of the TTCN-3 universal charstring at `position`. `position 0` denotes the first `UniversalChar` of the TTCN-3 universal charstring. Valid values for `position` are 0 to `length - 1`.
- `setChar` Set the `UniversalChar` at `position` to `value`. Valid values for `position` are 0 to `length - 1`.
- `getLength` Returns the length of this `UniversalCharstringValue` in `UniversalChars`, zero if the value of this `UniversalCharstringValue` is `omit`.
- `setLength` Sets the length of this `UniversalCharstringValue` in `UniversalChars` to `len`.

### 8.3.4.9 HexstringValue

**HexstringValue** is mapped to the following interface:

```
// TCI IDL HexstringValue
package org.etsi.ttcn.tci;
public interface HexstringValue {
    String getString ();
    void setString (String value);
    int getHex (int position);
    void setHex (int position, int value);
    int getLength ();
    void setLength (int len);
    public java.io.InputStream getInputStream();
    public void setInputStream(java.io.InputStream stream, int numberOfItems);
    boolean isMatchingAt (int position);
    MatchingMechanism getMatchingAt (int position);
    void setMatchingAt (int position, MatchingMechanism template);
}
```

#### Methods:

- **getString** Returns the textual representation of this HexstringValue, as defined in TTCN-3. E.g. the textual representation of 0xAFFEE is 'AFFEE'H. The textual representation of the empty TTCN-3 hexstring is 'H, while its length is zero. In some cases, the message data are available in the form of a byte stream and cannot be converted into a string by TCI (e.g. because of memory restrictions). In such cases, this method returns null and the getInputStream method shall be used for reading the data.
- **setString** Sets the value of this HexstringValue according to the textual representation as defined by value. E.g. the value of this HexstringValue will be 0xAFFEE if the textual representation in value is 'AFFEE'H.
- **getHex** Returns the value (0..15) at position of this TTCN-3 hexstring. position 0 denotes the first hex digits of the TTCN-3 hexstring. Valid values for position are 0 to length - 1.
- **setHex** Set the hex digit at position to value (0..16). position 0 denotes the first octet in the hexstring. Valid values for position are 0 to length - 1.
- **getLength** Returns the length of this HexstringValue in octets, zero if the value of this HexstringValue is omit.
- **setLength** Sets the length of this HexstringValue in hex digits to len.
- **getInputStream** Returns the content in the form of an input stream. Repeated calls to the same method return different stream instances. The method returns null if the hexstring contains matching symbols.
- **setInputStream** Sets the value of this HexstringValue by providing a source stream that is used by the HexstringValue object to read the value content. Values set this way do not contain matching symbols.
- **isMatchingAt** Returns true if the item at position of this TTCN-3 hexstring is a matching mechanism inside a value (AnyElement, AnyElementsOrNone) and false otherwise.
- **getMatchingAt** If the position of this TTCN-3 hexstring contains a matching mechanism inside a value (AnyElement, AnyElementsOrNone), the method returns it. Otherwise the distinct value null is returned.
- **setMatching** Sets a matching mechanism at position. Only two matching mechanisms are allowed: AnyElement and AnyElementsOrNone.

### 8.3.4.10 RecordValue

**RecordValue** is mapped to the following interface:

```
// TCI IDL RecordValue
package org.etsi.ttcn.tci;
public interface RecordValue {
    public Value    getField(String fieldName) ;
    public void    setField(String fieldName, Value value) ;
    public String[] getFieldNames() ;
    public void    setFieldOmitted(String fieldName);
}
```

#### Methods:

- `getField` Returns the value of the field named `fieldName`. The return value is the common abstract base type `Value`, as a record field can have any type defined in TTCN-3. If the field cannot be obtained from the record the distinct value `null` will be returned.
- `setField` Set the field named `fieldName` of the record to `value`. No assumption shall be made on how a field is stored in a record. An internal implementation might choose to store a reference to this value or to copy the value. It is safe to assume that the value will be copied. Therefore it should be assumed that subsequent modifications of `value` will not be considered in the record.
- `getFieldNames` Returns an array of `String` of field names, the empty sequence, if the record has no fields.
- `setFieldOmitted` Set the field named `fieldName` of the record to `omit`.

### 8.3.4.11 RecordOfValue

**RecordOfValue** is mapped to the following interface:

```
// TCI IDL RecordOfValue
package org.etsi.ttcn.tci;
public interface RecordOfValue {
    public Value    getField(String fieldName) ;
    public void    setField(int position, Value value) ;
    public void    appendField(Value value) ;
    public Type    getElementType() ;
    public int     getLength() ;
    public void    setLength(int len) ;
    public int     getOffset() ;
    public int     getPermutationCount () ;
    public Permutation getPermutation (int index);
    public Permutation newPermutation ();
    public void    definePermutation (Permutation permutation);
    public void    removePermutation (int index);
    public void    clearPermutations ();
}
```

#### Methods:

- `getField` Returns the value of the record `of` at `position` if `position` is between zero and `length - 1`, the distinct value `null` otherwise. The return value is the common abstract base type `Value`, as a `record of` can have fields of any type defined in TTCN-3.

- `setField` Sets the field at `position` to `value`. If `position` is greater than  $(length - 1)$  the record of will be extended to have the length  $(position + 1)$ . The record of elements between the original position at `length` and `position - 1` will be set to OMIT. No assumption shall be made on how a field is stored in a record of. An internal implementation might choose to store a reference to this value or to copy the value. It is safe to assume that the value will be copied. Therefore it should be assumed that subsequent modifications of `value` will not be considered in the record of.
- `appendField` Appends the value at the end of the record of, i.e. at position `length`. No assumption shall be made on how a field is stored in a record of. An internal implementation might choose to store a reference to this value or to copy the value. It is safe to assume that the value will be copied. Therefore it should be assumed that subsequent modifications of `value` will not be considered in the record of.
- `getElementType` This operation will return the `Type` of the elements of this record of.
- `getLength` Returns the actual length of the record of value, zero if the record of value is OMIT.
- `setLength` Set the length of the record of to `len`. If `len` is greater than the original length, newly created elements have the value OMIT. If `len` is less or equal than the original length this operation will be ignored.
- `getOffset` Returns the lowest possible index. For a record of or set of value this is always 0. For an array value, this is the lower index bound used in the type definition.
- `getPermutationCount` Returns the number of permutations in the record of or array value.
- `getPermutation` Returns the permutation at the specified index. The allowed index range is from 0 to  $(getPermutationCount() - 1)$ .
- `newPermutation` Creates a new instance of the `Permutation` interface.
- `definePermutation` Creates permutation from existing elements of a record of value. The `permutation` parameter shall not include elements that are already a part of other existing permutations attached to the same record of. No elements are added to the record of by this operation.
- `removePermutation` Removes the permutation at the specified index. The allowed index range is from 0 to  $(getPermutationCount() - 1)$ . No elements are removed from the record of by this operation. When the operation completes, the existing elements at positions specified by the removed permutation do not belong to any permutation.
- `clearPermutations` Removes all permutations from the value. The elements that belonged to the removed permutation are not removed.

### 8.3.4.12 UnionValue

**UnionValue** is mapped to the following interface:

```
// TCI IDL UnionValue
package org.etsi.ttcn.tci;
public interface UnionValue {
    Value      getVariant (String variantName);
    void      setVariant (String variantName, Value value);
    String     getPresentVariantName ();
    String[]   getVariantNames ();
}
```

**Methods:**

- `getVariant` Returns the value of the TTCN-3 union `variantName`, if `variantName` equals the result of `getPresentVariantName`, the distinct value `null` otherwise. `variantName` denotes the name of the union variant as defined in the TTCN-3 module.
- `setVariant` Sets `variantName` of the union to `value`. If `variantName` is not defined for this union this operation will be ignored. If another variant was selected the new variant will be selected instead.
- `getPresentVariantName` Returns the variant name that has a value in this union set as a `String`. The distinct value `null` will be returned if no variant is selected.
- `getVariantNames` Returns an array of `String` of variant names, the empty sequence, if the union has no fields. If the `UnionValue` represents the TTCN-3 anytype, i.e. the type class of the type obtained by `getType()` is `ANYTYPE`, all predefined and user-defined TTCN-3 types will be returned.

**8.3.4.13 EnumeratedValue**

**EnumeratedValue** is mapped to the following interface:

```
// TCI IDL EnumeratedValue
package org.etsi.ttcn.tci;
public interface EnumeratedValue {
    String  getEnum ();
    void    setEnum (String enumValue);
    int     getInt();
    void    setInt(int intValue);
}
```

**Methods:**

- `getEnum` Returns the string identifier of this `EnumeratedValue`. This identifier equals the identifier in the TTCN-3 specification.
- `setEnum` Set the enum to `enumValue`. If `enumValue` is not an allowed value for this enumeration the operation will be ignored.
- `getInt` Returns the integer value of this `EnumeratedValue`. This integer equals the user-assigned integer value in the TTCN-3 specification or the automatically assigned integer value.
- `setInt` Sets the integer value of this `EnumeratedValue`. This integer should equal the user-assigned integer value in the TTCN-3 specification or the automatically assigned integer value. If `intValue` is not an allowed value for this enumeration the operation is ignored.

**8.3.4.14 VerdictValue**

**VerdictValue** is mapped to the following interface:

```
// TCI IDL VerdictValue
package org.etsi.ttcn.tci;
public interface VerdictValue {
    public static final int NONE    = 0;
    public static final int PASS    = 1;
    public static final int INCONC  = 2;
    public static final int FAIL    = 3;
    public static final int ERROR   = 4;

    public int     getVerdict() ;
    public void    setVerdict(int verdict) ;
}
```

**Methods:**

- `getVerdict` Returns the integer value for this `VerdictValue`. The integer is one of the following constants: `ERROR`, `FAIL`, `INCONC`, `NONE`, `PASS`, `USER_ERROR`.
- `setVerdict` Sets this `VerdictValue` to `verdict`. Note that a `VerdictValue` can be set to any of the above mentioned verdicts at any time. The `VerdictValue` does not perform any verdict calculations as defined in TTCN-3. For example, it is legal to set the `VerdictValue` first to `INCONC` and then to `PASS`.

### 8.3.4.15 AddressValue

**AddressValue** is mapped to the following interface:

```
// TCI IDL Address_Value
package org.etsi.ttcn.tci;
public interface AddressValue {
    public int getAddress();
    public void setAddress(Value value);
}
```

**Methods:**

- `getAddress` Returns the value represented by this `AddressValue`.
- `setAddress` Sets this `AddressValue` to the value `value`.

## 8.3.5 Abstract template mapping

### 8.3.5.0 General principles

TTCN-3 matching mechanisms can be retrieved from the TE and constructed using the `MatchingMechanism` interface. The template mapping interface is constructed hierarchically with `MatchingMechanism` as the basic interface. Specialized interfaces for different types of matching mechanisms have been defined.

#### 8.3.5.1 MatchingMechanism

**MatchingMechanism** is mapped to the following interface:

```
// TCI IDL MatchingMechanism
package org.etsi.ttcn.tci;
public interface MatchingMechanism {
    public int getMatchingType ();
}
```

**Methods:**

- `getMatchingType` Returns the matching mechanism type.

#### 8.3.5.2 MatchingList

**MatchingList** is mapped to the following interface:

```
// TCI IDL MatchingList
package org.etsi.ttcn.tci;
public interface MatchingList {
    public int size ();
    public Value get (int position);
    public void add (Value item);
    public void remove (int position);
    public void clear ();
}
```



**Methods:**

- `size` Returns the number of items in the matching mechanism.
- `get` Returns a value or template at the specified position.
- `add` Adds a value or template to the matching mechanism.
- `remove` Removes a value or template from the specified position.
- `clear` Removes all values and templates from the matching mechanism.

### 8.3.5.3 ValueRange

**ValueRange** is mapped to the following interface:

```
// TCI IDL ValueRange
package org.etsi.ttcn.tci;
public interface ValueRange {
    public RangeBoundary getLowerBoundary ();
    public RangeBoundary getUpperBoundary ();
    public void setLowerBoundary (RangeBoundary boundary);
    public void setUpperBoundary (RangeBoundary boundary);
}
```

**Methods:**

- `getLowerBoundary` Returns the lower boundary of the range.
- `getUpperBoundary` Returns the upper boundary of the range.
- `setLowerBoundary` Sets the lower boundary of the range.
- `setUpperBoundary` Sets the upper boundary of the range.

### 8.3.5.4 CharacterPattern

**CharacterPattern** is mapped to the following interface:

```
// TCI IDL CharacterPattern
package org.etsi.ttcn.tci;
public interface CharacterPattern {
    public Value getPatternString ();
    public void setPatternString (Value pattern);
}
```

**Methods:**

- `getPatternString` Returns the character pattern definition of this pattern (either a `CharstringValue` or `UniversalCharstringValue`).
- `setPatternString` Sets the character pattern definition of this pattern. The `characterPattern` parameter shall contain either a `CharstringValue` or `UniversalCharstringValue`.

### 8.3.5.5 MatchDecodedContent

**MatchDecodedContent** is mapped to the following interface:

```
// TCI IDL MatchDecodedContent
package org.etsi.ttcn.tci;
public interface MatchDecodedContent {
    public Value getContent ();
    public void setContent (Value pattern);
}
```

**Methods:**

- `getContent` Returns the value or matching mechanism used as an argument of the `decmatch` matching mechanism.
- `setContent` Sets the value or matching mechanism that is used as an argument of the `decmatch` matching mechanism.

## 8.3.6 Abstract logging types mapping

### 8.3.6.0 General principles

Additional types are defined to ease the logging of matches between values and templates.

#### 8.3.6.1 TciValueTemplate

**TciValueTemplate** is mapped to the following interface:

```
// TCI IDL TciValueTemplate
package org.etsi.ttcn.tci;
public interface TciValueTemplate {
    public boolean isOmit();
    public boolean isAny();
    public boolean isAnyOrOmit();
    public String getTemplateDef();
}
```

**Methods:**

- `isOmit` Returns `true` if the template is `omit`, `false` otherwise.
- `isAny` Returns `true` if the template is `any`, `false` otherwise.
- `isAnyOrOmit` Returns `true` if the template is `anyoromit`, `false` otherwise.
- `getTemplateDef` This operation returns the template definition.

#### 8.3.6.2 TciNonValueTemplate

**TciNonValueTemplate** is mapped to the following interface:

```
// TCI IDL TciNonValueTemplate
package org.etsi.ttcn.tci;
public interface TciNonValueTemplate {
    public boolean isAny();
    public boolean isAll();
    public String getTemplateDef();
}
```

**Methods:**

- `isAny` Returns `true` if the template is `any`, `false` otherwise.
- `isAll` Returns `true` if the template is `all`, `false` otherwise.
- `getTemplateDef` This operation returns the template definition.

### 8.3.6.3 TciValueList

**TciValueList** is mapped to the following interface:

```
// TCI IDL TciValueList
package org.etsi.ttcn.tci;
public interface TciValueList{
    public int                size() ;
    public boolean            isEmpty() ;
    public Value              get(int index) ;
}
```

#### Methods:

- `size` Returns the number of values in this list.
- `isEmpty` Returns `true` if this list contains no values.
- `get` Returns the `Value` at the specified position.

### 8.3.6.4 TciValueDifference

**TciValueDifference** is mapped to the following interface:

```
// TCI IDL TciValueDifference
package org.etsi.ttcn.tci;
public interface TciValueDifference {
    public Value    getValue();
    public TciValueTemplate getTciValueTemplate();
    public String   getDescription();
}
```

#### Methods:

- `getValue` Returns the value of this `TciValueDifference`.
- `getTciValueTemplate` Returns the template of this `TciValueDifference`.
- `getDescription` Returns the description of the mismatch.

### 8.3.6.5 TciValueDifferenceList

**TciValueDifferenceList** is mapped to the following interface:

```
// TCI IDL TciValueDifferenceList
package org.etsi.ttcn.tci;
public interface TciValueDifferenceList{
    public int                size() ;
    public boolean            isEmpty() ;
    public TciValueDifference get(int index) ;
}
```

#### Methods:

- `size` Returns the number of differences in this list.
- `isEmpty` Returns `true` if this list contains no differences.
- `get` Returns the `TciValueDifference` at the specified position.

### 8.3.6.6 ComponentStatus

**ComponentStatus** is mapped to the following interface:

```
// TCI IDL ComponentStatus
package org.etsi.ttcn.tci;
public interface ComponentStatus {
    public static final int INACTIVE_C = 0;
    public static final int RUNNING_C = 1;
    public static final int STOPPED_C = 2;
    public static final int KILLED_C = 3;
    public static final int NULL_C = 4;

    public int      getComponentStatus() ;
    public void     setComponentStatus (int componentStatus) ;
}

```

### 8.3.6.7 TimerStatus

**TimerStatus** is mapped to the following interface:

```
// TCI IDL TimerStatus
package org.etsi.ttcn.tci;
public interface TimerStatus {
    public static final int RUNNING_T = 0;
    public static final int INACTIVE_T = 1;
    public static final int EXPIRED_T = 2;
    public static final int NULL_T = 3;

    public int      getTimerStatus() ;
    public void     setTimerStatus (int timerStatus) ;
}

```

### 8.3.6.8 TciStatus

**TciStatus** is mapped to the following interface:

```
// TCI IDL TciStatus
package org.etsi.ttcn.tci;
public interface TciStatus {
    public static final int TCI_OK = 0;
    public static final int TCI_ERROR = -1;

    public int      getTciStatus() ;
    public void     setTciStatus (int tciStatus) ;
}

```

## 8.4 Constants

Within this Java™ language mapping constants have been specified. All constants are defined `public final static` and are accessible from every object from every package. The constants defined within this clause are not defined with the IDL clause. Instead they result from the specification of the TCI IDL types marked as native.

The following constants can be used to determine the parameter passing mode of TTCN-3 parameters (see also clause 8.3.2.3).

- `org.etsi.ttcn.tci.TciParameterPassingMode.TCI_IN;`
- `org.etsi.ttcn.tci.TciParameterPassingMode.TCI_INOUT;`
- `org.etsi.ttcn.tri.TciParameterPassingMode.TCI_OUT.`

For the distinct parameter value `null`, the encoded parameter value shall be set to Java™ `null`.

The following constants shall be used for value handling (see also clause 8.3.2.4).

- `org.etsi.ttcn.tci.TciTypeClass.ADDRESS;`
- `org.etsi.ttcn.tci.TciTypeClass.ANYTYPE;`

- `org.etsi.ttcn.tci.TciTypeClass.BITSTRING;`
- `org.etsi.ttcn.tci.TciTypeClass.BOOLEAN;`
- `org.etsi.ttcn.tci.TciTypeClass.CHARSTRING;`
- `org.etsi.ttcn.tci.TciTypeClass.COMPONENT;`
- `org.etsi.ttcn.tci.TciTypeClass.ENUMERATED;`
- `org.etsi.ttcn.tci.TciTypeClass.FLOAT;`
- `org.etsi.ttcn.tci.TciTypeClass.HEXSTRING;`
- `org.etsi.ttcn.tci.TciTypeClass.INTEGER;`
- `org.etsi.ttcn.tci.TciTypeClass.OCTETSTRING;`
- `org.etsi.ttcn.tci.TciTypeClass.RECORD;`
- `org.etsi.ttcn.tci.TciTypeClass.RECORD_OF;`
- `org.etsi.ttcn.tci.TciTypeClass.SET;`
- `org.etsi.ttcn.tci.TciTypeClass.SET_OF;`
- `org.etsi.ttcn.tci.TciTypeClass.ARRAY;`
- `org.etsi.ttcn.tci.TciTypeClass.UNION;`
- `org.etsi.ttcn.tci.TciTypeClass.UNIVERSAL_CHARSTRING;`
- `org.etsi.ttcn.tci.TciTypeClass.VERDICT.`

The following constants shall be used for component handling (see also clause 8.3.2.5).

- `org.etsi.ttcn.tci.TciTestComponentKind.TCI_CTRL_COMP;`
- `org.etsi.ttcn.tci.TciTestComponentKind.TCI_MTC_COMP;`
- `org.etsi.ttcn.tci.TciTestComponentKind.TCI_PTC_COMP;`
- `org.etsi.ttcn.tci.TciTestComponentKind.TCI_SYSTEM_COMP;`
- `org.etsi.ttcn.tci.TciTestComponentKind.TCI_ALIVE_COMP.`

The following constants shall be used for component status (see also clause 8.3.6.6).

- `org.etsi.ttcn.tci.ComponentStatus.INACTIVE_C;`
- `org.etsi.ttcn.tci.ComponentStatus.RUNNING_C;`
- `org.etsi.ttcn.tci.ComponentStatus.STOPPED_C;`
- `org.etsi.ttcn.tci.ComponentStatus.KILLED_C;`
- `org.etsi.ttcn.tci.ComponentStatus.NULL_C.`

The following constants shall be used for timer status (see also clause 8.3.6.7).

- `org.etsi.ttcn.tci.TimerStatus.RUNNING_T;`
- `org.etsi.ttcn.tci.TimerStatus.INACTIVE_T;`
- `org.etsi.ttcn.tci.TimerStatus.EXPIRED_T;`
- `org.etsi.ttcn.tci.TimerStatus.NULL_T.`

The following constants shall be used for TCI status (see also clause 8.3.6.8).

- `org.etsi.ttcn.tci.TciStatus.TCI_OK;`

- `org.etsi.ttcn.tci.TciStatus.TCI_ERROR.`

## 8.5 Mapping of interfaces

### 8.5.0 Calling rules

The TCI IDL definition defines four interfaces, the **TCI-TM**, the **TCI-CH**, the **TCI-CD**, and the **TCI-TL** interface. The operations are defined for different directions within this interface, i.e. some operations can only be called by the TTCN-3 Executable (TE), the System Adaptor (SA) or the Platform Adaptor (PA) on the Test Management and Control (TMC) while others can only be called by the TMC on the TE. This is reflected by dividing the TCI IDL interfaces in two sub interfaces, each suffixed by `Required` or `Provided`.

**Table 4: Sub interfaces**

| Calling/Called | TE                           | TM                 | CD                 | CH                 | SA                           | PA                           | TL                 |
|----------------|------------------------------|--------------------|--------------------|--------------------|------------------------------|------------------------------|--------------------|
| <b>TE</b>      | -                            | TCI-TM<br>Provided | TCI-CD<br>Provided | TCI-CH<br>Provided | See ETSI<br>ES 201 873-5 [3] | See ETSI<br>ES 201 873-5 [3] | TCI-TL<br>Provided |
| <b>TM</b>      | TCI-TM<br>Required           | -                  | -                  | -                  | -                            | -                            | TCI-TL<br>Provided |
| <b>CD</b>      | TCI-CD<br>Required           | -                  | -                  | -                  | -                            | -                            | TCI-TL<br>Provided |
| <b>CH</b>      | TCI-CH<br>Required           | -                  | -                  | -                  | -                            | -                            | TCI-TL<br>Provided |
| <b>SA</b>      | See ETSI<br>ES 201 873-5 [3] | -                  | -                  | -                  | -                            | -                            | TCI-TL<br>Provided |
| <b>PA</b>      | See ETSI<br>ES 201 873-5 [3] | -                  | -                  | -                  | -                            | -                            | TCI-TL<br>Provided |
| <b>TL</b>      | -                            | -                  | -                  | -                  | -                            | -                            | -                  |

All methods defined in these interfaces should behave as defined in clause 7.

### 8.5.1 The TCI-TM interface

#### 8.5.1.1 TCI-TM provided

The **TCI-TM Provided** interface is mapped to the following interface:

```
// TCI-TM
// TE -> TM
package org.etsi.ttcn.tci;
public interface TciTMProvided {
    public void tciTestCaseStarted (TciTestCaseId testCaseId, TciParameterList parameterList, Float
timer);
    public void tciTestCaseTerminated (VerdictValue verdict, TciParameterList parameterList);
    public void tciControlTerminated ();
    public Value tciGetModulePar (TciModuleParameterId parameterId);
    public void tciLog (TriComponentId testComponentId, String message);
    public void tciError (String message);
    public void tciControlTerminatedWithResult (Value result, TciParameterList parameterList);
}
```

#### 8.5.1.2 TCI-TM required

The **TCI-TM Required** interface is mapped to the following interface:

```
// TCI-TM
// TM -> TE
package org.etsi.ttcn.tci;
public interface TciTMRequired {
    public void tciRootModule (TciModuleId moduleName);
    public TciModuleIdList tciGetImportedModules ();
    public TciModuleParameterList tciGetModuleParameters (TciModuleId moduleId);
    public TciTestCaseIdList tciGetTestCases ();
    public TciParameterTypeList tciGetTestCaseParameters (TciTestCaseId testCaseId);
}
```

```

public TriPortIdList      tciGetTestCaseTSI    (TciTestCaseId testCaseId);
public void               tciStartTestCase    (String testCaseId, TciParameterList parameterList );
public void               tciStopTestCase     ();
public TriComponentId     tciStartControl     ();
public void               tciStopControl     ();
public TciParameterTypeList tciGetControlParameters ();
public TriComponentId     tciStartControlWithParameters (TciParameterList parameterList);
}

```

## 8.5.2 The TCI-CD interface

### 8.5.2.1 TCI-CD provided

The TCI-CD Provided interface is mapped to the following interface:

```

// TCI-CD
// TE -> CD
package org.etsi.ttcn.tci;
public interface TciCDProvided {
    public Value      decode (TriMessage message, Type decodingHypothesis );
    public TriMessage encode (Value value);
    public TciDecodingResult decodeValue (TriMessage message, Type decodingHypothesis,
                                           String decodingInfo );
    public TriMessage  encodeValue (Value value, String encodingInfo);
}

```

### 8.5.2.2 TCI-CD required

The TCI-CD Required interface is mapped to the following interface:

```

// TCI-CD
// CD -> TE
package org.etsi.ttcn.tci;
public interface TciCDRequired {
    public Type      getTypeForName (String typeName);
    public Type      getInteger ();
    public Type      getFloat ();
    public Type      getBoolean ();
    public Type      getCharstring ();
    public Type      getUniversalCharstring ();
    public Type      getHexstring ();
    public Type      getBitstring ();
    public Type      getOctetstring ();
    public Type      getVerdict ();
    public void      tciErrorReq (String message);
}

```

## 8.5.3 The TCI-CH interface

### 8.5.3.1 TCI-CH provided

The TCI-CH Provided interface is mapped to the following interface:

```

// TciCHProvided
// TE -> CH
package org.etsi.ttcn.tci;
public interface TciCHProvided {
    public void tciSendConnected (TriPortId sender, TriComponentId receiver, Value sendMessage);
    public void tciSendConnectedBC (TriPortId sender, Value sendMessage);
    public void tciSendConnectedMC (TriPortId sender, TriComponentIdList receivers,
                                     Value sendMessage);

    public void tciCallConnected(TriPortId sender,
                                 TriComponentId receiver,
                                 TriSignatureId signature,
                                 TciParameterList parameterList) ;

    public void tciCallConnectedBC(TriPortId sender,
                                    TriSignatureId signature,
                                    TciParameterList parameterList) ;
}

```

```

public void      tciCallConnectedMC(TriPortId sender,
                                   TriComponentIdList receivers,
                                   TriSignatureId signature,
                                   TciParameterList parameterList) ;

public void      tciReplyConnected(TriPortId sender,
                                   TriComponentId receiver,
                                   TriSignatureId signature,
                                   TciParameterList parameterList,
                                   Value returnValue) ;

public void      tciReplyConnectedBC(TriPortId sender,
                                   TriSignatureId signature,
                                   TciParameterList parameterList,
                                   Value returnValue) ;

public void      tciReplyConnectedMC(TriPortId sender,
                                   TriComponentIdList receivers,
                                   TriSignatureId signature,
                                   TciParameterList parameterList,
                                   Value returnValue) ;

public void      tciRaiseConnected(TriPortId sender,
                                   TriComponentId receiver,
                                   TriSignatureId signature,
                                   Value except) ;

public void      tciRaiseConnectedBC(TriPortId sender,
                                   TriSignatureId signature,
                                   Value except) ;

public void      tciRaiseConnectedMC(TriPortId sender,
                                   TriComponentIdList receivers,
                                   TriSignatureId signature,
                                   Value except) ;

public TriComponentId  tciCreateTestComponentReq(int kind,
                                                  Type componentType,
                                                  String name,
                                                  Value hostId) ;

public void      tciStartTestComponentReq(TriComponentId comp,
                                           TciBehaviourId behaviour,
                                           TciParameterList parameterList) ;

public void      tciStopTestComponentReq(TriComponentId comp) ;

public void      tciConnectReq(TriPortId fromPort, TriPortId toPort) ;

public void      tciDisconnectReq(TriPortId fromPort, TriPortId toPort) ;

public void      tciTestComponentTerminatedReq(TriComponentId comp, VerdictValue verdict) ;

public boolean    tciTestComponentRunningReq(TriComponentId comp) ;

public TriComponentId  tciGetMTCReq() ;

public void      tciMapReq(TriPortId fromPort, TriPortId toPort);

public void      tciMapParamReq(TriPortId fromPort, TriPortId toPort,
                                TciParameterList parameterList);

public void      tciUnmapReq(TriPortId fromPort, TriPortId toPort);

public void      tciUnmapParamReq(TriPortId fromPort, TriPortId toPort,
                                TciParameterList parameterList);

public void      tciExecuteTestCaseReq(TriComponentId testComponentId,
                                       TriPortIdList tsiPortList);

public void      tciResetReq() ;

public boolean    tciTestComponentDoneReq(TriComponentId testComponentId, VerdictValue verdict) ;

public void      tciKillTestComponentReq(TriComponentId component);

public boolean    tciTestComponentAliveReq (TriComponentId component);

public boolean    tciTestComponentKilledReq (TriComponentId component, VerdictValue verdict);

public void      tciCallTestComponentReq (TriComponentId comp,
                                           TciBehaviourId behaviour,

```



```

        TciParameterList parameterList) ;

    public void    tciTestComponentCallTerminatedReq (TriComponentId comp,
                                                    VerdictValue verdict,
                                                    TciParameterList parameterList,
                                                    Value returnValue) ;
}

```

### 8.5.3.2 TCI-CH required

The TCI-CH Required interface is mapped to the following interface:

```

// TciCHRequired
// CH -> TE
package org.etsi.ttcn.tci;
public interface TciCHRequired extends TciCDRequired {
    public void    tciEnqueueMsgConnected(TriPortId sender,
                                        TriComponentId receiver,
                                        Value receivedMessage) ;

    public void    tciEnqueueCallConnected(TriPortId sender,
                                        TriComponentId receiver,
                                        TriSignatureId signature,
                                        TciParameterList parameterList) ;

    public void    tciEnqueueReplyConnected(TriPortId sender,
                                        TriComponentId receiver,
                                        TriSignatureId signature,
                                        TciParameterList parameterList,
                                        Value returnValue) ;

    public void    tciEnqueueRaiseConnected(TriPortId sender,
                                        TriComponentId receiver,
                                        TriSignatureId signature,
                                        Value except) ;

    public TriComponentId    tciCreateTestComponent(int kind, Type componentType, String name) ;

    public void    tciStartTestComponent(TriComponentId comp,
                                        TciBehaviourId behaviour,
                                        TciParameterList parameterList) ;

    public void    tciStopTestComponent(TriComponentId comp) ;

    public void    tciConnect(TriPortId fromPort, TriPortId toPort) ;

    public void    tciDisconnect(TriPortId fromPort, TriPortId toPort) ;

    public void    tciTestComponentTerminated(TriComponentId comp, VerdictValue verdict);

    public boolean tciTestComponentRunning(TriComponentId comp);

    public boolean tciTestComponentDone(TriComponentId comp, VerdictValue verdict);

    public TriComponentId    tciGetMTC ();

    public void    tciExecuteTestCase (TciTestCaseId testCaseId, TriPortIdList tsiPortList);

    public void    tciReset ();

    public void    tciMap (TriPortId fromPort, TriPortId toPort);

    public void    tciMapParam (TriPortId fromPort, TriPortId toPort,
                                TciParameterList parameterList);

    public void    tciUnmap (TriPortId fromPort, TriPortId toPort);

    public void    tciUnmapParam (TriPortId fromPort, TriPortId toPort,
                                TciParameterList parameterList);

    public void    tciKillTestComponent(TriComponentId component);

    public boolean tciTestComponentAlive (TriComponentId component);

    public boolean tciTestComponentKilled (TriComponentId component, VerdictValue verdict);

    public void    tciCallTestComponent (TriComponentId comp,

```

```

        TciBehaviourId behaviour,
        TciParameterList parameterList) ;

public void    tciTestComponentCallTerminated (TriComponentId comp,
        VerdictValue verdict,
        TciParameterList parameterList,
        Value returnValue) ;
}

```

## 8.5.4 The TCI-TL interface

### 8.5.4.1 TCI-TL provided

The TCI-TL Provided interface is mapped to the following interface:

```

// TCI-TL
// TE, TM,CH,CD, SA,PA -> TL
package org.etsi.ttcn.tci;
public interface TciTLProvided {
    public void tliTcExecute(String am, int ts, String src, int line, TriComponentId c,
        TciTestCaseId tcId, TciParameterList tciPars, TriTimerDuration dur);
    public void tliTcStart(String am, int ts, String src, int line, TriComponentId c,
        TciTestCaseId tcId, TciParameterList tciPars, TriTimerDuration dur);
    public void tliTcStop(String am, int ts, String src, int line, TriComponentId c, String reason);
    public void tliTcStarted(String am, int ts, String src, int line, TriComponentId c,
        TciTestCaseId tcId, TciParameterList tciPars, TriTimerDuration dur);
    public void tliTcTerminated(String am, int ts, String src, int line, TriComponentId c,
        TciTestCaseId tcId, TciParameterList tciPars, VerdictValue verdict, String reason);
    public void tliCtrlStart(String am, int ts, String src, int line, TriComponentId c);
    public void tliCtrlStop(String am, int ts, String src, int line, TriComponentId c);
    public void tliCtrlTerminated(String am, int ts, String src, int line, TriComponentId c);
    public void tliMSend_m(String am, int ts, String src, int line, TriComponentId c,
        TriPortId at, TriPortId to, Value msgValue, Value addrValue,
        TciStatus encoderFailure, TriMessage msg, TriAddress address,
        TriStatus transmissionFailure);
    public void tliMSend_m_BC(String am, int ts, String src, int line, TriComponentId c,
        TriPortId at, TriPortId to, Value msgValue,
        TciStatus encoderFailure, TriMessage msg, TriStatus transmissionFailure) ;
    public void tliMSend_m_MC(String am, int ts, String src, int line, TriComponentId c,
        TriPortId at, TriPortId to, Value msgValue, TciValueList addrValues,
        TciStatus encoderFailure, TriMessage msg, TriAddressList addresses,
        TriStatus transmissionFailure);
    public void tliMSend_c(String am, int ts, String src, int line, TriComponentId c,
        TriPortId at, TriPortId to, Value msgValue, TriStatus transmissionFailure);
    public void tliMSend_c_BC(String am, int ts, String src, int line, TriComponentId c,
        TriPortId at, TriPortIdList to, Value msgValue, TriStatus transmissionFailure);
    public void tliMSend_c_MC(String am, int ts, String src, int line, TriComponentId c,
        TriPortId at, TriPortIdList to, Value msgValue, TriStatus transmissionFailure);
    public void tliMDetected_m(String am, int ts, String src, int line, TriComponentId c,
        TriPortId at, TriPortId from, TriMessage msg, TriAddress address);
    public void tliMDetected_c(String am, int ts, String src, int line, TriComponentId c,
        TriPortId at, TriPortId from, Value msgValue );
    public void tliMMismatch_m(String am, int ts, String src, int line, TriComponentId c,
        TriPortId at, Value msgValue, TciValueTemplate msgTmpl, TciValueDifferenceList diffs,
        Value addrValue, TciValueTemplate addressTmpl);
    public void tliMMismatch_c(String am, int ts, String src, int line, TriComponentId c,
        TriPortId at, Value msgValue, TciValueTemplate msgTmpl, TciValueDifferenceList diffs,
        TriComponentId from, TciNonValueTemplate fromTmpl);
    public void tliMReceive_m(String am, int ts, String src, int line, TriComponentId c,
        TriPortId at, Value msgValue, TciValueTemplate msgTmpl,
        Value addrValue, TciValueTemplate addressTmpl);
    public void tliMReceive_c(String am, int ts, String src, int line, TriComponentId c,
        TriPortId at, Value msgValue, TciValueTemplate msgTmpl,
        TriComponentId from, TciNonValueTemplate fromTmpl);
    public void tliPrCall_m(String am, int ts, String src, int line, TriComponentId c,
        TriPortId at, TriPortId to, TriSignatureId signature, TciParameterList tciPars,
        Value addrValue, TciStatus encoderFailure, TriParameterList triPars,
        TriAddress address, TriStatus transmissionFailure);
    public void tliPrCall_m_BC(String am, int ts, String src, int line, TriComponentId c,
        TriPortId at, TriPortId to, TriSignatureId signature, TciParameterList tciPars,
        TciStatus encoderFailure, TriParameterList triPars,
        TriStatus transmissionFailure);
    public void tliPrCall_m_MC(String am, int ts, String src, int line, TriComponentId c,
        TriPortId at, TriPortId to, TriSignatureId signature, TciParameterList tciPars,
        TciValueList addrValues, TciStatus encoderFailure, TriParameterList triPars,

```

```

    TriAddressList addresses, TriStatus transmissionFailure);
public void tliPrCall_c(String am, int ts, String src, int line, TriComponentId c,
    TriPortId at, TriPortId to, TriSignatureId signature, TciParameterList tciPars,
    TriStatus transmissionFailure);
public void tliPrCall_c_BC(String am, int ts, String src, int line, TriComponentId c,
    TriPortId at, TriPortIdList to, TriSignatureId signature, TciParameterList tciPars,
    TriStatus transmissionFailure);
public void tliPrCall_c_MC(String am, int ts, String src, int line, TriComponentId c,
    TriPortId at, TriPortIdList to, TriSignatureId signature, TciParameterList tciPars,
    TriStatus transmissionFailure);
public void tliPrGetCallDetected_m(String am, int ts, String src, int line, TriComponentId c,
    TriPortId at, TriPortId from, TriSignatureId signature, TriParameterList triPars,
    TriAddress address);
public void tliPrGetCallDetected_c(String am, int ts, String src, int line, TriComponentId c,
    TriPortId at, TriPortId from, TriSignatureId signature, TciParameterList tciPars );
public void tliPrGetCallMismatch_m(String am, int ts, String src, int line, TriComponentId c,
    TriPortId at, TriSignatureId signature,
    TciParameterList tciPars, TciValueTemplate parsTmpl, TciValueDifferenceList diffs,
    Value addrValue, TciValueTemplate addressTmpl);
public void tliPrGetCallMismatch_c(String am, int ts, String src, int line, TriComponentId c,
    TriPortId at, TriSignatureId signature,
    TciParameterList tciPars, TciValueTemplate parsTmpl, TciValueDifferenceList diffs,
    TriComponentId from, TciNonValueTemplate fromTmpl);
public void tliPrGetCall_m(String am, int ts, String src, int line, TriComponentId c,
    TriPortId at, TriSignatureId signature,
    TciParameterList tciPars, TciValueTemplate parsTmpl,
    Value addrValue, TciValueTemplate addressTmpl);
public void tliPrGetCall_c(String am, int ts, String src, int line, TriComponentId c,
    TriPortId at, TriSignatureId signature,
    TciParameterList tciPars, TciValueTemplate parsTmpl,
    TriComponentId from, TciNonValueTemplate fromTmpl);
public void tliPrReply_m(String am, int ts, String src, int line, TriComponentId c,
    TriPortId at, TriPortId to, TriSignatureId signature, TciParameterList tciPars,
    Value replValue, Value addrValue,
    TriStatus encoderFailure, TriParameterList triPars,
    TriParameter repl, TriAddress address, TriStatus transmissionFailure);
public void tliPrReply_m_BC(String am, int ts, String src, int line, TriComponentId c,
    TriPortId at, TriPortId to, TriSignatureId signature, TciParameterList tciPars,
    Value replValue, TriStatus encoderFailure,
    TriParameterList triPars, TriParameter repl, TriStatus transmissionFailure);
public void tliPrReply_m_MC(String am, int ts, String src, int line, TriComponentId c,
    TriPortId at, TriPortId to, TriSignatureId signature, TciParameterList tciPars,
    Value replValue, TciValueList addrValues,
    TriStatus encoderFailure, TriParameterList triPars,
    TriParameter repl, TriAddressList addresses, TriStatus transmissionFailure);
public void tliPrReply_c(String am, int ts, String src, int line, TriComponentId c,
    TriPortId at, TriPortId to, TriSignatureId signature,
    TciParameterList tciPars, Value replValue,
    TriStatus transmissionFailure);
public void tliPrReply_c_BC(String am, int ts, String src, int line, TriComponentId c,
    TriPortId at, TriPortIdList to, TriSignatureId signature, TciParameterList tciPars,
    Value replValue, TriStatus transmissionFailure);
public void tliPrReply_c_MC(String am, int ts, String src, int line, TriComponentId c,
    TriPortId at, TriPortIdList to, TriSignatureId signature, TciParameterList tciPars,
    Value replValue, TriStatus transmissionFailure);
public void tliPrGetReplyDetected_m(String am, int ts, String src, int line, TriComponentId c,
    TriPortId at, TriPortId from, TriSignatureId signature, TriParameterListType triPars,
    TriParameter repl, TriAddress address);
public void tliPrGetReplyDetected_c(String am, int ts, String src, int line, TriComponentId c,
    TriPortId at, TriPortId from, TriSignatureId signature, TciParameterList tciPars,
    Value replValue);
public void tliPrGetReplyMismatch_m(String am, int ts, String src, int line, TriComponentId c,
    TriPortId at, TriSignatureId signature,
    TciParameterList tciPars, TciValueTemplate parsTmpl,
    Value replValue, TciValueTemplate replyTmpl, TciValueDifferenceList diffs,
    Value addrValue, TciValueTemplate addressTmpl);
public void tliPrGetReplyMismatch_c(String am, int ts, String src, int line, TriComponentId c,
    TriPortId at, TriSignatureId signature,
    TciParameterList tciPars, TciValueTemplate parsTmpl,
    Value replValue, TciValueTemplate replyTmpl, TciValueDifferenceList diffs,
    TriComponentId from, TciNonValueTemplate fromTmpl);
public void tliPrGetReply_m(String am, int ts, String src, int line, TriComponentId c,
    TriPortId at, TriSignatureId signature,
    TciParameterList tciPars, TciValueTemplate parsTmpl,
    Value replValue, TciValueTemplate replyTmpl,
    Value addrValue, TciValueTemplate addressTmpl);

```

```

public void tliPrGetReply_c(String am, int ts, String src, int line, TriComponentId c,
    TriPortId at, TriSignatureId signature,
    TciParameterList tciPars, TciValueTemplate parsTmpl,
    Value replValue, TciValueTemplate replyTmpl,
    TriComponentId from, TciNonValueTemplate fromTmpl);
public void tliPrRaise_m(String am, int ts, String src, int line, TriComponentId c,
    TriPortId at, TriPortId to,
    TriSignatureId signature, TciParameterList tciPars, Value excValue,
    Value addrValue, TciStatus encoderFailure, TriException exc,
    TriAddress address, TriStatus transmissionFailure);
public void tliPrRaise_m_BC(String am, int ts, String src, int line, TriComponentId c,
    TriPortId at, TriPortId to,
    TriSignatureId signature, TciParameterList tciPars, Value excValue,
    TciStatus encoderFailure, TriException exc, TriStatus transmissionFailure);
public void tliPrRaise_m_MC(String am, int ts, String src, int line, TriComponentId c,
    TriPortId at, TriPortId to,
    TriSignatureId signature, TciParameterList tciPars, Value excValue,
    TciValueList addrValues, TciStatus encoderFailure, TriException exc,
    TriAddressList addresses, TriStatus transmissionFailure);
public void tliPrRaise_c(String am, int ts, String src, int line, TriComponentId c,
    TriPortId at, TriPortId to, TriSignatureId signature,
    TciParameterList tciPars, Value excValue, TriStatus transmissionFailure);
public void tliPrRaise_c_BC(String am, int ts, String src, int line, TriComponentId c,
    TriPortId at, TriPortIdList to, TriSignatureId signature, TciParameterList tciPars,
    Value excValue, TriStatus transmissionFailure);
public void tliPrRaise_c_MC(String am, int ts, String src, int line, TriComponentId c,
    TriPortId at, TriPortIdList to, TriSignatureId signature, TciParameterList tciPars,
    Value excValue, TriStatus transmissionFailure);
public void tliPrCatchDetected_m(String am, int ts, String src, int line, TriComponentId c,
    TriPortId at, TriPortId from, TriSignatureId signature,
    TriException exc, TriAddress address);
public void tliPrCatchDetected_c(String am, int ts, String src, int line, TriComponentId c,
    TriPortId at, TriPortId from, TriSignatureId signature,
    Value excValue);
public void tliPrCatchMismatch_m(String am, int ts, String src, int line, TriComponentId c,
    TriPortId at, TriSignatureId signature,
    Value excValue, TciValueTemplate excTmpl, TciValueDifferenceList diffs,
    Value addrValue, TciValueTemplate addressTmpl);
public void tliPrCatchMismatch_c(String am, int ts, String src, int line, TriComponentId c,
    TriPortId at, TriSignatureId signature,
    Value excValue, TciValueTemplate excTmpl, TciValueDifferenceList diffs,
    TriComponentId from, TciNonValueTemplate fromTmpl);
public void tliPrCatch_m(String am, int ts, String src, int line, TriComponentId c,
    TriPortId at, TriSignatureId signature,
    Value excValue, TciValueTemplate excTmpl,
    Value addrValue, TciValueTemplate addressTmpl);
public void tliPrCatch_c(String am, int ts, String src, int line, TriComponentId c,
    TriPortId at, TriSignatureId signature,
    Value excValue, TciValueTemplate excTmpl,
    TriComponentId from, TciNonValueTemplate fromTmpl);
public void tliPrCatchTimeoutDetected(String am, int ts, String src, int line, TriComponentId c,
    TriPortId at, TriSignatureId signature);
public void tliPrCatchTimeout(String am, int ts, String src, int line, TriComponentId c,
    TriPortId at, TriSignatureId signature);
public void tliCCreate(String am, int ts, String src, int line, TriComponentId c,
    TriComponentId comp, String name, Boolean alive);
public void tliCStart(String am, int ts, String src, int line, TriComponentId c,
    TriComponentId comp, TciBehaviourId name, TciParameterList tciPars);
public void tliCRunning(String am, int ts, String src, int line, TriComponentId c,
    TriComponentId comp, ComponentStatus status);
public void tliCAlive(String am, int ts, String src, int line, TriComponentId c,
    TriComponentId comp, ComponentStatus status);
public void tliCStop(String am, int ts, String src, int line, TriComponentId c,
    TriComponentId comp);
public void tliCKill(String am, int ts, String src, int line, TriComponentId c,
    TriComponentId comp);
public void tliCDoneMismatch(String am, int ts, String src, int line, TriComponentId c,
    TriComponentId comp, TciNonValueTemplate compTmpl);
public void tliCDone(String am, int ts, String src, int line, TriComponentId c,
    TciNonValueTemplate compTmpl, VerdictValue verdict);
public void tliCKilledMismatch(String am, int ts, String src, int line, TriComponentId c,
    TriComponentId comp, TciNonValueTemplate compTmpl);
public void tliCKilled(String am, int ts, String src, int line, TriComponentId c,
    TciNonValueTemplate compTmpl, VerdictValue verdict);
public void tliCTerminated(String am, int ts, String src, int line, TriComponentId c,
    VerdictValue verdict, String reason);
public void tliPConnect(String am, int ts, String src, int line, TriComponentId c,
    TriPortId port1, TriPortId port2);

```

```

public void tliPDisconnect(String am, int ts, String src, int line, TriComponentId c,
    TriPortId port1, TriPortId port2);
public void tliPMap(String am, int ts, String src, int line, TriComponentId c,
    TriPortId port1, TriPortId port2);
public void tliPMapParam(String am, int ts, String src, int line, TriComponentId c,
    TriPortId port1, TriPortId port2, TciParameterList tciPars,
    TciStatus encoderFailure, TriParameterList triPars);
public void tliPUnmap(String am, int ts, String src, int line, TriComponentId c,
    TriPortId port1, TriPortId port2);
public void tliPUnmapParam(String am, int ts, String src, int line, TriComponentId c,
    TriPortId port1, TriPortId port2, TciParameterList tciPars,
    TciStatus encoderFailure, TriParameterList triPars);
public void tliPClear(String am, int ts, String src, int line, TriComponentId c,
    TriPortId port);
public void tliPStart(String am, int ts, String src, int line, TriComponentId c,
    TriPortId port);
public void tliPStop(String am, int ts, String src, int line, TriComponentId c,
    TriPortId port);
public void tliPHalt(String am, int ts, String src, int line, TriComponentId c,
    TriPortId port);
public void tliEncode(String am, int ts, String src, int line, TriComponentId c,
    Value val, TciStatus encoderFailure, TriMessage msg, String codec);
public void tliDecode(String am, int ts, String src, int line, TriComponentId c,
    TriMessage msg, TciStatus decoderFailure, Value val, String codec);
public void tliTimeoutDetected(String am, int ts, String src, int line, TriComponentId c,
    TriTimerId timer);
public void tliTimeoutMismatch(String am, int ts, String src, int line, TriComponentId c,
    TriTimerId timer, TciNonValueTemplate timerTpl);
public void tliTimeout(String am, int ts, String src, int line, TriComponentId c,
    TriTimerId timer, TciNonValueTemplate timerTpl);
public void tliTStart(String am, int ts, String src, int line, TriComponentId c,
    TriTimerId timer, TriTimerDuration dur);
public void tliTStop(String am, int ts, String src, int line, TriComponentId c,
    TriTimerId timer, TriTimerDuration dur);
public void tliTRead(String am, int ts, String src, int line, TriComponentId c,
    TriTimerId timer, TriTimerDuration elapsed);
public void tliTRunning(String am, int ts, String src, int line, TriComponentId c,
    TriTimerId timer, TimerStatus status);
public void tliSEnter(String am, int ts, String src, int line, TriComponentId c,
    QualifiedName name, TciParameterList tciPars, String kind);
public void tliSLeave(String am, int ts, String src, int line, TriComponentId c,
    QualifiedName name, TciParameterList tciPars, Value returnValue, String kind);
public void tliVAr(String am, int ts, String src, int line, TriComponentId c,
    QualifiedName name, Value varValue);
public void tliModulePar(String am, int ts, String src, int line, TriComponentId c,
    QualifiedName name, Value parValue);
public void tliGetVerdict(String am, int ts, String src, int line, TriComponentId c,
    VerdictValue verdict);
public void tliSetVerdict(String am, int ts, String src, int line, TriComponentId c,
    VerdictValue verdict, String reason);
public void tliLog(String am, int ts, String src, int line, TriComponentId c,
    String log);
public void tliAEnter(String am, int ts, String src, int line, TriComponentId c);
public void tliALeave(String am, int ts, String src, int line, TriComponentId c);
public void tliADefaults(String am, int ts, String src, int line, TriComponentId c);
public void tliAActivate(String am, int ts, String src, int line, TriComponentId c,
    QualifiedName name, TciParameterList tciPars, Value ref);
public void tliADeactivate(String am, int ts, String src, int line, TriComponentId c,
    Value ref);
public void tliANomatch(String am, int ts, String src, int line, TriComponentId c);
public void tliARepeat(String am, int ts, String src, int line, TriComponentId c);
public void tliAwait(String am, int ts, String src, int line, TriComponentId c);
public void tliAction(String am, int ts, String src, int line, TriComponentId c, String action);
public void tliMatch(String am, int ts, String src, int line, TriComponentId c, Value expr,
    TciValueTemplate tpl);
public void tliMatchMismatch(String am, int ts, String src, int line, TriComponentId c,
    Value expr, TciValueTemplate tpl, TciValueDifferenceList diffs);
public void tliInfo(String am, int ts, String src, int line, TriComponentId c,
    int level, String info);
public void tliMChecked_m(String am, int ts, String src, int line, TriComponentId c,
    TriPortId at, Value msgValue, TciValueTemplate msgTpl,
    Value addrValue, TciValueTemplate addressTpl);
public void tliMChecked_c(String am, int ts, String src, int line, TriComponentId c,
    TriPortId at, Value msgValue, TciValueTemplate msgTpl,
    TriComponentId from, TciNonValueTemplate fromTpl);
public void tliPrGetCallChecked_m(String am, int ts, String src, int line, TriComponentId c,
    TriPortId at, TriSignatureId signature, TciParameterList tciPars,
    TciValueTemplate parsTpl, Value addrValue, TciValueTemplate addressTpl);

```

```

public void tliPrGetCallChecked_c(String am, int ts, String src, int line, TriComponentId c,
    TriPortId at, TriSignatureId signature, TciParameterList tciPars,
    TciValueTemplate parsTmpl, TriComponentId from, TciNonValueTemplate fromTmpl);
public void tliPrGetReplyChecked_m(String am, int ts, String src, int line, TriComponentId c,
    TriPortId at, TriSignatureId signature,
    TciParameterList tciPars, TciValueTemplate parsTmpl,
    Value replValue, TciValueTemplate replyTmpl,
    Value addrValue, TciValueTemplate addressTmpl);
public void tliPrGetReplyChecked_c(String am, int ts, String src, int line, TriComponentId c,
    TriPortId at, TriSignatureId signature,
    TciParameterList tciPars, TciValueTemplate parsTmpl,
    Value replValue, TciValueTemplate replyTmpl,
    TriComponentId from, TciNonValueTemplate fromTmpl);
public void tliPrCatchChecked_m(String am, int ts, String src, int line, TriComponentId c,
    TriPortId at, TriSignatureId signature,
    Value excValue, TciValueTemplate excTmpl,
    Value addrValue, TciValueTemplate addressTmpl);
public void tliPrCatchChecked_c(String am, int ts, String src, int line, TriComponentId c,
    TriPortId at, TriSignatureId signature,
    Value excValue, TciValueTemplate excTmpl,
    TriComponentId from, TciNonValueTemplate fromTmpl);
public void tliCheckedAny_m(String am, int ts, String src, int line, TriComponentId c,
    TriPortId at, Value addrValue, TciValueTemplate addressTmpl);
public void tliCheckedAny_c(String am, int ts, String src, int line, TriComponentId c,
    TriPortId at, TriComponentId from, TciNonValueTemplate fromTmpl);
public void tliCheckAnyMismatch_m(String am, int ts, String src, int line,
    TriComponentId c, TriPortId at, Value addrValue, TciValueTemplate addressTmpl);
public void tliCheckAnyMismatch_c(String am, int ts, String src, int line,
    TriComponentId c, TriPortId at, TriComponentId from, TciNonValueTemplate fromTmpl);
public void tliRnd(String am, int ts, String src, int line,
    TriComponentId c, FloatValue val, FloatValue seed);
public void tliEvaluate(String am, int ts, String src, int line, TriComponentId c,
    QualifiedName name, Value evalResult);
public void tliCCall (String am, int ts, String src, int line, TriComponentId c,
    TriComponentId comp, TciBehaviourId name, TciParameterList tciPars);
public void tliCCallTerminated (String am, int ts, String src, int line, TriComponentId c,
    VerdictValue verdict, String reason, TciParameterList tciPars, Value returnValue);
public void tliCtrlStartWithParameters (String am, int ts, String src, int line,
    TriComponentId c, TciParameterList tciPars);
public void tliCtrlTerminatedWithResult (String am, int ts, String src, int line,
    TriComponentId c, Value result, TciParameterList tciPars);
}

```

## 8.6 Optional parameters

Clause 7.2.2 defines that a reserved value shall be used to indicate the absence of an optional parameter. For the Java™ language mapping the Java™ null value shall be used to indicate the absence of an optional value. For example, if in the `tciReplyConnected` operation the value parameter shall be omitted the operation invocation shall be `tciReplyConnected (sender, receiver, signature, parameterList, null)`.

## 8.7 TCI initialization

All methods are non-static, i.e. operations can only be called on objects. As the present document does not define concrete implementation strategies of TE, TM, CD and CH the mechanism how the TE, the TM, the CD or the CH get to know the handles on the respective objects is out of scope of the present document.

Tool vendors shall provide methods to the developers of TM, CD and CH to register the TE, TM, CD and CH to their respective communication partner.

## 8.8 Error handling

All operations called from the TM, CH or CD that return have succeeded. If an erroneous situation has been identified by the TE a test case error will be communicated to the user using the procedures as defined in clause 7.3.1.2.6 (`tciError`). If an operation called by the TE in the TM, CH, CD, or TL produces an error, this erroneous situation should be communicated to the TE using the procedures as defined in clause 7.3.2.1.12 (`tciErrorReq`).

Beside this error handling no additional error handling is defined with this Java™ language mapping. In particular, no exception handling mechanisms are defined.

## 9 ANSI C language mapping

### 9.1 Introduction

This clause defines the TCI ANSI-C [8] language mapping for the TCI data specified in clause 7.2 and for the TCI operations specified in clause 7.3.

### 9.2 Value interfaces

**Table 5**

| TCI IDL Interface                                      | ANSI C representation  | Notes and comments   |
|--|--|--|
| <b>Type</b>  |  |  |
| TciModuleIdType<br>getDefiningModule()                 | TciModuleIdType<br>tciGetDefiningModule(Type inst)                                 |  |
| Tstring getName()                                      | String tciGetName(Type inst)   | String type reused from IDL (OMG recommendation)   |
| TciTypeClassType<br>getTypeClass()                     | TciTypeClassType tciGetTypeClass<br>(Type inst)                                    |  |
| Value newInstance()                                    | Value tciNewInstance(Type inst)  |  |
| Value newTemplate<br>(TciMatchingType<br>matchingType) | Value tciNewTemplate(Type inst, TciMatchingTypeType<br>matchingType)               |  |
| TString getTypeEncoding()                              | String tciGetTypeEncoding(Type inst)   |  |
| TStringSeq getTypeExtension()                          | String* tciGetTypeExtension(Type inst)   | Returns null pointer or a null-pointer terminated array  |
| TString<br>getTypeEncodingVariant()                    | String tciGetTypeEncodingVariant(Type inst)  |  |
| TString getEncodeAttributes ()                         | String* tciGetTypeEncodeAttributes(Type inst)                                      | Returns null pointer or a null-pointer terminated array  |
| TString getVariantAttributes<br>(TString encoding)     | String* tciGetTypeVariantAttributes(Type inst,<br>String encoding)                 | Returns null pointer or a null-pointer terminated array  |
| Value parseValue(TString val)                          | Value tciParseValue(Type inst, String val)   |  |
| LengthRestriction<br>getTypeLengthRestriction()        | int tciGetTypeLengthRestriction<br>(Type inst, TciLengthRestriction * restriction) | Returns 0 for no restriction and -1 for restriction. The restriction is returned in the second parameter |
| RangeBoundary<br>getLowerTypeBoundary()                | int tciGetLowerTypeBoundary<br>(Type inst, TciRangeBoundary * boundary)            | Returns 0 for no boundary and -1 if boundary is present.   |
| RangeBoundary<br>getUpperTypeBoundary()                | int tciGetUpperTypeBoundary<br>(Type inst, TciRangeBoundary * boundary)            | The boundary is returned in the second parameter   |
| MatchingMechanism<br>getTypeMatchingMechanism()        | Value tciGetTypeMatchingMechanism<br>(Type inst)                                   | Get the restriction of type of value   |
| <b>Value</b>   |  |  |
| TString getValueEncoding()                             | String tciGetValueEncoding(Value inst)   |  |
| TString<br>getValueEncodingVariant()                   | String tciGetValueEncodingVariant(Value inst)                                      |  |
| TString getEncodeAttributes ()                         | String* tciGetValueEncodeAttributes(Type inst)                                     | Returns null pointer or a null-pointer terminated array  |
| TString getVariantAttributes<br>(TString encoding)     | String* tciGetValueVariantAttributes(Type inst,<br>String encoding)                | Returns null pointer or a null-pointer terminated array  |
| Type getType()   | Type tciGetType(Value inst)  |  |

| TCI IDL Interface  | ANSI C representation  | Notes and comments   |
|--|--|--|
| Tboolean notPresent()  | Boolean tciNotPresent(Value inst)  | Boolean type reused from IDL (OMG recommendation)  |
|  | void tciSetNull(Value inst)  | For optional parameters of operations, see clause 9.7  |
|  | Boolean tciIsNull(Value inst)  | For optional parameters of operations, see clause 9.7. Boolean type reused from IDL (OMG recommendation) |
| Tboolean isMatchingSymbol()                                  | Boolean tciIsMatchingSymbol(Value inst)  |  |
| TString valueToString()                                      | String tciValueToString(Value inst)  |  |
| Tboolean isLazy ()   | Boolean tciIsLazy(Value inst)  |  |
| Tboolean isFuzzy ()  | Boolean tciIsFuzzy(Value inst)   |  |
| Tboolean isEvaluated()                                       | Boolean tciIsEvaluated(Value inst)   |  |
|  | Boolean tciHasLengthRestriction(Value inst)  | Returns true if length restriction is present, false otherwise   |
| LengthRestriction<br>getLengthRestriction()                  | TciLengthRestriction tciGetLengthRestriction(Value inst)                             |  |
|  | void tciRemoveLengthRestriction(Value inst)  | Removes length restriction   |
| void setLengthRestriction<br>(LengthRestriction restriction) | void tciSetLengthRestriction(Value inst, TciLengthRestriction restriction)           |  |
| TBoolean isIfPresentEnabled()                                | Boolean tciIsIfPresentEnabled(Value inst)  |  |
| void setIfPresentEnabled(TBoolean enabled)                   | void tciSetIfPresentEnabled(Value inst, Boolean enabled)                             |  |
| LengthRestriction<br>getTypeLengthRestriction()              | int<br>tciGetValueLengthRestriction (Value inst, TciLengthRestriction * restriction) | Returns 0 for no restriction and -1 for restriction. The restriction is returned in the second parameter |
| RangeBoundary<br>getLowerTypeBoundary()                      | int<br>tciGetLowerValueBoundary<br>(Value inst, TciRangeBoundary * boundary)         | Returns 0 for no boundary and -1 if boundary is present.   |
| RangeBoundary<br>geUpperTypeBoundary()                       | int tciGetUpperValueBoundary<br>(Value inst, TciRangeBoundary * boundary)            | The boundary is returned in the second parameter   |
| MatchingMechanism<br>getTypeMatchingMechanism()              | Value tciGetValueMatchingMechanism (Value inst)                                      | Get the restriction of type of value   |
| Tboolean isOptional()  | Boolean tciIsOptional(Value inst)  |  |
| <b>IntegerValue</b>  |  |  |
| Tinteger getInt()  | String tciGetIntAbs(Value inst)  | Returns the (10-base) integer absolute value as an ASCII string  |
|  | unsigned long int tciGetIntNumberOfDigits<br>(Value inst)                            | Returns the number of digits in an integer value   |
|  | Boolean tciGetIntSign(Value inst)  | Returns true if the number is positive, false otherwise  |
|  | char tciGetIntDigit<br>(Value inst,<br>unsigned long int position)                   | Returns the value of the digit at position 'position', where position 0 is the least significant digit   |



| TCI IDL Interface  | ANSI C representation  | Notes and comments   |
|--|--|--|
|  | long long tciGetInt(Value inst)  | Alternative getInt realization for integers not exceeding the boundaries of signed 64-bit                                  |
| void setInt(in Tinteger value)                                     | void tciSetIntAbs(Value inst, String value)  | Sets the (10-base) absolute value of the integer via an ASCII string. The first digit shall not be 0 unless the value is 0 |
|  | Void tciSetIntNumberOfDigits<br>(Value inst,<br>unsigned long int dig_num)                       | Sets the number of digits in an integer value  |
|  | void tciSetIntSign<br>(Value inst,<br>Boolean sign)  | Sets the sign to + (true) or - (false)   |
|  | void tciSetIntDigit<br>(Value inst,<br>unsigned long int position,<br>char digit)                | Sets the value of the digit at position 'position', where position 0 is the least significant digit                        |
|  | void tciSetInt(Value inst, long long value)  | Alternative setInt realization for integers not exceeding the boundaries of signed 64-bit                                  |
| <b>FloatValue</b>  |  |  |
| Tfloat getFloat()  | double tciGetFloatValue(Value inst)  |  |
| void setFloat(in Tfloat value)                                     | void tciSetFloatValue(Value inst, double value)  |  |
| <b>BooleanValue</b>  |  |  |
| Tboolean getBoolean()  | Boolean tciGetBooleanValue(Value inst)   |  |
| void setBoolean (in Tboolean value)                                | void tciSetBooleanValue<br>(Value inst, Boolean value)   |  |
| <b>CharstringValue</b>   |  |  |
| Tstring getString()  | TciCharStringValue tciGetCStringValue(Value inst)  |  |
| void setString(in Tstring value)                                   | void tciSetCStringValue<br>(Value inst, TciCharStringValue value)                                |  |
| Tchar getChar (in Tinteger position)                               | char tciGetCStringCharValue<br>(Value inst, long int position)                                   |  |
| void setChar<br>(in Tinteger position, in Tchar value)             | void tciSetCStringCharValue<br>(Value inst,<br>long int position,<br>char value)                 |  |
| Tinteger getLength()   | unsigned long int tciGetCStringLength (Value inst)   |  |
| void setLength(in Tinteger len)                                    | void tciSetCStringLength<br>(Value inst,<br>unsigned long int len)                               |  |
| <b>UniversalCharstringValue</b>                                    |  |  |
| Tstring getString()  | TciUCStringValue tciGetUCStringValue(Value inst)   |  |
| void setString(in Tstring value)                                   | void tciSetUCStringValue<br>(Value inst, TciUCStringValue value)                                 |  |
| TuniversalChar getChar<br>(in Tinteger position)                   | void tciGetUCStringCharValue<br>(Value inst, unsigned long int position,<br>TciUCValue result)   |  |
| void setChar<br>(in Tinteger position,<br>in TuniversalChar value) | void tciSetUCStringCharValue<br>(Value inst,<br>unsigned long int position,<br>TciUCValue value) |  |
| Tinteger getLength()   | unsigned long int tciGetUCStringLength(Value inst)   |  |
| void setLength(in Tinteger len)                                    | void tciSetUCStringLength<br>(Value inst,<br>unsigned long int len)                              |  |

| TCI IDL Interface   | ANSI C representation   | Notes and comments |
|---|---|--------------------|
| <b>BitstringValue</b>   |   |                    |
| Tstring getString()   | String tciGetBStringValue(Value inst)   |                    |
| void setString(in Tstring value)  | void tciSetBStringValue<br>(Value inst, String value)                                     |                    |
| Tchar getBit (in integer position)  | int tciGetBStringBitValue<br>(Value inst, long int position)                              |                    |
| void setBit<br>(in Tinteger position,<br>in Tinteger value)                 | void tciSetBStringBitValue<br>(Value inst,<br>unsigned long int position,<br>int value)   |                    |
| Tinteger getLength()  | unsigned long int tciGetBStringLength(Value inst)   |                    |
| void setLength(in Tinteger len)   | void tciSetBStringLength<br>(Value inst,<br>long int len)                                 |                    |
| TBoolean isMatchingAt(in<br>Tinteger position)                              | Boolean tciIsBStringMatchingAt(Value inst, unsigned<br>long int position)                 |                    |
| MatchingMechanism<br>getMatchingAt(in Tinteger<br>position)                 | Value tciGetBStringMatchingAt(Value inst, unsigned<br>long int position)                  |                    |
| void setMatching(in Tinteger<br>position, in MatchingMechanism<br>template) | void tciSetBStringMatchingAt(Value inst, unsigned<br>long int position, Value template)   |                    |
| <b>HexstringValue</b>   |   |                    |
| Tstring getString()   | String tciGetHStringValue(Value inst)   |                    |
| void setString(in Tstring value)  | void tciSetHStringValue<br>(Value inst, String value)                                     |                    |
| Tchar getHex (in Tinteger<br>position)                                      | int tciGetHStringHexValue<br>(Value inst, unsigned long int position)                     |                    |
| void setBit<br>(in Tinteger position,<br>in Tinteger value)                 | void tciSetHStringHexValue<br>(Value inst,<br>unsigned long int position,<br>int value)   |                    |
| Tinteger getLength()  | long int tciGetHStringLength(Value inst)  |                    |
| void setLength(in Tinteger len)   | void tciSetHStringLength<br>(Value inst,<br>unsigned long int len)                        |                    |
| TBoolean isMatchingAt(in<br>Tinteger position)                              | Boolean tciIsHStringMatchingAt(Value inst, unsigned<br>long int position)                 |                    |
| MatchingMechanism<br>getMatchingAt(in Tinteger<br>position)                 | Value tciGetHStringMatchingAt(Value inst, unsigned<br>long int position)                  |                    |
| void setMatching(in Tinteger<br>position, in MatchingMechanism<br>template) | void tciSetHStringMatchingAt(Value inst, unsigned<br>long int position, Value template)   |                    |
| <b>OctetstringValue</b>   |   |                    |
| Tstring getString()   | String tciGetOStringValue(Value inst)   |                    |
| void setString(in Tstring value)  | void tciSetOStringValue<br>(Value inst, String value)                                     |                    |
| Tchar getOctet(in Tinteger<br>position)                                     | int tciGetOStringOctetValue<br>(Value inst, unsigned long int position)                   |                    |
| void setOctet<br>(in Tinteger position,<br>in Tinteger value)               | void tciSetOStringOctetValue<br>(Value inst,<br>unsigned long int position,<br>int value) |                    |
| Tinteger getLength()  | unsigned long int tciGetOStringLength(Value inst)   |                    |
| void setLength(in Tinteger len)   | void tciSetOStringLength<br>(Value inst,<br>unsigned long int len)                        |                    |
| TBoolean isMatchingAt(in<br>Tinteger position)                              | Boolean tciIsOStringMatchingAt(Value inst, unsigned<br>long int position)                 |                    |
| MatchingMechanism<br>getMatchingAt(in Tinteger<br>position)                 | Value tciGetOStringMatchingAt(Value inst, unsigned<br>long int position)                  |                    |
| void setMatching(in Tinteger<br>position, in MatchingMechanism<br>template) | void tciSetOStringMatchingAt(Value inst, unsigned<br>long int position, Value template)   |                    |

| TCI IDL Interface  | ANSI C representation   | Notes and comments  |
|--|---|---|
| <b>RecordValue</b>   |   |   |
| Value getField(in Tstring fieldName int)                       | Value tciGetRecFieldValue<br>(Value inst,<br>String fieldName int)                        |   |
| void setField<br>(in Tstring fieldName int,<br>in Value value) | void tciSetRecFieldValue<br>(Value inst,<br>String fieldName int,<br>Value value)         |   |
| Tstring[] getFieldNames()                                      | char** tciGetRecFieldNames(Value inst)  | Returns a<br>NULL-terminated<br>array of the field<br>names |
| void setFieldOmitted<br>(in Tstring fieldName int)             | void setFieldOmitted<br>(Value inst,<br>String fieldName int)                             |   |
| <b>RecordOfValue</b>   |   |   |
| Value getField(in Tinteger position)                           | Value tciGetRecOfFieldValue<br>(Value inst,<br>unsigned long int position)                |   |
| void setField<br>(in Tinteger position,<br>in Value value)     | void tciSetRecOfFieldValue<br>(Value inst,<br>unsigned long int position,<br>Value value) |   |
| void appendField(in Value value)                               | void tciAppendRecOfFieldValue<br>(Value inst,<br>Value value)                             |   |
| Type getElementType()  | Type tciGetRecOfElementType(Value inst)   |   |
| Tinteger getLength()   | unsigned long int tciGetRecOfLength(Value inst)   |   |
| void setLength(in Tinteger len)                                | void tciSetRecOfLength<br>(Value inst,<br>unsigned long int len)                          |   |
| Tinteger getOffset()   | unsigned long int tciGetOffset(Value inst)  |   |
| Tinteger getPermutationCount()                                 | unsigned long int tciGetPermutationCount(Value inst)                                      |   |
| Permutation<br>getPermutation(Tinteger index)                  | TciPermutation tciGetPermutation(Value inst,<br>unsigned long int index)                  |   |
| void<br>definePermutation(Permutation permutation)             | void tciDefinePermutation(Value inst, TciPermutation permutation)                         |   |
| void<br>removePermutation(Tinteger index)                      | void tciRemovePermutation(Value inst, unsigned long int index)                            |   |
| void clearPermutations()                                       | void tciClearPermutations(Value inst)   |   |
| <b>UnionValue</b>  |   |   |
| Value getVariant<br>(in Tstring variantName)                   | Value tciGetUnionVariant<br>(Value inst,<br>String variantName)                           |   |
| void setVariant<br>(in Tstring variantName,<br>in Value value) | void tciSetUnionVariant<br>(Value inst,<br>String variantName,<br>Value value)            |   |
| Tstring<br>getPresentVariantName()                             | String tciGetUnionPresentVariantName<br>(Value inst)                                      |   |
| Tstring[] getVariantNames()                                    | char** tciGetUnionVariantNames(Value inst)  | Returns a<br>NULL-terminated<br>array of the field<br>names |
| <b>EnumeratedValue</b>   |   |   |
| Tstring getEnum()  | String tciGetEnumValue(Value inst)  |   |
| void setEnum(in Tstring enumValue)                             | void tciSetEnumValue<br>(Value inst,<br>String enumValue)                                 |   |
| Tinteger getInt()  | long tciGetEnumInt(Value inst);   |   |
| setInt(in Tinteger intValue)                                   | void tciSetEnumInt(Value inst, long intValue);  |   |
| <b>VerdictValue</b>  |   |   |
| Tinteger getVerdict()  | int tciGetVerdictValue(Value inst)  |   |
| void setVerdict(in Tinteger verdict)                           | void tciSetVerdictValue(Value inst, int verdict)  |   |

| TCI IDL Interface   | ANSI C representation   | Notes and comments |
|---|---|--------------------|
| <b>AddressValue</b>                                       |   |                    |
| Value getAddress()  | Value tciGetAddressValue(Value inst)                                      |                    |
| void setAddress(in Value value)                           | void tciSetAddressValue(Value inst, Value value)                          |                    |
| <b>MatchingMechanism</b>                                  |   |                    |
| TciMatchingTypeType<br>getMatchingType()                  | TciMatchingTypeType tciGetMatchingType(Value inst)                        |                    |
| <b>MatchingList</b>                                       |   |                    |
| TInteger size()   | unsigned long int tciGetMatchingListSize(Value inst)                      |                    |
| Value get(TInteger position)                              | Value tciGetMatchingListItem(Value inst, unsigned long int position)      |                    |
| void add(Value item)                                      | void tciAddMatchingListItem(Value inst, Value item)                       |                    |
| void remove(TInteger position)                            | void tciRemoveMatchingListItem(Value inst, unsigned long int position)    |                    |
| void clear()  | void tciClearMatchingList(Value inst)                                     |                    |
| <b>ValueRange</b>   |   |                    |
| RangeBoundary<br>getLowerBoundary()                       | TciRangeBoundary tciGetLowerRangeBoundary(Value inst)                     |                    |
| RangeBoundary<br>getUpperBoundary()                       | TciRangeBoundary tciGetUpperRangeBoundary(Value inst)                     |                    |
| void setLowerBoundary<br>(RangeBoundary<br>lowerBoundary) | void tciSetLowerRangeBoundary(Value inst, TciRangeBoundary lowerBoundary) |                    |
| void setUpperBoundary<br>(RangeBoundary<br>upperBoundary) | void tciSetUpperRangeBoundary(Value inst, TciRangeBoundary upperBoundary) |                    |
| <b>CharacterPattern</b>                                   |   |                    |
| Value getPatternString ()                                 | Value tciGetPatternString(Value inst)                                     |                    |
| void setPatternString(Value<br>characterPattern)          | void tciSetPatternString(Value inst, Value characterPattern)              |                    |
| <b>MatchDecodedContent</b>                                |   |                    |
| Value getContent()  | Value tciGetDecodedMatchContent(Value inst)                               |                    |
| void setContent(Value content)                            | void tciSetDecodedMatchContent(Value inst, Value content)                 |                    |

## 9.3 Logging interface

Table 6

| TCI IDL Interface          | ANSI C representation  | Notes and comments                                |
|----------------------------|--|---|
| <b>TciValueTemplate</b>    |  |   |
| Tboolean isOmit()          | Boolean tciIsOmit(TciValueTemplate inst)                       | Boolean type reused from IDL (OMG recommendation) |
| Tboolean isAny()           | Boolean tciIsAny(TciValueTemplate inst)                        | Boolean type reused from IDL (OMG recommendation) |
| Tboolean isAnyOrOmit()     | Boolean tciIsAnyOrOmit(TciValueTemplate inst)                  | Boolean type reused from IDL (OMG recommendation) |
| Tstring getTemplateDef()   | String tciGetTemplateDef(TciValueTemplate inst)                | String type reused from IDL (OMG recommendation)  |
| <b>TciNonValueTemplate</b> |  |   |
| Tboolean isAny()           | Boolean tciIsAnyNonValue<br>(TciNonValueTemplate inst)         | Boolean type reused from IDL (OMG recommendation) |
| Tboolean isAll()           | Boolean tciIsAllNonValue<br>(TciNonValueTemplate inst)         | Boolean type reused from IDL (OMG recommendation) |
| Tstring getTemplateDef()   | String tciGetTemplateDefNonValue<br>(TciNonValueTemplate inst) | String type reused from IDL (OMG recommendation)  |

| TCI IDL Interface                         | ANSI C representation  | Notes and comments                                |
|---|--|---|
| <b>TciValueList</b>                       |  |   |
| Tinteger size()                           | int size(TciValueList inst)                                      |   |
| Tboolean isEmpty()                        | Boolean isEmpty(TciValueList inst)                               | Boolean type reused from IDL (OMG recommendation) |
| Value get(Tinteger index)                 | Value get(TciValueList inst, int index)                          |   |
| <b>TciValueDifference</b>                 |  |   |
| Value getValue()                          | Value getValue(TciValueDifference inst)                          |   |
| TcivalueTemplate<br>getTcivalueTemplate() | TcivalueTemplate<br>getTcivalueTemplate(TciValueDifference inst) |   |
| Tstring getDescription()                  | String getDescription(TciValueDifference inst)                   | String type reused from IDL (OMG recommendation)  |
| <b>TciValueDifferenceList</b>             |  |   |
| Tinteger size()                           | int size(TciValueDifferenceList inst)                            |   |
| Tboolean isEmpty()                        | Boolean isEmpty(TciValueDifferenceList inst)                     | Boolean type reused from IDL (OMG recommendation) |
| TcivalueDifference<br>get(Tinteger index) | TcivalueDifference get(TciValueDifferenceList inst, int index)   |   |

## 9.4 Operation interfaces

### 9.4.1 The TCI-TM interface

#### 9.4.1.1 TCI-TM provided

The TCI-TM Provided interface is mapped to the following interface:

```
void tciTestCaseStarted
    (TciTestCaseIdType testCaseId, TciParameterListType parameterList, double timer)
void tciTestCaseTerminated (VerdictValue verdict, TciParameterListType parameterlist)
void tciControlTerminated()
Value tciGetModulePar (TciModuleParameterIdType parameterId)
void tciLog(String message)
void tciError(String message)
void tciControlTerminatedWithResult (Value result, TciParameterListType parameterlist)
```

#### 9.4.1.2 TCI-TM required

The TCI-TM Required interface is mapped to the following interface:

```
void tciRootModule(String moduleId)
TciModuleIdListType tciGetImportedModules()
TciModuleParameterListType tciGetModuleParameters(TciModuleIdType moduleName)
TciTestCaseIdListType tciGetTestCases()
TciParameterTypeListType tciGetTestCaseParameters (TciTestCaseIdType testCaseId)
TriPortIdList tciGetTestCaseTSI (TciTestCaseIdType testCaseId)
void tciStartTestCase (TciTestCaseIdType testCaseId, TciParameterListType parameterlist)
void tciStopTestCase()
TriComponentId tciStartControl()
void tciStopControl()
TciParameterTypeListType tciGetControlParameters ()
TriComponentId tciStartControlWithParameters (TciParameterListType parameterlist)
```

## 9.4.2 The TCI-CD interface

### 9.4.2.1 TCI-CD provided

The TCI-CD Provided interface is mapped to the following interface:

```
Value tciDecode (BinaryString message, Type decHypothesis)
BinaryString tciEncode(Value value)
int tciDecodeValue (BinaryString * message, Type decHypothesis, String decodingInfo, Value *
    decodedValue)
BinaryString tciEncodeValue(Value value, string encodingInfo)
```

NOTE: BinaryString type reused from TRI.

### 9.4.2.2 TCI-CD required

The TCI-CD Required interface is mapped to the following interface:

```
Type tciGetTypeForName(String typeName)
Type tciGetIntegerType()
Type tciGetFloatType()
Type tciGetBooleanType()
Type tciGetCharType()
Type tciGetUniversalCharType()
Type tciGetTciCharstringType()
Type tciGetUniversalCharstringType()
Type tciGetHexstringType()
Type tciGetBitstringType()
Type tciGetOctetstringType()
Type tciGetVerdictType()
void tciErrorReq(String message)
```

## 9.4.3 The TCI-CH interface

### 9.4.3.1 TCI-CH provided

The TCI-CH Provided interface is mapped to the following interface:

```
void tciSendConnected(TriPortId sender, TriComponentId receiver, Value sendMessage)
void tciSendConnectedBC(TriPortId sender, Value sendMessage)
void tciSendConnectedMC
    (TriPortId sender, TriComponentIdList receivers, Value sendMessage)
void tciCallConnected
    (TriPortId sender, TriComponentId receiver, TriSignatureId signature,
    TciParameterListType parameterList)
void tciCallConnectedBC
    (TriPortId sender, TriSignatureId signature, TciParameterListType parameterList)
void tciCallConnectedMC
    (TriPortId sender, TriComponentIdList receivers, TriSignatureId signature,
    TciParameterListType parameterList)
void tciReplyConnected
    (TriPortId sender, TriComponentId receiver, TriSignatureId signature,
    TciParameterListType parameterList, Value returnValue)
void tciReplyConnectedBC
    (TriPortId sender, TriSignatureId signature, TciParameterListType parameterList,
    Value returnValue)
void tciReplyConnectedMC
    (TriPortId sender, TriComponentIdList receivers, TriSignatureId signature,
    TciParameterListType parameterList, Value returnValue)
void tciRaiseConnected
    (TriPortId sender, TriComponentId receiver, TriSignatureId signature, Value exception)
void tciRaiseConnectedBC
    (TriPortId sender, TriSignatureId signature, Value exception)
void tciRaiseConnectedMC
    (TriPortId sender, TriComponentIdList receivers, TriSignatureId signature, Value exception)
TriComponentId tciCreateTestComponentReq
    (TciTestComponentKindType kind, Type componentType, String name, Value hostId)
void tciStartTestComponentReq
    (TriComponentId component, TciBehaviourIdType behaviour, TciParameterListType parameterList)
void tciStopTestComponentReq (TriComponentId component)
void tciConnectReq(TriPortId fromPort, TriPortId toPort)
```

```

void          tciDisconnectReq(TriPortId fromPort, TriPortId toPort)
void          tciMapReq(TriPortId fromPort, TriPortId toPort)
void          tciMapParamReq
  (TriPortId fromPort, TriPortId toPort, TciParameterListType parameterList)
void          tciUnmapReq(TriPortId fromPort, TriPortId toPort)
void          tciUnmapParamReq
  (TriPortId fromPort, TriPortId toPort, TciParameterListType parameterList)
void          tciTestComponentTerminatedReq(TriComponentId component, VerdictValue verdict)
Boolean      tciTestComponentRunningReq(TriComponentId component)
Boolean      tciTestComponentDoneReq(TriComponentId component, int * verdict)
TriComponentId tciGetMTCReq()
void          tciExecuteTestCaseReq(TciTestCaseIdType testCaseId, TriPortIdList tsiPortList)
void          tciResetReq()
void          tciKillTestComponentReq(TriComponentId component)
Boolean      tciTestComponentAliveReq (TriComponentId component)
Boolean      tciTestComponentKilledReq (TriComponentId component, int * verdict)
void          tciCallTestComponentReq
  (TriComponentId component, TciBehaviourIdType behaviour, TciParameterListType parameterList)
void          tciTestComponentCallTerminatedReq
  (TriComponentId component, VerdictValue verdict, TciParameterListType parameterList,
  Value returnValue)

```

### 9.4.3.2 TCI-CH required

The TCI-CH Required interface is mapped to the following interface:

```

void          tciEnqueueMsgConnected
  (TriPortId sender, TriComponentId receiver, Value rcvdMessage)
void          tciEnqueueCallConnected
  (TriPortId sender, TriComponentId receiver, TriSignatureId signature,
  TciParameterListType parameterList)
void          tciEnqueueReplyConnected
  (TriPortId sender, TriComponentId receiver, TriSignatureId signature,
  TciParameterListType parameterList, Value returnValue)
void          tciEnqueueRaiseConnected
  (TriPortId sender, TriComponentId receiver, TriSignatureId signature, Value exception)
TriComponentId tciCreateTestComponent
  (TciTestComponentKindType kind, Type componentType, String name)
void          tciStartTestComponent
  (TriComponentId component, TciBehaviourIdType behaviour, TciParameterListType parameterList)
void          tciStopTestComponent(TriComponentId component)
void          tciConnect(TriPortId fromPort, TriPortId toPort)
void          tciDisconnect(TriPortId fromPort, TriPortId toPort)
void          tciMap (TriPortId fromPort, TriPortId toPort)
void          tciMapParam
  (TriPortId fromPort, TriPortId toPort, TciParameterListType parameterList)
void          tciUnmap(TriPortId fromPort, TriPortId toPort)
void          tciUnmapParam
  (TriPortId fromPort, TriPortId toPort, TciParameterListType parameterList)
void          tciTestComponentTerminated(TriComponentId component, VerdictValue verdict)
Boolean      tciTestComponentRunning(TriComponentId component)
Boolean      tciTestComponentDone(TriComponentId component, int * verdict)
TriComponentId tciGetMTC()
void          tciExecuteTestCase(TciTestCaseIdType testCaseId, TriPortIdList tsiPortList)
void          tciReset()
void          tciKillTestComponent(TriComponentId component)
Boolean      tciTestComponentAlive(TriComponentId component)
Boolean      tciTestComponentKilled(TriComponentId component, int * verdict)
void          tciCallTestComponent
  (TriComponentId component, TciBehaviourIdType behaviour, TciParameterListType parameterList)
void          tciTestComponentCallTerminated
  (TriComponentId component, VerdictValue verdict, TciParameterListType parameterList,
  Value returnValue)

```

## 9.4.4 The TCI-TL interface

### 9.4.4.1 TCI-TL provided

The TCI-TL Provided interface is mapped to the following interface:

```

void tliTcExecute
  (String am, int ts, String src, int line, TriComponentId c, TciTestCaseIdType tcId,
  TciParameterListType tciPars, TriTimerDuration dur)

```

```

void tliTcStart
  (String am, int ts, String src, int line, TriComponentId c, TciTestCaseIdType tcId,
   TciParameterListType tciPars, TriTimerDuration dur)
void tliTcStop
  (String am, int ts, String src, int line, TriComponentId c, String reason)
void tliTcStarted
  (String am, int ts, String src, int line, TriComponentId c, TciTestCaseIdType tcId,
   TciParameterListType tciPars, TriTimerDuration dur)
void tliTcTerminated
  (String am, int ts, String src, int line, TriComponentId c, TciTestCaseIdType tcId,
   TciParameterListType tciPars, VerdictValue verdict, String reason)

void tliCtrlStart(String am, int ts, String src, int line, TriComponentId c)
void tliCtrlStop(String am, int ts, String src, int line, TriComponentId c)
void tliCtrlTerminated(String am, int ts, String src, int line, TriComponentId c)

void tliMSend_m
  (String am, int ts, String src, int line, TriComponentId c, TriPortId at, TriPortId to,
   Value msgValue, Value addrValue, TciStatus encoderFailure, TriMessage msg,
   TriAddress address, TriStatus transmissionFailure)
void tliMSend_m_BC
  (String am, int ts, String src, int line, TriComponentId c, TriPortId at, TriPortId to,
   Value msgValue, TciStatus encoderFailure, TriMessage msg, TriStatus transmissionFailure)
void tliMSend_m_MC
  (String am, int ts, String src, int line, TriComponentId c, TriPortId at, TriPortId to,
   Value msgValue, TciValueList addrValues, TciStatus encoderFailure, TriMessage msg,
   TriAddressList addresses, TriStatus transmissionFailure)
void tliMSend_c
  (String am, int ts, String src, int line, TriComponentId c, TriPortId at, TriPortId to,
   Value msgValue, TriStatus transmissionFailure)
void tliMSend_c_BC
  (String am, int ts, String src, int line, TriComponentId c, TriPortId at, TriPortIdList to,
   Value msgValue, TriStatus transmissionFailure)
void tliMSend_c_MC
  (String am, int ts, String src, int line, TriComponentId c, TriPortId at, TriPortIdList to,
   Value msgValue, TriStatus transmissionFailure)
void tliMDetected_m
  (String am, int ts, String src, int line, TriComponentId c, TriPortId at, TriPortId from,
   TriMessage msg, TriAddress address)
void tliMDetected_c
  (String am, int ts, String src, int line, TriComponentId c, TriPortId at, TriPortId from,
   Value msgValue)
void tliMMismatch_m
  (String am, int ts, String src, int line, TriComponentId c, TriPortId at, Value msgValue,
   TciValueTemplate msgTmpl, TciValueDifferenceList diffs, Value addrValue,
   TciValueTemplate addressTmpl)
void tliMMismatch_c
  (String am, int ts, String src, int line, TriComponentId c, TriPortId at, Value msgValue,
   TciValueTemplate msgTmpl, TciValueDifferenceList diffs, TriComponentId from,
   TciNonValueTemplate fromTmpl)
void tliMReceive_m
  (String am, int ts, String src, int line, TriComponentId c, TriPortId at, Value msgValue,
   TciValueTemplate msgTmpl, Value addrValue, TciValueTemplate addressTmpl)
void tliMReceive_c
  (String am, int ts, String src, int line, TriComponentId c, TriPortId at, Value msgValue,
   TciValueTemplate msgTmpl, TriComponentId from, TciNonValueTemplate fromTmpl)

void tliPrCall_m
  (String am, int ts, String src, int line, TriComponentId c, TriPortId at,
   TriPortId to, TriSignatureId signature,
   TciParameterListType tciPars, Value addrValue, TciStatus encoderFailure,
   TriParameterList triPars, TriAddress address, TriStatus transmissionFailure)
void tliPrCall_m_BC
  (String am, int ts, String src, int line, TriComponentId c, TriPortId at, TriPortId to,
   TriSignatureId signature, TciParameterListType tciPars, TciStatus encoderFailure,
   TriParameterList triPars, TriStatus transmissionFailure)
void tliPrCall_m_MC
  (String am, int ts, String src, int line, TriComponentId c, TriPortId at, TriPortId to,
   TriSignatureId signature, TciParameterListType tciPars, TciValueList addrValues,
   TciStatus encoderFailure, TriParameterList triPars, TriAddressList addresses,
   TriStatus transmissionFailure)
void tliPrCall_c
  (String am, int ts, String src, int line, TriComponentId c, TriPortId at,
   TriPortId to, TriSignatureId signature,
   TciParameterListType tciPars, TriStatus transmissionFailure)
void tliPrCall_c_BC
  (String am, int ts, String src, int line, TriComponentId c, TriPortId at, TriPortIdList to,
   TriSignatureId signature, TciParameterListType tciPars, TriStatus transmissionFailure)

```



```

void tliPrCall_c_MC
  (String am, int ts, String srcint line, TriComponentId c, TriPortId at, TriPortIdList to,
   TriSignatureId signature, TciParameterListType tciPars, TriStatus transmissionFailure)
void tliPrGetCallDetected_m
  (String am, int ts, String src, int line, TriComponentId c, TriPortId at, TriPortId from,
   TriSignatureId signature, TriParameterList triPars, TriAddress address)
void tliPrGetCallDetected_c
  (String am, int ts, String src, int line, TriComponentId c, TriPortId at, TriPortId from,
   TriSignatureId signature, TciParameterListType tciPars)
void tliPrGetCallMismatch_m
  (String am, int ts, String src, int line, TriComponentId c, TriPortId at, TriSignatureId signature,
   TciParameterListType tciPars, TciValueTemplate parsTmpl, TciValueDifferenceList diffs,
   Value addrValue, TciValueTemplate addressTmpl)
void tliPrGetCallMismatch_c
  (String am, int ts, String src, int line, TriComponentId c, TriPortId at, TriSignatureId signature,
   TciParameterListType tciPars, TciValueTemplate parsTmpl, TciValueDifferenceList diffs,
   TriComponentId from, TciNonValueTemplate fromTmpl)
void tliPrGetCall_m
  (String am, int ts, String src, int line, TriComponentId c, TriPortId at, TriSignatureId signature,
   TciParameterListType tciPars, TciValueTemplate parsTmpl, Value addrValue,
   TciValueTemplate addressTmpl)
void tliPrGetCall_c
  (String am, int ts, String src, int line, TriComponentId c, TriPortId at, TriSignatureId signature,
   TciParameterListType tciPars, TciValueTemplate parsTmpl, TriComponentId from,
   TciNonValueTemplate fromTmpl)
void tliPrReply_m
  (String am, int ts, String src, int line, TriComponentId c, TriPortId at, TriPortId to,
   TriSignatureId signature, TciParameterListType tciPars, Value replValue,
   Value addrValue, TciStatus encoderFailure, TriParameterList triPars,
   TriParameter repl, TriAddress address, TriStatus transmissionFailure)
void tliPrReply_m_BC
  (String am, int ts, String src, int line, TriComponentId c, TriPortId at, TriPortId to,
   TriSignatureId signature, TciParameterListType tciPars, Value replValue,
   TciStatus encoderFailure, TriParameterList triPars, TriParameter repl,
   TriStatus transmissionFailure)
void tliPrReply_m_MC
  (String am, int ts, String src, int line, TriComponentId c, TriPortId at, TriPortId to,
   TriSignatureId signature, TciParameterListType tciPars, Value replValue,
   TciValueList addrValues, TriStatus encoderFailure, TriParameterList triPars,
   TriParameter repl, TriAddressList addresses, TciStatus transmissionFailure)
void tliPrReply_c
  (String am, int ts, String src, int line, TriComponentId c, TriPortId at, TriPortId to,
   TriSignatureId signature, TciParameterListType tciPars, Value replValue,
   TriStatus transmissionFailure)
void tliPrReply_c_BC
  (String am, int ts, String src, int line, TriComponentId c, TriPortId at, TriPortIdList to,
   TriSignatureId signature, TciParameterListType tciPars, Value replValue,
   TriStatus transmissionFailure)
void tliPrReply_c_MC
  (String am, int ts, String src, int line, TriComponentId c, TriPortId at, TriPortIdList to,
   TriSignatureId signature, TciParameterListType tciPars, Value replValue,
   TriStatus transmissionFailure)
void tliPrGetReplyDetected_m
  (String am, int ts, String src, int line, TriComponentId c, TriPortId at, TriPortId from,
   TriSignatureId signature, TriParameterList triPars, TriParameter repl, TriAddress address)
void tliPrGetReplyDetected_c
  (String am, int ts, String src, int line, TriComponentId c, TriPortId at, TriPortId from,
   TriSignatureId signature, TciParameterListType tciPars, Value replValue)
void tliPrGetReplyMismatch_m
  (String am, int ts, String src, int line, TriComponentId c, TriPortId at, TriSignatureId signature,
   TciParameterListType tciPars, TciValueTemplate parsTmpl, Value replValue,
   TciValueTemplate replyTmpl, TciValueDifferenceList diffs, Value addrValue,
   TciValueTemplate addressTmpl)
void tliPrGetReplyMismatch_c
  (String am, int ts, String src, int line, TriComponentId c, TriPortId at, TriSignatureId signature,
   TciParameterListType tciPars, TciValueTemplate parsTmpl, Value replValue,
   TciValueTemplate replyTmpl, TciValueDifferenceList diffs, TriComponentId from,
   TciNonValueTemplate fromTmpl)
void tliPrGetReply_m
  (String am, int ts, String src, int line, TriComponentId c, TriPortId at, TriSignatureId signature,
   TciParameterListType tciPars, TciValueTemplate parsTmpl, Value replValue,
   TciValueTemplate replyTmpl, Value addrValue, TciValueTemplate addressTmpl)
void tliPrGetReply_c
  (String am, int ts, String src, int line, TriComponentId c, TriPortId at, TriSignatureId signature,
   TciParameterListType tciPars, TciValueTemplate parsTmpl, Value replValue,
   TciValueTemplate replyTmpl, TriComponentId from, TciNonValueTemplate fromTmpl)
void tliPrRaise_m
  (String am, int ts, String src, int line, TriComponentId c, TriPortId at, TriPortId to,

```

```

    TriSignatureId signature, TciParameterListType tciPars, Value excValue, Value addrValue,
    TciStatus encoderFailure, TriException exc, TriAddress address, TriStatus transmissionFailure)
void tliPrRaise_m_BC
    (String am, int ts, String src, int line, TriComponentId c, TriPortId at, TriPortId to,
    TriSignatureId signature, TciParameterListType tciPars, Value excValue,
    TciStatus encoderFailure, TriException exc, TriStatus transmissionFailure)
void tliPrRaise_m_MC
    (String am, int ts, String src, int line, TriComponentId c, TriPortId at, TriPortId to,
    TriSignatureId signature, TciParameterListType tciPars, Value excValue,
    TciValueList addrValues, TciStatus encoderFailure, TriException exc,
    TriAddressList addresses, TriStatus transmissionFailure)
void tliPrRaise_c
    (String am, int ts, String src, int line, TriComponentId c, TriPortId at, TriPortId to,
    TriSignatureId signature, TciParameterListType tciPars, Value excValue,
    TriStatus transmissionFailure)
void tliPrRaise_c_BC
    (String am, int ts, String src, int line, TriComponentId c, TriPortId at, TriPortIdList to,
    TriSignatureId signature, TciParameterListType tciPars, Value excValue,
    TriStatus transmissionFailure)
void tliPrRaise_c_MC
    (String am, int ts, String src, int line, TriComponentId c, TriPortId at, TriPortIdList to,
    TriSignatureId signature, TciParameterListType tciPars, Value excValue,
    TriStatus transmissionFailure)
void tliPrCatchDetected_m
    (String am, int ts, String src, int line, TriComponentId c, TriPortId at, TriPortId from,
    TriSignatureId signature, TriException exc, TriAddress address)
void tliPrCatchDetected_c
    (String am, int ts, String src, int line, TriComponentId c, TriPortId at, TriPortId from,
    TriSignatureId signature, Value excValue)
void tliPrCatchMismatch_m
    (String am, int ts, String src, int line, TriComponentId c, TriPortId at, TriSignatureId signature,
    Value excValue, TciValueTemplate excTmpl, TciValueDifferenceList diffs, Value addrValue,
    TciValueTemplate addressTmpl)
void tliPrCatchMismatch_c
    (String am, int ts, String src, int line, TriComponentId c, TriPortId at, TriSignatureId signature,
    Value excValue, TciValueTemplate excTmpl, TciValueDifferenceList diffs, TriComponentId from,
    TciNonValueTemplate fromTmpl)
void tliPrCatch_m
    (String am, int ts, String src, int line, TriComponentId c, TriPortId at, TriSignatureId signature,
    Value excValue, TciValueTemplate excTmpl, Value addrValue, TciValueTemplate addressTmpl)
void tliPrCatch_c
    (String am, int ts, String src, int line, TriComponentId c, TriPortId at, TriSignatureId signature,
    Value excValue, TciValueTemplate excTmpl, TriComponentId from, TciNonValueTemplate fromTmpl)
void tliPrCatchTimeoutDetected
    (String am, int ts, String src, int line, TriComponentId c, TriPortId at, TriSignatureId signature)
void tliPrCatchTimeout
    (String am, int ts, String src, int line, TriComponentId c, TriPortId at, TriSignatureId signature)

void tliCCreate
    (String am, int ts, String src, int line, TriComponentId c, TriComponentId comp, String name,
    Boolean alive)
void tliCStart
    (String am, int ts, String src, int line, TriComponentId c, TriComponentId comp,
    TciBehaviourIdType name, TciParameterListType tciPars)
void tliCRunning
    (String am, int ts, String src, int line, TriComponentId c, TriComponentId comp,
    ComponentStatus status)
void tliCAlive
    (String am, int ts, String src, int line, TriComponentId c, TriComponentId comp,
    ComponentStatus status)
void tliCStop
    (String am, int ts, String src, int line, TriComponentId c, TriComponentId comp)
void tliCKill
    (String am, int ts, String src, int line, TriComponentId c, TriComponentId comp)
void tliCDoneMismatch
    (String am, int ts, String src, int line, TriComponentId c, TriComponentId comp,
    TciNonValueTemplate compTmpl)
void tliCDone
    (String am, int ts, String src, int line, TriComponentId c, TciNonValueTemplate compTmpl,
    VerdictValue verdict)
void tliCTerminated
    (String am, int ts, String src, int line, TriComponentId c, VerdictValue verdict, String reason)
void tliCKilledMismatch
    (String am, int ts, String src, int line, TriComponentId c, TriComponentId comp,
    TciNonValueTemplate compTmpl)
void tliCKilled
    (String am, int ts, String src, int line, TriComponentId c, TciNonValueTemplate compTmpl,
    VerdictValue verdict)

```

```

void tliPConnect
  (String am, int ts, String src, int line, TriComponentId c, TriPortId port1, TriPortId port2)
void tliPDisconnect
  (String am, int ts, String src, int line, TriComponentId c, TriPortId port1,
   TriPortId port2)
void tliPMap
  (String am, int ts, String src, int line, TriComponentId c, TriPortId port1, TriPortId port2)
void tliPMapParam
  (String am, int ts, String src, int line, TriComponentId c, TriPortId port1, TriPortId port2,
   TciParameterListType tciPars, TciStatus encoderFailure, TriParameterList triPars)
void tliPUnmap
  (String am, int ts, String src, int line, TriComponentId c, TriPortId port1,
   TriPortId port2)
void tliPUnmapParam
  (String am, int ts, String src, int line, TriComponentId c, TriPortId port1,
   TriPortId port2, TciParameterListType tciPars, TciStatus encoderFailure, TriParameterList triPars)
void tliPClear
  (String am, int ts, String src, int line, TriComponentId c, TriPortId port)
void tliPStart
  (String am, int ts, String src, int line, TriComponentId c, TriPortId port)
void tliPStop
  (String am, int ts, String src, int line, TriComponentId c, TriPortId port)
void tliPHalt
  (String am, int ts, String src, int line, TriComponentId c, TriPortId port)

void tliEncode
  (String am, int ts, String src, int line, TriComponentId c, Value val, TciStatus encoderFailure,
   TriMessage msg, String codec)
void tliDecode
  (String am, int ts, String src, int line, TriComponentId c, TriMessage msg,
   TciStatus decoderFailure, Value val, String codec)

void tliTimeoutDetected
  (String am, int ts, String src, int line, TriComponentId c, TriTimerId timer)
void tliTimeoutMismatch
  (String am, int ts, String src, int line, TriComponentId c, TriTimerId timer,
   TciNonValueTemplate timerTpl)
void tliTimeout
  (String am, int ts, String src, int line, TriComponentId c, TriTimerId timer,
   TciNonValueTemplate timerTpl)
void tliTStart
  (String am, int ts, String src, int line, TriComponentId c, TriTimerId timer, TriTimerDuration dur)
void tliTStop
  (String am, int ts, String src, int line, TriComponentId c, TriTimerId timer, TriTimerDuration dur)
void tliTRead
  (String am, int ts, String src, int line, TriComponentId c, TriTimerId timer,
   TriTimerDuration elapsed)
void tliTRunning
  (String am, int ts, String src, int line, TriComponentId c, TriTimerId timer, TimerStatus status)

void tliSEnter
  (String am, int ts, String src, int line, TriComponentId c, QualifiedName name,
   TciParameterListType tciPars, String kind)
void tliSLeave
  (String am, int ts, String src, int line, TriComponentId c, QualifiedName name,
   TciParameterListType tciPars, Value returnValue, String kind)

void tliVar
  (String am, int ts, String src, int line, TriComponentId c, QualifiedName name, Value varValue)
void tliModulePar
  (String am, int ts, String src, int line, TriComponentId c, QualifiedName name, Value parValue)

void tliGetVerdict(String am, int ts, String src, int line, TriComponentId c, VerdictValue verdict)
void tliSetVerdict
  (String am, int ts, String src, int line, TriComponentId c, VerdictValue verdict, String reason)

void tliLog(String am, int ts, String src, int line, TriComponentId c, String log)

void tliAEnter(String am, int ts, String src, int line, TriComponentId c)
void tliALeave(String am, int ts, String src, int line, TriComponentId c)
void tliADefaults(String am, int ts, String src, int line, TriComponentId c)
void tliAActivate
  (String am, int ts, String src, int line, TriComponentId c, QualifiedName name,
   TciParameterListType tciPars, Value ref)
void tliAdeactivate(String am, int ts, String src, int line, TriComponentId c, Value ref)
void tliANomatch(String am, int ts, String src, int line, TriComponentId c)
void tliARepeat(String am, int ts, String src, int line, TriComponentId c)

```

```

void tliAwait(String am, int ts, String src, int line, TriComponentId c)

void tliAction(String am, int ts, String src, int line, TriComponentId c, String action)

void tliMatch
  (String am, int ts, String src, int line, TriComponentId c, Value expr, TciValueTemplate tpl)
void tliMatchMismatch
  (String am, int ts, String src, int line, TriComponentId c, Value expr, TciValueTemplate tpl,
  TciValueDifferenceList diffs);

void tliInfo
  (String am, int ts, String src, int line, TriComponentId c, int level, String info)

void tliMChecked_m
  (String am, int ts, String src, int line, TriComponentId c, TriPortId at, Value msgValue,
  TciValueTemplate msgTpl, Value addrValue, TciValueTemplate addressTpl)
void tliMChecked_c
  (String am, int ts, String src, int line, TriComponentId c, TriPortId at, Value msgValue,
  TciValueTemplate msgTpl, TriComponentId from, TciNonValueTemplate fromTpl)
void tliPrGetCallChecked_m
  (String am, int ts, String src, int line, TriComponentId c, TriPortId at, TriSignatureId signature,
  TciParameterListType tciPars, TciValueTemplate parsTpl,
  Value addrValue, TciValueTemplate addressTpl)
void tliPrGetCallChecked_c
  (String am, int ts, String src, int line, TriComponentId c, TriPortId at, TriSignatureId signature,
  TciParameterListType tciPars, TciValueTemplate parsTpl,
  TriComponentId from, TciNonValueTemplate fromTpl)
void tliPrGetReplyChecked_m
  (String am, int ts, String src, int line, TriComponentId c, TriPortId at, TriSignatureId signature,
  TciParameterListType tciPars, TciValueTemplate parsTpl,
  Value replValue, TciValueTemplate replyTpl, Value addrValue, TciValueTemplate addressTpl)
void tliPrGetReplyChecked_c
  (String am, int ts, String src, int line, TriComponentId c, TriPortId at, TriSignatureId signature,
  TciParameterListType tciPars, TciValueTemplate parsTpl,
  Value replValue, TciValueTemplate replyTpl, TriComponentId from, TciNonValueTemplate fromTpl)
void tliPrCatchChecked_m
  (String am, int ts, String src, int line, TriComponentId c, TriPortId at, TriSignatureId signature,
  Value excValue, TciValueTemplate excTpl, Value addrValue, TciValueTemplate addressTpl)
void tliPrCatchChecked_c
  (String am, int ts, String src, int line, TriComponentId c, TriPortId at, TriSignatureId signature,
  Value excValue, TciValueTemplate excTpl, TriComponentId from, TciNonValueTemplate fromTpl)
void tliCheckedAny_m
  (String am, int ts, String src, int line, TriComponentId c, TriPortId at,
  Value addrValue, TciValueTemplate addressTpl)
void tliCheckedAny_c
  (String am, int ts, String src, int line, TriComponentId c, TriPortId at,
  TriComponentId from, TciNonValueTemplate fromTpl)
void tliCheckAnyMismatch_m
  (String am, int ts, String src, int line, TriComponentId c, TriPortId at,
  Value addrValue, TciValueTemplate addressTpl)
void tliCheckAnyMismatch_c
  (String am, int ts, String src, int line, TriComponentId c, TriPortId at,
  TriComponentId from, TciNonValueTemplate fromTpl)
void tliRnd
  (String am, int ts, String src, int line, TriComponentId c, Value val, Value seed)
void tliEvaluate
  (String am, int ts, String src, int line, TriComponentId c, QualifiedName name, Value evalResult)
void tliCCall
  (String am, int ts, String src, int line, TriComponentId c, TriComponentId comp,
  TciBehaviourIdType name, TciParameterListType tciPars)
void tliCCallTerminated
  (String am, int ts, String src, int line, TriComponentId c, VerdictValue verdict, String reason,
  TciParameterListType tciPars, Value returnValue)
void tliCtrlStartWithParameters
  (String am, int ts, String src, int line, TriComponentId c, TciParameterListType tciPars)
void tliCtrlTerminatedWithResult
  (String am, int ts, String src, int line, TriComponentId c, Value result,
  TciParameterListType tciPars)

```

## 9.5 Data

Table 7

| TCI IDL ADT                 | ANSI C representation (Type definition)  | Notes and comments                             |
|-----------------------------|--|--|
| TciModuleIdType             | QualifiedName  |  |
| TciModuleParameterType      | typedef struct TciModuleParameterType<br>{<br>QualifiedName parName;<br>Value defaultValue;<br>} TciModuleParameterType;   |  |
| TciModuleParameterListType  | typedef struct TciModuleParameterListType<br>{<br>long int length;<br>TciModuleParameterType *modParList;<br>} TciModuleParameterListType;   |  |
| TciParameterType            | typedef struct TciParameterType<br>{<br>String parName;<br>TciParameterPassingModeType parPassMode;<br>Value parValue;<br>} TciParameterType;  |  |
| TciParameterPassingModeType | typedef enum<br>{<br>TCI_IN_PAR = 0,<br>TCI_INOUT_PAR = 1,<br>TCI_OUT_PAR = 2<br>} TciParameterPassingModeType;  |  |
| TciParameterListType        | typedef struct TciParameterListType<br>{<br>long int length;<br>TciParameterType *parList;<br>} TciParameterListType;  | length 0 shall be interpreted as "empty list". |
| TciParameterTypeListType    | typedef struct TciParameterTypeListType<br>{<br>long int length;<br>TciParameterTypeType *parList;<br>} TciParameterTypeListType;  | length 0 shall be interpreted as "empty list". |
| TciParameterTypeType        | typedef struct TciParameterTypeType {<br>String parName;<br>Type parameterType;<br>TciParameterPassingModeType mode;<br>} TciParameterTypeType;  |  |
| TciTestCaseIdListType       | typedef struct TciTestCaseIdListType<br>{<br>long int length;<br>QualifiedName *idList;<br>} TciTestCaseIdListType;  | length 0 shall be interpreted as "empty list". |
| TciTypeClassType            | typedef enum<br>{<br>TCI_ADDRESS_TYPE = 0,<br>TCI_ANYTYPE_TYPE = 1,<br>TCI_BITSTRING_TYPE = 2,<br>TCI_BOOLEAN_TYPE = 3,<br>TCI_CHARSTRING_TYPE = 5,<br>TCI_COMPONENT_TYPE = 6,<br>TCI_ENUMERATED_TYPE = 7,<br>TCI_FLOAT_TYPE = 8,<br>TCI_HEXSTRING_TYPE = 9,<br>TCI_INTEGER_TYPE = 10,<br>TCI_OCTETSTRING_TYPE = 12,<br>TCI_RECORD_TYPE = 13,<br>TCI_RECORD_OF_TYPE = 14,<br>TCI_ARRAY_TYPE = 15,<br>TCI_SET_TYPE = 16,<br>TCI_SET_OF_TYPE = 17,<br>TCI_UNION_TYPE = 18,<br>TCI_UNIVERSAL_CHARSTRING_TYPE = 20,<br>TCI_VERDICT_TYPE = 21,<br>TCI_DEFAULT_TYPE = 22,<br>TCI_PORT_TYPE = 23,<br>TCI_TIMER_TYPE = 24<br>} TciTypeClassType; |  |

| TCI IDL ADT              | ANSI C representation (Type definition)  | Notes and comments                             |
|--------------------------|--|--|
| TciTestComponentKindType | <pre>typedef enum {     TCI_CTRL_COMP,     TCI_MTC_COMP,     TCI_PTC_COMP,     TCI_SYS_COMP,     TCI_ALIVE_COMP } TciTestComponentKindType;</pre>  |  |
| TciBehaviourIdType       | QualifiedName  |  |
| TciValueDifference       | <pre>typedef struct TciValueDifference {     Value          val;     TciValueTemplate tmpl;     String         desc; } TciValueDifference;</pre>   |  |
| TciValueDifferenceList   | <pre>typedef struct TciValueDifferenceList {     long int      length;     TciValueDifference* diffList; } TciValueDifferenceList;</pre>   | length 0 shall be interpreted as "empty list". |
| TciMatchingTypeType      | <pre>typedef enum {     TCI_TEMPLATE_LIST = 0,     TCI_COMPLEMENTED_LIST = 1,     TCI_ANY_VALUE = 2,     TCI_ANY_VALUE_OR_NONE = 3,     TCI_VALUE_RANGE = 4,     TCI_SUBSET = 5,     TCI_SUPERSET = 6,     TCI_ANY_ELEMENT = 7,     TCI_ANY_ELEMENTS_OR_NONE = 8,     TCI_PATTERN = 9,     TCI_MATCH_DECODED_CONTENT = 10,     TCI_OMIT_TEMPLATE = 11 } TciMatchingTypeType;</pre> |  |
| LengthRestriction        | <pre>typedef struct TciLengthRestriction {     unsigned long int lowerBoundary;     unsigned long int upperBoundary;     Boolean isUpperBoundaryInfinity; } TciLengthRestriction;</pre>  |  |
| Permutation              | <pre>typedef struct TciPermutation {     unsigned long int startPosition;     unsigned long int length; } TciPermutation;</pre>  |  |
| RangeBoundary            | <pre>typedef struct TciRangeBoundary {     Value boundary;     Boolean isInclusive;     Boolean isInfinity; } TciRangeBoundary;</pre>  |  |

## 9.6 Miscellaneous

Table 8

| TCI concept                   | ANSI C representation                | Notes and comments   |
|-------------------------------|--------------------------------------|--|
| <b>Verdict representation</b> |                                      |  |
| NONE                          | const int TCI_VERDICT_NONE = 0       | Since the VerdictValue interface is defined in terms of integers, consensus shall be established on which value defines which verdict. |
| PASS                          | const int TCI_VERDICT_PASS = 1       |  |
| INCONC                        | const int TCI_VERDICT_INCONC = 2     |  |
| FAIL                          | const int TCI_VERDICT_FAIL = 3       |  |
| ERROR                         | const int TCI_VERDICT_ERROR = 4      |  |
| USER_ERROR                    | const int TCI_VERDICT_USER_ERROR = 5 |  |

| TCI concept                                       | ANSI C representation   | Notes and comments |
|---|---|--------------------|
| <b>ComponentStatus</b>                            |   |                    |
| INACTIVE_C  | const int TCI_INACTIVE_C = 0  |                    |
| RUNNING_C   | const int TCI_RUNNING_C = 1   |                    |
| STOPPED_C   | const int TCI_STOPPED_C = 2   |                    |
| KILLED_C  | const int TCI_KILLED_C = 3  |                    |
| NULL_C  | const int TCI_NULL_C = 4  |                    |
| <b>TimerStatus</b>                                |   |                    |
| RUNNING_T   | const int TCI_RUNNING_T = 0   |                    |
| INACTIVE_T  | const int TCI_INACTIVE_T = 1  |                    |
| EXPIRED_T   | const int TCI_EXPIRED_T = 2   |                    |
| NULL_T  | const int TCI_NULL_T = 3  |                    |
| <b>TciStatus</b>                                  |   |                    |
| TCI_OK  | const int TCI_OK = 0  |                    |
| TCI_ERROR   | const int TCI_ERROR = -1  |                    |
| <b>CharstringValue representation</b>             |   |                    |
| TciCharString                                     | typedef struct TciCharStringValue<br>{<br>unsigned long int length;<br>char* string;<br>} TciCharStringValue    |                    |
| <b>Universal Character[string] representation</b> |   |                    |
| Universal Char                                    | typedef unsigned char TciUCValue[4]   |                    |
| Universal Charstring                              | typedef struct TciUCStringValue<br>{<br>unsigned long int length;<br>TciUCValue *string;<br>} TciUCStringValue; |                    |

## 9.7 Optional parameters

Clause 7.2.2 defines that a reserved value shall be used to indicate the absence of an optional parameter. For the C language mapping an explicit null shall be used. The function `tciSetNull` can be used to set a value to null and `tciIsNull` can be used to check whether a value represents null. `tciIsNull` returns true if the value is null, false otherwise.

For example, if in the `tciReplyConnected` operation the value parameter shall be omitted, then a value `reply` shall be created and set to null; the operation invocation shall be:

```
tciSetNull(reply);
tciReplyConnected (sender, receiver, signature, parameterList, reply).
```

---

## 10 C++ language mapping

### 10.1 Introduction

This clause introduces the TCI C++ language [9] mapping for the definitions given in clause 7.

### 10.2 Names and scopes

The namespace `ORG_ETSI_TTCN3_TCI` has been defined for the TCI C++ mapping, in order to avoid conflicts with the different names used, for example, in the C mapping.

C++ class identifiers are omitting the trailing "Type" at the end of the abstract definitions, e.g. the type `TciModuleIdType` is mapped to `TciModuleId` in C++.

## 10.3 Memory management

A general policy for memory management is not defined in this mapping. However, parameters are passed as pointers (or references) where possible, and a clone method has been added to the definition of every interface. The clone method can be used by the receiving entity to make a local copy where needed.

## 10.4 Error handling

No additional error handling has been defined for this mapping.

## 10.5 Type mapping

### 10.5.0 Basic concepts

This clause introduces the TRI C++ language mapping for the abstract types defined in clause 7.2. The following concepts have been used:

- Pure virtual classes have been used following the concept of an interface.
- C++ types have been encapsulated under abstract definitions like Tfloat or Tinteger.

### 10.5.1 Encapsulated C++ types

The following types have been defined in order to keep the definitions of data types and operations as general as possible:

|                                   |  |
|-----------------------------------|--|
| Boolean type definition:          | <code>typedef bool Tboolean</code>                 |
| Integer type definition:          | <code>typedef long int Tinteger</code>             |
| Size type definition:             | <code>typedef unsigned long int Tsize</code>       |
| Index type definition:            | <code>typedef unsigned long int Tindex</code>      |
| Float type definition:            | <code>typedef double Tfloat</code>                 |
| String type definition:           | <code>typedef std::string Tstring</code>           |
| Universal string type definition: | <code>typedef std::wstring TuniversalString</code> |
| Bit type definition:              | <code>typedef unsigned char Tbit</code>            |
| Char type definition:             | <code>typedef unsigned char Tchar</code>           |

### 10.5.2 General abstract data types

#### 10.5.2.1 TciBehaviourId

Identifies a TTCN-3 behaviour functions. It is mapped to the following pure virtual class:

```
class TciBehaviourId: public ORG_ETSI_TTCN3_TRI::QualifiedName {
public:
    virtual ~TciBehaviourId ();
    virtual Tboolean operator== (const TciBehaviourId &bid) const =0;
    virtual TciBehaviourId * clone () const =0;
    virtual Tboolean operator< (const TciBehaviourId &bid) const =0;
}
```

#### Methods:

|                              |  |
|------------------------------|--|
| <code>~TciBehaviourId</code> | Destructor                             |
| <code>operator==</code>      | Returns true if both objects are equal |
| <code>clone</code>           | Return a copy of the TciBehaviourId    |
| <code>operator&lt;</code>    | Operator < overload                    |



### 10.5.2.2 TciModuleId

A value of TciModuleId specifies the name of a TTCN-3 module. It is mapped to the following pure virtual class:

```
class TciModuleId {
public:
    virtual ~TciModuleId ()
    virtual const Tstring & getObject_name() const = 0;
    virtual void setObject_name (const Tstring &p_name)=0;
    virtual Tboolean operator== (const TciModuleId &mid) const =0;
    virtual TciModuleId * clone () const =0;
    virtual Tboolean operator< (const TciModuleId &mid) const =0;
}
```

#### Methods:

|                |  |
|----------------|--|
| ~TciModuleId   | Destructor                             |
| getObject_name | Get the moduleId name                  |
| setObject_name | Set the moduleId name                  |
| operator==     | Returns true if both objects are equal |
| clone          | Return a copy of the TciModuleId       |
| operator<      | Operator < overload                    |

### 10.5.2.3 TciModuleParameterId

A value of TciModuleParameterId specifies the name of a TTCN-3 module parameter as defined in the TTCN-3 module. It is mapped to the following pure virtual class:

```
class TciModuleParameterId : public ORG_ETSI_TTCN3_TRI::QualifiedName {
public:
    virtual ~TciModuleParameterId ();
    virtual Tboolean operator== (const TciModuleParameterId &mparId) const =0;
    virtual TciModuleParameterId * clone () const =0;
    virtual Tboolean operator< (const TciModuleParameterId &mparId) const =0;
}
```

#### Methods:

|                       |   |
|-----------------------|---|
| ~TciModuleParameterId | Destructor                                |
| operator==            | Returns true if both objects are equal    |
| clone                 | Return a copy of the TciModuleParameterId |
| operator<             | Operator < overload                       |

### 10.5.2.4 TciTestCaseId

A value of TciModuleParameterId specifies the name of a TTCN-3 testcase as defined in the TTCN-3 module. It is mapped to the following pure virtual class:

```
class TciTestCaseId : public TciBehaviourId {
public:
    virtual ~TciTestCaseId();
    virtual Tboolean operator== (const TciTestCaseId &tcid) const =0;
    virtual TciTestCaseId * clone () const =0;
    virtual Tboolean operator< (const TciTestCaseId &tcid) const =0;
}
```

**Methods:**

|                |  |
|----------------|--|
| ~TciTestCaseId | Destructor                             |
| operator==     | Returns true if both objects are equal |
| clone          | Return a copy of the TciTestCaseId     |
| operator<      | Operator < overload                    |

**10.5.2.5 TciModuleIdList**

A value of TciModuleIdList defines a list of TciModuleId elements. It is mapped to the following pure virtual class:

```
class TciModuleIdList {
public:
    virtual ~TciModuleIdList();
    virtual Tsize size () const =0;
    virtual Tboolean empty () const =0;
    virtual const TciModuleId *get (Tsize p_index) const =0;
    virtual void clear ()=0;
    virtual void push_back (const TciModuleId &comp)=0;
    virtual Tboolean operator== (const TciModuleIdList &midList) const =0;
    virtual TciModuleIdList * clone () const =0;
    virtual Tboolean operator< (const TciModuleIdList &midList) const =0;
}

```

**Methods:**

|                  |  |
|------------------|--|
| ~TciModuleIdList | Destructor                               |
| size             | Return the size of the list              |
| empty            | Return true if the list is empty         |
| get              | Return the requested element             |
| clear            | Remove all the components from this list |
| push_back        | Add a component to the end of this list  |
| operator==       | Returns true if both objects are equal   |
| clone            | Return a copy of the TciModuleId         |
| operator<        | Operator < overload                      |

**10.5.2.6 TciModuleParameter**

This abstract type is used to represent the parameter name and the default value of a module parameter. It is mapped to the following pure virtual class:

```
class TciModuleParameter {
public:
    virtual ~TciModuleParameter ();
    virtual const TciValue &getDefaultValue () const =0;
    virtual const Tstring &getModuleParameterName () const =0;
    virtual const TciModuleParameterId &getTciModuleParameterId () const =0;
    virtual Tboolean operator== (const TciModuleParameter &mpar) const =0;
    virtual TciModuleParameter * clone () const =0;
    virtual Tboolean operator< (const TciModuleParameter &mpar) const =0;
}

```

**Methods:**

```

~TciModuleParameter
    Destructor
getDefaultValue
    Return default value of the parameter
getModuleParameterName
    Return parameter name
getTciModuleParameterId
    Get the name of the module parameter as defined in the TTCN-3 module
operator==
    Returns true if both objects are equal
clone
    Return a copy of the TciModuleParameter
operator<
    Operator < overload

```

**10.5.2.7 TciModuleParameterList**

A value of TciModuleParameterList is a list of TciModuleParameter elements. It is mapped to the following pure virtual class:

```

class TciModuleParameterList {
public:
    virtual ~TciModuleParameterList ();
    virtual Tsize size () const =0;
    virtual Tboolean empty () const =0;
    virtual const TciModuleParameter *get (Tindex p_index) const =0;
    virtual void clear ()=0;
    virtual void push_back (const TciModuleParameter &comp)=0;
    virtual Tboolean operator== (const TciModuleParameterList &mparList) const =0;
    virtual TciModuleParameterList * clone () const =0;
    virtual Tboolean operator< (const TciModuleParameterList &mparList) const =0;
}

```

**Methods:**

```

~TciModuleParameterList
    Destructor
size
    Return the size of the list
empty
    Return true if the list is empty
get
    Retrieve the specified element
clear
    Remove all components from this list
push_back
    Add a component to the end of this list
operator==
    Returns true if both objects are equal
clone
    Return a copy of the TciModuleParameterList
operator<
    Operator < overload

```

**10.5.2.8 TciParameterPassingMode**

Defines the parameter passing mode. It is mapped to an enumeration:

```

typedef enum
{
    IN = 0,
    OUT = 1,
    INOUT = 2
} TciParameterPassingMode;

```

### 10.5.2.9 TciParameter

Includes a TTCN-3 Value and a TciParameterPassingMode. It is mapped to the following pure virtual class:

```
class TciParameter {
public:
    virtual ~TciParameter ();
    virtual TciValue & getValue ()=0;
    virtual void setValue (TciValue &value)=0;
    virtual const TciParameterPassingMode &getParameterPassingMode () const =0;
    virtual void setParameterPassingMode (const TciParameterPassingMode &mode)=0;
    virtual const Tstring & getParameterName () const =0;
    virtual void setParameterName (const Tstring &name)=0;
    virtual Tboolean operator== (const TciParameter &param) const =0;
    virtual TciParameter * clone () const =0;
    virtual Tboolean operator< (const TciParameter &param) const =0;
}
```

#### Methods:

```
~TciParameter
    Destructor
getValue
    Retrieve the TTCN-3 value
setValue
    Set the TTCN-3 value
getParameterPassingMode
    Return the parameter passing mode
setParameterPassingMode
    Set the parameter passing mode
getParameterName
    Return the name of the parameter
setParameterName
    Set the name of the parameter
operator==
    Returns true if both objects are equal
clone
    Return a copy of the TciParameter
operator<
    Operator < overload
```

### 10.5.2.10 TciParameterList

Defines a list of TciParameter elements. It is mapped to the following pure virtual class:

```
class TciParameterList {
public:
    virtual ~TciParameterList ();
    virtual Tsize size () const =0;
    virtual Tboolean empty () const =0;
    virtual TciParameter *get (Tindex p_index) =0;
    virtual void clear ()=0;
    virtual void push_back (const TciParameter &comp)=0;
    virtual Tboolean operator== (const TciParameterList &param) const =0;
    virtual TciParameterList * clone () const =0;
    virtual Tboolean operator< (const TciParameterList &param) const =0;
}
```

#### Methods:

```
~TciParameterList
    Destructor
size
    Return the size of the list
empty
    Return true if the list is empty
get
    Get the specified element
clear
    Remove all the components from this list
```

push\_back  
     Add a component to the end of this list  
 operator==  
     Returns true if both objects are equal  
 clone  
     Return a copy of the TciParameterList  
 operator<  
     Operator < overload

### 10.5.2.11 TciParameterType

Includes a TTCN-3 type, parameter name and a TciParameterPassingMode. It is mapped to the following pure virtual class:

```

class TciParameterType {
public:
    virtual ~TciParameterType ();
    virtual const Tstring & getParameterName () const =0;
    virtual const TciType & getType () const =0;
    virtual const TciParameterPassingMode & getParameterPassingMode () const =0;
    virtual Tboolean operator== (const TciParameterType &parType) const =0;
    virtual TciParameterType * clone () const =0;
    virtual Tboolean operator< (const TciParameterType &parType) const =0;
}
  
```

#### Methods:

~TciParameterType  
     Destructor  
 getType  
     Return the TTCN-3 Type  
 getParameterName  
     Return the name of the parameter  
 getParameterPassingMode  
     Get the parameter passing mode  
 operator==  
     Returns true if both objects are equal  
 clone  
     Return a copy of the TciParameterType  
 operator<  
     Operator < overload

### 10.5.2.12 TciParameterTypeList

Specifies a list of TciParameterType elements. It is mapped to the following pure virtual class:

```

class TciParameterTypeList {
public:
    virtual ~TciParameterTypeList ();
    virtual Tsize size () const =0;
    virtual Tboolean empty () const =0;
    virtual const TciParameterType *get (Tindex p_position) const =0;
    virtual void clear ()=0;
    virtual void push_back (const TciParameterType &comp)=0;
    virtual Tboolean operator== (const TciParameterTypeList &ptypeList) const =0;
    virtual TciParameterTypeList * clone () const =0;
    virtual Tboolean operator< (const TciParameterTypeList &ptypeList) const =0;
}
  
```

#### Methods:

~TciParameterTypeList  
     Destructor  
 size  
     Return the size of the list  
 empty  
     Returns true if the list is empty  
 get  
     Return the requested element

```

clear
    Remove all the components from this list
push_back
    Add a component to the end of this list
operator==
    Returns true if both objects are equal
clone ()
    Returns a copy of the TciParameterTypeList
operator< (const TciParameterTypeList &ptypeList)
    Operator < overload

```

### 10.5.2.13 TciTestComponentKind

Defines the test component kind. It is mapped to an enumeration:

```

typedef enum
{
    SYSTEM_COMP = 0,
    PTC_COMP = 1,
    PTC_ALIVE_COMP = 2,
    MTC_COMP = 3,
    CTRL_COMP = 4
} TciTestComponentKind;

```

### 10.5.2.14 TciTypeClass

Defines the type class. It is mapped to an enumeration:

```

typedef enum
{
    TCI_ADDRESS = 0,
    TCI_ANYTYPE = 1,
    TCI_BITSTRING = 2,
    TCI_BOOLEAN = 3,
    TCI_CHARSTRING = 5,
    TCI_COMPONENT = 6,
    TCI_ENUMERATED = 7,
    TCI_FLOAT = 8,
    TCI_HEXSTRING = 9,
    TCI_INTEGER = 10,
    TCI_OCTETSTRING = 12,
    TCI_RECORD = 13,
    TCI_RECORD_OF = 14,
    TCI_ARRAY = 15,
    TCI_SET = 16,
    TCI_SET_OF = 17,
    TCI_UNION = 18,
    TCI_UNIVERSAL_CHARSTRING = 20,
    TCI_VERDICT = 21,
    TCI_DEFAULT = 22,
    TCI_PORT = 23,
    TCI_TIMER = 24
} TciTypeClass;

```

### 10.5.2.15 TciTestCaseIdList

Specifies a list of TciTestCaseId elements. It is mapped to the following pure virtual class:

```

class TciTestCaseIdList {
public:
    virtual ~TciTestCaseIdList ();
    virtual Tsize size () const =0;
    virtual Tboolean empty () const =0;
    virtual const TciTestCaseId *get (Tindex p_position) const =0;
    virtual void clear ()=0;
    virtual void push_back (const TciTestCaseId &comp)=0;
    virtual Tboolean operator== (const TciTestCaseIdList &ptypeList) const =0;
    virtual TciTestCaseIdList * clone () const =0;
    virtual Tboolean operator< (const TciTestCaseIdList &ptypeList) const =0;
}

```

**Methods:**

```

~TciTestCaseIdList
    Destructor
size
    Return the size of the list
empty
    Returns true if the list is empty
get
    Return the requested element
clear
    Remove all the components from this list
push_back
    Add a component to the end of this list
operator==
    Returns true if both objects are equal
clone ()
    Returns a copy of the TciTestCaseIdList
operator< (const TciTestCaseIdList &ptypeList)
    Operator < overload

```

**10.5.2.16 TciMatchingType**

Defines the matching template type. It is mapped to an enumeration:

```

typedef enum
{
    TCI_TEMPLATE_LIST = 0,
    TCI_COMPLEMENTED_LIST = 1,
    TCI_ANY_VALUE = 2,
    TCI_ANY_VALUE_OR_NONE = 3,
    TCI_VALUE_RANGE = 4,
    TCI_SUBSET = 5,
    TCI_SUPERSET = 6,
    TCI_ANY_ELEMENT = 7,
    TCI_ANY_ELEMENTS_OR_NONE = 8,
    TCI_PATTERN = 9,
    TCI_MATCH_DECODED_CONTENT = 10,
    TCI_OMIT_TEMPLATE = 11
} TciMatchingType;

```

**10.5.2.17 LengthRestriction**

Specifies a length restriction. It is mapped to the following pure virtual class:

```

class LengthRestriction {
public:
    virtual ~LengthRestriction ();
    virtual Tinteger getLowerBoundary () const =0;
    virtual Tinteger getUpperBoundary () const =0;
    virtual void setLowerBoundary (Tinteger p_boundary) =0;
    virtual void setUpperBoundary (Tinteger p_boundary) =0;
    virtual Tboolean isUpperBoundaryInfinity () const =0;
    virtual void setInfiniteUpperBoundary () =0;
    virtual Tboolean operator== (const LengthRestriction &p_lenRestriction) const =0;
    virtual LengthRestriction * clone () const =0;
    virtual Tboolean operator< (const LengthRestriction &p_lenRestriction) const =0;
}

```

**Methods:**

```

~LengthRestriction
    Destructor
getLowerBoundary
    Returns the lower boundary of the length restriction
getUpperBoundary
    Returns the upper boundary of the length restriction
setLowerBoundary
    Sets the lower boundary value
setUpperBoundary
    Sets the upper boundary value

```

isUpperBoundaryInfinity  
Returns true if the upper boundary contains infinity and false otherwise

setInfiniteUpperBoundary  
Sets the upper boundary to infinity

operator==  
Returns true if both objects are equal

clone ()  
Returns a copy of the LengthRestriction

operator<  
Operator < overload

### 10.5.2.18 Permutation

Specifies a permutation. It is mapped to the following pure virtual class:

```
class Permutation {
public:
    virtual ~Permutation ();
    virtual Tindex getStartPosition () const =0;
    virtual void setStartPosition (Tindex p_position) =0;
    virtual Tsize getLength () const =0;
    virtual void setLength (Tsize p_length) =0;
    virtual Tboolean operator== (const Permutation &p_permutation) const =0;
    virtual Permutation * clone () const =0;
    virtual Tboolean operator< (const Permutation &p_permutation) const =0;
}
```

#### Methods:

~Permutation  
Destructor

getStartPosition  
Returns the position of the first item of the permutation in the RecordOfValue

setStartPosition  
Sets the position of the first item of the permutation in the RecordOfValue

getLength  
Returns the number of elements or matching mechanisms of the RecordOfValue that are included in the permutation

setLength  
Sets the number of elements or matching mechanisms of the RecordOfValue that are included in the permutation

operator==  
Returns true if both objects are equal

clone ()  
Returns a copy of the Permutation

operator<  
Operator < overload

### 10.5.2.19 RangeBoundary

Specifies a lower or upper boundary of a ValueRange. It is mapped to the following pure virtual class:

```
class RangeBoundary {
public:
    virtual ~RangeBoundary ();
    virtual TciValue& getBoundary () const =0;
    virtual Tboolean isInclusive () const =0;
    virtual void setBoundary (TciValue &p_value, Tboolean p_isInclusive) =0;
    virtual Tboolean isInfinity () const =0;
    virtual void setToInfinity () =0;
    virtual Tboolean operator== (const RangeBoundary &p_boundary) const =0;
    virtual RangeBoundary * clone () const =0;
    virtual Tboolean operator< (const RangeBoundary &p_boundary) const =0;
}
```

#### Methods:

~RangeBoundary  
Destructor

getBoundary  
Returns the boundary value



**isInclusive**  
 Returns true if the boundary value is a part of the allowed range and false otherwise  
**setBoundary**  
 Sets the boundary value  
**isInfinity**  
 Returns true if the boundary is equal to infinity or -infinity and false otherwise  
**setToInfinity**  
 Sets the boundary to infinity  
**operator==**  
 Returns true if both objects are equal  
**clone ()**  
 Returns a copy of the LengthRestriction  
**operator<**  
 Operator < overload

## 10.5.3 Abstract TTCN-3 data types and values

### 10.5.3.1 TciType

A value of TciType represents one of the TTCN-3 types in a TTCN-3 module. It is mapped to the following pure virtual class:

```

class TciType {
public:
    virtual ~TciType ();
    virtual const TciModuleId & getDefiningModule () const =0;
    virtual const Tstring & getName () const =0;
    virtual const TciTypeClass & getTypeClass () const =0;
    virtual const Tstring & getTypeEncoding () const =0;
    virtual const Tstring & getTypeEncodingVariant () const =0;
    virtual const std::vector<Tstring*> & getEncodeAttributes () const =0;
    virtual const std::vector<Tstring*> & getVariantAttributes (const Tstring * encoding) const =0;
    virtual const std::vector<Tstring*> & getTypeExtension() const =0;
    virtual TciValue * newInstance () const =0;
    virtual MatchingMechanism * newTemplate (TciMatchingType matchingType) const =0;
    virtual TciValue * parseValue (const Tstring & val) const =0;
    virtual const RangeBoundary * getLowerTypeBoundary() const = 0;
    virtual const RangeBoundary * getUpperTypeBoundary() const = 0;
    virtual const LengthRestriction * getTypeLengthRestriction() const = 0;
    virtual const MatchingMechanism * getTypeMatchingMechanism() const = 0;
    virtual Tboolean operator== (const TciType &typ) const =0;
    virtual TciType * clone () const =0;
    virtual Tboolean operator< (const TciType &typ) const =0;
}
  
```

#### Methods:

**~TciType**  
 Destructor  
**getDefiningModule**  
 Returns the defining module as defined in the TTCN-3 module  
**getName**  
 Returns type name as defined in the TTCN-3 module  
**getTypeClass**  
 Returns this type class  
**getTypeEncoding**  
 Returns type encoding as defined in the TTCN-3 module  
**getTypeEncodingVariant**  
 Returns encoding variant as defined in the TTCN-3 module  
**getEncodeAttributes**  
 Returns all encode attributes of the type as defined in the TTCN-3 module. The distinct value null is mapped to an empty vector  
**getVariantAttributes**  
 Returns all variant attributes of the type as defined in the TTCN-3 module. The distinct value null is mapped to an empty vector  
**getTypeExtension**  
 Returns type extension as defined in the TTCN-3 module  
**newInstance**  
 Returns a new Value instance of this type

`newTemplate`  
Returns a freshly created matching mechanism of this type. The `matchingType` parameter determines what kind of matching mechanism will be created. If the created matching mechanism contains additional data properties, these properties are uninitialized in the created matching mechanism

`parseValue`  
Returns a new `TciValue` instance in case of successful parsing or null pointer in case of parsing error or if value parsing is not supported by the tool

`getLowerTypeBoundary`  
Returns the lower boundary of the type restriction or `null`

`getUpperTypeBoundary`  
Returns the upper boundary of the type restriction or `null`

`getTypeLengthRestriction`  
Returns the type length restriction or `null`

`getTypeMatchingMechanism`  
Returns the matching mechanism restriction of the type or `null`

`operator==`  
Returns true if the types are equal

`clone`  
Returns a copy of the `TciType`

`operator<`  
Operator < overload

### 10.5.3.2 TciValue

A value of `TciValue` represents TTCN-3 values for a given type. It is mapped to the following pure virtual class:

```
class TciValue {
public:
    virtual ~TciValue ();
    virtual const TciType & getType () const =0;
    virtual const Tstring & getValueEncoding () const =0;
    virtual const Tstring & getValueEncodingVariant () const =0;
    virtual const std::vector<Tstring*> & getEncodeAttributes () const =0;
    virtual const std::vector<Tstring*> & getVariantAttributes (const Tstring * encoding) const =0;
    virtual Tboolean notPresent () const =0;
    virtual Tboolean isMatchingSymbol () const =0;
    virtual const Tstring & valueToString () const =0;
    virtual Tboolean isLazy () const =0;
    virtual Tboolean isFuzzy () const =0;
    virtual Tboolean isEvaluated () const =0;
    virtual LengthRestriction * getLengthRestriction () const = 0;
    virtual LengthRestriction * newLengthRestriction () const = 0;
    virtual void setLengthRestriction (const LengthRestriction * p_restriction) =0;
    virtual Tboolean isIfPresentEnabled () const =0;
    virtual void setIfPresentEnabled (Tboolean p_enabled) =0;
    virtual Tboolean isOptional () const =0;
    virtual RangeBoundary * getLowerTypeBoundary() const = 0;
    virtual RangeBoundary * getUpperTypeBoundary() const = 0;
    virtual LengthRestriction * getTypeLengthRestriction() const = 0;
    virtual MatchingMechanism * getTypeMatchingMechanism() const = 0;
    virtual Tboolean operator== (const TciValue &p_val) const =0;
    virtual TciValue * clone () const =0;
    virtual Tboolean operator< (const TciValue &p_val) const =0;
}

```

#### Methods:

`~TciValue`  
Destructor

`getType`  
Returns the type of the specified value

`getValueEncoding`  
Returns the value encoding attribute as defined in the TTCN-3 module

`getValueEncodingVariant`  
Returns the value encoding variant attribute as defined in the TTCN-3 module

`getEncodeAttributes`  
Returns all encode attributes of the value as defined in the TTCN-3 module. The distinct value `null` is mapped to an empty vector

`getVariantAttributes`  
Returns all variant attributes of the value as defined in the TTCN-3 module. The distinct value `null` is mapped to an empty vector

notPresent  
Returns true if the specified value is omit

isMatchingSymbol  
Returns true if the specified value is a matching symbol (see clause 7.2.2.2.1 for more details), false otherwise

valueToString  
Returns the same string as produced by the `any2unistr` predefined function

isLazy  
Returns true if the specified value is `@lazy`, false otherwise

isFuzzy  
Returns true if the specified value is `@fuzzy`, false otherwise

isEvaluated  
Returns true if the specified value contains an evaluation result, false otherwise (see clause 7.2.2.2.1 for more details)

getLengthRestriction  
Returns a length restriction matching attribute or null if no restriction is present

newLengthRestriction  
Creates a new instance of the `LengthRestriction` class

setLengthRestriction  
Adds a length restriction matching to the value or modifies an existing one. Null pointer can be used to remove an existing length restriction

isIfPresentEnabled  
Returns true if the `ifpresent` matching attribute is attached to the value and false otherwise

setIfPresentEnabled  
Sets the whether the `ifpresent` matching attribute is attached to the value or not

isOptional  
Returns whether the value is an optional field or a template without the present or value restriction

getLowerTypeBoundary  
Returns the lower boundary of the value's type restriction or null

getUpperTypeBoundary  
Returns the upper boundary of the value's type restriction or null

getTypeLengthRestriction  
Returns the value's type length restriction or null

getTypeMatchingMechanism  
Returns the matching mechanism type restriction of the value's type or null

operator==  
Returns true if both objects are equal

clone  
Return a copy of the `TciValue`

operator<  
Operator < overload

### 10.5.3.3 IntegerValue

TTCN-3 integer value support. It is mapped to the following pure virtual class:

```
class IntegerValue : public virtual TciValue {
public:
    virtual ~IntegerValue ();
    virtual Tinteger getInt () const =0;
    virtual void setInt (Tinteger p_value)=0;
    virtual Tboolean operator== (const IntegerValue &p_intVal) const =0;
    virtual IntegerValue * clone () const =0;
    virtual Tboolean operator< (const IntegerValue & p_intVal) const =0;
}
```

#### Methods:

`~IntegerValue`  
Destructor

`getInt`  
Return integer value

`setInt`  
Set integer value

`operator==`  
Returns true if both objects are equal

`clone`  
Return a copy of the `IntegerValue`

```
operator<
    Operator < overload
```

### 10.5.3.4 FloatValue

TTCN-3 float value support. It is mapped to the following pure virtual class:

```
class FloatValue : public virtual TciValue {
public:
    virtual ~FloatValue ();
    virtual Tfloat getFloat () const =0;
    virtual void setFloat (Tfloat p_floatValue)=0;
    virtual Tboolean operator== (const FloatValue & p_floatVal) const =0;
    virtual FloatValue * clone () const =0;
    virtual Tboolean operator< (const FloatValue & p_floatVal) const =0;
}
```

#### Methods:

```
~FloatValue
    Destructor
getFloat
    Return the float value
setFloat
    Set float value
operator==
    Returns true if both objects are equal
clone
    Return a copy of the FloatValue
operator<
    Operator < overload
```

### 10.5.3.5 BooleanValue

TTCN-3 boolean values support. It is mapped to the following pure virtual class:

```
class BooleanValue : public virtual TciValue {
public:
    virtual ~BooleanValue ();
    virtual Tboolean getBoolean () const =0;
    virtual void setBoolean (Tboolean p_booleanValue)=0;
    virtual Tboolean operator== (const BooleanValue & p_booleanVal) const =0;
    virtual BooleanValue * clone () const =0;
    virtual Tboolean operator< (const BooleanValue & p_booleanVal) const =0;
}
```

#### Methods:

```
~BooleanValue
    Destructor
getBoolean
    Return the boolean value
setBoolean
    Set the variable to booleanValue
operator==
    Returns true if both objects are equal
clone
    Return a copy of the BooleanValue
operator<
    Operator < overload
```

### 10.5.3.6 CharstringValue

TTCN-3 charstring value support. It is mapped to the following pure virtual class:

```
class CharstringValue : public virtual TciValue {
public:
    virtual ~CharstringValue ();
    virtual char getChar (Tindex p_position) const =0;
    virtual Tsize getLength () const =0;
    virtual const Tstring & getString () const =0;
    virtual void setChar (Tsize p_position, char p_char)=0;
    virtual void setLength (Tsize p_length)=0;
    virtual void setString (const Tstring &p_charValue)=0;
    virtual Tboolean operator== (const CharstringValue & p_charStr) const =0;
    virtual CharstringValue * clone () const =0;
    virtual Tboolean operator< (const CharstringValue & p_charStr) const =0;
}
```

#### Methods:

```
~CharstringValue
    Destructor
getChar
    Return the char at the specified position
getLength
    Return length of the string
getString
    Return the value of the string
setChar
    Set the char at the specified position
setLength
    Set length of the string
setString
    Set the value of the string
operator==
    Returns true if both objects are equal
clone
    Return a copy of the CharstringValue
operator<
    Operator < overload
```

### 10.5.3.7 UniversalCharstringValue

TTCN-3 universal charstring value support. It is mapped to the following pure virtual class:

```
class UniversalCharstringValue : public virtual TciValue {
public:
    virtual ~UniversalCharstringValue ();
    virtual wchar_t getChar (Tindex p_position) const =0;
    virtual Tsize getLength () const =0;
    virtual const TuniversalString & getString () const =0;
    virtual void setChar (Tindex p_position, const wchar_t p_ucValue)=0;
    virtual void setLength (Tsize p_length)=0;
    virtual void setString (const TuniversalString &p_ucsValue)=0;
    virtual Tboolean operator== (const UniversalCharstringValue & p_uniCharstr) const =0;
    virtual UniversalCharstringValue * clone () const =0;
    virtual Tboolean operator< (const UniversalCharstringValue & p_uniCharstr) const =0;
}
```

#### Methods:

```
~UniversalCharstringValue
    Destructor
getChar
    Return the requested element
getLength
    Return the length of the universal charstring
getString
    Return the textual representation of the string
setChar
    Set the char at the specified position
```

setLength  
     Set the length of the string  
 setString  
     Set the value of the string  
 operator==  
     Returns true if both objects are equal  
 clone  
     Return a copy of the UniversalCharstringValue  
 operator<  
     Operator < overload

### 10.5.3.8 BitstringValue

TTCN-3 bitstring value support. It is mapped to the following pure virtual class:

```

class BitstringValue : public virtual TciValue {
public:
    virtual ~BitstringValue ();
    virtual Tbit getBit (Tindex p_position) const =0;
    virtual Tsize getLength () const =0;
    virtual const Tstring & getString () const =0;
    virtual void setBit (Tindex p_position, Tbit p_bsValue)=0;
    virtual void setLength (Tindex p_new_length)=0;
    virtual void setString (const Tstring &p_bsValue)=0;
    virtual std::istream * getInputStream()=0;
    virtual void setInputStream(std::istream * stream, Tsize bitLen)=0;
    virtual Tboolean isMatchingAt (Tindex p_position) const =0;
    virtual MatchingMechanism & getMatchingAt (Tindex p_position) const =0;
    virtual void setMatchingAt (Tindex p_position, MatchingMechanism &p_template) = 0;
    virtual Tboolean operator== (const BitstringValue &p_bitStr) const =0;
    virtual BitstringValue * clone () const =0;
    virtual Tboolean operator< (const BitstringValue &p_bitStr) const =0;
}
  
```

#### Methods:

~BitstringValue  
     Destructor  
 getBit  
     Returns the bit at the specified position  
 getLength  
     Returns the length of the string  
 getString  
     Returns the value of the string. In some cases, the message data are available in the form of a stream and cannot be converted into a string by TCI (e.g. because of memory restrictions). In such cases, this method returns null and the `getInputStream` method shall be used for reading the data  
 setBit  
     Sets the bit value at the specified position  
 setLength  
     Sets the length of the string  
 setString  
     Sets the string value  
 getInputStream  
     Returns the bits in the form of an input stream. Repeated calls to the same method return different stream instances. The method returns null if the bitstring contains matching symbols  
 setInputStream  
     Sets the value of this `BitstringValue` by providing a source stream that is used by the `BitstringValue` object to read the value content. Values set this way do not contain matching symbols  
 isMatchingAt  
     Returns true if the item at the specified position is a matching mechanism inside a value  
 getMatchingAt  
     Returns a matching mechanism at the specified position  
 setMatchingAt  
     Sets the matching mechanism at the specified position  
 operator==  
     Returns true if both objects are equal  
 clone  
     Returns a copy of the `BitstringValue`  
 operator<  
     Operator < overload

### 10.5.3.9 OctetstringValue

TTCN-3 octetstring value support. It is mapped to the following pure virtual class:

```
class OctetstringValue : public virtual TciValue {
public:
    virtual ~OctetstringValue ();
    virtual Tsize getLength () const =0;
    virtual const Tchar getOctet (Tindex p_position) const =0;
    virtual const Tstring & getString () const =0;
    virtual void setLength (Tsize p_length)=0;
    virtual void setOctet (Tindex p_position, Tchar p_ochar)=0;
    virtual void setString (const Tstring &p_osValue)=0;
    virtual std::istream * getInputStream()=0;
    virtual void setInputStream(std::istream * stream)=0;
    virtual Tboolean isMatchingAt (Tindex p_position) const =0;
    virtual MatchingMechanism & getMatchingAt (Tindex p_position) const =0;
    virtual void setMatchingAt (Tindex p_position, MatchingMechanism &p_template) = 0;
    virtual Tboolean operator== (const OctetstringValue & p_octStr) const =0;
    virtual OctetstringValue * clone () const =0;
    virtual Tboolean operator< (const OctetstringValue & p_octStr) const =0;
}

```

#### Methods:

~OctetstringValue  
**Destructor**

getLength  
**Returns the length of the string**

getOctet  
**Returns the textual representation of the octetchar at the specified position**

getString  
**Returns the string value. In some cases, the message data are available in the form of a byte stream and cannot be converted into a string by TCI (e.g. because of memory restrictions). In such cases, this method returns null and the getInputStream method shall be used for reading the data**

setLength  
**Sets the length of the string**

setOctet  
**Sets the char at specified position**

setString  
**Sets the value of the string**

getInputStream  
**Returns the octets in the form of an input stream. Repeated calls to the same method return different stream instances. The method returns null if the octetstring contains matching symbols**

setInputStream  
**Sets the value of this OctetstringValue by providing a source stream that is used by the OctetstringValue object to read the value content. Values set this way do not contain matching symbols**

isMatchingAt  
**Returns true if the item at the specified position is a matching mechanism inside a value**

getMatchingAt  
**Returns a matching mechanism at the specified position**

setMatchingAt  
**Sets the matching mechanism at the specified position**

operator==  
**Returns true if both objects are equal**

clone  
**Returns a copy of the OctetstringValue**

operator<  
**Operator < overload**

### 10.5.3.10 HexstringValue

TTCN-3 hexstring value support. It is mapped to the following pure virtual class:

```
class HexstringValue : public virtual TciValue {
public:
    virtual ~HexstringValue ();
    virtual Tchar getHex (Tindex p_position) const =0;
    virtual Tsize getLength () const =0;
    virtual const Tstring & getString () const =0;
}

```

```

virtual void setHex (Tindex p_position, Tchar p_hcValue)=0;
virtual void setLength (Tsize p_length)=0;
virtual void setString (const Tstring &p_hsValue)=0;
virtual std::istream * getInputStream()=0;
virtual void setInputStream(std::istream * stream, Tsize numberOfItems)=0;
virtual Tboolean isMatchingAt (Tindex p_position) const =0;
virtual MatchingMechanism & getMatchingAt (Tindex p_position) const =0;
virtual void setMatchingAt (Tindex p_position, MatchingMechanism &p_template) = 0;
virtual Tboolean operator== (const HexstringValue & p_hexStr) const =0;
virtual HexstringValue * clone () const =0;
virtual Tboolean operator< (const HexstringValue & p_hexStr) const =0;
}

```

### Methods:

~HexstringValue  
Destructor

getHex  
Returns the element at the specified position

getLength  
Returns the length of the string

getString  
Returns the string value. In some cases, the message data are available in the form of a stream and cannot be converted into a string by TCI (e.g. because of memory restrictions). In such cases, this method returns null and the getInputStream method shall be used for reading the data

setHex  
Sets the hex value at the specified position

setLength  
Sets the length of the string

setString  
Sets the value of the string

getInputStream  
Returns the data in the form of an input stream. Repeated calls to the same method return different stream instances. The method returns null if the hexstring contains matching symbols

setInputStream  
Sets the value of this HexstringValue by providing a source stream that is used by the HexstringValue object to read the value content. Values set this way do not contain matching symbols

isMatchingAt  
Returns true if the item at the specified position is a matching mechanism inside a value

getMatchingAt  
Returns a matching mechanism at the specified position

setMatchingAt  
Sets the matching mechanism at the specified position

operator==  
Returns true if both objects are equal

clone  
Returns a copy of the HexstringValue

operator<  
Operator < overload

### 10.5.3.11 RecordValue

TTCN-3 record value support. It is mapped to the following pure virtual class:

```

class RecordValue : public virtual TciValue {
public:
    virtual ~RecordValue ();
    virtual TciValue &getField (const Tstring &p_field_name) =0;
    virtual void setField (const Tstring &p_field_name,const TciValue &p_new_value)=0;
    virtual const std::vector< Tstring *> &getFieldNames () const =0;
    virtual void setFieldOmitted (const Tstring &p_fieldName)=0;
    virtual Tboolean operator== (const RecordValue & p_rec) const =0;
    virtual RecordValue * clone () const =0;
    virtual Tboolean operator< (const RecordValue & p_rec) const =0;
}

```



**Methods:**

~RecordValue  
 Destructor  
 getField  
 Return a reference to the field name  
 setField  
 Set the value of a field  
 getFieldNames  
 Return a list which containing the names of all the fields  
 setFieldOmitted  
 Set omit in one field  
 operator==  
 Returns true if both objects are equal  
 clone  
 Return a copy of the RecordValue  
 operator<  
 Operator < overload

**10.5.3.12 RecordOfValue**

TTCN-3 record of value support. It is mapped to the following pure virtual class:

```
class RecordOfValue : public virtual TciValue {
public:
    virtual ~RecordOfValue ();
    virtual TciValue & getField (Tindex p_position)=0;
    virtual void setField (Tindex p_position, const TciValue &p_value)=0;
    virtual void appendField (const TciValue &p_value)=0;
    virtual const TciType & getElementType () const =0;
    virtual Tsize getLength () const =0;
    virtual void setLength (Tsize p_length)=0;
    virtual Tindex getOffset() const =0;
    virtual Tsize getPermutationCount () const =0;
    virtual Permutation & getPermutation (Tindex p_position) const =0;
    virtual Permutation * newPermutation () =0;
    virtual void definePermutation (const Permutation & permutation) =0;
    virtual void removePermutation (Tindex p_position) =0;
    virtual void clearPermutations () =0;
    virtual Tboolean operator== (const RecordOfValue &p_recOf) const =0;
    virtual RecordOfValue * clone () const =0;
    virtual Tboolean operator< (const RecordOfValue &p_recOf) const =0;
}
```

**Methods:**

~RecordOfValue  
 Destructor  
 getField  
 Return the field at the specified position  
 setField  
 Set the value at the specified position  
 appendField  
 Add a value at the end of the record of  
 getElementType  
 Return the type of the elements of this record of  
 getLength  
 Return the length of the object  
 setLength  
 Set length of the record of  
 getOffset  
 For arrays, return the lower index bound used in the type definition of arrays. Return 0 for record of and set of  
 getPermutationCount  
 Returns the number of permutations in the record of or array value  
 getPermutation  
 Returns the permutation at the specified index  
 getPermutation  
 Creates a new Permutation class instance  
 definePermutations  
 Creates permutation from existing elements of a record of value

removePermutation  
Removes the permutation at the specified index

clearPermutations  
Removes all permutations from the value

operator==  
Returns true if both objects are equal

clone  
Return a copy of the RecordOfValue

operator<  
Operator < overload

### 10.5.3.13 UnionValue

TTCN-3 union value support. It is mapped to the following pure virtual class:

```
class UnionValue : public virtual TciValue {
public:
    virtual ~UnionValue ()
    virtual void setVariant (const Tstring &p_variantName, const TciValue &p_value)=0;
    virtual TciValue & getVariant (const Tstring &p_variantName) =0;
    virtual const Tstring & getPresentVariantName () const =0;
    virtual const std::set< Tstring *> & getVariantNames () const =0;
    virtual Tboolean operator== (const UnionValue & p_unionVal) const =0;
    virtual UnionValue * clone () const =0;
    virtual Tboolean operator< (const UnionValue & p_unionVal) const =0;
}
```

#### Methods:

~UnionValue  
Destructor

setVariant  
Set the variant name to a value

getVariant  
Return the value of the variant if exists

getPresentVariantName  
Return the name of the current variant value. null if no initialized

getVariantNames  
Return a list which contains the variant names as defined in the TTCN-3 module

operator==  
Returns true if both objects are equal

clone  
Return a copy of the UnionValue

operator<  
Operator < overload

### 10.5.3.14 EnumeratedValue

TTCN-3 enumerated value support. It is mapped to the following pure virtual class:

```
class EnumeratedValue : public virtual TciValue {
public:
    virtual ~EnumeratedValue ();
    virtual const Tstring & getEnum () const =0;
    virtual void setEnum (const Tstring &p_value)=0;
    virtual Tinteger getInt() const =0;
    virtual void setInt(Tinteger p_int);
    virtual Tboolean operator== (const EnumeratedValue & p_enumVal) const =0;
    virtual EnumeratedValue * clone () const =0;
    virtual Tboolean operator< (const EnumeratedValue & p_enumVal) const =0;
}
```

#### Methods:

~EnumeratedValue  
Destructor

getEnum  
Return current value

setEnum  
Set the enumeration value

```

getInt      Return current integer value
setInt      Set the integer value
operator==  Returns true if both objects are equal
clone       Return a copy of the EnumeratedValue
operator<   Operator < overload

```

### 10.5.3.15 VerdictValue

TTCN-3 verdict value support. It is mapped to the following pure virtual class:

```

class VerdictValue : public virtual TciValue {
public:
    virtual ~VerdictValue ();
    virtual const VerdictValueEnum & getVerdict () const =0;
    virtual void setVerdict (const VerdictValueEnum & p_enum)=0;
    virtual Tboolean operator== (const VerdictValue & p_verdictVal) const =0;
    virtual VerdictValue * clone () const =0;
    virtual Tboolean operator< (const VerdictValue & p_verdictVal) const =0;
}

```

#### Methods:

```

~VerdictValue      Destructor
getVerdict         Return the value of the verdict
setVerdict         Set the value of the verdict
operator==         Returns true if both objects are equal
clone              Return a copy of the VerdictValue
operator<          Operator < overload

```

### 10.5.3.16 VerdictValueEnum

Defines verdict values as an enumeration:

```

typedef enum
{
    NONE = 0,
    PASS = 1,
    FAIL = 2,
    INCONC = 3,
    ERROR = 4,
    USER_ERROR = 5
} VerdictValueEnum;

```

### 10.5.3.17 AddressValue

TTCN-3 address value support. It is mapped to the following pure virtual class:

```

class AddressValue {
public:
    virtual ~AddressValue ();
    virtual TciValue & getAddress ()=0;
    virtual void setAddress ( const TciValue& T)=0;
    virtual Tboolean operator== (const AddressValue & p_addr) const =0;
    virtual AddressValue * cloneAddressValue () const =0;
    virtual Tboolean operator< (const AddressValue & p_addr) const =0;
}

```

**Methods:**

~AddressValue  
 Destructor  
 getAddress  
 Return the value of the address  
 setAddress  
 Set the value of the address  
 operator==  
 Returns true if both objects are equal  
 clone  
 Return a copy of the AddressValue  
 operator<  
 Operator < overload

**10.5.3.18 MatchingMechanism**

Represents a TTCN-3 matching mechanism. It is mapped to the following pure virtual class:

```
class MatchingMechanism : public virtual TciValue {
public:
    virtual ~MatchingMechanism ();
    virtual TciMatchingType getMatchingType () const =0;
    virtual Tboolean operator== (const MatchingMechanism &p_template) const =0;
    virtual MatchingMechanism * clone () const =0;
    virtual Tboolean operator< (const MatchingMechanism &p_template) const =0;
}
```

**Methods:**

~MatchingMechanism  
 Destructor  
 getMatchingType  
 Returns the matching mechanism type  
 operator==  
 Returns true if both objects are equal  
 clone  
 Return a copy of the MatchingMechanism  
 operator<  
 Operator < overload

**10.5.3.19 MatchingList**

Represents the following TTCN-3 matching mechanisms: template list, complemented template list, subset, superset. It is mapped to the following pure virtual class:

```
class MatchingList : public virtual MatchingMechanism {
public:
    virtual ~MatchingList ();
    virtual Tsize size () const =0;
    virtual TciValue& get (Tindex p_position) const =0;
    virtual void add (TciValue& p_val) =0;
    virtual void remove (Tindex p_position) =0;
    virtual void clear () =0;
    virtual Tboolean operator== (const MatchingList &p_list) const =0;
    virtual MatchingList * clone () const =0;
    virtual Tboolean operator< (const MatchingList &p_list) const =0;
}
```

**Methods:**

~MatchingList  
 Destructor  
 size  
 Returns the number of items in the matching list  
 get  
 Returns the value or template at the specified position inside the matching list  
 add  
 Adds a new item to the end of the matching list, increasing its size

remove  
Removes the value or template at the specified position inside the matching list

clear  
Removes all values and templates from the matching list

operator==  
Returns true if both objects are equal

clone  
Return a copy of the MatchingList

operator<  
Operator < overload

### 10.5.3.20 ValueRange

TTCN-3 value range support. It is mapped to the following pure virtual class:

```
class ValueRange : public virtual MatchingMechanism {
public:
    virtual ~ValueRange ();
    virtual RangeBoundary & getLowerBoundary () =0;
    virtual RangeBoundary & getUpperBoundary () =0;
    virtual void setLowerBoundary (const RangeBoundary & p_boundary) =0;
    virtual void setUpperBoundary (const RangeBoundary & p_boundary) =0;
    virtual Tboolean operator== (const ValueRange &p_range) const =0;
    virtual ValueRange * clone () const =0;
    virtual Tboolean operator< (const ValueRange &p_range) const =0;
}
```

#### Methods:

~ValueRange  
Destructor

getLowerBoundary  
Returns the lower boundary of the range

getUpperBoundary  
Returns the upper boundary of the range

setLowerBoundary  
Sets the lower boundary of the range

setUpperBoundary  
Sets the upper boundary of the range

operator==  
Returns true if both objects are equal

clone  
Return a copy of the ValueRange

operator<  
Operator < overload

### 10.5.3.21 CharacterPattern

TTCN-3 pattern support. It is mapped to the following pure virtual class:

```
class CharacterPattern : public virtual MatchingMechanism {
public:
    virtual ~CharacterPattern ();
    virtual TciValue & getPatternString () =0;
    virtual void setPatternString (const TciValue & p_string) =0;
    virtual Tboolean operator== (const CharacterPattern &p_pattern) const =0;
    virtual CharacterPattern * clone () const =0;
    virtual Tboolean operator< (const CharacterPattern &p_pattern) const =0;
}
```

#### Methods:

~CharacterPattern  
Destructor

getPatternString  
Returns the character pattern definition of this pattern

setPatternString  
Sets the character pattern definition of this pattern

operator==  
Returns true if both objects are equal

```
clone
    Return a copy of the CharacterPattern
operator<
    Operator < overload
```

### 10.5.3.22 MatchDecodedContent

TTCN-3 MatchDecodedContent support. It is mapped to the following pure virtual class:

```
class MatchDecodedContent : public virtual MatchingMechanism {
public:
    virtual ~MatchDecodedContent ();
    virtual TciValue & getContent () =0;
    virtual void setContent (const TciValue & p_content) =0;
    virtual Tboolean operator== (const MatchDecodedContent &p_content) const =0;
    virtual MatchDecodedContent * clone () const =0;
    virtual Tboolean operator< (const MatchDecodedContent &p_content) const =0;
}
```

#### Methods:

```
~MatchDecodedContent
    Destructor
getContent
    Returns the value or matching mechanism used as an argument of the decmatch matching mechanism
setContent
    Sets the value or matching mechanism used as an argument of the decmatch matching mechanism
operator==
    Returns true if both objects are equal
clone
    Return a copy of the MatchDecodedContent template
operator<
    Operator < overload
```

## 10.5.4 Abstract logging types

### 10.5.4.1 TciValueTemplate

Interface that defines the concrete operations of the TTCN-3 template. It is mapped to the following pure virtual class:

```
class TciValueTemplate {
public:
    virtual ~TciValueTemplate ();
    virtual Tboolean isOmit () const =0;
    virtual Tboolean isAny () const =0;
    virtual Tboolean isAnyOrOmit () const =0;
    virtual const Tstring & getTemplateDef () const =0;
    virtual Tboolean operator== (const TciValueTemplate &vtempl) const =0;
    virtual TciValueTemplate * clone () const =0;
    virtual Tboolean operator< (const TciValueTemplate &vtempl) const =0;
}
```

#### Methods:

```
~TciValueTemplate ()
    Destructor
isOmit ()
    Return true if value of template is omit
isAny ()
    Return true if value of template is any
isAnyOrOmit ()
    Return true value of template if any or omit
getTemplateDef ()
    Return the template definition as defined in the TTCN-3 module
operator== (const TciValueTemplate &vtempl)
    Returns true if both objects are equal
clone ()
    Return a copy of the TciValueTemplate
```

```
operator< (const TciValueTemplate &vtempl)
    Operator < overload
```

### 10.5.4.2 TciNonValueTemplate

Support *all* and *any* matching mechanisms over TTCN-3 components and timers. It is mapped to the following pure virtual class:

```
class TciNonValueTemplate {
public:
    virtual ~TciNonValueTemplate ();
    virtual Tboolean isAny () const =0;
    virtual Tboolean isAll () const =0;
    virtual const Tstring & getTemplateDef () const =0;
    virtual Tboolean operator== (const TciNonValueTemplate &nvtempl) const =0;
    virtual TciNonValueTemplate * clone () const =0;
    virtual Tboolean operator< (const TciNonValueTemplate &nvtempl) const =0;
}
```

#### Methods:

```
~TciNonValueTemplate ()
    Destructor
isAny ()
    Return true if value is any
isAll ()
    Return true if is value all
getTemplateDef ()
    Return template definition as defined in the TTCN-3 module
operator== (const TciNonValueTemplate &nvtempl)
    Returns true if both objects are equal
clone ()
    Return a copy of the TciNonValueTemplate
operator< (const TciNonValueTemplate &nvtempl)
    Operator < overload
```

### 10.5.4.3 TciValueList

A list of TciValues. It is mapped to the following pure virtual class:

```
class TciValueList {
public:
    virtual ~TciValueList (void);
    virtual Tsize size () const =0;
    virtual Tboolean empty () const =0;
    virtual const TciValue *get (Tindex index) const =0;
    virtual void clear ()=0;
    virtual void add (const TciValue &comp)=0;
    virtual Tboolean operator== (const TciValueList &valList) const =0;
    virtual TciValueList * clone () const =0;
    virtual Tboolean operator< (const TciValueList &valList) const =0;
}
```

#### Methods:

```
~TciValueList ()
    Destructor
size ()
    Return the size of the list
empty ()
    Return true if the list is empty
get (Tindex index)
    Return the value at the specified position
clear ()
    Remove all the elements from this list
add (const TciValue &comp)
    Add an element to the end of this list
operator== (const TciValueList &valList)
    Returns true if both objects are equal
```

```
clone ()
    Return a copy of the TciValueList
operator< (const TciValueList &valList)
    Operator < overload
```

#### 10.5.4.4 TciValueDifference

Represents the differences during a match operation. It is mapped to the following pure virtual class:

```
class TciValueDifference {
public:
    virtual ~TciValueDifference ();
    virtual const TciValue & getValue () const =0;
    virtual void setValue (TciValue &val)=0;
    virtual const TciValueTemplate & getTciValueTemplate () const =0;
    virtual void setTciValueTemplate (TciValueTemplate &valT)=0;
    virtual const Tstring & getDescription () const =0;
    virtual void setDescription (const Tstring &descr)=0;
    virtual Tboolean operator== (const TciValueDifference &vdiff) const =0;
    virtual TciValueDifference * clone () const =0;
    virtual Tboolean operator< (const TciValueDifference &vdiff) const =0;
}
```

##### Methods:

```
~TciValueDifference ()
    Destructor
getValue ()
    Return the value definition
setValue (TciValue &val)
    Set the value definition
getTciValueTemplate ()
    Return the template definition
setTciValueTemplate (TciValueTemplate &valT)
    Set the template definition
getDescription ()
    Return a string which describes the difference
setDescription (const Tstring &descr)
    Set description
operator== (const TciValueDifference &vdiff)
    Returns true if both objects are equal
clone ()
    Return a copy of the TciValueDifference
operator< (const TciValueDifference &vdiff)
    Operator < overload
```

#### 10.5.4.5 TciValueDifferenceList

Collection of TciValueDifferences. It is mapped to the following pure virtual class:

```
class TciValueDifferenceList {
public:
    virtual ~TciValueDifferenceList ();
    virtual Tsize size () const =0;
    virtual Tboolean empty () const =0;
    virtual const TciValueDifference *get (Tindex p_position) const =0;
    virtual void clear ()=0;
    virtual void add (const TciValueDifference &comp)=0;
    virtual Tboolean operator== (const TciValueDifferenceList &vdList) const =0;
    virtual TciValueDifferenceList * clone () const =0;
    virtual Tboolean operator< (const TciValueDifferenceList &vdList) const =0;
}
```

##### Methods:

```
~TciValueDifferenceList ()
    Destructor
size ()
    Return the size of the list
empty ()
    Return true if this list contains no elements
```



```

get (Tindex p_position)
    Return the requested difference
clear ()
    Remove all the components from this list
add (const TciValueDifference &comp)
    Add a component to the end of the list
operator== (const TciValueDifferenceList &vdList)
    Returns true if both objects are equal
clone ()
    Return a copy of the TciValueDifferenceList
operator< (const TciValueDifferenceList &vdList)
    Operator < overload

```

### 10.5.4.6 ComponentStatus

Defines component status as an enumeration:

```

typedef enum
{
    INACTIVE_C = 0,
    RUNNING_C = 1,
    STOPPED_C = 2,
    KILLED_C = 3
    NULL_C = 4
} ComponentStatus;

```

### 10.5.4.7 TimerStatus

Defines timer status as an enumeration:

```

typedef enum
{
    RUNNING_T = 0,
    INACTIVE_T = 1,
    EXPIRED_T = 2
    NULL_T = 3
} TimerStatus;

```

### 10.5.4.8 TciStatus

Defines TCI status as an enumeration:

```

typedef enum
{
    TCI_OK = 0,
    TCI_ERROR = -1
} TciStatus;

```

## 10.6 Operations mapping

### 10.6.1 TCI-TM

#### 10.6.1.1 TciTmRequired

Specifies the operations the TM requires from TE. It is mapped to the following interface:

```

//Destructor
virtual ~TciTmRequired ();

//Selects the indicated module for execution
virtual void tciRootModule (const TciModuleId *moduleName)=0;

//The TE provides to the management a list of imported modules of the root module
virtual const TciModuleIdList * getImportedModules () const =0;

//The TE provides to the management a list of module parameters of the identified module
virtual const TciModuleParameterList * tciGetModuleParameters (const TciModuleId *moduleName)=0;

```

```

//The TE provides to the management a list of test cases
virtual const TciTestCaseIdList * tciGetTestCases () const =0;

//The TE provides to the management a list of parameter types of the given test case
virtual const TciParameterTypeList * tciGetTestCaseParameters (const TciTestCaseId *testCaseId)
const =0;

//The TE provides to the management a list of system ports of the given test case
virtual const TriPortIdList * tciGetTestCaseTSI (const TciTestCaseId &testCaseId) const =0;

//Starts a testcase in the currently selected module with the given parameters
virtual void tciStartTestCase (const TciTestCaseId *testCaseId, const TciParameterList
*parameterList)=0;

//Stops the testcase currently being executed
virtual void tciStopTestCase ()=0;

//Starts the module control function of the selected module
virtual const TriComponentId * tciStartControl ()=0;

//Stops execution of the control part
virtual void tciStopControl ()=0;

//The TE provides to the management a list of parameter types of the module control function
virtual const TciParameterTypeList * tciGetControlParameters () const =0;

//Starts the module control function of the selected module with additional parameters
virtual const TriComponentId * tciStartControlWithParameters ()=0;

```

### 10.6.1.2 TciTmProvided

Specifies the operation the TM has to provide to the TE. It is mapped to the following interface:

```

//Destructor
virtual ~TciTmProvided ();

//Indicates to the TM that a test case with testCaseId has been started
virtual void tciTestCaseStarted (const TciTestCaseId &testCaseId, const TciParameterList
&parameterList, const Tfloat &timer)=0;

//Called to indicate that the test case has terminated execution
virtual void tciTestCaseTerminated (const VerdictValue &verdict, const TciParameterList
&parameterList)=0;

//Called to indicate that the control function of the selected module has just terminated execution
virtual void tciControlTerminated ()=0;

//The management provides to the TE a Value for the indicated parameterId
virtual TciValue * tciGetModulePar (const TciModuleParameterId &parameterId)=0;

//Indicates the occurrence of an unrecoverable error situation
virtual void tciError (const Tstring &message)=0;

//The TE indicates a message of a test component
virtual void tciLog (const TriComponentId &testComponentId, const Tstring &message)=0;

//Called to pass the result of the module control function execution to the TM
virtual void tciControlTerminatedWithResult (const TciValue &result, const TciParameterList
&parameterList)=0;

```

## 10.6.2 TCI-CD

### 10.6.2.1 TciCdRequired

This class defines the TCI\_CD required interface. It is mapped to the following interface:

```

//Destructor
virtual ~TciCdRequired ();

//Returns a type representing a ttcn type
virtual const TciType * getTypeForName (const Tstring typeName) const =0;

//Constructs and returns a basic TTCN-3 integer type
virtual const TciType & getInteger () const =0;

```

```

//Constructs and returns a basic TTCN-3 float type
virtual const TciType & getFloat () const =0;

//Constructs and returns a basic TTCN-3 boolean type
virtual const TciType & getBoolean () const =0;

//Constructs and returns a basic TTCN-3 charstring type
virtual const TciType & getCharstring () const =0;

//Constructs and returns a basic TTCN-3 universal charstring type
virtual const TciType & getUniversalCharstring () const =0;

//Constructs and returns a basic TTCN-3 hexstring type
virtual const TciType & getHexstring () const =0;

//Constructs and returns a basic TTCN-3 bitstring type
virtual const TciType & getBitstring () const =0;

//Constructs and returns a basic TTCN-3 octetstring type
virtual const TciType & getOctetstring () const =0;

//Constructs and returns a basic TTCN-3 verdict type
virtual const TciType & getVerdict () const =0;

//The TE will be notified about an unrecoverable error situation within the CD
virtual void tciErrorReq (const Tstring message)=0;

```

### 10.6.2.2 TciCdProvided

This class defines the TCI\_CD provided interface. It is mapped to the following interface:

```

//Destructor
virtual ~TciCdProvided ();

//This operation is called whenever the TE has to implicitly decode a value
virtual TciValue * decode (const TriMessage *p_message, const TciType *p_decodingHypothesis)=0;

//This operation is called whenever the TE has to implicitly encode a value
virtual TriMessage * encode (const TciValue *p_value)=0;

//This operation is called whenever the TE invokes decvalue
virtual Tinteger decodeValue (TriMessage *p_message, const TciType *p_decodingHypothesis,
    const TuniversalString & decodingInfo, TciValue ** decodedValue )=0;

//This operation is called whenever the TE invokes encvalue
virtual TriMessage * encodeValue (const TciValue *p_value, const TuniversalString & encodingInfo)=0;

```

## 10.6.3 TCI-CH

### 10.6.3.1 TciChRequired

This class defines the TCI\_CH required interface. It is mapped to the following interface:

```

//Default destructor
virtual ~TciChRequired ();

//This operation is called by the CH at the local TE when at a remote TE a provided
//tciSendConnected has been called
virtual void tciEnqueueMsgConnected (const TriPortId *sender, const TriComponentId *receiver,
    const TciValue *rcvdMessage)=0;

//This operation is called by the CH at the local TE when at a remote TE a provided
//tciCallConnected has been called
virtual void tciEnqueueCallConnected (const TriPortId *sender, const TriComponentId *receiver,
    const TriSignatureId *signature, const TciParameterList *parameterList)=0;

//This operation is called by the CH at the local TE when at a remote TE a provided
//tciReplyConnected has been called
virtual void tciEnqueueReplyConnected (const TriPortId *sender, const TriComponentId *receiver,
    const TriSignatureId *signature, const TciParameterList *parameterList,
    const TciValue *returnValue)=0;

```

```
//This operation is called by the CH at the local TE when at a remote TE a provided
//tciRaiseConnected has been called
virtual void tciEnqueueRaiseConnected (const TriPortId *sender, const TriComponentId *receiver,
    const TriSignatureId *signature, const TciValue *exception)=0;

//This operation is called by the CH at the local TE when at a remote TE a provided
//tciCreateTestComponentReq has been called
virtual const TriComponentId * tciCreateTestComponent (const TciTestComponentKind *kind,
    const TciType *componentType, const Tstring *name)=0;

//This operation is called by the CH at the local TE when at a remote TE a provided
//tciStartTestComponentReq has been called
virtual void tciStartTestComponent (const TriComponentId *component,
    const TciBehaviourId *behaviour, const TciParameterList *parameterList)=0;

//This operation is called by the CH at the local TE when at a remote TE a provided
//tciStopTestComponentReq has been called
virtual void tciStopTestComponent (const TriComponentId *component)=0;

//This operation is called by the CH at the local TE when at a remote TE a provided tciConnect
//has been called
virtual void tciConnect (const TriPortId *fromPort, const TriPortId *toPort)

//This operation is called by the CH at the local TE when at a remote TE a provided
//tciDisconnect has been called
virtual void tciDisconnect (const TriPortId *fromPort, const TriPortId *toPort)=0;

//This operation is called by the CH at the local TE when at a remote TE a provided tciMapReq
//has been called
virtual void tciMap (const TriPortId *fromPort, const TriPortId *toPort)=0;

//This operation is called by the CH at the local TE when at a remote TE a provided
//tciMapParamReq has been called
virtual void tciMapParam (const TriPortId *fromPort, const TriPortId *toPort,
    const TciParameterList *parameterList)=0;

//This operation is called by the CH at the local TE when at a remote TE a provided tciUnmapReq
//has been called
virtual void tciUnmap (const TriPortId *fromPort, const TriPortId *toPort)=0;

//This operation is called by the CH at the local TE when at a remote TE a provided
//tciUnmapParamReq has been called
virtual void tciUnmapParam (const TriPortId *fromPort, const TriPortId *toPort,
    const TciParameterList *parameterList)=0;

//This operation is called by the CH at the local TE when at a remote TE a provided
//tciTestComponentTerminatedReq has been called
virtual void tciTestComponentTerminated (const TriComponentId *component,
    const VerdictValue *verdict) const =0;

//This operation is called by the CH at the local TE when at a remote TE a provided
//tciTestComponentRunningReq has been called
virtual Tboolean tciTestComponentRunning (const TriComponentId *component) const =0;

//This operation is called by the CH at the local TE when at a remote TE a provided
//tciTestComponentDoneReq has been called
virtual Tboolean tciTestComponentDone (const TriComponentId *comp, VerdictValueEnum * verdict)
    const =0;

//This operation can be called by the CH at the appropriate local TE when at a remote TE a
//provided tciGetMTCReq has been called
virtual const TriComponentId * tciGetMTC () const =0;

//This operation is called by the CH at the appropriate local TE when at a remote TE a provided
//tciExecuteTestCaseReq has been called
virtual void tciExecuteTestCase (const TciTestCaseId *testCaseId,
    const TriPortIdList *tsiPortList)=0;

//This operation is called by the CH at appropriate local TEs when at a remote TE a provided
//tciResetReq has been called
virtual void tciReset ()=0;

//This operation is called by the CH at the local TE when at a remote TE a provided
//tciKillTestComponentReq has been called
virtual void tciKillTestComponent (const TriComponentId *comp, VerdictValueEnum * verdict)=0;
```

```

//This operation is called by the CH at the local TE when at a remote TE a provided
//tciTestComponentAliveReq has been called
virtual Tboolean tciTestComponentAlive (const TriComponentId *comp) const =0;

//This operation is called by the CH at the local TE when at a remote TE a provided
//tciTestComponentKilledReq has been called
virtual Tboolean tciTestComponentKilled (const TriComponentId *comp) const =0;

//This operation is called by the CH at the local TE when at a remote TE a provided
//tciCallTestComponentReq has been called
virtual void tciCallTestComponent (const TriComponentId *component,
    const TciBehaviourId *behaviour, const TciParameterList *parameterList)=0;

//This operation is called by the CH at the local TE when at a remote TE a provided
//tciTestComponentCallTerminatedReq has been called
virtual void tciTestComponentCallTerminated (const TriComponentId *component,
    const VerdictValue *verdict, const TciParameterList *parameterList,
    const TciValue *returnValue)=0;

```

### 10.6.3.2 TciChProvided

This class defines the TCI\_CH provided interface. It is mapped to the following interface:

```

//Destructor
virtual ~TciChProvided ();

//Called by the TE when it executes a TTCN-3 unicast send operation on a component port
virtual void tciSendConnected (const TriPortId *sender, const TriComponentId *receiver,
    const TciValue *sendMessage)=0;

//Called by the TE when it executes a TTCN-3 broadcast send operation on a component port
virtual void tciSendConnectedBC (const TriPortId *sender, const TciValue *sendMessage)=0;

//Called by the TE when it executes a TTCN-3 multicast send operation on a component port
virtual void tciSendConnectedMC (const TriPortId *sender, const TriComponentIdList *receivers,
    const TciValue *sendMessage)=0;

//Called by the TE when it executes a TTCN-3 unicast call operation on a component port
virtual void tciCallConnected (const TriPortId *sender, const TriComponentId *receiver,
    const TriSignatureId *signature, const TciParameterList *parameterList)=0;

//Called by the TE when it executes a TTCN-3 broadcast call operation on a component port
virtual void tciCallConnectedBC (const TriPortId *sender, const TriSignatureId *signature,
    const TciParameterList *parameterList)=0;

//Called by the TE when it executes a TTCN-3 multicast call operation on a component port
virtual void tciCallConnectedMC (const TriPortId *sender, const TriComponentIdList *receivers,
    const TriSignatureId *signature, const TciParameterList *parameterList)=0;

//Called by the TE when it executes a TTCN-3 unicast reply operation on a component port
virtual void tciReplyConnected (const TriPortId *sender, const TriComponentId *receiver,
    const TriSignatureId *signature, const TciParameterList *parameterList,
    const TciValue *returnValue)=0;

//Called by the TE when it executes a TTCN-3 broadcast reply operation on a component port
virtual void tciReplyConnectedBC (const TriPortId *sender, const TriSignatureId *signature,
    const TciParameterList *parameterList, const TciValue *returnValue)=0;

//Called by the TE when it executes a TTCN-3 multicast reply operation on a component
virtual void tciReplyConnectedMC (const TriPortId *sender, const TriComponentIdList *receivers,
    const TriSignatureId *signature, const TciParameterList *parameterList,
    const TciValue *returnValue)=0;

//Called by the TE when it executes a TTCN-3 unicast raise operation on a component port
virtual void tciRaiseConnected (const TriPortId *sender, const TriComponentId *receiver,
    const TriSignatureId *signature, const TciValue *exception)=0;

//Called by the TE when it executes a TTCN-3 broadcast raise operation on a component portvirtual
void tciRaiseConnectedBC (const TriPortId *sender, const TriSignatureId *signature,
    const TciValue *exception)=0;

//Called by the TE when it executes a TTCN-3 multicast raise operation on a component
virtual void tciRaiseConnectedMC (const TriPortId *sender, const TriComponentIdList *receiver,
    const TriSignatureId *signature, const TciValue *exception)=0;

```

```
//Called from the TE when a component has to be created
virtual const TriComponentId * tciCreateTestComponentReq (const TciTestComponentKind *kind,
  const QualifiedName *componentType, const Tstring &name, const TciValue *hostId)=0;

//Called by the TE when it executes the TTCN-3 start operation
virtual void tciStartTestComponentReq (const TriComponentId *component,
  const TciBehaviourId *behaviour, const TciParameterList *parameterList)=0;

//Called by the TE when it executes the TTCN-3 stop operation
virtual void tciStopTestComponentReq (const TriComponentId *component)=0;

//Called by the TE when it executes a TTCN-3 connect operation
virtual void tciConnectReq (const TriPortId *fromPort, const TriPortId *toPort)=0;

//Called by the TE when it executes a TTCN-3 disconnect operation
virtual void tciDisconnectReq (const TriPortId *fromPort, const TriPortId *toPort)=0;

//Called by the TE when it executes a TTCN-3 map operation
virtual void tciMapReq (const TriPortId *fromPort, const TriPortId *toPort)=0;

//Called by the TE when it executes a TTCN-3 map operation including parameters
virtual void tciMapParamReq (const TriPortId *fromPort, const TriPortId *toPort,
  const TciParameterList *parameterList)=0;

//Called by the TE when it executes a TTCN-3 unmap operation
virtual void tciUnmapReq (const TriPortId *fromPort, const TriPortId *toPort)=0;

//Called by the TE when it executes a TTCN-3 unmap operation including parameters
virtual void tciUnmapParamReq (const TriPortId *fromPort, const TriPortId *toPort,
  const TciParameterList *parameterList)=0;

//Called by the TE when a test component terminates execution
virtual void tciTestComponentTerminatedReq (const TriComponentId *component,
  const VerdictValue *verdict)=0;

//Called by the TE when it executes a TTCN-3 running operation
virtual Tboolean tciTestComponentRunningReq (const TriComponentId *component) const =0;

//Called by the TE when it executes a TTCN-3 done operation
virtual Tboolean tciTestComponentDoneReq (const TriComponentId *comp, VerdictValueEnum * verdict)
  const =0;

//Called by the TE when it executes a TTCN-3 mtc operation
virtual const TriComponentId * tciGetMTCReq () const =0;

//Called by the TE immediately before it starts the test case behaviour on the MTC
virtual void tciExecuteTestCaseReq (const TciTestCaseId *testCaseId,
  const TriPortIdList *tsiPortList)=0;

//Called by the TE at any time to reset the test system
virtual void tciResetReq ()=0;

//Called by the TE when it executes the TTCN-3 kill operation
virtual void tciKillTestComponentReq (const TriComponentId *comp)=0;

//Called by the TE when it executes the TTCN-3 alive operation
virtual Tboolean tciTestComponentAliveReq (const TriComponentId *comp) const =0;

//Called by the TE when it executes the TTCN-3 killed operation
virtual Tboolean tciTestComponentKilledReq (const TriComponentId *comp, VerdictValueEnum * verdict)
  const =0;

//Called by the TE when it starts executing the TTCN-3 call component operation
virtual void tciCallTestComponentReq (const TriComponentId *component,
  const TciBehaviourId *behaviour, const TciParameterList *parameterList)=0;

//Called by the TE when an execution of a test component call operation is finished
virtual void tciTestComponentCallTerminatedReq (const TriComponentId *component,
  const VerdictValue *verdict, const TciParameterList *parameterList,
  const TciValue *returnValue)=0;
```

## 10.6.4 TCI-TL

### 10.6.4.1 TciTlProvided

This class defines the TCI\_TL provided Tinterface:

```
//Default constructor
TciTlProvided ();

// Destructor
virtual ~TciTlProvided ();

//Called by TE to log the execute test case request
virtual void tliTcExecute (const Tstring &am, const timeval ts, const Tstring src, const Tinteger
line, const TriComponentId *c, const TciTestCaseId *tcId, const TciParameterList *tciPars, const
TriTimerDuration *dur)=0;

//Called by TE to log the start of a testcase. This event occurs before the testcase is started
virtual void tliTcStart (const Tstring &am, const timeval ts, const Tstring &src, const Tinteger
line, const TriComponentId *c, const TciTestCaseId *tcId, const TciParameterList *tciPars, const
TriTimerDuration *dur)=0;

//Called by TE to log the stop of a testcase
virtual void tliTcStop (const Tstring &am, const timeval ts, const Tstring &src, const Tinteger
line, const TriComponentId *c, const Tstring &reason)=0;

//Called by TE to log the start of a testcase
virtual void tliTcStarted (const Tstring &am, const timeval ts, const Tstring &src, const Tinteger
line, const TriComponentId *c, const TciTestCaseId *tcId, const TciParameterList *tciPars, const
TriTimerDuration *dur)=0;

//Called by TE to log the termination of a testcase
virtual void tliTcTerminated (const Tstring &am, const timeval ts, const Tstring &src, const
Tinteger line, const TriComponentId *c, const TciTestCaseId *tcId, const TciParameterList *tciPars,
const VerdictValue *verdict, const Tstring &reason)=0;

//Called by TE to log the start of the control part
virtual void tliCtrlStart (const Tstring &am, const timeval ts, const Tstring &src, const Tinteger
line, const TriComponentId *c)=0;

//Called by TE to log the stop of the control part. This event occurs after the control has
//stopped. If the control is not represented by TRI component, c is null
virtual void tliCtrlStop (const Tstring &am, const timeval ts, const Tstring &src, const Tinteger
line, const TriComponentId *c)=0;

//Called by TE to log the termination of the control part
virtual void tliCtrlTerminated (const Tstring &am, const timeval ts, const Tstring &src, const
Tinteger line, const TriComponentId *c)=0;

//Called by TE to log a unicast send operation
virtual void tliMSend_m (const Tstring &am, const timeval ts, const Tstring &src, const Tinteger
line, const TriComponentId *c, const TriPortId *at, const TriPortId *to, const TciValue *msgValue,
const TriAddress *address, const TciStatus *encoderFailure, const TriMessage *msg, const TriStatus
*transmissionFailure)=0;

//Called by TE to log a broadcast send operation
virtual void tliMSend_m_BC (const Tstring &am, const timeval ts, const Tstring &src, const Tinteger
line, const TriComponentId *c, const TriPortId *at, const TriPortId *to, const TciValue *msgValue,
const TciStatus *encoderFailure, const TriMessage *msg, const TriStatus *transmissionFailure)=0;

//Called by TE to log a multicast send operation
virtual void tliMSend_m_MC (const Tstring &am, const timeval ts, const Tstring &src, const Tinteger
line, const TriComponentId *c, const TriPortId *at, const TriPortId *to, const TciValue *msgValue,
const TriAddressList *addresses, const TciStatus *encoderFailure, const TriMessage *msg, const
TriStatus *transmissionFailure)=0;

//Called by TE to log a unicast send operation
virtual void tliMSend_c (const Tstring &am, const timeval ts, const Tstring src, const Tinteger
line, const TriComponentId *c, const TriPortId *at, const TriPortId *to, const TciValue *msgValue,
const TriStatus *transmissionFailure)=0;

//Called by TE to log a broadcast send operation
virtual void tliMSend_c_BC (const Tstring &am, const timeval ts, const Tstring src, const Tinteger
line, const TriComponentId *c, const TriPortId *at, const TriPortIdList *to, const TciValue
*msgValue, const TriStatus *transmissionFailure)=0;
```

```

//Called by TE to log a multicast send operation
virtual void tliMSend_c_MC (const Tstring &am, const timeval ts, const Tstring src, const Tinteger
line, const TriComponentId *c, const TriPortId *at, const TriPortIdList *to, const TciValue
*msgValue, const TriStatus *transmissionFailure)=0;

//Called by TE to log the enqueueing of a message
virtual void tliMDetected_m (const Tstring &am, const timeval ts, const Tstring &src, const Tinteger
line, const TriComponentId *c, const TriPortId *at, const TriPortId *from, const TriMessage *msg,
const TriAddress *address)=0;

//Called by CH to log the enqueueing of a message
virtual void tliMDetected_c (const Tstring &am, const timeval ts, const Tstring src, const Tinteger
line, const TriComponentId *c, const TriPortId *at, const TriPortId *from, const TciValue
*msgValue)=0;

//Called by TE to log the mismatch of a template
virtual void tliMMismatch_m (const Tstring &am, const timeval ts, const Tstring &src, const Tinteger
line, const TriComponentId *c, const TriPortId *at, const TciValue *msgValue, const TciValueTemplate
*msgTpl, const TciValueDifferenceList *diffs, const TciValue *addrValue, const TciValueTemplate
*addressTpl)=0;

//Called by TE to log the mismatch of a template
virtual void tliMMismatch_c (const Tstring &am, const timeval ts, const Tstring &src, const Tinteger
line, const TriComponentId *c, const TriPortId *at, const TciValue *msgValue, const TciValueTemplate
*msgTpl, const TciValueDifferenceList *diffs, const TriComponentId *from, const TciNonValueTemplate
*fromTpl)=0;

// Called by TE to log the receiving of a message
virtual void tliMReceive_m (const Tstring &am, const timeval ts, const Tstring &src, const Tinteger
line, const TriComponentId *c, const TriPortId *at, const TciValue *msgValue, const TciValueTemplate
*msgTpl, const TciValue *addrValue, const TciValueTemplate *addressTpl)=0;

//Called by TE to log the mismatch of a template
virtual void tliMReceive_c (const Tstring &am, const timeval ts, const Tstring &src, const Tinteger
line, const TriComponentId *c, const TriPortId *at, const TciValue *msgValue, const TciValueTemplate
*msgTpl, const TriComponentId *fromComp, const TciNonValueTemplate *fromTpl)=0;

//Called by TE to log a unicast call operation
virtual void tliPrCall_m (const Tstring &am, const timeval ts, const Tstring src, const Tinteger
line, const TriComponentId *c, const TriPortId *at, const TriPortId *to, const TriSignatureId
*signature, const TciParameterList *tciPars, const TriAddress *address, const TciStatus
*encoderFailure, const TriParameterList *triPars, const TriStatus *transmissionFailure)=0;

//Called by TE to log a broadcast call operation
virtual void tliPrCall_m_BC (const Tstring &am, const timeval ts, const Tstring src, const Tinteger
line, const TriComponentId *c, const TriPortId *at, const TriPortId *to, const TriSignatureId
*signature, const TciParameterList *tciPars, const TciStatus *encoderFailure, const TriParameterList
*triPars, const TriStatus *transmissionFailure)=0;

//Called by TE to log a multicast call operation
virtual void tliPrCall_m_MC (const Tstring &am, const timeval ts, const Tstring src, const Tinteger
line, const TriComponentId *c, const TriPortId *at, const TriPortId *to, const TriSignatureId
*signature, const TciParameterList *tciPars, const TriAddressList *addresses, const TciStatus
*encoderFailure, const TriParameterList *triPars, const TriStatus *transmissionFailure)=0;

//Called by TE to log a unicast call operation
virtual void tliPrCall_c (const Tstring &am, const timeval ts, const Tstring src, const Tinteger
line, const TriComponentId *c, const TriPortId *at, const TriPortId *to, const TriSignatureId
*signature, const TciParameterList *tciPars, const TriStatus *transmissionFailure)=0;

//Called by TE to log a broadcast call operation
virtual void tliPrCall_c_BC (const Tstring &am, const timeval ts, const Tstring src, const Tinteger
line, const TriComponentId *c, const TriPortId *at, const TriPortIdList *to, const TriSignatureId
*signature, const TciParameterList *tciPars, const TriStatus *transmissionFailure)=0;

//Called by TE to log a multicast call operation
virtual void tliPrCall_c_MC (const Tstring &am, const timeval ts, const Tstring src, const Tinteger
line, const TriComponentId *c, const TriPortId *at, const TriPortIdList *to, const TriSignatureId
*signature, const TciParameterList *tciPars, const TriStatus *transmissionFailure)=0;

//Called by TE to log the getcall enqueue operation
virtual void tliPrGetCallDetected_m (const Tstring &am, const timeval ts, const Tstring src, const
Tinteger line, const TriComponentId *c, const TriPortId *at, const TriPortId *from, const
TriSignatureId *signature, const TriParameterList *triPars, const TriAddress *address)=0;

```



```

//Called by TE to log the getcall enqueue operation
virtual void tliPrGetCallDetected_c (const Tstring &am, const timeval ts, const Tstring src, const
Tinteger line, const TriComponentId *c, const TriPortId *at, const TriPortId *from, const
TriSignatureId *signature, const TciParameterList *tciPars)=0;

//Called by TE to log the mismatch of a getcall
virtual void tliPrGetCallMismatch_m (const Tstring &am, const timeval ts, const Tstring src, const
Tinteger line, const TriComponentId *c, const TriPortId *at, const TriSignatureId *signature, const
TciParameterList *tciPars, const TciValueTemplate *parsTmpl, const TciValueDifferenceList *diffs,
const TciValue *addrValue, const TciValueTemplate *addressTmpl)=0;

//Called by TE to log the mismatch of a getcall
virtual void tliPrGetCallMismatch_c (const Tstring &am, const timeval ts, const Tstring src, const
Tinteger line, const TriComponentId *c, const TriPortId *at, const TriSignatureId *signature, const
TciParameterList *tciPars, const TciValueTemplate *parsTmpl, const TciValueDifferenceList *diffs,
const TriComponentId *from, const TciValueTemplate *fromTmpl)=0;

//Called by TE to log getting a call
virtual void tliPrGetCall_m (const Tstring &am, const timeval ts, const Tstring src, const Tinteger
line, const TriComponentId *c, const TriPortId *at, const TriSignatureId *signature, const
TciParameterList *tciPars, const TciValueTemplate *parsTmpl, const TciValue *addrValue, const
TciValueTemplate *addressTmpl)=0;

//Called by TE to log getting a call
virtual void tliPrGetCall_c (const Tstring &am, const timeval ts, const Tstring src, const Tinteger
line, const TriComponentId *c, const TriPortId *at, const TriSignatureId *signature, const
TciParameterList *tciPars, const TciValueTemplate *parsTmpl, const TriComponentId *from, const
TciNonValueTemplate *fromTmpl)=0;

//Called by TE to log a unicast reply operation
virtual void tliPrReply_m (const Tstring &am, const timeval ts, const Tstring src, const Tinteger
line, const TriComponentId *c, const TriPortId *at, const TriPortId *to, const TriSignatureId
*signature, const TciParameterList *tciPars, const TciValue *replValue, const TriAddress *address,
const TciStatus *encoderFailure, const TriParameterList *triPars, const TriParameter *repl, const
TriStatus *transmissionFailure)=0;

//Called by TE to log a broadcast reply operation
virtual void tliPrReply_m_BC (const Tstring &am, const timeval ts, const Tstring src, const Tinteger
line, const TriComponentId *c, const TriPortId *at, const TriPortId *to, const TriSignatureId
*signature, const TciParameterList *tciPars, const TciValue *replValue, const TciStatus
*encoderFailure, const TriParameterList *triPars, const TriParameter *repl, const TriStatus
*transmissionFailure)=0;

//Called by TE to log a multicast reply operation
virtual void tliPrReply_m_MC (const Tstring &am, const timeval ts, const Tstring src, const Tinteger
line, const TriComponentId *c, const TriPortId *at, const TriPortId *to, const TriSignatureId
*signature, const TciParameterList *tciPars, const TciValue *replValue, const TriAddressList
*addresses, const TciStatus *encoderFailure, const TriParameterList *triPars, const TriParameter
*repl, const TriStatus *transmissionFailure)=0;

//Called by TE to log a unicast reply operation
virtual void tliPrReply_c (const Tstring &am, const timeval ts, const Tstring src, const Tinteger
line, const TriComponentId *c, const TriPortId *at, const TriPortId *to, const TriSignatureId
*signature, const TciValue *parsValue, const TciValue *replValue, const TriStatus
*transmissionFailure)=0;

//Called by TE to log a broadcast reply operation
virtual void tliPrReply_c_BC (const Tstring &am, const timeval ts, const Tstring src, const Tinteger
line, const TriComponentId *c, const TriPortId *at, const TriPortIdList *to, const TriSignatureId
*signature, const TciValue *parsValue, const TciValue *replValue, const TriStatus
*transmissionFailure)=0;

//Called by TE to log a multicast reply operation
virtual void tliPrReply_c_MC (const Tstring &am, const timeval ts, const Tstring src, const Tinteger
line, const TriComponentId *c, const TriPortId *at, const TriPortIdList *to, const TriSignatureId
*signature, const TciValue *parsValue, const TciValue *replValue, const TriStatus
*transmissionFailure)=0;

//Called by TE to log the getreply enqueue operation
virtual void tliPrGetReplyDetected_m (const Tstring &am, const timeval ts, const Tstring src, const
Tinteger line, const TriComponentId *c, const TriPortId *at, const TriPortId *from, const
TriSignatureId *signature, const TriParameterList *triPars, const TriParameter *repl, const
TriAddress *address)=0;

//Called by CH to log the getreply enqueue operation
virtual void tliPrGetReplyDetected_c (const Tstring &am, const timeval ts, const Tstring src, const
Tinteger line, const TriComponentId *c, const TriPortId *at, const TriPortId *from, const
TriSignatureId *signature, const TciParameterList *tciPars, const TciValue *replValue)=0;

```

```

//Called by TE to log the mismatch of a getreply operation
virtual void tliPrGetReplyMismatch_m (const Tstring &am, const timeval ts, const Tstring src, const
Tinteger line, const TriComponentId *c, const TriPortId *at, const TriSignatureId *signature, const
TciParameterList *tciPars, const TciValueTemplate *parsTpl, const TciValue *replValue, const
TciValueTemplate *replyTpl, const TciValueDifferenceList *diffs, const TciValue *addrValue, const
TciValueTemplate *addressTpl)=0;

//Called by TE to log the mismatch of a getreply operation
virtual void tliPrGetReplyMismatch_c (const Tstring &am, const timeval ts, const Tstring src, const
Tinteger line, const TriComponentId *c, const TriPortId *at, const TriSignatureId *signature, const
TciParameterList *tciPars, const TciValueTemplate *parsTpl, const TciValue *replValue, const
TciValueTemplate *replyTpl, const TciValueDifferenceList *diffs, const TriComponentId *from, const
TciNonValueTemplate *fromTpl)=0;

//Called by TE to log getting a reply
virtual void tliPrGetReply_m (const Tstring &am, const timeval ts, const Tstring src, const Tinteger
line, const TriComponentId *c, const TriPortId *at, const TriSignatureId *signature, const
TciParameterList *tciPars, const TciValueTemplate *parsTpl, const TciValue *replValue, const
TciValueTemplate *replyTpl, const TciValue *addrValue, const TciValueTemplate *addressTpl)=0;

//Called by TE to log getting a reply
virtual void tliPrGetReply_c (const Tstring &am, const timeval ts, const Tstring src, const Tinteger
line, const TriComponentId *c, const TriPortId *at, const TriSignatureId *signature, const
TciParameterList *tciPars, const TciValueTemplate *parsTpl, const TciValue *replValue, const
TciValueTemplate *replyTpl, const TriComponentId *from, const TciNonValueTemplate *fromTpl)=0;

//Called by TE to log a unicast raise operation
virtual void tliPrRaise_m (const Tstring &am, const timeval ts, const Tstring src, const Tinteger
line, const TriComponentId *c, const TriPortId *at, const TriPortId *to, const TriSignatureId
*signature, const TciParameterList *tciPars, const TciValue *excValue, const TriAddress *address,
const TriStatus *encoderFailure, const TriException *exc, const TriStatus *transmissionFailure)=0;

//Called by TE to log a broadcast raise operation
virtual void tliPrRaise_m_BC (const Tstring &am, const timeval ts, const Tstring src, const Tinteger
line, const TriComponentId *c, const TriPortId *at, const TriPortId *to, const TriSignatureId
*signature, const TciParameterList *tciPars, const TciValue *excValue, const TriStatus
*encoderFailure, const TriException *exc, const TriStatus *transmissionFailure)=0;

//Called by TE to log a multicast raise operation
virtual void tliPrRaise_m_MC (const Tstring &am, const timeval ts, const Tstring src, const Tinteger
line, const TriComponentId *c, const TriPortId *at, const TriPortId *to, const TriSignatureId
*signature, const TciParameterList *tciPars, const TciValue *excValue, const TriAddressList
*addresses, const TriStatus *encoderFailure, const TriException *exc, const TriStatus
*transmissionFailure)=0;

//Called by TE to log a unicast raise operation
virtual void tliPrRaise_c (const Tstring &am, const timeval ts, const Tstring src, const Tinteger
line, const TriComponentId *c, const TriPortId *at, const TriPortId *to, const TriSignatureId
*signature, const TciParameterList *tciPars, const TciValue *excValue, const TriStatus
*transmissionFailure)=0;

//Called by TE to log a broadcast raise operation
virtual void tliPrRaise_c_BC (const Tstring &am, const timeval ts, const Tstring src, const Tinteger
line, const TriComponentId *c, const TriPortId *at, const TriPortIdList *to, const TriSignatureId
*signature, const TciParameterList *tciPars, const TciValue *excValue, const TriStatus
*transmissionFailure)=0;

//Called by TE to log a multicast raise operation
virtual void tliPrRaise_c_MC (const Tstring &am, const timeval ts, const Tstring src, const Tinteger
line, const TriComponentId *c, const TriPortId *at, const TriPortIdList *to, const TriSignatureId
*signature, const TciParameterList *tciPars, const TciValue *excValue, const TriStatus
*transmissionFailure)=0;

//Called by TE to log the catch enqueue operation
virtual void tliPrCatchDetected_m (const Tstring &am, const timeval ts, const Tstring src, const
Tinteger line, const TriComponentId *c, const TriPortId *at, const TriPortId *from, const
TriSignatureId *signature, const TriException *exc, const TriAddress *address)=0;

//Called by TE to log the catch enqueue operation
virtual void tliPrCatchDetected_c (const Tstring &am, const timeval ts, const Tstring src, const
Tinteger line, const TriComponentId *c, const TriPortId *at, const TriPortId *from, const
TriSignatureId *signature, const TciValue *excValue)=0;

//Called by TE to log the mismatch of a catch operation
virtual void tliPrCatchMismatch_m (const Tstring &am, const timeval ts, const Tstring src, const
Tinteger line, const TriComponentId *c, const TriPortId *at, const TriSignatureId *signature, const
TciValue *excValue, const TciValueTemplate *excTpl, const TciValueDifferenceList *diffs, const
TciValue *addrValue, const TciValueTemplate *addressTpl)=0;

```

```

//Called by TE to log the mismatch of a catch operation
virtual void tliPrCatchMismatch_c (const Tstring &am, const timeval ts, const Tstring src, const
Tinteger line, const TriComponentId *c, const TriPortId *at, const TriSignatureId *signature, const
TciValue *excValue, const TciValueTemplate *excTmpl, const TciValueDifferenceList *diffs, const
TriComponentId *from, const TciNonValueTemplate *fromTmpl)=0;

//Called by TE to log catching an exception
virtual void tliPrCatch_m (const Tstring &am, const timeval ts, const Tstring src, const Tinteger
line, const TriComponentId *c, const TriPortId *at, const TriSignatureId *signature, const TciValue
*excValue, const TciValueTemplate *excTmpl, const TciValue *addrValue, const TciValueTemplate
*addressTmpl)=0;

//Called by TE to log catching an exception
virtual void tliPrCatch_c (const Tstring &am, const timeval ts, const Tstring src, const Tinteger
line, const TriComponentId *c, const TriPortId *at, const TriSignatureId *signature, const TciValue
*excValue, const TciValueTemplate *excTmpl, const TriComponentId *from, const TciNonValueTemplate
*fromTmpl)=0;

//Called by TE to log the detection of a catch timeout
virtual void tliPrCatchTimeoutDetected (const Tstring &am, const timeval ts, const Tstring src,
const Tinteger line, const TriComponentId *c, const TriPortId *at, const TriSignatureId
*signature)=0;

//Called by TE to log catching a timeout
virtual void tliPrCatchTimeout (const Tstring &am, const timeval ts, const Tstring src, const
Tinteger line, const TriComponentId *c, const TriPortId *at, const TriSignatureId *signature)=0;

//Called by TE to log the create component operation
virtual void tliCCreate (const Tstring &am, const timeval ts, const Tstring src, const Tinteger
line, const TriComponentId *c, const TriComponentId *comp, const Tstring &name, const Tboolean
alive)=0;

//Called by TE to log the start component operation
virtual void tliCStart (const Tstring &am, const timeval ts, const Tstring &src, const Tinteger
line, const TriComponentId *c, const TriComponentId *comp, const TciBehaviourId *beh, const
TciParameterList *tciPars)=0;

//Called by TE to log the running component operation
virtual void tliCRunning (const Tstring &am, const timeval ts, const Tstring &src, const Tinteger
line, const TriComponentId *c, const TriComponentId *comp, const ComponentStatus status)=0;

//Called by TE to log the alive component operation
virtual void tliCAlive (const Tstring &am, const timeval ts, const Tstring &src, const Tinteger
line, const TriComponentId *c, const TriComponentId *comp, const ComponentStatus status)=0;

//Called by TE to log the stop component operation
virtual void tliCStop (const Tstring &am, const timeval ts, const Tstring &src, const Tinteger line,
const TriComponentId *c, const TriComponentId *comp)=0;

//Called by TE to log the kill component operation
virtual void tliCKill (const Tstring &am, const timeval ts, const Tstring &src, const Tinteger line,
const TriComponentId *c, const TriComponentId *comp)=0;

//Called by TE to log the mismatch of a done component operation
virtual void tliCDoneMismatch (const Tstring &am, const timeval ts, const Tstring &src, const
Tinteger line, const TriComponentId *c, const TriComponentId *comp, const TciNonValueTemplate
*compTmpl)=0;

//Called by TE to log the done component operation
virtual void tliCDone (const Tstring &am, const timeval ts, const Tstring &src, const Tinteger line,
const TriComponentId *c, const TciNonValueTemplate *compTmpl, const VerdictValue * verdict)=0;

//Called by TE to log the mismatch of a killed component operation
virtual void tliCKilledMismatch (const Tstring &am, const timeval ts, const Tstring &src, const
Tinteger line, const TriComponentId *c, const TciNonValueTemplate *compTmpl)=0;

//Called by TE to log the killed component operation
virtual void tliCKilled (const Tstring &am, const timeval ts, const Tstring &src, const Tinteger
line, const TriComponentId *c, const TciNonValueTemplate *compTmpl, const VerdictValue * verdict)=0;

//Called by TE to log the termination of a component
virtual void tliCTerminated (const Tstring &am, const timeval ts, const Tstring &src, const Tinteger
line, const TriComponentId *c, const VerdictValue *verdict, const TString &reason)=0;

//Called by TE to log the connect operation
virtual void tliPConnect (const Tstring &am, const timeval ts, const Tstring src, const Tinteger
line, const TriComponentId *c, const TriPortId *port1, const TriPortId *port2)=0;

```

```

//Called by TE to log the connect operation
virtual void tliPDisconnect (const Tstring &am, const timeval ts, const Tstring src, const Tinteger
line, const TriComponentId *c, const TriPortId *port1, const TriPortId *port2)=0;

//Called by TE to log the map operation
virtual void tliPMap (const Tstring &am, const timeval ts, const Tstring &src, const Tinteger line,
const TriComponentId *c, const TriPortId *port1, const TriPortId *port2)=0;

//Called by TE to log the map operation including param
virtual void tliPMapParam (const Tstring &am, const timeval ts, const Tstring &src, const Tinteger
line, const TriComponentId *c, const TriPortId *port1, const TriPortId *port2, const
TciParameterList *tciPars, const TriStatus *encoderFailure,
const TriParameterList *triPars)=0

//Called by TE to log the unmap operation
virtual void tliPUnmap (const Tstring &am, const timeval ts, const Tstring &src, const Tinteger
line, const TriComponentId *c, const TriPortId *port1, const TriPortId *port2)=0;

//Called by TE to log the unmap operation including param
virtual void tliPUnmapParam (const Tstring &am, const timeval ts, const Tstring &src, const Tinteger
line, const TriComponentId *c, const TriPortId *port1, const TriPortId *port2, const
TciParameterList *tciPars, const TriStatus *encoderFailure,
const TriParameterList *triPars)=0

//Called by TE to log the port clear operation
virtual void tliPClear (const Tstring &am, const timeval ts, const Tstring &src, const Tinteger
line, const TriComponentId *c, const TriPortId *port)=0;

//Called by TE to log the port start operation
virtual void tliPStart (const Tstring &am, const timeval ts, const Tstring &src, const Tinteger
line, const TriComponentId *c, const TriPortId *port)=0;

//Called by TE to log the port stop operation
virtual void tliPStop (const Tstring &am, const timeval ts, const Tstring &src, const Tinteger line,
const TriComponentId *c, const TriPortId *port)=0;

//Called by TE to log the port stop operation
virtual void tliPHalt (const Tstring &am, const timeval ts, const Tstring &src, const Tinteger line,
const TriComponentId *c, const TriPortId *port)=0;

//Called by TE to log the encode operation
virtual void tliEncode (const Tstring &am, const timeval ts, const Tstring &src, const Tinteger
line, const TriComponentId *c, const TciValue *val, const TciStatus *encoderFailure, const
TriMessage *msg, const Tstring &codec)=0;

//Called by TE to log the decode operation
virtual void tliDecode (const Tstring &am, const timeval ts, const Tstring &src, const Tinteger
line, const TriComponentId *c, const TriMessage *msg, const TciStatus *decoderFailure, const
TciValue *val, const Tstring &codec)=0;

//Called by TE to log the detection of a timeout
virtual void tliTTimeoutDetected (const Tstring &am, const timeval ts, const Tstring &src, const
Tinteger line, const TriComponentId *c, const TriTimerId *timer)=0;

//Called by TE to log a timeout mismatch
virtual void tliTTimeoutMismatch (const Tstring &am, const timeval ts, const Tstring &src, const
Tinteger line, const TriComponentId *c, const TriTimerId *timer, const TciNonValueTemplate
*timerTmpl)=0;

//Called by TE to log a timeout match
virtual void tliTTimeout (const Tstring &am, const timeval ts, const Tstring &src, const Tinteger
line, const TriComponentId *c, const TriTimerId *timer, const TciNonValueTemplate *timerTmpl)=0;

//Called by TE to log the start of a timer
virtual void tliTStart (const Tstring &am, const timeval ts, const Tstring &src, const Tinteger
line, const TriComponentId *c, const TriTimerId *timer, const TriTimerDuration *dur)=0;

//Called by TE to log the stop of a timer
virtual void tliTStop (const Tstring &am, const timeval ts, const Tstring &src, const Tinteger line,
const TriComponentId *c, const TriTimerId *timer, const TriTimerDuration *dur)=0;

//Called by TE to log the reading of a timer
virtual void tliTRead (const Tstring &am, const timeval ts, const Tstring &src, const Tinteger line,
const TriComponentId *c, const TriTimerId *timer, const TriTimerDuration *elapsed)=0;

```

```
//Called by TE to log the running timer operation
virtual void tliTRunning (const Tstring &am, const timeval ts, const Tstring &src, const Tinteger
line, const TriComponentId *c, const TriTimerId *timer, const TimerStatus status)=0;

//Called by TE to log the entering of a scope
virtual void tliSEnter (const Tstring &am, const timeval ts, const Tstring &src, const Tinteger
line, const TriComponentId *c, const QualifiedName &name, const TciParameterList *tciPars, const
Tstring &kind)=0;

//Called by TE to log the leaving of a scope
virtual void tliSLeave (const Tstring &am, const timeval ts, const Tstring &src, const Tinteger
line, const TriComponentId *c, const QualifiedName &name, const TciParameterList *tciPars, const
TciValue *returnValue, const Tstring &kind)=0;

//Called by TE to log the modification of the value of a variable
virtual void tliVar (const Tstring &am, const timeval ts, const Tstring &src, const Tinteger line,
const TriComponentId *c, const QualifiedName &name, const TciValue *varValue)=0;

//Called by TE to log the value of a module parameter
virtual void tliModulePar (const Tstring &am, const timeval ts, const Tstring &src, const Tinteger
line, const TriComponentId *c, const QualifiedName &name, const TciValue *parValue)=0;

//Called by TE to log the value of a module parameter
virtual void tliGetVerdict (const Tstring &am, const timeval ts, const Tstring &src, const Tinteger
line, const TriComponentId *c, const VerdictValue *verdict)=0;

//Called by TE to log the setverdict operation
virtual void tliSetVerdict (const Tstring &am, const timeval ts, const Tstring &src, const Tinteger
line, const TriComponentId *c, const VerdictValue *verdict, const Tstring &reason)=0;

//Called by TE to log the TTCN-3 statement log
virtual void tliLog (const Tstring &am, const timeval ts, const Tstring &src, const Tinteger line,
const TriComponentId *c, const Tstring *log)=0;

//Called by TE to log entering an alt
virtual void tliAEnter (const Tstring &am, const timeval ts, const Tstring &src, const Tinteger
line, const TriComponentId *c)=0;

//Called by TE to log leaving an alt
virtual void tliALeave (const Tstring &am, const timeval ts, const Tstring &src, const Tinteger
line, const TriComponentId *c)=0;

//Called by TE to log the nomatch of an alt
virtual void tliANomatch (const Tstring &am, const timeval ts, const Tstring &src, const Tinteger
line, const TriComponentId *c)=0;

//Called by TE to log repeating an alt
virtual void tliARepeat (const Tstring &am, const timeval ts, const Tstring &src, const Tinteger
line, const TriComponentId *c)=0;

//Called by TE to log entering the default section
virtual void tliADefaults (const Tstring &am, const timeval ts, const Tstring &src, const Tinteger
line, const TriComponentId *c)=0;

//Called by TE to log the activation of a default
virtual void tliAActivate (const Tstring &am, const timeval ts, const Tstring &src, const Tinteger
line, const TriComponentId *c, const QualifiedName &name, const TciParameterList *tciPars, const
TciValue *ref)=0;

//Called by TE to log the deactivation of a default
virtual void tliADeactivate (const Tstring &am, const timeval ts, const Tstring &src, const Tinteger
line, const TriComponentId *c, const TciValue *ref)=0;

//Called by TE to log entering an alt
virtual void tliAWait (const Tstring &am, const timeval ts, const Tstring &src, const Tinteger line,
const TriComponentId *c)=0;

//Called by TE to log that the component executed an SUT action
virtual void tliAction (const Tstring &am, const timeval ts, const Tstring &src, const Tinteger
line, const TriComponentId *c, const Tstring &action)=0;

//Called by TE to log that the component successfully executed a match operation
virtual void tliMatch (const Tstring &am, const timeval ts, const Tstring &src, const Tinteger line,
const TriComponentId *c, const TciValue &expr, const TciValueTemplate &tmpl)=0;
```

```

//Called by TE to log that the component executed a match operation, and a mismatch occurred
virtual void tliMatchMismatch (const Tstring &am, const timeval ts, const Tstring &src, const
Tinteger line, const TriComponentId *c, const TciValue &expr, const TciValueTemplate &tmpl, const
TciValueDifferenceList &diffs)=0;

//Can be called by the TE to log additional information during test execution
virtual void tliInfo (const Tstring &am, const timeval ts, const Tstring &src, const Tinteger line,
const TriComponentId *c, const Tinteger level, const Tstring &info)=0;

//Called by TE to log the checking of a message
virtual void tliMChecked_m (const Tstring &am, const timeval ts, const Tstring &src,
const Tinteger line, const TriComponentId *c, const TriPortId *at,
const TciValue *msgValue, const TciValueTemplate *msgTmpl,
const TciValue *address, const TciValueTemplate *addressTmpl)=0;

//Called by CH to log the checking of a message
virtual void tliMChecked_c (const Tstring &am, const timeval ts, const Tstring src,
const Tinteger line, const TriComponentId *c, const TriPortId *at,
const TciValue *msgValue, const TciValueTemplate *msgTmpl,
const TriComponentId *from, const TciNonValueTemplate *fromTmpl)=0;

//Called by TE to log checking of the getcall operation
virtual void tliPrGetCallChecked_m (const Tstring &am, const timeval ts, const Tstring src,
const Tinteger line, const TriComponentId *c, const TriPortId *at, const TriSignatureId *signature,
const TciParameterList *tciPars, const TciValueTemplate *parsTmpl,
const TciValue *address, const TciValueTemplate *addressTmpl)=0;

//Called by TE to log checking of the getcall operation
virtual void tliPrGetCallChecked_c (const Tstring &am, const timeval ts, const Tstring src,
const Tinteger line, const TriComponentId *c, const TriPortId *at, const TriSignatureId *signature,
const TciParameterList *tciPars, const TciValueTemplate *parsTmpl,
const TriComponentId *from, const TciNonValueTemplate *fromTmpl)=0;

//Called by TE to log checking of the getreply operation
virtual void tliPrGetReplyChecked_m (const Tstring &am, const timeval ts, const Tstring src,
const Tinteger line, const TriComponentId *c, const TriPortId *at, const TriSignatureId *signature,
const TciParameterList *tciPars, const TciValueTemplate *parsTmpl,
const TciValue *replValue, const TciValueTemplate *replyTmpl,
const TciValue *address, const TciValueTemplate *addressTmpl)=0;

//Called by CH to log checking of the getreply operation
virtual void tliPrGetReplyChecked_c (const Tstring &am, const timeval ts, const Tstring src,
const Tinteger line, const TriComponentId *c, const TriPortId *at, const TriSignatureId *signature,
const TciParameterList *tciPars, const TciValueTemplate *parsTmpl,
const TciValue *replValue, const TciValueTemplate *replyTmpl,
const TriComponentId *from, const TciNonValueTemplate *fromTmpl)=0;

//Called by TE to log checking of the catch operation
virtual void tliPrCatchChecked_m (const Tstring &am, const timeval ts, const Tstring src,
const Tinteger line, const TriComponentId *c, const TriPortId *at, const TriSignatureId *signature,
const TciValue *excValue, const TciValueTemplate *excTmpl,
const TciValue *address, const TciValueTemplate *addressTmpl)=0;

//Called by TE to log checking of the catch operation
virtual void tliPrCatchChecked_c (const Tstring &am, const timeval ts, const Tstring src,
const Tinteger line, const TriComponentId *c, const TriPortId *at, const TriSignatureId *signature,
const TciValue *excValue, const TciValueTemplate *excTmpl,
const TriComponentId *from, const TciNonValueTemplate *fromTmpl)=0;

//Called by TE to log the check any operation
virtual void tliCheckedAny_m (const Tstring &am, const timeval ts, const Tstring &src,
const Tinteger line, const TriComponentId *c, const TriPortId *at,
const TciValue *address, const TciValueTemplate *addressTmpl)=0;

//Called by CH to log the check any operation
virtual void tliCheckedAny_c (const Tstring &am, const timeval ts, const Tstring src,
const Tinteger line, const TriComponentId *c, const TriPortId *at,
const TriComponentId *from, const TciNonValueTemplate *fromTmpl)=0;

//Called by TE to log the mismatch in a check any operation
virtual void tliCheckAnyMismatch_m (const Tstring &am, const timeval ts, const Tstring &src,
const Tinteger line, const TriComponentId *c, const TriPortId *at,
const TciValue *addrValue, const TciValueTemplate *addressTmpl)=0;

//Called by CH to log the mismatch in a check any operation
virtual void tliCheckAnyMismatch_c (const Tstring &am, const timeval ts, const Tstring src,
const Tinteger line, const TriComponentId *c, const TriPortId *at,
const TriComponentId *from, const TciNonValueTemplate *fromTmpl)=0;

```

```

//Called by TE to log the generation of a random number
virtual void tliRnd (const Tstring &am, const timeval ts, const Tstring src, const Tinteger line,
const TriComponentId *c, const FloatValue *val, const FloatValue *seed)=0;

//Called by TE to log evaluation of a @fuzzy or @lazy template or variable
virtual void tliEvaluate (const Tstring &am, const timeval ts, const Tstring &src, const Tinteger
line, const TriComponentId *c, const QualifiedName &name, const TciValue *evalResult)=0;

//Called by TE to log the component call operation
virtual void tliCCall (const Tstring &am, const timeval ts, const Tstring &src, const Tinteger line,
const TriComponentId *c, const TriComponentId *comp, const TciBehaviourId *beh, const
TciParameterList *tciPars)=0;

//Called by TE to log the end of a component call
virtual void tliCCallTerminated (const Tstring &am, const timeval ts, const Tstring &src, const
Tinteger line, const TriComponentId *c, const VerdictValue *verdict, const Tstring &reason,
TciParameterList *tciPars, const TciValue *returnValue)=0;

//Called by TE to log the start of a parameterized module control function
virtual void tliCtrlStartWithParameters (const Tstring &am, const timeval ts, const Tstring &src,
const Tinteger line, const TriComponentId *c, const TciParameterList *tciPars)=0;

//Called by TE to log the termination of a parameterized module control function
virtual void tliCtrlTerminatedWithResult (const Tstring &am, const timeval ts, const Tstring &src,
const Tinteger line, const TriComponentId *c, const TciValue *val, const TciParameterList
*tciPars)=0;

```

---

## 11 W3C XML mapping

### 11.1 Introduction

This clause introduces the TCI XML mapping [10], [11] and [12] for the logging interface of TCI. The XML mapping for the logging interface defines how the IDL definitions for TCI-TL described in clause 7 are mapped to XML. The complete schema definitions for this mapping are given in annex B.

### 11.2 Scopes

The IDL module **tciInterface** is mapped to an XML schema with the name space [http://uri.etsi.org/ttcn-3/tci/TLI\\_v4\\_10\\_1.xsd](http://uri.etsi.org/ttcn-3/tci/TLI_v4_10_1.xsd).

This schema uses further schemas:

- [http://uri.etsi.org/ttcn-3/tci/SimpleTypes\\_v4\\_10\\_1.xsd](http://uri.etsi.org/ttcn-3/tci/SimpleTypes_v4_10_1.xsd)  
for the mapping of simple types to XML.
- [http://uri.etsi.org/ttcn-3/tci/Types\\_v4\\_10\\_1.xsd](http://uri.etsi.org/ttcn-3/tci/Types_v4_10_1.xsd)  
for the mapping of structured types to XML.
- [http://uri.etsi.org/ttcn-3/tci/Values\\_v4\\_10\\_1.xsd](http://uri.etsi.org/ttcn-3/tci/Values_v4_10_1.xsd)  
for the mapping of values to XML.
- [http://uri.etsi.org/ttcn-3/tci/Templates\\_v4\\_10\\_1.xsd](http://uri.etsi.org/ttcn-3/tci/Templates_v4_10_1.xsd)  
for the mapping of templates to XML.
- [http://uri.etsi.org/ttcn-3/tci/Events\\_v4\\_10\\_1.xsd](http://uri.etsi.org/ttcn-3/tci/Events_v4_10_1.xsd)  
for the mapping of logging events to XML.

## 11.3 Type mapping

### 11.3.1 Mapping of simple types

#### 11.3.1.1 TBoolean

The IDL **TBoolean** type is mapped to the xsd basic type `boolean`.

#### 11.3.1.2 TString

The IDL **TString** type is mapped to the xsd basic type `string`.

#### 11.3.1.3 TInteger

The IDL **TInteger** type is mapped to the xsd basic type `integer`.

#### 11.3.1.4 TriTimerDurationType

The IDL **TriTimerDurationType** type is mapped to the xsd basic type `float`.

#### 11.3.1.5 TciParameterPassingModeType

The IDL **TciParameterPassingModeType** type is mapped to the xsd basic type `string` with enumeration values "in", "out" and "inout".

#### 11.3.1.6 TriStatusType

The IDL **TriStatusType** type is mapped to the xsd basic type `string` with enumeration values "TRI\_Ok" and "TRI\_Error".

#### 11.3.1.7 TciStatusType

The IDL **TriStatusType** type is mapped to the xsd basic type `string` with enumeration values "TCI\_Ok" and "TCI\_Error".

#### 11.3.1.8 ComponentStatusType

The IDL **ComponentStatusType** type is mapped to the xsd basic type `string` with enumeration values "inactiveC", "runningC", "stoppedC", "killedC" and "nullC".

#### 11.3.1.9 TimerStatusType

The IDL **TimerStatusType** type is mapped to the xsd basic type `string` with enumeration values "runningT", "inactiveT", "expiredT", and "nullT".

#### 11.3.1.10 PortStatusType

The IDL **PortStatusType** type is mapped to the xsd basic type `string` with enumeration values "startedP", "haltedP" and "stoppedP".



## 11.3.2 Complex type mapping

### 11.3.2.1 TriPortIdType

**TriPortIdType** is mapped to the following complex type:

```
<xsd:complexType name="TriPortIdType">
  <xsd:sequence>
    <xsd:element name="comp" type="Types:TriComponentIdType" />
    <xsd:element name="port" type="Types:Port"/>
  </xsd:sequence>
</xsd:complexType>
```

#### Elements:

- `comp` The TRI component identifier.
- `port` The identification of the port.

#### Attributes:

- none.

### 11.3.2.2 TriComponentIdType

**TriComponentIdType** is mapped to the following complex type:

```
<xsd:complexType name="TriComponentIdType">
  <xsd:sequence>
    <xsd:choice>
      <xsd:element name="null" type="Templates:null"/>
      <xsd:element name="id" type="Types:Id"/>
    </xsd:choice>
  </xsd:sequence>
</xsd:complexType>
```

#### Elements:

- `id` The identifier of the TRI component.
- `null` The null identifier. To be used if there is no TRI component identifier.

#### Attributes:

- none.

### 11.3.2.3 TriComponentIdListType

**TriComponentIdListType** is mapped to the following complex type:

```
<xsd:complexType name="TriComponentIdListType">
  <xsd:sequence>
    <xsd:element name="comp" type="Types:TriComponentIdType" minOccurs="0"
      maxOccurs="unbounded"/>
  </xsd:sequence>
</xsd:complexType>
```

#### Elements:

- `comp` The identifiers of TRI components in that list.

#### Attributes:

- none.

### 11.3.2.4 Port

**Port** is mapped to the following complex type:

```
<xsd:complexType name="Port">
  <xsd:sequence>
    <xsd:element name="id" type="Types:Id"/>
    <xsd:element name="index" type="xsd:int"/>
  </xsd:sequence>
</xsd:complexType>
```

#### Elements:

- `id` The port identifier.
- `port` The port index.

#### Attributes:

- none.

### 11.3.2.5 Id

**Id** is used as identification for components, ports and timers and is mapped to the following complex type:

```
<xsd:complexType name="Id">
  <xsd:sequence>
    <xsd:element name="name" type="SimpleTypes:TString"/>
    <xsd:element name="id" type="SimpleTypes:TString" minOccurs="0"/>
    <xsd:element name="type" type="SimpleTypes:TString" minOccurs="0"/>
  </xsd:sequence>
</xsd:complexType>
```

#### Elements:

- `name` The name of the component, port or timer.
- `id` The internal representation of the component, port or timer.
- `type` The type of the component, port or timer.

#### Attributes:

- none.

### 11.3.2.6 TriMessageType

**TriMessageType** is mapped to the following complex type:

```
<xsd:complexType name="TriMessageType">
  <xsd:attribute name="val" type="xsd:hexBinary"/>
  <xsd:attribute name="paddingBits" type="xsd:integer" use="optional" default="0"/>
</xsd:complexType>
```

NOTE: `paddingBits` is optional with a default value of 0 and should only take values between 0 and 7.

The relation between `paddingBits` and `numberOfBits` is:

$$\text{numberOfBits} == (\text{length}(\text{val-attribute})/2) * 8 - \text{paddingBits}$$

In the byte-aligned case which is the typical one, the `paddingBits` attribute can be left out.

#### Elements:

- none.

#### Attributes:

- `val` The encoded message.
- `paddingBits` The padding bits of the encoded message.

### 11.3.2.7 TriParameterType

**TriParameterType** is mapped to the following complex type:

```
<xsd:complexType name="TriParameterType">
  <xsd:attribute name="val" type="xsd:hexBinary"/>
  <xsd:attribute name="paddingBits" type="xsd:integer" use="optional" default="0"/>
  <xsd:attribute name="name" type="SimpleTypes:TString"/>
  <xsd:attribute name="mode" type="SimpleTypes:TciParameterPassingModeType"/>
</xsd:complexType>
```

NOTE: paddingBits is optional with a default value of 0 and should only take values between 0 and 7.  
 The relation between paddingBits and numberOfBits is:  
 $numberOfBits == (\text{length}(\text{val-attribute})/2) * 8 - \text{paddingBits}$   
 In the byte-aligned case which is the typical one, the paddingBits attribute can be left out.

#### Elements:

- none.

#### Attributes:

- val The encoded parameter.
- paddingBits The padding bits of the encoded parameter.
- name The parameter name.
- mode The parameter passing mode.

### 11.3.2.8 TriParameterListType

**TriParameterListType** is mapped to the following complex type:

```
<xsd:complexType name="TriParameterListType">
  <xsd:sequence>
    <xsd:element name="par" type="Types:TriParameterType" minOccurs="0"
      maxOccurs="unbounded"/>
  </xsd:sequence>
</xsd:complexType>
```

#### Sequence of Elements:

- par The parameters in that list.

#### Attributes:

- none.

### 11.3.2.9 TriAddressType

**TriAddressType** is mapped to the following complex type:

```
<xsd:complexType name="TriAddressType">
  <xsd:attribute name="val" type="xsd:hexBinary"/>
  <xsd:attribute name="paddingBits" type="xsd:integer" use="optional" default="0"/>
</xsd:complexType>
```

NOTE: paddingBits is optional with a default value of 0 and should only take values between 0 and 7.  
 The relation between paddingBits and numberOfBits is:  
 $numberOfBits == (\text{length}(\text{val-attribute})/2) * 8 - \text{paddingBits}$   
 In the byte-aligned case which is the typical one, the paddingBits attribute can be left out.

#### Elements:

- none.

**Attributes:**

- `val` The address value.
- `paddingBits` The padding bits of the encoded address.

**11.3.2.10 TriAddressListType**

**TriAddressListType** is mapped to the following complex type:

```
<xsd:complexType name="TriAddressListType">
  <xsd:sequence>
    <xsd:element name="addr" type="Types:TriAddressType" minOccurs="0"
      maxOccurs="unbounded"/>
  </xsd:sequence>
</xsd:complexType>
```

**Elements:**

- `addr` The addresses in that list.

**Attributes:**

- none.

**11.3.2.11 TriExceptionType**

**TriExceptionType** is mapped to the following complex type:

```
<xsd:complexType name="TriExceptionType">
  <xsd:attribute name="val" type="xsd:hexBinary"/>
  <xsd:attribute name="paddingBits" type="xsd:integer" use="optional" default="0"/>
</xsd:complexType>
```

NOTE: `paddingBits` is optional with a default value of 0 and should only take values between 0 and 7.  
 The relation between `paddingBits` and `numberOfBits` is:  
 $\text{numberOfBits} == (\text{length}(\text{val-attribute})/2) * 8 - \text{paddingBits}$   
 In the byte-aligned case which is the typical one, the `paddingBits` attribute can be left out.

**Elements:**

- `val` The exception.

**Attributes:**

- none.

**11.3.2.12 TriSignatureIdType**

**TriSignatureIdType** is mapped to the following complex type:

```
<xsd:complexType name="TriSignatureIdType">
  <xsd:attribute name="val" type="SimpleTypes:TString" use="required"/>
</xsd:complexType>
```

**Elements:**

- `val` The signature.

**Attributes:**

- none.

### 11.3.2.13 TriTimerIdType

**TriTimerIdType** is mapped to the following complex type:

```
<xsd:complexType name="TriTimerIdType">
  <xsd:sequence>
    <xsd:element name="id" type="Types:Id"/>
  </xsd:sequence>
</xsd:complexType>
```

#### Elements:

- `id` The identification of the timer.

#### Attributes:

- none.

### 11.3.2.14 TriTimerDurationType

**TriTimerDurationType** is mapped to the following simple type:

```
<xsd:simpleType name="TriTimerDurationType">
  <xsd:restriction base="xsd:float"/>
</xsd:simpleType>
```

### 11.3.2.15 QualifiedName

**QualifiedName** is used to fully qualify module parameters, variables, etc and is mapped to the following complex type:

```
<xsd:complexType name="QualifiedName">
  <xsd:attribute name="moduleName" type="SimpleTypes:TString" use="required"/>
  <xsd:attribute name="baseName" type="SimpleTypes:TString" use="required"/>
</xsd:complexType>
```

#### Elements:

- `moduleName` The module name of the TTCN-3 module.
- `baseName` The name of the object that is fully qualified.

#### Attributes:

- none.

### 11.3.2.16 TciBehaviourIdType

**TciBehaviourIdType** is mapped to the following complex type:

```
<xsd:complexType name="TciBehaviourIdType">
  <xsd:sequence>
    <xsd:element name="name" type="Types:QualifiedName"/>
  </xsd:sequence>
</xsd:complexType>
```

#### Elements:

- `name` The qualified name of the behaviour.

#### Attributes:

- none.

### 11.3.2.17 TciTestCaseIdType

**TciTestCaseIdType** is mapped to the following complex type:

```
<xsd:complexType name="TciTestCaseIdType">
  <xsd:sequence>
    <xsd:element name="name" type="Types:QualifiedName"/>
  </xsd:sequence>
</xsd:complexType>
```

**Elements:**

- name The qualified name of the test case.

**Attributes:**

- none.

### 11.3.2.18 TciParameterType

**TciParameterType** is mapped to the following complex type:

```
<xsd:complexType name="TciParameterType">
  <xsd:sequence>
    <xsd:element name="val" type="Values:Value"/>
  </xsd:sequence>
  <xsd:attribute name="name" type="SimpleTypes:TString"/>
  <xsd:attribute name="mode" type="SimpleTypes:TciParameterPassingModeType"/>
</xsd:complexType>
```

**Elements:**

- val The encoded parameter.

**Attributes:**

- name The parameter name.
- mode The parameter passing mode.

### 11.3.2.19 TciParameterListType

**TciParameterListType** is mapped to the following complex type:

```
<xsd:complexType name="TciParameterListType">
  <xsd:sequence>
    <xsd:element name="par" type="Types:TciParameterType"
      minOccurs="0" maxOccurs="unbounded"/>
  </xsd:sequence>
</xsd:complexType>
```

**Sequence of Elements:**

- par The parameters in that list.

**Attributes:**

- none.

### 11.3.2.20 TriPortIdListType

**TriPortIdListType** is mapped to the following complex type:

```
<xsd:complexType name="TriPortIdListType">
  <xsd:sequence>
    <xsd:element name="port" type="Types:TriPortIdType"
      minOccurs="0" maxOccurs="unbounded"/>
  </xsd:sequence>
</xsd:complexType>
```

**Elements:**

- port The identifiers of TRI ports in that list.

**Attributes:**

- none.

## 11.3.3 Abstract value mapping

### 11.3.3.1 Value

**Value** is mapped to the following complex type:

```

<xsd:complexType name="Value" mixed="true">
  <xsd:group ref="Values:Value" />
  <xsd:attributeGroup ref="Values:ValueAtts" />
</xsd:complexType>

<xsd:group name="Value">
  <xsd:choice>
    <xsd:element name="integer" type="Values:IntegerValue" />
    <xsd:element name="float" type="Values:FloatValue" />
    <xsd:element name="boolean" type="Values:BooleanValue" />
    <xsd:element name="verdicttype" type="Values:VerdictValue" />
    <xsd:element name="bitstring" type="Values:BitstringValue" />
    <xsd:element name="hexstring" type="Values:HexstringValue" />
    <xsd:element name="octetstring" type="Values:OctetstringValue" />
    <xsd:element name="charstring" type="Values:CharstringValue" />
    <xsd:element name="universal_charstring" type="Values:UniversalCharstringValue" />
    <xsd:element name="record" type="Values:RecordValue" />
    <xsd:element name="record_of" type="Values:RecordOfValue" />
    <xsd:element name="set" type="Values:SetValue" />
    <xsd:element name="set_of" type="Values:SetOfValue" />
    <xsd:element name="enumerated" type="Values:EnumeratedValue" />
    <xsd:element name="union" type="Values:UnionValue" />
    <xsd:element name="anytype" type="Values:AnytypeValue" />
    <xsd:element name="address" type="Values:AddressValue" />
    <xsd:element name="component" type="Values:ComponentValue" />
    <xsd:element name="port" type="Values:PortValue" />
    <xsd:element name="default" type="Values:DefaultValue" />
    <xsd:element name="timer" type="Values:TimerValue" />
  </xsd:choice>
</xsd:group>
<xsd:simpleType name="ValueModifier">
  <xs:restriction base="SimpleTypes:TString">
    <xs:enumeration value="lazy" />
    <xs:enumeration value="fuzzy" />
  </xs:restriction>
</xsd:simpleType>

<xsd:attributeGroup name="ValueAtts">
  <xsd:attribute name="name" type="SimpleTypes:TString" use="optional" />
  <xsd:attribute name="type" type="SimpleTypes:TString" use="optional" />
  <xsd:attribute name="module" type="SimpleTypes:TString" use="optional" />
  <xsd:attribute name="modifier" type="Values:ValueModifier" use="optional" />
  <xsd:attribute name="annotation" type="SimpleTypes:TString" use="optional" />
</xsd:attributeGroup>

<xsd:group name="BaseValue">
  <xsd:choice>
    <xsd:sequence>
      <xsd:choice>
        <xsd:element name="value" type="SimpleTypes:TString" />
        <xsd:element name="matching_symbol" type="Templates:MatchingSymbol" />
      </xsd:choice>
      <xsd:element name="ifpresent" type="SimpleTypes:TEmpty" minOccurs="0" />
      <xsd:element name="length" type="Values:LengthRestriction" minOccurs="0" />
    </xsd:sequence>
    <xsd:element name="null" type="SimpleTypes:TEmpty" />
    <xsd:element name="omit" type="SimpleTypes:TEmpty" />
    <xsd:element name="not_evaluated" type="SimpleTypes:TEmpty" />
  </xsd:choice>

```

```

</xsd:group>

<xsd:complexType name="LengthRestriction">
  <xsd:sequence>
    <xsd:element name="lower" type="SimpleTypes:TInteger" />
    <xsd:element name="upper" type="SimpleTypes:TInteger" minOccurs="0" />
  </xsd:sequence>
</xsd:complexType>

```

### Value Group:

- `integer` An integer value.
- `float` A float value.
- `boolean` A boolean value.
- `verdicttype` A verdicttype value.
- `bitstring` A bitstring value.
- `hexstring` A hexstring value.
- `octetstring` An octetstring value.
- `charstring` A charstring value.
- `universal_charstring` A universal charstring value.
- `record` A record value.
- `record_of` A record of value.
- `array` An array value.
- `set` A set value.
- `set_of` A set of value.
- `enumerated` An enumerated value.
- `union` A union value.
- `anytype` An anytype value.
- `address` An address value.
- `component` A component value.
- `port` A port value.
- `default` A default value.
- `timer` A timer value.

### Attributes:

- `name` The name of the value, if known.
- `type` The type of the value, if known.
- `module` The module of the value, if known.
- `modifier` The value modifier, if used: either lazy or fuzzy.
- `annotation` A helper attribute to provide additional matching/mismatching information, etc.



**BaseValue Group:**

- `value` A value in the string format.
- `matching_symbol` A matching symbol when used instead of a value.
- `ifpresent` The `ifpresent` matching attribute.
- `length` The `length` matching attribute.
- `null` If no value is given.
- `omit` If the value is omitted.
- `not_evaluated` Used if a `@lazy` or `@fuzzy` value contains not evaluated content.

**LengthRestriction Element:**

- `lower` The lower bound of the length matching attribute.
- `upper` The upper bound of the length matching attribute. Omitted when equal to infinity.

**11.3.3.2 IntegerValue**

**IntegerValue** is mapped to the following complex type:

```
<xsd:complexType name="IntegerValue">
  <xsd:group ref="Values:BaseValue"/>
  <xsd:attributeGroup ref="Values:ValueAtts"/>
</xsd:complexType>
```

**Items:**

- `BaseValue` Integer value content described in clause 11.3.3.1.
- `ValueAtts` Value attributes described in clause 11.3.3.1.

**11.3.3.3 FloatValue**

**FloatValue** is mapped to the following complex type:

```
<xsd:complexType name="FloatValue">
  <xsd:group ref="Values:BaseValue"/>
  <xsd:attributeGroup ref="Values:ValueAtts"/>
</xsd:complexType>
```

**Items:**

- `BaseValue` Float value content described in clause 11.3.3.1.
- `ValueAtts` Value attributes described in clause 11.3.3.1.

**11.3.3.4 BooleanValue**

**BooleanValue** is mapped to the following complex type:

```
<xsd:complexType name="BooleanValue">
  <xsd:group ref="Values:BaseValue"/>
  <xsd:attributeGroup ref="Values:ValueAtts"/>
</xsd:complexType>
```

**Items:**

- `BaseValue` Boolean value content described in clause 11.3.3.1.
- `ValueAtts` Value attributes described in clause 11.3.3.1.

### 11.3.3.5 Void

### 11.3.3.6 VerdictValue

**VerdictValue** is mapped to the following complex type:

```
<xsd:complexType name="VerdictValue">
  <xsd:group ref="Values:BaseValue"/>
  <xsd:attributeGroup ref="Values:ValueAtts"/>
</xsd:complexType>
```

**Items:**

- BaseValue Verdict value content described in clause 11.3.3.1.
- ValueAtts Value attributes described in clause 11.3.3.1.

### 11.3.3.7 BitstringValue

**BitstringValue** is mapped to the following complex type:

```
<xsd:complexType name="BitstringValue">
  <xsd:group ref="Values:BaseValue"/>
  <xsd:attributeGroup ref="Values:ValueAtts"/>
</xsd:complexType>
```

**Items:**

- BaseValue Bitstring value content described in clause 11.3.3.1.
- ValueAtts Value attributes described in clause 11.3.3.1.

### 11.3.3.8 HexstringValue

**HexstringValue** is mapped to the following complex type:

```
<xsd:complexType name="HexstringValue">
  <xsd:attributeGroup ref="Values:ValueAtts"/>
  <xsd:attributeGroup ref="Values:ValueAtts"/>
</xsd:complexType>
```

**Items:**

- BaseValue Hexstring value content described in clause 11.3.3.1.
- ValueAtts Value attributes described in clause 11.3.3.1.

### 11.3.3.9 OctetstringValue

**OctetstringValue** is mapped to the following complex type:

```
<xsd:complexType name="OctetstringValue">
  <xsd:attributeGroup ref="Values:ValueAtts"/>
  <xsd:attributeGroup ref="Values:ValueAtts"/>
</xsd:complexType>
```

**Items:**

- BaseValue Octetstring value content described in clause 11.3.3.1.
- ValueAtts Value attributes described in clause 11.3.3.1.

### 11.3.3.10 CharstringValue

**CharstringValue** is mapped to the following complex type:

```
<xsd:complexType name="CharstringValue">
  <xsd:attributeGroup ref="Values:ValueAtts"/>
  <xsd:attributeGroup ref="Values:ValueAtts"/>
</xsd:complexType>
```

**Items:**

- BaseValue Charstring value content described in clause 11.3.3.1.
- ValueAtts Value attributes described in clause 11.3.3.1.

### 11.3.3.11 UniversalCharstringValue

**UniversalCharstringValue** is mapped to the following complex type:

```
<xsd:complexType name="UniversalCharstringValue">
  <xsd:attributeGroup ref="Values:ValueAtts"/>
  <xsd:attributeGroup ref="Values:ValueAtts"/>
</xsd:complexType>
```

**Items:**

- BaseValue Universal charstring value content described in clause 11.3.3.1.
- ValueAtts Value attributes described in clause 11.3.3.1.

### 11.3.3.12 RecordValue

**RecordValue** is mapped to the following complex type:

```
<xsd:complexType name="RecordValue">
  <xsd:choice>
    <xsd:sequence>
      <xsd:choice>
        <xsd:group ref="Values:Value" minOccurs="0" maxOccurs="unbounded"/>
        <xsd:element name="matching_symbol" type="Templates:MatchingSymbol"/>
      </xsd:choice>
      <xsd:element name="ifpresent" type="SimpleTypes:TEEmpty" minOccurs="0"/>
    </xsd:sequence>
    <xsd:element name="null" type="SimpleTypes:TEEmpty"/>
    <xsd:element name="omit" type="SimpleTypes:TEEmpty"/>
    <xsd:element name="not_evaluated" type="SimpleTypes:TEEmpty"/>
  </xsd:choice>
  <xsd:attributeGroup ref="Values:ValueAtts"/>
</xsd:complexType>
```

**Sequence of Elements:**

- Value The value group is specified in clause 11.3.3.1. It is used for describing individual elements of the record.
- matching\_symbol A matching symbol if used instead of a value.
- ifpresent The ifpresent matching attribute.
- null If no field is given.
- omit If the field is omitted.
- not\_evaluated Used if a @lazy or @fuzzy value contains not evaluated content.

**Attributes:**

- The same attributes as those of Value.

### 11.3.3.13 RecordOfValue

**RecordOfValue** is mapped to the following complex type:

```

<xsd:complexType name="RecordOfValue">
  <xsd:group ref="Values:Values"/>
  <xsd:attributeGroup ref="Values:ValueAtts"/>
</xsd:complexType>

<xsd:group name="Values">
  <xsd:choice>
    <xsd:sequence>
      <xsd:choice>
        <xsd:element name="integer" type="Values:IntegerValue" minOccurs="0"
          maxOccurs="unbounded"/>
        <xsd:element name="float" type="Values:FloatValue" minOccurs="0"
          maxOccurs="unbounded"/>
        <xsd:element name="boolean" type="Values:BooleanValue" minOccurs="0"
          maxOccurs="unbounded"/>
        <xsd:element name="bitstring" type="Values:BitstringValue"
          minOccurs="0" maxOccurs="unbounded"/>
        <xsd:element name="hexstring" type="Values:HexstringValue"
          minOccurs="0" maxOccurs="unbounded"/>
        <xsd:element name="octetstring" type="Values:OctetstringValue"
          minOccurs="0" maxOccurs="unbounded"/>
        <xsd:element name="charstring" type="Values:CharstringValue"
          minOccurs="0" maxOccurs="unbounded"/>
        <xsd:element name="universal_charstring"
          type="Values:UniversalCharstringValue" minOccurs="0"
          maxOccurs="unbounded"/>
        <xsd:element name="record" type="Values:RecordValue" minOccurs="0"
          maxOccurs="unbounded"/>
        <xsd:element name="record_of" type="Values:RecordOfValue"
          minOccurs="0" maxOccurs="unbounded"/>
        <xsd:element name="set" type="Values:SetValue" minOccurs="0"
          maxOccurs="unbounded"/>
        <xsd:element name="set_of" type="Values:SetOfValue"
          minOccurs="0" maxOccurs="unbounded"/>
        <xsd:element name="enumerated" type="Values:EnumeratedValue"
          minOccurs="0" maxOccurs="unbounded"/>
        <xsd:element name="union" type="Values:UnionValue" minOccurs="0"
          maxOccurs="unbounded"/>
        <xsd:element name="anytype" type="Values:AnytypeValue" minOccurs="0"
          maxOccurs="unbounded"/>
        <xsd:element name="address" type="Values:AddressValue" minOccurs="0"
          maxOccurs="unbounded"/>
        <xsd:element name="component" type="Values:ComponentValue" minOccurs="0"
          maxOccurs="unbounded"/>
        <xsd:element name="port" type="Values:PortValue" minOccurs="0"
          maxOccurs="unbounded"/>
        <xsd:element name="default" type="Values:DefaultValue" minOccurs="0"
          maxOccurs="unbounded"/>
        <xsd:element name="timer" type="Values:TimerValue" minOccurs="0"
          maxOccurs="unbounded"/>
        <xsd:element name="matching_symbol" type="Templates:MatchingSymbol"/>
      </xsd:choice>
      <xsd:element name="ifpresent" type="SimpleTypes:TEmpty" minOccurs="0"/>
      <xsd:element name="length" type="Values:LengthRestriction" minOccurs="0"/>
    </xsd:sequence>
    <xsd:element name="null" type="SimpleTypes:TEmpty"/>
    <xsd:element name="omit" type="SimpleTypes:TEmpty"/>
    <xsd:element name="not_evaluated" type="SimpleTypes:TEmpty"/>
  </xsd:choice>
</xsd:group>

```

#### Values Group:

- integer                      An integer value.
- float                        A float value.
- boolean                     A boolean value.
- verdicttype                A verdicttype value.

- `bitstring` A bitstring value.
- `hexstring` A hexstring value.
- `octetstring` An octetstring value.
- `charstring` A charstring value.
- `universal_charstring` A universal charstring value.
- `record` A record value.
- `record_of` A record of value.
- `array` An array value.
- `set` A set value.
- `set_of` A set of value.
- `enumerated` An enumerated value.
- `union` A union value.
- `anytype` An anytype value.
- `address` An address value.
- `component` A component value.
- `default` A default value.
- `matching_symbol` A matching symbol if used instead of a value.
- `ifpresent` The `ifpresent` matching attribute.
- `length` The `length` matching attribute.
- `null` If no field is given.
- `omit` If the field is omitted.
- `not_evaluated` Used if a `@lazy` or `@fuzzy` value contains not evaluated content.

**Attributes:**

- The same attributes as those of Value.

**11.3.3.14 ArrayValue**

**ArrayValue** is mapped to the following complex type:

```
<xsd:complexType name="ArrayValue">
  <xsd:group ref="Values:Values"/>
  <xsd:attributeGroup ref="Values:ValueAtts"/>
</xsd:complexType>
```

**Items:**

- `Values` Array value content described in clause 11.3.3.13.
- `ValueAtts` Value attributes described in clause 11.3.3.1.

### 11.3.3.15 SetValue

**SetValue** is mapped to the following complex type:

```
<xsd:complexType name="SetValue">
  <xsd:choice>
    <xsd:sequence>
      <xsd:choice>
        <xsd:group ref="Values:Value" minOccurs="0" maxOccurs="unbounded"/>
        <xsd:element name="matching_symbol" type="Templates:MatchingSymbol"/>
      </xsd:choice>
      <xsd:element name="ifpresent" type="SimpleTypes:TEEmpty" minOccurs="0"/>
    </xsd:sequence>
    <xsd:element name="null" type="SimpleTypes:TEEmpty"/>
    <xsd:element name="omit" type="SimpleTypes:TEEmpty"/>
    <xsd:element name="not_evaluated" type="SimpleTypes:TEEmpty"/>
  </xsd:choice>
  <xsd:attributeGroup ref="Values:ValueAtts"/>
</xsd:complexType>
```

#### Sequence of Elements:

- Value The value group is specified in clause 11.3.3.1. It is used for describing individual elements of the record.
- matching\_symbol A matching symbol if used instead of a value.
- ifpresent The ifpresent matching attribute.
- null If no field is given.
- omit If the field is omitted.
- not\_evaluated Used if a @lazy or @fuzzy value contains not evaluated content.

#### Attributes:

- The same attributes as those of Value.

### 11.3.3.16 SetOfValue

**SetOfValue** is mapped to the following complex type:

```
<xsd:complexType name="SetOfValue">
  <xsd:group ref="Values:Values"/>
  <xsd:attributeGroup ref="Values:ValueAtts"/>
</xsd:complexType>
```

#### Items:

- Values Set of value content described in clause 11.3.3.13.
- ValueAtts Value attributes described in clause 11.3.3.1.

### 11.3.3.17 EnumeratedValue

**EnumeratedValue** is mapped to the following complex type:

```
<xsd:complexType name="EnumeratedValue">
  <xsd:attributeGroup ref="Values:ValueAtts"/>
  <xsd:attributeGroup ref="Values:ValueAtts"/>
</xsd:complexType>
```

#### Items:

- BaseValue Enumerated value content described in clause 11.3.3.1.

- ValueAtts Value attributes described in clause 11.3.3.1.

### 11.3.3.18 UnionValue

**UnionValue** is mapped to the following complex type:

```
<xsd:complexType name="UnionValue">
  <xsd:choice>
    <xsd:sequence>
      <xsd:choice>
        <xsd:group ref="Values:Value"/>
        <xsd:element name="matching_symbol" type="Templates:MatchingSymbol"/>
      </xsd:choice>
      <xsd:element name="ifpresent" type="SimpleTypes:TEEmpty" minOccurs="0"/>
    </xsd:sequence>
    <xsd:element name="null" type="SimpleTypes:TEEmpty"/>
    <xsd:element name="omit" type="SimpleTypes:TEEmpty"/>
    <xsd:element name="not_evaluated" type="SimpleTypes:TEEmpty"/>
  </xsd:choice>
  <xsd:attributeGroup ref="Values:ValueAtts"/>
</xsd:complexType>
```

#### Choice of Elements:

- Value The chosen value. The value group is specified in clause 11.3.3.1.
- matching\_symbol A matching symbol if used instead of a value.
- ifpresent The ifpresent matching attribute.
- null If no field is given.
- omit If the field is omitted.
- not\_evaluated Used if a @lazy or @fuzzy value contains not evaluated content.

#### Attributes:

- The same attributes as those of Value.

### 11.3.3.19 AnytypeValue

**AnytypeValue** is mapped to the following complex type:

```
<xsd:complexType name="AnytypeValue">
  <xsd:choice>
    <xsd:sequence>
      <xsd:choice>
        <xsd:group ref="Values:Value"/>
        <xsd:element name="matching_symbol" type="Templates:MatchingSymbol"/>
      </xsd:choice>
      <xsd:element name="ifpresent" type="SimpleTypes:TEEmpty" minOccurs="0"/>
    </xsd:sequence>
    <xsd:element name="null" type="SimpleTypes:TEEmpty"/>
    <xsd:element name="omit" type="SimpleTypes:TEEmpty"/>
    <xsd:element name="matching_symbol" type="Templates:MatchingSymbol"/>
    <xsd:element name="not_evaluated" type="SimpleTypes:TEEmpty"/>
  </xsd:choice>
  <xsd:attributeGroup ref="Values:ValueAtts"/>
</xsd:complexType>
```

#### Choice of Elements:

- Value The chosen value. The value group is specified in clause 11.3.3.1.
- matching\_symbol A matching symbol if used instead of a value.
- ifpresent The ifpresent matching attribute.
- null If no field is given.

- `omit` If the field is omitted.
- `not_evaluated` Used if a `@lazy` or `@fuzzy` value contains not evaluated content.

**Attributes:**

- The same attributes as those of `Value`.

### 11.3.3.20 AddressValue

**AddressValue** is mapped to the following complex type:

```
<xsd:complexType name="AddressValue">
  <xsd:group ref="Values:Value" />
  <xsd:attributeGroup ref="Values:ValueAtts" />
</xsd:complexType>
```

**Items:**

- `Value` The value group is specified in clause 11.3.3.1. It is used for describing the content of the address value.
- `ValueAtts` Value attributes described in clause 11.3.3.1.

### 11.3.3.21 ComponentValue

Value type used for component instances is mapped to the complex type specified below. The content of the XML elements based on the `ComponentValue` type shall be equal to the string produced by the `valueToString` operation (described in clause 7.2.2.2.1):

```
<xsd:complexType name="ComponentValue">
  <xsd:group ref="Values:BaseValue" />
  <xsd:attributeGroup ref="Values:ValueAtts" />
</xsd:complexType>
```

**Items:**

- `BaseValue` Enumerated value content described in clause 11.3.3.1.
- `ValueAtts` Value attributes described in clause 11.3.3.1.

### 11.3.3.22 PortValue

Value type used for port instances is mapped to the complex type specified below. The content of the XML elements based on the `PortValue` type shall be equal to the string produced by the `valueToString` operation (described in clause 7.2.2.2.1):

```
<xsd:complexType name="PortValue">
  <xsd:choice>
    <xsd:element name="value" type="SimpleTypes:TString" />
    <xsd:element name="null" type="SimpleTypes:TEEmpty" />
    <xsd:element name="omit" type="SimpleTypes:TEEmpty" />
  </xsd:choice>
  <xsd:attributeGroup ref="Values:ValueAtts" />
</xsd:complexType>
```

**Choice of Elements:**

- `value` The universal charstring value as string.
- `null` If no value is given.
- `omit` If the value is omitted.

**Attributes:**

- The same attributes as those of `Value`.



### 11.3.3.23 DefaultValue

Value type used for default instances is mapped to the complex type specified below. The content of the XML elements based on the DefaultValue type shall be equal to the string produced by the valueToString operation (described in clause 7.2.2.2.1):

```
<xsd:complexType name="DefaultValue">
  <xsd:choice>
    <xsd:element name="value" type="SimpleTypes:TString"/>
    <xsd:element name="null" type="SimpleTypes:TEmpy"/>
    <xsd:element name="omit" type="SimpleTypes:TEmpy"/>
    <xsd:element name="not_evaluated" type="Values:NotEvaluated"/>
  </xsd:choice>
  <xsd:attributeGroup ref="Values:ValueAtts"/>
</xsd:complexType>
```

#### Choice of Elements:

- value                      The universal charstring value as string.
- null                        If no value is given.
- omit                        If the value is omitted.
- not\_evaluated              Used if a @lazy or @fuzzy value contains not evaluated content.

#### Attributes:

- The same attributes as those of Value.

### 11.3.3.24 TimerValue

Value type used for timer instances is mapped to the complex type specified below. The content of the XML elements based on the TimerValue type shall be equal to the string produced by the valueToString operation (described in clause 7.2.2.2.1):

```
<xsd:complexType name="TimerValue">
  <xsd:choice>
    <xsd:element name="value" type="SimpleTypes:TString"/>
    <xsd:element name="null" type="SimpleTypes:TEmpy"/>
    <xsd:element name="omit" type="SimpleTypes:TEmpy"/>
  </xsd:choice>
  <xsd:attributeGroup ref="Values:ValueAtts"/>
</xsd:complexType>
```

#### Choice of Elements:

- value                      The universal charstring value as string.
- null                        If no value is given.
- omit                        If the value is omitted.

#### Attributes:

- The same attributes as those of Value.

### 11.3.3.25 MatchingMechanism

**MatchingMechanism** is mapped into a sub-element of a typed value element. The sub-element is based on the complex type specified below:

```
<xsd:complexType name="MatchingSymbol">
  <xsd:choice>
    <xsd:element name="any_value" type="SimpleTypes:TEmpy"/>
    <xsd:element name="any_value_or_none" type="SimpleTypes:TEmpy"/>
    <xsd:element name="any_element" type="SimpleTypes:TEmpy"/>
    <xsd:element name="any_element_or_none" type="SimpleTypes:TEmpy"/>
    <xsd:element name="range" type="Templates:Range"/>
  </xsd:choice>
</xsd:complexType>
```

```

<xsd:element name="list" type="Templates:MatchingList"/>
<xsd:element name="complement" type="Templates:MatchingList"/>
<xsd:element name="subset" type="Templates:MatchingList"/>
<xsd:element name="superset" type="Templates:MatchingList"/>
<xsd:element name="permutation" type="Templates:MatchingList"/>
<xsd:element name="decmatch" type="Templates:DecMatch"/>
</xsd:choice>
</xsd:complexType>

```

### Choice of Elements:

- `any_value`                    The *AnyValue* matching symbol.
- `any_value_or_none`        The *AnyValueOrNone* matching symbol.
- `any_element`                The *AnyElement* matching symbol.
- `any_element_or_none`      The *AnyElementOrNone* matching symbol.
- `range`                        A range template.
- `list`                         A template list.
- `complement`                A complemented template list.
- `subset`                      A subset template.
- `superset`                    A superset template.
- `permutation`                A permutation.
- `pattern`                    A pattern.
- `decmatch`                  A *MatchDecodedContent* matching mechanism.

### Attributes:

- The same attributes as those of `Value`.

### 11.3.3.26 MatchingList

**MatchingList** is mapped to the following complex type. This complex type is also used for mapping of permutations.

```

<xsd:complexType name="MatchingList">
  <xsd:sequence>
    <xsd:group ref="Values:Value" minOccurs="0" maxOccurs="unbounded"/>
  </xsd:sequence>
</xsd:complexType>

```

### Items:

- `Value`                      Individual values present in the list. The `Value` group is specified in clause 11.3.3.1.

### 11.3.3.27 ValueRange

**ValueRange** is mapped to the following complex type:

```

<xsd:complexType name="Range">
  <xsd:sequence>
    <xsd:element name="excludeLower" minOccurs="0"/>
    <xsd:element name="lower" type="Values:Value" minOccurs="0"/>
    <xsd:element name="excludeUpper" minOccurs="0"/>
    <xsd:element name="upper" type="Values:Value" minOccurs="0"/>
  </xsd:sequence>
</xsd:complexType>

```

**Items:**

- `excludeLower` Present if the lower bound is excluded.
- `lower` The lower bound of the range. The element is omitted in case of integer range whose lower bound is equal to `-infinity`. The associated Value type is described in clause 11.3.3.1.
- `excludeUpper` Present if the upper bound is excluded.
- `upper` The upper bound of the range. The element is omitted in case of integer range whose upper bound is equal to `infinity`. The associated Value type is described in clause 11.3.3.1.

### 11.3.3.28 CharacterPattern

**CharacterPattern** is mapped to the following complex type:

```
<xsd:complexType name="Pattern">
  <xsd:sequence>
    <xsd:choice>
      <xsd:element name="charstring" type="Values:CharstringValue"/>
      <xsd:element name="universal_charstring" type="Values:UniversalCharstringValue"/>
    </xsd:choice>
  </xsd:sequence>
</xsd:complexType>
```

**Items:**

- `charstring` A pattern string in the charstring format.
- `universal_charstring` A pattern string in the universal charstring format.

### 11.3.3.29 MatchDecodedContent

**MatchDecodedContent** is mapped to the following complex type:

```
<xsd:complexType name="DecMatch">
  <xsd:sequence>
    <xsd:group ref="Values:Value"/>
  </xsd:sequence>
</xsd:complexType>
```

**Items:**

- `Value` The content of the *MatchDecodedContent* matching mechanism. The Value group is described in clause 11.3.3.1.

## 11.3.4 Abstract logging types mapping

### 11.3.4.1 TciValueTemplate

**TciValueTemplate** is mapped to the following complex type:

```
<xsd:group name="TypedTemplate">
  <xsd:choice>
    <xsd:element name="integer" type="Templates:SimpleTemplate"/>
    <xsd:element name="float" type="Templates:SimpleTemplate"/>
    <xsd:element name="boolean" type="Templates:SimpleTemplate"/>
    <xsd:element name="verdicttype" type="Templates:SimpleTemplate"/>
    <xsd:element name="bitstring" type="Templates:SimpleTemplate"/>
    <xsd:element name="hexstring" type="Templates:SimpleTemplate"/>
    <xsd:element name="octetstring" type="Templates:SimpleTemplate"/>
    <xsd:element name="charstring" type="Templates:SimpleTemplate"/>
    <xsd:element name="universal_charstring" type="Templates:SimpleTemplate"/>
    <xsd:element name="record" type="Templates:RecordTemplate"/>
    <xsd:element name="record_of" type="Templates:RecordOfTemplate"/>
  </xsd:choice>
</xsd:group>
```

```

<xsd:element name="array" type="Templates:RecordOfTemplate"/>
<xsd:element name="set" type="Templates:RecordTemplate"/>
<xsd:element name="set_of" type="Templates:RecordOfTemplate"/>
<xsd:element name="enumerated" type="Templates:SimpleTemplate"/>
<xsd:element name="union" type="Templates:UnionTemplate"/>
<xsd:element name="anytype" type="Templates:AnytypeTemplate"/>
<xsd:element name="address" type="Templates:AddressTemplate"/>
</xsd:choice>
</xsd:group>

<xsd:group name="SpecialTemplate">
  <xsd:choice>
    <xsd:element name="omit" type="Templates:omit"/>
    <xsd:element name="any" type="Templates:any"/>
    <xsd:element name="anyoromit" type="Templates:anyoromit"/>
    <xsd:element name="templateDef" type="SimpleTypes:TString"/>
  </xsd:choice>
</xsd:group>

<xsd:complexType name="TciValueTemplate">
  <xsd:choice>

    <xsd:group ref="Values:Value"/>
    <xsd:group ref="Templates:TypedTemplate"/>
    <xsd:group ref="Templates:SpecialTemplate"/>
  </xsd:choice>
</xsd:complexType>

```

### Choice of Elements:

- Value A structured and typed template definition.
- TypedTemplate A typed template definition. It is an obsolete feature kept for backwards compatibility reasons. The referenced group contains a choice of the following elements:
  - integer An integer template.
  - float A float template.
  - boolean A boolean template.
  - verdicttype A verdicttype template.
  - bitstring A bitstring template.
  - hexstring A hexstring template.
  - octetstring An octetstring template.
  - charstring A charstring template.
  - universal\_charstring A universal charstring template.
  - record A record template.
  - record\_of A record of template.
  - array An array template.
  - set A set template.
  - set\_of A set of template.
  - enumerated An enumerated template.
  - union A union template.
  - anytype An anytype template.

- address      An address template.
- **SpecialTemplate**      This group contains special matching elements. It is an obsolete feature kept for backwards compatibility reasons. The referenced group contains a choice of the following elements:
  - omit      An omit template.
  - any      An any template.
  - anyoromit      An anyoromit template.
  - templateDef      A complex template definition in text format.

**Attributes:**

- none.

**11.3.4.2 TciNonValueTemplate**

**TciNonValueTemplate** is mapped to the following complex type:

```
<xsd:complexType name="TciNonValueTemplate">
  <xsd:sequence>
    <xsd:choice>
      <xsd:element name="any" type="Templates:any"/>
      <xsd:element name="all" type="Templates:all"/>
      <xsd:element name="templateDef" type="SimpleTypes:TString"/>
      <xsd:element name="null" type="Templates:null"/>
      <xsd:group ref="Values:Value"/>
    </xsd:choice>
  </xsd:sequence>
</xsd:complexType>
```

**Choice of Elements:**

- any      An any template.
- all      An all template.
- templateDef      A complex template definition in text format.
- null      No template is given.
- Value      A structured and typed template definition.

**Attributes:**

- none.

**11.3.4.3 TciValueList**

**TciValueList** is mapped to the following complex type:

```
<xsd:complexType name="TciValueListType">
  <xsd:sequence>
    <xsd:element name="val" type="Values:Value"
      maxOccurs="unbounded"/>
  </xsd:sequence>
</xsd:complexType>
```

**Sequence of Elements:**

- val      The values in the value list.

**Attributes:**

- none.

### 11.3.4.4 TciValueDifference

**TciValueDifference** is mapped to the following complex type:

```
<xsd:complexType name="TciValueDifference">
  <xsd:sequence>
    <xsd:element name="val" type="SimpleTypes:xpath"/>
    <xsd:element name="tmpl"
type="SimpleTypes:xpath"/>
  </xsd:sequence>
  <xsd:attributeGroup ref="Values:ValueAtts"/>
  <xsd:attribute name="desc" type="SimpleTypes:TString"
use="optional"/>
</xsd:complexType>
```

#### Sequence of Elements:

- `val` A reference to the mismatching value.
- `tmpl` A reference to the template.

#### Attributes:

- The same attributes as those of Value.
- `desc` The reason of the mismatch.

### 11.3.4.5 TciValueDifferenceList

**TciValueDifferenceList** is mapped to the following complex type:

```
<xsd:complexType name="TciValueDifferenceList">
  <xsd:sequence>
    <xsd:element name="diff" type="Templates:TciValueDifference"
maxOccurs="unbounded"/>
  </xsd:sequence>
</xsd:complexType>
```

#### Sequence of Elements:

- `diff` The value/template differences in the value difference list.

#### Attributes:

- `none`.

## 11.4 Mapping of the operations on the logging interface

### 11.4.0 Mapping rules

Every operation provided at the logging interface has a corresponding complex type definition in XML. These complex type definitions are extensions of Event.

#### 11.4.1 Event

**Event** is mapped to the following complex type:

```
<!-- common definition for all events -->
<xsd:complexType name="Event" mixed="true">
  <xsd:sequence>
    <xsd:element name="am" type="SimpleTypes:TString"/>
  </xsd:sequence>
  <xsd:attribute name="ts" type="xsd:long" use="required"/>
  <xsd:attribute name="src" type="SimpleTypes:TString" use="optional"/>
  <xsd:attribute name="line" type="SimpleTypes:TInteger" use="optional"/>
```

```

<!-- general identifier structure for test components, ports and timer -->
  <xsd:attribute name="name" type="SimpleTypes:TString" use="required"/>
  <xsd:attribute name="id" type="SimpleTypes:TString" use="required"/>
  <xsd:attribute name="type" type="SimpleTypes:TString" use="required"/>
</xsd:complexType>

```

**Elements:**

- `am` A message, to be used for further information in the log.

**Attributes:**

- `ts` The time when the event is produced.
- `src` The source file of the test specification.
- `line` The line number where the request is performed.
- `name` The name of the component which produces this event.
- `id` The id of the component which produces this event.
- `type` The type of the component which produces this event.

## 11.4.2 The TCI-TL interface

### 11.4.2.1 TCI-TL provided

The TCI-TL Provided interface is mapped to the following interface:

```

<!-- testcases -->
<xsd:complexType name="tliTcExecute">
  <xsd:complexContent mixed="true">
    <xsd:extension base="Events:Event">
      <xsd:sequence>
        <xsd:element name="tcId" type="Types:TciTestCaseIdType"/>
        <xsd:element name="tciPars" type="Types:TciParameterListType" minOccurs="0"/>
        <xsd:element name="dur" type="SimpleTypes:TriTimerDurationType" minOccurs="0"/>
      </xsd:sequence>
    </xsd:extension>
  </xsd:complexContent>
</xsd:complexType>

<xsd:complexType name="tliTcStart">
  <xsd:complexContent mixed="true">
    <xsd:extension base="Events:Event">
      <xsd:sequence>
        <xsd:element name="tcId" type="Types:TciTestCaseIdType"/>
        <xsd:element name="tciPars" type="Types:TciParameterListType" minOccurs="0"/>
        <xsd:element name="dur" type="SimpleTypes:TriTimerDurationType" minOccurs="0"/>
      </xsd:sequence>
    </xsd:extension>
  </xsd:complexContent>
</xsd:complexType>

<xsd:complexType name="tliTcStop">
  <xsd:complexContent mixed="true">
    <xsd:extension base="Events:Event"/>
    <xsd:sequence>
      <xsd:element name="reason" type="SimpleTypes:TString" minOccurs="0"/>
    </xsd:sequence>
  </xsd:complexContent>
</xsd:complexType>

<xsd:complexType name="tliTcStarted">
  <xsd:complexContent mixed="true">
    <xsd:extension base="Events:Event">
      <xsd:sequence>
        <xsd:element name="tcId" type="Types:TciTestCaseIdType"/>
        <xsd:element name="tciPars" type="Types:TciParameterListType" minOccurs="0"/>
        <xsd:element name="dur" type="SimpleTypes:TriTimerDurationType" minOccurs="0"/>
      </xsd:sequence>
    </xsd:extension>
  </xsd:complexContent>
</xsd:complexType>

```

```

        </xsd:sequence>
      </xsd:extension>
    </xsd:complexContent>
  </xsd:complexType>

  <xsd:complexType name="tliTcTerminated">
    <xsd:complexContent mixed="true">
      <xsd:extension base="Events:Event">
        <xsd:sequence>
          <xsd:element name="tcId" type="Types:TciTestCaseIdType"/>
          <xsd:element name="tciPars" type="Types:TciParameterListType" minOccurs="0"/>
          <xsd:element name="verdict" type="Values:VerdictValue"/>
          <xsd:element name="reason" type="SimpleTypes:TString" minOccurs="0"/>
        </xsd:sequence>
      </xsd:extension>
    </xsd:complexContent>
  </xsd:complexType>

  <!-- control -->
  <xsd:complexType name="tliCtrlStart">
    <xsd:complexContent>
      <xsd:extension base="Events:Event"/>
    </xsd:complexContent>
  </xsd:complexType>

  <xsd:complexType name="tliCtrlStop">
    <xsd:complexContent>
      <xsd:extension base="Events:Event"/>
    </xsd:complexContent>
  </xsd:complexType>

  <xsd:complexType name="tliCtrlTerminated">
    <xsd:complexContent>
      <xsd:extension base="Events:Event"/>
    </xsd:complexContent>
  </xsd:complexType>

  <!-- asynchronous communication -->
  <xsd:complexType name="tliMSend_m">
    <xsd:complexContent mixed="true">
      <xsd:extension base="Events:Event">
        <xsd:sequence>
          <xsd:element name="at" type="Types:TriPortIdType"/>
          <xsd:element name="to" type="Types:TriPortIdType" minOccurs="0"/>
          <xsd:element name="msgValue" type="Values:Value"/>
          <xsd:element name="addrValue" type="Values:Value" minOccurs="0"/>
          <xsd:choice>
            <xsd:element name="encoder-failure" type="SimpleTypes:TciStatusType"
minOccurs="0"/>
            <xsd:sequence>
              <xsd:element name="msg" type="Types:TriMessageType" minOccurs="0"/>
              <xsd:element name="address" type="Types:TriAddressType" minOccurs="0"/>
              <xsd:element name="transmission-failure"
type="SimpleTypes:TriStatusType" minOccurs="0"/>
            </xsd:sequence>
          </xsd:choice>
        </xsd:sequence>
      </xsd:extension>
    </xsd:complexContent>
  </xsd:complexType>

  <xsd:complexType name="tliMSend_m_BC">
    <xsd:complexContent mixed="true">
      <xsd:extension base="Events:Event">
        <xsd:sequence>
          <xsd:element name="at" type="Types:TriPortIdType"/>
          <xsd:element name="to" type="Types:TriPortIdType" minOccurs="0"/>
          <xsd:element name="msgValue" type="Values:Value"/>
          <xsd:choice>
            <xsd:element name="encoder-failure" type="SimpleTypes:TciStatusType"
minOccurs="0"/>
            <xsd:sequence>
              <xsd:element name="msg" type="Types:TriMessageType" minOccurs="0"/>
              <xsd:element name="transmission-failure"
type="SimpleTypes:TriStatusType" minOccurs="0"/>
            </xsd:sequence>
          </xsd:choice>
        </xsd:sequence>
      </xsd:extension>
    </xsd:complexContent>
  </xsd:complexType>

```



```

    </xsd:extension>
  </xsd:complexContent>
</xsd:complexType>

<xsd:complexType name="tliMSend_m_MC">
  <xsd:complexContent mixed="true">
    <xsd:extension base="Events:Event">
      <xsd:sequence>
        <xsd:element name="at" type="Types:TriPortIdType"/>
        <xsd:element name="to" type="Types:TriPortIdType" minOccurs="0"/>
        <xsd:element name="msgValue" type="Values:Value"/>
        <xsd:element name="addrValues" type="Types:TciValueListType" minOccurs="0"/>
        <xsd:choice>
          <xsd:element name="encoder-failure" type="SimpleTypes:TciStatusType"
minOccurs="0"/>
          <xsd:sequence>
            <xsd:element name="msg" type="Types:TriMessageType" minOccurs="0"/>
            <xsd:element name="addresses" type="Types:TriAddressListType"
minOccurs="0"/>
            <xsd:element name="transmission-failure"
type="SimpleTypes:TriStatusType" minOccurs="0"/>
          </xsd:sequence>
        </xsd:choice>
      </xsd:sequence>
    </xsd:extension>
  </xsd:complexContent>
</xsd:complexType>

<xsd:complexType name="tliMSend_c">
  <xsd:complexContent mixed="true">
    <xsd:extension base="Events:Event">
      <xsd:sequence>
        <xsd:element name="at" type="Types:TriPortIdType"/>
        <xsd:element name="to" type="Types:TriPortIdType" minOccurs="0"/>
        <xsd:element name="msgValue" type="Values:Value"/>
        <xsd:element name="transmission-failure" type="SimpleTypes:TriStatusType"
minOccurs="0"/>
      </xsd:sequence>
    </xsd:extension>
  </xsd:complexContent>
</xsd:complexType>

<xsd:complexType name="tliMSend_c_BC">
  <xsd:complexContent mixed="true">
    <xsd:extension base="Events:Event">
      <xsd:sequence>
        <xsd:element name="at" type="Types:TriPortIdType"/>
        <xsd:element name="to" type="Types:TriPortIdListType" minOccurs="0"/>
        <xsd:element name="msgValue" type="Values:Value"/>
        <xsd:element name="transmission-failure" type="SimpleTypes:TriStatusType"
minOccurs="0"/>
      </xsd:sequence>
    </xsd:extension>
  </xsd:complexContent>
</xsd:complexType>

<xsd:complexType name="tliMSend_c_MC">
  <xsd:complexContent mixed="true">
    <xsd:extension base="Events:Event">
      <xsd:sequence>
        <xsd:element name="at" type="Types:TriPortIdType"/>
        <xsd:element name="to" type="Types:TriPortIdListType" minOccurs="0"/>
        <xsd:element name="msgValue" type="Values:Value"/>
        <xsd:element name="transmission-failure" type="SimpleTypes:TriStatusType"
minOccurs="0"/>
      </xsd:sequence>
    </xsd:extension>
  </xsd:complexContent>
</xsd:complexType>

<xsd:complexType name="tliMDetected_m">
  <xsd:complexContent mixed="true">
    <xsd:extension base="Events:Event">
      <xsd:sequence>
        <xsd:element name="at" type="Types:TriPortIdType"/>
        <xsd:element name="from" type="Types:TriPortIdType" minOccurs="0"/>
        <xsd:element name="msgValue" type="Types:TriMessageType"/>
        <xsd:element name="address" type="Types:TriAddressType" minOccurs="0"/>

```

```

        </xsd:sequence>
      </xsd:extension>
    </xsd:complexContent>
  </xsd:complexType>

  <xsd:complexType name="tliMDetected_c">
    <xsd:complexContent mixed="true">
      <xsd:extension base="Events:Event">
        <xsd:sequence>
          <xsd:element name="at" type="Types:TriPortIdType"/>
          <xsd:element name="from" type="Types:TriPortIdType" minOccurs="0"/>
          <xsd:element name="msgValue" type="Values:Value"/>
        </xsd:sequence>
      </xsd:extension>
    </xsd:complexContent>
  </xsd:complexType>

  <xsd:complexType name="tliMMismatch_m">
    <xsd:complexContent mixed="true">
      <xsd:extension base="Events:Event">
        <xsd:sequence>
          <xsd:element name="at" type="Types:TriPortIdType"/>
          <xsd:element name="msgValue" type="Values:Value"/>
          <xsd:element name="msgTpl" type="Templates:TciValueTemplate"/>
          <xsd:element name="diffs" type="Templates:TciValueDifferenceList"/>
          <xsd:element name="addrValue" type="Values:Value" minOccurs="0"/>
          <xsd:element name="addressTpl" type="Templates:TciValueTemplate"
minOccurs="0"/>
        </xsd:sequence>
      </xsd:extension>
    </xsd:complexContent>
  </xsd:complexType>

  <xsd:complexType name="tliMMismatch_c">
    <xsd:complexContent mixed="true">
      <xsd:extension base="Events:Event">
        <xsd:sequence>
          <xsd:element name="at" type="Types:TriPortIdType"/>
          <xsd:element name="msgValue" type="Values:Value"/>
          <xsd:element name="msgTpl" type="Templates:TciValueTemplate"/>
          <xsd:element name="diffs" type="Templates:TciValueDifferenceList"/>
          <xsd:element name="from" type="Types:TriComponentIdType" minOccurs="0"/>
          <xsd:element name="fromTpl" type="Templates:TciNonValueTemplate"
minOccurs="0"/>
        </xsd:sequence>
      </xsd:extension>
    </xsd:complexContent>
  </xsd:complexType>

  <xsd:complexType name="tliMReceive_m">
    <xsd:complexContent mixed="true">
      <xsd:extension base="Events:Event">
        <xsd:sequence>
          <xsd:element name="at" type="Types:TriPortIdType"/>
          <xsd:element name="msgValue" type="Values:Value" minOccurs="0"/>
          <xsd:element name="msgTpl" type="Templates:TciValueTemplate"
minOccurs="0"/>
          <xsd:element name="addrValue" type="Values:Value" minOccurs="0"/>
          <xsd:element name="addressTpl" type="Templates:TciValueTemplate"
minOccurs="0"/>
        </xsd:sequence>
      </xsd:extension>
    </xsd:complexContent>
  </xsd:complexType>

  <xsd:complexType name="tliMReceive_c">
    <xsd:complexContent mixed="true">
      <xsd:extension base="Events:Event">
        <xsd:sequence>
          <xsd:element name="at" type="Types:TriPortIdType"/>
          <xsd:element name="msgValue" type="Values:Value" minOccurs="0"/>
          <xsd:element name="msgTpl" type="Templates:TciValueTemplate"
minOccurs="0"/>
          <xsd:element name="from" type="Types:TriComponentIdType" minOccurs="0"/>
          <xsd:element name="fromTpl" type="Templates:TciNonValueTemplate"
minOccurs="0"/>
        </xsd:sequence>
      </xsd:extension>
    </xsd:complexContent>
  </xsd:complexType>

```

```

    </xsd:complexContent>
  </xsd:complexType>

  <!-- synchronous communication -->
  <xsd:complexType name="tliPrCall_m">
    <xsd:complexContent mixed="true">
      <xsd:extension base="Events:Event">
        <xsd:sequence>
          <xsd:element name="at" type="Types:TriPortIdType"/>
          <xsd:element name="to" type="Types:TriPortIdType" minOccurs="0"/>
          <xsd:element name="signature" type="Types:TriSignatureIdType"/>
          <xsd:element name="tciPars" type="Types:TciParameterListType" minOccurs="0"/>
          <xsd:element name="addrValue" type="Values:Value" minOccurs="0"/>
          <xsd:choice>
            <xsd:element name="encoder-failure" type="SimpleTypes:TciStatusType"
minOccurs="0"/>
            <xsd:sequence>
              <xsd:element name="triPars" type="Types:TriParameterListType"
minOccurs="0"/>
              <xsd:element name="address" type="Types:TriAddressType" minOccurs="0"/>
              <xsd:element name="transmission-failure"
type="SimpleTypes:TriStatusType" minOccurs="0"/>
            </xsd:sequence>
          </xsd:choice>
        </xsd:sequence>
      </xsd:extension>
    </xsd:complexContent>
  </xsd:complexType>

  <xsd:complexType name="tliPrCall_m_BC">
    <xsd:complexContent mixed="true">
      <xsd:extension base="Events:Event">
        <xsd:sequence>
          <xsd:element name="at" type="Types:TriPortIdType"/>
          <xsd:element name="to" type="Types:TriPortIdType" minOccurs="0"/>
          <xsd:element name="signature" type="Types:TriSignatureIdType"/>
          <xsd:element name="tciPars" type="Types:TciParameterListType" minOccurs="0"/>
          <xsd:choice>
            <xsd:element name="encoder-failure" type="SimpleTypes:TciStatusType"
minOccurs="0"/>
            <xsd:sequence>
              <xsd:element name="triPars" type="Types:TriParameterListType"
minOccurs="0"/>
              <xsd:element name="transmission-failure"
type="SimpleTypes:TriStatusType" minOccurs="0"/>
            </xsd:sequence>
          </xsd:choice>
        </xsd:sequence>
      </xsd:extension>
    </xsd:complexContent>
  </xsd:complexType>

  <xsd:complexType name="tliPrCall_m_MC">
    <xsd:complexContent mixed="true">
      <xsd:extension base="Events:Event">
        <xsd:sequence>
          <xsd:element name="at" type="Types:TriPortIdType"/>
          <xsd:element name="to" type="Types:TriPortIdType" minOccurs="0"/>
          <xsd:element name="signature" type="Types:TriSignatureIdType"/>
          <xsd:element name="tciPars" type="Types:TciParameterListType" minOccurs="0"/>
          <xsd:element name="addrValues" type="Types:TciValueListType" minOccurs="0"/>
          <xsd:choice>
            <xsd:element name="encoder-failure" type="SimpleTypes:TciStatusType"
minOccurs="0"/>
            <xsd:sequence>
              <xsd:element name="triPars" type="Types:TriParameterListType"
minOccurs="0"/>
              <xsd:element name="addresses" type="Types:TriAddressListType"
minOccurs="0"/>
              <xsd:element name="transmission-failure"
type="SimpleTypes:TriStatusType" minOccurs="0"/>
            </xsd:sequence>
          </xsd:choice>
        </xsd:sequence>
      </xsd:extension>
    </xsd:complexContent>
  </xsd:complexType>

```

```

<xsd:complexType name="tliPrCall_c">
  <xsd:complexContent mixed="true">
    <xsd:extension base="Events:Event">
      <xsd:sequence>
        <xsd:element name="at" type="Types:TriPortIdType"/>
        <xsd:element name="to" type="Types:TriPortIdType" minOccurs="0"/>
        <xsd:element name="signature" type="Types:TriSignatureIdType"/>
        <xsd:element name="tciPars" type="Types:TciParameterListType" minOccurs="0"/>
        <xsd:element name="transmission-failure" type="SimpleTypes:TriStatusType"
minOccurs="0"/>
      </xsd:sequence>
    </xsd:extension>
  </xsd:complexContent>
</xsd:complexType>

<xsd:complexType name="tliPrCall_c_BC">
  <xsd:complexContent mixed="true">
    <xsd:extension base="Events:Event">
      <xsd:sequence>
        <xsd:element name="at" type="Types:TriPortIdType"/>
        <xsd:element name="to" type="Types:TriPortIdListType" minOccurs="0"/>
        <xsd:element name="signature" type="Types:TriSignatureIdType"/>
        <xsd:element name="tciPars" type="Types:TciParameterListType" minOccurs="0"/>
        <xsd:element name="transmission-failure" type="SimpleTypes:TriStatusType"
minOccurs="0"/>
      </xsd:sequence>
    </xsd:extension>
  </xsd:complexContent>
</xsd:complexType>

<xsd:complexType name="tliPrCall_c_MC">
  <xsd:complexContent mixed="true">
    <xsd:extension base="Events:Event">
      <xsd:sequence>
        <xsd:element name="at" type="Types:TriPortIdType"/>
        <xsd:element name="to" type="Types:TriPortIdListType" minOccurs="0"/>
        <xsd:element name="signature" type="Types:TriSignatureIdType"/>
        <xsd:element name="tciPars" type="Types:TciParameterListType" minOccurs="0"/>
        <xsd:element name="transmission-failure" type="SimpleTypes:TriStatusType"
minOccurs="0"/>
      </xsd:sequence>
    </xsd:extension>
  </xsd:complexContent>
</xsd:complexType>

<xsd:complexType name="tliPrGetCallDetected_m">
  <xsd:complexContent mixed="true">
    <xsd:extension base="Events:Event">
      <xsd:sequence>
        <xsd:element name="at" type="Types:TriPortIdType"/>
        <xsd:element name="from" type="Types:TriPortIdType" minOccurs="0"/>
        <xsd:element name="signature" type="Types:TriSignatureIdType"/>
        <xsd:element name="triPars" type="Types:TriParameterListType" minOccurs="0"/>
        <xsd:element name="address" type="Types:TriAddressType" minOccurs="0"/>
      </xsd:sequence>
    </xsd:extension>
  </xsd:complexContent>
</xsd:complexType>

<xsd:complexType name="tliPrGetCallDetected_c">
  <xsd:complexContent mixed="true">
    <xsd:extension base="Events:Event">
      <xsd:sequence>
        <xsd:element name="at" type="Types:TriPortIdType"/>
        <xsd:element name="from" type="Types:TriPortIdType" minOccurs="0"/>
        <xsd:element name="signature" type="Types:TriSignatureIdType"/>
        <xsd:element name="tciPars" type="Types:TciParameterListType" minOccurs="0"/>
      </xsd:sequence>
    </xsd:extension>
  </xsd:complexContent>
</xsd:complexType>

<xsd:complexType name="tliPrGetCallMismatch_m">
  <xsd:complexContent mixed="true">
    <xsd:extension base="Events:Event">
      <xsd:sequence>
        <xsd:element name="at" type="Types:TriPortIdType"/>
        <xsd:element name="signature" type="Types:TriSignatureIdType"/>

```

```

        <xsd:element name="tciPars" type="Types:TciParameterListType" minOccurs="0"/>
        <xsd:element name="parsTmpl" type="Templates:TciValueTemplate" minOccurs="0"/>
        <xsd:element name="diffs" type="Templates:TciValueDifferenceList"/>
        <xsd:element name="addrValue" type="Values:Value" minOccurs="0"/>
        <xsd:element name="addressTmpl" type="Templates:TciValueTemplate"
minOccurs="0"/>
    </xsd:sequence>
</xsd:extension>
</xsd:complexContent>
</xsd:complexType>

<xsd:complexType name="tliPrGetCallMismatch_c">
    <xsd:complexContent mixed="true">
        <xsd:extension base="Events:Event">
            <xsd:sequence>
                <xsd:element name="at" type="Types:TriPortIdType"/>
                <xsd:element name="signature" type="Types:TriSignatureIdType"/>
                <xsd:element name="tciPars" type="Types:TciParameterListType" minOccurs="0"/>
                <xsd:element name="parsTmpl" type="Templates:TciValueTemplate" minOccurs="0"/>
                <xsd:element name="diffs" type="Templates:TciValueDifferenceList"/>
                <xsd:element name="from" type="Types:TriComponentIdType" minOccurs="0"/>
                <xsd:element name="fromTmpl" type="Templates:TciValueTemplate" minOccurs="0"/>
            </xsd:sequence>
        </xsd:extension>
    </xsd:complexContent>
</xsd:complexType>

<xsd:complexType name="tliPrGetCall_m">
    <xsd:complexContent mixed="true">
        <xsd:extension base="Events:Event">
            <xsd:sequence>
                <xsd:element name="at" type="Types:TriPortIdType"/>
                <xsd:element name="signature" type="Types:TriSignatureIdType"/>
                <xsd:element name="tciPars" type="Types:TciParameterListType" minOccurs="0"/>
                <xsd:element name="parsTmpl" type="Templates:TciValueTemplate" minOccurs="0"/>
                <xsd:element name="addrValue" type="Values:Value" minOccurs="0"/>
                <xsd:element name="addressTmpl" type="Templates:TciValueTemplate"
minOccurs="0"/>
            </xsd:sequence>
        </xsd:extension>
    </xsd:complexContent>
</xsd:complexType>

<xsd:complexType name="tliPrGetCall_c">
    <xsd:complexContent mixed="true">
        <xsd:extension base="Events:Event">
            <xsd:sequence>
                <xsd:element name="at" type="Types:TriPortIdType"/>
                <xsd:element name="signature" type="Types:TriSignatureIdType"/>
                <xsd:element name="tciPars" type="Types:TciParameterListType" minOccurs="0"/>
                <xsd:element name="parsTmpl" type="Templates:TciValueTemplate" minOccurs="0"/>
                <xsd:element name="from" type="Types:TriComponentIdType" minOccurs="0"/>
                <xsd:element name="fromTmpl" type="Templates:TciNonValueTemplate"
minOccurs="0"/>
            </xsd:sequence>
        </xsd:extension>
    </xsd:complexContent>
</xsd:complexType>

<xsd:complexType name="tliPrReply_m">
    <xsd:complexContent mixed="true">
        <xsd:extension base="Events:Event">
            <xsd:sequence>
                <xsd:element name="at" type="Types:TriPortIdType"/>
                <xsd:element name="to" type="Types:TriPortIdType" minOccurs="0"/>
                <xsd:element name="signature" type="Types:TriSignatureIdType"/>
                <xsd:element name="tciPars" type="Types:TciParameterListType" minOccurs="0"/>
                <xsd:element name="replValue" type="Values:Value" minOccurs="0"/>
                <xsd:element name="addrValue" type="Values:Value" minOccurs="0"/>
                <xsd:choice>
                    <xsd:element name="encoder-failure" type="SimpleTypes:TciStatusType"
minOccurs="0"/>
                    <xsd:sequence>
                        <xsd:element name="triPars" type="Types:TriParameterListType"
minOccurs="0"/>
                        <xsd:element name="repl" type="Types:TriParameterType" minOccurs="0"/>
                        <xsd:element name="address" type="Types:TriAddressType" minOccurs="0"/>
                        <xsd:element name="transmission-failure"

```

```

        type="SimpleTypes:TriStatusType" minOccurs="0"/>
      </xsd:sequence>
    </xsd:choice>
  </xsd:sequence>
</xsd:extension>
</xsd:complexContent>
</xsd:complexType>

<xsd:complexType name="tliPrReply_m_BC">
  <xsd:complexContent mixed="true">
    <xsd:extension base="Events:Event">
      <xsd:sequence>
        <xsd:element name="at" type="Types:TriPortIdType"/>
        <xsd:element name="to" type="Types:TriPortIdType" minOccurs="0"/>
        <xsd:element name="signature" type="Types:TriSignatureIdType"/>
        <xsd:element name="tciPars" type="Types:TciParameterListType" minOccurs="0"/>
        <xsd:element name="replValue" type="Values:Value" minOccurs="0"/>
        <xsd:choice>
          <xsd:element name="encoder-failure" type="SimpleTypes:TciStatusType"
            minOccurs="0"/>
          <xsd:sequence>
            <xsd:element name="triPars" type="Types:TriParameterListType"
              minOccurs="0"/>
            <xsd:element name="repl" type="Types:TriParameterType" minOccurs="0"/>
            <xsd:element name="transmission-failure"
              type="SimpleTypes:TriStatusType" minOccurs="0"/>
          </xsd:sequence>
        </xsd:choice>
      </xsd:sequence>
    </xsd:extension>
  </xsd:complexContent>
</xsd:complexType>

<xsd:complexType name="tliPrReply_m_MC">
  <xsd:complexContent mixed="true">
    <xsd:extension base="Events:Event">
      <xsd:sequence>
        <xsd:element name="at" type="Types:TriPortIdType"/>
        <xsd:element name="to" type="Types:TriPortIdType" minOccurs="0"/>
        <xsd:element name="signature" type="Types:TriSignatureIdType"/>
        <xsd:element name="tciPars" type="Types:TciParameterListType" minOccurs="0"/>
        <xsd:element name="replValue" type="Values:Value" minOccurs="0"/>
        <xsd:element name="addrValues" type="Types:TciValueListType" minOccurs="0"/>
        <xsd:choice>
          <xsd:element name="encoder-failure" type="SimpleTypes:TciStatusType"
            minOccurs="0"/>
          <xsd:sequence>
            <xsd:element name="triPars" type="Types:TriParameterListType"
              minOccurs="0"/>
            <xsd:element name="repl" type="Types:TriParameterType" minOccurs="0"/>
            <xsd:element name="addresses" type="Types:TriAddressListType"
              minOccurs="0"/>
            <xsd:element name="transmission-failure"
              type="SimpleTypes:TriStatusType" minOccurs="0"/>
          </xsd:sequence>
        </xsd:choice>
      </xsd:sequence>
    </xsd:extension>
  </xsd:complexContent>
</xsd:complexType>

<xsd:complexType name="tliPrReply_c">
  <xsd:complexContent mixed="true">
    <xsd:extension base="Events:Event">
      <xsd:sequence>
        <xsd:element name="at" type="Types:TriPortIdType"/>
        <xsd:element name="to" type="Types:TriPortIdType" minOccurs="0"/>
        <xsd:element name="signature" type="Types:TriSignatureIdType"/>
        <xsd:element name="tciPars" type="Types:TciParameterListType" minOccurs="0"/>
        <xsd:element name="replValue" type="Values:Value" minOccurs="0"/>
        <xsd:element name="transmission-failure" type="SimpleTypes:TriStatusType"
          minOccurs="0"/>
      </xsd:sequence>
    </xsd:extension>
  </xsd:complexContent>
</xsd:complexType>

```

```

<xsd:complexType name="tliPrReply_c_BC">
  <xsd:complexContent mixed="true">
    <xsd:extension base="Events:Event">
      <xsd:sequence>
        <xsd:element name="at" type="Types:TriPortIdType"/>
        <xsd:element name="to" type="Types:TriPortIdListType" minOccurs="0"/>
        <xsd:element name="signature" type="Types:TriSignatureIdType"/>
        <xsd:element name="tciPars" type="Types:TciParameterListType" minOccurs="0"/>
        <xsd:element name="replValue" type="Values:Value" minOccurs="0"/>
        <xsd:element name="transmission-failure" type="SimpleTypes:TriStatusType"
minOccurs="0"/>
      </xsd:sequence>
    </xsd:extension>
  </xsd:complexContent>
</xsd:complexType>

<xsd:complexType name="tliPrReply_c_MC">
  <xsd:complexContent mixed="true">
    <xsd:extension base="Events:Event">
      <xsd:sequence>
        <xsd:element name="at" type="Types:TriPortIdType"/>
        <xsd:element name="to" type="Types:TriPortIdListType" minOccurs="0"/>
        <xsd:element name="signature" type="Types:TriSignatureIdType"/>
        <xsd:element name="tciPars" type="Types:TciParameterListType" minOccurs="0"/>
        <xsd:element name="replValue" type="Values:Value" minOccurs="0"/>
        <xsd:element name="transmission-failure" type="SimpleTypes:TriStatusType"
minOccurs="0"/>
      </xsd:sequence>
    </xsd:extension>
  </xsd:complexContent>
</xsd:complexType>

<xsd:complexType name="tliPrGetReplyDetected_m">
  <xsd:complexContent mixed="true">
    <xsd:extension base="Events:Event">
      <xsd:sequence>
        <xsd:element name="at" type="Types:TriPortIdType"/>
        <xsd:element name="from" type="Types:TriPortIdType" minOccurs="0"/>
        <xsd:element name="signature" type="Types:TriSignatureIdType"/>
        <xsd:element name="triPars" type="Types:TriParameterListType" minOccurs="0"/>
        <xsd:element name="repl" type="Types:TriParameterType" minOccurs="0"/>
        <xsd:element name="address" type="Types:TriAddressType" minOccurs="0"/>
      </xsd:sequence>
    </xsd:extension>
  </xsd:complexContent>
</xsd:complexType>

<xsd:complexType name="tliPrGetReplyDetected_c">
  <xsd:complexContent mixed="true">
    <xsd:extension base="Events:Event">
      <xsd:sequence>
        <xsd:element name="at" type="Types:TriPortIdType"/>
        <xsd:element name="from" type="Types:TriPortIdType" minOccurs="0"/>
        <xsd:element name="signature" type="Types:TriSignatureIdType"/>
        <xsd:element name="tciPars" type="Types:TciParameterListType" minOccurs="0"/>
        <xsd:element name="replValue" type="Values:Value" minOccurs="0"/>
      </xsd:sequence>
    </xsd:extension>
  </xsd:complexContent>
</xsd:complexType>

<xsd:complexType name="tliPrGetReplyMismatch_m">
  <xsd:complexContent mixed="true">
    <xsd:extension base="Events:Event">
      <xsd:sequence>
        <xsd:element name="at" type="Types:TriPortIdType"/>
        <xsd:element name="signature" type="Types:TriSignatureIdType"/>
        <xsd:element name="tciPars" type="Types:TciParameterListType" minOccurs="0"/>
        <xsd:element name="parsTmpl" type="Templates:TciValueTemplate" minOccurs="0"/>
        <xsd:element name="replValue" type="Values:Value" minOccurs="0"/>
        <xsd:element name="replTmpl" type="Templates:TciValueTemplate" minOccurs="0"/>
        <xsd:element name="diffs" type="Templates:TciValueDifferenceList"/>
        <xsd:element name="addrValue" type="Values:Value" minOccurs="0"/>
        <xsd:element name="addressTmpl" type="Templates:TciValueTemplate"
minOccurs="0"/>
      </xsd:sequence>
    </xsd:extension>
  </xsd:complexContent>

```

```

</xsd:complexType>

<xsd:complexType name="tliPrGetReplyMismatch_c">
  <xsd:complexContent mixed="true">
    <xsd:extension base="Events:Event">
      <xsd:sequence>
        <xsd:element name="at" type="Types:TriPortIdType"/>
        <xsd:element name="signature" type="Types:TriSignatureIdType"/>
        <xsd:element name="tciPars" type="Types:TciParameterListType" minOccurs="0"/>
        <xsd:element name="parsTmpl" type="Templates:TciValueTemplate" minOccurs="0"/>
        <xsd:element name="replValue" type="Values:Value" minOccurs="0"/>
        <xsd:element name="replTmpl" type="Templates:TciValueTemplate" minOccurs="0"/>
        <xsd:element name="diffs" type="Templates:TciValueDifferenceList"/>
        <xsd:element name="from" type="Types:TriComponentIdType" minOccurs="0"/>
        <xsd:element name="fromTmpl" type="Templates:TciNonValueTemplate"
minOccurs="0"/>
      </xsd:sequence>
    </xsd:extension>
  </xsd:complexContent>
</xsd:complexType>

<xsd:complexType name="tliPrGetReply_m">
  <xsd:complexContent mixed="true">
    <xsd:extension base="Events:Event">
      <xsd:sequence>
        <xsd:element name="at" type="Types:TriPortIdType"/>
        <xsd:element name="signature" type="Types:TriSignatureIdType"/>
        <xsd:element name="tciPars" type="Types:TciParameterListType" minOccurs="0"/>
        <xsd:element name="parsTmpl" type="Templates:TciValueTemplate" minOccurs="0"/>
        <xsd:element name="replValue" type="Values:Value" minOccurs="0"/>
        <xsd:element name="replTmpl" type="Templates:TciValueTemplate" minOccurs="0"/>
        <xsd:element name="addrValue" type="Values:Value" minOccurs="0"/>
        <xsd:element name="addressTmpl" type="Templates:TciValueTemplate"
minOccurs="0"/>
      </xsd:sequence>
    </xsd:extension>
  </xsd:complexContent>
</xsd:complexType>

<xsd:complexType name="tliPrGetReply_c">
  <xsd:complexContent mixed="true">
    <xsd:extension base="Events:Event">
      <xsd:sequence>
        <xsd:element name="at" type="Types:TriPortIdType"/>
        <xsd:element name="signature" type="Types:TriSignatureIdType"/>
        <xsd:element name="tciPars" type="Types:TciParameterListType" minOccurs="0"/>
        <xsd:element name="parsTmpl" type="Templates:TciValueTemplate" minOccurs="0"/>
        <xsd:element name="replValue" type="Values:Value" minOccurs="0"/>
        <xsd:element name="replTmpl" type="Templates:TciValueTemplate" minOccurs="0"/>
        <xsd:element name="from" type="Types:TriComponentIdType" minOccurs="0"/>
        <xsd:element name="fromTmpl" type="Templates:TciNonValueTemplate"
minOccurs="0"/>
      </xsd:sequence>
    </xsd:extension>
  </xsd:complexContent>
</xsd:complexType>

<xsd:complexType name="tliPrRaise_m">
  <xsd:complexContent mixed="true">
    <xsd:extension base="Events:Event">
      <xsd:sequence>
        <xsd:element name="at" type="Types:TriPortIdType"/>
        <xsd:element name="to" type="Types:TriPortIdType" minOccurs="0"/>
        <xsd:element name="signature" type="Types:TriSignatureIdType"/>
        <xsd:element name="tciPars" type="Types:TciParameterListType" minOccurs="0"/>
        <xsd:element name="excValue" type="Values:Value" minOccurs="0"/>
        <xsd:element name="addrValue" type="Values:Value" minOccurs="0"/>
        <xsd:choice>
          <xsd:element name="encoder-failure" type="SimpleTypes:TciStatusType"
minOccurs="0"/>
          <xsd:sequence>
            <xsd:element name="exc" type="Types:TriExceptionType" minOccurs="0"/>
            <xsd:element name="address" type="Types:TriAddressType" minOccurs="0"/>
            <xsd:element name="transmission-failure"
type="SimpleTypes:TriStatusType" minOccurs="0"/>
          </xsd:sequence>
        </xsd:choice>
      </xsd:sequence>
    </xsd:extension>
  </xsd:complexContent>
</xsd:complexType>

```



```

    </xsd:extension>
  </xsd:complexContent>
</xsd:complexType>

<xsd:complexType name="tliPrRaise_m_BC">
  <xsd:complexContent mixed="true">
    <xsd:extension base="Events:Event">
      <xsd:sequence>
        <xsd:element name="at" type="Types:TriPortIdType"/>
        <xsd:element name="to" type="Types:TriPortIdType" minOccurs="0"/>
        <xsd:element name="signature" type="Types:TriSignatureIdType"/>
        <xsd:element name="tciPars" type="Types:TciParameterListType" minOccurs="0"/>
        <xsd:element name="excValue" type="Values:Value" minOccurs="0"/>
        <xsd:choice>
          <xsd:element name="encoder-failure" type="SimpleTypes:TciStatusType"
minOccurs="0"/>
          <xsd:sequence>
            <xsd:element name="exc" type="Types:TriExceptionType" minOccurs="0"/>
            <xsd:element name="transmission-failure"
type="SimpleTypes:TriStatusType" minOccurs="0"/>
          </xsd:sequence>
        </xsd:choice>
      </xsd:sequence>
    </xsd:extension>
  </xsd:complexContent>
</xsd:complexType>

<xsd:complexType name="tliPrRaise_m_MC">
  <xsd:complexContent mixed="true">
    <xsd:extension base="Events:Event">
      <xsd:sequence>
        <xsd:element name="at" type="Types:TriPortIdType"/>
        <xsd:element name="to" type="Types:TriPortIdType" minOccurs="0"/>
        <xsd:element name="signature" type="Types:TriSignatureIdType"/>
        <xsd:element name="tciPars" type="Types:TciParameterListType" minOccurs="0"/>
        <xsd:element name="excValue" type="Values:Value" minOccurs="0"/>
        <xsd:element name="addrValues" type="Types:TciValueListType" minOccurs="0"/>
        <xsd:choice>
          <xsd:element name="encoder-failure" type="SimpleTypes:TciStatusType"
minOccurs="0"/>
          <xsd:sequence>
            <xsd:element name="exc" type="Types:TriExceptionType" minOccurs="0"/>
            <xsd:element name="addresses" type="Types:TriAddressListType"
minOccurs="0"/>
            <xsd:element name="transmission-failure"
type="SimpleTypes:TriStatusType" minOccurs="0"/>
          </xsd:sequence>
        </xsd:choice>
      </xsd:sequence>
    </xsd:extension>
  </xsd:complexContent>
</xsd:complexType>

<xsd:complexType name="tliPrRaise_c">
  <xsd:complexContent mixed="true">
    <xsd:extension base="Events:Event">
      <xsd:sequence>
        <xsd:element name="at" type="Types:TriPortIdType"/>
        <xsd:element name="to" type="Types:TriPortIdType" minOccurs="0"/>
        <xsd:element name="signature" type="Types:TriSignatureIdType"/>
        <xsd:element name="tciPars" type="Types:TciParameterListType" minOccurs="0"/>
        <xsd:element name="excValue" type="Values:Value" minOccurs="0"/>
        <xsd:element name="transmission-failure" type="SimpleTypes:TriStatusType"
minOccurs="0"/>
      </xsd:sequence>
    </xsd:extension>
  </xsd:complexContent>
</xsd:complexType>

<xsd:complexType name="tliPrRaise_c_BC">
  <xsd:complexContent mixed="true">
    <xsd:extension base="Events:Event">
      <xsd:sequence>
        <xsd:element name="at" type="Types:TriPortIdType"/>
        <xsd:element name="to" type="Types:TriPortIdListType" minOccurs="0"/>
        <xsd:element name="signature" type="Types:TriSignatureIdType"/>
        <xsd:element name="tciPars" type="Types:TciParameterListType" minOccurs="0"/>
        <xsd:element name="excValue" type="Values:Value" minOccurs="0"/>
      </xsd:sequence>
    </xsd:extension>
  </xsd:complexContent>
</xsd:complexType>

```

```

        <xsd:element name="transmission-failure" type="SimpleTypes:TriStatusType"
minOccurs="0"/>
    </xsd:sequence>
</xsd:extension>
</xsd:complexContent>
</xsd:complexType>

<xsd:complexType name="tliPrRaise_c_MC">
    <xsd:complexContent mixed="true">
        <xsd:extension base="Events:Event">
            <xsd:sequence>
                <xsd:element name="at" type="Types:TriPortIdType"/>
                <xsd:element name="to" type="Types:TriPortIdListType" minOccurs="0"/>
                <xsd:element name="signature" type="Types:TriSignatureIdType"/>
                <xsd:element name="tciPars" type="Types:TciParameterListType" minOccurs="0"/>
                <xsd:element name="excValue" type="Values:Value" minOccurs="0"/>
                <xsd:element name="transmission-failure" type="SimpleTypes:TriStatusType"
minOccurs="0"/>
            </xsd:sequence>
        </xsd:extension>
    </xsd:complexContent>
</xsd:complexType>

<xsd:complexType name="tliPrCatchDetected_m">
    <xsd:complexContent mixed="true">
        <xsd:extension base="Events:Event">
            <xsd:sequence>
                <xsd:element name="at" type="Types:TriPortIdType"/>
                <xsd:element name="from" type="Types:TriPortIdType" minOccurs="0"/>
                <xsd:element name="signature" type="Types:TriSignatureIdType"/>
                <xsd:element name="exc" type="Types:TriExceptionType" minOccurs="0"/>
                <xsd:element name="address" type="Types:TriAddressType" minOccurs="0"/>
            </xsd:sequence>
        </xsd:extension>
    </xsd:complexContent>
</xsd:complexType>

<xsd:complexType name="tliPrCatchDetected_c">
    <xsd:complexContent mixed="true">
        <xsd:extension base="Events:Event">
            <xsd:sequence>
                <xsd:element name="at" type="Types:TriPortIdType"/>
                <xsd:element name="from" type="Types:TriPortIdType" minOccurs="0"/>
                <xsd:element name="signature" type="Types:TriSignatureIdType"/>
                <xsd:element name="excValue" type="Values:Value" minOccurs="0"/>
            </xsd:sequence>
        </xsd:extension>
    </xsd:complexContent>
</xsd:complexType>

<xsd:complexType name="tliPrCatchMismatch_m">
    <xsd:complexContent mixed="true">
        <xsd:extension base="Events:Event">
            <xsd:sequence>
                <xsd:element name="at" type="Types:TriPortIdType"/>
                <xsd:element name="signature" type="Types:TriSignatureIdType"/>
                <xsd:element name="excValue" type="Values:Value" minOccurs="0"/>
                <xsd:element name="excTmpl" type="Templates:TciValueTemplate" minOccurs="0"/>
                <xsd:element name="diffs" type="Templates:TciValueDifferenceList"/>
                <xsd:element name="addrValue" type="Values:Value" minOccurs="0"/>
                <xsd:element name="addressTmpl" type="Templates:TciValueTemplate"
minOccurs="0"/>
            </xsd:sequence>
        </xsd:extension>
    </xsd:complexContent>
</xsd:complexType>

<xsd:complexType name="tliPrCatchMismatch_c">
    <xsd:complexContent mixed="true">
        <xsd:extension base="Events:Event">
            <xsd:sequence>
                <xsd:element name="at" type="Types:TriPortIdType"/>
                <xsd:element name="signature" type="Types:TriSignatureIdType"/>
                <xsd:element name="excValue" type="Values:Value" minOccurs="0"/>
                <xsd:element name="excTmpl" type="Templates:TciValueTemplate" minOccurs="0"/>
                <xsd:element name="diffs" type="Templates:TciValueDifferenceList"/>
                <xsd:element name="from" type="Types:TriComponentIdType" minOccurs="0"/>
                <xsd:element name="fromTmpl" type="Templates:TciNonValueTemplate"

```

```

minOccurs="0"/>
    </xsd:sequence>
  </xsd:extension>
</xsd:complexContent>
</xsd:complexType>

<xsd:complexType name="tliPrCatch_m">
  <xsd:complexContent mixed="true">
    <xsd:extension base="Events:Event">
      <xsd:sequence>
        <xsd:element name="at" type="Types:TriPortIdType"/>
        <xsd:element name="signature" type="Types:TriSignatureIdType"/>
        <xsd:element name="excValue" type="Values:Value"/>
        <xsd:element name="excTpl" type="Templates:TciValueTemplate"/>
        <xsd:element name="addrValue" type="Values:Value" minOccurs="0"/>
        <xsd:element name="addressTpl" type="Templates:TciValueTemplate"
minOccurs="0"/>
      </xsd:sequence>
    </xsd:extension>
  </xsd:complexContent>
</xsd:complexType>

<xsd:complexType name="tliPrCatch_c">
  <xsd:complexContent mixed="true">
    <xsd:extension base="Events:Event">
      <xsd:sequence>
        <xsd:element name="at" type="Types:TriPortIdType"/>
        <xsd:element name="signature" type="Types:TriSignatureIdType"/>
        <xsd:element name="excValue" type="Values:Value" minOccurs="0"/>
        <xsd:element name="excTpl" type="Templates:TciValueTemplate" minOccurs="0"/>
        <xsd:element name="from" type="Types:TriComponentIdType" minOccurs="0"/>
        <xsd:element name="fromTpl" type="Templates:TciNonValueTemplate"
minOccurs="0"/>
      </xsd:sequence>
    </xsd:extension>
  </xsd:complexContent>
</xsd:complexType>

<xsd:complexType name="tliPrCatchTimeoutDetected">
  <xsd:complexContent mixed="true">
    <xsd:extension base="Events:Event">
      <xsd:sequence>
        <xsd:element name="at" type="Types:TriPortIdType"/>
        <xsd:element name="signature" type="Types:TriSignatureIdType"/>
      </xsd:sequence>
    </xsd:extension>
  </xsd:complexContent>
</xsd:complexType>

<xsd:complexType name="tliPrCatchTimeout">
  <xsd:complexContent mixed="true">
    <xsd:extension base="Events:Event">
      <xsd:sequence>
        <xsd:element name="at" type="Types:TriPortIdType"/>
        <xsd:element name="signature" type="Types:TriSignatureIdType"/>
      </xsd:sequence>
    </xsd:extension>
  </xsd:complexContent>
</xsd:complexType>

<!-- components -->
<xsd:complexType name="tliCCreate">
  <xsd:complexContent mixed="true">
    <xsd:extension base="Events:Event">
      <xsd:sequence>
        <xsd:element name="comp" type="Types:TriComponentIdType"/>
        <xsd:element name="name" type="SimpleTypes:TString"/>
        <xsd:element name="hostId" type="Values:Value" minOccurs="0"/>
        <xsd:element name="alive" type="SimpleTypes:TBoolean"/>
      </xsd:sequence>
    </xsd:extension>
  </xsd:complexContent>
</xsd:complexType>

<xsd:complexType name="tliCStart">
  <xsd:complexContent mixed="true">
    <xsd:extension base="Events:Event">
      <xsd:sequence>

```

```

        <xsd:element name="comp" type="Types:TriComponentIdType"/>
        <xsd:element name="name" type="Types:TciBehaviourIdType"/>
        <xsd:element name="tciPars" type="Types:TciParameterListType" minOccurs="0"/>
    </xsd:sequence>
</xsd:extension>
</xsd:complexContent>
</xsd:complexType>

<xsd:complexType name="tliCRunning">
    <xsd:complexContent mixed="true">
        <xsd:extension base="Events:Event">
            <xsd:sequence>
                <xsd:element name="comp" type="Types:TriComponentIdType"/>
                <xsd:element name="status" type="SimpleTypes:ComponentStatusType"/>
            </xsd:sequence>
        </xsd:extension>
    </xsd:complexContent>
</xsd:complexType>

<xsd:complexType name="tliCAlive">
    <xsd:complexContent mixed="true">
        <xsd:extension base="Events:Event">
            <xsd:sequence>
                <xsd:element name="comp" type="Types:TriComponentIdType"/>
                <xsd:element name="status" type="SimpleTypes:ComponentStatusType"/>
            </xsd:sequence>
        </xsd:extension>
    </xsd:complexContent>
</xsd:complexType>

<xsd:complexType name="tliCStop">
    <xsd:complexContent mixed="true">
        <xsd:extension base="Events:Event">
            <xsd:sequence>
                <xsd:element name="comp" type="Types:TriComponentIdType"/>
            </xsd:sequence>
        </xsd:extension>
    </xsd:complexContent>
</xsd:complexType>

<xsd:complexType name="tliCKill">
    <xsd:complexContent mixed="true">
        <xsd:extension base="Events:Event">
            <xsd:sequence>
                <xsd:element name="comp" type="Types:TriComponentIdType"/>
            </xsd:sequence>
        </xsd:extension>
    </xsd:complexContent>
</xsd:complexType>

<xsd:complexType name="tliCDoneMismatch">
    <xsd:complexContent mixed="true">
        <xsd:extension base="Events:Event">
            <xsd:sequence>
                <xsd:element name="comp" type="Types:TriComponentIdType"/>
                <xsd:element name="compTpl" type="Templates:TciNonValueTemplate"/>
            </xsd:sequence>
        </xsd:extension>
    </xsd:complexContent>
</xsd:complexType>

<xsd:complexType name="tliCKilledMismatch">
    <xsd:complexContent mixed="true">
        <xsd:extension base="Events:Event">
            <xsd:sequence>
                <xsd:element name="comp" type="Types:TriComponentIdType"/>
                <xsd:element name="compTpl" type="Templates:TciNonValueTemplate"/>
            </xsd:sequence>
        </xsd:extension>
    </xsd:complexContent>
</xsd:complexType>

<xsd:complexType name="tliCDone">
    <xsd:complexContent mixed="true">
        <xsd:extension base="Events:Event">
            <xsd:sequence>
                <xsd:element name="compTpl" type="Templates:TciNonValueTemplate"/>
            </xsd:sequence>
        </xsd:extension>
    </xsd:complexContent>
</xsd:complexType>

```

```

        <xsd:element name="verdict" type="Values:VerdictValue" minOccurs="0" />
      </xsd:sequence>
    </xsd:extension>
  </xsd:complexContent>
</xsd:complexType>

<xsd:complexType name="tliCKilled">
  <xsd:complexContent mixed="true">
    <xsd:extension base="Events:Event">
      <xsd:sequence>
        <xsd:element name="compTpl" type="Templates:TciNonValueTemplate"/>
        <xsd:element name="verdict" type="Values:VerdictValue" minOccurs="0" />
      </xsd:sequence>
    </xsd:extension>
  </xsd:complexContent>
</xsd:complexType>

<xsd:complexType name="tliCTerminated">
  <xsd:complexContent mixed="true">
    <xsd:extension base="Events:Event">
      <xsd:sequence>
        <xsd:element name="verdict" type="Values:VerdictValue" />
        <xsd:element name="reason" type="SimpleTypes:TString" minOccurs="0"/>
      </xsd:sequence>
    </xsd:extension>
  </xsd:complexContent>
</xsd:complexType>

<!-- ports -->
<xsd:complexType name="tliPConnect">
  <xsd:complexContent mixed="true">
    <xsd:extension base="Events:PortConfiguration"/>
  </xsd:complexContent>
</xsd:complexType>

<xsd:complexType name="tliPDisconnect">
  <xsd:complexContent mixed="true">
    <xsd:extension base="Events:PortConfiguration"/>
  </xsd:complexContent>
</xsd:complexType>

<xsd:complexType name="tliPMap">
  <xsd:complexContent mixed="true">
    <xsd:extension base="Events:PortConfiguration"/>
  </xsd:complexContent>
</xsd:complexType>

<xsd:complexType name="tliPMapParam">
  <xsd:complexContent mixed="true">
    <xsd:extension base="Events:tliPMap">
      <xsd:sequence>
        <xsd:element name="tciPars" type="Types:TciParameterListType" />
        <xsd:choice>
          <xsd:element name="encoder-failure" type="SimpleTypes:TciStatusType"
minOccurs="0"/>
          <xsd:element name="triPars" type="Types:TriParameterListType" />
        </xsd:choice>
      </xsd:sequence>
    </xsd:extension>
  </xsd:complexContent>
</xsd:complexType>

<xsd:complexType name="tliPUnmap">
  <xsd:complexContent mixed="true">
    <xsd:extension base="Events:PortConfiguration"/>
  </xsd:complexContent>
</xsd:complexType>

<xsd:complexType name="tliPUnmapParam">
  <xsd:complexContent mixed="true">
    <xsd:extension base="Events:tliPUnmap">
      <xsd:sequence>
        <xsd:element name="tciPars" type="Types:TciParameterListType" />
        <xsd:choice>
          <xsd:element name="encoder-failure" type="SimpleTypes:TciStatusType"
minOccurs="0"/>
          <xsd:element name="triPars" type="Types:TriParameterListType"/>

```

```

        </xsd:choice>
      </xsd:sequence>
    </xsd:extension>
  </xsd:complexContent>
</xsd:complexType>

<xsd:complexType name="tliPClear">
  <xsd:complexContent mixed="true">
    <xsd:extension base="Events:PortStatus"/>
  </xsd:complexContent>
</xsd:complexType>

<xsd:complexType name="tliPStart">
  <xsd:complexContent mixed="true">
    <xsd:extension base="Events:PortStatus"/>
  </xsd:complexContent>
</xsd:complexType>

<xsd:complexType name="tliPStop">
  <xsd:complexContent mixed="true">
    <xsd:extension base="Events:PortStatus"/>
  </xsd:complexContent>
</xsd:complexType>

<xsd:complexType name="tliPHalt">
  <xsd:complexContent mixed="true">
    <xsd:extension base="Events:PortStatus"/>
  </xsd:complexContent>
</xsd:complexType>

<!-- codec -->
<xsd:complexType name="tliEncode">
  <xsd:complexContent mixed="true">
    <xsd:extension base="Events:Event">
      <xsd:sequence>
        <xsd:element name="val" type="Values:Value"/>
        <xsd:choice>
          <xsd:element name="msg" type="Types:TriMessageType"/>
          <xsd:element name="encoder-failure" type="SimpleTypes:TciStatusType"
minOccurs="0"/>
        </xsd:choice>
        <xsd:element name="codec" type="SimpleTypes:TString"
          minOccurs="0"/>
      </xsd:sequence>
    </xsd:extension>
  </xsd:complexContent>
</xsd:complexType>

<xsd:complexType name="tliDecode" mixed="true">
  <xsd:complexContent mixed="true">
    <xsd:extension base="Events:Event">
      <xsd:sequence>
        <xsd:element name="msg" type="Types:TriMessageType"/>
        <xsd:choice>
          <xsd:element name="decoder-failure" type="SimpleTypes:TciStatusType"
minOccurs="0"/>
          <xsd:element name="val" type="Values:Value"/>
        </xsd:choice>
        <xsd:element name="codec" type="SimpleTypes:TString"
          minOccurs="0"/>
      </xsd:sequence>
    </xsd:extension>
  </xsd:complexContent>
</xsd:complexType>

<!-- timers -->
<xsd:complexType name="tliTimeoutDetected">
  <xsd:complexContent mixed="true">
    <xsd:extension base="Events:Event">
      <xsd:sequence>
        <xsd:element name="timer" type="Types:TriTimerIdType" />
      </xsd:sequence>
    </xsd:extension>
  </xsd:complexContent>
</xsd:complexType>

<xsd:complexType name="tliTimeoutMismatch">
  <xsd:complexContent mixed="true">

```

```

    <xsd:extension base="Events:Event">
      <xsd:sequence>
        <xsd:element name="timer" type="Types:TriTimerIdType" />
        <xsd:element name="timerTpl" type="Templates:TciNonValueTemplate" />
      </xsd:sequence>
    </xsd:extension>
  </xsd:complexContent>
</xsd:complexType>

<xsd:complexType name="tliTimeout">
  <xsd:complexContent mixed="true">
    <xsd:extension base="Events:Event">
      <xsd:sequence>
        <xsd:element name="timer" type="Types:TriTimerIdType" />
        <xsd:element name="timerTpl" type="Templates:TciNonValueTemplate" />
      </xsd:sequence>
    </xsd:extension>
  </xsd:complexContent>
</xsd:complexType>

<xsd:complexType name="tliTStart">
  <xsd:complexContent mixed="true">
    <xsd:extension base="Events:Event">
      <xsd:sequence>
        <xsd:element name="timer" type="Types:TriTimerIdType" />
        <xsd:element name="dur" type="SimpleTypes:TriTimerDurationType" />
      </xsd:sequence>
    </xsd:extension>
  </xsd:complexContent>
</xsd:complexType>

<xsd:complexType name="tliTStop">
  <xsd:complexContent mixed="true">
    <xsd:extension base="Events:Event">
      <xsd:sequence>
        <xsd:element name="timer" type="Types:TriTimerIdType" />
        <xsd:element name="dur" type="SimpleTypes:TriTimerDurationType" />
      </xsd:sequence>
    </xsd:extension>
  </xsd:complexContent>
</xsd:complexType>

<xsd:complexType name="tliTRead">
  <xsd:complexContent mixed="true">
    <xsd:extension base="Events:Event">
      <xsd:sequence>
        <xsd:element name="timer" type="Types:TriTimerIdType" />
        <xsd:element name="elapsed" type="SimpleTypes:TriTimerDurationType" />
      </xsd:sequence>
    </xsd:extension>
  </xsd:complexContent>
</xsd:complexType>

<xsd:complexType name="tliTRunning">
  <xsd:complexContent mixed="true">
    <xsd:extension base="Events:Event">
      <xsd:sequence>
        <xsd:element name="timer" type="Types:TriTimerIdType" />
        <xsd:element name="status" type="SimpleTypes:TimerStatusType" />
      </xsd:sequence>
    </xsd:extension>
  </xsd:complexContent>
</xsd:complexType>

<!-- scope -->
<xsd:complexType name="tliSEnter">
  <xsd:complexContent mixed="true">
    <xsd:extension base="Events:Event">
      <xsd:sequence>
        <xsd:element name="name" type="Types:QualifiedName" />
        <xsd:element name="tciPars" type="Types:TciParameterListType" minOccurs="0" />
        <xsd:element name="kind" type="SimpleTypes:TString" />
      </xsd:sequence>
    </xsd:extension>
  </xsd:complexContent>
</xsd:complexType>

<xsd:complexType name="tliSLeave">

```

```

<xsd:complexContent mixed="true">
  <xsd:extension base="Events:Event">
    <xsd:sequence>
      <xsd:element name="name" type="Types:QualifiedName" />
      <xsd:element name="tciPars" type="Types:TciParameterListType" minOccurs="0"/>
      <xsd:element name="returnValue" type="Values:Value" minOccurs="0"/>
      <xsd:element name="kind" type="SimpleTypes:TString"/>
    </xsd:sequence>
  </xsd:extension>
</xsd:complexContent>
</xsd:complexType>

<!-- variables and module parameter -->
<xsd:complexType name="tliVar">
  <xsd:complexContent mixed="true">
    <xsd:extension base="Events:Event">
      <xsd:sequence>
        <xsd:element name="name" type="Types:QualifiedName" />
        <xsd:element name="val" type="Values:Value" minOccurs="0"/>
      </xsd:sequence>
    </xsd:extension>
  </xsd:complexContent>
</xsd:complexType>

<xsd:complexType name="tliModulePar">
  <xsd:complexContent mixed="true">
    <xsd:extension base="Events:Event">
      <xsd:sequence>
        <xsd:element name="name" type="Types:QualifiedName" />
        <xsd:element name="val" type="Values:Value" minOccurs="0"/>
      </xsd:sequence>
    </xsd:extension>
  </xsd:complexContent>
</xsd:complexType>

<!-- verdicts -->
<xsd:complexType name="tliGetVerdict">
  <xsd:complexContent mixed="true">
    <xsd:extension base="Events:Event">
      <xsd:sequence>
        <xsd:element name="verdict" type="Values:VerdictValue"/>
      </xsd:sequence>
    </xsd:extension>
  </xsd:complexContent>
</xsd:complexType>

<xsd:complexType name="tliSetVerdict">
  <xsd:complexContent mixed="true">
    <xsd:extension base="Events:Event">
      <xsd:sequence>
        <xsd:element name="verdict" type="Values:VerdictValue"/>
        <xsd:element name="reason" type="SimpleTypes:TString" minOccurs="0"/>
      </xsd:sequence>
    </xsd:extension>
  </xsd:complexContent>
</xsd:complexType>

<!-- log -->
<xsd:complexType name="tliLog">
  <xsd:complexContent mixed="true">
    <xsd:extension base="Events:Event">
      <xsd:sequence>
        <xsd:element name="log" type="SimpleTypes:TString"/>
      </xsd:sequence>
    </xsd:extension>
  </xsd:complexContent>
</xsd:complexType>

<!-- alt -->
<xsd:complexType name="tliAEnter">
  <xsd:complexContent>
    <xsd:extension base="Events:Event" />
  </xsd:complexContent>
</xsd:complexType>

<xsd:complexType name="tliALeave">
  <xsd:complexContent>
    <xsd:extension base="Events:Event" />
  </xsd:complexContent>
</xsd:complexType>

```



```

    </xsd:complexContent>
  </xsd:complexType>

  <xsd:complexType name="tliADefaults">
    <xsd:complexContent>
      <xsd:extension base="Events:Event" />
    </xsd:complexContent>
  </xsd:complexType>

  <xsd:complexType name="tliAActivate">
    <xsd:complexContent mixed="true">
      <xsd:extension base="Events:Event">
        <xsd:sequence>
          <xsd:element name="name" type="Types:QualifiedName" />
          <xsd:element name="tciPars" type="Types:TciParameterListType" minOccurs="0"/>
          <xsd:element name="ref" type="Values:Value"/>
        </xsd:sequence>
      </xsd:extension>
    </xsd:complexContent>
  </xsd:complexType>

  <xsd:complexType name="tliADeactivate">
    <xsd:complexContent mixed="true">
      <xsd:extension base="Events:Event">
        <xsd:sequence>
          <xsd:element name="ref" type="Values:Value"/>
        </xsd:sequence>
      </xsd:extension>
    </xsd:complexContent>
  </xsd:complexType>

  <xsd:complexType name="tliANomatch">
    <xsd:complexContent mixed="true">
      <xsd:extension base="Events:Event" />
    </xsd:complexContent>
  </xsd:complexType>

  <xsd:complexType name="tliARepeat">
    <xsd:complexContent>
      <xsd:extension base="Events:Event" />
    </xsd:complexContent>
  </xsd:complexType>

  <xsd:complexType name="tliAWait">
    <xsd:complexContent>
      <xsd:extension base="Events:Event" />
    </xsd:complexContent>
  </xsd:complexType>

  <xsd:complexType name="tliAction">
    <xsd:complexContent mixed="true">
      <xsd:extension base="Events:Event">
        <xsd:sequence>
          <xsd:element name="action" type="SimpleTypes:TString"/>
        </xsd:sequence>
      </xsd:extension>
    </xsd:complexContent>
  </xsd:complexType>

  <xsd:complexType name="tliMatch">
    <xsd:complexContent mixed="true">
      <xsd:extension base="Events:Event">
        <xsd:sequence>
          <xsd:element name="expr" type="Values:Value"/>
          <xsd:element name="tmpl" type="Templates:TciValueTemplate"/>
        </xsd:sequence>
      </xsd:extension>
    </xsd:complexContent>
  </xsd:complexType>

  <xsd:complexType name="tliMatchMismatch">
    <xsd:complexContent mixed="true">
      <xsd:extension base="Events:Event">
        <xsd:sequence>
          <xsd:element name="expr" type="Values:Value"/>
          <xsd:element name="tmpl" type="Templates:TciValueTemplate"/>
          <xsd:element name="diffs" type="Templates:TciValueDifferenceList"/>
        </xsd:sequence>
      </xsd:extension>
    </xsd:complexContent>
  </xsd:complexType>

```

```

        </xsd:extension>
      </xsd:complexContent>
    </xsd:complexType>

    <xsd:complexType name="tliInfo">
      <xsd:complexContent mixed="true">
        <xsd:extension base="Events:Event">
          <xsd:sequence>
            <xsd:element name="level" type="SimpleTypes:TInteger"/>
            <xsd:element name="info" type="SimpleTypes:TString"/>
          </xsd:sequence>
        </xsd:extension>
      </xsd:complexContent>
    </xsd:complexType>

    <xsd:complexType name="tliMChecked_m">
      <xsd:complexContent mixed="true">
        <xsd:extension base="Events:Event">
          <xsd:sequence>
            <xsd:element name="at" type="Types:TriPortIdType"/>
            <xsd:element name="msgValue" type="Values:Value" minOccurs="0"/>
            <xsd:element name="msgTmpl" type="Templates:TciValueTemplate" minOccurs="0"/>
            <xsd:element name="addrValue" type="Values:Value" minOccurs="0"/>
            <xsd:element name="addressTmpl" type="Templates:TciValueTemplate"
              minOccurs="0"/>
          </xsd:sequence>
        </xsd:extension>
      </xsd:complexContent>
    </xsd:complexType>

    <xsd:complexType name="tliMChecked_c">
      <xsd:complexContent mixed="true">
        <xsd:extension base="Events:Event">
          <xsd:sequence>
            <xsd:element name="at" type="Types:TriPortIdType"/>
            <xsd:element name="msgValue" type="Values:Value"/>
            <xsd:element name="msgTmpl" type="Templates:TciValueTemplate"
              minOccurs="0"/>
            <xsd:element name="from" type="Types:TriComponentIdType" minOccurs="0"/>
            <xsd:element name="fromTmpl" type="Templates:TciNonValueTemplate"
              minOccurs="0"/>
          </xsd:sequence>
        </xsd:extension>
      </xsd:complexContent>
    </xsd:complexType>

    <xsd:complexType name="tliPrGetCallChecked_m">
      <xsd:complexContent mixed="true">
        <xsd:extension base="Events:Event">
          <xsd:sequence>
            <xsd:element name="at" type="Types:TriPortIdType"/>
            <xsd:element name="signature" type="Types:TriSignatureIdType"/>
            <xsd:element name="tciPars" type="Types:TciParameterListType" minOccurs="0"/>
            <xsd:element name="parsTmpl" type="Templates:TciValueTemplate" minOccurs="0"/>
            <xsd:element name="addrValue" type="Values:Value" minOccurs="0"/>
            <xsd:element name="addressTmpl" type="Templates:TciValueTemplate"
              minOccurs="0"/>
          </xsd:sequence>
        </xsd:extension>
      </xsd:complexContent>
    </xsd:complexType>

    <xsd:complexType name="tliPrGetCallChecked_c">
      <xsd:complexContent mixed="true">
        <xsd:extension base="Events:Event">
          <xsd:sequence>
            <xsd:element name="at" type="Types:TriPortIdType"/>
            <xsd:element name="signature" type="Types:TriSignatureIdType"/>
            <xsd:element name="tciPars" type="Types:TciParameterListType" minOccurs="0"/>
            <xsd:element name="parsTmpl" type="Templates:TciValueTemplate" minOccurs="0"/>
            <xsd:element name="from" type="Types:TriComponentIdType" minOccurs="0"/>
            <xsd:element name="fromTmpl" type="Templates:TciNonValueTemplate"
              minOccurs="0"/>
          </xsd:sequence>
        </xsd:extension>
      </xsd:complexContent>
    </xsd:complexType>

    <xsd:complexType name="tliPrGetReplyChecked_m">

```

```

<xsd:complexContent mixed="true">
  <xsd:extension base="Events:Event">
    <xsd:sequence>
      <xsd:element name="at" type="Types:TriPortIdType"/>
      <xsd:element name="signature" type="Types:TriSignatureIdType"/>
      <xsd:element name="tciPars" type="Types:TciParameterListType" minOccurs="0"/>
      <xsd:element name="parsTmpl" type="Templates:TciValueTemplate" minOccurs="0"/>
      <xsd:element name="replValue" type="Values:Value" minOccurs="0"/>
      <xsd:element name="replTmpl" type="Templates:TciValueTemplate" minOccurs="0"/>
      <xsd:element name="addrValue" type="Values:Value" minOccurs="0"/>
      <xsd:element name="addressTmpl" type="Templates:TciValueTemplate"
        minOccurs="0"/>
    </xsd:sequence>
  </xsd:extension>
</xsd:complexContent>
</xsd:complexType>

<xsd:complexType name="tliPrGetReplyChecked_c">
  <xsd:complexContent mixed="true">
    <xsd:extension base="Events:Event">
      <xsd:sequence>
        <xsd:element name="at" type="Types:TriPortIdType"/>
        <xsd:element name="signature" type="Types:TriSignatureIdType"/>
        <xsd:element name="tciPars" type="Types:TciParameterListType" minOccurs="0"/>
        <xsd:element name="parsTmpl" type="Templates:TciValueTemplate" minOccurs="0"/>
        <xsd:element name="replValue" type="Values:Value" minOccurs="0"/>
        <xsd:element name="replTmpl" type="Templates:TciValueTemplate" minOccurs="0"/>
        <xsd:element name="from" type="Types:TriComponentIdType" minOccurs="0"/>
        <xsd:element name="fromTmpl" type="Templates:TciNonValueTemplate"
          minOccurs="0"/>
      </xsd:sequence>
    </xsd:extension>
  </xsd:complexContent>
</xsd:complexType>

<xsd:complexType name="tliPrCatchChecked_m">
  <xsd:complexContent mixed="true">
    <xsd:extension base="Events:Event">
      <xsd:sequence>
        <xsd:element name="at" type="Types:TriPortIdType"/>
        <xsd:element name="signature" type="Types:TriSignatureIdType"/>
        <xsd:element name="excValue" type="Values:Value" minOccurs="0"/>
        <xsd:element name="excTmpl" type="Templates:TciValueTemplate" minOccurs="0"/>
        <xsd:element name="addrValue" type="Values:Value" minOccurs="0"/>
        <xsd:element name="addressTmpl" type="Templates:TciValueTemplate"
          minOccurs="0"/>
      </xsd:sequence>
    </xsd:extension>
  </xsd:complexContent>
</xsd:complexType>

<xsd:complexType name="tliPrCatchChecked_c">
  <xsd:complexContent mixed="true">
    <xsd:extension base="Events:Event">
      <xsd:sequence>
        <xsd:element name="at" type="Types:TriPortIdType"/>
        <xsd:element name="signature" type="Types:TriSignatureIdType"/>
        <xsd:element name="excValue" type="Values:Value" minOccurs="0"/>
        <xsd:element name="excTmpl" type="Templates:TciValueTemplate" minOccurs="0"/>
        <xsd:element name="from" type="Types:TriComponentIdType" minOccurs="0"/>
        <xsd:element name="fromTmpl" type="Templates:TciNonValueTemplate"
          minOccurs="0"/>
      </xsd:sequence>
    </xsd:extension>
  </xsd:complexContent>
</xsd:complexType>

<xsd:complexType name="tliCheckedAny_m">
  <xsd:complexContent mixed="true">
    <xsd:extension base="Events:Event">
      <xsd:sequence>
        <xsd:element name="at" type="Types:TriPortIdType"/>
        <xsd:element name="addrValue" type="Values:Value" minOccurs="0"/>
        <xsd:element name="addressTmpl" type="Templates:TciValueTemplate"
          minOccurs="0"/>
      </xsd:sequence>
    </xsd:extension>
  </xsd:complexContent>
</xsd:complexType>

```

```

</xsd:complexType>

<xsd:complexType name="tliCheckedAny_c">
  <xsd:complexContent mixed="true">
    <xsd:extension base="Events:Event">
      <xsd:sequence>
        <xsd:element name="at" type="Types:TriPortIdType"/>
        <xsd:element name="from" type="Types:TriComponentIdType"
          minOccurs="0"/>
        <xsd:element name="fromTmpl" type="Templates:TciNonValueTemplate"
          minOccurs="0"/>
      </xsd:sequence>
    </xsd:extension>
  </xsd:complexContent>
</xsd:complexType>

<xsd:complexType name="tliCheckMismatch_m">
  <xsd:complexContent mixed="true">
    <xsd:extension base="Events:Event">
      <xsd:sequence>
        <xsd:element name="at" type="Types:TriPortIdType"/>
        <xsd:element name="addrValue" type="Values:Value" minOccurs="0"/>
        <xsd:element name="addressTmpl" type="Templates:TciValueTemplate"
          minOccurs="0"/>
      </xsd:sequence>
    </xsd:extension>
  </xsd:complexContent>
</xsd:complexType>

<xsd:complexType name="tliCheckMismatch_c">
  <xsd:complexContent mixed="true">
    <xsd:extension base="Events:Event">
      <xsd:sequence>
        <xsd:element name="at" type="Types:TriPortIdType"/>
        <xsd:element name="from" type="Types:TriComponentIdType"
          minOccurs="0"/>
        <xsd:element name="fromTmpl" type="Templates:TciNonValueTemplate"
          minOccurs="0"/>
      </xsd:sequence>
    </xsd:extension>
  </xsd:complexContent>
</xsd:complexType>

<xsd:complexType name="tliRnd">
  <xsd:complexContent mixed="true">
    <xsd:extension base="Events:Event">
      <xsd:sequence>
        <xsd:element name="val" type="Values:FloatValue"/>
        <xsd:element name="seed" type="Values:FloatValue"/>
      </xsd:sequence>
    </xsd:extension>
  </xsd:complexContent>
</xsd:complexType>

<xsd:complexType name="tliEvaluate">
  <xsd:complexContent mixed="true">
    <xsd:extension base="Events:Event">
      <xsd:sequence>
        <xsd:element name="name" type="Types:QualifiedName" />
        <xsd:element name="evalResult" type="Values:Value" minOccurs="0"/>
      </xsd:sequence>
    </xsd:extension>
  </xsd:complexContent>
</xsd:complexType>

<xsd:complexType name="tliCCall">
  <xsd:complexContent mixed="true">
    <xsd:extension base="Events:Event">
      <xsd:sequence>
        <xsd:element name="comp" type="Types:TriComponentIdType"/>
        <xsd:element name="name" type="Types:TciBehaviourIdType"/>
        <xsd:element name="tciPars" type="Types:TciParameterListType" minOccurs="0"/>
      </xsd:sequence>
    </xsd:extension>
  </xsd:complexContent>
</xsd:complexType>

```

```

<xsd:complexType name="tliCCallTerminated">
  <xsd:complexContent mixed="true">
    <xsd:extension base="Events:Event">
      <xsd:sequence>
        <xsd:element name="verdict" type="Values:VerdictValue" />
        <xsd:element name="reason" type="SimpleTypes:TString" minOccurs="0"/>
        <xsd:element name="tciPars" type="Types:TciParameterListType" minOccurs="0"/>
        <xsd:element name="returnValue" type="Values:Value" minOccurs="0"/>
      </xsd:sequence>
    </xsd:extension>
  </xsd:complexContent>
</xsd:complexType>

<!-- control -->
<xsd:complexType name="tliCtrlStartWithParameters">
  <xsd:complexContent>
    <xsd:extension base="Events:Event">
      <xsd:sequence>
        <xsd:element name="tciPars" type="Types:TciParameterListType" minOccurs="0"/>
      </xsd:sequence>
    </xsd:extension>
  </xsd:complexContent>
</xsd:complexType>

<xsd:complexType name="tliCtrlTerminatedWithResult">
  <xsd:complexContent>
    <xsd:extension base="Events:Event">
      <xsd:sequence>
        <xsd:element name="result" type="Values:Value" minOccurs="0"/>
        <xsd:element name="tciPars" type="Types:TciParameterListType" minOccurs="0"/>
      </xsd:sequence>
    </xsd:extension>
  </xsd:complexContent>
</xsd:complexType>

```

---

## 12 C# mapping

### 12.1 Introduction

The C# mapping for the TTCN-3 Control Interface defines how the IDL [6] definitions described in clause 7 are mapped to the .Net language C# [13].

### 12.2 Names and scopes

#### 12.2.1 Names

Although there are almost no conflicts between identifiers used in the IDL definition and C#, some naming translation rules are applied to the IDL identifiers.

C# interfaces are omitting the trailing Type used in the IDL definition. In addition to that, the capital letter "I" is added to the beginning of interface names.

**EXAMPLE 1:** The IDL type **TciTestCaseIdType** maps to **ITciTestCaseId** in C#.

C# names of enumerated items start with a capital letter and the remaining letters are low-case letters. If the enumerated item name is composed of several worlds, each word starts with a capital letter.

**EXAMPLE 2:** The identifier for boolean type defined in **TciTypeClassType** enumeration is **BooleanType** in C#.

The resulting mapping conforms to the standard C# coding conventions.

## 12.2.2 Scopes

The TCI interfaces are mapped to the namespace `Etsi.Ttcn3.Tci`. All IDL type declarations are mapped to C# interface declarations within this namespace. The associated assembly file is `Etsi.Ttcn3.Tci.dll`.

## 12.3 Null value mapping

The distinct value `null` specified in the IDL definition is equal to `null` in C#.

## 12.4 Type mapping

### 12.4.1 Basic type mapping

#### 12.4.1.0 Mapped types

Table 9 gives an overview on how the used basic IDL types are mapped to the .Net types.

**Table 9: Basic type mapping**

| IDL Type       | C# Type/Interface |
|----------------|-------------------|
| Boolean        | bool              |
| TChar          | char              |
| TFloat         | double            |
| TInteger       | int / TciVerdict  |
| TString        | string            |
| TStringSeq     | string[]          |
| TUniversalChar | uint              |

#### **TBoolean**

The IDL `TBoolean` type is mapped to the C# type `bool`.

#### **TFloat**

The IDL `TFloat` type is mapped to the C# type `double`.

#### **TChar**

The IDL `TChar` type is mapped to the C# type `char`.

#### **TInteger**

The IDL `TInteger` type is usually mapped to the C# type `int`. Only in case of operations defined for the IDL type `TciVerdictValue`, the IDL `TInteger` type is mapped to `Etsi.Ttcn3.Tci.TciVerdict` enumeration.

#### **TString**

The IDL `TString` type is mapped to the C# class `string` without range checking or bounds for characters in the string. All possible strings defined in TTCN-3 can be converted to C# `string` class.

#### **TStringSeq**

The IDL `TStringSeq` type is mapped to a string array.

#### **TUniversalChar**

The IDL `TUniversalChar` type is mapped to the C# type `uint`. The integer uses the canonical form as defined in ISO/IEC 10646 [5], clause 6.2.

### 12.4.1.1 TciVerdict

In case of verdict operations, the IDL TInteger type is mapped to the **TciVerdict** enumeration. This enumeration is defined as follows:

```
public enum TciVerdict {
    None = 0,
    Pass = 1,
    Inconc = 2,
    Fail = 3,
    Error = 4
    User_Error = 5
}
```

## 12.4.2 Structured type mapping

### 12.4.2.0 Mapping rules

The TCI IDL description defines user-defined types as native types. In the C# mapping, these types are mapped to C# interfaces. The interfaces define methods and properties being available for classes implementing this interface.

### 12.4.2.1 TciParameterPassingModeType

**TciParameterPassingModeType** is mapped to the following enumeration:

```
public enum TciParameterPassingMode {
    TciIn = 0,
    TciInOut = 1,
    TciOut = 2
}
```

### 12.4.2.2 TciParameterType

**TciParameterType** is mapped to the following interface:

```
public interface ITciParameter {
    string ParameterName { get; set; }
    TciParameterPassingMode ParameterPassingMode { get; set; }
    ITciValue Parameter { get; set; }
}
```

#### Members:

- **ParameterName**  
Gets or sets the parameter name.
- **ParameterPassingMode**  
Gets or sets the parameter passing mode of this parameter.
- **Parameter**  
Used for getting or setting value of the parameter. The parameter can be an instance of **ITciValue** or the distinct value **null**.

### 12.4.2.3 TciParameterListType

**TciParameterListType** is mapped to the following interface:

```
public interface ITciParameterList: System.Collections.IEnumerable {
    int Size { get; }
    bool IsEmpty { get; }
    ITciParameter this[int index] { get; }
    void Clear();
    void Add(ITciParameter comp);
}
```

**Members:**

- `Size`  
Returns the number of parameters in this list.
- `IsEmpty`  
Returns `true` if this list contains no parameters.
- `GetEnumerator`  
Inherited from `IEnumerable`. Returns an enumerator for this object and allows to use the list in a `foreach` loop.
- `operator`  
Returns a `ITciParameter` instance at the specified position. `IndexOutOfRangeException` is thrown if the index is less than zero or greater or equal to the list size.
- `Clear`  
Removes all parameters from the list.
- `Add`  
Adds a parameter to the end of the list.

**12.4.2.4 TciTypeClassType**

**TciTypeClassType** is mapped to the following enumeration:

```
public enum TciTypeClass {
    Address = 0,
    Anytype = 1,
    Bitstring = 2,
    BooleanType = 3,
    Charstring = 5,
    Component = 6,
    Enumerated = 7,
    Float = 8,
    Hexstring = 9,
    IntegerType = 10,
    Octetstring = 12,
    Record = 13,
    RecordOf = 14,
    Array = 15
    Set = 16,
    SetOf = 17,
    Union = 18,
    UniversalCharstring = 20,
    Verdict = 21
}
```

**12.4.2.5 TciTestComponentKindType**

**TciTestComponentKindType** is mapped to the following enumeration:

```
public enum TciTestComponentKind {
    TciCtrlComp = 0,
    TciMtcComp = 1,
    TciPtcComp = 2,
    TciSystemComp = 3,
    TciAliveComp = 4
}
```

**12.4.2.6 TciBehaviourIdType**

**TciBehaviourIdType** C# mapping is derived from the `IQualifiedName` interface:

```
public interface ITciBehaviourId : IQualifiedName {}
```



### 12.4.2.7 TciTestCaseIdType

**TciTestCaseIdType** C# mapping is derived from the `IQualifiedName` interface:

```
public interface ITciTestCaseId : IQualifiedName { }
```

### 12.4.2.8 TciTestCaseIdListType

**TciTestCaseIdListType** is mapped to the following interface:

```
public interface ITciTestCaseIdList: System.Collections.IEnumerable {
    int Size { get; }
    bool IsEmpty { get; }
    ITciTestCaseId this[int index] { get; }
}
```

#### Members:

- `Size`  
Returns the number of test case identifiers in this list.
- `IsEmpty`  
Returns `true` if this list contains no parameters.
- `GetEnumerator`  
Inherited from `IEnumerable`. Returns an enumerator for this object and allows to use the list in a `foreach` loop.
- `operator`  
Returns a `ITciTestCaseId` instance at the specified position. `IndexOutOfRangeException` is thrown if the index is less than zero or greater or equal to the list size.

### 12.4.2.9 TciModuleIdType

**TciModuleIdType** C# mapping is derived from the `IQualifiedName` interface:

```
public interface ITciModuleId : IQualifiedName {
}
```

### 12.4.2.10 TciModuleIdListType

**TciModuleIdListType** is mapped to the following interface:

```
public interface ITciModuleIdList: System.Collections.IEnumerable {
    int Size { get; }
    bool IsEmpty { get; }
    ITciModuleId this[int index] { get; }
}
```

#### Members:

- `Size`  
Returns the number of module identifiers in this list.
- `IsEmpty`  
Returns `true` if this list contains no parameters.
- `GetEnumerator`  
Inherited from `IEnumerable`. Returns an enumerator for this object and allows to use the list in a `foreach` loop.
- `operator`  
Returns a `ITciModuleId` instance at the specified position. `IndexOutOfRangeException` is thrown if the index is less than zero or greater or equal to the list size.

### 12.4.2.11 TciModuleParameterIdType

**TciModuleIdType** C# mapping is derived from the `IQualifiedName` interface:

```
public interface ITciModuleParameterId : IQualifiedName {
}
```

### 12.4.2.12 TciModuleParameterType

**TciModuleParameterType** is mapped to the following interface:

```
public interface ITciModuleParameter {
    ITciModuleParameterId ModuleParameterName { get; }
    ITciValue DefaultValue { get; }
}
```

#### Members:

- `ModuleParameterName`  
Returns the qualified module parameter name as defined in the TTCN-3 specification.
- `DefaultValue`  
Returns the default value of this `TciModuleParameter` or the distinct value `null` if the default value is not specified.

### 12.4.2.13 TciModuleParameterListType

**TciModuleParameterListType** is mapped to the following interface:

```
public interface ITciModuleParameterList : System.Collections.IEnumerable {
    int Size { get; }
    bool IsEmpty { get; }
    ITciModuleParameter this[int index] { get; }
}
```

#### Members:

- `Size`  
Returns the number of module identifiers in this list.
- `IsEmpty`  
Returns `true` if this list contains no parameters.
- `GetEnumerator()`  
Inherited from `IEnumerable`. Returns an enumerator for this object and allows to use the list in a `foreach` loop.
- Indexing operator  
Returns a `ITciModuleId` instance at the specified position. `IndexOutOfRangeException` is thrown if the index is less than zero or greater or equal to the list size.

### 12.4.2.14 TciParameterTypeType

**TciParameterTypeType** is mapped to the following interface:

```
public interface ITciParameterType {
    string ParameterName { get; }
    ITciType ParameterType { get; }
    TciParameterPassingMode ParameterPassingMode { get; }
}
```

#### Members:

- `ParameterName`  
Returns the name of the parameter.

- `ParameterType`  
Returns the type of the parameter.
- `ParameterPassingMode`  
Returns the passing mode of this parameter.

#### 12.4.2.15 `TciParameterTypeListType`

**`TciParameterListType`** is mapped to the following interface:

```
public interface ITciParameterTypeList: System.Collections.IEnumerable {
    int Size { get; }
    bool IsEmpty { get; }
    ITciParameterType this[int index] { get; }
}
```

##### Members:

- `Size`  
Returns the number of parameters in this list.
- `IsEmpty`  
Returns `true` if this list contains no parameters.
- `GetEnumerator`  
Inherited from `IEnumerable`. Returns an enumerator for this object and allows to use the list in a `foreach` loop.
- Indexing operator  
Returns a `ITciParameter` instance at the specified position. `IndexOutOfRangeException` is thrown if the index is less than zero or greater or equal to the list size.
- `Clear`  
Removes all parameters from the list.
- `Add`  
Adds a parameter to the end of the list.

#### 12.4.2.16 `TciMatchingTypeType`

**`TciMatchingTypeType`** is mapped to the following enumeration:

```
public enum TciMatchingType
{
    TemplateList = 0,
    ComplementedList = 1,
    AnyValue = 2,
    AnyValueOrNone = 3,
    ValueRange = 4,
    Subset = 5,
    Superset = 6,
    AnyElement = 7,
    AnyElementsOrNone = 8,
    Pattern = 9,
    MatchDecodedContent = 10,
    OmitTemplate = 11
}
```

#### 12.4.2.17 `LengthRestriction`

**`LengthRestriction`** is mapped to the following interface:

```
public interface ITciLengthRestriction
{
    long LowerBoundary { get; set; }
    long UpperBoundary { get; set; }
    bool IsUpperBoundaryInfinity { get; set; }
}
```

**Methods:**

- `LowerBoundary` Gets or sets the lower boundary of the length restriction.
- `UpperBoundary` Gets or sets the upper boundary of the length restriction.
- `IsUpperBoundaryInfinity` Gets or sets the upper boundary infinity setting.

### 12.4.2.18 Permutation

**Permutation** is mapped to the following interface:

```
public interface ITciPermutation
{
    long StartPosition { get; set; }
    long Length { get; set; }
}
```

**Methods:**

- `StartPosition` Gets or sets the position of the first item of the permutation in the `RecordOfValue`.
- `Length` Gets or sets the number of elements or matching mechanisms of the `RecordOfValue` that are included in the permutation.

### 12.4.2.19 RangeBoundary

**RangeBoundary** is mapped to the following interface:

```
public interface ITciRangeBoundary
{
    ITciValue Boundary { get; set; }
    bool IsInclusive { get; set; }
    bool IsInfinity { get; set; }
}
```

**Methods:**

- `Boundary` Gets or sets the boundary value.
- `IsInclusive` Gets or sets whether the boundary value is a part of the allowed range or not.
- `IsInfinity` Gets or sets whether the boundary is infinity.

## 12.4.3 Abstract type mapping

### 12.4.3.0 Mapping rules

The TTCN-3 data types are modelled in C# using the abstract type mapping as defined in this clause. The `ITciType` interface defines only operations used to retrieve in TTCN-3 defined types. No TTCN-3 types can be constructed using the `ITciType` interface. Types are modelled using the single interface `ITciType`, that provides methods to identify types and to retrieve values of a given type.

### 12.4.3.1 Type

The IDL type **Type** is mapped to the following interface:

```
public interface ITciType {
    ITciModuleId DefiningModule { get; }
    string Name { get; }
    TciTypeClass TypeClass { get; }
    ITciValue NewInstance();
    ITciMatchingMechanism NewTemplate(TciMatchingType matchingType);
}
```

```

string TypeEncoding { get; }
string TypeEncodingVariant { get; }
string[] EncodeAttributes { get; }
string[] GetVariantAttributes(string encoding);
string[] TypeExtension { get; }
ITciValue ParseValue (string val);
ITciRangeBoundary LowerTypeBoundary { get; }
ITciRangeBoundary UpperTypeBoundary { get; }
ITciLengthRestriction TypeLengthRestriction { get; }
ITciMatchingMechanism TypeMatchingMechanism { get; }
}

```

### Members:

- **DefiningModule**  
Returns the module identifier of the module the type has been defined in. If the type represents a TTCN-3 base type the distinct value `null` will be returned.
- **Name**  
Returns name of the type as defined in the TTCN-3 module.
- **TypeClass**  
Returns the type class of the respective type.
- **NewInstance**  
Returns a freshly created value of the given type. This initial value of the created value is undefined.
- **NewTemplate**  
Returns a freshly created matching mechanism of this type. The `matchingType` parameter determines what kind of matching mechanism will be created. If the created matching mechanism contains additional data properties, these properties are uninitialized in the created matching mechanism.
- **TypeEncoding**  
Returns the type encoding attribute as defined in the TTCN-3 module, if any. If no encoding attribute has been defined, the distinct value `null` will be returned.
- **TypeEncodingVariant**  
This property returns the type encoding variant attribute as defined in TTCN-3, if any. If no encoding variant attribute has been defined, the distinct value `null` will be returned.
- **EncodeAttributes**  
Returns all encode attributes of the type as defined in the TTCN-3 module. If no encode attribute has been defined, the distinct value `null` is returned.
- **GetVariantAttributes**  
Returns all variant attributes of the type as defined in the TTCN-3 module. If no encoding attribute has been defined, the distinct value `null` is returned.
- **TypeExtension**  
Returns the type extension attributes as defined in the TTCN-3 module. If no extension attributes have been defined, the distinct value `null` will be returned.
- **ParseValue**  
Parses the value provided in the parameter and in case of successful parsing returns a `Value` object representing the parsed value. In case of an error or if value parsing is not supported by the tool, the method returns `null`.
- **LowerTypeBoundary**  
Gets the lower range boundary of the type or `null`.
- **UpperTypeBoundary**  
Gets the upper range boundary of the type or `null`.
- **TypeLengthRestriction**  
Gets the length restriction of the type or `null`.

- `TypeMatchingMechanism`  
Gets the matching mechanism restricting the type or null.

## 12.4.4 Abstract value mapping

### 12.4.4.0 Mapping rules

TTCN-3 values can be retrieved from the TE and constructed using the `ITCiValue` interface. The value mapping interface is constructed hierarchically with `ITCiValue` as the basic interface. Specialized interfaces for different types of values have been defined.

#### 12.4.4.1 Value

The IDL type **Value** is mapped to the following interface:

```
public interface ITCiValue {
    ITCiType Type { get; }
    bool NotPresent { get; }
    string ValueEncoding { get; }
    string ValueEncodingVariant { get; }
    string[] EncodeAttributes { get; }
    string[] GetVariantAttributes(string encoding);
    bool IsMatchingSymbol { get; }
    string ValueToString();
    bool IsLazy { get; }
    bool IsFuzzy { get; }
    bool IsEvaluated { get; }
    ITCiLengthRestriction LengthRestriction { get; set; }
    ITCiLengthRestriction NewLengthRestriction ();
    bool IsIfPresentEnabled { get; set; }
    ITCiRangeBoundary LowerTypeBoundary { get; }
    ITCiRangeBoundary UpperTypeBoundary { get; }
    ITCiLengthRestriction TypeLengthRestriction { get; }
    ITCiMatchingMechanism TypeMatchingMechanism { get; }
    bool IsOptional { get; }
}
```

#### Members:

- `Type`  
Returns the type of the specified value.
- `NotPresent`  
Returns `true` if the specified value is omit, `false` otherwise.
- `ValueEncoding`  
This property returns the value encoding attribute as defined in TTCN-3, if any. If no encoding attribute has been defined the distinct value `null` will be returned.
- `ValueEncodingVariant`  
This property returns the value encoding variant attribute as defined in TTCN-3, if any. If no encoding variant attribute has been defined the distinct value `null` will be returned.
- `EncodeAttributes`  
Returns all encode attributes of the value as defined in the TTCN-3 module. If no encode attribute has been defined, the distinct value `null` is returned.
- `GetVariantAttributes`  
Returns all variant attributes of the value as defined in the TTCN-3 module. If no encoding attribute has been defined, the distinct value `null` is returned.
- `IsMatchingSymbol`  
Returns `true` if the specified value is a matching symbol (see clause 7.2.2.2.1 for more details), `false` otherwise.

- `ValueToString`  
Returns the same string as produced by the `any2unistr` predefined function with the specified value as its parameter.
- `IsLazy`  
Returns `true` if the specified value is `@lazy`, `false` otherwise.
- `IsFuzzy`  
Returns `true` if the specified value is `@fuzzy`, `false` otherwise.
- `IsEvaluated`  
Returns `true` if the specified value contains an evaluation result, `false` otherwise (see clause 7.2.2.2.1 for more details).
- `LengthRestriction`  
Gets or sets a length restriction matching attribute attached to the value.
- `NewLengthRestriction`  
Creates a new instance of the `LengthRestriction` interface.
- `IfPresentEnabled`  
Gets or sets whether the `ifpresent` matching attribute is attached to the value or not.
- `LowerTypeBoundary`  
Gets the value's type's lower range boundary or null.
- `UpperTypeBoundary`  
Gets the value's type's upper range boundary or null.
- `TypeLengthRestriction`  
Gets the value's type's length restriction or null.
- `TypeMatchingMechanism`  
Gets the values's type restriction matching mechanism.
- `IsOptional`  
Returns whether the value is either an optional field or a template without the `present` or `value` restriction.

#### 12.4.4.2 IntegerValue

**IntegerValue** is mapped to the following interface:

```
public interface ITciIntegerValue : ITciValue {
    long IntegerValue { get; set; }
    string StringValue { get; set; }
}
```

##### Members:

- `IntegerValue`  
Gets or sets the numeric value of the object. In case the numeric value exceeds the allowed value range of the long type, `long.MaxValue` or `long.MinValue` is returned.
- `StringValue`  
Get or sets the value of the object. The string assigned to the property shall have the same format as TTCN-3 integer literals. The integer literal can be optionally preceded by a sign character ('+' or '-').

### 12.4.4.3 FloatValue

**FloatValue** is mapped to the following interface:

```
public interface ITciFloatValue : ITciValue {
    double FloatValue { get; set; }
    string StringValue { get; set; }
}
```

**Members:**

- **FloatValue**  
Gets or sets the numeric value of the object. In case the numeric value exceeds the allowed value range of the double type, `double.MaxValue` or `double.MinValue` is returned.
- **StringValue**  
Get or sets the value of the object. The string assigned to the property shall have the same format as TTCN-3 float literals. The float literal can be optionally preceded by a sign character ('+' or '-').

### 12.4.4.4 BooleanValue

**BooleanValue** is mapped to the following interface:

```
public interface ITciBooleanValue : ITciValue {
    bool BooleanValue { get; set; }
}
```

**Members:**

- **BooleanValue**  
Gets or sets the boolean value of the object.

### 12.4.4.5 CharstringValue

**CharstringValue** is mapped to the following interface:

```
public interface ITciCharstringValue : ITciValue {
    string StringValue { get; set; }
    char this[int position] { get; set; }
    int Length { get; set; }
}
```

**Members:**

- **StringValue**  
Gets or sets the string value of the TTCN-3 charstring. Strings assigned to this property shall contain only characters allowed in TTCN-3 charstring type.
- **Indexing operator**  
Get or sets the character value of the TTCN-3 charstring at the specified position. `IndexOutOfRangeException` is thrown if the position is less than zero or greater or equal to the string length.
- **Length**  
Gets or sets the length of this `ITciCharstringValue` in characters. The property returns zero if the value of this object is `omit`. In case the new length is greater than the length of the current string, characters with ordinal value 0 are added to the end of the string. If the new length is less than the length of the current string, the current string is truncated.



### 12.4.4.6 BitstringValue

**BitstringValue** is mapped to the following interface:

```
public interface ITciBitstringValue : ITciValue {
    string StringValue { get; set; }
    byte this[int position] { get; set; }
    int Length { get; set; }
    System.IO.Stream GetInputStream ();
    void SetInputStream(System.IO.Stream stream, int numberOfBits);
    bool IsMatchingAt (int position);
    ITciMatchingMechanism GetMatchingAt (int position);
    void SetMatchingAt (int position, ITciMatchingMechanism template);
}
```

#### Members:

- **StringValue**  
Gets or sets the string value of the TTCN-3 bitstring. The only allowed characters in the string passed to this property are '0' and '1'. The string returned by the property contains a sequence of '0' and '1' digits. In some cases, the message data are available in the form of a stream and cannot be converted into a string by TCI (e.g. because of memory restrictions). In such cases, this property returns `null` and the `GetInputStream` method shall be used for reading the data.
- **Indexing operator**  
Get or sets the value of the bit at the specified position. All non-zero values shall be interpreted as if the bit was present. `IndexOutOfRangeException` is thrown if the position is less than zero or greater or equal to the string length.
- **Length**  
Gets or sets the length of this `ITciBitstringValue` in bits. The property returns zero if the value of this object is `omit`. In case the new length is greater than the length of the current bitstring, the bitstring is padded with empty bits. If the new length is less than the length of the current bitstring, the current bitstring is truncated.
- **GetInputStream**  
Returns the bits in the form of an input stream. Repeated calls to the same method return different stream instances. The method returns `null` if the bitstring contains matching symbols.
- **SetInputStream**  
Sets the value of this `BitstringValue` by providing a source stream that is used by the `BitstringValue` object to read the value content. Values set this way do not contain matching symbols.
- **IsMatchingAt**  
Returns `true` if the item at `position` of this TTCN-3 bitstring is a matching mechanism inside a value (`AnyElement`, `AnyElementsOrNone`) and `false` otherwise.
- **GetMatchingAt**  
If the `position` of this TTCN-3 bitstring contains a matching mechanism inside a value (`AnyElement`, `AnyElementsOrNone`), the method returns it. Otherwise the distinct value `null` is returned.
- **SetMatchingAt**  
Sets a matching mechanism at `position`. Only two matching mechanisms are allowed: `AnyElement` and `AnyElementsOrNone`.

### 12.4.4.7 OctetstringValue

**OctetstringValue** is mapped to the following interface:

```
public interface ITciOctetstringValue : ITciValue {
    string StringValue { get; set; }
    byte this[int position] { get; set; }
    int Length { get; set; }
    System.IO.Stream GetInputStream ();
    void SetInputStream(System.IO.Stream stream);
    bool IsMatchingAt (int position);
    ITciMatchingMechanism GetMatchingAt (int position);
    void SetMatchingAt (int position, ITciMatchingMechanism template);
}
```

#### Members:

- **StringValue**  
Gets or sets the string value of the TTCN-3 octetstring. The only allowed characters in the string passed to this property are hexadecimal digits. The length of the string passed to this property shall be even. The string returned by this property is a sequence of pairs of hexadecimal digits. In some cases, the message data are available in the form of a byte stream and cannot be converted into a string by TCI (e.g. because of memory restrictions). In such cases, this property returns null and the `GetInputStream` method shall be used for reading the data.
- **Indexing operator**  
Get or sets the value of the octet at the specified position. `IndexOutOfRangeException` is thrown if the position is less than zero or greater or equal to the string length.
- **Length**  
Gets or sets the length of this `ITciOctetstringValue` in octets. The property returns zero if the value of this object is `omit`. In case the new length is greater than the length of the current octetstring, the octetstring is padded with empty octets. If the new length is less than the length of the current octetstring, the current octetstring is truncated.
- **GetInputStream**  
Returns the octets in the form of an input stream. Repeated calls to the same method return different stream instances. The method returns null if the octetstring contains matching symbols.
- **SetInputStream**  
Sets the value of this `OctetstringValue` by providing a source stream that is used by the `OctetstringValue` object to read the value content. Values set this way do not contain matching symbols.
- **IsMatchingAt**  
Returns true if the item at `position` of this TTCN-3 octetstring is a matching mechanism inside a value (`AnyElement`, `AnyElementsOrNone`) and false otherwise.
- **GetMatchingAt**  
If the `position` of this TTCN-3 octetstring contains a matching mechanism inside a value (`AnyElement`, `AnyElementsOrNone`), the method returns it. Otherwise the distinct value `null` is returned.
- **SetMatchingAt**  
Sets a matching mechanism at `position`. Only two matching mechanisms are allowed: `AnyElement` and `AnyElementsOrNone`.

### 12.4.4.8 UniversalCharstringValue

**UniversalCharstringValue** is mapped to the following interface:

```
public interface ITciUniversalCharstringValue : ITciValue {
    string StringValue { get; set; }
    uint this[int position] { get; set; }
    int Length { get; set; }
}
```

**Members:**

- **StringValue**  
Gets or sets the string value of the TTCN-3 universal charstring. If the TTCN-3 universal charstring value contains characters that have higher ordinal value than `char.MaxValue`, these characters will be represented by a character `0xFFFFD` (the Unicode replacement character) in the string returned by this property.
- **Indexing operator**  
Get or sets the character value of the TTCN-3 universal charstring at the specified position. The unsigned number used by this property is character ordinal value. `IndexOutOfRangeException` is thrown if the position is less than zero or greater or equal to the string length.
- **Length**  
Gets or sets the length of this `ITciUniversalCharstringValue` in characters. The property returns zero if the value of this object is `omit`. In case the new length is greater than the length of the current string, characters with ordinal value 0 are added to the end of the string. If the new length is less than the length of the current string, the current string is truncated.

**12.4.4.9 HexstringValue**

**HexstringValue** is mapped to the following interface:

```
public interface ITciHexstringValue : ITciValue {
    string StringValue { get; set; }
    byte this[int position] { get; set; }
    int Length { get; set; }
    System.IO.Stream GetInputStream ();
    void SetInputStream(System.IO.Stream stream, int numberOfItems);
    bool IsMatchingAt (int position);
    ITciMatchingMechanism GetMatchingAt (int position);
    void SetMatchingAt (int position, ITciMatchingMechanism template);
}
```

**Members:**

- **StringValue**  
Gets or sets the string value of the TTCN-3 hexstring. The only allowed characters in the string passed to this property are hexadecimal digits. The string returned by this property is a sequence of hexadecimal digits. In some cases, the message data are available in the form of a stream and cannot be converted into a string by TCI (e.g. because of memory restrictions). In such cases, this property returns `null` and the `GetInputStream` method shall be used for reading the data.
- **Indexing operator**  
Get or sets the hex digit at the specified position. Only the lower four bits of the passed value are used in this assignment. The upper four bits are ignored. `IndexOutOfRangeException` is thrown if the position is less than zero or greater or equal to the string length.
- **Length**  
Gets or sets the length of this `ITciHexstringValue` in hex digits. The property returns zero if the value of this object is `omit`. In case the new length is greater than the length of the current hexstring, the hexstring is padded with zeroes. If the new length is less than the length of the current hexstring, the current hexstring is truncated.
- **GetInputStream**  
Returns the content in the form of an input stream. Repeated calls to the same method return different stream instances. The method returns `null` if the hexstring contains matching symbols.
- **SetInputStream**  
Sets the value of this `HexstringValue` by providing a source stream that is used by the `HexstringValue` object to read the value content. Values set this way do not contain matching symbols.
- **IsMatchingAt**  
Returns `true` if the item at `position` of this TTCN-3 hexstring is a matching mechanism inside a value (`AnyElement`, `AnyElementsOrNone`) and `false` otherwise.

- `GetMatchingAt`  
If the `position` of this TTCN-3 hexstring contains a matching mechanism inside a value (`AnyElement`, `AnyElementsOrNone`), the method returns it. Otherwise the distinct value `null` is returned.
- `SetMatchingAt`  
Sets a matching mechanism at `position`. Only two matching mechanisms are allowed: `AnyElement` and `AnyElementsOrNone`.

#### 12.4.4.10 RecordValue

**RecordValue** is mapped to the following interface:

```
public interface ITciRecordValue : ITciValue {
    ITciValue GetField(string fieldName);
    void SetField(string fieldName, ITciValue value);
    string[] GetFieldNames();
    void SetFieldOmitted(string fieldName);
}
```

##### Members:

- `GetField`  
Returns the value of the field named `fieldName`. The return value is the common abstract base type `ITciValue`, as a record field can have any type defined in TTCN-3. If the field cannot be obtained from the record the distinct value `null` will be returned.
- `SetField`  
Sets the field named `fieldName` of the record to `value`. No assumption shall be made on how a field is stored in a record. An internal implementation might choose to store a reference to this value or to copy the value. It is safe to assume that the value will be copied. Therefore it should be assumed that subsequent modifications of value will not be considered in the record.
- `GetFieldNames`  
Returns an array of `String` of field names, the empty sequence, if the record has no fields.
- `SetFieldOmitted`  
Sets the field named `fieldName` of the record to omit.

#### 12.4.4.11 RecordOfValue

**RecordOfValue** is mapped to the following interface:

```
public interface ITciRecordOfValue : ITciValue, System.Collections.IEnumerable {
    ITciValue this[int position] { get; set; }
    void AppendField(ITciValue value);
    ITciType ElementType { get; }
    int Length { get; set; }
    int Offset { get; }
    int PermutationCount { get; }
    ITciPermutation GetPermutation (int index);
    ITciPermutation NewPermutation ();
    void DefinePermutation (ITciPermutation permutation);
    void RemovePermutation (int index);
    void ClearPermutations ();
}
```

**Members:**

- `Indexing operator`  
Returns or sets the value of the record of at the specified position. The class of this property is the common abstract base interface `ITciValue`, as a `record of` can have fields of any type defined in TTCN-3. When getting the value an `ITciValue` instance is returned only if `position` is between zero and  $(\text{length} - 1)$ . The distinct value `null` is returned otherwise. When setting the value, if `position` is greater than the current length, the record of will be extended to have the length  $(\text{position} + 1)$ . The record of elements between the original position at `length` and  $(\text{position} - 1)$  will be set to `omit`. No assumption shall be made on how a field is stored in a `record of`. An internal implementation might choose to store a reference to this value or to copy the value. It is safe to assume that the value will be copied. Therefore it should be assumed that subsequent modifications of value will not be considered in the `record of`.
- `GetEnumerator`  
Inherited from `IEnumerable`. Returns an enumerator for this object and allows to use the object in a `foreach` loop.
- `appendField`  
Appends the value at the end of the `record of`, i.e. at position `length`. No assumption shall be made on how a field is stored in a `record of`. An internal implementation might choose to store a reference to this value or to copy the value. It is safe to assume that the value will be copied. Therefore it should be assumed that subsequent modifications of value will not be considered in the `record of`.
- `ElementType`  
Returns the type of the elements of this `record of`.
- `Length`  
Gets or sets the actual length of the `record of` value. When getting the length, zero is returned if the `record of` value is `omit`. When setting the length, if the new length is greater than the original length, newly created elements have the value `omit`. If the new length is less or equal than the original length, this operation will be ignored.
- `Offset`  
Returns the lowest possible index. For a record of or set of value this is always 0. For an array value, this is the lower index bound used in the type definition.
- `PermutationCount`  
Returns the number of permutations in the `record of` or array value.
- `GetPermutation`  
Returns the permutation at the specified index. The allowed index range is from 0 to  $(\text{getPermutationCount}() - 1)$ .
- `NewPermutation`  
Creates a new instance of the `Permutation` interface.
- `DefinePermutation`  
Creates permutation from existing elements of a `record of` value. The permutation parameter shall not include elements that are already a part of other existing permutations attached to the same `record of`. No elements are added to the `record of` by this operation.
- `RemovePermutation`  
Removes the permutation at the specified index. The allowed index range is from 0 to  $(\text{getPermutationCount}() - 1)$ . No elements are removed from the `record of` by this operation. When the operation completes, the existing elements at positions specified by the removed permutation do not belong to any permutation.
- `ClearPermutations`  
Removes all permutations from the value. The elements that belonged to the removed permutation are not removed.

### 12.4.4.12 UnionValue

**UnionValue** is mapped to the following interface:

```
public interface ITciUnionValue : ITciValue {
    ITciValue GetVariant(string variantName);
    void SetVariant(string variantName, ITciValue value);
    string PresentVariantName { get; }
    string[] GetVariantNames();
}
```

#### Members:

- **GetVariant**  
Returns the value of the TTCN-3 union variant, if `variantName` equals the result of `GetPresentVariantName`. The distinct value `null` is returned otherwise. `variantName` denotes the name of the union variant as defined in TTCN-3.
- **SetVariant**  
Sets `variantName` of the union to `value`. If `variantName` is not defined for this union this operation will be ignored. If another variant was selected the new variant will be selected instead.
- **GetPresentVariantName**  
Returns the variant name that has a value in this union set as a `string`. The distinct value `null` will be returned if no variant is selected.
- **GetVariantNames**  
Returns an array of `string` of variant names, the empty sequence, if the union has no fields. If the `UnionValue` represents the TTCN-3 `anytype`, i.e. the value of the `Type` property is `TciTypeClass.Anytype`, all predefined and user-defined TTCN-3 types will be returned.

### 12.4.4.13 EnumeratedValue

**EnumeratedValue** is mapped to the following interface:

```
public interface ITciEnumeratedValue : ITciValue {
    string EnumValue { get; set; }
    int IntValue { get; set; }
}
```

#### Members:

- **EnumValue**  
Returns or sets the enumerated value. The value of the property is equal to the identifier in the TTCN-3 specification. If the value assigned to the property is not an allowed value for this enumeration, the assignment will be ignored.
- **IntValue**  
Returns or sets the integer value. This integer should equal the user-assigned integer value in the TTCN-3 specification or the automatically assigned integer value. If the integer assigned to the property is not allowed for this enumeration, the assignment will be ignored.

### 12.4.4.14 VerdictValue

**VerdictValue** is mapped to the following interface:

```
public interface ITciVerdictValue : ITciValue {
    TciVerdict Verdict { get; set; }
}
```

**Members:**

- `Verdict`  
Returns the value of this `VerdictValue`. Note that a `VerdictValue` can be set to any of the verdicts defined in the `TciVerdict` enumeration at any time. The `VerdictValue` does not perform any verdict calculations as defined in TTCN-3. For example, it is legal to set the `VerdictValue` first to `TciVerdict.ErrorVerdict` and then to `TciVerdict.Pass`.

### 12.4.4.15 AddressValue

**AddressValue** is mapped to the following interface:

```
public interface ITciAddressValue : ITciValue {
    ITciValue Address { get; set; }
}
```

**Members:**

- `Address`  
Gets or sets the value represented by this `AddressValue`.

## 12.4.5 Abstract template mapping

### 12.4.5.0 Mapping rules

TTCN-3 matching mechanisms can be retrieved from the TE and constructed using the `ITciMatchingMechanism` interface. The template mapping interface is constructed hierarchically with `ITciMatchingMechanism` as the basic interface. Specialized interfaces for different types of matching mechanisms have been defined.

#### 12.4.5.1 MatchingMechanism

The IDL type **MatchingMechanism** is mapped to the following interface:

```
public interface ITciMatchingMechanism : ITciValue
{
    TciMatchingType MatchingType { get; }
}
```

**Members:**

- `MatchingType`  
Returns the matching mechanism type.

#### 12.4.5.2 MatchingList

The IDL type **MatchingList** is mapped to the following interface:

```
public interface ITciMatchingList : ITciMatchingMechanism
{
    int Size { get; }
    ITciValue this[int position] { get; }
    void Add (ITciValue item);
    void Remove (int position);
    void Clear ();
}
```

**Methods:**

- `Size`  
Returns the number of items in the matching mechanism.
- `Indexing operator`  
Returns a value or template at the specified position.

- **Add**  
Adds a value or template to the matching mechanism.
- **Remove**  
Removes a value or template from the specified position.
- **Clear**  
Removes all values and templates from the matching mechanism.

### 12.4.5.3 ValueRange

The IDL type **ValueRange** is mapped to the following interface:

```
public interface ITciValueRange : ITciMatchingMechanism
{
    ITciRangeBoundary LowerBoundary { get; set; }
    ITciRangeBoundary UpperBoundary { get; set; }
}
```

#### Methods:

- **LowerBoundary**  
Gets or sets the lower boundary of the range.
- **UpperBoundary**  
Gets or sets the upper boundary of the range.

### 12.4.5.4 CharacterPattern

The IDL type **CharacterPattern** is mapped to the following interface:

```
public interface ITciCharacterPattern : ITciMatchingMechanism
{
    ITciValue PatternString { get; set; }
}
```

#### Methods:

- **PatternString** Gets or sets the character pattern definition of this pattern (either a `ITciCharstringValue` or `ITciUniversalCharstringValue`).

### 12.4.5.5 MatchDecodedContent

The IDL type **MatchDecodedContent** is mapped to the following interface:

```
public interface ITciMatchDecodedContent : ITciMatchingMechanism
{
    ITciValue Content { get; set; }
}
```

#### Methods:

- **Content** Gets or sets the value or matching mechanism used as an argument of the `decmatch` matching mechanism.

## 12.4.6 Abstract logging types mapping

### 12.4.6.0 Mapping rules

Additional types are defined to ease the logging of object states and matches between values and templates.



### 12.4.6.1 TciValueTemplate

**TciValueTemplate** is mapped to the following interface:

```
public interface ITciValueTemplate {
    bool IsOmit { get; }
    bool IsAny { get; }
    bool IsAnyOrOmit { get; }
    string TemplateDef { get; }
}
```

#### Members:

- `IsOmit`  
Returns `true` if the template is omit, `false` otherwise.
- `IsAny`  
Returns `true` if the template is any, `false` otherwise.
- `IsAnyOrOmit`  
Returns `true` if the template is `AnyValueOrNone`, `false` otherwise.
- `TemplateDef`  
This property returns the template definition.

### 12.4.6.2 TciNonValueTemplate

**TciNonValueTemplate** is mapped to the following interface:

```
public interface ITciNonValueTemplate {
    bool IsAny { get; }
    bool IsAll { get; }
    string TemplateDef { get; }
}
```

#### Members:

- `IsAny`  
Returns `true` if the template is any, `false` otherwise.
- `IsAll`  
Returns `true` if the template is all, `false` otherwise.
- `TemplateDef`  
This operation returns the template definition.

### 12.4.6.3 TciValueList

**TciValueList** is mapped to the following interface:

```
public interface ITciValueList: IEnumerable {
    int Size { get; }
    bool IsEmpty { get; }
    ITciValue this[int index] { get; }
}
```

#### Members:

- `Size`  
Returns the number of values in this list.
- `IsEmpty`  
Returns `true` if this list contains no values.

- `GetEnumerator`  
Inherited from `IEnumerable`. Returns an enumerator for this object and allows to use the list in a foreach loop.
- Indexing operator  
Returns a `ITciValue` instance at the specified position. `IndexOutOfRangeException` is thrown if the index is less than zero or greater or equal to the list size.

#### 12.4.6.4 TciValueDifference

**TciValueDifference** is mapped to the following interface:

```
public interface ITciValueDifference {
    ITciValue Value { get; }
    ITciValueTemplate ValueTemplate { get; }
    string Description { get; }
}
```

**Members:**

- `Value`  
Returns the value of this `ITciValueDifference`.
- `Template`  
Returns the template of this `ITciValueDifference`.
- `Description`  
Returns the description of the mismatch.

#### 12.4.6.5 TciValueDifferenceList

**TciValueDifferenceList** is mapped to the following interface:

```
public interface ITciValueDifferenceList : IEnumerable {
    int Size { get; }
    bool IsEmpty { get; }
    ITciValueDifference this[int index] { get; }
}
```

**Members:**

- `Size`  
Returns the number of differences in this list.
- `IsEmpty`  
Returns `true` if this list contains no parameters.
- `GetEnumerator`  
Inherited from `IEnumerable`. Returns an enumerator for this object and allows to use the list in a foreach loop.
- Indexing operator  
Returns a `ITciValueDifference` instance at the specified position. `IndexOutOfRangeException` is thrown if the index is less than zero or greater or equal to the list size.

#### 12.4.6.6 TciStatusType

**TciStatusType** is mapped to the following enumeration:

```
public enum TciStatus {
    TciOk = 0,
    TciError = -1
}
```

### 12.4.6.7 ComponentStatusType

**ComponentStatusType** is mapped to the following enumeration:

```
public enum TciComponentStatus {
    InactiveC = 0,
    RunningC = 1,
    StoppedC = 2,
    KilledC = 3,
    NullC = 4
}
```

### 12.4.6.8 TimerStatusType

**TimerStatusType** is mapped to the following enumeration:

```
public enum TciTimerStatus {
    RunningT = 0,
    InactiveT = 1,
    ExpiredT = 2,
    NullT = 3
}
```

## 12.5 Mapping of interfaces

### 12.5.0 Calling rules

The TCI IDL definition defines four interfaces, the TCI-TM, the TCI-CH, the TCI-CD, and the TCI-TL interface. The operations are defined for different directions within this interface, i.e. some operations can only be called by the TTCN-3 Executable (TE), the System Adaptor (SA) or the Platform Adaptor (PA) on the Test Management and Control (TMC) while others can only be called by the TMC on the TE. This is reflected by dividing the TCI IDL interfaces in two sub interfaces, each suffixed by Required or Provided.

**Table 10: TCI sub-interfaces**

| Calling                 | Called | Interface      |
|-------------------------|--------|----------------|
| TE                      | TMC    | ITciTMProvided |
| TMC                     | TE     | ITciTMRequired |
| TE                      | CD     | ITciCDProvided |
| CD                      | TE     | ITciCDRequired |
| TE                      | CH     | ITciCHProvided |
| CH                      | TE     | ITciCHRequired |
| TE, TMC, CD, CH, SA, PA | TL     | ITciTLProvided |

For better readability, references to types and interfaces defined in the Etsi.Ttcn3.Tci namespace and Etsi.Ttcn3.Tri namespace (described in [3]) that appear in the following interface definitions use a simple identifier form instead of a fully qualified one. Names of these types and interfaces start with a prefix that can be used for identification of its origin.

### 12.5.1 TCI-TM interface

#### 12.5.1.1 TCI-TM provided

The **TCI-TM provided** interface is mapped to the following interface:

```
public interface ITciTMProvided {
    void TciTestCaseStarted(ITciTestCaseId testCaseId,
        ITciParameterList parameterList, double timer);
    void TciTestCaseTerminated(ITciVerdictValue verdict,
        ITciParameterList parameterList);
    void TciControlTerminated();
    ITciValue TciGetModulePar(ITciModuleParameterId parameterId);
    void TciLog(ITriComponentId testComponentId,
        string message);
}
```

```

void TciError(string message);
void TciControlTerminatedWithResult (ITciValue result,
    ITciParameterList parameterList);
}

```

### 12.5.1.2 TCI-TM required

The **TCI-TM required** interface is mapped to the following interface:

```

public interface ITciTMRequired {
    void TciRootModule(ITciModuleId moduleId);
    ITciModuleIdList TciGetImportedModules();
    ITciModuleParameterList TciGetModuleParameters(ITciModuleId moduleId);
    ITciTestCaseIdList TciGetTestCases();
    ITciParameterTypeList TciGetTestCaseParameters(ITciTestCaseId testCaseId);
    ITriPortIdList TciGetTestCaseTsi(
        ITciTestCaseId testCaseId);
    void TciStartTestCase(ITciTestCaseId testCaseId,
        ITciParameterList parameterList);
    void TciStopTestCase();
    ITriComponentId TciStartControl();
    void TciStopControl();
    ITciParameterTypeList TciGetControlParameters ();
    ITriComponentId TciStartControlWithParameters (ITciParameterList parameterList);
}

```

## 12.5.2 TCI-CD interface

### 12.5.2.1 TCI-CD provided

The **TCI-CD provided** interface is mapped to the following interface:

```

public interface ITciCDProvided {
    ITciValue Decode(ITriMessage message,
        ITciType decodingHypothesis);
    ITriMessage Encode(ITciValue value);
    int DecodeValue(ITriMessage message,
        ITciType decodingHypothesis,
        string decodingInfo,
        out ITciValue decodedValue);
    ITriMessage EncodeValue(ITciValue value,
        string encodingInfo);
}

```

### 12.5.2.2 TCI-CD required

The **TCI-CD required** interface is mapped to the following interface:

```

public interface ITciCDRequired {
    ITciType GetTypeForName(string typeName);
    ITciType GetInteger();
    ITciType GetFloat();
    ITciType GetBoolean();
    ITciType GetCharstring();
    ITciType GetUniversalCharstring();
    ITciType GetHexstring();
    ITciType GetBitstring();
    ITciType GetOctetstring();
    ITciType GetVerdict();
    void TciErrorReq(string message);
}

```

## 12.5.3 TCI-CH interface

### 12.5.3.1 TCI-CH provided

The **TCI-CH provided** interface is mapped to the following interface:

```
public interface ITciCHProvided {
    void TciSendConnected(ITriPortId sender,
        ITriComponentId receiver, ITciValue sendMessage);
    void TciSendConnectedBC(ITriPortId sender,
        ITciValue sendMessage);
    void TciSendConnectedMC(ITriPortId sender,
        ITriComponentIdList receivers,
        ITciValue sendMessage);
    void TciCallConnected(ITriPortId sender,
        ITriComponentId receiver,
        ITriSignatureId signature,
        ITciParameterList parameterList);
    void TciCallConnectedBC(ITriPortId sender,
        ITriSignatureId signature,
        ITciParameterList parameterList);
    void TciCallConnectedMC(ITriPortId sender,
        ITriComponentIdList receivers,
        ITriSignatureId signature,
        ITciParameterList parameterList);
    void TciReplyConnected(ITriPortId sender,
        ITriComponentId receiver,
        ITriSignatureId signature,
        ITciParameterList parameterList, ITciValue returnValue);
    void TciReplyConnectedBC(ITriPortId sender,
        ITriSignatureId signature,
        ITciParameterList parameterList, ITciValue returnValue);
    void TciReplyConnectedMC(ITriPortId sender,
        ITriComponentIdList receivers,
        ITriSignatureId signature,
        ITciParameterList parameterList, ITciValue returnValue);
    void TciRaiseConnected(ITriPortId sender,
        ITriComponentId receiver,
        ITriSignatureId signature, ITciValue except);
    void TciRaiseConnectedBC(ITriPortId sender,
        ITriSignatureId signature, ITciValue except);
    void TciRaiseConnectedMC(ITriPortId sender,
        ITriComponentIdList receivers,
        ITriSignatureId signature, ITciValue except);
    ITriComponentId TciCreateTestComponentReq(int kind,
        ITciType componentType, string name, ITciValue hostId);
    void TciStartTestComponentReq(ITriComponentId comp,
        ITciBehaviourId behavior, ITciParameterList parameterList);
    void TciStopTestComponentReq(ITriComponentId comp);
    void TciConnectReq(ITriPortId fromPort,
        ITriPortId toPort);
    void TciDisconnectReq(ITriPortId fromPort,
        ITriPortId toPort);
    void TciTestComponentTerminatedReq(ITriComponentId comp,
        ITciVerdictValue verdict);
    bool TciTestComponentRunningReq(ITriComponentId comp);
    ITriComponentId TciGetMmcReq();
    void TciMapReq(ITriPortId fromPort,
        ITriPortId toPort);
    void TciMapParamReq(ITriPortId fromPort,
        ITriPortId toPort, Etsi.Ttcn3.Tci.ITciParameterList parameterList);
    void TciUnmapReq(ITriPortId fromPort,
        ITriPortId toPort);
    void TciUnmapParamReq(ITriPortId fromPort,
        ITriPortId toPort, Etsi.Ttcn3.Tci.ITciParameterList parameterList);
    void TciExecuteTestCaseReq(ITriComponentId component,
        ITriPortIdList tsiPortList);
    void TciResetReq();
    bool TciTestComponentDoneReq(ITriComponentId component, out TciVerdict verdict);
    void TciKillTestComponentReq(ITriComponentId component);
    bool TciTestComponentAliveReq(ITriComponentId component);
    bool TciTestComponentKilledReq(ITriComponentId component, out TciVerdict verdict);
    void TciCallTestComponentReq (ITriComponentId comp,
        ITciBehaviourId behavior, ITciParameterList parameterList);
    void TciTestComponentCallTerminatedReq (ITriComponentId comp,
        ITciVerdictValue verdict, ITciParameterList parameterList, ITciValue returnValue);
}
```

```
}

```

### 12.5.3.2 TCI-CH required

The **TCI-CH required** interface is mapped to the following interface:

```
public interface ITciCHRequired {
    void TciEnqueueMsgConnected(ITriPortId sender,
        ITriComponentId receiver,
        ITciValue receivedMessage);
    void TciEnqueueCallConnected(ITriPortId sender,
        ITriComponentId receiver,
        ITriSignatureId signature,
        ITciParameterList parameterList);
    void TciEnqueueReplyConnected(ITriPortId sender,
        ITriComponentId receiver,
        ITriSignatureId signature,
        ITciParameterList parameterList, ITciValue returnValue);
    void TciEnqueueRaiseConnected(ITriPortId sender,
        ITriComponentId receiver,
        ITriSignatureId signature, ITciValue except);
    ITriComponentId TciCreateTestComponent(int kind,
        ITciType componentType, string name);
    void TciStartTestComponent(ITriComponentId comp,
        ITciBehaviourId behavior, ITciParameterList parameterList);
    void TciStopTestComponent(ITriComponentId comp);
    void TciConnect(ITriPortId fromPort,
        ITriPortId toPort);
    void TciDisconnect(ITriPortId fromPort,
        ITriPortId toPort);
    void TciTestComponentTerminated(ITriComponentId comp,
        ITciVerdictValue verdict);
    bool TciTestComponentRunning(ITriComponentId comp);
    bool TciTestComponentDone(ITriComponentId comp, out TciVerdict verdict);
    ITriComponentId TciGetMtc();
    void TciExecuteTestCase (ITciTestCaseId testCaseId,
        ITriPortIdList tsiPortList);
    void TciReset();
    void TciMap(ITriPortId fromPort,
        ITriPortId toPort);
    void TciMapParam(ITriPortId fromPort,
        ITriPortId toPort, Etsi.Ttcn3.Tci.ITciParameterList parameterList);
    void TciUnmap(ITriPortId fromPort,
        ITriPortId toPort);
    void TciUnmapParam(ITriPortId fromPort,
        ITriPortId toPort, Etsi.Ttcn3.Tci.ITciParameterList parameterList);
    void TciKillTestComponent(ITriComponentId component);
    bool TciTestComponentAlive (ITriComponentId component);
    bool TciTestComponentKilled(ITriComponentId component, out TciVerdict verdict);
    void TciCallTestComponent (ITriComponentId comp,
        ITciBehaviourId behavior, ITciParameterList parameterList);
    void TciTestComponentCallTerminated (ITriComponentId comp,
        ITciVerdictValue verdict, ITciParameterList parameterList, ITciValue returnValue);
}

```

## 12.5.4 TCI-TL interface

### 12.5.4.1 TCI-TL provided

The **TCI-TL provided** interface is mapped to the following interface:

```
public interface ITciTLProvided {
    void TliTcExecute(string am, System.DateTime ts, string src, int line,
        ITriComponentId c, ITciTestCaseId tcId,
        ITciParameterList tciPars, ITriTimerDuration dur);
    void TliTcStart(string am, System.DateTime ts, string src, int line,
        ITriComponentId c, ITciTestCaseId tcId,
        ITciParameterList tciPars, ITriTimerDuration dur);
    void TliTcStop(string am, System.DateTime ts, string src, int line,
        ITriComponentId c, string reason);
    void TliTcStarted(string am, System.DateTime ts, string src, int line,
        ITriComponentId c, ITciTestCaseId tcId,
        ITciParameterList tciPars, ITriTimerDuration dur);
    void TliTcTerminated(string am, System.DateTime ts, string src, int line,

```

```

    ITricomponentId c, ITciTestCaseId tcId,
    ITciParameterList tciPars, ITciVerdictValue verdict,
    string reason);
void TliCtrlStart(string am, System.DateTime ts, string src, int line,
    ITricomponentId c);
void TliCtrlStop(string am, System.DateTime ts, string src, int line,
    ITricomponentId c);
void TliCtrlTerminated(string am, System.DateTime ts, string src, int
    line, ITricomponentId c);
void TliMSend_m(string am, System.DateTime ts, string src, int line,
    ITricomponentId c, ITriPortId at,
    ITriPortId to, ITciValue msgValue,
    ITciValue addrValue, TciStatus encoderFailure,
    ITriMessage msg, ITriAddress address,
    TriStatus transmissionFailure);
void TliMSend_m_BC(string am, System.DateTime ts, string src, int line,
    ITricomponentId c, ITriPortId at,
    ITriPortId to, ITciValue msgValue,
    TciStatus encoderFailure, ITriMessage msg,
    TriStatus transmissionFailure);
void TliMSend_m_MC(string am, System.DateTime ts, string src, int line,
    ITricomponentId c, ITriPortId at,
    ITriPortId to, ITciValue msgValue,
    ITciValueList addrValues, TciStatus encoderFailure,
    ITriMessage msg,
    ITriAddressList addresses,
    TriStatus transmissionFailure);
void TliMSend_c(string am, System.DateTime ts, string src, int line,
    ITricomponentId c, ITriPortId at,
    ITriPortId to, ITciValue msgValue,
    TriStatus transmissionFailure);
void TliMSend_c_BC(string am, System.DateTime ts, string src, int line,
    ITricomponentId c, ITriPortId at,
    ITriPortIdList to, ITciValue msgValue,
    TriStatus transmissionFailure);
void TliMSend_c_MC(string am, System.DateTime ts, string src, int line,
    ITricomponentId c, ITriPortId at,
    ITriPortIdList to, ITciValue msgValue,
    TriStatus transmissionFailure);
void TliMDetected_m(string am, System.DateTime ts, string src, int line,
    ITricomponentId c, ITriPortId at,
    ITriPortId from, ITriMessage msg,
    ITriAddress address);
void TliMDetected_c(string am, System.DateTime ts, string src, int line,
    ITricomponentId c, ITriPortId at,
    ITriPortId from, ITciValue msgValue);
void TliMMismatch_m(string am, System.DateTime ts, string src, int line,
    ITricomponentId c, ITriPortId at,
    ITciValue msgValue, ITciValueTemplate msgTpl,
    ITciValueDifferenceList diffs, ITciValue address,
    ITciValueTemplate addressTpl);
void TliMMismatch_c(string am, System.DateTime ts, string src, int line,
    ITricomponentId c, ITriPortId at,
    ITciValue msgValue, ITciValueTemplate msgTpl,
    ITciValueDifferenceList diffs, ITricomponentId from,
    ITciNonValueTemplate fromTpl);
void TliMReceive_m(string am, System.DateTime ts, string src, int line,
    ITricomponentId c, ITriPortId at,
    ITciValue msgValue, ITciValueTemplate msgTpl, ITciValue address,
    ITciValueTemplate addressTpl);
void TliMReceive_c(string am, System.DateTime ts, string src, int line,
    ITricomponentId c, ITriPortId at,
    ITciValue msgValue, ITciValueTemplate msgTpl,
    ITricomponentId fromComp,
    ITciNonValueTemplate fromTpl);
void TliPrCall_m(string am, System.DateTime ts, string src, int line,
    ITricomponentId c, ITriPortId at,
    ITriPortId to,
    ITriSignatureId signature,
    ITciParameterList tciPars, ITciValue addrValue,
    TciStatus encoderFailure, ITriParameterList triPars,
    ITriAddress address,
    TriStatus transmissionFailure);
void TliPrCall_m_BC(string am, System.DateTime ts, string src, int line,
    ITricomponentId c, ITriPortId at,
    ITriPortId to,
    ITriSignatureId signature, ITciParameterList tciPars,
    TciStatus encoderFailure, ITriParameterList triPars,

```

```

    TriStatus transmissionFailure);
void TliPrCall_m_MC(string am, System.DateTime ts, string src, int line,
    ITriComponentId c, ITriPortId at,
    ITriPortId to,
    ITriSignatureId signature, ITciParameterList tciPars,
    ITciValueList addrValues, TciStatus encoderFailure,
    ITriParameterList triPars,
    ITriAddressList addresses,
    TriStatus transmissionFailure);
void TliPrCall_c(string am, System.DateTime ts, string src, int line,
    ITriComponentId c, ITriPortId at,
    ITriPortId to,
    ITriSignatureId signature,
    ITciParameterList tciPars,
    TriStatus transmissionFailure);
void TliPrCall_c_BC(string am, System.DateTime ts, string src, int line,
    ITriComponentId c, ITriPortId at,
    ITriPortIdList to,
    ITriSignatureId signature, ITciParameterList tciPars,
    TriStatus transmissionFailure);
void TliPrCall_c_MC(string am, System.DateTime ts, string src, int line,
    ITriComponentId c, ITriPortId at,
    ITriPortIdList to,
    ITriSignatureId signature, ITciParameterList tciPars,
    TriStatus transmissionFailure);
void TliPrGetCallDetected_m(string am, System.DateTime ts, string src,
    int line, ITriComponentId c,
    ITriPortId at, ITriPortId from,
    ITriSignatureId signature,
    ITriParameterList triPars,
    ITriAddress address);
void TliPrGetCallDetected_c(string am, System.DateTime ts, string src,
    int line, ITriComponentId c,
    ITriPortId at, ITriPortId from,
    ITriSignatureId signature,
    ITciParameterList tciPars);
void TliPrGetCallMismatch_m(string am, System.DateTime ts, string src,
    int line, ITriComponentId c,
    ITriPortId at,
    ITriSignatureId signature, ITciParameterList tciPars,
    ITciValueTemplate parsTpl, ITciValueDifferenceList diffs,
    ITciValue address, ITciValueTemplate addressTpl);
void TliPrGetCallMismatch_c(string am, System.DateTime ts, string src,
    int line, ITriComponentId c,
    ITriPortId at,
    ITriSignatureId signature,
    ITciParameterList tciPars, ITciValueTemplate parsTpl,
    ITciValueDifferenceList diffs, ITriComponentId from,
    ITciNonValueTemplate fromTpl);
void TliPrGetCall_m(string am, System.DateTime ts, string src, int line,
    ITriComponentId c, ITriPortId at,
    ITriSignatureId signature,
    ITciParameterList tciPars, ITciValueTemplate parsTpl,
    ITciValue address, ITciValueTemplate addressTpl);
void TliPrGetCall_c(string am, System.DateTime ts, string src, int line,
    ITriComponentId c, ITriPortId at,
    ITriSignatureId signature,
    ITciParameterList tciPars, ITciValueTemplate parsTpl,
    ITriComponentId from, ITciNonValueTemplate fromTpl);
void TliPrReply_m(string am, System.DateTime ts, string src, int line,
    ITriComponentId c, ITriPortId at,
    ITriPortId to,
    ITriSignatureId signature, ITciParameterList tciPars,
    ITciValue replValue, ITciValue addrValue, TciStatus encoderFailure,
    ITriParameterList triPars,
    ITriParameter repl,
    ITriAddress address,
    TriStatus transmissionFailure);
void TliPrReply_m_BC(string am, System.DateTime ts, string src, int line,
    ITriComponentId c, ITriPortId at,
    ITriPortId to,
    ITriSignatureId signature, ITciParameterList tciPars,
    ITciValue replValue, TciStatus encoderFailure,
    ITriParameterList triPars,
    ITriParameter repl,
    TriStatus transmissionFailure);
void TliPrReply_m_MC(string am, System.DateTime ts, string src, int line,
    ITriComponentId c, ITriPortId at,

```



```

ITriPortId to,
ITriSignatureId signature, ITciParameterList tciPars,
ITciValue replValue, ITciValueList addrValues,
TciStatus encoderFailure, ITriParameterList triPars,
ITriParameter repl,
ITriAddressList addresses,
TriStatus transmissionFailure);
void TliPrReply_c(string am, System.DateTime ts, string src, int line,
ITriComponentId c, ITriPortId at,
ITriPortId to,
ITriSignatureId signature, ITciParameterList tciPars,
ITciValue replValue, TriStatus transmissionFailure);
void TliPrReply_c_BC(string am, System.DateTime ts, string src, int line,
ITriComponentId c, ITriPortId at,
ITriPortIdList to,
ITriSignatureId signature, ITciParameterList tciPars,
ITciValue replValue, TriStatus transmissionFailure);
void TliPrReply_c_MC(string am, System.DateTime ts, string src, int line,
ITriComponentId c, ITriPortId at,
ITriPortIdList to,
ITriSignatureId signature, ITciParameterList tciPars,
ITciValue replValue, TriStatus transmissionFailure);
void TliPrGetReplyDetected_m(string am, System.DateTime ts, string src,
int line, ITriComponentId c,
ITriPortId at, ITriPortId from,
ITriSignatureId signature,
ITriParameterList triPars,
ITriParameter repl,
ITriAddress address);
void TliPrGetReplyDetected_c(string am, System.DateTime ts, string src,
int line, ITriComponentId c,
ITriPortId at, ITriPortId from,
ITriSignatureId signature, ITciParameterList tciPars,
ITciValue replValue);
void TliPrGetReplyMismatch_m(string am, System.DateTime ts, string src,
int line, ITriComponentId c,
ITriPortId at,
ITriSignatureId signature, ITciParameterList tciPars,
ITciValueTemplate parsTpl, ITciValue replValue,
ITciValueTemplate replyTpl, ITciValueDifferenceList diffs,
ITciValue address, ITciValueTemplate addressTpl);
void TliPrGetReplyMismatch_c(string am, System.DateTime ts, string src,
int line, ITriComponentId c,
ITriPortId at,
ITriSignatureId signature, ITciParameterList tciPars,
ITciValueTemplate parsTpl, ITciValue replValue,
ITciValueTemplate replyTpl, ITciValueDifferenceList diffs,
ITriComponentId from, ITciNonValueTemplate fromTpl);
void TliPrGetReply_m(string am, System.DateTime ts, string src, int line,
ITriComponentId c, ITriPortId at,
ITriSignatureId signature, ITciParameterList tciPars,
ITciValueTemplate parsTpl, ITciValue replValue,
ITciValueTemplate replyTpl, ITciValue address,
ITciValueTemplate addressTpl);
void TliPrGetReply_c(string am, System.DateTime ts, string src, int line,
ITriComponentId c, ITriPortId at,
ITriSignatureId signature,
ITciParameterList tciPars, ITciValueTemplate parsTpl,
ITciValue replValue, ITciValueTemplate replyTpl,
ITriComponentId from, ITciNonValueTemplate fromTpl);
void TliPrRaise_m(string am, System.DateTime ts, string src, int line,
ITriComponentId c, ITriPortId at,
ITriPortId to,
ITriSignatureId signature, ITciParameterList tciPars,
ITciValue excValue, ITciValue addrValue, TciStatus encoderFailure,
ITriException exc,
ITriAddress address,
TriStatus transmissionFailure);
void TliPrRaise_m_BC(string am, System.DateTime ts, string src, int line,
ITriComponentId c, ITriPortId at,
ITriPortId to,
ITriSignatureId signature, ITciParameterList tciPars,
ITciValue excValue, TciStatus encoderFailure,
ITriException exc,
TriStatus transmissionFailure);
void TliPrRaise_m_MC(string am, System.DateTime ts, string src, int line,
ITriComponentId c, ITriPortId at,
ITriPortId to,

```

```

ITriSignatureId signature, ITciParameterList tciPars,
ITciValue excValue, ITciValueList addrValues,
TciStatus encoderFailure, ITriException exc,
ITriAddressList addresses,
TriStatus transmissionFailure);
void TliPrRaise_c(string am, System.DateTime ts, string src, int line,
ITriComponentId c, ITriPortId at,
ITriPortId to,
ITriSignatureId signature, ITciParameterList tciPars,
ITciValue excValue, TriStatus transmissionFailure);
void TliPrRaise_c_BC(string am, System.DateTime ts, string src, int line,
ITriComponentId c, ITriPortId at,
ITriPortIdList to,
ITriSignatureId signature,
ITciParameterList tciPars, ITciValue excValue,
TriStatus transmissionFailure);
void TliPrRaise_c_MC(string am, System.DateTime ts, string src, int line,
ITriComponentId c, ITriPortId at,
ITriPortIdList to,
ITriSignatureId signature, ITciParameterList tciPars,
ITciValue excValue, TriStatus transmissionFailure);
void TliPrCatchDetected_m(string am, System.DateTime ts, string src,
int line, ITriComponentId c,
ITriPortId at, ITriPortId from,
ITriSignatureId signature,
ITriException exc,
ITriAddress address);
void TliPrCatchDetected_c(string am, System.DateTime ts, string src,
int line, ITriComponentId c,
ITriPortId at, ITriPortId from,
ITriSignatureId signature, ITciValue excValue);
void TliPrCatchMismatch_m(string am, System.DateTime ts, string src,
int line, ITriComponentId c,
ITriPortId at,
ITriSignatureId signature, ITciValue excValue,
ITciValueTemplate excTpl, ITciValueDifferenceList diffs,
ITciValue address, ITciValueTemplate addressTpl);
void TliPrCatchMismatch_c(string am, System.DateTime ts, string src,
int line, ITriComponentId c,
ITriPortId at,
ITriSignatureId signature,
ITciValue excValue, ITciValueTemplate excTpl,
ITciValueDifferenceList diffs, ITriComponentId from,
ITciNonValueTemplate fromTpl);
void TliPrCatch_m(string am, System.DateTime ts, string src, int line,
ITriComponentId c, ITriPortId at,
ITriSignatureId signature,
ITciValue excValue, ITciValueTemplate excTpl, ITciValue address,
ITciValueTemplate addressTpl);
void TliPrCatch_c(string am, System.DateTime ts, string src, int line,
ITriComponentId c, ITriPortId at,
ITriSignatureId signature,
ITciValue excValue, ITciValueTemplate excTpl,
ITriComponentId from, ITciNonValueTemplate fromTpl);
void TliPrCatchTimeoutDetected(string am, System.DateTime ts, string src,
int line, ITriComponentId c,
ITriPortId at,
ITriSignatureId signature);
void TliPrCatchTimeout(string am, System.DateTime ts, string src,
int line, ITriComponentId c,
ITriPortId at,
ITriSignatureId signature);
void TliCCreate(string am, System.DateTime ts, string src, int line,
ITriComponentId c,
ITriComponentId comp, string name, bool alive);
void TliCStart(string am, System.DateTime ts, string src, int line,
ITriComponentId c,
ITriComponentId comp, ITciBehaviourId name,
ITciParameterList tciPars);
void TliCRunning(string am, System.DateTime ts, string src, int line,
ITriComponentId c,
ITriComponentId comp, TciComponentStatus status);
void TliCAlive(string am, System.DateTime ts, string src, int line,
ITriComponentId c,
ITriComponentId comp, TciComponentStatus status);
void TliCStop(string am, System.DateTime ts, string src, int line,
ITriComponentId c,
ITriComponentId comp);

```

```

void TliCKill(string am, System.DateTime ts, string src, int line,
    ITriComponentId c,
    ITriComponentId comp);
void TliCDoneMismatch(string am, System.DateTime ts, string src, int line,
    ITriComponentId c,
    ITriComponentId comp, ITciNonValueTemplate compTpl);
void TliCDone(string am, System.DateTime ts, string src, int line,
    ITriComponentId c, ITciNonValueTemplate compTpl, ITciVerdictValue verdict);
void TliCKilledMismatch(string am, System.DateTime ts, string src,
    int line, ITriComponentId c,
    ITriComponentId comp, ITciNonValueTemplate compTpl);
void TliCKilled(string am, System.DateTime ts, string src, int line,
    ITriComponentId c, ITciNonValueTemplate compTpl, ITciVerdictValue verdict);
void TliCTerminated(string am, System.DateTime ts, string src, int line,
    ITriComponentId c, ITciVerdictValue verdict,
    string reason);
void TliPConnect(string am, System.DateTime ts, string src, int line,
    ITriComponentId c, ITriPortId port1,
    ITriPortId port2);
void TliPDisconnect(string am, System.DateTime ts, string src, int line,
    ITriComponentId c, ITriPortId port1,
    ITriPortId port2);
void TliPMap(string am, System.DateTime ts, string src, int line,
    ITriComponentId c, ITriPortId port1,
    ITriPortId port2);
void TliPUnmap(string am, System.DateTime ts, string src, int line,
    ITriComponentId c, ITriPortId port1,
    ITriPortId port2);
void TliPClear(string am, System.DateTime ts, string src, int line,
    ITriComponentId c, ITriPortId port);
void TliPStart(string am, System.DateTime ts, string src, int line,
    ITriComponentId c, ITriPortId port);
void TliPStop(string am, System.DateTime ts, string src, int line,
    ITriComponentId c, ITriPortId port);
void TliPHalt(string am, System.DateTime ts, string src, int line,
    ITriComponentId c, ITriPortId port);
void TliEncode(string am, System.DateTime ts, string src, int line,
    ITriComponentId c, ITciValue val,
    TciStatus encoderFailure, ITriMessage msg,
    string codec);
void TliDecode(string am, System.DateTime ts, string src, int line,
    ITriComponentId c, ITriMessage msg,
    TciStatus decoderFailure, ITciValue val, string codec);
void TliTTimeoutDetected(string am, System.DateTime ts, string src,
    int line, ITriComponentId c,
    ITriTimerId timer);
void TliTTimeoutMismatch(string am, System.DateTime ts, string src,
    int line, ITriComponentId c,
    ITriTimerId timer, ITciNonValueTemplate timerTpl);
void TliTTimeout(string am, System.DateTime ts, string src, int line,
    ITriComponentId c, ITriTimerId timer,
    ITciNonValueTemplate timerTpl);
void TliTStart(string am, System.DateTime ts, string src, int line,
    ITriComponentId c, ITriTimerId timer,
    ITriTimerDuration dur);
void TliTStop(string am, System.DateTime ts, string src, int line,
    ITriComponentId c, ITriTimerId timer,
    ITriTimerDuration dur);
void TliTRead(string am, System.DateTime ts, string src, int line,
    ITriComponentId c, ITriTimerId timer,
    ITriTimerDuration elapsed);
void TliTRunning(string am, System.DateTime ts, string src, int line,
    ITriComponentId c, ITriTimerId timer,
    TciTimerStatus status);
void TliSEnter(string am, System.DateTime ts, string src, int line,
    ITriComponentId c,
    IQualifiedName name, ITciParameterList tciPars,
    string kind);
void TliSLeave(string am, System.DateTime ts, string src, int line,
    ITriComponentId c,
    IQualifiedName name, ITciParameterList tciPars,
    ITciValue returnValue, string kind);
void TliVar(string am, System.DateTime ts, string src, int line,
    ITriComponentId c,
    IQualifiedName name, ITciValue varValue);
void TliModulePar(string am, System.DateTime ts, string src, int line,
    ITriComponentId c,
    IQualifiedName name, ITciValue parValue);

```

```

void TliGetVerdict(string am, System.DateTime ts, string src, int line,
    ITricomponentId c, ITciVerdictValue verdict);
void TliSetVerdict(string am, System.DateTime ts, string src, int line,
    ITricomponentId c, ITciVerdictValue verdict,
    string reason);
void TliLog(string am, System.DateTime ts, string src, int line,
    ITricomponentId c, string log);
void TliAEnter(string am, System.DateTime ts, string src, int line,
    ITricomponentId c);
void TliALeave(string am, System.DateTime ts, string src, int line,
    ITricomponentId c);
void TliADefaults(string am, System.DateTime ts, string src, int line,
    ITricomponentId c);
void TliAActivate(string am, System.DateTime ts, string src, int line,
    ITricomponentId c,
    IQualifiedName name, ITciParameterList tciPars,
    ITciValue expr);
void TliADeactivate(string am, System.DateTime ts, string src, int line,
    ITricomponentId c, ITciValue expr);
void TliANomatch(string am, System.DateTime ts, string src, int line,
    ITricomponentId c);
void TliARepeat(string am, System.DateTime ts, string src, int line,
    ITricomponentId c);
void TliAwait(string am, System.DateTime ts, string src, int line,
    ITricomponentId c);
void TliAction(string am, System.DateTime ts, string src, int line,
    ITricomponentId c, string action);
void TliMatch(string am, System.DateTime ts, string src, int line,
    ITricomponentId c, ITciValue expr,
    ITciValueTemplate tpl);
void TliMatchMismatch(string am, System.DateTime ts, string src, int line,
    ITricomponentId c, ITciValue expr,
    ITciValueTemplate tpl, ITciValueDifferenceList diffs);
void TliInfo (string am, System.DateTime ts, string src, int line,
    ITricomponentId c, int level, string info);
void TliMChecked_m(string am, System.DateTime ts, string src, int line,
    ITricomponentId c, ITriPortId at,
    ITciValue msgValue, ITciValueTemplate msgTpl,
    ITciValue address, ITciValueTemplate addressTpl);
void TliMChecked_c(string am, System.DateTime ts, string src, int line,
    ITricomponentId c, ITriPortId at,
    ITciValue msgValue, ITciValueTemplate msgTpl,
    ITricomponentId fromComp, ITciNonValueTemplate fromTpl);
void TliPrGetCallChecked_m(string am, System.DateTime ts, string src,
    int line, ITricomponentId c,
    ITriPortId at, ITriSignatureId signature,
    ITciParameterList tciPars, ITciValueTemplate parsTpl,
    ITciValue address, ITciValueTemplate addressTpl);
void TliPrGetCallChecked_c(string am, System.DateTime ts, string src,
    int line, ITricomponentId c,
    ITriPortId at, ITriSignatureId signature,
    ITciParameterList tciPars, ITciValueTemplate parsTpl,
    ITricomponentId from, ITciNonValueTemplate fromTpl);
void TliPrGetReplyChecked_m(string am, System.DateTime ts, string src,
    int line, ITricomponentId c,
    ITriPortId at, ITriSignatureId signature,
    ITciParameterList tciPars, ITciValueTemplate parsTpl,
    ITciValue replValue, ITciValueTemplate replyTpl,
    ITciValue address, ITciValueTemplate addressTpl);
void TliPrGetReplyChecked_c(string am, System.DateTime ts, string src,
    int line, ITricomponentId c,
    ITriPortId at, ITriSignatureId signature,
    ITciParameterList tciPars, ITciValueTemplate parsTpl,
    ITciValue replValue, ITciValueTemplate replyTpl,
    ITricomponentId from, ITciNonValueTemplate fromTpl);
void TliPrCatchChecked_m(string am, System.DateTime ts, string src,
    int line, ITricomponentId c,
    ITriPortId at, ITriSignatureId signature,
    ITciValue excValue, ITciValueTemplate excTpl,
    ITciValue address, ITciValueTemplate addressTpl);
void TliPrCatchChecked_c(string am, System.DateTime ts, string src,
    int line, ITricomponentId c,
    ITriPortId at, ITriSignatureId signature,
    ITciValue excValue, ITciValueTemplate excTpl,
    ITricomponentId from, ITciNonValueTemplate fromTpl);
void TliCheckedAny_m(string am, System.DateTime ts, string src, int line,
    ITricomponentId c, ITriPortId at,
    ITciValue address, ITciValueTemplate addressTpl);

```

```

void TliCheckedAny_c(string am, System.DateTime ts, string src, int line,
    ITriComponentId c, ITriPortId at,
    ITriComponentId from, ITciNonValueTemplate fromTpl);
void TliCheckAnyMismatch_m(string am, System.DateTime ts, string src, int line,
    ITriComponentId c, ITriPortId at,
    ITciValue address, ITciValueTemplate addressTpl);
void TliCheckAnyMismatch_c(string am, System.DateTime ts, string src, int line,
    ITriComponentId c, ITriPortId at,
    ITriComponentId from, ITciNonValueTemplate fromTpl);
void TliRnd(string am, System.DateTime ts, string src, int line,
    ITriComponentId c, ITciFloatValue val, ITciFloatValue seed);
void TliEvaluate (string am, System.DateTime ts, string src, int line,
    ITriComponentId c, IQualifiedName name, ITciValue evalResult);
void TliCCall (string am, System.DateTime ts, string src, int line,
    ITriComponentId c,
    ITriComponentId comp, ITciBehaviourId name,
    ITciParameterList tciPars);
void TliCCallTerminated (string am, System.DateTime ts, string src, int line,
    ITriComponentId c, ITciVerdictValue verdict,
    string reason, ITciParameterList tciPars, ITciValue returnValue);
void TliCtrlStartWithParameters (string am, System.DateTime ts, string src, int line,
    ITriComponentId c, ITciParameterList tciPars);
void TliCtrlTerminatedWithResult (string am, System.DateTime ts, string src, int line,
    ITriComponentId c, ITciValue result, ITciParameterList tciPars);
}

```

## 12.6 Optional parameters

Clause 7.3 in [1] defines that a reserved value shall be used to indicate the absence of an optional parameter. For the C# language mapping the distinct value `null` shall be used to indicate the absence of an optional value. For example, if in the `TciReplyConnected` operation the value parameter shall be omitted the operation invocation shall be `TciReplyConnected (sender, receiver, signature, parameterList, null)`.

## 12.7 Error Handling

All operations called from the TM, CH or CD that return have succeeded. If an erroneous situation has been identified by the TE a test case error will be communicated to the user using the procedures as defined in clause 7.3.1.2.6 (`TciError`). If an operation called by the TE in the TM, CH, CD, or TL produces an error, this erroneous situation should be communicated to the TE using the procedures as defined in clause 7.3.2.1.12 (`TciErrorReq`).

Beside this error handling and exceptions specified for indexing operators no additional error handling is defined in the C# mapping.

## Annex A (normative): IDL Specification of TCI

This annex defines the TTCN-3 Control Interfaces using the Interface Definition Language (IDL).

```
// *****
// * Interface definitions for the TTCN-3 Control Interfaces
// *****

module tciInterface {

    /* Forward declaration */
    interface Value;
    interface Type;

    // *****
    // * Data types taken from the TRI definitions
    // *****

    // Connection
    native TriPortIdType ;
    native TriPortIdListType;
    native TriComponentIdType ;
    native TriComponentIdListType;

    // Communications
    native TriMessageType;
    native TriParameterType;
    native TriParameterListType;
    native TriAddressType;
    native TriAddressListType;
    native TriExceptionType;
    native TriSignatureIdType;

    // Miscellaneous
    native TriStatusType;
    native TriTimerIdType;
    native TriTimerDurationType;

    native TciStatusType;

    // *****
    // * General Abstract Data Types
    // *****

    // Basic definitions
    native TBoolean;
    native TFloat;
    native TChar;
    native TInteger;
    native TString;
    native TUniversalChar;
    typedef sequence <TString> TStringSeq;

    struct QualifiedName {
        TString moduleName;
        TString baseName;
    };

    // General TCI abstract data types
    typedef QualifiedName TciBehaviourIdType;
    typedef QualifiedName TciModuleIdType;
    typedef QualifiedName TciModuleParameterIdType;
    typedef QualifiedName TciTestCaseIdType;

    enum TciParameterPassingModeType {
        IN_MODE,
        OUT_MODE,
        INOUT_MODE
    };

    struct TciParameterType {
        TciModuleParameterIdType parameterName;
        Value parameterValue;
        TciParameterPassingModeType mode;
    };
};
```

```

};

typedef sequence <TciParameterType> TciParameterListType;

struct TciParameterTypeType {
    Type parameterType;
    TciParameterPassingModeType mode;
};

typedef sequence <TciParameterTypeType> TciParameterTypeListType;

struct TciModuleParameterType {
    TciModuleParameterIdType parameterName;
    Value defaultValue;
};

typedef sequence <TciModuleIdType> TciModuleIdListType ;

typedef sequence <TciModuleParameterType> TciModuleParameterListType;

typedef sequence <TciTestCaseIdType> TciTestCaseIdListType;

enum TciTestComponentKindType {
    CONTROL,
    MTC,
    PTC,
    SYSTEM,
    PTC_ALIVE
};

enum ComponentStatusType{
    inactiveC,
    runningC,
    stoppedC,
    killedC,
    nullC
};

enum TimerStatusType{
    runningT,
    inactiveT,
    expiredT,
    nullT
};

enum PortStatusType{
    startedP,
    haltedP,
    stoppedP
};

enum TciTypeClassType {
    ADDRESS_CLASS,
    ANYTYPE_CLASS,
    BITSTRING_CLASS,
    BOOLEAN_CLASS,
    CHARSTRING_CLASS,
    COMPONENT_CLASS,
    ENUMERATED_CLASS,
    FLOAT_CLASS,
    HEXSTRING_CLASS,
    INTEGER_CLASS,
    OCTETSTRING_CLASS,
    RECORD_CLASS,
    RECORDOF_CLASS,
    ARRAY_CLASS,
    SET_CLASS,
    SETOF_CLASS,
    UNION_CLASS,
    UNIVERSALCHARSTRING_CLASS,
    VERDICT_CLASS
    DEFAULT_CLASS,
    PORT_CLASS,
    TIMER_CLASS
};
};

```

```

// *****
// * Abstract TTCN-3 Data Types And Values
// *****

// Abstract data type "Type"
interface Type {
  TciModuleIdType  getDefiningModule ();
  TString          getName ();
  TciTypeClassType getTypeClass ();
  Value           newInstance ();
  TString          getTypeEncoding ();
  TString          getTypeEncodingVariant ();
  TStringSeq      getTypextension ();
  Value           parseValue(in TString val);
};

// Abstract TTCN-3 Values
interface Value {
  TString          getValueEncoding ();
  TString          getValueEncodingVariant ();
  Type            getType ();
  TBoolean        notPresent ();
  TBoolean        isMatchingSymbol ();
  TString          valueToString ();
};

interface RecordOfValue : Value {
  Value          getField (in TInteger position);
  void           setField (
    in TInteger position,
    in Value value
  );
  void           appendField (in Value value);
  Type           getElementType ();
  TInteger       getLength ();
  void           setLength (in TInteger len);
  TInteger       getOffset ();
};

interface RecordValue : Value {
  Value          getField (in TString fieldName);
  void           setField (
    in TString fieldName,
    in Value value
  );
  TStringSeq     getFieldNames ();
  void           setFieldOmitted (in TString fieldName);
};

interface VerdictValue : Value {
  TInteger       getVerdict ();
  void           setVerdict (in TInteger verdict);
};

interface BitstringValue : Value {
  TString        getString ();
  void           setString (in TString value);
  TInteger       getBit (in TInteger position);
  void           setBit (
    in TInteger position,
    in TInteger value
  );
  TInteger       getLength ();
  void           setLength (in TInteger len);
};

interface OctetstringValue : Value {
  TString        getString ();
  void           setString (in TString value);
  TInteger       getOctet (in TInteger position);
  void           setOctet (
    in TInteger position,
    in TInteger value
  );
  TInteger       getLength ();
  void           setLength (in TInteger len);
};

```



```

interface FloatValue : Value {
    TFloat getFloat ();
    void setFloat (in TFloat value);
};

interface HexstringValue : Value {
    TString getString ();
    void setString (in TString value);
    TInteger getHex (in TInteger position);
    void setHex (
        in TInteger position,
        in TInteger value
    );
    TInteger getLength ();
    void setLength (in TInteger len);
};

interface EnumeratedValue : Value {
    void setEnum (in TString enumValue);
    TString getEnum ();
};

interface IntegerValue : Value {
    TInteger getInt ();
    void setInt (in TInteger value);
};

interface CharValue : Value {
    TChar getChar ();
    void setChar (in TChar value);
};

interface CharstringValue : Value {
    TString getString ();
    void setString (in TString value);
    TChar getChar (in TInteger position);
    void setChar (
        in TInteger position,
        in TChar value
    );
    TInteger getLength ();
    void setLength (in TInteger len);
};

interface BooleanValue : Value {
    TBoolean getBoolean ();
    void setBoolean (in TBoolean value);
};

interface UniversalCharValue : Value {
    TUniversalChar getUniversalChar ();
    void setUniversalChar (in TUniversalChar value);
};

interface UniversalCharstringValue : Value {
    TString getString ();
    void setString (in TString value);
    TUniversalChar getChar (in TInteger position);
    void setChar (
        in TInteger position,
        in TUniversalChar value
    );
    TInteger getLength ();
    void setLength (in TInteger len);
};

interface UnionValue : Value {
    Value getVariant (in TString variantName);
    void setVariant (
        in TString variantName,
        in Value value
    );
    TString getPresentVariantName ();
    TStringSeq getVariantNames ();
};

```

```

// *****
// * Abstract Logging Types
// *****

interface TciValueTemplate : Value {
    TBoolean isOmit ();
    TBoolean isAny();
    TBoolean isAnyOrOmit();
    TString getTemplateDef();
};

interface TciNonValueTemplate {
    TBoolean isAny();
    TBoolean isAll();
    TString getTemplateDef();
};

typedef sequence <Value> TciValueListType;

struct TciValueDifferenceType
{
    TString desc;
    Value val;
    TciValueTemplate tmpl;
};

typedef sequence <TciValueDifferenceType> TciValueDifferenceListType;

interface TciValueList {
    attribute TciValueListType inst;
    TInteger size();
    TBoolean isEmpty();
    Value get(in TInteger index);
};

interface TciValueDifference {
    attribute TciValueDifferenceType inst;
    Value getValue();
    TciValueTemplate getTciValueTemplate();
    TString getDescription();
};

interface TciValueDifferenceList {
    attribute TciValueDifferenceListType inst;
    TInteger size();
    TBoolean isEmpty();
    TciValueDifference get(in TInteger index);
};

// *****
// Coding Decoding Interface
// - Required
// *****

interface TCI_CD_Required {
    Type getTypeForName (in TString typeName);
    Type getInteger ();
    Type getFloat ();
    Type getBoolean ();
    Type getChar ();
    Type getUniversalChar ();
    Type getCharstring ();
    Type getUniversalCharstring ();
    Type getHexstring ();
    Type getBitstring ();
    Type getOctetstring ();
    Type getVerdict ();
    void tciErrorReq (in TString message);
};

```

```

// *****
// Coding Decoding interface
// - Provided
// *****

interface TCI_CD_Provided {
    Value decode (
        in TriMessageType message,
        in Type decodingHypothesis
    );
    TriMessageType encode (in Value value);
};

// *****
// Test Management Interface
// - Required
// *****

interface TCI_TM_Required : TCI_CD_Required {
    void tciRootModule (in TciModuleIdType moduleName);
    TciModuleIdListType tciGetImportedModules();
    TciModuleParameterListType tciGetModuleParameters (in TciModuleIdType moduleName);
    TciTestCaseIdListType tciGetTestCases ();
    TciParameterTypeListType tciGetTestCaseParameters (
        in TciTestCaseIdType testCaseId
    );
    TriPortIdListType tciGetTestCaseTSI (
        in TciTestCaseIdType testCaseId
    );
    void tciStartTestCase (
        in TciTestCaseIdType testCaseId,
        in TciParameterListType parameterList
    );
    void tciStopTestCase ();
    TriComponentIdType tciStartControl ();
    void tciStopControl ();
    TciParameterTypeListType tciGetControlParameters ();
    TriComponentIdType tciStartControlWithParameters (in TciParameterListType parameterList);
};

// *****
// Test Management Interface
// - Provided
// *****

interface TCI_TM_Provided {
    void tciTestCaseStarted (
        in TciTestCaseIdType testCaseId,
        in TciParameterListType parameterList,
        in TFloat timer
    );
    void tciTestCaseTerminated (
        in VerdictValue verdict,
        in TciParameterListType parameterList
    );
    void tciControlTerminated ();
    Value tciGetModulePar (
        in TciModuleParameterIdType parameterId
    );
    void tciLog (
        in TriComponentIdType testComponentId,
        in TString message
    );
    void tciError (in TString message);
    void tciControlTerminatedWithResult (
        in Value result,
        in TciParameterListType parameterList
    );
};

// *****
// Component Handling Interface
// - Required
// *****

```

```

interface TCI_CH_Required : TCI_CD_Required {
    void tciEnqueueMsgConnected (
        in TriPortIdType sender,
        in TriComponentIdType receiver,
        in Value receivedMessage
    );
    void tciEnqueueCallConnected (
        in TriPortIdType sender,
        in TriComponentIdType receiver,
        in TriSignatureIdType signature,
        in TciParameterListType parameterList
    );
    void tciEnqueueReplyConnected (
        in TriPortIdType sender,
        in TriComponentIdType receiver,
        in TriSignatureIdType signature,
        in TciParameterListType parameterList,
        in Value returnValue
    );
    void tciEnqueueRaiseConnected (
        in TriPortIdType sender,
        in TriComponentIdType receiver,
        in TriSignatureIdType signature,
        in Value except
    );
    TriComponentIdType tciCreateTestComponent (
        in TciTestComponentKindType kind,
        in Type componentType,
        in TString name
    );
    void tciStartTestComponent (
        in TriComponentIdType comp,
        in TciBehaviourIdType behavior,
        in TciParameterListType parameterList
    );
    void tciStopTestComponent (
        in TriComponentIdType comp
    );
    void tciConnect (
        in TriPortIdType fromPort,
        in TriPortIdType toPort
    );
    void tciDisconnect (
        in TriPortIdType fromPort,
        in TriPortIdType toPort
    );
    void tciTestComponentTerminated (
        in TriComponentIdType comp,
        in VerdictValue verdict
    );
    TBoolean tciTestComponentRunning (
        in TriComponentIdType comp
    );
    TriComponentIdType tciGetMTC ();
    void tciMap (
        in TriPortIdType fromPort,
        in TriPortIdType toPort
    );
    void tciUnmap (
        in TriPortIdType fromPort,
        in TriPortIdType toPort
    );
    void tciExecuteTestCase (
        in TciTestCaseIdType testCaseId,
        in TriPortIdListType tsiPortList
    );
    TBoolean tciTestComponentDone (
        in TriComponentIdType comp
    );
    void tciReset ();
};

// *****
// Component Handling Interface
// - Provided
// *****

```

```

interface TCI_CH_Provided {
    void tciSendConnected (
        in TriPortIdType sender,
        in TriComponentIdType receiver,
        in Value sendMessage
    );
    void tciSendConnectedBC (
        in TriPortIdType sender,
        in Value sendMessage
    );
    void tciSendConnectedMC (
        in TriPortIdType sender,
        in TriComponentIdListType receivers,
        in Value sendMessage
    );

    void tciCallConnected (
        in TriPortIdType sender,
        in TriComponentIdType receiver,
        in TriSignatureIdType signature,
        in TciParameterListType parameterList
    );
    void tciCallConnectedBC (
        in TriPortIdType sender,
        in TriSignatureIdType signature,
        in TciParameterListType parameterList
    );
    void tciCallConnectedMC (
        in TriPortIdType sender,
        in TriComponentIdListType receivers,
        in TriSignatureIdType signature,
        in TciParameterListType parameterList
    );

    void tciReplyConnected (
        in TriPortIdType sender,
        in TriComponentIdType receiver,
        in TriSignatureIdType signature,
        in TciParameterListType parameterList,
        in Value returnValue
    );
    void tciReplyConnectedBC (
        in TriPortIdType sender,
        in TriSignatureIdType signature,
        in TciParameterListType parameterList,
        in Value returnValue
    );
    void tciReplyConnectedMC (
        in TriPortIdType sender,
        in TriComponentIdListType receivers,
        in TriSignatureIdType signature,
        in TciParameterListType parameterList,
        in Value returnValue
    );

    void tciRaiseConnected (
        in TriPortIdType sender,
        in TriComponentIdType receiver,
        in TriSignatureIdType signature,
        in Value except
    );
    void tciRaiseConnectedBC (
        in TriPortIdType sender,
        in TriSignatureIdType signature,
        in Value except
    );
    void tciRaiseConnectedMC (
        in TriPortIdType sender,
        in TriComponentIdListType receivers,
        in TriSignatureIdType signature,
        in Value except
    );

    TriComponentIdType tciCreateTestComponentReq (
        in TciTestComponentKindType kind,
        in Type componentType,
        in TString name,
        in Value hostId
    )

```

```

    );
void tciStartTestComponentReq (
    in TriComponentIdType comp,
    in TciBehaviourIdType behavior,
    in TciParameterListType parameterList
);
void tciStopTestComponentReq (
    in TriComponentIdType comp
);
void tciConnectReq (
    in TriPortIdType fromPort,
    in TriPortIdType toPort
);
void tciDisconnectReq (
    in TriPortIdType fromPort,
    in TriPortIdType toPort
);
void tciTestComponentTerminatedReq (
    in TriComponentIdType comp,
    in VerdictValue verdict
);
TBoolean tciTestComponentRunningReq (
    in TriComponentIdType comp
);
TriComponentIdType tciGetMTCReq ();
void tciMapReq (
    in TriPortIdType fromPort,
    in TriPortIdType toPort
);
void tciUnmapReq (
    in TriPortIdType fromPort,
    in TriPortIdType toPort
);
void tciExecuteTestCaseReq (
    in TciTestCaseIdType testCaseId,
    in TriPortIdListType tsiPortList
);
void tciResetReq ();
TBoolean tciTestComponentDoneReq (
    in TriComponentIdType comp
);
};

// *****
// Test Logging Interface
// - Provided
// *****

interface TCI_TL_Provided {
    void tliTcExecute(
        in TString am, in TInteger ts, in TString src, in TInteger line,
        in TriComponentIdType c, in TciTestCaseIdType tcId,
        in TciParameterListType tciPars, in TriTimerDurationType dur
    );
    void tliTcStart(
        in TString am, in TInteger ts, in TString src, in TInteger line,
        in TriComponentIdType c, in TciTestCaseIdType tcId,
        in TciParameterListType tciPars, in TriTimerDurationType dur
    );
    void tliTcStop(
        in TString am, in TInteger ts, in TString src, in TInteger line,
        in TriComponentIdType c, in TString reason
    );
    void tliTcStarted(
        in TString am, in TInteger ts, in TString src, in TInteger line,
        in TriComponentIdType c, in TciTestCaseIdType tcId,
        in TciParameterListType tciPars, in TriTimerDurationType dur
    );
    void tliTcTerminated(
        in TString am, in TInteger ts, in TString src, in TInteger line,
        in TriComponentIdType c, in TciTestCaseIdType tcId,
        in TciParameterListType tciPars, in VerdictValue verdict, in TString reason);

    void tliCtrlStart(
        in TString am, in TInteger ts, in TString src, in TInteger line,
        in TriComponentIdType c
    );
};

```

```

void tliCtrlStop(
    in TString am, in TInteger ts, in TString src, in TInteger line,
    in TriComponentIdType c
);
void tliCtrlTerminated(
    in TString am, in TInteger ts, in TString src, in TInteger line,
    in TriComponentIdType c);

void tliMSend_m(
    in TString am, in TInteger ts, in TString src, in TInteger line,
    in TriComponentIdType c, in TriPortIdType at, in TriPortIdType to, in Value msgValue,
    in Value addrValue, in TciStatusType encoderFailure,
    in TriMessageType msg, in TriAddressType address, in TriStatusType transmissionFailure
);
void tliMSend_m_BC(
    in TString am, in TInteger ts, in TString src, in TInteger line,
    in TriComponentIdType c, in TriPortIdType at, in TriPortIdType to, in Value msgValue,
    in TciStatusType encoderFailure, in TriMessageType msg,
    in TriStatusType transmissionFailure
);
void tliMSend_m_MC(
    in TString am, in TInteger ts, in TString src, in TInteger line,
    in TriComponentIdType c, in TriPortIdType at, in TriPortIdType to, in Value msgValue,
    in TciValueList addrValues, in TciStatusType encoderFailure,
    in TriMessageType msg, in TriAddressListType addresses,
    in TriStatusType transmissionFailure
);

void tliMSend_c(
    in TString am, in TInteger ts, in TString src, in TInteger line,
    in TriComponentIdType c, in TriPortIdType at, in TriPortIdType to, in Value msgValue,
    in TriStatusType transmissionFailure
);
void tliMSend_c_BC(
    in TString am, in TInteger ts, in TString src, in TInteger line,
    in TriComponentIdType c, in TriPortIdType at, in TriPortIdListType to, in Value msgValue,
    in TriStatusType transmissionFailure
);
void tliMSend_c_MC(
    in TString am, in TInteger ts, in TString src, in TInteger line,
    in TriComponentIdType c, in TriPortIdType at, in TriPortIdListType to, in Value msgValue,
    in TriStatusType transmissionFailure);

void tliMDetected_m(
    in TString am, in TInteger ts, in TString src, in TInteger line,
    in TriComponentIdType c, in TriPortIdType at, in TriPortIdType from,
    in TriMessageType msg,
    in TriAddressType address
);
void tliMDetected_c(
    in TString am, in TInteger ts, in TString src, in TInteger line,
    in TriComponentIdType c, in TriPortIdType at, in TriPortIdType from, in Value msgValue
);
void tliMMismatch_m(
    in TString am, in TInteger ts, in TString src, in TInteger line,
    in TriComponentIdType c, in TriPortIdType at, in Value msgValue,
    in TciValueTemplate msgTpl, in TciValueDifferenceList diffs,
    in Value addrValue, in TciValueTemplate addressTpl
);
void tliMMismatch_c(
    in TString am, in TInteger ts, in TString src, in TInteger line,
    in TriComponentIdType c, in TriPortIdType at, in Value msgValue,
    in TciValueTemplate msgTpl, in TciValueDifferenceList diffs,
    in TriComponentIdType from, in TciNonValueTemplate fromTpl
);
void tliMReceive_m(
    in TString am, in TInteger ts, in TString src, in TInteger line,
    in TriComponentIdType c, in TriPortIdType at, in Value msgValue,
    in TciValueTemplate msgTpl, in Value addrValue,
    in TciValueTemplate addressTpl
);
void tliMReceive_c(
    in TString am, in TInteger ts, in TString src, in TInteger line,
    in TriComponentIdType c, in TriPortIdType at, in Value msgValue,
    in TciValueTemplate msgTpl, in TriComponentIdType from,
    in TciNonValueTemplate fromTpl
);

```

```

void tliPrCall_m(
    in TString am, in TInteger ts, in TString src, in TInteger line,
    in TriComponentIdType c, in TriPortIdType at, in TriPortIdType to,
    in TriSignatureIdType signature, in TciParameterListType tciPars,
    in Value addrValue, in TciStatusType encoderFailure,
    in TriParameterListType triPars, in TriAddressType address,
    in TriStatusType transmissionFailure
);
void tliPrCall_m_BC(
    in TString am, in TInteger ts, in TString src, in TInteger line,
    in TriComponentIdType c, in TriPortIdType at, in TriPortIdType to,
    in TriSignatureIdType signature, in TciParameterListType tciPars,
    in TciStatusType encoderFailure, in TriParameterListType triPars,
    in TriStatusType transmissionFailure
);
void tliPrCall_m_MC(
    in TString am, in TInteger ts, in TString src, in TInteger line,
    in TriComponentIdType c, in TriPortIdType at, in TriPortIdType to,
    in TriSignatureIdType signature, in TciParameterListType tciPars,
    in TciValueList addrValues, in TciStatusType encoderFailure,
    in TriParameterListType triPars, in TriAddressListType addresses,
    in TriStatusType transmissionFailure
);

void tliPrCall_c(
    in TString am, in TInteger ts, in TString src, in TInteger line,
    in TriComponentIdType c, in TriPortIdType at, in TriPortIdType to,
    in TriSignatureIdType signature, in TciParameterListType tciPars,
    in TriStatusType transmissionFailure
);
void tliPrCall_c_BC(
    in TString am, in TInteger ts, in TString src, in TInteger line,
    in TriComponentIdType c, in TriPortIdType at, in TriPortIdListType to,
    in TriSignatureIdType signature, in TciParameterListType tciPars,
    in TriStatusType transmissionFailure
);
void tliPrCall_c_MC(
    in TString am, in TInteger ts, in TString src, in TInteger line,
    in TriComponentIdType c, in TriPortIdType at, in TriPortIdListType to,
    in TriSignatureIdType signature, in TciParameterListType tciPars,
    in TriStatusType transmissionFailure
);

void tliPrGetCallDetected_m(
    in TString am, in TInteger ts, in TString src, in TInteger line,
    in TriComponentIdType c, in TriPortIdType at, in TriPortIdType from,
    in TriSignatureIdType signature, in TriParameterListType triPars,
    in TriAddressType address
);
void tliPrGetCallDetected_c(
    in TString am, in TInteger ts, in TString src, in TInteger line,
    in TriComponentIdType c, in TriPortIdType at, in TriPortIdType from,
    in TriSignatureIdType signature, in TciParameterListType tciPars
);
void tliPrGetCallMismatch_m(
    in TString am, in TInteger ts, in TString src, in TInteger line,
    in TriComponentIdType c, in TriPortIdType at,
    in TriSignatureIdType signature, in TciParameterListType tciPars,
    in TciValueTemplate parsTpl, in TciValueDifferenceList diffs,
    in Value addrValue, in TciValueTemplate addressTpl
);
void tliPrGetCallMismatch_c(
    in TString am, in TInteger ts, in TString src, in TInteger line,
    in TriComponentIdType c, in TriPortIdType at,
    in TriSignatureIdType signature, in TciParameterListType tciPars,
    in TciValueTemplate parsTpl, in TciValueDifferenceList diffs,
    in TriComponentIdType from, in TciNonValueTemplate fromTpl
);
void tliPrGetCall_m(
    in TString am, in TInteger ts, in TString src, in TInteger line,
    in TriComponentIdType c, in TriPortIdType at,
    in TriSignatureIdType signature, in TciParameterListType tciPars,
    in TciValueTemplate parsTpl, in Value addrValue,
    in TciValueTemplate addressTpl
);
void tliPrGetCall_c(
    in TString am, in TInteger ts, in TString src, in TInteger line,
    in TriComponentIdType c, in TriPortIdType at,

```



```

    in TriSignatureIdType signature, in TciParameterListType tciPars,
    in TciValueTemplate parsTpl, in TriComponentIdType from,
    in TciNonValueTemplate fromTpl
    );

void tliPrReply_m(
    in TString am, in TInteger ts, in TString src, in TInteger line,
    in TriComponentIdType c, in TriPortIdType at, in TriPortIdType to,
    in TriSignatureIdType signature, in TciParameterListType tciPars,
    in Value replValue, in Value addrValue,
    in TciStatusType encoderFailure, in TriParameterListType triPars,
    in TriParameterType repl, in TriAddressType address, in TriStatusType transmissionFailure
    );

void tliPrReply_m_BC(
    in TString am, in TInteger ts, in TString src, in TInteger line,
    in TriComponentIdType c, in TriPortIdType at, in TriPortIdType to,
    in TriSignatureIdType signature, in TciParameterListType tciPars, in Value replValue,
    in TciStatusType encoderFailure, in TriParameterListType triPars,
    in TriParameterType repl, in TriStatusType transmissionFailure
    );

void tliPrReply_m_MC(
    in TString am, in TInteger ts, in TString src, in TInteger line,
    in TriComponentIdType c, in TriPortIdType at, in TriPortIdType to,
    in TriSignatureIdType signature, in TciParameterListType tciPars, in Value replValue,
    in TciValueListType addrValues, in TciStatusType encoderFailure,
    in TriParameterListType triPars, in TriParameterType repl,
    in TriAddressListType addresses, in TriStatusType transmissionFailure
    );

void tliPrReply_c(
    in TString am, in TInteger ts, in TString src, in TInteger line,
    in TriComponentIdType c, in TriPortIdType at, in TriPortIdType to,
    in TriSignatureIdType signature, in TciParameterListType tciPars,
    in Value replValue, in TriStatusType transmissionFailure
    );

void tliPrReply_c_BC(
    in TString am, in TInteger ts, in TString src, in TInteger line,
    in TriComponentIdType c, in TriPortIdType at, in TriPortIdListType to,
    in TriSignatureIdType signature, in Value parsValue, in Value replValue,
    in TriStatusType transmissionFailure
    );

void tliPrReply_c_MC(
    in TString am, in TInteger ts, in TString src, in TInteger line,
    in TriComponentIdType c, in TriPortIdType at, in TriPortIdListType to,
    in TriSignatureIdType signature, in Value parsValue, in Value replValue,
    in TriStatusType transmissionFailure
    );

void tliPrGetReplyDetected_m(
    in TString am, in TInteger ts, in TString src, in TInteger line,
    in TriComponentIdType c, in TriPortIdType at, in TriPortIdType from,
    in TriSignatureIdType signature, in TriParameterListType triPars,
    in TriParameterType repl, in TriAddressType address
    );

void tliPrGetReplyDetected_c(
    in TString am, in TInteger ts, in TString src, in TInteger line,
    in TriComponentIdType c, in TriPortIdType at, in TriPortIdType from,
    in TriSignatureIdType signature, in TciParameterListType tciPars,
    in Value replValue
    );

void tliPrGetReplyMismatch_m(
    in TString am, in TInteger ts, in TString src, in TInteger line,
    in TriComponentIdType c, in TriPortIdType at,
    in TriSignatureIdType signature,
    in TciParameterListType tciPars, in TciValueTemplate parsTpl,
    in Value replValue, in TciValueTemplate replyTpl,
    in TciValueDifferenceList diffs, in Value addrValue,
    in TciValueTemplate addressTpl
    );

void tliPrGetReplyMismatch_c(
    in TString am, in TInteger ts, in TString src, in TInteger line,
    in TriComponentIdType c, in TriPortIdType at,
    in TriSignatureIdType signature,
    in TciParameterListType tciPars, in TciValueTemplate parsTpl,
    in Value replValue, in TciValueTemplate replyTpl,
    in TciValueDifferenceList diffs, in TriComponentIdType from,
    in TciNonValueTemplate fromTpl
    );

```

```

void tliPrGetReply_m(
    in TString am, in TInteger ts, in TString src, in TInteger line,
    in TriComponentIdType c, in TriPortIdType at,
    in TriSignatureIdType signature,
    in TciParameterListType tciPars, in TciValueTemplate parsTmpl,
    in Value replValue, in TciValueTemplate replyTmpl,
    in Value addrValue, in TciValueTemplate addressTmpl
);

void tliPrGetReply_c(
    in TString am, in TInteger ts, in TString src, in TInteger line,
    in TriComponentIdType c, in TriPortIdType at,
    in TriSignatureIdType signature,
    in TciParameterListType tciPars, in TciValueTemplate parsTmpl,
    in Value replValue, in TciValueTemplate replyTmpl,
    in TriComponentIdType from, in TciNonValueTemplate fromTmpl
);

void tliPrRaise_m(
    in TString am, in TInteger ts, in TString src, in TInteger line,
    in TriComponentIdType c, in TriPortIdType at, in TriPortIdType to,
    in TriSignatureIdType signature, in TciParameterListType tciPars,
    in Value excValue, in Value addrValue, in TciStatusType encoderFailure,
    in TriExceptionType exc, in TriAddressType address, in TriStatusType transmissionFailure
);

void tliPrRaise_m_BC(
    in TString am, in TInteger ts, in TString src, in TInteger line,
    in TriComponentIdType c, in TriPortIdType at, in TriPortIdType to,
    in TriSignatureIdType signature, in TciParameterListType tciPars,
    in Value excValue, in TciStatusType encoderFailure, in TriExceptionType exc,
    in TriStatusType transmissionFailure
);

void tliPrRaise_m_MC(
    in TString am, in TInteger ts, in TString src, in TInteger line,
    in TriComponentIdType c, in TriPortIdType at, in TriPortIdType to,
    in TriSignatureIdType signature, in TciParameterListType tciPars,
    in Value excValue, in TciValueListType addrValues,
    in TciStatusType encoderFailure, in TriExceptionType exc,
    in TriAddressListType addresses, in TriStatusType transmissionFailure
);

void tliPrRaise_c(
    in TString am, in TInteger ts, in TString src, in TInteger line,
    in TriComponentIdType c, in TriPortIdType at, in TriPortIdType to,
    in TriSignatureIdType signature, in TciParameterListType tciPars,
    in Value excValue, in TriStatusType transmissionFailure
);

void tliPrRaise_c_BC(
    in TString am, in TInteger ts, in TString src, in TInteger line,
    in TriComponentIdType c, in TriPortIdType at, in TriPortIdListType to,
    in TriSignatureIdType signature, in TciParameterListType tciPars,
    in Value excValue, in TriStatusType transmissionFailure
);

void tliPrRaise_c_MC(
    in TString am, in TInteger ts, in TString src, in TInteger line,
    in TriComponentIdType c, in TriPortIdType at, in TriPortIdListType to,
    in TriSignatureIdType signature, in TciParameterListType tciPars,
    in Value excValue, in TriStatusType transmissionFailure
);

void tliPrCatchDetected_m(
    in TString am, in TInteger ts, in TString src, in TInteger line,
    in TriComponentIdType c, in TriPortIdType at, in TriPortIdType from,
    in TriSignatureIdType signature,
    in TriExceptionType exc, in TriAddressType address
);

void tliPrCatchDetected_c(
    in TString am, in TInteger ts, in TString src, in TInteger line,
    in TriComponentIdType c, in TriPortIdType at, in TriPortIdType from,
    in TriSignatureIdType signature, in Value excValue
);

void tliPrCatchMismatch_m(
    in TString am, in TInteger ts, in TString src, in TInteger line,
    in TriComponentIdType c, in TriPortIdType at,
    in TriSignatureIdType signature,
    in Value excValue, in TciValueTemplate excTmpl,
    in TciValueDifferenceList diffs, in Value addrValue,
    in TciValueTemplate addressTmpl
);

```

```

void tliPrCatchMismatch_c(
    in TString am, in TInteger ts, in TString src, in TInteger line,
    in TriComponentIdType c, in TriPortIdType at,
    in TriSignatureIdType signature,
    in Value excValue, in TciValueTemplate excTmpl,
    in TciValueDifferenceList diffs, in TriComponentIdType from,
    in TciNonValueTemplate fromTmpl
);
void tliPrCatch_m(
    in TString am, in TInteger ts, in TString src, in TInteger line,
    in TriComponentIdType c, in TriPortIdType at,
    in TriSignatureIdType signature,
    in Value excValue, in TciValueTemplate excTmpl,
    in Value addrValue, in TciValueTemplate addressTmpl
);
void tliPrCatch_c(
    in TString am, in TInteger ts, in TString src, in TInteger line,
    in TriComponentIdType c, in TriPortIdType at,
    in TriSignatureIdType signature,
    in Value excValue, in TciValueTemplate excTmpl,
    in TriComponentIdType from, in TciNonValueTemplate fromTmpl
);
void tliPrCatchTimeoutDetected(
    in TString am, in TInteger ts, in TString src, in TInteger line,
    in TriComponentIdType c, in TriPortIdType at,
    in TriSignatureIdType signature
);
void tliPrCatchTimeout(
    in TString am, in TInteger ts, in TString src, in TInteger line,
    in TriComponentIdType c, in TriPortIdType at,
    in TriSignatureIdType signature
);
void tlicCreate(
    in TString am, in TInteger ts, in TString src, in TInteger line,
    in TriComponentIdType c, in TriComponentIdType comp,
    in TString name, in TBoolean alive
);
void tlicStart(
    in TString am, in TInteger ts, in TString src, in TInteger line,
    in TriComponentIdType c, in TriComponentIdType comp,
    in TciBehaviourIdType name, in TciParameterListType tciPars
);
void tlicRunning(
    in TString am, in TInteger ts, in TString src, in TInteger line,
    in TriComponentIdType c, in TriComponentIdType comp, in ComponentStatusType status
);
void tlicAlive(
    in TString am, in TInteger ts, in TString src, in TInteger line,
    in TriComponentIdType c,
    in TriComponentIdType comp, in ComponentStatusType status
);
void tlicStop(
    in TString am, in TInteger ts, in TString src, in TInteger line,
    in TriComponentIdType c, in TriComponentIdType comp
);
void tlicKill(
    in TString am, in TInteger ts, in TString src, in TInteger line,
    in TriComponentIdType c, in TriComponentIdType comp
);
void tlicDoneMismatch(
    in TString am, in TInteger ts, in TString src, in TInteger line,
    in TriComponentIdType c, in TriComponentIdType comp, in TciNonValueTemplate compTmpl
);
void tlicKilledMismatch(
    in TString am, in TInteger ts, in TString src, in TInteger line,
    in TriComponentIdType c, in TriComponentIdType comp, in TciNonValueTemplate compTmpl
);
void tlicDone(in TString am, in TInteger ts, in TString src, in TInteger line,
    in TriComponentIdType c, in TciNonValueTemplate compTmpl
);
void tlicKilled(
    in TString am, in TInteger ts, in TString src, in TInteger line,
    in TriComponentIdType c, in TciNonValueTemplate compTmpl
);
void tlicTerminated(
    in TString am, in TInteger ts, in TString src, in TInteger line,
    in TriComponentIdType c, in VerdictValue verdict, in TString reason
);

```

```

void tliPConnect(
    in TString am, in TInteger ts, in TString src, in TInteger line,
    in TriComponentIdType c, in TriPortIdType port1, in TriPortIdType port2
);
void tliPDisconnect(
    in TString am, in TInteger ts, in TString src, in TInteger line,
    in TriComponentIdType c, in TriPortIdType port1,
    in TriPortIdType port2
);
void tliPMap(
    in TString am, in TInteger ts, in TString src, in TInteger line,
    in TriComponentIdType c, in TriPortIdType port1, in TriPortIdType port2
);
void tliPUnmap(
    in TString am, in TInteger ts, in TString src, in TInteger line,
    in TriComponentIdType c, in TriPortIdType port1,
    in TriPortIdType port2
);
void tliPClear(
    in TString am, in TInteger ts, in TString src, in TInteger line,
    in TriComponentIdType c, in TriPortIdType port
);
void tliPStart(
    in TString am, in TInteger ts, in TString src, in TInteger line,
    in TriComponentIdType c, in TriPortIdType port
);
void tliPStop(
    in TString am, in TInteger ts, in TString src, in TInteger line,
    in TriComponentIdType c, in TriPortIdType port
);
void tliPHalt(
    in TString am, in TInteger ts, in TString src, in TInteger line,
    in TriComponentIdType c, in TriPortIdType port
);
void tliEncode(
    in TString am, in TInteger ts, in TString src, in TInteger line,
    in TriComponentIdType c, in Value val, in TciStatusType encoderFailure,
    in TriMessageType msg, in TString codec
);
void tliDecode(
    in TString am, in TInteger ts, in TString src, in TInteger line,
    in TriComponentIdType c, in TriMessageType msg,
    in TciStatusType decoderFailure, in Value val, in TString codec
);
void tliTimeoutDetected(
    in TString am, in TInteger ts, in TString src, in TInteger line,
    in TriComponentIdType c, in TriTimerIdType timer
);
void tliTimeoutMismatch(
    in TString am, in TInteger ts, in TString src, in TInteger line,
    in TriComponentIdType c, in TriTimerIdType timer, in TciNonValueTemplate timerTpl
);
void tliTimeout(
    in TString am, in TInteger ts, in TString src, in TInteger line,
    in TriComponentIdType c, in TriTimerIdType timer, in TciNonValueTemplate timerTpl
);
void tliTStart(
    in TString am, in TInteger ts, in TString src, in TInteger line,
    in TriComponentIdType c, in TriTimerIdType timer,
    in TriTimerDurationType dur
);
void tliTStop(
    in TString am, in TInteger ts, in TString src, in TInteger line,
    in TriComponentIdType c, in TriTimerIdType timer, in TriTimerDurationType dur
);
void tliTRead(
    in TString am, in TInteger ts, in TString src, in TInteger line,
    in TriComponentIdType c, in TriTimerIdType timer,
    in TriTimerDurationType elapsed
);
void tliTRunning(
    in TString am, in TInteger ts, in TString src, in TInteger line,
    in TriComponentIdType c, in TriTimerIdType timer, in TimerStatusType status
);

```

```

void tliSEnter(
    in TString am, in TInteger ts, in TString src, in TInteger line,
    in TriComponentIdType c, in QualifiedName name, in TciParameterListType tciPars,
    in TString kind
);
void tliSLeave(
    in TString am, in TInteger ts, in TString src, in TInteger line,
    in TriComponentIdType c, in QualifiedName name, in TciParameterListType tciPars,
    in Value returnValue, in TString kind
);
void tliVar(
    in TString am, in TInteger ts, in TString src, in TInteger line,
    in TriComponentIdType c, in QualifiedName name, in Value varValue
);
void tliModulePar(
    in TString am, in TInteger ts, in TString src, in TInteger line,
    in TriComponentIdType c, in QualifiedName name, in Value parValue
);
void tliGetVerdict(
    in TString am, in TInteger ts, in TString src, in TInteger line,
    in TriComponentIdType c, in VerdictValue verdict
);
void tliSetVerdict(
    in TString am, in TInteger ts, in TString src, in TInteger line,
    in TriComponentIdType c, in VerdictValue verdict, in TString reason
);
void tliLog(
    in TString am, in TInteger ts, in TString src, in TInteger line,
    in TriComponentIdType c, in TString log
);
void tliAEnter(
    in TString am, in TInteger ts, in TString src, in TInteger line,
    in TriComponentIdType c
);
void tliALeave(
    in TString am, in TInteger ts, in TString src, in TInteger line,
    in TriComponentIdType c
);
void tliADefaults(
    in TString am, in TInteger ts, in TString src, in TInteger line,
    in TriComponentIdType c
);
void tliAActivate(
    in TString am, in TInteger ts, in TString src, in TInteger line,
    in TriComponentIdType c, in QualifiedName name, in TciParameterListType tciPars,
    in Value ref
);
void tliAdeactivate(
    in TString am, in TInteger ts, in TString src, in TInteger line,
    in TriComponentIdType c, in Value ref
);
void tliANomatch(
    in TString am, in TInteger ts, in TString src, in TInteger line,
    in TriComponentIdType c
);
void tliARepeat(
    in TString am, in TInteger ts, in TString src, in TInteger line,
    in TriComponentIdType c
);
void tliAwait(
    in TString am, in TInteger ts, in TString src, in TInteger line,
    in TriComponentIdType c
);
void tliAction(
    in TString am, in TInteger ts, in TString src, in TInteger line,
    in TriComponentIdType c, in TString action
);
void tliMatch(
    in TString am, in TInteger ts, in TString src, in TInteger line,
    in TriComponentIdType c, in Value expr, in TciValueTemplate tpl
);
void tliMatchMismatch(
    in TString am, in TInteger ts, in TString src,
    in TInteger line, in TriComponentIdType c, in Value expr,
    in TciValueTemplate tpl, in TciValueDifferenceList diffs
);

```

```

void tliInfo(
    in TString am, in TInteger ts, in TString src,
    in TInteger line, in TriComponentIdType c,
    in TInteger level, in TString info
);
void tliMChecked_m(
    in TString am, in TInteger ts,
    in TString src, in TInteger line, in TriComponentIdType c,
    in TriPortIdType at,
    in Value msgValue, in TciValueTemplate msgTpl,
    in Value addrValue, in TciValueTemplate addressTpl
);
void tliMChecked_c(
    in TString am, in TInteger ts,
    in TString src, in TInteger line, in TriComponentIdType c,
    in TriPortIdType at,
    in Value msgValue in TciValueTemplate msgTpl,
    in TriComponentIdType from, in TciNonValueTemplate fromTpl
);
void tliPrGetCallChecked_m(
    in TString am, in TInteger ts,
    in TString src,
    in TInteger line, in TriComponentIdType c,
    in TriPortIdType at,
    in TriSignatureIdType signature,
    in TciParameterListType tciPars, in TciValueTemplate parsTpl,
    in Value addrValue, in TciValueTemplate addressTpl
);
void tliPrGetCallChecked_c(
    in TString am, in TInteger ts,
    in TString src,
    in TInteger line, in TriComponentIdType c,
    in TriPortIdType at,
    in TriSignatureIdType signature,
    in TciParameterListType tciPars, in TciValueTemplate parsTpl,
    in TriComponentIdType from, in TciNonValueTemplate fromTpl
);
void tliPrGetReplyChecked_m(
    in TString am, in TInteger ts,
    in TString src,
    in TInteger line, in TriComponentIdType c,
    in TriPortIdType at,
    in TriSignatureIdType signature,
    in TciParameterListType tciPars, in TciValueTemplate parsTpl,
    in Value replValue, in TciValueTemplate replyTpl,
    in Value addrValue, in TciValueTemplate addressTpl
);
void tliPrGetReplyChecked_c(
    in TString am, in TInteger ts,
    in TString src,
    in TInteger line, in TriComponentIdType c,
    in TriPortIdType at,
    in TriSignatureIdType signature,
    in TciParameterListType tciPars, in TciValueTemplate parsTpl,
    in Value replValue, in TciValueTemplate replyTpl,
    in TriComponentIdType from, in TciNonValueTemplate fromTpl
);
void tliPrCatchChecked_m(
    in TString am, in TInteger ts,
    in TString src,
    in TInteger line, in TriComponentIdType c,
    in TriPortIdType at,
    in TriSignatureIdType signature,
    in Value excValue, in TciValueTemplate excTpl,
    in Value addrValue, in TciValueTemplate addressTpl
);
void tliPrCatchChecked_c(
    in TString am, in TInteger ts,
    in TString src,
    in TInteger line, in TriComponentIdType c,
    in TriPortIdType at,
    in TriSignatureIdType signature,
    in Value excValue, in TciValueTemplate excTpl,
    in TriComponentIdType from, in TciNonValueTemplate fromTpl
);
void tliCheckedAny_m(
    in TString am, in TInteger ts,
    in TString src, in TInteger line, in TriComponentIdType c,

```

```

        in TriPortIdType at,
        in Value addrValue,
        in TciValueTemplate addressTpl
    );
void tliCheckedAny_c(
    in TString am, in TInteger ts,
    in TString src, in TInteger line, in TriComponentIdType c,
    in TriPortIdType at,
    in TriComponentIdType from,
    in TciNonValueTemplate fromTpl
);
void tliCheckAnyMismatch_m(
    in TString am, in TInteger ts,
    in TString src, in TInteger line, in TriComponentIdType c,
    in TriPortIdType at,
    in Value addrValue,
    in TciValueTemplate addressTpl
);
void tliCheckAnyMismatch_c(
    in TString am, in TInteger ts,
    in TString src, in TInteger line, in TriComponentIdType c,
    in TriPortIdType at,
    in TriComponentIdType from,
    in TciNonValueTemplate fromTpl
);
void tliRnd(
    in TString am, in TInteger ts,
    in TString src, in TInteger line, in TriComponentIdType c,
    in FloatValue val, in FloatValue seed
);
};
void tliEvaluate(
    in TString am, in TInteger ts,
    in TString src, in TInteger line, in TriComponentIdType c,
    in QualifiedName name, in Value evalResult
);
void tliCCall(
    in TString am, in TInteger ts,
    in TString src, in TInteger line, in TriComponentIdType c,
    in TciBehaviourIdType name, in TciParameterListType tciPars
);
void tliCCallTerminated(
    in TString am, in TInteger ts,
    in TString src, in TInteger line, in TriComponentIdType c,
    in VerdictValue verdict, in TString reason,
    in TciParameterListType tciPars, in Value returnValue
);
void tliCtrlStartWithParameters (
    in TString am, in TInteger ts, in TString src, in TInteger line,
    in TriComponentIdType c, in TciParameterListType tciPars
);
void tliCtrlTerminatedWithResult (
    in TString am, in TInteger ts, in TString src, in TInteger line,
    in TriComponentIdType c, in Value result, in TciParameterListType tciPars);
};

```

# Annex B (normative): XML Mapping for TCI TL Provided

## B.0 Introduction

This annex defines a mapping for the logging interface of TCI using eXtended Markup Language (XML) schema definitions.

## B.1 TCI-TL XML Schema for Simple Types

```
<?xml version="1.0" encoding="UTF-8"?>
<xsd:schema xmlns:xsd="http://www.w3.org/2001/XMLSchema"
  targetNamespace="http://uri.etsi.org/ttcn-3/tci/SimpleTypes_v4_10_1.xsd"
  xmlns:SimpleTypes="http://uri.etsi.org/ttcn-3/tci/SimpleTypes_v4_10_1.xsd"
  elementFormDefault="qualified">

  <!-- Basic definitions -->
  <xsd:simpleType name="xpath">
    <!-- this string should be XPATH compliant -->
    <xsd:restriction base="xsd:string"/>
  </xsd:simpleType>

  <xsd:simpleType name="TBoolean">
    <xsd:restriction base="xsd:boolean"/>
  </xsd:simpleType>

  <xsd:simpleType name="TString">
    <xsd:restriction base="xsd:string"/>
  </xsd:simpleType>

  <xsd:simpleType name="TInteger">
    <xsd:restriction base="xsd:integer"/>
  </xsd:simpleType>

  <!-- Miscellaneous -->
  <xsd:simpleType name="TriTimerDurationType">
    <xsd:restriction base="xsd:float"/>
  </xsd:simpleType>

  <xsd:simpleType name="TciParameterPassingModeType">
    <xsd:restriction base="xsd:string">
      <xsd:enumeration value="in"/>
      <xsd:enumeration value="inout"/>
      <xsd:enumeration value="out"/>
    </xsd:restriction>
  </xsd:simpleType>

  <xsd:simpleType name="TriStatusType">
    <xsd:restriction base="xsd:string">
      <xsd:enumeration value="TRI_Ok"/>
      <xsd:enumeration value="TRI_Error"/>
    </xsd:restriction>
  </xsd:simpleType>

  <xsd:simpleType name="TciStatusType">
    <xsd:restriction base="xsd:string">
      <xsd:enumeration value="TCI_Ok"/>
      <xsd:enumeration value="TCI_Error"/>
    </xsd:restriction>
  </xsd:simpleType>

  <xsd:simpleType name="ComponentStatusType">
    <xsd:restriction base="xsd:string">
      <xsd:enumeration value="inactiveC"/>
      <xsd:enumeration value="runningC"/>
      <xsd:enumeration value="stoppedC"/>
      <xsd:enumeration value="killedC"/>
      <xsd:enumeration value="nullC"/>
    </xsd:restriction>
  </xsd:simpleType>
</xsd:schema>
```



```

    </xsd:restriction>
</xsd:simpleType>

<xsd:simpleType name="TimerStatusType">
  <xsd:restriction base="xsd:string">
    <xsd:enumeration value="runningT"/>
    <xsd:enumeration value="inactiveT"/>
    <xsd:enumeration value="expiredT"/>
    <xsd:enumeration value="nullT"/>
  </xsd:restriction>
</xsd:simpleType>

<xsd:simpleType name="PortStatusType">
  <xsd:restriction base="xsd:string">
    <xsd:enumeration value="startedP"/>
    <xsd:enumeration value="haltedP"/>
    <xsd:enumeration value="stoppedP"/>
  </xsd:restriction>
</xsd:simpleType>

<xsd:complexType name="TEmpty" />

</xsd:schema>

```

---

## B.2 TCI-TL XML Schema for Types

```

<?xml version="1.0" encoding="UTF-8"?>
<xsd:schema xmlns:xsd="http://www.w3.org/2001/XMLSchema"
  targetNamespace="http://uri.etsi.org/ttcn-3/tci/Types_v4_10_1.xsd"
  xmlns:Types="http://uri.etsi.org/ttcn-3/tci/Types_v4_10_1.xsd"
  xmlns:SimpleTypes="http://uri.etsi.org/ttcn-3/tci/SimpleTypes_v4_10_1.xsd"
  xmlns:Values="http://uri.etsi.org/ttcn-3/tci/Values_v4_10_1.xsd"
  xmlns:Templates="http://uri.etsi.org/ttcn-3/tci/Templates_v4_10_1.xsd"
  elementFormDefault="qualified">

  <xsd:import namespace="http://uri.etsi.org/ttcn-3/tci/Values_v4_10_1.xsd"
    schemaLocation="Values_v4_10_1.xsd"/>
  <xsd:import namespace="http://uri.etsi.org/ttcn-3/tci/SimpleTypes_v4_10_1.xsd"
    schemaLocation="SimpleTypes_v4_10_1.xsd"/>
  <xsd:import namespace="http://uri.etsi.org/ttcn-3/tci/Templates_v4_10_1.xsd"
    schemaLocation="Templates_v4_10_1.xsd"/>

  <!-- Connection -->
  <xsd:complexType name="TriPortIdType">
    <xsd:sequence>
      <xsd:element name="comp" type="Types:TriComponentIdType" />
      <xsd:element name="port" type="Types:Port" />
    </xsd:sequence>
  </xsd:complexType>

  <xsd:complexType name="TriPortIdListType">
    <xsd:sequence>
      <xsd:element name="port" type="Types:TriPortIdType" minOccurs="0"
        maxOccurs="unbounded"/>
    </xsd:sequence>
  </xsd:complexType>

  <xsd:complexType name="Port">
    <xsd:sequence>
      <xsd:element name="id" type="Types:Id" />
      <xsd:element name="index" type="xsd:int" minOccurs="0" />
    </xsd:sequence>
  </xsd:complexType>

  <xsd:complexType name="TriComponentIdType">
    <xsd:sequence>
      <xsd:choice>
        <xsd:element name="null" type="Templates:null"/>
        <xsd:element name="id" type="Types:Id" />
      </xsd:choice>
    </xsd:sequence>
  </xsd:complexType>

  <xsd:complexType name="TriComponentIdListType">
    <xsd:sequence>

```

```

        <xsd:element name="comp" type="Types:TriComponentIdType" minOccurs="0"
          maxOccurs="unbounded" />
      </xsd:sequence>
    </xsd:complexType>

    <!-- Communication -->
    <xsd:complexType name="TriMessageType">
      <xsd:attribute name="val" type="xsd:hexBinary" />
      <xsd:attribute name="paddingBits" type="xsd:integer" use="optional" default="0" />
    </xsd:complexType>

    <xsd:complexType name="TriParameterType">
      <xsd:attribute name="val" type="xsd:hexBinary" />
      <xsd:attribute name="paddingBits" type="xsd:integer" use="optional" default="0" />
      <xsd:attribute name="name" type="SimpleTypes:TString" />
      <xsd:attribute name="mode" type="SimpleTypes:TciParameterPassingModeType" />
    </xsd:complexType>

    <xsd:complexType name="TriParameterListType">
      <xsd:sequence>
        <xsd:element name="par" type="Types:TriParameterType" minOccurs="0"
          maxOccurs="unbounded" />
      </xsd:sequence>
    </xsd:complexType>

    <xsd:complexType name="TriExceptionType">
      <xsd:attribute name="val" type="xsd:hexBinary" />
    </xsd:complexType>

    <xsd:complexType name="TciValueListType">
      <xsd:complexContent>
        <xsd:extension base="Values:RecordValue" />
      </xsd:complexContent>
    </xsd:complexType>

    <xsd:complexType name="TriSignatureIdType">
      <xsd:attribute name="val" type="SimpleTypes:TString" use="required" />
    </xsd:complexType>

    <xsd:complexType name="TriAddressType">
      <xsd:attribute name="val" type="xsd:hexBinary" />
      <xsd:attribute name="paddingBits" type="xsd:integer" use="optional" default="0" />
    </xsd:complexType>

    <xsd:complexType name="TriAddressListType">
      <xsd:sequence>
        <xsd:element name="addr" type="Types:TriAddressType" minOccurs="0"
          maxOccurs="unbounded" />
      </xsd:sequence>
    </xsd:complexType>

    <!-- Miscellaneous -->
    <xsd:complexType name="TriTimerIdType">
      <xsd:sequence>
        <xsd:element name="id" type="Types:Id" />
      </xsd:sequence>
    </xsd:complexType>

    <!-- Basic definitions -->
    <xsd:complexType name="QualifiedName">
      <xsd:attribute name="moduleName" type="SimpleTypes:TString" use="required" />
      <xsd:attribute name="baseName" type="SimpleTypes:TString" use="required" />
    </xsd:complexType>

    <!-- general TCI abstract data types -->
    <xsd:complexType name="TciBehaviourIdType">
      <xsd:sequence>
        <xsd:element name="name" type="Types:QualifiedName" />
      </xsd:sequence>
    </xsd:complexType>

    <xsd:complexType name="TciTestCaseIdType">
      <xsd:sequence>
        <xsd:element name="name" type="Types:QualifiedName" />
      </xsd:sequence>
    </xsd:complexType>

```

```

<xsd:complexType name="TciParameterType">
  <xsd:sequence>
    <xsd:element name="val" type="Values:Value" />
  </xsd:sequence>
  <xsd:attribute name="name" type="SimpleTypes:TString"/>
  <xsd:attribute name="mode" type="SimpleTypes:TciParameterPassingModeType"/>
</xsd:complexType>

<xsd:complexType name="TciParameterListType">
  <xsd:sequence>
    <xsd:element name="par" type="Types:TciParameterType" minOccurs="0"
maxOccurs="unbounded"/>
  </xsd:sequence>
</xsd:complexType>

<!-- general identifier structure for test components, ports and timer -->
<xsd:complexType name="Id">
  <xsd:sequence>
    <xsd:element name="name" type="SimpleTypes:TString" />
    <xsd:element name="id" type="SimpleTypes:TString" minOccurs="0"/>
    <xsd:element name="type" type="SimpleTypes:TString" minOccurs="0"/>
  </xsd:sequence>
</xsd:complexType>

</xsd:schema>

```

---

## B.3 TCI-TL XML Schema for Values

```

<?xml version="1.0" encoding="UTF-8"?>
<xsd:schema xmlns:xsd="http://www.w3.org/2001/XMLSchema"
  targetNamespace="http://uri.etsi.org/ttcn-3/tci/Values_v4_10_1.xsd"
  xmlns:Values="http://uri.etsi.org/ttcn-3/tci/Values_v4_10_1.xsd"
  xmlns:Templates="http://uri.etsi.org/ttcn-3/tci/Templates_v4_10_1.xsd"
  xmlns:SimpleTypes="http://uri.etsi.org/ttcn-3/tci/SimpleTypes_v4_10_1.xsd"
  elementFormDefault="qualified">

  <xsd:import namespace="http://uri.etsi.org/ttcn-3/tci/Templates_v4_10_1.xsd"
    schemaLocation="Templates_v4_10_1.xsd"/>
  <xsd:import namespace="http://uri.etsi.org/ttcn-3/tci/SimpleTypes_v4_10_1.xsd"
    schemaLocation="SimpleTypes_v4_10_1.xsd"/>

  <xsd:simpleType name="ValueModifier">
    <xsd:restriction base="SimpleTypes:TString">
      <xsd:enumeration value="lazy"/>
      <xsd:enumeration value="fuzzy"/>
    </xsd:restriction>
  </xsd:simpleType>

  <xsd:attributeGroup name="ValueAtts">
    <xsd:attribute name="name" type="SimpleTypes:TString" use="optional"/>
    <xsd:attribute name="type" type="SimpleTypes:TString" use="optional"/>
    <xsd:attribute name="module" type="SimpleTypes:TString" use="optional"/>
    <xsd:attribute name="modifier" type="Values:ValueModifier" use="optional"/>
    <xsd:attribute name="annotation" type="SimpleTypes:TString" use="optional"/>
  </xsd:attributeGroup>

  <xsd:group name="BaseValue">
    <xsd:choice>
      <xsd:sequence>
        <xsd:choice>
          <xsd:element name="value" type="SimpleTypes:TString"/>
          <xsd:element name="matching_symbol" type="Templates:MatchingSymbol"/>
        </xsd:choice>
        <xsd:element name="ifpresent" type="SimpleTypes:TEmpty" minOccurs="0"/>
        <xsd:element name="length" type="Values:LengthRestriction" minOccurs="0"/>
      </xsd:sequence>
      <xsd:element name="null" type="SimpleTypes:TEmpty"/>
      <xsd:element name="omit" type="SimpleTypes:TEmpty"/>
      <xsd:element name="not_evaluated" type="SimpleTypes:TEmpty"/>
    </xsd:choice>
  </xsd:group>

  <xsd:group name="Value">
    <xsd:choice>
      <xsd:element name="integer" type="Values:IntegerValue"/>

```

```

<xsd:element name="float" type="Values:FloatValue"/>
<xsd:element name="boolean" type="Values:BooleanValue"/>
<xsd:element name="verdicttype" type="Values:VerdictValue"/>
<xsd:element name="bitstring" type="Values:BitstringValue"/>
<xsd:element name="hexstring" type="Values:HexstringValue"/>
<xsd:element name="octetstring" type="Values:OctetstringValue"/>
<xsd:element name="charstring" type="Values:CharstringValue"/>
<xsd:element name="universal_charstring" type="Values:UniversalCharstringValue"/>
<xsd:element name="record" type="Values:RecordValue"/>
<xsd:element name="record_of" type="Values:RecordOfValue"/>
<xsd:element name="set" type="Values:SetValue"/>
<xsd:element name="set_of" type="Values:SetOfValue"/>
<xsd:element name="enumerated" type="Values:EnumeratedValue"/>
<xsd:element name="union" type="Values:UnionValue"/>
<xsd:element name="anytype" type="Values:AnytypeValue"/>
<xsd:element name="address" type="Values:AddressValue"/>
<xsd:element name="component" type="Values:ComponentValue"/>
<xsd:element name="port" type="Values:PortValue"/>
<xsd:element name="default" type="Values:DefaultValue"/>
<xsd:element name="timer" type="Values:TimerValue"/>
</xsd:choice>
</xsd:group>

<xsd:group name="Values">
  <xsd:choice>
    <xsd:sequence>
      <xsd:choice>
        <xsd:element name="integer" type="Values:IntegerValue" minOccurs="0"
          maxOccurs="unbounded"/>
        <xsd:element name="float" type="Values:FloatValue" minOccurs="0"
          maxOccurs="unbounded"/>
        <xsd:element name="boolean" type="Values:BooleanValue" minOccurs="0"
          maxOccurs="unbounded"/>
        <xsd:element name="bitstring" type="Values:BitstringValue"
          minOccurs="0" maxOccurs="unbounded"/>
        <xsd:element name="hexstring" type="Values:HexstringValue"
          minOccurs="0" maxOccurs="unbounded"/>
        <xsd:element name="octetstring" type="Values:OctetstringValue"
          minOccurs="0" maxOccurs="unbounded"/>
        <xsd:element name="charstring" type="Values:CharstringValue"
          minOccurs="0" maxOccurs="unbounded"/>
        <xsd:element name="universal_charstring"
          type="Values:UniversalCharstringValue" minOccurs="0"
          maxOccurs="unbounded"/>
        <xsd:element name="record" type="Values:RecordValue" minOccurs="0"
          maxOccurs="unbounded"/>
        <xsd:element name="record_of" type="Values:RecordOfValue"
          minOccurs="0" maxOccurs="unbounded"/>
        <xsd:element name="set" type="Values:SetValue" minOccurs="0"
          maxOccurs="unbounded"/>
        <xsd:element name="set_of" type="Values:SetOfValue"
          minOccurs="0" maxOccurs="unbounded"/>
        <xsd:element name="enumerated" type="Values:EnumeratedValue"
          minOccurs="0" maxOccurs="unbounded"/>
        <xsd:element name="union" type="Values:UnionValue" minOccurs="0"
          maxOccurs="unbounded"/>
        <xsd:element name="anytype" type="Values:AnytypeValue" minOccurs="0"
          maxOccurs="unbounded"/>
        <xsd:element name="address" type="Values:AddressValue" minOccurs="0"
          maxOccurs="unbounded"/>
        <xsd:element name="component" type="Values:ComponentValue" minOccurs="0"
          maxOccurs="unbounded"/>
        <xsd:element name="port" type="Values:PortValue" minOccurs="0"
          maxOccurs="unbounded"/>
        <xsd:element name="default" type="Values:DefaultValue" minOccurs="0"
          maxOccurs="unbounded"/>
        <xsd:element name="timer" type="Values:TimerValue" minOccurs="0"
          maxOccurs="unbounded"/>
        <xsd:element name="matching_symbol" type="Templates:MatchingSymbol"/>
      </xsd:choice>
      <xsd:element name="ifpresent" type="SimpleTypes:TEmpty" minOccurs="0"/>
      <xsd:element name="length" type="Values:LengthRestriction" minOccurs="0"/>
    </xsd:sequence>
    <xsd:element name="null" type="SimpleTypes:TEmpty"/>
    <xsd:element name="omit" type="SimpleTypes:TEmpty"/>
    <xsd:element name="not_evaluated" type="SimpleTypes:TEmpty"/>
  </xsd:choice>
</xsd:group>

```

```

<xsd:complexType name="Value" mixed="true">
  <xsd:group ref="Values:Value" />    <xsd:attributeGroup ref="Values:ValueAtts" />
</xsd:complexType>

<xsd:complexType name="LengthRestriction">
  <xsd:sequence>
    <xsd:element name="lower" type="SimpleTypes:TInteger" />
    <xsd:element name="upper" type="SimpleTypes:TInteger" minOccurs="0" />
  </xsd:sequence>
</xsd:complexType>

<xsd:complexType name="Value" mixed="true">
  <xsd:group ref="Values:Value" />
  <xsd:attributeGroup ref="Values:ValueAtts" />
</xsd:complexType>

<!-- general event elements -->
<xsd:complexType name="IntegerValue">
  <xsd:group ref="Values:BaseValue" />
  <xsd:attributeGroup ref="Values:ValueAtts" />
</xsd:complexType>

<xsd:complexType name="FloatValue">
  <xsd:group ref="Values:BaseValue" />
  <xsd:attributeGroup ref="Values:ValueAtts" />
</xsd:complexType>

<xsd:complexType name="BooleanValue">
  <xsd:group ref="Values:BaseValue" />
  <xsd:attributeGroup ref="Values:ValueAtts" />
</xsd:complexType>

<xsd:complexType name="VerdictValue">
  <xsd:group ref="Values:BaseValue" />
  <xsd:attributeGroup ref="Values:ValueAtts" />
</xsd:complexType>

<xsd:complexType name="BitstringValue">
  <xsd:group ref="Values:BaseValue" />
  <xsd:attributeGroup ref="Values:ValueAtts" />
</xsd:complexType>

<xsd:complexType name="HexstringValue">
  <xsd:group ref="Values:BaseValue" />
  <xsd:attributeGroup ref="Values:ValueAtts" />
</xsd:complexType>

<xsd:complexType name="OctetstringValue">
  <xsd:group ref="Values:BaseValue" />
  <xsd:attributeGroup ref="Values:ValueAtts" />
</xsd:complexType>

<xsd:complexType name="CharstringValue">
  <xsd:group ref="Values:BaseValue" />
  <xsd:attributeGroup ref="Values:ValueAtts" />
</xsd:complexType>

<xsd:complexType name="UniversalCharstringValue">
  <xsd:group ref="Values:BaseValue" />
  <xsd:attributeGroup ref="Values:ValueAtts" />
</xsd:complexType>

<xsd:complexType name="RecordValue">
  <xsd:choice>
    <xsd:sequence>
      <xsd:choice>
        <xsd:group ref="Values:Value" minOccurs="0" maxOccurs="unbounded" />
        <xsd:element name="matching_symbol" type="Templates:MatchingSymbol" />
      </xsd:choice>
      <xsd:element name="ifpresent" type="SimpleTypes:TEmpty" minOccurs="0" />
    </xsd:sequence>
    <xsd:element name="null" type="SimpleTypes:TEmpty" />
    <xsd:element name="omit" type="SimpleTypes:TEmpty" />
    <xsd:element name="not_evaluated" type="SimpleTypes:TEmpty" />
  </xsd:choice>
  <xsd:attributeGroup ref="Values:ValueAtts" />

```

```

</xsd:complexType>

<xsd:complexType name="RecordOfValue">
  <xsd:group ref="Values:Values"/>
  <xsd:attributeGroup ref="Values:ValueAtts"/>
</xsd:complexType>

<xsd:complexType name="ArrayValue">
  <xsd:group ref="Values:Values"/>
  <xsd:attributeGroup ref="Values:ValueAtts"/>
</xsd:complexType>

<xsd:complexType name="SetValue">
  <xsd:choice>
    <xsd:sequence>
      <xsd:choice>
        <xsd:group ref="Values:Value" minOccurs="0" maxOccurs="unbounded"/>
        <xsd:element name="matching_symbol" type="Templates:MatchingSymbol"/>
      </xsd:choice>
      <xsd:element name="ifpresent" type="SimpleTypes:TEEmpty" minOccurs="0"/>
    </xsd:sequence>
    <xsd:element name="null" type="SimpleTypes:TEEmpty"/>
    <xsd:element name="omit" type="SimpleTypes:TEEmpty"/>
    <xsd:element name="not_evaluated" type="SimpleTypes:TEEmpty"/>
  </xsd:choice>
  <xsd:attributeGroup ref="Values:ValueAtts"/>
</xsd:complexType>

<xsd:complexType name="SetOfValue">
  <xsd:group ref="Values:Values"/>
  <xsd:attributeGroup ref="Values:ValueAtts"/>
</xsd:complexType>

<xsd:complexType name="EnumeratedValue">
  <xsd:group ref="Values:BaseValue"/>
  <xsd:attributeGroup ref="Values:ValueAtts"/>
</xsd:complexType>

<xsd:complexType name="UnionValue">
  <xsd:choice>
    <xsd:sequence>
      <xsd:choice>
        <xsd:group ref="Values:Value"/>
        <xsd:element name="matching_symbol" type="Templates:MatchingSymbol"/>
      </xsd:choice>
      <xsd:element name="ifpresent" type="SimpleTypes:TEEmpty" minOccurs="0"/>
    </xsd:sequence>
    <xsd:element name="null" type="SimpleTypes:TEEmpty"/>
    <xsd:element name="omit" type="SimpleTypes:TEEmpty"/>
    <xsd:element name="not_evaluated" type="SimpleTypes:TEEmpty"/>
  </xsd:choice>
  <xsd:attributeGroup ref="Values:ValueAtts"/>
</xsd:complexType>

<xsd:complexType name="AnytypeValue">
  <xsd:choice>
    <xsd:sequence>
      <xsd:choice>
        <xsd:group ref="Values:Value"/>
        <xsd:element name="matching_symbol" type="Templates:MatchingSymbol"/>
      </xsd:choice>
      <xsd:element name="ifpresent" type="SimpleTypes:TEEmpty" minOccurs="0"/>
    </xsd:sequence>
    <xsd:element name="null" type="SimpleTypes:TEEmpty"/>
    <xsd:element name="omit" type="SimpleTypes:TEEmpty"/>
    <xsd:element name="not_evaluated" type="SimpleTypes:TEEmpty"/>
  </xsd:choice>
  <xsd:attributeGroup ref="Values:ValueAtts"/>
</xsd:complexType>

<xsd:complexType name="AddressValue">
  <xsd:group ref="Values:Value"/>
  <xsd:attributeGroup ref="Values:ValueAtts"/>
</xsd:complexType>

<xsd:complexType name="ComponentValue">
  <xsd:group ref="Values:BaseValue"/>
  <xsd:attributeGroup ref="Values:ValueAtts"/>

```

```

</xsd:complexType>

<xsd:complexType name="PortValue">
  <xsd:choice>
    <xsd:element name="value" type="SimpleTypes:TString"/>
    <xsd:element name="null" type="SimpleTypes:TEmpy"/>
    <xsd:element name="omit" type="SimpleTypes:TEmpy"/>
  </xsd:choice>
  <xsd:attributeGroup ref="Values:ValueAtts"/>
</xsd:complexType>

<xsd:complexType name="DefaultValue">
  <xsd:choice>
    <xsd:element name="value" type="SimpleTypes:TString"/>
    <xsd:element name="null" type="SimpleTypes:TEmpy"/>
    <xsd:element name="omit" type="SimpleTypes:TEmpy"/>
    <xsd:element name="not_evaluated" type="SimpleTypes:TEmpy"/>
  </xsd:choice>
  <xsd:attributeGroup ref="Values:ValueAtts"/>
</xsd:complexType>

<xsd:complexType name="TimerValue">
  <xsd:choice>
    <xsd:element name="value" type="SimpleTypes:TString"/>
    <xsd:element name="null" type="SimpleTypes:TEmpy"/>
    <xsd:element name="omit" type="SimpleTypes:TEmpy"/>
  </xsd:choice>
  <xsd:attributeGroup ref="Values:ValueAtts"/>
</xsd:complexType>
</xsd:schema>

```

---

## B.4 TCI-TL XML Schema for Templates

```

<?xml version="1.0" encoding="UTF-8"?>
<xsd:schema xmlns:xsd="http://www.w3.org/2001/XMLSchema"
  targetNamespace="http://uri.etsi.org/ttcn-3/tci/Templates_v4_10_1.xsd"
  xmlns:Templates="http://uri.etsi.org/ttcn-3/tci/Templates_v4_10_1.xsd"
  xmlns:Values="http://uri.etsi.org/ttcn-3/tci/Values_v4_10_1.xsd"
  xmlns:SimpleTypes="http://uri.etsi.org/ttcn-3/tci/SimpleTypes_v4_10_1.xsd"
  elementFormDefault="qualified">

  <xsd:import namespace="http://uri.etsi.org/ttcn-3/tci/Values_v4_10_1.xsd"
    schemaLocation="Values_v4_10_1.xsd"/>
  <xsd:import namespace="http://uri.etsi.org/ttcn-3/tci/SimpleTypes_v4_10_1.xsd"
    schemaLocation="SimpleTypes_v4_10_1.xsd"/>

  <xsd:group name="TypedTemplate">
    <xsd:choice>
      <xsd:element name="integer" type="Templates:SimpleTemplate"/>
      <xsd:element name="float" type="Templates:SimpleTemplate"/>
      <xsd:element name="boolean" type="Templates:SimpleTemplate"/>
      <xsd:element name="verdictttype" type="Templates:SimpleTemplate"/>
      <xsd:element name="bitstring" type="Templates:SimpleTemplate"/>
      <xsd:element name="hexstring" type="Templates:SimpleTemplate"/>
      <xsd:element name="octetstring" type="Templates:SimpleTemplate"/>
      <xsd:element name="charstring" type="Templates:SimpleTemplate"/>
      <xsd:element name="universal_charstring" type="Templates:SimpleTemplate"/>
      <xsd:element name="record" type="Templates:RecordTemplate"/>
      <xsd:element name="record_of" type="Templates:RecordOfTemplate"/>
      <xsd:element name="array" type="Templates:RecordOfTemplate"/>
      <xsd:element name="set" type="Templates:RecordTemplate"/>
      <xsd:element name="set_of" type="Templates:RecordOfTemplate"/>
      <xsd:element name="enumerated" type="Templates:SimpleTemplate"/>
      <xsd:element name="union" type="Templates:UnionTemplate"/>
      <xsd:element name="anytype" type="Templates:AnytypeTemplate"/>
      <xsd:element name="address" type="Templates:AddressTemplate"/>
    </xsd:choice>
  </xsd:group>

  <xsd:group name="SpecialTemplate">
    <xsd:choice>
      <xsd:element name="omit" type="Templates:omit"/>
      <xsd:element name="any" type="Templates:any"/>
      <xsd:element name="anyoromit" type="Templates:anyoromit"/>
      <xsd:element name="templateDef" type="SimpleTypes:TString"/>
    </xsd:choice>
  </xsd:group>

```

```

    </xsd:choice>
</xsd:group>

<xsd:complexType name="TciValueTemplate">
  <xsd:choice>
    <xsd:group ref="Values:Value"/>
    <xsd:group ref="Templates:TypedTemplate"/>
    <xsd:group ref="Templates:SpecialTemplate"/>
  </xsd:choice>
</xsd:complexType>

<xsd:complexType name="omit">
  <xsd:attributeGroup ref="Values:ValueAtts"/>
</xsd:complexType>

<xsd:complexType name="any">
  <xsd:attributeGroup ref="Values:ValueAtts"/>
</xsd:complexType>

<xsd:complexType name="anyoromit">
  <xsd:attributeGroup ref="Values:ValueAtts"/>
</xsd:complexType>

<xsd:complexType name="MatchingSymbol">
  <xsd:choice>
    <xsd:element name="any_value" type="SimpleTypes:TEmpty"/>
    <xsd:element name="any_value_or_none" type="SimpleTypes:TEmpty"/>
    <xsd:element name="any_element" type="SimpleTypes:TEmpty"/>
    <xsd:element name="any_element_or_none" type="SimpleTypes:TEmpty"/>
    <xsd:element name="range" type="Templates:Range"/>
    <xsd:element name="list" type="Templates:MatchingList"/>
    <xsd:element name="complement" type="Templates:MatchingList"/>
    <xsd:element name="subset" type="Templates:MatchingList"/>
    <xsd:element name="superset" type="Templates:MatchingList"/>
    <xsd:element name="permutation" type="Templates:MatchingList"/>
    <xsd:element name="pattern" type="Templates:Pattern"/>
    <xsd:element name="decmatch" type="Templates:DecMatch"/>
  </xsd:choice>
</xsd:complexType>

<xsd:complexType name="Range">
  <xsd:sequence>
    <xsd:element name="excludeLower" minOccurs="0"/>
    <xsd:element name="lower" type="Values:Value" minOccurs="0"/>
    <xsd:element name="excludeUpper" minOccurs="0"/>
    <xsd:element name="upper" type="Values:Value" minOccurs="0"/>
  </xsd:sequence>
</xsd:complexType>

<xsd:complexType name="MatchingList">
  <xsd:sequence>
    <xsd:group ref="Values:Value" minOccurs="0" maxOccurs="unbounded"/>
  </xsd:sequence>
</xsd:complexType>

<xsd:complexType name="Pattern">
  <xsd:sequence>
    <xsd:choice>
      <xsd:element name="charstring" type="Values:CharstringValue"/>
      <xsd:element name="universal_charstring" type="Values:UniversalCharstringValue"/>
    </xsd:choice>
  </xsd:sequence>
</xsd:complexType>

<xsd:complexType name="DecMatch">
  <xsd:sequence>
    <xsd:group ref="Values:Value"/>
  </xsd:sequence>
</xsd:complexType>

<xsd:complexType name="TciNonValueTemplate">
  <xsd:sequence>
    <xsd:choice>
      <xsd:element name="any" type="Templates:any"/>
      <xsd:element name="all" type="Templates:all"/>
      <xsd:element name="templateDef" type="SimpleTypes:TString"/>
      <xsd:element name="null" type="Templates:null"/>
      <xsd:group ref="Values:Value"/>
    </xsd:choice>
  </xsd:sequence>
</xsd:complexType>

```



```

    </xsd:choice>
  </xsd:sequence>
</xsd:complexType>

<xsd:complexType name="all">
  <xsd:attributeGroup ref="Values:ValueAtts"/>
</xsd:complexType>

<xsd:complexType name="null">
  <xsd:attributeGroup ref="Values:ValueAtts"/>
</xsd:complexType>

<xsd:complexType name="TciValueDifference">
  <xsd:sequence>
    <xsd:element name="val" type="SimpleTypes:xpath"/>
    <xsd:element name="tmpl" type="SimpleTypes:xpath"/>
  </xsd:sequence>
  <xsd:attributeGroup ref="Values:ValueAtts"/>
  <xsd:attribute name="desc" type="SimpleTypes:TString" use="optional"/>
</xsd:complexType>

<xsd:complexType name="TciValueDifferenceList">
  <xsd:sequence>
    <xsd:element name="diff" type="Templates:TciValueDifference"
maxOccurs="unbounded"/>
  </xsd:sequence>
</xsd:complexType>

<xsd:complexType name="SimpleTemplate">
  <xsd:choice>
    <xsd:element name="value" type="SimpleTypes:TString"/>
    <xsd:group ref="Templates:SpecialTemplate"/>
  </xsd:choice>
  <xsd:attributeGroup ref="Values:ValueAtts"/>
</xsd:complexType>
<xsd:complexType name="RecordTemplate">
  <xsd:choice>
    <xsd:group ref="Templates:TypedTemplate" minOccurs="0" maxOccurs="unbounded"/>
    <xsd:group ref="Templates:SpecialTemplate"/>
    <xsd:element name="null" type="Templates:null"/>
  </xsd:choice>
  <xsd:attributeGroup ref="Values:ValueAtts"/>
</xsd:complexType>

<xsd:complexType name="RecordOfTemplate">
  <xsd:choice minOccurs="0" maxOccurs="unbounded">
    <xsd:element name="integer" type="Templates:SimpleTemplate" minOccurs="0"
maxOccurs="unbounded"/>
    <xsd:element name="float" type="Templates:SimpleTemplate" minOccurs="0"
maxOccurs="unbounded"/>
    <xsd:element name="boolean" type="Templates:SimpleTemplate" minOccurs="0"
maxOccurs="unbounded"/>
    <xsd:element name="verdicttype" type="Templates:SimpleTemplate" minOccurs="0"
maxOccurs="unbounded"/>
    <xsd:element name="bitstring" type="Templates:SimpleTemplate"
minOccurs="0" maxOccurs="unbounded"/>
    <xsd:element name="hexstring" type="Templates:SimpleTemplate"
minOccurs="0" maxOccurs="unbounded"/>
    <xsd:element name="octetstring" type="Templates:SimpleTemplate"
minOccurs="0" maxOccurs="unbounded"/>
    <xsd:element name="charstring" type="Templates:SimpleTemplate"
minOccurs="0" maxOccurs="unbounded"/>
    <xsd:element name="universal_charstring"
type="Templates:SimpleTemplate" minOccurs="0"
maxOccurs="unbounded"/>
    <xsd:element name="record" type="Templates:RecordTemplate" minOccurs="0"
maxOccurs="unbounded"/>
    <xsd:element name="record_of" type="Templates:RecordOfTemplate"
minOccurs="0" maxOccurs="unbounded"/>
    <xsd:element name="array" type="Templates:RecordOfTemplate" minOccurs="0"
maxOccurs="unbounded"/>
    <xsd:element name="set" type="Templates:RecordTemplate" minOccurs="0"
maxOccurs="unbounded"/>
    <xsd:element name="set_of" type="Templates:RecordOfTemplate"
minOccurs="0" maxOccurs="unbounded"/>
    <xsd:element name="enumerated" type="Templates:SimpleTemplate"
minOccurs="0" maxOccurs="unbounded"/>
    <xsd:element name="union" type="Templates:UnionTemplate" minOccurs="0"

```

```

        maxOccurs="unbounded"/>
        <xsd:element name="anytype" type="Templates:AnytypeTemplate" minOccurs="0"
        maxOccurs="unbounded"/>
        <xsd:element name="address" type="Templates:AddressTemplate" minOccurs="0"
        maxOccurs="unbounded"/>
        <xsd:group ref="Templates:SpecialTemplate"/>
type="Templates:null"/>
        <xsd:choice>
        <xsd:attributeGroup ref="Values:ValueAtts"/>
    </xsd:complexType>

<xsd:complexType name="UnionTemplate">
    <xsd:choice>
        <xsd:group ref="Templates:TypedTemplate" />
        <xsd:group ref="Templates:SpecialTemplate"/>
        <xsd:element name="null" type="Templates:null"/>
    </xsd:choice>
    <xsd:attributeGroup ref="Values:ValueAtts"/>
</xsd:complexType>

<xsd:complexType name="AnytypeTemplate">
    <xsd:choice>
        <xsd:group ref="Templates:TypedTemplate" />
        <xsd:group ref="Templates:SpecialTemplate"/>
        <xsd:element name="null" type="Templates:null"/>
    </xsd:choice>
    <xsd:attributeGroup ref="Values:ValueAtts"/>
</xsd:complexType>

<xsd:complexType name="AddressTemplate">
    <xsd:choice>
        <xsd:group ref="Templates:TypedTemplate" />
        <xsd:group ref="Templates:SpecialTemplate"/>
        <xsd:element name="null" type="Templates:null"/>
    </xsd:choice>
    <xsd:attributeGroup ref="Values:ValueAtts"/>
</xsd:complexType>
</xsd:schema>

```

## B.5 TCI-TL XML Schema for Events

```

<?xml version="1.0" encoding="UTF-8"?>
<xsd:schema xmlns:xsd="http://www.w3.org/2001/XMLSchema"
    targetNamespace="http://uri.etsi.org/ttcn-3/tci/Events_v4_10_1.xsd"
    xmlns:Events="http://uri.etsi.org/ttcn-3/tci/Events_v4_10_1.xsd"
    xmlns:Types="http://uri.etsi.org/ttcn-3/tci/Types_v4_10_1.xsd"
    xmlns:Templates="http://uri.etsi.org/ttcn-3/tci/Templates_v4_10_1.xsd"
    xmlns:SimpleTypes="http://uri.etsi.org/ttcn-3/tci/SimpleTypes_v4_10_1.xsd"
    xmlns:Values="http://uri.etsi.org/ttcn-3/tci/Values_v4_10_1.xsd"
    elementFormDefault="qualified">

    <xsd:import namespace="http://uri.etsi.org/ttcn-3/tci/SimpleTypes_v4_10_1.xsd"
        schemaLocation="SimpleTypes_v4_10_1.xsd"/>
    <xsd:import namespace="http://uri.etsi.org/ttcn-3/tci/Types_v4_10_1.xsd"
    schemaLocation="Types_v4_10_1.xsd"/>
    <xsd:import namespace="http://uri.etsi.org/ttcn-3/tci/Values_v4_10_1.xsd"
        schemaLocation="Values_v4_10_1.xsd"/>
    <xsd:import namespace="http://uri.etsi.org/ttcn-3/tci/Templates_v4_10_1.xsd"
        schemaLocation="Templates_v4_10_1.xsd"/>

    <!-- common definition for all events -->
    <xsd:complexType name="Event" mixed="true">
        <xsd:sequence>
            <xsd:element name="am" type="SimpleTypes:TString"/>
        </xsd:sequence>
        <xsd:attribute name="ts" type="xsd:long" use="required"/>
        <xsd:attribute name="src" type="SimpleTypes:TString" use="optional"/>
        <xsd:attribute name="line" type="SimpleTypes:TInteger" use="optional"/>

        <!-- general identifier structure for test components, ports and timer -->
        <xsd:attribute name="name" type="SimpleTypes:TString" use="required"/>
        <xsd:attribute name="id" type="SimpleTypes:TString" use="required"/>
        <xsd:attribute name="type" type="SimpleTypes:TString" use="required"/>
    </xsd:complexType>

```

```

<!-- this event is extended by all port configuration events -->
<xsd:complexType name="PortConfiguration">
  <xsd:complexContent mixed="true">
    <xsd:extension base="Events:Event">
      <xsd:sequence>
        <xsd:element name="port1" type="Types:TriPortIdType" />
        <xsd:element name="port2" type="Types:TriPortIdType" />
      </xsd:sequence>
    </xsd:extension>
  </xsd:complexContent>
</xsd:complexType>

<!-- this event is extended by all port status events -->
<xsd:complexType name="PortStatus">
  <xsd:complexContent mixed="true">
    <xsd:extension base="Events:Event">
      <xsd:sequence>
        <xsd:element name="port" type="Types:TriPortIdType"/>
        <xsd:element name="stat" type="SimpleTypes:PortStatusType" minOccurs="0"/>
      </xsd:sequence>
    </xsd:extension>
  </xsd:complexContent>
</xsd:complexType>

<!-- testcases -->
<xsd:complexType name="tliTcExecute">
  <xsd:complexContent mixed="true">
    <xsd:extension base="Events:Event">
      <xsd:sequence>
        <xsd:element name="tcId" type="Types:TciTestCaseIdType"/>
        <xsd:element name="tciPars" type="Types:TciParameterListType" minOccurs="0"/>
        <xsd:element name="dur" type="SimpleTypes:TriTimerDurationType" minOccurs="0"/>
      </xsd:sequence>
    </xsd:extension>
  </xsd:complexContent>
</xsd:complexType>

<xsd:complexType name="tliTcStart">
  <xsd:complexContent mixed="true">
    <xsd:extension base="Events:Event">
      <xsd:sequence>
        <xsd:element name="tcId" type="Types:TciTestCaseIdType"/>
        <xsd:element name="tciPars" type="Types:TciParameterListType" minOccurs="0"/>
        <xsd:element name="dur" type="SimpleTypes:TriTimerDurationType" minOccurs="0"/>
      </xsd:sequence>
    </xsd:extension>
  </xsd:complexContent>
</xsd:complexType>

<xsd:complexType name="tliTcStop">
  <xsd:complexContent mixed="true">
    <xsd:extension base="Events:Event"/>
    <xsd:sequence>
      <xsd:element name="reason" type="SimpleTypes:TString" minOccurs="0"/>
    </xsd:sequence>
  </xsd:complexContent>
</xsd:complexType>

<xsd:complexType name="tliTcStarted">
  <xsd:complexContent mixed="true">
    <xsd:extension base="Events:Event">
      <xsd:sequence>
        <xsd:element name="tcId" type="Types:TciTestCaseIdType"/>
        <xsd:element name="tciPars" type="Types:TciParameterListType" minOccurs="0"/>
        <xsd:element name="dur" type="SimpleTypes:TriTimerDurationType" minOccurs="0"/>
      </xsd:sequence>
    </xsd:extension>
  </xsd:complexContent>
</xsd:complexType>

<xsd:complexType name="tliTcTerminated">
  <xsd:complexContent mixed="true">
    <xsd:extension base="Events:Event">
      <xsd:sequence>
        <xsd:element name="tcId" type="Types:TciTestCaseIdType"/>
        <xsd:element name="tciPars" type="Types:TciParameterListType" minOccurs="0"/>
        <xsd:element name="verdict" type="Values:VerdictValue"/>
      </xsd:sequence>
    </xsd:extension>
  </xsd:complexContent>
</xsd:complexType>

```

```

        <xsd:element name="reason" type="SimpleTypes:TString" minOccurs="0"/>
      </xsd:sequence>
    </xsd:extension>
  </xsd:complexContent>
</xsd:complexType>

<!-- control -->
<xsd:complexType name="tliCtrlStart">
  <xsd:complexContent>
    <xsd:extension base="Events:Event"/>
  </xsd:complexContent>
</xsd:complexType>

<xsd:complexType name="tliCtrlStop">
  <xsd:complexContent>
    <xsd:extension base="Events:Event"/>
  </xsd:complexContent>
</xsd:complexType>

<xsd:complexType name="tliCtrlTerminated">
  <xsd:complexContent>
    <xsd:extension base="Events:Event"/>
  </xsd:complexContent>
</xsd:complexType>

<!-- asynchronous communication -->
<xsd:complexType name="tliMSend_m">
  <xsd:complexContent mixed="true">
    <xsd:extension base="Events:Event">
      <xsd:sequence>
        <xsd:element name="at" type="Types:TriPortIdType"/>
        <xsd:element name="to" type="Types:TriPortIdType" minOccurs="0"/>
        <xsd:element name="msgValue" type="Values:Value"/>
        <xsd:element name="addrValue" type="Values:Value" minOccurs="0"/>
        <xsd:choice>
          <xsd:element name="encoder-failure" type="SimpleTypes:TciStatusType"
minOccurs="0"/>
          <xsd:sequence>
            <xsd:element name="msg" type="Types:TriMessageType" minOccurs="0"/>
            <xsd:element name="address" type="Types:TriAddressType" minOccurs="0"/>
            <xsd:element name="transmission-failure"
type="SimpleTypes:TriStatusType" minOccurs="0"/>
          </xsd:sequence>
        </xsd:choice>
      </xsd:sequence>
    </xsd:extension>
  </xsd:complexContent>
</xsd:complexType>

<xsd:complexType name="tliMSend_m_BC">
  <xsd:complexContent mixed="true">
    <xsd:extension base="Events:Event">
      <xsd:sequence>
        <xsd:element name="at" type="Types:TriPortIdType"/>
        <xsd:element name="to" type="Types:TriPortIdType" minOccurs="0"/>
        <xsd:element name="msgValue" type="Values:Value"/>
        <xsd:choice>
          <xsd:element name="encoder-failure" type="SimpleTypes:TciStatusType"
minOccurs="0"/>
          <xsd:sequence>
            <xsd:element name="msg" type="Types:TriMessageType" minOccurs="0"/>
            <xsd:element name="transmission-failure"
type="SimpleTypes:TriStatusType" minOccurs="0"/>
          </xsd:sequence>
        </xsd:choice>
      </xsd:sequence>
    </xsd:extension>
  </xsd:complexContent>
</xsd:complexType>

<xsd:complexType name="tliMSend_m_MC">
  <xsd:complexContent mixed="true">
    <xsd:extension base="Events:Event">
      <xsd:sequence>
        <xsd:element name="at" type="Types:TriPortIdType"/>
        <xsd:element name="to" type="Types:TriPortIdType" minOccurs="0"/>
        <xsd:element name="msgValue" type="Values:Value"/>
        <xsd:element name="addrValues" type="Types:TciValueListType" minOccurs="0"/>

```

```

        <xsd:choice>
          <xsd:element name="encoder-failure" type="SimpleTypes:TciStatusType"
minOccurs="0"/>
          <xsd:sequence>
            <xsd:element name="msg" type="Types:TriMessageType" minOccurs="0"/>
            <xsd:element name="addresses" type="Types:TriAddressListType"
minOccurs="0"/>
            <xsd:element name="transmission-failure"
type="SimpleTypes:TciStatusType" minOccurs="0"/>
          </xsd:sequence>
        </xsd:choice>
      </xsd:sequence>
    </xsd:extension>
  </xsd:complexContent>
</xsd:complexType>

  <xsd:complexType name="tliMSend_c">
    <xsd:complexContent mixed="true">
      <xsd:extension base="Events:Event">
        <xsd:sequence>
          <xsd:element name="at" type="Types:TriPortIdType"/>
          <xsd:element name="to" type="Types:TriPortIdType" minOccurs="0"/>
          <xsd:element name="msgValue" type="Values:Value"/>
          <xsd:element name="transmission-failure" type="SimpleTypes:TciStatusType"
minOccurs="0"/>
        </xsd:sequence>
      </xsd:extension>
    </xsd:complexContent>
  </xsd:complexType>

  <xsd:complexType name="tliMSend_c_BC">
    <xsd:complexContent mixed="true">
      <xsd:extension base="Events:Event">
        <xsd:sequence>
          <xsd:element name="at" type="Types:TriPortIdType"/>
          <xsd:element name="to" type="Types:TriPortIdListType" minOccurs="0"/>
          <xsd:element name="msgValue" type="Values:Value"/>
          <xsd:element name="transmission-failure" type="SimpleTypes:TciStatusType"
minOccurs="0"/>
        </xsd:sequence>
      </xsd:extension>
    </xsd:complexContent>
  </xsd:complexType>

  <xsd:complexType name="tliMSend_c_MC">
    <xsd:complexContent mixed="true">
      <xsd:extension base="Events:Event">
        <xsd:sequence>
          <xsd:element name="at" type="Types:TriPortIdType"/>
          <xsd:element name="to" type="Types:TriPortIdListType" minOccurs="0"/>
          <xsd:element name="msgValue" type="Values:Value"/>
          <xsd:element name="transmission-failure" type="SimpleTypes:TciStatusType"
minOccurs="0"/>
        </xsd:sequence>
      </xsd:extension>
    </xsd:complexContent>
  </xsd:complexType>

  <xsd:complexType name="tliMDetected_m">
    <xsd:complexContent mixed="true">
      <xsd:extension base="Events:Event">
        <xsd:sequence>
          <xsd:element name="at" type="Types:TriPortIdType"/>
          <xsd:element name="from" type="Types:TriPortIdType" minOccurs="0"/>
          <xsd:element name="msgValue" type="Types:TriMessageType"/>
          <xsd:element name="address" type="Types:TriAddressType" minOccurs="0"/>
        </xsd:sequence>
      </xsd:extension>
    </xsd:complexContent>
  </xsd:complexType>

  <xsd:complexType name="tliMDetected_c">
    <xsd:complexContent mixed="true">
      <xsd:extension base="Events:Event">
        <xsd:sequence>
          <xsd:element name="at" type="Types:TriPortIdType"/>
          <xsd:element name="from" type="Types:TriPortIdType" minOccurs="0"/>
          <xsd:element name="msgValue" type="Values:Value"/>
        </xsd:sequence>
      </xsd:extension>
    </xsd:complexContent>
  </xsd:complexType>

```

```

        </xsd:sequence>
      </xsd:extension>
    </xsd:complexContent>
  </xsd:complexType>

  <xsd:complexType name="tliMMismatch_m">
    <xsd:complexContent mixed="true">
      <xsd:extension base="Events:Event">
        <xsd:sequence>
          <xsd:element name="at" type="Types:TriPortIdType"/>
          <xsd:element name="msgValue" type="Values:Value"/>
          <xsd:element name="msgTmpl" type="Templates:TciValueTemplate"/>
          <xsd:element name="diffs" type="Templates:TciValueDifferenceList"/>
          <xsd:element name="addrValue" type="Values:Value" minOccurs="0"/>
          <xsd:element name="addressTmpl" type="Templates:TciValueTemplate"
minOccurs="0"/>
        </xsd:sequence>
      </xsd:extension>
    </xsd:complexContent>
  </xsd:complexType>

  <xsd:complexType name="tliMMismatch_c">
    <xsd:complexContent mixed="true">
      <xsd:extension base="Events:Event">
        <xsd:sequence>
          <xsd:element name="at" type="Types:TriPortIdType"/>
          <xsd:element name="msgValue" type="Values:Value"/>
          <xsd:element name="msgTmpl" type="Templates:TciValueTemplate"/>
          <xsd:element name="diffs" type="Templates:TciValueDifferenceList"/>
          <xsd:element name="from" type="Types:TriComponentIdType" minOccurs="0"/>
          <xsd:element name="fromTmpl" type="Templates:TciNonValueTemplate"
minOccurs="0"/>
        </xsd:sequence>
      </xsd:extension>
    </xsd:complexContent>
  </xsd:complexType>

  <xsd:complexType name="tliMReceive_m">
    <xsd:complexContent mixed="true">
      <xsd:extension base="Events:Event">
        <xsd:sequence>
          <xsd:element name="at" type="Types:TriPortIdType"/>
          <xsd:element name="msgValue" type="Values:Value" minOccurs="0"/>
          <xsd:element name="msgTmpl" type="Templates:TciValueTemplate"
minOccurs="0"/>
          <xsd:element name="addrValue" type="Values:Value" minOccurs="0"/>
          <xsd:element name="addressTmpl" type="Templates:TciValueTemplate"
minOccurs="0"/>
        </xsd:sequence>
      </xsd:extension>
    </xsd:complexContent>
  </xsd:complexType>

  <xsd:complexType name="tliMReceive_c">
    <xsd:complexContent mixed="true">
      <xsd:extension base="Events:Event">
        <xsd:sequence>
          <xsd:element name="at" type="Types:TriPortIdType"/>
          <xsd:element name="msgValue" type="Values:Value" minOccurs="0"/>
          <xsd:element name="msgTmpl" type="Templates:TciValueTemplate"
minOccurs="0"/>
          <xsd:element name="from" type="Types:TriComponentIdType" minOccurs="0"/>
          <xsd:element name="fromTmpl" type="Templates:TciNonValueTemplate"
minOccurs="0"/>
        </xsd:sequence>
      </xsd:extension>
    </xsd:complexContent>
  </xsd:complexType>

  <!-- synchronous communication -->
  <xsd:complexType name="tliPrCall_m">
    <xsd:complexContent mixed="true">
      <xsd:extension base="Events:Event">
        <xsd:sequence>
          <xsd:element name="at" type="Types:TriPortIdType"/>
          <xsd:element name="to" type="Types:TriPortIdType" minOccurs="0"/>
          <xsd:element name="signature" type="Types:TriSignatureIdType"/>
          <xsd:element name="tciPars" type="Types:TciParameterListType" minOccurs="0"/>

```

```

        <xsd:element name="addrValue" type="Values:Value" minOccurs="0"/>
        <xsd:choice>
          <xsd:element name="encoder-failure" type="SimpleTypes:TciStatusType"
minOccurs="0"/>
          <xsd:sequence>
            <xsd:element name="triPars" type="Types:TriParameterListType"
minOccurs="0"/>
            <xsd:element name="address" type="Types:TriAddressType" minOccurs="0"/>
            <xsd:element name="transmission-failure"
type="SimpleTypes:TriStatusType" minOccurs="0"/>
          </xsd:sequence>
        </xsd:choice>
      </xsd:sequence>
    </xsd:extension>
  </xsd:complexContent>
</xsd:complexType>

  <xsd:complexType name="tliPrCall_m_BC">
    <xsd:complexContent mixed="true">
      <xsd:extension base="Events:Event">
        <xsd:sequence>
          <xsd:element name="at" type="Types:TriPortIdType"/>
          <xsd:element name="to" type="Types:TriPortIdType" minOccurs="0"/>
          <xsd:element name="signature" type="Types:TriSignatureIdType"/>
          <xsd:element name="tciPars" type="Types:TciParameterListType" minOccurs="0"/>
          <xsd:choice>
            <xsd:element name="encoder-failure" type="SimpleTypes:TciStatusType"
minOccurs="0"/>
            <xsd:sequence>
              <xsd:element name="triPars" type="Types:TriParameterListType"
minOccurs="0"/>
              <xsd:element name="transmission-failure"
type="SimpleTypes:TriStatusType" minOccurs="0"/>
            </xsd:sequence>
          </xsd:choice>
        </xsd:sequence>
      </xsd:extension>
    </xsd:complexContent>
  </xsd:complexType>

  <xsd:complexType name="tliPrCall_m_MC">
    <xsd:complexContent mixed="true">
      <xsd:extension base="Events:Event">
        <xsd:sequence>
          <xsd:element name="at" type="Types:TriPortIdType"/>
          <xsd:element name="to" type="Types:TriPortIdType" minOccurs="0"/>
          <xsd:element name="signature" type="Types:TriSignatureIdType"/>
          <xsd:element name="tciPars" type="Types:TciParameterListType" minOccurs="0"/>
          <xsd:element name="addrValues" type="Types:TciValueListType" minOccurs="0"/>
          <xsd:choice>
            <xsd:element name="encoder-failure" type="SimpleTypes:TciStatusType"
minOccurs="0"/>
            <xsd:sequence>
              <xsd:element name="triPars" type="Types:TriParameterListType"
minOccurs="0"/>
              <xsd:element name="addresses" type="Types:TriAddressListType"
minOccurs="0"/>
              <xsd:element name="transmission-failure"
type="SimpleTypes:TriStatusType" minOccurs="0"/>
            </xsd:sequence>
          </xsd:choice>
        </xsd:sequence>
      </xsd:extension>
    </xsd:complexContent>
  </xsd:complexType>

  <xsd:complexType name="tliPrCall_c">
    <xsd:complexContent mixed="true">
      <xsd:extension base="Events:Event">
        <xsd:sequence>
          <xsd:element name="at" type="Types:TriPortIdType"/>
          <xsd:element name="to" type="Types:TriPortIdType" minOccurs="0"/>
          <xsd:element name="signature" type="Types:TriSignatureIdType"/>
          <xsd:element name="tciPars" type="Types:TciParameterListType" minOccurs="0"/>
          <xsd:element name="transmission-failure" type="SimpleTypes:TriStatusType"
minOccurs="0"/>
        </xsd:sequence>
      </xsd:extension>
    </xsd:complexContent>
  </xsd:complexType>

```

```

    </xsd:complexContent>
  </xsd:complexType>

  <xsd:complexType name="tliPrCall_c_BC">
    <xsd:complexContent mixed="true">
      <xsd:extension base="Events:Event">
        <xsd:sequence>
          <xsd:element name="at" type="Types:TriPortIdType"/>
          <xsd:element name="to" type="Types:TriPortIdListType" minOccurs="0"/>
          <xsd:element name="signature" type="Types:TriSignatureIdType"/>
          <xsd:element name="tciPars" type="Types:TciParameterListType" minOccurs="0"/>
          <xsd:element name="transmission-failure" type="SimpleTypes:TriStatusType"
minOccurs="0"/>
        </xsd:sequence>
      </xsd:extension>
    </xsd:complexContent>
  </xsd:complexType>

  <xsd:complexType name="tliPrCall_c_MC">
    <xsd:complexContent mixed="true">
      <xsd:extension base="Events:Event">
        <xsd:sequence>
          <xsd:element name="at" type="Types:TriPortIdType"/>
          <xsd:element name="to" type="Types:TriPortIdListType" minOccurs="0"/>
          <xsd:element name="signature" type="Types:TriSignatureIdType"/>
          <xsd:element name="tciPars" type="Types:TciParameterListType" minOccurs="0"/>
          <xsd:element name="transmission-failure" type="SimpleTypes:TriStatusType"
minOccurs="0"/>
        </xsd:sequence>
      </xsd:extension>
    </xsd:complexContent>
  </xsd:complexType>

  <xsd:complexType name="tliPrGetCallDetected_m">
    <xsd:complexContent mixed="true">
      <xsd:extension base="Events:Event">
        <xsd:sequence>
          <xsd:element name="at" type="Types:TriPortIdType"/>
          <xsd:element name="from" type="Types:TriPortIdType" minOccurs="0"/>
          <xsd:element name="signature" type="Types:TriSignatureIdType"/>
          <xsd:element name="triPars" type="Types:TriParameterListType" minOccurs="0"/>
          <xsd:element name="address" type="Types:TriAddressType" minOccurs="0"/>
        </xsd:sequence>
      </xsd:extension>
    </xsd:complexContent>
  </xsd:complexType>

  <xsd:complexType name="tliPrGetCallDetected_c">
    <xsd:complexContent mixed="true">
      <xsd:extension base="Events:Event">
        <xsd:sequence>
          <xsd:element name="at" type="Types:TriPortIdType"/>
          <xsd:element name="from" type="Types:TriPortIdType" minOccurs="0"/>
          <xsd:element name="signature" type="Types:TriSignatureIdType"/>
          <xsd:element name="tciPars" type="Types:TciParameterListType" minOccurs="0"/>
        </xsd:sequence>
      </xsd:extension>
    </xsd:complexContent>
  </xsd:complexType>

  <xsd:complexType name="tliPrGetCallMismatch_m">
    <xsd:complexContent mixed="true">
      <xsd:extension base="Events:Event">
        <xsd:sequence>
          <xsd:element name="at" type="Types:TriPortIdType"/>
          <xsd:element name="signature" type="Types:TriSignatureIdType"/>
          <xsd:element name="tciPars" type="Types:TciParameterListType" minOccurs="0"/>
          <xsd:element name="parsTpl" type="Templates:TciValueTemplate" minOccurs="0"/>
          <xsd:element name="diffs" type="Templates:TciValueDifferenceList"/>
          <xsd:element name="addrValue" type="Values:Value" minOccurs="0"/>
          <xsd:element name="addressTpl" type="Templates:TciValueTemplate"
minOccurs="0"/>
        </xsd:sequence>
      </xsd:extension>
    </xsd:complexContent>
  </xsd:complexType>

```



```

<xsd:complexType name="tliPrGetCallMismatch_c">
  <xsd:complexContent mixed="true">
    <xsd:extension base="Events:Event">
      <xsd:sequence>
        <xsd:element name="at" type="Types:TriPortIdType"/>
        <xsd:element name="signature" type="Types:TriSignatureIdType"/>
        <xsd:element name="tciPars" type="Types:TciParameterListType" minOccurs="0"/>
        <xsd:element name="parsTmpl" type="Templates:TciValueTemplate" minOccurs="0"/>
        <xsd:element name="diffs" type="Templates:TciValueDifferenceList"/>
        <xsd:element name="from" type="Types:TriComponentIdType" minOccurs="0"/>
        <xsd:element name="fromTmpl" type="Templates:TciNonValueTemplate"
minOccurs="0"/>
      </xsd:sequence>
    </xsd:extension>
  </xsd:complexContent>
</xsd:complexType>

<xsd:complexType name="tliPrGetCall_m">
  <xsd:complexContent mixed="true">
    <xsd:extension base="Events:Event">
      <xsd:sequence>
        <xsd:element name="at" type="Types:TriPortIdType"/>
        <xsd:element name="signature" type="Types:TriSignatureIdType"/>
        <xsd:element name="tciPars" type="Types:TciParameterListType" minOccurs="0"/>
        <xsd:element name="parsTmpl" type="Templates:TciValueTemplate" minOccurs="0"/>
        <xsd:element name="addrValue" type="Values:Value" minOccurs="0"/>
        <xsd:element name="addressTmpl" type="Templates:TciValueTemplate"
minOccurs="0"/>
      </xsd:sequence>
    </xsd:extension>
  </xsd:complexContent>
</xsd:complexType>

<xsd:complexType name="tliPrGetCall_c">
  <xsd:complexContent mixed="true">
    <xsd:extension base="Events:Event">
      <xsd:sequence>
        <xsd:element name="at" type="Types:TriPortIdType"/>
        <xsd:element name="signature" type="Types:TriSignatureIdType"/>
        <xsd:element name="tciPars" type="Types:TciParameterListType" minOccurs="0"/>
        <xsd:element name="parsTmpl" type="Templates:TciValueTemplate" minOccurs="0"/>
        <xsd:element name="from" type="Types:TriComponentIdType" minOccurs="0"/>
        <xsd:element name="fromTmpl" type="Templates:TciNonValueTemplate"
minOccurs="0"/>
      </xsd:sequence>
    </xsd:extension>
  </xsd:complexContent>
</xsd:complexType>

<xsd:complexType name="tliPrReply_m">
  <xsd:complexContent mixed="true">
    <xsd:extension base="Events:Event">
      <xsd:sequence>
        <xsd:element name="at" type="Types:TriPortIdType"/>
        <xsd:element name="to" type="Types:TriPortIdType" minOccurs="0"/>
        <xsd:element name="signature" type="Types:TriSignatureIdType"/>
        <xsd:element name="tciPars" type="Types:TciParameterListType" minOccurs="0"/>
        <xsd:element name="replValue" type="Values:Value" minOccurs="0"/>
        <xsd:element name="addrValue" type="Values:Value" minOccurs="0"/>
        <xsd:choice>
          <xsd:element name="encoder-failure" type="SimpleTypes:TciStatusType"
minOccurs="0"/>
          <xsd:sequence>
            <xsd:element name="triPars" type="Types:TriParameterListType"
minOccurs="0"/>
            <xsd:element name="repl" type="Types:TriParameterType" minOccurs="0"/>
            <xsd:element name="address" type="Types:TriAddressType" minOccurs="0"/>
            <xsd:element name="transmission-failure"
type="SimpleTypes:TriStatusType" minOccurs="0"/>
          </xsd:sequence>
        </xsd:choice>
      </xsd:sequence>
    </xsd:extension>
  </xsd:complexContent>
</xsd:complexType>

<xsd:complexType name="tliPrReply_m_BC">
  <xsd:complexContent mixed="true">

```

```

    <xsd:extension base="Events:Event">
      <xsd:sequence>
        <xsd:element name="at" type="Types:TriPortIdType"/>
        <xsd:element name="to" type="Types:TriPortIdType" minOccurs="0"/>
        <xsd:element name="signature" type="Types:TriSignatureIdType"/>
        <xsd:element name="tciPars" type="Types:TciParameterListType" minOccurs="0"/>
        <xsd:element name="replValue" type="Values:Value" minOccurs="0"/>
        <xsd:choice>
          <xsd:element name="encoder-failure" type="SimpleTypes:TciStatusType"
            minOccurs="0"/>
          <xsd:sequence>
            <xsd:element name="triPars" type="Types:TriParameterListType"
minOccurs="0"/>
            <xsd:element name="repl" type="Types:TriParameterType" minOccurs="0"/>
            <xsd:element name="transmission-failure"
              type="SimpleTypes:TriStatusType" minOccurs="0"/>
          </xsd:sequence>
        </xsd:choice>
      </xsd:sequence>
    </xsd:extension>
  </xsd:complexContent>
</xsd:complexType>

<xsd:complexType name="tliPrReply_m_MC">
  <xsd:complexContent mixed="true">
    <xsd:extension base="Events:Event">
      <xsd:sequence>
        <xsd:element name="at" type="Types:TriPortIdType"/>
        <xsd:element name="to" type="Types:TriPortIdType" minOccurs="0"/>
        <xsd:element name="signature" type="Types:TriSignatureIdType"/>
        <xsd:element name="tciPars" type="Types:TciParameterListType" minOccurs="0"/>
        <xsd:element name="replValue" type="Values:Value" minOccurs="0"/>
        <xsd:element name="addrValues" type="Types:TciValueListType" minOccurs="0"/>
        <xsd:choice>
          <xsd:element name="encoder-failure" type="SimpleTypes:TciStatusType"
            minOccurs="0"/>
          <xsd:sequence>
            <xsd:element name="triPars" type="Types:TriParameterListType"
minOccurs="0"/>
            <xsd:element name="repl" type="Types:TriParameterType" minOccurs="0"/>
            <xsd:element name="addresses" type="Types:TriAddressListType"
minOccurs="0"/>
            <xsd:element name="transmission-failure"
              type="SimpleTypes:TriStatusType" minOccurs="0"/>
          </xsd:sequence>
        </xsd:choice>
      </xsd:sequence>
    </xsd:extension>
  </xsd:complexContent>
</xsd:complexType>

<xsd:complexType name="tliPrReply_c">
  <xsd:complexContent mixed="true">
    <xsd:extension base="Events:Event">
      <xsd:sequence>
        <xsd:element name="at" type="Types:TriPortIdType"/>
        <xsd:element name="to" type="Types:TriPortIdType" minOccurs="0"/>
        <xsd:element name="signature" type="Types:TriSignatureIdType"/>
        <xsd:element name="tciPars" type="Types:TciParameterListType" minOccurs="0"/>
        <xsd:element name="replValue" type="Values:Value" minOccurs="0"/>
        <xsd:element name="transmission-failure" type="SimpleTypes:TriStatusType"
minOccurs="0"/>
      </xsd:sequence>
    </xsd:extension>
  </xsd:complexContent>
</xsd:complexType>

<xsd:complexType name="tliPrReply_c_BC">
  <xsd:complexContent mixed="true">
    <xsd:extension base="Events:Event">
      <xsd:sequence>
        <xsd:element name="at" type="Types:TriPortIdType"/>
        <xsd:element name="to" type="Types:TriPortIdListType" minOccurs="0"/>
        <xsd:element name="signature" type="Types:TriSignatureIdType"/>
        <xsd:element name="tciPars" type="Types:TciParameterListType" minOccurs="0"/>
        <xsd:element name="replValue" type="Values:Value" minOccurs="0"/>
        <xsd:element name="transmission-failure" type="SimpleTypes:TriStatusType"
minOccurs="0"/>
      </xsd:sequence>
    </xsd:extension>
  </xsd:complexContent>
</xsd:complexType>

```

```

        </xsd:sequence>
      </xsd:extension>
    </xsd:complexContent>
  </xsd:complexType>

  <xsd:complexType name="tliPrReply_c_MC">
    <xsd:complexContent mixed="true">
      <xsd:extension base="Events:Event">
        <xsd:sequence>
          <xsd:element name="at" type="Types:TriPortIdType"/>
          <xsd:element name="to" type="Types:TriPortIdListType" minOccurs="0"/>
          <xsd:element name="signature" type="Types:TriSignatureIdType"/>
          <xsd:element name="tciPars" type="Types:TciParameterListType" minOccurs="0"/>
          <xsd:element name="replValue" type="Values:Value" minOccurs="0"/>
          <xsd:element name="transmission-failure" type="SimpleTypes:TriStatusType"
minOccurs="0"/>
        </xsd:sequence>
      </xsd:extension>
    </xsd:complexContent>
  </xsd:complexType>

  <xsd:complexType name="tliPrGetReplyDetected_m">
    <xsd:complexContent mixed="true">
      <xsd:extension base="Events:Event">
        <xsd:sequence>
          <xsd:element name="at" type="Types:TriPortIdType"/>
          <xsd:element name="from" type="Types:TriPortIdType" minOccurs="0"/>
          <xsd:element name="signature" type="Types:TriSignatureIdType"/>
          <xsd:element name="triPars" type="Types:TriParameterListType" minOccurs="0"/>
          <xsd:element name="repl" type="Types:TriParameterType" minOccurs="0"/>
          <xsd:element name="address" type="Types:TriAddressType" minOccurs="0"/>
        </xsd:sequence>
      </xsd:extension>
    </xsd:complexContent>
  </xsd:complexType>

  <xsd:complexType name="tliPrGetReplyDetected_c">
    <xsd:complexContent mixed="true">
      <xsd:extension base="Events:Event">
        <xsd:sequence>
          <xsd:element name="at" type="Types:TriPortIdType"/>
          <xsd:element name="from" type="Types:TriPortIdType" minOccurs="0"/>
          <xsd:element name="signature" type="Types:TriSignatureIdType"/>
          <xsd:element name="tciPars" type="Types:TciParameterListType" minOccurs="0"/>
          <xsd:element name="replValue" type="Values:Value" minOccurs="0"/>
        </xsd:sequence>
      </xsd:extension>
    </xsd:complexContent>
  </xsd:complexType>

  <xsd:complexType name="tliPrGetReplyMismatch_m">
    <xsd:complexContent mixed="true">
      <xsd:extension base="Events:Event">
        <xsd:sequence>
          <xsd:element name="at" type="Types:TriPortIdType"/>
          <xsd:element name="signature" type="Types:TriSignatureIdType"/>
          <xsd:element name="tciPars" type="Types:TciParameterListType" minOccurs="0"/>
          <xsd:element name="parsTmpl" type="Templates:TciValueTemplate" minOccurs="0"/>
          <xsd:element name="replValue" type="Values:Value" minOccurs="0"/>
          <xsd:element name="replTmpl" type="Templates:TciValueTemplate" minOccurs="0"/>
          <xsd:element name="diffs" type="Templates:TciValueDifferenceList"/>
          <xsd:element name="addrValue" type="Values:Value" minOccurs="0"/>
          <xsd:element name="addressTmpl" type="Templates:TciValueTemplate"
minOccurs="0"/>
        </xsd:sequence>
      </xsd:extension>
    </xsd:complexContent>
  </xsd:complexType>

  <xsd:complexType name="tliPrGetReplyMismatch_c">
    <xsd:complexContent mixed="true">
      <xsd:extension base="Events:Event">
        <xsd:sequence>
          <xsd:element name="at" type="Types:TriPortIdType"/>
          <xsd:element name="signature" type="Types:TriSignatureIdType"/>
          <xsd:element name="tciPars" type="Types:TciParameterListType" minOccurs="0"/>
          <xsd:element name="parsTmpl" type="Templates:TciValueTemplate" minOccurs="0"/>
          <xsd:element name="replValue" type="Values:Value" minOccurs="0"/>

```

```

        <xsd:element name="replTmpl" type="Templates:TciValueTemplate" minOccurs="0"/>
        <xsd:element name="diffs" type="Templates:TciValueDifferenceList"/>
        <xsd:element name="from" type="Types:TriComponentIdType" minOccurs="0"/>
        <xsd:element name="fromTmpl" type="Templates:TciNonValueTemplate"
minOccurs="0"/>
    </xsd:sequence>
</xsd:extension>
</xsd:complexContent>
</xsd:complexType>

<xsd:complexType name="tliPrGetReply_m">
    <xsd:complexContent mixed="true">
        <xsd:extension base="Events:Event">
            <xsd:sequence>
                <xsd:element name="at" type="Types:TriPortIdType"/>
                <xsd:element name="signature" type="Types:TriSignatureIdType"/>
                <xsd:element name="tciPars" type="Types:TciParameterListType" minOccurs="0"/>
                <xsd:element name="parsTmpl" type="Templates:TciValueTemplate" minOccurs="0"/>
                <xsd:element name="replValue" type="Values:Value" minOccurs="0"/>
                <xsd:element name="replTmpl" type="Templates:TciValueTemplate" minOccurs="0"/>
                <xsd:element name="addrValue" type="Values:Value" minOccurs="0"/>
                <xsd:element name="addressTmpl" type="Templates:TciValueTemplate"
minOccurs="0"/>
            </xsd:sequence>
        </xsd:extension>
    </xsd:complexContent>
</xsd:complexType>

<xsd:complexType name="tliPrGetReply_c">
    <xsd:complexContent mixed="true">
        <xsd:extension base="Events:Event">
            <xsd:sequence>
                <xsd:element name="at" type="Types:TriPortIdType"/>
                <xsd:element name="signature" type="Types:TriSignatureIdType"/>
                <xsd:element name="tciPars" type="Types:TciParameterListType" minOccurs="0"/>
                <xsd:element name="parsTmpl" type="Templates:TciValueTemplate" minOccurs="0"/>
                <xsd:element name="replValue" type="Values:Value" minOccurs="0"/>
                <xsd:element name="replTmpl" type="Templates:TciValueTemplate" minOccurs="0"/>
                <xsd:element name="from" type="Types:TriComponentIdType" minOccurs="0"/>
                <xsd:element name="fromTmpl" type="Templates:TciNonValueTemplate"
minOccurs="0"/>
            </xsd:sequence>
        </xsd:extension>
    </xsd:complexContent>
</xsd:complexType>

<xsd:complexType name="tliPrRaise_m">
    <xsd:complexContent mixed="true">
        <xsd:extension base="Events:Event">
            <xsd:sequence>
                <xsd:element name="at" type="Types:TriPortIdType"/>
                <xsd:element name="to" type="Types:TriPortIdType" minOccurs="0"/>
                <xsd:element name="signature" type="Types:TriSignatureIdType"/>
                <xsd:element name="tciPars" type="Types:TciParameterListType" minOccurs="0"/>
                <xsd:element name="excValue" type="Values:Value" minOccurs="0"/>
                <xsd:element name="addrValue" type="Values:Value" minOccurs="0"/>
                <xsd:choice>
                    <xsd:element name="encoder-failure" type="SimpleTypes:TciStatusType"
minOccurs="0"/>
                    <xsd:sequence>
                        <xsd:element name="exc" type="Types:TriExceptionType" minOccurs="0"/>
                        <xsd:element name="address" type="Types:TriAddressType" minOccurs="0"/>
                        <xsd:element name="transmission-failure"
type="SimpleTypes:TriStatusType" minOccurs="0"/>
                    </xsd:sequence>
                </xsd:choice>
            </xsd:sequence>
        </xsd:extension>
    </xsd:complexContent>
</xsd:complexType>

<xsd:complexType name="tliPrRaise_m_BC">
    <xsd:complexContent mixed="true">
        <xsd:extension base="Events:Event">
            <xsd:sequence>
                <xsd:element name="at" type="Types:TriPortIdType"/>
                <xsd:element name="to" type="Types:TriPortIdType" minOccurs="0"/>
                <xsd:element name="signature" type="Types:TriSignatureIdType"/>

```

```

        <xsd:element name="tciPars" type="Types:TciParameterListType" minOccurs="0"/>
        <xsd:element name="excValue" type="Values:Value" minOccurs="0"/>
        <xsd:choice>
            <xsd:element name="encoder-failure" type="SimpleTypes:TciStatusType"
minOccurs="0"/>
            <xsd:sequence>
                <xsd:element name="exc" type="Types:TriExceptionType" minOccurs="0"/>
                <xsd:element name="transmission-failure"
type="SimpleTypes:TciStatusType" minOccurs="0"/>
            </xsd:sequence>
        </xsd:choice>
    </xsd:sequence>
</xsd:extension>
</xsd:complexContent>
</xsd:complexType>

<xsd:complexType name="tliPrRaise_m_MC">
    <xsd:complexContent mixed="true">
        <xsd:extension base="Events:Event">
            <xsd:sequence>
                <xsd:element name="at" type="Types:TriPortIdType"/>
                <xsd:element name="to" type="Types:TriPortIdType" minOccurs="0"/>
                <xsd:element name="signature" type="Types:TriSignatureIdType"/>
                <xsd:element name="tciPars" type="Types:TciParameterListType" minOccurs="0"/>
                <xsd:element name="excValue" type="Values:Value" minOccurs="0"/>
                <xsd:element name="addrValues" type="Types:TciValueListType" minOccurs="0"/>
                <xsd:choice>
                    <xsd:element name="encoder-failure" type="SimpleTypes:TciStatusType"
minOccurs="0"/>
                    <xsd:sequence>
                        <xsd:element name="exc" type="Types:TriExceptionType" minOccurs="0"/>
                        <xsd:element name="addresses" type="Types:TriAddressListType"
minOccurs="0"/>
                    </xsd:sequence>
                </xsd:choice>
                <xsd:element name="transmission-failure"
type="SimpleTypes:TciStatusType" minOccurs="0"/>
            </xsd:sequence>
        </xsd:extension>
    </xsd:complexContent>
</xsd:complexType>

<xsd:complexType name="tliPrRaise_c">
    <xsd:complexContent mixed="true">
        <xsd:extension base="Events:Event">
            <xsd:sequence>
                <xsd:element name="at" type="Types:TriPortIdType"/>
                <xsd:element name="to" type="Types:TriPortIdType" minOccurs="0"/>
                <xsd:element name="signature" type="Types:TriSignatureIdType"/>
                <xsd:element name="tciPars" type="Types:TciParameterListType" minOccurs="0"/>
                <xsd:element name="excValue" type="Values:Value" minOccurs="0"/>
                <xsd:element name="transmission-failure" type="SimpleTypes:TciStatusType"
minOccurs="0"/>
            </xsd:sequence>
        </xsd:extension>
    </xsd:complexContent>
</xsd:complexType>

<xsd:complexType name="tliPrRaise_c_BC">
    <xsd:complexContent mixed="true">
        <xsd:extension base="Events:Event">
            <xsd:sequence>
                <xsd:element name="at" type="Types:TriPortIdType"/>
                <xsd:element name="to" type="Types:TriPortIdListType" minOccurs="0"/>
                <xsd:element name="signature" type="Types:TriSignatureIdType"/>
                <xsd:element name="tciPars" type="Types:TciParameterListType" minOccurs="0"/>
                <xsd:element name="excValue" type="Values:Value" minOccurs="0"/>
                <xsd:element name="transmission-failure" type="SimpleTypes:TciStatusType"
minOccurs="0"/>
            </xsd:sequence>
        </xsd:extension>
    </xsd:complexContent>
</xsd:complexType>

<xsd:complexType name="tliPrRaise_c_MC">
    <xsd:complexContent mixed="true">
        <xsd:extension base="Events:Event">
            <xsd:sequence>

```

```

        <xsd:element name="at" type="Types:TriPortIdType"/>
        <xsd:element name="to" type="Types:TriPortIdListType" minOccurs="0"/>
        <xsd:element name="signature" type="Types:TriSignatureIdType"/>
        <xsd:element name="tciPars" type="Types:TciParameterListType" minOccurs="0"/>
        <xsd:element name="excValue" type="Values:Value" minOccurs="0"/>
        <xsd:element name="transmission-failure" type="SimpleTypes:TriStatusType"
minOccurs="0"/>
    </xsd:sequence>
</xsd:extension>
</xsd:complexType>
</xsd:complexType>

<xsd:complexType name="tliPrCatchDetected_m">
    <xsd:complexContent mixed="true">
        <xsd:extension base="Events:Event">
            <xsd:sequence>
                <xsd:element name="at" type="Types:TriPortIdType"/>
                <xsd:element name="from" type="Types:TriPortIdType" minOccurs="0"/>
                <xsd:element name="signature" type="Types:TriSignatureIdType"/>
                <xsd:element name="exc" type="Types:TriExceptionType" minOccurs="0"/>
                <xsd:element name="address" type="Types:TriAddressType" minOccurs="0"/>
            </xsd:sequence>
        </xsd:extension>
    </xsd:complexContent>
</xsd:complexType>

<xsd:complexType name="tliPrCatchDetected_c">
    <xsd:complexContent mixed="true">
        <xsd:extension base="Events:Event">
            <xsd:sequence>
                <xsd:element name="at" type="Types:TriPortIdType"/>
                <xsd:element name="from" type="Types:TriPortIdType" minOccurs="0"/>
                <xsd:element name="signature" type="Types:TriSignatureIdType"/>
                <xsd:element name="excValue" type="Values:Value" minOccurs="0"/>
            </xsd:sequence>
        </xsd:extension>
    </xsd:complexContent>
</xsd:complexType>

<xsd:complexType name="tliPrCatchMismatch_m">
    <xsd:complexContent mixed="true">
        <xsd:extension base="Events:Event">
            <xsd:sequence>
                <xsd:element name="at" type="Types:TriPortIdType"/>
                <xsd:element name="signature" type="Types:TriSignatureIdType"/>
                <xsd:element name="excValue" type="Values:Value" minOccurs="0"/>
                <xsd:element name="excTpl" type="Templates:TciValueTemplate" minOccurs="0"/>
                <xsd:element name="diffs" type="Templates:TciValueDifferenceList"/>
                <xsd:element name="addrValue" type="Values:Value" minOccurs="0"/>
                <xsd:element name="addressTpl" type="Templates:TciValueTemplate"
minOccurs="0"/>
            </xsd:sequence>
        </xsd:extension>
    </xsd:complexContent>
</xsd:complexType>

<xsd:complexType name="tliPrCatchMismatch_c">
    <xsd:complexContent mixed="true">
        <xsd:extension base="Events:Event">
            <xsd:sequence>
                <xsd:element name="at" type="Types:TriPortIdType"/>
                <xsd:element name="signature" type="Types:TriSignatureIdType"/>
                <xsd:element name="excValue" type="Values:Value" minOccurs="0"/>
                <xsd:element name="excTpl" type="Templates:TciValueTemplate" minOccurs="0"/>
                <xsd:element name="diffs" type="Templates:TciValueDifferenceList"/>
                <xsd:element name="from" type="Types:TriComponentIdType" minOccurs="0"/>
                <xsd:element name="fromTpl" type="Templates:TciNonValueTemplate"
minOccurs="0"/>
            </xsd:sequence>
        </xsd:extension>
    </xsd:complexContent>
</xsd:complexType>

<xsd:complexType name="tliPrCatch_m">
    <xsd:complexContent mixed="true">
        <xsd:extension base="Events:Event">
            <xsd:sequence>
                <xsd:element name="at" type="Types:TriPortIdType"/>

```

```

        <xsd:element name="signature" type="Types:TriSignatureIdType"/>
        <xsd:element name="excValue" type="Values:Value" minOccurs="0"/>
        <xsd:element name="excTmpl" type="Templates:TciValueTemplate" minOccurs="0"/>
        <xsd:element name="addrValue" type="Values:Value" minOccurs="0"/>
        <xsd:element name="addressTmpl" type="Templates:TciValueTemplate"
minOccurs="0"/>
    </xsd:sequence>
</xsd:extension>
</xsd:complexContent>
</xsd:complexType>

<xsd:complexType name="tliPrCatch_c">
    <xsd:complexContent mixed="true">
        <xsd:extension base="Events:Event">
            <xsd:sequence>
                <xsd:element name="at" type="Types:TriPortIdType"/>
                <xsd:element name="signature" type="Types:TriSignatureIdType"/>
                <xsd:element name="excValue" type="Values:Value" minOccurs="0"/>
                <xsd:element name="excTmpl" type="Templates:TciValueTemplate" minOccurs="0"/>
                <xsd:element name="from" type="Types:TriComponentIdType" minOccurs="0"/>
                <xsd:element name="fromTmpl" type="Templates:TciNonValueTemplate"
minOccurs="0"/>
            </xsd:sequence>
        </xsd:extension>
    </xsd:complexContent>
</xsd:complexType>

<xsd:complexType name="tliPrCatchTimeoutDetected">
    <xsd:complexContent mixed="true">
        <xsd:extension base="Events:Event">
            <xsd:sequence>
                <xsd:element name="at" type="Types:TriPortIdType"/>
                <xsd:element name="signature" type="Types:TriSignatureIdType"/>
            </xsd:sequence>
        </xsd:extension>
    </xsd:complexContent>
</xsd:complexType>

<xsd:complexType name="tliPrCatchTimeout">
    <xsd:complexContent mixed="true">
        <xsd:extension base="Events:Event">
            <xsd:sequence>
                <xsd:element name="at" type="Types:TriPortIdType"/>
                <xsd:element name="signature" type="Types:TriSignatureIdType"/>
            </xsd:sequence>
        </xsd:extension>
    </xsd:complexContent>
</xsd:complexType>

<!-- components -->
<xsd:complexType name="tliCCreate">
    <xsd:complexContent mixed="true">
        <xsd:extension base="Events:Event">
            <xsd:sequence>
                <xsd:element name="comp" type="Types:TriComponentIdType"/>
                <xsd:element name="name" type="SimpleTypes:TString"/>
                <xsd:element name="hostId" type="Values:Value" minOccurs="0"/>
                <xsd:element name="alive" type="SimpleTypes:TBoolean"/>
            </xsd:sequence>
        </xsd:extension>
    </xsd:complexContent>
</xsd:complexType>

<xsd:complexType name="tliCStart">
    <xsd:complexContent mixed="true">
        <xsd:extension base="Events:Event">
            <xsd:sequence>
                <xsd:element name="comp" type="Types:TriComponentIdType"/>
                <xsd:element name="name" type="Types:TciBehaviourIdType"/>
                <xsd:element name="tciPars" type="Types:TciParameterListType" minOccurs="0"/>
            </xsd:sequence>
        </xsd:extension>
    </xsd:complexContent>
</xsd:complexType>

<xsd:complexType name="tliCRunning">
    <xsd:complexContent mixed="true">
        <xsd:extension base="Events:Event">

```

```

        <xsd:sequence>
          <xsd:element name="comp" type="Types:TriComponentIdType"/>
          <xsd:element name="status" type="SimpleTypes:ComponentStatusType"/>
        </xsd:sequence>
      </xsd:extension>
    </xsd:complexContent>
  </xsd:complexType>

  <xsd:complexType name="tliCAlive">
    <xsd:complexContent mixed="true">
      <xsd:extension base="Events:Event">
        <xsd:sequence>
          <xsd:element name="comp" type="Types:TriComponentIdType"/>
          <xsd:element name="status" type="SimpleTypes:ComponentStatusType"/>
        </xsd:sequence>
      </xsd:extension>
    </xsd:complexContent>
  </xsd:complexType>

  <xsd:complexType name="tliCStop">
    <xsd:complexContent mixed="true">
      <xsd:extension base="Events:Event">
        <xsd:sequence>
          <xsd:element name="comp" type="Types:TriComponentIdType"/>
        </xsd:sequence>
      </xsd:extension>
    </xsd:complexContent>
  </xsd:complexType>

  <xsd:complexType name="tliCKill">
    <xsd:complexContent mixed="true">
      <xsd:extension base="Events:Event">
        <xsd:sequence>
          <xsd:element name="comp" type="Types:TriComponentIdType"/>
        </xsd:sequence>
      </xsd:extension>
    </xsd:complexContent>
  </xsd:complexType>

  <xsd:complexType name="tliCDoneMismatch">
    <xsd:complexContent mixed="true">
      <xsd:extension base="Events:Event">
        <xsd:sequence>
          <xsd:element name="comp" type="Types:TriComponentIdType"/>
          <xsd:element name="compTpl" type="Templates:TciNonValueTemplate"/>
        </xsd:sequence>
      </xsd:extension>
    </xsd:complexContent>
  </xsd:complexType>

  <xsd:complexType name="tliCKilledMismatch">
    <xsd:complexContent mixed="true">
      <xsd:extension base="Events:Event">
        <xsd:sequence>
          <xsd:element name="comp" type="Types:TriComponentIdType"/>
          <xsd:element name="compTpl" type="Templates:TciNonValueTemplate"/>
        </xsd:sequence>
      </xsd:extension>
    </xsd:complexContent>
  </xsd:complexType>

  <xsd:complexType name="tliCDone">
    <xsd:complexContent mixed="true">
      <xsd:extension base="Events:Event">
        <xsd:sequence>
          <xsd:element name="compTpl" type="Templates:TciNonValueTemplate"/>
        </xsd:sequence>
      </xsd:extension>
    </xsd:complexContent>
  </xsd:complexType>

  <xsd:complexType name="tliCKilled">
    <xsd:complexContent mixed="true">
      <xsd:extension base="Events:Event">
        <xsd:sequence>
          <xsd:element name="compTpl" type="Templates:TciNonValueTemplate"/>
        </xsd:sequence>
      </xsd:extension>
    </xsd:complexContent>
  </xsd:complexType>

```



```

    </xsd:complexContent>
  </xsd:complexType>

  <xsd:complexType name="tliCTerminated">
    <xsd:complexContent mixed="true">
      <xsd:extension base="Events:Event">
        <xsd:sequence>
          <xsd:element name="verdict" type="Values:VerdictValue" />
          <xsd:element name="reason" type="SimpleTypes:TString" minOccurs="0"/>
        </xsd:sequence>
      </xsd:extension>
    </xsd:complexContent>
  </xsd:complexType>

  <!-- ports -->
  <xsd:complexType name="tliPConnect">
    <xsd:complexContent mixed="true">
      <xsd:extension base="Events:PortConfiguration"/>
    </xsd:complexContent>
  </xsd:complexType>

  <xsd:complexType name="tliPDisconnect">
    <xsd:complexContent mixed="true">
      <xsd:extension base="Events:PortConfiguration"/>
    </xsd:complexContent>
  </xsd:complexType>

  <xsd:complexType name="tliPMap">
    <xsd:complexContent mixed="true">
      <xsd:extension base="Events:PortConfiguration"/>
    </xsd:complexContent>
  </xsd:complexType>

  <xsd:complexType name="tliPMapParam">
    <xsd:complexContent mixed="true">
      <xsd:extension base="Events:tliPMap">
        <xsd:sequence>
          <xsd:element name="tciPars" type="Types:TciParameterListType" />
          <xsd:choice>
            <xsd:element name="encoder-failure" type="SimpleTypes:TciStatusType"
minOccurs="0"/>
            <xsd:element name="triPars" type="Types:TriParameterListType" />
          </xsd:choice>
        </xsd:sequence>
      </xsd:extension>
    </xsd:complexContent>
  </xsd:complexType>

  <xsd:complexType name="tliPUnmap">
    <xsd:complexContent mixed="true">
      <xsd:extension base="Events:PortConfiguration"/>
    </xsd:complexContent>
  </xsd:complexType>

  <xsd:complexType name="tliPUnmapParam">
    <xsd:complexContent mixed="true">
      <xsd:extension base="Events:tliPUnmap">
        <xsd:sequence>
          <xsd:element name="tciPars" type="Types:TciParameterListType" />
          <xsd:choice>
            <xsd:element name="encoder-failure" type="SimpleTypes:TciStatusType"
minOccurs="0"/>
            <xsd:element name="triPars" type="Types:TriParameterListType"/>
          </xsd:choice>
        </xsd:sequence>
      </xsd:extension>
    </xsd:complexContent>
  </xsd:complexType>

  <xsd:complexType name="tliPClear">
    <xsd:complexContent mixed="true">
      <xsd:extension base="Events:PortStatus"/>
    </xsd:complexContent>
  </xsd:complexType>

  <xsd:complexType name="tliPStart">
    <xsd:complexContent mixed="true">
      <xsd:extension base="Events:PortStatus"/>

```

```

    </xsd:complexContent>
  </xsd:complexType>

  <xsd:complexType name="tliPStop">
    <xsd:complexContent mixed="true">
      <xsd:extension base="Events:PortStatus"/>
    </xsd:complexContent>
  </xsd:complexType>

  <xsd:complexType name="tliPHalt">
    <xsd:complexContent mixed="true">
      <xsd:extension base="Events:PortStatus"/>
    </xsd:complexContent>
  </xsd:complexType>

  <!-- codec -->
  <xsd:complexType name="tliEncode">
    <xsd:complexContent mixed="true">
      <xsd:extension base="Events:Event">
        <xsd:sequence>
          <xsd:element name="val" type="Values:Value"/>
          <xsd:choice>
            <xsd:element name="msg" type="Types:TriMessageType"/>
            <xsd:element name="encoder-failure" type="SimpleTypes:TciStatusType"
minOccurs="0"/>
          </xsd:choice>
          <xsd:element name="codec" type="SimpleTypes:TString"
            minOccurs="0"/>
        </xsd:sequence>
      </xsd:extension>
    </xsd:complexContent>
  </xsd:complexType>

  <xsd:complexType name="tliDecode" mixed="true">
    <xsd:complexContent mixed="true">
      <xsd:extension base="Events:Event">
        <xsd:sequence>
          <xsd:element name="msg" type="Types:TriMessageType"/>
          <xsd:choice>
            <xsd:element name="decoder-failure" type="SimpleTypes:TciStatusType"
minOccurs="0"/>
            <xsd:element name="val" type="Values:Value"/>
          </xsd:choice>
          <xsd:element name="codec" type="SimpleTypes:TString"
            minOccurs="0"/>
        </xsd:sequence>
      </xsd:extension>
    </xsd:complexContent>
  </xsd:complexType>

  <!-- timers -->
  <xsd:complexType name="tliTimeoutDetected">
    <xsd:complexContent mixed="true">
      <xsd:extension base="Events:Event">
        <xsd:sequence>
          <xsd:element name="timer" type="Types:TriTimerIdType" />
        </xsd:sequence>
      </xsd:extension>
    </xsd:complexContent>
  </xsd:complexType>

  <xsd:complexType name="tliTimeoutMismatch">
    <xsd:complexContent mixed="true">
      <xsd:extension base="Events:Event">
        <xsd:sequence>
          <xsd:element name="timer" type="Types:TriTimerIdType" />
          <xsd:element name="timerTpl" type="Templates:TciNonValueTemplate" />
        </xsd:sequence>
      </xsd:extension>
    </xsd:complexContent>
  </xsd:complexType>

  <xsd:complexType name="tliTimeout">
    <xsd:complexContent mixed="true">
      <xsd:extension base="Events:Event">
        <xsd:sequence>
          <xsd:element name="timer" type="Types:TriTimerIdType" />
          <xsd:element name="timerTpl" type="Templates:TciNonValueTemplate" />

```

```

        </xsd:sequence>
      </xsd:extension>
    </xsd:complexContent>
  </xsd:complexType>

  <xsd:complexType name="tliTStart">
    <xsd:complexContent mixed="true">
      <xsd:extension base="Events:Event">
        <xsd:sequence>
          <xsd:element name="timer" type="Types:TriTimerIdType"/>
          <xsd:element name="dur" type="SimpleTypes:TriTimerDurationType"/>
        </xsd:sequence>
      </xsd:extension>
    </xsd:complexContent>
  </xsd:complexType>

  <xsd:complexType name="tliTStop">
    <xsd:complexContent mixed="true">
      <xsd:extension base="Events:Event">
        <xsd:sequence>
          <xsd:element name="timer" type="Types:TriTimerIdType"/>
          <xsd:element name="dur" type="SimpleTypes:TriTimerDurationType"/>
        </xsd:sequence>
      </xsd:extension>
    </xsd:complexContent>
  </xsd:complexType>

  <xsd:complexType name="tliTRead">
    <xsd:complexContent mixed="true">
      <xsd:extension base="Events:Event">
        <xsd:sequence>
          <xsd:element name="timer" type="Types:TriTimerIdType"/>
          <xsd:element name="elapsed" type="SimpleTypes:TriTimerDurationType"/>
        </xsd:sequence>
      </xsd:extension>
    </xsd:complexContent>
  </xsd:complexType>

  <xsd:complexType name="tliTRunning">
    <xsd:complexContent mixed="true">
      <xsd:extension base="Events:Event">
        <xsd:sequence>
          <xsd:element name="timer" type="Types:TriTimerIdType"/>
          <xsd:element name="status" type="SimpleTypes:TimerStatusType"/>
        </xsd:sequence>
      </xsd:extension>
    </xsd:complexContent>
  </xsd:complexType>

  <!-- scope -->
  <xsd:complexType name="tliSEnter">
    <xsd:complexContent mixed="true">
      <xsd:extension base="Events:Event">
        <xsd:sequence>
          <xsd:element name="name" type="Types:QualifiedName" />
          <xsd:element name="tciPars" type="Types:TciParameterListType" minOccurs="0"/>
          <xsd:element name="kind" type="SimpleTypes:TString"/>
        </xsd:sequence>
      </xsd:extension>
    </xsd:complexContent>
  </xsd:complexType>

  <xsd:complexType name="tliSLeave">
    <xsd:complexContent mixed="true">
      <xsd:extension base="Events:Event">
        <xsd:sequence>
          <xsd:element name="name" type="Types:QualifiedName" />
          <xsd:element name="tciPars" type="Types:TciParameterListType" minOccurs="0"/>
          <xsd:element name="returnValue" type="Values:Value" minOccurs="0"/>
          <xsd:element name="kind" type="SimpleTypes:TString"/>
        </xsd:sequence>
      </xsd:extension>
    </xsd:complexContent>
  </xsd:complexType>

  <!-- variables and module parameter -->
  <xsd:complexType name="tliVar">
    <xsd:complexContent mixed="true">

```

```

    <xsd:extension base="Events:Event">
      <xsd:sequence>
        <xsd:element name="name" type="Types:QualifiedName" />
        <xsd:element name="val" type="Values:Value" minOccurs="0"/>
      </xsd:sequence>
    </xsd:extension>
  </xsd:complexContent>
</xsd:complexType>

<xsd:complexType name="tliModulePar">
  <xsd:complexContent mixed="true">
    <xsd:extension base="Events:Event">
      <xsd:sequence>
        <xsd:element name="name" type="Types:QualifiedName" />
        <xsd:element name="val" type="Values:Value" minOccurs="0"/>
      </xsd:sequence>
    </xsd:extension>
  </xsd:complexContent>
</xsd:complexType>

<!-- verdicts -->
<xsd:complexType name="tliGetVerdict">
  <xsd:complexContent mixed="true">
    <xsd:extension base="Events:Event">
      <xsd:sequence>
        <xsd:element name="verdict" type="Values:VerdictValue"/>
      </xsd:sequence>
    </xsd:extension>
  </xsd:complexContent>
</xsd:complexType>

<xsd:complexType name="tliSetVerdict">
  <xsd:complexContent mixed="true">
    <xsd:extension base="Events:Event">
      <xsd:sequence>
        <xsd:element name="verdict" type="Values:VerdictValue"/>
        <xsd:element name="reason" type="SimpleTypes:TString" minOccurs="0"/>
      </xsd:sequence>
    </xsd:extension>
  </xsd:complexContent>
</xsd:complexType>

<!-- log -->
<xsd:complexType name="tliLog">
  <xsd:complexContent mixed="true">
    <xsd:extension base="Events:Event">
      <xsd:sequence>
        <xsd:element name="log" type="SimpleTypes:TString"/>
      </xsd:sequence>
    </xsd:extension>
  </xsd:complexContent>
</xsd:complexType>

<!-- alt -->
<xsd:complexType name="tliAEnter">
  <xsd:complexContent>
    <xsd:extension base="Events:Event"/>
  </xsd:complexContent>
</xsd:complexType>

<xsd:complexType name="tliALeave">
  <xsd:complexContent>
    <xsd:extension base="Events:Event"/>
  </xsd:complexContent>
</xsd:complexType>

<xsd:complexType name="tliADefaults">
  <xsd:complexContent>
    <xsd:extension base="Events:Event"/>
  </xsd:complexContent>
</xsd:complexType>

<xsd:complexType name="tliAActivate">
  <xsd:complexContent mixed="true">
    <xsd:extension base="Events:Event">
      <xsd:sequence>
        <xsd:element name="name" type="Types:QualifiedName" />
        <xsd:element name="tciPars" type="Types:TciParameterListType" minOccurs="0"/>
      </xsd:sequence>
    </xsd:extension>
  </xsd:complexContent>
</xsd:complexType>

```

```

        <xsd:element name="ref" type="Values:Value"/>
      </xsd:sequence>
    </xsd:extension>
  </xsd:complexContent>
</xsd:complexType>

<xsd:complexType name="tliADeactivate">
  <xsd:complexContent mixed="true">
    <xsd:extension base="Events:Event">
      <xsd:sequence>
        <xsd:element name="ref" type="Values:Value"/>
      </xsd:sequence>
    </xsd:extension>
  </xsd:complexContent>
</xsd:complexType>

<xsd:complexType name="tliANomatch">
  <xsd:complexContent mixed="true">
    <xsd:extension base="Events:Event"/>
  </xsd:complexContent>
</xsd:complexType>

<xsd:complexType name="tliARepeat">
  <xsd:complexContent>
    <xsd:extension base="Events:Event"/>
  </xsd:complexContent>
</xsd:complexType>

<xsd:complexType name="tliAwait">
  <xsd:complexContent>
    <xsd:extension base="Events:Event"/>
  </xsd:complexContent>
</xsd:complexType>

<xsd:complexType name="tliAction">
  <xsd:complexContent mixed="true">
    <xsd:extension base="Events:Event">
      <xsd:sequence>
        <xsd:element name="action" type="SimpleTypes:TString"/>
      </xsd:sequence>
    </xsd:extension>
  </xsd:complexContent>
</xsd:complexType>

<xsd:complexType name="tliMatch">
  <xsd:complexContent mixed="true">
    <xsd:extension base="Events:Event">
      <xsd:sequence>
        <xsd:element name="expr" type="Values:Value"/>
        <xsd:element name="tmpl" type="Templates:TciValueTemplate"/>
      </xsd:sequence>
    </xsd:extension>
  </xsd:complexContent>
</xsd:complexType>

<xsd:complexType name="tliMatchMismatch">
  <xsd:complexContent mixed="true">
    <xsd:extension base="Events:Event">
      <xsd:sequence>
        <xsd:element name="expr" type="Values:Value"/>
        <xsd:element name="tmpl" type="Templates:TciValueTemplate"/>
        <xsd:element name="diffs" type="Templates:TciValueDifferenceList"/>
      </xsd:sequence>
    </xsd:extension>
  </xsd:complexContent>
</xsd:complexType>

<xsd:complexType name="tliInfo">
  <xsd:complexContent mixed="true">
    <xsd:extension base="Events:Event">
      <xsd:sequence>
        <xsd:element name="level" type="SimpleTypes:TInteger"/>
        <xsd:element name="info" type="SimpleTypes:TString"/>
      </xsd:sequence>
    </xsd:extension>
  </xsd:complexContent>
</xsd:complexType>

```

```

<xsd:complexType name="tliMChecked_m">
  <xsd:complexContent mixed="true">
    <xsd:extension base="Events:Event">
      <xsd:sequence>
        <xsd:element name="at" type="Types:TriPortIdType"/>
        <xsd:element name="msgValue" type="Values:Value" minOccurs="0"/>
        <xsd:element name="msgTmpl" type="Templates:TciValueTemplate" minOccurs="0"/>
        <xsd:element name="addrValue" type="Values:Value" minOccurs="0"/>
        <xsd:element name="addressTmpl" type="Templates:TciValueTemplate"
          minOccurs="0"/>
      </xsd:sequence>
    </xsd:extension>
  </xsd:complexContent>
</xsd:complexType>

<xsd:complexType name="tliMChecked_c">
  <xsd:complexContent mixed="true">
    <xsd:extension base="Events:Event">
      <xsd:sequence>
        <xsd:element name="at" type="Types:TriPortIdType"/>
        <xsd:element name="msgValue" type="Values:Value" minOccurs="0"/>
        <xsd:element name="msgTmpl" type="Templates:TciValueTemplate"
          minOccurs="0"/>
        <xsd:element name="from" type="Types:TriComponentIdType" minOccurs="0"/>
        <xsd:element name="fromTmpl" type="Templates:TciNonValueTemplate"
          minOccurs="0"/>
      </xsd:sequence>
    </xsd:extension>
  </xsd:complexContent>
</xsd:complexType>

<xsd:complexType name="tliPrGetCallChecked_m">
  <xsd:complexContent mixed="true">
    <xsd:extension base="Events:Event">
      <xsd:sequence>
        <xsd:element name="at" type="Types:TriPortIdType"/>
        <xsd:element name="signature" type="Types:TriSignatureIdType"/>
        <xsd:element name="tciPars" type="Types:TciParameterListType" minOccurs="0"/>
        <xsd:element name="parsTmpl" type="Templates:TciValueTemplate" minOccurs="0"/>
        <xsd:element name="addrValue" type="Values:Value" minOccurs="0"/>
        <xsd:element name="addressTmpl" type="Templates:TciValueTemplate"
          minOccurs="0"/>
      </xsd:sequence>
    </xsd:extension>
  </xsd:complexContent>
</xsd:complexType>

<xsd:complexType name="tliPrGetCallChecked_c">
  <xsd:complexContent mixed="true">
    <xsd:extension base="Events:Event">
      <xsd:sequence>
        <xsd:element name="at" type="Types:TriPortIdType"/>
        <xsd:element name="signature" type="Types:TriSignatureIdType"/>
        <xsd:element name="tciPars" type="Types:TciParameterListType" minOccurs="0"/>
        <xsd:element name="parsTmpl" type="Templates:TciValueTemplate" minOccurs="0"/>
        <xsd:element name="from" type="Types:TriComponentIdType" minOccurs="0"/>
        <xsd:element name="fromTmpl" type="Templates:TciNonValueTemplate"
          minOccurs="0"/>
      </xsd:sequence>
    </xsd:extension>
  </xsd:complexContent>
</xsd:complexType>

<xsd:complexType name="tliPrGetReplyChecked_m">
  <xsd:complexContent mixed="true">
    <xsd:extension base="Events:Event">
      <xsd:sequence>
        <xsd:element name="at" type="Types:TriPortIdType"/>
        <xsd:element name="signature" type="Types:TriSignatureIdType"/>
        <xsd:element name="tciPars" type="Types:TciParameterListType" minOccurs="0"/>
        <xsd:element name="parsTmpl" type="Templates:TciValueTemplate" minOccurs="0"/>
        <xsd:element name="replValue" type="Values:Value" minOccurs="0"/>
        <xsd:element name="replTmpl" type="Templates:TciValueTemplate" minOccurs="0"/>
        <xsd:element name="addrValue" type="Values:Value" minOccurs="0"/>
        <xsd:element name="addressTmpl" type="Templates:TciValueTemplate"
          minOccurs="0"/>
      </xsd:sequence>
    </xsd:extension>
  </xsd:complexContent>
</xsd:complexType>

```

```

    </xsd:complexContent>
  </xsd:complexType>

  <xsd:complexType name="tliPrGetReplyChecked_c">
    <xsd:complexContent mixed="true">
      <xsd:extension base="Events:Event">
        <xsd:sequence>
          <xsd:element name="at" type="Types:TriPortIdType"/>
          <xsd:element name="signature" type="Types:TriSignatureIdType"/>
          <xsd:element name="tciPars" type="Types:TciParameterListType" minOccurs="0"/>
          <xsd:element name="parsTmpl" type="Templates:TciValueTemplate" minOccurs="0"/>
          <xsd:element name="replValue" type="Values:Value" minOccurs="0"/>
          <xsd:element name="replTmpl" type="Templates:TciValueTemplate" minOccurs="0"/>
          <xsd:element name="from" type="Types:TriComponentIdType" minOccurs="0"/>
          <xsd:element name="fromTmpl" type="Templates:TciNonValueTemplate"
            minOccurs="0"/>
        </xsd:sequence>
      </xsd:extension>
    </xsd:complexContent>
  </xsd:complexType>

  <xsd:complexType name="tliPrCatchChecked_m">
    <xsd:complexContent mixed="true">
      <xsd:extension base="Events:Event">
        <xsd:sequence>
          <xsd:element name="at" type="Types:TriPortIdType"/>
          <xsd:element name="signature" type="Types:TriSignatureIdType"/>
          <xsd:element name="excValue" type="Values:Value" minOccurs="0"/>
          <xsd:element name="excTmpl" type="Templates:TciValueTemplate" minOccurs="0"/>
          <xsd:element name="addrValue" type="Values:Value" minOccurs="0"/>
          <xsd:element name="addressTmpl" type="Templates:TciValueTemplate"
            minOccurs="0"/>
        </xsd:sequence>
      </xsd:extension>
    </xsd:complexContent>
  </xsd:complexType>

  <xsd:complexType name="tliPrCatchChecked_c">
    <xsd:complexContent mixed="true">
      <xsd:extension base="Events:Event">
        <xsd:sequence>
          <xsd:element name="at" type="Types:TriPortIdType"/>
          <xsd:element name="signature" type="Types:TriSignatureIdType"/>
          <xsd:element name="excValue" type="Values:Value" minOccurs="0"/>
          <xsd:element name="excTmpl" type="Templates:TciValueTemplate" minOccurs="0"/>
          <xsd:element name="from" type="Types:TriComponentIdType" minOccurs="0"/>
          <xsd:element name="fromTmpl" type="Templates:TciNonValueTemplate"
            minOccurs="0"/>
        </xsd:sequence>
      </xsd:extension>
    </xsd:complexContent>
  </xsd:complexType>

  <xsd:complexType name="tliCheckedAny_m">
    <xsd:complexContent mixed="true">
      <xsd:extension base="Events:Event">
        <xsd:sequence>
          <xsd:element name="at" type="Types:TriPortIdType"/>
          <xsd:element name="addrValue" type="Values:Value" minOccurs="0"/>
          <xsd:element name="addressTmpl" type="Templates:TciValueTemplate"
            minOccurs="0"/>
        </xsd:sequence>
      </xsd:extension>
    </xsd:complexContent>
  </xsd:complexType>

  <xsd:complexType name="tliCheckedAny_c">
    <xsd:complexContent mixed="true">
      <xsd:extension base="Events:Event">
        <xsd:sequence>
          <xsd:element name="at" type="Types:TriPortIdType"/>
          <xsd:element name="from" type="Types:TriComponentIdType"
            minOccurs="0"/>
          <xsd:element name="fromTmpl" type="Templates:TciNonValueTemplate"
            minOccurs="0"/>
        </xsd:sequence>
      </xsd:extension>
    </xsd:complexContent>
  </xsd:complexType>

```

```

</xsd:complexType>

<xsd:complexType name="tliCheckMismatch_m">
  <xsd:complexContent mixed="true">
    <xsd:extension base="Events:Event">
      <xsd:sequence>
        <xsd:element name="at" type="Types:TriPortIdType"/>
        <xsd:element name="addrValue" type="Values:Value" minOccurs="0"/>
        <xsd:element name="addressTmpl" type="Templates:TciValueTemplate"
          minOccurs="0"/>
      </xsd:sequence>
    </xsd:extension>
  </xsd:complexContent>
</xsd:complexType>

<xsd:complexType name="tliCheckMismatch_c">
  <xsd:complexContent mixed="true">
    <xsd:extension base="Events:Event">
      <xsd:sequence>
        <xsd:element name="at" type="Types:TriPortIdType"/>
        <xsd:element name="from" type="Types:TriComponentIdType"
          minOccurs="0"/>
        <xsd:element name="fromTmpl" type="Templates:TciNonValueTemplate"
          minOccurs="0"/>
      </xsd:sequence>
    </xsd:extension>
  </xsd:complexContent>
</xsd:complexType>

<xsd:complexType name="tliRnd">
  <xsd:complexContent mixed="true">
    <xsd:extension base="Events:Event">
      <xsd:sequence>
        <xsd:element name="val" type="Values:FloatValue"/>
        <xsd:element name="from" type="Values:FloatValue"/>
      </xsd:sequence>
    </xsd:extension>
  </xsd:complexContent>
</xsd:complexType>

<xsd:complexType name="tliEvaluate">
  <xsd:complexContent mixed="true">
    <xsd:extension base="Events:Event">
      <xsd:sequence>
        <xsd:element name="name" type="Types:QualifiedName" />
        <xsd:element name="evalResult" type="Values:Value" minOccurs="0"/>
      </xsd:sequence>
    </xsd:extension>
  </xsd:complexContent>
</xsd:complexType>

<xsd:complexType name="tliCCall">
  <xsd:complexContent mixed="true">
    <xsd:extension base="Events:Event">
      <xsd:sequence>
        <xsd:element name="comp" type="Types:TriComponentIdType"/>
        <xsd:element name="name" type="Types:TciBehaviourIdType"/>
        <xsd:element name="tciPars" type="Types:TciParameterListType" minOccurs="0"/>
      </xsd:sequence>
    </xsd:extension>
  </xsd:complexContent>
</xsd:complexType>

<xsd:complexType name="tliCCallTerminated">
  <xsd:complexContent mixed="true">
    <xsd:extension base="Events:Event">
      <xsd:sequence>
        <xsd:element name="verdict" type="Values:VerdictValue" />
        <xsd:element name="reason" type="SimpleTypes:TString" minOccurs="0"/>
        <xsd:element name="tciPars" type="Types:TciParameterListType" minOccurs="0"/>
        <xsd:element name="returnValue" type="Values:Value" minOccurs="0"/>
      </xsd:sequence>
    </xsd:extension>
  </xsd:complexContent>
</xsd:complexType>

```



```

<xsd:complexType name="tliCtrlStartWithParameters">
  <xsd:complexContent>
    <xsd:extension base="Events:Event">
      <xsd:sequence>
        <xsd:element name="tciPars" type="Types:TciParameterListType" minOccurs="0"/>
      </xsd:sequence>
    </xsd:extension>
  </xsd:complexContent>
</xsd:complexType>

<xsd:complexType name="tliCtrlTerminatedWithResult">
  <xsd:complexContent>
    <xsd:extension base="Events:Event">
      <xsd:sequence>
        <xsd:element name="result" type="Values:Value" minOccurs="0"/>
        <xsd:element name="tciPars" type="Types:TciParameterListType" minOccurs="0"/>
      </xsd:sequence>
    </xsd:extension>
  </xsd:complexContent>
</xsd:complexType>

</xsd:schema>

```

---

## B.6 TCI-TL XML Schema for a Log

```

<?xml version="1.0" encoding="UTF-8"?>
<xsd:schema xmlns:xsd="http://www.w3.org/2001/XMLSchema"
  targetNamespace="http://uri.etsi.org/ttcn-3/tci/TLI_v4_10_1.xsd"
  xmlns:TLI="http://uri.etsi.org/ttcn-3/tci/TLI_v4_10_1.xsd"
  xmlns:Events="http://uri.etsi.org/ttcn-3/tci/Events_v4_10_1.xsd"
  elementFormDefault="qualified">

  <xsd:import namespace="http://uri.etsi.org/ttcn-3/tci/Events_v4_10_1.xsd"
    schemaLocation="Events_v4_10_1.xsd"/>

  <xsd:element name="logfile" type="TLI:LogModule"/>
  <xsd:complexType name="LogModule">
    <xsd:sequence>
      <xsd:element name="header" type="TLI:Header"/>
      <xsd:element name="body" type="TLI:Body"/>
      <xsd:element name="trailer" type="TLI:Trailer" minOccurs="0"/>
    </xsd:sequence>
  </xsd:complexType>
  <xsd:complexType name="Header">
    <xsd:sequence>
      <!-- logging version -->
      <xsd:element name="version" type="xsd:string"/>
      <!-- begin of the log -->
      <xsd:element name="ts" type="xsd:long"/>
    </xsd:sequence>
  </xsd:complexType>
  <xsd:complexType name="Trailer">
    <xsd:choice>
      <xsd:any namespace="##any" processContents="skip" minOccurs="0" maxOccurs="unbounded"/>
    </xsd:choice>
  </xsd:complexType>

  <xsd:complexType name="Body">
    <xsd:choice maxOccurs="unbounded">

      <!-- test cases operations -->
      <xsd:element name="tliTcExecute" type="Events:tliTcExecute"/>
      <xsd:element name="tliTcStart" type="Events:tliTcStart"/>
      <xsd:element name="tliTcStop" type="Events:tliTcStop"/>
      <xsd:element name="tliTcStarted" type="Events:tliTcStarted"/>
      <xsd:element name="tliTcTerminated" type="Events:tliTcTerminated"/>

      <!-- control operations -->
      <xsd:element name="tliCtrlStart" type="Events:tliCtrlStart"/>
      <xsd:element name="tliCtrlStop" type="Events:tliCtrlStop"/>
      <xsd:element name="tliCtrlTerminated" type="Events:tliCtrlTerminated"/>

      <!-- asynchronous communication -->
      <xsd:element name="tliMSend_m" type="Events:tliMSend_m"/>
      <xsd:element name="tliMSend_c" type="Events:tliMSend_c"/>
    </xsd:choice>
  </xsd:complexType>

```

```

<xsd:element name="tliMSend_m_BC" type="Events:tliMSend_m_BC"/>
<xsd:element name="tliMSend_c_BC" type="Events:tliMSend_c_BC"/>
<xsd:element name="tliMSend_m_MC" type="Events:tliMSend_m_MC"/>
<xsd:element name="tliMSend_c_MC" type="Events:tliMSend_c_MC"/>
<xsd:element name="tliMDetected_m" type="Events:tliMDetected_m"/>
<xsd:element name="tliMDetected_c" type="Events:tliMDetected_c"/>
<xsd:element name="tliMMismatch_m" type="Events:tliMMismatch_m"/>
<xsd:element name="tliMMismatch_c" type="Events:tliMMismatch_c"/>
<xsd:element name="tliMReceive_m" type="Events:tliMReceive_m"/>
<xsd:element name="tliMReceive_c" type="Events:tliMReceive_c"/>

<!-- synchronous communication -->
<xsd:element name="tliPrCall_m" type="Events:tliPrCall_m"/>
<xsd:element name="tliPrCall_c" type="Events:tliPrCall_c"/>
<xsd:element name="tliPrCall_m_BC" type="Events:tliPrCall_m_BC"/>
<xsd:element name="tliPrCall_c_BC" type="Events:tliPrCall_c_BC"/>
<xsd:element name="tliPrCall_m_MC" type="Events:tliPrCall_m_MC"/>
<xsd:element name="tliPrCall_c_MC" type="Events:tliPrCall_c_MC"/>

<xsd:element name="tliPrGetCallDetected_m" type="Events:tliPrGetCallDetected_m"/>
<xsd:element name="tliPrGetCallDetected_c" type="Events:tliPrGetCallDetected_c"/>
<xsd:element name="tliPrGetCallMismatch_m" type="Events:tliPrGetCallMismatch_m"/>
<xsd:element name="tliPrGetCallMismatch_c" type="Events:tliPrGetCallMismatch_c"/>
<xsd:element name="tliPrGetCall_m" type="Events:tliPrGetCall_m"/>
<xsd:element name="tliPrGetCall_c" type="Events:tliPrGetCall_c"/>

<xsd:element name="tliPrReply_m" type="Events:tliPrReply_m"/>
<xsd:element name="tliPrReply_c" type="Events:tliPrReply_c"/>
<xsd:element name="tliPrReply_m_BC" type="Events:tliPrReply_m_BC"/>
<xsd:element name="tliPrReply_c_BC" type="Events:tliPrReply_c_BC"/>
<xsd:element name="tliPrReply_m_MC" type="Events:tliPrReply_m_MC"/>
<xsd:element name="tliPrReply_c_MC" type="Events:tliPrReply_c_MC"/>

<xsd:element name="tliPrGetReplyDetected_m" type="Events:tliPrGetReplyDetected_m"/>
<xsd:element name="tliPrGetReplyDetected_c" type="Events:tliPrGetReplyDetected_c"/>
<xsd:element name="tliPrGetReplyMismatch_m" type="Events:tliPrGetReplyMismatch_m"/>
<xsd:element name="tliPrGetReplyMismatch_c" type="Events:tliPrGetReplyMismatch_c"/>
<xsd:element name="tliPrGetReply_m" type="Events:tliPrGetReply_m"/>
<xsd:element name="tliPrGetReply_c" type="Events:tliPrGetReply_c"/>

<xsd:element name="tliPrRaise_m" type="Events:tliPrRaise_m"/>
<xsd:element name="tliPrRaise_c" type="Events:tliPrRaise_c"/>
<xsd:element name="tliPrRaise_m_BC" type="Events:tliPrRaise_m_BC"/>
<xsd:element name="tliPrRaise_c_BC" type="Events:tliPrRaise_c_BC"/>
<xsd:element name="tliPrRaise_m_MC" type="Events:tliPrRaise_m_MC"/>
<xsd:element name="tliPrRaise_c_MC" type="Events:tliPrRaise_c_MC"/>

<xsd:element name="tliPrCatchDetected_m" type="Events:tliPrCatchDetected_m"/>
<xsd:element name="tliPrCatchDetected_c" type="Events:tliPrCatchDetected_c"/>
<xsd:element name="tliPrCatchMismatch_m" type="Events:tliPrCatchMismatch_m"/>
<xsd:element name="tliPrCatchMismatch_c" type="Events:tliPrCatchMismatch_c"/>
<xsd:element name="tliPrCatch_m" type="Events:tliPrCatch_m"/>
<xsd:element name="tliPrCatch_c" type="Events:tliPrCatch_c"/>

<xsd:element name="tliPrCatchTimeoutDetected"
                type="Events:tliPrCatchTimeoutDetected"/>
<xsd:element name="tliPrCatchTimeout" type="Events:tliPrCatchTimeout"/>

<!-- components -->
<xsd:element name="tlicCreate" type="Events:tlicCreate"/>
<xsd:element name="tlicStart" type="Events:tlicStart"/>
<xsd:element name="tlicRunning" type="Events:tlicRunning"/>
<xsd:element name="tlicAlive" type="Events:tlicAlive"/>
<xsd:element name="tlicStop" type="Events:tlicStop"/>
<xsd:element name="tlicKill" type="Events:tlicKill"/>
<xsd:element name="tlicDoneMismatch" type="Events:tlicDoneMismatch"/>
<xsd:element name="tlicDone" type="Events:tlicDone"/>
<xsd:element name="tlicKilledMismatch" type="Events:tlicKilledMismatch"/>
<xsd:element name="tlicKilled" type="Events:tlicKilled"/>
<xsd:element name="tlicTerminated" type="Events:tlicTerminated"/>

<!-- ports -->
<xsd:element name="tliPConnect" type="Events:tliPConnect"/>
<xsd:element name="tliPDisconnect" type="Events:tliPDisconnect"/>
<xsd:element name="tliPMap" type="Events:tliPMap"/>
<xsd:element name="tliPMapParam" type="Events:tliPMapParam"/>
<xsd:element name="tliPUnmap" type="Events:tliPUnmap"/>
<xsd:element name="tliPUnmapParam" type="Events:tliPUnmapParam"/>

```

```

<xsd:element name="tliPClear" type="Events:tliPClear"/>
<xsd:element name="tliPStart" type="Events:tliPStart"/>
<xsd:element name="tliPStop" type="Events:tliPStop"/>
<xsd:element name="tliPHalt" type="Events:tliPHalt"/>

<!-- codec -->
<xsd:element name="tliDecode" type="Events:tliDecode"/>
<xsd:element name="tliEncode" type="Events:tliEncode"/>

<!-- timers -->
<xsd:element name="tliTTimeoutDetected" type="Events:tliTTimeoutDetected"/>
<xsd:element name="tliTTimeoutMismatch" type="Events:tliTTimeoutMismatch"/>
<xsd:element name="tliTTimeout" type="Events:tliTTimeout"/>
<xsd:element name="tliTStart" type="Events:tliTStart"/>
<xsd:element name="tliTStop" type="Events:tliTStop"/>
<xsd:element name="tliTRead" type="Events:tliTRead"/>
<xsd:element name="tliTRunning" type="Events:tliTRunning"/>

<!-- scopes -->
<xsd:element name="tliSEnter" type="Events:tliSEnter"/>
<xsd:element name="tliSLeave" type="Events:tliSLeave"/>

<!-- statements -->
<xsd:element name="tliVar" type="Events:tliVar"/>
<xsd:element name="tliModulePar" type="Events:tliModulePar"/>
<xsd:element name="tliGetVerdict" type="Events:tliGetVerdict"/>
<xsd:element name="tliSetVerdict" type="Events:tliSetVerdict"/>
<xsd:element name="tliLog" type="Events:tliLog"/>

<!-- alt -->
<xsd:element name="tliAEnter" type="Events:tliAEnter"/>
<xsd:element name="tliALeave" type="Events:tliALeave"/>
<xsd:element name="tliADefaults" type="Events:tliADefaults"/>
<xsd:element name="tliAActivate" type="Events:tliAActivate"/>
<xsd:element name="tliAdeactivate" type="Events:tliAdeactivate"/>
<xsd:element name="tliANomatch" type="Events:tliANomatch"/>
<xsd:element name="tliARepeat" type="Events:tliARepeat"/>
<xsd:element name="tliAWait" type="Events:tliAWait"/>

<!-- action -->
<xsd:element name="tliAction" type="Events:tliAction"/>

<!-- match -->
<xsd:element name="tliMatch" type="Events:tliMatch"/>
<xsd:element name="tliMatchMismatch" type="Events:tliMatchMismatch"/>

<!-- info -->
<xsd:element name="tliInfo" type="Events:tliInfo"/>

<!-- check -->
<xsd:element name="tliMChecked_m" type="Events:tliMChecked_m"/>
<xsd:element name="tliMChecked_c" type="Events:tliMChecked_c"/>
<xsd:element name="tliPrGetCallChecked_m" type="Events:tliPrGetCallChecked_m"/>
<xsd:element name="tliPrGetCallChecked_c" type="Events:tliPrGetCallChecked_c"/>
<xsd:element name="tliPrGetReplyChecked_m" type="Events:tliPrGetReplyChecked_m"/>
<xsd:element name="tliPrGetReplyChecked_c" type="Events:tliPrGetReplyChecked_c"/>
<xsd:element name="tliPrCatchChecked_m" type="Events:tliPrCatchChecked_m"/>
<xsd:element name="tliPrCatchChecked_c" type="Events:tliPrCatchChecked_c"/>
<xsd:element name="tliCheckedAny_m" type="Events:tliCheckedAny_m"/>
<xsd:element name="tliCheckedAny_c" type="Events:tliCheckedAny_c"/>
<xsd:element name="tliCheckAnyMismatch_m" type="Events:tliCheckAnyMismatch_m"/>
<xsd:element name="tliCheckAnyMismatch_c" type="Events:tliCheckAnyMismatch_c"/>

<!-- rnd -->
<xsd:element name="tliRnd" type="Events:tliRnd"/>

<!-- evaluation of @lazy and @fuzzy variables -->
<xsd:element name="tliEvaluate" type="Events:tliEvaluate"/>

<!-- components -->
<xsd:element name="tliCCall" type="Events:tliCCall"/>
<xsd:element name="tliCCallTerminated" type="Events:tliCCallTerminated"/>

<!-- module control function -->
<xsd:element name="tliCtrlStartWithParameters"
  type="Events:tliCtrlStartWithParameters"/>
<xsd:element name="tliCtrlTerminatedWithResult"
  type="Events:tliCtrlTerminatedWithResult"/>

```

```
</xsd:choice>  
</xsd:complexType>  
</xsd:schema>
```

---

## Annex C (informative): Use scenarios

### C.0 Introduction

This annex contains use scenarios that should help users of the TCI and tool vendors providing the TCI understand the semantics of the operations defined within the present document.

The scenarios are defined in terms of UML sequence diagrams. The sequence diagram shows the interactions between the TCI entities. The scenarios are explained and where applicable underpinned with a TTCN-3 fragment corresponding to the scenario.

---

### C.1 Initialization, collecting information, logging

#### C.1.1 Use scenario: initialization

##### C.1.1.0 Scenario description

The scenario in figure C.1 shows the initialization phase for a test system when a TTCN-3 module is to be selected for execution. At first, a root module has to be set with `tciRootModule`. The module parameters of the root module can be obtained with `tciGetModuleParameters`. Module parameter information can be used to ask the test system user for concrete values for each module parameter. The list of test cases available in the root module can be retrieved with `tciGetTestCases`. These test cases can be directly executed from the test management. Their parameters and their test system interface can be obtained with `tciGetTestCaseParameters` and `tciGetTestCaseTSI`, respectively.

### C.1.1.1 Sequence diagram

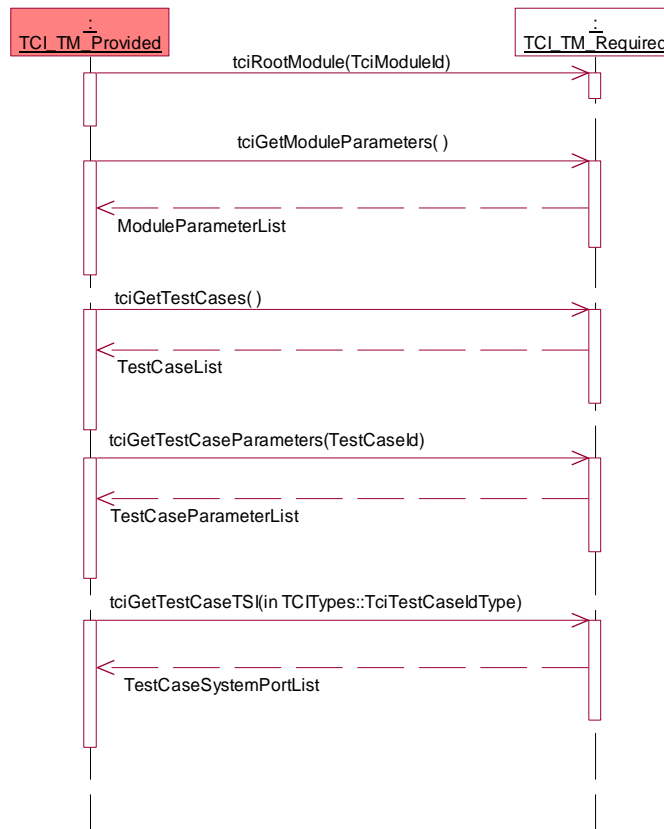

**Figure C.1: Use scenario - initialization**

### C.1.1.2 TTCN-3 fragment

The initialization is outside the scope of TTCN-3.

## C.1.2 Use scenario: requesting module parameters

### C.1.2.0 Scenario description

The scenario in figure C.2 shows how a test component requests the actual value of a module parameter needed for the execution of its test behaviour. At first, the type of a module parameter is requested, then the value can be constructed by the TM and given to the TE.

### C.1.2.1 Sequence diagram

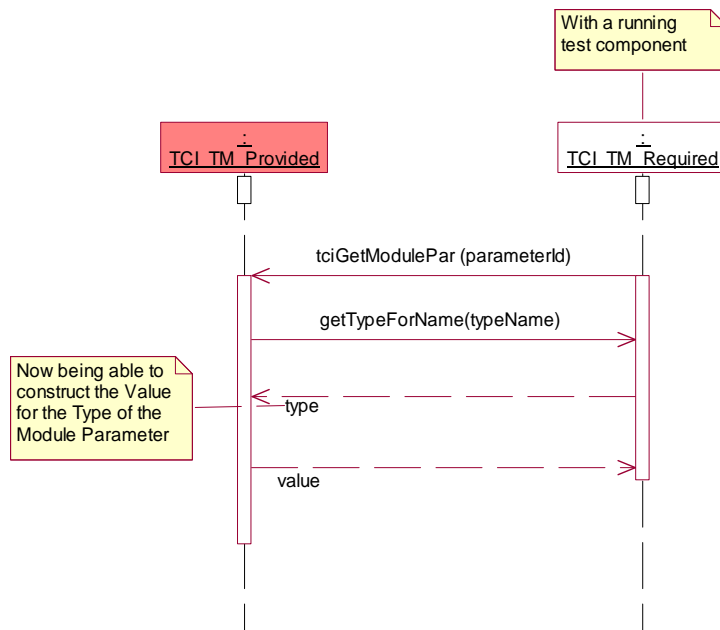

Figure C.2: Use scenario - requesting module Pars

### C.1.2.2 TTCN-3 fragment

```

module AModule {
  ...
  modulepar {
    integer AModulePar
  }
  ...
  function AFunction (...) ... {
    integer x;
    ...
    x:= 2+AModulePar; // an expression with a module parameter
    ...
  }
  ...
}
  
```

## C.1.3 Use scenario: logging

### C.1.3.0 Scenario description

The scenario in figure C.3 shows logging of information during the execution of a test behaviour by a test component. The message to be logged is propagated to the test logging.

### C.1.3.1 Sequence diagram

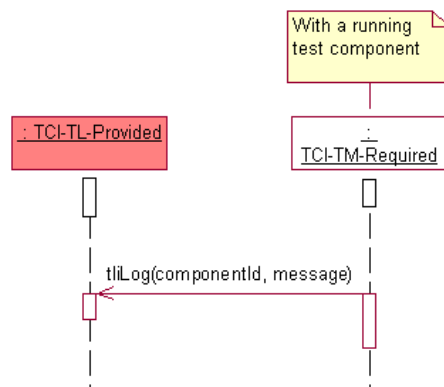

Figure C.3: Use scenario - logging

### C.1.3.2 TTCN-3 fragment

```

module AModule {
  ...
  function AFunction (...) ... {
    ...
    log("AMessage");
    ...
  }
  ...
}

```

---

## C.2 Execution of test cases and control

### C.2.1 Use scenario: execution of control

#### C.2.1.0 Scenario description

The scenario in figure C.4 shows the sequence of operations to execute the control part of a TTCN-3 module. The module containing the control part is selected first, then the control is started, then it is executed until the execution is terminated by TE.



### C.2.1.1 Sequence diagram

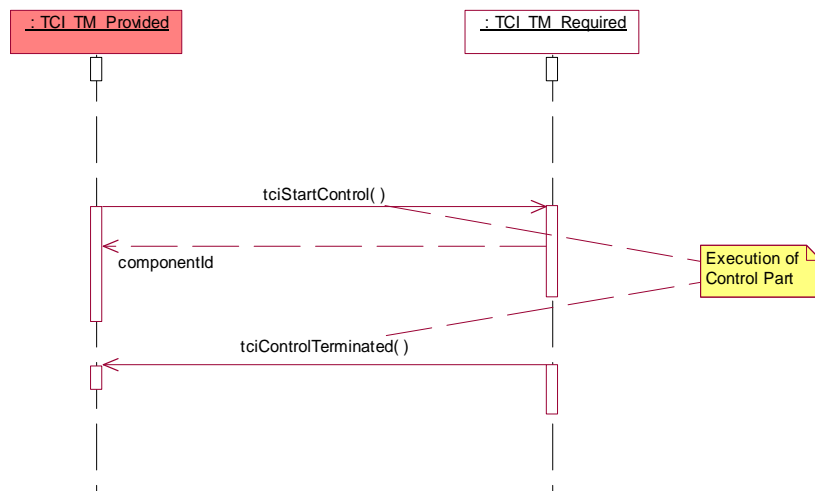

**Figure C.4: Use scenario - execution of control**

### C.2.1.2 TTCN-3 fragment

```

module AModule {
  ...
  control {
    ...
  }
  ...
}

```

## C.2.2 Use scenario: test case execution within control

### C.2.2.0 Scenario description

The scenario in figure C.5 shows how a test case is executed within the control part.

### C.2.2.1 Sequence diagram

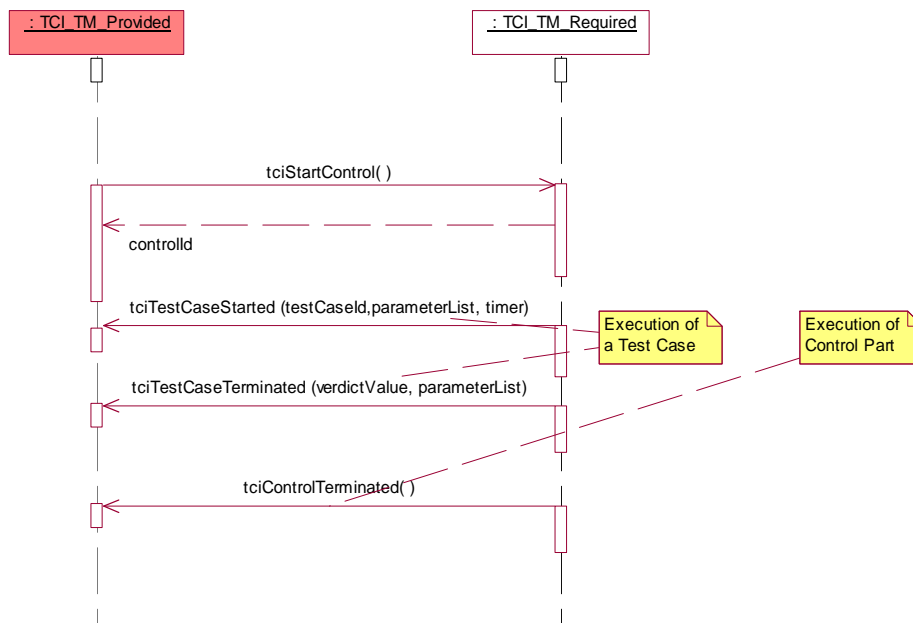

Figure C.5: Use scenario - test case execution within control

### C.2.2.2 TTCN-3 fragment

```

module AModule {
  ...
  testcase ATestCase(...)... {
    ... //the test case behaviour
  }
  ...
  control {
    ...
    execute(ATestCase(...));
    ...
  }
  ...
}
  
```

## C.2.3 Use scenario: direct test case execution

### C.2.3.0 Scenario description

The scenario in figure C.6 shows how a test case can be directly executed from the test management outside the control part. After selecting the TTCN-3 module containing the test case to be executed, the start of the test case is requested. When the test case completes its execution, the test management is informed by the TE of the test case termination.

### C.2.3.1 Sequence diagram

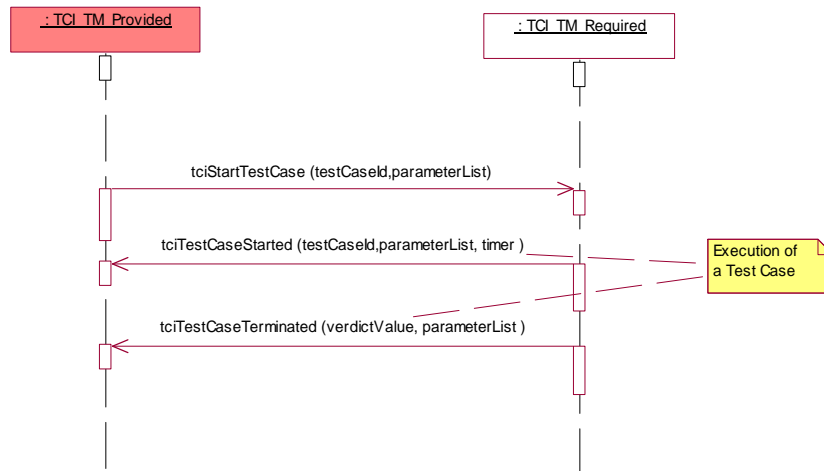

**Figure C.6: Use scenario - direct test case execution**

### C.2.3.2 TTCN-3 fragment

The direct execution of a test case is outside the scope of TTCN-3.

## C.2.4 Use scenario: execute test case to TRI

### C.2.4.0 Scenario description

The scenario in figure C.7 shows how the TRI is informed about the execution of a test case so that it can set up and initialize system ports when needed. The execute test case request has to be issued before the test behaviour on the MTC of the current test case is started.

### C.2.4.1 Sequence diagram

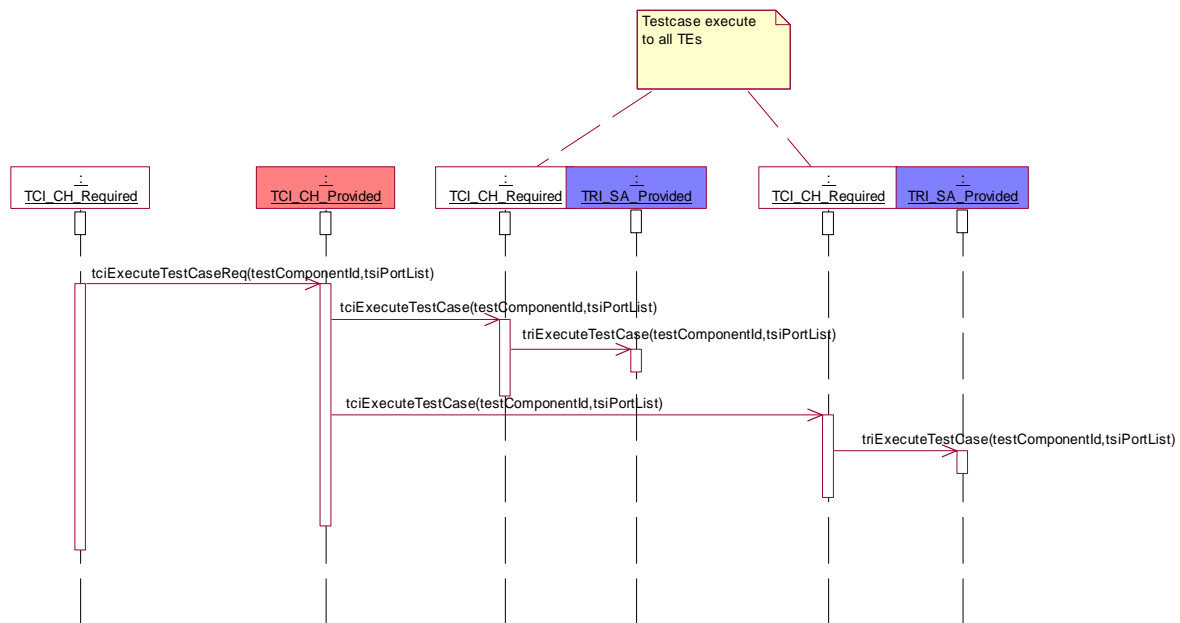

Figure C.7: Use scenario - execute test case to TRI

### C.2.4.2 TTCN-3 fragment

```

module AModule {
  ...
  testcase ATestCase(...)... {
    ... //the test case behaviour
  }
  ...
  control {
    ...
    execute(ATestCase(...));
    ...
  }
  ...
}

```

## C.3 Component handling

### C.3.1 Use scenario: local control component creation

#### C.3.1.0 Scenario description

The scenario in figure C.8 demonstrates the creation of the control component on the same node where the user interface to the test management TCI-TM resides. A control component is created whenever the control part of a TTCN-3 module is executed. Whenever the test management TCI-TM issues the start of the control part, a create test component request is sent to the TCI-CH, which propagates it to the TE where the control component should be created. In this case it is the TE on the same node. The identifier for the control component is returned and given to the TCI-TM. The identifier is then used to start the behaviour of the control part on the control component.

### C.3.1.1 Sequence diagram

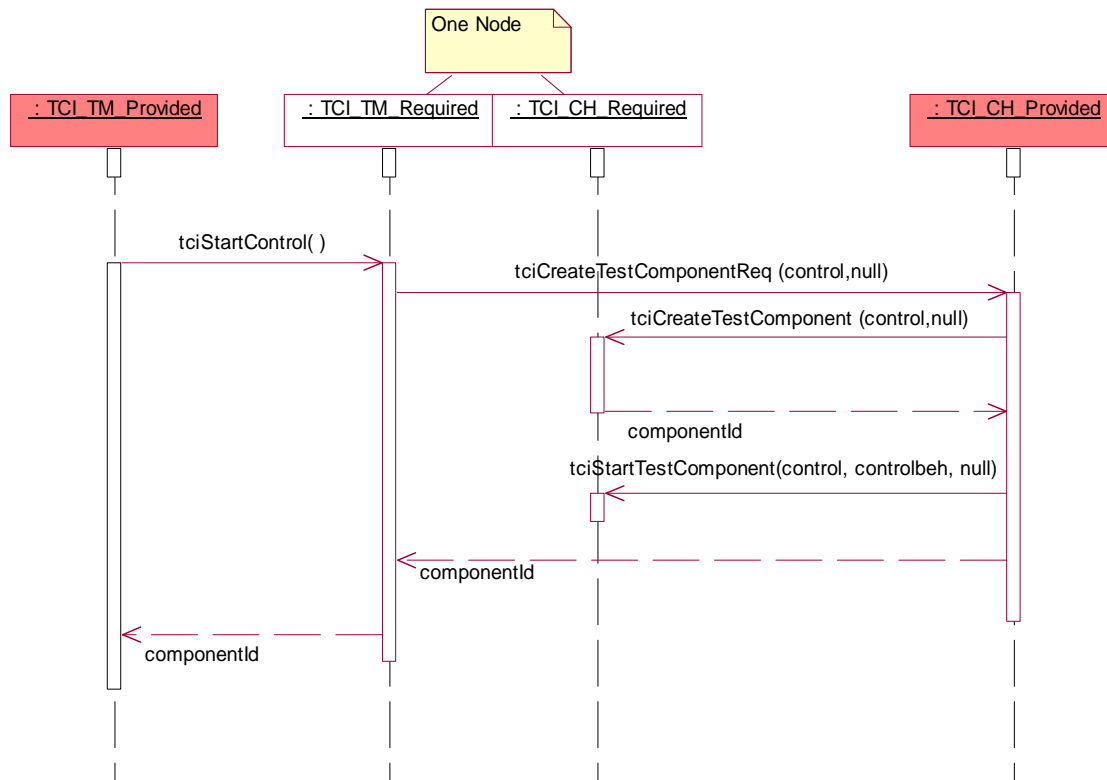

Figure C.8: Use scenario - local control component creation

### C.3.1.2 TTCN-3 fragment

```

module AModule {
  ...
  control {
    ...
  }
  ...
}
  
```

## C.3.2 Use scenario: remote control component creation

### C.3.2.0 Scenario description

The scenario in figure C.9 demonstrates the creation of the control component on another node than where the user interface to the test management TCI-TM resides. A control component is created whenever the control part of a TTCN-3 module is executed. Whenever the test management TCI-TM issues the start of the control part, a create test component request is sent to the TCI-CH, which propagates it to the TE where the control component should be created. In this case it is the TE on another remote node. The identifier for the control component is returned and given to the TCI-TM. The identifier is then used to start the behaviour of the control part on the control component.

### C.3.2.1 Sequence diagram

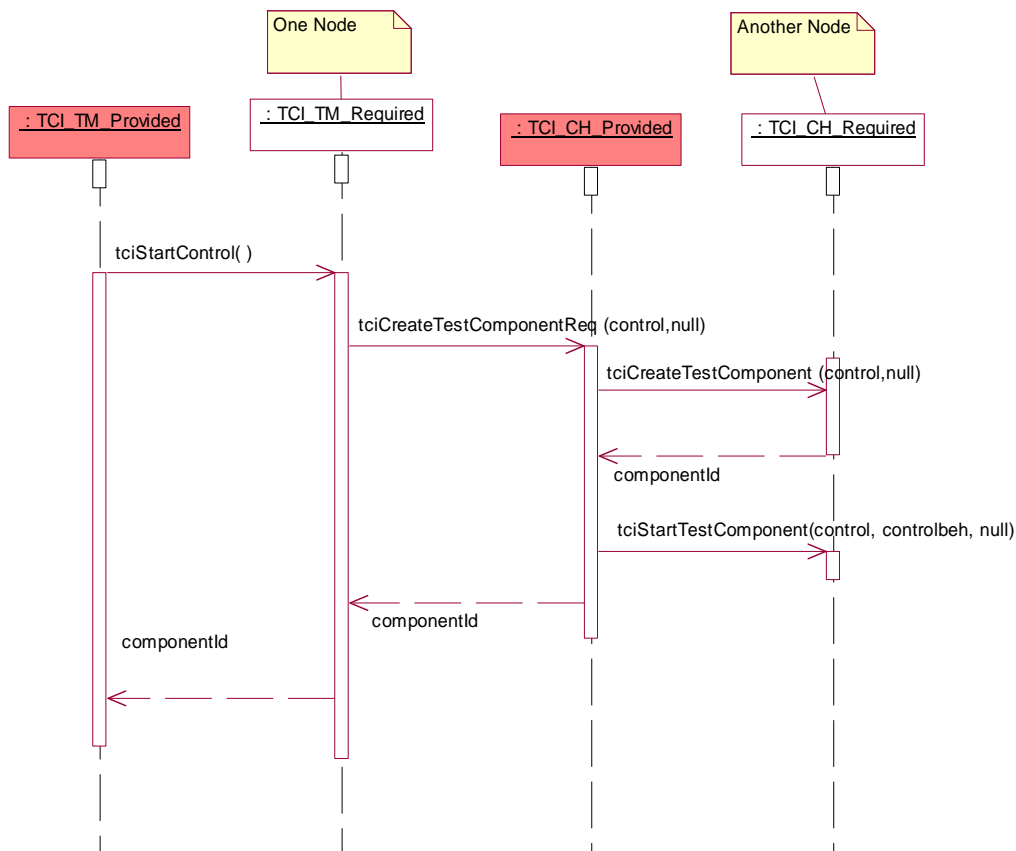

Figure C.9: Use scenario - remote control component creation

### C.3.2.2 TTCN-3 fragment

```

module AModule {
  ...
  control {
    ...
  }
  ...
}

```

## C.3.3 Use scenario: local MTC creation

### C.3.3.0 Scenario description

The scenario in figure C.10 demonstrates the local creation of the main test component. Local is meant for two cases:

- 1) on the same node where the user interface to the test management TCI-TM resides (when a test case is started directly); or
- 2) on the same node where the control component resides (when a test case is executed from a control part).

A main test component is created whenever a test case is executed: a create test component request is sent to the TCI-CH, which propagates it to the TE where the main test component should be created. In this case it is the TE on the same node. The identifier for the main test component is returned and given to the TCI-TM. The identifier is then used to start the test case behaviour on the main test component (this is not shown here, but handled the same way as in the scenarios described in clauses C.2.2 and C.2.3).

### C.3.3.1 Sequence diagram

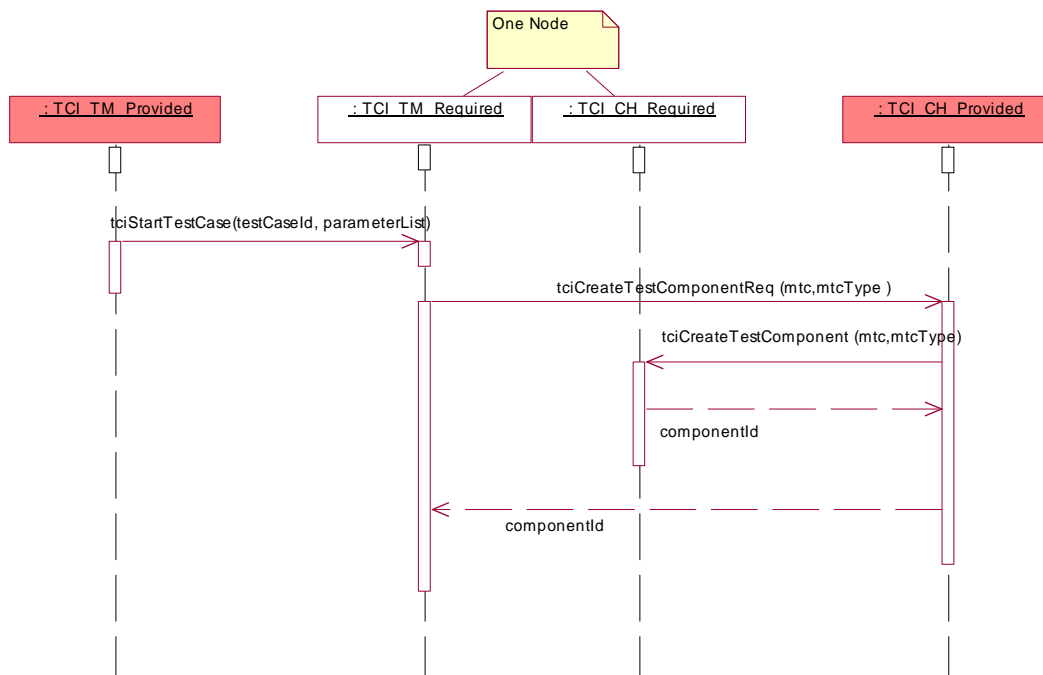

Figure C.10: Use scenario - local MTC creation

### C.3.3.2 TTCN-3 fragment

```

module AModule {
  ...
  testcase ATestCase (...)runs on MTCType... {
    ... //the test case behaviour
  }
  ...
}
  
```

## C.3.4 Use scenario: remote MTC creation

### C.3.4.0 Scenario description

The scenario in figure C.11 demonstrates the remote creation of the main test component. Remote is meant for two cases:

- 1) on another node than where the user interface to the test management TCI-TM resides (when a test case is started directly); or
- 2) on another node than where the control component resides (when a test case is executed from a control part).

A main test component is created whenever a test case is executed: a create test component request is sent to the TCI-CH, which propagates it to the TE where the main test component should be created. In this case it is the TE on another node. The identifier for the main test component is returned and given to the TCI-TM. The identifier is then used to start the test case behaviour on the main test component (this is not shown here, but handled the same way as in the scenarios described in clauses C.2.2 and C.2.3).

### C.3.4.1 Sequence diagram

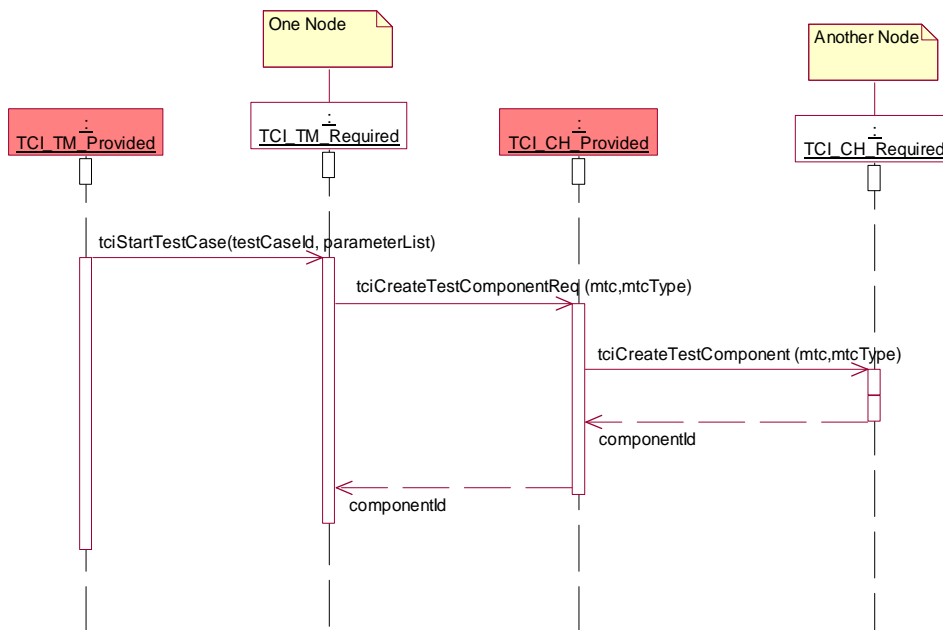

Figure C.11: Use scenario - remote MTC creation

### C.3.4.2 TTCN-3 fragment

```

module AModule {
  ...
  testcase ATestCase(...)runs on MTCType ... {
    ... //the test case behaviour
  }
  ...
}

```

## C.3.5 Use scenario: component handling for test case execution within control

### C.3.5.0 Scenario description

The scenario in figure C.12 demonstrates the handling of components for the test case execution within a control part. When the control part is started, a control component is created and its component identifier returned to the test management. For each test case to be executed within the control part, a main test component is created and the component identifier returned to the control component. Afterwards, the test case behaviour is started on the main test component and the test management is informed about the start of the test case. When the main test component terminates, a request for the main test component termination together with the local verdict of the main test component is propagated to enable the derivation of the global test verdict and to enable the information about the test case termination.



### C.3.5.1 Sequence diagram

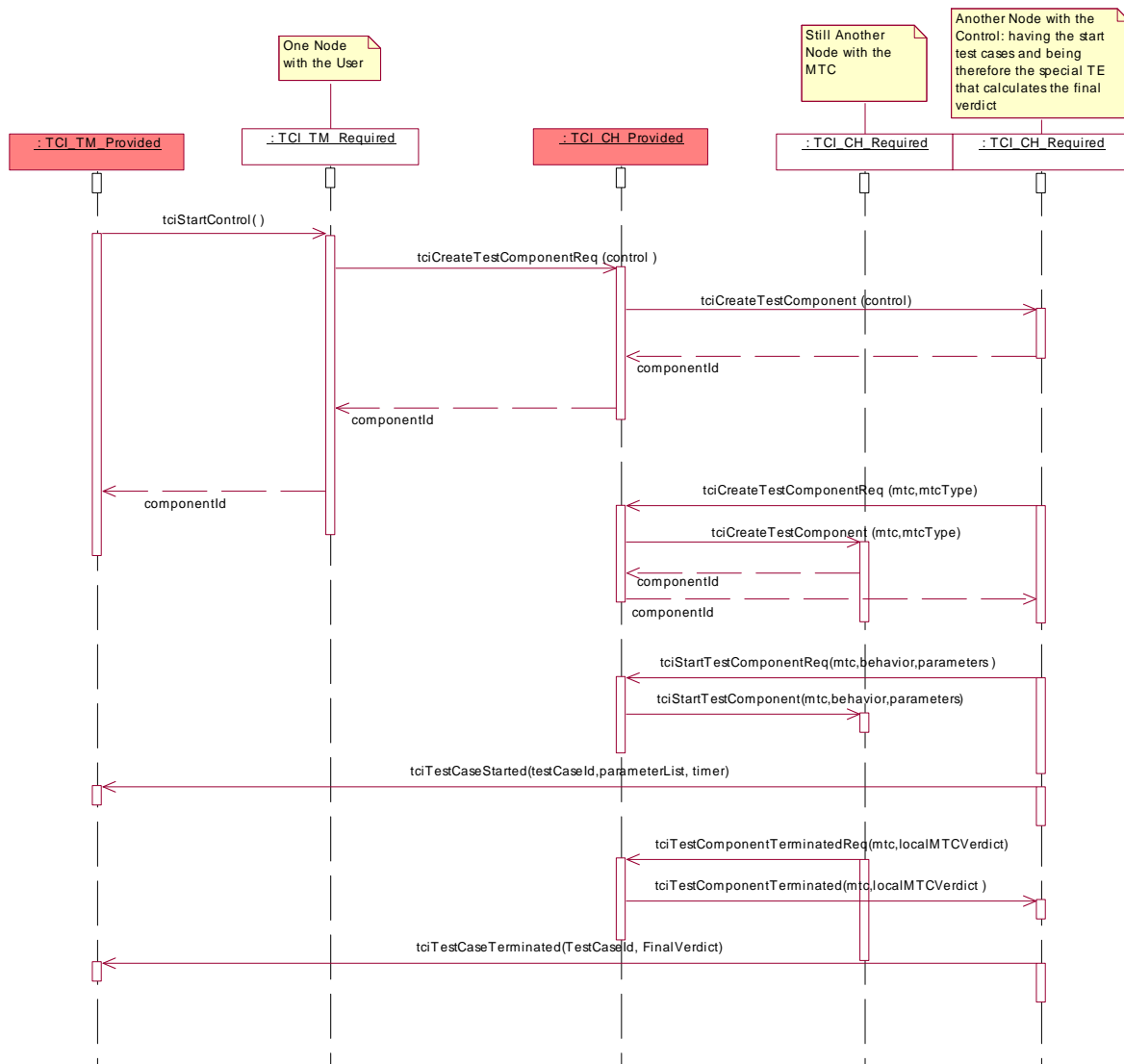

Figure C.12: Use scenario: component handling for test case execution within control

### C.3.5.2 TTCN-3 fragment

```

module AModule {
  ...
  testcase ATestCase(...)... {
    ... //the test case behaviour
  }
  ...
  control {
    ...
    execute(ATestCase(...));
    ...
  }
  ...
}

```

## C.3.6 Use scenario: component handling for direct test case execution

### C.3.6.0 Scenario description

The scenario in figure C.13 shows how test components are handled when a test case is executed directly, i.e. outside a control part. When a test case is started, the main test component is created and the test case behaviour started on this main test component at first. Whenever a parallel test component is used within a test case, it is handled the same: the parallel test component is started first: giving a test component create request to the TCI-CH entity, which propagates the test component create to the TE in which the parallel test component is to be created. The identifier for the created parallel test component is returned. The identifier is then used to start the PTC behaviour for the start operation. When the PTC terminates its execution, a test component terminate request together with the local test verdict is issued to inform TCI-CH about this termination. The same is done when the main test component terminates. In addition, the termination of the main test component leads to the overall termination of the test case.

### C.3.6.1 Sequence diagram

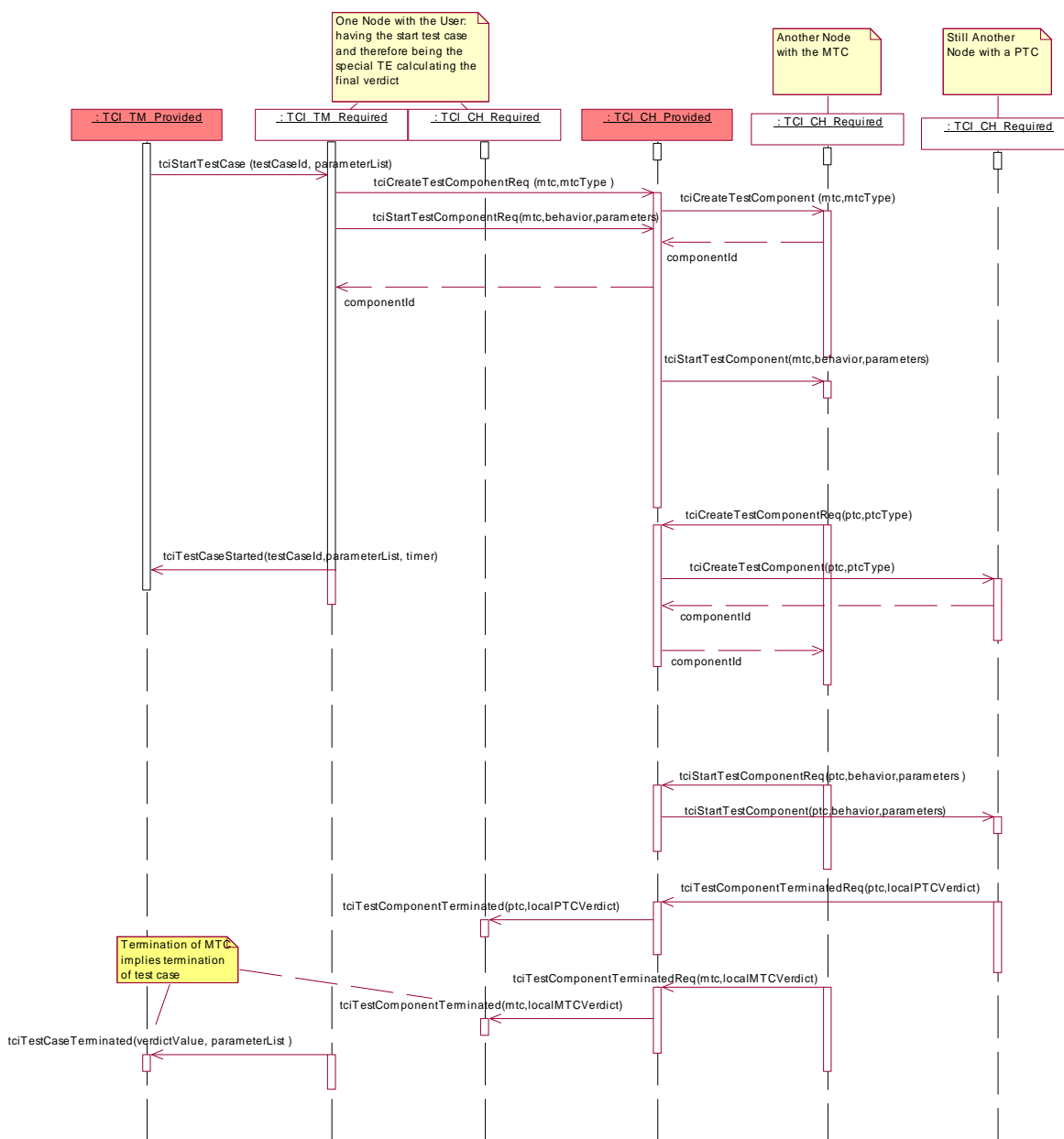

Figure C.13: Use scenario: component handling for direct test case execution

### C.3.6.2 TTCN-3 fragment

```

module AModule {
  ...
  function APTCBehaviour(...) runs on APTCType {
    ... //the PTC behaviour
  }
  ...
  testcase ATestCase(...)... {
    ... //the test case behaviour
    var APTCType PTC:= APTCType.create;
    ...
    PTC.start(APTCBehaviour(...));
    ...
  }
  ...
}

```

## C.3.7 Use scenario: propagation of map/connect

### C.3.7.0 Scenario description

The scenario in figure C.14 shows how ports are mapped. The request to map a port is propagated to the TE where the map is finally performed. The propagation of connect requests works analogously.

### C.3.7.1 Sequence diagram

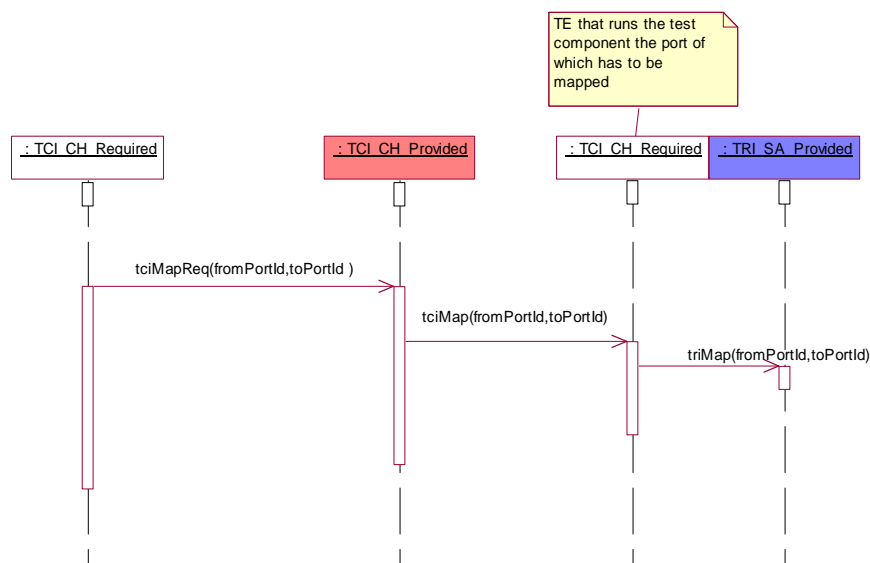

Figure C.14: Use scenario: propagation of map

### C.3.7.2 TTCN-3 fragment

```

module AModule {
  ...
  type port A { ... }
  type component CA { port A a }
  type component CB { port A a }
  ...
  testcase ATestCase(...)runs on CA system CB {
    var CA ptc := CA.create;
    ... //the test case behaviour
    map(ptc:a, System:a);
    ...
  }
  ...
}

```

## C.3.8 Use scenario: propagation of unmap/disconnect

### C.3.8.0 Scenario description

The scenario in figure C.15 shows how ports are unmapped. The request to unmap a port is propagated to the TE where the unmap is finally performed. The propagation of disconnect requests works analogously.

### C.3.8.1 Sequence diagram

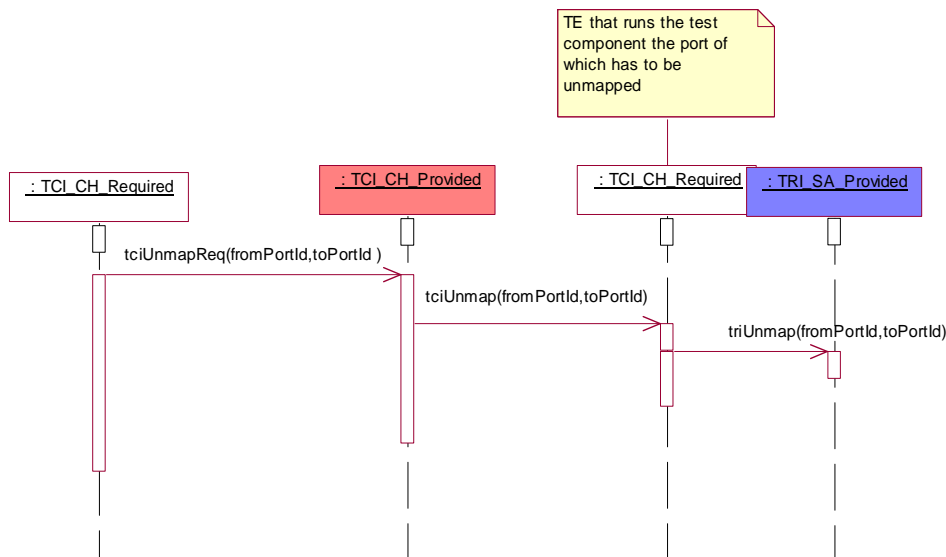

Figure C.15: Use scenario - propagation of map

### C.3.8.2 TTCN-3 fragment

```

module AModule {
  ...
  type port A { ... }
  type component CA { port A a }
  type component CB { port A a }
  ...
  testcase ATestCase(...)runs on CA system CB {
    var CA ptc := CA.create;
    ... //the test case behaviour
    unmap(ptc:a,system:a);
    ...
  }
  ...
}

```

---

## C.4 Termination of test cases and control

### C.4.1 Use scenario: stop a test case

#### C.4.1.0 Scenario description

The scenario in figure C.16 shows how a test case is stopped from the test management during test case execution. Once the TM has received information about a started test case, a stop test case can be requested up until receiving the information that the test case has been terminated. Upon stopping a test case, all parallel test components will be stopped and the test system will be reset.

### C.4.1.1 Sequence diagram

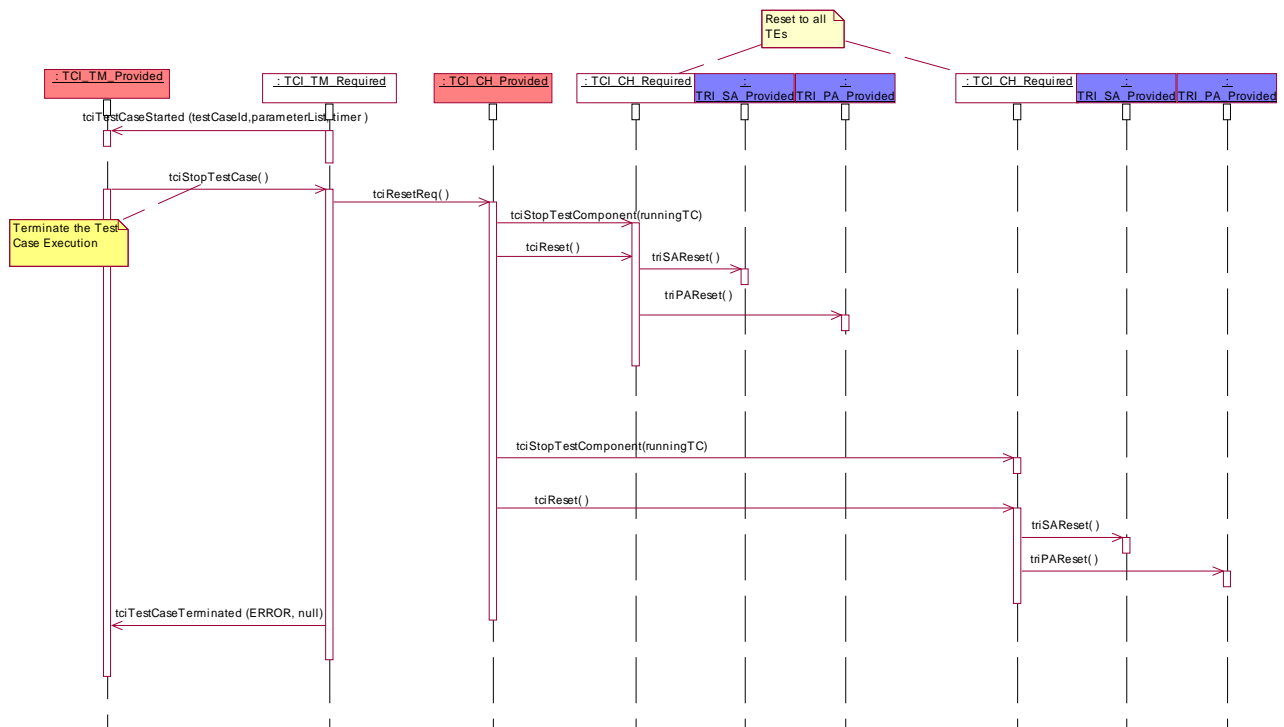

Figure C.16: Use scenario: stop a test case

### C.4.1.2 TTCN-3 fragment

There is no TTCN-3 code related to how the TM chooses to implement test case termination. This is outside the scope of TTCN-3.

## C.4.2 Use scenario: stop control

### C.4.2.0 Scenario description

The scenario in figure C.17 shows how a control part is stopped from the test management during control part execution. A control part can be stopped in between starting the control and its termination. If the control part receives a stop test case request while a test case is executing, the executing test case is to be stopped. Furthermore, the test system is to be reset as described in figure C.16.

### C.4.2.1 Sequence diagram

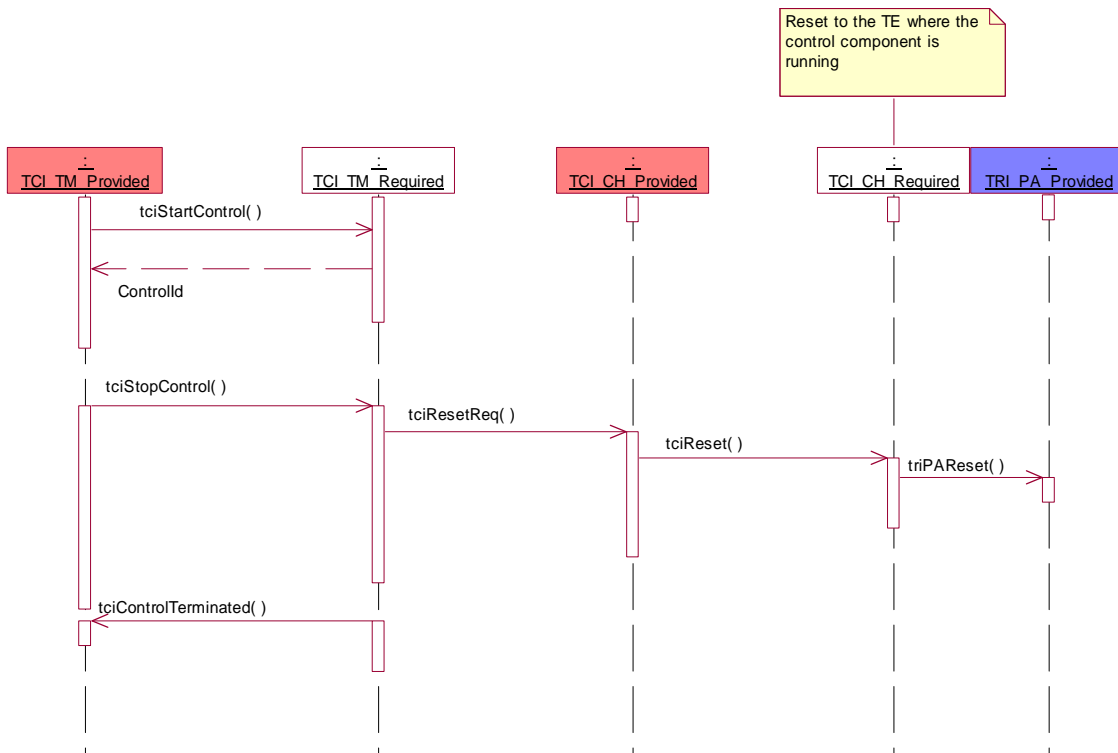

Figure C.17: Use scenario - stop control

### C.4.2.2 TTCN-3 fragment

Stopping a control part from the test management is outside the scope of TTCN-3 so that no TTCN-3 fragment exists.

## C.4.3 Use scenario: termination of control after error

### C.4.3.0 Scenario description

The scenario in figure C.18 shows the handling of error situations during the execution of a control part when no test case is being executed. The test management is informed about the error situation and has then to terminate the execution of the control part explicitly. Upon termination of the control part, the test system will be reset.

### C.4.3.1 Sequence diagram

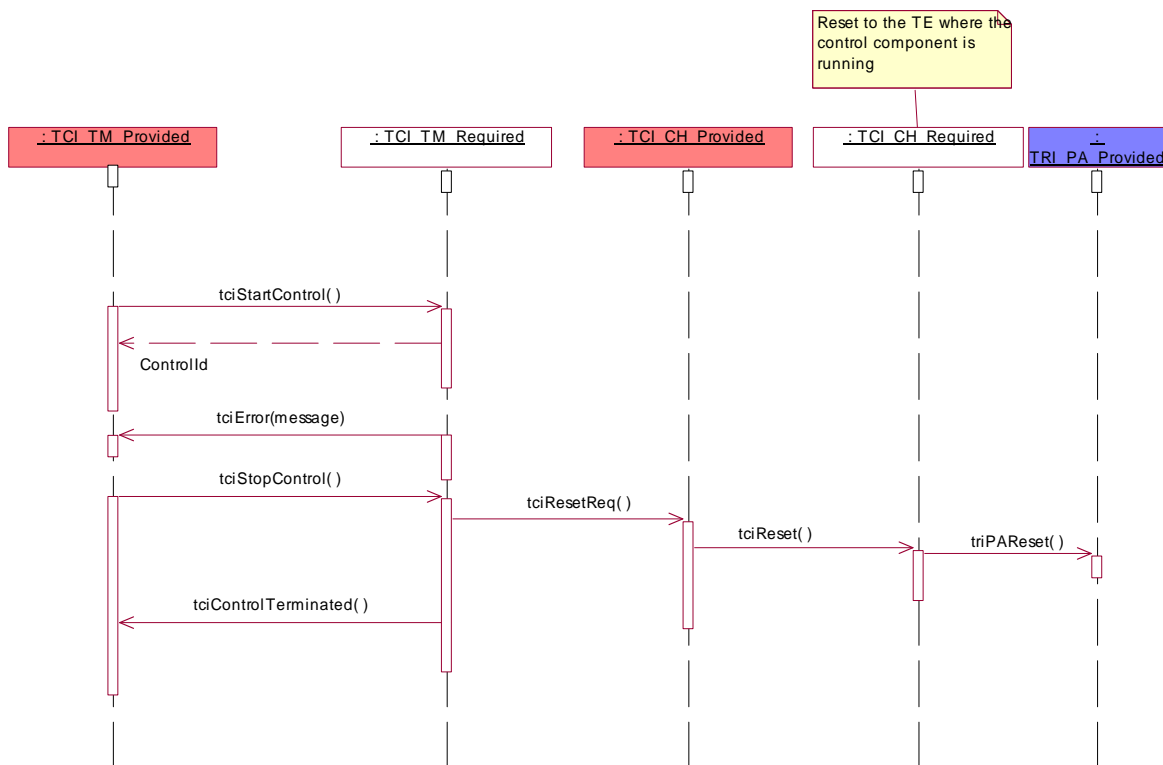

Figure C.18: Use scenario - termination of control after error

### C.4.3.2 TTCN-3 fragment

There is no TTCN-3 fragment for this scenario since error situations are exceptional cases in a test system and not a TTCN-3 concept as such. Rather, the TTCN-3 semantics describes various potential error situations in a test system.

## C.4.4 Use scenario: termination of a test case after error

### C.4.4.0 Scenario description

The scenario in figure C.19 shows the handling of error situations during the direct execution of a test case. The test management is informed about the error situation. The TM has then to explicitly terminate test case execution. Upon stopping a test case, the parallel test components will be stopped and the test system is to be reset.

## C.4.4.1 Sequence diagram

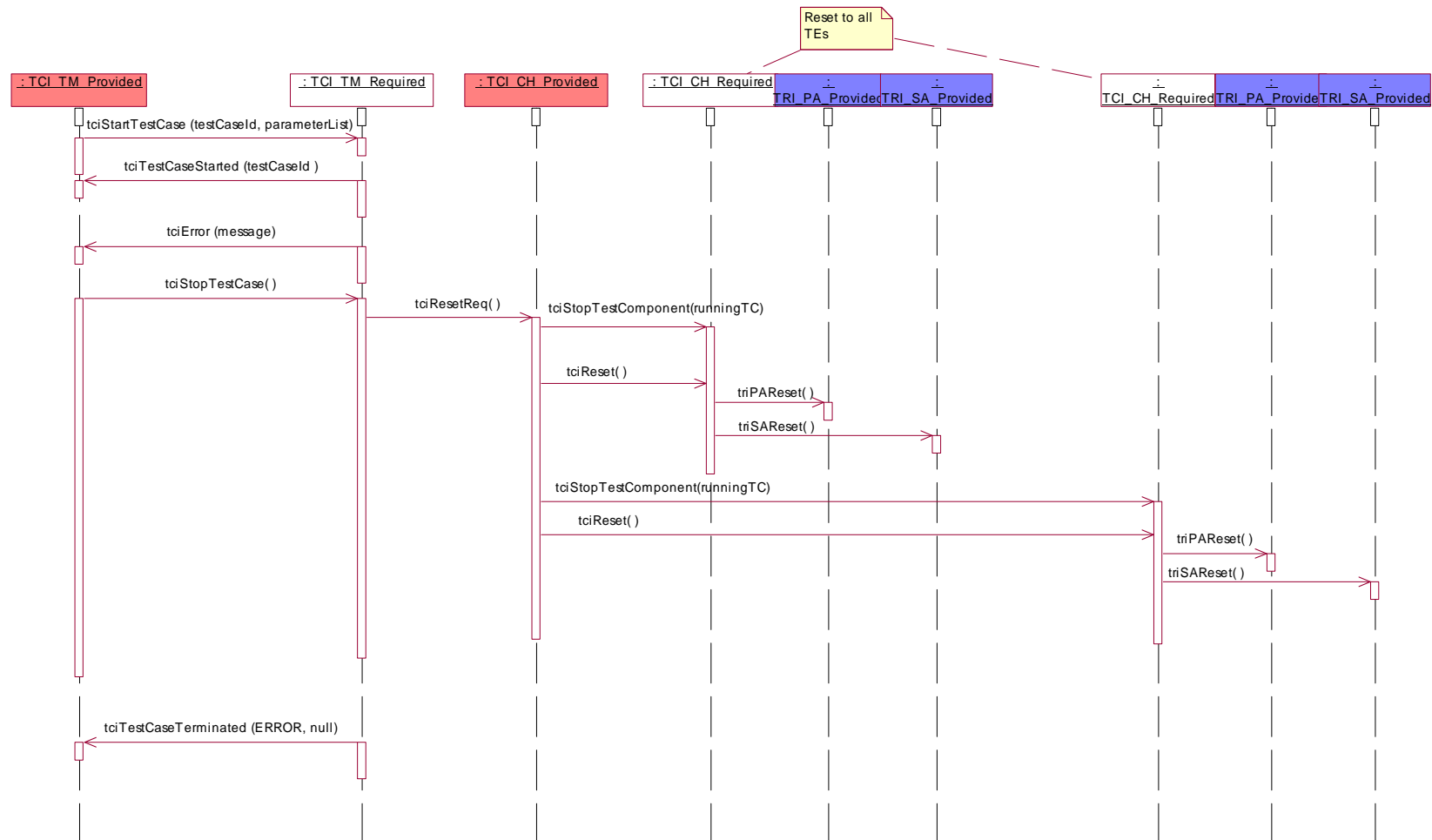

Figure C.19: Use scenario - termination of a test case after error



### C.4.4.2 TTCN-3 fragment

There is no TTCN-3 fragment for this scenario since error situations are exceptional cases in a test system and not a TTCN-3 concept as such. Rather, the TTCN-3 semantics describes various potential error situations in a test system.

## C.4.5 Use scenario: reset

### C.4.5.0 Scenario description

The scenario in figure C.20 shows the reset of the test system. In that case all involved TEs together with their TRI System Adaptors (SA) and Platform Adaptors (PA) are reset.

### C.4.5.1 Sequence diagram

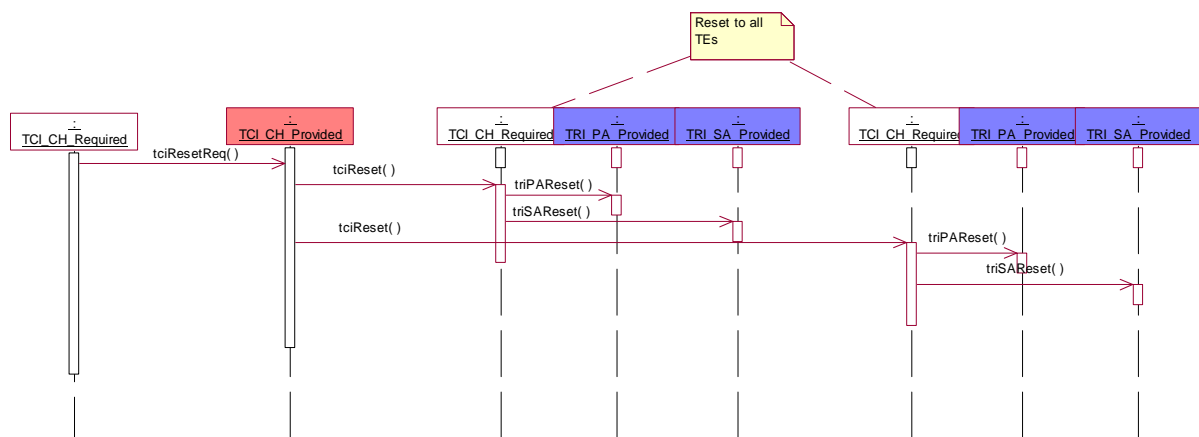

Figure C.20: Use scenario - reset

### C.4.5.2 TTCN-3 fragment

There is no TTCN-3 fragment for this scenario since reset as required after error situations are exceptional cases in a test system and not a TTCN-3 concept as such.

## C.5 Communication

### C.5.1 Use scenario: local intercomponent communication

#### C.5.1.0 Scenario description

The scenario in figure C.21 shows the communication between test components (main test component or parallel test components), which reside on the same node. A communication request is given to the TCI-CH, which then decide where to enqueue this communication template. In this case, the communication is done locally via the TE on the same node. The scenario shows a message-based communication using the send operation - the scenario is the same for call, reply, and raise operations.

### C.5.1.1 Sequence diagram

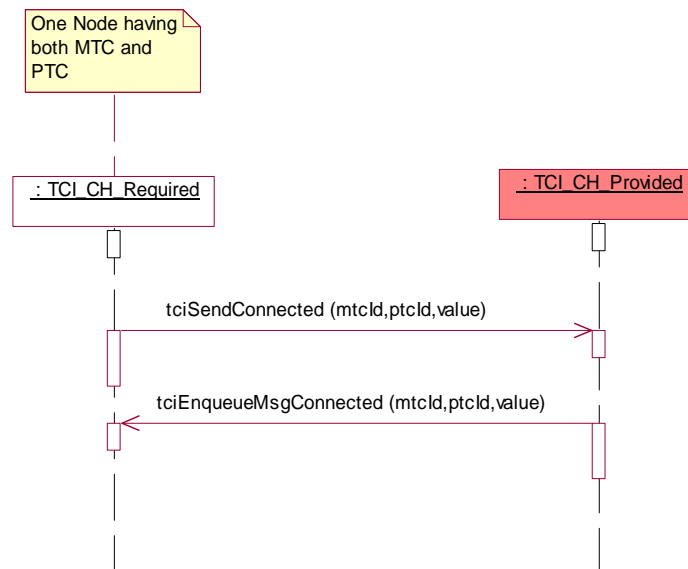

Figure C.21: Use scenario - local intercomponent communication

### C.5.1.2 TTCN-3 fragment

```

module AModule {
  ...
  type port APortType message { ... }
  ...
  type component ATCType {
    ...
    APortType APort;
    ...
  }
  ...
  template AType AMessageTemplate { ... }
  ...
  function APTCBehaviour(...) runs on APTCType {
    ... //the PTC behaviour
  }
  ...
  testcase ATestCase(...) runs on ATCType... {
    ... //the test case behaviour
    var ATCType PTC1:= ATCType.create;
    connect(PTC1:APort,mtc:APort);
    ...
    PTC1.start(APTCBehaviour(...));
    APort.send(AMessageTemplate); //sending data to a test component
    ...
  }
  ...
}

```

## C.5.2 Use scenario: internode communication between test components

### C.5.2.0 Scenario description

The scenario in figure C.22 shows the communication between test components (main test component or parallel test components), which reside on different nodes. A communication request is given to the TCI-CH, which then decides where to enqueue this communication template. In this case, the communication is done remotely via the TE on another node. The scenario shows a message based communication using the send operation - the scenario is the same for call, reply, and raise operations.

### C.5.2.1 Sequence diagram

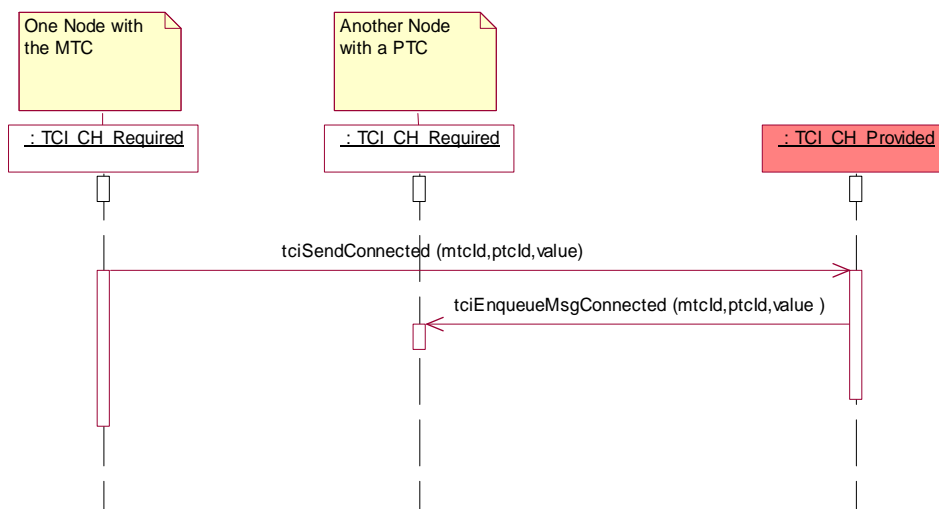

Figure C.22: Use scenario - internode communication between test components

### C.5.2.2 TTCN-3 fragment

```

module AModule {
  ...
  type port APortType message { ... }
  ...
  type component ATCType {
    ...
    APortType APort;
    ...
  }
  ...
  template AType AMessageTemplate { ... }
  ...
  function APTCBehaviour(...) runs on APTCType {
    ... //the PTC behaviour
  }
  ...
  testcase ATestCase(...) runs on ATCType... {
    ... //the test case behaviour
    var ATCType PTC1:= ATCType.create;
    connect(PTC1:APort,mtc:APort);
    ...
    PTC1.start(APTCBehaviour(...));
    APort.send(AMessageTemplate); //sending data to a test component
  }
  ...
}

```

## C.5.3 Use scenario: encoding

### C.5.3.0 Scenario description

The scenario in figure C.23 shows the encoding of data, which is sent to the SUT. The encoded data is received from the coding/decoding entity via the TCI-CD. The encoded value is sent to the SUT via the TRI-SA. The scenario is the same for the call, the reply, and the raise operations.

### C.5.3.1 Sequence diagram

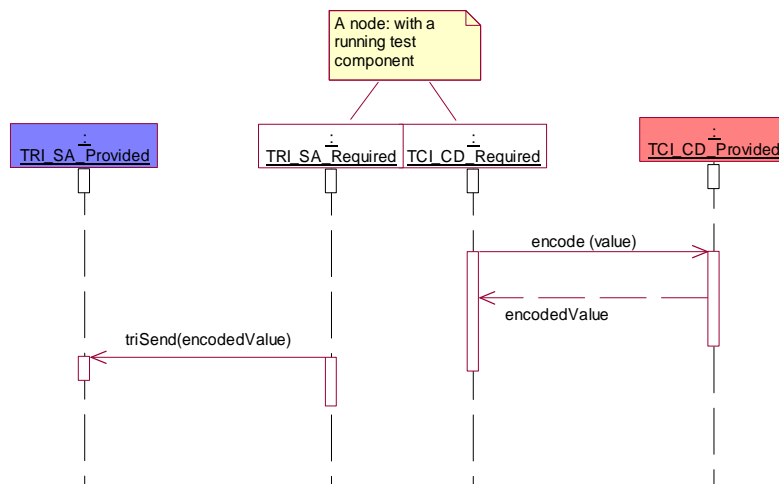

Figure C.23: Use scenario - encoding

### C.5.3.2 TTCN-3 fragment

```

module AModule {
  ...
  type port APortType message { ... }
  ...
  type component APTCType {
    ...
    APortType APort;
    ...
  }
  ...
  template AType AMessageTemplate { ... }
  ...
  testcase ATestCase(...) runs on APTCType system APTCType {
    ... //the test case behaviour
    map(mtc:APort,system:APort);
    ...
    APort.send(AMessageTemplate); //sending data to the SUT
    ...
  }
  ...
} with { encoding "..."}
  
```

## C.5.4 Use scenario: decoding

### C.5.4.0 Scenario description

The scenario in figure C.24 shows the decoding of data, which is received from the SUT via the TRI-SA. The decoded data is received from the coding/decoding entity via the TCI-CD. The scenario is the same for the receive, the getcall, the getreply, the catch, and the check operations.

### C.5.4.1 Sequence diagram

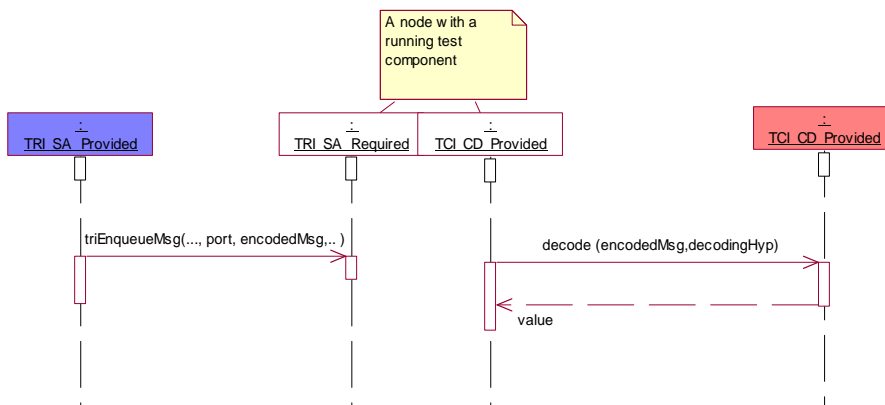

Figure C.24: Use scenario - decoding

### C.5.4.2 TTCN-3 fragment

```

module AModule {
  ...
  type port APortType message { ... }
  ...
  type component APTCType {
    ...
    APortType APort;
    ...
  }
  ...
  template AType AMessageTemplate { ... }
  ...
  testcase ATestCase(...) runs on APTCType system APTCType {
    ... //the test case behaviour
    map(mtc:APort, system:APort);
    ...
    APort.receive(AMessageTemplate); //receiving data from the SUT
    ...
  }
  ...
} with { encoding "..."}
  
```

---

## Annex D (informative): Bibliography

- INTOOL CGI/NPL038 (V2.2): "Generic Compiler/Interpreter interface; GCI Interface Specification" Infrastructural Tools, December 1996.
- ISO/IEC 9646-3 (1998): "Information technology - Open Systems Interconnection - Conformance testing methodology and framework - Part 3: The Tree and Tabular combined Notation (TTCN)".

## History

| <b>Document history</b> |                |   |
|-------------------------|----------------|---|
| V1.1.1                  | July 2003      | Publication   |
| V3.1.1                  | June 2005      | Publication   |
| V3.2.1                  | February 2007  | Publication   |
| V3.3.1                  | April 2008     | Publication   |
| V3.4.1                  | September 2008 | Publication   |
| V4.1.1                  | June 2009      | Publication   |
| V4.2.1                  | July 2010      | Publication   |
| V4.3.1                  | June 2011      | Publication   |
| V4.4.1                  | April 2012     | Publication   |
| V4.5.1                  | April 2013     | Publication   |
| V4.6.1                  | June 2014      | Publication   |
| V4.7.1                  | June 2015      | Publication   |
| V4.8.1                  | July 2016      | Publication   |
| V4.9.1                  | May 2017       | Publication   |
| V4.10.1                 | May 2018       | Publication   |
| V4.11.1                 | April 2019     | Publication   |
| V4.12.1                 | May 2020       | Publication   |
| V4.13.1                 | February 2022  | Membership Approval Procedure    MV 20220424:    2022-02-23 to 2022-04-25 |
| V4.13.1                 | April 2022     | Publication   |