



TECHNICAL
BASIS for
REGULATION

DRAFT
pr **TBR 24**

August 1995

Source: ETSI TC-BTC

Reference: DTBR/BTC-02056

ICS: 33.040.40

Key words: leased line, terminal equipment, interface

**Business TeleCommunications (BTC);
34 Mbit/s digital unstructured and structured leased lines
(D34U and D34S);
Attachment requirements for terminal equipment interface**

ETSI

European Telecommunications Standards Institute

ETSI Secretariat

Postal address: F-06921 Sophia Antipolis CEDEX - FRANCE

Office address: 650 Route des Lucioles - Sophia Antipolis - Valbonne - FRANCE

X.400: c=fr, a=atlas, p=etsi, s=secretariat - **Internet:** secretariat@etsi.fr

Tel.: +33 92 94 42 00 - Fax: +33 93 65 47 16

Copyright Notification: No part may be reproduced except as authorized by written permission. The copyright and the foregoing restriction extend to reproduction in all media.

© European Telecommunications Standards Institute 1995. All rights reserved.

Contents

Foreword	5
Introduction	5
1 Scope	7
2 Normative references	7
3 Definitions, symbols and abbreviations	8
3.1 Definitions	8
3.2 Symbols	8
3.3 Abbreviations	8
4 Requirements	9
4.1 Mechanical characteristics	9
4.2 Electrical characteristics	10
4.2.1 Output port	10
4.2.1.1 Signal coding	10
4.2.1.2 Waveform shape	10
4.2.1.3 Output timing	11
4.2.1.4 Output jitter	11
4.2.1.5 Output frame structure	12
4.2.2 Input port	13
4.3 Safety	13
4.4 Overvoltage protection	13
4.5 ElectroMagnetic Compatibility (EMC)	13
Annex A (normative): Test methods	14
A.1 General	14
A.1.1 Equipment connection	14
A.1.2 Test environment	14
A.2 Test methods	15
A.2.1 Signal coding at the output port	15
A.2.2 Waveform shape at the output port	15
A.2.3 Output timing	16
A.2.4 Output jitter	16
A.2.5 Frame structure	18
Annex B (normative): Definition of HDB3 code	19
B.1 General	19
B.2 Definition	19
Annex C (normative): Definition of frame structure	20
C.1 Frame structure at 34 368 kbit/s	20
Annex D (normative): TBR Requirements Table (TBR-RT)	21
Annex E (informative): Bibliography	22
History	23

Blank page

Foreword

This draft Technical Basis for Regulation (TBR) has been produced by the Business Telecommunications (BTC) Technical Committee, in conjunction with the Terminal Equipment (TE) and Transmission and Multiplexing (TM) Technical Committees, of the European Telecommunications Standards Institute (ETSI), and is now submitted for the Public Enquiry phase of the ETSI standards approval procedure.

This TBR resulted from a mandate from the Commission of the European Community (CEC) to provide harmonised standards for the support of the Second Phase Directive (91/263/EEC).

This TBR is based on information from ITU-T Recommendations and ETSI publications and the relevant documents are quoted where appropriate.

Introduction

The Council Directive on the application of Open Network Provision (ONP) to leased lines (92/44/EEC) concerns the harmonisation of conditions for open and efficient access to, and use of, the leased lines provided over public telecommunications networks, and the availability throughout the European Community (EC) of a minimum set of leased lines with harmonised technical characteristics.

At the date of publication of this TBR, the 34 Mbit/s unstructured and structured leased lines are not part of the minimum set of leased lines under the Leased Line Directive and it is not planned that they will be added to the minimum set.

Two classes of standard will be used for the interfaces of terminal equipment designed for connection to the ONP leased lines. European Telecommunications Standards (ETs), which are voluntary, give the full technical specifications for these interfaces, whereas TBRs give the essential requirements under the Second Phase Directive (91/263/EEC) for attachment to the leased lines. This TBR is a subset of the corresponding prETS 300 689.

ETS 300 166 and CCITT Recommendation G.703 are used as the basis for the terminal equipment interface.

Blank page

1 Scope

This TBR specifies the attachment requirements and the corresponding conformance tests for a terminal equipment interface for:

- connection to the Network Termination Points (NTPs) of 34 368 kbit/s Digital Unstructured leased lines (D34U); and
- connection to the NTPs of 34 368 kbit/s Digital Structured leased lines (D34S) with an information transfer rate of 33 920 kbit/s without restriction on binary content.

These leased lines are defined in prETS 300 686 and prETS 300 687.

The term "attachment requirements" in the context of this TBR refers to the essential requirements for access that apply under articles 4d and 4f of the Second Phase Directive (91/263/EEC). Conformance to these requirements does not guarantee end-to-end interoperability. Essential requirements under articles 4c and 4e are not applicable to this TBR.

This TBR is applicable to all interfaces intended for connection to the D34U or D34S leased line. It covers the essential requirements for the mechanical and electrical characteristics of the terminal equipment interface. Interfaces intended only for connection to the D34U leased lines which do not comply with the specified requirements on output structure, do not satisfy the attachment requirements for connection to the D34S structured leased line.

Customer premises wiring and installation between the terminal equipment and the NTP are outside the scope of this TBR.

2 Normative references

This TBR incorporates by dated or undated reference, provisions from other publications. These references are cited at the appropriate places in the text and the publications are listed hereafter. For dated references, subsequent amendments to, or revisions of any of these publications apply to this TBR only when incorporated into it by amendment or revision. For undated references the latest edition of the publication referred to applies.

- [1] CCITT Recommendation G.703 (1991): "Physical/electrical characteristics of hierarchical digital interfaces".
- [2] CCITT Recommendation O.151 (1992): "Error performance measuring equipment for digital systems at the primary rate and above".
- [3] CCITT Recommendation O.171 (1992): "Timing jitter measuring equipment for digital systems".

NOTE: This TBR also contains a number of informative references which have been included to indicate the sources from which various material has been derived, hence they do not have an associated normative reference number. Details of these publications are given in annex E. In some cases the same publication may have been referenced in both a normative and an informative manner.

3 Definitions, symbols and abbreviations

3.1 Definitions

For the purposes of this TBR, the following definitions apply:

frame: A repetitive set of consecutive bits in which the position of each bit can be identified by reference to a frame alignment signal.

frame alignment signal: The distinctive signal inserted in every frame always occupying the same relative position within the frame and used to establish and maintain frame alignment.

leased lines: The telecommunications facilities provided by a public telecommunications network that provide defined transmission characteristics between NTPs, and that do not include switching functions that the user can control (e.g. on-demand switching).

Network Termination Point (NTP): All physical connections and their technical access specifications which form part of the public telecommunications network and are necessary for access to and efficient communication through that public network.

Safety Extra-Low Voltage (SELV) circuit: A secondary circuit which is so designed and protected that under normal and single fault conditions, the voltage between any two accessible parts and, for class 1 equipment, between any accessible part and the equipment protective earthing terminal does not exceed a safe value (subclause 1.2.8.5 of EN 60950).

terminal equipment: Equipment intended to be connected to the public telecommunications network, i.e.:

- to be connected directly to the termination of a public telecommunication network; or
- to interwork with a public telecommunications network being connected directly or indirectly to the termination of a public telecommunications network,

in order to send, process, or receive information.

3.2 Symbols

None

3.3 Abbreviations

For the purposes of this TBR, the following abbreviations apply:

ac	alternating current
AMI	Alternate Mark Inversion
BNC	Bayonet Nut Connector
D34S	34 Mbit/s Digital Structured leased line
D34U	34 Mbit/s Digital Unstructured leased line
dc	direct current
EMC	ElectroMagnetic Compatibility
FA1	Frame Alignment byte 1
FA2	Frame Alignment byte 2
HDB3	High Density Binary code 3
LSB	Least Significant Bit
MSB	Most Significant Bit
NTP	Network Termination Point
ONP	Open Network Provision
ppm	parts per million
PRBS(2 ²³ -1)	Pseudo Random Bit Sequence as defined in subclause 2.2 of CCITT Recommendation O.151 [2]
RX	RX is a signal input (at either the terminal equipment or the test equipment, see figure 1)
SELV	Safety Extra-Low Voltage

TBR-RT	TBR-Requirements Table
TX	TX is a signal output (at either the terminal equipment or the test equipment, see figure 1)
UI	Unit Interval

4 Requirements

The terminal equipment is for use with D34U or D34S leased lines.

The D34U 34 368 kbit/s unstructured leased line provides a bidirectional point-to-point digital connection with an information transfer rate of 34 368 kbit/s without restriction on binary content. Any structuring of the data is the responsibility of the user.

The D34S 34 368 kbit/s structured leased line provides a bidirectional point-to-point digital connection with an information transfer rate of 33 920 kbit/s without restriction on binary content. Any structuring of the data within the transparent 33 920 kbit/s part of the frame is the responsibility of the user.

For both D34U and D34S the provision of timing is the responsibility of the user; however, in certain installations the leased line provider may be able to offer a leased line that is synchronised to the network.

4.1 Mechanical characteristics

Justification: Without a means of connection, it is impossible for the terminal equipment to connect to the network, therefore this is included in order for the terminal equipment to interwork with the network (article 4f).

Requirement: The terminal equipment interface shall provide two coaxial 75 Ω connectors, one each for transmit and receive. The outer conductor of the output connector shall be connected to signal ground.

There is no requirement under this TBR for a particular plug or socket to be provided on the terminal equipment.

NOTE 1: prETS 300 689 specifies that the terminal equipment shall provide either:

- two coaxial sockets, one each for transmit and receive; these sockets being either 75 Ω Bayonet Nut Connector (BNC) sockets or 75 Ω sockets of the type specified in IEC 169-13; or
- two coaxial plugs at the end of a cord (or cords), one each for transmit and receive; these plugs being either 75 Ω BNC plugs or 75 Ω plugs of the type specified in IEC 169-13.

NOTE 2: The transmit pair is the output from the terminal equipment interface. The receive pair is the input to the terminal equipment interface, as shown in figure 1. Where the terms "output" and "input" are used without qualification in this TBR, they refer to the terminal equipment interface.

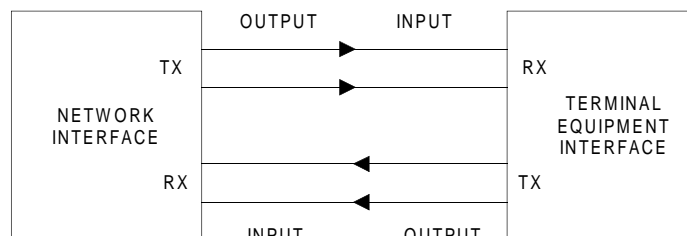

Figure 1

Test: There shall be a visual inspection that two 75 Ω connectors are provided.

4.2 Electrical characteristics

4.2.1 Output port

4.2.1.1 Signal coding

Justification: The correct signal coding is necessary for the output signals from the terminal equipment to be recognised correctly at the input to the NTP. Failure to provide the correct coding may cause error reports within the network. A requirement on signal coding is therefore included in order to prevent harm to the network (article 4d).

Requirement: The signal transmitted at the output port shall comply with the High Density Binary code 3 (HDB3) encoding rules (see annex B).

Test: The test shall be conducted according to subclause A.2.1.

4.2.1.2 Waveform shape

Justification: The correct waveform shape both limits the voltages to line and ensures correct recognition of the pulses. Incorrect recognition of pulses may cause error reports within the network. A requirement on waveform shape is therefore included in order to prevent harm to the network (article 4d).

Requirement: The pulse at the output port shall comply with the requirements given in figure 2 and table 1; based on CCITT Recommendation G.703.

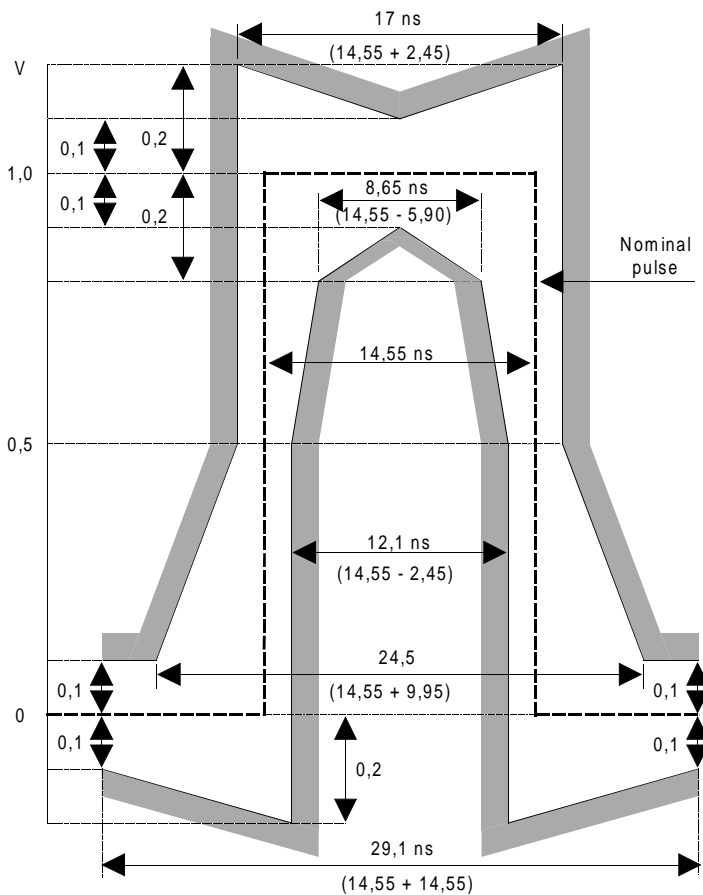

Figure 2: Pulse mask for 34 Mbit/s pulse

Table 1: Waveform shape at output port

Pulse shape (nominally rectangular)	All marks of a valid signal must conform with the mask (see figure 2). The value V corresponds to the nominal peak voltage of a mark.
Test load impedance	75 Ω non-reactive
Nominal peak voltage V of a mark	1,0 V
Peak voltage of a space	0 \pm 0,1 V
Nominal pulse width	14,55 ns
Ratio of the amplitudes of positive and negative pulses at the centre of the pulse interval	0,95 to 1,05
Ratio of the widths of positive and negative pulses at the nominal half amplitude	0,95 to 1,05

Test: The test shall be conducted according to subclause A.2.2.

4.2.1.3 Output timing

Justification: Pulses at the wrong bit rate may not be properly recognised and may cause error reports within the network. A requirement on output timing is therefore included in order to prevent harm to the network (article 4d).

The terminal equipment may derive its timing from:

- a) an internal source (e.g. an internal clock);
- b) an external reference signal input;
- c) the received signal at the input port.

Requirement: For each of the timing arrangements intended for use, the bit rate at the output port shall be within the limits of 34 368 kbit/s \pm 20 parts per million (ppm), when any relevant external reference signal, including the received signal at the input port, is within its stated tolerance.

Test: The test shall be conducted according to subclause A.2.3.

4.2.1.4 Output jitter

Justification: A high level of jitter causes error reports within some networks, therefore this requirement is included to prevent harm to the network (article 4d).

Requirement: The peak-to-peak output jitter shall not exceed the limits of table 2 when measured with a band pass filter with the defined cut-off frequencies. At frequencies below the lower 3 dB point, the attenuation of the high pass filter shall rise with a value greater than, or equal to, 20 dB per decade. At frequencies above the upper 3 dB point, the attenuation of the low pass filtration shall rise with a value greater than, or equal to, 60 dB per decade.

For the purpose of testing, any signal input from which the output timing is derived shall be provided with the maximum tolerable input jitter, and with the maximum tolerable input frequency deviation, as specified by the manufacturer.

Where the output timing of the terminal equipment is taken from the leased line, the input to the terminal equipment shall be provided with components of sinusoidal jitter at points on the curve of figure 3 and table 3.

Table 2: Maximum output jitter

Measurement filter bandwidth		Output jitter
Lower cut-off (high pass)	Upper cut-off (low pass)	Unit Interval (UI) peak-to-peak (maximum)
100 Hz	800 kHz	0,075

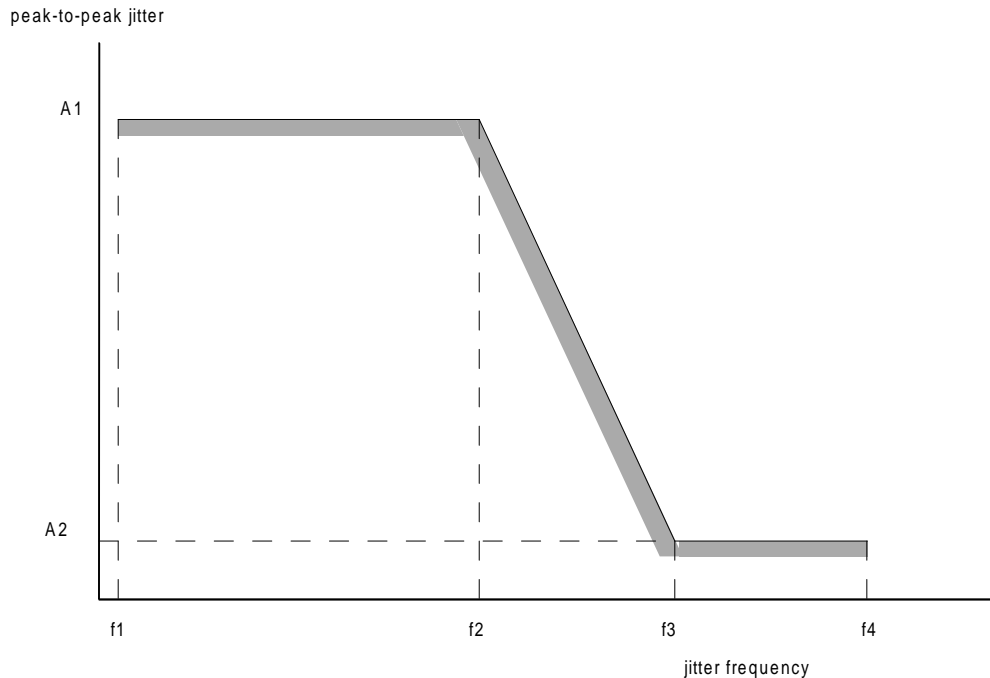

Figure 3: Input jitter tolerance

Table 3: Input jitter tolerance

Peak-to-peak amplitude (UI)		Frequency			
A1	A2	f1	f2	f3	f4
1,5	0,15	100 Hz	1 kHz	10 kHz	800 kHz

Test: The test shall be conducted according to subclause A.2.4.

4.2.1.5 Output frame structure

Justification: If the input bit stream to the structured leased line does not have the correct Frame Alignment byte 1 (FA1) and Frame Alignment byte 2 (FA2), the leased line will not be able to achieve frame alignment for the purposes of monitoring the line and may cause error reports. Therefore a requirement on the frame alignment signals is included to prevent harm to the network (article 4d).

Requirement: For terminal equipments intended for connection to the D34S structured leased line, the bit stream transmitted at the output of the terminal equipment shall be structured as defined in annex C.

Test: The test shall be conducted according to subclause A.2.5.

4.2.2 Input port

There are no requirements on the input port under this TBR.

Justification: The requirements imposed on the terminal equipment output port do not require the correct receipt of data at the terminal equipment input port. The network output port should be protected against both short circuit and open circuit. Therefore there are no requirements within the base standard prETS 300 689 that can be considered as essential requirements.

4.3 Safety

There are no safety requirements under this TBR.

NOTE: Safety requirements are imposed under the Low Voltage Directive (73/23/EEC) and articles 4a and 4b of the Second Phase Directive (91/263/EEC). Subclause 4.3 of prETS 300 689 defines the terminal equipment interface as an Safety Extra-Low Voltage (SELV) circuit. Detailed requirements for SELV circuits are given in EN 60950.

4.4 Overvoltage protection

There are no overvoltage protection requirements under this TBR.

NOTE: Requirements for overvoltage protection requirements on a 75 Ω interface are under study. Requirements may be added to this TBR when appropriate specifications become available.

4.5 ElectroMagnetic Compatibility (EMC)

There are no EMC requirements under this TBR.

NOTE: General EMC requirements are imposed under the EMC Directive (89/336/EEC). Requirements for conducted emissions will be added to this TBR when appropriate specifications become available if these requirements are not imposed under the EMC Directive.

Annex A (normative): Test methods

A.1 General

This annex describes the test principles to determine the compliance of a terminal equipment against the requirements of this TBR.

It is outside the scope of this TBR to identify the specific details of the implementation of the tests.

A terminal equipment may be designed for through-connecting and may fulfil the electrical requirements only if through-connected. In these cases the requirements of this TBR are valid and the tests are carried out with the through-connection terminated as specified by the equipment supplier.

Details of test equipment accuracy and the specification tolerance of the test devices are not included in all cases. Where such details are provided they shall be complied with, but the way they are expressed shall not constrain the method of implementing the test.

NOTE: Attention is drawn to the issue of measurement uncertainty which may be addressed in future documents. Not all the required test results make allowance for spurious events during testing (e.g. errors due to EMC effects), which may make it necessary to repeat a test.

The given test configurations do not imply a specific realisation of the test equipment or test arrangement, or the use of specific test devices. However any test configuration used shall provide those test conditions specified under "interface state", "stimulus" and "monitor" for each individual test.

The test equipment shall be a device, or a group of devices, generating a stimulus signal conforming to this annex and capable of monitoring the signal received from the interface.

The terminal equipment interface under test shall have the ability to transmit a bit pattern for test purposes, e.g. a Pseudo Random Bit Sequence (PRBS(2²³-1)) as defined in subclause 2.2 of CCITT Recommendation O.151 [2] (PRBS(2²³-1)). Where this cannot be provided, an alternative method of conducting the test shall be provided.

A.1.1 Equipment connection

The tests shall be applied at the sockets or plugs supplied with the terminal equipment for connection to the leased line interface. Connecting cable between the sockets and test equipment shall be kept to a minimum, except where cable is specified as part of the test.

Where plugs are provided at the end of a cord, the tests specified in subclause A.2.2 may be performed at the point of connection of the cord to the terminal equipment, since the requirements are based on CCITT Recommendation G.703 which makes no allowance for any plug and cord.

A.1.2 Test environment

All tests shall be performed at:

- an ambient temperature in the range +19 °C to +25 °C;
- a relative humidity in the range 5 % to 75 %.

For terminal equipment which is not designed to operate within the environmental range specified above, all tests shall be performed in an environmental condition as specified by the supplier.

For terminal equipment which is directly powered (either wholly or partly) from the mains supply, all tests shall be carried out with $\pm 5\%$ of the rated voltage of that supply. If the equipment is powered by other means and those means are not supplied as part of the apparatus (e.g. batteries, stabilised alternating current (ac) supplies, direct current (dc)) all tests shall be carried out within the power supply limit declared by the supplier. If the power supply is ac, the test shall be conducted within $\pm 4\%$ of the rated frequency.

A.2 Test methods

One test may cover more than one requirement. The scope of each test is defined under the heading "purpose".

A.2.1 Signal coding at the output port

Purpose: To verify that the signal coding at the terminal equipment output port complies with the HDB3 coding rules as required by subclause 4.2.1.1.

Test configuration: Figure A.1.

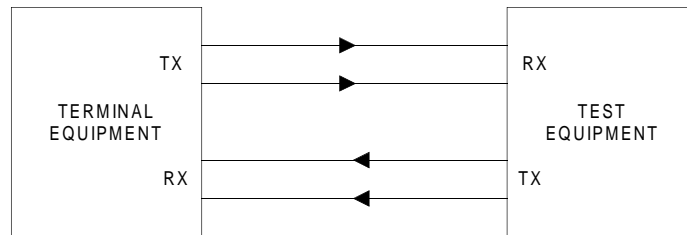

Figure A.1: Signal coding at output port

Interface state: Powered.

Stimulus: The terminal equipment shall transmit a bit stream including the sequences <0000><even number of binary ONES><0000> and <0000><odd number of binary ONES><0000> which shall be encoded into HDB3; where 0 = space and 1 = mark input to the HDB3 encoder.

NOTE: A pseudo random bit stream, e.g. PRBS($2^{23}-1$), will be acceptable if the bit patterns of the above subclause are included in the bit stream. For terminal equipment which can generate a structured signal in accordance with annex C, the PRBS may be transmitted in the payload section of the frame. For terminal equipment which cannot generate such a structured signal, the PRBS should be transmitted in the whole bit stream.

Monitor: The output bit stream for a test period of sufficient time to allow transmission of 100 occurrences of the above patterns plus the latency period of the error detection mechanism.

Results: There shall be no errors in the HDB3 encoding.

A.2.2 Waveform shape at the output port

Purpose: To verify conformance of the output waveform shape with the requirements of subclause 4.2.1.2.

Test configuration: Figure A.2.

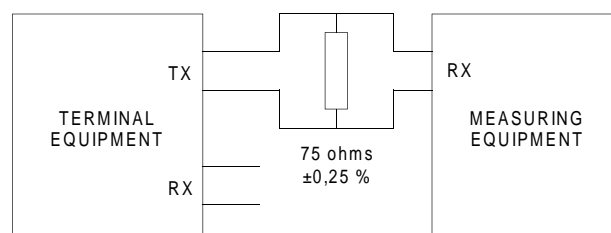

Figure A.2: Waveform shape at output port

Interface state: Powered.

Stimulus: Undefined.

Monitor: Marks and spaces transmitted from the NTP, measuring the amplitude and shape of positive and negative pulses (measured at the centre of the pulse interval) and the time duration of positive and negative pulses (measured at the nominal half of the pulse amplitude, i.e. 0,5 V).

The overall measurement accuracy shall be better than 30 mV. All the measurements shall be performed using measuring equipment capable of recording dc. A bandwidth of 200 MHz or greater shall be used to ensure the capture of over or undershoot of the pulse.

Results: Both positive and negative pulses shall be within the mask of figure 2, where the nominal pulse amplitude is 1 V.

The bit interval corresponding to a space shall not present voltages higher than $\pm 0,1$ V.

The ratio between the amplitude of positive and negative pulses shall be in the range from 0,95 to 1,05.

The ratio between the pulse widths of positive and negative pulses shall be in the range from 0,95 to 1,05.

A.2.3 Output timing

Purpose: To measure the output timing as defined in subclause 4.2.1.3.

Test Configuration: Figure A.3.

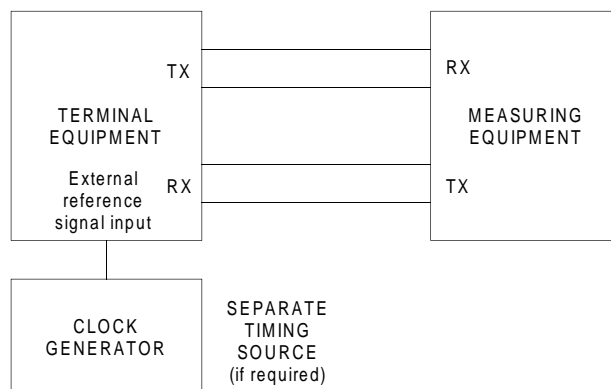

Figure A.3: Output timing

Interface state: Powered.

Stimulus: The terminal equipment shall be configured to provide output timing from each of its intended timing arrangements. Any external reference signal input, including the input port, from which timing can be derived, shall be provided with timing at the bit rate limits as specified by the terminal equipment manufacturer.

Monitor: The bit rate of the signal decoded from output port of the terminal equipment.

Results: The bit rate shall be within the limits given in subclause 4.2.1.3.

A.2.4 Output jitter

Purpose: To measure the maximum output jitter as defined in subclause 4.2.1.4.

NOTE: Further information on the measurement of jitter can be found in CCITT Supplement number 3.8, Fascicle IV.4 (1988).

Test Configuration: Figure A.4.

The terminal equipment shall be tested in each of the following configurations (where these modes of operation are supported):

- output timing referenced to the internal clock; and
- output timing referenced to any external clock source from which timing can be derived (including derivation from the input signal).

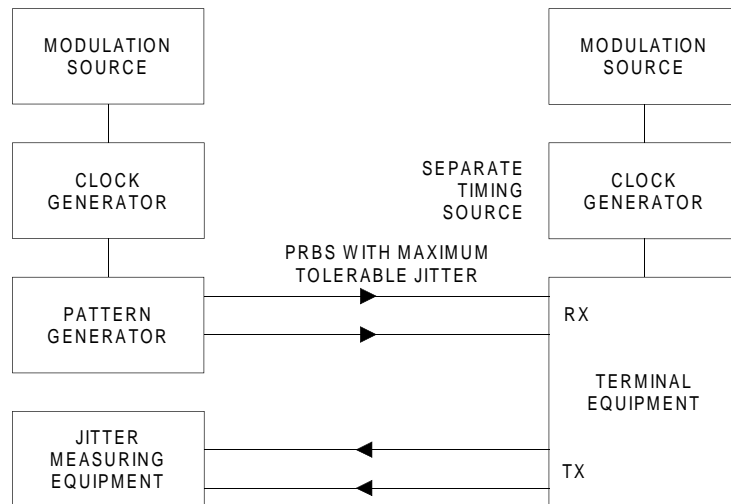

NOTE: The modulation source may be included in the clock generator and/or the pattern generator, or it may be provided separately.

Figure A.4: Jitter measurement

Interface state: Powered.

Stimulus: The output signal of the test equipment shall be HDB3 encoded and conform to a pulse shape as defined in figure 17 of CCITT Recommendation G.703 [1], which is reproduced in figure 2 of this TBR. For terminal equipment which can accept a structured signal in accordance with annex C, the bit stream shall be structured into frames according to annex C. The binary content of the data contained in the payload of the frame shall be a PRBS(2²³-1). For terminal equipment which cannot accept such a structured signal, the PRBS should be transmitted in the whole bit stream.

Measurements shall be made with both the input signals at the digital rate limits of 34 368 kbit/s ± 20 ppm and between these limits, sufficient to verify jitter compliance over the specified frequency range. As a minimum the test shall be performed at the upper and lower limits and at the nominal rate.

The modulation source for the terminal equipment input bit stream shall generate individual components of sinusoidal jitter at points on the curve of figure 3 and table 3 of this TBR.

The modulation source for the external timing (if needed) shall be independent from that for the input signal and shall generate the maximum tolerable jitter, and maximum frequency deviation, as specified by the manufacturer of the terminal equipment.

It may be necessary to synchronise the two clock generators to avoid a high occurrence of slips.

Monitor: The jitter at the output port using equipment complying with CCITT Recommendation O.171 [3].

Results: The peak-to-peak jitter shall comply with table 2 of subclause 4.2.1.4.

A.2.5 Frame structure

Purpose: To verify compliance with the requirements for terminal equipment output structure defined in subclause 4.2.1.5. The test verifies the presence of the FA1 and FA2 within a frame of 537 octets.

Test configuration: Figure A.5.

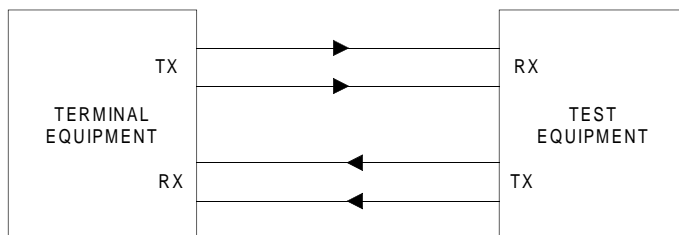

Figure A.5: Structure

Interface state: Powered.

Stimulus: The terminal equipment shall transmit a pseudo random bit stream, e.g. PRBS($2^{23}-1$) within the payload section of the frame.

If necessary, an HDB3 encoded stimuli shall be applied to the input of the terminal equipment at a bit rate within the limits of 34 368 kbit/s \pm 20 ppm.

Monitor: The bit stream at the output of the terminal equipment.

Results: The output bit stream shall comprise consecutive frames of 537 octets commencing with the two octets FA1 and FA2 as defined in annex C.

Annex B (normative): Definition of HDB3 code

B.1 General

This annex specifies the modified Alternate Mark Inversion (AMI) code HDB3. The contents of this annex are based on annex A of CCITT Recommendation G.703.

In this code, binary 1 bits are represented by alternate positive and negative pulses, and binary 0 bits by spaces. Exceptions are made when strings of successive 0 bits occur in the binary signal.

In the definition below, B represents an inserted pulse corresponding to the AMI rule, and V represents an AMI violation.

B.2 Definition

Each block of 4 successive zeros is replaced by 000V or B00V. The choice of 000V or B00V is made so that the number of B pulses between consecutive V pulses is odd. In other words, successive V pulses are of alternate polarity so that no dc component is introduced.

Annex C (normative): Definition of frame structure

C.1 Frame structure at 34 368 kbit/s

The basic frame structure at 34 368 kbit/s for attachment to the D34S leased line shall comprise 537 octets, the first two bytes of which comprise the frame alignment bytes; this is defined in figures C.1 and C.2. The order of transmission of information in figure C.1 is first from left to right and then top to bottom. Within each byte the Most Significant Bit (MSB) is transmitted first. The MSB (bit 1) is illustrated at the left of figure C.2.

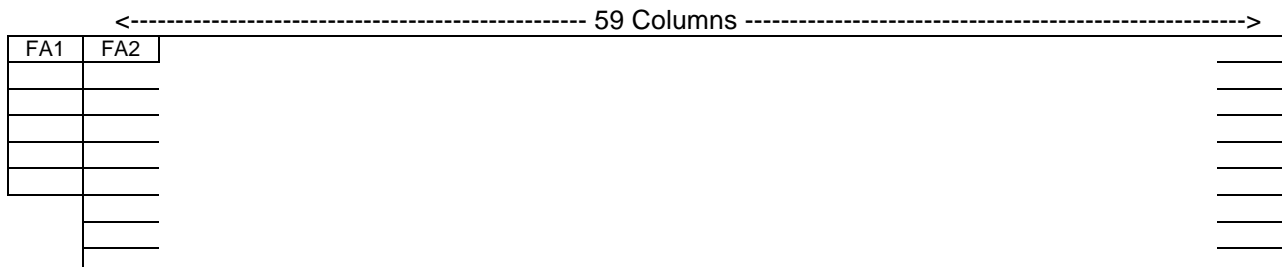
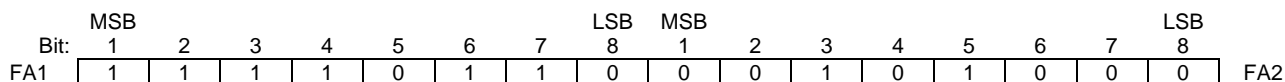

Figure C.1: Frame structure at 34 368 kbit/s



LSB: Least Significant Bit

Figure C.2: Frame alignment signal at 34 368 kbit/s

NOTE: The 537 octet frame will normally comprise 7 octets of path overhead and 530 octets of payload. Further details are given in prETS 300 689.

Annex D (normative): TBR Requirements Table (TBR-RT)

Notwithstanding the provisions of the copyright clause related to the text of this TBR, ETSI grants that users of this TBR may freely reproduce the TBR-RT proforma in this annex so that it can be used for its intended purposes and may further publish the completed TBR-RT.

Table D.1: TBR conditions table for attachment requirements for terminal equipment to digital 34 Mbit/s leased lines (D34U and D34S) as given in prTBR 24

Reference	Condition	Status	Support (Y/N)
C1	Is the terminal equipment intended for connection to the D34S structured leased line?	If YES then M else N	

Table D.2: TBR requirements table for attachment requirements for terminal equipment to digital 34 Mbit/s leased lines (D34U and D34S) as given in prTBR 24

TBR Reference		prTBR 24		
Item	Reference	Requirement	Status note 1	Support note 2
1	4.1	Mechanical characteristics	M	
2	4.2.1.1	Signal coding	M	
3	4.2.1.2	Waveform shape	M	
4	4.2.1.3	Output timing	M	
5	4.2.1.3 (a)	- internal source of timing	O	
6	4.2.1.3 (b)	- external timing reference (note 3)	O	
7	4.2.1.3 (c)	- timing derived from input port	O	
8	4.2.1.4	Output jitter	M	
9	4.2.1.5	Output frame structure	C1	
10	4.2.2	Input port	N	
11	4.3	Safety	N	
12	4.4	Overvoltage protection	N	
13	4.5	Electromagnetic compatibility	N	
NOTE 1:	Status is "Mandatory (M)", "Not a requirement (N)", "Optional (O)" or "Conditional (Cx)". For Conditional see table D.1.			
NOTE 2:	The support column has been added to the requirements table so that the table may be used as an implementation conformance statement proforma. Support is Y (equipment claims to fully implement the requirement of the TBR) or N (equipment does not claim to conform to the requirement of the TBR).			
NOTE 3:	Where the timing may be derived from an external reference signal, the terminal equipment supplier shall declare the maximum input jitter and maximum timing deviation of this signal for the purpose of testing the output timing accuracy of subclause 4.2.1.3 and the output jitter limits of subclause 4.2.1.4.			

Annex E (informative): Bibliography

- 89/336/EEC: "Council Directive of 3 May 1989 on the approximation of the laws of Member States relating to electromagnetic compatibility".
- 91/263/EEC: "Council Directive of 29 April 1991 on the approximation of the laws of Member States concerning telecommunications terminal equipment, including the mutual recognition of their conformity".
- 92/44/EEC: "Council Directive of 5 June 1992 on the application of Open Network Provision to leased lines".
- CCITT Recommendation G.703 (1991): "Physical/electrical characteristics of hierarchical digital interfaces".
- CCITT Supplement number 3.8, Fascicle IV.4 (1988): "Guidelines concerning the measurement of jitter".
- prETS 300 686: "Business TeleCommunications (BTC); 34 Mbit/s and 140 Mbit/s digital leased lines (D34U, D34S, D140U and D140S), Network interface presentation".
- prETS 300 687: "Business TeleCommunications (BTC); 34 Mbit/s digital leased lines (D34U and D34S), Connection characteristics".
- prETS 300 689: "Business TeleCommunications (BTC); 34 Mbit/s digital leased lines (D34U and D34S), Terminal equipment interface".
- EN 60950 (1992): "Safety of information technology equipment including electrical business equipment".
- ETS 300 166 (1993): "Transmission and Multiplexing (TM); Physical and electrical characteristics of hierarchical digital interfaces for equipment using the 2 048 kbit/s-based plesiochronous or synchronous digital hierarchies".
- IEC 169-13 (1976): Part 13: "R.F. coaxial connectors with inner diameter of outer conductor 5,6 mm (0,22 in) - Characteristic impedance 75 ohms (Type 1,6/5,6) - Characteristic impedance 50 ohms (Type 1,8/5,6) with similar mating dimensions".

History

Document history	
August 1995	Public Enquiry PE 89: 1995-08-07 to 1995-12-01
May 1996	Converted into Adobe Acrobat Portable Document Format (PDF)