

TR 101 115 V6.0.0 (1998-01)

Technical Report

**Digital cellular telecommunications system;
(GSM Radio Access Phase 3);
Background for Radio Frequency (RF) requirements;
(GSM 05.50 version 6.0.0)**

GSM®

GLOBAL SYSTEM FOR
MOBILE COMMUNICATIONS



European Telecommunications Standards Institute

Reference

DTR/SMG-020550N (abo03004.PDF)

Keywords

Digital cellular telecommunications system,
Global System for Mobile communications (GSM)

ETSI Secretariat

Postal address

F-06921 Sophia Antipolis Cedex - FRANCE

Office address

650 Route des Lucioles - Sophia Antipolis
Valbonne - FRANCE
Tel.: +33 4 92 94 42 00 Fax: +33 4 93 65 47 16
Siret N° 348 623 562 00017 - NAF 742 C
Association à but non lucratif enregistrée à la
Sous-Préfecture de Grasse (06) N° 7803/88

X.400

c= fr; a=atlas; p=etsi; s=secretariat

Internet

secretariat@etsi.fr
<http://www.etsi.fr>

Copyright Notification

No part may be reproduced except as authorized by written permission.
The copyright and the foregoing restriction extend to reproduction in all media.

Contents

Intellectual Property Rights.....	7
Foreword.....	7
1 Scope.....	8
2 Information available.....	8
3 DCS 1800 system scenarios.....	8
4 GSM 900 small cell system scenarios.....	9
5 GSM 900 and DCS 1800 microcell system scenarios.....	9
6 Conversion factors.....	10
7 Repeaters.....	11
8 Error Patterns for Speech Coder Developments.....	11
9 Simulations of Performance.....	11
10 GSM 900 railway system scenarios.....	11
11 Simulation results for GPRS receiver performance.....	12
Annex A: DCS 1800 System scenarios.....	13
Annex B: GSM 900 Small Cell System scenarios.....	31
Annex C: Microcell System Scenarios.....	37
Annex D: Conversion factors.....	50
Annex E: Repeater Scenarios.....	54
Annex F: Error Patterns for Speech Coder Development.....	69
F.0 Introduction.....	69
F.1 Channel Conditions.....	69
F.1.1 Simulation Conditions.....	69
F.1.2 Available Error Patterns.....	69
F.2 Test Data for the half rate speech coder.....	70
F.2.1 File description.....	70
F.2.2 Soft decision values and chip error patterns.....	70
F.2.3 Error patterns of corresponding TCH/FS.....	71
Annex G: Simulation of Performance.....	73
G.1 Implementation Losses and Noise Figure.....	73
G.1.1 Assumed Equalizer.....	73
G.1.2 Accuracy of Simulations.....	73
G.1.3 Simulation Results.....	73
G.2 Reference Structure.....	83
G.2.1 Error Concealment.....	83
G.2.2 Implementation Losses and Noise Figure.....	83
G.2.3 Assumed Equalizer.....	83
G.2.4 Simulation Results.....	83
G.2.5 Proposed Values for Recommendation GSM 05.05.....	84

Annex H:	GSM 900 Railway System Scenarios	85
H.1	Scope.....	85
H.1.1	List of some abbreviations	85
H.2	Constraints	85
H.2.1	GSM based systems in the 900 MHz band	85
H.2.2	Other systems.....	86
H.2.3	UIC systems outline	86
H.2.4	Fixed UIC RF parameters	86
H.3	Methodology	87
H.3.1	Scenarios.....	87
H.3.2	Format of calculations.....	88
H.3.3	GSM900 systems parameters.....	89
H.3.4	Minimum Coupling Loss	90
H.3.5	Interference margins	91
H.3.6	Differences between E- and P-GSM	91
H4	Transmitter requirements	92
H.4.1	Transmitter requirements summary.....	93
H.5.	Receiver requirements.....	94
H.5.1	Receiver requirements summary.....	95
H.6.	Wanted signals levels.....	95
H.6.1	Maximum wanted signal level	95
H.6.2	Dynamic range of wanted signals	96
Annex J:	GSM 900 Railway System Scenarios	97
J.1	Introduction.....	97
J.2	Basic considerations.....	97
J.2.1	Types of equipment and frequency ranges.....	97
J.3	Discussion of the individual sections in 05.05	98
J.3.1	Scope	98
J.3.2	Frequency bands and channel arrangement.....	98
J.3.3	Reference configuration.....	99
J.3.4	Transmitter characteristics	99
J.3.4.1	Output power.....	99
J.3.4.2.1	Spectrum due to the modulation and wide band noise.....	99
J.3.4.2.2a	MS spectrum due to switching transients.....	100
J.3.4.2.2b	BTS spectrum due to switching transients.....	100
J.3.4.3.1	Spurious emissions	100
J.3.4.3.2	BTS spurious emissions.....	101
J.3.4.3.3	MS spurious emissions	102
J.3.4.3.4	MS spurious emissions onto downlinks.....	102
J.3.4.4	Radio frequency tolerance.....	104
J.3.4.5	Output level dynamic operation	104
J.3.4.5.1	BTS output level dynamic operation	104
J.3.4.5.2	MS output level dynamic operation.....	104
J.3.4.6	Phase accuracy	104
J.3.4.7.1	Intra BTS intermod attenuation	104
J.3.4.7.2	Intermodulation between MS (DCS1800 only)	105
J.3.4.7.3	Mobile PBX.....	105
J.3.5.	Receiver characteristics	105
J.3.5.1	Blocking characteristics	106
J.3.5.2	Blocking characteristics (in-band).....	106
J.3.5.3	Blocking characteristics (out-of-band)	106
J.3.5.4	AM suppression characteristics	107
J.3.5.5	Intermodulation characteristics	107
J.3.5.6	Spurious emissions	107

J.3.6	Transmitter/receiver performance	107
J.3.6.1	Nominal error rates	107
J.3.6.2	Reference sensitivity level.....	107
Annex K:	Block Erasure Rate Performance for GPRS	108
K.1	Introduction.....	108
K.2	Simulation Model.....	108
K.3	Results.....	108
K.4	Conclusions.....	109
Annex L:	Proposal on how to report GPRS performance into GSM 05.05	111
L.1.	Introduction.....	111
L.2.	GPRS BLER performance	111
L.3.	GPRS throughput analyses.....	112
L.3.1	TU50 ideal FH.....	113
L.3.2	TU3 no FH.....	114
L.4.	Proposals for GPRS performance in GSM 05.05	115
L.4.1	TU50 ideal FH.....	115
L.4.2	TU3 no FH.....	115
L.5	Conclusions.....	116
Annex M:	GPRS simulation results in TU 3 and TU 50 no FH	117
M.1	Introduction.....	117
M.2	Simulation Model.....	117
M.3	Maximum GPRS throughput.....	119
M.4	Conclusion	120
M.5	References.....	120
Annex N:	C/I_c and E_b/N₀ Radio Performance for the GPRS Coding Schemes	122
N.1	Introduction.....	122
N.2	C/I simulation results	122
N.3.	E _b /N ₀ performance.....	124
N.4	Conclusions.....	126
N.5	References.....	126
Annex P:	Block Error Rate and USF Error Rate for GPRS.....	127
P.1	Introduction.....	127
P.2	Simulation Assumptions	127
P.3	Simulation Results	128
P.3.1	Interference Simulations	128
P.3.1.1	TU50 Ideal Frequency Hopping.....	128
P.3.1.2	TU50 No Frequency Hopping.....	129
P.3.1.3	TU3 Ideal Frequency Hopping.....	130
P.3.1.4	TU3 No Frequency Hopping.....	131
P.3.1.5	RA250 No Frequency Hopping.....	132
P.3.2	Sensitivity Simulations.....	133
P.3.2.1	TU50 Ideal Frequency Hopping.....	133

P.3.2.2	TU50 No Frequency Hopping.....	134
P.3.2.3	HT100 No Frequency Hopping.....	135
P.3.2.4	RA250 No Frequency Hopping.....	136
P.3.2.5	Static Channel	137
Annex Q:	Block Error Rate and USF Error Rate for GPRS, 1800 MHz.....	139
Q.1	Introduction.....	139
Q.2	Simulation Assumptions	139
Q.3	Simulation Results	140
Q.3.1	Interference Simulations, 1800 MHz.....	140
Q.3.1.2	TU50, Ideal Frequency Hopping.....	140
Q.3.1.3	TU50 No Frequency Hopping.....	141
Q.3.2	Sensitivity Simulations, 1800 MHz	142
Q.3.2.1	TU50 Ideal Frequency Hopping.....	142
Q.3.2.2	TU50 No Frequency Hopping.....	143
Q.3.2.3	HT100 No Frequency Hopping.....	144
History	146

Intellectual Property Rights

IPRs essential or potentially essential to the present document may have been declared to ETSI. The information pertaining to these essential IPRs, if any, is publicly available for **ETSI members and non-members**, and can be found in ETR 314: "*Intellectual Property Rights (IPRs); Essential, or potentially Essential, IPRs notified to ETSI in respect of ETSI standards*", which is available **free of charge** from the ETSI Secretariat. Latest updates are available on the ETSI Web server (<http://www.etsi.fr/ipr>).

Pursuant to the ETSI Interim IPR Policy, no investigation, including IPR searches, has been carried out by ETSI. No guarantee can be given as to the existence of other IPRs not referenced in ETR 314 (or the updates on <http://www.etsi.fr/ipr>) which are, or may be, or may become, essential to the present document.

Foreword

This ETSI Technical Report (TR) has been produced by the Special Mobile Group (SMG) of the European Telecommunications Standards Institute (ETSI).

This TR is an informative document and gives background information on how the Radio Frequency (RF) requirements of GSM 900 and DCS 1800 systems have been derived.

This TR is a SMG approved **GSM Radio Access Phase 3** technical specification version 6, which contains **Release 97** enhancements/features.

ETSI SMG has created the GSM Radio Access Phase 3 specifications to enable the evolution of the GSM standard (e.g., for the GSM radio access with the introduction of GPRS and other high data rate features).

The contents of this TR are subject to continuing work within SMG and may change following formal SMG approval. Should SMG modify the contents of this TR it will then be republished by ETSI with an identifying change of release date and an increase in version number as follows:

Version 6.x.y

where:

- y the third digit is incremented when editorial only changes have been incorporated in the specification;
- x the second digit is incremented for all other types of changes, i.e. technical enhancements, corrections, updates, etc.

NOTE; The specification from which this TR has been derived was originally based on CEPT documentation, hence the presentation of this TR may not be entirely in accordance with the ETSI rules.

1 Scope

This report gives background information on how the RF requirements of GSM 900 and DCS 1800 systems have been derived.

2 Information available

This report collects together temporary documents of ETSI SMG and STC SMG2 which can be seen as base line material for the RF requirements in GSM 05.05. The documents are divided into eight groups:

- GSM 900 small cell system scenarios;
- DCS 1800 system scenarios;
- GSM 900 microcell system scenarios;
- conversion factors to compare different requirements;
- repeaters;
- speech codec error patterns;
- simulation of performance;
- GSM 900 railway system scenarios.

In the following clauses there is a short description of the documents. The documents themselves are annexed to this report.

A list of phase 2 change requests to SMG2 related documents are annexed to the SMG meeting reports.

3 DCS 1800 system scenarios

There are two documents describing the basis of the DCS 1800 RF requirements. They are:

- DCS 1800 System scenarios (TDoc SMG 259/90, reproduced as TDoc SMG 60/91).
- Justifications for the DCS 1800 05.05 (TDoc SMG 260/90, revised as TDoc SMG 60/91)).

These documents have been derived first by the UK PCN operators and later by GSM2 ad hoc group working on DCS 1800 requirements during 1990. The documents were presented to TC SMG in October 1990.

DCS 1800 System Scenarios describes six scenarios which are considered to be the relevant cases for DCS 1800. The six scenarios described are

- Single MS - Single BTS.
- Multiple MSs - Multiple co-ordinated BTSs.
- Multiple MSs - Multiple uncoordinated BTSs.
- Co-located MSs, co-ordinated/uncoordinated.
- Co-located BTSs, co-ordinated/uncoordinated.
- Co-location with other systems.

On each of these scenarios the system constraints related to the scenario are described, the RF requirements affected by the scenario are identified and the input information needed to study the scenario in detail is listed.

Justifications for the DCS 1800 05.05 includes the analysis of the system scenarios to detailed RF requirements and presents and justifies the proposed changes to GSM 05.05 for DCS 1800. In the analysis part the relevant scenario calculations are made for each RF requirement and the most critical scenario requirement identified. The justification part then looks at the identified scenario requirement, compares it to the corresponding existing GSM 900 requirement and taking also into account the implementation issues and finally gives reasoning to the proposed change of the specific RF requirement.

These documents are in Annex A

The DCS 1800 requirements were originally developed for Phase 1 as a separate set of specifications, called DCS-specifications. For Phase two the DCS 1800 and GSM 900 requirements are merged. The main Phase 2 change requests of SMG2 in which the requirements for the DCS 1800 system were included into are listed below.

CR 05.01-04	Combination of GSM 900 and DCS 1800 specifications.
CR 05.05-37 rev1	Combination of 05.05 (GSM 900) and 05.05-DCS (DCS 1800) specifications.
CR 05.08-55 rev1	Combination of GSM 900 and DCS 1800 and addition of National roaming.

Further development of the DCS 1800 requirements for Phase 2 can be found in the other Phase 2 CRs of SMG2, the vast majority of which are valid both for DCS 1800 and GSM 900. The list of Phase 2 CRs of SMG2 can be found in Annex E.

4 GSM 900 small cell system scenarios

There is one document which discusses the small cell system scenarios for GSM 900. The document is

- Small cell system scenarios for GSM 900 (TDoc SMG2 104/92, revised as TDoc SMG2 104/92 rev1).

Small cell system scenarios for GSM 900 uses the DCS 1800 system scenarios and justification document and derives from them the scenario requirements for GSM 900 small cells. It also calculates the worst case requirements based on minimum coupling loss of 59 dB.

The document on GSM 900 small cell system scenarios is in Annex B.

CR 03.30-02 on "Propagation models for different types of cells" gives a definition for a small cell and the typical cell parameters to calculate the propagation loss in a small cell.

5 GSM 900 and DCS 1800 microcell system scenarios

GSM 900 and DCS 1800 microcells have been discussed by SMG2 in various meetings since late 1991. In SMG2#2 (May 1992) a small group was formed to collect together the various documents and make a proposal for the microcell RF parameters. As agreed by SMG2 there should be four microcell specific requirements, namely

- transmit power;
- receive sensitivity;
- wideband noise;
- blocking.

As a result of the subgroup and other SMG2 activities there are three documents which can be used as baseline material for the microcell requirements. They are:

- Microcell BTS RF parameters (TDoc SMG2 163/92);
- Comments and proposals on Microcell RF parameters (TDoc 144/92);
- Revised proposal for microcell RF parameters (TDoc SMG2 ad hoc 4/92).

Microcell BTS RF parameters and **Comments and proposals on Microcell RF parameters** are joint papers giving the microcell scenarios and the requirements. The first one describes the two microcell scenarios, namely range and

proximity, and presents the method to derive the detailed requirements starting from the scenarios. The latter document includes some corrections/updates to the scenarios, and proposes the detailed requirements. As described in the documents there are three classes of microcells, depending on the expected Minimum Coupling Loss between BTS and MS. This is to guarantee the optimum choice of BTS transmit powers while maintaining the operability of the system. The last of the microcell documents, **Revised proposal for microcell RF parameters** includes updates to the detailed requirement figures.

All the microcell requirements were collected together and were presented to and approved by SMG#5.

The documents on GSM 900 and DCS 1800 microcells are in Annex C.

The relevant change requests where the detailed microcell requirements can be found, are listed below.

CR 03.30-04	Microcell Radio planning aspects;
CR 03.30-08	Microcell minimum coupling loss for small frequency offsets;
CR 05.05-69 rev1	Microcell BTS RF parameters;
CR 05.05-79 rev1	Alignment of microcell maximum peak power requirement presentation;
CR 05.05-90	Update of DCS 1800 microcell RF parameters.

6 Conversion factors

One of the tasks in ETSI/STC SMG2 has been to align the different RF requirements for the Phase 2 specifications. This was found necessary because in phase 1 some of the RF requirements dominated over others making them almost obsolete. Related to the alignment process it was found necessary to introduce a set of conversion factors to be able to compare different types of requirements measured with different measurement techniques. The original work assumptions were agreed on at SMG2#1 in February 1992 and they were reviewed in SMG2 ad hoc meeting in April 1992.

There are two documents related to the conversion factors. They are:

- Report of the ad hoc meeting on RF parameters (TDoc SMG2 61/92).
- Agreed SMG2 conversion factors (TDoc SMG2 287/92).

Report of the ad hoc meeting on RF parameters describes the process of deriving the conversion factors. In the ad hoc meeting there were number of input papers with practical measurement results of different measurement techniques, and in the ad hoc those measurement results were compared and the average of the results was chosen as a conversion factor. The following conversion factors were agreed on.

- conversion from maximum peak power to average power in a 30 kHz bandwidth on carrier:
=> - 8 dB.
- conversion from average power to maximum peak power in 30 kHz bandwidth:
=> + 8 dB at zero offset from carrier and + 9 dB at all other offsets.
- conversion from average power in 100 kHz bandwidth to maximum peak power in 30 kHz bandwidth:
=> + 5 dB at offset above 1800 kHz from carrier.

On the conversion factor from maximum peak power in 300 kHz bandwidth to maximum peak power in 30 kHz bandwidth no agreement was reached in the ad hoc meeting and hence the working assumption agreed on in SMG2 meeting is still assumed while pending for further validation.

=> - 8 dB at offset above 6 MHz from the carrier

Agreed SMG2 conversion factors lists the above agreed conversion factors and proposes further a conversion factor of + 5 dB for conversions from 100 kHz bandwidth to 300 kHz bandwidth at offsets above 1800 kHz from the carrier.

These documents are in Annex D

7 Repeaters

There are a number of documents describing the background to repeater scenarios. These are:

- Repeater operating scenarios (Tdoc SMG2 29/94);
- Repeater scenarios for DCS1800 (Tdoc SMG2 24/94);
- Repeater scenarios (Tdoc SMG2 25/94);
- Repeater out of band gain (Tdoc SMG2-RPT 20/94).

Repeater operating scenarios describes the many different scenarios for which a repeater device might be used.

Repeater scenarios for DCS 1800 describes two scenarios for DCS 1800 repeaters, the outdoor scenario and the indoor scenario. For each scenario, the performance requirements on the repeater are derived.

Repeater scenarios derives the equations that describe the uplink and downlink performance of a repeater. Co-ordinated and uncoordinated scenarios are analysed resulting in outline proposals for repeater hardware requirements in GSM 05.05 and outline planning guidelines in GSM 03.30.

Repeater out of band gain derives the requirements for the repeater out of band gain and provides planning guidelines when a repeater is in close proximity to other communication systems.

These documents are in Annex E.

The documents were presented to STC SMG2 in March 1994. In conclusion, it was decided that no single repeater specification would serve the large number of repeater scenarios that exist. As a consequence, it was agreed to add a specification for the repeater out of band performance to GSM 05.05 with guidelines for the specification and planning of repeaters in the GSM/DCS bands in GSM 03.30.

8 Error Patterns for Speech Coder Developments

TD 164/95 in Annex F describes available error patterns.

9 Simulations of Performance

Several documents in Annex G gives background information and simulation results of the GSM performance.

10 GSM 900 railway system scenarios

In 1993, the "Union Internationale de Chemin de Fer", UIC, decided to base a new railways pan-European system on GSM technology operating in the 900 MHz band.

In 1995, the CEPT, in recommendation T/R25-09, decided that " the international requirements without excluding national requirements of railways for non-public digital radiocommunication system in the 900 MHz band should be covered by selecting appropriate sub-bands from the designated band 876-880 MHz (mobile station transmit) paired with 921-925 MHz (base station transmit) with a duplex separation of 45 MHz."

During 1996, SMG2 in a two-step process discussed the RF parameters in GSM 05.05 for GSM-type equipments operating in this frequency band, called UIC equipments. Two documents were elaborated for this purpose. They are:

- UIC system scenarios requirements;
- UIC RF parameters.

In **UIC system scenarios requirements**, the relevant system and interference scenarios for UIC equipments are identified and the noise levels allowed and the signal levels arising out of the worst cases are derived, both as regards intra-systems performance of a UIC network and towards other GSM-type systems in the neighbouring frequency bands.

Basing on the former, **UIC RF parameters** discusses all the parameters in GSM 05.05 and determines the RF requirements for UIC equipments, to be in line with the scenario requirements where possible and feasible, or being a reasonable compromise where not. The specifications for other GSM900 and DCS1800 types of equipment are not affected, except possibly where there is absolutely no implications for their implementation.

These documents are in annex H.1 and H.2, respectively.

The resulting specifications were incorporated into GSM 05.05 by Change Request no. A027.

11 Simulation results for GPRS receiver performance

The documents in annexes K, L, M, N, P and Q give background information and simulation results of GPRS receiver performance

Annex A:

DCS 1800 System scenarios

ETSI GSM TC

TDoc GSM 259/90

Corfu, 1-5 October 1990

Source: GSM2 Ad Hoc on DCS1800, Bristol

Title: DCS1800 - System Scenarios**0. INTRODUCTION.**

This paper discusses system scenarios for DCS1800 operation primarily in respect of the 05.05 series of recommendations. To develop the DCS1800 standard, all the relevant scenarios need to be considered for each part of 05.05 and the most critical case identified. The process may then be iterated to arrive at final parameters that meet both service and implementation requirements.

Each scenario has three sections:

- a) lists the system constraints such as the separation of the MS and BTS, antenna height etc
- b) lists those sections of 05.05 that are affected by the constraints
- c) lists the inputs required to examine the implications of the scenarios

The following scenarios are discussed:

- 1) Single MS, single BTS
- 2) Multiple MS and BTS where operation of BTS's is coordinated
- 3) Multiple MS and BTS where operation of BTS's is uncoordinated
- 4) Colocated MS
- 5) Colocated BTS
- 6) Colocation with other systems

1 SCENARIO 1 - SINGLE BTS AND MS.**1.1. Constraints**

Aside from the frequency bands, the main constraint is the physical separation of the MS and BTS. The extreme conditions are when the MS is close to or remote from the BTS.

1.1.1 Frequency Bands and Channel Arrangement (Section 2 of 05.05)

The system is required to operate in the following frequency bands

- 1710 - 1785 MHz: mobile transmit, base receive;
- 1805 - 1880 MHz: base transmit, mobile receive;

with a carrier spacing of 200 kHz.

In order to ensure the compliance with the radio regulations outside the band, a guard band of 200 kHz between the edge of the band and the first carrier is needed at the bottom of each of the two subbands. Consequently, if we call $F_1(n)$ the n th carrier frequency in the lower band, and $F_u(n)$ the n th carrier frequency in the upper band, we have

$$- F_l(n) = 1710.2 + 0.2 \cdot (n-512) \quad (\text{MHz}) \quad (512 < n < 885)$$

$$- F_u(n) = F_l(n) + 95 \quad (\text{MHz})$$

The value n is called the ABSOLUTE RADIO FREQUENCY CHANNEL NUMBER (ARFCN). To protect other services, channels 512 and 885 will not normally be used, except for local arrangements.

1.1.2. Proximity

Table 1 shows examples of close proximity scenarios in urban and rural environments. Different antenna heights are considered; 15 m high antennas are assumed to have lower gain (10 dBi) than 30 m high antennas (18 dBi).

Table 1. Worst case proximity scenarios

	<u>Rural</u>		<u>Urban</u>		
		Building [1]	Street	Building [1]	Street
BTS height, H_b (m)	20	15	15	30	30
MS height, H_m (m)	1.5	15	1.5	20	1.5
Horizontal separation (m) [4]	30	30	15	60	15
BTS antenna gain, G_b (dB) [2]	18	10	10	18	18
BTS antenna gain, G'_b (dB) [3]	0	10	2	13	0
MS antenna gain, G_m (dB)	0	0	0	0	0
Path loss into building (dB)		6		6	
Cable/Connector Loss (dB)	2	2	2	2	2
Body Loss (dB)	1	1	1	1	1
Path loss - antenna gain (dB)	71	66	65	69	71

Notes: 1) Handset at height H_m in building

- 2) Bore-sight gain
- 3) Gain in direction of MS
- 4) Horizontal separation between MS and BTS

Path loss is assumed to be free space i.e. $37.5 + 20 \log d(m)$ dB, where d is the length of the sloping line connecting the transmit and receive antennas.

These examples suggest that the worst (ie lowest) coupling loss occurs in urban areas where the MS is in a street below the BTS. The coupling loss is then 65dB. The coupling loss is defined as that between the transmit and receive antenna connectors.

1.1.3. Range

Table 2 shows examples of range scenarios. The ranges quoted are the maximum anticipated for DCS1800 operation. In rural areas, this implies relatively flat terrain with little foliage loss. In urban areas, up to 1 km cells should be supported. In each case, an allowance must be made for in-building penetration loss. The figures shown are examples of those needed to achieve these cell sizes. In many situations, however, smaller cells may be used depending on the local conditions of terrain and traffic demand.

Table 2. Worst case range scenarios

	Rural	Urban
BTS height, H_b (m)	60	50
MS height, H_m (m)	1.5	1.5
BTS antenna gain, G_b (dB)	18	18
MS antenna gain, G_m (dB)	0	0
Path loss into building (dB)	[10]	[15]
Target range (km)	8	1

1.2. 05.05 Paragraphs Affected

Paragraph	Title
2	Frequency bands and channel arrangement
4.1.	Output power
6.1.	Nominal error rates (maximum receiver levels)
6.2.	Reference sensitivity level

1.3. Inputs needed

Working assumptions

Propagation model	Hata model (down to 1 km) Free space (up to [200] m maximum)
Log normal shadow margin	[6] dB
Building penetration loss	- urban [15] dB - rural [10] dB
External noise (continuous and impulsive)	Negligible
MS noise figure:	[12] dB
BTS noise figure:	[8] dB
E_c/N_0 :	6 dB + 2 dB (implementation margin)
Location probability, P_S :	75% at cell boundary
Implementation losses	
Body loss	[3] dB (typical)

2. SCENARIO 2 - MULTIPLE MS AND BTS, COORDINATED

Coordinated operation is assumed ie BTS's belong to same PLMN. Colocated MS's and colocated BTS's are dealt with in Scenarios 4 and 5, respectively.

2.1. Constraints

The constraints are the same as those for scenario 1.

2.2. 05.05 paragraphs affected

Paragraph	Title
4.1.	Adaptive power control - reduces co- and adjacent- channel interference - controls near/far effect for multiple MS's to same BTS
4.2.	Output RF spectrum - to limit adjacent channel interference
4.3.	Spurious emissions (in-band) - near/far effect to same BTS - see Fig 2.1.
4.5.	Output level dynamic operation - near/far effect to same BTS - required limits comparable with spurious
4.7.1.	Intermodulation attenuation, BTS - see Fig 2.2.
4.7.2.	Intra BTS intermodulation attenuation - see Fig 2.3.
5.1.	Blocking, in-band - near/far effect
6.3.	Reference interference level

2.3. Inputs needed

Target Cluster size Assume 9 cell , i.e. 3 site, 120 degree sectored

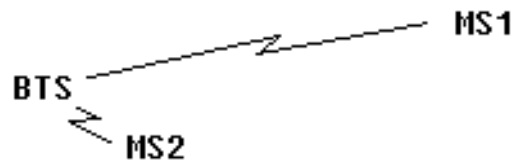
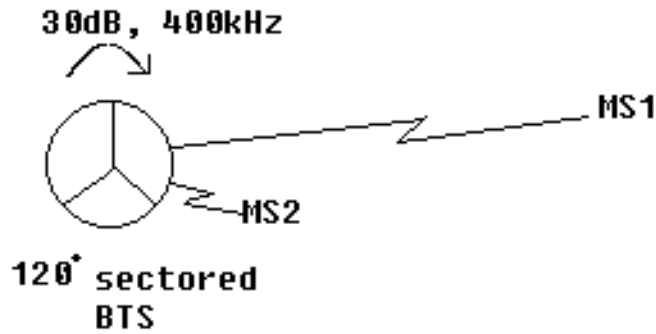

Fig 2.1. Near/far effect



3 cell, 120 degree sectored BTS.
 400 kHz channel separation between sectors.
 30 dB BTS transmitter/receiver coupling or transmitter/transmitter coupling.

Fig 2.2. Scenario for Intermodulation distortion

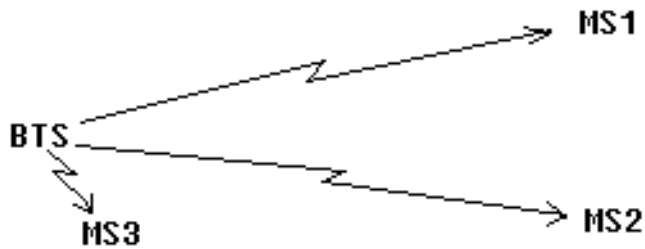

Fig 2.3. Intra BTS intermodulation attenuation

3. SCENARIO 3 - MULTIPLE MS AND BTS, UNCOORDINATED

BTS's and MS's may belong to different DCS1800 networks.

3.1. Constraints

The constraints are as in scenario 2 except that the MS's and BTS's belong to different PLMNS's and their operation is uncoordinated.

3.2. 05.05 paragraphs affected

Paragraph	Title
4.2.	Output RF spectrum
4.3.	Spurious emissions (in-band, up and down links) - near/far effect to same BTS, see Fig 3.1
4.5.	Output level dynamic operation - near/far effect to same BTS

- 4.7 Intermodulation
See Fig 3.2
- 5.1. Blocking, in-band, up and down links
See Fig 3.1.
- 5.2. Intermodulation, in-band
See Fig 3.2.
- 5.3. Spurious response rejection

3.3. Inputs needed

Minimum frequency separation of carriers in BTS; assume 400kHz as for cluster size of 9.

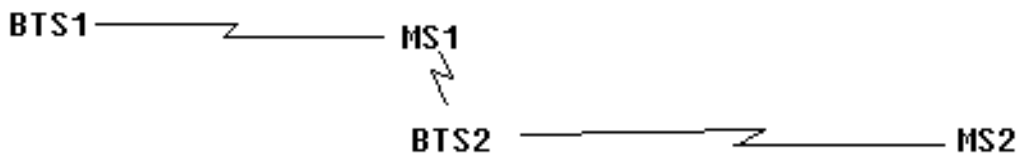
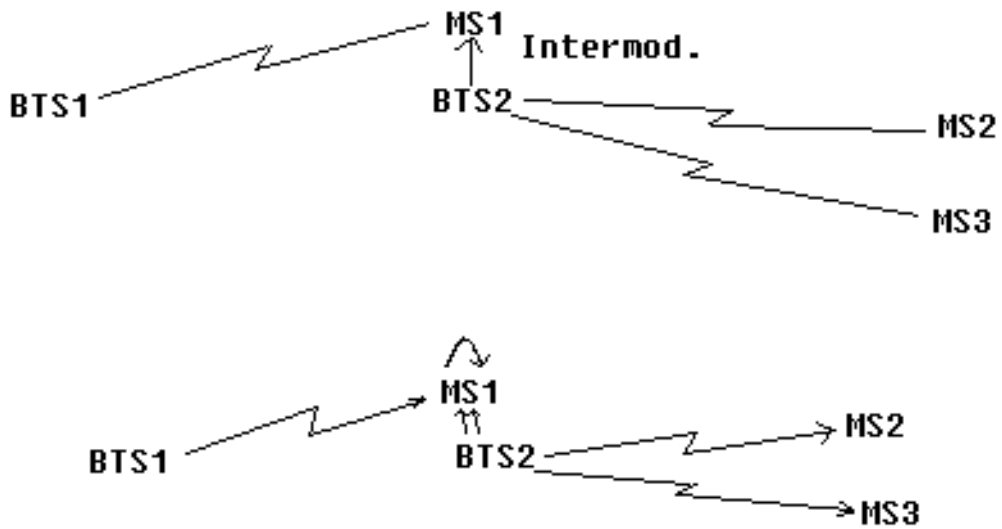
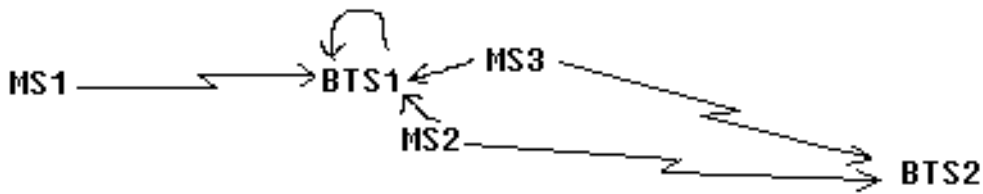

Figure 3.1 Blocking and Spurious



BTS1 and BTS2 belong to different PLMN's

MS1 affiliated to BTS1 PLMN; MS2 and MS3 affiliated to BTS2 PLMN



Intermodulation products in BTS1 receiver

Fig 3.2. Intermodulation

4. SCENARIO 4 - COLOCATED MS

Colocated MS which may be served by BTS from different networks ie MS's not synchronised.

4.1. Constraints

Minimum separation of MS	1 m
Guard band between up and down links	20 MHz
Bandwidth of up and downlink bands	75 MHz.

4.2. 05.05 paragraphs affected

Paragraph	Title
4.3.3.	Spurious emissions, out-of-band
5.1.	Blocking, out-of-band
5.3.	Spurious response rejection
5.4.	Spurious emissions

[New 4.7.3 Intermodulation between MS]

See Fig 4.1.

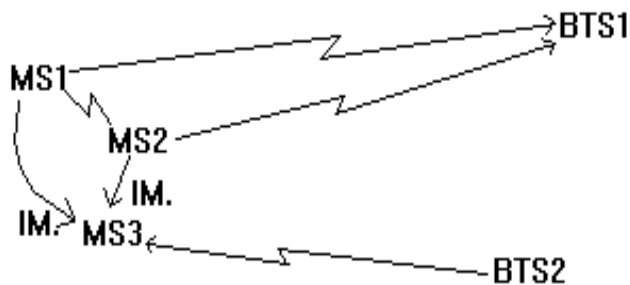

Out-of-band intermods; MS1 and MS2 at full power

Received signal at MS3 from BTS2 at reference sensitivity. By symmetry, MS1 will be affected by an I.M. product from MS2 and MS3 whenever MS3 is affected as shown above.

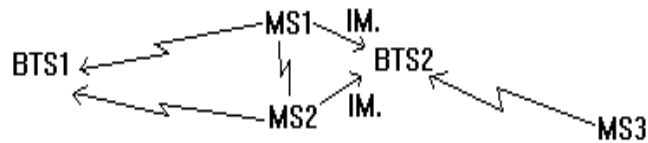

In-band intermods.

Fig 4.1. Intermodulation between MS

4.3. Inputs needed

Additional body losses; assume [3dB]

5. SCENARIO 5 - COLOCATED BTS

Two or more colocated BTS possibly from different PLMN's.

5.1. Constraints

Coupling between BTS's may result either from the co-siting of BTS's or from several BTS's in close proximity with directional antenna. The maximum coupling between BTS' should be assumed to be [30] dB. This is defined as the loss between the transmitter combiner output and the receiver multi-coupler input.

5.2. 05.05 paragraphs affected

Paragraph	Title
4.3.	Spurious emissions
4.7.1.	Intermodulation attenuation, BTS (See Fig 5.1.)
5.1.	Blocking [30] dB coupling between BTS TX - RX [30] dB coupling between BTS TX - TX [30] dB coupling between BTS RX - RX BTS either same or different PLMN
5.3.	Spurious response rejection
5.4.	Spurious emissions

5.3. Inputs needed

None

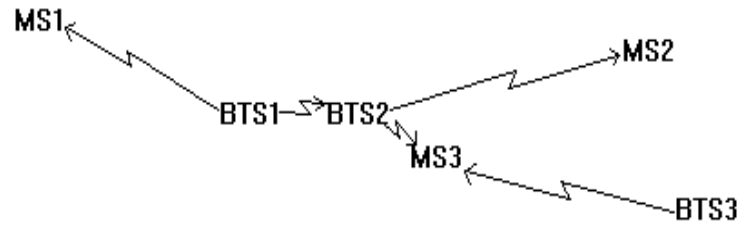

BTS3 different PLMN from BTS 1 and 2.

Intermodulation products at MS3 receiver.

Fig 5.1. Intermodulation scenario

6. SCENARIO 6 - COLOCATION WITH OTHER SYSTEMS

DCS1800 systems will have to work in the presence of other mobile radio systems.

6.1. Constraints

Operation of DCS1800 mobiles to be considered in close proximity with other systems.

GSM phase 1

GSM phase 2

DECT

Analogue cellular (TACS, NMT450/900, C450, R2000)

and CT2 mobiles.

6.2. 05.05 paragraphs affected

Paragraph	Title
4.3.	Spurious emissions, out-of-band
5.1.	Blocking, out-of-band
5.3.	Spurious response rejection
5.4.	Spurious emissions

6.3. Inputs needed

Performance specifications of other systems.

ETSI GSM TC

TDoc GSM 60/91

Saarbrücken, 14-18 January 1991

Source: GSM2

Title: Justifications for the proposed Rec. 05.05_DCS

I INTRODUCTION

The DCS1800 system requirements are defined in a paper entitled 'DCS1800 - System Scenarios' (GSM TDoc 259/90) and the parameters chosen either meet these requirements or represent a compromise between them and what can be manufactured at an appropriate cost. Changes to the 900 MHz standard have only been made where there is a specific system advantage or cost saving. Consideration has been given to methods of measurement for the changed specifications.

Section II expands the scenarios paper into more detailed requirements for RF parameters. Section III follows the section numbering of Rec 05.05 and justifies the desired changes for DCS1800. This document does not comment on simple changes from GSM900 to DCS1800 frequency bands since this change is assumed.

II METHODOLOGY

Unless otherwise stated the results of scenario calculations assume transmit powers of 39 dBm for the base and a 30 dBm for the mobile, both measured at their respective antenna connectors. The equivalent noise bandwidth of the transmitted signal is taken to be 120 kHz and that of the receiver 180 kHz. Worst case scenarios usually involve a "near/far" problem of some kind, the component scenario assumptions (as given in the scenarios paper for "near" and "far" can be summarised as follows.

"Near"	Coupling loss (dB)
BTS -> MS	65
MS -> BTS	65
MS-> MS	40.5
BTS -> BTS	30

The coupling loss is defined between antenna connectors. The powers and sensitivities are discussed in section III of this paper, they are quoted here to enable scenario calculations to be performed. The transmitter power and receiver sensitivity are measured at the respective antenna connectors.

"Far"	Tx power (dBm)	Rx Sensitivity (dBm)
BTS	39	-104
MS	30	-100

Scenarios can involve uncoordinated or co-ordinated entities (MS or BTS) depending on whether they are from the same PLMN. With uncoordinated operation handover and power control are not used in response to the proximity of the BTS and more severe near/far problems can arise, however, co-ordinated scenarios are often more likely spatially and more likely to occur at lower frequency offsets. Unco-ordinated scenarios become critical when they involve mobiles being simultaneously on the edge of their serving cell and close to another operator's BTS, also the transmitter and affected receiver will be in different operator frequency allocations. It is most important that the co-ordinated scenario requirements are met where possible.

The probability and consequences of the various scenarios must be taken into account when choosing the actual specification. For example, jamming a whole base station is a more serious consequence than jamming a single mobile and intermodulation scenarios which involve the co-location of 3 entities are consequently less likely than those which only involve 2.

The remainder of this section outlines the key scenario calculations which affect the choice of parameters for Rec 05.05. Transmitted levels are those in the receiver bandwidth, although in many cases the test bandwidths are narrower because of the need to avoid switching transients affecting the measurement.

1 Transmitter

1.1 Modulation, Spurs and Noise.

1.1.1 Co-ordinated, BTS -> MS (Scenario 2, Fig 2.1)

Since the affected MS is close to its own base we only need to ensure adequate C/I at the BTS.

Max. Tx noise level in Rx bandwidth = [BTS power] - [Power control range] - [C/I margin] - [Multiple interferers margin] = 39 - 30 - 9 - 10 = **-10 dBm**.

(BTS dynamic power control is optional, in the worst case it will be employed on the link to the affected MS but the other link will be at full power).

1.1.2 Uncoordinated, BTS -> MS (Scenario 3, Fig 3.1)

Max. Tx. level of **noise** in Rx. bandwidth = [MS sensitivity] - [C/I margin] - [Multiple interferers margin] + [Coupling loss] = -100 - 9 - 10 + 65 = **-54 dBm**.

Max. Tx level of **spur** in Rx bandwidth = [MS sensitivity] - [C/I margin] + [Coupling loss] = -100 - 9 + 65 = **-44 dBm**.

1.1.3 Co-ordinated & Uncoordinated MS -> BTS (Scenarios 2 & 3, Figs 2.1 & 3.1)

Max. Tx level in Rx bandwidth = [BTS sensitivity] - [C/I margin] + [Coupling loss] = -104 - 9 + 65 = **-48 dBm**.

Although the absolute spec. is the same the MS may find it easier to meet scenario 2 because it will be powered down.

1.1.4 Co-ordinated & Uncoordinated MS->MS (Scenario 4)

Max Tx level in Rx bandwidth = [MS sensitivity] - [C/I margin] + [Coupling loss] = -100 - 9 + 40.5 = **-68.5 dBm**

1.1.5 Co-ordinated & Uncoordinated BTS->BTS (Scenario 5)

Max Tx level **noise** in Rx bandwidth= [BTS sensitivity] - [C/I margin] - [Multiple interferers margin] + [Coupling loss] = -104 - 9 - 10 + 30 = **-93 dBm**

1.2 Switching Transients

The peak level of transients in a 5 pole synchronously tuned measurement filter of bandwidth 100 kHz simulates their effect on the receiver. The transients only effect a few bits per timeslot and have approximately 20 dB less effect than continuous interference. Their peak level falls off at 20 dB decade both with increasing frequency offset and measurement bandwidth.

1.2.1 Uncoordinated MS -> BTS (Scenario 3, Fig 3.1)

Max. peak level in effective Rx BW at MS = [Base sensitivity] - [C/I margin] + [Coupling loss] + [Transient margin] = -104 - 9 + 65 + 20 = **-28 dBm**

1.2.2 Uncoordinated BTS -> MS (Scenario 3, Fig 3.1)

Max. peak level in effective Rx BW at BTS = [MS sensitivity] - [C/I margin] + [Coupling loss] + [Transient margin] = -100 - 9 + 65 + 20 = **-24 dBm**

1.3 Intermodulation*1.3.1 Co-ordinated, BTS -> MS (Scenario 2 , Fig 2.2 & 2 .3)*

(Level of input signal 30 dB below wanted transmission).

Required IM attenuation in BTS = [C/I margin] + [BTS power control range] + [margin for other IMs] = 9 + 30 + 3 = **42 dB**

1.3.2 Uncoordinated, BTS ->MS (Scenario 3, Fig 3.2 top)

(Level of input signal 30 dB below wanted transmission).

Required IM attenuation in BTS = [BTS power] - {[Max. allowed level at MS1] + [coupling loss BTS2->MS1]} = 39 - {-100 - 9 - 3} + 65} = **86 dB**

1.3.3 Uncoordinated, MS&MS-> BTS (Scenario 4, Fig 4.1 bottom)

(Level of input signal 40.5 dB below wanted transmission).

Required IM attenuation in MS = [MS power] - {[Max. allowed level at BTS2] + [coupling loss MS->BTS2]} = 30 - {-104 - 9 - 3} + 65} = **81 dB**

1.3.4 Uncoordinated MS&MS-> MS (Scenario 4, Fig 4.1 top)

(Level of input signal 40.5 dB below wanted transmission).

Required IM attenuation in MS = [MS power] - {[Max. allowed level at MS3] + [coupling loss MS->MS3]} = 30 - {-100 - 9 - 3} + 40.5} = **101.5 dB**

2 Receiver

2.1 Blocking

2.1.1 Co-ordinated & Uncoordinated BTS-> MS (Scenario 2&3, Fig 2.1 & Fig 3.1)

Max. level at MS receiver = [BTS power] + [Multiple interferers margin] - [Coupling loss] = 39 + 10 - 65 = **-16 dBm**

2.1.2 Co-ordinated MS-> BTS (Scenario 2, Fig 2.1)

Max level at BTS receiver = [MS power] - [Power control range] - [Coupling loss] =

30 - 20 - 65 = **-55 dBm**

2.1.3 Uncoordinated MS-> BTS (Scenario 3, Fig 3.1)

Max level at BTS receiver = [MS power] - [Coupling loss] = 30 - 65 = **-35 dBm**

2.1.4 Co-ordinated & Uncoordinated MS-> MS (Scenario 4)

Max. level at MS receiver = [MS power] - [Coupling loss] = 30 - 40.5 = **-10.5 dBm**

2.1.5 Co-ordinated & Uncoordinated BTS-> BTS (Scenario 5)

Max. level at BTS receiver = [BTS power] + [Multiple interferers margin] - [Coupling loss] = 39 + 10 - 30 = **19 dBm**

2.2 Intermodulation

2.2.1 Co-ordinated & Uncoordinated BTS-> MS (Scenarios 2 & 3, Fig 3.2 middle)

Max. received level at MS1 = [BTS power] - [Coupling loss BTS2->MS1] + [Margin for other IMs] = 39 - 65 + 3 = **-23 dBm**

Required IM attenuation in MS is 42 dB for scenario 2 and 86 dB for scenario 3. The Rec. 05.05 section 5.2 test simulates scenario 3.

2.2.2 Co-ordinated MS & MS -> BTS (Scenario 4)

Max. received level at BTS1 = [MS power] - [MS power control range] - [Coupling loss MS-> BTS1] + [Margin for other IMs] = 30 - 20 - 65 + 3 = **-52 dBm**

2.2.3 Uncoordinated MS & MS -> BTS (Scenario 4, Fig 3.2 lower)

Max. received level at BTS1 = [MS power] - [Coupling loss MS-> BTS1] + [Margin for other IM's] = 30 - 65 + 3 = **-32 dBm**

2.3 Maximum level

2.3.1 Co-ordinated MS -> BTS (Scenario 1)

Max level at BTS = [MS power] - [Coupling loss] = 30 - 65 = **-35 dBm.**

(The BTS must be capable of decoding the RACH which is at full power).

2.3.2 Co-ordinated BTS -> MS (Scenario 1)

Max level at MS = [BTS power] - [Coupling loss] = 39 - 65 = **-26 dBm**.

(BTS dynamic power control is optional, in the worst case it will not be employed, also the MS must be capable of decoding the BCCH carrier).

III JUSTIFICATIONS

1 SCOPE:

2 FREQUENCY BANDS AND CHANNEL ARRANGEMENT:

The up and downlink frequencies have been changed to cover the 1.8 GHz band. The 374 carrier frequencies have been assigned ARFCNs starting at 512 .

3 REFERENCE CONFIGURATION:

4 TRANSMITTER CHARACTERISTICS:

4.1 Output power:

4.1.1 Mobile Station:

MS power classes of 1 and ¼W have been chosen for DCS1800 defined in the same way as for GSM900. With a 30 m antenna height Hata's model predicts that the higher MS power class will not quite meet the target ranges given in the system scenarios paper both for urban and rural areas. The requirement for a cheap, small, low power handset is also an important constraint. It is felt that the chosen power classes represent a reasonable compromise between these conflicting requirements.

A 20 dB power control range has been chosen for both classes of mobile since it is believed that this will give most of the available improvement in uplink co-channel interference.

Since the chosen power classes and hence power control levels are even numbers in dBm they will not fit into the existing numbering scheme, so a new one has been used. These numbers are only of editorial significance.

The absolute tolerance on power control levels below 13 dBm has been increased by

1 dB because of manufacturers' concerns about implementation.

4.1.2 Base Station:

Following GSM 900, the BTS power classes are specified at the combiner input. In order to provide the operator some flexibility four power classes have been specified in the range 34 to 43 dBm. In fact the four lowest power classes from GSM 900 have been retained although the numbering has been changed. The 39 dBm BTS power measured at the antenna connector might typically match a 30 dBm mobile.

The tolerance on the BTS static power control step size has been relaxed to simplify implementation, control of the BTS power to an accuracy of less than 1dB was felt to be unnecessary.

The penultimate paragraph has been reworded because a class 1 mobile no longer has 15 power steps.

4.2 Output RF spectrum:

The BTS is not tested in frequency hopping mode. If the BTS uses baseband frequency hopping then it would add little to test in FH mode; if it uses RF hopping then the test will be complicated by permissible intermodulation products (see section 4.7) from BTSs which do not de-activate unallocated timeslots.

4.2.1 Spectrum due to the modulation:

The relaxation for MSs with integral antennas has been removed.

The measurement has been extended to cover the whole transmit band and beyond 1800 kHz from carrier measurements are only taken on DCS1800 carrier frequencies using a 100 kHz bandwidth. This technique still avoids permissible switching transients, is fairly quick and closely reflects the receiver bandwidth and hence the system scenario. It is now a measurement of broadband noise as well as modulation.

The technique proposed in CR 30 for counting spur exceptions in FH mode for Rec 05.05 is also included here,

The table has been split into those parts which apply to the mobile and those which apply to the base reflecting the difference in their respective scenario requirements.

When operating at full power, the table below shows the frequency offset at which scenario requirements are met

	39 dBm BTS at ant. conn.	30 dBm MS
Scenario 2	400 kHz(1.1.1)	400 kHz (1.1.3)
Scenario 3	missed by 10dB at 6 MHz(1.1.2)	6 MHz (1.1.3)

The figures in brackets are the relevant scenario requirement sub-section numbers in section II of this document.

Exceptions i and ii below the table define the maximum number of exception channels appropriate to the frequency bands tested. For the BTS permissible intermodulation products must be avoided.

Since the table entries are relative, as the power level of the transmitter is reduced, the absolute specification becomes tighter. Exceptions iii and iv stop the transmitters having to exceed the requirement of scenario 3. Further relaxations are permitted at low frequency offsets; for the MS scenario 3 is unlikely below 600 kHz and the requirement of scenario 2 is used; for the BTS, the 10 dB multiple interferers margin is excessive below 1800 kHz and the minimum level is increased by 5 dB.

4.2.2 *Spectrum due to switching transients:*

a) Mobile Station

The table has been modified in accordance with the new mobile power classes. The transients are always above the modulation at 400 kHz offset and so the table collapses to a single row.

Requirement 1.2.1 for scenario 3 becomes -38.5 dBm in 30 kHz. The current specification meets this requirement at offsets above 2.4 MHz while the 4.2.1 test only meets scenario 3 at offsets above 6MHz. The specification on transients is not the limiting case and need not be changed.

b) Base Station

Requirement 1.2.2 for scenario 3 becomes -34.5 dBm in 30 kHz. With the current specification a 39 dBm BTS meets this requirement at 600 kHz. Again no change is proposed. This figure assumes that "dBc" means relative to the on-carrier power in

30 kHz; a possible ambiguity in the wording has been removed.

4.3 Spurious emissions:

4.3.1 *Principle of the specification:*

Although 4.2.1 now covers the whole transmit band, the in band part of 4.3.1 is still required to check the behaviour of switching transients beyond 1800 kHz and to catch any spurs missed in 4.2.1.

4.3.2 *Base Station:*

The protection of frequencies outside the DCS1800 band is unchanged, but the spurious emissions in the transmit band are only permitted up to -36 dBm which is below the CEPT limit of -30 dBm but the same as Rec. 05.05. The same applies to the MS transmit band in 4.3.3. The new base receive band is given the same protection as before measured in the modified conditions of 4.2.1, this meets scenario requirement 1.1.5 scaled to a measurement bandwidth of 100 kHz. The GSM 900 base receive band is also protected but only when the co-siting of GSM and DCS BTSs occurs.

4.3.3 *Mobile Station:*

This section consists of two blanket specifications one for transmit mode and one for idle mode Specific tests of the MS receive band are also given.

When allocated a channel, the transmit band and out-of-band specifications are the same as for the BTS in 4.3.2. These are consistent with 4.2.1 and the CEPT specifications for spurious emissions.

In idle mode the CEPT specification below 1 GHz is also applied to the DCS transmit and receive bands using a 100 kHz measurement bandwidth, this specification also exceeds scenario requirement 1.1.3 for the MS transmit band. however, the number of mobiles in idle mode may be quite large.

The test of the MS receive band meets scenario requirement 1.1.4 and uses the modified conditions of 4.2.1. 5 exception channels are permitted for discrete spurious, it is rather unlikely that two MS will be one metre apart and receiving at one of these exception channels. Protection of the GSM 900 MS receive band is also provided. The specification is 6 dB tighter reflecting the reduced propagation loss between colocated MS at 900 MHz. The dependence of this test on power class has been removed since all mobiles are hand portables. No extra testing of the MS receive band in idle mode is made because it is unlikely to be worse than when allocated a channel.

4.4 Radio frequency tolerance:

4.5 Output level dynamic operation:

4.5.1 Base station:

This specification only affects the interference experienced by co-channel cells in the same PLMN. The requirement on the relative power level of unactivated timeslots has been relaxed from -70 to -30 dBc in line with the BTS power control range. It is understood that "dBc" includes the static but not dynamic power control. The specification has been extended to cover the whole transmit band because the residual power may not be highest on carrier.

The measurement bandwidth is specified as **at least** 300 kHz due to problems with ringing of the measurement filter just after an active burst has finished.

4.5.2 Mobile station:

The power level between active bursts from the MS affects the serving BTS receiver. The power measured in 100 kHz on carrier will be similar to that measured in the receiver bandwidth which must be less than -48 dBm to meet scenario requirement 1.1.3. The absolute specification has been tightened from -36 to -47 dBm in line with this requirement but the relative specification has been retained. Allowing 10 dB for the peak-to-mean ratio of the power between active bursts if it is noise-like, the relative specification will meet this scenario requirement for a 1W MS.

4.6 Phase accuracy:

4.7 Intermodulation attenuation:

The definition of intermodulation attenuation has been moved from 4.7.1 to 4.7 to make it clear that it applies to subsections 4.7.1, 4.7.2 and 4.7.3. A note concerning possible problems with VHF broadcast signals has been added because these are at the difference between the DCS up and downlink frequencies.

4.7.1 Base transceiver station:

4.7.2 Intra BTS intermodulation attenuation:

4.7.3 Intermodulation between MS:

Section 4.7.3 of the 900 MHz specification concerned the mobile PBX. The mobile PBX is no longer included in Rec. 02.06, there is no type approval for it and consequently the original section 4.7.3 text has been removed. The new section 4.7.3 relates to intermodulation between MS transmitters, an area which was not covered in the 900 MHz standard.

In the proposed measurement, the level of the interfering signal simulates that from a very close MS and the required IM attenuation is to protect MS or BS receivers in the vicinity. MS transmit intermods are covered by scenario requirements 1.3.3 and 1.3.4. If the product lands in the BTS receive band 81 dB IM attenuation is required, if the product lands in the MS receive band 101.5 dB IM attenuation is required in the MS transmitter which produces the IM.

Both these scenarios require the co-location of 3 objects (MS or BTS) with the correct frequency relationship. Experiments performed by manufacturers on 900 MHz PA's indicate that 50 dB attenuation is achievable at all frequency offsets. A tighter specification would require the use of an isolator or more linearity in the PA design. A specification of 50 dB tested at 800 kHz offset was agreed.

5 RECEIVER CHARACTERISTICS:

A clarification of the of the measurement point for the receiver specifications in line with that for the transmitter has been made.

5.1 Blocking characteristics:

The MS blocking specification close to the received channel has not been changed, this is limited by the receive synthesizer phase noise. At higher frequency offsets the blocking specification relates to the DCS1800 band and the feasibility of the receive filter. The proposed specification is shown below, the dashed line shows a possible receive filter frequency response.

The blocking specification at > 3 MHz offset in the receive band misses the scenario requirement 2.1.1 (-16 dBm) by 10 dB, but the transmit band specification meets scenario requirement 2.1.4 (-10.5 dBm). Power consumption considerations make it undesirable to tighten the receive band specification. The outside the DCS1800 band the 0 dBm specification has been retained. The combination of these proposals amounts to a filter specification over the MS receive band as shown below.

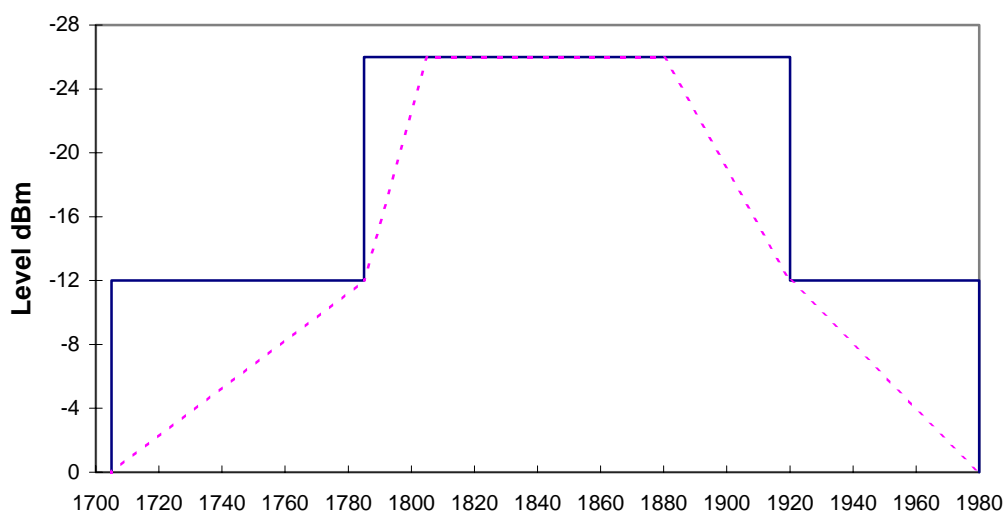

The BTS blocking requirement has been significantly relaxed because the MS power classes are lower. Scenario requirement 2.1.2 is -55 dBm which considers blocking from the bases own MS's. Requirement 2.1.3 is -35 dBm which is for mobiles from other operators. The proposal meets the scenario requirements even at 600 kHz offset and exceeds it by 10 dB beyond 800 kHz.

The consequence of failing to meet this scenario is that the whole base station is blocked. For this reason it is desirable for the base station to exceed the scenario requirement if possible.

The out-of-band specification has not been changed, although it does not meet scenario requirement 2.1.5 (19 dBm). This is because the 30 dB coupling loss assumption between base stations is rather pessimistic, it corresponds to two 18 dBi antennas on boresight 17 m apart. Under these circumstances, operators may need to adopt specific mutual arrangements (eg. extra operator specific receive filters) which need not form part of the DCS1800 standard.

5.2 Intermodulation characteristics:

The 900 MHz standard for handportables limits the maximum level to -49 dBm. Any tightening of this specification will increase the power consumption of the receiver. Since DCS1800 is designed for handportables this figure is now applied to all MSs. The proposed level of -49 dBm for the MS fails to meet scenario requirement 2.2.1 by

23 dB, but the only consequence is that the MS is de-sensed when close to a BTS with the appropriate transmitters active.

The worst case for BTS receiver IMs is when two MSs approach the base, the scenario requirement is covered in sections 2.2.2 & 2.2.3 and is -55 dBm for co-ordinated mobiles and -35 dBm for uncoordinated.

Again -49 dBm has been proposed since the probability of the uncoordinated scenario is low both spatially and spectrally. If the coupling loss between both MSs and the BTS increases by 1dB the level of a third order IM product

will reduce by 3 dB, thus if the coupling loss assumption between MS and BTS is increased by 5 dB to 70 dB then the scenario would be met.

A note concerning the VHF broadcast problem has been added as in 4.7 for transmitter intermodulation.

5.3 Spurious response rejection:

This section concerns exceptions to the blocking specification due to spurs in the receive synthesizer and mixer causing spurious responses. The numbers of exception channels has been doubled to reflect the wider receive band. For the BTS the in-band blocking specification can cover frequency offsets of

± 95 MHz depending on the receive frequency and including the 20 MHz extension of the receive band defined in section 5.1. Thus the boundary between parts a and b of the specification has been moved from 45 to 95 MHz because the receive band is now 50 MHz wider.

Following the above logic the breakpoint between parts a and b for the MS should occur at -95 and +115 MHz but in the interests of simplicity the same breakpoint is proposed as for the BTS.

5.4 Spurious emissions:

Since the MS receiver spurious emissions are covered by the idle mode aspect of 4.3.3 this section now only refers to the BTS.

6 TRANSMITTER/RECEIVER PERFORMANCE:

6.1 Nominal error rates (NER):

The scenario requirement for the maximum received level at the MS is -26 dBm (requirement 2.3.2). The figure of -23 dBm is also in approximate alignment with the blocking specification at > 3 MHz

The required NER for the static channel above at -23 dBm has been increased to ½% in line with CR 28

Under multipath conditions the peak signal level exceeds the mean level. In order to prevent significant clipping the maximum level under multipath conditions has been set to -40 dBm. Multipath reception conditions occur when there is no line of sight path and the received signal level is likely to be lower.

The same specifications have been applied to the BTS receiver.

6.2 Reference sensitivity level:

Simulations of TU50 and HT100 at 1.8 GHz have been performed and table 1 has been modified appropriately. The RA130 results at 1.8 GHz are taken from the RA250 results at 900 MHz. Allowance has been made for enhanced bad frame indication in accordance with CR 27.

The MS sensitivity has been relaxed by 2 dB to simplify the MS at the expense of a slightly higher BTS power requirement, to balance the up and downlinks.

6.3 Reference interference level:

TU1.5 and RA 130 results at 1.8 GHz in table 2 are taken from TU3 and RA250 in Rec 05.05 respectively. TU 50 at 1.8 GHz has been simulated and the results are incorporated in the table. Allowance has been made for enhanced bad frame indication in accordance with CR 27.

The effect of doubling the Doppler spread is in general to improve the performance without FH due to increased decorrelation between bursts and to slightly degrade performance with FH because the channel is less stationary during the burst.

6.4 Erroneous frame indication performance:

Annex B: GSM 900 Small Cell System scenarios

ETSI/STC/SMG2

T.Doc 104/92 - Rev. 1

Strasbourg

1 - 4 September 1992

Title: Small Cell System Scenarios for GSM900.

Source: Vodafone, UK

Introduction

Small cells are defined in GSM 03.30 as having antennas above median roof height but below maximum, whereas Large cells have antennas above the maximum roof height. Median roof heights vary with location, in particular between City Centre and Suburban locations. Suburban median roof heights vary with type of housing and may often be characteristic of a particular country but are likely to fall between 8m and 20m.

Small cells feature much lower antennas than large cells and as such the minimum coupling loss between base and mobile antenna is significantly decreased. In practice small cells are likely to operate at a lower transmit power level, being aimed at providing limited coverage, but not necessarily capacity, in urban/suburban environments.

This paper presents the results of applying the propagation loss at 100m BTS to MS antenna separation from the 03.30 Small Cell example, to the system scenarios in TDoc GSM 61/91 which details system scenarios for DCS1800. The results are presented in a similar manner as TDoc GSM 60/91 and will be applicable to a 75% location probability.

A further set of results is presented for the worst case scenario where the agreed Minimum Coupling Loss (MCL) of 59dB from T.Doc SMG 49/91 is used.

Both sets of results assume a Class 2 coordinated and uncoordinated MS but the effect of MS power control is taken into account for the coordinated MS.

Small Cell Example

The definition of the small cell example in 03.30 Appendix A4 is as follows;

Base TX Configuration

Antenna Gain:	+16dBi	(BAG)
Antenna Height:	17m	
Roof Height	15m	
Antenna Feeder Loss:	2dB	(BFL)

Mobile RX Configuration

Antenna Gain:	2dBi	(MAG)
Antenna Height	1.5m	
Antenna Feeder Loss:	2dB	(MFL)

Propagation Loss

$$\text{Loss (dB)} = 132.8 + 38\log(d/\text{km})$$

The coupling loss for this scenario is then;

$$132.8 + 38\log(d/\text{km}) - \text{BAG} + \text{BFL} - \text{MAG} + \text{MFL}$$

$$= 80.8\text{dB at a MS to base separation of 100m}$$

The system scenarios at 100m are presented in Appendix 1.

Minimum Coupling Loss Case

The system scenarios based on the same small cell example as above but using a MCL of 59dB are presented in Appendix 2.

It should be noted that this produces worse case figures, assuming operation at limit sensitivity, i.e. in a noise limited environment. For the small cell case the MS at least, is likely to be operating in an interference limited environment with an effective sensitivity worse than limit sensitivity.

Appendix 1 - System Scenarios for Small Cell GSM900

Near	Coupling loss
BTS -> MS	81
MS -> BTS	81
MS -> MS	34,5
BTS -> BTS	25

Far	Tx power (dBm)	Rx Sensitivity (dBm)
BTS	38	-104
MS	39	-104

BTS power control range	30
MS power control range	26
C/I margin	9
Multiple interferers margin	10
Transient margin	20
margin for other IMs	3

NOTE: All results are in dBm except for section 1.3 where the results are dB

1. Transmitter

1.1 Modulation, Spurs and Noise

1.1.1 Co-ordinated, BTS -> MS:

$$\text{Max. Tx noise level in RX bandwidth} = [\text{BTS power}] - [\text{Pwr control range}] - [\text{C/I margin}] - [\text{Multiple interferers margin}] = -11$$

1.1.2 Uncoordinated, BTS -> MS:

$$\text{Max Tx level of noise in Rx bandwidth} = [\text{MS sensitivity}] - [\text{C/I margin}] - [\text{multiple interferers margin}] + [\text{coupling loss}] = -42$$

$$\text{Max Tx level of spur in Rx bandwidth} = [\text{MS sensitivity}] - [\text{C/I margin}] + [\text{coupling loss}] = -32$$

1.1.3 Co-ordinated & Uncoordinated MS -> BTS:

$$\text{Max Tx level in Rx bandwidth} = [\text{BTS sensitivity}] - [\text{C/I margin}] + [\text{coupling loss}] = -32$$

1.1.4 Co-ordinated & Uncoordinated MS -> MS:

$$\text{Max Tx level in Rx bandwidth} = [\text{MS sensitivity}] - [\text{C/I margin}] + [\text{Coupling loss}] = -78,5$$

1.1.5 Co-ordinated & Uncoordinated BTS -> BTS:

$$\text{Max Tx level noise in Rx bandwidth} = [\text{BTS sensitivity}] - [\text{C/I margin}] - [\text{multiple interferers margin}] + [\text{coupling loss}] = -98$$

1.2 Switching Transients

1.2.1 Uncoordinated MS -> BTS:

Max peak level in effective Rx BW at MS = [Base sensitivity]-[C/I margin]+[coupling loss]+[Transient margin] = -12

1.2.2 Uncoordinated BTS -> MS:

Max peak level in effective Rx BW at BTS = [MS sensitivity] -[C/I margin]+[coupling loss]+[transient margin] = -12

1.3 Intermodulation

1.3.1 Coordinated, BTS -> MS:

Required IM attenuation in BTS = [C/I margin]+[BTS pwr control range]+[margin for other IMs] = 42

1.3.2 Uncoordinated, BTS -> MS:

Required IM attenuation in BTS = [BTS power]-{[Max allowed level at MS1]+[coupling loss BTS2 -> MS1]} = 73

NOTE: [Max allowed level at MS1] = [MS sensitivity-C/I margin-margin for other IMs]

1.3.3 Uncoordinated, MS&MS -> BTS:

Required IM attenuation in MS = [MS power] - {[Max allowed level at BTS2] + [coupling loss MS -> BTS2]} = 74

NOTE: [Max allowed level at BTS2] = [BTS sensitivity-C/I margin-margin for other IMs]

1.3.4 Uncoordinated MS&MS -> MS:

Required IM attenuation in MS = [MS power]-{[Max allowed level at MS3]+[coupling loss MS -> MS3]} = 120,5

NOTE: [Max allowed level at MS3] = [MS sensitivity-C/I margin-margin for other IMs]

2. Receiver**2.1 Blocking**

2.1.1 Co-ordinated & Uncoordinated BTS -> MS:

Max level at MS receiver = [BTS power]+[multiple interferers margin]-[coupling loss] = -33

2.1.2 Co-ordinated MS -> BTS:

Max level at BTS receiver = [MS power]-[Power control range]-[coupling loss] = -68

2.1.3 Uncoordinated MS -> BTS:

Max level at BTS receiver = [MS power]-[coupling loss] = -42

2.1.4 Co-ordinated & Uncoordinated MS -> MS:

Max level at MS receiver = [MS power]-[coupling loss] = 4,5

2.1.5 Co-ordinated and Uncoordinated BTS -> BTS:

Max level at BTS receiver = [BTS power]+[multiple interferers margin]-[coupling loss] = 23

2.2 Intermodulation

2.2.1 Co-ordinated & Uncoordinated BTS -> MS:

Max received level at MS1 = [BTS power]-[coupling loss BTS2->MS1]+[margin for other IMs] = -40

2.2.2 Co-ordinated MS & MS -> BTS:

Max received level at BTS1 = [MS pwr]-[MS pwr control range]-[coupling loss MS -> BTS1]+[margin for other IMs] = -65

2.2.3 Uncoordinated MS & MS -> BTS:

Max. received level at BTS1 = [MS power]-[coupling loss MS -> BTS1]+[Margin for other IMs] = -39

2.3 Maximum level

2.3.1 Co-ordinated MS -> BTS:

Max level at BTS = [MS power]-[coupling loss] = 42

2.3.2 Co-ordinated BTS -> MS:

Max level at MS = [BTS power]-[coupling loss] = -43

Appendix 2 - System Scenarios for Small Cell GSM900, 59dB MCL

Near	Coupling loss
BTS -> MS	59
MS -> BTS	59
MS -> MS	34,5
BTS -> BTS	25

Far	Tx power (dBm)	Rx Sensitivity (dBm)
BTS	38	-104
MS	39	-104

BTS power control range	30
MS power control range	26
C/I margin	9
Multiple interferers margin	10
Transient margin	20
margin for other IMs	3

NOTE: All results are in dBm except for section 1.3 where the results are dB

1. Transmitter

1.1 Modulation, Spurs and Noise

1.1.1 Co-ordinated, BTS -> MS:

Max. Tx noise level in RX bandwidth = [BTS power]-[Pwr control range]-[C/I margin]-[Multiple interferers margin] = -11

1.1.2 Uncoordinated, BTS -> MS:

Max Tx level of noise in Rx bandwidth = [MS sensitivity]-[C/I margin]-[multiple interferers margin]+[coupling loss] == -64

Max Tx level of spur in Rx bandwidth = [MS sensitivity]-[C/I margin] + [coupling loss] = -54

1.1.3 Co-ordinated & Uncoordinated MS -> BTS:

Max Tx level in Rx bandwidth = [BTS sensitivity]-[C/I margin]+[coupling loss] = -54

1.1.4 Co-ordinated & Uncoordinated MS -> MS:

Max Tx level in Rx bandwidth = [MS sensitivity]-[C/I margin]+[Coupling loss] = -78,5

1.1.5 Co-ordinated & Uncoordinated BTS -> BTS:

Max Tx level noise in Rx bandwidth = [BTS sensitivity]-[C/I margin]-[multiple interferers margin]+[coupling loss] = -98

1.2 Switching Transients

1.2.1 Uncoordinated MS -> BTS:

Max peak level in effective Rx BW at MS = [Base sensitivity]-[C/I margin]+[coupling loss]+[Transient margin] = -34

1.2.2 Uncoordinated BTS -> MS:

Max peak level in effective Rx BW at BTS = [MS sensitivity] -[C/I margin]+[coupling loss]+[transient margin] = -34

1.3 Intermodulation

1.3.1 Coordinated, BTS -> MS:

Required IM attenuation in BTS = [C/I margin]+[BTS pwr control range]+[margin for other IMs] = 42

1.3.2 Uncoordinated, BTS -> MS:

Required IM attenuation in BTS = [BTS power]-{[Max allowed level at MS1]+[coupling loss BTS2 -> MS1]} = 95

NOTE: [Max allowed level at MS1] = [MS sensitivity-C/I margin-margin for other IMs]

1.3.3 Uncoordinated, MS&MS -> BTS:

Required IM attenuation in MS = [MS power] - {[Max allowed level at BTS2] + [coupling loss MS -> BTS2]} = 96

NOTE: [Max allowed level at BTS2] = [BTS sensitivity-C/I margin-margin for other IMs]

1.3.4 Uncoordinated MS&MS -> MS:

Required IM attenuation in MS = [MS power]-{[Max allowed level at MS3]+[coupling loss MS -> MS3]} = 120,5

NOTE: [Max allowed level at MS3] = [MS sensitivity-C/I margin-margin for other IMs]

2. Receiver

2.1 Blocking

2.1.1 Co-ordinated & Uncoordinated BTS -> MS:

Max level at MS receiver = [BTS power]+[multiple interferers margin]-[coupling loss] = -11

2.1.2 Co-ordinated MS -> BTS:

Max level at BTS receiver = [MS power]-[Power control range]-[coupling loss] = -46

2.1.3 Uncoordinated MS -> BTS:

Max level at BTS receiver = [MS power]-[coupling loss] = -20

2.1.4 Co-ordinated & Uncoordinated MS -> MS:

Max level at MS receiver = [MS power]-[coupling loss] = 4,5

2.1.5 Co-ordinated and Uncoordinated BTS -> BTS:

Max level at BTS receiver = [BTS power]+[multiple interferers margin]-[coupling loss] = 23

2.2 Intermodulation

2.2.1 Co-ordinated & Uncoordinated BTS -> MS:

Max received level at MS1 = [BTS power]-[coupling loss BTS2->MS1]+[margin for other IMs] = -18

2.2.2 Co-ordinated MS & MS -> BTS:

Max received level at BTS1 = [MS pwr]-[MS pwr control range]-[coupling loss MS -> BTS1]+[margin for other IMs] = -43

2.2.3 Uncoordinated MS & MS -> BTS:

Max. received level at BTS1 = [MS power]-[coupling loss MS -> BTS1]+[Margin for other IMs] = -17

2.3 Maximum level

2.3.1 Co-ordinated MS -> BTS:

Max level at BTS = [MS power]-[coupling loss] = 20

2.3.2 Co-ordinated BTS -> MS:

Max level at MS = [BTS power]-[coupling loss] = -21

Annex C: Microcell System Scenarios

ETSI STC SMG2 No.3

T Doc SMG2 63 /92

1st- 4th September 1992

Strasbourg

Source: BTL (UK)

Subject: **Microcell BTS RF Parameters**

Background

Since the Ronneby meeting of SMG2 there have been a number of input papers concerning the specification of RP parameters for a microcell BTS. In particular T.Docs 184/91, 16/92, 28/92, 80/92, 86/92 and 90/92 from AT&T NSI, MPC, BTL and Alcatel propose specific RF parameters. At the Turin SMG2 meeting it was agreed that the best way to include a microcell BTS specification into the GSM recommendations was as an Annex to 05.05 that would specify :-

- Transmit powers
- Receive sensitivities
- Wideband noise
- Blocking

It was also agreed that it would not be practical to specify a single microcell BTS for all applications and that a number of BTS classes would need to be specified. It was noted that this may require guidelines to be added to 03.30 to ensure successful operation.

Scenario Requirements

In order to clarify the requirements for microcell BTS RF parameters we must first look at the scenario requirements. It was agreed at the Amsterdam meeting that the 2 groups of scenarios were 'range' and 'close proximity' as shown in Fig.1.

Range

The general requirements of the range scenario are that :-

- Maximum BTS receive sensitivity is required for some applications
- The uplink and downlink paths should be capable of being balanced

It has been agreed that the COST 231 propagation model will be used for microcell propagation when a fine of sight street canyon exist. This has been included in 03.30 for guidance (T.Docs 88/92 and 93/92). In order to estimate the maximum, worst case path loss experienced by a microcell BTS we would also have to define :-

Table 2: Close Proximity Parameters

	GSM900	DCS 1800
Minimum Coupling Loss (MCL)	44dB	50dB
Multiple Interferers Margin (MIM)	10dB	10dB
C/I margin	9dB	9dB

Before we can calculate the scenario requirements shown in Fig.1 we must identify some further MS RF parameters in addition to those in Table 1 :-

Table 3: Further MS RF Parameters

	GSM900 (class 5)	DCS1800 (class 1)
Most stringent blocking requirement	-23dBm	-26dBm
Wideband noise emission in 200kHz	-44dB	-48dB

* - Currently no specification for GSM900 MS wideband noise beyond 1.8MHz offset and therefore figures proposed at Aalborg meeting used (as shown in T.Doc 11 1/92).

The wideband noise figures in Table 3 have been adjusted by 3dB since they are specified in a 100kHz bandwidth in 05.05 but are required in a receiver bandwidth for the scenarios (200kHz).

BTS Tx power

This requirement (as shown in Fig.1) is the maximum microcell BTS transmit power that can be tolerated in order to prevent MS blocking.

BTS Tx power = [MCL] ~ [blocking requirement]

GSM900 BTS Tx power = 44 + (-23) = 21dBm

DCS1800 BTS Tx power = 50 + (-26) = 24dBm

BTS wideband noise

This requirement (as shown in Fig.1) is the maximum microcell BTS wideband noise that can be tolerated in order to prevent MS 'noise masking'. A signal level IOdB above limit sensitivity is taken.

BTS wideband noise (in 100kHz) = [signal lever] - [C/I margin] - [MIM] + [MCL] - [200-100kHz BW conversion]

GSM900 BTS wideband noise = (-92) - 9 - 10 + 44 -3 = -70dBm DCS1800 BTS wideband noise = (-90) - 9 - 10 + 50 -3 = -62dBm

- Non fine of sight propagation model
- Log normal fading margin
- Rician fading margin
- Corner attenuation
- Building penetration loss

To find the range from this path loss we would have to define the link budget parameters such as antennae gains and cable losses. It is thought to be impractical to define all these parameters as part of this work. However, if we substitute some approximate numbers for the above parameters (such as those in T.Doc 80/92) we can see that with -104dBm receive sensitivity at the microcell BTS worst case ranges could still be as low as 200-300m.

In order to define relationships for path balancing we need only to identify the mobile RF parameters and any differences in the uplink and downlink paths (e.g. diversity). The assumptions made here are :-

- Class 5 MS for GSM900 and Class 1 MS for DCS1800
- Same antennae used for transmit and receive at MS and BTS (therefore gain cancers)
- No diversity
- Path balancing performed for maximum MS transmit power (to give absolute max. BTS transmit power required)

The following MS RF parameters are used :-

Table 1: MS RF Parameter

	MS Tx power	MS Rx sensitivity
GSM900	29dBm	-102dBm
DCS1800	30dBm	-100dBm

For balanced paths the uplink max path loss must equal the downlink max path loss. In other words :-

$$[\text{MS Tx power}] + [-\text{BTS Rx sens}] = [\text{BTS Tx power}] + [-\text{MS Rx sens}]$$

The following relationships can therefore be defined :-

$$\text{GSM900 } [\text{BTS Tx power}] + 73 = - [\text{BTS Rx sensitivity}]$$

$$\text{DCS1800 } [\text{BTS Tx power}] + 70 = - [\text{BTS Rx sensitivity}]$$

Close Proximity

At the Amsterdam microcell sub-group the Minimum Coupling Losses (MCL) for Microcell BTS to MS coupling were agreed (T.Doc 41/92 Rev 1). Further work showed that these figures were very worst case and had a low probability of occurring (T.Doc 90/92). The following parameters will be used in the close proximity scenarios :

BTS blocking

This requirement (as shown in Fig. 1) is the maximum signal level that may be presented to a microcell BTS from an uncoordinated MS.

$$\text{BTS blocking level} = [\text{MS Tx power}] - [\text{MCL}]$$

$$\text{GSM900 BTS blocking level} = 29 - 44 = -15\text{dBm}$$

$$\text{DCS1800 BTS blocking level} = 30 - 50 = -20\text{dBm}$$

BTS Rx sensitivity

This requirement (as shown in Fig.1) is the maximum receive sensitivity a microcell BTS can have in order to prevent 'noise masking' from an uncoordinated MS.

$$\text{BTS Rx sensitivity} = [\text{wideband noise from MS}] + [\text{C/I margin}] - [\text{MCL}]$$

$$\text{GSM900 BTS Rx sensitivity} = -44 + 9 - 44 = -79\text{dBm}$$

$$\text{DCS1800 BTS Rx sensitivity} = \sim 8 + 9 - 50 = -89\text{dBm}$$

Practical specification

So far, we have identified the requirements for the range and close proximity scenarios for a microcell BTS. We now need to move towards a practical specification.

Microcell BTS Tx power and Rx sensitivity

If we study the scenario requirements for transmit power and receive sensitivity we find the following :-

- The Rx sensitivities needed to satisfy the close proximity scenarios are much less those required for the range scenarios.
- The Tx powers and Rx sensitivities from the close proximity scenarios lead to a 15dB downlink bias for GSM900 and a 5dB downlink bias for DCS1800.

In order to satisfy both the path balance relationships in the range scenario and the close proximity scenarios we can either reduce the Tx power or reduce the Rx sensitivity even further. Since the Rx sensitivity is well short of the range requirements already we shall choose to balance paths by reducing Tx power. This gives the following Tx powers :-

$$\text{GSM900 BTS Tx power} = -(-79) + 73 = 6\text{dBm}$$

$$\text{DCS1800 BTS Tx power} = -(-89) + 70 = 19\text{dBm}$$

However, if we want to specify microcell BTS classes with better Rx sensitivities than these (and hence higher Tx powers) then the value for MCL has to be increased in order to ensure the close proximity scenarios are satisfied. Popular Rx sensitivities to choose in order to optimise microcell BTS size and cost are -89dBm and -95dBm (from SMG2 input papers). Since the limiting close proximity scenario is MS wideband noise masking the microcell BTS

receiver we must use this to determine the new MCL requirements as follows :-

$$\text{MCL} = [\text{wideband noise from MS}] + [\text{C/I margin}] - [\text{BTS Rx sensitivity}]$$

Having done this we can path balance to find the new Tx powers. These results are shown in Table 4.

Table 4: New MCLs with balanced Rx sens and Tx powers

	MCL	Rx sens	Tx power
GSM900	44dB	-79dBm	6dBm
	54dB	-89dBm	16dBm
	60dB	-95dBm	22dBm
	69dB	-104dBm	31dBm
DCS1800	50dB	-89dBm	19dBm
	56dB	-95dBm	25dBm
	65dB	-104dBm	34dBm

Microcell blocking

It has been agreed that by reducing the Rx sensitivity we do not want to imply a relaxation in the blocking requirements for the microcell BTS. Therefore the blocking values will simply be increased by the same amount as the Rx sensitivity has decreased.

Table 5 Change in blocking requirement ,

	Rx sens	Change in blocking values
GSM900	-79dBm	+25dB
	-89dBm	+15dB
	-95dBm	+9dB
	-104dBm	No change
DCS1800	-89dBm	+15dB
	-95dBm	+5dB
	-104dBm	No change

Microcell BTS wideband noise

The scenario requirement for wideband noise will obviously change with the MCL. The wideband noise specification currently in 05.05 is -80dBc at greater than 6MHz offsets. For low Tx power BTSs a noise floor of -57dBm is specified for DCS 1800 and 45dBm (>6MHz) for GSM900. Table 6 shows the scenario requirements for wideband noise with the -80dBc

values (relative to the microcell. Tx power - not shown) and the current specification values (i.e. either the -80dBc or the noise floor value).

Table 6: Wideband noise requirements

	MCL	Scenario Requirement	-80dBc values	Current Spec
GSM900	44dB	70dBm	-74dBm	-45dBm
	54dB	-60dBm	-64dBm	-45dBm
	60dB	-54dBm	-58dBm	-45dBm
	69dB	-45dBm	-49dBm	-45dBm
DCS1800	50dB	-62dBm	-61dBm	-57dBm
	56dB	-56dBm	-55dBm	-55dBm
	65dB	-47dBm	-46dBm	-46dBm

It can be seen that for DCS1800 the current specification satisfies the scenario requirements. However, for GSM900 there is up to a 25dB discrepancy. A noise floor of -60dBm is proposed for GSM900 which would change the specification to -60dBm, -60dBm, -58dBm and -49dBm in the top right hand 4 boxes of table 6. This meets the scenario requirement in three cases and exceeds it by 10dB in one case.

Proposed changes to GSM recommendations

The following changes have been Proposed to GSM 05.05 :-

Table 7: Microcell BTS Classes

	Microcell BTS Class	Tx power (dBm)	Rx sensitivity	Blocking (rel to current)
GSM900	1	31	-104	No change
	2	22	-95	+9dB
	3	16	-89	+15dB
	4	6	-79	+25dB
DCS1800	1	34	-104	No change
	2	25	-95	+9dB
	3	19	-89	+15dB

Although the longer classes came from the original MCL figures it is recommended that certainly the GSM900 Class 4 BTS be removed as not practical and possibly both Class 3 BTSs also. This is open for discussion.

We have also shown that :-

- The GSM900 MS wideband noise needs specifying to the band edge (as for DCS1800 MSs) with values at least as good as those proposed in Aalborg.
- The wideband noise floor for GSM900 microcell BTSs needs to be -60dBm. No change is required for DCS1800.

The following additions are proposed to 03.30 :-

The recommended MCL values for the different microcell BTS classes should be included in 03.30 for guidance on installation. These MCL values are connector to connector values and therefore include antennae effects. The following should be added :-

Table 8: Recommended MCLs

	Microcell BTS Class	Recommended MCL (dB)
GSM 900	1	69
	2	60
	3	54
	4	44
DCS 1800	1	65
	2	56
	3	50

Removing the GSM900 Class 4 BTS would eliminate the 44dB MCL from the table. It can be seen that higher MCLs are needed for GSM900 than for DCS 1800. This will translate into even larger separations in the field due to the 6dB fall in path loss when moving from 1.8GHz to 900MHz. The only way to restore this balance is to specify a tighter MS wideband noise specification for GSM900 than that proposed in Aalborg.

Microcell BTS Scenarios

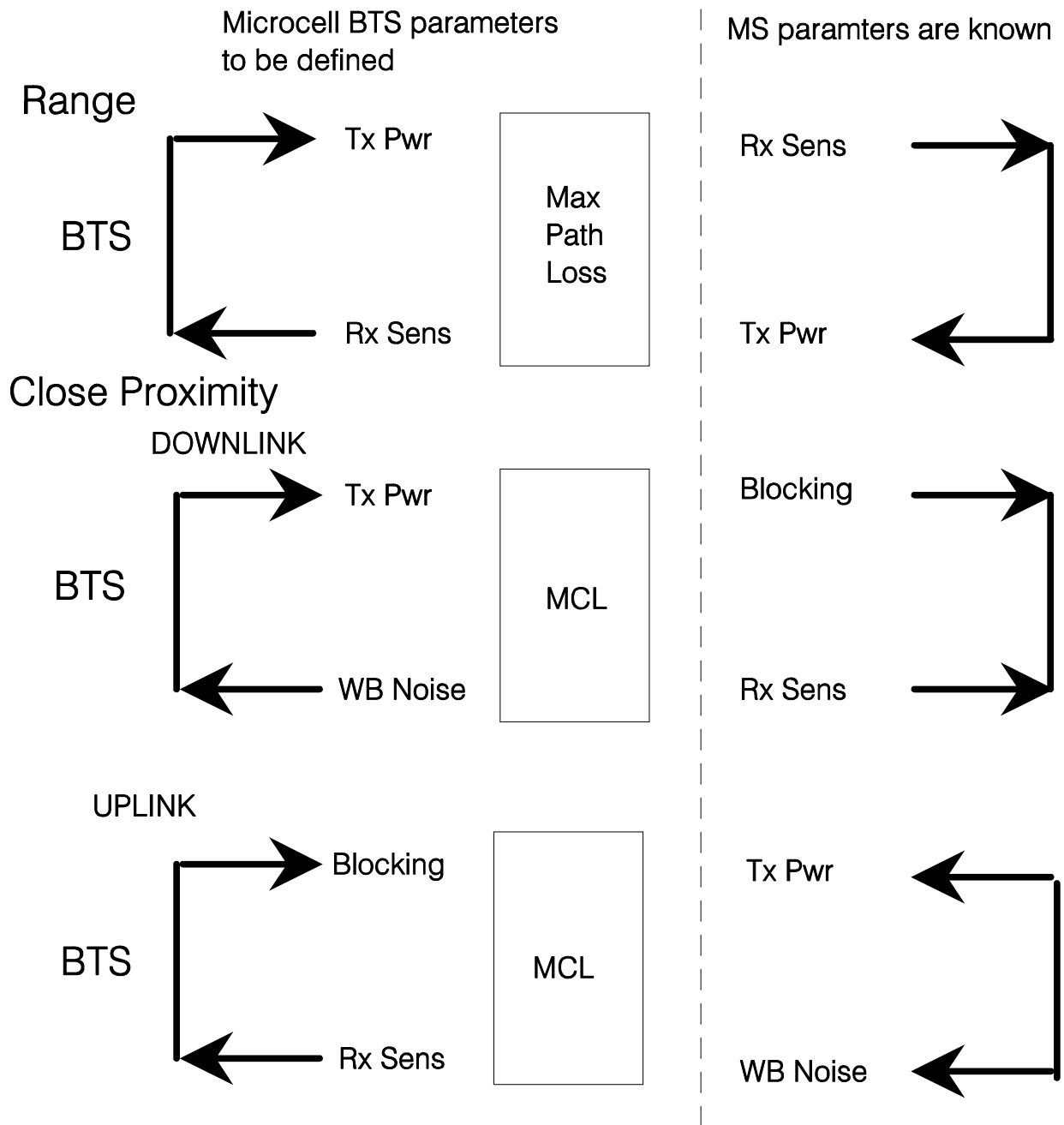

Figure 1

ETSI/STC SMG 2

T.doc.144/92

Strasbourg, 1-4 September 1992

Source: Mercury Personal Communications

Title: Comments and Proposals on Microcell RF Parameters

Having read the paper from BTL on this subject and as a result of discussions with the author, the following additional comments and proposals have been agreed with him.

- 1) uBTS classes can be defined to meet MCLs in 5 dB steps GSM {45, 50, 55, 60} DCS {50, 55, 60}. This will aid the cell planner and manufacturers in choosing appropriate equipment for a given ucell site. It is also simpler.
- 2) Since DCS 1800 r.f. parameters were defined using the scenarios approach used here for microcells, a DCS uBTS with a sensitivity of -104 dBm will be identical to a permitted normal BTS and there is therefore little point in defining it.
- 3) Diversity is possible in ucells. I suggest we allow 3 dB for this in the uBTS maximum power.
- 4) Parameters which affect the uBTS receiver should meet the MCL. Those which only affect the closest mobile can miss the MCL by 10 dB. The Telia research measurements (SMG2 T.doc. 90/92) show that this 10 dB translates a 0.1% probability to 10% probability of interference.
- 5) uBTS blocking should exceed the MCL requirement by 10 dB.
 - a) to allow for interfering signals from outside the system
 - b) because the consequences of the BTS being blocked are severe
 - c) to improve the MCL performance with MSs which exceed their noise spec.

Proposed Procedure for Defining the Parameters (Similar to the BTL paper)

- 1) Choose uBTS sensitivity to match MS noise at MCL
- 2) Choose uBTS power to balance links
- 3) Set uBTS noise and blocking to be the same as for a normal BTS relative to the power and sensitivity respectively
- 4) Relax the uBTS noise and blocking where possible to the point where it just meets the MCL requirements.

Spread Sheets giving uBTS RF Parameters (Figures 1 to 3)

- 1) Microcell RF parameters proposed by BTL paper
- 2) Parameters after stages 1-3 in the procedure above.
- 3) Proposed parameters after stages 1-4 above.

The final proposals are in figure 3. Notice that the class 1 uBTS can be converted into a class 2 with the addition of 5 dB attenuators on transmit and receive paths.

Figure 1 Microcell RF Parameters as in BTL Paper

	Baseline		Normal	Class 1	Class 2	Class 3	Class 4	Normal	Class 1	Class 2	Class 3
	GSM	DCS	GSM	GSM	GSM	GSM	GSM	DCS	DCS	DCS	DCS
C/I	9	9	9	9	9	9	9	9	9	9	9
BTS MIM	10	10	10	10	10	10	10	10	10	10	10
MS Margin	10	10	10	10	10	10	10	10	10	10	10
BTS Div. Gain	0	0	0	0	0	0	0	0	0	0	0
MS Power	29	30	29	29	29	29	29	30	30	30	30
MS Noise	-44	-48	-44	-44	-44	-44	-44	-48	-48	-48	-48
MS Blocking	-23	-26	-23	-23	-23	-23	-23	-26	-26	-26	-26
MS Sensitivity	-102	-100	-102	-102	-102	-102	-102	-100	-100	-100	-100
BTS Power	21	24	34	31	22	16	6	37	34	25	19
BTS Noise	-67	-59	-49	-42	-51	-57	-67	-46	-44	-53	-59
BTS Blocking	-15	-20	-13	-13	-4	2	12	-25	-25	-16	-10
BTS Sensitivity	-79	-89	-104	-104	-95	-89	-79	-104	-104	-95	-89
Base MCL	44	50	69	69	60	54	44	65	65	56	50
Margins for MCLs (+ve = good);											
MS Blocking	0	0	12	15	15	15	15	2	5	5	5
BTS Noise	0	0	7	0	0	0	0	2	0	0	0
BTS Blocking	0	0	27	27	27	27	27	10	10	10	10
MS Noise	0	0	0	0	0	0	0	0	0	0	0
D/L Bias	15	5	3	0	0	0	0	3	0	0	0
Max Loss	108	119	133	133	124	118	108	134	134	125	119
MCL	44	50	69	69	60	54	44	65	65	56	50
Dyn Range	64	69	64	64	64	64	64	69	69	69	69

Notes

See annex 1 for further information

Shaded boxes are changeable parameters

Max loss excludes any antenna gain / cable loss

Powers and sensitivities are specified at the antenna connector

Noise measured in 180 kHz.

Figure 2. Microcell RF Parameters after Stages 1 to 3

	Baseline		Normal	Class 1	Class 2	Class 3	Class 4	Normal	Class 1	Class 2	Class 3
	GSM	DCS	GSM	GSM	GSM	GSM	GSM	DCS	DCS	DCS	DCS
C/I	9	9	9	9	9	9	9	9	9	9	9
BTS MIM	10	10	10	10	10	10	10	10	10	10	10
MS Margin	10	10	10	10	10	10	10	10	10	10	10
BTS Div. Gain	3	3	3	3	3	3	3	3	3	3	3
MS Power	29	30	29	29	29	29	29	30	30	30	30
MS Noise	-44	-48	-44	-44	-44	-44	-44	-48	-48	-48	-48
MS Blocking	-23	-26	-23	-23	-23	-23	-23	-26	-26	-26	-26
MS Sensitivity	-102	-100	-102	-102	-102	-102	-102	-100	-100	-100	-100
BTS Power	21	24	34	25	20	15	10	37	32	27	22
BTS Noise	-67	-59	-49	-58	-63	-68	-73	-46	-51	-56	-61
BTS Blocking	-15	-20	-13	-4	1	6	11	-25	-20	-15	-10
BTS Sensitivity	-79	-89	-104	-95	-90	-85	-80	-104	-99	-94	-89
Base MCL	44	50	69	60	55	50	45	65	60	55	50
Margins for MCLs (+ve = good);											
MS Blocking	0	0	12	12	12	12	12	2	2	2	2
BTS Noise	0	0	7	7	7	7	7	2	2	2	2
BTS Blocking	0	0	27	27	27	27	27	10	10	10	10
MS Noise	0	0	0	0	0	0	0	0	0	0	0
D/L Bias	12	2	0	0	0	0	0	0	0	0	0
Max Loss	111	122	136	127	122	117	112	137	132	127	122
MCL	44	50	69	60	55	50	45	65	60	55	50
Dyn Range	67	72	67	67	67	67	67	72	72	72	72

Notes

See annex 1 for further information

Shaded boxes are changeable parameters

Max loss excludes any antenna gain / cable loss

Powers and sensitivities are specified at the antenna connector

Noise measured in 180 kHz.

Figure 3 Microcell RF Parameters after Stages 1 to 4

	Baseline		Normal	Class 1	Class 2	Class 3	Class 4	Normal	Class 1	Class 2	Class 3
	GSM	DCS	GSM	GSM	GSM	GSM	GSM	DCS	DCS	DCS	DCS
C/I	9	9	9	9	9	9	9	9	9	9	9
BTS MIM	10	10	10	10	10	10	10	10	10	10	10
MS Margin	10	10	10	10	10	10	10	10	10	10	10
BTS Div. Gain	3	3	3	3	3	3	3	3	3	3	3
MS Power	29	30	29	29	29	29	29	30	30	30	30
MS Noise	-44	-48	-44	-44	-44	-44	-44	-48	-48	-48	-48
MS Blocking	-23	-26	-23	-23	-23	-23	-23	-26	-26	-26	-26
MS Sensitivity	-102	-100	-102	-102	-102	-102	-102	-100	-100	-100	-100
BTS Power	21	24	34	25	20	15	10	37	32	27	22
BTS Noise	-67	-59	-49	-51	-56	-61	-66	-46	-49	-54	-59
BTS Blocking	-15	-20	-13	-21	-16	-11	-6	-25	-20	-15	-10
BTS Sensitivity	-79	-89	-104	-95	-90	-85	-80	-104	-99	-94	-89
Base MCL	44	50	69	60	55	50	45	65	60	55	50

Margins for MCLs (+ve = good);

MS Blocking	0	0	12	12	12	12	12	2	2	2	2
BTS Noise	0	0	7	0	0	0	0	2	0	0	0
BTS Blocking	0	0	27	10	10	10	10	10	10	10	10
MS Noise	0	0	0	0	0	0	0	0	0	0	0
D/L Bias	12	2	0	0	0	0	0	0	0	0	0
Max Loss	111	122	136	127	122	117	112	137	132	127	122
MCL	44	50	69	60	55	50	45	65	60	55	50
Dyn Range	67	72	67	67	67	67	67	72	72	72	72

Notes

See annex 1 for further information

Shaded boxes are changeable parameters

Max loss excludes any antenna gain / cable loss

Powers and sensitivities are specified at the antenna connector

Noise measured in 180 kHz.

Annex 1 Microcell RF Parameters**Abbreviations**

P = Power (dBm)

N = Noise floor in Rx bandwidth (dBm) (> 6 MHz)

B = Blocking level (dBm) (> 3 MHz)

S = Reference sensitivity (dBm)

MIM = Multiple interferers margin from BTS (dB)

MSM = MS margin (dB) amount by which MS can fail the scenarios, cf base station

MCL = Minimum coupling loss (dB) between antenna connectors (proximity)

Max. loss = Maximum coupling loss (dB) between antenna connectors (range excluding antennas and cables)

C/I = Reference co-channel interference ratio, assumed to equal interference margin below sensitivity

Equations for Deriving Minimum uBTS specifications from those of the MS such that a given MCL is guaranteed

$$P_{BTS} = MCL + B_{MS} - MIM + MSM \quad (1)$$

$$N_{BTS} = MCL + (S_{MS} + MSM - C/I) - MIM \quad (2)$$

$$B_{BTS} = P_{MS} - MCL \quad (3)$$

$$S_{BTS} = N_{MS} - MCL + C/I \quad (4)$$

uBTS Performance Equations

$$[\text{Down link bias}] = P_{BTS} - S_{MS} - (P_{MS} - S_{BTS} + [\text{Diversity Gain}]) \quad (5)$$

$$[\text{Max. loss}] = \min (\quad P_{BTS} - S_{MS}, \quad P_{MS} - S_{BTS} + [\text{Diversity Gain}]) \quad (6)$$

$$MCL = \max (\quad P_{BTS} + MIM - B_{MS} - MSM, \quad N_{BTS} + MIM - (S_{MS} + MSM - C/I), \quad P_{MS} - B_{BTS}, \quad N_{MS} - S_{BTS} + C/I) \quad (7)$$

$$[\text{Dyn. Range}] = [\text{Max. loss}] - MCL \quad (8)$$

ETSI/STC SMG2 Ad Hoc

T.doc 4/92

Bristol, 3-4 November 1992

Source: The Technology Partnership (UK)

Title: REVISED PROPOSALS FOR MICROCELL RF PARAMETERS

This document is an update to SMG2 T.doc 144/92 presented in Strasbourg to include:

- 1) the new proposed GSM MS noise figures*
- 2) the method of interpreting 05.05 section 4.2.1 agreed at the SMG2 ad hoc in Malmesbury (a 2 dB correction).

The table below shows the calculation of the noise floor.

	MS power	4.2.1 table entry	at frequency offset	level in 100 kHz	level in 180 kHz
GSM	29 dBm	-71 dB	1.8 MHz	-50 dBm	-43 dBm
DCS	30 dBm	-75 dB	6 MHz	-53 dBm	-50 dBm

The conversion factor of total MS power to that measured in 30 kHz on carrier is taken to be 8 dB rather than the 6 dB assumed for phase 1 DCS1800.

The revised proposals are shown in Figure 1 and are otherwise calculated in the same manner as described in SMG2 T.doc 144/92. Since the MS noise was the limiting factor in close proximity performance, the change leads to a significant improvement in the overall system especially for microcells.

* The figures proposed in Strasbourg were

MS power	4.2.1 table entry ≥ 1.8 MHz
≥ 43 dBm	-81 dB
41 dBm	-79 dB
.	.
.	.
≤ 33 dBm	-71 dB

Figure 1. Microcell RF Parameters with proposed GSM MS noise.

	Baseline		Normal	Class 1	Class 2	Class 3	Class 4	Normal	Class 1	Class 2	Class 3
	GSM	DCS	GSM	GSM	GSM	GSM	GSM	DCS	DCS	DCS	DCS
C/I	9	9	9	9	9	9	9	9	9	9	9
BTS MIM	10	10	10	10	10	10	10	10	10	10	10
MS Margin	10	10	10	10	10	10	10	10	10	10	10
BTS Div. Gain	3	3	3	3	3	3	3	3	3	3	3
MS Power	29	30	29	29	29	29	29	30	30	30	30
MS Noise	-47	-50	-47	-47	-47	-47	-47	-50	-50	-50	-50
MS Blocking	-23	-26	-23	-23	-23	-23	-23	-26	-26	-26	-26
MS Sensitivity	-102	-100	-102	-102	-102	-102	-102	-100	-100	-100	-100
BTS Power	21	24	34	28	23	18	13	37	34	29	24
BTS Noise	-67	-59	-49	-51	-56	-61	-66	-46	-49	-54	-59
BTS Blocking	-15	-20	-13	-21	-16	-11	-6	-25	-20	-15	-10
BTS Sensitivity	-82	-89	-104	-98	-93	-88	-83	-104	-101	-96	-91
Base MCL	44	50	69	60	55	50	45	65	60	55	50
Margins for MCLs (+ve = good);											
MS Blocking	0	0	12	9	9	9	9	2	0	0	0
BTS Noise	0	0	7	0	0	0	0	2	0	0	0
BTS Blocking	0	0	27	10	10	10	10	10	10	10	10
MS Noise	0	2	3	0	0	0	0	2	0	0	0
D/L Bias	9	2	0	0	0	0	0	0	0	0	0
Max Loss	114	122	136	130	125	120	115	137	134	129	124
MCL	44	50	66	60	55	50	45	63	60	55	50
Dyn Range	70	72	70	70	70	70	70	74	74	74	74

Notes

Shaded boxes are changeable parameters

Max loss excludes any antenna gain / cable loss

Powers and sensitivities are specified at the antenna connector

Noise measured in 180 kHz.

NOTE: -71dB used for class 5 MS but is going to be -67dB, i.e. raises 4dB higher

Annex D: Conversion factors

REPORT OF AD HOC MEETING ON RF PARAMETERS

The aim of the meeting was to define BTS transmitter requirements that are consistent with each other (TD 42/92), the following are the specifications that were discussed:

Modulation Mask
Switching Transients
Spurious Emissions
Intermodulation

The following plan was agreed:

1. Agree normalised measurement conversion numbers.
2. Define the modulation mask based upon scenario requirements and what is practically feasible.
3. Define new specifications that provide consistent requirements and propose these changes at the next SMG2 meeting in May.

SCENARIO REQUIREMENTS

MPC presented TD 46/92 that described the scenario requirements for DCS1800 which are derived from GSM TDs 60/91 and 61/91. The following

principles are contained in TD 46/92:

- A) Specifications should satisfy the requirements of the system scenarios unless evidence is presented that they are not practical.
- B) Since all specifications must be met, only the most stringent is important.
- C) So far as possible, a test should be the tightest constraint on what it is intended to measure. for example, the 4.2.1 test on modulation and noise should be the toughest requirement on these quantities.

The document proposes a change to the modulation mask at 1.8MHz offset to align with the spurious test. It was also stated that the intra-intermodulation requirement at 1.8MHz offset from carrier is tighter than the modulation test, TD 46/92 proposed that the test be modified to say that if the test failed, all carriers but the nearest one be switched off. If the measured level remains the same then the failure can be attributed to modulation and can be ignored. TD 46/92 also proposed a tightening of the modulation requirement at 6MHz offset to comply with the scenario requirement. There was much discussion on this subject and the values used in the scenario were questioned particularly the Minimum Coupling Loss (MCL) and the MS threshold level. It was stated by Motorola that -65dB appears to be too stringent for MCL. AT&T stated that it was unusual to design coverage or reference sensitivity at the cell boundary. AEG questioned the statistical reasoning behind a tightening of the specification for modulation. It was generally agreed that the more important scenario was with the BTS as the victim and not the MS as the victim.

Vodafone presented TD 52/92 that covered the system scenarios for GSM900, the MCL that was used for GSM900 was 59dB. In conclusion it was recommended to try to improve limits if at all possible.

NORMALISATION OF CONVERSION NUMBERS.

The TDs presented were 47, 48, 49, 50, 51, 53, 54 and 55/92. It was decided to discuss TD 47/92 at the next SMG2 meeting. TD 48/92 (AT&T) was an updated version of TD 42/92 including the normalisation numbers agreed at the Amsterdam meeting of SMG2. TD 49/92 (CSELT) illustrates the differences between peak and average in a 30kHz bandwidth at different offsets using three different commercial spectrum analysers. A bandwidth of 300kHz is also used but due to the low offset from carrier it was commented that a resolution bandwidth of 300kHz was too large to be accurate. TD 50/92 (France Telecom) presented information on scaling factors to be used in the normalisation process. From the plots provided in TD 50/92 evidently below 1.8MHz offset the resolution bandwidth has to be set to less than

or equal to 30kHz for an accurate representation of the signal. TD 51/92 (Vodafone) shows that an additional allowance needs to be considered depending on the effect of a particular kind of interference. The example shown is that switching transients have an effect that is 20dB less than continuous interference, therefore, a relaxation of modulation to allow consistency would have more of an effect than a relaxation of switching transients. TD 53/92 (Cellnet) investigates the propositions outlined in TD 42/92 using practical measurements. The paper supports all the propositions of TD 42/92 apart from one. TD 42/92 was in error in the description of the bandwidth used for the average to peak conversion, this error had been corrected in TD 48/92. TD 54/92 (BTL) describes normalisation parameters derived from measurement and states that the following measurements are equal to or below the modulation mask; GSM900 switching transients beyond 1200kHz to 1800kHz, all in-band spurious values and Intermodulation products less than 6MHz are masked by the modulation. TD 55/92 (Motorola) presents measured values of modulation at various offsets, using an average 30kHz bandwidth. Peak measurements using 30kHz, 100kHz and 300kHz bandwidths at various offsets are also presented. The conversion factors are then measured at varying offsets. On the basis of the conversion tables in TD 55/92 it was stated that a 100kHz resolution bandwidth is only meaningful at offsets greater than 1.2MHz and a 300kHz bandwidth is only meaningful at offsets greater than 6MHz. This corresponds with the plots in TD 50/92.

To derive the conversion numbers to be used in the normalisation process a comparison of all the numbers presented to the meeting was discussed.

It was agreed that the conversion process would be combined into three distinct steps, these steps are :

1. Average in a 30kHz BW to peak in a 30kHz BW. All offsets.
2. Average in a 100kHz BW to peak in a 30kHz BW. Offsets greater than or equal to 1.8MHz.
3. Peak in a 300kHz bandwidth to peak in a 30kHz bandwidth. Offsets greater than or equal to 6MHz.

During the meeting it was decided that a clarification of the definition of peak hold is required in 05.05 Section 4. MPC prepared a CR that stated what had been decided at the meeting. However, there was no time to discuss the CR and it will be presented at the next SMG2 plenary.

Difference between peak power and average (30kHz BW) zero offset

AT&T	8.0
CSELT	7.5
Cellnet	8.2
France Telecom	7.4
BTL	8.0
Motorola	7.3
Average	7.7

A value of 8dB was agreed.

Average to Peak in a 30kHz bandwidth.

Org.	0kHz	400kHz	600kHz	1200kHz	1800kHz	6MHz
AT&T	8dB	9dB				
FT	6.2dB					
CSELT	7.3dB	10.1dB	9.9dB	10.1dB		
BTL	9dB					
Motorola	7dB	8.5dB	8.3dB	10dB	9.4dB	8.6dB
Average	7.5dB	9.2dB	9.1dB	10dB	9.4dB	8.6dB

The agreed conversion factors are 8dB at zero offset and 9dB at all other offsets.

Average in a 100kHz bandwidth to Peak in a 30kHz bandwidth.

It was agreed that the conversion factor should be 5dB at offsets above 1800kHz.

Peak in a 300kHz bandwidth to Peak in a 30kHz bandwidth.

No agreement was reached on this value so the working assumption as agreed at SMG2 was assumed pending any further validation. The conversion factor is 8dB at offsets greater than or equal to 6MHz.

MODULATION MASK

It was agreed that the title for section 4.2.1 should be changed to 'Spectrum due to the Modulation and Wide band Noise'.

In accordance with TD 46/92 (MPC) the modulation mask was tightened at 1800kHz offset to align with the spurious requirement for DCS1800.

BTS power (dBm)	<33	35	37	39	41	>43
Table entry in 4.2.1 (dB)	-65	-67	-69	-71	-73	-75

This was also agreed for GSM900.

It was also agreed to define the modulation mask beyond 1800kHz for GSM900 and the value specified would be the same as the present DCS1800 requirements.

To account for lower GSM900 power levels an additional note will be added to 4.2.1:

- vi) For GSM900 BTS, if the limit according to the above table between 1800kHz to 6MHz is below -40dBm, a value of
 -40dBm shall be used instead. If the limit above 6MHz is below
 -45dBm, a value of -45dBm shall be used instead.

It was noted that this additional note for GSM900 was based upon an alignment with the spurious requirement and the scenario requirement was not discussed.

ETSI/SMG2

Tdoc 287/92

The Hague

15-18 December 1992

Source: SMG2

Title: Agreed SMG2 Conversion Factors

Maximum peak power to average power in a 30 kHz bandwidth on carrier:

A conversion factor of -8 dB was agreed.

Average to Peak power in a 30 kHz bandwidth:

The agreed conversion factors are +8 dB at zero offset and +9 dB at all other offsets.

Average in a 100 kHz bandwidth to Peak in a 30 kHz bandwidth:

It was agreed that the conversion factor shall be +5 dB at offsets above 1800 kHz from carrier.

Peak in a 300 kHz bandwidth to Peak in a 30 kHz bandwidth:

No agreement was reached on this value so the working assumption as agreed at SMG2 was assumed pending any further validation. The conversion factor is -8 dB at offsets greater than or equal to 6 MHz.

Bandwidth conversion from 100 kHz to 300 kHz:

This was not discussed but a working assumption of +5 dB can be assumed at greater than 1.8 MHz offset from carrier.

EXAMPLE

To calculate the absolute level of wideband noise for a GSM900 BTS at greater than or equal to 1.8 MHz offset for BTS power greater than or equal to +43 dBm measured in a 300 kHz bandwidth.

The specification is -75 dB (100 kHz bandwidth) relative to an average measurement in a 30 kHz bandwidth at zero offset.

Therefore, the difference between peak power and average (30 kHz bandwidth) at zero offset = +8 dB.

Therefore, the absolute level = BTS power(+43 dBm) - 8 - 75

= -40 dBm (100 kHz)

= -35 dBm (300 kHz)

The above conversion factors can also be used to compare all transmitter parameters using a normalised peak measurement in a 30 kHz bandwidth.

Annex E: Repeater Scenarios

ETSI SMG2 ad-hoc ~

Tdoc. 24/94

Rome, 8 March 1994

Title: REPEATER SCENARIOS FOR DCS1800

Source: Mercury One-2-One

1. INTRODUCTION

Repeaters represent a relatively low cost means of enhancing a network's coverage in certain locations. Their behaviour is fundamentally different to BTS's in that their output power levels are input level dependent. The RF requirements for these repeater should therefore not be automatically derived from existing BTS specifications, but rather should be derived from realistic scenarios, with due attention paid to what is feasible and economically reasonable to implement.

2. REPEATER APPLICATIONS - OUTDOOR AND INDOOR

Mercury One_2_One considers that most repeater applications fall into two types: outdoor and indoor.

In *outdoor* applications there is normally a need to cover a limited outdoor area into which propagation from existing cell sites is restricted due to terrain or other shadowing effects. Minimum coupling losses from the repeater to nearby MSs are similar to those for existing BTSs (65 dB), and the required gain to provide a reasonable area of effective enhancement is of the order of 70 dB.

Indoor applications are characterised by smaller minimum coupling losses (45 dB), and in order to avoid very high output powers towards the BTS as a result of close-by MSs, the gain of such indoor repeaters is smaller and of the order of 40 dB.

Both of these applications will be considered in more detail in the following sections.

3. OUTDOOR REPEATER SCENARIO

Figure 3 below illustrates a typical outdoor repeater scenario.

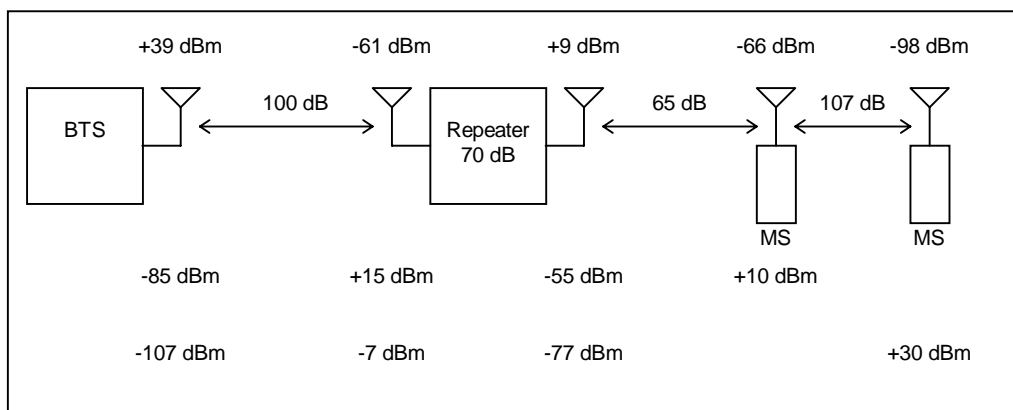

Figure 3 Outdoor Repeater Scenario

The repeater is typically located close to an area of marginal coverage (-95 dBm average signal strength at "ground level). By placing a directional antenna (20 dBi) on a tower (15 dB gain from extra height and shadowing avoidance), the received signal strength can be increased around -60 dBm, equivalent to a typical pattern loss between BTS and repeater antenna connectors of 100 dB. A variation of 10 dB either side of this figure is assumed to provide flexibility to deal with local site variations.

The minimum coupling loss between the MS and the repeater is assumed to be 65 dB, the same as a normal DCS 1800 BTS.

Two cases for differing mobile locations with respect to the repeater are shown in figure 3: an MS near to the repeater at the MCL values, and an MS at the edge of the repeater coverage area. A diversity gain of; 3 dB is assumed. The dynamic range of the repeater is seen to be 42 dB.

4 OUTDOOR REPEATER PERFORMANCE Requirements

In this section we consider the performance requirements for the outdoor repeater scenario.

4.1 Wideband Noise

The wideband noise requirement can be split into two separate case for inside and outside of the repeaters gain bandwidth.

Within the gain bandwidth, a co-ordinated scenario is applicable, whereby the noise should be an interference margin below the minimum signal likely be output by the repeater. For the downlink, the permitted in-repeater-band noise level is therefore given by the following:

$$\begin{aligned} \text{In-repeater-band Noise Level} &< \text{Output Power} - C/I - \text{BTS_Power_Control_Range} \\ (\text{in 180 Hz}) &< +9 - 9 - 30 \\ &< \mathbf{-30 dBm} \end{aligned}$$

The wideband noise level out of the repeaters gain bandwidth is a more serious problem and can desensitise uncoordinated MSs belonging to other operators. The required level to prevent desensitisation is given by:

$$\begin{aligned} \text{Out-of-rep.-band Noise level} &< \text{MS Sensitivity} - C/I + \text{MCL} \\ &< -100 - 9 + 65 \\ &< \mathbf{-44 dBm} \end{aligned}$$

Note that, as compared to the BTS wideband noise calculations, there is no multiple interferer margin in the above calculation, as a single repeater can serve many carriers. Assuming no post amplification filtering is employed, this level is equivalent to a noise figure of 7 dB.

It is proposed that this value becomes applicable 400 kHz away from the bandedge of the repeater.

For the uplink direction, the in-repeater band noise level must be such as to not desensitise the BTS at the minimum path loss between repeater and BTS. The level is therefore given by:

$$\begin{aligned} \text{In-repeater-band Noise level} &< \text{BTS_Sensitivity} - C/I + \text{Min. BTS_Rep. Path_Loss} \\ &< 104 - 9 + 90 \\ &< \mathbf{-23 dBm} \end{aligned}$$

For the out-of-band noise requirement, it is proposed that the same level of -44 dBm as calculated for the downlink is adopted. This will protect desensitisation of uncoordinated BTSs with path losses of greater than +69 dB.

4.2 Intermodulation Products and Spurious Emissions

From a scenario perspective, the level of downlink spurious emissions and intermodulation products that might cause desensitisation of uncoordinated MSs is the same level as for wideband noise, i.e. -44 dBm. However, for normal BTSs, since spurious emissions and intermodulation products are limited in frequency extent and would be difficult to reduce, the maximum level was relaxed for BTSs to -36 dBm. It is proposed that the same **-36 dBm** limit should apply to outdoor repeaters.

For intermodulation products in the downlink direction, if we take the minimum BTS to repeater path loss of 90 dB, for the resultant output power of +19 dBm in the downlink direction, we can calculate the required third order intercept point (TOI) for intermodulation products falling within the downlink transmit band:

$$\begin{aligned} \text{TOI} &> (1.5 \times \text{Output Power}) - (0.5 \times \text{Intermodulation Product Power}) \\ &> (1.5 \times 19) - (0.5 \times -36) \\ &> \mathbf{+47.5 \text{ dBm}} \end{aligned}$$

For broadband repeaters with duplexors in which it is possible for intermodulation products generated in the downlink direction to fall into the uplink; repeater pass band, additional protection is required. The intermodulation product at the MS end of the repeater should at least 9 dB less than the minimum input levels for MSs at the edge of coverage served by that repeater (-86 dBm in scenario considered, and -96 dBm for scenario with 90 dB BTS to repeater path loss).

In the uplink direction, the output power of the repeater when the MS at the MCL distance is +15 dBm. The required third order intercept point is therefore given by:

$$\begin{aligned} \text{TOI} &> \text{Output Power} - (0.5 \times \text{Intermodulation Product Power}) \\ &> 1.5 \times 15 - (0.5 \times -36) \\ &> \mathbf{+40.5 \text{ dBm}} \end{aligned}$$

It should be noted that the above maximum uplink output of **+15 dBm** only applies to powered-down MSs. At the start of a call the MS will be at higher power and this may cause a higher temporary intermodulation product if two mobiles at the start of calls are both transmitting in the same timeslot. It is recommended that this unlikely transient scenario is ignored.

4.3 Output Power

In the downlink direction, the maximum single carrier output power of +19 dBm with a BTS to repeater path loss of 90 dB needs to be multiplied by a factor to allow for the amplification of multiple carriers. If we assume 10 carriers, this gives a maximum output power of the repeater, as determined by the 1 dB compression point, of **+29 dBm**.

In the **uplink** direction, it is important that the repeater does not seriously distort the initial access bursts transmitted at full power by a nearby mobile. The required 1 dB compression point for correct amplification of such bursts is therefore **+35 dB**.

4.4 Blocking by Uncoordinated BTS

The bandedge filtering should provide adequate rejection of other operators frequencies to ensure that the output power and intermodulation product requirements specified in section 4.2 and 4.3 are not exceeded if the repeater is placed close to a BTS of a different operator.

In order to ensure this the limit to the gain for the operators channels is given by:

$$\begin{aligned} \text{Gain in other operator's band} &< \text{Max repeater output} - \text{BTS Output Power} + \\ &\quad \text{Min_BTS_Rep_Path_Loss} \\ &< 19 - 39 + 69 \\ &< \mathbf{49\text{dB}} \end{aligned}$$

This represents a rejection of 21 dB compared to the repeaters in-band gain.

4.5 Summary of Outdoor Repeater Requirements

Table 4.4 below summarises the outdoor repeater requirements

Table 4.4 Outdoor Repeater Requirements

	Downlink	Uplink
Gain	70 dB	70 dB
Noise Level	-30 dBm (in-repeater-band) -44 dBm (out-of-rep.-band)	-23 dBm (in-repeater-band) -44 dBm (out-of-rep.-band)
Spurious	-36 dBm	-36 dBm
Third Order Intercept	+47.5 dBm	+40.5 dBm
1 dB Compression Point	29 dBm	+35 dBm

5. INDOOR REPEATER SCENARIO

Figure 5 below illustrates a typical indoor repeater scenario.

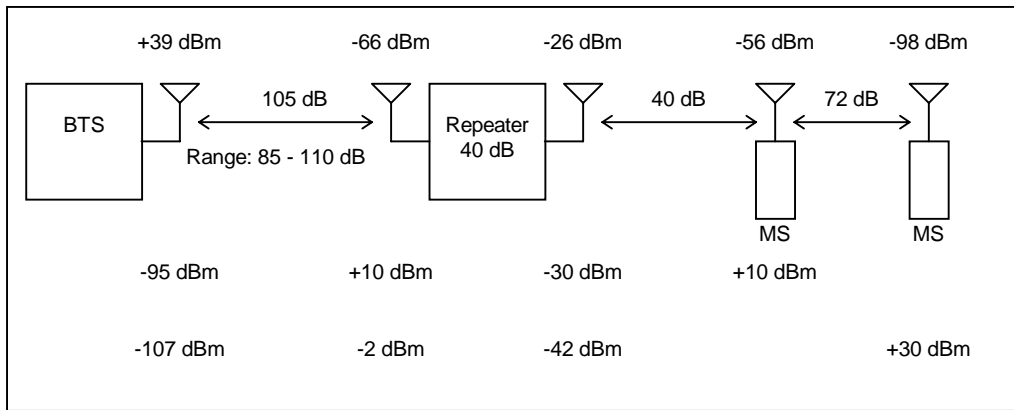

Figure 5 Indoor Repeater Scenario

The repeater is typically located in an area of marginal outdoor coverage (-95 dBm average signal strength at ground level) where in-building coverage cannot be achieved. By placing a directional antenna (20 dBi) on the roof of the building (10 dB gain from extra height and shadowing avoidance), the received signal strength can be increased to around -65 dBm, equivalent to a typical path loss between BTS and repeater antenna connectors of 105 dB. A variation of +5, -20 dB either side of this figure is to provide flexibility to deal with local site variations.

The minimum coupling loss between the MS and the repeater is assumed to be 40 dB, equivalent to a free space distance of 1.33 m.

It should be noted that with the -105 dB path loss between the BTS and repeater, the receive level at the BTS is -95 dBm, assuming the MS is fully powered down and at the MCL distance. This will be close to the minimum BTS signal level threshold required for powering down the mobile. Therefore, for BTS to repeater path losses of more than 105 dB, the MS may not get fully powered_down when at the MCL distance.

6. INDOOR REPEATER PERFORMANCE REQUIREMENTS

6.1 Wideband Noise

For the downlink, using the same calculation as in 4.1, the maximum wideband noise levels are:

In-repeater-band Noise Level < Output Power -C/I - BTS Power Control Range

(in 180 kHz) < -26 - 9 -30

< **-65 dBm**

Out-of-rep.-band Noise level < MS Sensitivity - C/I + MCL

< -100 -9 + 40

< **-69 dBm**

Assuming no post amplification filtering is employed, the out-of-repeater-band level is equivalent to a noise figure of 12 dB, which is readily achievable.

For the uplink, the in-repeater maximum noise level is given by:

In-repeater-band Noise level < BTS_Sensitivity - C/I + Min._BTS_Rep._Path_Loss

< -104 - 9 + 85

< **-28 dBm**

For the uplink out-of-band noise requirement it is proposed that the same level of **-44 dBm** is adopted as in the outdoor repeater case. This will protect desensitisation of uncoordinated BTSs with path losses of greater than +69 dBm.

6.2 Intermodulation Products and Spurious Emissions

In the downlink direction, it is proposed to reduce the permissible spurious and intermodulation product levels by 25 dB, from -36 to -61 dBm because of the reduced MCL.

For the intermodulation product with an output level of -6 dBm (for BTS to repeater path loss of 85 dB), this equates to a third order intercept point of:

TOI > (1.5 x Output Power) - (0.5 x Intermodulation Product Power)

> (1.5 x -6) - (0.5 x -61)

> **+21.5 dBm**

For the uplink to minimise costs of the indoor repeater amplifiers, it is proposed that the CEPT input of **-30 dBm** should apply to intermodulation products, rather than the **-36 dBm** GSM figure. This is justified on the basis that the much smaller coverage area of the indoor enhancer will make it unlikely for two MSs close to the enhancer to be using the same timeslot at the same time.

In calculating the third order intercept point requirement for intermodulation products the uplink repeater output level in figure 5 is increased by 5 dB in order to cover the case where the MS is not fully powered down. The third order intercept point therefore becomes:

TOI > (1.5 x Output Power) - (0.5 x Intermodulation Product Power)

> (1.5 x 15) - (0.5 x -30)

> **+37.5 dBm**

6.3 Output Power

In the downlink direction, allowing for ten carrier each at an output power of -6 dB (value for BTS to repeater path loss of 95 dB), the maximum output power, as determined the 1 dB compression point is **+4 dBm**.

In the uplink direction, as in the case of the outdoor repeater, it is important that the repeater does not seriously distort the initial access bursts transmitted at full power by a nearby MS. The required 1 dB compression point for correct amplification of such bursts is **+30 dB**.

6.4 Blocking by Uncoordinated BTS

The bandedge filtering should provide adequate rejection of other operators frequencies to ensure that the output power and intermodulation product requirements specified in section 6.2 and 6.3 are not exceeded if the repeater is placed close to a BTS of a different operator.

In order to ensure this the limit to the gain for the operators channels is given by:

$$\begin{aligned} \text{Gain in other operator's band} &< \text{Max repeater output} - \text{BTS Output Power} + \\ &\text{Min_BTS_Rep_Path_Loss} \\ &< -6 - 39 + 69 \\ &< \mathbf{24 \text{ dB}} \end{aligned}$$

This represents a rejection of 16 dB compared to the repeater's in-band gain. From a scenario perspective, this could be relaxed if higher downlink; output powers and TOI were implemented.

6.5 Summary of Indoor Repeater Requirements

Table 6.4 Indoor Repeater Requirements

	Downlink	Uplink
Gain	40 dB	40 dB
Noise level (in 180 kHz)	-65 dBm (in-repeater-band) -69 dBm (out -of-rep.-band)	-18 dBm (in-repeater-band) -44 dBm (out-of-rep.-band)
Spurious	-61 dBm	-30 dBm
Third Order Intercept	+21.5 dBm	+37.5 dBm
1 dB Compression point	+4 dBm	+30 dBm

ETSI SMG2 (Ad hoc meeting - Repeaters),

Tdoc SMG2 25/94

Meeting 1/94,

Rome, ITALY.

Title: Repeater Scenarios

Source: Vodafone

Date 8 March 1994

1. Introduction.

Tdoc SMG2 274/93 presented to the Madrid meeting introduced the concept of repeaters for use in rural and urban applications and the idea of shared repeaters through coordination between operators

This paper analyses the parameters affecting the performance of repeaters and the necessary constraints on the repeater device. Basic equations governing their performance are derived and applied to different repeater scenarios. This results in a draft specification for repeater devices and a number of planning rules that should be considered when installing repeaters.

2. Repeater performance.

In this section the basic equations defining the operation of a repeater are derived. The situation where two BTS, A and B (which may belong to different operators) are in the vicinity of a repeater is illustrated in figure 1. CL1 represents the BTS to repeater coupling loss and CL2 the MS to repeater coupling loss (terminal to terminal).

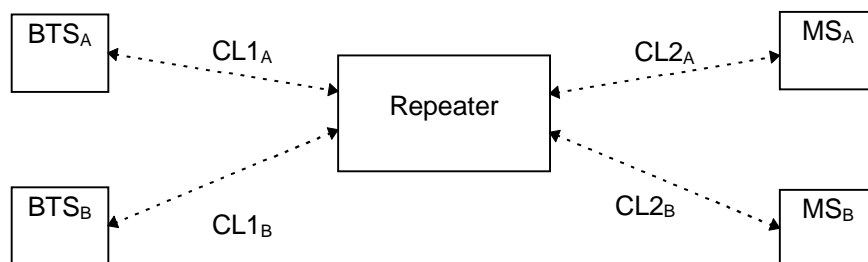

Figure 1

In the analysis, the following are assumed:

- Equal gain, G, is used in the uplink; and downlink; paths to maintain balance.
- The repeater complies with the CEPT requirements for spurious and IM3.

2.1 Link Equations

Consider the case for BTS_A . Assume that MS_A is power controlled through the repeater and a noise free system. Given a scenario requirement for the minimum MS_A to repeater coupling loss, $CL_{2A\ min}$, and BTS_A to repeater coupling loss, CL_{1A} , in the uplink direction:

$$[MS_{A_TXpwr_min}] - [CL_{2A\ min}] + [G] - [CL_{1A}] = [BTS_{A_RXlev_max}] \quad \text{Eq. 1}$$

$$\Rightarrow G = [BTS_{A_RXlev_max}] - [MS_{A_TXpwr_min}] + [CL_{1A}] + [CL_{2A\ min}]$$

Where $MS_{A_TXpwr_min}$ is the minimum transmit power for MS_A , G the repeater gain and $BTS_{A_RXlev_max}$, the maximum allowed receive level at the BTS before MS power control is applied. At the maximum coupling loss between MS_A and repeater, $CL_{2A\ max}$:

$$[MS_{A_TXpwr_max}] - [CL_{2A\ max}] + [G] - [CL_{1A}] = [BTS_{A_sensitivity}]$$

where $MS_{A_TXpwr_max}$ is the maximum MS transmit power for MS_A and $BTS_{A_sensitivity}$, the reference sensitivity level for BTS_A . The operating dynamic range for MS_A is:

$$[CL_{2A}max] - [CL_{2A}min] = [MS_A_TXpwr_max] - [MS_A_TXpwr_min] - [BTS_A_sensitivity] + [BTS_A_RXlev_max] \quad \text{Eq. 2}$$

and the repeater output powers in the uplink; and downlink; directions given by the equations:

$$\text{Uplink operating power} = [MS_A_TXpwr_min] - [CL_{2A}min] + [G]$$

$$\text{Max. uplink RACH power} = [MS_A_TXpwr_max] - [CL_{2A}min] + [G]$$

$$\text{Downlink operating power} = [BTS_A_TXpwr] - [CL_{1A}] + [G]$$

2.2 Co-ordinated Scenario

In the co-ordinated scenario, MS_B is also power controlled by BTS_B through the repeater. A similar analysis for BTS_B , leads to the following equations for the minimum MS transmit power, operating dynamic range and repeater output powers:

$$[MS_B_TXpwr_min] - [CL_{2B}min] + [G] - [CL_{1B}] = [BTS_B_RXlev_max] \quad \text{Eq. 3}$$

$$[CL_{2B}max] - [CL_{2B}min] = [MSB_TXpwr_max] - [MSB_TXpwr_min] - [BTS_B_sensitivity] + [BTS_B_RXlev_max] \quad \text{Eq. 4}$$

$$\text{Uplink operating power} = [MS_B_TXpwr_min] - [CL_{2B}min] + [G]$$

$$\text{Max uplink; RACH power} = [MSB_TXpwr_max] - [CL_{2B}min] + [G]$$

$$\text{Downlink operating power} = [BTS_B_TXpwr] - [CL_{1B}] + [G]$$

If the following assumptions are made,

$$MS_A_TXpwr_max = MS_B_TXpwr_max$$

$$CL_{2A}min = CL_{2B}min$$

$$\text{and } BTS_A_sensitivity = BTS_B_sensitivity$$

Then, subtracting Equation 4 from Equation 2, and using equations 1 and 3 to eliminate the minimum MS transmit powers leads to the difference in operating dynamic range between the two systems:

$$[CL_{2A}max] - [CL_{2A}min] - ([CL_{2B}max] - [CL_{2B}min]) = CL_{1B} - CL_{1A}$$

It can be seen that both BTS_A and BTS_B , must be equally coupled into the repeater if the operating dynamic range is to be optimised for both donor BTS.

In the co-ordinated scenario the repeater would be configured to operate across the whole of the GSM band.

2.3 Uncoordinated Scenario

In the uncoordinated scenario, MS_B will not be power controlled through the repeater. This is only true if the BTS-repeater-MS path loss is greater than the direct BTS-MS path loss.

It is important that the repeater wideband noise (see section 2.4) does not desense an uncoordinated MS. The repeater gain to uncoordinated signals also needs to be controlled, which will require filtering within the repeater device. At the minimum coupling loss, the level of enhanced signal/WBN for an uncoordinated MS should be at least 9 dB lower than the uncoordinated wanted signal level.

2.4 Wideband Noise

Noise considerations are likely to limit the maximum useable gain of the repeater. Considering thermal noise, in the GSM receiver bandwidth (assuming a bandwidth in kHz), the noise output of a repeater with noise figure NF and gain G is described by the equation:

$$\text{Noise output in GSM Rx BW} = -144 + 10 \cdot \log(RX_BW) + G + NF$$

For low CL2min and high gains, the wideband noise generated by the MS may be amplified by the repeater to a significant level. To prevent degradation of the BTS receivers, the repeater gain will be limited to the minimum value of G_1 or G_2 calculated from the following equations:

$$G_1 = [\text{BTS sensitivity}] - [\text{C/I margin}] - [\text{MS WBN in Rxr BW}] + [\text{CL2min}] + [\text{CL1}]$$

$$G_2 = [\text{BTS sensitivity}] - [\text{C/I margin}] + [\text{CL1}] - (-144 + 10 \cdot \log(\text{RX_BU})) - [\text{NF}]$$

2.5 3rd order Intermodulation (IM3) performance/Spurious emissions:

If N carriers, each with output powers RPT_TXpwr, are amplified by a repeater with a 3rd order intercept point ICP, the highest level of 3rd order intermodulation tones produced P_{IM3} is given by the formula:

$$P_{\text{IM3}} = \text{RPT_TXpwr} - 2(\text{ICP} - [\text{RPT_TXpwr}]) + 20 \log(N/2)$$

Therefore, to meet the CEPT limits of -36dBm below 1 GHz and -30 dBm above 1 GHz, the repeater should have an output intercept point calculated as follows:

$$\text{ICP} = (3 \cdot [\text{RPT_TXpwr}] - [\text{CEPT limit}]) / 2 + 10 \log(N/2)$$

Where an IM3 tone is generated in the duplex passband, sufficient isolation is required between the duplex paths of the repeater to prevent re-amplification of the IM3 product in the duplex path. The requirement on the BTS IM3 products in the BTS receive band of -91 dBm exists to protect the BTS receivers from their respective transmitters and co-located operators BTS transmitters. In practice close coupling between a BTS and repeater should be avoided if spurious/IM3 products or wideband noise from a BTS is not to be amplified by the high repeater gain. Therefore, the -91 dBm BTS requirement is not necessary for the repeater. With careful planning of the repeater site the CEPT limits are sufficient.

Spurious emissions should meet the -36 dBm CEPT requirement.

In normal operation, the IM3 products generated by the repeater will be largely due to intermodulation between BCCH/TCH bursts. However, during RACH bursts increased levels of IMP will be produced in the uplink path. Automatic gain control (AGC) that is activated at a threshold above the normal uplink operating power may be necessary to prevent these increased levels from exceeding the CEPT limits.

The AGC threshold will be set 3 dB above the maximum allowed power per tone for two tones whose IM3 products just meet the CEPT limits. Careful design of the attack and delay characteristics of the AGC is required to prevent adverse interactions with MS power control and this is for further study. When AGC is activated, all channels operating, through the repeater will be subject to a gain reduction.

3. Repeater scenarios

Example repeater scenarios are presented below. The figures have been calculated using the equations derived in sections 2 and 3.

3.1 Rural scenario

Typical parameters for a repeater operating in a rural environment are:

CL1:	90 dB
CT2min:	75 dB
MS_TXpwr_max:	39 dBm (class 2)
MS_sensitivity:	-104 dBm
BTS_TXpwr	43 dBm
BTS_Rxlev_rmax:	-70dBm
Repeater noise figure	8 dB
N (no of carriers)	4

Assuming that the MS is powered controlled down to 30 dBm at CL2min ($\text{MS_TXpwr_min} = 30 \text{ dBm}$), the repeater operating parameters are as follows:

Dynamic range:	43 dB
Gain:	65 dB
Uplink operating power:	20 dBm
Downlink operating power:	18 dBm
Min. 3rd order ICP	51 dBm (based on 20 dBm operating power)

3.2 Urban Scenario

Typical parameters for a repeater operating in a rural environment are:

CL1:	80 dB
CL2min:	45dB
MS_TXpwr_max:	33 dBm (class 4)
MS_sensitivity:	-102 dBm
BTS Txpwr:	36 dBm
BTS_Rxlev_max:	-70 dBm
Repeater noise figure	6 dB
N (no of carriers)	2

Assuming that the MS is powered controlled down to 20 dBm at CL2min (MS_TXpwr_rnin = 20 dBm), the repeater operating parameters are as follows:

Dynamic range:	47 dB
Gain:	35 dB
Uplink; operating power:	10 dBm
Downlink; operating power:	-9 dBm
Min. 3rd order ICP	36 dBm

4. Summary

It has been illustrated how repeater devices operate in the co-ordinated and uncoordinated environments. Example figures have been presented based on urban and rural scenarios. The following repeater specification and planning considerations are proposed.

4.1 Repeater Specification

Selectivity out of band (i.e. outside the GSM band):

Offset from band edge	Filter rejection
1 Mhz	30 dB
2 MHz	50 dB

Spurious Emissions (including wideband noise):

Below 1 GHz:	less than -36 dBm measured in 100 kHz bandwidth.
Above 1Ghz:	less than -30 dBm measured in 100 kHz bandwidth.

Intermodulation products:

Below 1 GHz:	less than -36 dBm measured in 100 kHz bandwidth.
--------------	--

Above 1 Ghz: less than -30 dBm measured in 100 kHz bandwidth.

4.2 Planning considerations

The following planning rules are proposed:

- Where a number of BTS operate through a repeater, operators must consider carefully the coupling between BTS and repeater. The operating dynamic range will only be optimised for all BTS when they are equally coupled into the repeater.
- When selecting a repeater site consideration needs to be given to the proximity of the repeater to uncoordinated BTS. IM3 products/WBN generated in the BTS receive band by the repeater may be transmitted at a level defined by the CEPT limit. This requires a minimum coupling loss:

$$[CL1min] = [CEPT\ limit] - [BTS\ sensitivity] + [C/I\ margin]$$

Below 1 GHz this equates to 77 dB. Where IM3 products generated by the repeater are the limiting factor, separate repeater transmit and receive antennas can be used to reduce the minimum coupling loss.

- For co-ordinated MS, the maximum repeater gain shall be the minimum value of G_1 , G_2 and G_3 , calculated from the following equations.

$$G_1 = [BTS\ sensitivity] - [C/I\ margin] - [MS\ WBN\ in\ Rxr\ BW] + [CL2min] + [CL1]$$

$$G_2 = [BTS\ sensitivity] - [C/I\ margin] + [CL1] - (-144 + 10*\log(RX_BW)) - [NF]$$

$$G_3 = [BTS_A_RXlev_max] - [MS_A_TXpwr_min] + [CL1] + [CL2min]$$

- For uncoordinated MS, filtering is necessary to reject the uncoordinated frequencies from the repeater. When selecting a repeater site, operators should implement sufficient filtering of uncoordinated frequencies to ensure that the following is satisfied. At CL2min (the minimum coupling loss between MS and repeater), uncoordinated frequencies enhanced by the repeater shall be at least 9 dB below the wanted signals of the uncoordinated operator.
- These factors will require review during the lifetime of the repeater to account for the developments in both the co-ordinated and uncoordinated networks.

ETSI SMG-2 ad-hoc

Sophia Antipolis 12 July 1994

REPEATER OUT OF BAND GAIN

Source: Hutchison Telecom.

This paper proposes additional text to GSM 05.05 Annex E (normative): Repeater characteristics and GSM 03.30-RPT Version Annex D PLANNING GUIDELINES FOR REPEATERS. There is also text describing the background to the requirements.

GSM 05.05 Annex E (normative): Repeater characteristics

4. Out of band Gain

The following requirements apply at all frequencies from 9 kHz to 12.75 GHz excluding the GSM/DCS1800 bands defined in GSM 05.05 and declared by the manufacturer as the operational bands for the equipment.

The out of band gain in both directions through the repeater shall be less than +25 dB at [5] MHz and greater from the GSM and DCS1800 band edges. The repeater gain shall fall to 0 dB at [10] MHz and greater from the GSM and DCS 1800 band edges.

In special circumstances additional filtering may be required out of band and reference should be made to GSM 03.30.

PLANNING GUIDELINES FOR REPEATERS**6. Indoor Repeater Scenario**

For equipment used inside public buildings where other communication systems could operate in very close vicinity (less than [5]m) of the repeater, antennas special care must be taken such that out of band signals are not re-radiated from within the building to the outside via the repeater system and vice versa. When using repeaters with an antenna mounted on the outside of a building the effect of any additional height gain should be considered. If the close coupled communication system is usually constrained, within the building it may be necessary to consider the negation of building penetration loss when planning the installation. It is the operator's responsibility to ensure that the out of band gain of the repeater does not cause disruption to other existing and future co-located radio communication equipment. This can be done by careful choice of the repeater antennas and siting or if necessary, the inclusion of in-line filters to attenuate the out of band signals from other systems operating in the close vicinity of the repeater.

The following equation can be used to ensure an adequate safety margin in these cases:

$$G_{\text{sys}} \leq G_{\text{com}_3} + CL_3 - M_s$$

Where G_{sys} is the out of band repeater gain plus the gain of external repeater antenna less the cable loss to that antenna. G_{com_3} is the antenna gain of the close coupled communication system (use 2dBi if not known). CL_3 is the measured or estimated out of band coupling loss between the close coupled communication system and the repeater (terminal to terminal) and M_s is the safety margin which should include the height gain of the external repeater antenna plus, if appropriate, the out of band building penetration loss (use 15dB if not known). See above.

REPEATER OUT OF BAND REQUIREMENT BACK GROUND

Consider the signals passing between two systems, which could be any desired radio communication systems (eg. mobile to base) or incompatible systems (eg. two different mobiles or bases operating on the same frequency). There will be a path loss between these systems which we need to ensure is not significantly affected by the addition of a GSM/DCS repeater in the environment. These systems are uncoordinated with GSM/DCS and the words *out of band* are used below to refer to the repeater performance outside of the allocated GSM/DCS bands. See below:

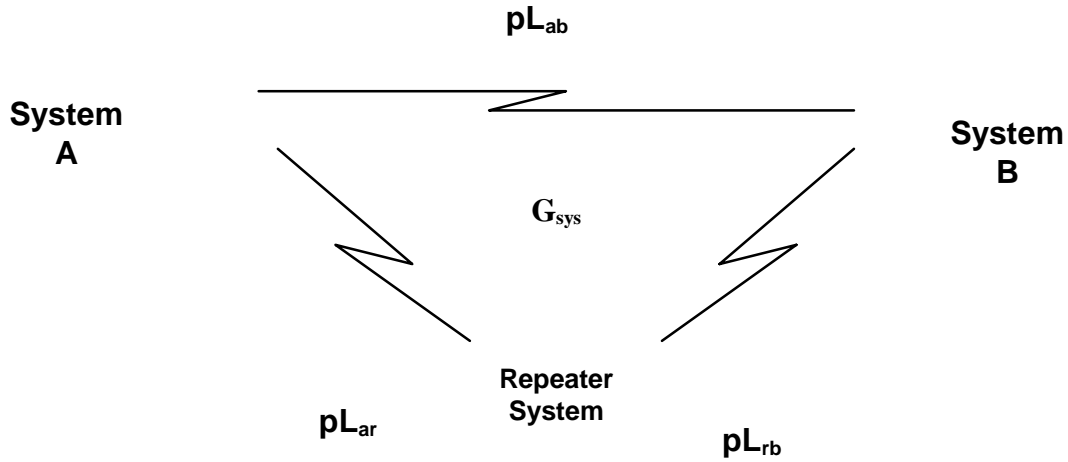

Taking the simple outdoor case first and assuming a general propagation loss model of the form $C + k \log(r)$ the total gain budget between System A and System B via a repeater system with out of band gain G_{sys} (which includes antenna gain) is:

$$-pL_{ar} + G_{sys} - pL_{rb} = -2C - k(\log x + \log y) + G_{sys} \quad \text{dB}$$

Where x is the distance from System A to the repeater system and y is the distance between the repeater and System B.

Thus the minimum total path loss occurs when either x or y is at its minimum value independent of the propagation type. In other words the worse case situation will arise when the repeater is physically close to one or other of the systems (A or B). In this case the "direct" path loss pL_{ab} can be assumed to be very similar to the path loss from the repeater system to the far system excluding, for the moment, any differences in the height gain. i.e.: $pL_{ab} \cong pL_{rb}$ for System A close to the repeater System.

The coupling losses between the radio stations in each system will also depend upon the respective antenna gains. In the following situation a repeater and Station A are closely coupled.

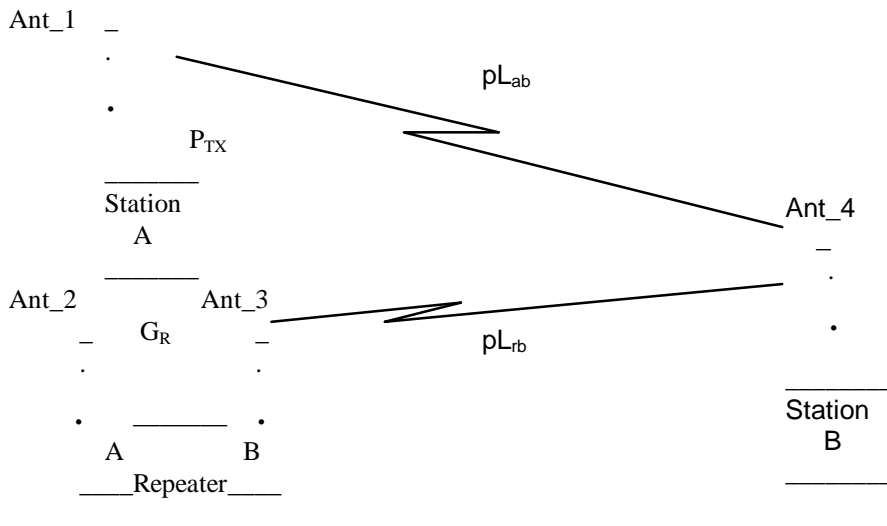

Since the path loss between System B and the repeater (pL_{rb}) and System A and B (pL_{ab}) is similar for a closely coupled situation it is useful to compare the EIRP of a signal transmitted from Station A with the signal re-transmitted from the repeater.

$$EIRP_A = P_{TX} + G_{ANT_1}$$

$$EIRP_R = P_{TX} - C_{ar} + G_R + G_{ANT_3}$$

Where C_{ar} is the close coupling loss between the terminals of System A and the repeater, G_R is the gain of the repeater in the direction A to B, G_{ANT_1} and G_{ANT_3} are the gain of Ant_1 and Ant_3 respectively (including cable loss).

If we constrain $EIRP_R$ to be less than $EIRP_A$ by a safety margin M_S dB to "protect" System B against height gain differences between Ant_1 and Ant_3 and any other implementation factor we wish to include (eg: building penetration losses) then:

$$EIRP_R + M_S + EIRP_A$$

And the repeater gain at a given frequency out of band should be:

$$G_R \leq G_{ANT_1} + C_{ar} - G_{ANT_3} - M_S$$

The above also holds for the effect of System B upon A if the value of repeater gain out of band in the direction B to A is substituted for G_R .

This value of gain would ensure that an out of band system would see an added component via the repeater no greater than the "direct" path. This must be considered further for the case when the systems A and B are part of a desired radio communication link. The worse case scenario would be if a direct line of sight exists between Ant_4 and Ant_1 and also Ant_3, producing strong Rayleigh fading. Although this is unlikely since Ant_1 and Ant_2 must be closely coupled and Ant_2 must be physically remote from Ant_3 to achieve the desired isolation in band operators should take steps to avoid this occurrence. In a typical urban situation a large number of multipath components are more likely and the effect of the repeater would be to increase the signal mean (about 3 dB?) and erode some of the fade margin. This should be well within the implementation margin of all mobile communication systems. It is not anticipated that static communication systems would suffer either (however if the unforeseen case arose the repeater antenna could be easily re-sited to give the required isolation). Note that the susceptible area will depend upon the directional properties of Ant_3 and therefore will be smaller for a higher gain antenna.

Since the out of band frequency response adjacent to the inband frequencies will be the most design critical the values for parameters in band are used for the out of band frequencies. Thus the values given in GSM 03.30 can be used in the limiting case to calculate the safety margin for the adjacent out of band systems.

Taking the scenario for a repeater antenna mounted on a building or tower with undesired close coupling between an out of band system and the repeater at ground level, GSM 03.30 gives a value for height gain of 9 dB for a change in reference height from 1.5 to 10 m. A safety margin of +9dB is proposed for the outdoor case.

A practical figure of 50dB for the close coupling (terminal to terminal) is proposed for C_{ar} . The worst case re-radiation of undesired signals arises when the gain of Ant_3 is much larger than the gain of Ant_1, therefore the following figures are used to calculate the out of band gain for the repeater from the equation above:

$$M_S = +9 \text{ dB}$$

$$C_{ar} = 50 \text{ dB}$$

$$G_{ANT_3} = +18 \text{ dBi}$$

$$G_{ANT_1} = +2 \text{ dBi}$$

This gives the maximum bi-directional out of band gain for the repeater as + 25 dB for the worst outdoor case.

In the vast majority of cases the coupling loss between the repeater and the out of band communication system will be greater than 50 dB and the safety margin accordingly much higher. For out of band frequencies far from the inband frequencies the safety margin above will not degrade therefore a roll off in the repeater response does not seem to be necessary but has been included in the specification to avoid leaving the gain wideband and uncontrolled. Further study is required to check that transmitted power levels from out of band systems will not compromise the in-band performance with this level of gain.

In-building Public, Case

The scenario below is relevant to a repeater installed in a public building where other out of band communication systems may be operating in close vicinity. If close coupling between an indoor out of band system and a repeater with an externally mounted antenna takes place the normal building penetration loss are not experienced by the out of band

system, this will affect the safety margin. Figures for building penetration losses are notoriously varied and a range of values for building penetration losses are discussed in GSM 03.30. A value of 15 dB is proposed as representative. Building penetration losses tend to increase with frequency and this will affect the safety margin. On the other hand path losses are greater at higher frequencies so that the areas that might be affected are smaller. It is possible that the externally mounted repeater antenna may have additional height gain if it is mounted on an upper floor. In these cases it is the responsibility of the operator to ensure that close coupling between an out of band system and the repeater is avoided or reduced to cause no disruption to other radio communication systems.

Because of the range in operational and installation possibilities it is more appropriate to give general guidance in GSM 03.03 on the use of in-building repeaters rather than to specify a gain figure for indoor applications. A simple formulae to estimate the maximum gain the repeater should be set to is given in GSM 03.30 to allow the operator to plan installations on a site by site basis.

Annex F: Error Patterns for Speech Coder Development

F.0 Introduction

This Annex attempts to summarise all necessary background information for "Error Patterns for Speech Codec Development", (Change request SMG 117/96 to GSM 05.50, SMG2 TDoc 164/95). The Annex contains information on the file structure and the usage of given soft decision values.

F.1 Channel Conditions

The number of test conditions have to be limited in order not to have too many subjective test conditions. Therefore pure rayleigh fading has been chosen as a propagation condition. This condition represents all multipath conditions which have a delay spread significant shorter than one bit period (3.7μ seconds.). Therefore the pure rayleigh fading statistics of bit errors is similar to those of TU and RA (although this is a rice statistic) propagation conditions. Even for HT the energy of paths with big delay is small compared to the energy transmitted in the first bit period. Therefore the HT bit error statistics is not so far away from pure rayleigh fading. Significant differences can be expected for EQ conditions or a real two path model with equal strength of both paths. Nevertheless pure rayleigh fading seems to be sufficient for speech codec optimization.

For the FH case vehicular speed within one time slot is assumed to be zero and consecutive time slots are completely decorrelated (ideal FH). It has to be noted that up to 200 /100 km/H for GSM /DCS the variation of the channel impulse response within one time slot can be neglected. Also for RA250 / 130 the effect is not very big. Therefore no vehicle speed within one time slot is a reasonable assumption. Complete decorrelation of consecutive time slots can be achieved by a vehicle speed of 70 / 35 km / h for GSM/ DCS without FH or by FH over a sufficient frequency range depending on the vehicular speed (4 frequencies spread over 10 Mhz should be sufficient to achieve almost ideal FH performance at low vehicular speed). Therefore ideal FH is a good assumption for a lot of cases in GSM. Especially at the beginning of GSM FH is not always available. Therefore for TCH / HS development two error patterns without FH and 3 km / h were provided.

As a disturbance source co-channel interference has been chosen .It can be stated that the bit error statistics for the noise and adjacent channel interference is similar to co-channel interference. Therefore this condition is sufficient for codec development.

F.1.1 Simulation Conditions

All simulations are based on floating point calculations in all parts of the transmission chain. No quantization effects are taken into account. Channel filtering is assumed in order to achieve the performance for co-and adjacent channel performance. No tolerance of the filter bandwidth are taken into account . The equalizer consists of a 16 state viterbi equalizer.

F.1.2 Available Error Patterns

For TCH/ HS 6 error patterns were available. They are described in the attached documents from 1991. Due to the fact that this error patterns are not available anymore at ETSI 4 new patterns with ideal FH and co-channel interference have been produced and will be distributed SEG (4, 7, 10 and 13 dB).

F.2 Test Data for the half rate speech coder

F.2.1 File description

This section gives a description of the test pattern available for the development of the half rate speech coder and the associated channel coding.

All files mentioned in this document are recorded on 1600 BPI.

There are six different test patterns : EP1, EP2, EP3, EP4, EP5 and EP6. Two files are available for each error pattern. The first one contains the soft decision values and chip errors and the second the error patterns of the corresponding TCH / FS channel. All test patterns are generated under the condition of rayleigh fading and co-channel interference.

EP1/ 2 / 3 are without any speed (no doppler spectrum) but with frequency hopping over an unlimited number of frequencies. This means, that the fading of different time slots is uncorrelated.

EP4 and EP5 is without frequency hopping and the mobile speed is 3 km/h.

EP6 is with a random input (noise).

In the following table the file names are given for each test pattern.

Test pattern	File name Soft decision values and chip error patterns	File name Error pattern TCH / FS
EP1	SDCEPCI10RFFH_1.DAT	EPTCHFSCI10RFFH_1.DAT
EP2	SDCEPCI7RFFH_1.DAT	EPTCHFSCI7RFFH_1.DAT
EP3	SDCEPCI4RFFH_1.DAT	EPTCHFSCI4RFFH_1.DAT
EP4	SDCEPCI10RFNFH_1.DAT	EPTCHFSCI10RFNFH_1.DAT
EP5	SDCEPCI7RFNFH_1.DAT	EPTCHFSCI7RFNFH_1.DAT
EP6	SDCEPRAN_1.DAT	EPTCHFSRAN_1.DAT

F.2.2 Soft decision values and chip error patterns

Each file consists of 6001 records with a fixed record length of 512 byte.

The program RCEPSD.FOR can read these files (FORTRAN 77). The error patterns and soft decision values of selected records are written to SYS\$OUTPUT. The first record contains some parameters of the simulation in the order as described in the following:

1. NTSLOT : number of times slots (INTEGER*4)
2. EBN : Chip energy divided by noise density (REAL*4)
if greater than 50 no noise at all
3. SIDB : co-channel interference C/I (REAL *4)
if greater than 50 no interference at all
4. LFN : Indication frequency hopping (LOGICAL* 4)
=.TRUE with frequency hopping
=.FALSE. without frequency hopping

In the following records the time slots of a GSM full rate TCH are stored (two half rate channels). The test data are starting at the beginning of a 26-frame multiframe. One record contains four time slots and each time slot consists of $2 \times 57 = 114$ bytes (one byte for one info chip of a time slot). The last 56 byte of each record are not used. Each byte contains a seven bit integer value and a sign (twos complement representation, range -128 to 127). This data representation is supported by VAX FORTRAN 77 BYTE representation. The soft decision value of a demodulated chip can be calculated by dividing the stored integer value by eight and by taking the absolute value. If the chip is demodulated correctly, the sign is positive and in the case of a chip error the sign is negative. The soft decision information is given by the following equation:

$$sd = - \ln(P_e / (1 - P_e))$$

P_e - error probability of a chip

In the case of a TCH/FS the error patterns can be used in the following way (multiplication of the bits with the soft decision values including the sign):

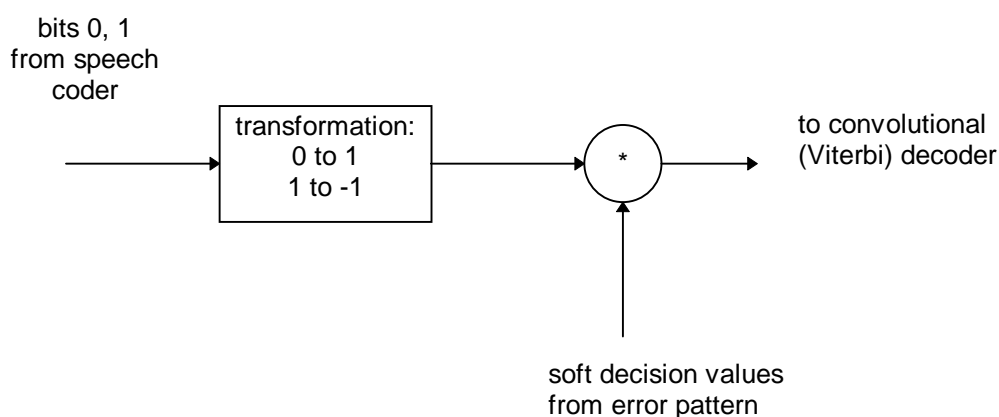

Figure A.1

The input of the Viterbi decoder can be used for the metric computation in the usual way. For the TCH / HS the error patterns can be used in the same way for convolutional coding. If block codes with hard decision only are used the soft decision has to be exchanged by the hard decision value.

F.2.3 Error patterns of corresponding TCH/FS

These error patterns are generated from the soft decision values described above. They consist of the error positions of the speech frames. The program REPTCHFS.FOR can read files containing error patterns of a TCH / FS (FORTRAN 77). The record length used in the files is not fixed. The following table gives the structure of the file. Each line is one record:

NBITCI, NBICHI, IDUMMY	3 values INTEGER*4
NLOOP	1 value INTEGER*4
LFH	1 value LOGICAL*4
EBN	1 value REAL*4
SIDB	1 value REAL*4
DUMMY	1 value REAL*4
ILOOP	1 value INTEGER*4
NFEHLERG, IED	2 values INTEGER*2
IFV(I), I=1,.....,NFEHLER	NFEHLERG values INTEGER*4

ILOOP	1 value INTEGER*4
NFEHLERG, IED	2 values INTEGER*2
IFV(I), I=1,.....,NFEHLER	NFEHLERG values INTEGER*4
ILOOP	1 value INTEGER*4
NFEHLERG, IED	2 values INTEGER*2
IFV(I), I=1,.....,NFEHLERG	NFEHLERG values INTEGER*4
-1	1 value INTEGER*4
PFEHLCI,PFEHVCII,DUMMY	3 values REAL*4

In the following example the variables are described with more details:

NBITCI	- number of bits in class I
NBITCII	- number of bits in class II
EBN, SIDB, LFH	- as described above
NLOOP	- number of the next speech frames
ILOOP	- position of the next speech frame with bit errors 1 i= ILOOP i= NLOOP
NFEHLERG	- number of errors in this speech frame
IED	- bad frame indication of this speech frame = 1 : bad frame detected = 0 : no bad frame detected
IFV (I)	- array with all error positions in this speech frame: possible positions of class I : 1,.....,182 possible positions of class II : 183,.....,260
PFEHLCI	- error probability class I
PFEHLCII	- error probability class II
DUMMY, IDUMMY	- these values have no information (for compatibility reasons necessary)

Speech frames without any errors are not included in the error pattern.

The number of correct speech frames can be calculated by the difference of numbers ILOOP. The end of the error pattern is indicated by the ILOOP =-1.

In the data delivered by the TCH / FS speech coder bits have to be changed at the positions indicated in the error patterns.

Annex G: Simulation of Performance

G.1 Implementation Losses and Noise Figure

All simulations are based on floating point calculations in all parts of the transmission chain. No quantization effects are taken into account. Channel filtering is assumed in order to achieve the performance for co.- and adjacent channel performance. No tolerance of the filter bandwidth are taken into account. In order to cover the performance of a real receiver an additional implementation margin of two dB shall be allowed. This means, that a simulated value at 7 dB C/I_c corresponds to the performance of a real receiver at 9 dB C/I_c . Taking a reasonable noise figure (8 dB) into account a simulated value of 6 dB E_b/N_0 corresponds to the performance of a real receiver at 8 dB E_b/N_0 which corresponds to the ref. Sensitivity input level of GSM 05.05.

G.1.1 Assumed Equalizer

The equalizer consists of a 16 state viterbi equalizer.

G.1.2 Accuracy of Simulations

At very low error rates the accuracy of the simulations become poor. The following table gives the lowest error rate for a certain GSM channel at which error rates can be taken from the simulations.

TCH / F4.8 10^{-4}

TCH / F2.4 10^{-5}

TCH / H2.4 10^{-4}

In case that a simulated value is below the given minimum in the curves the minimum is indicated.

G.1.3 Simulation Results

Fig 1 to 18 show the performance (simulated values) for ref.sensitivity and dynamic propagation conditions.

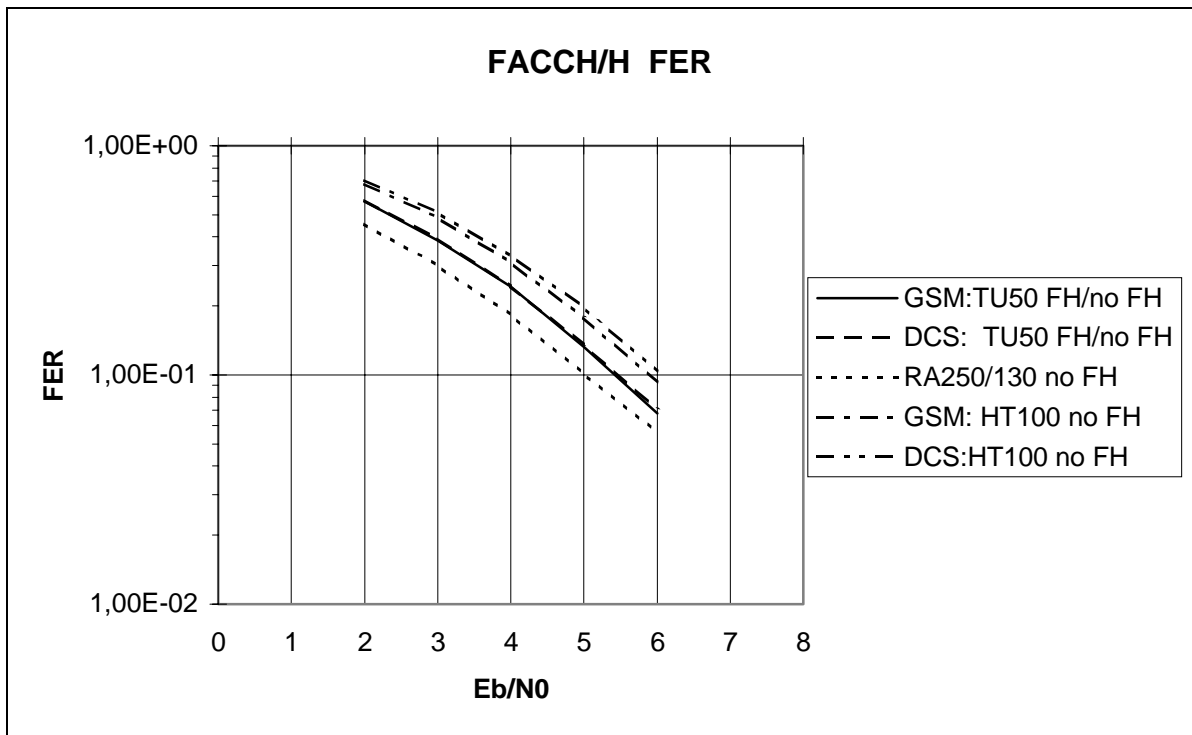

Figure 1

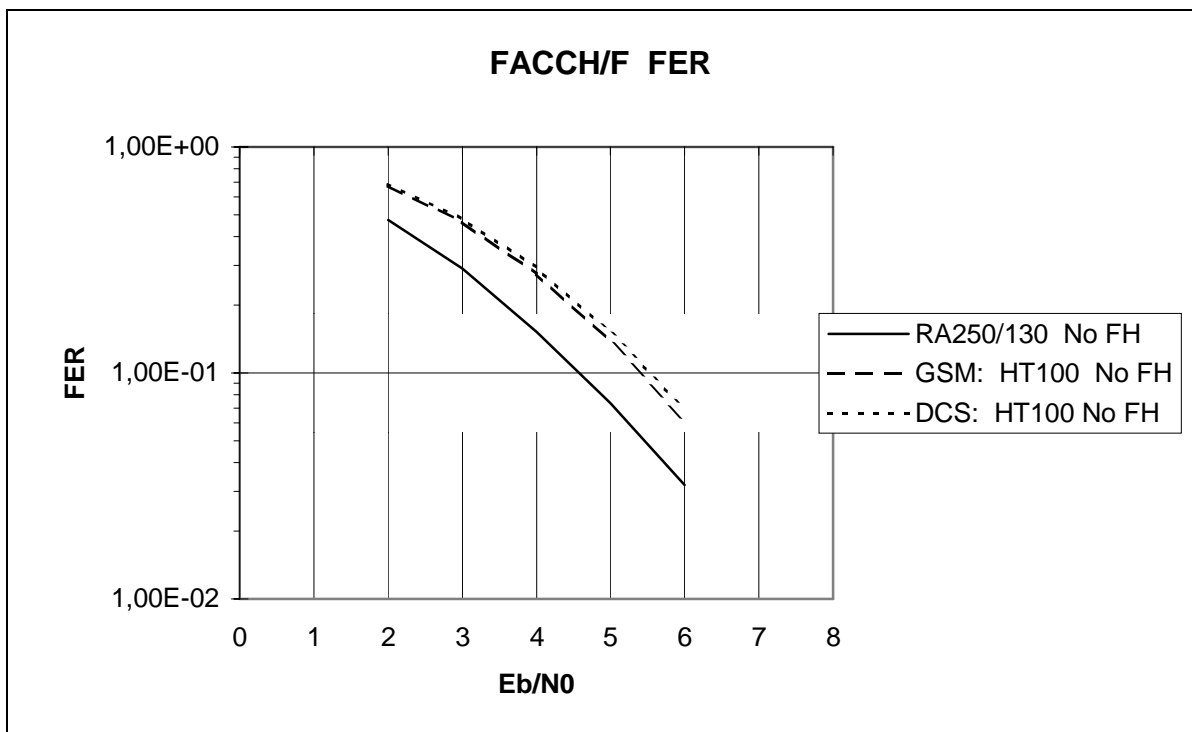

Figure 2

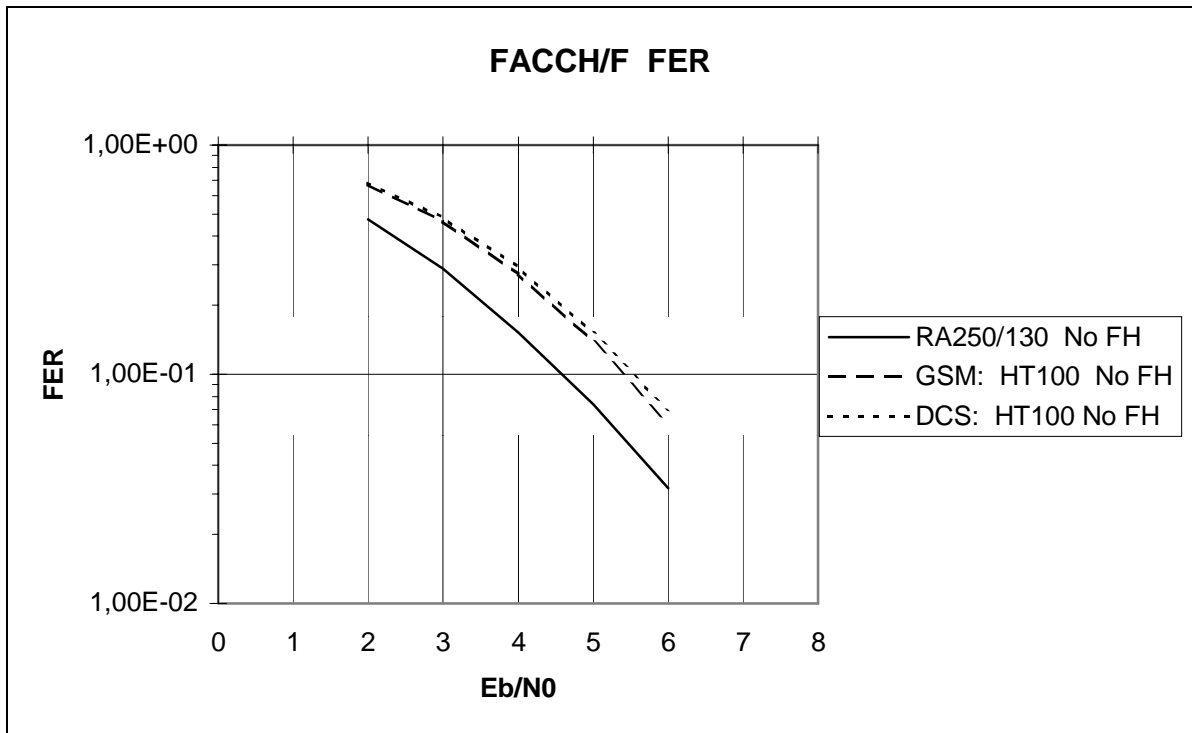

figure 3

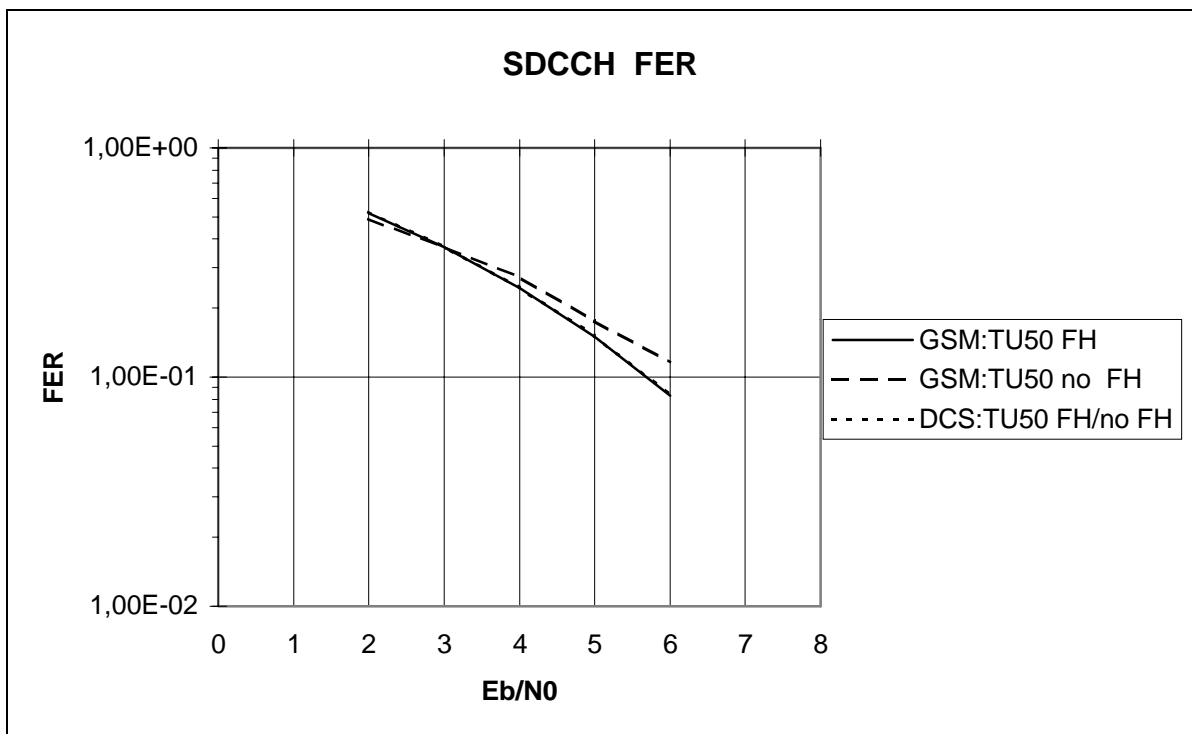

Figure 4

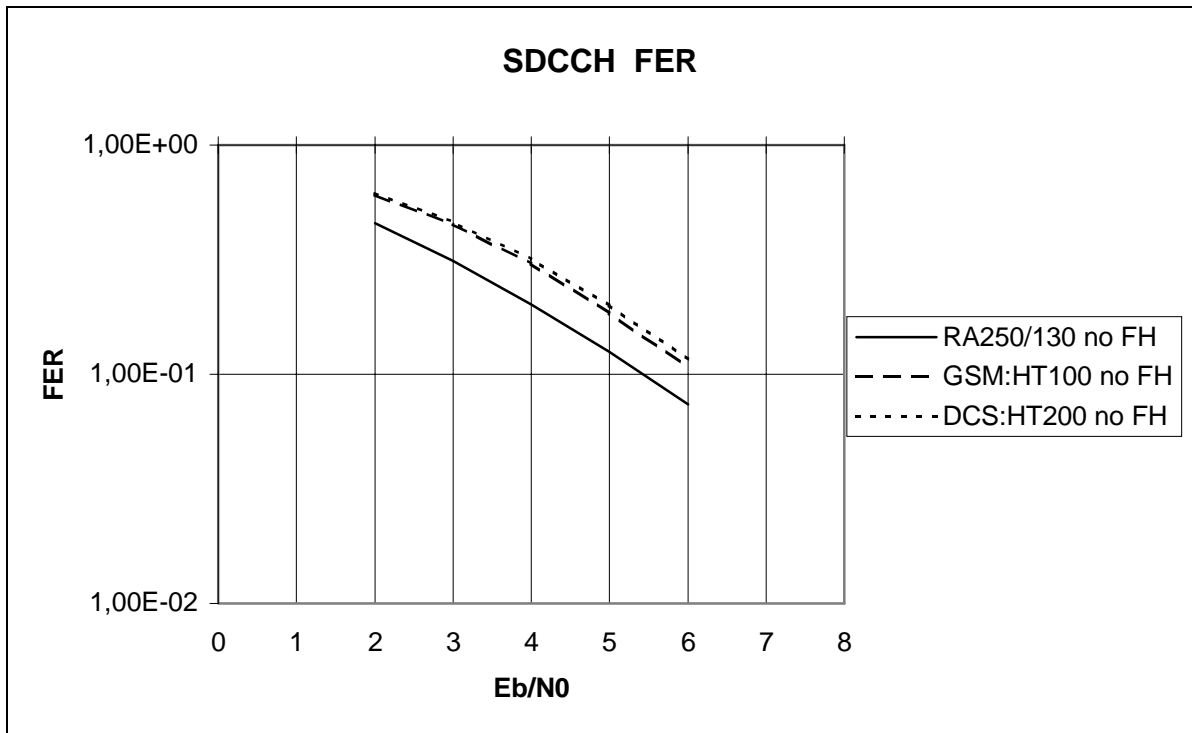

Figure 5

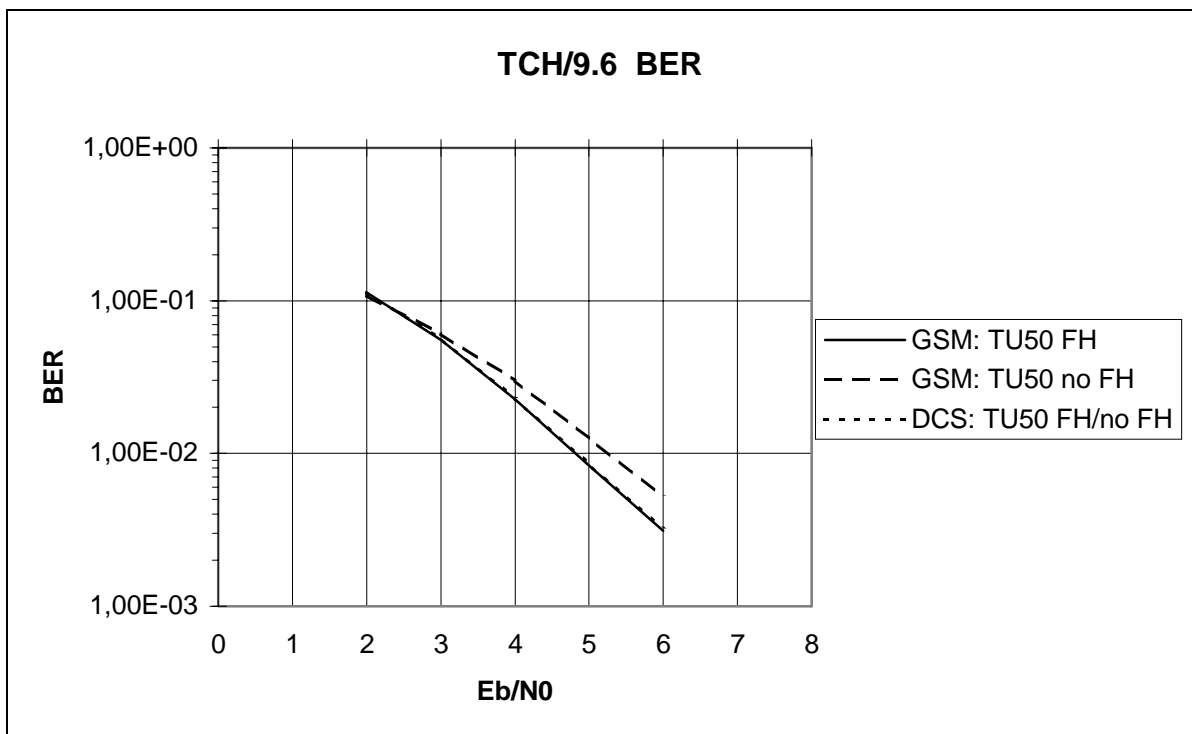

figure 6

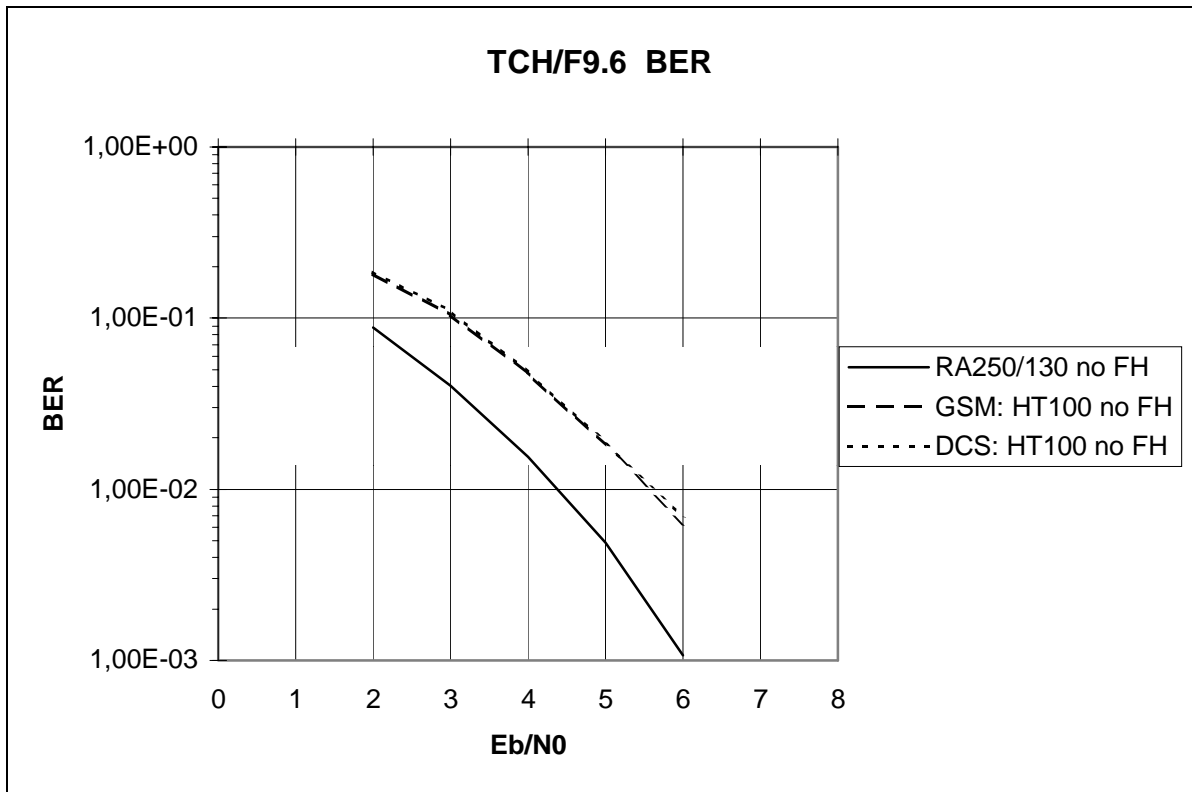

figure 7

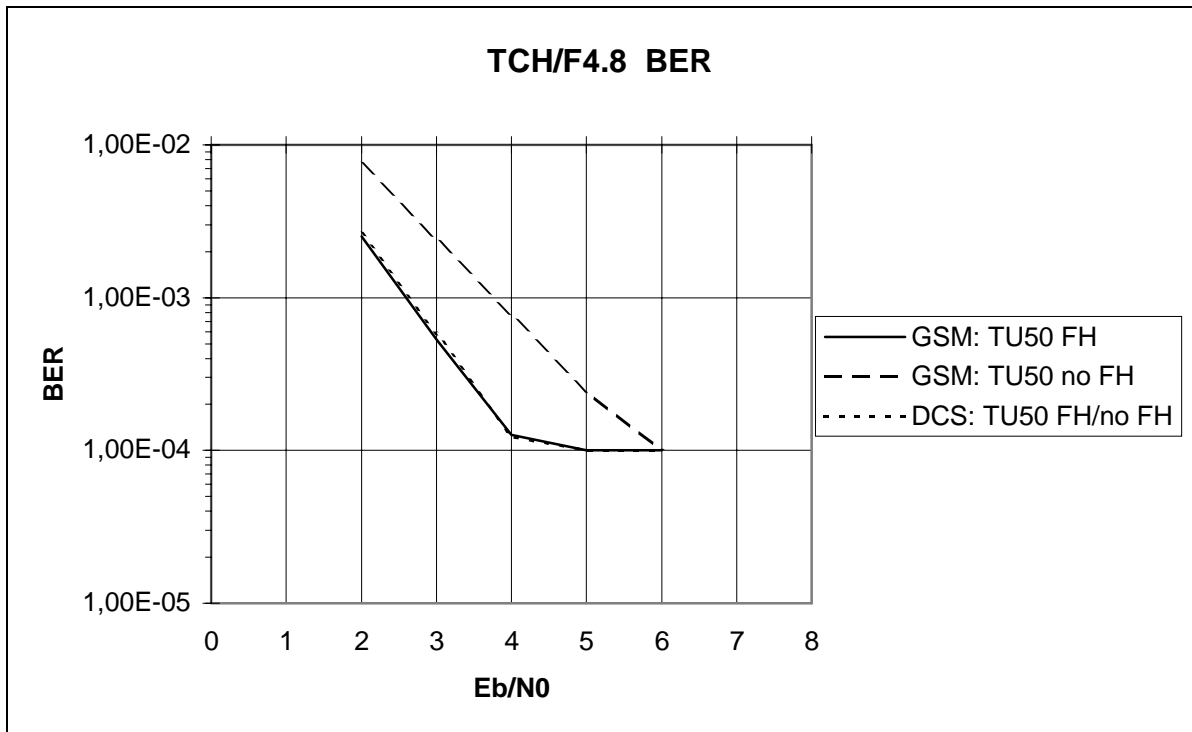

figure 8

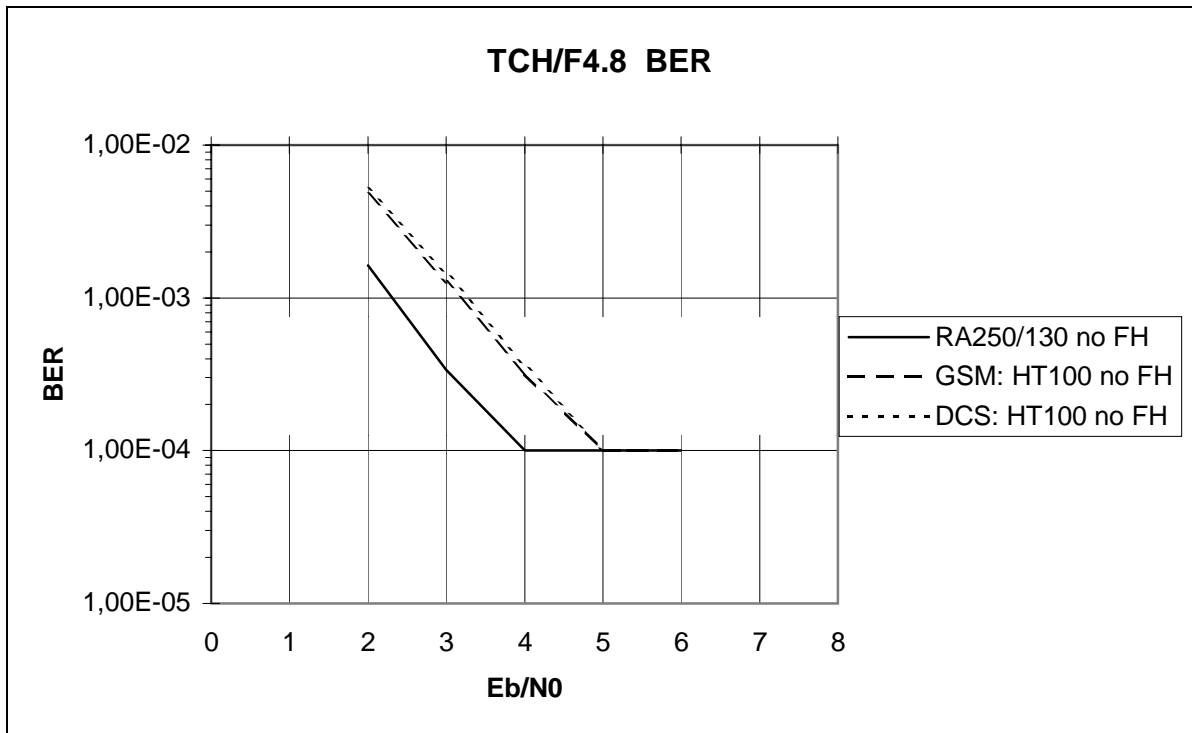

figure 9

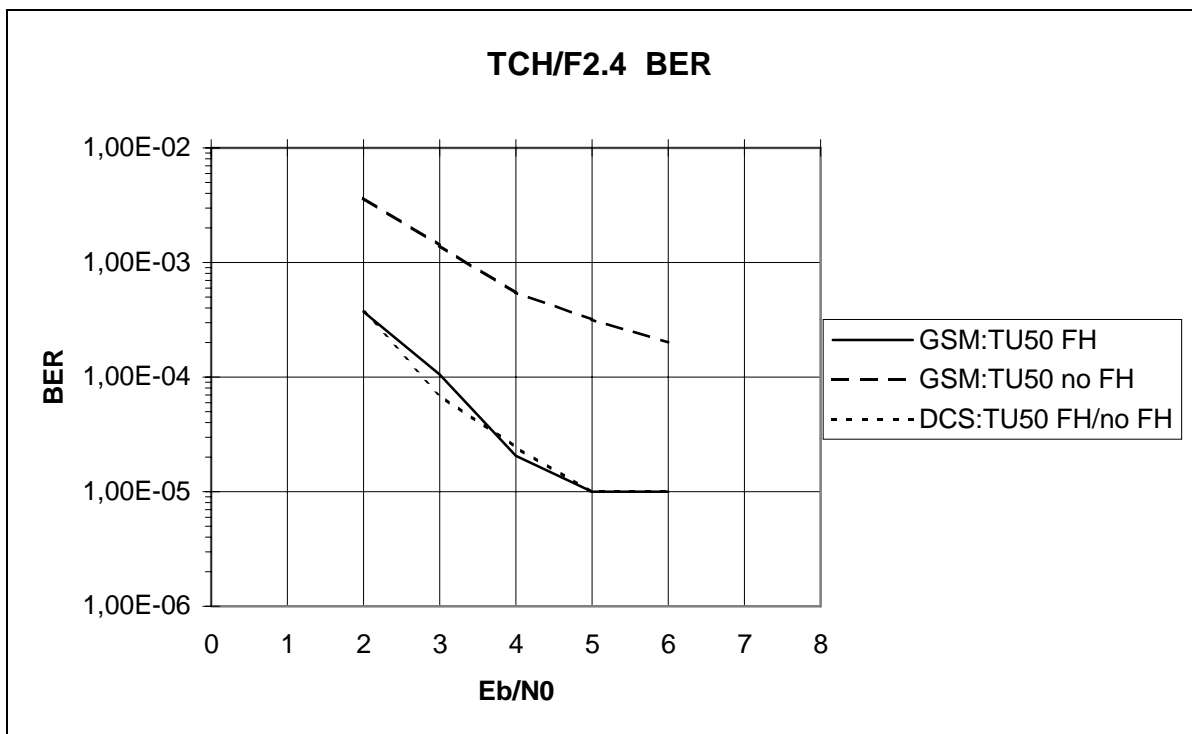

figure 10

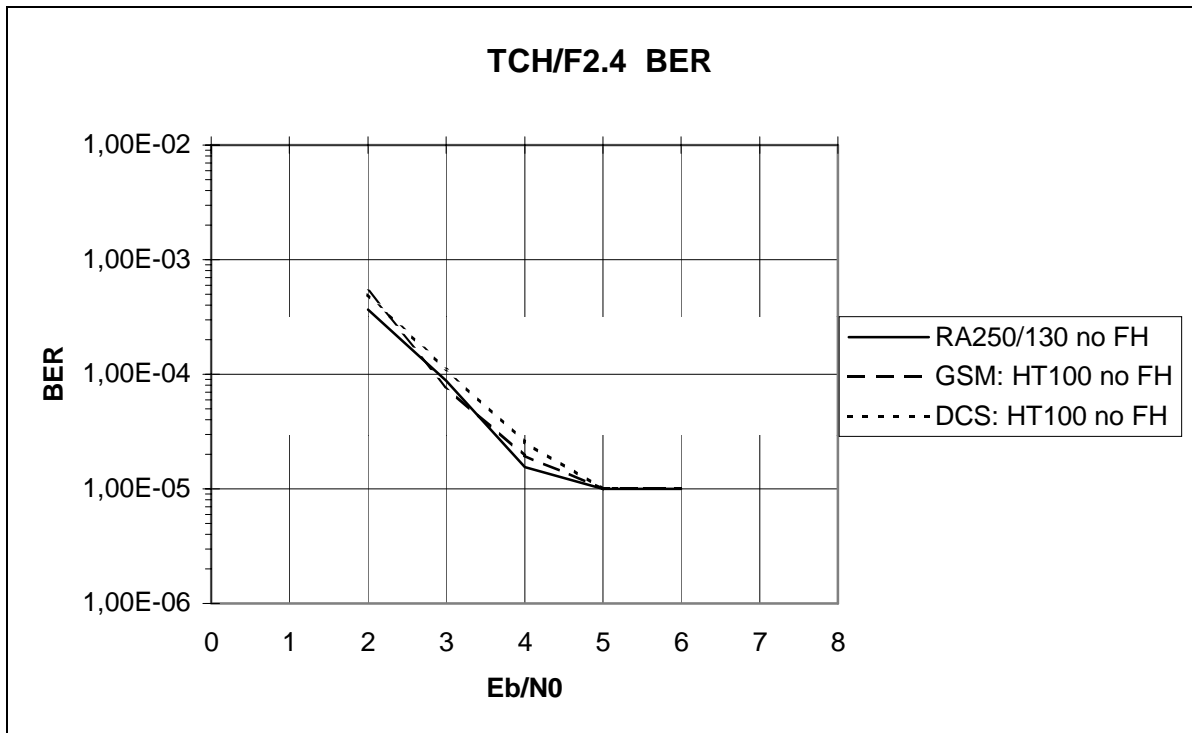

figure 11

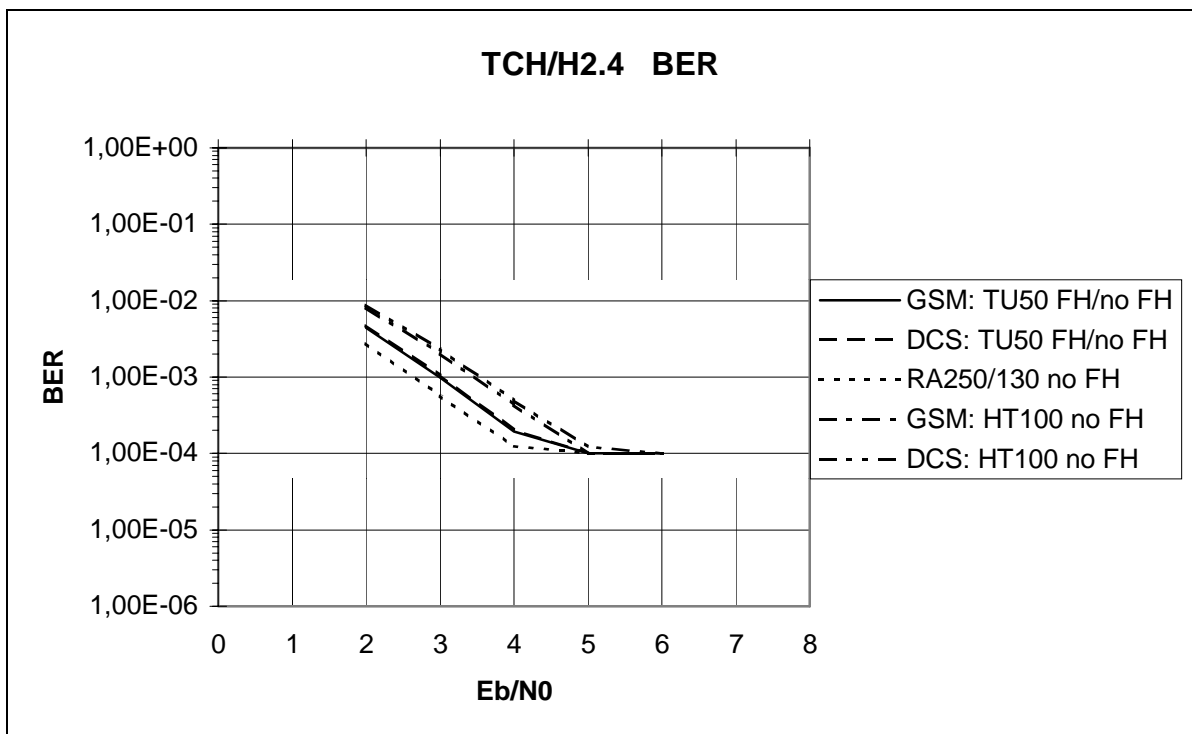

figure 12

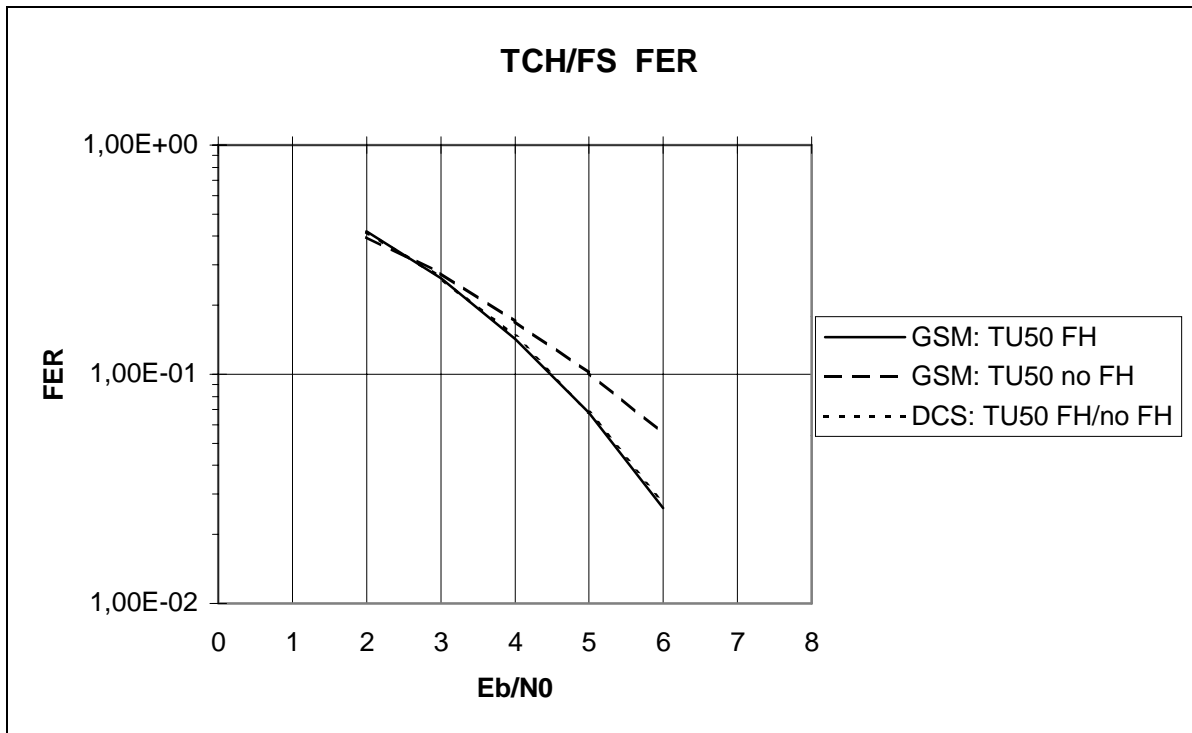

figure 13

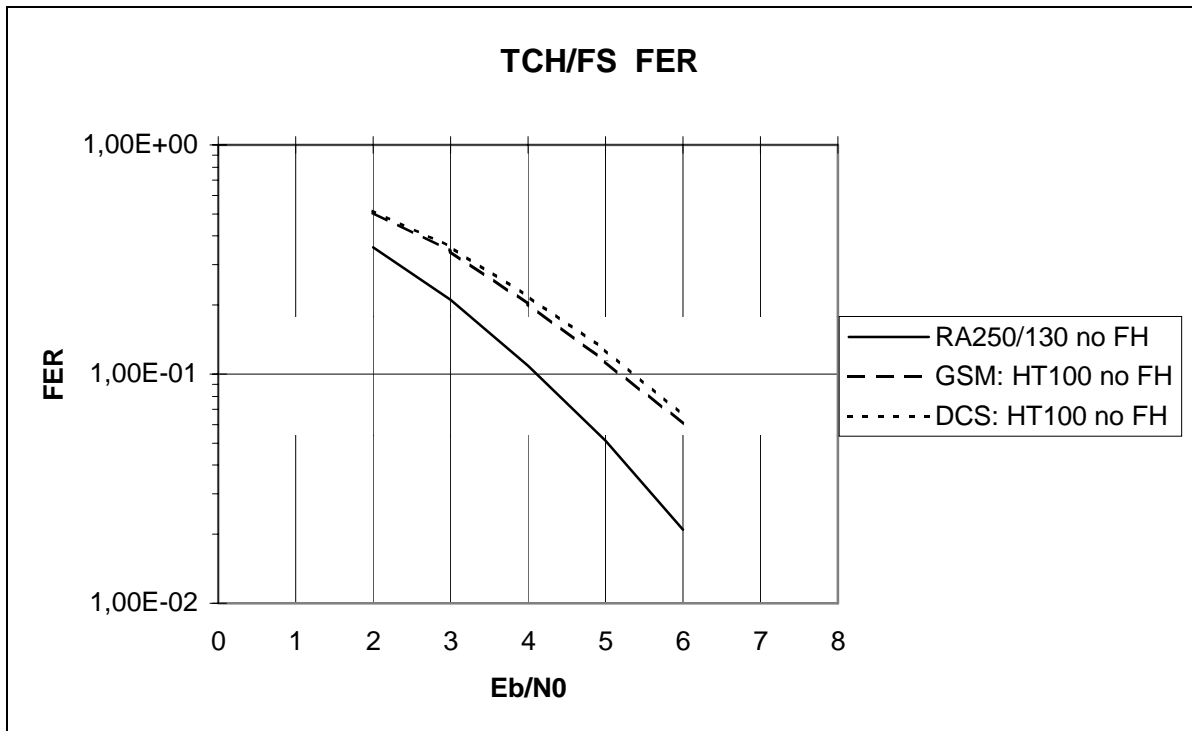

figure 14

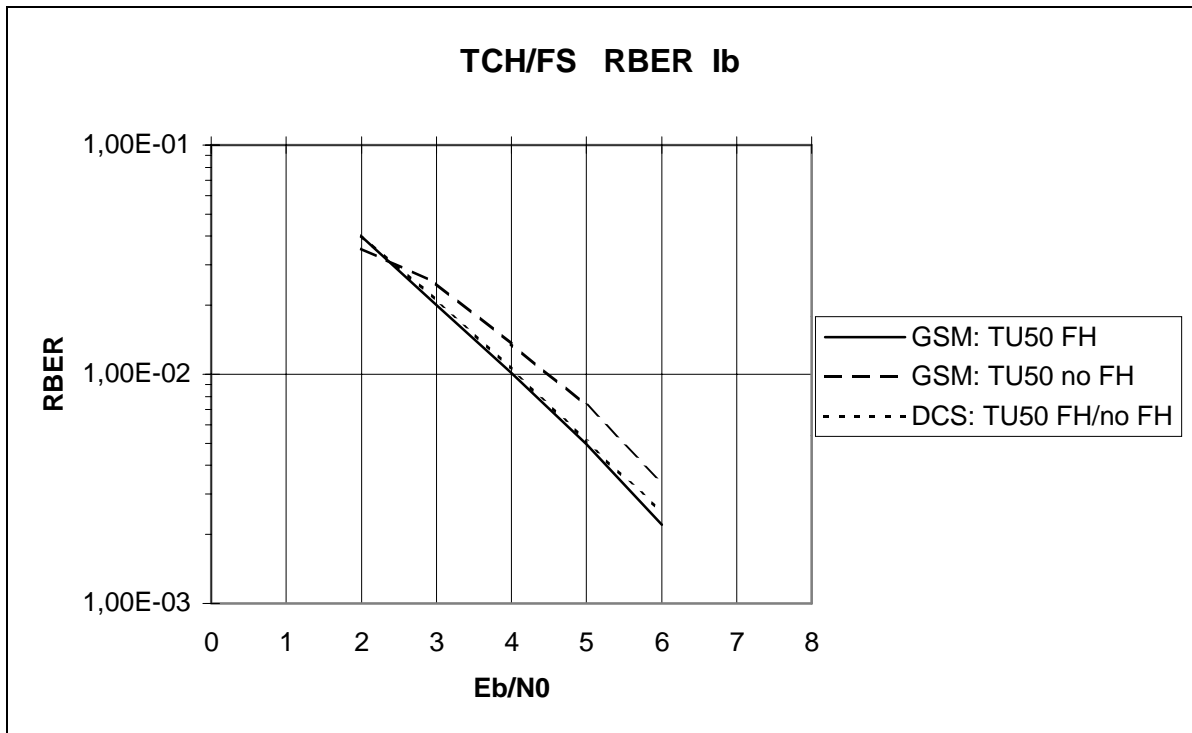

figure 15

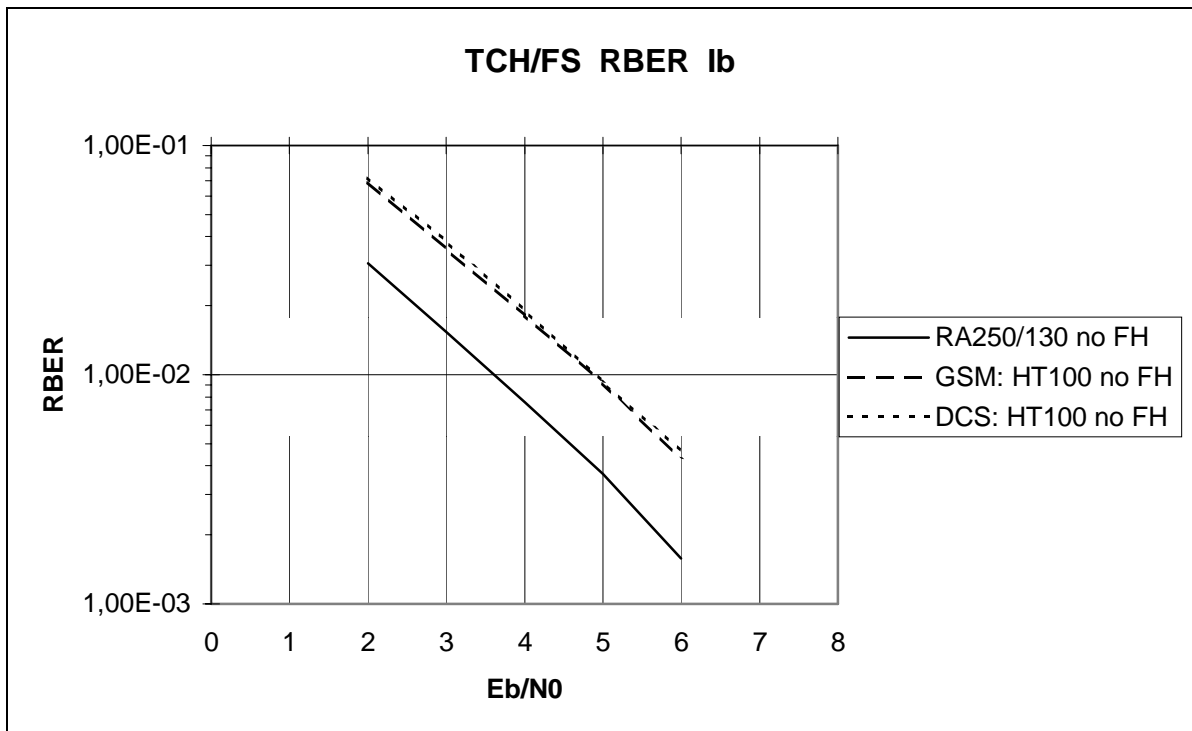

figure 16

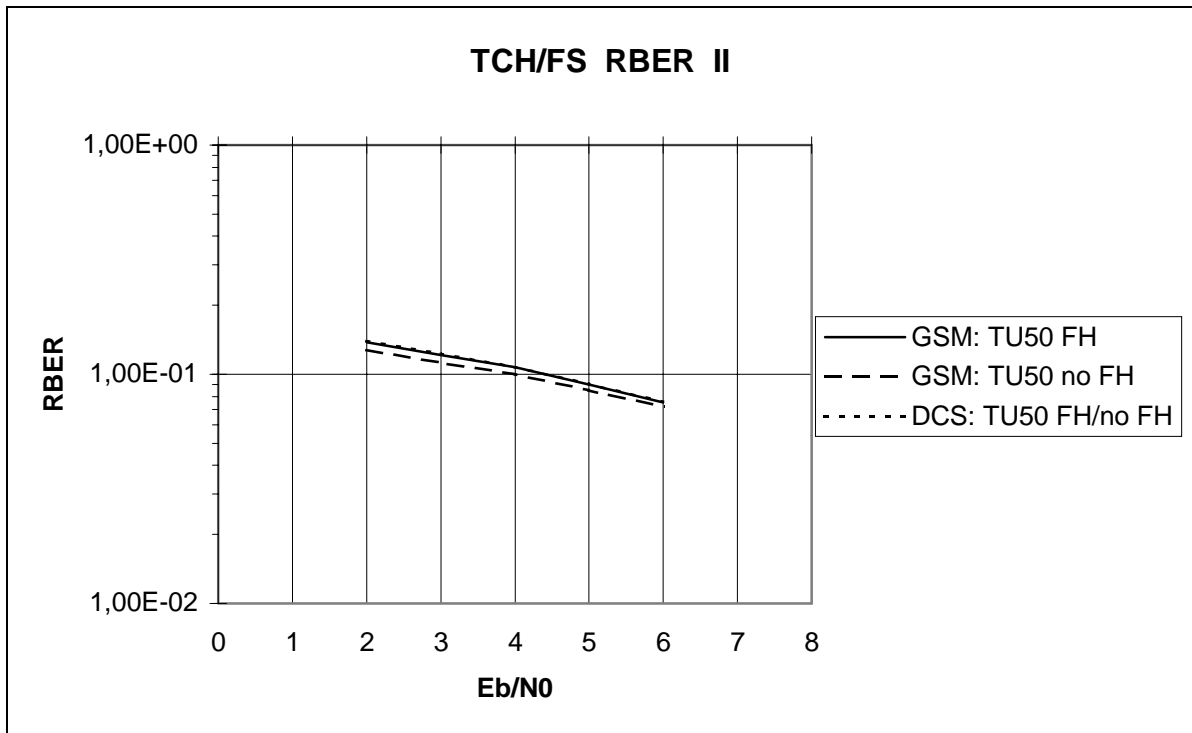

figure 17

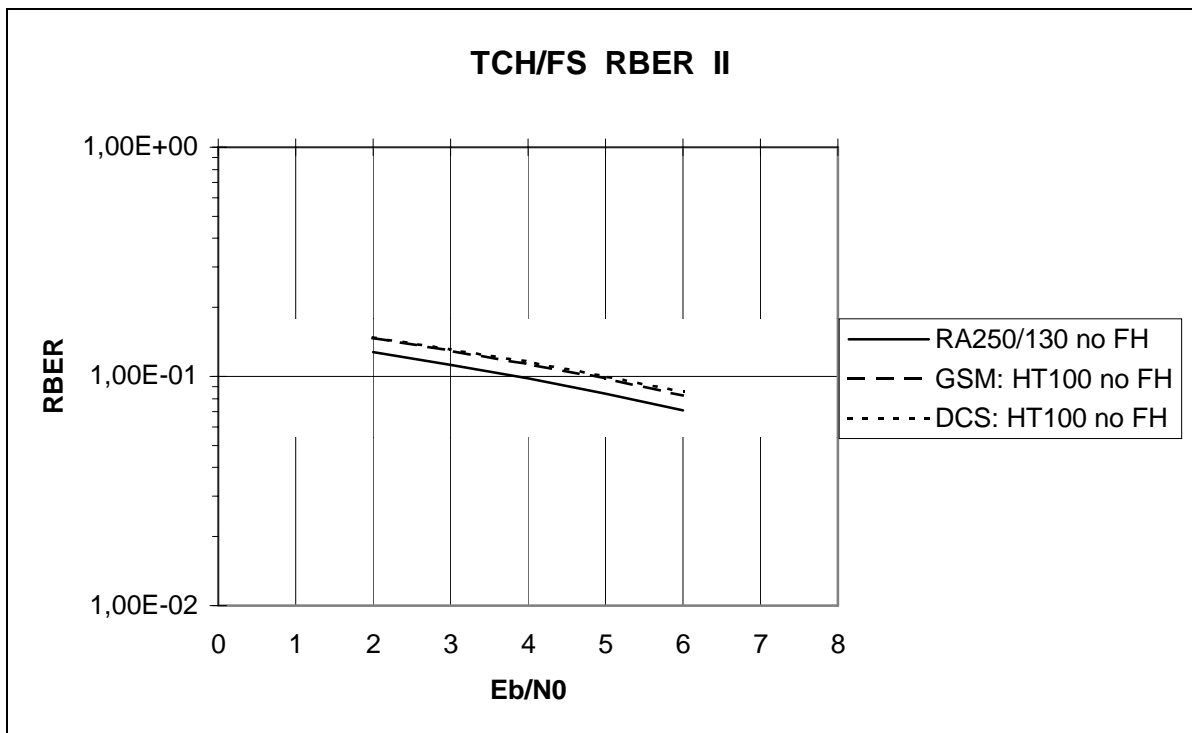

figure 18

G.2 Reference Structure

The reference configuration with respect to channel coding is according to 'Proposed text for draft Recommendation GSM 05.03', August 1994 from Alcatel (vers. 4.1.2H). 'Most recent text for section 3.2 of GSM 05.03', Motorola ,Sept. 1994 contains a slightly modified interleaving scheme'. This means the exchange of the ,mapping of bits on even and odd positions within a time slot. It can be stated that the performance is independent from the modification.

In the following the most significant bits of class I which are protected by a CRC code are called class Ia. The other bits of class I are called class Ib. The terms FER and RBER have the same meanings described in GSM 05.05 for the TCH/FS.

G.2.1 Error Concealment

Error concealment is done in a way as described in the TCH/HS C-code which is provided by Motorola. This means that bad frames are detected by the CRC and an additional criterium in the channel decoder. Computation of FER and RBER includes the use of both criteria. Therefore no specification of the α factor is required. In addition the UFI according to the ANT proposal is calculated. It has to be noted that this document does not include additional BFI according to a set UFI flag and an inconsistency in the speech codec data. This means that type approval and testing has to be done only with BFI and UFI indication given by the channel decoder.

G.2.2 Implementation Losses and Noise Figure

All simulation are based on floating point calculations in all parts of the transmission chain.

No quantization effects are taken into account . Channel filtering is assumed in order to achieve the performance for co- and adjacent channel performance. No tolerance of the filter bandwidth are taken into account. In order to cover the performance of a real receiver an additional implementation margin of two dB shall be allowed. This means, that a simulated value at 7 db C/I_c corresponds to the performance of a real receiver at 9 dB C/I_c .

Taking a reasonable noise figure (8dB) into account a simulated value of 6 dB Eb/NO corresponds to the performance of a real receiver at 8 dB Eb/NO which corresponds to the ref. Sensitivity input level of GSM 05.05.

G.2.3 Assumed Equalizer

The equalizer consists of a 16 state viterbi equalizer.

G.2.4 Simulation Results

All simulations are based on 40000 simulated speech frames. fig. 1 to 15 show the performance (simulated values) for ref. sensitivity and interference propagation conditions. The FER and RBER class Ib and II is given.

Furthermore the probability that the BFI or UFI is set is given: FER (BFI or UFI). A RBER class Ib is given for those frames which have not a BFI or UFI indication (bit error in those frames which are considered not to be bad or unreliable): UFI RBER class Ib.

G.2.5 Proposed Values for Recommendation GSM 05.05

The following values are proposed for ref. Sensitivity of GSM900 in Recommendation GSM 05.05:

	Static	TU50 no FH	TU50 ideal FH	RA250 no FH	HT100 no FH
FER	0.025%	4.1%	4.1%	4.1%	4.5%
RBER class Ib	0.001%	0.36%	0.36%	0.28%	0.56%
RBER classII	0.72%	6.9%	6.9%	6.8%	7.6%
FER (BFI or UFI)	0.048%	5.6%	5.6%	5.0%	7.5%
UFI RBER class Ib	0.001%	0.24%	0.24%	0.21%	0.32%

The following values are proposed for ref. Sensitivity of DCS1800 in Rec. GSM 05.05:

	Static	TU50 no FH	TU50 ideal FH	RA130 no FH	HT100 no FH
FER	0.025%	4.2%	4.2%	4.1%	5.0%
RBER class Ib	0.001%	0.38%	0.38%	0.28%	0.63%
RBER classII	0.72%	6.9%	6.9%	6.8%	7.8%
FER (BFI or UFI)	0.048%	5.7%	5.7%	5.0%	8.1%
UFI RBER class Ib	0.001%	0.26%	0.26%	0.21%	0.35%

It has to be noted that for the static case the error rates for FER, UFI and RBER class Ib are so low that an upper bound according to the simulation results at 3 dB E_b / N_o has been taken.

The following values are proposed for ref. Interference of GSM900 in Rec. GSM 05.05:

	Static	TU3 ideal FH	TU50 no FH	TU50 ideal FH	RA250 no FH
FER	19.1%	5.0%	5.0%	5.0%	4.7%
RBER class Ib	0.52%	0.27%	0.29%	0.29%	0.21%
RBER classII	2.8%	7.1%	7.1%	7.1%	7.0%
FER (BFI or UFI)	20.7%	6.2%	6.1%	6.1%	5.6%
UFI RBER class Ib	0.29%	0.20%	0.21%	0.21%	0.17%

The following values are proposed for ref. Interference of DCS1800 in Rec. GSM 05.05:

	TU1.5 no FH	TU1.5 ideal FH	TU50 no FH	TU50 ideal FH	RA130 no FH
FER	19.1%	5.0%	5.0%	5.0%	4.7%
RBER class Ib	0.52%	0.27%	0.29%	0.29%	0.21%
RBER classII	2.8%	7.1%	7.2%	7.2%	7.0%
FER (BFI or UFI)	20.7%	6.2%	6.1%	6.1%	5.6%
UFI RBER class Ib	0.29%	0.20%	0.21%	0.21%	0.17%

For a random RF input the overall reception performance shall be such that, on average less than one undetected bad speech frame (false bad frame indication BFI) in 10 seconds will be measured.

Annex H: GSM 900 Railway System Scenarios

Title: UIC system scenarios requirements
Source: UIC / DSB
Date: 04.09.1996

H.1 Scope

This document discusses relevant system and interference scenarios of UIC equipments as a first step in determining the RF requirements in GSM 05.05 for the R-GSM band, both as regards intra-system performance of a UIC network and towards other systems.

H.1.1 List of some abbreviations

AG	Antenna Gain, incl. cable losses etc.
FPL	Free Path Loss
MCL	Minimum Coupling Loss, incl. cable losses etc.
MIM	Multiple Interferers Margin
sMS	Small MS

H.2 Constraints

H.2.1 GSM based systems in the 900 MHz band

Following the decision by CEPT ERC in their June 95 meeting to shift the UIC frequencies and to amend CEPT recommendation TR 25-09 accordingly, UIC systems are now designated on a European basis the band 876–880 MHz (mobile station transmit) paired with 921–925 MHz (base station transmit).

The GSM based systems in the 900 MHz band are thus, cf. GSM 05.05 and TD 139/95 of SMG2#15):

	ARFCN's	Uplink carriers	Downlink carriers
P-GSM	1..124	890,2–914,8	935,2–959,8
E-GSM	975..124 (mod1024)	880,2–914,8	925,2–959,8
UIC	955..974	876,2–880,0	921,2–925,0

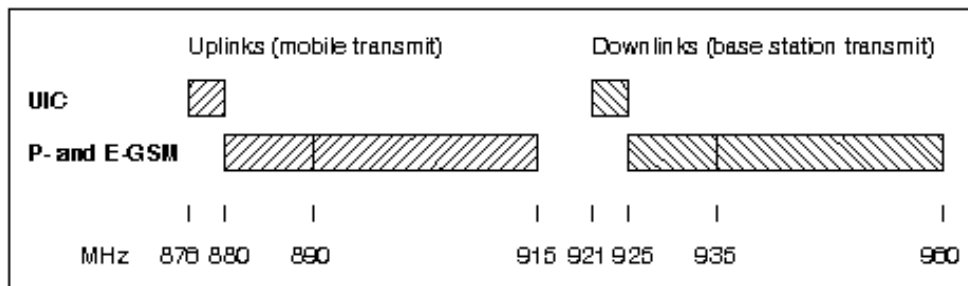

H.2.2 Other systems

Other possible systems in the 900 MHz band include TETRA and various national public and military systems. These systems are not considered any further in this document.

Neither is UIC co-existence with DCS1800 considered in any detail, assuming that the RF requirements for UIC equipments at frequencies far away from the operational frequencies shall be identical to P-GSM.

H.2.3 UIC systems outline

For reasons of economies of scale, timescales required, availability of equipment, the possibility to use also public networks, etc., it has been important for the UIC that its new radio system for integrated train communications as far as possible is based on an existing standard, namely GSM900.

This also implies that UIC RF parameters should not be different to P-GSM, except where justified by the different frequency band requiring modified filters.

In order to be able to roam onto public networks, a UIC MS as a minimum shall be able to operate over both the UIC and the P-GSM band and it must meet the RF requirements of either. This requires a pass band of any "duplex" filters in the UIC MS of 39 MHz. At the same time the transition band is only 6 MHz between the downlink (of UIC) and the uplink (of P-GSM). This implies a greater filter complexity than for P-GSM and probably even E-GSM, unless possibly some related RF performance parameters are relaxed for the UIC MS, e.g. blocking and wide band noise — in line with the scenarios.

It should be studied whether the UIC MS filtering can be of a less order if operation is not required or tolerances (filter ripple) are relaxed in the GSM extension band.

H.2.4 Fixed UIC RF parameters

At least the following GSM900 parameters in GSM 05.05 are expected to apply equally to UIC equipments, referred to by the relevant section in 05.05:

- 4.1 Output power and power levels
- 4.4 Radio frequency tolerance
- 4.6 Phase accuracy
- 6.2 Ref. sensitivity level
- 6.3 Ref. interference level
- 6.4 Erroneous frame indication performance

H.3 Methodology

The relevant scenarios of interference are identified and a worst case analysis is applied along the lines of GSM TR 05.50. Thus, assuming a single interferer, the performance required to avoid the interference altogether is calculated based on the minimum coupling loss to the victim.

This method is justified by its simplicity and the typical applications of a UIC system for train control purposes and exchange of voice messages to override signalling information etc., whereby safety is a major concern. Furthermore, UIC systems will typically be noise limited, and any interference scenario not meeting the requirements will lead to a less reliable coverage.

To take in account any multiple interferers, the likelihood of a scenario and the possible consequences of it not being met, interference margins to the worst case requirement may be introduced.

H.3.1 Scenarios

The identification of relevant scenarios is based on the system scenarios of TD SMG 61/91 (part of technical report GSM 05.50). These are

1. Single BTS and MS
2. Multiple MS and BTS, one network
3. Multiple MS and BTS, different networks
4. Colocated MS, different networks
5. Colocated BTS, different networks
6. Colocation with other systems.

Only the scenario aspects related to close proximity are considered, as the fixed UIC RF parameters set the range as for GSM.

For UIC systems there will not be more than one operator in a region. Even at the border between such regions, the train control applications shall assure that an MS does not get close to a new BTS while still remaining on the old network. Thus 1 and 2 above are the only relevant UIC intra-system close proximity scenarios, with the addition of 4bis (colocated MS, one network) and 5bis (colocated BTS, one network).

Scenarios 3–5 are related to coexistence between UIC and other GSM900 systems.

Other systems in the 900 MHz band (scenario 6) are not considered further, as explained in section 2.2.

Thus the scenarios for investigation are as follows

Scenario 1: Single BTS and MS (UIC only)

Consider a UIC MS close to its serving BTS and no interferers, i.e. only the wanted signal levels involved and no interferers.

Scenario 2: Multiple MS and BTS of one network (UIC only)

Consider multiple UIC MS at different distances from a common serving site, i.e. mostly near-far effects. The site will typically be a single BTS with one or two carriers. Sectorised cells or umbrella cells will seldom be used in railways networks.

Scenario 3: Multiple MS and BTS of different networks (UIC vs GSM)

Consider interference between a BTS and foreign MS's at close proximity: An MS being distant from its own BTS may transmit at maximum power close to a foreign BTS, and may be exposed to that one transmitting at maximum power to distant MS's of its own.

Scenario 4: Colocated MS of different networks (UIC vs GSM)

Consider GSM and UIC MS's at close proximity, each being served by its own BTS, neither colocated nor synchronised. Thus the uplink of the one MS transmitting at full power can interfere with the downlink of the other MS receiving at reference sensitivity.

Scenario 4bis: Colocated UIC MS (UIC only)

Consider UIC MS's at close proximity, transmitting at full power and receiving at the limit sensitivity.

Scenario 5: Colocated BTS of different networks (UIC vs GSM)

Consider a BTS transmitting to a distant MS at full power, thus possibly interfering with a close proximity BTS of the other system receiving a faint signal from a distant MS.

A co-siting and optimised UIC BTS - GSM BTS scenario could be relevant in some cases, e.g. where a public GSM operator operates a UIC system on behalf of a railway, or where the same sites (e.g. a leaky cable system in tunnels) are used for the UIC system and a public GSM system, in order to provide public service to train passengers or to reduce cost for either system.

Scenario 5bis: Colocated UIC BTS (UIC only)

Consider the interactions between transmitters and receivers of a single or cosited BTS's.

H.3.2 Format of calculations

The max emissions level allowed is calculated to give the requirement on any noise of the source of interference, overlapping the wanted signal of the victim receiver at reference sensitivity (assume 200kHz bandwidth).

The maximum exposure signal level is calculated to give the requirement on the victim resilience against a strong signal off the channel of its wanted signal.

The interference signal levels are calculated at the antenna connector of the equipments, in line with GSM 05.05. For equipment with integral antenna only, a reference antenna with 0dBi gain is assumed.

Correspondingly, the Minimum Coupling Loss is defined between the antenna connectors of either end of the interference link, i.e. it includes the antenna gains and any losses.

H.3.3 GSM900 systems parameters

Throughout the analysis the following parameter values are assumed, using values from GSM 03.30 annex A2 where applicable

	UIC	GSM
<u>MS (vehicle mounted):</u>		
Antenna gain	4dBi	2dBi
Cable and connector losses	2dB	2dB
Antenna height	4m	1.5m
Output power	39dBm	39dBm

Small MS (sMS): ¹⁾

Antenna gain	0dBi	0dBi
Body losses ²⁾	3dB	10dB
Antenna height	1.5m	1.5m
Output power	33dBm	33dBm

BTS:

Antenna gain, bore sight	18dBi ³⁾	12dBi
Antenna gain, 30 degr. off bore sight	4dBi	4dBi
Cable and connector losses	2dB	2dB
Antenna height	30m	30m
Output power ⁴⁾	39dBm	39dBm

Interference limit ⁵⁾

= Sensitivity – C/I – interference degradation margin ⁶⁾

=

BTS and vehicle mounted MS: $-104 - 9 - 3 = -116$ dBm

Small MS: $-102 - 9 - 3 = -114$ dBm

Note: All power levels are at the antenna connector of the equipment.

Note 1: As defined in GSM 05.05, a small UIC MS pertains to power class 4 or 5 (i.e. max 2W) and is not designed to be vehicle mounted.

Note 2: For GSM sMS a body loss of 10dB is assumed, in line with recent experiences and measurements. The lower value of 3dB assumed for UIC sMS may reflect a typical use, being carried on the body rather than held at the head. By the way, this is also the value given in GSM 03.30.

Note 3: For UIC base stations, especially serving high speed line sections, it is likely that high directivity antennas with a correspondingly high gain will be used to provide the required high grade and quality of coverage.

Note 4: BTS RX diversity has not been considered. If this should be the case the BTS transmit power should be increased about 3 dB.

Note 5: In receiver bandwidth: Assume 200kHz.

Note 6: For a noise limited system, the GSM reference sensitivity is not valid if the receiver is exposed to interference at the same time, nor is the 9 dB C/I ratio valid at the sensitivity limit. Thus a 3 db interference degradation margin is added in the worst case analysis in accordance with GSM 03.30. This is a compromise value, that allows a slight desensitisation of the victim in the case of interference.

H.3.4 Minimum Coupling Loss

The minimum coupling loss is calculated assuming free space path loss at 900 MHz ($31.5\text{dB} + 20\log(d) [m]$), a reasonable assumption for the close proximity scenarios in question.

For all MS to BTS scenarios, as a simple assumption, the minimum coupling loss is assumed to be at a downward angle of 30 deg. off bore sight (i.e. double the vertical distance) with a reduced BTS antenna gain as given above.

Scenario	Equipm#1	Equipm#2	Dist. m	FPL dB	AG#1 dB	AG#2 dB	MCL dB
1&2	UIC MS	UIC BTS	52	66	2	2	62
1&2	UIC sMS	UIC BTS	57	67	-3	2	68
4bis	UIC MS	UIC MS	2	38	2	2	34
4bis	UIC MS	UIC sMS	5	45	2	-3	46
4bis	UIC sMS	UIC sMS	2	38	-3	-3	44
5bis	UIC BTS	UIC BTS	— as for GSM				30
3	GSM MS	UIC BTS	57	67	0	2	65
3	GSM sMS	UIC BTS	57	67	-10	2	75
3	UIC MS	GSM BTS	52	66	2	2	62
3	UIC sMS	GSM BTS	57	67	-3	2	68
4	UIC MS	GSM MS	20	58	2	0	56
4	UIC MS	GSM sMS	5	45	2	-10	53
4	UIC sMS	GSM MS	20	58	-3	0	61
4	UIC sMS	GSM sMS	2	38	-3	-10	51
5	UIC BTS	GSM BTS	— see section 3.1				40

H.3.5 Interference margins

A Multiple Interferers Margin (MIM) of 6dB is introduced to tighten the scenarios requirements where GSM base stations are the source of interference, to take into account their multiple and continuous carriers. The likelihood of multiple close proximity mobiles active on overlapping timeslots is considered rather small, so no MIM applies for mobiles producing interference. Also for interfering UIC base stations no MIM applies, considering the low number of carriers.

However, no MIM shall apply for scenario requirements for blocking, which is considered a non-additive narrow band phenomenon.

H.3.6 Differences between E- and P-GSM

Concluding the above determination of scenarios and parameters, it may be noted that no differences apply between E- and P-GSM as regards co-existence scenarios with UIC.

H4 Transmitter requirements

If not otherwise stated, the max emissions level allowed from an interference source for a given scenario is calculated as follows

$$= \text{Victim interference limit} \quad (\text{see section 3.3}) \\ + \text{MCL} \quad (\text{see section 3.4}) \\ - \text{MIM} \quad (\text{see section 3.5})$$

Scenario	Source	Victim	Intf. limit	MCL	MIM	Max emissions	
5	GSM BTS	UIC BTS	-116	40	6	-82	
3	GSM BTS	UIC MS	-116	62	6	-60	
3	GSM BTS	UIC sMS	-114	68	6	-52	
3	GSM MS	UIC BTS	-116	65	0	-51	
4	GSM MS	UIC MS	-116	56	0	-60	
4	GSM MS	UIC sMS	-114	61	0	-53	
3	GSM sMS	UIC BTS	-116	75	0	-41	
4	GSM sMS	UIC MS	-116	53	0	-63	
4	GSM sMS	UIC sMS	-114	51	0	-63	
5	UIC BTS	GSM BTS	-116	40	0	-76	
3	UIC BTS	GSM MS	-116	65	0	-51	
3	UIC BTS	GSM sMS	-114	75	0	-39	
5bis	UIC BTS	UIC BTS	-116	30	0	-86	
2	UIC BTS	UIC MS	—	62	0	0	Note
2	UIC BTS	UIC sMS	—	68	0	0	Note
3	UIC MS	GSM BTS	-116	62	0	-54	
4	UIC MS	GSM MS	-116	56	0	-60	
4	UIC MS	GSM sMS	-114	53	0	-61	
2	UIC MS	UIC BTS	-116	62	0	-54	
4bis	UIC MS	UIC MS	-116	34	0	-82	
4bis	UIC MS	UIC sMS	-114	46	0	-68	
3	UIC sMS	GSM BTS	-116	68	0	-48	
4	UIC sMS	GSM MS	-116	61	0	-55	
4	UIC sMS	GSM sMS	-114	51	0	-63	
2	UIC sMS	UIC BTS	-116	68	0	-48	
4bis	UIC sMS	UIC MS	-116	46	0	-70	
4bis	UIC sMS	UIC sMS	-114	44	0	-70	

Note: Max BTS emissions allowed onto another downlink:
 = min BTS output power on the other downlink – C/I – MIM
 = Source output power – Power control range – C/I = 39 – 30 – 9
 = 0dBm

H.4.1 Transmitter requirements summary

From the results above, selecting the more stringent requirement where either MS or sMS is involved at the other end of an interference link, the following table summarises the maximum allowed unwanted emissions of the equipments in order to meet the scenarios, measured in dBm in a 200kHz bandwidth.

<u>(Victim uplinks)</u>		<u>(Victim downlinks)</u>	
UIC	GSM	UIC	GSM
876	(880) 890	921	(925) 935
- 880	- 915	- 925	- 960 MHz

(Source:)

UIC BTS	-86	-76	0	-51
UIC MS	-54	-54	-82	-61
UIC sMS	-48	-48	-70	-63
GSM BTS	-82		-60	
GSM MS	-51		-60	
GSM sMS	-41		-63	

H.5. Receiver requirements

Applicable to blocking requirements, if not otherwise stated, the max exposure (off-channel) signal level presented to a victim for a given scenario is calculated as follows

= Interference source output power (see section 3.3)
 – MCL (see section 3.4)

Scenario	Source pwr.	Outp.	Victim	MCL	Max exposure	
5	UIC BTS	39	GSM BTS	40	-1	
3	UIC MS	39	GSM BTS	62	-23	
3	UIC sMS	33	GSM BTS	68	-35	
3	UIC BTS	39	GSM MS	65	-26	
4	UIC MS	39	GSM MS	56	-17	
4	UIC sMS	33	GSM MS	61	-28	
3	UIC BTS	39	GSM sMS	75	-36	
4	UIC MS	39	GSM sMS	53	-14	
4	UIC sMS	33	GSM sMS	51	-18	
5	GSM BTS	39	UIC BTS	40	-1	
3	GSM MS	39	UIC BTS	65	-26	
3	GSM sMS	33	UIC BTS	75	-42	
5bis	UIC BTS	39	UIC BTS	30	9	
2	UIC MS	5	UIC BTS	62	-57	Note
2	UIC sMS	5	UIC BTS	68	-63	Note
3	GSM BTS	39	UIC MS	62	-23	
4	GSM MS	39	UIC MS	56	-17	
4	GSM sMS	33	UIC MS	53	-20	
2	UIC BTS	39	UIC MS	62	-23	
4bis	UIC MS	39	UIC MS	34	5	
4bis	UIC sMS	33	UIC MS	46	-13	
3	GSM BTS	39	UIC sMS	68	-29	
4	GSM MS	39	UIC sMS	61	-22	
4	GSM sMS	33	UIC sMS	51	-18	
2	UIC BTS	39	UIC sMS	68	-29	
4bis	UIC MS	39	UIC sMS	46	-7	
4bis	UIC sMS	33	UIC sMS	44	-11	

NOTE: Power control is assumed.

H.5.1 Receiver requirements summary

From the results above, selecting the more stringent requirement where either MS or sMS is involved at the other end of an interference link, the following table summarises the required resilience of the equipments against strong off-channel signals in order to meet the scenarios, measured in dBm.

<u>(Source uplinks)</u>		<u>(Source downlinks)</u>	
UIC	GSM	UIC	GSM
876	(880) 890	921	(925) 935
- 880	- 915	- 925	- 960 MHz

(Victim:)

UIC BTS	-57	-26	+9	-1
UIC MS	+5	-17	-23	-23
UIC sMS	-7	-18	-29	-29
GSM BTS	-23		-1	
GSM MS	-17		-26	
GSM sMS	-14		-36	

H.6. Wanted signals levels

In this section the intra UIC system wanted signal levels are calculated.

H.6.1 Maximum wanted signal level

Scenario 1, single MS and BTS, refers.

Adaptive power control is not considered. At very high speeds and a BTS antenna located close to the track, it is expected to be too slow to react quickly enough to reduce the signal levels substantially at the passage of the mast.

Vehicle Mounted MS:

- 1) Max MS RX wanted signal level:
Source output power – MCL = 39 – 62
= –23dBm
- 2) Max BTS RX wanted signal level:
Source output power – MCL = 39 – 62
= –23dBm

Small MS:

- 1) Max sMS RX wanted signal level:
Source output power – MCL = 39 – 68
= –29dBm
- 2) Max BTS RX wanted signal level:
Source output power – MCL = 33 – 68
= –35dBm
i.e. the value above takes precedence.

H.6.2 Dynamic range of wanted signals

Scenario 2, multiple MS and BTS of one network, refers.

Within one carrier, in the extreme the BTS adjacent timeslots RX levels may range between the max level calculated above and the reference sensitivity.

Annex J: GSM 900 Railway System Scenarios

Title: UIC RF parameters

Source: UIC / DSB

Date: 28.11.1996

J.1 Introduction

This document presents the results of a small working group aiming to determine the RF-parameters for UIC equipments, to be in line with the scenario requirements where possible and feasible, and to find a reasonable compromise where not.

The current specifications for GSM and DCS equipments are not changed, except possibly where absolutely no implications for their implementation are expected. It has not been investigated, if and to what extent this means that some close proximity co-existence scenarios towards UIC equipments are not met.

The document is largely structured as follows:

- Basic considerations
- Discussion of transmitter characteristics
- Discussion of receiver characteristics
- Discussion of transmitter/receiver performance

At the end of the document, a list of references is given.

J.2 Basic considerations

As explained in [2], for reasons of economies of scale, availability of equipment and the timescales required, in principle, the RF-parameters for UIC equipments should not be different to standard GSM, except where affected by the different frequency band requiring modified filters.

In order to be able to roam onto public networks, a UIC mobile as a minimum shall be able to operate over both the band designated for the UIC and the P-GSM band, fulfilling the RF requirements of either.

This requires a pass band of any "duplex" filters in the UIC mobile of 39 MHz. At the same time the transition band is only 6 MHz between the downlink (of UIC) and the uplink (of P-GSM). This implies a greater filter complexity than for P-GSM and probably even E-GSM. Therefore relaxations should be sought for RF parameters related to the filter in the UIC mobile, where possible while still meeting the scenario requirements. It should also be studied whether the filtering in the UIC mobile can be of a less order, if operation is not required or performance and tolerances are relaxed in the GSM extension band.

J.2.1 Types of equipment and frequency ranges

For reasons of interoperability and economies of scales, all UIC mobiles must have the capability to operate in the frequency bands mentioned above. UIC base stations, however, in general will only be required to operate in the UIC band, although co-operation arrangements could be envisaged with public band operators, requiring base stations to operate on either band.

One way of reflecting this is to define the R-GSM band to cover the UIC band only, and to require UIC mobiles to have "multiband" capabilities. However, the current principle in 05.05 requires multiband equipment to meet all requirements for each of the bands supported (and this is only described for mobiles). At the same time, in-band performances in general are referred to the frequencies of the individual bands, rather than considering that only GSM type scenarios apply within the full relevant GSM900 band, whereas the unwanted out-of-band signals originate from the other link direction and from other systems. For the UIC equipments, this approach leads to an unnecessary overlapping of the more strict out-of-band requirements with the in-band performance required to meet the relevant scenarios.

An alternative approach, to define the R-GSM band to cover both the UIC, P- and possibly E-GSM bands, is not appropriate for the general type of UIC base stations, and it does not reflect what is needed for railways operation, namely a stand alone band which mobiles would only leave under controlled circumstances for roaming.

The approach taken in here is the pragmatic one, wherever relevant for the specification, to discuss and describe the frequency ranges that must actually apply for the "UIC equipment" types described above, when later elaborating the exact wordings.

"UIC mobiles" is used throughout the text to designate either of the following:

- an MS, being a vehicle mounted equipment, or
- a small MS, for which the abbreviation "sMS" is used.

J.3 Discussion of the individual sections in 05.05

This section discusses the RF-parameters for UIC equipments and the changes required in GSM TS 05.05 [1] for their inclusion in GSM phase 2+.

Where possible and feasible, the RF-parameters are derived from the scenario requirements as set out in [2]. Otherwise a reasonable compromise is sought.

J.3.1 Scope

No change required.

J.3.2 Frequency bands and channel arrangement

As a working assumption, the UIC GSM 900 band is to be included in the 05.xx series under the term R-GSM, as described and agreed by SMG2 in [3]. Please refer to this document for the details of the CR required for the change, but to summarise it, the GSM based systems in the 900MHz band are:

	ARFCN's	Uplink carriers	Downlink carriers
P-GSM	1..124	890,2–914,8	935,2–959,8
E-GSM	975..124 (mod1024)	880,2–914,8	925,2–959,8
UIC	955..974	876,2–880,0	921,2–925,0

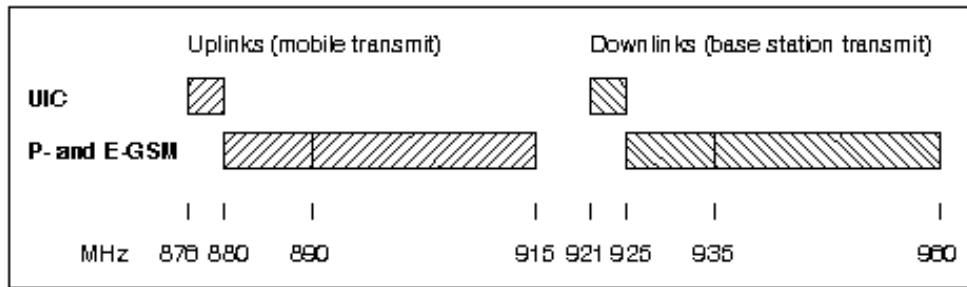

J.3.3 Reference configuration

No changes are required in this section of 05.05.

J.3.4 Transmitter characteristics

The following table, copied from section 4 in [2], gives the scenarios requirements for the maximum allowed unwanted emissions of a UIC transmitter, in order not to interfere with another link.

The values corresponds to average measurements in dBm in a 200kHz bandwidth. As in 05.05, the reference point is the antenna connector of the equipment.

<u>(Victim uplinks)</u>		<u>(Victim downlinks)</u>	
UIC	GSM	UIC	GSM
876 - 880	(880) 890 - 915	921 - 925	(925) 935 - 960 MHz

(Source:)

UIC BTS	-86	-76	0	-51
UIC MS	-54	-54	-82	-61
UIC sMS	-48	-48	-70	-63

J.3.4.1 Output power

No change is required.

Note: Also for UIC mobiles the lowest power control level is assumed to be 5dBm.

Note: Micro BTS is not expected to be used in UIC networks.

J.3.4.2.1 Spectrum due to the modulation and wide band noise

This specification is related to in-band performance only, and is closely related to the modulation, i.e. it does not include any effects of the "duplex" filter. Thus the performance should be as for standard GSM, also because the requirements are already close to what is obtainable.

Thus, as a working assumption, no change is proposed to this section of 05.05.

Note: Comparing with the applicable scenario requirements:

- UIC BTS victimising UIC downlink: 0dBm;

- UIC MS or sMS victimising the UIC uplink: -54dBm and -48dBm , respectively;

the performance specified in 05.05 is fully sufficient for the BTS, whereas the scenarios will not be met in all cases involving MS or sMS. A detailed calculation, however, has not been performed.

J.3.4.2.2a MS spectrum due to switching transients

This being a specification close to the carrier, the applicable scenarios deal with UIC MS or sMS victimising UIC or GSM uplinks:

MS	sMS		
-54	-48	dBm	Scenarios requirement
$+20$	$+20$	dB	Transient margin (05.50 p. A-18 [4])
-8	-8	dB	Bandwidth conversion factor into 30kHz
—	—		
-42	-36	dBm	Performance requirement

For feasibility reasons, this is compared with the requirement in 05.05 at 1800 kHz offset only, implying a tightening for UIC MS. Nevertheless, no change is proposed, because this could make it difficult to use standard GSM technology, and because only a balanced specification with the 'spectrum due to the modulation and wide band noise' makes sense, by which the scenario requirement is not fully met anyhow, as discussed above (see 4.2.1).

J.3.4.2.2b BTS spectrum due to switching transients

Here, for one, the scenario of UIC BTS victimising the UIC downlink applies. The corresponding requirement is 0dBm, which is uncritical and requires no change to 05.05.

Note: The high value reflects the assumption that there will only be one UIC operator in an area, and thus only the coordinated case with power control to consider.

At the upper end of the transmit band, however, UIC BTS switching transients may extend into and victimise the E-GSM downlink, whereby the following applies:

-51	dBm	Scenarios requirement
$+20$	dB	Transient margin (05.50 p. A-18 [4])
-8	dB	Bandwidth conversion factor into 30kHz
—		
-39	dBm	Performance requirement onto E-GSM downlink

The UIC BTS power being 39dBm measured in a 300kHz bandwidth, this corresponds to -78dBc . The requirement in 05.05 at 1,2–1,8MHz from the carrier is -74dBc or -36dBm , whichever is the higher.

Nevertheless, it is suggested to stay with the 05.05 specification, considering that only mobiles operating on the outermost frequencies of the E-GSM and very close to their reference sensitivity will possibly be interfered with.

J.3.4.3.1 Spurious emissions

The principle of the spurious emissions specification in 05.05 is basically a split in two, an in-band part a), and an out-of-band part b) with more strict requirements. However, the specification is not fully clear on what is the in-band part: Does the term "relevant transmit band" refer to

- the actual transmit band of an equipment; or
- the total combined range of GSM900 as opposed to DCS1800?

The latter seems the more appropriate, assuming that the out-of-band requirement is adapted from general CEPT limits to protect all other various applications of radio reception, whereas the in-band part of the requirements should relate to co-existence scenarios for GSM network operation.

For implementation of E- or P-GSM equipments, the difference between the two interpretations may be negligible, but in any case the latter is more relaxed than the first.

For UIC equipments, capable of operation over the full GSM900 band, however, the latter definition must apply. Otherwise, requiring for multiband operation that all the requirements for each of the bands must be met, unnecessarily strict requirements would result by overlapping an out-of-band with the in-band of another band.

Thus, for UIC equipments, the "relevant transmit band" shall be:

MS and sMS: 876–915MHz;

BTS: 921–960MHz.

J3.4.3.2 BTS spurious emissions

In order to keep a balanced specification, the BTS spurious emissions requirement in the first paragraph of this section of 05.05, referring to the conditions specified in 4.3.1a (at 1,8MHz or greater offset from the carrier), should not be tighter than what is applied for the switching transients (in 4.2.2b, at 1,8MHz or less offset from the carrier), i.e. also here the current 05.05 specification should be kept.

A tighter specification would not be of much use anyhow. For UIC, with its narrow downlink band, the BTS noise closer to the carrier is expected to be dominant, and even this is not critical, due to the coordinated scenarios. For GSM mobiles suffering this kind of interference when being close to a base station, in most cases the source would rather be a GSM BTS (by their multitude, and being closer in frequency).

In the second paragraph of the section, referring to the conditions in 4.3.1b, the "out-of-band" requirements should not be changed, assuming these are adopted from general CEPT limits.

Regarding protection of the BTS receive band, the UIC BTS victimising UIC or GSM uplinks scenarios apply:

UIC	GSM		
-86	-76	dBm	Scenarios requirement
-3 -3	dB		Bandwidth conversion factor into 100kHz
—	—		
-89	-79	dBm	Performance requirement

Note: The less tight requirement against the E- and P-GSM bands reflects the scenarios assumption that such cosittings would be subject to optimised arrangements providing a coupling loss of at least 40dB, see [2].

Thus, for UIC, a limit of -89dBm towards the full BTS receive band should apply, taking the more strict value. This still forms a relaxation compared with standard GSM that can assist the implementation, considering the narrower transition band for the filtering implicated.

Note: The relaxation largely reflects that no multiple interferers margin is applied for a UIC BTS.

No change is suggested against DCS, assuming implementations based on standard GSM and thus meeting the current requirement.

Considering the above relaxation of the protection of the UIC uplink as compared with GSM, the 05.05 note on protection from co-sited DCS transmitters should be sufficient for protection of the UIC band as well, if ever needed. Nevertheless, it is suggested to include it in the GSM uplink frequency range specified for protection (to read 876–915MHz). This downwards extension by 4MHz should pose no problem for actual DCS equipments, considering the large spacing to its wanted signal.

By the same principle, also in the last paragraph of this section of 05.05, for protection of the GSM downlink from DCS, the frequency range should be extended to include the UIC band (to read 921–960MHz), and again this should pose no problems for actual DCS equipments.

J3.4.3.3 MS spurious emissions

For the "in-band" part of the specification, the applicable scenarios deal with UIC MS or sMS victimising UIC or GSM uplinks:

MS	sMS	
-54	-48	dBm Scenarios requirement
+20	+20	dB Transient margin
-8 -8	dB	Bandwidth conversion factor into 30kHz
—	—	
-42	-36	dBm Performance requirement

The first paragraph of 05.05 section 4.3.3 should be amended accordingly, to include the above more strict requirement on UIC MS, whereas it is unchanged for UIC sMS.

As above in 4.3.2, the "out-of-band" requirements in the second paragraph should not be changed, assuming these are adopted from general CEPT limits.

Regarding the requirements in idle mode in the 3'rd paragraph, the following applies towards the UIC and GSM uplinks:

MS	sMS	
-54	-48	dBm Scenarios requirement
-3 -3	dB	Bandwidth conversion factor into 100kHz
—	—	
-57	-51	dBm Performance requirement

Comparing this with the existing requirements, for UIC the following differences arise:

- UIC MS: -57dBm throughout, below 1GHz;
- UIC sMS: -51dBm in the frequency band 876–915MHz.

No change is assumed above 1GHz.

J3.4.3.4 MS spurious emissions onto downlinks

For UIC MS or sMS victimising the UIC downlink, the scenario requirement is -82 and -70dBm, i.e. the performance requirement is -85 and -73dBm in 100kHz, respectively.

However, for UIC mobiles, featuring all 3 GSM bands and having a narrower duplex gap of 6MHz only, it is considered unrealistic to have a performance any better than for GSM MS and sMS. For such, a maximum of -79 and -67dBm is allowed in the P-GSM and E-GSM downlink bands, respectively. By a simple extrapolation of $79 - 67\text{dB} / 10\text{MHz} = 1,2\text{ dB/MHz}$ as a roll-off function towards the edge of the E-GSM downlink, the estimated performance of GSM mobiles in the UIC downlink band is -62dBm. This is summarised in the figure below.

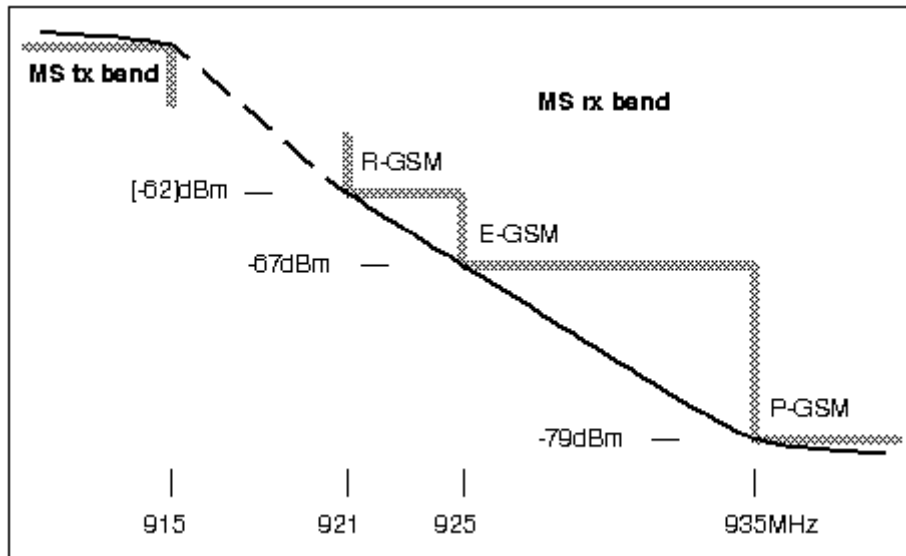

More detailed investigations and measurements by Philips Semiconductors [5], however, have shown that -60dBm is a more realistic and feasible value at 921MHz , using currently available GSM duplexers without extra effort or costs.

It should also be noted, that if UIC mobiles would have a better performance than GSM, then the GSM sMS would remain as the more significant interference source, considering their large numbers and similar close proximity scenarios. Actually, it would be more important to set a corresponding limit for GSM equipments, considering that none exists currently.

Thus a limit of -60dBm is proposed to go into 05.05 for UIC MS and sMS in the UIC downlink frequency range, and to maintain the limits for the GSM downlink. This satisfies the scenario requirements for UIC mobiles victimising the GSM downlink, whereas the scenario requirements for close proximity between UIC mobiles are not met.

Therefore a backwards calculation is performed to determine the resulting minimum distances required to avoid the interference, see also [2]:

Source:	UIC MS	UIC MS	UIC SMS	UIC SMS
Victim:	UIC MS	UIC SMS	UIC MS	UIC sMS
Victim interference limit	-116	-114	-116	-114
Assumed noise in RX band	-60	-60	-60	-60
MCL of the scenario	56	54	56	54
AG source	2	2	-3	-3
AG victim	2	-3	2	-3
FPL required	60	53	55	48
Distance required [m]	27	12	15	7
Scenarios requirement	2	5	5	2

- AG = Antenna Gain, incl. cable losses etc.
- FPL = Free Path Loss
- MCL = Minimum Coupling Loss, incl. cable losses etc.

When evaluating the consequences of these UIC mobile to mobile close proximity scenarios not being met, the following preconditions for the interference actually to occur must be borne in mind, that significantly decrease the likelihood of interference:

- although the interference limit applies also to the idle mode, in practice, the worst case is expected to require that the victim and the interfering mobile are both active and operating on overlapping timeslots;
- the victim mobile must be receiving at reference sensitivity.

In addition, for the UIC vehicle mounted MS to MS scenario, along a railways line two locomotives moving in opposite directions must be within 27 m of each other. Thus the overall likelihood of the UIC MS to MS interference is considered small enough to be acceptable, also when seen in relation to the large number of operating GSM MS and SMS, each of which presents a similar potential level of interference.

Wherever UIC SMS are typically being used, such as in stations and shunting yards, a better radio coverage is needed to provide service for such equipments. This implies generally higher wanted signal levels in scenarios involving an SMS, further decreasing the overall likelihood of interference. Thus it is considered acceptable that the scenarios involving UIC SMS are missed by a factor of about 3.

No changes are proposed to the last two paragraphs of this section of 05.05.

J.3.4.4 Radio frequency tolerance

No issues, no change required.

J.3.4.5 Output level dynamic operation

As in section 4.3.3, also here it is not fully clear what is the "relevant transmit band". Assuming again that "in-band" requirements relate to co-existence scenarios for operation of GSM networks, it is proposed to apply the same definition, i.e. it is the total combined range of GSM900.

J.3.4.5.1 BTS output level dynamic operation

No changes required.

J.3.4.5.2 MS output level dynamic operation

For this specification, the applicable scenarios deal with UIC MS or SMS victimising UIC or GSM uplinks.

For the UIC MS, the scenario requirement is -54dBm . At the lowest transmit power level, 5dBm , this corresponds to -59dBc , assuming 17 power control steps as for standard GSM. I.e. no change is required to 05.05.

For the UIC SMS, the scenario requirement is no tighter than -48dBm . This relaxation should be included in 05.05.

J.3.4.6 Phase accuracy

No issues, no change required.

J.3.4.7.1 Intra BTS intermod attenuation

Throughout this section of 05.05, it is supposed that the BTS transmit and receive bands are referred to, although this is not clearly stated in the first paragraph.

The second paragraph is understood only to give requirements on intermodulation products falling into the BTS transmit band, i.e. victimising downlinks.

The scenario requirement for UIC BTS victimising the UIC downlink is 0dBm , which is absolutely no problem with the current specification.

Note: This reflects the assumption, that for UIC only coordinated scenarios apply, whereas for GSM the intermodulation product could interfere with a close proximity foreign mobile at reference sensitivity.

However, for any UIC BTS intermodulation product falling into the GSM downlink, a scenario requirement of -51dBm applies. For comparison, for GSM uncoordinated networks the corresponding traditional scenario requirement calculation is

-104 dBm Reference sensitivity
 -9 dB C/I
 $+59\text{ dB MCL}$
 —
 -54 dBm Performance limit

This is not met by the specification either, probably for feasibility reasons.

Thus no change is proposed to the second paragraph of this section in 05.05.

Considering the likely network implementation, with a UIC BTS operating only in the UIC band, normally no 3'rd order intermodulation products will fall into any of the UIC or GSM uplinks. In any case, the scenarios requirements for UIC BTS victimising UIC and GSM uplinks are -86 and -76dBm , respectively. These are the same scenario requirements as in 4.3.2, and for which a TX filter is introduced to protect the BTS receive bands in general. Thus the requirement in the 3'rd paragraph of this section in 05.05 is not a significant problem, and no change is proposed here either.

J.3.4.7.2 Intermodulation between MS (DCS1800 only)

Not applicable.

J.3.4.7.3 Mobile PBX

No change proposed.

J.3.5. Receiver characteristics

The following table of scenario requirements, copied from section 5 in [2], gives the required blocking performance of UIC receivers against strong off-channel signals of another link.

The values are given in dBm. As in 05.05, the reference point is the antenna connector of the equipment.

<u>(Source uplinks)</u>		<u>(Source downlinks)</u>	
UIC	GSM	UIC	GSM
876	(880) 890	921	(925) 935
–	– 915	–	– 960 MHz
8		9	
8		2	
0		5	

(Victim:)

UIC BTS	-57	-26	$+9$	-1
UIC MS	$+5$	-17	-23	-23
UIC sMS	-7	-18	-29	-29

J.3.5.1 Blocking characteristics

The "in-band" and "out-of-band" frequency ranges to apply for the blocking performance of a UIC receiver are determined as follows:

- 1) one of the out-of-bands must include the combined unwanted UIC and GSM transmit band;
- 2) the in-band, containing wanted as well as unwanted signals and having the more relaxed performance, adjoins the above out-of-band on the one side;
- 3) the in-band adjoins the other out-of-band at 20MHz beyond the combined wanted UIC and GSM band.

Note: Referring to the combined ranges of UIC and GSM bands is necessary, in 1) to cover the UIC/UIC as well as the UIC/GSM scenarios, and in 3) to avoid possibly extending the stricter requirements of the out-of-band to where the corresponding scenarios are not applicable. This definition is also in line with the assumed wide band capabilities of UIC equipments.

The following results:

	UIC BTS	UIC mobiles
out-of-band, incl TX band	>921	<915
in-band	856–921	915–980
other out-of-band	<856	>980

Thus the table in 05.05 for GSM900 MS applies to UIC MS as well with no change, whereas a new entry is needed for the UIC BTS.

The specification in 05.05 on exceptions is proposed not to be changed.

The changes needed to the 05.05 blocking specification for the UIC equipments are discussed in the following.

As micro BTS is not considered an issue for UIC networks, no changes apply to the last table in section 5.1 of 05.05.

J.3.5.2 Blocking characteristics (in-band)

For UIC MS in-band blocking performance, the scenario requirement is -23dBm to protect against unwanted UIC and GSM downlinks. This is in line with the current specification.

For UIC sMS, the scenario requirement is -29dBm to protect against unwanted UIC and GSM downlinks.

For UIC BTS, to protect against unwanted GSM uplinks, the scenario requirement is -26dBm . To protect against unwanted UIC uplinks, the requirement is only -57dBm , reflecting the coordinated scenario.

In summary, this points to the possibility of relaxing some in-band blocking requirements for UIC equipments as compared with GSM. However, there are a number of good reasons not to do so: These requirements are not related to the different frequency band and the narrower duplex gap for filtering. They are not difficult to meet. And this allows for a better performance than for the typical close proximity scenarios, e.g. in a BTS-MS case where antennas are used at the mouth of tunnels to provide inside coverage. Thus it is proposed to retain the same in-band specification as for GSM throughout the table in 05.05.

J.3.5.3 Blocking characteristics (out-of-band)

For UIC MS out-of-band blocking performance, the scenario requirement is $+5\text{dBm}$ or -13dBm , where the source is a UIC MS or sMS uplink, respectively (see [2]). However, the UIC MS / UIC MS scenario is being failed by the MS spurious emissions anyhow (27m distance required instead of 2m, as discussed above on section 4.3.3). Thus it is proposed to maintain the 0dBm specification in 05.05.

For UIC MS, to protect against the GSM uplink, the scenario requirement is -17dBm . Thus, in the band 880–915MHz the out-of-band requirement is suggested to be relaxed to -5dBm , as in note 2 of 05.05.

For UIC sMS, -7dBm is sufficient to protect against either of the UIC and GSM uplinks. Thus, a relaxation to -7dBm is suggested for the UIC sMS in the frequency range 876–915MHz.

For UIC BTS, to protect against other UIC and GSM downlinks, the scenario requirements are $+9$ and -1dBm , respectively. This is only a very small difference to the requirements in 05.05, and thus no change is proposed, incl. retaining note 3 although a relaxation to an inside part of the out-of-band is probably not usefull for the UIC BTS.

J.3.5.4 AM suppresion characteristics

No change is proposed.

J.3.5.5 Intermodulation characteristics

No change is assumed, as this specification is not directly based on system scenarios.

J.3.5.6 Spurious emissions

This section has not been examined in detail, but no change is assumed.

J.3.6 Transmitter/receiver performance

J.3.6.1 Nominal error rates

For UIC equipments the highest wanted signal levels are:

UIC BTS	-23
UIC MS	-23
UIC sMS	-29 dBm .

Although this reflects a possible relaxation, it is proposed to stay with the current specification in 05.05, considering, that in the worst case UIC BTS and mobiles may be much closer to each other than in the more typical case used to calculate the scenario, and that the requirement poses no problem for implementation anyhow.

Thus, no changes are suggested for this section of 05.05.

J.3.6.2 Reference sensitivity level

No changes are assumed to this section of 05.05. This also applies to the last paragraph, which is assumed to reflect feasibility.

Hint: In some places of a radio network design, not the natural noise floor may be dominant (as assumed in determining the sensitivity), but rather other uncoordinated mobiles by their wide band noise setting an artificial and actual higher noise floor, desensitising the BTS.

The rest of 05.05

No change is assumed, except for annex D.

Annex D Environmental conditions

To be considered for UIC equipments on another occation.

IV References

- [1] GSM Technical Specification 05.05, vers. 5.2.0.
- [2] "UIC system scenarios requirements" (First part of this annex)
- [3] "AR's on the UIC frequency band" (SMG2#15 TDoc. 139/95)
- [4] GSM Technical Report 05.50
- [5] "MS spurious emissions onto downlink of UIC" (SMG2#20 Tdoc. 239 / 96)

Annex K: Block Erasure Rate Performance for GPRS

ETSI STC SMG2 WPB

Tdoc SMG2 WPB 47/97

Meeting no 1
Edinburgh, Scotland
22 - 26 September 1997

Agenda Item 6.1

Title: Block Erasure Rate Performance for GPRS/CS-1, CS-2, CS-3 and CS-4 in TU50 ideal FH and TU3 no FH, in the presence of co-channel interference

Source: CSELT, Ericsson

K.1 Introduction

Block Erasure Rate (BLER) performance for GPRS/CS-1, CS-2, CS-3 and CS-4 are provided in the case of Typical Urban 50 km/h with ideal frequency hopping and TU3 no FH, in the presence of co-channel interference. CS-1 BLER performance is to be compared with SDCCH FER performance provided by AEG and used for specifying the reference performance in GSM 05.05.

K.2 Simulation Model

Hereunder the main assumptions used for carrying out the simulations are reported:

TU50 ideal FH and TU3 no FH propagation models, as defined in GSM 05.05

In case of ideal FH, independent fadings over consecutive bursts are assumed

Varying fading during one burst

One single interfering signal

$E_b/N_0 = 28$ dB (according to GSM 05.05)

No antenna diversity

Burst synchronisation recovery based on the cross-correlation properties of the training sequence

Soft output equaliser

Channel decoding (for CS-1, performance includes Fire decoding and correction, as for AEG SDCCH FER performance; for CS-2, CS-3 and CS-4, CRC are used for detection only)

K.3 Results

Fig. 1 shows Block Erasure Rate curves for GPRS/CS-1, CS-2, CS-3 and CS-4 in TU50 ideal FH, coming from CSELT and Ericsson. Moreover SDCCH FER performance from AEG is reported.

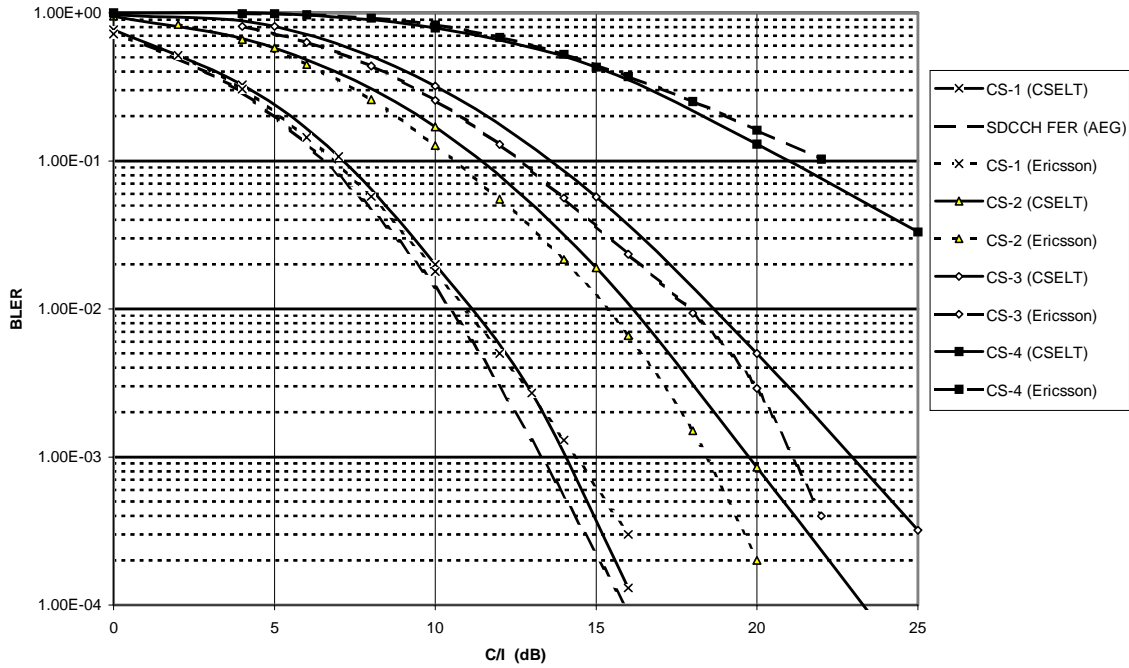

Figure 1 - BLER vs. C/I for GPRS/CS-1, CS-2, CS-3 and CS-4 in TU50 ideal FH. SDCCH FER performance is reported as a reference for GPRS/CS-1 performance

Fig. 2 reports BLER versus C/I in TU3 no FH.

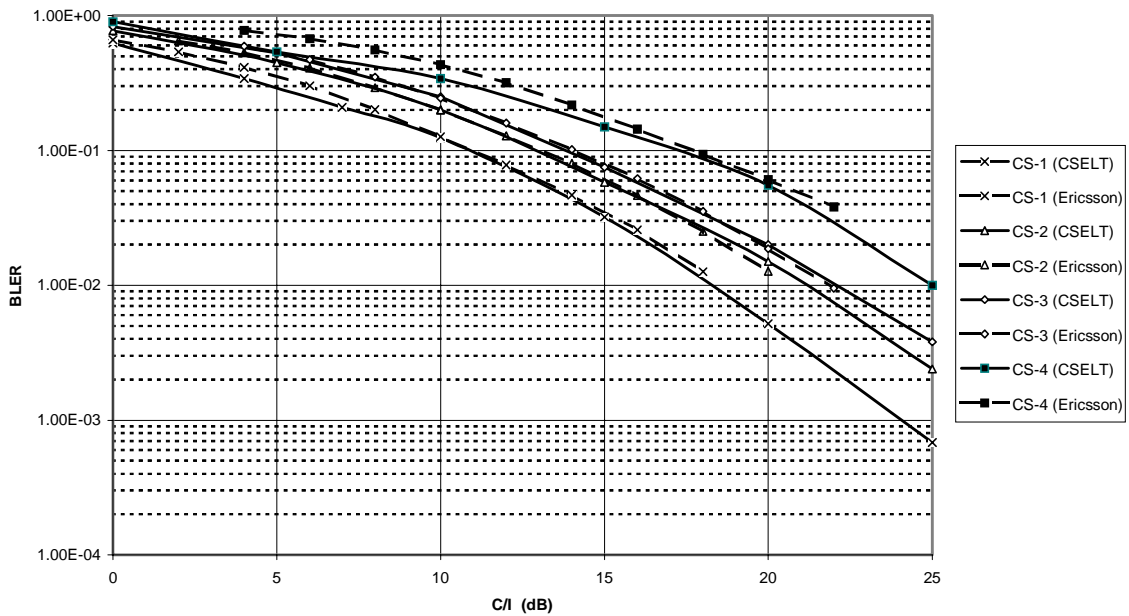

Figure 2 - BLER vs. C/I for GPRS/CS-1, CS-2, CS-3 and CS-4 in TU3 no FH

K.4 Conclusions

CSELT and Ericsson results are similar for all the 4 coding schemes and may be assumed as a basis for specifying the reference values in GSM 05.05. For CS-1 the results are very similar and there is also a good alignment with SDCCH FER results provided by AEG, especially at BLER = 10%, which is the proposed reference performance value.

Annex L: Proposal on how to report GPRS performance into GSM 05.05

ETSI STC SMG2 WPB

Tdoc SMG2 WPB 48/97

Meeting no 1
Edinburgh, Scotland
22 - 26 September 1997

Agenda Item 6.1

Title: *Proposal on how to report GPRS performance into GSM 05.05*

Source: *CSELT*

L.1. Introduction

This document reports GPRS Block Erasure Rate (BLER) performance and throughput analyses obtained by simulations for GPRS/CS-1, CS-2, CS-3 and CS-4 coding schemes, in order to provide reference performance in GSM 05.05. The considered propagation models are TU50 ideal FH and TU3 no FH.

L.2. GPRS BLER performance

Figures 1 and 2 show the BLER performance for CS-1 to CS-4 in TU50 ideal FH and TU3 no FH, in the presence of co-channel interference. These curves have been obtained with the following assumptions:

- TU50 ideal FH and TU3 no FH propagation models, as defined in GSM05.05
- In case of ideal FH, independent fadings over consecutive bursts are assumed
- Varying fading during one burst
- One single interfering signal
- $E_b/N_0 = 28$ dB (according to 05.05)
- No antenna diversity
- Burst synchronisation recovery based on the cross-correlation properties of the training sequence
- Soft output equaliser
- Channel decoding (for CS-1, performance includes Fire decoding and correction; for CS-2, CS-3 and CS-4, CRC are used for detection only)

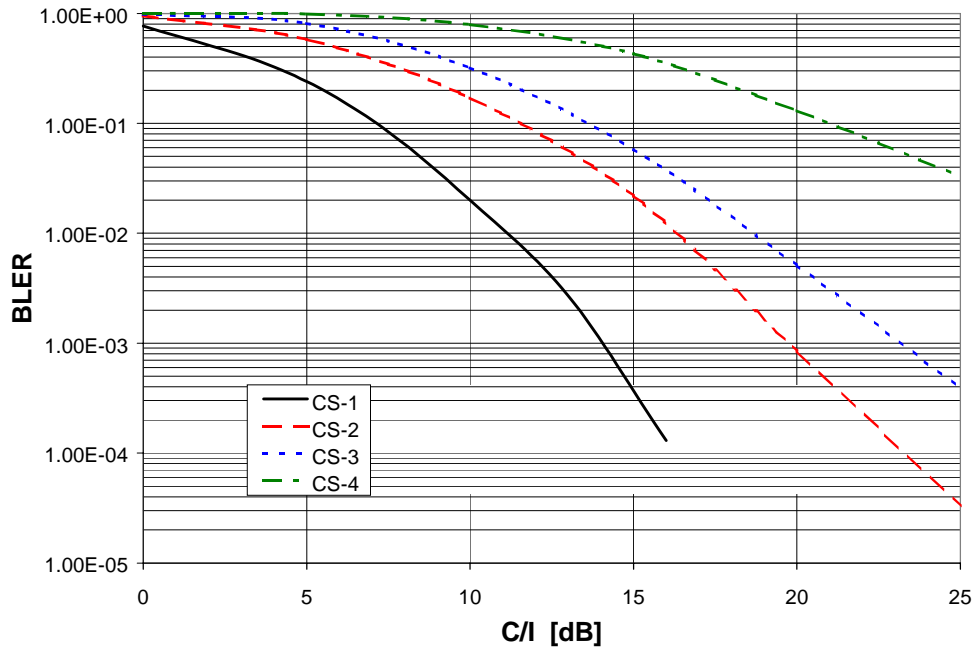

Figure 1 - BLER vs. C/I_c , TU50 ideal FH

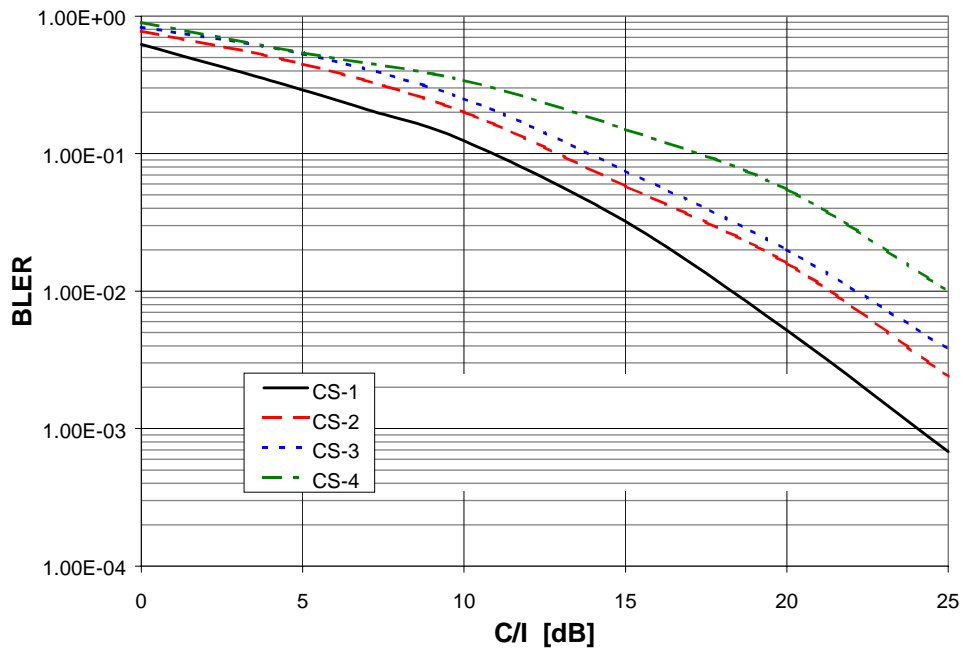

Figure 2 - BLER vs. C/I_c , TU3 no FH

L.3. GPRS throughput analyses

Throughput performance has been evaluated for CS-1 to CS-4 versus C/I_c with the following assumptions:

- GPRS MAC/RLC protocol
- C/I distribution: log-normal with variable mean value and standard deviation of 7 dB

- Traffic Model: Poisson distribution of the packet inter-arrival time and packet length distributed according to the Railway traffic model
- Single-slot MSs
- A single PDCH dedicated to data traffic
- Up-link performance

L.3.1 TU50 ideal FH

Figure 3 shows the throughput vs. C/I_c curves in the case of TU50 ideal FH. It is also indicated the C/I_c value at BLER=10% for each coding scheme.

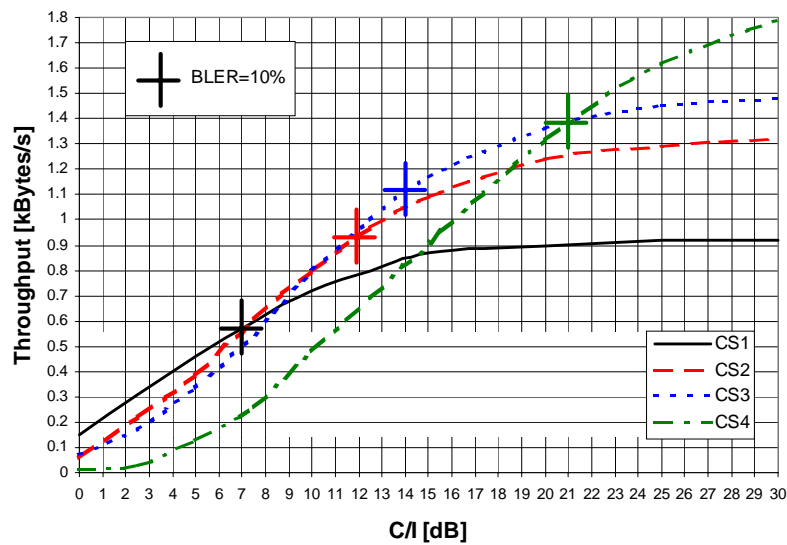

Figure 3 - Throughput vs. C/I_c , TU50 ideal FH. Each cross corresponds to a BLER=10%

Figure 4 shows the BLER vs. C/I_c curves for each coding scheme in the case of TU50 ideal FH. Arrows show for which range of C/I_c values each coding scheme provides the highest throughput: for instance, CS-1 has the best performance for C/I_c lower than 7.5 dB, and CS-2 has the highest throughput for $7.5\text{dB} < C/I_c < 10\text{dB}$.

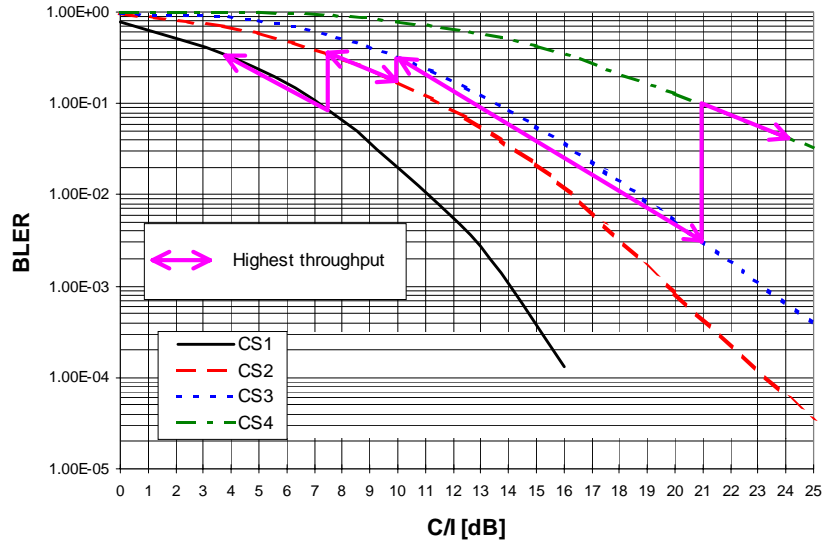

Figure 4 - BLER vs. C/I_c , TU50 ideal FH. Arrows indicate the highest throughput ranges

L.3.2 TU3 no FH

Figure 5 shows the throughput performance in the case of TU3 no FH. It is also indicated the C/I_c value at BLER=10% for each coding scheme.

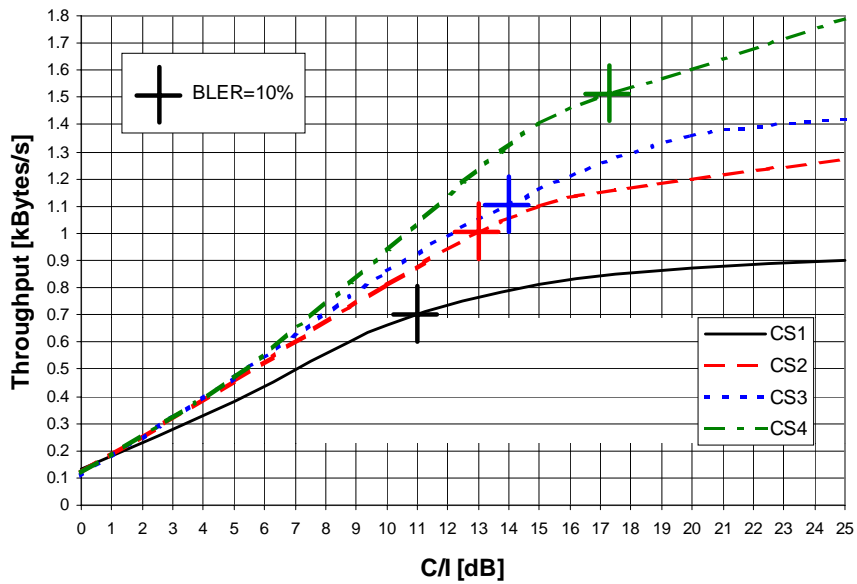

Figure 5 - Throughput vs. C/I_c , TU3 no FH. Each cross corresponds to a BLER=10%

L.4. Proposals for GPRS performance in GSM 05.05

L.4.1 TU50 ideal FH

Hereunder two alternatives have been considered for TU50 ideal FH (2 dB implementation margin has been taken into account to specify the C/I_c values):

1) Variable BLER (Figure 4)

In this case the coding schemes are evaluated for different reference BLER values, corresponding to the ranges of the highest throughput.

Coding scheme	BLER - C/I_c
CS-1	8.5% - 9.5 dB
CS-2	35% - 9.5 dB
CS-3	32% - 12 dB
CS-4	10% - 23 dB

2) Fixed BLER (Figure 3)

In this case, the coding schemes are evaluated for a fixed BLER reference value (BLER=10%), in order to try to maximise the throughput performance.

Coding scheme	C/I_c at BLER=10%
CS-1	9 dB
CS-2	13.8 dB
CS-3	16 dB
CS-4	23 dB

L.4.2 TU3 no FH

As far as TU3 no FH is considered, the throughput analysis has shown that option 2) should be considered. A BLER reference value equal to 10% still represents a good trade-off, in order to try to maximise the throughput performance.

Fixed BLER (Figure 5)

Coding scheme	C/I_c at BLER=10%
CS-1	13 dB
CS-2	15 dB
CS-3	16 dB
CS-4	19.3 dB

L.5 Conclusions

Based on the presented results, a BLER reference value equal to 10% for all the coding schemes is proposed, in order to specify performance in GSM 05.05. An implementation margin equal to 2 dB has been taken into account in the proposed C/I_c values.

Annex M: GPRS simulation results in TU 3 and TU 50 no FH

ETSI STC SMG2 WPB#2

Tdoc SMG2 WPB 99/97

Bonn 3-7 November 1997

Title : GPRS simulation results in TU 3 and TU 50 no FH**Source : GIE CEGETEL**

M.1 Introduction

This document presents the performances of the 4 GPRS coding schemes on the GSM radio interface. The performances in terms of BLER and throughput as a function of the C/I are provided to SMG2 WPB for information.

M.2 Simulation Model

The conditions for the simulations are :

- TU3 and TU50 propagation models as defined in GSM 05.05 (without frequency hopping for both models)
- one single interferer experiencing the same propagation conditions as the wanted signal with independent fading on the two channels
- Varying fading during one burst
- noise floor such that $E_b/N_0 = 26$ dB
- soft output equaliser

The results are obtained by processing 40000 radio blocks for each coding scheme which represents a transfer duration of about 13 minutes. At the end of the simulation a file containing the Block Error Pattern is generated.

Below, the C/I giving a BLER of 10^{-1} are presented for information.

Interference ratio at Reference performance

Type of channel	Tu3 (no FH)	Tu50 (no FH)
CS1	13.5 dB	10.5 dB
CS2	15.5 dB	13.5 dB
CS3	17.5 dB	16 dB
CS4	20 dB	24 dB

C/I for a BLER = 10^{-1} (including the implementation margin of 2 dB)

These results are aligned with the results presented by Lucent, CSELT and Ericsson. Simulations were also ran without the co-channel interferer considering white noise as the perturbation. These simulations were ran to find the sensitivity level at the reference performance ($BLER = 10^{-1}$).

Sensitivity level (for normal BTS) at reference performance

Type of channel	Tu50 (no FH)
CS1	-103 dBm
CS2	-100.5 dBm
CS3	-98 dBm
CS4	-90.7 dBm

signal strength needed for a $BLER = 10^{-1}$

Performances in TU 3 with a co-channel interferer

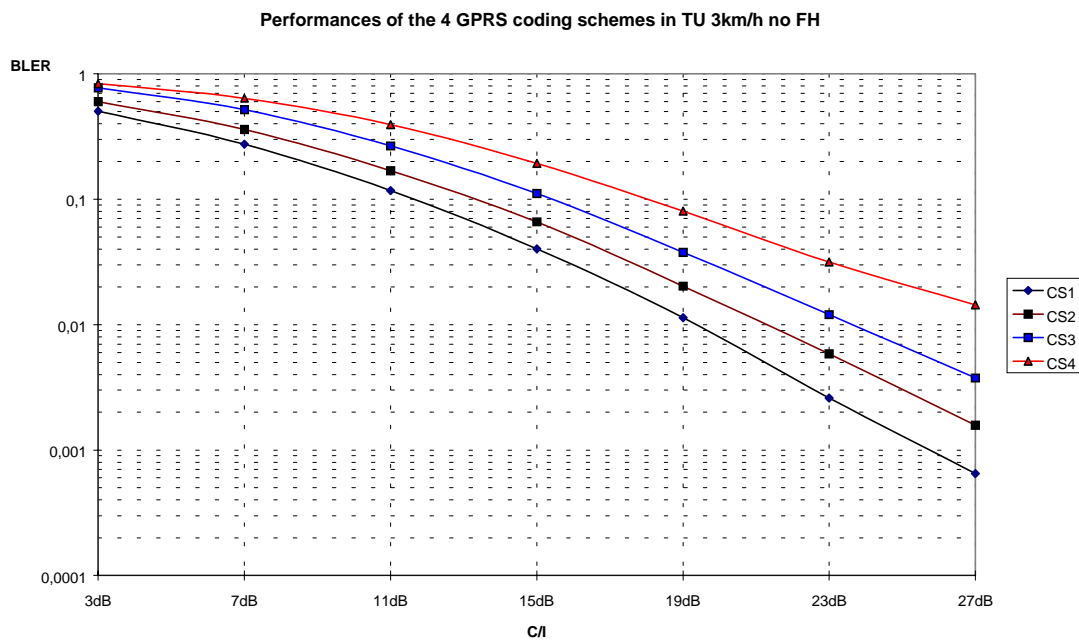

Performances in TU 50 with a co-channel interferer

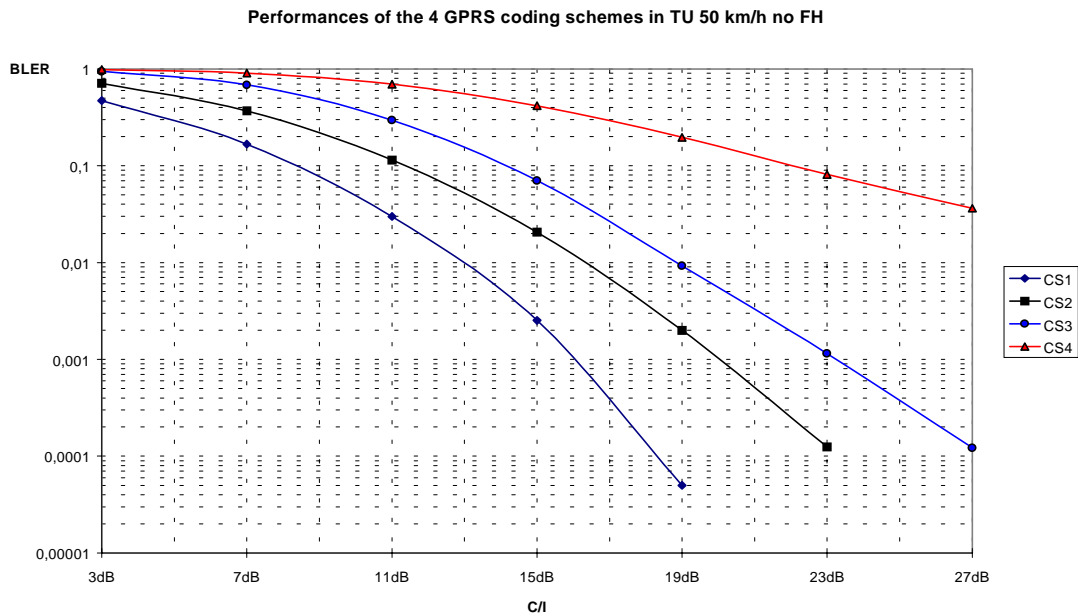

M.3 Maximum GPRS throughput

In this section, the methodology used to measure the throughput is presented. The GPRS MAC/RLC protocol was implemented according to 03.64 [1] and Tdoc 175/97 [3]. The maximum throughput achievable at a given C/I is measured for each coding scheme. Therefore the traffic load is not considered in the simulations. Furthermore PRACH and PAGCH are always considered correctly decoded.

- the MS is always sending RLC blocks and there is always enough free radio resources to initiate the transfer (the intracell traffic is not considered)
- Same C/I on uplink and downlink
- the response time between the MS - BSS is 2 TDMA frames
- The timer T11 (Wait for Acknowledgement) is set to 100 ms as in [2]
- when T11 is reset, the MS releases the connection then initiates a new procedure for random access. The time elapsed from the release of the resource and reception of the new Ack/Nack is set to 180 ms including
 - ⇒ transmission of PRACH
 - ⇒ reception of PAGCH from the network
 - ⇒ transmission of a RLC block with the old TFI
 - ⇒ reception of the missing Ack/Nack from the network

Performances in TU 3 with a co-channel interferer

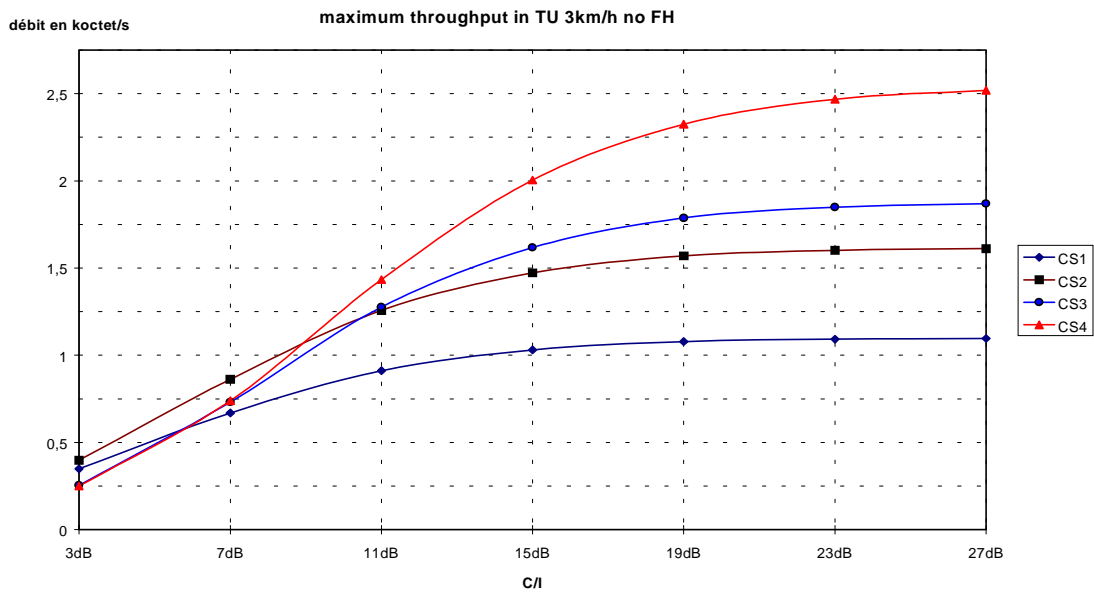

Performances in TU 50 with a co-channel interferer

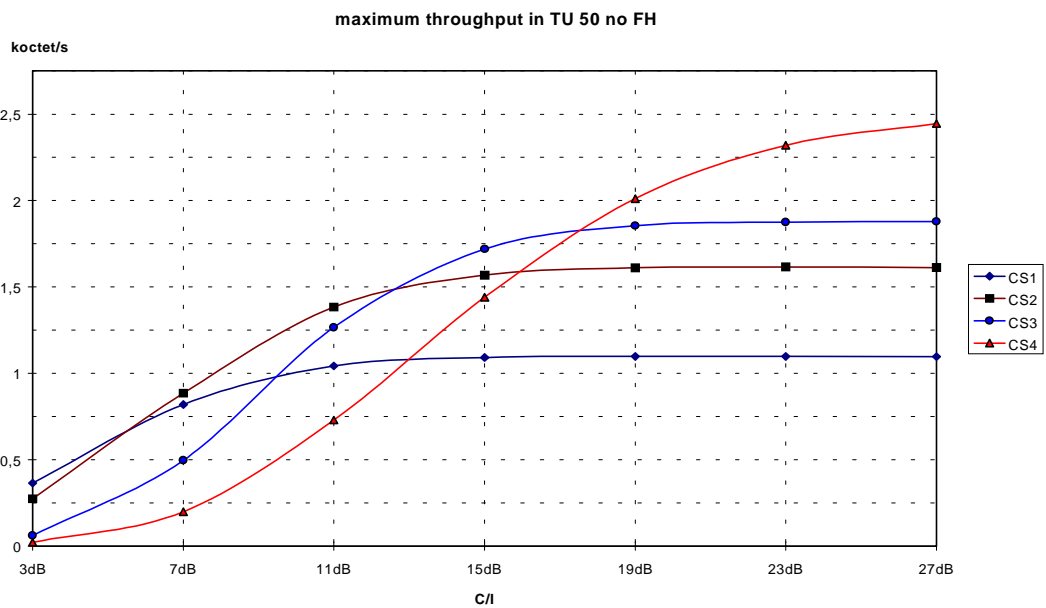

M.4 Conclusion

BLER and throughput performances are analysed in this document for TU3 and TU50 environments (no FH). The throughput curves give the upper bound of each coding scheme at a given C/I.

M.5 References

- [1] SMG2 GPRS Tdoc 175/97, "GPRS RLC/MAC Temporary Block Flow Procedures", Ericsson January 1997
- [2] SMG2 GPRS Tdoc 218/97, "Evaluation of Channel Coding Schemes CS2 and CS4", CSELT February 1997

[3] draft GSM 03.64 v 5.0.0, "Overall description of the GPRS radio interface", Stage 2, July 1997

Annex N: C/I_c and E_b/N₀ Radio Performance for the GPRS Coding Schemes

ETSI STC SMG2 WPB

TDoc SMG2 WPB 100/97

Meeting no 2
Bonn, Germany
3 - 7 November 1997

Agenda Item 6.1

Title: *C/I_c and E_b/N₀ Radio Performance for the GPRS Coding Schemes*

Source: *CSELT*

N.1 Introduction

This document reports C/I_c radio performance for the GPRS coding schemes in propagation models for both GSM 900 (TU50 no FH, RA250 no FH) and DCS1800 (TU50 no FH, TU50 ideal FH), in order to provide reference performance in GSM 05.05. Moreover, E_b/N₀ performance are reported, in the range around 10% for BLER.

N.2 C/I simulation results

The following figures show BLER vs. C/I_c performance for CS-1 to CS-4 in different propagation models. These curves have been obtained with the same assumptions reported in [1,2,3].

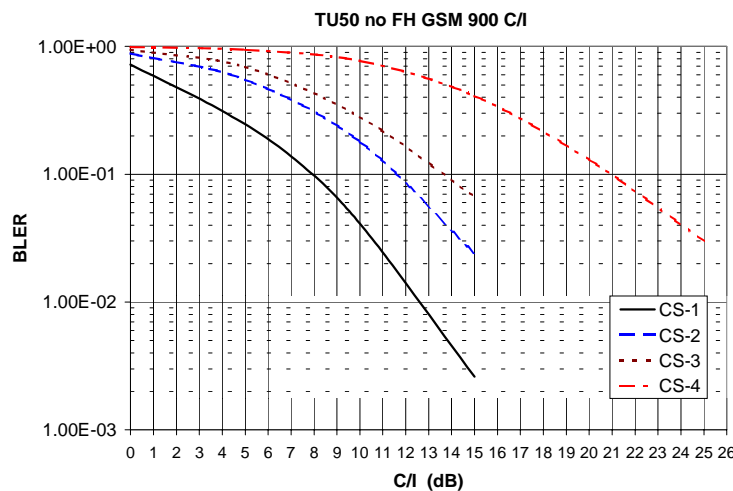

Figure 1 - BLER vs. C/I_c, TU50 no FH, GSM900

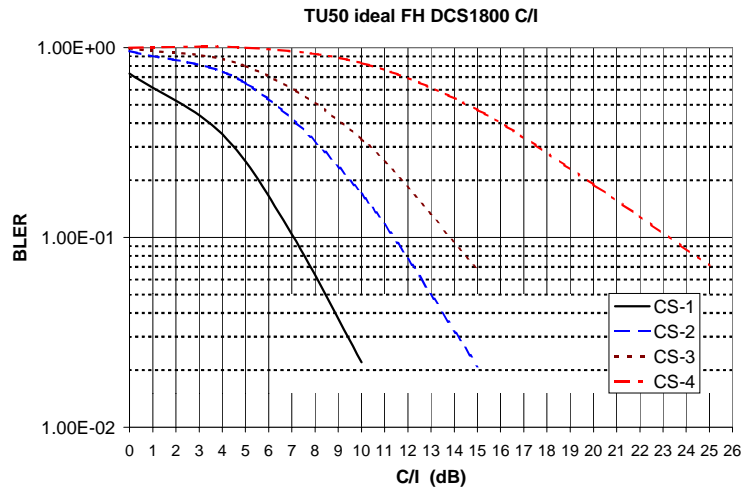

Figure 2 - BLER vs. C/I_c, TU50 ideal FH, DCS1800

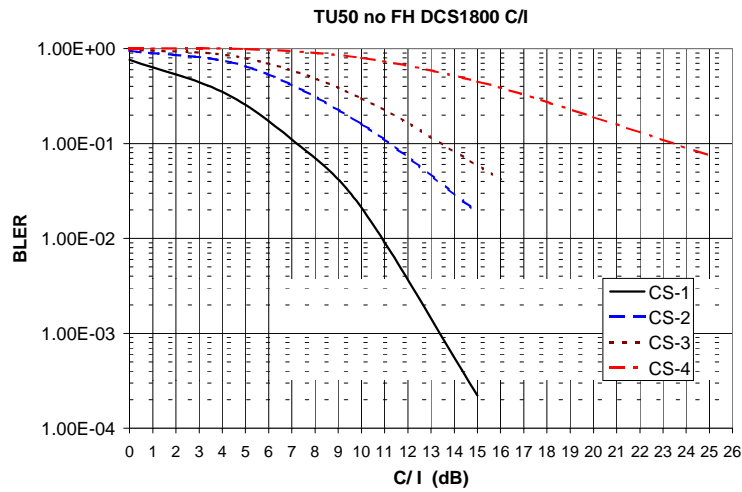

Figure 3 - BLER vs. C/I_c, TU50 no FH, DCS1800

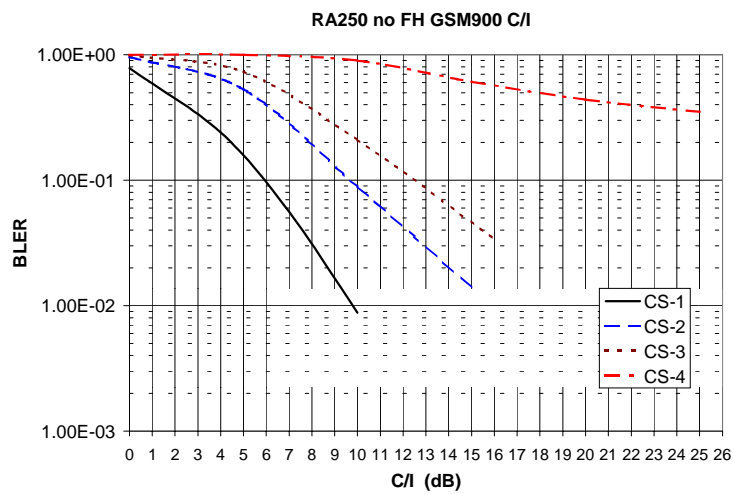

Figure 4 - BLER vs. C/I_c, RA250 no FH, GSM900

N.3. E_b/N_0 performance

The following figures show BLER vs. E_b/N_0 performance for CS-1 to CS-4 in different propagation models.

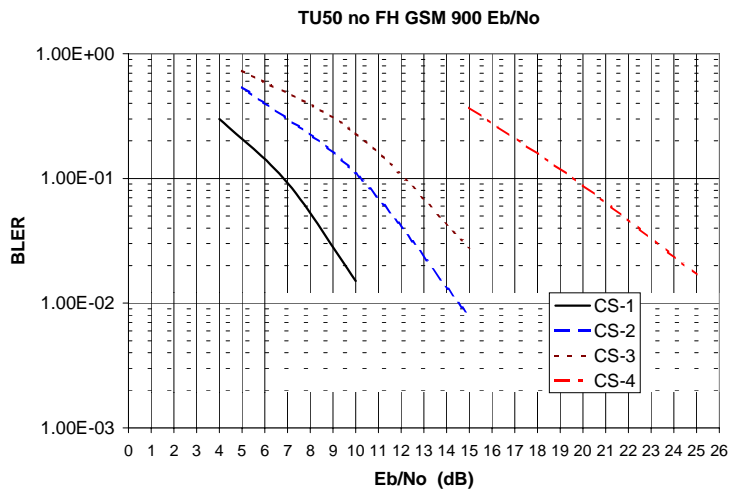

Figure 5 - BLER vs. E_b/N_0 , TU50 no FH, GSM900

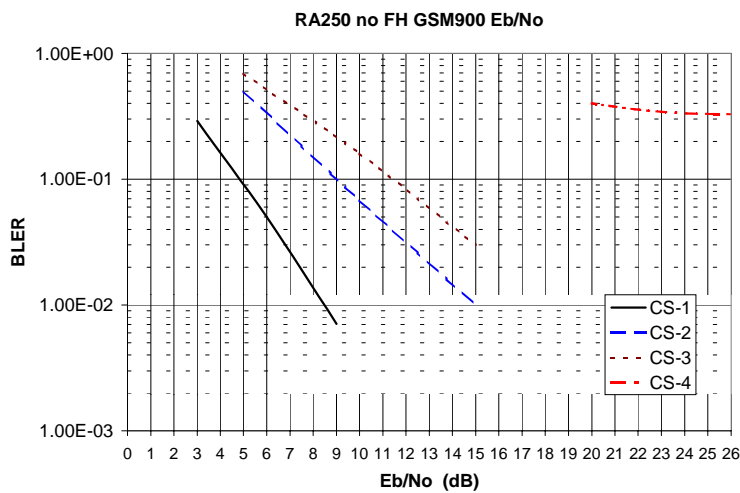

Figure 6 - BLER vs. E_b/N_0 , RA250 no FH, GSM900

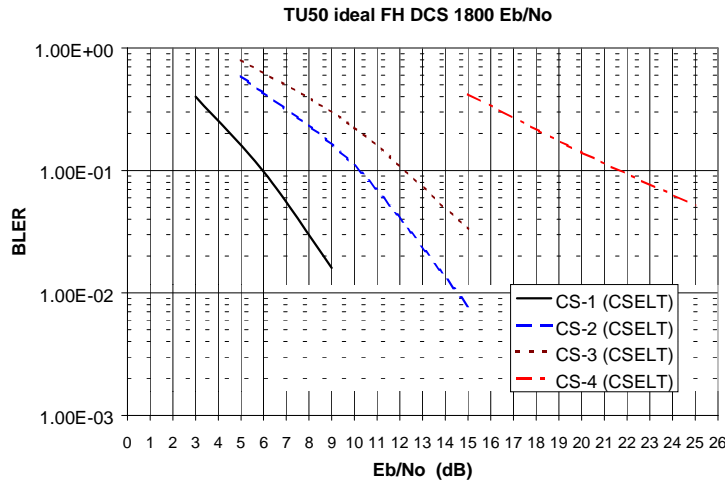

Figure 7 - BLER vs. E_b/N_0 , TU50 ideal FH, DCS1800

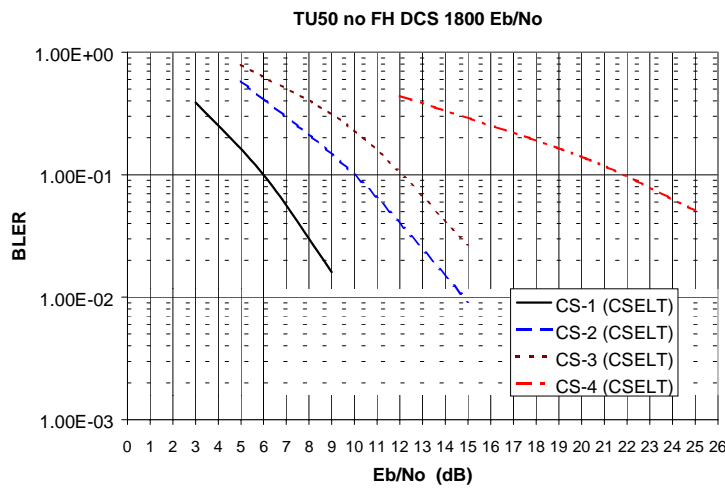

Figure 8 - BLER vs. E_b/N_0 , TU50 no FH, DCS1800

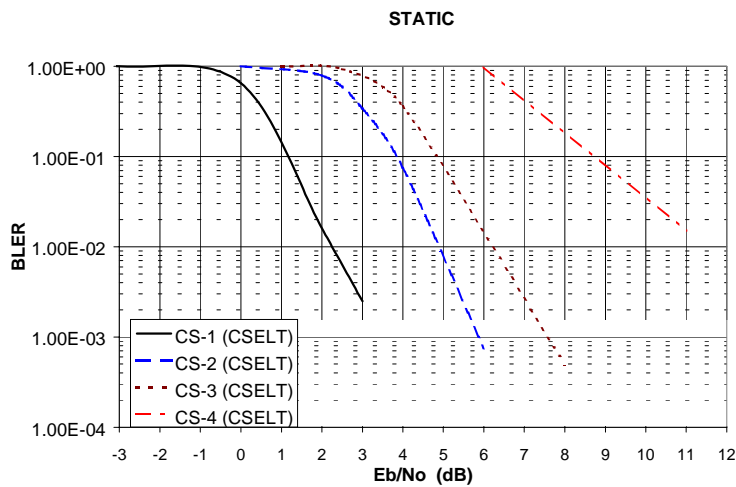

Figure 9 - BLER vs. E_b/N_0 , static

N.4 Conclusions

Based on the reported simulations results, the input signal level and the interference ratio can be derived at the reference BLER performance of 10% and they are included in [4] by adding a 2 dB implementation margin. At the specified reference performance our results do not allow for a specification of the input level in the case of CS-4 in GSM900 RA250 no FH (and as a consequence in DCS1800 RA130 no FH). The same applies for the interference ratio in GSM900 RA250 no FH (and DCS1800 RA130 no FH). Before taking a decision on how to deal with that, we encourage other companies to provide simulation results in the same conditions in order to check if the same problem occurs.

N.5 References

- [1] TDoc SMG2 WPB 42/97 "Block Error Rate and USF Error Rate for GPRS"; Ericsson, 22-26 September, 1997-Edinburgh, Scotland
- [2] TDoc SMG2 WPB 47/97 "Block Erasure Rate Performance for GPRS/CS-1, CS-2, CS-3 and CS-4 in TU50 ideal FH and TU3 no FH, in the presence of co-channel interference"; CSELT-Ericsson, 22-26 September, 1997-Edinburgh, Scotland
- [3] TDoc SMG2 WPB 48/97 "Proposal on how to report GPRS performance into GSM 05.05"; CSELT, 22-26 September, 1997- Edinburgh, Scotland
- [4] TDoc SMG2 WPB 101/97 "CR 05.05- A062 for input signal level and interference ratio at reference performance"; CSELT, 3-7 November, 1997- Bonn, Germany

Annex P: Block Error Rate and USF Error Rate for GPRS

ETSI STC SMG2 WPB

TDoc SMG2 WPB 127/97

November 3-7, 1997

Bonn, Germany

Title: Block Error Rate and USF Error Rate for GPRS

Source: Ericsson

P.1 Introduction

BLER (Block Error Rate) and USF (Uplink State Flag) error rate for GPRS are presented for different channel assumptions. Simulations have been performed for all reference environments defined in GSM05.05 at 900 MHz..

P.2 Simulation Assumptions

Assumptions used in the simulations are:

- Varying channel during each burst according to the velocity
- Interference simulations: Interference from one single interferer, $E_b/N_0=28$ dB
- No antenna diversity
- Synchronization on burst basis
- 16-state soft output MLSE-equalizer
- Channel coding according to GSM03.64

For CS-2, CS-3 and CS-4, decoding of USF is performed by soft correlation with the eight possible 12-bit codewords. For CS-1, USF error is detected after normal decoding of the convolutional code. This means that the performance for the USF is equal for CS-2, CS-3 and CS-4. For CS-1 a slightly worse performance is achieved but it is still significantly better than the corresponding BLER.

P.3 Simulation Results

P.3.1 Interference Simulations

P.3.1.1 TU50 Ideal Frequency Hopping

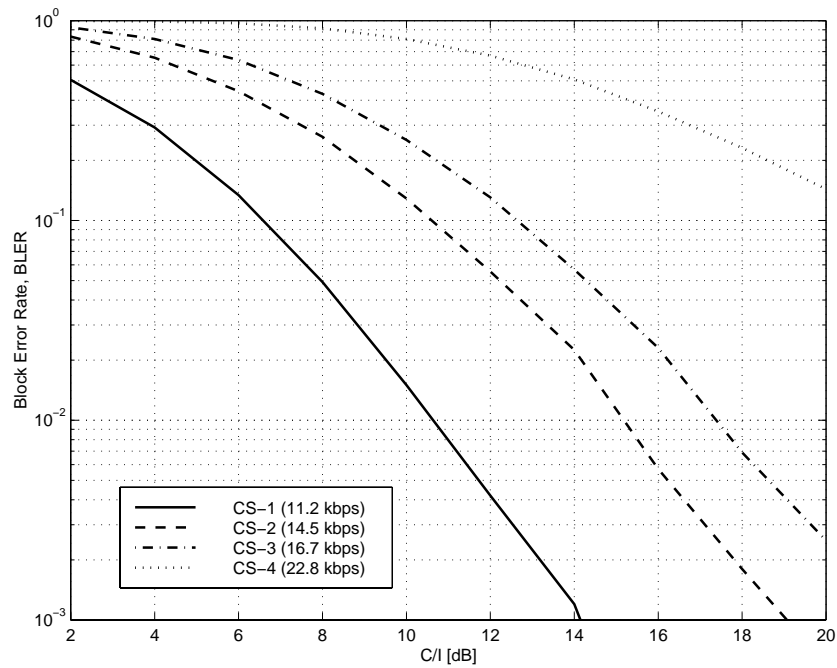

Figure 1 BLER for TU50 ideal frequency hopping

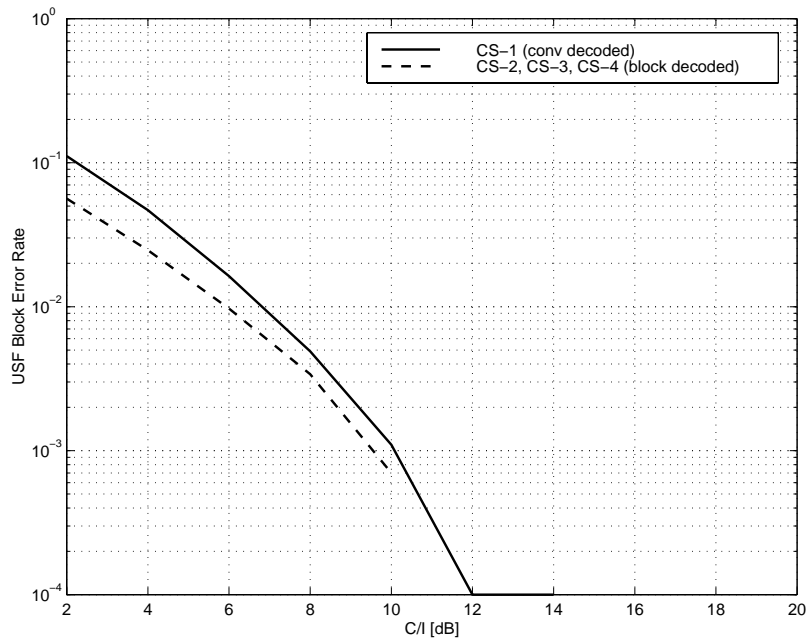

Figure 2: USF performance for TU50 ideal frequency hopping

P.3.1.2 TU50 No Frequency Hopping

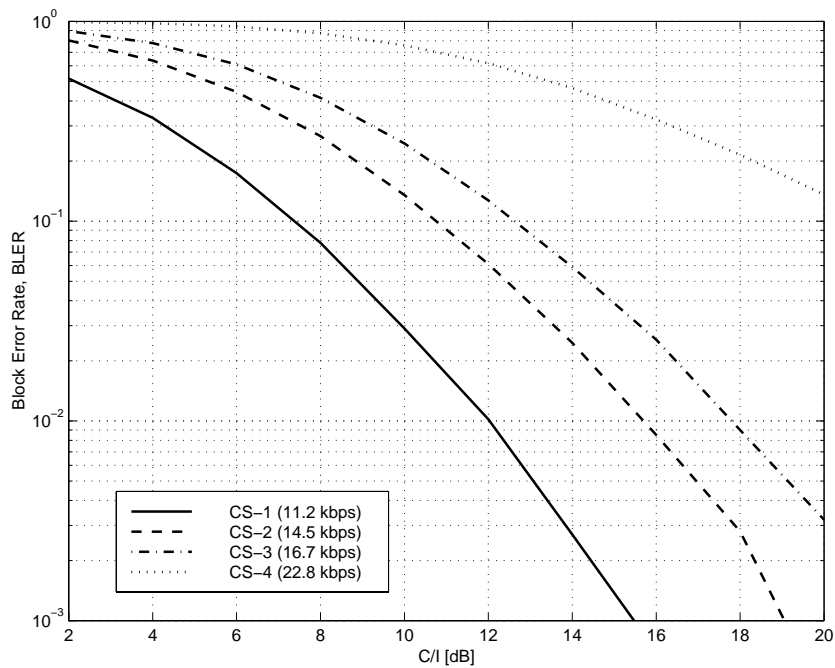

Figure 3: BLER for TU50 no frequency hopping

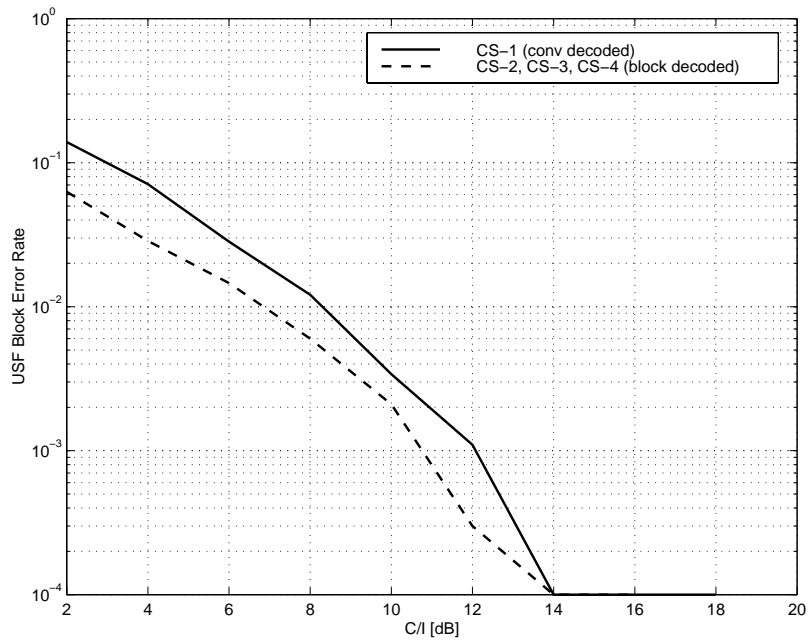

Figure 4: USF performance for TU50 no frequency hopping

P.3.1.3 TU3 Ideal Frequency Hopping

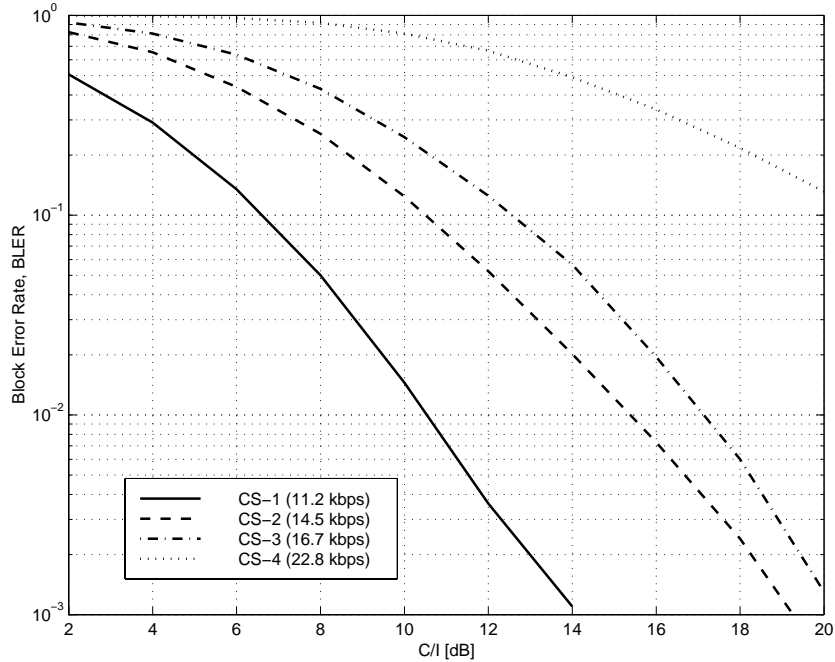

Figure 5: BLER for TU3 ideal frequency hopping

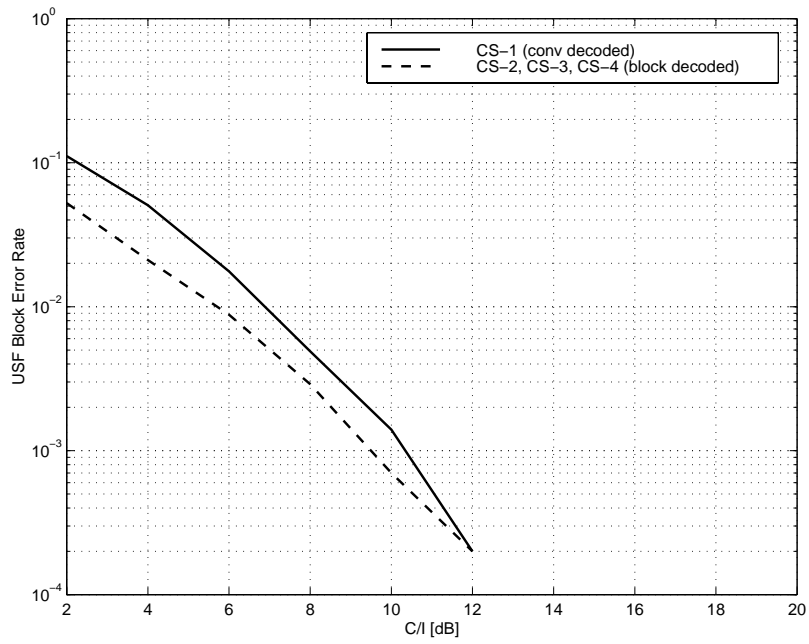

Figure 6: USF performance for TU3 ideal frequency hopping

P.3.1.4 TU3 No Frequency Hopping

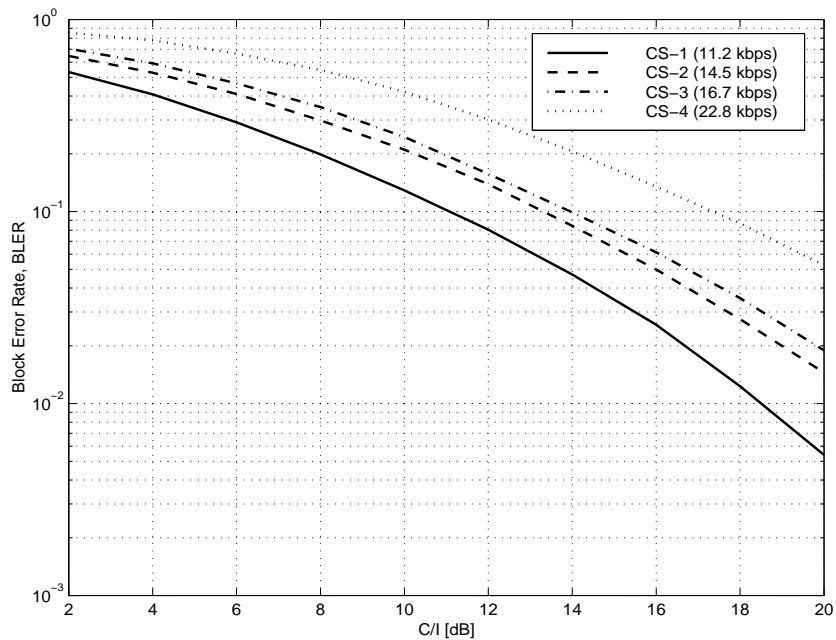

Figure 7: BLER for TU3 no frequency hopping

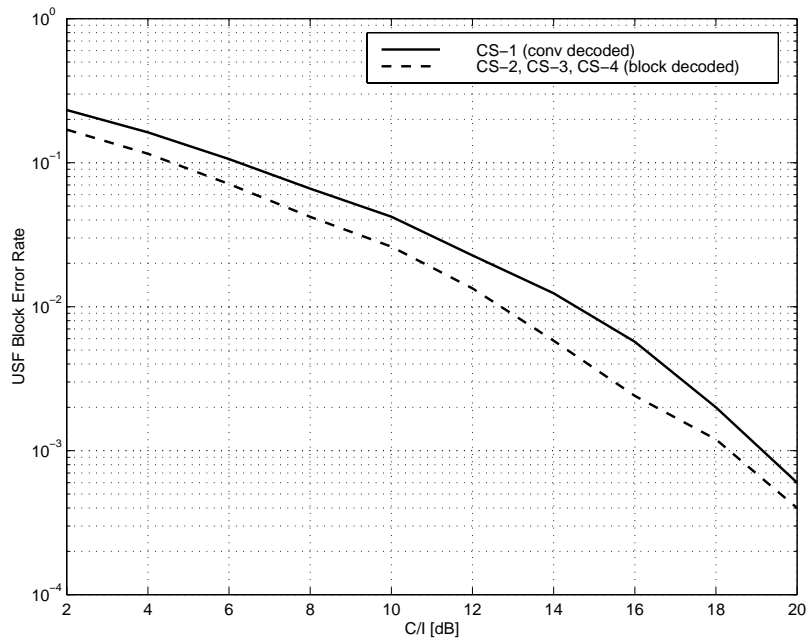

Figure 8: USF performance for TU3 no frequency hopping

P.3.1.5 RA250 No Frequency Hopping

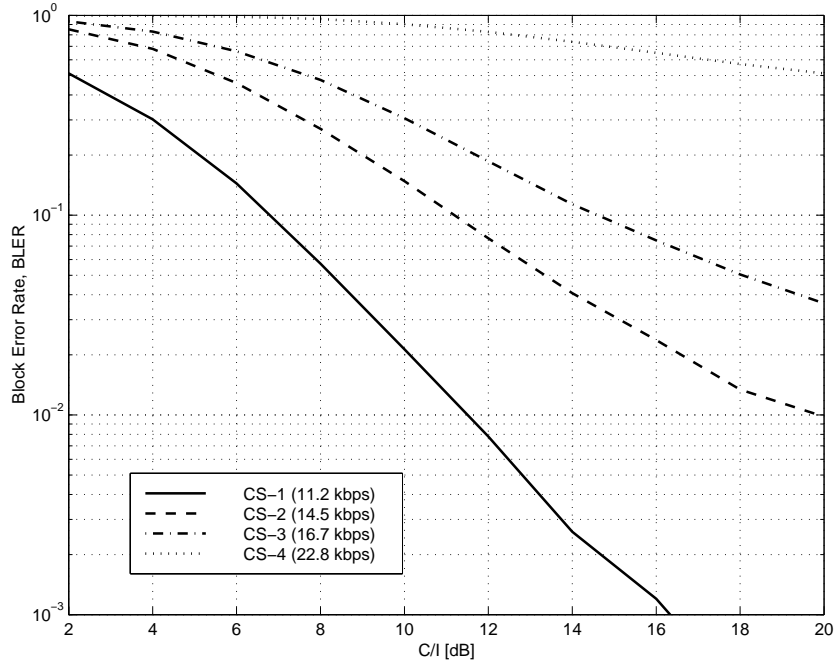

Figure 9: BLER for RA250 no frequency hopping

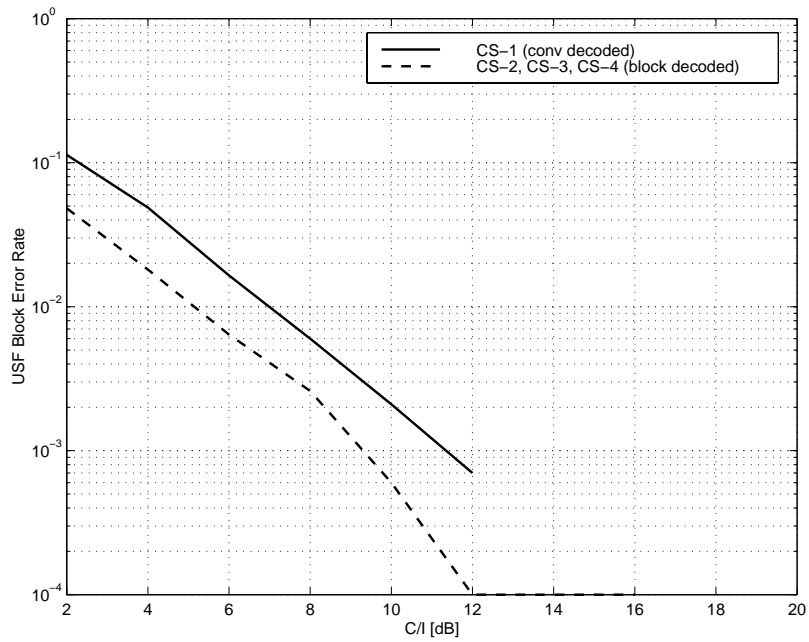

Figure 10: USF performance for RA250 no frequency hopping

P.3.2 Sensitivity Simulations

P.3.2.1 TU50 Ideal Frequency Hopping

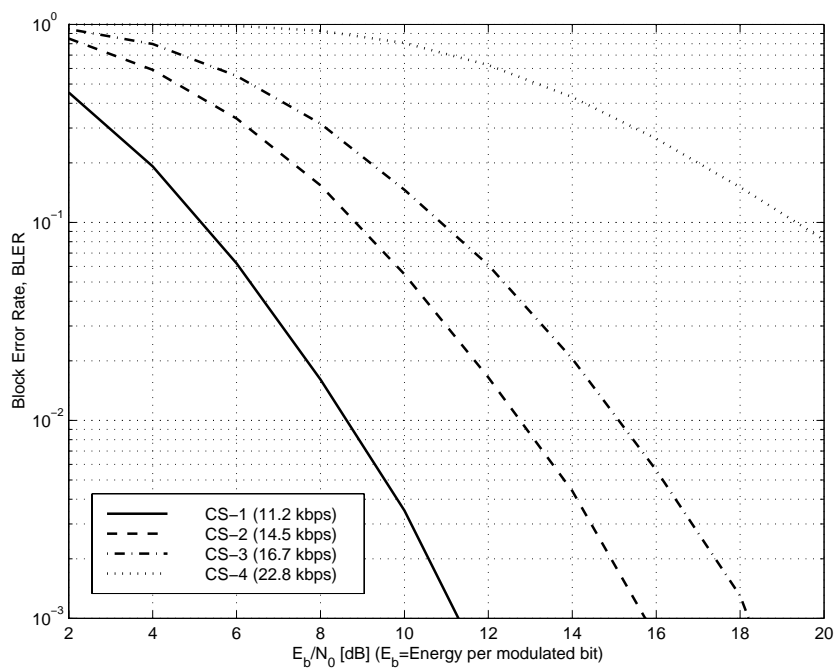

Figure 11: BLER for TU50 ideal frequency hopping

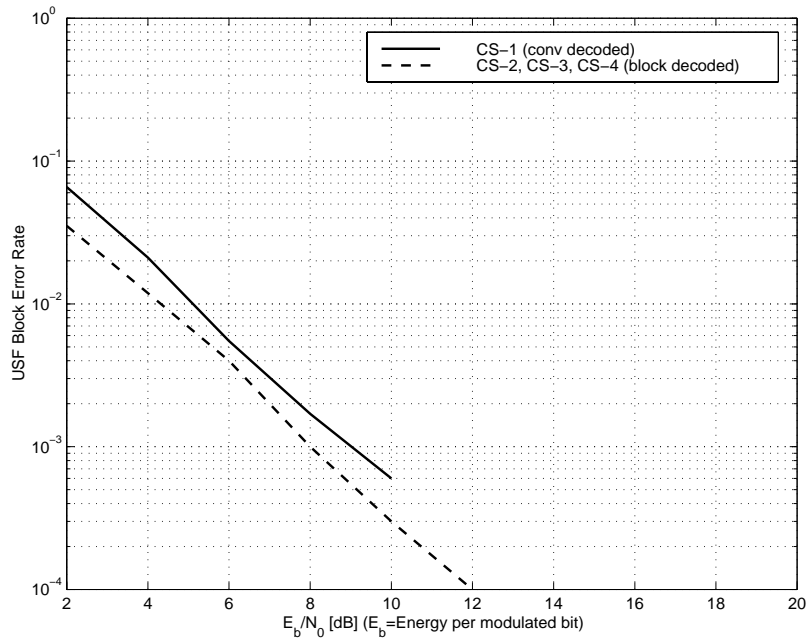

Figure 12: USF performance for TU50 ideal frequency hopping

P.3.2.2 TU50 No Frequency Hopping

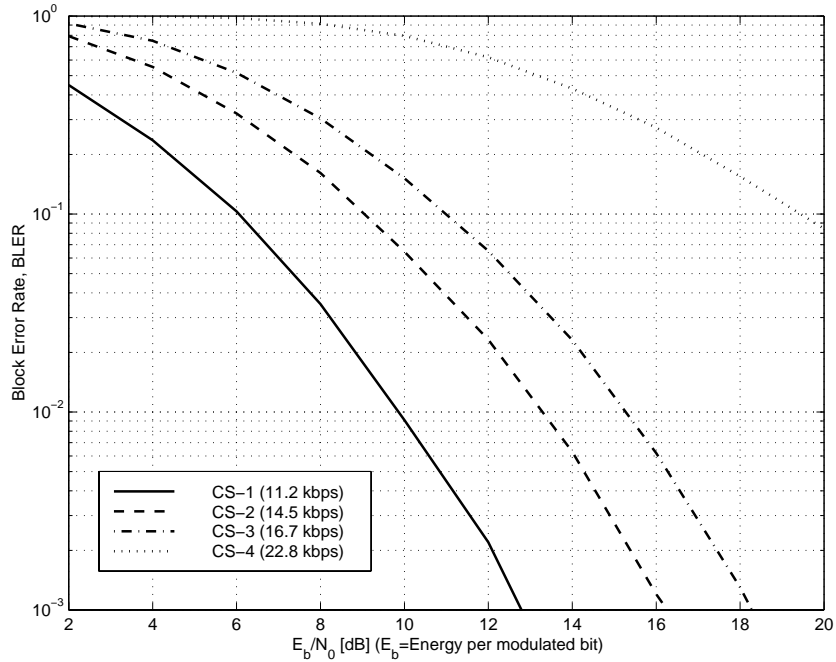

Figure 13: BLER for TU50 no frequency hopping

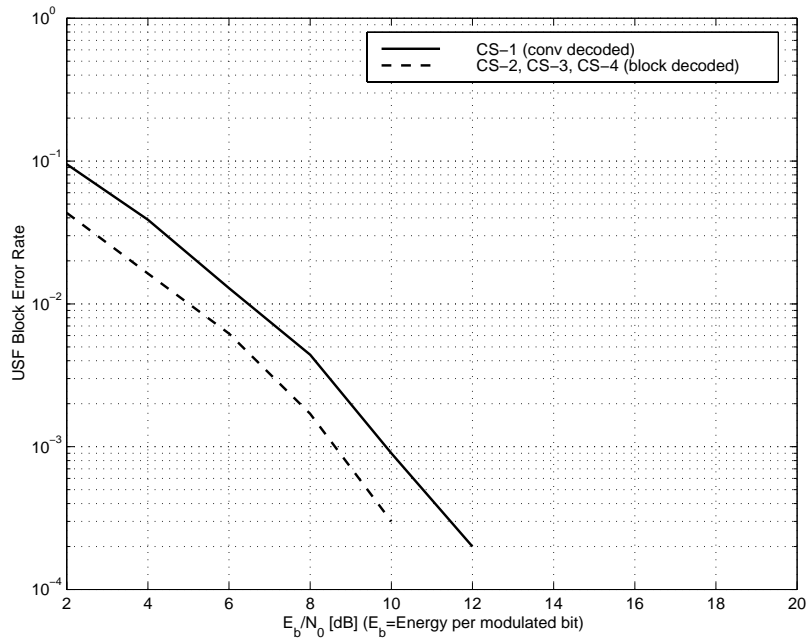

Figure 14: USF performance for TU50 no frequency hopping

P.3.2.3 HT100 No Frequency Hopping

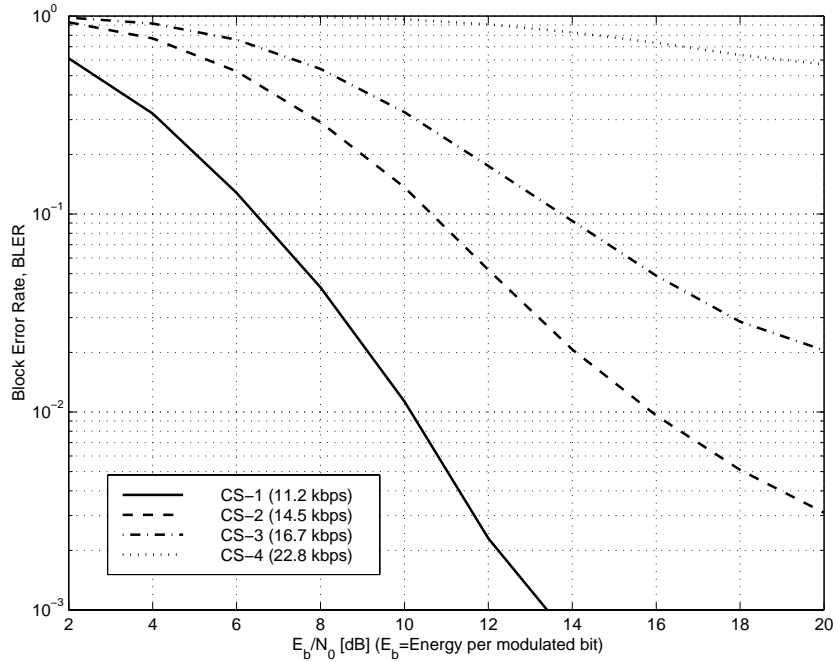

Figure 15: BLER for HT100 no frequency hopping

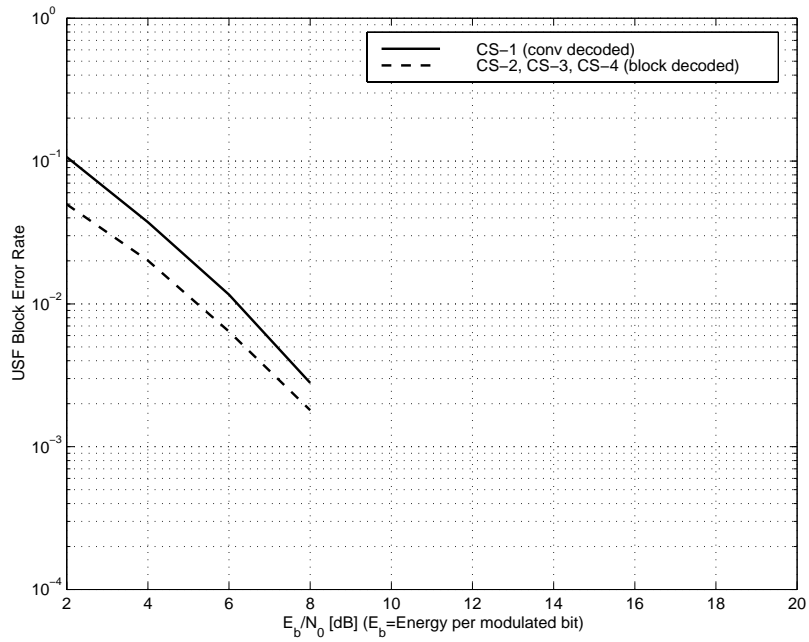

Figure 16: USF performance for HT100 no frequency hopping

P.3.2.4 RA250 No Frequency Hopping

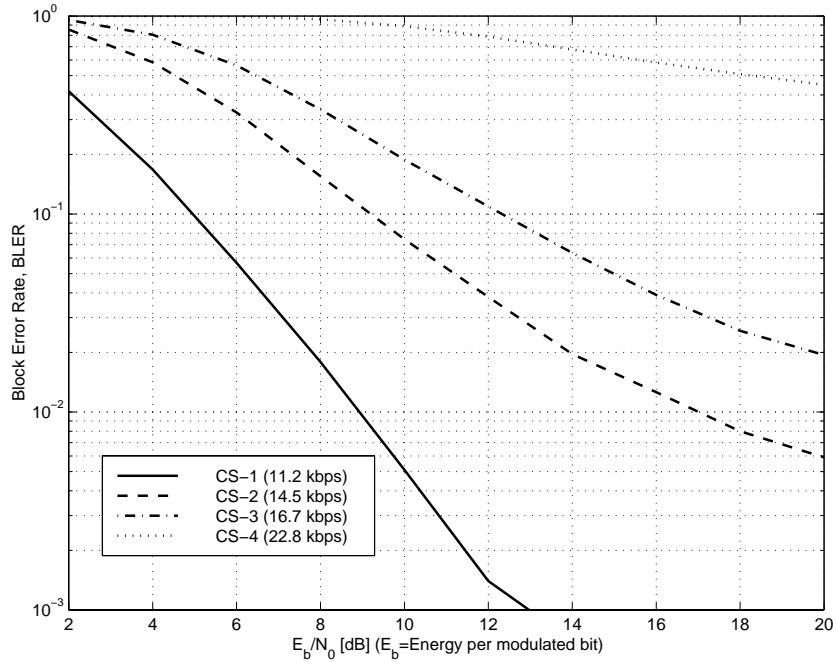

Figure 17: BLER for RA250 no frequency hopping

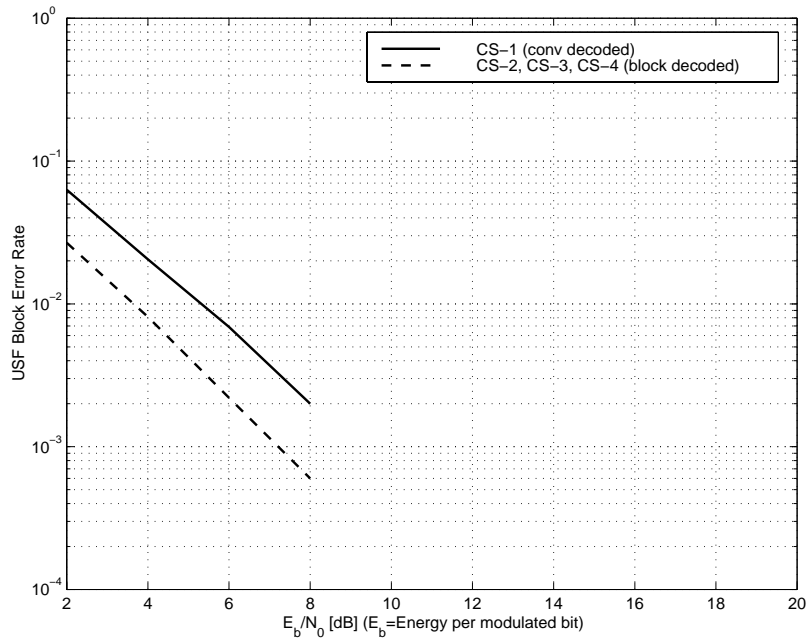

Figure 18: USF performance for RA250 no frequency hopping

P.3.2.5 Static Channel

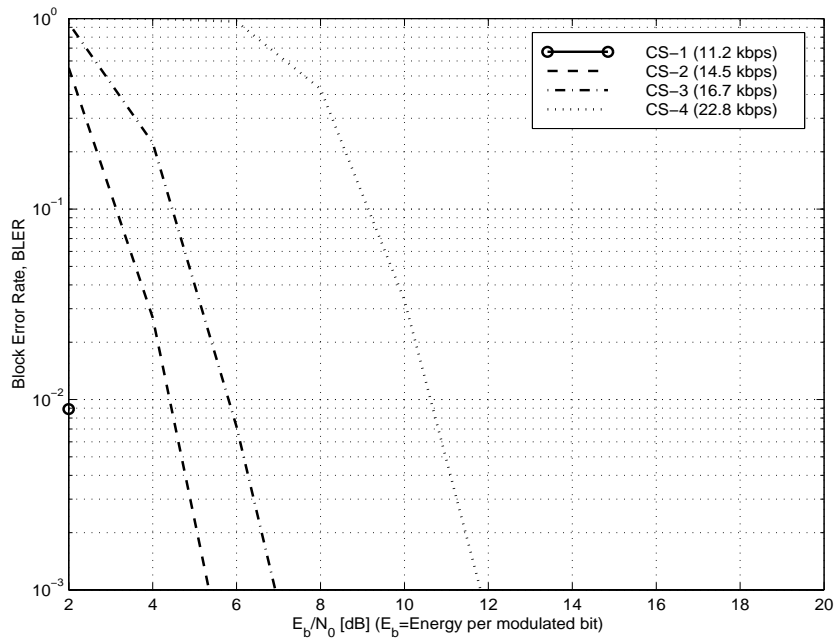

Figure 19: BLER for static channel

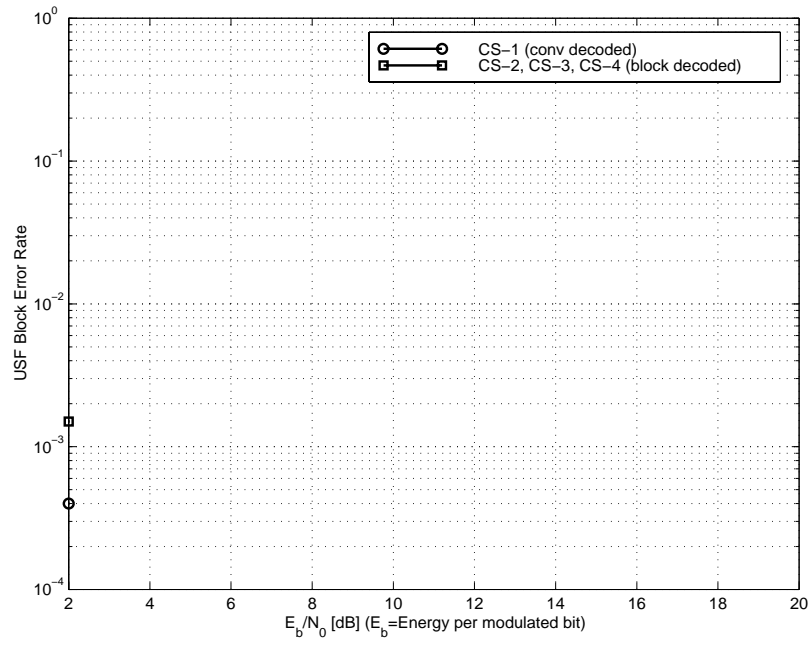

Figure 20: USF performance for static channel

Annex Q: Block Error Rate and USF Error Rate for GPRS, 1800 MHz

ETSI STC SMG2
Meeting no 24
Cork, Ireland

TDoc SMG2 374/97

Agenda item 5.2.3

1 - 5 December 1997

Title: Block Error Rate and USF Error Rate for GPRS, 1800 MHz

Source: Ericsson

Q.1 Introduction

BLER (Block Error Rate) and USF (Uplink State Flag) error rate for GPRS are presented for different channel assumptions. Simulations have been performed for 1800 MHz for those reference environments defined in GSM05.05 that can not be derived from the 900 MHz simulations.

Q.2 Simulation Assumptions

Assumptions used in the simulations are (the same as for 900 MHz):

- Varying channel during each burst according to the velocity
- Interference simulations: Interference from one single interferer, $E_b/N_0=28$ dB
- No antenna diversity
- Synchronization on burst basis
- 16-state soft output MLSE-equalizer
- Channel coding according to GSM03.64

For CS-2, CS-3 and CS-4, decoding of USF is performed by soft correlation with the eight possible 12-bit codewords. For CS-1, USF error is detected after normal decoding of the convolutional code. This means that the performance for the USF is equal for CS-2, CS-3 and CS-4. For CS-1 a slightly worse performance is achieved but it is still significantly better than the corresponding BLER.

Q.3 Simulation Results

Q.3.1 Interference Simulations, 1800 MHz

Q.3.1.2 TU50, Ideal Frequency Hopping

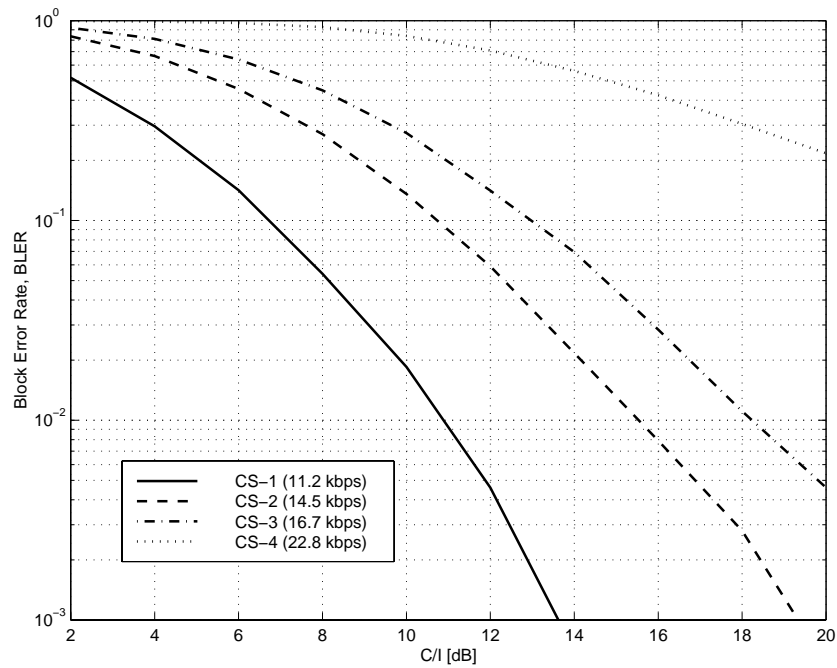

Figure 21: BLER for TU50 ideal frequency hopping, 1800 MHz

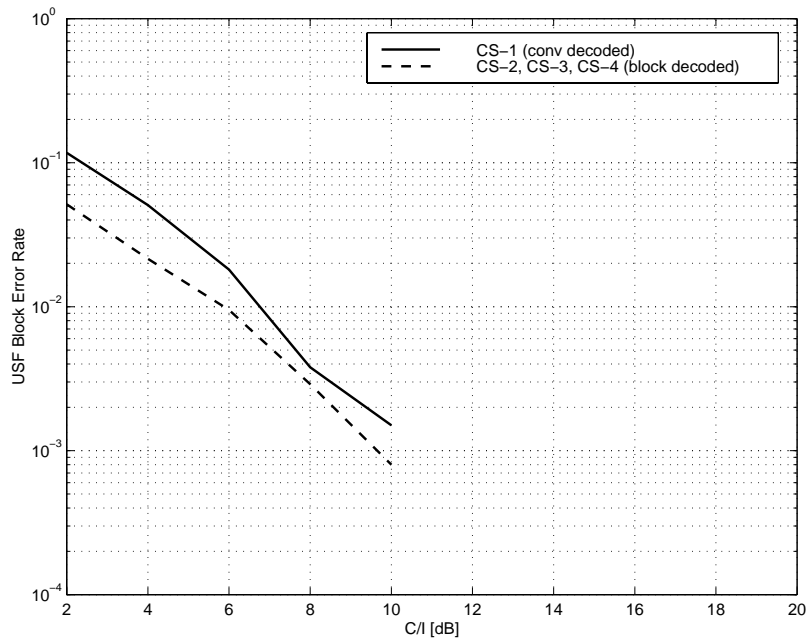

Figure 22: USF performance for TU50 ideal frequency hopping, 1800 MHz

Q.3.1.3 TU50 No Frequency Hopping

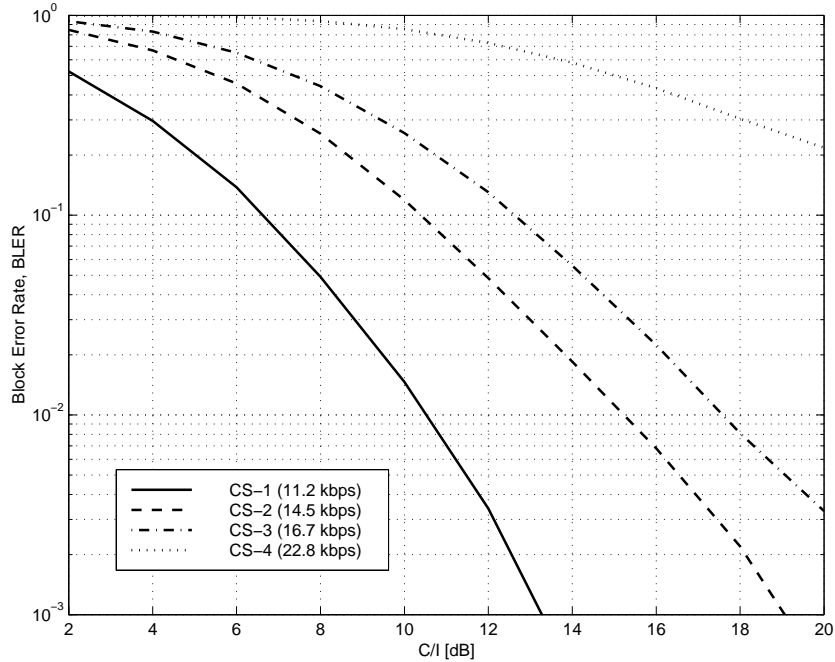

Figure 23: BLER for TU50, no frequency hopping, 1800 MHz

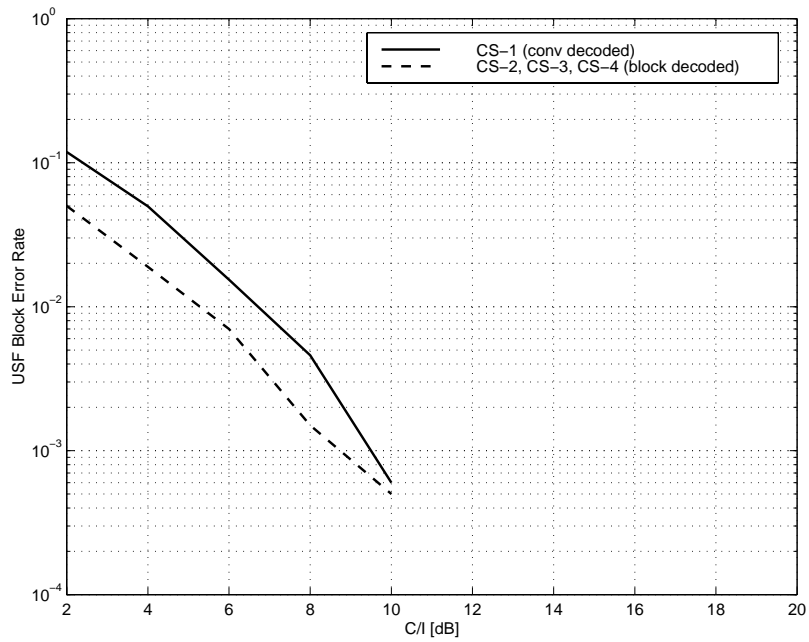

Figure 24: USF performance for TU50, no frequency hopping, 1800 MHz

Q.3.2 Sensitivity Simulations, 1800 MHz

Q.3.2.1 TU50 Ideal Frequency Hopping

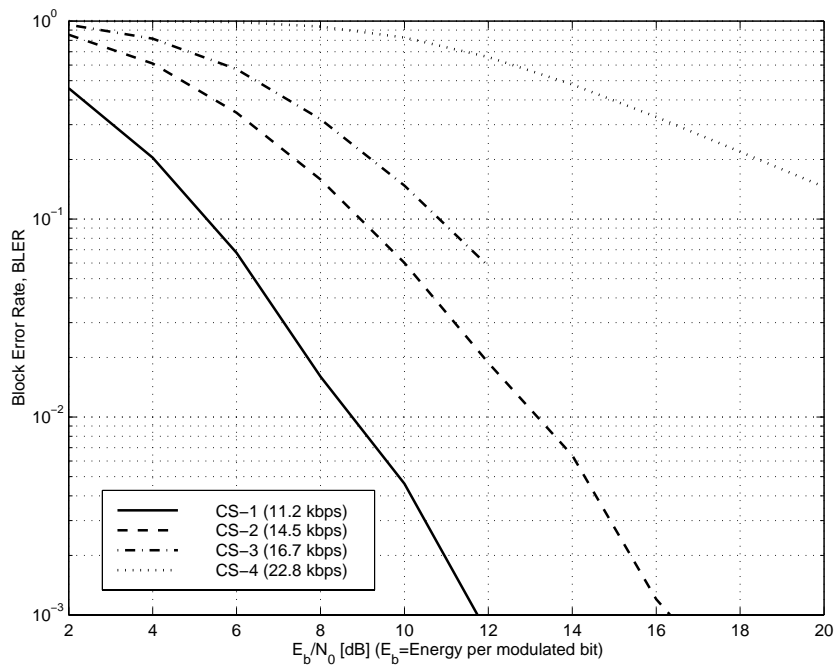

Figure 25: BLER for TU50 ideal frequency hopping, 1800 MHz

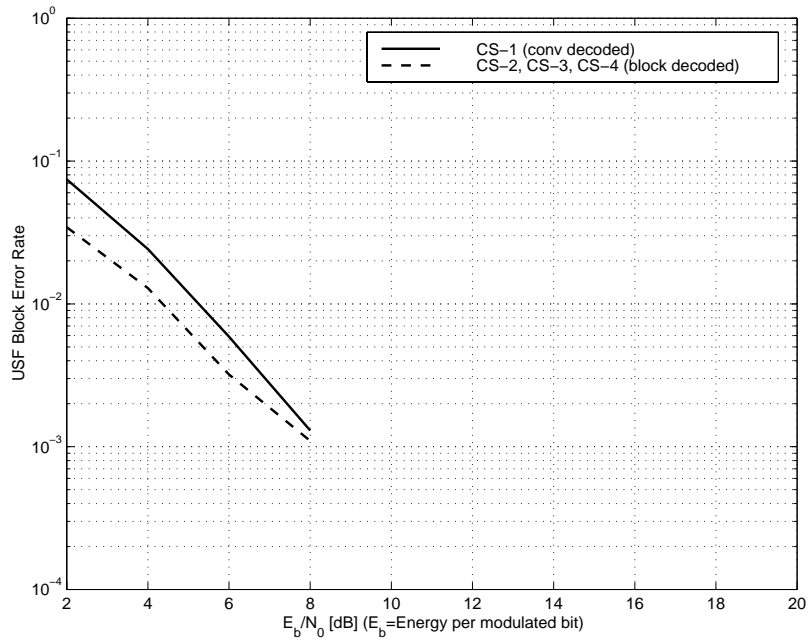

Figure 26: USF performance for TU50 ideal frequency hopping, 1800 MHz

Q.3.2.2 TU50 No Frequency Hopping

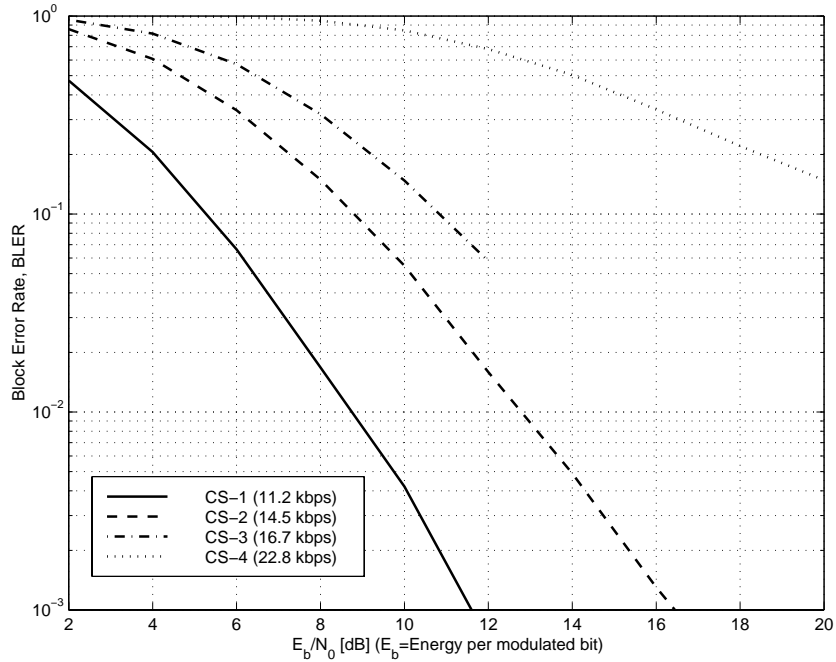

Figure 27: BLER for TU50 no frequency hopping, 1800 MHz

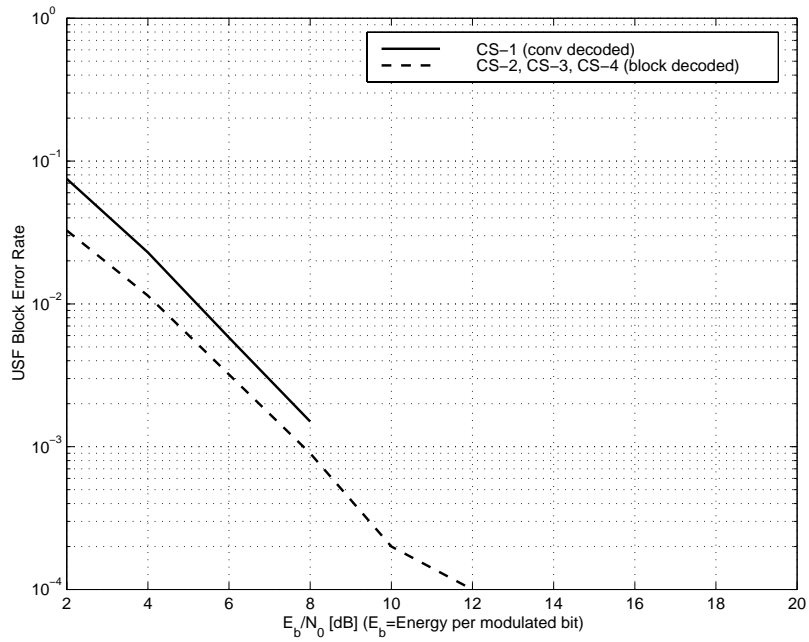

Figure 28: USF performance for TU50 no frequency hopping, 1800 MHz

Q.3.2.3 HT100 No Frequency Hopping

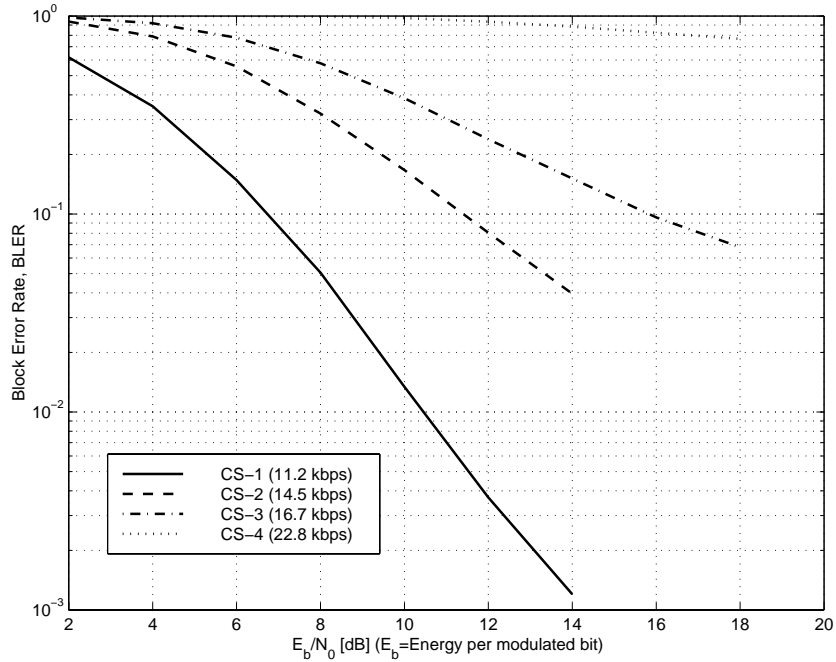

Figure 29: BLER for HT100 no frequency hopping, 1800 MHz

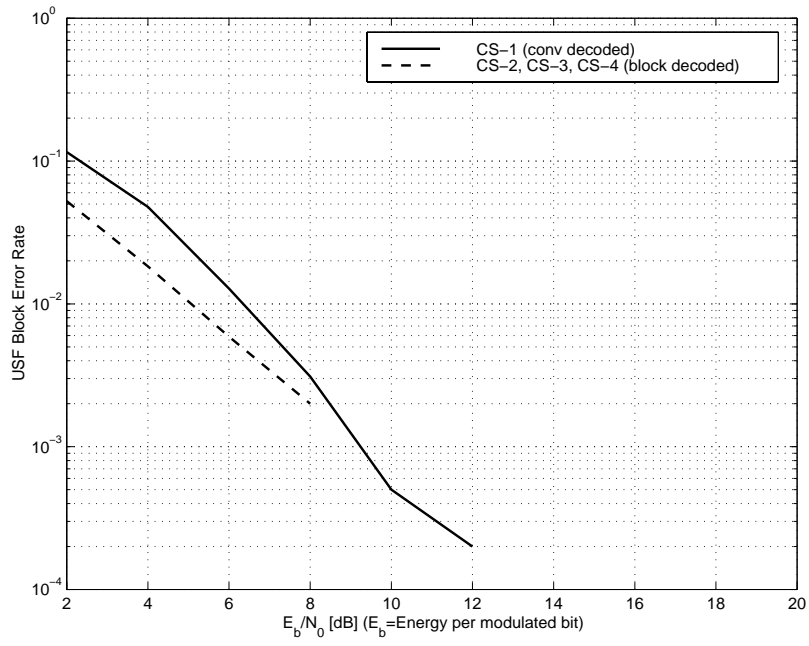

Figure 30: USF performance for HT100 no frequency hopping, 1800 MHz

History

Document history		
V5.1.1	November 1997	Publication
V6.0.0	January 1998	Publication