

**Fixed Radio Systems;  
Point-to-point and point-to-multipoint equipment;  
Use of circular polarization in multipoint systems;  
Part 3: Antennas for multipoint fixed radio systems  
in the 1 GHz to 11 GHz band**

---



---

**Reference**

DTR/TM-04108-3

---

**Keywords**antenna, CDMA, DRRS, FDMA, multipoint, radio,  
RLL, TDMA**ETSI**

---

650 Route des Lucioles  
F-06921 Sophia Antipolis Cedex - FRANCE

Tel.: +33 4 92 94 42 00 Fax: +33 4 93 65 47 16

Siret N° 348 623 562 00017 - NAF 742 C  
Association à but non lucratif enregistrée à la  
Sous-Préfecture de Grasse (06) N° 7803/88

---

**Important notice**

Individual copies of the present document can be downloaded from:

<http://www.etsi.org>

The present document may be made available in more than one electronic version or in print. In any case of existing or perceived difference in contents between such versions, the reference version is the Portable Document Format (PDF). In case of dispute, the reference shall be the printing on ETSI printers of the PDF version kept on a specific network drive within ETSI Secretariat.

Users of the present document should be aware that the document may be subject to revision or change of status. Information on the current status of this and other ETSI documents is available at

<http://portal.etsi.org/tb/status/status.asp>

If you find errors in the present document, send your comment to:

[editor@etsi.fr](mailto:editor@etsi.fr)

---

**Copyright Notification**

No part may be reproduced except as authorized by written permission.  
The copyright and the foregoing restriction extend to reproduction in all media.

© European Telecommunications Standards Institute 2002.  
All rights reserved.

# Contents

Intellectual Property Rights .....	4
Foreword.....	4
1 Scope .....	5
2 References .....	5
3 Definitions, symbols and abbreviations .....	6
3.1 Definitions .....	6
3.2 Symbols.....	7
3.3 Abbreviations .....	7
4 Frequency bands.....	7
5 Types of antennas.....	8
5.1 Antenna types.....	8
5.2 Antenna classifications.....	9
5.2.1 Central Station (CS) classes.....	9
5.2.2 Terminal Station (TS) classes .....	9
6 Electrical characteristics.....	9
6.1 Terminal Station (TS) antennas.....	9
6.1.1 TS Radiation Pattern Envelopes (RPE) .....	9
6.1.1.1 Range 1 (1,0 GHz to 3,0 GHz).....	10
6.1.1.2 Range 2 (3,0 GHz to 5,9 GHz).....	11
6.1.1.3 Range 3 (5,9 GHz to 8,5 GHz).....	13
6.1.1.4 Range 4 (8,5 GHz to 11,0 GHz).....	14
6.1.2 Terminal Station (TS) minimum antenna boresight gain.....	15
6.2 Central Station (CS) sectored antennas .....	15
6.2.1 CS Azimuth Radiation Pattern Envelopes (RPE), sectored .....	15
6.2.2 Minimum boresight gain, sectored .....	17
6.3 Central Station (CS) omni-directional antennas .....	17
6.4 Central Station (CS) omni and sectored elevation RPEs.....	17
6.4.1 Symmetric elevation RPEs .....	17
6.4.2 Asymmetric elevation patterns .....	19
6.5 Radomes .....	19
6.6 Antenna polarization .....	20
7 Conformance tests .....	20
<b>Annex A: Antenna characteristics .....</b>	<b>21</b>
A.1 Mechanical characteristics .....	21
A.1.1 Environmental characteristics .....	21
A.1.2 Antenna stability .....	21
A.2 Antenna input connectors.....	21
A.3 VSWR at the input ports .....	22
A.4 Inter-port isolation.....	22
A.5 Antenna labelling .....	22
A.6 Passive Intermodulation Performance.....	22
<b>Annex B: Bibliography .....</b>	<b>23</b>
History .....	24

---

## Intellectual Property Rights

IPRs essential or potentially essential to the present document may have been declared to ETSI. The information pertaining to these essential IPRs, if any, is publicly available for **ETSI members and non-members**, and can be found in ETSI SR 000 314: "*Intellectual Property Rights (IPRs); Essential, or potentially Essential, IPRs notified to ETSI in respect of ETSI standards*", which is available from the ETSI Secretariat. Latest updates are available on the ETSI Web server (<http://webapp.etsi.org/IPR/home.asp>).

Pursuant to the ETSI IPR Policy, no investigation, including IPR searches, has been carried out by ETSI. No guarantee can be given as to the existence of other IPRs not referenced in ETSI SR 000 314 (or the updates on the ETSI Web server) which are, or may be, or may become, essential to the present document.

---

## Foreword

This Technical Report (TR) has been produced by ETSI Technical Committee Transmission and Multiplexing (TM).

The purpose of the present document is to set out the format of a standard for the use of circularly polarized antennas in conjunction with MultiPoint (MP) systems in the frequency bands 1 GHz to 3 GHz and 3 GHz to 11 GHz.

The present document is part 3 of a multi-part deliverable covering the Fixed Radio Systems; Point-to-point and point-to-multipoint equipment; Use of circular polarization in multipoint systems, as identified below:

Part 1: "Systems aspects";

Part 2: "Antenna parameters";

**Part 3: "Antennas for multipoint fixed radio systems in the 1GHz to 11 GHz band".**

---

# 1 Scope

The present document specifies the essential electrical requirements for circular polarization fixed beam antennas to be utilized with MultiPoint (MP) systems, including central station, repeater stations, and terminal station applications, operating in frequency bands from 1 GHz to 11 GHz. These systems use various multiple access schemes. Electronically steerable antennas, and linearly polarized antennas are not considered under the present document.

Where circumstances merit, and after a consultation period with operators and manufacturers, the Regulatory Authority may impose the use of tighter requirements than the minimum values given in the present document, in order to maximize the use of scarce spectrum resources.

---

# 2 References

For the purposes of this Technical Report (TR), the following references apply:

- [1] CEPT Recommendation T/R 13-01: "Preferred channel arrangements for fixed services in the range 1-3 GHz".
- [2] ITU-R Recommendation F.746-3: "Radio-frequency channel arrangements for radio-relay systems".
- [3] ITU-R Recommendation F.1098-1: "Radio-frequency channel arrangements for radio-relay systems in the 1 900-2 300 MHz band".
- [4] Final Acts of the World Radiocommunications Conference for dealing with frequency allocations in certain parts of the spectrum: "(WARC-92), Malaga-Torremolinas 1992".
- [5] ETSI EN 301 126-3-2: "Fixed Radio Systems; Conformance testing; Part 3-2: Point-to-Multipoint antennas - Definitions, general requirements and test procedures".
- [6] ETSI EN 301 525: "Fixed Radio Systems; Point-to-Multipoint Antennas; Antennas for Point-to-Multipoint fixed radio systems in the 1 GHz to 3 GHz band".
- [7] ETSI ETS 300 019-1-4: "Equipment Engineering (EE); Environmental conditions and environmental tests for telecommunications equipment; Part 1-4: Classification of environmental conditions; Stationary use at non-weatherprotected locations".
- [8] CENELEC EN 122150: "Sectional Specification: Radio frequency coaxial connectors - Series EIA flange".
- [9] ETSI EN 302 085: "Fixed Radio Systems; Point-to-Multipoint Antennas; Antennas for point-to-multipoint fixed radio systems in the 3 GHz to 11 GHz band".
- [10] CEPT/ERC/REC 12-05: "Harmonised radio frequency channel arrangements for digital terrestrial fixed systems operating in the band 10,0 GHz to 10,68 GHz".
- [11] CEPT/ERC/REC 14-03: "Harmonised radio frequency channel arrangements for low and medium capacity systems in the band 3 400 MHz to 3 600 MHz".
- [12] ETSI EN 301 126-3-2: "Fixed Radio Systems; Conformance testing; Part 3-2: Point-to-Multipoint antennas; Definitions, general requirements and test procedures".
- [13] IEC 60339-1: "General purpose rigid coaxial transmission lines and their associated flange connectors. Part 1: General requirements and measuring methods".
- [14] IEC 60339-2: "General purpose rigid coaxial transmission lines and their associated flange connectors - Part 2: Detail specifications".
- [15] IEC 60169-1: "Radio-frequency connectors. Part 1: General requirements and measuring methods".

---

## 3 Definitions, symbols and abbreviations

### 3.1 Definitions

For the purposes of the present document, the following terms and definitions apply:

**antenna:** part of the transmitting or receiving system that is designed to radiate or receive electromagnetic waves

**axial ratio:** ratio of maximum to minimum power contained in the field components of the polarization ellipse

**boresight:** axis of the main beam in a directional antenna

**Central Station (CS):** base station which communicates with many terminal stations, and in some cases repeater stations

**co-polar pattern:** diagram representing the radiation pattern of a test antenna when the reference antenna is similarly polarized, scaled in dB relative to the peak measured antenna gain at the test frequency

**cross-polar pattern:** diagram representing the radiation pattern of a test antenna when the reference antenna is polarized in the opposite sense, scaled in dB relative to the measured maximum co-polar pattern

**fixed beam:** radiation pattern in use is fixed relative to a defined mechanical reference plane

**gain:** ratio of the radiation intensity, in a given direction, to the radiation intensity that would be obtained if the power accepted by the antenna was radiated isotropically

**half power beamwidth:** angle between the two directions at which the measured co-polar pattern is 3 dB below the value on the main beam axis

**input port(s):** flange(s) or connector(s) through which access to the antenna is provided

**interport isolation:** ratio in dB of the power level applied to one port of a multi-port antenna to the power level received in any other port of the same antenna as a function of frequency

**isotropic radiator:** hypothetical, lossless antenna having equal radiation intensity in all directions

**left hand (anticlockwise) polarized wave:** elliptically (or circularly) polarized wave, in which the electric field vector, observed in any fixed plane, normal to the direction of propagation, rotates in time in a left-hand or anticlockwise direction

**main beam:** radiation lobe containing the direction of maximum radiation

**main beam axis:** direction for which the radiation intensity is maximum

**mechanical tilt:** fixed angular shift in elevation of the antenna main beam axis by a change to the physical mounting

**radiation pattern:** diagram relating power flux density at a constant distance from the antenna to the direction relative to the antenna main beam axis

**radiation pattern envelope:** envelope below which the radiation pattern shall fit

**radome:** cover of dielectric material, intended to protect an antenna from the effects of its physical environment

**Repeater Station (RS):** radio station providing the connection via the air to the central station, the terminal stations and other repeater stations

NOTE: The repeater station may also provide the interfaces to the subscriber equipment if applicable.

**right hand (clockwise) polarized wave:** elliptically (or circularly) polarized wave, in which the electric field vector, observed in any fixed plane, normal to the direction of propagation, rotates in time in a right-hand or clockwise direction

**sector angle:** declared angle of coverage in azimuth of a sectored antenna

NOTE: It is defined as  $2\alpha$  in the present document.

**Terminal Station (TS):** remote (out) station which communicates with a central station

**tilt:** fixed, angular shift of the antenna main beam axis (boresight) in the elevation plane by either electrical, electronic or mechanical means

**zero degree reference direction:** declared direction as reference to the antenna mechanical characteristics, used as reference for RPE

## 3.2 Symbols

For the purposes of the present document, the following symbols apply:

dBIC	DeciBels relative to an isotropic circularly polarized source
dBi	DeciBels relative to an isotropic radiator
GHz	GigaHertz
MHz	MegaHertz
$\alpha$	alpha (= half the sector angle)
fo	nominal centre frequency of declared antenna operating range

## 3.3 Abbreviations

For the purposes of the present document, the following abbreviations apply:

CS	Central Station
HPBW	Half Power BeamWidth
LHCP	Left Hand Circular Polarization
MP	MultiPoint
PIM	Passive InterModulation
P-MP	Point-to-MultiPoint
RHCP	Right Hand Circular Polarization
RPE	Radiation Pattern Envelope
RS	Repeater Station
TS	Terminal Station
VSWR	Voltage Standing Wave Ratio

---

## 4 Frequency bands

For the purpose of the present document, the overall frequency bands 1 GHz to 11 GHz are divided into four ranges as follows:

Range 1	1GHz to 3 GHz;
Range 2	3 GHz to 5,9 GHz;
Range 3	5,9 GHz to 8,5 GHz;
Range 4	8,5 GHz to 11 GHz.

## 5 Types of antennas

### 5.1 Antenna types

The present document addresses fixed beam antennas used in the Central (CS) and Terminal (TS) Stations including Repeaters (RS).

The antennas are used in a system which can generally be described as in figure 1.

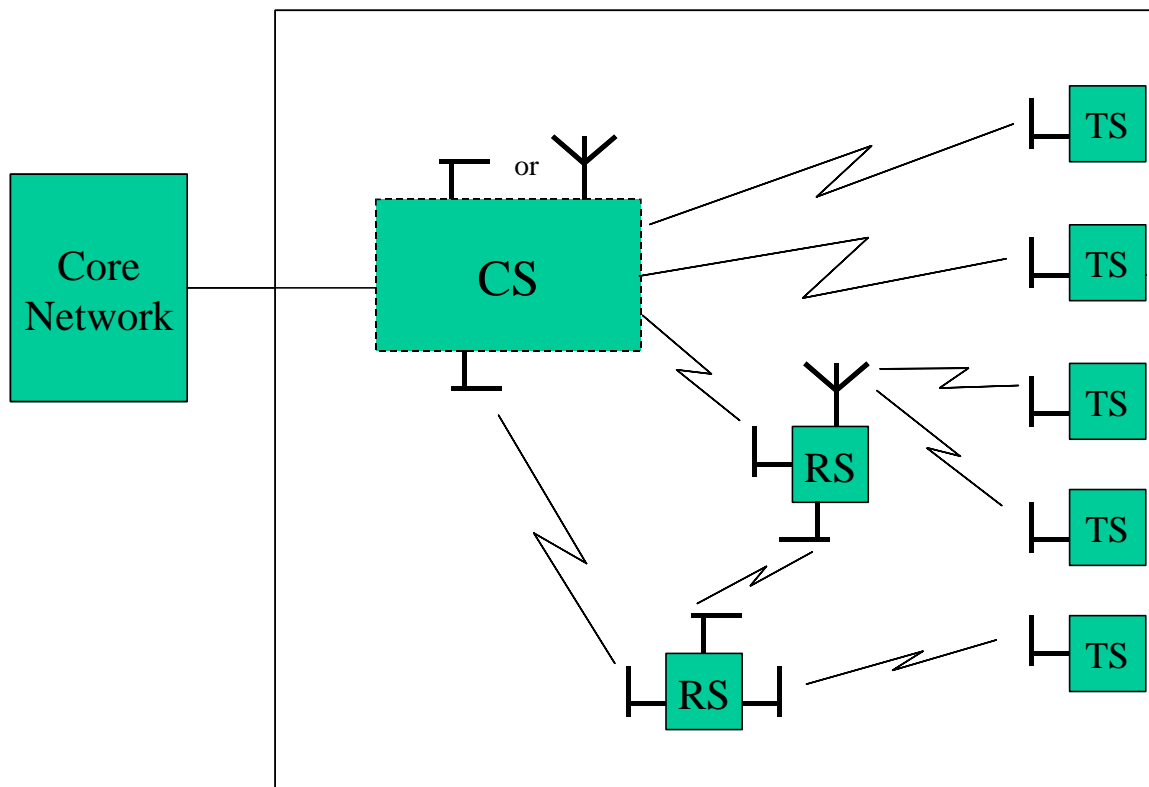

- CS:** Central Station, which is linked to remote stations (repeater or terminal stations) by microwave transmission paths.
- TS:** Terminal Station (outstation with subscriber interfaces).
- RS:** Repeater Station (radio repeater outstation with or without subscriber interfaces). An RS may serve one or more TSs.

**Figure 1: General multipoint system architecture**

The antennas shall be grouped into the following types:

#### Central and Repeater Stations:

- Omni-directional;
- Sectored;
- Directional, as per Terminal Stations.

#### Terminal Stations:

- Directional.



## 5.2 Antenna classifications

### 5.2.1 Central Station (CS) classes

The appropriate Radiation Pattern Envelopes (RPE) are CS, CS1, CS2 and CS3.

### 5.2.2 Terminal Station (TS) classes

The Radiation Pattern Envelopes (RPE) are TS1, up to as high as TS5, in the four frequency ranges.

NOTE: Not all ranges have 5 classes.

## 6 Electrical characteristics

The present document defines several types of CS and TS antenna. For the purpose of the present document, an antenna is specific to a type, class, the frequency range of operation and the mid-band gain. An antenna which employs a radome shall meet the requirements of the present document with the radome in place.

A 0° reference direction shall be defined for each antenna. The radiation characteristics in the present document are all referred to this 0° reference direction.

RPE(s) and gains of defined antenna types and classes are described later in the present document.

The co-polar and cross-polar radiation patterns for both azimuth and elevation shall not exceed the RPE(s) defined in the present document.

### 6.1 Terminal Station (TS) antennas

The RPEs and gain parameters apply for antennas using either RHCP or LHCP.

#### 6.1.1 TS Radiation Pattern Envelopes (RPE)

The co-polar and cross-polar radiation patterns for both azimuth and elevation (unless otherwise stated) shall not exceed the RPEs defined in the following list of tables, figure 2 indicates a typical normalized template, although the number of points in the co- and cross-polar templates may vary. All values in brackets are provisional for guidance only, and are derived from the current linearly polarized specifications.

Range 1 (1,0 GHz to 3,0 GHz) Class TS 1: table 1

Class TS 2: table 2

Class TS 3: table 3

Range 2 (3,0 GHz to 5,9 GHz) Class TS 1: table 4

Class TS 2: table 5

Class TS 3: table 6

Class TS 4: table 7

Class TS 5: table 8

Range 3 (5,9 GHz to 8,5 GHz) Class TS 1: table 9

Class TS 2: table 10

Class TS 3: table 11

Range 4 (8,5 GHz to 11,0 GHz) Class TS 1: table 12

Class TS 2: table 13

Class TS 3: table 14

Class TS 4: table 15

The gain values defined are all relative to maximum, actual gain.

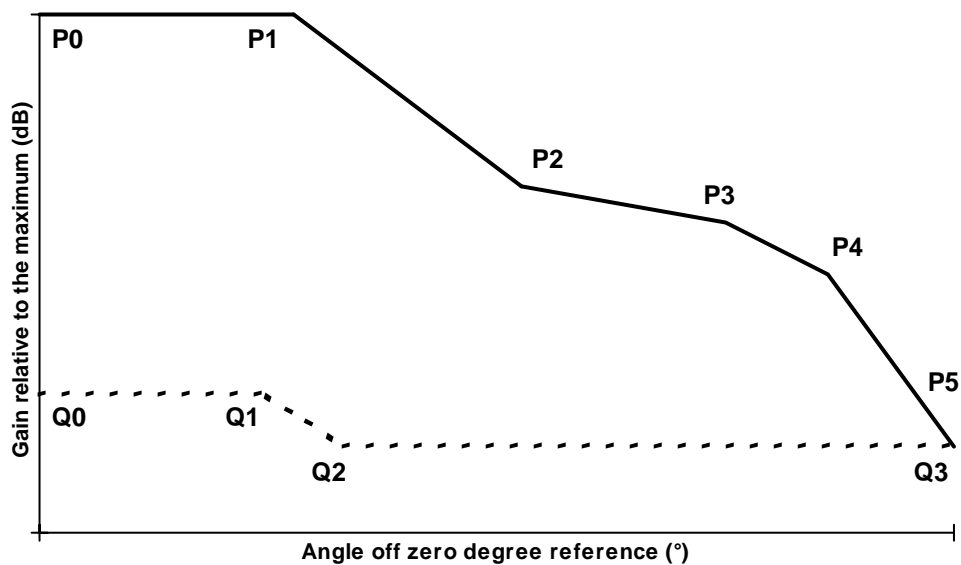

Figure 2: Normalized RPE for TS azimuth and elevation

#### 6.1.1.1 Range 1 (1,0 GHz to 3,0 GHz)

In this frequency range only, the cross polar requirement shall apply to azimuth only.

Table 1: Class TS1, range 1

Co-polar	Angle (degree)	Relative gain (dB)
P0	[0]	[0]
P1	[30]	[0]
P2	[60]	[-5]
P3	[110]	[-14]
P4	[180]	[-16]
Cross polar	Angle (degree)	Relative gain (dB)
Q0	[0]	[-13]
Q1	[30]	[-13]
Q2	[60]	[-18]
Q3	[110]	[-20]
Q4	[180]	[-20]

Table 2: Class TS2, range 1

Co-polar	Angle (degree)	Relative gain (dB)
P0	[0]	[0]
P1	[10]	[0]
P2	[30]	[-8]
P3	[90]	[-15]
P4	[150]	[-20]
P5	[180]	[-20]
Cross polar	Angle (degree)	Relative gain (dB)
Q0	[0]	[-15]
Q1	[90]	[-15]
Q2	[90]	[-20]
Q3	[180]	[-20]

Table 3: Class TS3, range 1

Co-polar	Angle (degree)	Relative gain (dB)
P0	[0]	[0]
P1	[20]	[0]
P2	[40]	[-10]
P3	[90]	[-10]
P4	[120]	[-26]
P5	[180]	[-26]
Cross polar	Angle (degree)	Relative gain (dB)
Q0	[0]	[-14]
Q1	[40]	[-14]
Q2	[100]	[-29]
Q3	[180]	[-29]

## 6.1.1.2 Range 2 (3,0 GHz to 5,9 GHz)

Table 4: Class TS1, range 2

Co-polar	Angle (degree)	Relative gain (dB)
P0	[0]	[0]
P1	[90]	[0]
P2	[90]	[-10]
P3	[180]	[-10]
Cross polar	Angle (degree)	Relative gain (dB)
Q0	[0]	[-15]
Q1	[180]	[-15]

Table 5: Class TS2, range 2

Co-polar	Angle (degree)	Relative gain (dB)
P0	[0]	[0]
P1	[12]	[0]
P2	[30]	[-10]
P3	[90]	[-15]
P4	[150]	[-20]
P5	[180]	[-20]
Cross polar	Angle (degree)	Relative gain (dB)
Q0	[0]	[-15]
Q1	[90]	[-15]
Q2	[150]	[-20]
Q3	[180]	[-20]

Table 6: Class TS3, range 2

Co-polar	Angle (degree)	Relative gain (dB)
P0	[0]	[0]
P1	[10]	[0]
P2	[20]	[-12]
P3	[70]	[-14]
P4	[150]	[-29]
P5	[180]	[-29]
Cross polar	Angle (degree)	Relative gain (dB)
Q0	[0]	[-19]
Q1	[90]	[-19]
Q2	[150]	[-25]
Q3	[180]	[-25]

Table 7: Class TS4, range 2

Co-polar	Angle (degree)	Relative gain (dB)
P0	[0]	[0]
P1	[10]	[0]
P2	[30]	[-17]
P3	[90]	[-17]
P4	[150]	[-30]
P5	[180]	[-30]
Cross polar	Angle (degree)	Relative gain (dB)
Q0	[0]	[-20]
Q1	[90]	[-20]
Q2	[150]	[-30]
Q3	[180]	[-30]

Table 8: Class TS5, range 2

Co-polar	Angle (degree)	Relative gain (dB)
P0	[0]	[0]
P1	[12]	[0]
P2	[30]	[-17]
P3	[90]	[-17]
P4	[150]	[-30]
P5	[180]	[-30]
Cross polar	Angle (degree)	Relative gain (dB)
Q0	[0]	[-20]
Q1	[90]	[-20]
Q2	[100]	[-25]
Q3	[180]	[-25]

## 6.1.1.3 Range 3 (5,9 GHz to 8,5 GHz)

Table 9: Class TS1, range 3

Co-polar	Angle (degree)	Relative gain (dB)
P0	[0]	[0]
P1	[9]	[0]
P2	[22]	[-12]
P3	[90]	[-17]
P4	[150]	[-25]
P5	[180]	[-25]
Cross polar	Angle (degree)	Relative gain (dB)
Q0	[0]	[-17]
Q1	[90]	[-17]
Q2	[150]	[-25]
Q3	[180]	[-25]

Table 10: Class TS2, range 3

Co-polar	Angle (degree)	Relative gain (dB)
P0	[0]	[0]
P1	[8]	[0]
P2	[20]	[-20]
P3	[90]	[-22]
P4	[150]	[-35]
P5	[180]	[-35]
Cross polar	Angle (degree)	Relative gain (dB)
Q0	[0]	[-25]
Q1	[90]	[-25]
Q2	[150]	[-35]
Q3	[180]	[-35]

Table 11: Class TS3, range 3

Co-polar	Angle (degree)	Relative gain (dB)
P0	[0]	[0]
P1	[9]	[0]
P2	[22]	[-18]
P3	[90]	[-21]
P4	[150]	[-33]
P5	[180]	[-33]
Cross polar	Angle (degree)	Relative gain (dB)
Q0	[0]	[-25]
Q1	[90]	[-25]
Q2	[100]	[-30]
Q3	[180]	[-30]

## 6.1.1.4 Range 4 (8,5 GHz to 11,0 GHz)

Table 12: Class TS1, range 4

Co-polar	Angle (degree)	Relative gain (dB)
P0	[0]	[0]
P1	[7]	[0]
P2	[15]	[-13]
P3	[90]	[-20]
P4	[130]	[-30]
P5	[180]	[-30]
Cross polar	Angle (degree)	Relative gain (dB)
Q0	[0]	[-20]
Q1	[90]	[-20]
Q2	[130]	[-30]
Q3	[180]	[-30]

Table 13: Class TS2, range 4

Co-polar	Angle (degree)	Relative gain (dB)
P0	[0]	[0]
P1	[5]	[0]
P2	[15]	[-20]
P3	[90]	[-30]
P4	[130]	[-40]
P5	[180]	[-40]
Cross polar	Angle (degree)	Relative gain (dB)
Q0	[0]	[-30]
Q1	[90]	[-30]
Q2	[130]	[-40]
Q3	[180]	[-40]

Table 14: Class TS3, range 4

Co-polar	Angle (degree)	Relative gain (dB)
P0	[0]	[0]
P1	[6]	[0]
P2	[15]	[-13]
P3	[90]	[-24]
P4	[150]	[-36]
P5	[180]	[-36]
Cross polar	Angle (degree)	Relative gain (dB)
Q0	[0]	[-28]
Q1	[90]	[-28]
Q2	[100]	[-33]
Q3	[180]	[-33]

Table 15: Class TS4, range 4

Co-polar	Angle (degree)	Relative gain (dB)
P0	[0]	[0]
P1	[10]	[0]
P2	[30]	[-10]
P3	[90]	[-15]
P4	[150]	[-20]
P5	[180]	[-20]
Cross polar	Angle (degree)	Relative gain (dB)
Q0	[0]	[-12]
Q1	[90]	[-12]
Q2	[130]	[-17]
Q3	[180]	[-17]

## 6.1.2 Terminal Station (TS) minimum antenna boresight gain

The TS RPEs specified in tables 1 to 15 inclusive are for maximum allowed co- and cross- polar gains, relative to boresight actual gain.

The TS antenna shall meet the minimum boresight gain described by the following expression:

Minimum boresight gain =  $\lceil \text{ROUND}(0.85f_0 + 5) \rceil$  dBi.

## 6.2 Central Station (CS) sectored antennas

### 6.2.1 CS Azimuth Radiation Pattern Envelopes (RPE), sectored

The Central Station azimuth templates for sectored (i.e. not omni-directional) antennas are given in figure 3, and tables 16-19 for CS (frequency range 1 only), CS1, CS2 and CS3 (frequency ranges 2, 3 and 4) respectively, for sector widths in the range  $15^\circ$  to  $180^\circ$ . This template shall apply for the frequencies indicated in the 1 GHz to 11 GHz band, and where  $f_0$  refers to the centre frequency in GHz. Co-polar and Cross-polar patterns are defined over the full angular range. The sector width is defined here as  $2\alpha$ , and corresponds to the nominal declared sector angle for the antenna under test. This has to be declared by the supplier. The gain values defined are all relative to maximum gain in the declared sector width.

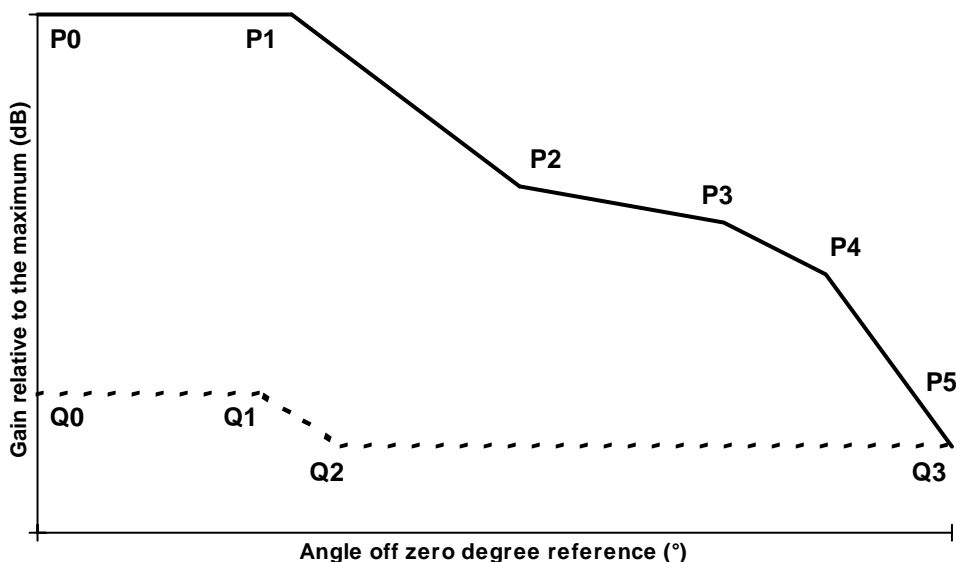

Figure 3: Normalized RPE for CS azimuth

#### Co-Polar and Cross-Polar RPEs

Point P0 is fixed whereas the positions of P1 to P5 are dependent on centre frequency and/or sector angle. Tables 13 and 14 summarize the expressions which describe all these co-polar azimuth RPE points for the respective classes.

The tables shall apply for all frequencies in the 1 GHz to 11 GHz band, where  $f_0$  is the nominal centre frequency in GHz and all expressions are rounded to the nearest integer value.

Table 16: CS Class, range 1

Co-polar	Angle (degree)	Relative gain (dB)
P0	[0]	[0]
P1	$[\alpha+5]$	[0]
P2	$[\alpha+(105-7fo)]$	$[-0,7fo-16]$
P3	$[184,4-4,4fo]$	$[-1,4fo-20]$
P4	[180]	$[-1,4fo-20]$
Cross polar	Angle (degree)	Relative gain (dB)
Q0	[0]	[-20]
Q1	$[\alpha+(57,5-5fo)]$	[-20]
Q2	$[\alpha+(87,5-5fo)]$	$[-1,4fo-20]$
Q3	[180]	$[-1,4fo-20]$

Table 17: CS Class 1, ranges 2, 3 and 4

Co-polar	Angle (degree)	Relative gain (dB)
P0	[0]	[0]
P1	$[\alpha+5]$	[0]
P2	[160]	[-20]
P3	[180]	[-20]
Cross polar	Angle (degree)	Relative gain (dB)
Q0	[0]	[-12]
Q1	$[\alpha+5]$	[-15]
Q2	[160]	[-20]
Q3	[180]	[-20]

Table 18: CS Class 2, ranges 2, 3 and 4

Co-polar	Angle (degree)	Relative gain (dB)
P0	[0]	[0]
P1	$[\alpha+5]$	[0]
P2	$[\alpha+(105-7fo)]$	[-20]
P3	$[195-7fo]$	[-20]
P4	$[186-4,4fo]$	[-25]
P5	[180]	[-25]
Cross polar	Angle (degree)	Relative gain (dB)
Q0	[0]	[-20]
Q1	$[\alpha+(57,5-5fo)]$	[-20]
Q2	$[\alpha+(87,5-5fo)]$	[-25]
Q3	[180]	[-25]

Table 19: CS Class 3, ranges 2, 3 and 4

Co-polar	Angle (degree)	Relative gain (dB)
P0	[0]	[0]
P1	$[\alpha+(20-1,4fo)]$	[0]
P2	$[\alpha+(75-4,3fo)]$	[-23]
P3	$[165-4,3fo]$	[-23]
P4	[150]	$[-1,4fo-20]$
P5	[180]	$[-1,4fo-20]$
Cross polar	Angle (degree)	Relative gain (dB)
Q0	[0]	$[-0,7fo-17,5]$
Q1	$[\alpha+(20-1,4fo)]$	$[-0,7fo-17,5]$
Q2	$[\alpha+(75-4,3fo)]$	$[-1,4fo-20]$
Q3	180	$[-1,4fo-20]$



## 6.2.2 Minimum boresight gain, sectored

The CS (sectored) antenna boresight gain shall exceed the values defined in figure 4 as a function of sector angle,  $2\alpha$ , in the range  $15^\circ$  to  $180^\circ$  and for all frequencies in the 1 GHz to 11 GHz frequency band.

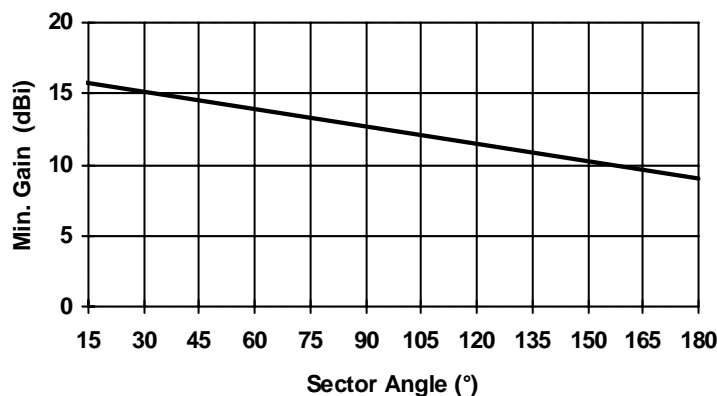

Figure 4: CS sector antenna minimum boresight gain limits

## 6.3 Central Station (CS) omni-directional antennas

For omni-directional CS antennas the following parameters shall apply for the frequencies outlined below:

Minimum nominal gain:	[5] dBiC 1-3 GHz, [8] dBiC 3-11 GHz;
Gain ripple (azimuth):	[3] dB maximum (peak to peak);
Cross Polar (on azimuth main beam):	[-20] dB maximum in the azimuth plane.

## 6.4 Central Station (CS) omni and sectored elevation RPEs

Three CS antenna elevation RPEs are defined: two for antennas designed to exhibit symmetric RPEs about the zero degree reference direction in the two frequency ranges described (see figures 5 and 6) and one for antennas designed for asymmetric RPEs (see figure 7). For antennas designed without any tilt the zero degree reference direction normally corresponds to boresight.

It may be necessary in practical deployments to use electrical or mechanical tilt, or a combination of these two, to achieve the required cell coverage, taking into account the surrounding terrain, for example.

These elevation patterns are considered appropriate to the commonly used range of  $0^\circ$  to  $-10^\circ$  for electrical downtilt. For sector antennas only further mechanical tilt of up to  $\pm 10^\circ$  may be suitable for some situations.

An electrical tilt is translated onto the corresponding pattern as a  $\pm$  shift along the elevation angle axis.

NOTE: Positive angles are for above boresight (up) and negative angles are for below (down).

### 6.4.1 Symmetric elevation RPEs

For **omni-symmetric** antennas the co- and cross-polar limits in tables 20 and 21 and figure 5 shall apply, up to a limit of  $\pm 90^\circ$ , there are no limits beyond these angles. For **sectored symmetric** antennas only, the co-polar limits in tables 20 and 21 and figures 5 and 6 shall be linearly interpolated beyond the value at the  $\pm 90^\circ$  point out to the point defined at  $180^\circ$  by the appropriate azimuth class of antennas per tables 16 to 19. For Central Station antennas of all classes in every frequency range, the cross-polar limit shall be linearly interpolated between the  $0^\circ$  and  $180^\circ$  points defined in the appropriate class of azimuth specification.

Table 20: Elevation RPE for symmetric CS antennas, range 1

Angle (degree)	Co-polar (dB)
[0]	[0]
[12]	[0]
[12]	[-3]
[14]	[-5]
[20]	[-5]
[60]	[-13]
[60]	[-18]
[90]	[-18]

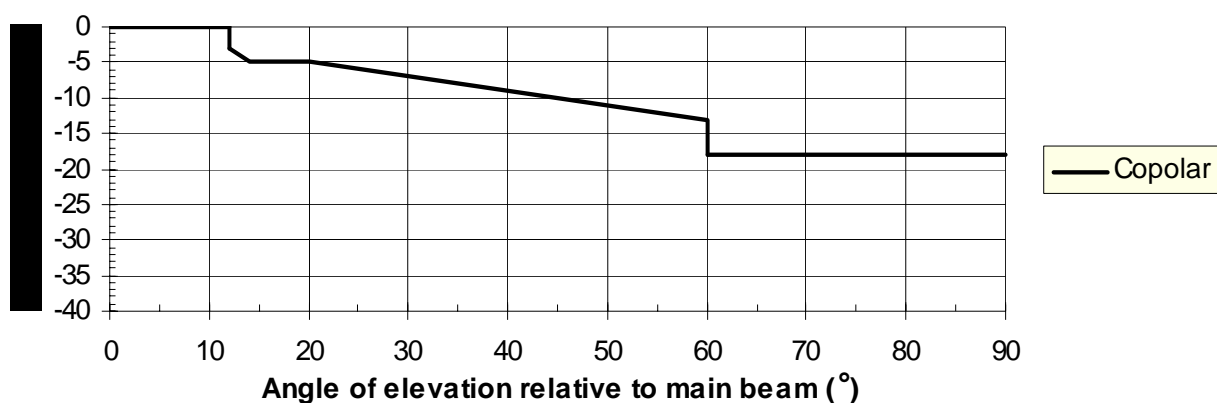

Figure 5: Symmetric CS antenna elevation pattern, range 1

Table 21: Elevation RPE for symmetric CS1, CS2 and CS3 antennas, ranges 2 to 4

Angle (degree)	Co-polar (dB)
[0]	[0]
[10]	[0]
[25]	[-15]
[90]	[-19]

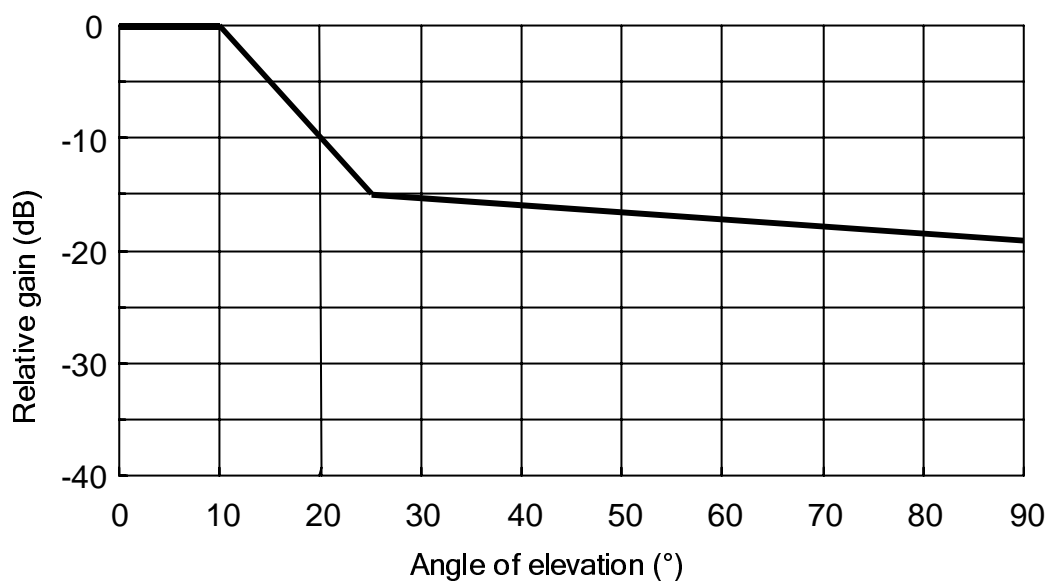

Figure 6: Elevation RPE for symmetric CS1, CS2 and CS3 antennas, ranges 2 to 4

## 6.4.2 Asymmetric elevation patterns

For **omni-asymmetric** antennas the co-polar limits in figure 7 shall apply, up to a limit of  $\pm 90^\circ$ . There are no limits beyond these angles. The cross-polar limit indicated shall be limited to the range  $-4^\circ$  to  $+4^\circ$ , elsewhere the co-polar limits shall apply.

For **sectorized asymmetric** antennas only, the co-polar limit in figure 7 shall be linearly interpolated:

- beyond the -3 dB,  $-30^\circ$  point (down) out to the point defined at  $180^\circ$  for the appropriate azimuth class of antennas as taken from tables 13 or 14; and
- beyond the -8 dB,  $+90^\circ$  point (up) out to the point defined at  $180^\circ$  for the appropriate azimuth class of antennas as taken from tables 13 or 14.

The zero degree reference angle shall be taken as the declared nominal tilt angle of the antenna. This has to be declared by the supplier.

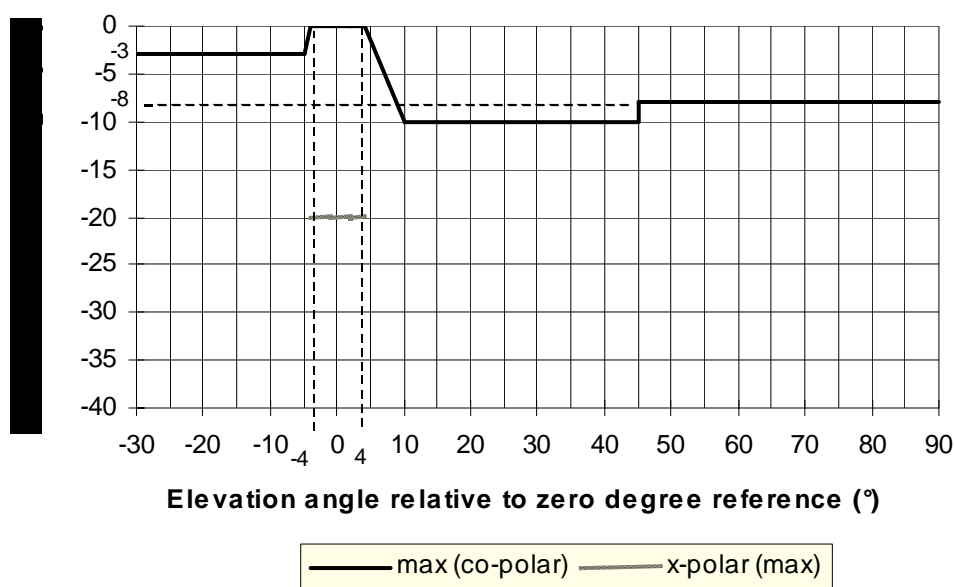

Figure 7: Asymmetric CS antenna elevation patterns

Table 22: Elevation RPE for asymmetric antennas

Angle (degree)	Co-Polar (dB)	Cross-Polar (dB)
-30	-3	-3
-5	-3	-3
-4	0	0
-4	0	-20
4	0	-20
4	0	0
10	-10	-10
45	-10	-10
45	-8	-8
90	-8	-8

## 6.5 Radomes

Antenna adopting radomes shall conform to the absolute gain and radiation pattern values stipulated in the classes above, with the radome in place.

## 6.6 Antenna polarization

The antenna system shall radiate circular (single or dual) right hand or left hand polarization.

---

## 7 Conformance tests

For antenna parameters EN 301 126-3-2 shall apply.

## Annex A: Antenna characteristics

### A.1 Mechanical characteristics

#### A.1.1 Environmental characteristics

The antenna should be designed to operate within a temperature range of  $-45^{\circ}\text{C}$  to  $+45^{\circ}\text{C}$  with a relative humidity up to 100 % with salt mist, industrial atmosphere, UV-irradiation etc.

The temperature range could be divided in two parts where at least one of the following ranges should be covered:

- 1)  $-33^{\circ}\text{C}$  to  $+40^{\circ}\text{C}$ ;
- 2)  $-45^{\circ}\text{C}$  to  $+45^{\circ}\text{C}$ .

The antenna should be designed to meet wind survival ratings specified in table A.1.

**Table A.1: Wind survival ratings**

Antenna type	Wind velocity m/s (km/h)	Ice load (density $7 \text{ kN/m}^3$ )
Normal duty	55 (200)	25 mm radial ice
Heavy duty	70 (252)	25 mm radial ice

#### A.1.2 Antenna stability

The antenna equipment should be stable under the most severe operational conditions at the site of intended application

The deviation of the antenna main beam axis should not be more than 0,3 times the smaller of the two azimuthal and elevation HPBW, as a general guide, under the conditions specified in table A.2

**Table A.2: Antenna stability**

Antenna type	Wind velocity m/s (km/h)	Ice load (density $7 \text{ kN/m}^3$ )
Normal duty	30 (110)	25 mm radial ice
Heavy duty	45 (164)	25 mm radial ice

Further guidance can be obtained from ETS 300 019-1-4 [7].

## A.2 Antenna input connectors

The input connector on the antenna should be mechanically compatible with the radio equipment, this should be agreed between the antenna supplier and the purchaser in line with the overall systems design requirements. For antennas which are integrated with the radio equipment proprietary connection designs may be utilized. In both cases, a suitable test fixture should be agreed and used for test purposes.

Attention is drawn to a range of coaxial connectors referred to in IEC Publication 339, parts 1 [13] and 2 [14], IEC Publication 169-1 [15], and EN 122150 [8]. However, it should be noted that these standards are not exhaustive. The impedance of the input ports should be nominally  $50 \Omega$  coaxial.

---

## A.3 VSWR at the input ports

The maximum Voltage Standing Wave Ratio (VSWR) should be agreed between the equipment supplier and purchaser in line with the overall system design requirements. For guidance, antennas with a VSWR in the range 1,9 to 1,1 are typical.

---

## A.4 Inter-port isolation

Concerning dual polarized antennas, the isolation between the two inputs should be agreed between the equipment supplier and purchaser in line with the overall system design requirements. For guidance, inter-port isolation better than 15 dB is typical for circularly polarized antennas.

---

## A.5 Antenna labelling

Antennas should be clearly identified with a weather-proof and permanent label(s) showing the manufacturers name, antenna type, serial number(s), polarization(s) and where appropriate, the antenna should be identified with a label showing the type approval number. It should be noted that integrated antennas may share a common label with the outdoor equipment.

---

## A.6 Passive Intermodulation Performance

For some P-MP access methods the minimum Passive InterModulation (PIM) performance of the antenna may need to be taken into account. In such cases the PIM performance should be agreed between the equipment supplier and the purchaser in line with the overall system design requirements.

For guidance PIM product limits can often exceed -100 dBc.

---

## Annex B: Bibliography

ANSI/EIA Standard 195-C: "Electrical and Mechanical Characteristics for Terrestrial Microwave Relay System Antennas and Passive Reflector".

---

## History

<b>Document history</b>		
V1.1.1	January 2002	Publication