

ETSI TR 126 909 V18.0.0 (2024-05)



**Universal Mobile Telecommunications System (UMTS);  
LTE;  
5G;  
Study on improved streaming Quality of Experience (QoE)  
reporting in 3GPP services and networks  
(3GPP TR 26.909 version 18.0.0 Release 18)**



---

**Reference**

RTR/TSGS-0426909vi00

---

**Keywords**

5G,LTE,UMTS

**ETSI**

---

650 Route des Lucioles  
F-06921 Sophia Antipolis Cedex - FRANCE

Tel.: +33 4 92 94 42 00 Fax: +33 4 93 65 47 16

Siret N° 348 623 562 00017 - APE 7112B  
Association à but non lucratif enregistrée à la  
Sous-Préfecture de Grasse (06) N° w061004871

---

**Important notice**

The present document can be downloaded from:

<https://www.etsi.org/standards-search>

The present document may be made available in electronic versions and/or in print. The content of any electronic and/or print versions of the present document shall not be modified without the prior written authorization of ETSI. In case of any existing or perceived difference in contents between such versions and/or in print, the prevailing version of an ETSI deliverable is the one made publicly available in PDF format at [www.etsi.org/deliver](http://www.etsi.org/deliver).

Users of the present document should be aware that the document may be subject to revision or change of status.

Information on the current status of this and other ETSI documents is available at

<https://portal.etsi.org/TB/ETSIDeliverableStatus.aspx>

If you find errors in the present document, please send your comment to one of the following services:

<https://portal.etsi.org/People/CommitteeSupportStaff.aspx>

If you find a security vulnerability in the present document, please report it through our  
Coordinated Vulnerability Disclosure Program:

<https://www.etsi.org/standards/coordinated-vulnerability-disclosure>

---

**Notice of disclaimer & limitation of liability**

The information provided in the present deliverable is directed solely to professionals who have the appropriate degree of experience to understand and interpret its content in accordance with generally accepted engineering or other professional standard and applicable regulations.

No recommendation as to products and services or vendors is made or should be implied.

No representation or warranty is made that this deliverable is technically accurate or sufficient or conforms to any law and/or governmental rule and/or regulation and further, no representation or warranty is made of merchantability or fitness for any particular purpose or against infringement of intellectual property rights.

In no event shall ETSI be held liable for loss of profits or any other incidental or consequential damages.

Any software contained in this deliverable is provided "AS IS" with no warranties, express or implied, including but not limited to, the warranties of merchantability, fitness for a particular purpose and non-infringement of intellectual property rights and ETSI shall not be held liable in any event for any damages whatsoever (including, without limitation, damages for loss of profits, business interruption, loss of information, or any other pecuniary loss) arising out of or related to the use of or inability to use the software.

---

**Copyright Notification**

No part may be reproduced or utilized in any form or by any means, electronic or mechanical, including photocopying and microfilm except as authorized by written permission of ETSI.

The content of the PDF version shall not be modified without the written authorization of ETSI.

The copyright and the foregoing restriction extend to reproduction in all media.

© ETSI 2024.  
All rights reserved.

---

# Intellectual Property Rights

## Essential patents

IPRs essential or potentially essential to normative deliverables may have been declared to ETSI. The declarations pertaining to these essential IPRs, if any, are publicly available for **ETSI members and non-members**, and can be found in ETSI SR 000 314: "*Intellectual Property Rights (IPRs); Essential, or potentially Essential, IPRs notified to ETSI in respect of ETSI standards*", which is available from the ETSI Secretariat. Latest updates are available on the ETSI Web server (<https://ipr.etsi.org/>).

Pursuant to the ETSI Directives including the ETSI IPR Policy, no investigation regarding the essentiality of IPRs, including IPR searches, has been carried out by ETSI. No guarantee can be given as to the existence of other IPRs not referenced in ETSI SR 000 314 (or the updates on the ETSI Web server) which are, or may be, or may become, essential to the present document.

## Trademarks

The present document may include trademarks and/or tradenames which are asserted and/or registered by their owners. ETSI claims no ownership of these except for any which are indicated as being the property of ETSI, and conveys no right to use or reproduce any trademark and/or tradename. Mention of those trademarks in the present document does not constitute an endorsement by ETSI of products, services or organizations associated with those trademarks.

**DECT™**, **PLUGTESTS™**, **UMTS™** and the ETSI logo are trademarks of ETSI registered for the benefit of its Members. **3GPP™** and **LTE™** are trademarks of ETSI registered for the benefit of its Members and of the 3GPP Organizational Partners. **oneM2M™** logo is a trademark of ETSI registered for the benefit of its Members and of the oneM2M Partners. **GSM®** and the GSM logo are trademarks registered and owned by the GSM Association.

---

# Legal Notice

This Technical Report (TR) has been produced by ETSI 3rd Generation Partnership Project (3GPP).

The present document may refer to technical specifications or reports using their 3GPP identities. These shall be interpreted as being references to the corresponding ETSI deliverables.

The cross reference between 3GPP and ETSI identities can be found under <https://webapp.etsi.org/key/queryform.asp>.

---

# Modal verbs terminology

In the present document "**should**", "**should not**", "**may**", "**need not**", "**will**", "**will not**", "**can**" and "**cannot**" are to be interpreted as described in clause 3.2 of the [ETSI Drafting Rules](#) (Verbal forms for the expression of provisions).

"**must**" and "**must not**" are **NOT** allowed in ETSI deliverables except when used in direct citation.

# Contents

Intellectual Property Rights .....	2
Legal Notice .....	2
Modal verbs terminology.....	2
Foreword.....	4
1 Scope .....	5
2 References .....	5
3 Abbreviations .....	5
4 A/V Quality Monitoring Support for 3GPP PSS.....	6
4.1 WebTV Quality Monitoring .....	6
4.1.1 Use case .....	6
4.1.2 Potential Recommended requirements.....	7
4.2 ITU-T P.NATS Quality Assessment Model for HTTP Adaptive Streaming .....	9
4.3 Gap analysis of PSS QoE metrics for support of ITU-T P.NATS .....	11
4.3.1 Supported Mode.....	11
4.3.2 Supported Input parameter.....	11
4.3.3 Further Parameters for Supporting Video Quality Monitoring .....	15
4.3.3.1 Additional Input Parameters.....	15
4.3.3.2 Dependency of Video Quality Test Results on Visual Size .....	15
4.3.3.3 Relation between Video Quality MOS and QP Parameter .....	16
4.4 Calculation of A/V MOS estimation .....	17
4.4.0 General.....	17
4.4.1 Network Optimization .....	17
4.4.2 MOS Models.....	17
4.4.3 MOS Windowing.....	17
4.4.4 Conclusion .....	18
4.5 Options for applying higher P.NATS Modes .....	18
5 QoE metrics support for managed streaming service .....	20
5.1 Use case: Managed Streaming Service QoE Improvement .....	20
5.1.1 Introduction.....	20
5.1.2 Use case #1 .....	20
5.1.3 Use case #2 .....	21
5.2 Managed streaming service deployment model consideration .....	21
5.2.1 Introduction.....	21
5.2.2 Managed streaming service deployment model.....	22
5.3 Recommended requirements .....	23
5.4 GAP Analysis and Evaluation.....	23
5.4.1 Introduction.....	23
5.4.2 Analysis of Activation/Deactivation of QoE reporting.....	23
5.5 Assumptions .....	24
5.6 Solution .....	24
5.6.1 Possible Candidate Options .....	24
5.6.2 QoE metrics collection within a certain geographic area.....	26
5.6.3 QoE metrics collection of a streaming service of a specific 3rd party.....	26
5.7 QoE Handler API Considerations .....	26
5.8 Privacy issue on QoE metric collection.....	28
5.8.1 Analysis .....	28
5.8.2 Solutions .....	28
6 Conclusion.....	28
<b>Annex A: Change history .....</b>	<b>30</b>
History .....	31

---

# Foreword

This Technical Report has been produced by the 3<sup>rd</sup> Generation Partnership Project (3GPP).

The contents of the present document are subject to continuing work within the TSG and may change following formal TSG approval. Should the TSG modify the contents of the present document, it will be re-released by the TSG with an identifying change of release date and an increase in version number as follows:

Version x.y.z

where:

- x the first digit:
  - 1 presented to TSG for information;
  - 2 presented to TSG for approval;
  - 3 or greater indicates TSG approved document under change control.
- y the second digit is incremented for all changes of substance, i.e. technical enhancements, corrections, updates, etc.
- z the third digit is incremented when editorial only changes have been incorporated in the document.

---

# 1 Scope

The present document describes the enhancement of Quality of Experience (QoE) for operator managed streaming service, 3<sup>rd</sup> party managed streaming service and Over-The-Top (OTT) streaming service.

---

# 2 References

The following documents contain provisions which, through reference in this text, constitute provisions of the present document.

- References are either specific (identified by date of publication, edition number, version number, etc.) or non-specific.
- For a specific reference, subsequent revisions do not apply.
- For a non-specific reference, the latest version applies. In the case of a reference to a 3GPP document (including a GSM document), a non-specific reference implicitly refers to the latest version of that document *in the same Release as the present document*.

- [1] 3GPP TR 21.905: "Vocabulary for 3GPP Specifications".
- [2] Yiting Liao, et al. "Achieving high QoE across the compute continuum: How compression, content, and devices interact." 7th International Workshop on Video Processing and Quality Metrics for Consumer Electronics, Scottsdale, Arizona, USA. 2013.
- [3] ITU-T SG12 "T13-SG12-150505-TD-GEN-0671!R1!MSW-E-P.NATS Terms of Reference (ToR)".
- [4] 3GPP TS 26.247: "Transparent end-to-end Packet-switched Streaming Service (PSS); Progressive Download and Dynamic Adaptive Streaming over HTTP (3GP-DASH)".
- [5] 3GPP TS 26.233: "Transparent end-to-end packet switched streaming service (PSS); General description".
- [6] 3GPP TR 26.938: "Packet-switched Streaming Service (PSS); Improved support for dynamic adaptive streaming over HTTP in 3GPP".
- [7] 3GPP TS 26.244: "Transparent end-to-end packet switched streaming service (PSS); 3GPP file format (3GP)".
- [8] Recommendation ITU-R BT.500: "Methodology for the subjective assessment of the quality of television pictures".
- [9] DASH-IF Position Paper: "Proposed QoE Media Metrics standardization for segmented media playback": <http://dashif.org/wp-content/uploads/2016/10/ProposedMediaMetricsforSegmentedMediaDelivery-r12.pdf>
- [10] ISO/IEC 23001-10: "Information technology -- MPEG systems technologies -- Part 10: Carriage of timed metadata metrics of media in ISO base media file format".
- [11] 3GPP TS 32.422: "Telecommunication management; Subscriber and equipment trace; Trace control and configuration management".

---

# 3 Abbreviations

For the purposes of the present document, the abbreviations given in 3GPP TR 21.905 [1] and the following apply. An abbreviation defined in the present document takes precedence over the definition of the same abbreviation, if any, in 3GPP TR 21.905 [1].

A/V MOS      Audio/Video Mean Opinion Score

IQoE	Improved Quality of Experience
DASH	Dynamic Adaptive Streaming over HTTP
KPI	Key Performance Indicators
KQI	Key Quality Indicator
MDT	Minimization of Drive Tests
MNO	Mobile Network Operator
MOS	Mean Opinion Score
MOS-AVQO	Audio-Visual-Quality-Objective
MPD	Media Presentation Description
OTT	Over The Top
PSS	Packet Streaming Server
TCE	Trace Collection Entity
VSSQM	Video Streaming Service Quality Monitoring

---

## 4 A/V Quality Monitoring Support for 3GPP PSS

### 4.1 WebTV Quality Monitoring

#### 4.1.1 Use case

Over-The-Top video streaming is increasingly dominating the traffic in the networks. An increasing number of services employing a variety of streaming formats are appearing. In addition, movie services are increasingly causing traffic in mobile networks.

It is crucial for mobile network operators to manage the video traffic in their networks and services in an optimal manner. A major objective is to ensure that the customers remain satisfied. Hence monitoring the users QoE with an appropriate quality indicator is of fundamental importance.

The derivation of quality indicators for the streaming quality may be supported by the service to a lesser or greater extend. Further dedicated agreements between mobile operator and service provider would help to obtain better quality indicators. The level of accuracy on the quality indicator would depend on the level of agreement between the mobile network operator and the service provider.

The main Key Performance Indicators (KPIs) for characterizing insufficient video streaming performance as perceived by the user are:

- initial stalling of the playout;
- periods of stalling and freezing of the video while playing;
- interruption of the audio while playing;
- low coding quality appearing as blurring, macroblocking or mosquito artefacts;
- varying coding quality while playing.

Beside these KPIs the monitoring system will also provide a Key Quality Indicator (KQI) characterizing the user's quality experience.

Quality is fundamentally related to the subjective assessment of the considered aspect. The KQI will be related to corresponding subjective quality assessments. The quality often is rated as an opinion score on a 5-point scale ranging from "bad" (1), "poor" (2), "fair" (3), "good" (4) to "excellent" (5). The average of these scores calculated from a group of subjects is the Mean Opinion Score (MOS).

For operational tasks instrumental measurement tools are required. Hence, the subjective test results are used to develop instrumental methods that replicates the MOS scores obtained in subjective tests. Ideally, the derived quality model will be established as internationally agreed standard specification, for increasing the confidence that the measured quality results are reliable and comparable. The estimated MOS values will be labelled as result stemming from an objective model. For example, the estimated AV-streaming MOS could be named MOS-AVQO (Audio-Visual-Quality-Objective).

The use of a KQI, estimating the MOS of a video streaming session has the major advantage of combining the quality impact of occurring stalling and coding effects in a single number. By this means the service can be monitored efficiently.

In addition to the KPIs and KQI, further the related data such as time, location, service and network will be collected for each considered streaming session.

The use case "WebTV Quality Monitoring" demands for means that allow collecting accurate KPIs and the audio-visual KQI for supporting the quality management of the networks and customer services. The collected KPI and KQI data supports a wide range of utilizations such as the short-term detection of problems and the long term quality monitoring. With additional other monitoring data sources, the complete delivery chain, from server, via networks, to the user's terminal can be observed. Data analytics methods can be applied to reveal inherent quality dependencies. The detection of critical combinations of KPIs with the help of a KQI focuses on the user's quality experience and is therefore very efficient. In conclusion, the MOS-AVQO is foreseen as mean to increase the usefulness of the quality monitoring systems significantly.

#### 4.1.2 Potential Recommended requirements

The proposed potential requirements for implementing the WebTV Quality Monitoring use case are based on the assumption that the user's end device is collecting and aggregating the QoE-related data. The collected QoE-related data then is further processed and forwarded to a central QoE monitoring server in a next step:

- The monitoring software of the end device can provide a generic applicable subsystem for Video Streaming Service Quality Monitoring (VSSQM).
- The VSSQM subsystem provides an API for logging QoE related events. The API provides a handler for receiving and digesting QoE related events and for retrieval of QoE-related data to be reported to a QoE Server using an appropriate communication channel.
- VSSQM subsystem provides an API for third party QoE monitoring applications running on the end device. This API allows retrieving the aggregated QoE-related data. The QoE monitoring application may transmit the QoE-related data to a third party QoE Monitoring Service.

Figure 4.1-1 illustrates the Video Streaming Service Quality Monitoring subsystem with the provided API's for QoE-related event logging and for QoE data digestion.

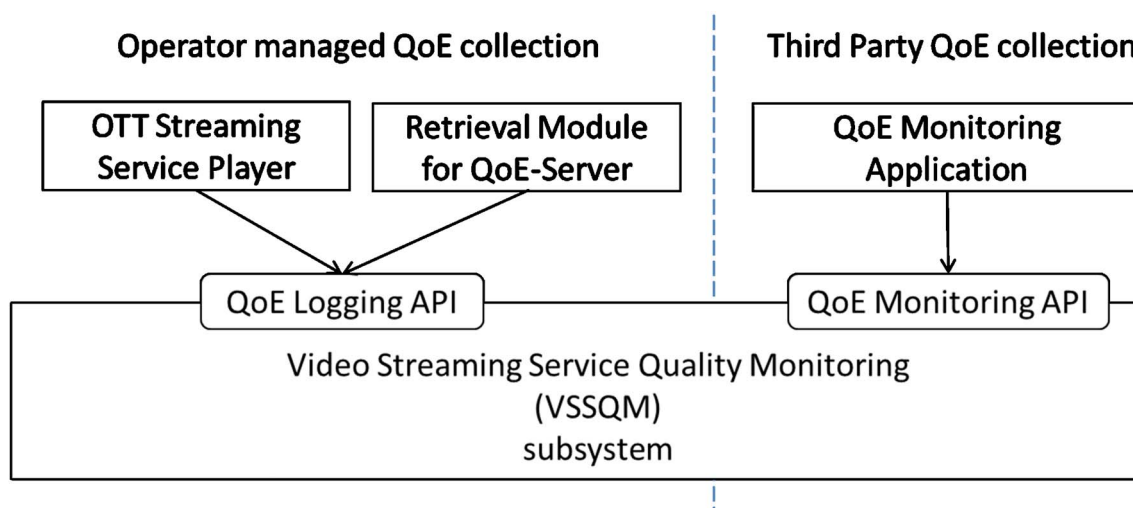

**Figure 4.1-1: Proposed subsystem for logging and digesting QoE-related data for Video Streaming Service Quality Monitoring**

##### Detailed proposed requirements for the VSSQM Logging API

1. The VSSQM subsystems provides an interface for registering video streaming service and its player for monitoring the play-out performance
2. The player of the streaming service is recommended to support the sending of following events:



- AnnouncementOfVideoStreamingSession (ServiceProvider)
- InitialisingPlayer (AudioCodec, VideoCodec, Profile)
- ChangeProfile (Profile)
- LoadingContent (SourceIP)
- Playing
- BitrateReport(Audio,Video)
- Stalling
- Pause
- ScrollForward
- ScrollBackward

3. The mobile clients provides additional related information such as:

- Time
- Location
- Network: 2G, 3G, 4G, Cell-ID, WLAN
- Route: Source IP, destination IP, ...
- Device: brand, screen parameters, headphones, processing power, battery usage

The VSSQM subsystem would collect this information via the appropriate API's in that moment when the player event is processed.

1. The QoE Logging API supports the retrieval of the raw QoE data with different aggregation levels. A QoE data retrieval module forwards these reports to a QoE server using an appropriate communication channel.
2. Video streaming traffic may be monitored also with a traffic analysis tool operating on the client network interface. Such a tool would register at the VSSQM in the same manner as streaming services. The tool may help to observe video streams that do not register and provide QoE related monitoring events.

#### **Detailed proposed requirements for the QoE Monitoring API**

1. The QoE Monitoring API allows deriving aggregated QoE reports. A third party monitoring application can process the data and forward derived QoE reports to a third party QoE server.
2. The QoE Monitoring Application may support to derive the following metrics:
  - Initial stalling of the playout
  - Periods of stalling and freezing of the video while playing
  - Interruption of the audio while playing
  - Statistics on coding quality
  - Statistics on varying coding quality while playing
  - Estimation on overall audio-visual quality (MOS-AVQO)

## 4.2 ITU-T P.NATS Quality Assessment Model for HTTP Adaptive Streaming

ITU-T P.NATS project ([3]) will develop the objective assessment model for progressive download and adaptive type media streaming. It supports both the OTT and operator managed video service. The supported protocol scope includes HTTP/TCP/IP, RTMP/TCP/IP, HLS/HTTP/TCP/IP, and DASH/HTTP/TCP/IP. It supports 3GPP, MP4 and other file format, and the model is agnostic to the type of file format.

It will support sequence duration of 60 sec to 5 min for quality evaluation. The supported video resolution is 240p, 360p, 480p, 720p and 1080p. The supported frame rate range is 8 to 50 fps.

ITU-T P.NATS phase 2 aims at extending the quality model for supporting 2K and 4K.

The current working model agreed in P.NATS project is depicted in figure 4.2-1.

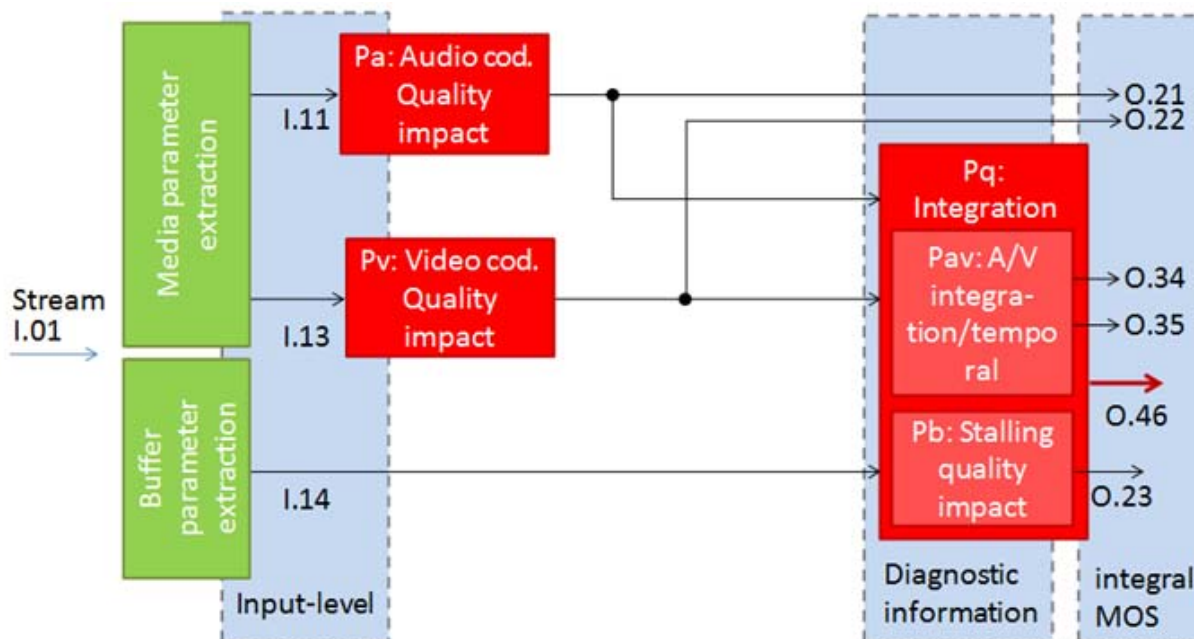

Figure 4.2-1: Building blocks of the P.NATS model

As shown in table 4-1, P.NATS will support 4 modes.

Table 4-1: Different modes defined in P.NATS

Mode	Encryption	Input
0	Encrypted media payload and media frame headers	Meta-data
1	Encrypted media payload	Meta-data and frame header information
2	No encryption	Meta-data and up-to 2% of the media stream
3	No encryption	Meta-data and any information from the video stream

The P.NATS model will receive media information and prior knowledge about the media stream or streams. The model receives the following input signals regardless of the mode of operation:

- I.GEN: display resolution and device type
- I.11: audio coding information
- I.13: video coding information

- I.14: Stalling events

The P.NATS model input parameters are provided in table 4-2 below.

**Table 4-2: ITU-T P.NATS model input parameters.**

ID	Description	Values	Frequency	Modes available
<b>I.GEN</b>				
0	The resolution of the image displayed to the user	Number of pixels (WxH) in displayed video	Per media session	All
1	The device type on which the media is played	pc or mobile	Per media session	All
<b>I.11</b>				
7	Target Audio bit-rate	Bit-rate in kbps.	Per media segment	All
8	Segment duration	Duration in seconds	Per media segment	All
9	Audio frame number	Integer, starting with 1	Per media segment	1,2,3
10	Audio frame size	Size of the frame in bytes	Per audio frame	1,2,3
11	Audio frame duration	Duration in seconds	Per audio frame	1,2,3
12	Audio codec	One of: AAC-LC, AAC-HEV1, AAC-HEV2, AC3	Per media segment	All
13	Audio sampling frequency	In Hz	Per media segment	All
14	Number of audio channels	2	Per media segment	All
15	Audio bit-stream	Encoded audio bytes for the frame	Per audio frame	2,3
<b>I.13</b>				
16	Target Video bit-rate	Bit-rate in kbps.	Per media segment	All
13	Video frame-rate	Frame rate in frames per second.	Per media segment	All
14	Segment duration	Duration in seconds	Per media segment	All
15	Video encoding resolution	Number of pixels (WxH) in transmitted video	Per media segment	All
16	Video codec and profile	One of: H264-baseline, H264-high, H264-main	Per media segment	All
17	Video frame number	Integer, starting at 1, denoting the frame sequence number in encoding order.	Per video frame	1,2,3
18	Video frame duration	Duration of the frame in seconds	Per video frame	1,2,3
19	Frame presentation timestamp	The frame presentation timestamp	Per video frame	1,2,3
20	Frame decoding timestamp	The frame decoding timestamp	Per video frame	1,2,3
21	Video frame size	The size of the encoded video frame in bytes	Per video frame	1,2,3
22	Type of each picture	"I" or "Non-I" for mode 1	Per video frame	1,2,3
23	Video bit-stream	Encoded video bytes for the frame	Per video frame	2,3
<b>I.14</b>				
22	Buffering event start	The start time of the buffering/stalling event in seconds relative to the start of the original video clip, expressed in media time (not wall clock time) NOTE: This is 0 for initial buffering.	Per buffering/ stalling event	All
23	Event duration	The duration of the buffering/stalling event in seconds.	Per buffering/ stalling event	All

The P.NATS model outputs are as follows:

- O.21: Audio coding quality per output sampling interval
- Multiple segment scores provided per session and on a 1-5 quality scale.

- O.22: Video coding quality per output sampling interval
  - Multiple segment scores provided per session and on a 1-5 quality scale.
- O.23: Perceptual buffering indication
  - Single score on a 1-5 quality scale for the session.
- O.34: Audiovisual segment coding quality per output sampling interval.
  - Multiple segment scores provided per session.
  - Window-size same as for/synced with O.21, O.22
- O.35: Final audio-visual coding quality score
  - Single score for the session, on a 1-5 quality scale.
  - Includes aspects of temporal integration.
- O.46: Final media session quality score
  - Single score for the session, on a 1-5 quality scale.
  - Includes initial buffering and stalling aspects.

## 4.3 Gap analysis of PSS QoE metrics for support of ITU-T P.NATS

### 4.3.1 Supported Mode

For operator managed streaming service, media information, prior knowledge about the media stream and/or stream is visible to the operator, which mode can be configured by the operator. The P.NATS mode selection is the tradeoff between quality assessment accuracy and processing complexity.

For OTT streaming service, stream information is not visible to the operator any more especially if HTTP is in place. P.NATS mode 1 to 3 does not apply to OTT streaming service any more.

It is proposed to introduce Mode 0 for both OTT and operator managed streaming service. Other Mode is FFS.

### 4.3.2 Supported Input parameter

In order to support Mode 0 quality assessment, the required parameter is listed in table 4-3 below.

Table 4-3: ITU-T P.NATS model input parameter for Mode 0.

ID	Description	Values	Frequency	Modes available
I.GEN				
0	The resolution of the image displayed to the user	Number of pixels (WxH) in displayed video	Per media session	All
1	The device type on which the media is played	pc or mobile	Per media session	All
I.11				
7	Target Audio bit-rate	Bit-rate in kbps.	Per media segment	All
8	Segment duration	Duration in seconds	Per media segment	All
12	Audio codec	One of: AAC-LC, AAC-HEv1, AAC-HEv2, AC3	Per media segment	All
13	Audio sampling frequency	In Hz	Per media segment	All
14	Number of audio channels	2	Per media segment	All
I.13				
16	Target Video bit-rate	Bit-rate in kbps.	Per media segment	All
13	Video frame-rate	Frame rate in frames per second.	Per media segment	All
14	Segment duration	Duration in seconds	Per media segment	All
15	Video encoding resolution	Number of pixels (WxH) in transmitted video	Per media segment	All
16	Video codec and profile	One of: H264-baseline, H264-high, H264-main	Per media segment	All
I.14				
22	Buffering event start	The start time of the buffering/stalling event in seconds relative to the start of the original video clip, expressed in media time (not wall clock time) NOTE: This is 0 for initial buffering.	Per buffering/stalling event	All
23	Event duration	The duration of the buffering/stalling event in seconds.	Per buffering/stalling event	All

TS 26.247 ([4]) develops QoE metrics used for quality evaluation, in order to support video MOS calculation by 3GPP system. The mapping and check between TS 26.247 and P.NATS are provided below.

**Table 4-4: mapping between QoE metrics defined in TS 26.247 and input in P.NATS model for video stream**

Video Metrics needed for P.NATS model		QoE metrics defined in TS 26.247		Remark
Description	Value	Metric	Description	
Target Video bit-rate	Bit-rate in kbps.	Mpdinfo	Provides the MPD information for the representation or subrepresentation identified by <i>representationid</i> and <i>subreplevel</i> , if present. Related attributes: <i>@bandwidth</i> , <i>@width</i> , <i>@height</i> , <i>@duration</i> , and <i>@codecs</i> . Note: codec attribute includes video codec profile information and video frame rate information	Target Video bit-rate has been supported by <i>@bandwidth</i> attribute. Video frame-rate and Video codec and profile have been supported by <i>@codec</i> attribute. <i>Segment duration</i> has been supported by <i>@duration</i> attribute. <i>Video encoding resolution</i> has been supported by <i>@width</i> and <i>@height</i> attributes.
Video frame-rate	Frame rate in frames per second.			
Segment duration	Duration in seconds			
Video encoding resolution	Number of pixels (WxH) in transmitted video			
Video codec and profile	One of: H264-baseline, H264-high, H264-main			

**Table 4-5: mapping between QoE metrics defined in TS 26.247 and input in P.NATS model for audio stream**

Audio Metrics needed for P.NATS model		QoE metrics defined in TS 26.247		Remark
Description	Value	Metric	Description	
Target Audio bit-rate	Bit-rate in kbps.	Mpdinfo	Provides the MPD information for the representation or subrepresentation identified by <i>representationid</i> and <i>subreplevel</i> , if present. Related attributes: <i>@bandwidth</i> , <i>@duration</i> , and <i>@codecs</i> . Note: codec attribute includes audio codec profile information, audio sampling frequency and Number of audio channels information	<i>Target Audio bit-rate</i> has been supported by <i>@bandwidth</i> attribute. <i>Audio codec</i> , <i>Audio sampling frequency</i> and <i>Number of audio channels</i> have been supported by <i>@codecs</i> attribute. <i>Segment duration</i> has been supported by <i>@duration</i> attribute.
Segment duration	Duration in seconds			
Audio codec	One of: AAC-LC, AAC-HEv1, AAC-HEv2, AC3			
Audio sampling frequency	In Hz			
Number of audio channels	2			

**Table 4-6: mapping between QoE metrics defined in TS 26.247 and input in P.NATS model for stalling**

Metrics needed for P.NATS model		QoE metrics defined in TS 26.247		Remark
Description	Value	Metric	Description	
Buffering event start	The start time of the buffering/stalling event in seconds relative to the start of the original video clip, expressed in media time (not wall clock time) Note: This is 0 for initial buffering.	<i>InitialPlayoutDelay</i>	The playout delay for media start-up is measured as the time in milliseconds from the time instant of DASH player receives play-back-start trigger to the instant of media playout. If the MPD has been delivered earlier before the user clicks, it may include the process time of MPD, the fetch time of some media segments which are required for media presentation, the process time of segments, and the time for media decode and render to the user. If no MPD has been fetched earlier, it also needs to add the fetch time of MPD.	It is only for initial buffering delay event
Event duration	The duration of the buffering/stalling event in seconds.	Play List	A list of playback periods. A playback period is the time interval between a user action and whichever occurs soonest of the next user action, the end of playback or a failure that stops playback.	For the buffering event afterwards

The buffering event defined in P.NATS includes initial buffering and stalling information. Initial buffering delay in P.NATS is defined as the start time of the buffering/stalling event in seconds relative to the start of the original video clip and can map to the '*InitialPlayoutDelay*' in TS 26.247.

For stalling information, P.NATS model requires the start time and end time of a stalling event. In TS 26.247, QoE metric '*Play List*' logs a list of playback periods of continuous delivery triggered by a user action (e.g., play, seek or resume action) till the stop of playout either due to re-buffering event, a user action, the end of the content, or a permanent failure. The stalling duration can be derived through those collected logged information.

As shown in figure 4.3-1, the '*Play List*' logged information includes T1, T2, T3, and T4 with associated information. The re-buffering duration equals to T2-T1.



**Figure 4.3-1: Logging information in Play List**

Table 4-7: other input for P.NATS

Metrics needed for P.NATS model		QoE metrics defined in TS 26.247		Remark
Description	Value	Metric	Description	
The resolution of the image displayed to the user	Number of pixels (WxH) in displayed video	N/A		It is not specified in TS 26.247. For operator managed streaming service, it may be obtained via other way, which is outside of scope. For OTT streaming service, the enhancement of QoE metrics is required.
The device type on which the media is played	pc or mobile	N/A		'Visual size' is adopted in ITU-T P.NATS, it needs to be reflected in TS 26.247.

Based on the above analysis, required inputs I.11, I.12, I.13 and I.14 for P.NATS are supported by QoE metrics in TS 26.247 already. I.GEN input for P.NATS may require enhancement to TS 26.247.

### 4.3.3 Further Parameters for Supporting Video Quality Monitoring

#### 4.3.3.1 Additional Input Parameters

Two additional input parameters in consideration with potential benefit for enhancing video MOS estimation are provided in table 4-8 below.

Table 4.8

ID	Description	Values	Frequency	Modes available
A1	Visual size	Diagonal size of the viewed video area in cm	Per media session	All
A2	Video QP	Average QP value	Per media segment	See Note

NOTE: This parameter is not currently applicable to Mode 0. Applicability to other modes is TBD.

Clauses 4.3.3.2 and 4.3.3.3 provide subjective quality evaluation results demonstrating the dependency of video quality MOS on these input parameters.

#### 4.3.3.2 Dependency of Video Quality Test Results on Visual Size

Nowadays, with the variety of devices such as 2-in-1 laptops, tablets, phablets emerge in the market, it becomes more and more difficult to cut a fine line between PC and mobile. Meanwhile, the size of the display could vary from 4in to 100+ in. Using a simple PC vs. mobile device type may not capture the perceptual video quality impact introduced by the device form factor. As shown in Table 4-9, when same videos are displayed on different devices with a similar resolution, the video quality MOS varies because of the visual size of the viewed video area (The subjective experiments are conducted following ITU-R BT.500 standard [8]. More details about the subjective testing can be found in [2]). When displayed on a 10.1" screen, the video MOS is 0.8 lower than on a 4.8" screen on average. Since the screen size, more specifically the visual size of the viewed video area, has a great impact on the video quality MOS, it is desirable to consider it as an additional input parameter for video MOS estimation.



**Table 4-9: Video Quality MOS on different devices (encoded at 1.5 Mbps with 768x432 resolution)**

Video clip name	Video Quality MOS (10.1" tablet, 1280x800)	Video Quality MOS (4.8" phone, 1280x720)
Aspen	2.2	3.5
Crowdrun	2.0	3.1
Redkayak	2.2	3.4
westwindeasy	3.4	3.9
Backsneak	3.4	4.2
Bbscore	3.5	4.1
controlledburn	3.5	4.3
Tractor	3.7	4.4
Frontend	3.9	4.6
pedestrianarea	3.6	4.3
Speedbag	4.2	4.6
Sunflower	4.4	4.8
AVERAGE	3.3	4.1

#### 4.3.3.3 Relation between Video Quality MOS and QP Parameter

Video resolution, frame rate, encoding bitrate, etc. play an important role in video quality modeling. In addition to those parameters, video encoding QP is also very critical for video MOS estimation, because different video segments could have very different content characteristics and they yield to a wide range of video quality MOS even when encoded at the same bitrate. For example, table 4-10 shows quality and QP values (mean luma QP averaged over the segment duration) of different video clips encoded at the same bitrate. When the videos share the input parameters such as resolution, frame rate, bitrate, etc. and are displayed on the same device, the MOS still varies in a wide range due to the content characteristic difference and the difference is well captured by the QP value. Table 4-11 shows the correlation of the bitrate/QP and the video quality scores. For videos encoded at the same bitrate, their estimated video MOS has a strong correlation to QP value, which indicates the video content complexity.

**Table 4-10: Videos Encoded at the Same Bitrate with a Wide Range of Video Quality MOS**

Video clip name	Bitrate (kbps)	QP	PSNR (dB)	MS-SSIM	Video Quality MOS (10.1" tablet)
aspen	1454	35.9	26.9	0.834	2.2
crowdrun	1482	39.3	23.9	0.745	2.0
redkayak	1451	36.5	31.1	0.829	2.2
westwindeasy	1467	35.9	28.0	0.880	3.4
backsneak	1459	32.5	35.0	0.930	3.4
bbscore	1466	29.7	32.4	0.907	3.5
controlledburn	1476	29.1	31.5	0.924	3.5
tractor	1456	32.2	32.6	0.917	3.7
frontend	1429	23.7	30.8	0.946	3.9
pedestrianarea	1463	27.6	35.7	0.944	3.6
speedbag	1455	25.8	38.5	0.971	4.2
sunflower	1460	25.9	38.2	0.975	4.4

**Table 4-11: Correlation between Bitrate/QP and Video Quality Scores**

Correlation	PSNR	MS-SSIM	Video Quality MOS
Bitrate	-0.25	-0.39	-0.27
QP	-0.75	-0.90	-0.87

From Table 4-10 it also becomes obvious the video quality MOS for different video clips with the same encoding parameters, such as video resolution, frame rate and encoding bitrate, as used for P.NATS Mode 0 may lead to quite different video quality MOS. A video quality MOS estimator that uses, only the P.NATS Mode 0 parameters will produce the same MOS score for all the video clips in Table 4-10. However, Table 4-10 has shown that those clips have MOS scores varying in a very large range (2.0 ~ 4.4), which is due to the quality dependency on the video content. The video content complexity is well captured by the QP parameter as shown in Table 4-11.

## 4.4 Calculation of A/V MOS estimation

### 4.4.0 General

There are 2 options: Calculation done in the client and Calculation done in a QoE server based on the "raw" QoE metrics data reported by the client. The detail comparison of those 2 options and conclusion are provided in following clauses.

### 4.4.1 Network Optimization

To do advanced network optimization requires that you understand not only the final MOS values for the video streaming sessions, but also can see the underlying raw metrics. For instance, some sessions might simply have a low MOS value due to the content not having high enough original quality, while other sessions might have problems with rebuffering. Understanding the root cause requires access to the basic metrics, not only the final MOS values.

### 4.4.2 MOS Models

The MOS models standardized in ITU-T typically develop over time. For instance, P.NATS will have several phases, with later phase adding e.g. support for more codecs. Each time the ITU-T MOS model is updated, the corresponding updates will be done to the implemented calculations as well.

Having the calculation done in the client means that when a new ITU-T model is released, it will take substantial time before all, or even the majority, of the clients have this implemented. On the other hand, updating the MOS model calculation in a single QoE server is very easy (of course provided that the raw QoE metrics reported are sufficient for the calculation).

### 4.4.3 MOS Windowing

Even if ITU-T standardizes the P.NATS MOS models, the standard does not define how often such a MOS value will be calculated. For instance, it could be calculated every minute, every two minutes, or just for the complete session. This windowing decision is more or less up to the operator, and is much easier to handle if the windowing is done in the QoE server rather than by configuring window lengths towards all of the clients. It would also easily be possible to calculate MOS values for several windowing lengths in parallel in the server, while handling this in the client becomes rather complex.

One reason for using different windowing for calculating the MOS scores is that P.NATS models the human memory effects when watching video. Thus if a person is asked about his opinion regarding the media quality, and there has been a very recent problem, such as a buffering or low-resolution content, he will remember this, and lower his score. On the other hand, if similar problems were happening longer back in time, say several minutes, and the last part of the session had very good quality, he will give a higher score.

This is typically handled in P.NATS by weighting the short-term media quality differently over time, so that the weight is high for the most recent time, and then starts to drop for media which is placed longer back in memory. Figure 4.4-1 below illustrates this for an example 4-minute session, where either four 1-minute MOS scores are evaluated (red lines), or one 4-minute MOS score (dashed blue line). For the 1-minute scores the weight is almost not decreasing at all, while for the 4-minute score the weight is going down more for the older parts. Note that the figure is only illustrative and not an accurate representation of the final P.NATS algorithm.

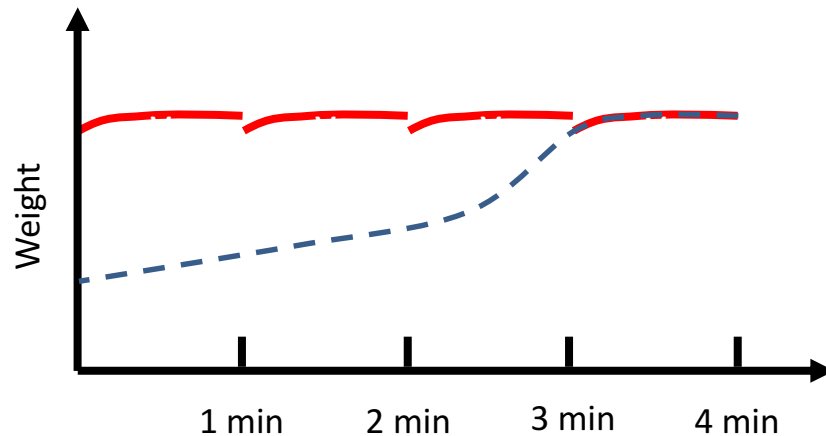

**Figure 4.4-1: Weighting of media quality to model the human memory effect**

Thus depending on the operator targets, different MOS windowing can be used. With shorter windowing the resulting MOS scores are more representative of the short-term quality, without almost any memory effect. With longer windowing, the results include more memory effects, and is more representative of the session quality. As stated earlier, if the MOS score is calculated in the QoE server several different windowing can be done in parallel, to facilitate different kind of operator analysis.

#### 4.4.4 Conclusion

While MOS calculation in the client is possible, it severely limits the use of advanced network optimization, use of flexible MOS windowing, and also introduces problems when the MOS model calculation needs to be updated. A better solution is to make sure that the raw reported QoE metrics are enough to be able to calculate the final MOS value in the QoE server.

The Packet Streaming Server (PSS) client collects required metrics and reports it to the PSS server. The PSS server calculates A/V MOS using the model developed in P.NATS. The operator and/or OTT 3<sup>rd</sup> party can evaluate network delivery performance based on the result A/V MOS with following benefit:

- Avoid different interpretation of DASH QoE metrics by the Mobile Network Operator (MNO) for different UEs consuming the same streaming content with same encoding scheme.
- Avoid different interpretation of DASH QoE metrics by the OTT 3<sup>rd</sup> party for different UEs consuming the same streaming content with same encoding scheme over different MNO's network.

It is proposed to introduce A/V MOS developed by P.NATS for 3GPP PSS.

A/V MOS estimation and associated information (encoding information, InitialPlayoutDelay, etc.) may be used by the operator to evaluate network delivery performance in case:

- The streaming content is encoded with different coding schemes; advanced encoding scheme consumes less network bandwidth.
- DASH player implementation prefers downloading more data before playing.

## 4.5 Options for applying higher P.NATS Modes

The ITU-T P.NATS quality model will support four modes (see clause 4.1). Mode 0, Mode 1 and Mode 3 are of special interest for client-based QoE monitoring.

Mode 0 supports estimating the quality based on metadata information such as audio codec, video codec and bitrates. This quality estimation requires very low processing power and the meta information is typically available even for media streams encrypted at the chunk level.

Mode 1 uses in addition information on the GOP structure and frame sizes. This is possible for unencrypted streams or streams encrypted only on elementary stream level. It requires low processing power and the estimation of video quality is better over mode 0.

Mode 3 takes the bitstream itself into account. The video quality model considers the, quantization parameters and further coding-related features in addition to the codec's profile, video framing and bitrates for getting a significant better estimation of the video coding quality. A tradeoff is that Mode 3 requires more processing power and an unencrypted bitstream. Therefore, is deploying P.NATS Mode 3 on the user end devices is unlikely, but Mode 3 can be applied by splitting the processing for the model in one part processing the coding quality on the server side and another part processing the stalling and overall quality integration part on the client side.

As shown in figure 4.2-1, the P.NATS quality model is composed of separate modules for estimating the audio quality (Pa), video quality (Pv) and for integrating audio, video and stalling quality (Pq). This modular approach allows separating the quality estimation into a server-side estimation of the audio and video coding quality and a client-side integration of the coding quality in combination with stalling events that may have occurred on the client. The outputs of the audio module (O.21) and the video module (O.22) are provided with a sampling frequency of 1 Hz. The integration module Pq takes the samples of the audio and video coding quality output for an appropriate measurement interval and combines them with the occurred stalling events. The result is an estimate for the audio-visual quality of the stream, named "MOS-AVQO". It is to be noted that the Pq integration model is identical for all modes.

Figure 4.5-1 illustrates different possible scenarios for applying the P.NATS quality model for monitoring HTTP Adaptive Streaming services.

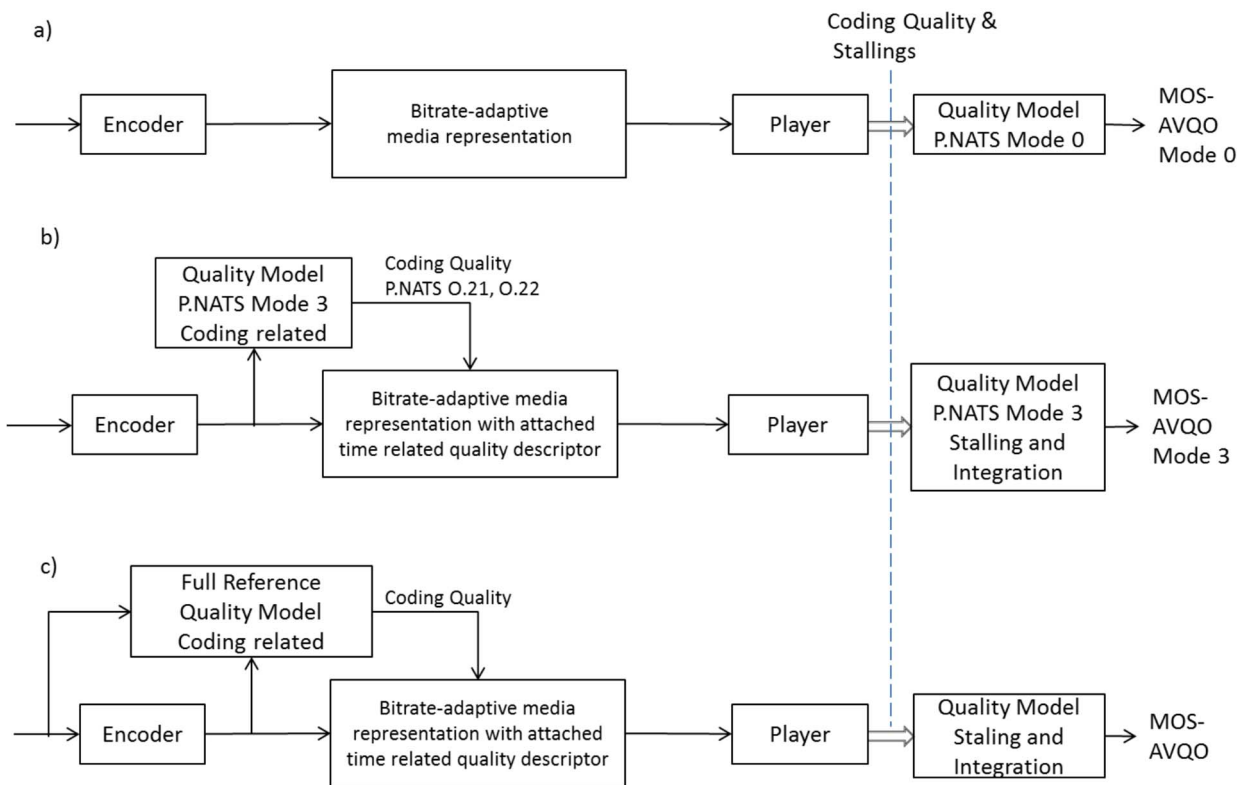

- a) Mode 0: Deriving codec info and bitrate from the meta information
- b) Mode 3: Deriving the coding related quality at server attaching to the media description,
- c) Possible extended mode: Deriving coding related quality with a full reference model

**Figure 4.5-1: Possible scenarios for applying the ITU-T P.NATS quality model for monitoring HTTP Adaptive Streaming services**

- a) Mode 0 implements a simple efficient quality estimation. The input parameters to estimate audio-visual quality are taken from the metadata description of the audio-visual stream (codecs, bitrate).

- b) Mode 3 uses the unencrypted bitstream to derive the coding quality. Beside the codec information, video resolution, framerate, bitrate, GOP structure, also the QP parameters and further coding features are derived and considered. As the required processing (bitstream parsing) may be computationally intensive for terminals, it is appropriate to derive O.21(m) and O22(m) for all possible representations of the adaptive stream already at the server side. As explained above, P.NATS Mode 3 foresees a sample frequency of 1 Hz of the output of the audio and video quality estimation module. Hence, for example, for a segment with a length of 6 seconds, one would calculate 12 quality scores (6 audio, 6 video) and transmit them along with the audio-visual data to a client device, which then calculates the integrated MOS-AVQO.

NOTE: The coding quality information could be attached with enhancement of timed metadata track, as described in clause 16 of TS 26.244 [7], clause 6.17 of TR 26.938 [6] – this approach relies on MPEG's ISO/IEC 23001-10 [10].

- c) In future, standardized quality models for HTTP adaptive streaming may support a full-reference quality model. This way, the quality monitoring would take also the possibly varying quality of the encoder into account. The Phase 2 for the P.NATS development ("AVHD / P.NATS Phase 2") foresees the additional support of a full-reference pixel-based model for video quality estimation.

As discussed in e.g. clause 4.4 in the present document, it may be an advantage to calculate the P.1203 (P.NATS) scores at the server responsible for QoE monitoring.

Thus to be able to divide the P.NATS model execution as described, it is imperative that this can be done in such a way that the final P.NATS score can still be calculated on the network side. This would mean that the Pa and Pv scores which are sent to the client, would also be needed at the QoE Server. Then these scores (together with the other client QoE reported metrics, such as buffering info), can then be used in the QoE Server to finally calculate the P.NATS score.

If the CDN (and thus the Pa/Pv scores) is accessible for the operator owning the QoE Server, then this is not a major problem, as the Pa and Pv scores can then potentially be communicated between the CDN and the QoE Server. There will be a need for some kind of synchronization to know which Pa and Pv scores belong to which QoE reports, but in principle it is possible to handle.

However, if the CDN is not accessible then the Pa and Pv scores, which are sent from the CDN to the client, will be reported back from the client to the QoE Server. Otherwise the QoE Server cannot calculate the P.NATS score. This situation is also the reason for the existing "MPD Information" in TS 26.247 (see clause 10.2.8), to make the needed MPD information available to a QoE Server which does not have MPD access.

Note that the use of distributed P.NATS calculation is most straightforward for non-live content, as live content puts additional requirements on the Pa and Pv calculations. Thus the use for live content needs further study.

---

## 5 QoE metrics support for managed streaming service

### 5.1 Use case: Managed Streaming Service QoE Improvement

#### 5.1.1 Introduction

Managed streaming service refers to a service for which the MNO and the service provider have some agreement in order to exchange information, specifically the streaming service provider allows meta-data (e.g., MPD) of the streaming content can be collected by the operator and the service provider provides certain metrics of the streaming service to the MNO in real-time.

#### 5.1.2 Use case #1

The operator #1 offers mobile broadband service to the subscriber. The subscribers of operator #1 access different managed streaming services offered by different streaming service providers which content is compliant to DASH format.

### Sub case #1

The operator #1 wants to ensure that the subscriber's experience of streaming service is consistent from network delivery perspective without the assistance of managed streaming service provider. The operator #1 collects relevant QoE metrics available from either UE or network, maybe both to evaluate the QoE of managed streaming service.

### Sub case #2

In a business area #CBD, several subscribers encounter stalling while they access managed streaming service. These subscribers complain to the operator #1. Operator #1 cares about those subscribers and starts to investigate what is the cause. The operator #1 collects QoE metrics of managed streaming service within a geographic area covering that business area, QoE metrics from neighbour cells are also collected by the operator #1. Through analysis, operator #1 does not find any network problem based on the collected QoE metrics and other internal network information. Operator #1 derives that the problem may be caused by the server owned by Content Delivery Network (CDN) providers or managed streaming service provider. Operator #1 works with managed streaming service provider closely; the problem of a server, which serves the business area, in the CDN network is identified and fixed. The operator #1 receives no further complaints of managed streaming service afterwards.

### Sub case #3

In a metro station, several subscribers encounter stalling while they access a managed streaming service. These subscribers complain to the operator #1. Operator #1 cares about those subscribers and starts to investigate what is the cause. The operator #1 collects QoE metrics of managed streaming service within a geographic area covering the transportation hub, QoE metrics from neighbour cells are also collected by the operator #1. Operator #1 identifies it is a network problem. To further locates the problem, Operator #1 collects QoE metrics and associated radio measurement information in a timely manner for ongoing managed streaming services. It is found that the surging managed streaming service consuming along with other non-streaming service access degrade the user experience. Operator #1 performs access control for certain type of traffic, and diverts some type of traffic or users to a spare carrier and the problem is addressed.

## 5.1.3 Use case #2

The operator #2 offers a mobile broadband service to the subscriber. The subscribers of operator #2 access different managed streaming services offered by different streaming service provider which content is compliant to DASH format. The streaming service provider allows meta-data (e.g., MPD) of the streaming content can be collected by the operator.

### Sub case #1

Streaming service provider #Streaming #A expects Operator #2 to support QoE of network delivery for all or selected managed streaming service of #Streaming #A. Operator #2 collects relevant QoE metrics available from either UE or network, maybe both, for all or selected streaming services of #Streaming #A in order to verify that the QoE expectations of Streaming #A are fulfilled.

## 5.2 Managed streaming service deployment model consideration

### 5.2.1 Introduction

PSS architecture defined in TS 26.233 [5] supports both progress download and 3GPP-DASH, and is depicted in figures 5.2-1 and 5.2-2 respectively.

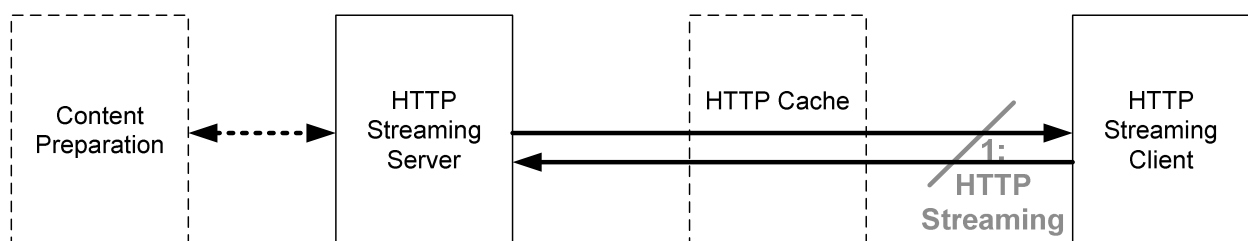

Figure 5.2-1: Architecture for Progressive Download over HTTP

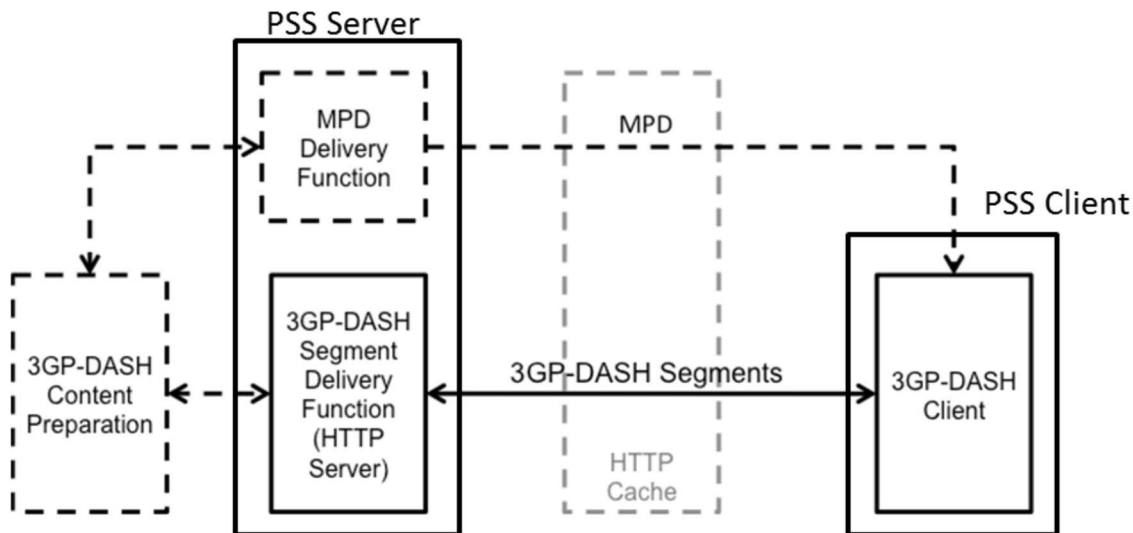

Figure 5.2-2: Architecture for 3GP-DASH

The QoE feature is optional for both PSS server and clients. Once QoE feature is supported, the PSS server can configure the QoE metrics collected by PSS client via PSS signalling (e.g., MPD, RTSP) or OMA-DM. Current architecture model assumes that the PSS server collecting QoE metrics delivers the streaming content too. This assumption is valid when the streaming service is hosted by the operator. This assumption cannot apply to managed streaming service case.

### 5.2.2 Managed streaming service deployment model

A typical managed streaming service deployment model is provided in figure 5.2-3.

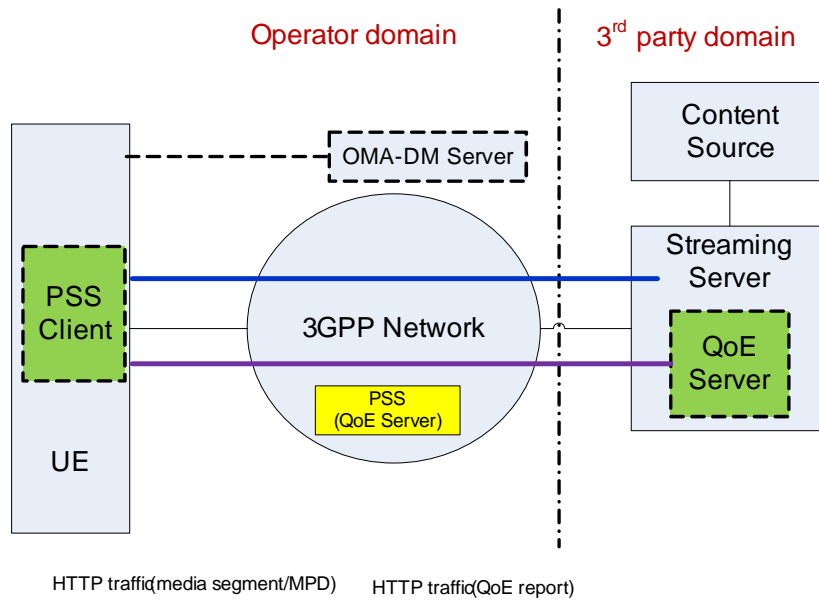

Figure 5.2-3: Managed streaming service deployment model

It is assumed the PSS client is able to collect and report meta-data of streaming service operated by 3rd party. PSS Client retrieves streaming content from the 3rd party streaming server shown as **solid blue line**. The streaming content is 3GPP streaming file format complied. Streaming server can configure the PSS client to report QoE metrics by itself. The PSS client reports QoE metrics to 3rd party QoE server shown as **solid purple line**.

Besides the 3<sup>rd</sup> party evaluation of QoE of streaming service, it is of great importance for the operator to evaluate the network performance of managed streaming service support without the access of streaming content itself. QoE server in operator domain could be a PSS server containing QoE reporting functionality only. It is expected that the QoE server in operator domain is able to configure and receive QoE metrics for streaming service operated by 3<sup>rd</sup> party.

OMA-DM server is used for QoE metrics configuration, and it is an optional entity. If OMA-DM server does not exist in some operator's network, then the configuration of QoE metrics for streaming service operated by 3<sup>rd</sup> party need enhancement.

NOTE: PSS client may interact with application running in the UE to collect relevant QoE metrics which are out of control of operator.

## 5.3 Recommended requirements

The recommended requirements are summarized below:

- The 3GPP network needs to be able to collect QoE metrics of managed streaming service for user experience and 3GPP network performance evaluation purpose.
- The 3GPP network needs to be able to allow the operator to collect QoE metrics of managed streaming service within a certain geographic area designated by the operator.
- The 3GPP network needs to support a mechanism to allow the operator to configure the QoE metrics of a managed streaming service collection for network problem identification purpose.

NOTE: The co-ordination with RAN group may be needed.

- The 3GPP network need to be able to allow the operator to collect QoE metrics of any managed streaming service.

## 5.4 GAP Analysis and Evaluation

### 5.4.1 Introduction

The QoE metric reporting feature can be configured by either OMA-DM or MPD, and the configuration includes:

- Activation/deactivation of the QoE feature
- QoE metric
- ReportingServer information
- ReportingInterval
- Other configurations, such as APN, Samplepercentage, etc.

In order to allow the QoE metrics of 3<sup>rd</sup> hosted streaming service collected by the MNO, the MNO needs to be able to configure QoE metrics to the DASH client.

### 5.4.2 Analysis of Activation/Deactivation of QoE reporting

When the MNO is configured with OMA-DM server, DASH client is configured with OMA DM QoE MOs by OMA-DM. When QoE reporting is triggered via the MPD or OMA DM QoE Management Object, the DASH client collects quality metrics according to the QoE configuration. Current OMA-DM approach allows the MNOs to collect QoE metrics of 3<sup>rd</sup> party hosted streaming service. No gap is identified.

When the MNO is not configured with OMA-DM server, MPD is one possible way to configure QoE metrics to DASH client. However, it requires the MNO to request 3<sup>rd</sup> party to configure QoE metrics in each MPD. The MNO has no knowledge of which streaming service hosted by any 3<sup>rd</sup> party in advance. The feasibility and scalability issues are big challenge to the MNO, so MPD approach is not feasible. A new approach is needed.



## 5.5 Assumptions

The following assumptions are considered during the development of this project:

- QoE server owned by the operator locates inside of 3GPP network and is different from the QoE server inside the 3<sup>rd</sup> party streaming server.
- The PSS client is able to collect meta-data (e.g., MPD) of streaming service operated by 3<sup>rd</sup> party.
- Subject to the agreement between the operator and 3<sup>rd</sup> party, QoE metrics of streaming service operated by 3<sup>rd</sup> party visible to the operator is able to be collected by the operator.
- QoE metrics collected by the QoE server owned by operator is supposed to work for both non OMA-DM and OMA-DM cases.
- QoE metrics collected by operator for managed streaming service can work for both HTTP and HTTPs options.
- The meta-data (e.g., MPD) of the streaming service owned by 3<sup>rd</sup> party can be collected by the operator.
- The service provider provides certain metrics of the streaming service to the MNO in real-time.

## 5.6 Solution

### 5.6.1 Possible Candidate Options

Option 1: DASH proxy approach

A PSS proxy located behind the P-GW is introduced into the MNO network. The PSS proxy is able to intercept HTTP: request message for MPD initiated by DASH client, it forwards HTTP: request message to 3<sup>rd</sup> party streaming server. The PSS proxy receives HTTP: response message including MPD. The PSS proxy modifies MPD with QoE metrics and forwards it to DASH client. The DASH client collects QoE metrics to the QoE server configured by the PSS proxy.

Option 2: RAN network assisted approach

Trace Collection Entity (TCE) is specified in TS 32.422 [11] for control and configuration of the Trace, Minimization of Drive Tests (MDT) and Radio Link Failure (RLF) reporting functionality. Considering the MNO expects the collected QoE metrics result to be used for network performance evaluation and problem identification purpose, enhancement of MDT mechanism is proposed here.

The concept of MDT enhancement is depicted in figure 5.6-1.

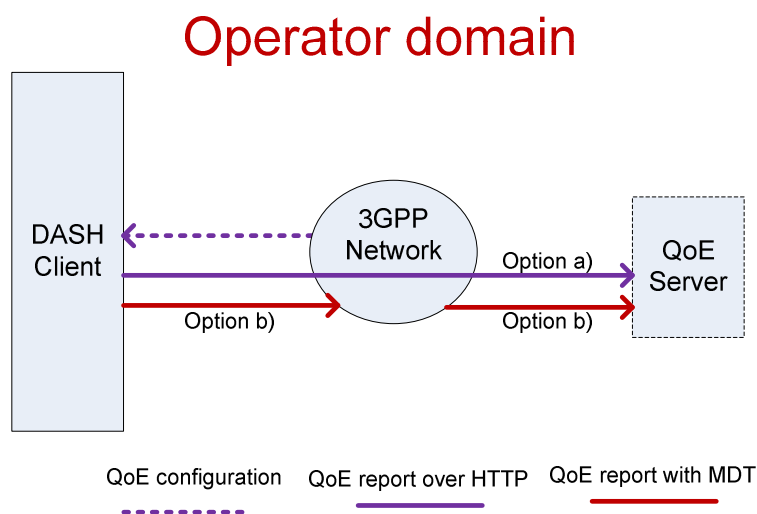

Figure 5.6-1: MDT enhancement for supporting QoE reporting

The TCE uses MDT configuration method to configure the QoE metrics to the DASH client. There are 2 options for QoE reporting. Option a) is QoE metrics is collected by DASH client, and the DASH client uses QoE reporting protocol specified in TS 26.247 and reports to the QoE server. Option b) is QoE metrics is collected by DASH client and reported to TCE via MDT procedure, the TCE then forwards the QoE results to QoE server.

Option 1 requires the PSS proxy to intercept all traffic from the UE, the high processing loading of PSS proxy used only for QoE configuration purpose needs more justification, it also does not work for HTTPs based streaming service since the PSS proxy is unable to intercept HTTPs message, so option 1 is not recommended. Option 2 works for HTTPs encrypted streaming service and it is feasible. It is recommended to adopt option 2.

Within option 2, RAN2 agrees that option b) is feasible from RRC signalling perspective. Considering the RAN2 input, following criteria are further considered:

#### (1) QoE metrics

3GPP Network can achieve not only the final evaluation result of streaming services (e.g. A/V MOS estimation), but also the related metrics for evaluation (e.g. reported QoE measurements from the UE side), which can be combined with radio measurements for well understanding of UE experience

- The network optimization related metrics
- Whether the terminal or the streaming original quality of the network which impacts

#### (2) 3GPP Network control

Operators could control when, where and how often to collect QoE measurements in order for A/V MOS estimation, for the need might vary from place to place and the A/V MOS estimation is the trade off of UE/network burden and usefulness.

#### (3) Unified QoE measurements

Unified QoE measurements and a unified interpretation of A/V MOS estimation are beneficial for operators to evaluate the real user experience for streaming services.

#### (4) Network optimization

Operators can optimize the 3GPP networks for better streaming service experience according to the collected QoE measurements combining with radio measurements.

In table 5-1, comparison between both option a) and option b) in option 2 according to above criteria are listed:

**Table 5-1: comparison of QoE reporting option a and option b in option 2**

	Option a	Option b
QoE metrics	No. QoE measurements are reported from UE to QoE server via HTTP protocol, and thus 3GPP Network is "transparent"	Yes
3GPP Network control	Yes	Yes
Unified QoE measurements	Yes	Yes
Network optimization	No. QoE measurements are reported from UE to QoE server via HTTP protocol, and thus 3GPP Network is "transparent"	Yes
NOTE: Yes means that this option meets the corresponding criterion. No means that this option does not meet the corresponding criterion and the reasons are also provided as following.		

Option b) could meet all above aspects because the QoE measurements are known at 3GPP network side (e.g. RAN or TCE) when OMA-DM is not supported in operator's network. Option b) is agreed in SA4 and relevant working groups (i.e., RAN2, RAN3 and SA5) are asked to specify option b).

The recommended solution of QoE reporting when OMA-DM is not supported is summarized in figure 5.6-2.

## Operator domain

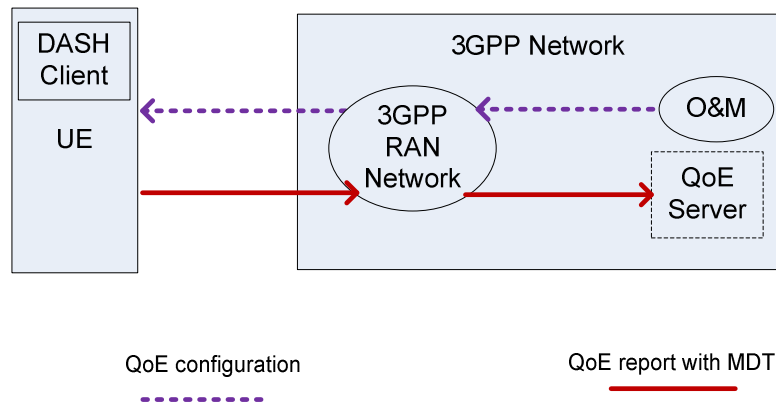

**Figure 5.6-2: MDT enhancement for supporting QoE reporting when OMA-DM is not supported**

The TCE uses MDT configuration method to configure the QoE metrics to the DASH client. QoE metrics is collected by DASH client and reported to TCE via MDT procedure, the TCE then forwards the QoE results to QoE server.

NOTE 1: Existing MDT metrics are RAN aware. Whether QoE metrics is RAN aware or RAN transparent is up to RAN2 own decision.

NOTE 2: Configuration accuracy for large area may need consideration with MDT based approach.

### 5.6.2 QoE metrics collection within a certain geographic area

This scenario is to allow the MNO to collect QoE metrics of 3<sup>rd</sup> party hosted streaming service within a certain geographic area, the geographic area information is missing in current QoE metrics configuration. The format of geographic area could be one or more cell-IDs. It is proposed to add geographic area information into QoE metrics configuration.

### 5.6.3 QoE metrics collection of a streaming service of a specific 3<sup>rd</sup> party

This scenario is to allow the MNO to collect QoE metrics of a streaming service of a specific 3<sup>rd</sup> party, the streaming service identifier and/or the 3<sup>rd</sup> party identifier are missing in current QoE metrics configuration. The format of streaming service identifier and 3<sup>rd</sup> party identifier could be URL format.

It is proposed to add the streaming service identifier and/or the 3<sup>rd</sup> party identifier information into QoE metrics configuration.

## 5.7 QoE Handler API Considerations

There can be a number of DASH streaming clients in the UE, both clients provided by the UE vendor, and clients installed by the user. Each of these will have the capability to communicate with the QoE management functionality in the network, to receive QoE configurations, and to report QoE metrics. Thus the UE will have some kind of lower-layer QoE Handler which typically would be implemented by the UE vendor. This QoE Handler exposes an API to allow for the needed client functionality.

To make this API as simple as possible it needs to be minimalistic and based on the existing QoE configuration and metrics reporting. Basically the following API primitives need to be available:

- QoE Client Registration: A client which supports QoE measurements registers towards the QoE Handler when it starts.

- QoE Configuration: When new QoE configurations are received by the QoE Handler from the network, these are sent to all registered clients. The format of the QoE configuration is recommended to re-use the XML format specified in TS 26.247, clause 10.4.
- QoE Metrics: Each client sends QoE metrics to the QoE Handler according to the latest received configuration. The format of the QoE reports is recommended to re-use the XML format specified in TS 26.247, clause 10.2.
- QoE Client De-registration: Before exiting, a client de-registers from the QoE Handler.

However, it is expected that the data volume and sending frequency will be much higher for the QoE metrics reporting than for the QoE configuration, and in some cases the extra control plane load due to QoE reporting might be large enough to cause potential problems for the network. This is extra problematic as there are few mechanisms for down-prioritizing certain content in the control plane.

While the QoE configuration does need to use the control plane to allow full operator control, the same restriction does not necessarily apply to the QoE metrics reporting. For instance, an operator which only use the QoE metrics for statistical performance measurements does not really benefit from having the QoE metrics reports sent over the control plane.

To handle this case, the QoE configuration received over the control plane contains a CP/UP flag. The flag will not change the API towards the DASH clients, but controls in which way the QoE Handler in the UE will send back the QoE metrics. If the flag is set to "UP", the reporting is done via the user plane instead of the control plane. In this case, the flag would also be accompanied by an IP address, which indicates the receiving node for the user-plane reporting.

This is illustrated in the figure 5.7-1:

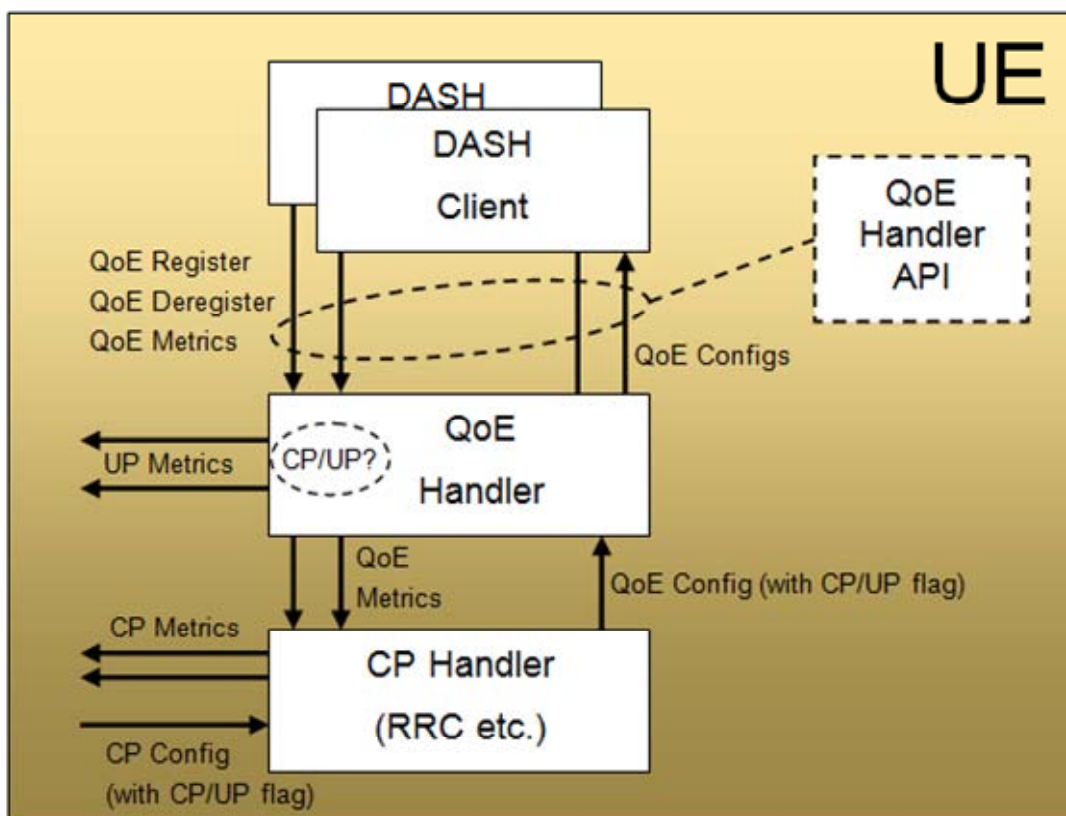

**Figure 5.7-1: QoE Handler Concept**

In this way the operator can easily decide which metrics reporting mechanism that will be used, either globally, for a certain cell area or even for individual UEs. If the operator would like to take RAN actions on the QoE reports, but due to control plane capacity reasons still use UP reporting, the operator would have to relay a copy of the UP QoE reports to relevant RAN node(s). Such relaying could be handled either in a proprietary way, or possibly later be standardized.

NOTE: The QoE handler is RAN relevant and RAN investigation is required.

## 5.8 Privacy issue on QoE metric collection

### 5.8.1 Analysis

The current QoE metrics in TS 26.247 includes the possibility of requesting detailed HTTP information in the HttpList metric. However, as this metric contains the URL to the media, this could be seen as sensitive information, and a possible breach of privacy.

For almost all relevant QoE-related use-cases there is no need to request the detailed HttpList metric, as this does not help in understanding the end-user quality. It can possibly be somewhat useful for specific trouble-shooting, but such trouble-shooting can probably be handled by other means (specific test clients, etc.).

Activating detailed HttpList reporting would also mean that the QoE reports from the client would become pretty large, taking valuable capacity in the uplink on either the user-plane or (worse) the control plane.

The non-usefulness of detailed HTTP metrics for QoE purposes has also been recognized in other foras, such as DASH-IF in their position paper "*Proposed QoE Metrics...*" (see [9]), where they state that "*Low-level metrics, such as HTTP and TCP session-related data, or decoding data, are out of scope.*"

### 5.8.2 Solutions

There are several possible different ways of handling this privacy issue:

- 1) Each user could be requested to give his active consent before any QoE metrics can be reported.
- 2) Each user could be requested to give his active consent before any HttpList metrics can be reported.
- 3) Each user could be requested to give his active consent before any URL entries can be reported.
- 4) The URL entries can be hashed by the client (so that access to the same URL will give the same anonymized hash value), and only this hash value is reported (this would at least enable correlation between different requests for the same URL).
- 5) The URL entries can be removed from the HttpList report.
- 6) The total HttpList metric is removed from TS 26.247.

Adding a requirement for active consent (options 1-3) would mean additional administrative issues, as well as an unnecessary and possibly worrying decision needed by the end-user. It is also likely that many end-users would not give their consent, which at least for option 1 would severely decrease the coverage and usefulness of the complete QoE reporting concept.

To avoid the need for any type of active consent implies that one of options 4-6 are recommended. As the practical usage of the HttpList metrics can be questioned, the simplest solution would be to totally remove the HttpList metric from TS 26.247, as proposed in option 6.

---

## 6 Conclusion

The gap analysis of PSS QoE metrics for support of ITU-T P.NATS mode 0 is presented in clause 4, and the analysis of enhanced streaming configuration and reporting is presented in clause 5. Based on the studies, the following conclusions can be drawn:

- To support calculation of the P.1203 mode 0 model for video streaming, the existing PSS QoE metrics "MpdInfo", "InitialPlayoutDelay" and "PlayList" specified in TS 26.247 need to be collected. A new metric "DeviceInformation" is also recommended to be added to support the P.1203 model.

- To enhance reporting of PSS QoE metrics, the following functionalities are recommended:
  - QMC (QoE Measurement Collection) is recommended to be used to support control and configuration of QoE reporting. QMC is based on the MDT concept, so QoE Configuration is done over the control plane, and QoE Reporting from the DASH client is also sent back via the control plane, for further forwarding towards the QoE Server.
  - Enable operators to specify collection of QoE metrics only for certain geographic area , or only for certain streaming services.

## Annex A: Change history

Change history							
Date	TSG #	TSG Doc.	CR	Rev	Subject/Comment	Old	New
2016-12	74	SP-160774			Presented to TSG SA#74 (for information)		1.0.0
2017-03	75	SP-170026			Presented to TSG SA#75 (for approval)	1.0.0	2.0.0
2017-03	75				Version 14.0.0		14.0.0
2018-06	80				Version 15.0.0		15.0.0
2020-07	-	-	-	-	Update to Rel-16 version (MCC)	15.0.0	<b>16.0.0</b>
2022-04	-	-	-	-	Update to Rel-17 version (MCC)	16.0.0	<b>17.0.0</b>
2024-03	-	-	-	-	Update to Rel-18 version (MCC)	17.0.0	<b>18.0.0</b>

---

# History

<b>Document history</b>		
V18.0.0	May 2024	Publication