

ETSI TR 126 917 V19.0.0 (2025-10)



TECHNICAL REPORT

**LTE;
5G;**

Multimedia Broadcast Multicast Services (MBMS) and Packet-switched Streaming Service (PSS) enhancements to support television services (3GPP TR 26.917 version 19.0.0 Release 19)



Reference

RTR/TSGS-0426917vj00

Keywords

5G,LTE

ETSI

650 Route des Lucioles
F-06921 Sophia Antipolis Cedex - FRANCE

Tel.: +33 4 92 94 42 00 Fax: +33 4 93 65 47 16

Siret N° 348 623 562 00017 - APE 7112B
Association à but non lucratif enregistrée à la
Sous-Préfecture de Grasse (06) N° w061004871

Important notice

The present document can be downloaded from the
[ETSI Search & Browse Standards application](#).

The present document may be made available in electronic versions and/or in print. The content of any electronic and/or print versions of the present document shall not be modified without the prior written authorization of ETSI. In case of any existing or perceived difference in contents between such versions and/or in print, the prevailing version of an ETSI deliverable is the one made publicly available in PDF format on [ETSI deliver repository](#).

Users should be aware that the present document may be revised or have its status changed, this information is available in the [Milestones listing](#).

If you find errors in the present document, please send your comments to the relevant service listed under [Committee Support Staff](#).

If you find a security vulnerability in the present document, please report it through our [Coordinated Vulnerability Disclosure \(CVD\)](#) program.

Notice of disclaimer & limitation of liability

The information provided in the present deliverable is directed solely to professionals who have the appropriate degree of experience to understand and interpret its content in accordance with generally accepted engineering or other professional standard and applicable regulations.

No recommendation as to products and services or vendors is made or should be implied.

No representation or warranty is made that this deliverable is technically accurate or sufficient or conforms to any law and/or governmental rule and/or regulation and further, no representation or warranty is made of merchantability or fitness for any particular purpose or against infringement of intellectual property rights.

In no event shall ETSI be held liable for loss of profits or any other incidental or consequential damages.

Any software contained in this deliverable is provided "AS IS" with no warranties, express or implied, including but not limited to, the warranties of merchantability, fitness for a particular purpose and non-infringement of intellectual property rights and ETSI shall not be held liable in any event for any damages whatsoever (including, without limitation, damages for loss of profits, business interruption, loss of information, or any other pecuniary loss) arising out of or related to the use of or inability to use the software.

Copyright Notification

No part may be reproduced or utilized in any form or by any means, electronic or mechanical, including photocopying and microfilm except as authorized by written permission of ETSI.

The content of the PDF version shall not be modified without the written authorization of ETSI.

The copyright and the foregoing restriction extend to reproduction in all media.

© ETSI 2025.
All rights reserved.

Intellectual Property Rights

Essential patents

IPRs essential or potentially essential to normative deliverables may have been declared to ETSI. The declarations pertaining to these essential IPRs, if any, are publicly available for **ETSI members and non-members**, and can be found in ETSI SR 000 314: "*Intellectual Property Rights (IPRs); Essential, or potentially Essential, IPRs notified to ETSI in respect of ETSI standards*", which is available from the ETSI Secretariat. Latest updates are available on the [ETSI IPR online database](#).

Pursuant to the ETSI Directives including the ETSI IPR Policy, no investigation regarding the essentiality of IPRs, including IPR searches, has been carried out by ETSI. No guarantee can be given as to the existence of other IPRs not referenced in ETSI SR 000 314 (or the updates on the ETSI Web server) which are, or may be, or may become, essential to the present document.

Trademarks

The present document may include trademarks and/or tradenames which are asserted and/or registered by their owners. ETSI claims no ownership of these except for any which are indicated as being the property of ETSI, and conveys no right to use or reproduce any trademark and/or tradename. Mention of those trademarks in the present document does not constitute an endorsement by ETSI of products, services or organizations associated with those trademarks.

DECT™, **PLUGTESTS™**, **UMTS™** and the ETSI logo are trademarks of ETSI registered for the benefit of its Members. **3GPP™**, **LTE™** and **5G™** logo are trademarks of ETSI registered for the benefit of its Members and of the 3GPP Organizational Partners. **oneM2M™** logo is a trademark of ETSI registered for the benefit of its Members and of the oneM2M Partners. **GSM®** and the GSM logo are trademarks registered and owned by the GSM Association.

Legal Notice

This Technical Report (TR) has been produced by ETSI 3rd Generation Partnership Project (3GPP).

The present document may refer to technical specifications or reports using their 3GPP identities. These shall be interpreted as being references to the corresponding ETSI deliverables.

The cross reference between 3GPP and ETSI identities can be found at [3GPP to ETSI numbering cross-referencing](#).

Modal verbs terminology

In the present document "**should**", "**should not**", "**may**", "**need not**", "**will**", "**will not**", "**can**" and "**cannot**" are to be interpreted as described in clause 3.2 of the [ETSI Drafting Rules](#) (Verbal forms for the expression of provisions).

"**must**" and "**must not**" are **NOT** allowed in ETSI deliverables except when used in direct citation.

Contents

Intellectual Property Rights	2
Legal Notice	2
Modal verbs terminology.....	2
Foreword.....	6
Introduction	6
1 Scope	7
2 References	7
3 Definitions and abbreviations.....	8
3.1 Definitions	8
3.2 Abbreviations	8
4 Context and Motivation.....	10
4.1 3GPP enhancement for TV service	10
4.2 Stage-1 Service Requirements.....	11
4.3 Service Architecture Enhancements.....	11
4.4 Radio Access Network Enhancements.....	13
4.5 Objective of the present document.....	13
5 Existing TV Service Layers and Essential Functionalities for TV Services	14
5.1 Introduction	14
5.2 Existing Service Layer Functions.....	14
5.2.1 Introduction.....	14
5.2.2 Broadcast TV Service Signaling	14
5.2.3 DVB.....	14
5.2.3.1 General Description	14
5.2.3.2 DVB SI.....	15
5.2.4 ATSC 3.0.....	17
5.2.4.1 General Description	17
5.2.4.2 Service Signaling	19
5.2.4.2.1 Introduction	19
5.2.4.2.2 Low Level Signaling	19
5.2.4.2.3 Service Layer Signaling.....	20
5.3 Typical Functionalities for TV Services.....	21
6 Use Cases	22
6.1 Introduction	22
6.2 TV Service Delivery over eMBMS	22
6.2.1 Description.....	22
6.2.2 Working Assumptions	22
6.2.3 Available Enablers and Gap Analysis.....	23
6.2.4 Optimization Potentials.....	28
6.2.5 Potential Solutions	28
6.2.5.1 General	28
6.2.5.2 Option 1: Extend USD with DTT Transport Signaling and EPG.....	28
6.2.5.3 Option 2: EPG Metadata Carried in Application Service Description	29
6.2.5.4 Option 3: EPG Data Delivery as Standalone MBMS User Service	29
6.2.5.5 Pros and Cons of the Alternative Methods.....	29
6.3 IP-Based Broadcast	31
6.3.1 Description.....	31
6.3.2 Working Assumptions	31
6.3.3 Recommended Requirements	32
6.3.4 Available Enablers in 3GPP.....	32
6.3.5 Gap Analysis.....	32
6.4 FTA Linear TV to Mobiles.....	32
6.4.1 Description.....	32

6.4.2	Working Assumptions	32
6.4.3	Recommended Requirements	33
6.4.4	Available Enablers in 3GPP, Gap Analysis and Optimization Potentials	33
6.5	FTA Linear TV to Stationary TVs	34
6.5.1	Description.....	34
6.5.2	Working Assumptions	35
6.5.3	Recommended Requirements	35
6.5.4	Available Enablers in 3GPP, Gap Analysis and Optimization Potentials.....	35
6.6	FTA Linear TV to Stationary TV and Mobiles	37
6.6.1	Description.....	37
6.6.2	Working Assumptions	37
6.6.3	Recommended Requirements	37
6.6.4	Realization Options.....	37
6.6.4.1	Objective	37
6.6.4.2	DVB Service Layer Reuse	37
6.6.4.3	MBMS Service Layer	38
6.6.5	Gap Analysis.....	39
6.6.5.1	DVB Service Layer Reuse	39
6.6.5.2	MBMS Service Layer Reuse.....	39
6.7	Extensibility	40
6.7.1	Description.....	40
6.7.2	Working Assumptions	40
6.7.3	Recommended Requirements	40
6.7.4	Available Enablers in 3GPP, Gap Analysis and Potential for Optimization.....	40
6.8	TV Service Delivery over Full MBMS Service Mode	41
6.8.1	Description.....	41
6.8.2	Working Assumptions	41
6.8.3	Recommended Requirements	41
6.9	File Delivery Services over MBMS	42
6.9.1	Use Cases and Descriptions	42
6.9.2	High-level Requirements on Content Ingestion and Transmission over MBMS	42
6.9.2.1	Introduction.....	42
6.9.2.2	Top-10 YouTube Video Delivery	42
6.9.3.3	Stock Ticker Service	43
6.9.3.4	Movie Download for Time-Shifted Viewing	43
6.9.3.5	Firmware Updates	44
6.9.3.6	eNews Delivery.....	44
6.9.3.7	Digital Signage.....	44
6.9.4	Use Case Independent Requirements.....	44
6.10	ATSC Service Layer in enTV	45
6.10.1	ATSC 3.0 Overview	45
6.10.2	Content Format and Protocol Model for ATSC 3.0 Service and Metadata Delivery over xMB	47
6.10.3	ATSC 3.0 Service Data Content Format and Protocol Model	47
6.10.4	ATSC 3.0 Service Content Protocol Stack over xMB-U	48
7	Architectural Considerations.....	49
7.1	MBMS Service Type 1: Transport only mode	49
7.1.1	Architecture and Interfaces	49
7.1.2	User Plane Modes	50
7.1.3	Control Plane for Receive-Only Mode	50
7.1.4	Working Assumptions	52
7.1.4.1	General.....	52
7.1.4.2	XMB Interface	52
7.1.4.3	BMSC to MBMS Client delivery.....	52
7.1.4.4	MBMS client to E-UTRAN	52
7.1.4.5	Service Announcement	52
7.1.4.6	MBMS-API.....	52
7.1.5	Gap Analysis.....	53
7.1.5.1	xMB	53
7.1.5.2	BMSC to MBMS Client delivery.....	53
7.1.5.3	MBMS-API.....	53
7.1.6	Optimization Potentials.....	53

7.1.6.1 BMSC to MBMS Client delivery 53

7.2 MBMS Service Type 2: Full MBMS service mode 53

7.2.1 Architecture and Interfaces 53

7.2.2 User Plane Modes 55

7.2.3 Control Plane 55

7.2.4 Available Enablers in 3GPP, Gap Analysis and Optimization Potentials..... 55

8 Summary on Addressing Stage-1 Service Requirements 55

9 Conclusions and Recommendations..... 59

Annex A: Change history 62

History 63

Foreword

This Technical Report has been produced by the 3rd Generation Partnership Project (3GPP).

The contents of the present document are subject to continuing work within the TSG and may change following formal TSG approval. Should the TSG modify the contents of the present document, it will be re-released by the TSG with an identifying change of release date and an increase in version number as follows:

Version x.y.z

where:

- x the first digit:
 - 1 presented to TSG for information;
 - 2 presented to TSG for approval;
 - 3 or greater indicates TSG approved document under change control.
- y the second digit is incremented for all changes of substance, i.e. technical enhancements, corrections, updates, etc.
- z the third digit is incremented when editorial only changes have been incorporated in the document.

Introduction

SA1 has summarized service requirements in TS 22.101 [13], clause 32 for TV Enhancements.

According to TS 22.101 [13], clause 32.1, *"3GPP enhancement for TV service support is a feature whereby 3GPP networks can provide unicast and broadcast transport, referred to as "TV transport services", to support distribution of TV programs. TV transport services can support the three types of TV services – Free-to-air (FTA), Free-to-view (FTV), and Subscribed services. Each type of TV service has different requirements in order to meet regulatory obligations and public service and commercial broadcaster's requirements regarding content distribution, hence many requirements captured below are optional to implement depending on the type of TV transport services an MNO chooses to offer."*

There is interest for the TV industry to be able to deliver broadcast television (TV services) to connected consumer devices (smartphones, tablets and TVs) anywhere, by using cellular networks.

Audio/Video content is already a significant and growing traffic type. There is an opportunity to leverage the support for this content, and 3GPP delivery methods such as eMBMS, to provide TV broadcast and on-the-go TV/video services:

- There is an interest from Over-the-top (OTT) TV/video service providers to be able to reach their customers regardless of location, and available access technology, particularly when the consumers have cellular access but not access to a broadcast TV signal (if that signal exists at all).
- There may be opportunities in the near future for LTE-based cellular TV broadcast services, in particular, the free-to-air TV service in some regions of Europe.

1 Scope

The present document collects use cases, recommended requirements, architectural considerations, gaps, and optimization potentials for PSS and MBMS User Services in order to enable Television Services on top of PSS/MBMS User Services and MBMS bearer services. The present document also provides conclusions and recommendations for normative work.

2 References

The following documents contain provisions which, through reference in this text, constitute provisions of the present document.

- References are either specific (identified by date of publication, edition number, version number, etc.) or non-specific.
- For a specific reference, subsequent revisions do not apply.
- For a non-specific reference, the latest version applies. In the case of a reference to a 3GPP document (including a GSM document), a non-specific reference implicitly refers to the latest version of that document *in the same Release as the present document*.

- [1] 3GPP TR 21.905: "Vocabulary for 3GPP Specifications".
- [2] ETSI EN 300 468: "Digital Video Broadcasting (DVB); Specification for Service Information (SI) in DVB systems", V1.15.1 (2016-03).
- [3] ISO/IEC 13818-1:2015, "Information technology -- Generic coding of moving pictures and associated audio information -- Part 1: Systems", 2015-07-01.
- [4] ATSC A/331: "ATSC Candidate Standard: Signaling, Delivery, Synchronization and Error Protection", Candidate Standard.
- [5] ETSI TS 101 211: "Digital Video Broadcasting (DVB); Guidelines on implementation and usage of Service Information (SI), V1.12.1 (2013-12).
- [6] OMA: "Service Guide for Mobile Broadcast Services," Version 1.1, document OMA-TS-BCAST_Service_Guide-V1_1-20131029-A, Open Mobile Alliance, 29 October 2013.
- [7] ATSC A/332: "ATSC Candidate Standard: Service Announcement", Candidate Standard.
- [8] ISO/IEC 23008-1: "Information technology – High efficiency coding and media delivery in heterogeneous environments – Part 1: MPEG media transport (MMT), 2nd Edition.
- [9] DASH IF: "Guidelines for Implementation: DASH-IF Interoperability Points for ATSC 3.0", Version 1.0," DASH Interoperability Forum.
- [10] ISO/IEC 23009-1: "Information technology – Dynamic adaptive streaming over HTTP (DASH) – Part 1: Media presentation description and segment formats", 3rd Edition.
- [11] IEEE 1588-2008™: "IEEE Standard for a Precision Clock Synchronization Protocol for Networked Measurement and Control Systems".
- [12] OASIS: "Common Alerting Protocol", Version 1.2, 1 July 2010.
- [13] 3GPP TS 22.101: "Service aspects; Service principles".
- [14] 3GPP TS 26.346: "Multimedia Broadcast/Multicast Service (MBMS); Protocols and codecs".
- [15] 3GPP TR 22.816: "3GPP enhancement for TV service".
- [16] 3GPP TR 23.746: "Study on System Architecture Enhancements to eMBMS for Television Video Service".

- [17] ETSI TS 101 154: "Specification for the use of Video and Audio Coding in Broadcasting Applications based on the MPEG-2 Transport Stream, V2.2.1 (2015-06).
- [18] 3GPP TS 23.468: "Group Communication System Enablers for LTE (GCSE_LTE); Stage 2".
- [19] W3C Recommendations: "TTML Profiles for Internet Media Subtitles and Captions 1.0 (IMSC1)," April 2016.
- [20] 3GPP TS 36.201: "Evolved Universal Terrestrial Radio Access (E-UTRA); Long Term Evolution (LTE) physical layer; General description."
- [21] 3GPP TS 36.211: "Evolved Universal Terrestrial Radio Access (E-UTRA); Physical channels and modulation."
- [22] 3GPP TS 23.246: "Multimedia Broadcast/Multicast Service (MBMS); Architecture and functional description".
- [23] 3GPP TS 26.347: "Multimedia Broadcast/Multicast Service (MBMS); MBMS APIs and URL".
- [24] 3GPP TS 29.116: "Representational state transfer over xMB reference point between content provider and BM-SC".
- [25] 3GPP TS 24.117: "TV Service Configuration Management Object".
- [26] 3GPP TS 24.116 "Stage 3 aspects of MBMS service for Receive Only Mode".
- [27] W3C TTML Profiles for Internet Media Subtitles and Captions 1.0 (IMSC1).
- [28] 3GPP TS 26.247: "Transparent end-to-end Packet-switched Streaming Service (PSS); Progressive Download and Dynamic Adaptive Streaming over HTTP (3GP-DASH)".
- [29] 3GPP TR 26.949: "Video formats for 3GPP service".
- [30] 3GPP TS 26.116: "Television (TV) over 3GPP services; Video profiles".
- [31] 3GPP TR 26.953: "Interactivity support for 3GPP-based streaming and download services".
- [32] 3GPP TS 26.234: "Transparent end-to-end Packet-switched Streaming Service (PSS); Protocols and codecs".
- [33] 3GPP TS 26.307: "Presentation layer for 3GPP services".

3 Definitions and abbreviations

3.1 Definitions

For the purposes of the present document, the terms and definitions given in 3GPP TR 21.905 [1] and the following apply. A term defined in the present document takes precedence over the definition of the same term, if any, in 3GPP TR 21.905 [1].

Next Generation Audio: audio formats and coding enabling new sound experiences such as three dimensions, immersion and interactivity

3.2 Abbreviations

For the purposes of the present document, the abbreviations given in 3GPP TR 21.905 [1] and the following apply. An abbreviation defined in the present document takes precedence over the definition of the same abbreviation, if any, in 3GPP TR 21.905 [1].

AEA	Advanced Emergency Alert
AEAT	Advanced Emergency Alert Table
AL-FEC	Application Layer Forward Error Correction

APD	Associated Procedure Description
ATSC	Advanced Television Systems Committee
BAT	Bouquet Association Table
CA	Conditional Access
CAS	Conditional Access System
CAP	Common Alerting Protocol
CAT	Conditional Access Table
CP	Cyclic Prefix
DASH	Dynamic Adaptive Streaming over HTTP
DRM	Digital Rights Management
DVB	Digital Video Broadcasting
DVB-T/T2	DVB Terrestrial/Terrestrial version 2
DWD	Distribution Window Description
EA	Emergency Alert
EIT	Event Information Table
ESG	Electronic Service Guide
FDT	File Delivery Table
FTA	Free-To-Air
HDR	High Dynamic Range
IRD	Integrated Receiver Decoder
ISD	Inter-Site Distance
LLS	Lower Layer Signaling
MMT	MPEG Media Transport
MMTP	MPEG Media Transport Protocol
MPD	Media Presentation Description
MPU	Media Processing Unit
NGA	Next Generation Audio
NIT	Network Information Table
PAT	Program Association Table
PMT	Program Map Table
PSI	Program Specific Information
PTP	Precision Time Protocol
RRT	Rating Region Table
ROUTE	Real-time Object delivery over Unidirectional TransfEr
RST	Running Status Table
S-TSID	Service-based Transport Session Instance Description
SDO	Standard Defining Organization
SDT	Service Description Table
SLS	Service Layer Signaling
SLT	Service List Table
SI	Service Information
ST	Stuffing Table
TAI	International Atomic Time
TDT	Time and Date Table
TOT	Time Offset Table
TS	Transport Stream
TSDT	Transport Stream Description Table
TV	TeleVision
UI	User Interface
USBD	User Service Bundle Description
USD	User Service Description
UTC	Coordinated Universal Time
V2X	Vehicular-to-Anything
VoD	Video-on-Demand
XML	eXtensible Markup Language

4 Context and Motivation

4.1 3GPP enhancement for TV service

The Technical Report TR 22.816 [15] describes use cases, proposes assumptions and potential requirements and analyses the gap in order to enhance 3GPP systems for TV service support. The supported TV service includes linear TV, Live, Video on Demand, smart TV, and Over The Top (OTT) content.

The Technical Report includes 20 use cases that are related to enhancements of the 3GPP system for TV services. The use cases of specific relevance for service layer, protocols and codecs are:

- Use Case 1: UHD content delivery
 - Ultra-High Definition (UHD) content (3840 x 2160 resolutions) has been widely supported by OTT providers and TV makers. The highest display resolution supported by smart phone in the market is Quad HD (QHD, 2560 x 1440 resolutions). It is expected that display resolution of smart phone will keep evolving and support UHD resolution in the future. It is also expected that 4K TV can consume the UHD content from OTT providers via a UE.
 - UHD content delivery requires 8Mbps-20Mbps bandwidth in current deployed fixed network(e.g. using H.265 @ 60fps).
 - UHD content delivery is expected to be supported by 3GPP network. The recommended data rate for UHD content delivery is [8 Mbps-20 Mbps].
- Use Case 2: Concurrent UHD content delivery
 - Considering each OTT provider provides several live UHD 4K TV programs concurrently, there are many OTT providers offering live UHD 4K TV programs at the same time. User accesses to each live UHD 4K TV program per user's preference/interest. Within a geographic region, several concurrent live UHD 4K TV programs are consumed by different user groups in parallel. To improve user experience and use network capacity efficiently, it is expected to deliver concurrent live UHD 4K TV programs using broadcast delivery method as much as possible by 3GPP network.
 - In the broadcast industry, the number of concurrent broadcast channel in the air is around 10 to 24 with HD (High Definition,720p) or SD (Standard Definition,480i or 576i) resolution. The higher number of concurrent channel is also foreseen. The exact concurrent channel number is subject to content resolution, network capacity and user's watching behaviour.
- Use Case 13: Service Layer Function and Codec Support
 - A TV Content Provider partners with an MNO to distribute a subset of the channels offered on its DTT service.
 - Rather than re-encode all existing encoded content for mobile distribution as per the profiles set out in the pre-Release 14 MBMS service layer, the broadcaster partners with an MNO that enables a formats, codecs and service layer functions suitable and necessary for the rebroadcast of existing content which can comply with the regulatory requirements of the region.
- Use Case 16: Decoupled eMBMS content, service and transport
 - A content provider partners with a MNO to distribute as subset of its video/TV services offered by the content provider.
 - Rather than re-encode all existing encoded content for 3GPP-based distribution as per the profiles set out in the MBMS service layer, and transpose the service initialization metadata to the format provided by the MBMS service layer, the content provider requests to be able to access only the MBMS transport.
 - As a result, the MNO provides the facility for the content provider to feed metadata and streamed content into the MNO core network for transport to a population maintained by the content provider.

- Use Case 19: Fixed Reception of TV Program
 - An MNO provides a TV service over an LTE network. A TV service consists of one or more TV programmes and associated programme information. The TV service may be a linear TV service, an on-demand TV service or a complementary offer of both types. The MNO wants to make available these TV services by means of stationary roof-top antennas in order to exploit the higher received signal level achievable by such an antenna. For linear TV services, at least until today fixed roof-top reception constitutes the bulk of service consumption in many countries.
- Use Case 20: Hybrid TV Delivery
 - A TV content provider provides hybrid TV delivery over a digital terrestrial TV (DTT) network and a 3GPP network run by an MNO. The most popular TV content is delivered over the DTT network using the technology available (e.g. DVB-T). This DTT delivery is primarily targeting fixed installations but can also be made available to mobile devices through for instance WiFi access points. The on demand and long tail of less popular scheduled or live content is delivered using unicast in the 3GPP network targeting all kind of devices, while the most popular content reaching mobile phones will be delivered in a separate broadcast in the MNO network.
 - The purpose with Hybrid delivery is to optimize for cost and spectral efficiency, by configuring the networks so that broadcast is used only when viewing volumes motivates it. The target is to ensure highly specialised streams for each situation that are more efficient than a combined, compromised stream.

Other use cases may also partially affect service layer, protocols and codecs.

4.2 Stage-1 Service Requirements

Based on the use cases collected in TR 22.816 [15] a set of stage-1 service requirements are documented in TS 22.101 [14], clause 32. The use cases and requirements encourage work on the different aspects of the 3GPP system, including the radio access network, the service architecture as well as on the service layer, protocol and codecs. The service requirements are reviewed in clause 8 including a gap analysis against existing specification in Rel-14.

4.3 Service Architecture Enhancements

The key requirements with primary focus to Service Layer, Protocol and Codecs are summarized below. From the service requirements, the following functionalities are expected to be supported by the 3GPP network and UE:

- 1) content delivery up to UHD resolution.
- 2) mechanisms to restrict the reception of some or all Subscribed TV services to groups of subscribers (e.g. based on the recipients of the services are subscribers of the MNO, roaming subscribers of other MNOs, or not subscribed to any MNO).
- 3) combinations of SD, FHD and UHD resolution TV transport services.
- 4) flexible change between broadcast and unicast per traffic demand over the same carrier.
- 5) support network broadcast geographic area coverage management considering following criteria:
 - OTT provider request (including the potential coverage information of TV service information)
 - available network unicast/broadcast capacity of 3GPP network
 - number of users under broadcast network coverage
 - The location information of UE
- 6) ability to deliver media content via unicast and broadcast in an efficient manner.
- 7) capability of ensuring the timing sequence of different media content received by different UEs at the same location, even via different transport path, aligning with the timing sequence of TV service of the OTT provider in order to maintain synchronism.

- 8) support audio and video formats typically supported by TV Content Providers for SD and HD TV transport services and UHD TV transport services.
- 9) support codecs typically supported by TV Content Providers for HD TV services and UHD TV services.
- 10) support accessibility functions typically supported by TV Content Providers (e.g. subtitling, closed captioning, audio descriptions, anonymous reception, reporting to support ratings, reporting enforcement, etc.).
- 11) regulatory mandates typically supported by TV Content Providers (blackouts, emergency alerts, etc.).
- 12) interactivity functions typically supported by TV Content Providers (interactive services, second screen, personalization, etc.).
- 13) ad insertion use cases typically supported by TV Content Providers (targeted ad insertion, ad replacement, etc.).
- 14) encryption, security and conditional access functions typically supported by TV Content Providers.
- 15) concurrent delivery of multiple application components (TV service application signalling, statistical multiplexing, etc.).
- 16) random access and channel change times comparable to existing HD TV services.
- 17) TV service content delivery over broadcast only, unicast only and combinations of the two.
- 18) delivery of real-time and non-real-time content.
- 19) enable extensibility and forward-compatibility to new requirements, formats, codecs and other functions to the extent possible.
- 20) ability to transport TV streams formatted not compliant to 3GPP standards.
- 21) Ability to access an eMBMS transport session with the support of only transport metadata.
- 22) Ability to be initiated by a UE with sufficient metadata provided by a mechanism other than User Service Description for non 3GPP transport services.

Based on these requirements, several 3GPP specification have been updated to support different features:

- Standardized xMB interface towards the (TV) content provider
 - Unified framework for service type negotiations and agreements with content providers
 - Enables dynamic service/session establishment
 - Extensible to other types of content and content providers (V2X etc.)
- Receive-only mode
 - Receive Only mode: enable devices without SIM card or 3GPP subscription
 - Expand the reach of MBMS into traditional TV receivers
 - Enable Free-to-Air content broadcast over MBMS
 - Receive Only mode with independent unicast: enable interactive services feeding off of TV live broadcast
 - Opportunity for more cost-effective data plans for mobile TV (bundled plans)
- Transport-only mode (also referred to in TS 23.746 [16] as "MBMS Service Type 1", or "Transport only mode")
 - Provide pass-through MBMS bearer service type
 - Enable TV broadcasters to provide the content via MBMS in the native format without transcoding
 - Simple receiver design
 - Use MBMS network as common delivery platform for different content types and services

- Shared MBMS Broadcast
 - Operators can aggregate their MBMS networks into a shared MBMS content distribution platform
 - Avoid broadcasting the same content at the same time over different networks
 - Improve coverage, bandwidth efficiency

For this purpose the following specifications are updated in Release-14:

- 3GPP TS 23.246 [22] MBMS Architecture (Annex D and Annex E)
- 3GPP TS 26.346 [14] MBMS Protocols and Codecs
- 3GPP TS 26.347 [23] MBMS APIs and URL
- 3GPP TS 29.116 [24] xMB Interface
- 3GPP TS 24.117 [25] TV Service Configuration Management Object
- 3GPP TS 24.116 [26] Stage 3 aspects of MBMS service for Receive Only Mode

4.4 Radio Access Network Enhancements

In order to support enhanced TV services, radio access network enhancements were introduced in 3GPP TS 36.201 [20] and 3GPP TS 36.211 [21]. A brief summary the following extensions are provided:

- Support of larger inter-site distance: Larger cyclic prefix (200 μ s) designed to cover 15 km Inter-Site-Distance (ISD), Target spectral efficiency of 2 bps/Hz with rooftop antennas, and introduction of an intermediate numerology with 33 μ s CP (Cyclic Prefix).
- Dedicated or mixed MBMS carrier: Mixed unicast/broadcast from same carrier, up to 100% MBMS allocation, and a self-contained system information and sync signals for dedicated carriers.
- Different types of devices: Enhanced support for roof-top reception, handheld devices and car-mounted antenna, as well as multiple numerologies (15 kHz, 7.5 kHz and 1.25 kHz) designed for different deployment/mobility scenarios.
- New subframe type: New type of MBSFN subframe without unicast control region to reduces overhead in MBMS transmissions with respect to previous releases.
- Shared MBMS Broadcast: Operators can aggregate their MBMS networks into a shared MBMS content distribution platform. This avoids broadcasting the same content at the same time over different networks and therefore improves coverage and bandwidth efficiency.

4.5 Objective of the present document

In order to address the use cases and service requirements, also taking into account the context of other 3GPP system aspects, this technical report addresses:

- Functionalities that are fulfilled by existing service layers and essential service layer functions that need to be provided by 3GPP systems in clause 5.
- Relevant service layer centric use cases in order to prioritize the work and address relevant gaps and optimization potentials in clause 6. In addition also working assumptions, recommended requirements and potential solutions are discussed for each use case.
- Architectural considerations, taking into account the existing service architecture and any enhancements done in the context of the service requirements documented in TS 22.101 [14] in clause 7.
- A gap analysis and proposed solutions wrt to the stage 1 service requirements in clause 8.
- Conclusions and recommendations for potentially normative work in clause 9.

5 Existing TV Service Layers and Essential Functionalities for TV Services

5.1 Introduction

In order to replicate functionalities provided by existing TV Service Layers, this clause collects the service model and functionalities of existing and deployed TV services in clause 5.2. Based on this, essential TV service layer functionalities are extracted and summarized in clause 5.3.

5.2 Existing Service Layer Functions

5.2.1 Introduction

This clause provides an overview of broadcast TV service layer functionality as defined in DVB and ATSC, with focus on service level signaling. Broadcast TV service layer functionality described in the present document are defined by two different organizations/SDOs:

- 1) DVB/ETSI, in the form of *Service Information* (SI) associated with TV services delivery over DVB-T/T2 systems (as well as via satellite and cable network distribution), and
- 2) ATSC, via *Service Signaling* for TV services delivery over ATSC 3.0 defined transport.

5.2.2 Broadcast TV Service Signaling

With some functional similarity to MBMS User Service Announcement/Discovery metadata [14], DVB has defined Service Information (SI) that is carried in the broadcast bitstreams. A portion of the SI contains information to assist end user selection of services and/or programs within the bitstream, and is specified in ETSI EN 300 468 [2]. Another portion of the SI enables automatic configuration of the TV receiver (referred to as an Integrated Receiver Decoder, or IRD) for reception of the selected service, and is mostly specified in ISO/IEC 13818-1 [3] as Program Specific Information (PSI). Similar to the DVB SI, ATSC, in A/331 [4] has defined service signaling, in two functional tiers. The lower layer, referred to as *Low Level Signaling* (LLS), enables rapid acquisition of basic service information by the receiver, and provides auxiliary metadata to the receiver such as system time, content rating, and emergency alert related information. The upper layer signaling, referred to as *Service Layer Signaling* (SLS) contains basic information for the user to perform service selection, as well as provides various transport and content level information for the receiver to download and process content components of the selected service. There is considerable similarities between SLS metadata fragments and the MBMS User Service Announcement/Discovery fragments, as described below in clause 4.

5.2.3 DVB

5.2.3.1 General Description

DVB's generic service delivery model, which depicts service distribution not only over terrestrial broadcast TV networks, but also via satellite and cable systems, is shown in Figure 1 below:

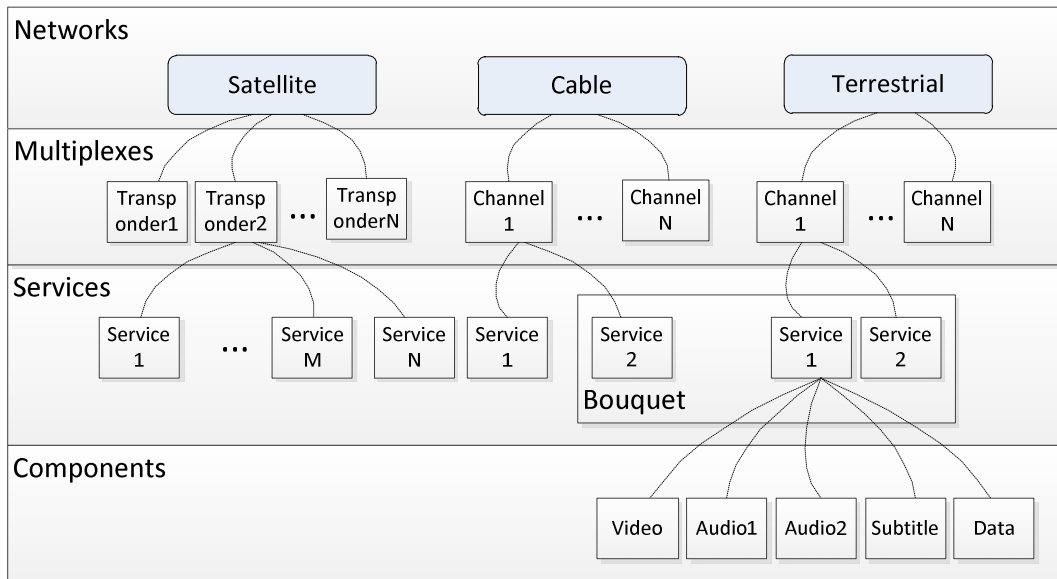

Figure 1: DVB Service Delivery Model

In DVB, a network consists of one or more Transport Streams that are broadcast by the same entity. A Transport Stream (TS) is an MPEG-2 stream containing several services, and each service is a TV channel, comprising a series of events one after the other. In DVB standards, the term "service" is synonymous to a TV channel. Each event is a single TV show, and consists of a number of elementary streams, where each elementary stream is a packetized MPEG-2 stream containing MPEG-2 encoded audio, video or binary data. The SI is one type of binary data carried in the TS. Multiple services, possibly from several different Transport Streams, can be grouped together logically in a *bouquet*. Every service in a DVB network can be uniquely identified by three values. These values are the *original network ID* (the ID of the network that originally broadcast the service), the *Transport Stream ID* (to identify a particular TS from that network) and the *service ID* to identify a service within that TS. The structure of a DVB Transport Stream is shown in Figure 2.

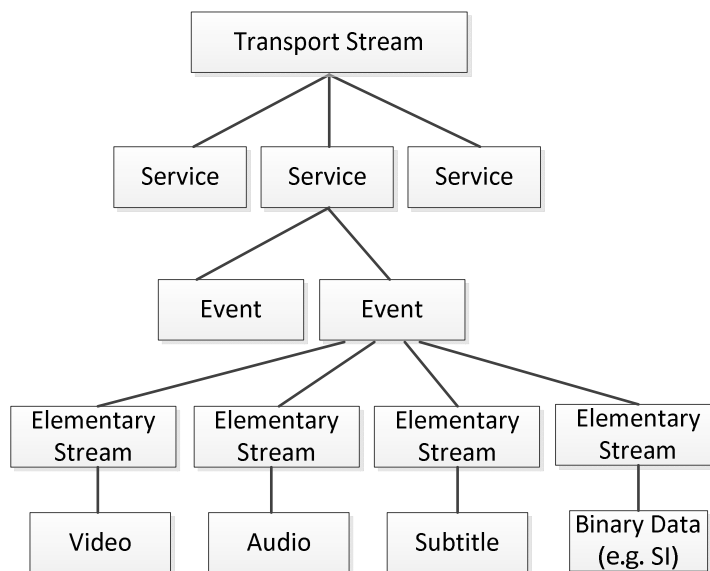

Figure 2: DVB Service Delivery Model

5.2.3.2 DVB SI

DVB SI, as specified in ETSI TS 101 211 [5], is a set of binary-coded signaling tables which describe the delivery system, and the content and scheduling/timing of services and events. It includes some of the MPEG-2 Program Specific Information (PSI) as defined in ISO/IEC 13818-1 [3], along with DVB-defined extensions which, collectively, describe the contents of Transport Stream packets for the purpose of the multiplexing and presentation of programs. The overall structure of the DVB SI tables is shown below in Figure 3.

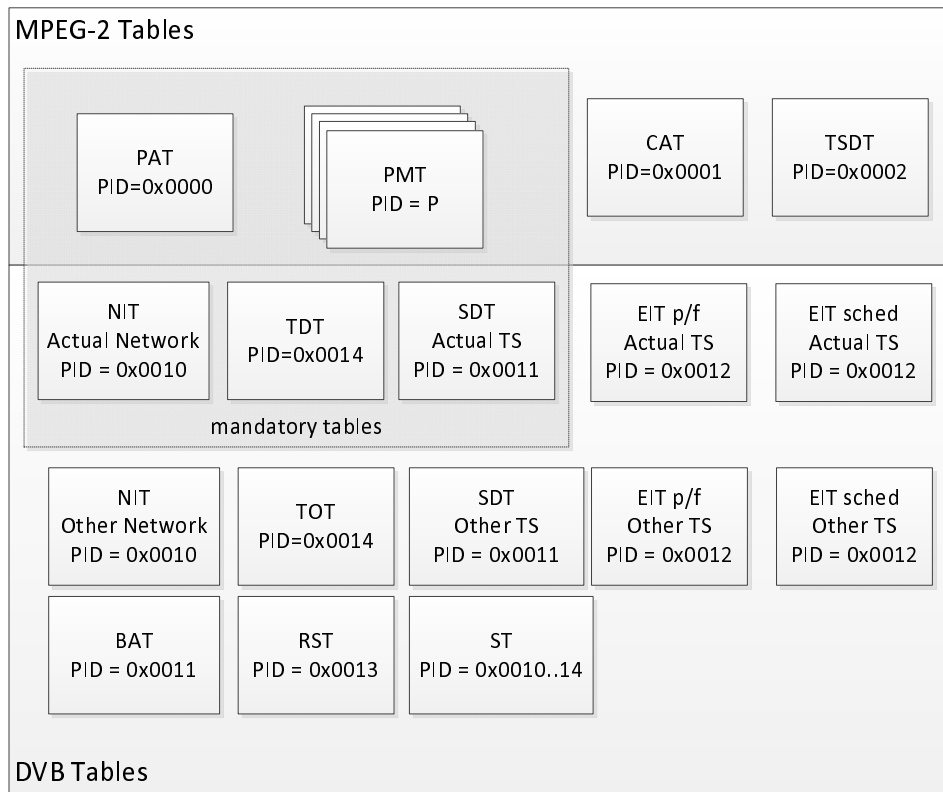

Figure 3: Structure of DVB Service Information

The full names of the DVB SI Tables as given by their abbreviations in Figure 3 are listed below, and described in clause 3.2:

- PAT – Program Association Table
- PMT – Program Map Table
- CAT – Conditional Access Table
- TSMT – Transport Stream Description Table
- NIT – Network Information Table
- TDT – Time and Date Table
- SDT – Service Description Table
- EIT – Event Information Table
- TOT – Time Offset Table
- BAT – Bouquet Association Table
- RST – Running Status Table
- ST – Stuffing Table

Since DVB SI tables can sometimes be quite large, they are split to fit inside a transport packet. Each such segment of data is known as a *section*, which may be variable in length, and can be used to hold any type of binary data, not just SI tables. The section number, an 8-bit field, is incremented each time a new table section is sent. The maximum number of sections per table is 256. The section length for all tables is 1021 bytes, except for the EIT (Event Information Table) which is 4096. Each section is uniquely identified by the combination of:

- table_id,
- table_id_extension,

- section_number,
- version_number, and
- current_next_indicator.

Sections that contain data and not audio or video streams are typically known as *private sections*, even when the data format is publicly known. These sections mostly follow a standard format. Each SI table section may contain one or more *descriptors* to provide extended information. Each descriptor will include an 8-bit *descriptor_tag* field identifying the descriptor, and an 8-bit *descriptor_length* field specifying the total size of the data portion of the descriptor following this field. The complete set of DVB SI descriptors, and in which SI tables these may be included, is shown in Table 12 in clause 6.1 of ETSI EN 300 468 [2].

Four of these SI tables, namely the Program Association Table (PAT), Program Map Table (PMT), Conditional Access Table (CAT), and the Transport Stream Description Table (TSDT), originate from and are identical to the Program Specific Information (PSI) tables with the same names as specified in ISO/IEC 13818-1 [3]. As shown in Figure 3, the mandatory SI tables in DVB system implementations are the PAT, PMT, NIT (Network Information Table) for the current network, TDT (Time and Data Table) and the SDT (Service Description Table) for the present document.

5.2.4 ATSC 3.0

5.2.4.1 General Description

ATSC 3.0 service delivery model is based on service signaling and IP-based delivery of a variety of ATSC 3.0 services and contents to ATSC 3.0-capable receivers over broadcast, broadband and hybrid broadcast/broadband networks. Service signaling corresponds to the data formats and information components necessary to discover and acquire:

- Linear services – (e.g., linear TV or radio services).
- Application-based services – non-linear services based on applications that provide the User Interface (UI) and functionality of the service, e.g., Video on-Demand (VoD) content items such as catch-up TV episodes.
- Data services – services for which the primary content consists of discrete or continuous content items that might be delivered via broadcast and locally cached for time-shifted consumption, or retrieved via unicast for immediate consumption.

ATSC 3.0 service signaling is used for service discovery and acquisition. ATSC 3.0 service signaling is composed of LLS (Low Level Signaling) and SLS (Service Layer Signaling). The SLT (Service List Table) is a service signaling table as one of the LLS signaling tables. The SLT lists all ATSC 3.0 services delivered via the broadcast stream in which SLT is being delivered, and the combination of SLT and the SLS information is required for the discovery and acquisition of ATSC 3.0 services. Its Service Layer Signaling (SLS) component is functionally equivalent to the user service announcement/discovery functionality and metadata as defined for MBMS. ATSC 3.0 also defines an electronic service guide (ESG), referred to as "Service Announcement" in ATSC terminology, and is based on the OMA BCAST Service Guide [6] with certain restrictions and extensions. The ATSC 3.0 ESG data model is described in the A/332 standard [7]. The ESG, as an application layer function, is mainly intended for consumption by the end user, whereas service signaling is for use by the receiver device to discover the location and acquire the content components of the user-selected service in the broadcast stream. Despite the logical separation between ATSC 3.0's service signaling and service guide metadata, there is a core linkage between them in the form of a globally-unique service identifier, present in the SLT for each of the ATSC 3.0 services available to the end user. Because 3GPP's interest is primarily on the service signaling function of the broadcast TV service layer, the ESG will not be further discussed in the present document.

The IP-based delivery functionality specifies two application transport protocols for the carriage of media content and service signaling data over broadcast and/or broadband networks to receivers: MMTP (MPEG Media Transport Protocol) as defined in ISO/IEC 23008-1 [8] and profiled in ATSC A/331 [4], and ROUTE (Real-Time Object Delivery over Unidirectional Transport) as specified in A/331 [4]. The delivery functionality also includes mechanisms for the synchronization of media components delivered on the same or different transport networks, and application-layer forward error correction methods that enable error-free reception and consumption of media streams or discrete file objects.

As indicated, a primary difference between ATSC 3.0 and DVB-T/T2 service delivery operation is the native use in ATSC 3.0 of IP for the packetization and transport of service contents over the broadcast channel, vs. the use of MPEG-2 TS based encapsulation and delivery of service contents over the broadcast network in DVB-T/T2.

The ATSC 3.0 protocol stack model is shown in Figure 4.

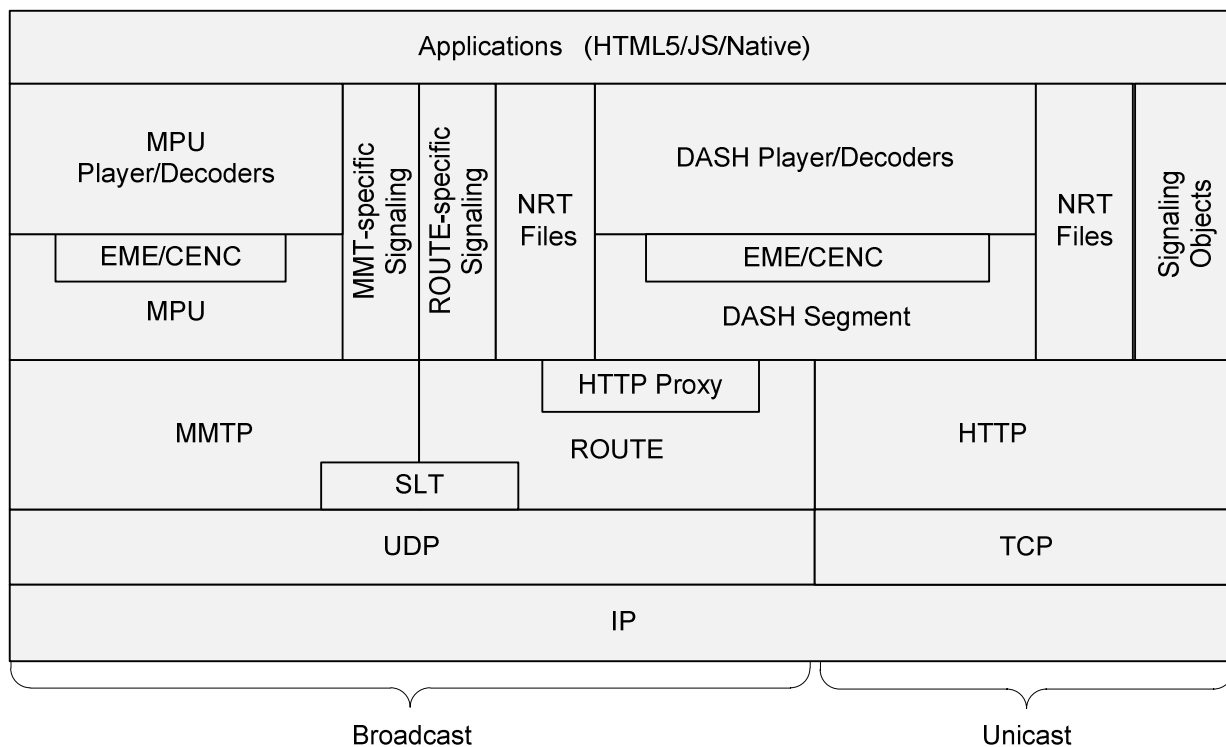

Figure 4: Conceptual Protocol Stack Model of ATSC 3.0

Service Signaling in ATSC 3.0 provides service discovery and description information, and comprises two main functional components: Low Level Signaling (LLS) providing bootstrap information for fast channel acquisition, and Service Layer Signaling (SLS) providing detailed service discovery and acquisition information for the ATSC 3.0 receiver device. Five basic types of ATSC 3.0 services are defined:

- 1) Linear Audio/Video Service.
- 2) Linear Audio-Only Service
- 3) App-Based Service.
- 4) ESG (Electronic Service Guide) Service.
- 5) EA (Emergency Alert) Service.

Linear services may be carried by the ROUTE or MMTP protocol, whereas app-based services, the ESG service, and the EA service are strictly delivered using the ROUTE protocol.

Each ROUTE session comprises one or more LCT channels which carry as a whole, or in part, the content components that make up the ATSC 3.0 service. In streaming services delivery, an LCT channel may carry an individual component of a user service such as an audio, video or closed caption stream. Streaming media as DASH Segments is formatted per the DASH/ATSC profile [9] of MPEG DASH [10], produced by the DASH-IF, as DASH Segments. Each MMTP session comprises one or more MMTP packet flows which carry MMT signaling messages or as a whole, or in part, the content component. An MMTP packet flow may carry MMT signaling messages or components formatted per ISO/IEC 23008-1 [8] as MPUs.

Figure 5 illustrates the types of services and their constituent content components as defined for ATSC 3.0:

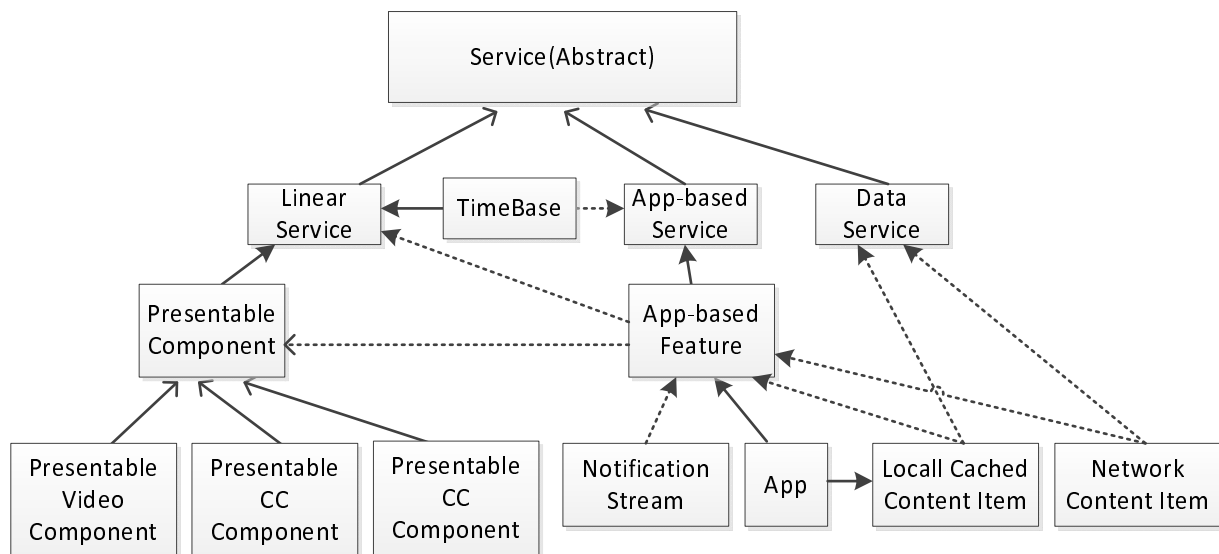

Figure 5: Conceptual model of ATSC 3.0 Services and Constituent Content Components

5.2.4.2 Service Signaling

5.2.4.2.1 Introduction

The combination of the ATSC 3.0 LLS and SLS metadata will be considered in the functional comparison with/mapping to MBMS User Service Announcement information (the 'USD').

5.2.4.2.2 Low Level Signaling

The LLS represents service signaling information which supports rapid channel scans and bootstrapping of service acquisition by the receiver. There are five types of LLS information, each carried in the form of a LLS Table:

- **Service List Table (SLT).** The SLT supports a rapid channel scan which allows a receiver to build a list of all the services it can receive, with their channel name, channel number, etc., and provides bootstrap information to enable the receiver to discover the SLS for each service. For ROUTE/DASH-delivered services, the bootstrap information includes the destination IP address and destination port of the LCT channel that carries the SLS.
- **Rating Region Table (RRT).** The RRT is an XML instance document, one or more of which may be contained in the broadcast emission for a given ATSC 3.0 service, each corresponding to a particular identified value of a *Rating Region* (for example, United States, Canada, Mexico, Korea). Each RRT instance contains content advisory rating information, in the form of both an integer value and human-readable string, according to one or more *dimensions* ("violence", "comedy", etc.), with each dimension comprising one more levels.
- **SystemTime fragment.** The System Time fragment is an XML document that carries auxiliary, time-related information with respect to the system time delivered in the ATSC 3.0 PHY layer (a 32-bit count of the number of seconds and a 10-bit fraction of a second (in units of milliseconds) since January 1, 1970 00:00:00, International Atomic Time (TAI), which is the Precision Time Protocol (PTP) epoch as defined in IEEE 1588 [11]). The auxiliary data carried in this fragment includes time offset between the TAI and UTC, time offset between UTC and the time zone of the originating broadcast station, leap second information, and Daylight Savings Time status. The System Time fragment is functionally similar to the combination of the TDT and TOT in the DVB SI.
- **AEAT (Advanced Emergency Alert Table).** An XML document that describes an advanced emergency alert mechanism including the emergency alert text banner and associated AEA (Advanced Emergency Alert) rich media resources delivered through an ATSC 3.0 Emergency Alert (EA) service.
- **Onscreen Message Notification fragment.** An XML document that indicates to a receiver the broadcaster's preference for the receiver to avoid obscuring any part of the video images.

5.2.4.2.3 Service Layer Signaling

SLS provides information for discovery and acquisition of ATSC 3.0 services and their content components. Taking for example the use of ROUTE as the application transport protocols for broadband and unicast delivery of ATSC 3.0 services, and DASH as the streaming media format, the SLS for the ROUTE/HTTP/DASH system ("ROUTE/DASH" for short) includes the User Service Bundle Description (USBD), the S-TSID (Service-based Transport Session Instance Description), the DASH Media Presentation Description (MPD), the HTML Entry packages Location Description (HELD), the Distribution Window Description (DWD) and optionally the Associated Procedure Description (APD). Similar to the MBMS USD, each of these SLS fragments is instantiated as an XML document. The data model of the ROUTE SLS information is shown in Figure 6:

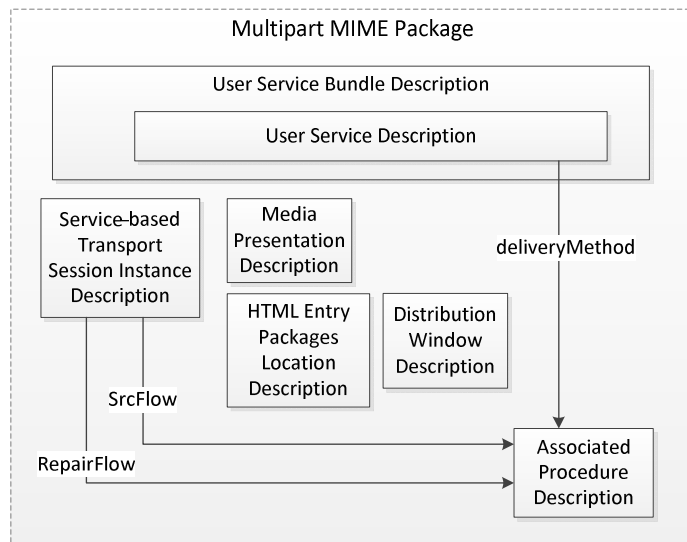

Figure 6: SLS Data Model for ROUTE/DASH

Notice the similarities between the ROUTE/DASH SLS and that of the MBMS USD data models. Substantial effort was undertaken in the development of A/331 [4] to align with MBMS service signaling where possible and practical. Table 1 provides a brief description for each of the SLS fragments for ROUTE/DASH.

Table 1: Summary Descriptions of ROUTE/DASH SLS Fragments in ATSC 3.0

SLS Fragment Name	Functional Description	Comments
USB	"Entry point" SLS fragment, providing basic information for a single ATSC 3.0 service, such as service ID, name, language and status (active/inactive), and identifies the delivery method(s) for the service	Based on MBMS' USB, but contains fewer parameters. Information in the ATSC USB are assumed to be generally static.
S-TSID	A sort of aggregated Service Description Fragment for the multiple content components of the ATSC 3.0 service described by the USB, and in which the ATSC 3.0's File Delivery Table, referred to as 'EFDT', or Extended FDT, may be either embedded or referenced.	Centralized as opposed to the distributed SDPs as employed in the MBMS USD for describing the transport and AL-FEC information for the different content components. Another key difference is to enable out-of-band and advanced delivery of FDT Instance parameters prior to the delivery session of the content the FDT describes
MPD	In the case of DASH-formatted services, the DASH MPD, delivered as a metadata fragment, to be forwarded by the receiver platform/middleware to the DASH client in the receiver	Identical function as the Media Presentation Description fragment in MBMS USD
HELD	In the event that an ATSC 3.0 service contains one or more app-based enhancements, this signaling fragment contains application-related metadata which enables a runtime environment to execute an application associated with the ATSC 3.0 service and defines the application life cycle.	Similar functionality to the AIT in HbbTV, but contains fewer parameters.
DWD	Optional metadata fragment to indicate the schedule of delivery of application files via ROUTE.	
APD	Optional metadata fragment in support of file repair	Only file repair functionality is specified at this time in the ATSC 3.0 APD (i.e., it does not contain reception reporting or consumption reporting signaling)

5.3 Typical Functionalities for TV Services

Based on the DVB and ATSC service model, the following functionalities are typical for TV Services:

- TV Service: The definition of a service that is typically real-time and continuous and can be accessed at well-known entry points. Typically TV services are linear, but also app-based and data services have been introduced recently to adapt to new consumption and delivery models. Services and related access information are explicitly described in service signalling such as DVB SI or ATSC 3.0 SLS.
- Multiplex: a physical grouping of TV services that are sub-grouped as interleaved data packets for broadcast over a network or modulated on a multiplexed medium.
- Bouquet or service bundle: A logical grouping of services, for example the services offered from one broadcaster.
- Program: a segment of content intended for broadcast, other than a commercial, trailer, or any other segment of content not serving as attraction for viewership. It may be a single production, or more commonly, a series of related productions (also called a television show).
- Event: Schedule information of programs within a TV service that can be referenced from external, for example by an EPG.
- Media Components: Programs are composed of content components of different media types. Typical media types are audio, video, subtitles, and other data such as graphics or images. Media components are explicitly defined in service signaling.

- Notifications and alerts: In TV services, notifications and alerts may be used to inform users about non-media related events such emergency alerts, etc. Notifications may also be targeted for device or application consumption, for example, as indication of the occurrence of interactivity events in the course of a linear TV program.
- Conditional Access or Digital Rights Management: Conditional access (abbreviated CA) or conditional access system (abbreviated CAS) or Digital Rights Management (DRM) refer to the protection and control of content consumption, for example by requiring certain criteria to be met before granting access to the content/service/program, or imposing rules regarding the consumption or storage of service content.
- Content advisory ratings: program attribute(s) that describe the associated content, for the purposes of parental control or personalization. Content advisory ratings are usually region-specific.

6 Use Cases

6.1 Introduction

This clause collects a set of use cases that are, beyond those defined in TR 22.816 [15] and documented in clause 4.1, emphasize service layer aspects.

6.2 TV Service Delivery over eMBMS

6.2.1 Description

A broadcast TV service provider 'ZZZZ', i.e., TV broadcaster, wishes to enable reception of its DTT (Digital Terrestrial TV) services on eMBMS UEs. These UEs are assumed to contain both the eMBMS radio receiver/modem and the eMBMS client or middleware functions. Examples of such UEs are LTE Broadcast capable handsets or tablets which already contain the MBMS client, as well as fixed TV sets which contain both eMBMS radio receiver and eMBMS client functions. ZZZZ wishes for certain native DTT service layer syntax and semantics employed in DTT networks such as DVB-T or DVB-T2 to be employed in service delivery over the eMBMS network to UEs. These may include, for example:

- DTT identifier formats of service bundles, individual services, and programs within a service;
- Country-based service availability control;
- End-user specific description of services and programs (i.e., EPG functionality);
- Identification of media components of a service or program;
- Time-shifting characteristics of Near Video-On-Demand (NVOD) service offerings;
- Parental rating information;
- Signaling of interactive applications associated with a DTT service.

The TV broadcaster realizes that because the receiving device will utilize MBMS service layer functions for reception of the DTT services, some form of translation will be required from native DTT service layer functionality to that of the MBMS service layer, for the associated service delivery over an eMBMS system. It also realizes that native DTT media encoding and encapsulation formats will need to be converted to 3GPP media encoding and encapsulation formats.

6.2.2 Working Assumptions

The following set of working assumptions are applicable to this use case:

- DTT services will be delivered over the eMBMS system as MBMS User Services, and carried over MBMS bearers.

- The method of DTT service delivery over eMBMS in this case is also referred to as "MBMS Service Type 2: Full MBMS service mode", as described in TR 23.746 [16].
- Targeted devices for reception of such DTT-over-eMBMS service delivery will contain at minimum the eMBMS radio receiver and the eMBMS client.
- The MBMS service layer, for example MBMS USD functionality, may need to be extended to support certain native DTT service capabilities not currently defined by 3GPP, in TS 26.346.
- Transcoding of native DTT media encoding format to 3GPP media encoding format may need to be performed for DTT-over-eMBMS service delivery.
- Conversion via de-capsulation and re-encapsulation of native DTT transport formats to 3GPP transport formats may need to be performed for DTT-over-eMBMS service delivery.
- Implementation mechanisms and network location of where media transcoding and re-formatting, and service layer translation functionality occur may depend on the details of a standardized network interface between the TV broadcaster and the eMBMS network operator.
- An example network architecture showing the media encoding and format conversion as well as service layer translation from DTT Service Information to MBMS USD could be as represented by Figure 7 below:

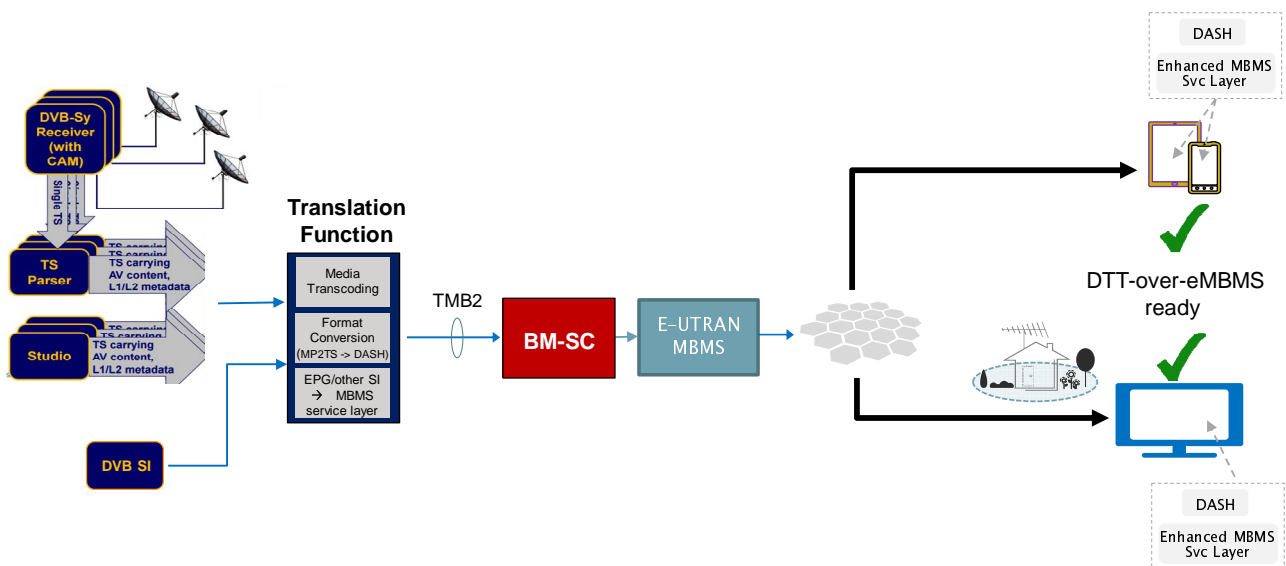

Figure 7: Example DTT-over-eMBMS Service Delivery Network Architecture

6.2.3 Available Enablers and Gap Analysis

A tabulation of the functions potentially provided by the DVB SI tables BAT (Bouquet Association Table), SDT (Service Description Table) and EIT (Event Information Table), which will be shown later in this section to be among the key DVB SI tables whose functionality are missing in the MBMS USD is provided in Table 2. The set of *descriptors*, or distinct service signaling functional components, which may reside in these tables (some of which are mandatory and others optional to implement by DVB broadcasters) is shown in Table 2. These descriptors, as described in ETSI EN 300 468 [2], provide the basis for the gap analysis whose results are given in Table 3.

Table 2: Descriptor (service signalling components)

Descriptor	Tag value	BAT	SDT	EIT
service_list_descriptor	0x41	*	-	-
stuffing_descriptor	0x42	*	*	*
bouquest_name_descriptor	0x47	*	-	-
service_descriptor	0x48	-	*	-
country_availability_descriptor	0x49	*	*	-
linkage_descriptor	0x4A	*	*	*
NVOD_reference_descriptor	0x4B	-	*	-
time_shifted_service_descriptor	0x4C	-	*	-
short_event_descriptor	0x4D	-	-	*
extended_event_descriptor	0x4E	-	-	*
time_shifted_event_descriptor	0x4F	-	-	*
component_descriptor	0x50	-	*	*
mosaic_descriptor	0x51	-	*	-
CA_identifier_descriptor	0x53	*	*	*
content_descriptor	0x54	-	-	*
parental_rating_descriptor	0x55	-	-	*
telephone_descriptor	0x57	-	*	*
local_time_offset_descriptor	0x58	-	-	-
multilingual_bouquet_name_descriptor	0x5C	*	-	-
multilingual_service_name_descriptor	0x5D	-	*	-
multilingual_component_descriptor	0x5E	-	-	*
private_data_specifier_descriptor	0x5F	*	*	*
short_smoothing_buffer_descriptor	0x61	-	-	*
data_broadcast_descriptor	0x64	-	*	*
PDC_descriptor	0x69	-	-	*
announcement_support_descriptor	0x6E	-	*	-
service_identifier_descriptor (see [15])	0x71	-	*	-
service_availability_descriptor	0x72	-	*	-
default_authority_descriptor (ETSI TS 102 323 [13])	0x73	*	*	-
TVA_id_descriptor (ETSI TS 102 323 [13])	0x75	-	-	*
content_identifier_descriptor (ETSI TS 102 323 [13])	0x76	-	-	*
XAIT location descriptor (see [i.3])	0x7D	*	*	*
FTA_content_management_descriptor	0x7E	*	*	*
extension descriptor (see note 5)	0x7F	*	*	*
user defined	0x80 to 0xFE			
forbidden	0xFF			

Table 3 below contains descriptions of all the DVB SI tables. These include the signaling tables as defined in ETSI EN 300 468 [2] and associated with classical, receive-only linear TV services, as well as the Application Information Table which signal interactive applications associated with TV services/programs consumed on hybrid broadcast/broadband TV sets. For each DVB SI table, Table 6.2 in ETSI EN 300 468 [2] provides:

- Identification of the MBMS User Service Discovery/Announcement, or collective "USD" metadata and other related MBMS service layer mechanisms, that provides similar functionality to that SI table.
- Indication of whether the SI table functionality is necessary to enable acquisition by the receiver and consumption by the user, and in accordance to rules/requirements set by the broadcaster, content provider, or regulatory organizations, of the nominal TV service content when delivered by eMBMS as opposed to DVB-T/T2 as the broadcast technology.
- Determination of existing gaps in MBMS service signaling relative to the DVB SI functionality considered essential for supporting broadcast TV services delivery.

NOTE: Portions of DVB SI's BAT, SDT and EIT convey EPG functionality for display to the end-user. The MBMS USD primarily conveys transport signaling for use by the MBMS receiver to acquire service contents. It is not designed to contain, and for the MBMS client to process, application service specific information such as EPG metadata.

Table 3: Comparison between DVB SI and MBMS USD Functionality

Table Name	Functional Description	Similar or Equivalent Function in 3GPP/MBMS Service Layer	Relevant Metadata to Provide in 3GPP/MBMS Service Layer?	Gaps in 3GPP/MBMS Service Layer?
PAT (Program Association Table)	Provides Packet ID (PID) values of TS packets carrying the PMT (Program Map Table)	NONE (not applicable)	NO – represents component of service discovery bootstrap mechanism used in MPEG-2 TS which is completely different from bootstrapping in native IP service delivery	NO (n/a for eMBMS)
PMT (Program Map Table)	Identifies and indicates the locations (PID values) of Transport Streams that make up each service and the location of the Program Clock Reference fields for a service	NONE (not applicable)	same as above	NO (n/a for eMBMS)
Conditional Access Table (CAT)	Provides info on the CA systems used in the multiplex	USD's Security Description supports service protection; reference to MPEG Common Encryption (ISO/IEC 23001-7) [4] for DASH-over-MBMS service supports content protection; absence of any metadata that identifies CA systems as defined in DVB	YES – for content protection of broadcast TV services carried over eMBMS	YES – if CA-based content protection will be supported NO – if DRM-based content protection via CENC would suffice NOTE: DVB's registered CA system IDs, as shown in http://www.dvbservice.com/identifiers/ca_system_id include: OMA BCAST 1.0 (U)SIM Smartcard Profile using 3GPP GBA_U, and OMA BCAST 1.0 (U)SIM Smartcard Profile using 3GPP GBA_ME If these GBA-based CA systems are acceptable by DVB broadcasters, MBMS service layer and security, with associated enhancements (i.e. support for OMA BCAST [5] defined LTKM and STKM as extension to MSK and MTK messages in MBMS security per TS 33.246 [6] would suffice in supporting DVB CA.
Network Information Table (NIT)	Provide information about the physical network, incl. syntax and semantics	NONE (not applicable)	NO – totally different PHY layers and corresponding parameters between DVB-T and eMBMS	NO (n/a for eMBMS)

Table Name	Functional Description	Similar or Equivalent Function in 3GPP/MBMS Service Layer	Relevant Metadata to Provide in 3GPP/MBMS Service Layer?	Gaps in 3GPP/MBMS Service Layer?
Time and Date Table (TDT)	Provides present UTC time and date info, which may be used to synchronize the receiver's internal clock. The receiver displays the time based on the information of this table.	BM-SC offers SNTP time server for use by the MBMS UEs to synchronize its clock with the BM-SC	YES – existing MBMS service layer capability to support accurate synchronization of receiver's clock to that of BM-SC, necessary for service reception and rendering to user	NO (capability already exists)
Bouquet Association Table (BAT)	Listing and description of a group of services, which may be carried in multiple TSs and which could be carried in multiple networks, that a receiver presents as a single service package to a user	USB-D fragment, for which the service bundle may comprise a single or multiple services	YES – it should be possible to indicate a TV service offering to the end user as a bundle of multiple TV services/channels	YES USB-D currently lacks service package/bundle level information as provided by the BAT It should be further studied whether and how MBMS service layer should be enhanced to support EPG functionality
Service Description Table (SDT)	Describe services that are contained within a particular TS, including the service name, service provider, service running status, and whether the service is encrypted, whether EIT (Event Information Table) schedule is present in the present document	USB-D fragment, which provides basic MBMS User Service information such as service ID, name and language, but lacks support for carrying comprehensive info available in SDT (e.g. service type, textual service identifier, service provider name, alerts, component description, time-shifting, CA system ID, country availability, linkage to other info about current service, etc.	YES – it may be desirable/necessary to provide such additional info to enable receiver acquisition and user selection of services without requiring the use of a program/service guide	YES USB-D currently lacks those additional service-level information as provided by the SDT It should be further studied whether and how MBMS service layer should be enhanced to support EPG functionality

Table Name	Functional Description	Similar or Equivalent Function in 3GPP/MBMS Service Layer	Relevant Metadata to Provide in 3GPP/MBMS Service Layer?	Gaps in 3GPP/MBMS Service Layer?
Event Information Table (EIT)	Contains schedule info about events (i.e. TV programs) in a service, such as event ID, start time, duration, running status, scrambling indication, etc. A large set of additional information on each event can be provided by descriptors included in the EIT, such as event name and textual description, genre/classification, component and content descriptions, linkage to additional info about the event, parental rating, time-shifting, etc.	Essentially NONE, although scheduling info in EIT is in part provided by the USD's Schedule Description fragment	YES – it may be desirable/necessary to provide such additional info to enable receiver acquisition and user selection of programs without separate delivery of a program/service guide	YES MBMS USD metadata fragments currently does not include program-level information as provided by the EIT It should be further studied whether and how MBMS service layer should be enhanced to support EPG functionality
Time Offset Table (TOT)	Provides information relating to the present time and date and local time offset	NONE	MAYBE, should this information be deemed important and typically carried in DVB SI	MAYBE If time offset info is necessary to be provided for DVB broadcast TV services delivery over eMBMS Needs further study.
Running Status Table (RST)	Provides accurate and rapid updating of the timing status of one or more events in a service, i.e., running, not running, starts in a few seconds, pausing, service is off-air). RST may be necessary for events which start early or late due to scheduling changes.	NONE	YES – to announce dynamic schedule changes in airing of programs	YES It should be possible for USD metadata to indicate dynamic temporal changes in the delivery of broadcast programs
Stuffing Table (ST)	Provides the means to replace or invalidate either sub-tables or complete SI tables	Inband delivery of USD fragments to dynamically update an existing fragment, in case the nominal validity time of the current fragment, as given in the metadata envelope has not yet expired	YES – to enable dynamic updating of service signaling information	NO Functionality is already supported by inband USD metadata fragment delivery
Application Information Table (AIT)	Provides information about interactive application associated with the broadcast TV service	No explicitly defined functional counterpart in MBMS USD to the AIT.	YES – MBMS service layer should support the DVB and HbbTV model of discovery, acquisition and life cycle control of TV service-bound application services	YES It should be possible for USD metadata to support the signaling of interactive application associated with DTT services and programs contained within each service

6.2.4 Optimization Potentials

As shown in Table 6.1 in ETSI EN 300 468 [2], the functionality of a number of DVB SI tables are not applicable for the delivery of DTT services as MBMS User Services over eMBMS. Certain SI information, for example, as contained in the NIT (Network Information Table), are specific to DVB physical and network layer mechanisms and irrelevant in the carriage of broadcast TV service contents over LTE Broadcast systems, with different physical, link and network layer definitions. Also, since the encapsulation format of streaming media content carried over MBMS bearers will be converted from MPEG-2 Transport Stream to DASH, SI tables associated with the discovery and identification of media content and service signaling components carried in MPEG-2 Transport Streams are not applicable due to native IP transport of user and control plane data in MBMS. Certain DVB system functions indicated in the SI can be mapped to similar MBMS service layer capabilities, such as support for time synchronization between the network and the device, as well as the means for the network to update or invalidate service signaling information. For these functions, no specific gaps are present.

On the other hand, there are numerous DVB SI functionality that have no clearly similar or equivalent counterparts in the MBMS service layer/USD.

Transport signaling related. There are DVB-defined identifiers, such as Conditional Access (CA) system identification for services or programs that are content protected by CA technology (see <http://www.dvbservices.com/identifiers/index.php>). Similarly, there may be use of identifiers associated with the DVB "ecosystem", such as authority and content identifiers defined by the (now inactive) TV-Anytime Forum (<http://www.tv-anytime.org/>). In addition, DVB SI allocates 16-bit service and event (i.e. "program") IDs to be assigned by DVB broadcasters, which will need to be supported by the MBMS USD. There are also functional concepts unique DVB which have no equivalent in the MBMS USD. For example, due to the possibility that a given broadcaster may offer DTT services in multiple, neighbouring countries, *country_availability* indication may be signaled in various SI tables (e.g. BAT, SDT, and EIT). Another broadcast TV specific function is that of *FTA_content_management* which enables certain control by the broadcaster on the usage and/or remote distribution of content items delivered in free-to-air (FTA) services – for example, a) without restriction, b) only within a managed domain, c) only after a certain time has elapsed since the original program airing, etc.

Application signaling related. The DVB SI, mainly via the EIT, but also including functionality of the BAT and SDT, contain EPG metadata that enables an EPG application built into the DVB receiver to produce a program guide for the end user. Such application service and related signaling functionality is outside the scope of the MBMS USD, and the current MBMS client, as recipient of the USD metadata, does not perform application service specific functionality, such as producing an EPG with associated UI and application logic to enable program guide display to and interaction with the user. In fact, application signaling metadata such as the Media Presentation Description metadata fragment simply serves as a container for the MPD created by the DASH service provider, to be passed transparently by the MBMS client to the DASH player, the latter entity acting as an application client. Whether and how such EPG metadata should be handled as part of the service layer conversion from DVB SI to MBMS USD is an area for further study and discussion.

6.2.5 Potential Solutions

6.2.5.1 General

It is understood that the MBMS USD currently defines only transport-level service signaling, to enable the MBMS receiver to identify the available MBMS User Services, which are defined as transport services, and the means to acquire the constituent content components of a given service. Auxiliary mechanism associated with the transport signaling include the means to ensure reliability of service reception, such as AL-FEC and/or file repair configuration information, and the reporting of reception statistics for QoE measurement, or the determination of service popularity, by the network. The DVB SI, as defined in ETSI EN 300 468 [3], contains not only such transport signaling, but also application-level, EPG metadata, to enable the receiver which is assumed to contain an EPG application client, to process that metadata in the creation of a service/program guide for display to the user. Although not defined in the DVB SI [3], the EPG application may include end-user navigation and selection capabilities via additional UI function and associated application logic. A key question to be addressed in the analysis of possible solution frameworks is whether and/or how the MBMS USD should be extended to support EPG-like functionality.

6.2.5.2 Option 1: Extend USD with DTT Transport Signaling and EPG

In Option 1, the MBMS USD will be enhanced to provide both the necessary broadcast TV specific transport signaling (identifiers of CA system, service package, service and program, country of service availability, identification of

constituent media components, content management rules, etc.) and EPG metadata as defined by the DTT system. To do so, it is anticipated that the following changes to the MBMS USD data structure will be necessary:

- 1) Extension of existing metadata fragments, especially the USBD fragment which includes both service bundle (or package) and service level semantics, by introducing new elements or attributes to carry additional service and service package related information.
- 2) Definition of new metadata fragments to carry DVB SI information not supported by, or inappropriate to functionally extend, existing MBMS USD metadata fragments. These pertain to metadata intended either for processing by the MBMS receiver, or display to the end user. Examples include program-level descriptions, identification of media components contained in a service or individual program, parental rating metadata, and signaling of applications associated with a service or program (e.g. targeted ads, interactive quiz, voting of favourite performer).

6.2.5.3 Option 2: EPG Metadata Carried in Application Service Description

In Option 2, the Application Service Description, as a "container" USD metadata fragment for entry point information of an application service, will carry all EPG metadata associated with the DTT service. In other words, the application service client or "consumer" of this Application Service Description is the EPG application. TS 26.346 indicates that the application service type is defined by the Internet Media (i.e. MIME) type given by the attribute *mimeType* of *r12:appService*, and the associated Application Service Description could be a Media Presentation Description fragment corresponding to a unified MPD, or an HTML page representing the home page of an HTML application service. In this method, transport signaling and application service specific metadata are separated for containment in different USD metadata fragments. DTT service specific transport signaling will be carried in existing USD fragments and/or in newly-defined fragments that strictly contain transport signaling, while EPG metadata will be carried in the associated Application Service Description.

It is for further discussion whether the data structure of the Application Service Description for carrying EPG metadata should be standardized by 3GPP, or left undefined and implementation-specific. While requiring additional work effort, the former approach should reduce device complexity and enhance interoperability. If the EPG-based Application Service Description data structure is proprietary, UEs may have to support multiple EPG clients in order to interwork with different translations of DVB EPG metadata formats as supplied by various eMBMS operators, to be carried inside the Application Service Description fragment.

6.2.5.4 Option 3: EPG Data Delivery as Standalone MBMS User Service

In Option 3, Broadcast TV EPG information is delivered as the contents of an individual MBMS User Service. All DTT service specific transport signaling will be carried in existing USD fragments and/or in newly-defined fragments that strictly contain transport signaling, as in Option 2. There are two possible ways of bootstrapping the discovery and selection of the main TV service using the EPG service. In the first, the Service ID (attribute *serviceId* of the *userServiceDescription* element) is only known by the EPG application, which will request that MBMS User Service from the MBMS client upon registration, via the registration API as defined in TRAPI [4]. Alternatively, the EPG service has a pre-configured Service ID or Service Class value in the MBMS client, which will automatically download and provide the contents of this service to the EPG application upon registration of that application with the MBMS client.

6.2.5.5 Pros and Cons of the Alternative Methods

Option 1 may be considered as offering the benefit of ensuring full 3GPP control of MBMS USD definition to support DTT services delivery over the MBMS system as MBMS User Services. However, it is not a clean approach in mixing transport signaling and application service metadata in the same metadata fragment. In particular, the MBMS client has been designed to only support transport signaling to enable reliable service/content reception. Should EPG semantics be added to existing USD metadata fragments and/or in newly-defined fragments, it would essentially require the MBMS client to act additionally as an EPG application, in constructing a program guide for end-user display and possibly user manipulation via a graphical and interactive user interface, along with application logic to support the user interface. Furthermore, the EPG application may need to interact with a backend server of the TV broadcaster for service subscription and charging/payment functions. Supporting such EPG application could significantly increase the complexity of the MBMS client, and potentially delay the practical introduction of DTT service delivery over eMBMS via reuse of the MBMS service layer.

Option 2 may be attractive in offering cleaner separation of transport and application service related signaling functionality in the service layer. It leverages the intended role of the existing Application Service Description for

carrying EPG-related information as an application service entry point document, which in turn would be forwarded by the MBMS client to a local EPG application client for processing. In the meantime, the required extension to the remaining MBMS USD would be limited to strictly new parameters added to existing metadata fragments, or introduction of new fragments, that pertain strictly to DTT service specific transport signaling. This method will likely impose considerably less burden on the MBMS client than Option 1, since it continues to process only transport signaling associated with DTT service reception on UEs. As such, it might also accelerate the timeframe that mobile operators can practically offer full service layer reused based eMBMS delivery of DTT services to capable receiving devices. The tradeoffs between whether or not to standardize the data structure of such EPG-based Application Service Description were discussed in clause 6.2.5.3.

Option 3 would represent the simplest approach to supporting the delivery of DTT service EPG metadata. Similar to Option 2, it maintains clean separation of transport signaling from application service specific signaling in the MBMS service layer for DTT service delivery support. It would also avoid the debate on whether the EPG-specific Application Service Description should be defined by 3GPP. One downside of this approach is that it is not fully aligned with USD design/operating principle that entry point info for any MBMS-aware application should be contained in Application Service Description, which is the mechanism adopted in Option 2. Also, it may potentially impose implementation complexity for the BM-SC to have to parse the service and signaling information provided by the DTT broadcaster across the XMB interface, to create and provision an individual MBMS User Service containing EPG metadata, as compared to sending the EPG information in the MBMS USD. *(This last point needs verification by infrastructure vendors.)*

A summary of the three alternatives is shown in Table 4.

Table 4: Comparison of Options 1, 2 and 3 for Translating DVB SI to MBMS Service Layer Signaling

Method	Description	Pros	Cons
Mixed transport and EPG metadata in USD fragments	"Horizontal" extension of MBMS USD fragments (existing and newly-added) to carry both transport and application service signaling	Full 3GPP control of MBMS USD definition to supporting DTT-over-eMBMS as MBMS User Service	<ul style="list-style-type: none"> - Not a clean approach by mixing transport signaling with application service metadata - Imposes significant complexity on MBMS client to support EPG application, including UI and application logic, and interaction with broadcasters' provisioning and billing systems - May delay launch of DTT-over-eMBMS via MBMS service layer reuse
EPG carriage in Application Service Description	Separation of transport and application service signaling in MBMS service – all EPG metadata carried in Application Service Description	<ul style="list-style-type: none"> - Cleaner separation between transport and application service signaling in MBMS service layer - Leverages intended role of the Application Service Description for carrying EPG info as application service entry point document - Imposes considerably less burden on MBMS client than Option 1, by only having to process transport signaling 	<p>None in particular</p> <p>Open question on whether the data format of such EPG-based Application Service Description fragment should be standardized</p>

		associated with DTT service reception - May accelerate launch of DTT-over-eMBMS via MBMS service layer reuse	
EPG carriage as standalone MBMS User Service	Separation of transport and application service signaling in MBMS service – EPG metadata carried as standalone MBMS User Service	- Simplest approach to supporting delivery of DTT service EPG metadata	- Diverges from USD design/operating principle that entry point info for any MBMS-aware application should be contained in Application Service Description - <i>(requires verification)</i> May be more operationally complex than Options 1 and 2 for the mobile operator infrastructure as it has to parse service signaling, i.e. DVB SI, provided by DTT broadcaster over XMB interface to extract EPG metadata, and provision a unique MBMS User Service pertaining to EPG info, including pre-defining unique serviceId and/or service class values for that service

6.3 IP-Based Broadcast

6.3.1 Description

A broadcaster that has TV services over IP-based broadcast (such as ATSC 3.0 or ARIB) is interested in extending its reach to mobile devices and in improving the in-door reception for the fixed receivers. The broadcaster reaches an agreement with a mobile operator to distribute some of the TV channels over mobile broadcast using eMBMS. However, the broadcaster wants to maintain control over the content components and workflow and reuse existing players for the playback of the content. It also needs to maintain the service aspects that are related to regulatory commitments of the broadcaster.

6.3.2 Working Assumptions

Based on the previous use case and requirements, the following working assumptions are determined:

- The BM-SC will forward the IP-based broadcast stream as is as user plane multicast data over the XMB interface.
- The BM-SC creates a minimal service announcement that serves the purpose of bootstrapping.
- The MBMS API offers access to the raw IP-based broadcast stream.

- The BM-SC may offer additional functionality to support delivery over MBMS. The technical and commercial viability of these features will be studied on case by case basis.

6.3.3 Recommended Requirements

- An eMBMS transport layer should be able to transport TV streams formatted not compliant to 3GPP standards.
- It is possible to deliver IP-based terrestrial broadcast streams without modifications to the contents of the stream.

6.3.4 Available Enablers in 3GPP

The group communication delivery method as defined in 8A of TS 26.346 may enable functionalities in this context.

6.3.5 Gap Analysis

The group communication is primarily defined for the group communication application service as defined in 3GPP TS 23.468 [18]. In addition, the group communication relies session description of GC1.

In addition, the service may be constant bitrate or variable bitrate. Both modes are expected to be supported.

6.4 FTA Linear TV to Mobiles

6.4.1 Description

A linear TV service can be made accessible to mobiles through a 3GPP cellular infrastructure in order to broadly provide free-to-air TV services to mobile phones and other 3GPP-connected devices.

A linear service is the traditional way of offering TV services where the content is organised in a sequence that may consist of e.g. news, shows, drama, movies, or documentaries. That sequence is distributed as a stream of programmes that reach the viewer according to a pre-defined schedule. The viewer can tune in to a programme but cannot alter the schedule. Linear TV is the most common way of delivering live content (e.g. sport events, concerts, news). The Linear TV Service is considered Free-to-Air (FTA), i.e. no subscription is required with a TV service provider and that the service is also characterised by no content encryption and is made available at no additional cost to the end user as defined in TS 22.101.

The TV service may be made available regionally or nationally.

The TV service may include SD, HD and UHD services.

The TV service may include audio in different languages.

The TV service may include subtitles.

Access services may have to be supported.

It is desirable that different type of ad insertion models can be supported.

6.4.2 Working Assumptions

There is no reason why the image formats as specified in TS 26.116 cannot be used.

The required audio formats include stereo. Loudness control (For details see: EBU Recommendation R 128:2014: "Loudness normalization and permitted maximum level of audio signals") is expected to be supported. Multiple audio tracks may be present, for example for different languages. There may be services that require support for multiple languages where the language is pre-mixed with music and effects.

A sufficient set of audio and video codecs are required to allow for encoding and distribution of legacy and new formats in an efficient manner. If legacy content is expected to be distributed (e.g. MPEG-2 video or audio technologies), it may be transcoded prior to distribution.

Subtitling formats may include both textual and graphical types.

Access services may include subtitling, signing, audio descriptions and audio subtitling.

Ad insertion solutions may include one of the following options: splicing in a live stream, as a targeted stream requested by the user device, or retrieved from local storage on the device.

6.4.3 Recommended Requirements

The following enablers need to be provided:

- Video Formats and Codecs for SD, HD and UHD formats
- Stereo Audio Formats and Codecs
- Loudness control
- Multiple language support
- Subtitling formats for text and graphics
- Signalling for access services
- Splicing of content in network and on the device

6.4.4 Available Enablers in 3GPP, Gap Analysis and Optimization Potentials

If the transport-only mode is used, then codecs and service layer aspects are outside of the control of 3GPP.

If the MBMS service layer mode (also referred to in TR 23.746 [16] as "MBMS Service Type 2" or "Full MBMS service mode") is used, then the following enablers exist and gaps and optimization potentials are identified:

- Video Formats and Codecs for SD, HD and UHD formats
 - Available Enablers:
 - According to TS 26.346 [14], clause 10.5.5: "If the 3GPP MBMS client supports Television (TV) over 3GPP Services, it shall comply with the 720p H.264 (AVC) Operation Point Receiver requirements and should comply with the Full HD H.264 (AVC), 720p H.265 (HEVC), FullHD H.265 (HEVC) and UHD H.265 (HEVC) Operation Points Receiver requirements as specified in TS 26.116."
 - 3GPP supports the relevant video codecs and formats
 - Optimization: UHD has other dimensions than 4K, including High Dynamic Range (HDR) and High Frame Rate (HFR).
 - Stereo Audio Formats and Codecs
 - Available Enablers:
 - According to TS 26.346 [14], clause 10.5.5: "If audio is supported, then the following two audio decoders should be supported:
 - Enhanced aacPlus, as specified in 3GPP TS 26.401, 3GPP TS 26.410 and 3GPP TS 26.411.
 - Extended AMR-WB, as specified in 3GPP TS 26.290, 3GPP TS 26.304 and 3GPP TS 26.273."
 - Both codecs support stereo formats.
 - Loudness control
 - Gap: Loudness control is not supported in 3GPP
 - Multiple language support
 - Available enablers:

- 3GP-DASH supports late binding, so language can be distributed independently of the video.
- 3GP-DASH supports signalling multiple languages by using the @lang attribute with Adaptation Sets. The mixing of the music and effects and the language track is done at the sender.
- Optimizations:
 - Distribution of objects (e.g. music&effects, different languages) separately in order to combine at the receiver.
- Subtitling formats for text and graphics
 - Available Enablers:

For details see: EBU Recommendation R 128:2014: "Loudness normalization and permitted maximum level of audio signals".- Gap:

 - No streaming support for TS 26.245, i.e. it is not supported for fragmentation.
 - Alternative richer formats such as IMSC1 text or IMSC1 with images [27].
- Signaling for access services
 - Available Enablers:
 - 3GP-DASH supports signaling using the Accessibility descriptor and using the MPEG DASH Role scheme.
 - Optimization:
 - Consistent signaling of the Accessibility functions.
 - Consistent receiver behaviour to select the Adaptation Sets related to accessibility.

Splicing of content in network and on the device

- 3GP-DASH supports multi-Period content.
- Optimizations:
 - Consistent use of multi-Period content for splicing in network
 - Consistent use of multi-Period content for splicing in device

6.5 FTA Linear TV to Stationary TVs

6.5.1 Description

Linear FTA broadcast TV to stationary TV sets is generally enabled via traditional broadcast networks. However, there is no reason to not explore the possibility of replicating this use case in a 3GPP environment.

A linear TV service is accessible to stationary TV sets through a 3GPP cellular infrastructure in order to provide FTA TV Services to stationary TV sets.

Conventional TVs do not have uplink capability but connected TVs do (either integrated in a TV set or in a set-top box). Connected TV sets are capable of connecting to the Internet, usually via a home gateway. This means that uplink capability may be present to enhance the service, but cannot be assumed to exist for all types of devices.

The TV service may be made available regionally or nationally.

For TV centric services, the audio and video formats defined in TS 101 154 [17] (DVB codec specification) are expected to be used.

Subtitling formats may be required.

Access services may be required.

It is desirable that different type of ad insertion models can be supported. Note that not all ad insertion models may be supported by all end devices, for example depending on whether the device has uplink capabilities.

6.5.2 Working Assumptions

For video this includes SD, HD and UHD formats according to TS 101 154 [17].

The required audio formats include stereo and multi-channel audio, but also next generation object- and scene-based audio systems may be enabled as well. Loudness control is expected to be supported. Multiple audio tracks may be present, for example for different languages. There may be services that require support for multiple languages where the language is pre-mixed with the music and effects.

A sufficient set of audio and video codecs are required to allow for encoding and distribution of legacy and new formats in an efficient manner. There is a benefit of aligning with ETSI TS 101 154 [17]. If legacy content is expected to be distributed (e.g. MPEG-2 video or audio technologies), this may be transcoded prior to distribution.

Subtitling formats may be required, including both textual and graphical ones.

Access services may have to be supported that include subtitling, signing, audio descriptions and audio subtitling.

Ad insertion includes splicing in a live stream, as well as a targeted stream requested by the user device, or from a local storage on the device.

6.5.3 Recommended Requirements

The following enablers need to be provided:

- Video Formats and Codecs following TS 101 154 [17].
- Audio Formats and Codecs following TS 101 154 [17].
- Loudness control.
- Multiple language support.
- Subtitling formats for text and graphics.
- Signalling for access services.
- Splicing of content in network and on the device with the ability to provide fallback for UE that do not support an uplink.

6.5.4 Available Enablers in 3GPP, Gap Analysis and Optimization Potentials

If the transport-only mode is used, then codecs and service layer aspects are outside of the control of 3GPP.

If the MBMS service layer mode is used, then the following enablers exist and gaps and optimization potentials are identified:

- Video Formats and Codecs following TS 101 154 [17]
- Available Enablers:
 - According to TS 26.346 [14], clause 10.5.5: "If the 3GPP MBMS client supports Television (TV) over 3GPP Services, it shall comply with the 720p H.264 (AVC) Operation Point Receiver requirements and should comply with the Full HD H.264 (AVC), 720p H.265 (HEVC), FullHD H.265 (HEVC) and UHD H.265 (HEVC) Operation Points Receiver requirements as specified in TS 26.116."
 - There is significant overlap between 3GPP and DVB codecs.
- OPTIMIZATION: UHD has other dimensions than 4K, including High Dynamic Range (HDR) and High Frame Rate (HFR).

- Audio Formats and Codecs following TS 101 154 [17]
 - Available Enablers:
 - According to TS 26.346 [14], clause 10.5.5: Enhanced aacPlus, as specified in 3GPP TS 26.401, 3GPP TS 26.410 and 3GPP TS 26.411.
 - For stereo, enhanced aacPlus and HE-AACv2 are basically identical.
 - Gaps:
 - The differences between enhanced aacPlus and HE-AACv2 need to be verified and understood.
 - No support for any other codecs in TS 101 154 in 3GPP.
 - Loudness control
 - Gap: Loudness control is not supported in 3GPP
 - Multiple language support
 - Available Enablers:
 - 3GP-DASH supports late binding, so language can be distributed independently of the video.
 - 3GP-DASH supports signalling multiple languages by using the @lang attribute with Adaptation Sets. The mixing of the music and effects and the language track is done at the sender.
 - Optimizations:
 - Distribution of objects (e.g., music&effects, different languages) separately in order to combine at the receiver.
 - Subtitling formats for text and graphics
 - According to TS 26.346 [14], clause 10.10: "If timed text is supported, MBMS clients shall support 3GPP TS 26.245. Timed text may be transported over RTP or downloaded contained in 3GP files using Basic profile."
 - Gaps:
 - No streaming support for TS 26.245, i.e. it is not supported for fragmentation.
 - Alternative richer formats such as IMSC1 text or IMSC1 with graphics [27].
 - Signaling for access services
 - 3GP-DASH supports signaling using the Accessibility descriptor and using the MPEG DASH Role scheme.
 - Optimization:
 - Consistent signaling of the Accessibility functions.
 - Consistent receiver behaviour in selection of the Adaptation Sets related to accessibility.

Splicing of content in network and on the device with the ability to provide fallback for UE that do not support an uplink

- 3GP-DASH supports multi-Period content and resolve to zero xlink.
- Optimizations:
 - Consistent use of multi-Period content for splicing.
 - Consistent use of device-based ad insertion.

6.6 FTA Linear TV to Stationary TV and Mobiles

6.6.1 Description

A broadcaster may provide an FTA Linear TV service to Mobiles and Stationary TVs according to the scenarios in use in clause 6.4 and 6.5 in a cost- and spectrum-efficient manner.

6.6.2 Working Assumptions

Simulcasting of services is considered not being cost and spectrum efficient. The service may be targeted for mobile coverage or for stationary coverage.

6.6.3 Recommended Requirements

It is possible to distribute the same signal over the 3GPP bearer service for both type of receptions.

It is possible to distribute encapsulation, media formats and codecs supported by both type of end devices. stationary TVs and mobiles.

6.6.4 Realization Options

6.6.4.1 Objective

In order to fulfil this use case, the service layer architecture will support the distribution of content to both, stationary TV as well as mobile devices. This is shown in Figure 8. Different candidate architecture may be considered to fulfil the use case.

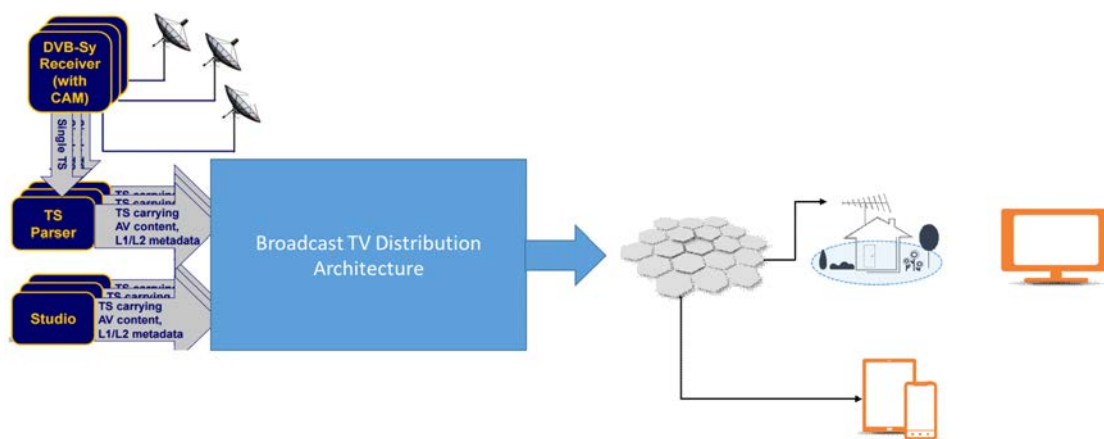

Figure 8 Classical TV service and mapping to cellular MBMS network

Figure 8

Two realization options are discussed in clauses 6.6.4.2 and 6.6.4.3.

6.6.4.2 DVB Service Layer Reuse

Figure 9 provides an architecture, for which the MPEG-2 TS based service layer is reused. In this case the MPEG-2 TS is carried over the eMBMS network. In this case, stationary TV set can reuse the existing service layer and only the physical layer is replaced. However, such an architecture provides challenges in terms of support on mobile devices as 3GPP specifications do not support the DVB service layer as defined.

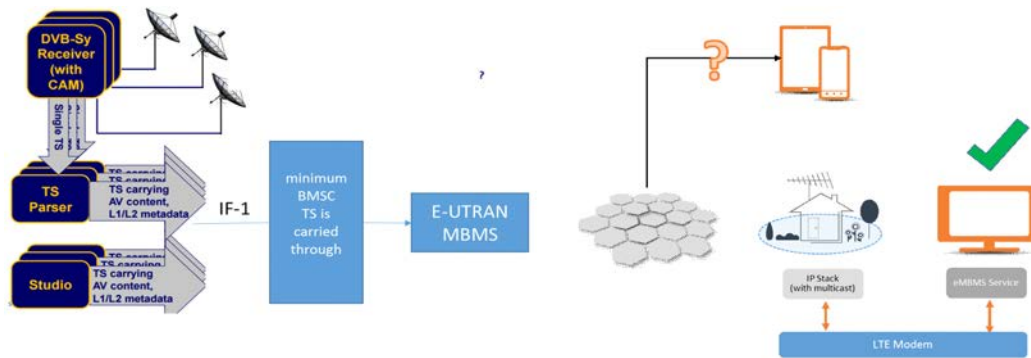

Figure 9 Service Layer reuse from traditional broadcast system

Figure 9

It is assumed that the MPEG-2 TS is carried over an MBMS bearer.

Within the above concept, yet two additional options are worthwhile to be considered:

- 1) The service access information, including the MBMS radio parameters for each service, are carried inband of the MPEG-2 TS.
- 2) There is a dedicated service announcement channel that distributes the network information for each service to enable service bootstrapping.

Note that the MPEG-2 TS may be a single program stream or a multi program stream, i.e. multiple programs are multiplexed.

There are three options on this architecture:

- 1) 3GPP excludes this architecture entirely.
- 2) 3GPP fully defines an MPEG-2 TS based service layer with the objective of alignment with the DVB service layer.
- 3) 3GPP defines the minimum bootstrapping parameters for service discovery and access, but leaves the inclusion of those to the organization that owns the service layer.

It is recommended to only address option 3, i.e. enable the feature, but leave definition to outside world.

6.6.4.3 MBMS Service Layer

Figure 10 provides an architecture that is centric to the reuse of the MBMS Service Layer for TV distribution. In this case the broadcaster-centric services, typically available in MPEG-2 TS (see some discussion clause 5.2), need to be converted to MBMS Service Layer. This may include issues such as:

- converting DVB service layer information to the MBMS USD where possible, and extending the MBMS USD as necessary
- provide suitable encapsulation
- transcoding of media to 3GPP codecs
- new multiplexing requirements

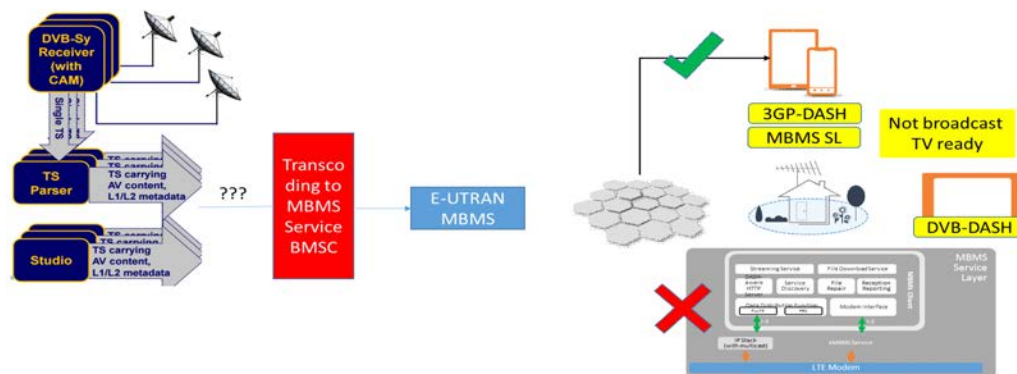

Figure 10 MBMS Service Layer Usage

Figure 10

The MBMS User Services should support all required features that permit to replicate an existing service.

It may be the case that broadcasters already produce content for mobiles or for DASH Linear TV services. It may well be that no transcoding is necessary, only a mapping to the MBS service.

6.6.5 Gap Analysis

6.6.5.1 DVB Service Layer Reuse

Following the recommendation, in order to enable this architecture, at least the following aspects need to be considered:

- Necessary information for accessing an MBMS bearer.
- Interface from content provider to BMSC to carry such information.
- Interface from BMSC to content provider to provide the information on an MBMS bearer. The actual encoding is done by the one that generates the service layer.
- Interfaces in the device for TRAPI to provide these generic functionalities.
- Possibly others.

For more details, refer to generic gap analysis in clause 7.1.

6.6.5.2 MBMS Service Layer Reuse

In order to enable this architecture, at least the following aspects need to be considered:

- Understanding all existing functionalities of existing service layers including codecs, etc.
- Provide a mapping of these functions to MBMS user service functions.
- If gaps are identified, those gaps are expected to be fulfilled as part of any normative work.
- Interfaces in the device for TRAPI to provide TV service centric APIs.
- Necessary exchange between content provided and BMSC, addressed by MI-TV.

A key issue is that stationary TV sets will not support the 3GPP MBMS Service Layer yet. Hence, all necessary functions and tools need to be provided to support integration of the service layer to stationary TV sets. It is considered that DASH can be the converging format.

For more details, refer to generic gap analysis in clause 7.2.

6.7 Extensibility

6.7.1 Description

Assume that in the year 2020, a broadcaster runs linear TV Broadcast Services using the 3GPP Service layer. The broadcaster wants to introduce a Virtual reality broadcast service running over the same radio network. The service can be targeted to new devices that implement the new services, whereas legacy devices ignore the service and provide a service with similar content, but with lower quality or inferior user experience.

6.7.2 Working Assumptions

- The same service announcement is used to describe the services.
- The broadcaster may provide services for different device types, possibly implementing different Releases of the 3GPP TV Service Layer.
- The broadcaster may simulcast services for different device types. However, the broadcaster typically wants to reduce the amount of simulcast options for different device types.
- The broadcaster wants to avoid service reception should the device capabilities be insufficient to consume the service.
- The broadcaster wants to provide services which are only supported by a subset of all devices.

6.7.3 Recommended Requirements

- The service signalling provides sufficient information such that the device can acquire and consume the service, or ignore it.
- The service layer defines service profiles that match receiver profiles, i.e. a service profile can be consumed by a receiver supporting a specific set of profiles.
- The amount of receiver profiles is small in order to avoid extensive simulcasting.
- Receiver profiles that fully support multiple service profiles, are beneficial.

6.7.4 Available Enablers in 3GPP, Gap Analysis and Potential for Optimization

Available Enablers:

- MBMS User Service Description includes features and feature requirements as documented in TS 26.346 [14], clause 11.9. This can be used and extended to meet required receiver profiles.
- The feature requirements include features such as service announcement profiles, specific codecs, specific delivery methods, etc.
- DASH supports the Media Presentation Profile profile signalling that can be exposed and included in the media type. The Internet media type can be signalled on User Service Description level. The Media Presentation Profile may include signalling on codecs and DASH features.

Optimization Potential:

- Consistent packaging of a baseline TV service profile and a proper signalling on DASH and MBMS User Service Level
- Signalling for extensions for advanced receivers and optional features on DASH and MBMS User Service Level

6.8 TV Service Delivery over Full MBMS Service Mode

6.8.1 Description

A mobile network operator wants to offer TV services from one or more TV content providers using Full MBMS Service Mode (Service Type 2). A TV content provider may provide the data for one or more TV channels. It is assumed that the TV Content Provider creates a continuous, linear content stream, which is composed out of a sequence of individual programs, advertisements and other components. The TV Content Provider may distribute the same continuous stream as TV service over traditional TV distribution paths or may adjust the services (in terms of programs and content) to other paths. The mobile operator wants to offer the service in the full network coverage, either using MBMS bearers or using unicast bearers. Note, the full network coverage can be larger than the MBMS services area, but limited by national borders or other constraints. Based on agreement with the TV content provider, either broadcast areas are defined statically or broadcast areas are created dynamically e.g. based on current usage.

The mobile network operator wants to offer similar functions like a traditional DTT (Digital Terrestrial TV) platform through the Full MBMS Service Mode. In particular:

- Information to identify individual TV services.
- Description of available programs for instance by providing an Electronic Program Guide (EPG).
- Multiple Media components such as audio and video.
- The TV receiver in this context is a full 3GPP device.
- Upon request from the TV content provider, the mobile operator offers (anonymized) reception statistics and (anonymized) quality feedback to the TV content provider.

6.8.2 Working Assumptions

The following set of working assumptions is applicable to this use case:

- TV services utilize MBMS User Services features as defined in TS 26.346, in particular MBMS bearer and unicast delivery. This corresponds to the Full MBMS Service Mode, which is Service Type 2 in TR 23.746.
- 3GPP Devices in context of this use-case are capable of MBMS reception and unicast reception. The 3GPP UE functions may be integrated into Smartphone or other devices like TV Sets or Set-top Boxes.
- Devices support at least Service Continuity, i.e. switch between Unicast and MBMS bearer usage. Devices may also support MBMS operations on Demand (MooD), i.e. allow the network to measure the current interest in the service.
- Needed service and program information are offered to the MBMS aware application.
- The mobile operator provides in collaboration with the TV content providers the application.
- The TV content provider provides TV related media in 3GPP encoding format. Optionally, the mobile network operator offers a transcoding service, which converts the streams to a 3GPP encoding format.
- The Application is provided by or in collaboration with the content provider. The Application can be installed by the user or may be pre-installed on the device.

6.8.3 Recommended Requirements

- The 3GPP System can offer all components of the TV service via unicast and MBMS bearers.
- The MBMS aware application handles TV service and program related information.

6.9 File Delivery Services over MBMS

6.9.1 Use Cases and Descriptions

Table 5 lists a set of example use cases for file-based services from 3rd-party content providers for delivery over MBMS and a brief description for each. The rationale and basic operation for these use cases should be mostly self-evident.

Table 5: Example Use Cases for Content Provider's File-based Services over MBMS

Use Case	Description
"Top-10" videos	Daily delivery over MBMS of the latest top-10 rated social media videos in multiple categories. The composition of these 10 video clips in a given category may change during the course of the day due to changes in popularity of the collection of videos in that category.
Stock ticker service	Continuous delivery of dynamic and near real-time market prices of a pre-selected set of company stocks, during the trading day of the NASDAQ stock exchange. The stock ticker service could be a standalone service to be subscribed and accessed for display by the UE, or is an application feature affiliated to another, main service (for example, a linear TV service). This service is nominally expected to be delivered as a Datacasting service, via either the scheduled-and-periodic or back-to-back delivery mode as defined in TS 26.346.
Movie download for time-shifted viewing	Scalable delivery of movies over-night for viewing during the next day.
Firmware updates	UE manufacturers' firmware updates via MBMS delivery.
Electronic newspaper delivery	Daily delivery of a collection of popular newspapers, the contents of which may change during the day.
Digital signage	Display of possibly time-varying, multimedia content pertaining to a variety of applications (advertisements, emergency alerts, highway conditions, etc.) on digital billboards.

6.9.2 High-level Requirements on Content Ingestion and Transmission over MBMS

6.9.2.1 Introduction

With regards to the use cases in Table 5, this section summarizes at a high level functional requirements regarding content ingestion at the BM-SC from the BM-SC perspective. Additionally, it contains requirements on User Service announcement/discovery and MBMS transmission of file-based services delivery, inferred or derived from the Content Provider's requirements. These latter requirements will be managed by the BM-SC based on the relevant information it obtains from the Content Provider (CP), for example, via xMB APIs. An alternative to conveying the information relating to service announcement and MBMS delivery requirements via the xMB Control Plane or User Plane API, such information could be built into the service level agreement between the MNO and the CP.

6.9.2.2 Top-10 YouTube Video Delivery

Ingestion-related requirements (from the BM-SC's perspective):

- The BM-SC will be informed whether the content ingestion mode is push or pull based;
- The resource location (file URL) for each video file is expected to be made available to the BM-SC in support of pull-based ingestion mode;
- In the event of pull-based ingestion of the video file from the CP server, the BM-SC is expected to be informed of the earliest wall-clock time that it can initiate a request for a given file from the Content Provider server;

- In the event of pull-based ingestion of the video file from the CP server, the BM-SC is expected to be informed of the latest wall-clock time that it can initiate a request for a given file from the Content Provider server;
- In the event of push-based ingestion, an HTTP(s) URL based resource location, identifying the BM-SC and associated directory structure for content ingestion, is expected to be provided to the CP server;
- In the event of push-based ingestion, the BM-SC is expected to be ready to accept the content whenever the CP server decides to send a video file;
- The BM-SC is expected to be informed of the actual sizes, and if not possible, at least the minimum and maximum size of the video files to be provided by the CP, via either pull- or push-based ingestion mode.

Inferred MBMS service announcement and delivery related requirements (from the Content Provider's service requirements):

- The BM-SC ought to be informed by the CP on whether the video files can be fetched by the UE over unicast from the CP server, and if so, the BM-SC ought to be provided their resource locations as HTTP(s) URLs (this information will be in turn provided to the UE via service announcement);
- The BM-SC ought to be informed by the CP about basic characteristics of the service such as service name and service language;
- The BM-SC ought to be informed by the CP of the earliest time that a given video file is expected to be available to the MBMS-aware application for rendering, if the CP imposes such a requirement;
- The BM-SC ought to be informed by the CP of the latest time that a given file is expected to be available to the MBMS-aware application for rendering, if the CP imposes such a requirement;
- The BM-SC ought to be informed by the CP as to whether dynamic changes may occur during the day in the composition of the "Top-10" video files (for a given category), and if so, for pull-based content ingestion, it ought to be notified by the CP of such changes, to enable subsequently informing the UE of such changes and scheduling MBMS delivery of the modified/new content.

6.9.3.3 Stock Ticker Service

Ingestion-related requirements:

- Same as those for the top-10 videos use case but with the follow exceptions (in addition to replacing the term "video file" by "stock quote file"):
 - Pull-based ingestion, and related requirements, are likely inappropriate for this type of very frequently updated and time-sensitive file content;
 - It is unlikely that the BM-SC will need to know minimum and maximum size of the incoming files from the CP, as these are likely to be relatively small, and of similar size (e.g. a few hundred bytes).

Inferred MBMS service announcement and delivery-related requirements:

- The BM-SC is expected to be informed by the CP on whether the stock quote files can be fetched by the UE over unicast from the CP server, and if so, the BM-SC is expected to be provided their resource locations as HTTP(s) URLs (this information will be in turn provided to the UE via service announcement);
- The BM-SC is expected to be informed by the CP about basic characteristics of the service such as service name and service language;
- Assuming the stock ticker service is delivered as a Datacasting service, the BM-SC is expected to be informed by the CP on the expected periodic update interval of the stock prices in the reported collection (in order to set the values of the child element interval and attribute @mode of the r12:recurrenceAndMonitoring element in the session schedule, in defining the use of the scheduled-and-periodic or back-to-back delivery mode).

6.9.3.4 Movie Download for Time-Shifted Viewing

Ingestion-related requirements:

- Same as those for the top-10 videos use case (except for replacing the term "video file" by "movie file").

Inferred MBMS service announcement and delivery related requirements:

- Same as those for the top-10 videos use case (except for replacing the term "video file" by "movie file").

6.9.3.5 Firmware Updates

Ingestion-related requirements:

- Same as those for the top-10 videos use case (except for replacing the term "video file" by "firmware file").

Inferred MBMS service announcement and delivery related requirements:

- Same as those for the top-10 videos use case (except for replacing the term "video file" by "firmware file"), but preclude the following:
 - The BM-SC ought to be informed about basic characteristics of the service such as service name and service language.

6.9.3.6 eNews Delivery

Ingestion-related requirements:

- Same as those for the top-10 videos use case (except for replacing the term "video file" by "eNews file").

Inferred MBMS service announcement and delivery related requirements:

- Same as those for the top-10 videos use case (except for replacing the term "video file" by "eNews file").

6.9.3.7 Digital Signage

Ingestion-related requirements:

- Same as those for the top-10 videos use case (except for replacing the term "video file" by "signage file").

Inferred MBMS service announcement and delivery related requirements:

- Same as those for the top-10 videos use case (except for replacing the term "video file" by "signage file"), but preclude the following:
 - The BM-SC ought to be informed about basic characteristics of the service such as service name and service language.

6.9.4 Use Case Independent Requirements

The following requirements apply to all of the above use cases:

- Assuming that the SLA between the MNO and the CP allows notification of MBMS network/service/session related events to be provided to the CP, and depending on whether the pull or push based notification method will be employed, the corresponding pull or push URL ought to be provided to the CP server or BM-SC, respectively, by the opposite entity.
- If the service is intended by the CP to be delivered to specific geographical areas via MBMS or unicast bearers, the BM-SC ought to be informed by the CP on the target/restricted delivery area(s).

6.10 ATSC Service Layer in enTV

6.10.1 ATSC 3.0 Overview

The Advanced Television Systems Committee (ATSC) is developing ATSC 3.0 as the next generation ATSC Digital Television (DTV) transmission standard for use over terrestrial broadcast, cable and satellite networks. ATSC 3.0 systems will be deployed in South Korea in 2017 and later in the USA, and likely in the future in other major North American countries such as Canada and Mexico. ATSC 3.0 comprises a family of 19 component specifications which include the physical layer, IP-based transport protocols, service and application level signaling, content formats for carriage of streaming media services, security and content protection, and a W3C-compliant and Web application based runtime environment. The specific specification which defines, among other functionality, the media content format and application transport protocols of ATSC 3.0 services is A/331, "Signaling, Delivery, Synchronization, and Error Protection" [3].

Media content produced by ATSC 3.0-compliant audio and video codecs and closed captioning systems are encapsulated in ISO BMFF (Base Media File Format) container structures. Two types of ISO BMFF compliant file formats are defined in A/331:

- 1) MPEG-DASH as defined by ISO/IEC 23009-1 [4] and further profiled by the DASH-IF Interoperability Point for ATSC 3.0 [5], and
- 2) MPU (Media Processing Unit) as defined by ISO-IEC 23008-1 [6], the latter specification also known as MMT or MPEG Media Transport.

Broadcast transmission of ATSC 3.0 streaming services, e.g. linear TV services, may employ either the ROUTE (Real-Time Object Delivery over Unidirectional Transport) protocol, as defined in A/331 [3], for the delivery of DASH-formatted content, or the MMTP protocol (MPEG Media Transport Protocol) as defined in ISO/IEC 23008-1 [6] for the delivery of MPU-formatted content. File delivery services, as well as other Non-Real-Time (NRT) content such as ROUTE-specific service signaling, application signaling, application content, Electronic Service Guide (ESG) and emergency alert messages, are strictly delivered using the ROUTE protocol. The protocol stack model of an ATSC 3.0 reference receiver is shown in Figure 11 below.

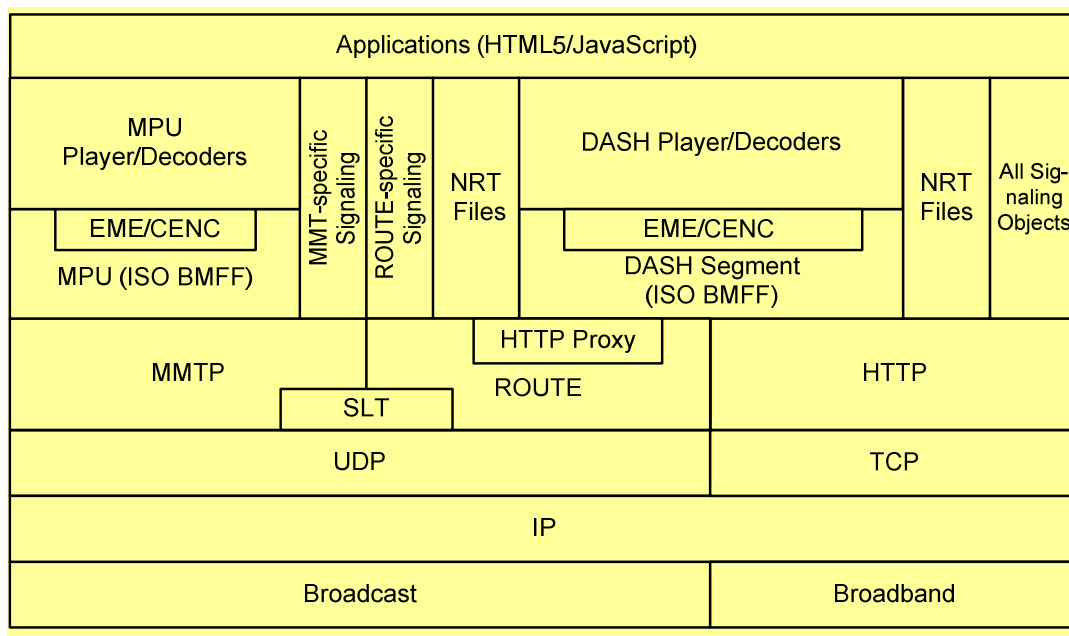

Figure 11: ATSC 3.0 Reference Receiver Protocol Stack

Note that broadcast delivery of ATSC 3.0 Real-Time (RT) and NRT services/content is natively IP-based. There is no use of MPEG-2 Transport Stream for the encapsulation and packetization of streaming media content in the form of Packetized Elementary Streams (PES) as done in DVB-T. For broadcast RT or streaming content, encoded samples of video and/or audio elementary stream are encapsulated in ISO BMFF and transported by ROUTE or MMTP over UDP/IP. For broadcast NRT content of different types, the associated file objects are delivered by ROUTE over UDP/IP. IP packets containing either RT or NRT content are encapsulated in ALP (ATSC Link-Layer Protocol) packets as defined by A/330 [7], which are in turn enclosed in Baseband Packets of Physical Layer Pipes (PLP) as defined by A/322 [8]. The protocol stack models for RT and NRT content delivery are shown in Figures 12 and 13, respectively.

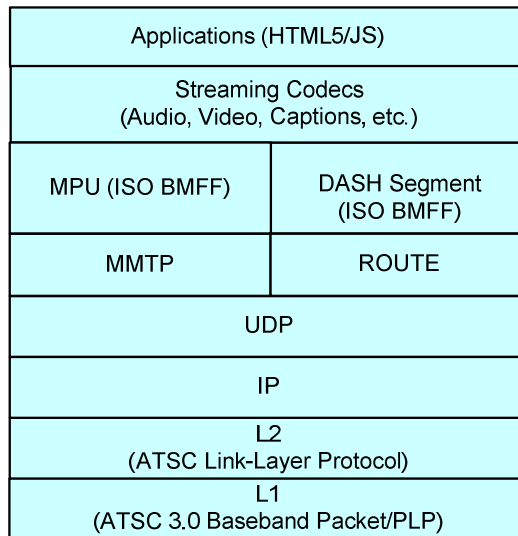

Figure 12: ATSC 3.0 Protocol Model for Broadcast Delivery of RT Content

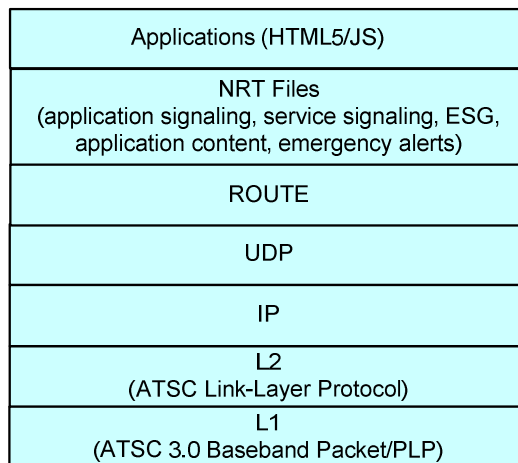

Figure 13: ATSC 3.0 Protocol Model for Broadcast Delivery of NRT Content

6.10.2 Content Format and Protocol Model for ATSC 3.0 Service and Metadata Delivery over xMB

This section and its sub-sections describe the format and protocol structure of user plane data, in the form of ATSC 3.0 service content and service metadata, delivered from the TV Content Provider to the BM-SC of the MBMS network operator, across the xMB interface. As previously indicated, these formats and protocol stack models apply to both the transport-only mode, as well as the MBMS User Service mode with content formatting/translation to MBMS service layer functionality performed by the BM-SC. In addition, the content format and protocol model for the exchange over xMB of native ATSC 3.0 service metadata and auxiliary contents such as application signaling, service announcement/discovery signaling, ESG and other auxiliary information, are also described.

6.10.3 ATSC 3.0 Service Data Content Format and Protocol Model

For streaming TV services such as live events, linear TV programs and video-on-demand (VoD), ATSC 3.0 specifies HEVC for video encoding and includes features such as Spatial Scalable Coding, High Dynamic Range, Wide Color Gamut, 3D, and temporal layering, as defined in ATSC A/341 [9]. For audio, the specified ATSC 3.0 codecs are AC-4 and MPEG-H, as defined in the ATSC A/342 Parts 2 and 3 standards [10], [11]. Video encoding is typically expected to be set to operate in Variable Bit Rate (VBR) mode. Audio encoding is expected to be set to either VBR or CBR (Constant Bite Rate) mode. ATSC 3.0's captioning and subtitling mechanism as defined in ATSC A/343 [12] is based

on SMPTE Timed Text (SMPTE-TT) as specified in SMPTE 2052-1 [13], and in particular, employs the subset of SMPTE-TT features defined by W3C's "TTML Text and Image Profiles for Internet Media Subtitles and Captions (IMSC1) [14].

NRT content such as download files of an ATSC 3.0's App-based Service, or files of an App-based feature bound to a linear service, for display to the user under application control, are delivered over the ROUTE protocol, defined in A/331 [3], as file objects described by file metadata in the form of the Extended FDT, similar to the FDT in the FLUTE protocol as specified by IETF RFC 6726 [15].

6.10.4 ATSC 3.0 Service Content Protocol Stack over xMB-U

The user plane protocol stack model for ATSC 3.0 service data delivery across xMB-U is depicted below in Figure 14.

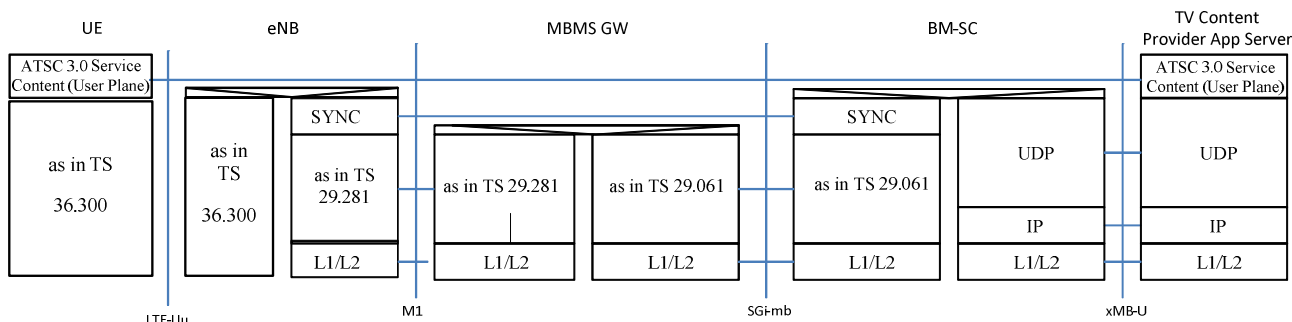

Figure 14: ATSC 3.0 Service Content Protocol Stack over xMB-U reference point and in the EPC

Due to the encapsulation of user plane data in IP, this protocol model has similarity to the MB2-U interface between the Group Communication Service Application Server (GCS AS) and the Broadcast-Multicast Service Centre (BM-SC) as defined in TS 29.468 [17]. In broadcast delivery of ATSC 3.0 streaming services over xMB-U, user plane data comprises ISO base media files containing encoded media samples and carried as DASH Media Segments or MPUs by the ROUTE or MMTP protocol, respectively. This is shown in Figure 15. The user plane protocol model for broadcast delivery of NRT file objects over xMB-U is shown in Figure 16. Similar to the operation of GCS application data delivery over MBMS, ATSC 3.0 User Plane data are transparently transported between the TV Content Provider's Application Server (AS) and the UE. The BM-SC forwards these protocol layers transparently.

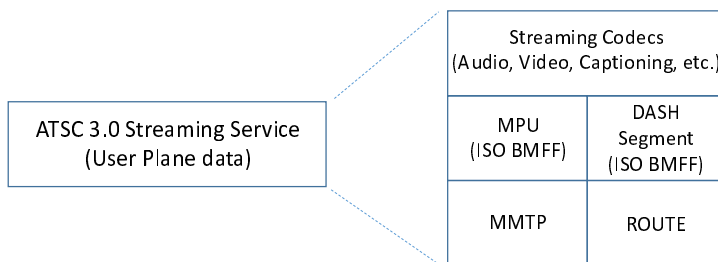

Figure 15: ATSC 3.0 Streaming Service Protocol Stack over xMB-U



Figure 16: ATSC 3.0 NRT Service Protocol Stack over xMB-U

7 Architectural Considerations

7.1 MBMS Service Type 1: Transport only mode

7.1.1 Architecture and Interfaces

Based on the analysis and use cases in clause 6 and taking into account the service modes in Figure 17 provides an end to end architecture for the transport-only mode. It is assumed that the service is provided from the content provider and there is an ability for pass-through delivery of media content from the content provider, via user plane service on the XMB, referred to as XMB-U, to the application through a TRAPI user plane interface, referred to as TRAPI-U. This user service is transparently maintained end to end in order to reuse existing service layers provided by the content provider and existing service layer consumption modules in the application.

In addition to the user plane, the appropriate control interfaces over xMB (i.e. xMB-C) need to be defined in order to enable the end to end delivery.

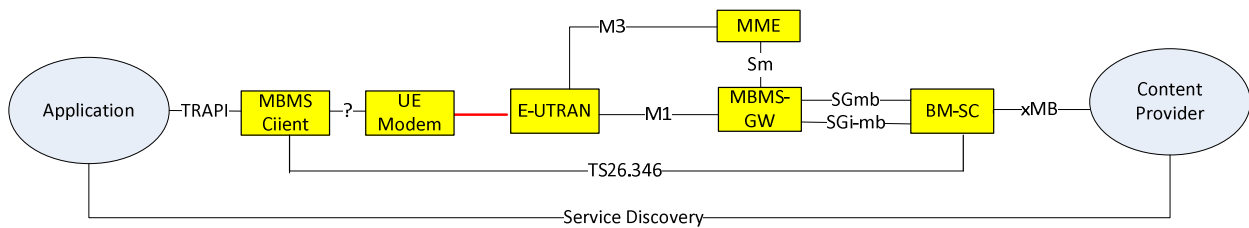

Figure 17: Architecture for Transport-only Mode

One of the main properties of the Transport-only mode is the ability to reuse the existing and externally-provided service and media clients via the MBMS-API interface as shown in Figure 18.

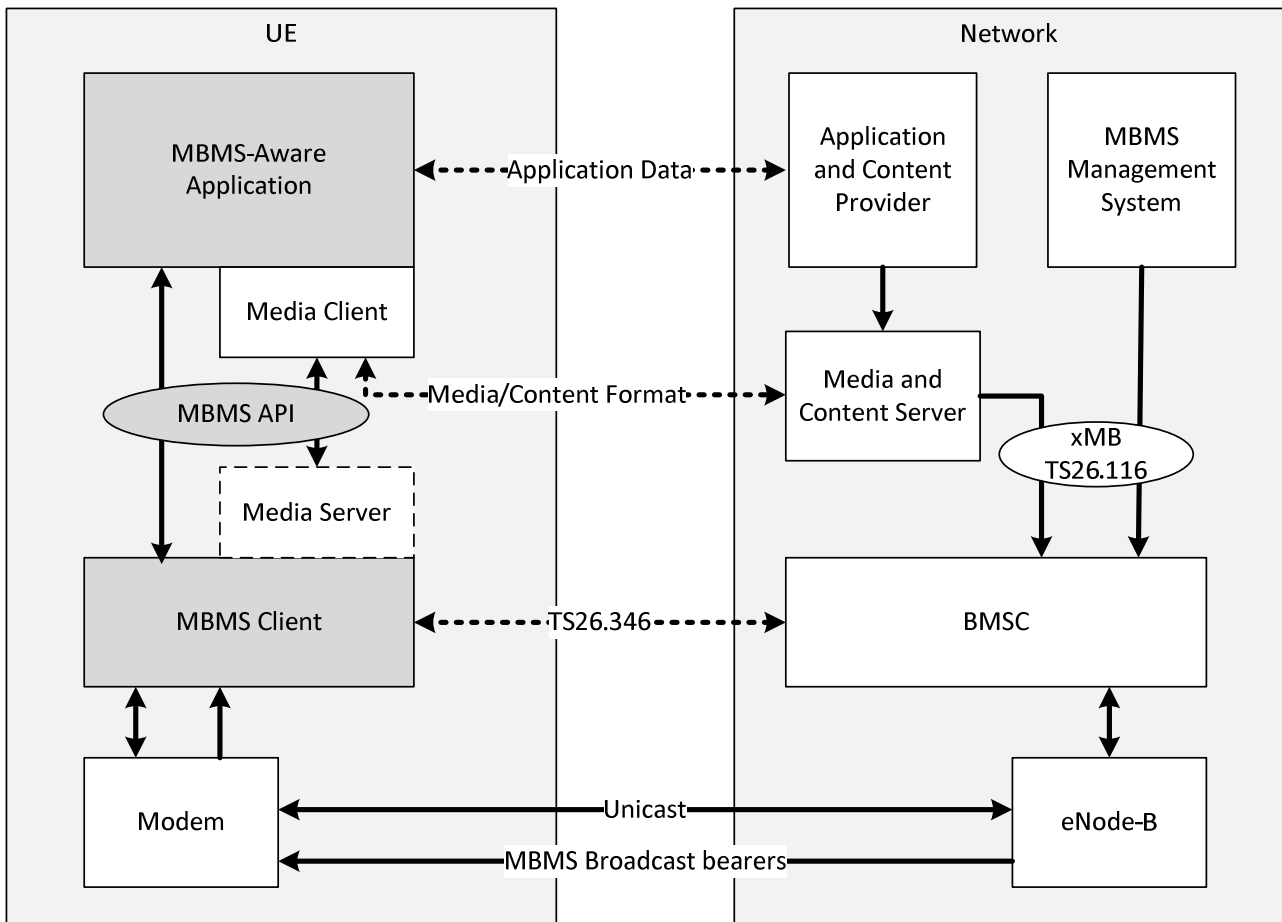

Figure 18: APIs and interfaces on Content Provider and Receiver

7.1.2 User Plane Modes

Based on the use cases in clause 6, the following modes for the user plane may deliver the following content on xMB-U and MBMS-API-U:

- 1) Circuit-switched MPEG-2 Transport stream with constant bitrate. The stream may contain a single TV service, typically referred to as Single Program Transport Stream (SPTS) or may be a multiplex of multiple TV Services, typically referred to as Multi-Program Transport Stream (MPTS).
- 2) A service with IP encapsulation with constant bitrate. The stream may contain a single TV service, or may be a multiplex of multiple TV Services.
- 3) A service with IP encapsulation with a capped variable bitrate. The stream may contain a single TV service, or may be a multiplex of multiple TV Services.

In all cases the streams may be encrypted or non-encrypted.

In order for receivers and applications functioning properly in all use cases, the stream needs to be provided with certain properties to the application, similar as defined by the Hypothetical FEC Receiver in TS 26.346 for Streaming Delivery Mode. Details on the requirements on bitrates and other properties require additional discussions.

The Content provider may in addition assign other required QoS parameters, for example maximum tolerated loss rate, maximum service access time or maximum end-to-end delay of the service.

7.1.3 Control Plane for Receive-Only Mode

In order to enable the delivery of such a pass-through mode, there needs to be an end-to-end call flow in place. Figure 19 shows an example for the case of mode 1 from above, i.e. a constant bitrate delivery is provided and no additional.

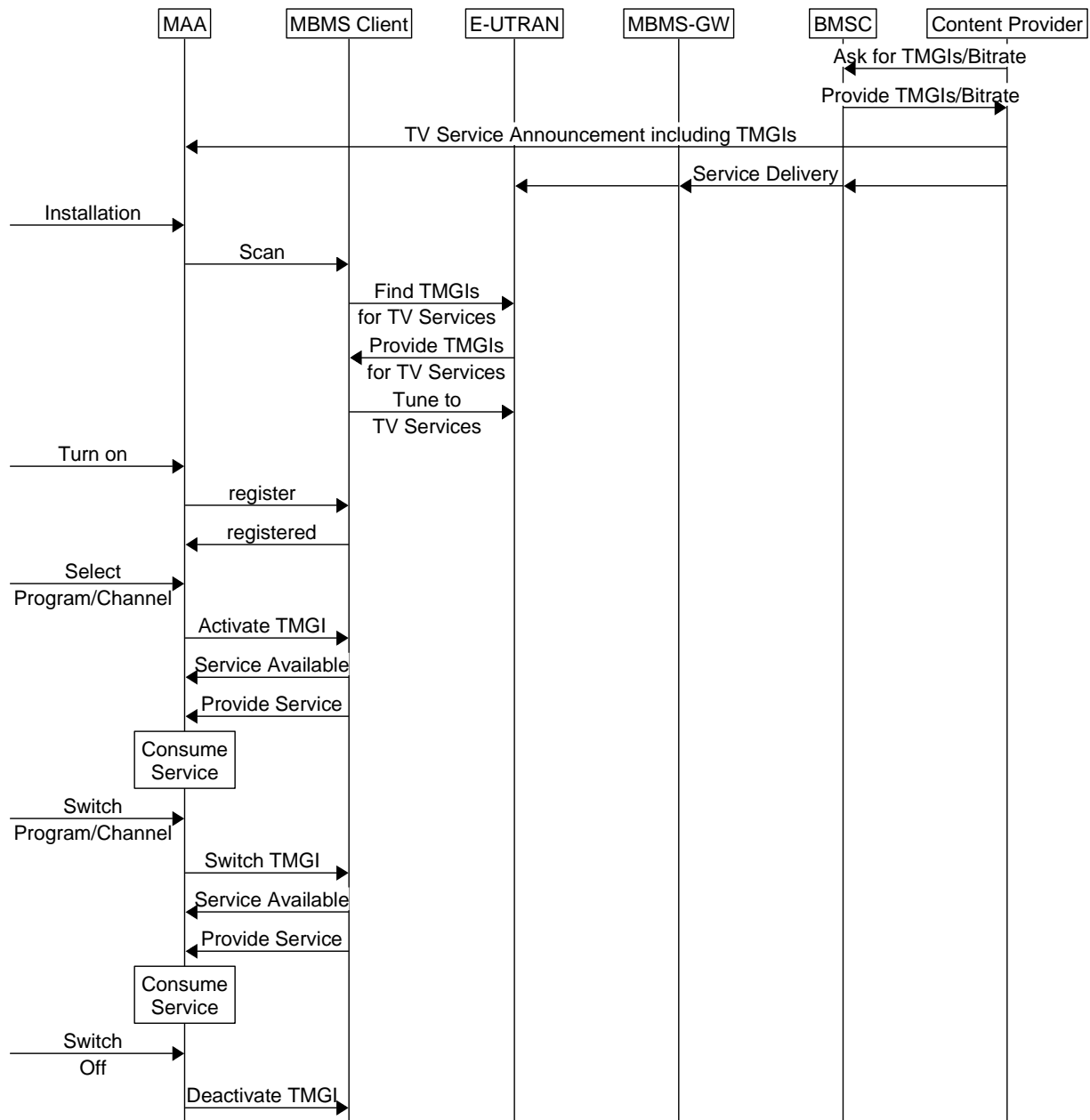

<http://msc-generator.sourceforge.net v5.4>

Figure 19: Procedures for Control Plane in Receive-only mode for Circuit-Switched Case

- 1) The content provider has an SLA in place with the eMBMS operator and is assigned a set of pre-allocated TMGIs and bitrates.
- 2) The Content Provider announces the pre-allocated TMGIs to the Application, out-of-band. These may be statically assigned forever or may be dynamic, but the dynamic updates is in control of the Content Provider.
- 3) The Content Provider delivers the services to the BMSC and the BMSC relays the services to the E-UTRAN. The service runs continuously.
- 4) An Application is installed and scans for all TV services.
- 5) An Application is turned on and registers with the MBMS client.
- 6) A program is selected and the application uses the Service Announcement to select a specific service by activating the TMGI.
- 7) The Application informs the MBMS client through TRAPI on the selected TMGI. The MBMS client selects that service and provides it through TRAPI-U to the Application.

- 8) The Application may switch program which results in selecting a new TMGI.
- 9) The Application may terminate the reception of the of the TV service.

For the IP-based mode, the BMSC should also provide the IP delivery information to the content provider in order for the content provider to perform the proper service announcement.

7.1.4 Working Assumptions

7.1.4.1 General

- The delivery supports the following modes:
 - Circuit-switched MPEG-2 Transport stream with constant bitrate
 - A service with IP encapsulation with constant bitrate
 - A service with IP encapsulation with a capped variable bitrate
- The streams may be encrypted or non-encrypted.

7.1.4.2 XMB Interface

- The xMB interface for these modes provides a control and user plane interface.
- The content provider delivers the service over xMB-U using a protocol that provides sufficient information in order for the BMSC and MBMS network to enable recovery of the relevant stream properties on MBMS-API data interface.
- The content provider may provide some quality-of-service parameters for the service, such as maximum loss rate, start-up latency or BMSC-to-MBMS client delay.
- The streams may include markers for modifications, such as SCTE-35 messages. However, the use of such markers for example for targeted ad insertion, content splicing, content replacement, black-outs and so on is outside the scope of the present document.

7.1.4.3 BMSC to MBMS Client delivery

- The delivery is IP-based
- The delivery is not the group communication delivery
- The delivery does not require any changes for the core and radio network interfaces

7.1.4.4 MBMS client to E-UTRAN

- The MBMS client can select the service by information provided from the Application through the TRAPI control interface, typically the TMGI and possibly some IP address or filtering.

7.1.4.5 Service Announcement

- The TV service announcement is done by the application.

7.1.4.6 MBMS-API

- The API provides a control and user plane interface.

7.1.5 Gap Analysis

7.1.5.1 xMB

- User plane mode to deliver the three identified type of streams from the Content Provider to the BMSC
- Delivery of information on the stream properties that need to be recovered at the MBMS-API-U interface
- Resource allocation request
- Resource allocation confirmation and provisioning of Service access parameters

These features are fulfilled by TS 29.116 [24] in Rel-14 for CBR modes.

7.1.5.2 BMSC to MBMS Client delivery

- BMSC delivery mode with IP (need some fixed parameters), similar to the Group Communication delivery enabler
- BMSC delivery mode for circuit-switched, similar to the Group Communication delivery enabler, but requiring an IP encapsulation in the delivery from the BMSC to MBMS client
- Basic service announcement may be necessary for certain modes, likely SDP information

These features are fulfilled by TS26.346 [14] in Rel-14 using the transparent delivery mode.

7.1.5.3 MBMS-API

- MBMS-API control plane API for service selection, service switching and service deselection including different types of error handling
- MBMS-API user plane API for service handling in order to feed data into regular Protocol stack

These features are fulfilled by TS26.347 [23] in Rel-14 using the Packet APIs for transport only and transport only with receive only mode.

7.1.6 Optimization Potentials

7.1.6.1 BMSC to MBMS Client delivery

- Basis FEC framework to enable improved QoS if delay permits based on Streaming Delivery FEC Framework in TS 26.346
- Addition of unicast modes to the delivery
- Addition of MBMS-on-Demand modes

These features have not been addressed in Rel-14, but are not considered critical.

7.2 MBMS Service Type 2: Full MBMS service mode

7.2.1 Architecture and Interfaces

Based on the analysis and use cases in clause 6 and taking into account the service modes in Figure 20 provides an end to end architecture more for the full service layer mode.

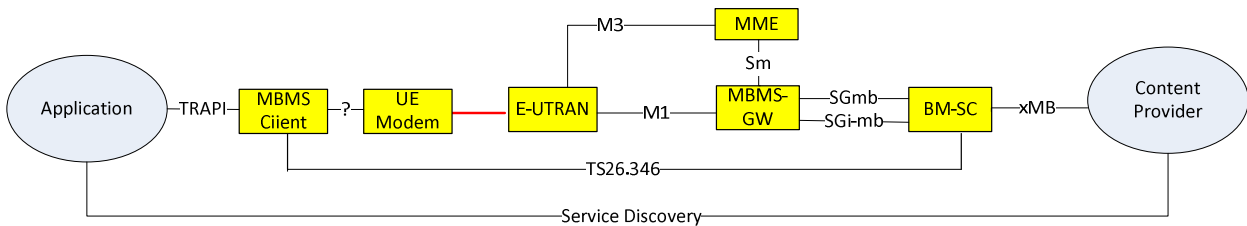

Figure 20: Architecture for Full MBMS Service Mode

One of the main properties of the Full MBMS service mode is the ability to reuse existing 3GPP service layer for consumption of the media. The Content Provider in this case offers the service conforming to 3GPP TV services. The DASH Server and DASH client are expected to comply with the 3GPP DASH formats as defined in TS 26.247 [28].

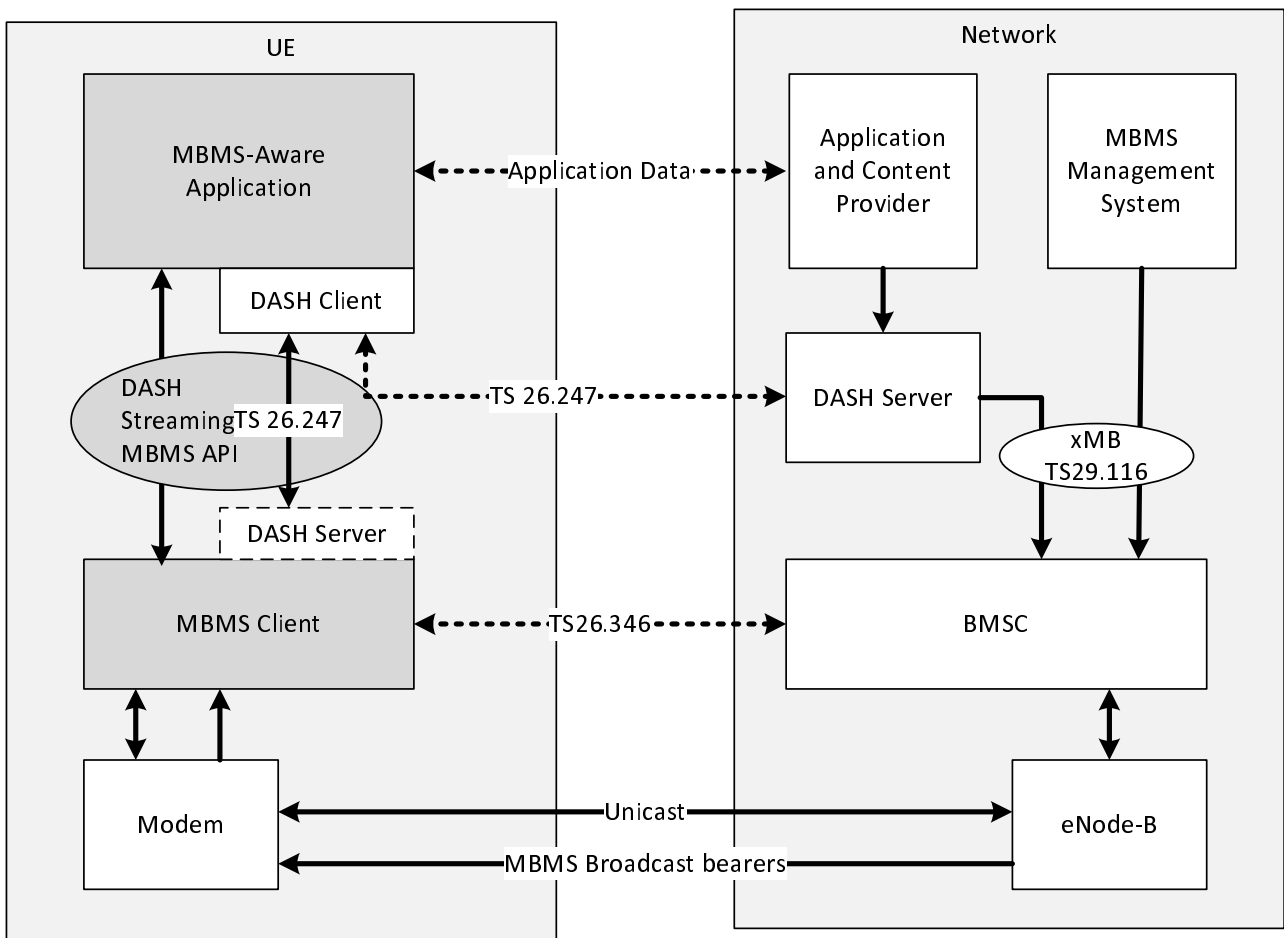

Figure 21: APIs and interfaces on Content Provider and Receiver

Two deployment scenarios may be considered:

- 1) The DASH Server (together with the 3GPP formats for media) are owned by the content provider. In this case the content provider produces the formatted media that can be distributed by following the requirements in 3GPP specifications in order to use the 3GPP defined media, DASH client, and the formats need to be distributed over xMB.
- 2) The DASH Server (together with the 3GPP formats for media) are owned by the network operator. In this case the content provider may provide any type of formats and services, but the network provider will convert the service and formats in accordance to the 3GPP requirements. This may for example include changing the metadata, delivery format or even full transcoding.

7.2.2 User Plane Modes

Based on the use cases in clause 6, the following content may be delivered on xMB-U and MBMS-API-U for the first deployment scenario:

- 1) DASH Streaming Services using the appropriate 3GPP profile.
- 2) RTP Streaming service using the appropriate 3GPP profile.
- 3) File-delivery services for which the content complies with the appropriate 3GPP profile.

For the second deployment scenario, the content on xMB may be not follow a 3GPP profile, in which case transcoding will be necessary.

The Content provider may in addition assign other required QoS parameters, for example maximum tolerated loss rate, maximum service access time or maximum end-to-end delay of the service.

7.2.3 Control Plane

In the case of using a 3GPP profile on the user plane, the control plane needs to announce the details of the service parameters. For details refer to TS 26.346 [14], clause 5.4A and TS 29.116 [24].

7.2.4 Available Enablers in 3GPP, Gap Analysis and Optimization Potentials

For technical enablers on format level, refer to clause 6.5.4.

xMB and MBMS-APIs support the services since Rel-14 in TS 29.116 [24] and TS 26.347 [23], respectively.

Open issue and gaps remain. For more discussion refer to the summary in clause 8.

8 Summary on Addressing Stage-1 Service Requirements

Table 6 provides an overview on the Stage-1 Service Requirements and to what extent those are fulfilled in 3GPP with the completion of Rel-14 specifications.

Table 6: Stage-1 Service Requirements and Mapping to 3GPP specifications

Requirement	3GPP Service Layer	Transport-only
The eMBMS service layer should support audio and video formats typically supported by TV Content Providers for SD and HD TV transport services and UHD TV transport services.	<p>Typical TV service formats are documented in TR 26.949 [29].</p> <p>Video:</p> <ul style="list-style-type: none"> - Fulfilled through formats in TS 26.116 [30] - Formats to support UHD-1 phase 2 as for example defined in DVB are not supported in 3GPP yet, but suggestions are provided in TR 26.949 [29] to address those. <p>Audio:</p> <ul style="list-style-type: none"> - 3GPP supports stereo audio through eAAC+ (HE-AACv2) - Multichannel and next generation audio formats are not available in 3GPP <p>For more details also refer to clauses 6.4.4 and 6.5.4.</p>	Pass-through of the externally-define formats, syntax and semantics of the service layer, for example by DVB or ATSC3.0. The video formats defined in the TV Video profiles TS 26.116 [30] are aligned with DVB UHD-1 phase 1. 3GPP does not have any requirements or recommendations on external service layers.
The eMBMS service layer should support codecs typically supported by TV Content Providers for HD TV services and UHD TV services.	<p>Typically supported TV codecs are summarized in TR 26.949 [29].</p> <p>Video:</p> <ul style="list-style-type: none"> - Fulfilled through codecs in TS 26.116 [30] - Codecs to support UHD-1 phase 2 as for example defined in DVB are not supported yet, but suggestions are added in TR 26.949 [29] to address those. <p>Audio:</p> <ul style="list-style-type: none"> - eAAC+ is aligned with HE-AACv2 which is supported in DVB as stereo codec - Codecs recommendations to support multichannel beyond stereo and Next Generation Audio (NGA) are not specified in 3GPP <p>For more details also refer to clauses 6.4.4 and 6.5.4.</p>	Pass-through of the codecs of the externally-defined service layer, for example by DVB or ATSC3.0. The video codecs defined in the TV Video profiles TS 26.116 [30] are aligned with DVB UHD-1 phase 1. 3GPP does not have any requirements or recommendations on external service layers.
The eMBMS service layer should support accessibility functions typically supported by TV Content Providers (e.g. subtitling, closed captioning, audio descriptions, anonymous reception, reporting to support ratings, reporting enforcement, etc.).	3GPP service layer does not support these functionality. For more details also refer to clauses 5.3, 6.4.4 and 6.5.4.	Pass-through of the externally-defined service layer functionality. 3GPP does not have any requirements on external service layers.
The eMBMS service layer should support regulatory mandates typically supported by TV Content Providers (blackouts, emergency alerts, etc.).	3GPP service layer does not support these functionalities. For more details also refer to clause 5.3.	Pass-through of the externally-defined service layer functionality. 3GPP does not have any requirements on external service layers.
The eMBMS service layer should support interactivity functions typically supported by TV Content Providers (interactive services, second screen, personalization, etc.).	<p>3GPP service layer supports the HTML-5 based presentations as documented TS 26.307 [33] which enables certain functionalities. However, the details on whether the documented APIs are sufficient to fulfil the use cases as well as the carriage over MBMS are not complete.</p> <p>A more detailed analysis on use cases, requirements and gaps for interactive services is provided in TR 26.953 [31].</p>	Pass-through of the externally-defined service layer functionality. 3GPP can support interactivity by combining broadcast services with unicast services based on LTE. 3GPP does not have any requirements on external service layers.

<p>The eMBMS service layer should support ad insertion use cases typically supported by TV Content Providers (targeted ad insertion, ad replacement, etc.),</p>	<p>3GPP service layer and DASH supports ad insertion and also targeting and personalization using Periods, for example using xlink based referencing. However, no specific aspects on ad selection are included and support on network elements is for further study. For more details also refer to clauses 6.4.4 and 6.5.4.</p>	<p>Pass-through of the externally-defined service layer functionality. 3GPP does not have any requirements on external service layers.</p>
<p>The eMBMS service layer should support encryption, security and conditional access functions typically supported by TV Content Providers.</p>	<p>3GPP service layer supports a set of security functions, primarily targeting transport security. However, the applicability to TV services is not yet studied. For DRM, no consistent encryption scheme is defined.</p>	<p>Pass-through of the externally-defined service layer functionality. However, 3GPP does not have any requirements on external service layers.</p>
<p>The eMBMS service layer should support efficient concurrent delivery of multiple application components (TV service application signalling, statistical multiplexing, etc.).</p>	<p>3GPP service layer supports delivering multiple services and multiplexing the services on a single TMGI or on multiple TMGIs. Statistical service multiplexing on xMB is not supported. A more detailed study on statistical multiplexing would be beneficial, but should be backed by very concrete use cases and requirements and need a full end-to-end study from content provider, xMB, encoding, service layer, radio layer, MBMS client, APIs and applications.</p>	<p>Pass-through of the externally-defined service layer functionality permits efficient concurrent delivery, but with limitations. For example, efficient statistical multiplexing is for further study.</p>
<p>The eMBMS service layer should support random access and channel change times comparable to existing HD TV services.</p>	<p>3GPP service layer supports these functionalities in principle, random access is addressed in TV video profiles in TS 26.116. Channel change times and latency may be optimized and are for further study.</p>	<p>Pass-through of the externally-defined service layer functionality. 3GPP does not have any requirements on external service layers.</p>
<p>The eMBMS service layer should support TV service content delivery over broadcast only, unicast only and combinations of the two.</p>	<p>Broadcast only is supported and with receive-only mode even a pure receive-only mode is available. Unicast only is supported in 3GPP since Rel-12 with Mood, but the service is still considered an MBMS service. The combinations of the two are supported by Mood and unified MPD, but simultaneous usage of broadcast and unicast is for further study.</p>	<p>Broadcast only is supported and with receive-only mode even a pure receive-only mode is available. Unicast is not supported in 3GPP for transport-only. The combinations are supported by the independent use of unicast and broadcast through an external service layer, e.g. HbbTV.</p>
<p>The eMBMS service layer should support delivery of real-time and non-real-time content.</p>	<p>Supported by the delivery modes and services in 3GPP TS 26.346, specifically download delivery and DASH-over-MBMS.</p>	<p>The transport-only mode with the transparent delivery permits delivery of real-time external services. The functionality carries through from the external service layers. 3GPP does not have any requirements on external service layers.</p>
<p>The eMBMS service layer should enable extensibility and forward-compatibility to new requirements, formats, codecs and other functions to the extent possible.</p>	<p>Supported by usage of XML in the User Service Description as well as the MBMS features in clause 11.9 of TS 26.346. The formats in use such as DASH, 3GP file format and protocols are extensible. For more details also refer to clause 6.7.</p>	<p>Pass-through of the externally-defined service layer functionality. 3GPP does not have any requirements on external service layers.</p>

An eMBMS transport layer should be able to transport TV streams formatted not compliant to 3GPP standards.	For the service layer, the use of download delivery permits to distribute any format in NRT. With the use of the APIs the application can access the files. The Generic Application Service as defined in clause 5.7 of TS 26.346 permits to distribute timed objects beyond DASH formats.	The transport-only mode with the transparent delivery permits real-time delivery of external services. Pass-through of the externally-defined service layer functionality. 3GPP does not have any requirements on external service layers.
A UE should be able to access an eMBMS transport session with the support of only transport metadata.	Following the above, the delivery modes may be used together with the MBMS Service Announcement. Profiles for Service Announcement are defined in TS 26.346 [14], clauses L.2 and L.3.	Following the above, the transparent delivery mode may be used together with the MBMS Service Announcement. Service Announcement profile is defined in TS 26.346 [14], clause L.5.
An eMBMS system should be able to be initiated by a UE with sufficient metadata provided by a mechanism other than User Service Description for non 3GPP transport services.	Not available for the MBMS service layer, but not considered as a gap.	The BMSC may inform the content provider through xMB on the bearer parameters and the content provider may provide this information to the UE by other means than the User service description.

9 Conclusions and Recommendations

In course of Rel-14 the following gaps have been addressed to fulfil enhanced TV Services

- Standardized xMB interface towards the (TV) content provider
- Receive-only mode
- Transparent delivery method (also referred to in TS 23.746 [16] as "MBMS Service Type 1", or "Transport only mode")
- Shared MBMS Broadcast
- For this purpose the following specifications are updated in Release-14:
 - 3GPP TS 23.246 [22] MBMS Architecture (Annex D and Annex E)
 - 3GPP TS 26.346 [14] MBMS Protocols and Codecs
 - 3GPP TS 26.347 [23] MBMS APIs and URL
 - 3GPP TS 29.116 [24] stage 3 aspects of xMB Interface
 - 3GPP TS 24.117 [25] TV Service Configuration Management Object
 - 3GPP TS 24.116 [26] Stage 3 aspects of MBMS service for Receive Only Mode
- Radio Enhancements as documented in clause 4.4 of the present document.
- A full TV service using the transport-only mode with the transparent delivery in TS 26.346 [14] the Service Announcement profile is defined in TS 26.346 [14], clause L.5, and the MBMS-APIs for transparent mode.
- Video formats and codecs are to a large extent supported through formats in TS 26.116 [30].
- 3GPP audio formats and codecs support stereo audio only through eAAC+ (HE-AACv2) as specified in TS 26.234 [32] and TS 26.346 [14].
- 3GPP service layer supports the HTML-5 based presentations as documented TS 26.307 [33] which enable certain functionalities for interactivity and app-based support of TV services.

- 3GPP service layer and DASH supports basic enablers for ad insertion and also targeting and personalization using Periods, for example using xlink based referencing.
- 3GPP service layer supports delivering multiple services and multiplexing the services on a single MBMS bearers or on multiple MBMS bearers. An MBMS bearer is identified by an TMGI.
- 3GPP service layer supports random access functionalities in principle through DASH and TV video profiles in TS 26.116 [30].
- 3GPP service layer supports broadcast only with receive-only mode, unicast only is supported in 3GPP since Rel-12 with Mood.
- Real-time and non real-time services are supported by the delivery modes and services in 3GPP TS 26.346, specifically download delivery and DASH-over-MBMS.
- The 3GPP service layer supports to distribute any format in NRT by the use of download delivery permits and with the use of the APIs the application can access the files. In addition, 3GPP service layer permits to distribute timed objects beyond DASH formats using the Generic Application Service as defined in clause 5.7 of TS 26.346.
- The 3GPP service layer supports access of an eMBMS transport session with the support of only transport metadata using the transparent delivery mode with the MBMS Service Announcement.
- 3GPP supports the initiation of a TV service by a UE with sufficient metadata other than User Service Description.

The following gaps and optimization potentials up to Release-14 on the MBMS service layer have been identified to fulfil enhanced TV Services:

- generally
 - Video formats and codecs to support UHD-1 phase 2 as for example defined in DVB are not supported in 3GPP.
 - Multichannel beyond stereo and next generation audio (NGA) formats and codecs are not specified in 3GPP.
 - Not all accessibility functions typically supported by TV Content Providers (e.g. subtitling, closed captioning, audio descriptions, etc.) are yet specified in 3GPP.
 - interactivity functions typically supported by TV Content Providers (interactive services, second screen, personalization, etc.) are not yet specified in 3GPP except a generic HTML-5 profile. A detailed gap analysis on interactive services is provided in TR 26.953 [31].
- specifically for the transparent delivery method (transport-only mode)
 - Unicast is not supported in 3GPP for transport-only, but not considered as a gap as combinations are supported by the independent use of unicast and broadcast through an external service layer, e.g. HbbTV.
- specifically for the full MBMS service mode
 - typical TV functions as defined in clause 5 are not available for the full MBMS service layer mode.
 - consistent support for ad insertion use cases typically supported by TV Content Providers are not fully defined. For details refer to clauses 6.4.4 and 6.5.4.
 - consistent support for conditional access and digital rights management use cases typically supported by TV Content Providers is not fully defined.
 - Statistical service multiplexing on xMB is not supported. Statistical multiplexing on the delivery is for further study, more detailed use cases and the combination with unicast requires more study.
 - Random access, channel change times and end-to-end latency matching TV service requirements may be subject for optimization, but would require more detailed study.

- Simultaneous usage of broadcast and unicast for the same service and user has not been explicitly defined in 3GPP, but the tools available for MooD and unicast fallback may be sufficient, but requires further study backed by use cases.

The following recommendations are collected:

- follow the recommendations in TR 26.949 [29] to add video formats and codecs to support UHD-1 phase 2 as for example defined in DVB.
- Consider generating a specification for TV audio profiles in 3GPP and consider adding multichannel and next generation audio formats.
- Consider generating a specification for TV subtitling profiles in 3GPP aligned with common industry practices.
- Consider generating specifications, where necessary, for typical TV functions as defined in clause 5.3 taking into account new consumption models including app-based TV consumption and MBMS / unicast reception.
- Follow the recommendations in TR 26.953 [31] to support interactivity functions typically supported by TV Content Providers.
- Consider future work for consistent support of different ad insertion use cases (yet to be collected) in the full MBMS service layer mode and DASH (i.e. on MBMS bearers and unicast).
- Consider a future work on consistent support for conditional access and digital rights management use cases in the full MBMS service layer mode and DASH.
- Consider future work on service multiplexing and statistical multiplexing backed by concrete use cases and requirements including a full end-to-end study from content provider, xMB, encoding, service layer, radio layer, MBMS client, APIs and applications and also including unicast fallback and MooD.
- Consider future work on consistent support for random access, channel change times and end-to-end latency matching TV service requirements in full MBMS service layer mode and DASH (backed by concrete use cases and requirements).
- Consider future work on consistent support of hybrid services (i.e. Simultaneous usage of broadcast and unicast for the same service and user) in full MBMS service layer mode and DASH (backed by concrete use cases and requirements).

Annex A: Change history

Change history							
Date	Meeting	TDoc	CR	Re v	Cat	Subject/Comment	New version
2016-12	SA#74	SP-160776				Presented to TSG SA #74 (for information)	1.0.0
2017-09	SA#77	SP-170606				Presented to TSG SA #77 (for approval)	2.0.0
2017-09	SA#77					Version 15.0.0	15.0.0
2017-09	SA#77					Version 15.0.0 (expanded abbreviations in the title)	15.0.1
2020-07	-	-	-	-	-	Update to Rel-16 version (MCC)	16.0.0
2022-04	-	-	-	-	-	Update to Rel-17 version (MCC)	17.0.0
2024-03	-	-	-	-	-	Update to Rel-18 version (MCC)	18.0.0
2025-10	-	-	-	-	-	Update to Rel-19 version (MCC)	19.0.0

History

Document history		
V19.0.0	October 2025	Publication