



**Digital cellular telecommunications system (Phase 2+) (GSM);
Universal Mobile Telecommunications System (UMTS);
LTE;
5G;
Packet Switched (PS) conversational multimedia applications;
Performance characterisation of default codecs
(3GPP TR 26.935 version 18.0.0 Release 18)**



Reference

RTR/TSGS-0426935vi00

Keywords

5G,GSM,LTE,UMTS

ETSI

650 Route des Lucioles
F-06921 Sophia Antipolis Cedex - FRANCE

Tel.: +33 4 92 94 42 00 Fax: +33 4 93 65 47 16

Siret N° 348 623 562 00017 - APE 7112B
Association à but non lucratif enregistrée à la
Sous-Préfecture de Grasse (06) N° w061004871

Important notice

The present document can be downloaded from:

<https://www.etsi.org/standards-search>

The present document may be made available in electronic versions and/or in print. The content of any electronic and/or print versions of the present document shall not be modified without the prior written authorization of ETSI. In case of any existing or perceived difference in contents between such versions and/or in print, the prevailing version of an ETSI deliverable is the one made publicly available in PDF format at www.etsi.org/deliver.

Users of the present document should be aware that the document may be subject to revision or change of status.

Information on the current status of this and other ETSI documents is available at

<https://portal.etsi.org/TB/ETSIDeliverableStatus.aspx>

If you find errors in the present document, please send your comment to one of the following services:

<https://portal.etsi.org/People/CommitteeSupportStaff.aspx>

If you find a security vulnerability in the present document, please report it through our
Coordinated Vulnerability Disclosure Program:

<https://www.etsi.org/standards/coordinated-vulnerability-disclosure>

Notice of disclaimer & limitation of liability

The information provided in the present deliverable is directed solely to professionals who have the appropriate degree of experience to understand and interpret its content in accordance with generally accepted engineering or other professional standard and applicable regulations.

No recommendation as to products and services or vendors is made or should be implied.

No representation or warranty is made that this deliverable is technically accurate or sufficient or conforms to any law and/or governmental rule and/or regulation and further, no representation or warranty is made of merchantability or fitness for any particular purpose or against infringement of intellectual property rights.

In no event shall ETSI be held liable for loss of profits or any other incidental or consequential damages.

Any software contained in this deliverable is provided "AS IS" with no warranties, express or implied, including but not limited to, the warranties of merchantability, fitness for a particular purpose and non-infringement of intellectual property rights and ETSI shall not be held liable in any event for any damages whatsoever (including, without limitation, damages for loss of profits, business interruption, loss of information, or any other pecuniary loss) arising out of or related to the use of or inability to use the software.

Copyright Notification

No part may be reproduced or utilized in any form or by any means, electronic or mechanical, including photocopying and microfilm except as authorized by written permission of ETSI.

The content of the PDF version shall not be modified without the written authorization of ETSI.

The copyright and the foregoing restriction extend to reproduction in all media.

© ETSI 2024.
All rights reserved.

Intellectual Property Rights

Essential patents

IPRs essential or potentially essential to normative deliverables may have been declared to ETSI. The declarations pertaining to these essential IPRs, if any, are publicly available for **ETSI members and non-members**, and can be found in ETSI SR 000 314: "*Intellectual Property Rights (IPRs); Essential, or potentially Essential, IPRs notified to ETSI in respect of ETSI standards*", which is available from the ETSI Secretariat. Latest updates are available on the ETSI Web server (<https://ipr.etsi.org/>).

Pursuant to the ETSI Directives including the ETSI IPR Policy, no investigation regarding the essentiality of IPRs, including IPR searches, has been carried out by ETSI. No guarantee can be given as to the existence of other IPRs not referenced in ETSI SR 000 314 (or the updates on the ETSI Web server) which are, or may be, or may become, essential to the present document.

Trademarks

The present document may include trademarks and/or tradenames which are asserted and/or registered by their owners. ETSI claims no ownership of these except for any which are indicated as being the property of ETSI, and conveys no right to use or reproduce any trademark and/or tradename. Mention of those trademarks in the present document does not constitute an endorsement by ETSI of products, services or organizations associated with those trademarks.

DECT™, **PLUGTESTS™**, **UMTS™** and the ETSI logo are trademarks of ETSI registered for the benefit of its Members. **3GPP™** and **LTE™** are trademarks of ETSI registered for the benefit of its Members and of the 3GPP Organizational Partners. **oneM2M™** logo is a trademark of ETSI registered for the benefit of its Members and of the oneM2M Partners. **GSM®** and the GSM logo are trademarks registered and owned by the GSM Association.

Legal Notice

This Technical Report (TR) has been produced by ETSI 3rd Generation Partnership Project (3GPP).

The present document may refer to technical specifications or reports using their 3GPP identities. These shall be interpreted as being references to the corresponding ETSI deliverables.

The cross reference between 3GPP and ETSI identities can be found under <https://webapp.etsi.org/key/queryform.asp>.

Modal verbs terminology

In the present document "**should**", "**should not**", "**may**", "**need not**", "**will**", "**will not**", "**can**" and "**cannot**" are to be interpreted as described in clause 3.2 of the [ETSI Drafting Rules](#) (Verbal forms for the expression of provisions).

"**must**" and "**must not**" are **NOT** allowed in ETSI deliverables except when used in direct citation.

Contents

Intellectual Property Rights	2
Legal Notice	2
Modal verbs terminology.....	2
Foreword.....	6
1 Scope	7
2 References	7
3 Abbreviations	8
3.1 Abbreviations	8
4 General Overview.....	9
4.1 Introduction	9
4.2 Tests over DCH radio channels.....	9
4.3 Tests over HSDPA/EUL radio channels	10
5 Test bed and test plan for Phase 1	10
5.1 Test methodology.....	11
5.2 Test arrangement.....	11
5.2.1 Description of the testing system.....	11
5.2.2 Network simulator	12
5.2.3 UMTS simulator choices	13
5.2.3.1 RAB and protocols.....	13
5.2.3.2 Description of the RLC implementation	14
5.2.3.3 Physical Layer Implementation.....	15
5.2.4 Headsets and Sound Card	17
5.2.5 Test environment	17
5.2.6 Calibration and test conditions monitoring.....	17
5.2.6.1 Speech level	17
5.2.6.2 Delay.....	17
5.3 Test conditions for AMR-NB codec.....	18
5.4 Test conditions for AMR-WB codec.....	19
6 Test bed and test plan for Phase 2	20
6.1 Test arrangement.....	21
6.1.1 Description of the proposed testing system	21
6.1.2 Network simulator	22
6.1.3 Calibration and test conditions monitoring.....	22
6.2 Test Conditions	23
7 Analysis of test results for DCH channels for Phase 1 and 2.....	23
7.1 Conversation Tests	23
7.2 Experimental Design and Statistical Procedures	24
7.3 Narrowband Test - Symmetric conditions (<i>Set 1</i>)	25
7.4 Narrowband Test – Asymmetric Conditions (<i>Set 2</i>).....	31
7.5 Wideband Test – Symmetric Conditions (<i>Set 3</i>)	33
7.6 Wideband Test – Asymmetric Conditions (<i>Set 4</i>).....	38
7.7 Phase 2 - ITU-T Codec Tests (<i>Set 5</i>).....	41
7.8 Summary of Test Result Analysis	44
8 Performance characterisation of VoIMS over HSDPA/EUL channels	44
8.A Listening only tests.....	44
8.A.1 Test methodology for listening only tests	44
8.A.2 Test arrangement	44
8.A.3 Jitter buffer implementations	45
8.A.3.1 Fixed JBM.....	45
8.A.3.2 Adaptive JBM	45
8.A.4 Network conditions.....	45

8.A.5	Listening experiments.....	46
8.A.6	Test Results.....	47
8.A.7	Delay analysis.....	52
8.A.8	Listening only test conclusions	58
8.B	Conversation Tests	58
8.B.1	Introduction.....	58
8.B.2	The Test Plan	58
8.B.3	Cross-check of Test Lab Results.....	60
8.B.4	Test Results.....	60
8.B.4.1	Mean Scores by Experiment and by Test Lab.....	60
8.B.4.2	Subject Consistency Measures for Test Labs.....	64
8.B.4.3	Multivariate Analysis of Variance (MANOVA).....	64
8.B.4.3.1	MANOVA Results and Statistics	65
8.B.4.3.2	Composite Scores – Conversational Quality	67
8.B.4.3.3	Conversational Quality by Experimental Factors.....	69
8.B.5	Conversation tests conclusions	73
9	Conclusions	73
9.1	Tests over DCH radio channels.....	73
9.2	Tests over HSDPA/EUL radio channels; listening only tests.....	73
9.3	Tests over HSDPA/EUL radio channels; conversation tests	73
9.4	General consideration.....	73
Annex A:	Conversation test composite dependent variable scores by condition and Lab	74
Annex B:	Instructions to subjects.....	76
Annex C:	Example Scenarios for the conversation test.....	77
Annex D:	Test Plan for the AMR Narrow-Band Packet Switched Conversation Test.....	79
Annex E:	Test Plan for the AMR Wide-Band Packet Switched Conversation Test.....	96
Annex F:	Test plan for Packet Switched Conversation Tests for Comparison of Quality Offered by Different Speech Coders	113
Annex G:	Test Plan for Global Analysis of PSS Conversation Tests.....	125
Annex H:	Test Plan for Performance characterisation of VoIMS over HSDPA/EUL channels; listening only tests	131
H.1	Introduction	131
H.2	Listening only test conditions.....	131
H.3	End-to-end delay analysis	132
H.4	Listening only experiments	132
H.5	Test material processing.....	133
Annex I:	Illustrative scheme for jitter buffer management.....	135
I.1	Pseudo code.....	135
I.2	Verification against the minimum performance requirements	140
I.2.1	Delay performance	141
I.2.2	JBM induced error concealment operations	144
Annex J:	Test processing for listening only tests.....	145
J.1	Speech preparation	145
J.2	Pre-processing	145
J.3	Processing of speech/background noise signal.....	145

J.4	Up and Down-Sampling, Rounding and Scaling	146
J.5	Processing for Direct Conditions	147
J.6	Processing for MNRU conditions	147
J.7	Processing of voice over IMS over HSPA	147
J.8	Post-processing.....	148
J.9	Test conditions	148
Annex K:	Radio network simulation for HSDPA/EUL performance characterization	151
Annex L:	Test Plan for the AMR NB/WB Conversation Test in UMTS over HSDPA/EUL	155
L.1	Introduction	155
L.2	General Information	155
L.2.1	Permanent Documents.....	155
L.2.2	Key Acronyms.....	155
L.2.3	Contacts.....	156
L.2.4	Participants	156
L.3	Test Methodology	157
L.3.1	Introduction	157
L.3.2	Test Design.....	158
L.3.2.1	Description of the Test Bed	158
L.3.2.2	Transmission System	159
L.3.2.3	Radio Access Bearers	159
L.3.2.4	Test environment	160
L.3.3	Test Conditions	160
L.4	Test Procedure.....	165
L.4.1	Time Projection.....	165
L.4.2	Instructions to the Subjects.....	166
L.4.3	Test Materials	167
L.4.4	Deliverables.....	167
L.4.5	Data Analysis	167
L.5	Working Document for the Performance Characterization of VoIMS over HSDPA/EDCH.....	168
L.5.1	Introduction	168
L.5.2	System Overview	168
L.5.3	Radio Access Bearers.....	169
L.5.4	Delay	172
L.5.5	RN Simulator.....	174
L.5.6	Core Network	175
L.5.7	VoIP Client.....	175
L.5.8	Interfaces	177
L.5.8.1	Interface 1	178
L.5.8.2	Interface 2	178
L.5.8.3	Interface 3	178
L.5.9	Simulated HSPA Air-Interface.....	179
L.5.9.1	General Description	179
L.5.9.2	Error-Delay Profiles.....	179
L.5.A.1	Network Parameters	183
L.5.A.2	Traffic Assumptions (example: AMR 7.95).....	184
L.5.A.3	Other Assumptions.....	185
L.5.A.4	Simulation Methodology.....	186
	Bibliography	186
Annex M:	Change history	187
	History	188

Foreword

This Technical Report has been produced by the 3rd Generation Partnership Project (3GPP).

The contents of the present document are subject to continuing work within the TSG and may change following formal TSG approval. Should the TSG modify the contents of the present document, it will be re-released by the TSG with an identifying change of release date and an increase in version number as follows:

Version x.y.z

where:

- x the first digit:
 - 1 presented to TSG for information;
 - 2 presented to TSG for approval;
 - 3 or greater indicates TSG approved document under change control.
- y the second digit is incremented for all changes of substance, i.e. technical enhancements, corrections, updates, etc.
- z the third digit is incremented when editorial only changes have been incorporated in the document.

1 Scope

The present document provides information on the performances of default speech codecs in packet switched conversational multimedia applications. The codecs under test are AMR-NB (Adaptive Multi-Rate Narrowband) and AMR-WB (Adaptive Multi-Rate Wideband). In addition, several ITU-T codecs (G.723.1, G.729, G.722 and G.711) are included in the testing. Experimental test results from the speech quality testing are reported to illustrate the behaviour of these codecs.

The results give information of the performance of PS conversational multimedia applications under various operating and transmission conditions (e.g., considering radio transmission errors, IP packet losses, end-to-end delays, and several types of background noise). The performance results can be used e.g. as guidance for network planning and to appropriately adjust the radio network parameters.

2 References

The following documents contain provisions which, through reference in this text, constitute provisions of the present document.

- References are either specific (identified by date of publication, edition number, version number, etc.) or non-specific.
- For a specific reference, subsequent revisions do not apply.
- For a non-specific reference, the latest version applies. In the case of a reference to a 3GPP document (including a GSM document), a non-specific reference implicitly refers to the latest version of that document *in the same Release as the present document*

- [1] ITU-T Recommendation P.800: "Methods for Subjective Determination of Transmission Quality".
- [2] ITU-T Recommendation P.831: "Subjective performance evaluation of network echo cancellers".
- [3] ITU-T Recommendation G.711: "Pulse code modulation (PCM) of voice frequencies".
- [4] ITU-T Recommendation G.729: "Coding of speech at 8 kbit/s using conjugate-structure algebraic-code-excited linear-prediction (CS-ACELP)".
- [5] ITU-T Recommendation G.723.1: "Dual rate speech coder for multimedia communications transmitting at 5.3 and 6.3 kbit/s".
- [6] ITU-T Recommendation G.722: "7 kHz audio-coding within 64 kbit/s".
- [7] IETF RFC 1889: "RTP: A Transport Protocol for Real-Time Applications".
- [8] IETF RFC 3267: "Real-Time Transport Protocol (RTP) Payload Format and File Storage Format for the Adaptive Multi-Rate (AMR) Adaptive Multi-Rate Wideband (AMR-WB) Audio Codecs".
- [9] 3GPP TS 34.121: "Terminal Conformance Specification, Radio Transmission and Reception (FDD)" (downlink).
- [10] 3GPP TS 25.141: " Base Station (BS) conformance testing (FDD)" (uplink).
- [11] 3GPP TR 25.853 "Delay budget within the access stratum".
- [12] 3GPP TS 26.235: "Packet switched conversational multimedia applications; Default codecs".
- [13] 3GPP TS 26.071: "AMR speech Codec; General description".
- [14] 3GPP TS 26.171: "AMR speech codec, wideband; General description".
- [15] 3GPP TS 25.322: "Radio Link Control (RLC) protocol specification".
- [16] IETF RFC 3095: "RObust Header Compression (ROHC): Framework and four profiles: RTP, UDP, ESP, and uncompressed".

- [17] 3GPP TS 34.108: "Common test environments for User Equipment (UE) conformance testing".
- [18] ETSI TR 101 112: "Universal Mobile Telecommunications System (UMTS); Selection procedures for the choice of radio transmission technologies of the UMTS" (UMTS 30.03 v3.1.0).
- [19] 3GPP TS 26.114 : "IP Multimedia Subsystem (IMS); Multimedia Telephony; Media handling and interaction"
- [20] ITU-T Recommendation P.805 (P.CONV): "Subjective evaluation of conversational quality"

3 Abbreviations

3.1 Abbreviations

For the purposes of the present document, the following abbreviations apply:

AMR-NB (or AMR)	Adaptive Multi-Rate Narrowband Speech Codec
AMR-WB	Adaptive Multi-Rate Wideband Speech Codec
ANOVA	Analysis of Variance
ASY	ASYmmetric conditions
BLER	Block Error Rate
CDF	Cumulative Distribution Function
CMR	Codec Mode Request
COND	Test CONDitions
CN	Core Network
CQ	Conversational Quality
CRC	Cyclic Redundancy Check
DCH	Dedicated Channel
DL	Downlink
DMOS	Degradation Mean Opinion Score
DPCH	Dedicated Physical Channel
DTCH	Dedicated Traffic Channel
Eb/No	Ratio of energy per modulating bit to the noise spectral density
EID	Error Insertion Device
FER	Frame Erasure Rate, Frame Error Rate
GAL	Global Analysis Laboratory
GQ	Global Quality (of the conversation)
HM	High Mobility
HT	High Traffic
HSDPA/EUL	High Speed Downlink Packet Access/Enhanced UpLink
IA	InterAction (with your partner)
IP	Internet Protocol
ITU-T	International Telecommunication Union - Telecommunications Standardization Sector
JBM	Jitter Buffer Management
LAB	Listening LABoratory
LM	Low Mobility
LT	LowTraffic
MAC	Medium access control
MANOVA	Multivariate Analysis of Variance
Log-MAP	Logarithmic Maximum A Posteriori
MOS	Mean Opinion Score
NB	Narrowband
PC	PerCeption of impairments (also: Personal Computer)
PDCP	Packet Data Convergence Protocol
PDU	Protocol Data Unit
Pa	Sound Pressure Level (in Pascal)
PL	Packet Loss
plc	Packet Loss Concealment
RC	Radio Conditions
PS	Packet Switched

RB	Radio Bearer
RAB	Radio Access Bearer
RCV	Receive
RLC	Radio Link Control
ROHC	Robust Header Compression
RRM	Radio Resource Management
RTCP	Real-Time Control Protocol
RTP	Real-time Transport Protocol
SYM	SYMmetric conditions
TB size	Transport Block size
TF	Transport Format
ToC	Table of Content
TrCH	Transmission Channel
TTI	Transmission Time Interval
UDP	User Datagram Protocol
UE	User Equipment
UL	Uplink
UM	Unacknowledged Mode
UMD	Unacknowledged Mode Data
US	difficulty UnderStAnding (your partner)
VOIP	Voice over IP
VQ	Voice Quality (of your partner)
WB	Wideband
XMIT	Transmit

4 General Overview

4.1 Introduction

The performance of default speech codecs (AMR-NB and AMR-WB) for packet switched conversational multimedia [12, 19] was characterised over DCH channels and over HSDPA/EUL radio channels.

The testing over DCH channels was carried out from October 2003 until February 2004. Further subjective testing was carried out from June until October 2007 in order to characterize the performance over HSDPA/EUL radio channels. The main purpose of the latter testing was to evaluate and verify adequate performance of the AMR-NB and AMR-WB speech codecs used as defined in IMS Multimedia Telephony TS 26.114 [19] with a specific focus on jitter buffer management.

4.2 Tests over DCH radio channels

The tests over DCH channels were separated into two phases: Phase 1 considered the default speech codecs AMR-NB [13] and AMR-WB [14] in various operating conditions. Phase 2 considered also several other codecs including ITU-T codecs G.723.1 [5], G.729 [4], G.722 [6] and G.711 [3].

In Phase 1, France Telecom R&D acted as host laboratory. The subjective testing laboratories were ARCON for the North American English language, France Telecom R&D for the French language and NTT-AT for the Japanese language. Phase 1 tests consisted of 24 test conditions both for the AMR codec (modes 6.7 and 12.2 kbit/s) and the AMR-WB codec (modes 12.65 and 15.85 kbit/s) with error conditions covering both IP packet loss of 0% and 3% and radio conditions with 10^{-2} , 10^{-3} and $5 \cdot 10^{-4}$ BLER (Block Error Rate). End-to-end delays of 300 and 500 ms were covered. Robust Header Compression (ROHC), an optional UMTS functionality, was included for some test cases for AMR-WB. Three types of background noise were used: car, street and cafeteria.

In Phase 2, France Telecom R&D acted as host and listening laboratory. Two languages were used (French and Arabic). The following codecs were tested: AMR-NB (modes 6.7 and 12.2 kbit/s), AMR-WB (modes 12.65 and 15.85 kbit/s), ITU-T G.723.1 (mode 6.4 kbit/s), ITU-T G.729 (mode 8 kbit/s), ITU-T G.722 (mode 64 kbit/s) and ITU-T G.711 (64 kbit/s). Transmission error conditions covered IP packet loss of 0% and 3%.

Siemens provided the real time air interface simulator for the Phase 1. France Telecom provided the IP core network simulator and terminal simulator used in both experiments Phase 1 and Phase 2. IPv6 was employed in the testing. (IPv6 is fully simulated over the radio interface. The CN simulator employs IPv4 but since the only impact is a marginal difference in the end-to-end delay - of the order of ~16 is - the use of a particular IP-version in CN part has no impact on the performance results.)

These tests were the first ever conversational tests conducted in any standardization body. Performance evaluation consisted of assessment of 5 aspects: 1) voice quality, 2) difficulty of understanding words, 3) quality of interaction, 4) degree of impairments, and 5) global communication quality. A 5-category rating scale was used for each aspect.

Dynastat performed the global analysis for Phases 1 and 2. The results are contained in Clause 7.

4.3 Tests over HSDPA/EUL radio channels

These listening-only tests characterized the performance of AMR-NB and AMR-WB speech codecs over HSDPA/EUL channels when conducting buffer adaptation to the network delay variations using a simple jitter buffer management (JBM) algorithm. The tests focused on the effect of channel errors and channel jitter to speech quality instead of the impact of overall end-to-end delay in speech conversation. The end-to-end delay impact was considered separately by conducting a delay analysis on the whole processed test material.

The subjective listening-only tests were conducted in Finnish and Swedish languages at Nokia and Ericsson, respectively. The tests consisted of eight different channel conditions in clean speech and in background noise conditions. AMR-NB was tested in 12.2 and 5.9 kbit/s modes, and AMR-WB at 12.65 kbit/s. The outstanding issue was to evaluate the performance of adaptive JBM operation in HSDPA/EUL channel conditions. The applied adaptive jitter buffer was a simple implementation conducting buffer adaptation mainly during discontinuous transmission, i.e. speech pauses, and not using any time scaling operation. A non-implementable fixed jitter buffer with the full a priori knowledge on the channel characteristics was used as a reference. Although the average end-to-end delays of both adaptive and fixed jitter buffers were the same, the number and locations of jitter buffer induced frame losses were different depending on the channel conditions.

The results are contained in Clause 8A.

A program of Conversation Tests was organized to evaluate the performance of AMR-NB and AMR-WB for UMTS over HSDPA/EUL. Three test labs were contracted to conduct the conversation tests and deliver raw voting data to Dynastat, the Global Analysis Lab (GAL), for processing and statistical analysis.

Three conversation tests were conducted in each of three test labs. The test labs were FTRD, testing in the French language, BIT, testing in the Chinese language, and Dynastat, testing in North American English. Each of the three conversation tests involved a different speech codec:

- Exp.1 - AMR operating at 5.9k bps
- Exp.2 - AMR operating at 12.2k bps
- Exp.3 - AMR-WB operating at 12.65k bps

The experiments were conducted according to specifications contained in the ITU-T Recommendation for Conversation Testing, P.805 [20]. Alcatel-Lucent provided the network impairment simulation test-bed. The raw voting data for each test lab and each Experiment was delivered to the GAL. The GAL conducted statistical analyses on the raw voting data and the results of those analyses are contained in Clause 8B.

5 Test bed and test plan for Phase 1

This section describes the test plan for the Phase 1 of the conversation test of the AMR-NB (AMR) and AMR-WB in PS networks. All the laboratories participating to this conversation test phase used the same test plan, just the language of the conversation changed. Even if the test rooms or the test equipments are not exactly the same in all the laboratories, the calibration procedures and the tests equipment characteristics and performance guaranteed the similarity of the test conditions.

Annex B contains the instructions for the subjects participating to the conversation tests.

5.1 Test methodology

The protocol described below evaluates the effect of degradation such as delay and dropped packets on the quality of the communications. It corresponds to the conversation-opinion tests recommended by the ITU-T P.800 [1]. First of all, conversation-opinion tests allow subjects passing the test to be in a more realistic situation, close to the actual service conditions experienced by telephone customers. In addition, conversation-opinion tests are suited to assess the effects of impairments that can cause difficulty while conversing (such as delay).

Subjects participate to the test by couple; they are seated in separate sound-proof rooms and are asked to hold a conversation through the transmission chain performed by means of UMTS simulators, and communications are impaired by means of an IP impairments simulator part of the CN simulator and by the air interface simulator, as Figure 1 describes it.

The network configurations (including the terminal equipments) are symmetrical (in the two transmission paths). The only dissymmetry will be due to presence of background noise in one of the test rooms.

5.2 Test arrangement

5.2.1 Description of the testing system

Figure 1 describes the simulation system.

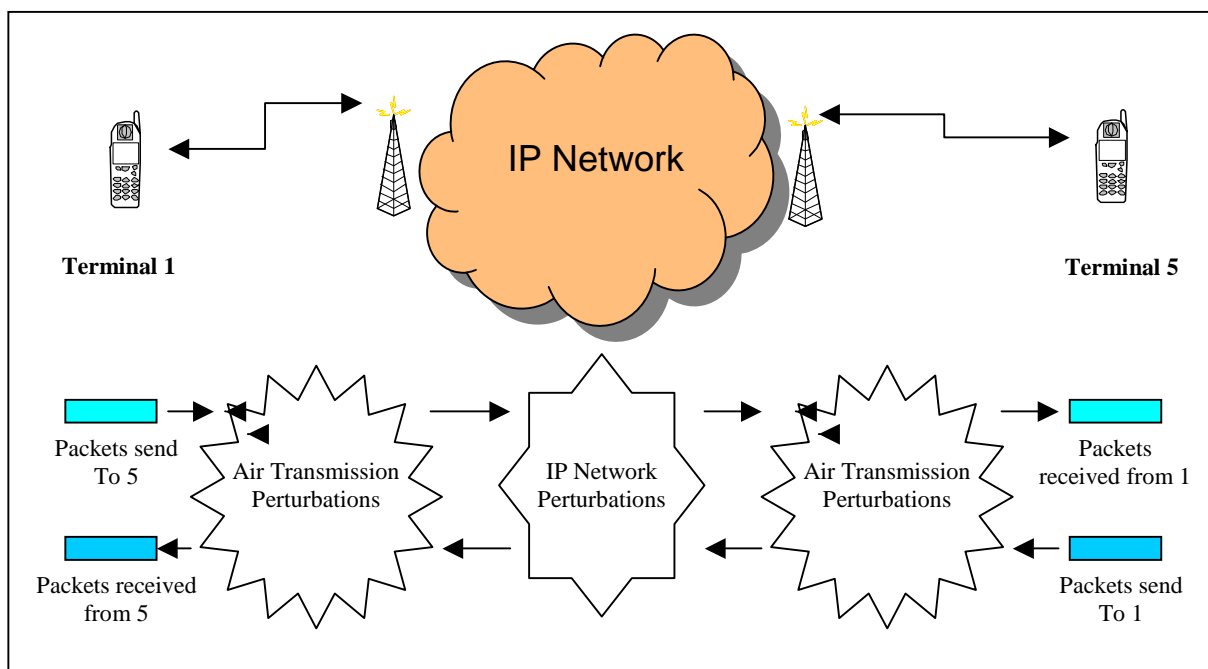

Figure 1: Packet switch audio communication simulator

The PS audio communication has been simulated using 5 PCs as shown in Figure 2.

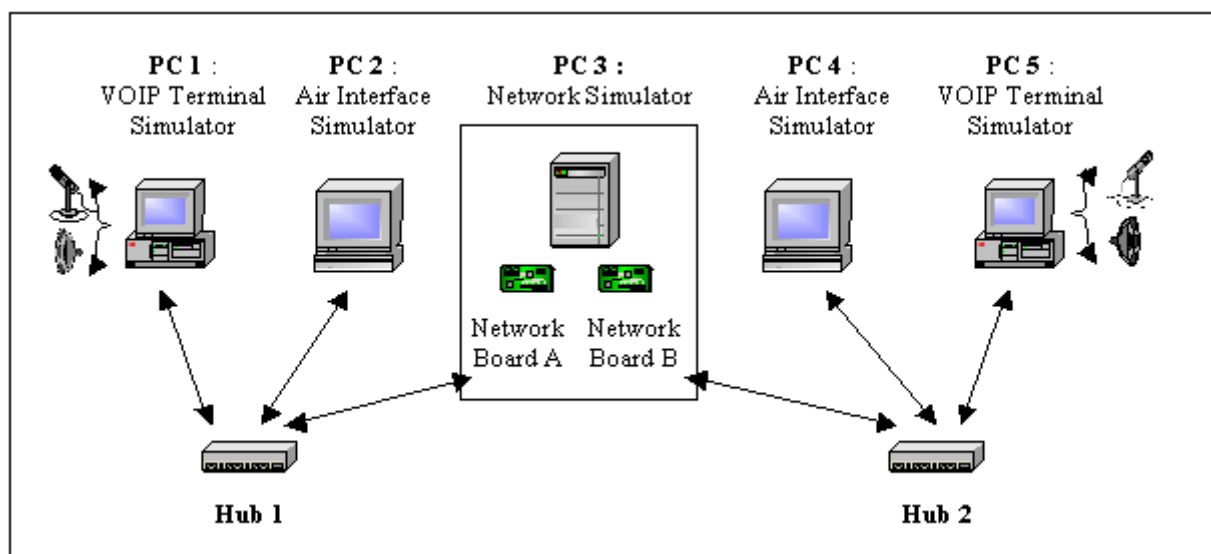

Figure 2: Simulation Platform

PC 1 and PC 5 are running under Windows OS with the VOIP Terminal Simulator Software of France Telecom R&D. PC 2 and PC 4 run under Linux OS with the Air Interface Simulator coming from Siemens AG. And PC 3 runs under WinNT OS with Network Simulator Software (NetDisturb).

The platform simulates a PS interactive communication between two users using PC 1 and PC 5 as their relative VOIP terminals. PC 1 sends AMR (or AMR-WB) encoded packets that are encapsulated using IP/UDP/RTP headers to PC 5. PC 1 receives IP/UDP/RTP audio packets from PC 5.

In fact, the packets created in PC 1 are sent to PC 2. PC 2 simulates the air interface uplink (UL) transmission and then forwards the transmitted packets to PC 4.

In the same way, PC 4 simulates the air interface downlink (DL) transmission and then forwards the packets to PC 5. PC 5 decodes and plays the speech back to the listener.

5.2.2 Network simulator

The core network simulator, as implemented, works under IPv4. However, as the core network simulator acts only on packets (loss, delay,...) the use of IPv4 or IPv6 is equivalent for this test conversation context. Considering the networks perturbations introduced by the simulator and the context of the interactive communications, the simulation using IPv4 perturbation network simulator is adapted to manage and simulate the behaviours of an IPv6 core network.

Figure 3 shows the possible network simulator parameters that can be modified.

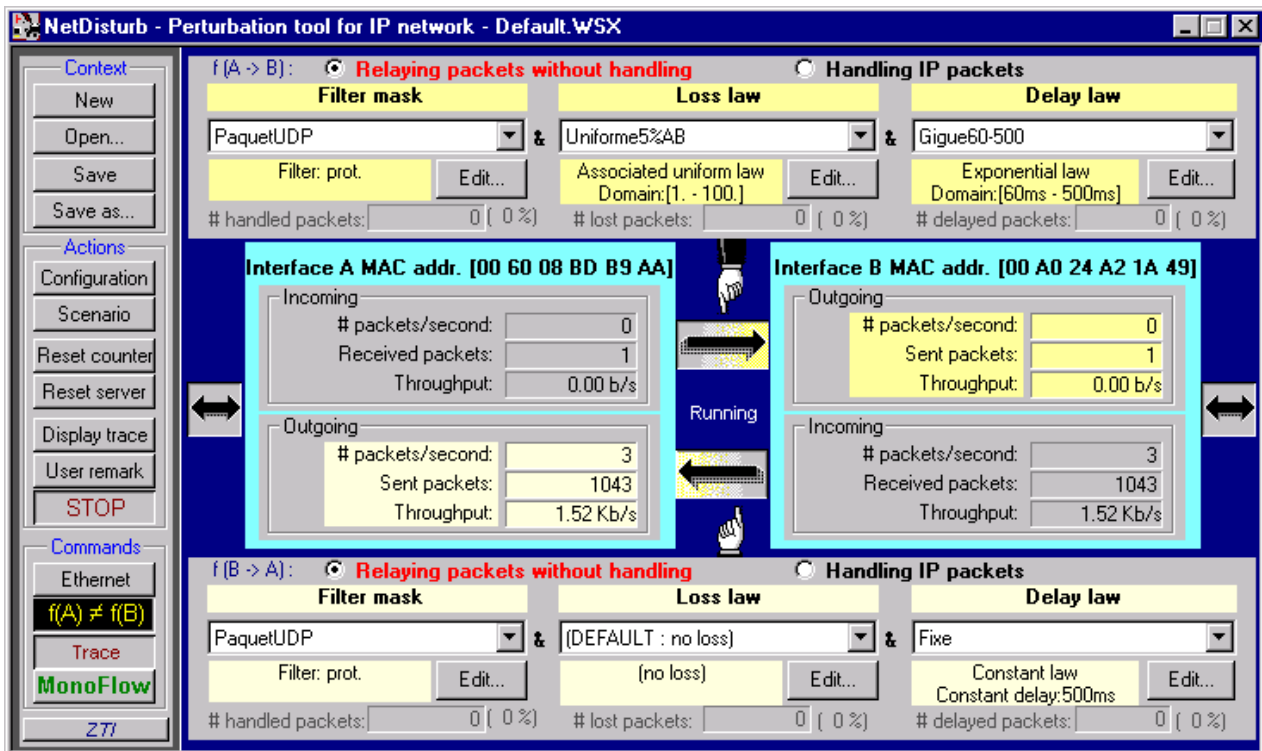

Figure 3: IP simulator interface

On both links, one can choose delay and loss laws. Both links can be treated separately or in the same way. For example, delay can be set to a fixed value but can also be set to another law such as exponential law.

Only loss law and delay law were given values, for delay law the values are 0 or 200 ms and for loss law the possible values: 0% or 3% under bursty law. Both links were treated in the same way.

5.2.3 UMTS simulator choices

The transmission of IP/UDP/RTP/AMR (or AMR-WB) packets over the UMTS air interface is simulated using the RAB described in Section 5.2.3.1. The required functions of the RLC layer are implemented according to [15] and work in real-time. The underlying Physical Layer is simulated offline. Error patterns of block errors (i.e. discarded RLC PDUs) are inserted in the real-time simulation as described in Section 5.2.3.2. For more details on the parameter settings of the Physical Layer simulations see Section 5.2.3.3.

5.2.3.1 RAB and protocols

For the narrowband conversational tests, the AMR is encoded with a maximum of 12.2 kbit/s. The bitstream is encapsulated using IP/UDP/RTP protocols. The air interface simulator receives IPv4 packets from the CN simulator. The RTP packets are extracted and before transmission over the air interface, IPv6/UDP headers are inserted. Finally real IPv6 packets are transmitted over the air interface simulator.

The payload format is the following:

- RTP payload format for AMR-NB (cf. [8]) is used;
- Bandwidth efficient mode is used;
- One speech frame is encapsulated in each RTP packet;
- Interleaving is not used;

The payload header consists of the 4 bits of the CMR (Codec Mode Request). Then 6 bits are added for the ToC (Table of Content). For IPv4, this corresponds to a maximum of 72 bytes per frame that is to say 28.8 kbit/s. This goes up to 92 bytes (36.8 kbit/s) when using IPv6 protocol on the air interface.

RTCP packets are sent. However, in the test conditions defined in the conversation test plans, RTCP is not mandatory, as it is not in a multicast environment (cf. [7]). RTCP reports were sent but not used.

ROHC is an optional functionality in UMTS. In order to reduce the size of the tests and the number of conditions, the ROHC algorithm is not used for the AMR-NB conversation test. This functionality is only tested in the wideband condition.

For the WB conversational tests, the AMR-WB encodes speech at a maximum of 15.85 kbit/s. The bitstream is also encapsulated and transmitted in the same way as for the NB case. For IPv4 a maximum of 81 bytes (41 bytes for the AMR and its payload header plus the 40 bytes of the IP/UDP/RTP headers) per frame are transmitted that is to say 32.4 kbit/s, this goes up to 101 bytes (40.4 kbit/s) when using IPv6 protocol on the air interface.

ROHC algorithm is supported in the AMR-WB conversation test, for the 12.65 kbit/s mode and the 15.85 modes. Header compression is done on the IP/UDP/RTP headers (profile 1). ROHC starts in the unidirectional mode and switches to bi-directional mode as soon as a packet has reached the decompressor and replied with a feedback packet indicating that a mode transition is desired.

The Conversational / Speech / UL:46 DL:46 kbps / PS RAB coming from [17] was used. It is not an optimal RAB for PS conversational test but it was the only one available at the time the test bed and the air interface simulator were designed. The RAB description is given in Table 1.

Table 1: RAB description

Higher layer	RAB/Signalling RB		RAB
PDCP	PDCP header size, bit		8
RLC	Logical channel type		DTCH
	RLC mode		UM
	Payload sizes, bit		920, 304, 96
	Max data rate, bps		46000
MAC	UMD PDU header, bit		8
	MAC header, bit		0
	MAC multiplexing		N/A
Layer 1	TrCH type		DCH
	TB sizes, bit		928, 312, 104
	TFS	TF0, bits	0x928
		TF1, bits	1x104
		TF2, bits	1x312
		TF3, bits	1x928
	TTI, ms		20
	Coding type		TC
	CRC, bit	16	
	Max number of bits/TTI after channel coding		2844
	Uplink: Max number of bits/radio frame before rate matching		1422
	RM attribute		180-220

5.2.3.2 Description of the RLC implementation

The UMTS air interface simulator (implemented in PC 2 and 4) receives IP/UDP/RTP/AMR (or AMR-WB) packets on a specified port of the network card (see Figure 4). The IP/UDP/RTP/AMR (or AMR-WB) packets are given to the transmission buffer of the RLC layer, which works in Unacknowledged Mode (UM). The RLC segments or concatenates the IP bitstream in RLC PDUs, adding appropriate RLC headers (sequence number and length indicators). It is assumed that always Transport Format TF 3 is chosen on the physical layer, providing an RLC PDU length including header of 928 bits. In the regular case, one IP packet is placed into an RLC PDU that is filled up with padding bits. Due to delayed packets from the network simulator it may also occur that there are none or no more than one IP packet in the RLC transmission buffer to transmit in the current TTI.

Each TTI of 20ms, an RLC PDU is formed. It is then given to the error insertion block that decides if the RLC PDU is transmitted successfully over the air interface or if it is discarded due to a block error after channel decoding. The physical layer is not simulated in real time, but error pattern files are provided. The error patterns of the air interface transmission are simulated offline according to the settings given in Section 5.2.3.1. They consist of binary decisions for each transmitted RLC PDU, resulting in a certain BLER.

After the error pattern insertion, the RLC of the air interface receiver site receives RLC PDUs in the reception buffer. The sequence numbers of the RLC headers are checked to detect when RLC PDUs have been discarded due to block errors. A discarded RLC PDU can result in one or more lost IP packets, resulting in a certain packet loss rate of the IP packets and thereby in a certain FER of the AMR (or AMR-WB) frames. The IP/UDP/RTP/AMR (or AMR-WB) packets are reassembled and transmitted to the next PC. This PC is either the network simulator (PC 3) in case of uplink transmission, or is one of the terminals (PC 1 or PC 5) in case of downlink transmission.

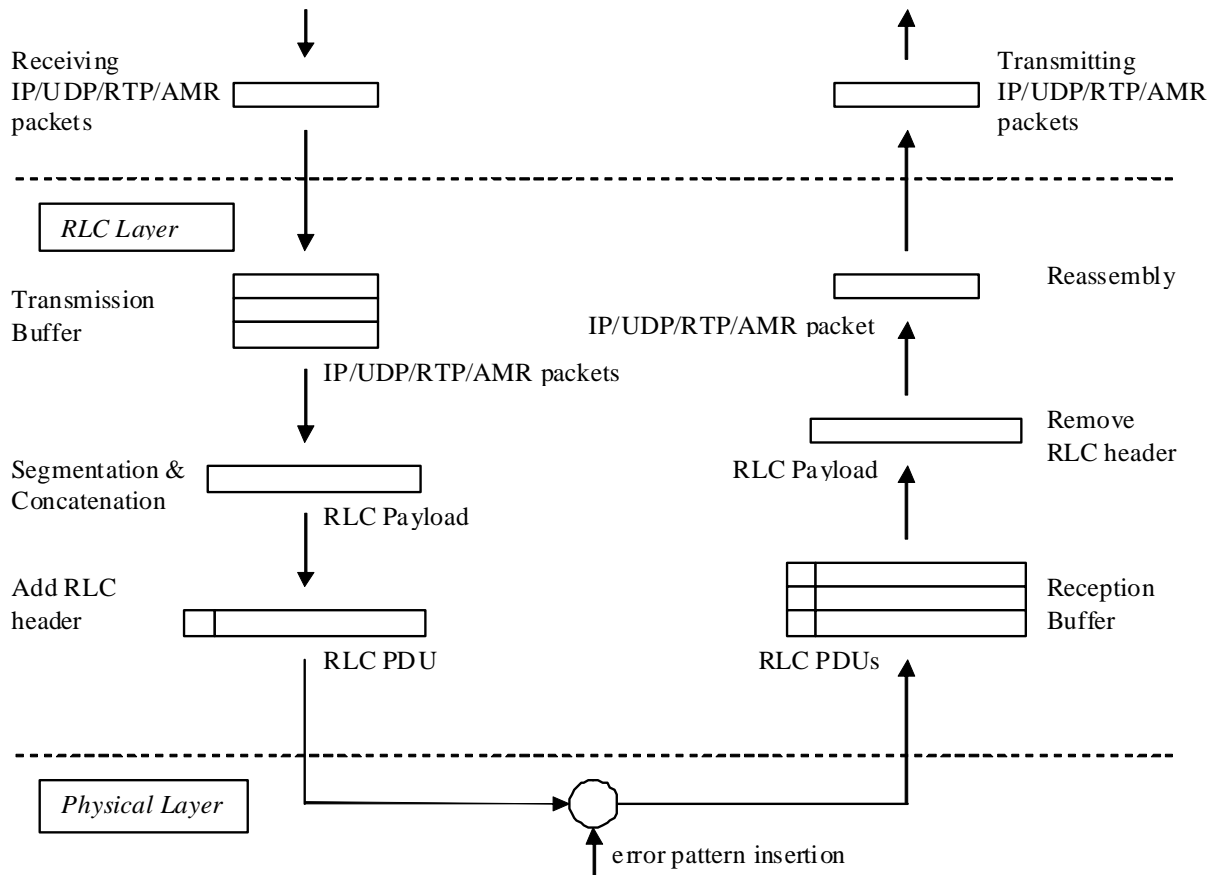

Figure 4: UMTS air interface simulation

5.2.3.3 Physical Layer Implementation

The parameters of the physical layer simulation were set according to the parameters for a DCH in multipath fading conditions given in [9] for the downlink and [10] for the uplink. The TB size is 928 bits and the Turbo decoder uses the Log-MAP algorithm with 4 iterations. The rake receiver has 6 fingers at 60 possible positions.

The different channel conditions given in Tables 2, 3 and 4 were extracted from [18] (Selection procedures for the choice of radio transmission technologies of the UMTS).

Table 2: Indoor Office Test Environment Tapped-Delay-Line Parameters

Tap	Channel A		Doppler
	Rel. Delay (nsec)	Avg. Power (dB)	Spectrum
1	0	0	FLAT
2	50	-3.0	FLAT
3	110	-10.0	FLAT
4	170	-18.0	FLAT
5	290	-26.0	FLAT
6	310	-32.0	FLAT

Table 3: Vehicular Test Environment, High Antenna, Tapped-Delay-Line Parameters

Tap	Channel A		Doppler
	Rel. Delay (nsec)	Avg. Power (dB)	Spectrum
1	0	0.0	CLASSIC
2	310	-1.0	CLASSIC
3	710	-9.0	CLASSIC
4	1090	-10.0	CLASSIC
5	1730	-15.0	CLASSIC
6	2510	-20.0	CLASSIC

Table 4: Outdoor to Indoor and Pedestrian Test Environment Tapped-Delay-Line Parameters

Tap	Channel A		Doppler
	Rel. Delay (nsec)	Avg. Power (dB)	Spectrum
1	0	0	CLASSIC
2	110	-9.7	CLASSIC
3	190	-19.2	CLASSIC
4	410	-22.8	CLASSIC
5	-	-	CLASSIC
6	-	-	CLASSIC

Table 5 (DL) and Table 6 (UL) show approximate results of the air interface simulation for $\frac{DPCH - E_c}{I_{or}}$ and E_b/N_0 corresponding to the considered BLERs.

Table 5: Downlink performance - approximate $\frac{DPCH - E_c}{I_{or}}$ for the different channels and BLER

Channel	BLER			
	$5 \cdot 10^{-2}$	$1 \cdot 10^{-2}$	$1 \cdot 10^{-3}$	$5 \cdot 10^{-4}$
Indoor, 3 km/h ($\hat{I}_{or}/I_{oc} = 9$ dB)	-13.1 dB	-8.9 dB	-3.4 dB	-2.4 dB
Outdoor to Indoor, 3 km/h ($\hat{I}_{or}/I_{oc} = 9$ dB)	-13.2 dB	-9.7 dB	-5.9 dB	-5.2 dB
Vehicular, 50 km/h ($\hat{I}_{or}/I_{oc} = -3$ dB)	-9.35 dB	-8.2 dB	-6.9 dB	-6.55 dB
Vehicular, 120 km/h ($\hat{I}_{or}/I_{oc} = -3$ dB)	-9.7 dB	-8.95 dB	-7.95 dB	-7.55 dB

Table 6: Uplink performance - approximate E_b/N_0 for the different channels and BLER

Channel	BLER			
	$5 \cdot 10^{-2}$	$1 \cdot 10^{-2}$	$1 \cdot 10^{-3}$	$5 \cdot 10^{-4}$
Indoor, 3 km/h	3.9 dB	6.4 dB	9.2 dB	9.8 dB
Outdoor to Indoor, 3 km/h	3.7 dB	6.1 dB	8.6 dB	9.2 dB
Vehicular, 50 km/h	-0.9 dB	-0.15 dB	0.55 dB	0.75 dB
Vehicular, 120 km/h	0.2 dB	0.6 dB	1.1 dB	1.3 dB

Outdoor to Indoor channel was used for uplink and downlink in the simulations.

5.2.4 Headsets and Sound Card

To avoid echo problems headsets were used instead of handsets. The monaural headsets are connected to the sound cards of the PCs supporting the speech codec simulators.

The sound level in the earphones can be adjusted, if needed, by the users. But, in practice, the original settings, defined during the preliminary tests, and producing a comfortable listening level, are not modified. The microphones are protected by a foam ball in order to reduce the "pop" effect. It is also suggested to the user to avoid placing the acoustic opening of the microphone in front of the mouth.

5.2.5 Test environment

Each of the two subjects participating to the conversations are installed in a test room. They sit on an armchair, in front of a table. The test rooms are acoustically insulated. All the test equipments are installed in a third room, connected to the test rooms. When needed, the background noise is generated in the appropriate test room through a set of 4 loudspeakers. The background noise level is adjusted and controlled by a sound level meter. The measurement microphone, connected to the Sound level meter is located at the equivalent of the center of the subject's head. The noise level is A weighted.

5.2.6 Calibration and test conditions monitoring

5.2.6.1 Speech level

Before the beginning of a set of experiment, the end-to-end transmission level is checked subjectively, to ensure that there is no problem. If it is necessary to check the speech level following procedure is applied. An artificial mouth placed in front of the microphone of the Headset A, in the LRGP position (see ITU-T Rec. P.64), generates in the artificial ear (according to ITU-T Rec. P57), coupled to the earphone of the Headset B, the nominal level. If necessary, the level is adjusted with the receiving volume control of the headset. Similar calibration is done by inverting headsets A and B.

5.2.6.2 Delay

The overall delay (from the input of sound card A to the output of sound card B) is calculated as shown: On the air interface side, the simulator only receives packets on its network card, processes them and transmits every 20 ms these packets to the following PC. Only processing delay and a possible delay due to a jitter can be added (a packet arrives just after the sending window of the air interface).

The delay is calculated as shown below:

- Encoder side: delay due to account framing, look-ahead, processing and packetization = 45ms
 - Uplink delay between UE and Iu: 84.4 ms (see [11])
 - Core network delay: a few ms
 - Routing through IP: depending on the number of routers.
 - Downlink delay between Iu and UE: 71.8 ms (see [11])
 - Decoder side, taking into account jitter buffer, de-packetization and processing: 40 ms

The total delay to be considered is at least: 241.2 ms.

5.3 Test conditions for AMR-NB codec

Tables 7 - 9 summarise the test conditions used for AMR-NB testing.

For both AMR-NB and AMR-WB codecs two representative modes were chosen for the testing. The lowest codec modes (such as AMR-NB 4.75) were not included since these are intended to be used mainly temporarily to cope with poor radio conditions. They were expected to provide insufficient quality for conversational applications if used throughout the call (as done in these characterisation tests).

Table 7: Test conditions for AMR-NB

Cond.	Background noise in Room A	Background noise in Room B	Experimental factors		
			Radio cond. (BLER)	IP cond. (Packet loss ratio)	Mode + delay
1	No	No	10^{-2}	0%	6.7 kbit/s (delay 300 ms)
2	No	No	10^{-2}	0%	12.2 kbit/s (delay 500 ms)
3	No	No	10^{-2}	0%	12.2 kbit/s (delay 300 ms)
4	No	No	10^{-2}	3%	6.7 kbit/s (delay 300 ms)
5	No	No	10^{-2}	3%	12.2kbit/s (delay 500 ms)
6	No	No	10^{-2}	3%	12.2 kbit/s (delay 300 ms)
7	No	No	10^{-3}	0%	6.7 kbit/s (delay 300 ms)
8	No	No	10^{-3}	0%	12.2 kbit/s (delay 500 ms)
9	No	No	10^{-3}	0%	12.2 kbit/s (delay 300 ms)
10	No	No	10^{-3}	3%	6.7 kbit/s (delay 300 ms)
11	No	No	10^{-3}	3%	12.2 kbit/s (delay 500 ms)
12	No	No	10^{-3}	3%	12.2 kbit/s (delay 300 ms)
13	No	No	$5 \cdot 10^{-4}$	0%	6.7kbit/s (delay 300 ms)
14	No	No	$5 \cdot 10^{-4}$	0%	12.2kbit/s (delay 500 ms)
15	No	No	$5 \cdot 10^{-4}$	0%	12.2 kbit/s (delay 300 ms)
16	No	No	$5 \cdot 10^{-4}$	3%	6.7kbit/s (delay 300 ms)
17	No	No	$5 \cdot 10^{-4}$	3%	12.2 kbit/s (delay 500 ms)
18	No	No	$5 \cdot 10^{-4}$	3%	12.2 kbit/s (delay 300 ms)
19	Car	No	$5 \cdot 10^{-4}$	3%	12.2 kbit/s (delay 300 ms)
20	No	Car	$5 \cdot 10^{-4}$	3%	12,2 kbit/s (delay 300 ms)
21	Cafeteria	No	$5 \cdot 10^{-4}$	0%	6.7 kbit/s (delay 300 ms)
22	No	Cafeteria	$5 \cdot 10^{-4}$	0%	6.7 kbit/s (delay 300 ms)
23	Street	No	$5 \cdot 10^{-4}$	0%	12.2kbit/s (delay 500 ms)
24	No	Street	$5 \cdot 10^{-4}$	0%	12.2kbit/s (delay 500 ms)

Table 8: Noise types for AMR-NB

Noise type	Level (dB Pa)
Car	60
Street	55
Cafeteria	50

Table 9: Test details for AMR-NB

Listening Level	1	79 dB SPL
Listeners	32	Naïve Listeners
Groups	16	2 subjects/group
Rating Scales	5	
Languages	3	North American English, French, Japanese
Listening System	1	Monaural headset (flat response in the audio bandwidth of interest: 50Hz-7kHz). The other ear is open.
Listening Environment		Room Noise: Hoth Spectrum at 30dBA (as defined by ITU-T Recommendation P.800: Annex A, section A.1.1.2.2.1 Room Noise, with table A.1 and Figure A.1), except when background noise is needed (see Table 8 of this TR).

5.4 Test conditions for AMR-WB codec

Tables 10 - 13 summarise the test conditions used for AMR-WB testing.

Table 10: Test conditions for AMR-WB

Cond.	Experimental factors		
	Radio conditions (BLER)	IP conditions (Packet loss ratio)	Mode
1	10^{-2}	0%	12,65 kbit/s, ROHC
2	10^{-2}	0%	12,65 kbit/s
3	10^{-2}	0%	15,85 kbit/s, ROHC
4	10^{-2}	3%	12,65 kbit/s, ROHC
5	10^{-2}	3%	12,65 kbit/s
6	10^{-2}	3%	15,85 kbit/s, ROHC
7	10^{-3}	0%	12,65 kbit/s, ROHC
8	10^{-3}	0%	12,65 kbit/s
9	10^{-3}	0%	15,85 kbit/s, ROHC
10	10^{-3}	3%	12,65 kbit/s, ROHC
11	10^{-3}	3%	12,65 kbit/s
12	10^{-3}	3%	15,85 kbit/s, ROHC
13	$5 \cdot 10^{-4}$	0%	12,65 kbit/s, ROHC
14	$5 \cdot 10^{-4}$	0%	12,65 kbit/s
15	$5 \cdot 10^{-4}$	0%	15,85 kbit/s, ROHC
16	$5 \cdot 10^{-4}$	3%	12,65 kbit/s, ROHC
17	$5 \cdot 10^{-4}$	3%	12,65 kbit/s
18	$5 \cdot 10^{-4}$	3%	15,85 kbit/s, ROHC

Table 11: Test conditions with noise for AMR-WB

Cond.	Additional Background noise Room A	Additional Background noise Room B	Experimental factors		
			Radio conditions (BLER)	IP conditions (Packet loss ratio)	Mode
19	Car	No	$5 \cdot 10^{-4}$	3%	12,65 kbit/s, ROHC
20	No	Car	$5 \cdot 10^{-4}$	3%	12,65 kbit/s, ROHC
21	Cafeteria	No	$5 \cdot 10^{-4}$	0%	12,65 kbit/s
22	No	Cafeteria	$5 \cdot 10^{-4}$	0%	12,65 kbit/s
23	Street	No	$5 \cdot 10^{-4}$	0%	15,85 kbit/s, ROHC
24	No	Street	$5 \cdot 10^{-4}$	0%	15,85 kbit/s, ROHC

Table 12: Noise Types for AMR-WB

Noise type	Level (dB Pa)
Car	60
Street	55
Cafeteria	50

Table 13: Test details for AMR-WB

Listening Level	1	79 dB SPL
Listeners	32	Naïve Listeners
Groups	16	2 subjects/group
Rating Scales	5	
Languages	3	North American English, French, Japanese
Listening System	1	Monaural headset (flat response in the audio bandwidth of interest: 50Hz-7kHz). The other ear is open.
Listening Environment		Room Noise: Hoth Spectrum at 30dBA (as defined by ITU-T Recommendation P.800: Annex A, section A.1.1.2.2.1 Room Noise, with table A.1 and Figure A.1), except when background noise is needed (see Table 12 of this TR)

6 Test bed and test plan for Phase 2

The Phase 2 of the listening test was conducted by one listening test laboratory (FT R&D). The different speech coders used in this test are:

- Adaptive Multi-Rate Narrow-Band (AMR-NB), in modes 6.7 kbit/s and 12.2 kbit/s,
- Adaptive Multi-Rate Wide-Band (AMR-WB), in modes 12.65 kbit/s and 15.85 kbit/s,
- ITU-T G.723.1, in mode 6.4 kbit/s,
- ITU-T G.729, in mode 8 kbit/s,
- ITU-T G.722 (wideband codec), in mode 64 kbit/s, with packet loss concealment and,
- ITU-T G.711, with packet loss concealment.

As there is no standardized packet loss concealment for G.711 and G.722, proprietary packet loss concealment algorithms were used for them. The simulated network was tested under two values of IP packet loss (0% and 3%). The testing was done in one test laboratory only, but in two different languages (Arabic and French).

The IP packet contains 20 ms speech frames except for G.723.1 for which IP packet contains 30 ms speech. For G.729 the 20 ms packet consists of two 10 ms frames.

The test methodology was the same as the one applied in Phase 1.

Annex B contains the instructions for the subjects participating to the conversation tests.

6.1 Test arrangement

6.1.1 Description of the proposed testing system

Figure 5 describes the system that was simulated.

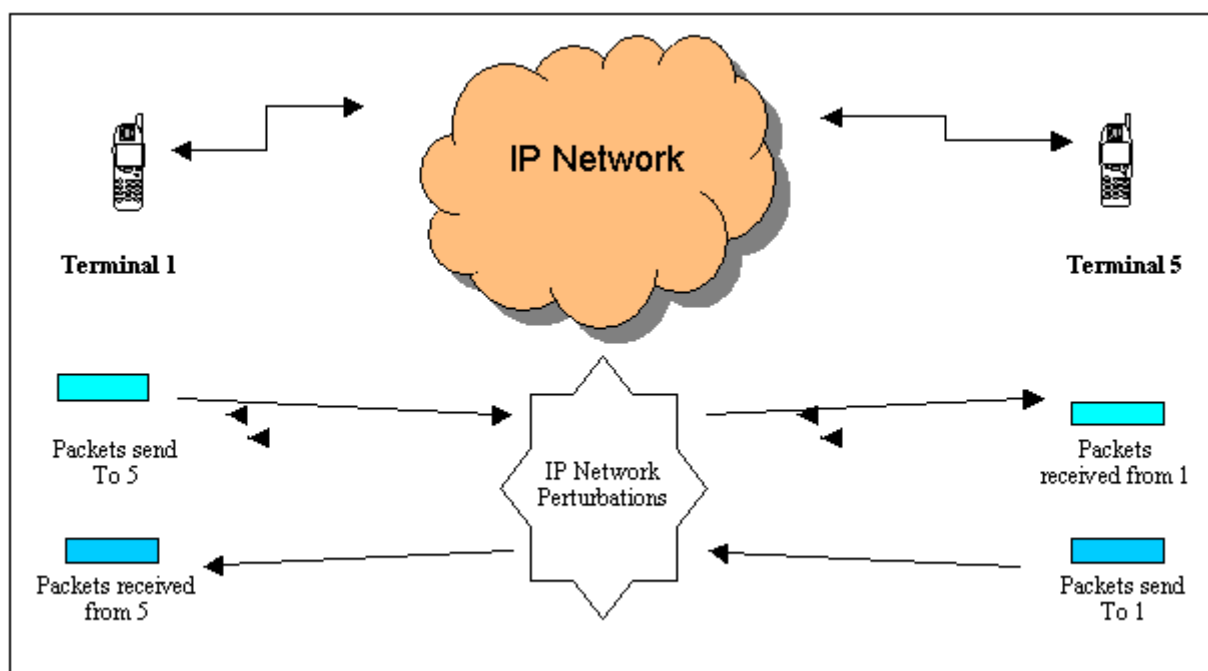

Figure 5: Packet Switched audio communication simulator

This was simulated using 3 PCs as shown in Figure 6.

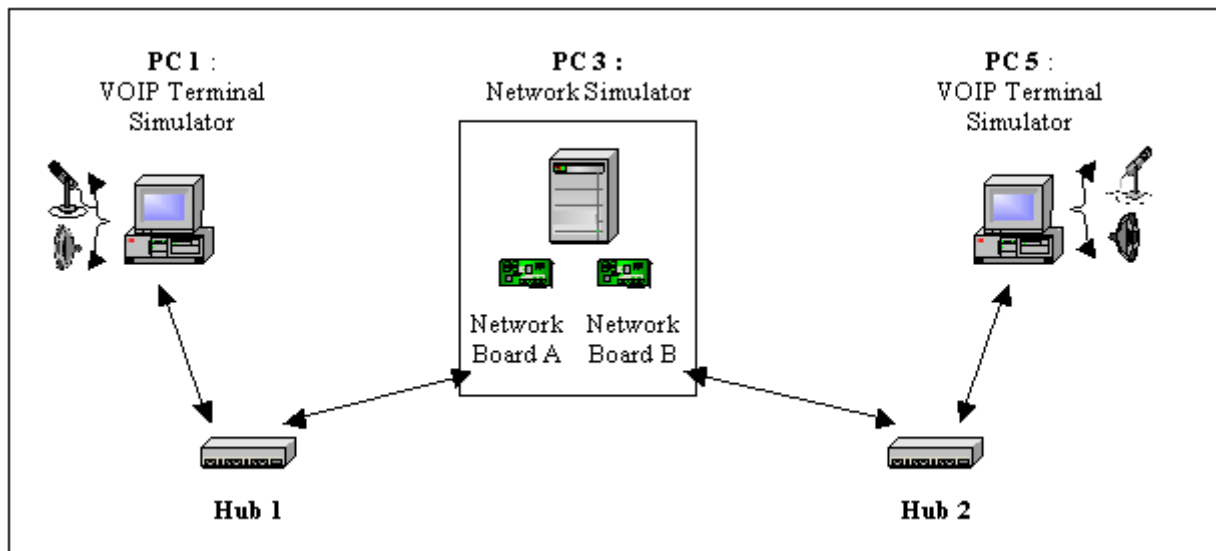

Figure 6: Simulation Platform

PC 1 and PC 5 run under Windows OS with VOIP Terminal Simulator Software of France Telecom R&D. PC 3 run under WinNT OS with Network Simulator Software (NetDisturb).

The platform simulates a packet switched interactive communication between two users using PC 1 and PC 5 as their relative VOIP terminals. PC 1 sends encoded packets that are encapsulated using IP/UDP/RTP headers to PC 5. PC 1 receives these IP/UDP/RTP audio packets from PC 5.

6.1.2 Network simulator

The core network simulator is the same as the one presented in Section 5. The different parameters that can be modified are presented in Figure 3 (Section 5.2.2).

In this test, only "loss law" has two values, all the others settings are fixed. On both links, one can choose delay and loss laws. Both links can be treated separately or in the same way. For example, delay can be set to a fixed value but it can also be set to another law such as exponential law. Only loss law was given values: 0% or 3% under bursty law. Both links were treated in the same way.

Headsets were here also used to reduce echo problems. The monaural headsets are connected to the sound cards of the PCs supporting the different codecs.

The sound level in the earphones can be adjusted, if needed, by the users. But, in practice, the original settings, defined during the preliminary tests, and producing a comfortable listening level, are not modified. The microphones are protected by a foam ball in order to reduce the "pop" effect. It is also suggested to the user to avoid placing the acoustic opening of the microphone in front of the mouth.

The same test environment as in test Phase 1 is used. Each of the two subjects participating to the conversations are installed in a test room. They sit on an armchair, in front of a table. The test rooms are acoustically insulated. All the test equipments are installed in a third room, connected to the test rooms. The background noise level is checked by a sound level meter. The measurement microphone, connected to the Sound level meter is located at the equivalent of the center of the subject's head. The noise level is A weighted.

6.1.3 Calibration and test conditions monitoring

The speech level checking is done in the same way as for Phase 1 (see Section 5.2.6.1).

The overall delay (from the input of sound card A to the output of sound card B) is adjusted for each test condition taking into account the delay of the related codec in order to have a fixed delay around 250ms. This value of 250ms is close to the hypothetical delay computed for AMR-NB and AMR-WB through the UMTS network.

6.2 Test Conditions

The test conditions and details are described in Tables 14 and 15.

Table 14: Test conditions

Cond.	Experimental factors	
	IP conditions (Packet loss ratio)	Mode
1	0%	AMR-NB 6,7kbit/s
2	0%	AMR-NB 12,2 kbit/s
3	0%	AMR-WB 12,65 kbit/s
4	0%	AMR-WB 15,85 kbit/s
5	0%	G. 723.1 6,4 kbit/s
6	0%	G.729 8 kbit/s
7	0%	G.722 64 kbit/s + plc
8	0%	G.711 + plc
9	3%	AMR-NB 6,7kbit/s
10	3%	AMR-NB 12,2 kbit/s
11	3%	AMR-WB 12,65 kbit/s
12	3%	AMR-WB 15,85 kbit/s
13	3%	G. 723.1 6,4 kbit/s
14	3%	G.729 8 kbit/s
15	3%	G.722 64 kbit/s + plc
16	3%	G.711 + plc

Table 15: Test details

Listening Level	1	79 dB SPL
Listeners	32	Naïve Listeners per language
Groups	16	2 subjects/group
Rating Scales	5	
Languages	2	French, Arabic
Listening System	1	Monaural headset (flat response in the audio bandwidth of interest: 50Hz-7kHz). The other ear is open.
Listening Environment		Room Noise: Hoth Spectrum at 30dBA (as defined by ITU-T Recommendation P.800: Annex A, section A.1.1.2.2.1 Room Noise, with table A.1 and Figure A.1)

7 Analysis of test results for DCH channels for Phase 1 and 2

This section presents the Global Analysis of the results. The analysis work was performed by Dynastat in its function as the Global Analysis Laboratory (GAL). Annex G presents the GAL Test Plan for characterizing the results of the conversation tests. (Detailed test plans are given in Annexes D and E for Phase 1 and in Annex F for Phase 2).

It should be noted that this is the first instance in any standardisation body of conversation tests being used to characterize the performance of standardized speech codecs, and the first instance of codecs in 3GPP being characterized for packet-switched networks. Moreover, the analyses reported in this document represent a new approach to evaluating the results of conversation tests.

7.1 Conversation Tests

The Phase 1 test plan describes the methodology for conducting the conversation tests. In general, the procedure involved a pair of subjects located in different rooms and communicating over a simulated packet-switched network. The subjects were involved in a task, which required them to communicate in order to solve a specific problem. At the end of their task, each subject was required to rate various aspects of the quality of their conversation. Each of these

ratings involved a five-point scale with descriptors appropriate to the aspect of the conversation being rated. Table 16 shows a summary of the five rating scales. (The first row in each column shows the scale abbreviation that will be used throughout this report).

Table 16: Summary of Rating Scales used in the Conversation Tests

VQ		US		IA		PC		GQ	
Voice Quality of your partner		Difficulty Understanding your partner		Interaction with your partner		Perception of impairments		Global Quality of the conversation	
5	Excellent	5	Never	5	Excellent	5	None	5	Excellent
4	Good	4	Rarely	4	Good	4	Not disturbing	4	Good
3	Fair	3	Sometimes	3	Fair	3	Slightly disturbing	3	Fair
2	Poor	2	Often	2	Poor	2	Disturbing	2	Poor
1	Bad	1	All the time	1	Bad	1	Very Disturbing	1	Bad

Since each subject makes five ratings for each condition, there are five dependent variables involved in analyses of the response data. We would expect the ratings on the scales in Table 16 to show some degree of inter-correlation across test conditions. If, in fact, all five were perfectly correlated then we would conclude that they were each measuring the same underlying variable. In this scenario, we could combine them into a single measure (e.g., by averaging them) for purposes of statistical analyses and hypothesis testing. If, on the other hand, the ratings were uncorrelated, we would conclude that each scale is measuring a different underlying variable and should be treated separately in subsequent analyses. In practice, the degree of intercorrelation among such dependent variables usually falls somewhere between these two extremes. Multivariate Analysis of Variance (MANOVA) is a statistical technique designed to evaluate the results of experiments with multiple dependent variables and determine the nature and number of underlying variables. MANOVA was proposed in the GAL test plan for the conversation tests and was used extensively in the analyses presented in this report.

7.2 Experimental Design and Statistical Procedures

The two Phase 1 test plans, AMR Narrowband (AMR-NB) and AMR Wideband (AMR-WB), described similar experimental designs, each experiment involving 24 test conditions (*COND*) and 16 pairs of subjects. The test plans also specified that the experiments would be conducted by three Listening Laboratories (*LAB*), each in a different language: Arcon for North American English, NTT-AT for Japanese, and France Telecom for French.

Of the 24 conditions in both the NB and WB experiments, 18 were described as Symmetrical conditions (*SYM*), six as Asymmetrical (*ASY*). In the *SYM* conditions all subjects were located in a Quiet room, i.e., with no introduced background noise. The six *ASY* conditions were actually three pairs of conditions where one subject in each conversation-pair was located in a noisy background and the other subject was in the quiet. The data from these sets of paired conditions were sorted to effect a comparison of *sender in noise/receiver in quiet* and *sender in quiet/receiver in noise* for the three conditions involving noise in the rooms.

The Phase 2 test plan described a single experiment involving 16 conditions conducted by one listening lab (France Telecom) but in two languages, French and Arabic.

For purposes of the GAL, the data from the three experiments, Phase 1-NB, Phase 1-WB, and Phase 2 were separated into five *Sets* of conditions for statistical analyses:

Set 1. Phase 1 - NB/*SYM* conditions (1-18)

Set 2. Phase 1 - NB/*ASY* conditions (19-24)

Set 3. Phase 1 - WB/*SYM* conditions (1-18)

Set 4. Phase 2 - WB/*ASY* conditions (19-24)

Set 5. Phase 2 - Ph2 conditions (1-16)

For each of these five set of conditions, a three-step statistical process was undertaken to attempt to simplify the final analyses and arrive at the most parsimonious and unambiguous statistical method for characterizing the results of the conversation tests. These procedures involved the following steps:

- Step 1) Compute an intercorrelation matrix among the dependent variables for the *Set* of conditions. Substantial inter-correlation among the dependent variables (i.e., correlation coefficients $> .50$ or $< -.50$) indicates that the number of dependent variables can be reduced - that there is a reduced set of underlying variables accounting for the variance in the dependent variables.
- Step 2) Conduct a MANOVA on the *Set* of scores for the effects of conditions (*COND*) in the *Set*, (18 *COND* for *Set 1*, 6 *COND* for *Set 2*, etc.) ignoring other factors. The MANOVA procedure determines the linear combination of the dependent variables that best separates the linear combination of the independent variable, i.e., *COND*. The initial linear combination of dependent variables is the *root* that accounts for maximum variance in the independent variables - it also represents the first underlying variable. A Chi-square test is conducted to determine the significance of the root. Subsequent roots are also extracted from the residual variance and tested with Chi-square for significance with each subsequent root being orthogonal to the preceding root. The number of significant roots indicates the number of significant underlying variables that account for the variance in the dependent variables.
- Step 3) If there is only one significant root for the *COND* effect, the *Canonical coefficients* for that root are used to compute a weighted average of the dependent variables to estimate the underlying variable. This composite dependent variable is then used in a univariate ANOVA to test the factors involved in the experiment. Such ANOVA's will produce results that are more parsimonious and less complicated than presenting the results in the multi-dimensional space which would be necessary with multiple dependent variables.

7.3 Narrowband Test - Symmetric conditions (*Set 1*)

Table 18 shows the 1 to 18 test conditions involved in the NB symmetric condition conversation tests. Also shown in the table are the Mean scores for each rating scale by condition and by listening lab. Each score shown in the table is the average of ratings from 32 subjects.

The first step in the process described in the previous section is to examine the inter-correlations among the dependent variables for indications of underlying variables. Table 17 shows the inter-correlation matrix of the five dependent variables for the NB/SYM conditions. Absolute values of correlation above .50 have been bolded in the table. The table shows a high degree of inter-correlation among the dependent variables indicating the presence of a reduced set of underlying variables.

Table 17: Intercorrelations Among the Dependent Variables for the NB/SYM Conditions

NB/S	VQ	US	IA	PC	GQ
VQ	1				
US	0.65	1			
IA	0.40	0.58	1		
PC	0.61	0.71	0.56	1	
GQ	0.81	0.66	0.47	0.69	1

The second step in the analysis is designed to determine how many underlying variables account for the variance in the five dependent variables. MANOVA for the effects of *COND* was conducted on the NB/SYM data – conditions 1-18. Table 19 summarizes the results of the MANOVA analysis. The table contains two sections. The top section shows the analysis for the main effect of *COND*. It includes the results of univariate ANOVA's for each of the five dependent variables followed by results for the Multivariate-ANOVA (i.e., the MANOVA) for the combination of dependent variables. In Table 19 we can see that the *COND* main effect is highly significant for each of the five individual dependent variables in the univariate ANOVA's as well as for the combination of dependent variables

Table 18: Test Conditions and Mean Scores for each Condition and for each Lab for the Narrowband Experiment

Narrowband - Experimental Parameters							Voice Quality			Understanding			Interaction			Perception			Global Quality		
Cond	Rm-A	Rm-B	RC	PL	Mode	Del	Arcon	FT	NTT	Arcon	FT	NTT	Arcon	FT	NTT	Arcon	FT	NTT	Arcon	FT	NTT
1	Quiet	Quiet	10 ⁻²	0	6.7	300	3.47	3.81	3.28	3.94	4.06	4.34	3.78	3.69	4.63	4.00	3.84	4.13	3.56	3.53	3.34
2	Quiet	Quiet	10 ⁻²	0	12.2	500	3.50	3.81	3.06	4.16	4.16	4.09	3.59	3.66	4.09	4.06	4.00	3.81	3.66	3.63	3.13
3	Quiet	Quiet	10 ⁻²	0	12.2	300	3.81	3.63	3.47	4.16	3.94	4.34	3.88	3.72	4.56	4.19	3.84	4.19	3.88	3.56	3.53
4	Quiet	Quiet	10 ⁻²	3	6.7	300	3.25	3.22	2.75	3.66	3.31	3.78	3.66	3.13	4.25	3.66	2.94	3.59	3.28	2.81	2.72
5	Quiet	Quiet	10 ⁻²	3	12.2	500	3.44	3.38	2.84	3.69	3.66	3.63	3.72	3.38	4.00	3.84	2.94	3.72	3.50	2.94	2.72
6	Quiet	Quiet	10 ⁻²	3	12.2	300	3.41	3.63	3.16	3.88	3.78	4.03	3.88	3.56	4.41	3.88	3.44	4.00	3.41	3.22	3.13
7	Quiet	Quiet	10 ⁻³	0	6.7	300	3.91	4.16	3.41	4.19	4.47	4.44	3.94	4.00	4.84	4.34	4.38	4.31	3.78	4.00	3.50
8	Quiet	Quiet	10 ⁻³	0	12.2	500	3.72	4.22	3.59	4.22	4.41	4.50	3.72	4.03	4.72	4.09	4.44	4.53	3.97	4.06	3.72
9	Quiet	Quiet	10 ⁻³	0	12.2	300	4.00	4.56	3.47	4.38	4.69	4.44	4.03	4.38	4.72	4.44	4.78	4.31	4.16	4.50	3.44
10	Quiet	Quiet	10 ⁻³	3	6.7	300	3.28	3.66	3.16	3.72	3.94	4.16	3.78	3.88	4.44	3.91	3.72	4.00	3.31	3.41	3.16
11	Quiet	Quiet	10 ⁻³	3	12.2	500	3.75	3.84	3.19	4.13	3.97	4.31	3.81	3.56	4.38	3.94	3.91	4.13	3.66	3.69	3.25
12	Quiet	Quiet	10 ⁻³	3	12.2	300	3.50	3.91	3.41	4.00	4.22	4.44	3.97	4.09	4.66	3.88	4.13	4.25	3.53	3.97	3.53
13	Quiet	Quiet	5 x 10 ⁻⁴	0	6.7	300	3.91	4.25	3.59	4.19	4.63	4.47	4.06	4.16	4.72	4.38	4.59	4.44	4.00	4.25	3.59
14	Quiet	Quiet	5 x 10 ⁻⁴	0	12.2	500	3.97	4.34	3.50	4.22	4.47	4.56	3.75	3.97	4.44	4.31	4.53	4.44	3.94	3.97	3.44
15	Quiet	Quiet	5 x 10 ⁻⁴	0	12.2	300	4.03	4.44	4.03	4.53	4.50	4.75	4.09	4.19	4.88	4.47	4.50	4.69	3.97	4.19	3.97
16	Quiet	Quiet	5 x 10 ⁻⁴	3	6.7	300	3.63	3.84	3.19	3.91	3.97	4.25	4.03	3.72	4.63	3.91	3.75	4.06	3.50	3.56	3.34
17	Quiet	Quiet	5 x 10 ⁻⁴	3	12.2	500	3.66	3.88	3.22	4.03	4.22	4.25	3.78	3.78	4.34	4.13	4.13	4.09	3.69	3.78	3.19
18	Quiet	Quiet	5 x 10 ⁻⁴	3	12.2	300	3.56	3.75	3.25	4.03	3.88	4.22	3.69	3.63	4.59	4.09	3.78	4.19	3.72	3.44	3.19
19	Car	Quiet	5 x 10 ⁻⁴	3	12.2	300	3.16	3.63	2.88	3.13	2.97	3.34	3.84	3.06	3.88	3.66	2.72	3.66	3.41	2.53	2.81
20	Quiet	Car	5 x 10 ⁻⁴	3	12.2	300	3.81	3.88	3.50	4.13	3.91	4.44	3.94	3.63	4.44	4.31	3.78	4.25	3.78	3.28	3.53
21	Cafeteria	Quiet	5 x 10 ⁻⁴	0	6.7	300	3.69	4.06	3.13	3.59	3.69	3.88	3.97	3.53	4.38	4.13	3.44	4.00	3.78	3.28	3.16
22	Quiet	Cafeteria	5 x 10 ⁻⁴	0	6.7	300	3.97	4.31	3.53	4.41	4.50	4.50	4.06	4.06	4.66	4.34	4.50	4.38	3.69	4.09	3.56
23	Street	Quiet	5 x 10 ⁻⁴	0	12.2	500	3.66	4.03	3.25	3.53	3.72	4.16	4.00	3.47	4.28	3.94	3.44	4.22	3.81	3.31	3.22
24	Quiet	Street	5 x 10 ⁻⁴	0	12.2	500	3.84	4.19	3.53	4.22	4.38	4.28	4.00	3.91	4.47	4.44	4.22	4.19	3.91	3.91	3.53

Rm-A/Rm-B (Noise environment) RC (Radio Conditions) PL (% Packet Loss) Mode (Bit rate in kbps) Del (Delay in msec)

The bottom section of Table 19 shows the Chi-square tests of the MANOVA roots. It shows only a single significant root (1 through 5), indicating that a single underlying variable accounts for the significant variation in the dependent variables for these conditions. The canonical coefficients for this root are also shown in the table and are used to compute the composite dependent variable that represents the underlying variable for the NB/SYM conditions. The composite dependent variable (**NB/S-CTQ** for **NarrowBand/Symmetric-Conversation Test Quality**) is used to characterize the ratings in the NB/SYM conditions. NB/S-CTQ scores for all conditions and all LAB's in *Set 1* are listed in the Annex A. Equation 1 shows the formula used to compute the composite score for the NB/SYM conditions.

Table 19: Results of MANOVA for COND for NB/SYM Conditions

Univariate ANOVA's for Effect COND (df = 17, 1710)					
Dep.Var.	VQ	US	IA	PC	GQ
F-Rato	8.25	8.07	5.51	11.80	10.99
Prob.	0.00	0.00	0.00	0.00	0.00
MANOVA for Effect: COND					
Statistic	Value	F-Statistic	df	Prob	
Pillai Trace	0.16	3.38	85, 8550	0.00	
Test of Residual Roots					
Roots	Chi-Square	df	Prob	Dep.Var.	Canon.Coeff. for Root 1-5
1 through 5	292.56	85	0.00	VQ	0.0382
2 through 5	73.44	64	0.20	US	0.0555
3 through 5	34.14	45	0.88	IA	-0.0013
4 through 5	11.27	28	1.00	PC	0.5073
5 through 5	4.23	13	0.99	GQ	0.4004

Formula used to compute the Conversation Test Quality Score (NB/S-CTQ) for the conditions in Set 1:

$$NB/S-CTQ = .0426*VQ + .0620*US - .0015 * IA + .5664 * PC + .4470 * GQ \tag{1}$$

The SYM conditions in the NB experiment are categorized by four experimental factors:

- Radio conditions – 10^{-2} , 10^{-3} , and 5×10^{-4}
 - Packet Loss – 0% and 3%
 - AMR-NB mode or bit rate – 6.7 kbps and 12.2 kbps
 - Delay – 300 msec and 500 msec

These conditions are assigned to two factorial experimental designs for analysing the effects of three of these factors. Table 20a shows the allocation of the 12 conditions used to evaluate the effects of Radio Conditions, Packet Loss, and Mode – with Delay held constant at 300 msec. Table 20b shows the allocation of the 12 conditions used to evaluate the effects of Radio Conditions, Packet Loss, and Delay – with Mode held constant at 12.2 kbit/s.

Table 20a: NB/SYM: Factorial Design for the Effects of Radio Cond., Packet Loss, and Mode

No Noise - 300 msec delay			
6.7kbps / 0% PL		6.7kbps / 3% PL	
RC	Cond.#	RC	Cond.#
10 ⁻²	1	10 ⁻²	4
10 ⁻³	7	10 ⁻³	10
5x10 ⁻⁴	13	5x10 ⁻⁴	16
12.2kbps / 0% PL		12.2kbps / 3% PL	
RC	Cond.#	RC	Cond.#
10 ⁻²	3	10 ⁻²	6
10 ⁻³	9	10 ⁻³	12
5x10 ⁻⁴	15	5x10 ⁻⁴	18

Table 20b: NB/SYM: Factorial Design for the Effects of Radio Cond., Packet Loss, and Delay

No Noise - 12.2 kbps			
300 msec / 0% PL		300 msec / 3% PL	
RC	Cond.#	RC	Cond.#
10 ⁻²	3	10 ⁻²	6
10 ⁻³	9	10 ⁻³	12
5x10 ⁻⁴	15	5x10 ⁻⁴	18
500 msec / 0% PL		500 msec / 3% PL	
RC	Cond.#	RC	Cond.#
10 ⁻²	2	10 ⁻²	5
10 ⁻³	8	10 ⁻³	11
5x10 ⁻⁴	14	5x10 ⁻⁴	17

The composite dependent variable, NB/S-CTQ, was computed for the NB/SYM conditions using the equation shown in Eq.1. These composite scores were subjected to factorial ANOVA for the two experimental designs shown in Tables 20a and 20b. The results of those ANOVA's are shown in Tables 21 and 22, respectively.

Table 21: Results of ANOVA of NB/S-CTQ for the Effects of Lab, Radio Conditions (RC), Packet Loss (PL), and Mode

ANOVA for Composite Variable NB/S-CTQ					
Source	Sum-of-Squares	df	Mean-Square	F-ratio	Prob
LAB	1.12	2	0.56	0.79	0.46
RC	39.49	2	19.74	27.61	0.00
PL	64.20	1	64.20	89.79	0.00
MODE	9.74	1	9.74	13.62	0.00
LAB*RC	10.37	4	2.59	3.62	0.01
LAB*PL	4.42	2	2.21	3.09	0.05
LAB*MODE	0.08	2	0.04	0.06	0.94
RC*PL	0.63	2	0.32	0.44	0.64
RC*MODE	1.76	2	0.88	1.23	0.29
PL*MODE	0.51	1	0.51	0.71	0.40
LAB*RC*PL	2.17	4	0.54	0.76	0.55
LAB*RC*MODE	2.69	4	0.67	0.94	0.44
LAB*PL*MODE	0.43	2	0.22	0.30	0.74
RC*PL*MODE	0.91	2	0.46	0.64	0.53
LAB*RC*PL*MODE	2.36	4	0.59	0.82	0.51
Error	797.99	1116	0.72		
Total	938.88	1151			

Table 21 shows that the main effects for *Radio Conditions*, *Packet Loss*, and *Mode* are significant ($p < .05$) for the NB/S-CTQ composite variable as are the interactions of *LAB x RC* and *LAB x PL*. Figure 7 shows the NB/S-CTQ scores with 95% confidence-interval bars for the factors tested in Table 21. The significant interactions of *RC x LAB* and *PL x LAB* indicate that the pattern of scores for the levels of RC and PL were significantly different across the three LAB's. Figure 9 illustrates the interaction of *LAB x RC*, Fig.10 the interaction of *LAB x PL*.

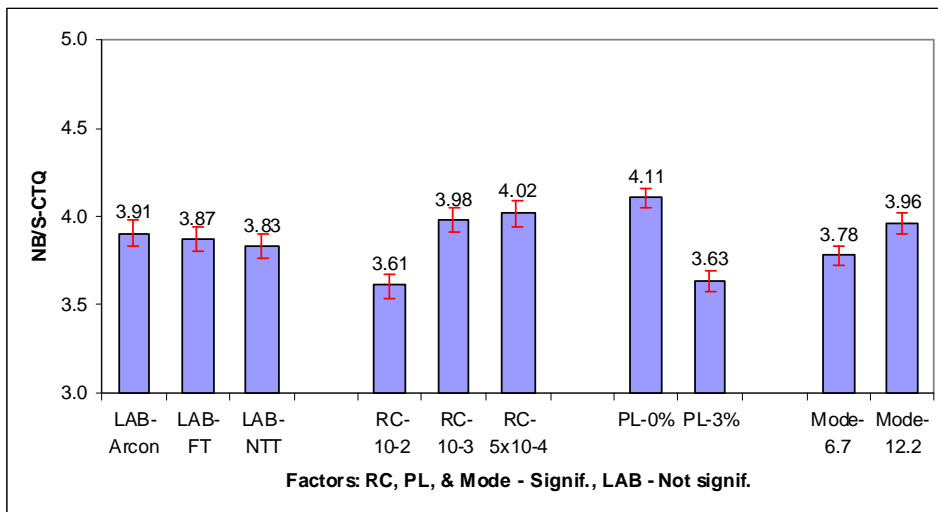

Figure 7: NB/S-CTQ Scores for the Effects of LAB, Radio Conditions, Packet Loss, and Mode

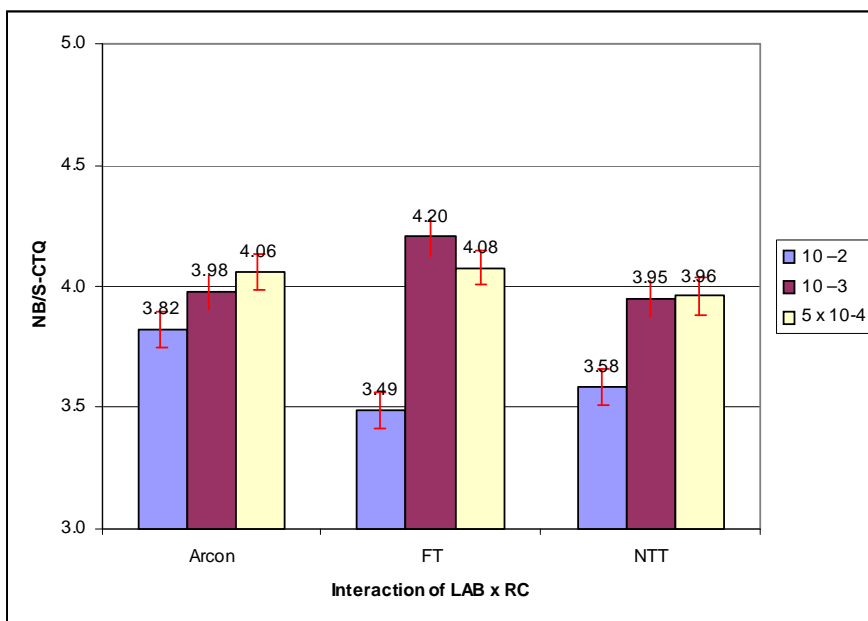

Figure 8: NB/S-CTQ Scores showing the Interaction of LAB x Radio Conditions

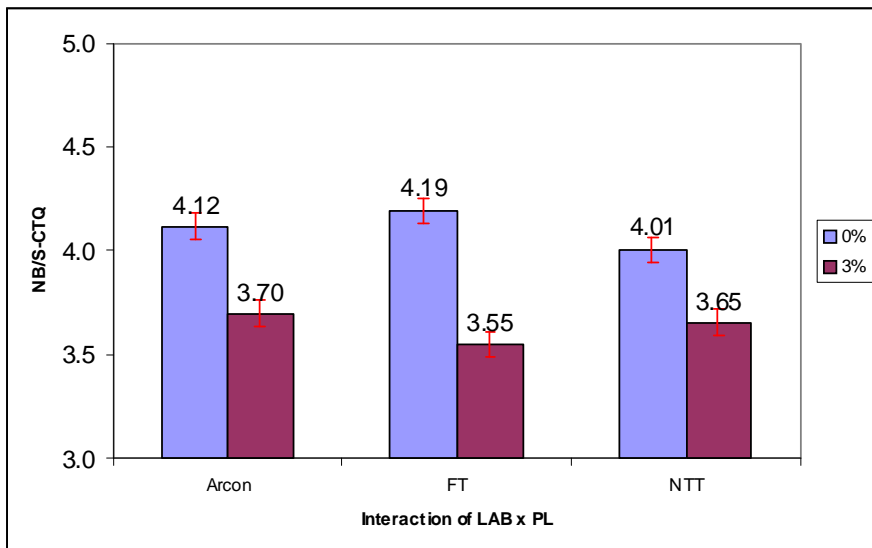

Figure 9: NB/S-CTQ Scores showing the Interaction of LAB x Packet Loss

Table 22: Results of ANOVA of NB/S-CTQ for the Effects of LAB, Radio Conditions (RC), Packet Loss (PL), and Delay

ANOVA for Composite Variable NB/S-CTQ					
Source	Sum-of-Squares	df	Mean-Square	F-ratio	Prob
LAB	3.10	2	1.55	2.41	0.09
RC	42.54	2	21.27	33.10	0.00
PL	44.72	1	44.72	69.61	0.00
DELAY	4.06	1	4.06	6.32	0.01
LAB*RC	10.47	4	2.62	4.07	0.00
LAB*PL	3.52	2	1.76	2.74	0.07
LAB*DELAY	0.64	2	0.32	0.50	0.61
RC*PL	0.10	2	0.05	0.08	0.92
RC*DELAY	1.01	2	0.50	0.79	0.46
PL*DELAY	0.37	1	0.37	0.58	0.45
LAB*RC*PL	1.45	4	0.36	0.57	0.69
LAB*RC*DELAY	4.46	4	1.12	1.74	0.14
LAB*PL*DELAY	0.80	2	0.40	0.62	0.54
RC*PL*DELAY	1.81	2	0.90	1.41	0.25
LAB*RC*PL*DELAY	4.29	4	1.07	1.67	0.15
Error	717.03	1116	0.64		
Total	840.39	1151			

The results in Table 22 show that the main effects for Radio Conditions, Packet Loss, and Delay are significant while only one interaction, LAB x RC, is significant. Figure 10 shows the NB/S-CTQ scores with 95% confidence-interval bars for the factors tested in Table 22. Figure 11 illustrates the significant interaction of Lab x RC. The figure shows that the pattern of scores for RC is significantly different across LAB's.

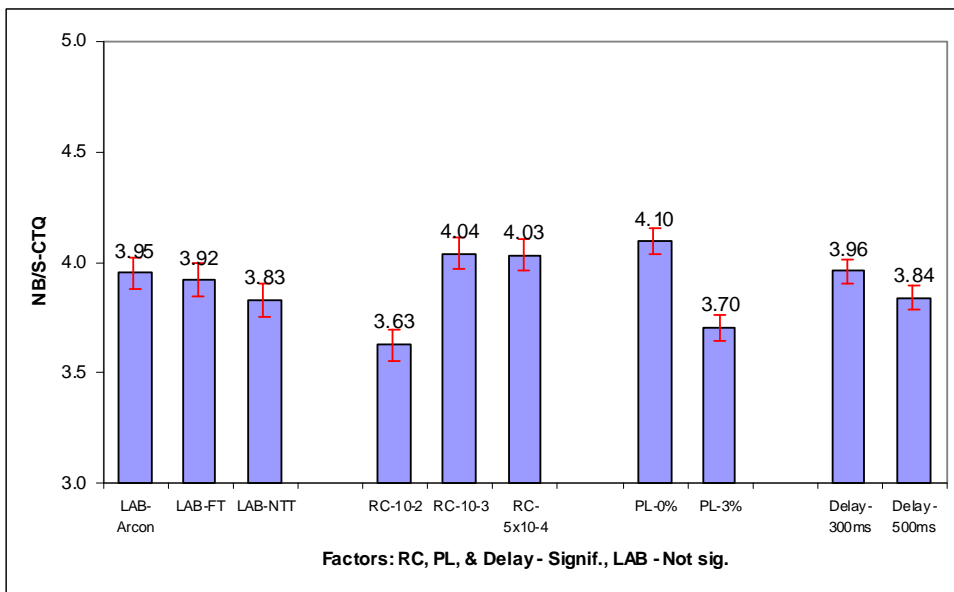

Figure 10: NB/S-CTQ Scores for the Effects of LAB, Radio Conditions, Packet Loss, and Delay

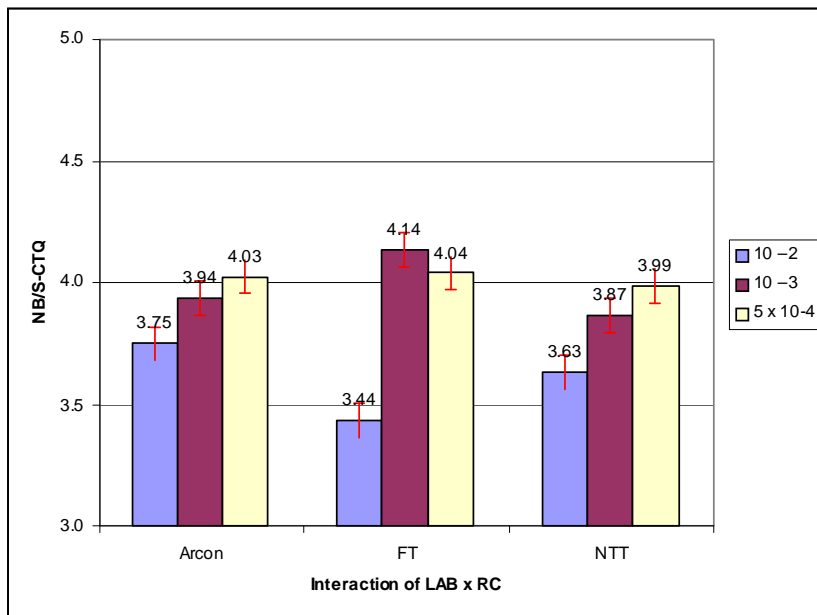

Figure 11: NB/S-CTQ Scores showing the Interaction of LAB x Radio Conditions

7.4 Narrowband Test – Asymmetric Conditions (Set 2)

Table 18 shows the 6 test conditions involved in the NB asymmetric condition conversation tests (conditions 19 to 24). Also shown in the table are the Mean scores for each rating scale by condition and by listening lab. Each score shown in the table is the average of ratings from 32 subjects.

Table 23 shows the inter-correlation matrix for the dependent variables in the NB/ASY conditions. The degree of inter-correlation among the dependent variables suggests that a reduced set of underlying variables accounts for their variation.

Table 23: Inter-correlations Among the Dependent Variables for the NB/ASY Conditions

WB/A	VQ	US	IA	PC	GQ
VQ	1				
US	0.60	1			
IA	0.35	0.56	1		
PC	0.44	0.65	0.59	1	
GQ	0.65	0.64	0.56	0.68	1

Table 24 shows the results of MANOVA for the effects of *COND* for the NB/ASY conditions. The analysis shows significant *COND* effects for all the univariate ANOVA's as well as for the MANOVA. The Chi-square tests of the MANOVA roots shows only a single significant root (1 through 5), indicating that a single underlying variable accounts for the significant variation in the dependent variables for these conditions. The canonical coefficients for this root are used to estimate the composite dependent variable that represents the underlying variable for the NB/ASY conditions. The composite dependent variable (**NB/A-CTQ** for **N**arrow**B**and/**A**symmetric-**C**onversation **T**est **Q**uality) is used to characterize the ratings in the NB/ASY conditions. NB/A-CTQ scores for all conditions and all LAB's in *Set 2* are listed in Annex A. Equation 2 shows the formula that was used to compute the values of the composite variable, NB/A-CTQ, for characterizing the NB/ASY conditions.

Table 24: Results of MANOVA for *COND* for NB/ASY Conditions

Univariate ANOVA's for Effect: <i>COND</i> (df = 5, 570)					
	VQ	US	IA	PC	GQ
F-Ratio	7.05	22.40	5.99	13.32	10.20
Prob	0.00	0.00	0.00	0.00	0.00
MANOVA for effect: <i>COND</i>					
Statistic	Value	F-Ratio	df	Prob	
Pillai Trace	0.18	4.38	25, 2850	0.00	
Test of Residual Roots					Dependent
Roots	Chi-Square	df	Prob	Variable	Canonical Coefficient
1 through 5	114.89	25	0.00	VQ	0.0894
2 through 5	7.23	16	0.97	US	0.3420
3 through 5	2.70	9	0.98	IA	0.1851
4 through 5	0.31	4	0.99	PC	0.2761
5 through 5	0.04	1	0.84	GQ	0.1074

Formula used to compute the Conversation Test Quality Score (NB/A-CTQ) for the NB/ASY conditions:

$$NB/A-CTQ = .0894*VQ + .3420*US + .1851 * IA + .2761 * PC + .1074 * GQ \tag{2}$$

The six NB/ASY conditions are distinguished by two factors. One factor has three levels with each level differing along a number of dimensions – Noise, Packet Loss, Mode, and Delay. These differences are listed in Table 18, but the factor will be referred to in the following analyses by the factor-name, *Noise*, noting that the conditions differ in more dimensions than noise alone. The second factor relates to the source of the noise. The noise is either in the room of the transmitting subject or in the room of the receiving subject. This factor will be referred to as *Room*. Table 25 shows the results of ANOVA for NB/A for the factors of *LAB*, *Noise*, and *Room*.

Table 25: Results of ANOVA of NB/A-CTQ for the Effects of LAB, Noise, and Room

ANOVA for Composite Variable - NB/A-CTQ					
Source	Sum-of-Squares	df	Mean-Square	F-ratio	Prob
LAB	7.09	2	3.55	5.66	0.00
Noise	17.07	2	8.54	13.62	0.00
Room	43.76	1	43.76	69.80	0.00
LAB x Noise	3.28	4	0.82	1.31	0.27
LAB x Room	2.39	2	1.19	1.90	0.15
NOISE x Room	3.31	2	1.65	2.64	0.07
LAB x Noise x Room	1.19	4	0.30	0.48	0.75
Error	349.80	558	0.63		
Total	427.89	575			

The results of the ANOVA for NB/A-CTQ show that all three factors, *LAB*, *Noise*, and *Room*, are significant, but that none of the interactions are significant. Figure 12 shows the NB/A-CTQ scores with 95% confidence-interval bars for the three factors tested in Table 25.

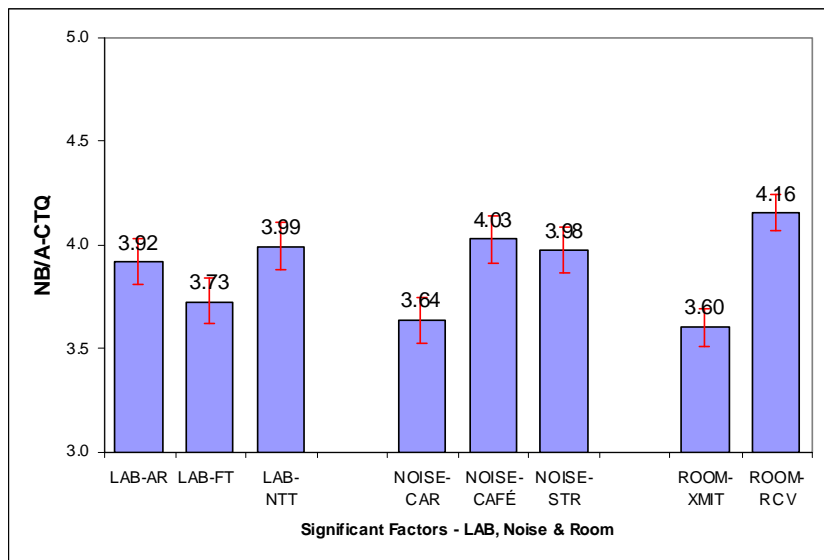

Figure 12: NB/A-CTQ Scores for the Effects of LAB, Noise, and Room

7.5 Wideband Test – Symmetric Conditions (Set 3)

Table 27 shows the 18 test conditions involved in the AMR-WB conversation tests (conditions 1 to 18). Also shown in the table are the Mean scores for each rating scale by condition and by listening lab. Each score shown in the table is the average of ratings from 32 subjects.

The initial step in the analysis is to examine the inter-correlation among the dependent variables for indications of underlying variables. Table 26 shows the inter-correlation matrix of the dependent variables for the WB/SYM conditions. Absolute values of correlation above .50 have been bolded in the table. The table shows a high degree of inter-correlation among the dependent variables indicating the presence of a reduced set of significant underlying variables.

Table 26: Intercorrelations Among the Dependent Variables for the WB/SYM Conditions

WB/S	VQ	US	IA	PC	GQ
VQ	1				
US	0.66	1			
IA	0.49	0.51	1		
PC	0.59	0.59	0.51	1	
GQ	0.79	0.68	0.55	0.66	1

The second step in the analysis is designed to determine how many underlying variables account for the variance in the five dependent variables. MANOVA for the effects of *COND* was conducted on the WB/SYM data – conditions 1-18. Table 28 summarizes the results of the analysis. The top section shows the analysis for the main effect of *COND*. This section includes the results of the univariate ANOVA's for each of the five dependent variables followed by the results of the MANOVA. In the table we can see that the *COND* main effect is highly significant for each of the five individual dependent variables in the univariate ANOVA's as well as for the combination of dependent variables in the MANOVA.

The bottom section of the table shows the Chi-square test of the MANOVA roots or underlying variables extracted from the five dependent variables. In Table 28, only the first root (1 through 5) is significant, indicating that a single underlying variable accounts for the significant variation in the dependent variables for these conditions. The canonical coefficients shown in the table are used to estimate the composite dependent variable that represents this root or underlying variable. The composite dependent variable (**WB/S-CTQ** for **WideBand/Symmetric-Conversation Test Quality**) is computed and used in the third step – ANOVA's to test and characterize the factors of interest in the Wideband/SYM conditions. WB/S-CTQ scores for all conditions and all LAB's for *Set 3* are listed in Annex A. Equation 3 shows the formula that was used to compute the values of the composite variable, WB/S-CTQ, for characterizing the WB/SYM conditions.

Table 27: Test Conditions and Mean Scores for each LAB for the Wideband Experiment

Wideband - Experimental Parameters							Voice Quality			Understanding			Interaction			Perception			Global Quality		
Cond	Rm-A	Rm-B	RC	PL	Mode	RoHC	Arcon	FT	NTT	Arcon	FT	NTT	Arcon	FT	NTT	Arcon	FT	NTT	Arcon	FT	NTT
1	Quiet	Quiet	10 ⁻²	0	12.65	RoHC	4.09	4.22	3.84	4.38	4.41	4.34	4.25	4.13	4.53	4.47	4.25	4.31	4.09	4.06	3.75
2	Quiet	Quiet	10 ⁻²	0	12.65	-	4.00	4.44	3.97	4.22	4.84	4.53	4.06	4.38	4.72	4.28	4.41	4.31	3.78	4.31	4.00
3	Quiet	Quiet	10 ⁻²	0	15.85	RoHC	4.13	4.28	4.13	4.38	4.50	4.69	4.31	4.19	4.66	4.50	4.28	4.59	4.28	4.09	4.22
4	Quiet	Quiet	10 ⁻²	3	12.65	RoHC	3.88	3.72	3.72	4.19	4.09	4.03	3.91	4.09	4.28	4.34	3.84	4.06	3.88	3.53	3.59
5	Quiet	Quiet	10 ⁻²	3	12.65	-	3.63	3.75	3.72	4.06	3.88	4.06	3.91	3.81	4.38	4.22	3.88	4.16	3.72	3.63	3.69
6	Quiet	Quiet	10 ⁻²	3	15.85	RoHC	3.91	3.97	3.84	4.19	4.44	4.28	4.06	4.13	4.53	4.22	4.03	4.28	3.84	3.84	3.81
7	Quiet	Quiet	10 ⁻³	0	12.65	RoHC	4.22	4.38	4.00	4.50	4.56	4.69	4.25	4.22	4.75	4.69	4.56	4.63	4.28	4.19	4.00
8	Quiet	Quiet	10 ⁻³	0	12.65	-	4.06	4.47	4.06	4.28	4.69	4.72	4.22	4.25	4.69	4.31	4.47	4.69	4.16	4.25	4.22
9	Quiet	Quiet	10 ⁻³	0	15.85	RoHC	3.88	4.63	3.94	4.34	4.75	4.53	4.16	4.38	4.75	4.44	4.50	4.53	3.94	4.38	4.06
10	Quiet	Quiet	10 ⁻³	3	12.65	RoHC	3.97	4.31	3.97	4.19	4.50	4.41	4.13	4.13	4.66	4.47	4.19	4.53	4.03	3.94	3.97
11	Quiet	Quiet	10 ⁻³	3	12.65	-	4.03	4.25	3.75	4.41	4.56	4.34	4.09	4.16	4.50	4.69	4.16	4.28	3.94	3.97	3.81
12	Quiet	Quiet	10 ⁻³	3	15.85	RoHC	4.03	4.03	3.91	4.34	4.38	4.47	4.16	4.09	4.66	4.28	4.22	4.38	4.00	3.81	3.91
13	Quiet	Quiet	5 x 10 ⁻⁴	0	12.65	RoHC	4.09	4.34	4.19	4.34	4.63	4.66	4.16	4.22	4.81	4.59	4.53	4.63	4.00	4.13	4.22
14	Quiet	Quiet	5 x 10 ⁻⁴	0	12.65	-	4.09	4.59	4.06	4.47	4.81	4.59	4.16	4.44	4.75	4.50	4.56	4.56	4.16	4.38	4.09
15	Quiet	Quiet	5 x 10 ⁻⁴	0	15.85	RoHC	4.19	4.47	4.03	4.47	4.69	4.66	4.44	4.31	4.78	4.59	4.47	4.59	4.38	4.16	4.06
16	Quiet	Quiet	5 x 10 ⁻⁴	3	12.65	RoHC	3.94	3.97	3.91	4.25	4.53	4.41	4.00	3.97	4.63	4.25	4.16	4.38	3.84	3.88	4.00
17	Quiet	Quiet	5 x 10 ⁻⁴	3	12.65	-	4.06	4.19	3.88	4.25	4.47	4.41	4.19	4.13	4.47	4.59	4.28	4.28	4.09	3.94	3.84
18	Quiet	Quiet	5 x 10 ⁻⁴	3	15.85	RoHC	4.13	4.34	3.81	4.38	4.53	4.56	4.31	4.06	4.59	4.59	4.19	4.44	4.09	3.91	3.81
19	Car	Quiet	5 x 10 ⁻⁴	3	12.65	RoHC	3.50	4.09	2.97	3.59	3.63	3.00	3.97	3.66	3.47	4.03	3.38	3.19	3.81	3.34	2.78
20	Quiet	Car	5 x 10 ⁻⁴	3	12.65	RoHC	3.97	4.03	3.78	4.09	4.34	4.38	4.19	3.97	4.50	4.34	3.88	4.31	4.03	3.75	3.84
21	Cafeteria	Quiet	5 x 10 ⁻⁴	0	12.65	-	3.75	4.38	3.66	3.78	4.38	3.88	3.94	4.09	4.06	4.31	3.97	3.84	3.81	3.81	3.34
22	Quiet	Cafeteria	5 x 10 ⁻⁴	0	12.65	-	4.16	4.56	4.13	4.47	4.72	4.69	4.25	4.25	4.72	4.59	4.44	4.59	4.13	4.16	4.22
23	Street	Quiet	5 x 10 ⁻⁴	0	15.85	RoHC	3.81	4.31	3.72	3.63	3.91	4.22	4.13	3.75	4.19	4.41	3.34	4.19	4.13	3.41	3.59
24	Quiet	Street	5 x 10 ⁻⁴	0	15.85	RoHC	3.94	4.44	4.16	4.31	4.59	4.69	4.19	4.03	4.66	4.56	4.25	4.69	4.03	4.09	4.16

Rm-A/Rm-B (Noise environment) RC (Radio Conditions) PL (% Packet Loss) Mode (Bit rate in kbps) RoHC

Table 28: Results of MANOVA for COND for WB/SYM Conditions

Univariate ANOVA's for Effect COND (df = 17, 1710)					
Dep.Var.	VQ	US	IA	PC	GQ
F-Rato	3.35	4.36	2.84	3.98	4.14
Prob.	0.00	0.00	0.00	0.00	0.00
MANOVA for Effect: COND					
Statistic	Value	F-Statistic	df	Prob	
Pillai Trace	0.08	1.55	85, 8550	0.00	
Test of Residual Roots					
Roots	Chi-Square	df	Prob	Dep.Var.	Canon.Coeff. for Root 1-5
1 through 5	132.56	85	0.00	VQ	0.0685
2 through 5	43.32	64	0.98	US	0.3519
3 through 5	25.17	45	0.99	IA	0.1612
4 through 5	8.55	28	1.00	PC	0.2619
5 through 5	2.35	13	1.00	GQ	0.1565

The following formula is used to compute the Conversation Test Quality Score (WB/S-CTQ) for the WB/SYM conditions:

$$WB/S-CTQ = .0685*VQ + .3519*US + .1612 * IA + .2619 * PC + .1565 * GQ \tag{3}$$

The SYM conditions in the WB experiment are categorized by four experimental factors:

- Radio conditions – 10^{-2} , 10^{-3} , and 5×10^{-4}
- Packet Loss – 0% and 3%
- AMR-WB mode or bit rate – 12.65 kbps and 15.85 kbps
- ROHC

These conditions are assigned to two factorial experimental designs for analysing the effects through ANOVA of three of these factors. Table 29a shows the allocation of the 12 conditions used to evaluate the effects of Radio Conditions, Packet Loss, and Mode – with ROHC held constant. Table 29b shows the allocation of the 12 conditions used to evaluate the effects of Radio Conditions, Packet Loss, and ROHC – Mode held constant at 12.65kbps.

Table 29a: WB/SYM: Factorial Design for the Effects of Radio Cond., Packet Loss, and Mode

No Noise - RoHC			
12.65kbps / 0% PL		12.65 kbps / 3% PL	
RC	Cond.#	RC	Cond.#
10^{-2}	1	10^{-2}	4
10^{-3}	7	10^{-3}	10
5×10^{-4}	13	5×10^{-4}	16
15.85 kbps / 0% PL		15.85 kbps / 3% PL	
RC	Cond.#	RC	Cond.#
10^{-2}	3	10^{-2}	6
10^{-3}	9	10^{-3}	12
5×10^{-4}	15	5×10^{-4}	18

Table 29b: WB/SYM: Factorial Design for the Effects of Radio Cond., Packet Loss, and Mode

No Noise - 12.65 kbps			
RoHC / 0% PL		RoHc / 3% PL	
RC	Cond.#	RC	Cond.#
10^{-2}	1	10^{-2}	4
10^{-3}	7	10^{-3}	10
5×10^{-4}	13	5×10^{-4}	16
No RoHC / 0% PL		No RoHC / 3% PL	
RC	Cond.#	RC	Cond.#
10^{-2}	2	10^{-2}	5
10^{-3}	8	10^{-3}	11
5×10^{-4}	14	5×10^{-4}	17

The composite dependent variable, WB/S-CTQ, was computed for the WB/SYM conditions and subjected to factorial ANOVA for the two experimental designs shown in Tables 29a and 29b. The results of the ANOVA's are shown in Tables 30 and 31, respectively.

Table 30: Results of ANOVA of WB/S-CTQ for the Effects of *Lab*, *Radio Conditions* (RC), *Packet Loss* (PL), and *Mode*

ANOVA for Composite Variable WB/S-CTQ					
Source	Sum-of-Squares	df	Mean-Square	F-ratio	Prob
LAB	6.53	2	3.26	6.52	0.00
RC	6.90	2	3.45	6.90	0.00
PL	14.33	1	14.33	28.65	0.00
MODE	1.41	1	1.41	2.81	0.09
LAB*RC	0.98	4	0.24	0.49	0.75
LAB*PL	0.23	2	0.12	0.23	0.79
LAB*MODE	0.04	2	0.02	0.04	0.96
RC*PL	0.35	2	0.18	0.35	0.70
RC*MODE	1.96	2	0.98	1.96	0.14
PL*MODE	0.09	1	0.09	0.17	0.68
LAB*RC*PL	0.45	4	0.11	0.23	0.92
LAB*RC*MODE	2.25	4	0.56	1.12	0.34
LAB*PL*MODE	0.11	2	0.05	0.11	0.90
RC*PL*MODE	0.01	2	0.01	0.01	0.99
LAB*RC*PL*MODE	1.00	4	0.25	0.50	0.74
Error	558.34	1116	0.50		
Total	594.97	1151			

Table 30 shows that the main effects for *LAB*, *Radio Conditions*, and *Packet Loss* are significant for the WB/S-CTQ composite variable. The factor *Mode* is not significant nor are any of the interactions. Figure 13 shows the WB/S-CTQ scores with 95% confidence-interval bars for the factors tested in Table 30.

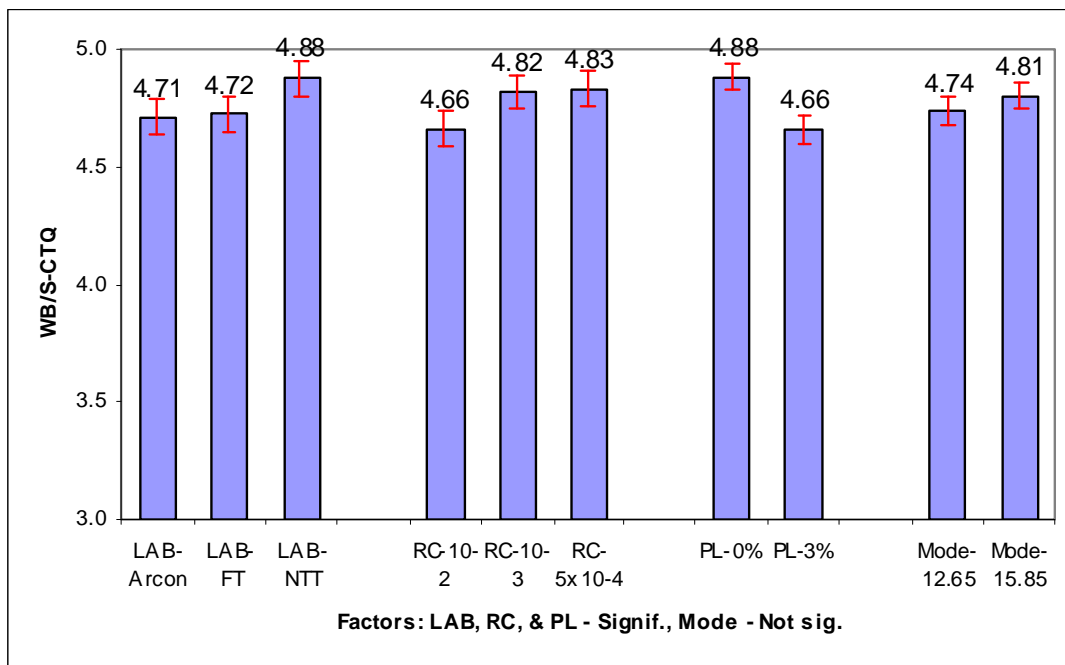

Figure 13: WB/S-CTQ Scores for the Effects of *LAB*, *Radio Conditions*, *Packet Loss*, and *Mode*

Table 31: Results of ANOVA of WB/S-CTQ for the Effects of LAB, Radio Conditions (RC), Packet Loss (PL), and ROHC

ANOVA for Composite Variable WB/S-CTQ					
Source	Sum-of-Squares	df	Mean-Square	F-ratio	Prob
LAB	5.24	2	2.62	5.10	0.01
RC	13.59	2	6.80	13.23	0.00
PL	19.41	1	19.41	37.79	0.00
ROHC	0.07	1	0.07	0.14	0.71
LAB*RC	0.80	4	0.20	0.39	0.82
LAB*PL	2.46	2	1.23	2.39	0.09
LAB*ROHC	0.70	2	0.35	0.68	0.51
RC*PL	1.57	2	0.78	1.52	0.22
RC*ROHC	0.24	2	0.12	0.24	0.79
PL*ROHC	0.11	1	0.11	0.21	0.65
LAB*RC*PL	0.98	4	0.25	0.48	0.75
LAB*RC*ROHC	1.90	4	0.47	0.92	0.45
LAB*PL*ROHC	2.02	2	1.01	1.97	0.14
RC*PL*ROHC	0.50	2	0.25	0.48	0.62
LAB*RC*PL*ROHC	0.85	4	0.21	0.41	0.80
Error	573.40	1116	0.51		
Total	623.84	1151			

The results in Table 31 show that the main effects for LAB, Radio Conditions, and Packet Loss are significant. The factor ROHC is not significant nor are any of the interactions. Figure 14 shows the WB/S-CTQ scores with 95% confidence-interval bars for the factors tested in Table 31.

These listening tests were conducted using a fixed size RAB available at this time (size: 46 kbit/s). The test results show that when using ROHC the quality stays the same and the bitrate can be drastically reduced by suppressing the IP/UDP/RTP headers. As a result, a smaller RAB could be used.

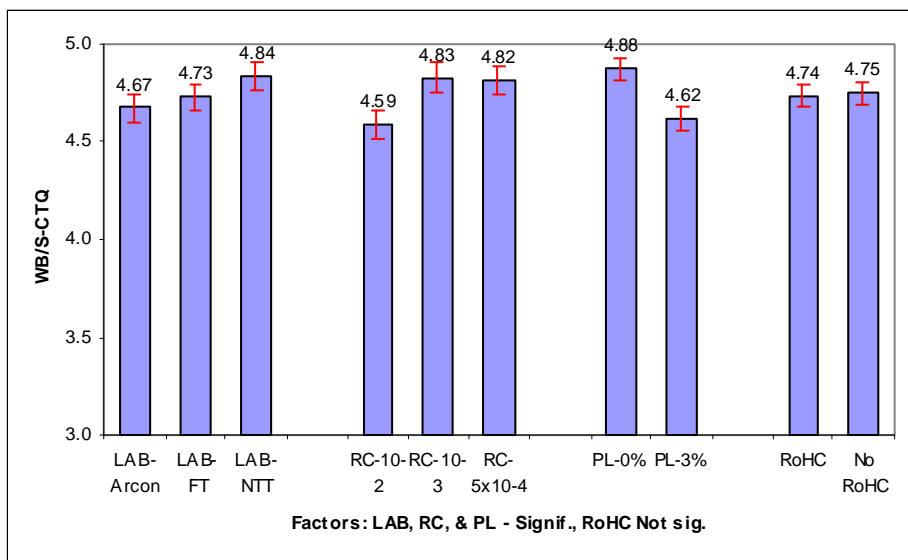

Figure 14: WB/S-CTQ Scores for the Effects of LAB, Radio Conditions, Packet Loss, and ROHC

7.6 Wideband Test – Asymmetric Conditions (Set 4)

Table 27 shows the 6 test conditions involved in the AMR-WB asymmetric condition conversation tests (condition 19 to 24). Also shown in the table are the Mean scores for each rating scale by condition and by listening lab. Each score shown in the table is the average of ratings from 32 subjects.

Table 32 shows the inter-correlation matrix for the dependent variables in the WB/ASY conditions. The high degree of inter-correlation shown in the table suggests that a reduced set of underlying variables accounts for the variation in the five dependent variables.

Table 32: Inter-correlations Among the Dependent Variables for the WB/ASY Conditions

WB/S	VQ	US	IA	PC	GQ
VQ	1				
US	0.67	1			
IA	0.56	0.64	1		
PC	0.55	0.65	0.66	1	
GQ	0.72	0.73	0.69	0.73	1

Table 33 shows the results of MANOVA for the effects of *COND* for the WB/ASY conditions. The analysis shows significant *COND* effects for all the univariate ANOVA's as well as for the MANOVA. The Chi-square tests of the MANOVA roots show only a single significant root (1 through 5), indicating that a single underlying variable accounts for the significant variation in the dependent variables for these conditions. The canonical coefficients for this root were used to compute the composite dependent variable that represents the underlying variable for the WB/Asymmetric conditions. The composite dependent variable (**WB/A-CTQ** for **WideBand/Asymmetric-Conversation Test Quality**) is used to characterize the ratings in the WB/ASY conditions. WB/A-CTQ scores for all conditions and all LAB's for *Set 4* are listed Annex A. Equation 4 shows the formula that was used to compute the values of the composite variable, WB/A-CTQ, for characterizing the WB/ASY conditions.

Table 33: Results of MANOVA for COND for WB/ASY Conditions

Univariate ANOVA's for Effect: <i>COND</i> (df = 5, 570)					
	VQ	US	IA	PC	GQ
F-Ratio	8.38	21.63	8.16	14.10	10.97
Prob	0.00	0.00	0.00	0.00	0.00
MANOVA for effect: <i>COND</i>					
Statistic	Value	F-Ratio	df	Prob	
Pillai Trace	0.19	4.53	25, 2850	0.00	
Test of Residual Roots					
Roots	Chi-Square	df	Prob	Dependent Variable	Canonical Coefficient
1 through 5	118.45	25	0.00	VQ	-0.0970
2 through 5	11.19	16	0.80	US	0.8979
3 through 5	3.80	9	0.92	IA	-0.1103
4 through 5	1.85	4	0.76	PC	0.4136
5 through 5	0.00	1	0.99	GQ	-0.1042

The following formula used to compute the Conversation Test Quality Score (WB/ACTQ) for the WB/ASY conditions.

$$WB/A-CTQ = -.0970 * VQ + .8979 * US - .1103 * IA + .4136 * PC - .1042 * GQ \tag{4}$$

The six WB/ASY conditions are distinguished by two factors. One factor has three levels with each level differing along a number of dimensions – Noise, Packet Loss, Mode, and ROHC. These differences are listed in Table 27 but the factor will be referred to in the following analyses by the factor-name, *Noise*, noting that the conditions differ in more dimensions than noise alone. The second factor relates to the source of the noise and has two levels. The noise is either in the room of the transmitting subject or in the room of the receiving subject. This factor is referred to as *Room* in the following analyses. Table 34 shows the results of ANOVA for WB/A-CTQ for the factors of *LAB*, *Noise*, and *Room*.

Table 34: Results of ANOVA of WB/A-CTQ for the Effects of LAB, Noise, and Room

ANOVA for Composite Variable - WB/A-CTQ					
Source	Sum-of-Squares	df	Mean-Square	F-ratio	Prob
LAB	6.06	2	3.03	3.80	0.02
NOISE	20.41	2	10.21	12.82	0.00
ROOM	63.10	1	63.10	79.24	0.00
LAB*NOISE	8.15	4	2.04	2.56	0.04
LAB*ROOM	3.16	2	1.58	1.98	0.14
NOISE*ROOM	2.19	2	1.09	1.37	0.25
LAB*NOISE*ROOM	6.20	4	1.55	1.95	0.10
Error	444.37	558	0.80		
Total	553.64	575			

The results of the ANOVA for WB/A-CTQ show that all three factors, *LAB*, *Noise*, and *Room*, are significant but only one of the interactions, *LAB x Noise* is significant. Figure 15 shows the WB/A-CTQ scores with 95% confidence-interval bars for the three factors tested in Table 34. Figure 16 shows how the pattern of scores for the Noise factor is different over the three LAB's resulting in the significant interaction of *Lab x Noise*.

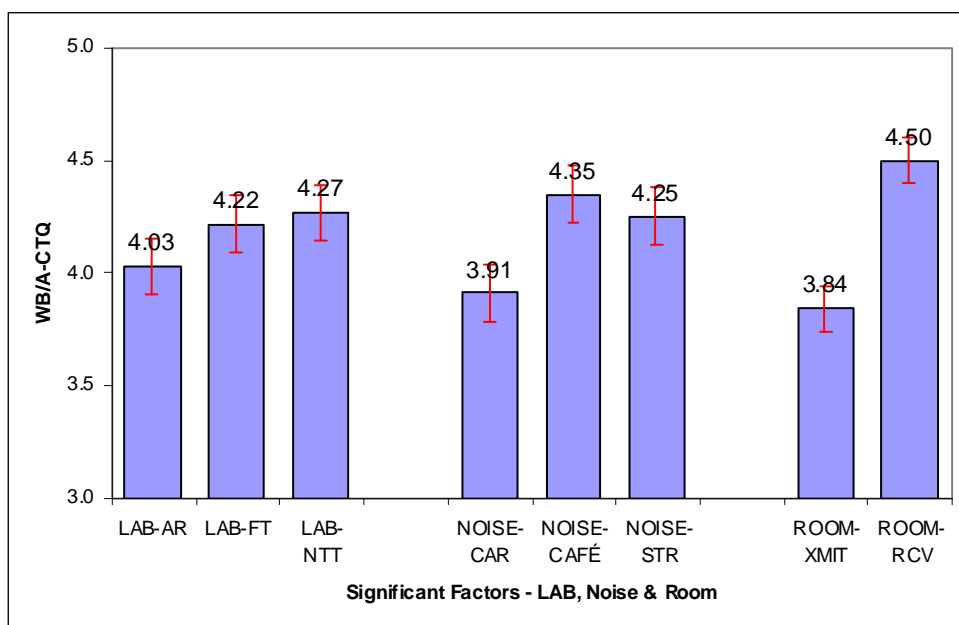

Figure 15: WB/A-CTQ Scores for the Effects of LAB, Noise, and Room

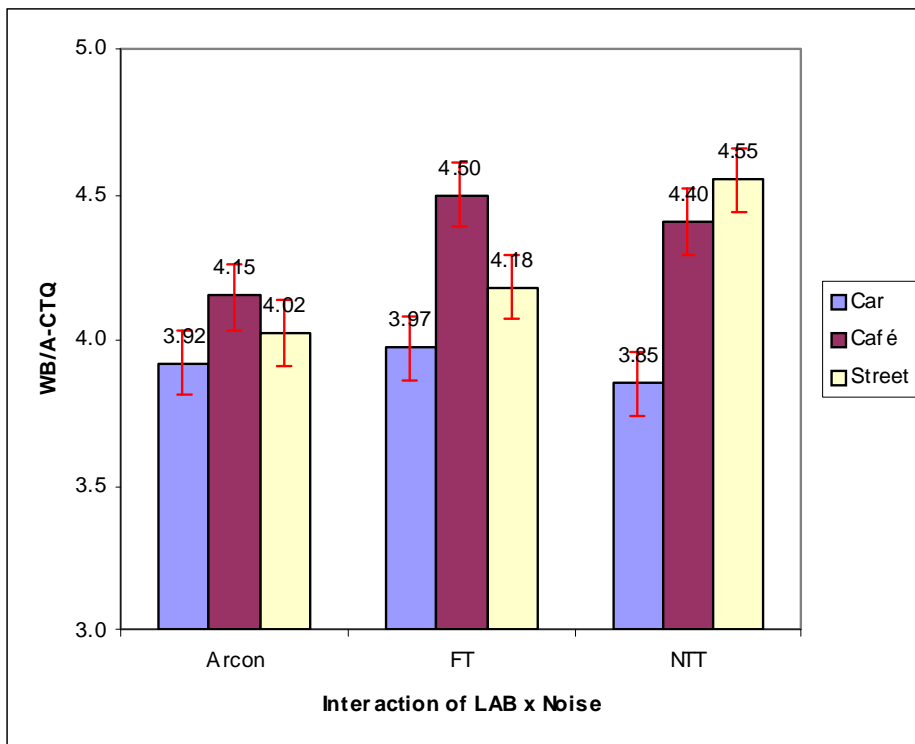

Figure 16: WB/A-CTQ Scores for the Interaction of LAB x Noise

7.7 Phase 2 - ITU-T Codec Tests (Set 5)

Table 35 shows the test conditions involved in the conversation tests designed to compare the performance of standardized ITU-T codecs in packet switched networks. The test involves eight codecs and two levels of packet loss, 0% and 3%. Scores are shown for each of the five dependent variables by Condition and by Language (Language is referred to by factor-name LAB in the following analyses). Each score shown in the table is the average of ratings from 32 listeners.

Table 35: Test Conditions and Scores for each Condition and Lab (Language) for the Codec (Phase 2) Experiment

Set 5 - Phase II Experimental Parameters			Ph2-CTQ Scores		
Cond	PL	Codec, Mode	French	Arabic	Average
1	0	AMR-NB, 6.7kbit/s	4.22	3.94	4.08
2	0	AMR-NB, 12.2kbit/s	4.31	4.05	4.18
3	0	AMR-WB, 12.65kbit/s	4.33	4.30	4.32
4	0	AMR-WB, 15.85kbit/s	4.46	4.31	4.38
5	0	G. 723., 6.4 kbit/s	4.15	3.98	4.07
6	0	G.729, 8kbit/s	4.11	4.18	4.14
7	0	G.722, 64 kbit/s + plc	4.34	4.13	4.24
8	0	G.711 + plc	4.32	4.28	4.30
9	3	AMR-NB, 6.7kbit/s	3.79	3.58	3.68
10	3	AMR-NB, 12.2 kbit/s	4.03	3.88	3.95
11	3	AMR-WB, 12.65kbit/s	4.28	4.04	4.16
12	3	AMR-WB, 15.85kbit/s	4.14	3.99	4.07
13	3	G. 723.1, 6.4 kbit/s	3.87	3.51	3.69
14	3	G.729, 8kbit/s	3.99	3.82	3.90
15	3	G.722, 64 kbit/s + plc	4.33	4.30	4.32
16	3	G.711 + plc	4.34	4.33	4.34

Table 36 shows the inter-correlation matrix for the dependent variables in the Phase 2 experiment. The moderate degree of inter-correlation shown in the table suggests that a reduced set of underlying variables may account for the variation in the five dependent variables.

The following acronyms were used in the tables PL for Packet Loss, FR for French and AB-Arabic.

Table 36: Inter-correlations Among the Dependent Variables for the Codec Conditions.

WB/S	VQ	US	IA	PC	GQ
VQ	1				
US	0.47	1			
IA	0.50	0.54	1		
PC	0.48	0.42	0.51	1	
GQ	0.60	0.53	0.62	0.61	1

Table 37 shows the results of MANOVA for the effects of *COND* for the Phase 2 experiment. The analysis shows significant *COND* effects for all the univariate ANOVA's as well as for the MANOVA. The Chi-square tests of the MANOVA roots show only a single significant root (1 through 5), indicating that a single underlying variable accounts for the significant variation in the dependent variables for these conditions. The canonical coefficients for this root were used to compute the composite dependent variable that represents the underlying variable for the Phase 2 conditions. The composite dependent variable (**Ph2-CTQ for Phase2-Conversation Test Quality**) is computed and used to characterize the ratings in the Phase 2 experiment. Ph2-CTQ scores for all conditions and all LAB's for *Set 5* are listed in the Appendix. Equation 5 shows the formula that was used to compute the values of the composite variable, Ph2-CTQ, for characterizing the Phase 2 conditions.

Table 37: Results of MANOVA for COND for the Phase 2 Conditions

Univariate ANOVA's for Effect: <i>COND</i> (df = 15, 1008)						
	VQ	US	IA	PC	GQ	
F-Ratio	5.64	2.43	2.68	2.54	4.25	
Prob	0.00	0.00	0.00	0.00	0.00	
MANOVA for effect: <i>COND</i>						
Statistic	Value	F-Ratio	df	Prob		
Pillai Trace	0.12	1.61	75, 5040	0.00		
Test of Residual Roots					Dependent	Canonical
Roots	Chi-Square	df	Prob	Variable	Coefficient	
1 through 5	122.26	75	0.00	VQ	0.5995	
2 through 5	32.44	56	1.00	US	0.0860	
3 through 5	19.29	39	1.00	IA	-0.0092	
4 through 5	10.45	24	0.99	PC	0.0459	
5 through 5	2.58	11	1.00	GQ	0.2778	

The following formula was used to compute the Conversation Test Quality Score (Ph2-CTQ) for the Phase 2 conditions:

$$\text{Ph2-CTQ} = .5995 * \text{VQ} + .0860 * \text{US} - .0092 * \text{IA} + .0459 * \text{PC} + .2778 * \text{GQ}$$

The 16 Phase 2 conditions are distinguished by two factors, *Codec* and *Packet Loss*. Table 38 shows the results of ANOVA for Ph2-CTQ for these factors.

Table 38: Results of ANOVA of Ph2-CTQ for the Effects of *Codec* and *Packet Loss*

ANOVA for Composite Variable - Ph2-CTQ					
Source	Sum-of-Squares	df	Mean-Square	F-ratio	Prob
LAB	5.71	1	5.71	11.93	0.00
CODEC	27.44	7	3.92	8.19	0.00
PL	10.33	1	10.33	21.59	0.00
LAB*CODEC	1.70	7	0.24	0.51	0.83
LAB*PL	0.07	1	0.07	0.14	0.71
CODEC*PL	7.09	7	1.01	2.12	0.04
LAB*CODEC*PL	1.45	7	0.21	0.43	0.88
Error	474.61	992	0.48		
Total	528.38	1023			

The results of the ANOVA for Ph2-CTQ show that all three factors, *LAB*, *Codec*, and *Packet Loss*, are significant as well as the interaction *Codec x Packet Loss*. Figure 17 shows the Ph2-CTQ scores with 95% confidence-interval bars for the factors tested in Table 38. Figure 18 illustrates the interaction of *Codec x Packet Loss*.

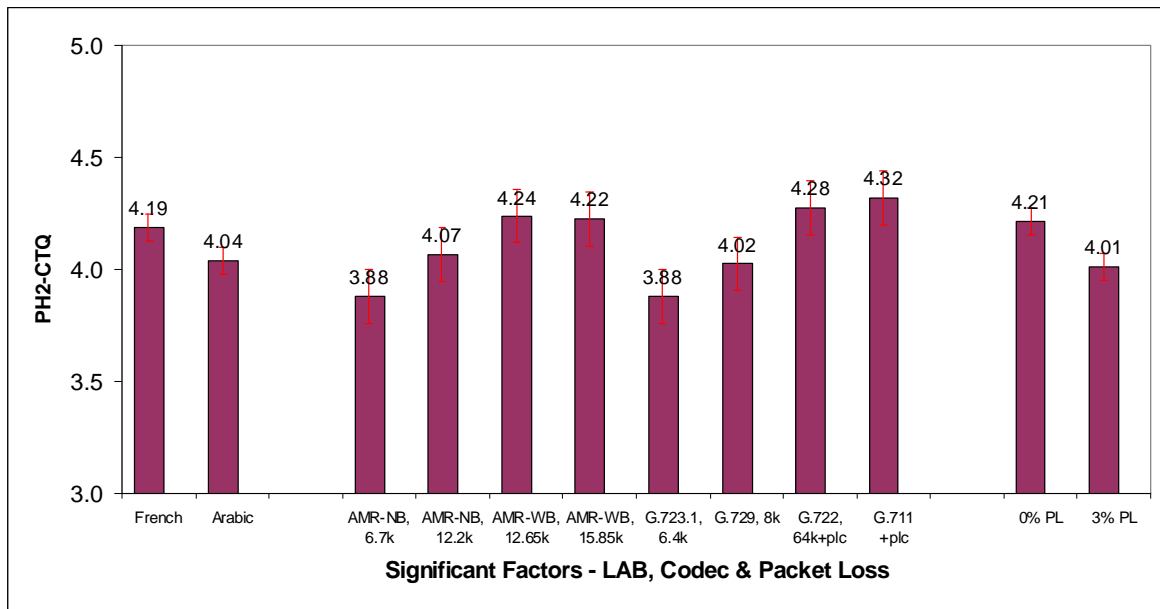

Figure 17: Ph2-CTQ Scores for the Effects of *LAB*, *Codec*, and *Packet Loss*

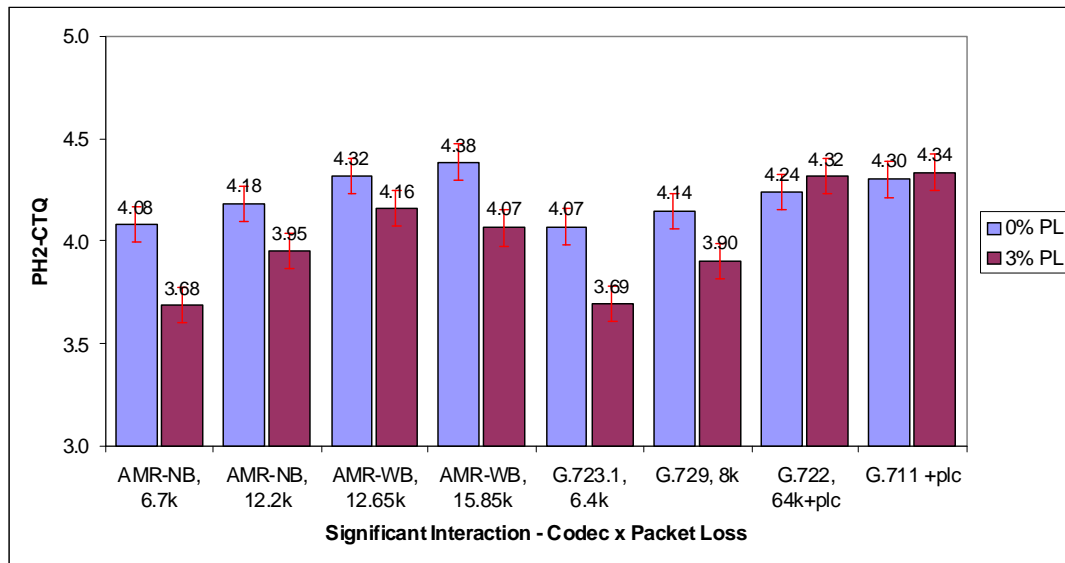

Figure 18: Ph2-CTQ Scores Showing the Interaction of Factors *Codec* and *Packet Loss*

7.8 Summary of Test Result Analysis

For each of the five sets of conditions in the Packet-Switched Conversation Tests, analysis by MANOVA revealed a single underlying variable that accounts for the significant variation in the five opinion rating scales, VQ, US, IA, PC, and GQ. Conversation Test Quality (CTQ) scores were computed for each set of conditions. The CTQ scores were analysed through ANOVA to characterize the conditions involved in the Conversation Tests.

8 Performance characterisation of VoIMS over HSDPA/EUL channels

8.A Listening only tests

8.A.1 Test methodology for listening only tests

The HSPDA/EUL listening only characterisation tests were conducted by two listening test laboratories (Nokia and Ericsson). Tested languages were Finnish and Swedish.

The tested speech codecs were:

- Adaptive Multi-Rate narrowband (AMR-NB), in modes 12.2 kbit/s and 5.9 kbit/s,
- Adaptive Multi-Rate wideband (AMR-WB), in mode 12.65 kbit/s.

The tested jitter buffer implementations were:

- Fixed reference jitter buffer (as a reference),
- Adaptive jitter buffer compliant with the functional and performance requirements in TS 26.114.

Subjective quality score and delay were used as metrics to evaluate the results. The test was designed based on P.800.Sec.6.2.

8.A.2 Test arrangement

The subjective tests evaluated the impact of the HSDPA/EUL radio channel conditions on the speech quality especially when the channel is subject to packet losses and jitter. The test items were processed using an error insertion device

(EID) introducing jitter and packet losses into simulated RTP packet stream. The performance of AMR-NB and AMR-WB was evaluated with adaptive jitter buffer management (JBM). Description of the processing of speech material is found in Annex J.

8.A.3 Jitter buffer implementations

Two different jitter buffer implementations were used in the tests; a fixed JBM and an adaptive JBM. Both are briefly described in the following subsections.

8.A.3.1 Fixed JBM

The fixed jitter buffer – i.e. a buffer that does not change the end-to-end delay during a session – used in the tests was only used together with the tested codecs as a reference condition. The buffer was not conducting any buffer adaptation at all. The role of the fixed JBM reference condition was to show the performance of a fixed JBM, which was tuned to give the (fixed) end-to-end delay equal to the average end-to-end delay of the adaptive JBM in the same channel condition. This was done by setting the initial buffering delay in a value resulting in the desired end-to-end delay for each channel condition separately. The initial buffer delay for the fixed jitter buffer was thus set having the full a priori knowledge of the behaviour of the transmission channel over the whole session and the transmission delay of the first incoming packet. Such an approach can not be used in real-life implementations where both the (future) channel behaviour and the delay of the first received packet are not known by the receiver. Hence, the fixed JBM was non-causal and thus impossible to use in a real-life implementation. Furthermore, due to its nature of non-adaptivity, it does not pass the minimum performance requirements for JBM schemes set in 3GPP TS 26.114 [19].

8.A.3.2 Adaptive JBM

As opposed to the fixed JBM, an adaptive JBM may change the end-to-end delay during a session with the aim to optimise the trade-off between buffering delay and buffer induced frame losses. The adaptive jitter buffer management algorithm used in the listening only tests was a simple algorithm conducting buffer adaptation mainly during inactive speech without any time scale modifications with the option to adapt during active speech only to avoid excessive frame losses. Thus, the adaptation was mainly based on insertion and removal of comfort noise frames. Note, however, that to avoid excessive losses the adaptation may also have taken place during active speech if a sudden increase in transmission delay was detected. The algorithm met both the functional requirements and the minimum performance requirements set in 3GPP TS 26.114. The outline of the operation of this adaptive JBM is described in Annex I of this document. Contrary to the fixed JBM described in the previous section, this JBM could be used in real-life implementations and provides performance according to the test results presented in the following sections in this report.

8.A.4 Network conditions

The network conditions used when the test material was processed were divided into eight different channels. The conditions were characterized by low mobility, high mobility, low traffic (LT) and high traffic (HT) in the uplink and downlink respectively. All conditions were presented as channel profiles where the transmission end-to-end delay and link losses could be extracted for test file processing.

The following radio network condition definitions were used.

Table 39: Definition of Radio Network Conditions

Condition Name	Network Load: 40/45/60 per cell	Network Load: 80/100 per cell
DL: PedB3_km+PedA3_km	DL-LT	DL-HT
DL: VehA30km+Veh120km+PedB30km	DH-LT	DH-HT
UL: PedB3_km+PedA3_km	UL	
UL: VehA30km+Veh120km+PedB30km	UH	

Based on the radio network conditions in the table above, eight different channels were constructed. These network conditions were composed into channel conditions for the listening tests in the following way.

Table 40: Definition of Radio Network Channels conditions

Channel	Radio Network Condition
Ch1	DL-LT-UL
Ch2	DL-LT-UH
Ch3	DL-HT-UL
Ch4	DL-HT-UH
Ch5	DH-LT-UL
Ch6	DH-LT-UH
Ch7	DH-HT-UL
Ch8	DH-HT-UH

The radio networks conditions were simulated using HSDPA in the downlink and EUL in the uplink. The actual configurations of the radio network simulators can be found in Annex K. The 8 resulting channels all showed a 1% link loss and delay variations in the range of 30-300 msec. The delay profiles of the conditions are shown together with the adaptive JBM buffering in section 8.7 in this report.

8.A.5 Listening experiments

Tables from 41 to 46 provide a summary of the listening-only test conditions, and the full test plan is provided in Annex H.

Table 41: Noise types for listening only test

Noise type	Level (dBSNR)
Clean	-
Car	15 dB
Cafeteria	20 dB

Table 42: Test details for listening only

Listening Level	1	79 dBSPL
Reference Conditions (narrowband)	8	MNRU 5, 13, 21, 29, 37 dB, direct, clean 5.9 kbit/s, clean 12.2 kbit/s
Reference Conditions (wideband)	8	MNRU 5, 13, 21, 29, 37, 45 dB, direct, clean 12.65 kbit/s
Test Conditions	2	Fixed buffer (buffer size set to the average of adaptive JBM in the same network condition), adaptive JBM
Listeners	32	Naïve Listeners
Groups	4	8 subjects/group
Rating Scales	1	P.800.2 ACR (clean condition), DCR (background noise)
Languages	2	Finnish and Swedish
Listening System	1	Monaural headset audio bandwidth 3.4kHz (narrowband) 7.0 kHz (wideband). The other ear is open.
Listening Environment		Room Noise: Hoth Spectrum at 30dBA (as defined by ITU-T Recommendation P.800: Annex A, section A.1.1.2.2.1)
Number of Talkers	8	4 males, 4 females
Number of Samples/Talker	5	4 for the test, 1 for the preliminary items

AMR and AMR-WB codecs were tested in both clean and background noise in various channel conditions.

Table 43: Test conditions for listening-only tests with AMR-NB

Cond.	Noise Type	Frame Loss Rate	Channel	AMR-Modes (fixed RTP delay)

1-1	Clean	0.01	Ch1	5.9kbit/s (150 ms)
1-2	Clean	0.01	Ch2	5.9kbit/s (150 ms)
1-3	Clean	0.01	Ch3	12.2kbit/s (150 ms)
1-4	Clean	0.01	Ch4	12.2kbit/s (150 ms)

Table 44: Test conditions for listening-only tests with AMR-NB in background noise

Cond.	Noise Type	Frame Loss Rate	Channel	AMR-Modes (fixed RTP delay)
2-1	Car	0.01	Ch5	5.9kbit/s (150 ms)
2-2	Cafeteria	0.01	Ch6	5.9kbit/s (150 ms)
2-3	Car	0.01	Ch7	12.2kbit/s (150 ms)
2-4	Cafeteria	0.01	Ch8	12.2kbit/s (150 ms)

Table 45: Test conditions for listening-only tests with AMR-WB

Cond.	Noise Type	Frame Loss Rate	Channel	AMR-WB (fixed RTP delay)
3-1	Clean	0.01	Ch1	12.65 kbit/s (150 ms)
3-2	Clean	0.01	Ch2	12.65 kbit/s (150 ms)
3-3	Clean	0.01	Ch3	12.65 kbit/s (150 ms)
3-4	Clean	0.01	Ch4	12.65 kbit/s (150 ms)

Table 46: Test conditions for listening-only tests with AMR-WB in background noise

Cond.	Noise Type	Frame Loss Rate	Channel	AMR-WB (fixed RTP delay)
4-1	Car	0.01	Ch5	12.65 kbit/s (150 ms)
4-2	Car	0.01	Ch6	12.65 kbit/s (150 ms)
4-3	Cafeteria	0.01	Ch7	12.65 kbit/s (150 ms)
4-4	Cafeteria	0.01	Ch8	12.65 kbit/s (150 ms)

8.A.6 Test Results

Figures from 19 to 26 provide the listening-only test results. For each test condition the MOS/DMOS score with 95 % confidence intervals is shown.

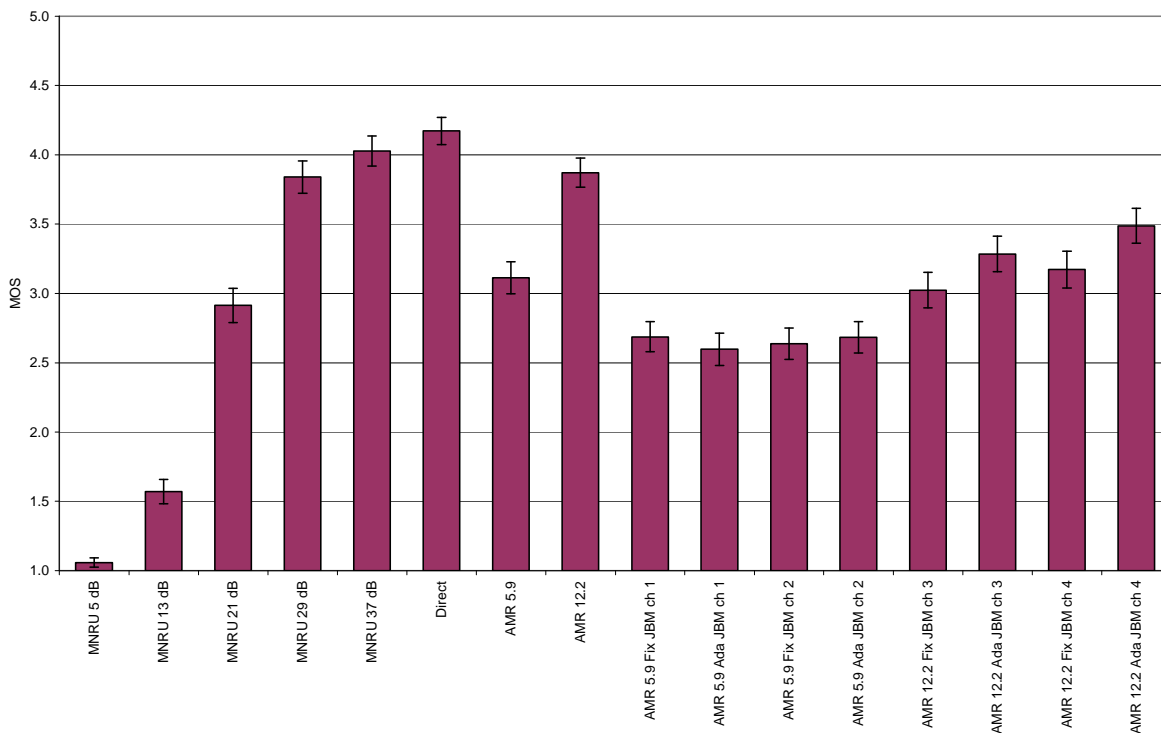

Figure 19: Experiment 1 (32 listeners, laboratory 1, Finnish)

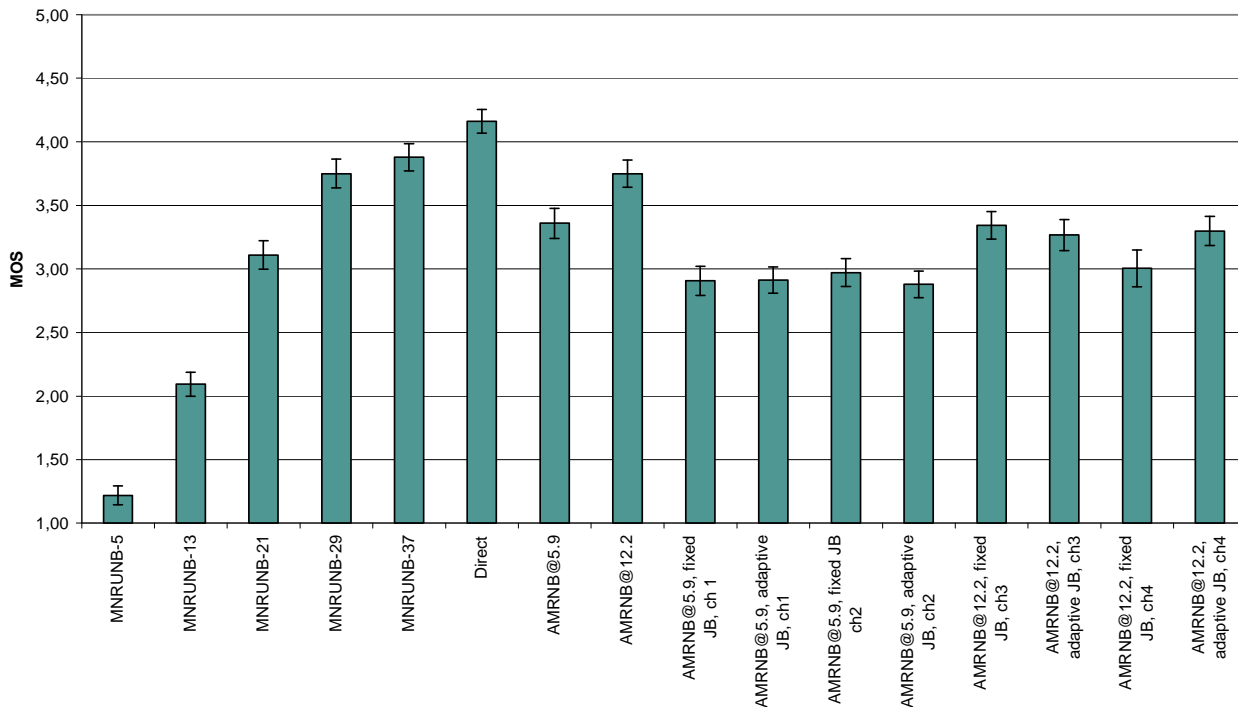

Figure 20: Experiment 1 (31 listeners, laboratory 2, Swedish)

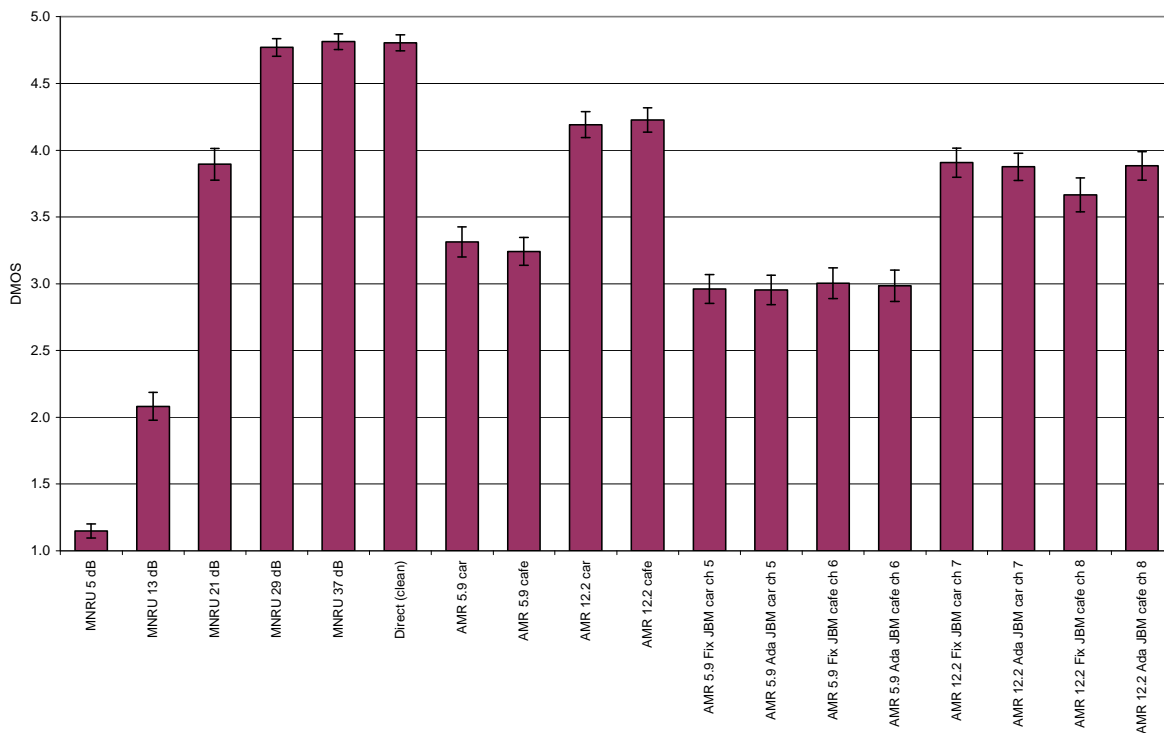

Figure 21: Experiment 2 (32 listeners, laboratory 1, Finnish)

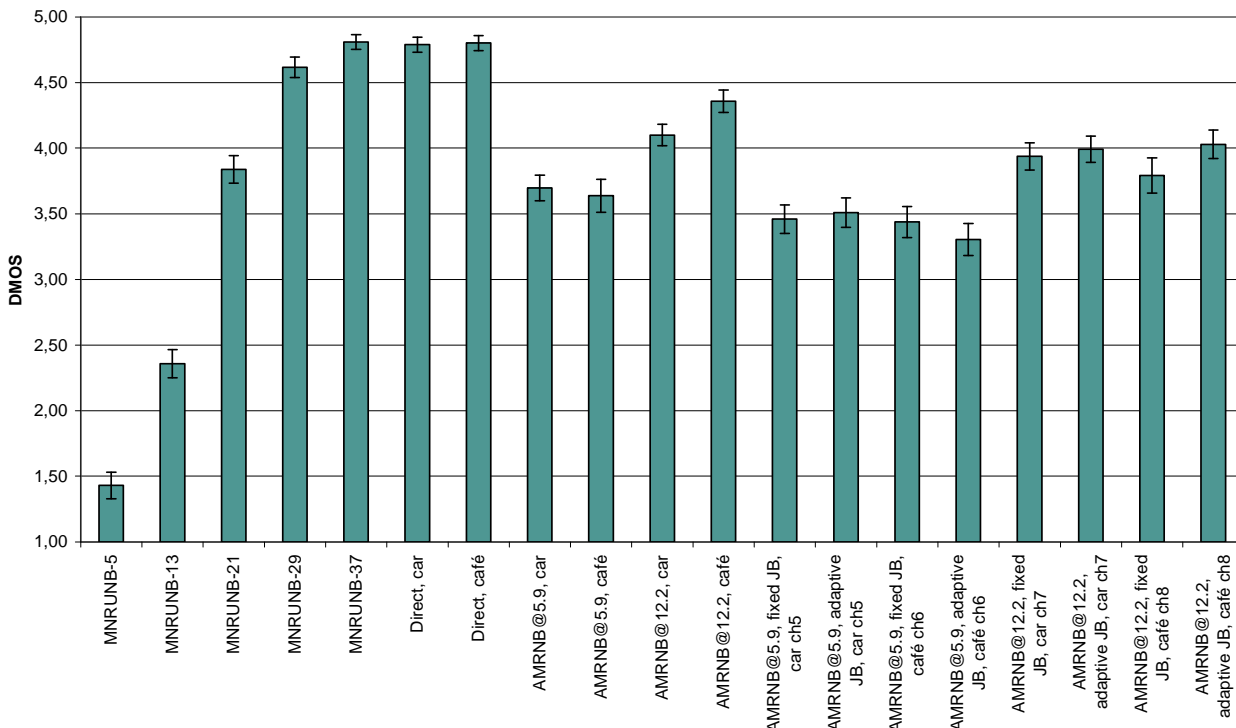

Figure 22: Experiment 2 (30 listeners, laboratory 2, Swedish)

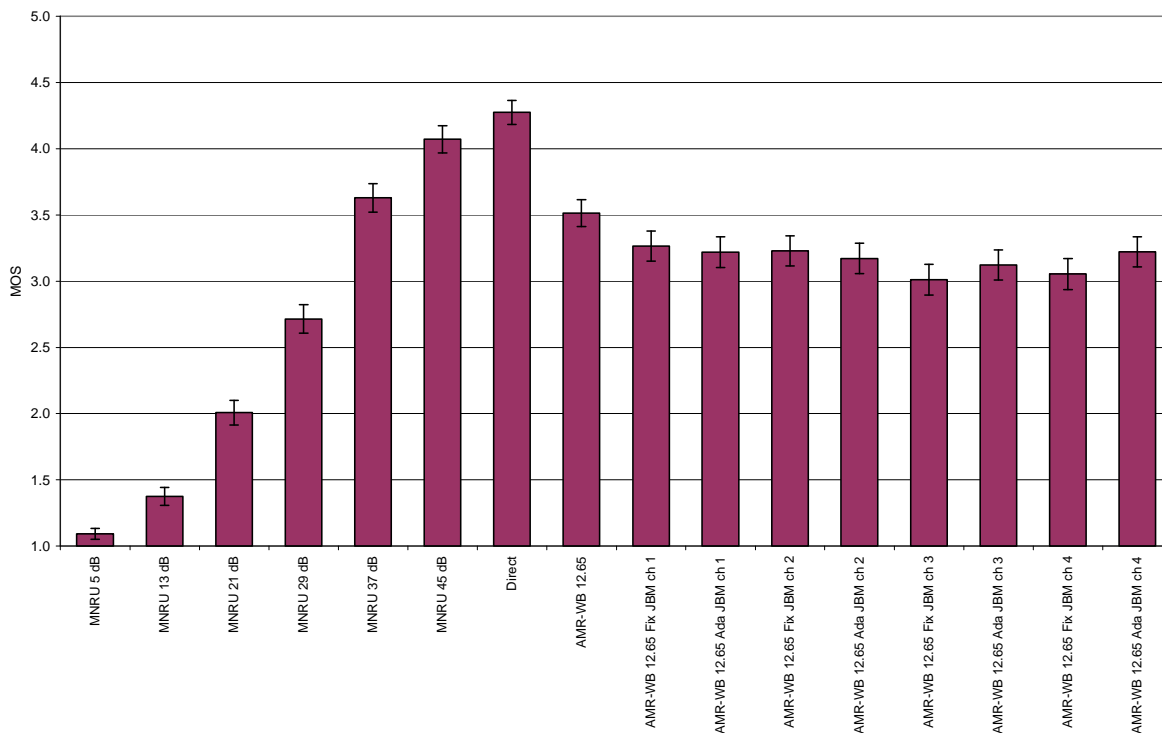

Figure 23: Experiment 3 (32 listeners, laboratory 1, Finnish)

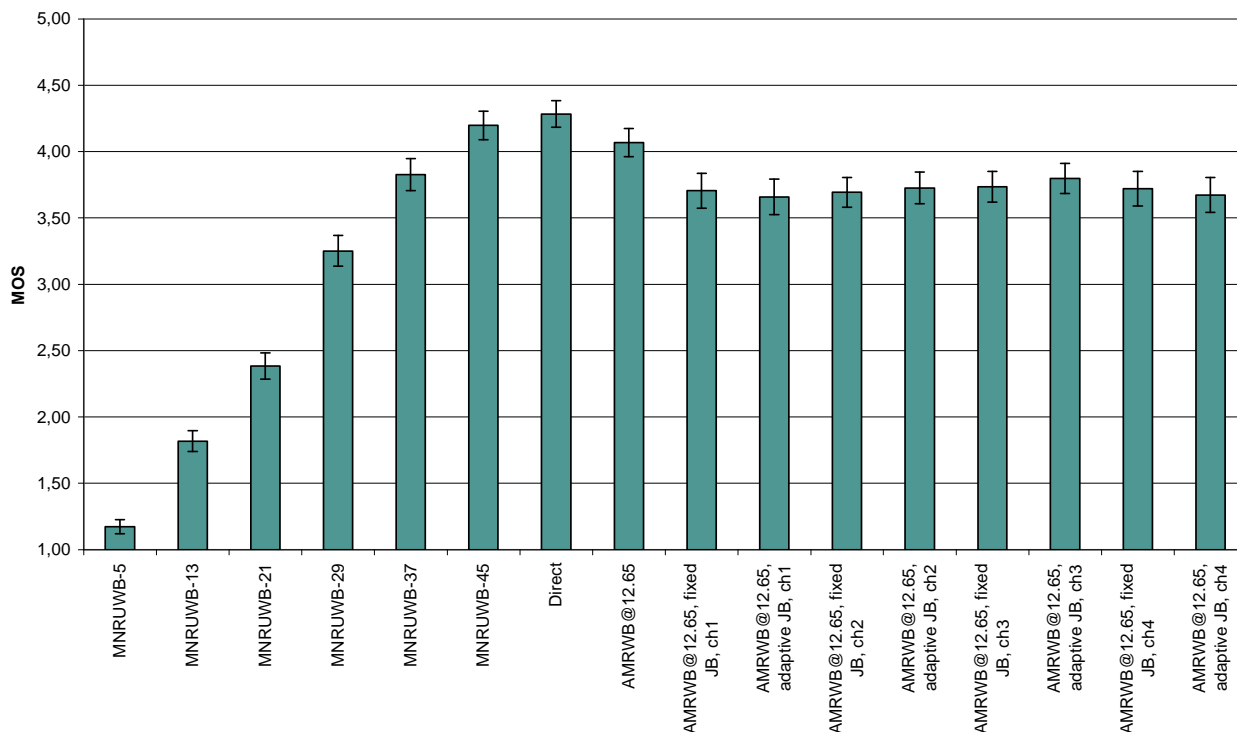

Figure 24: Experiment 3 (26 listeners, laboratory 2, Swedish)

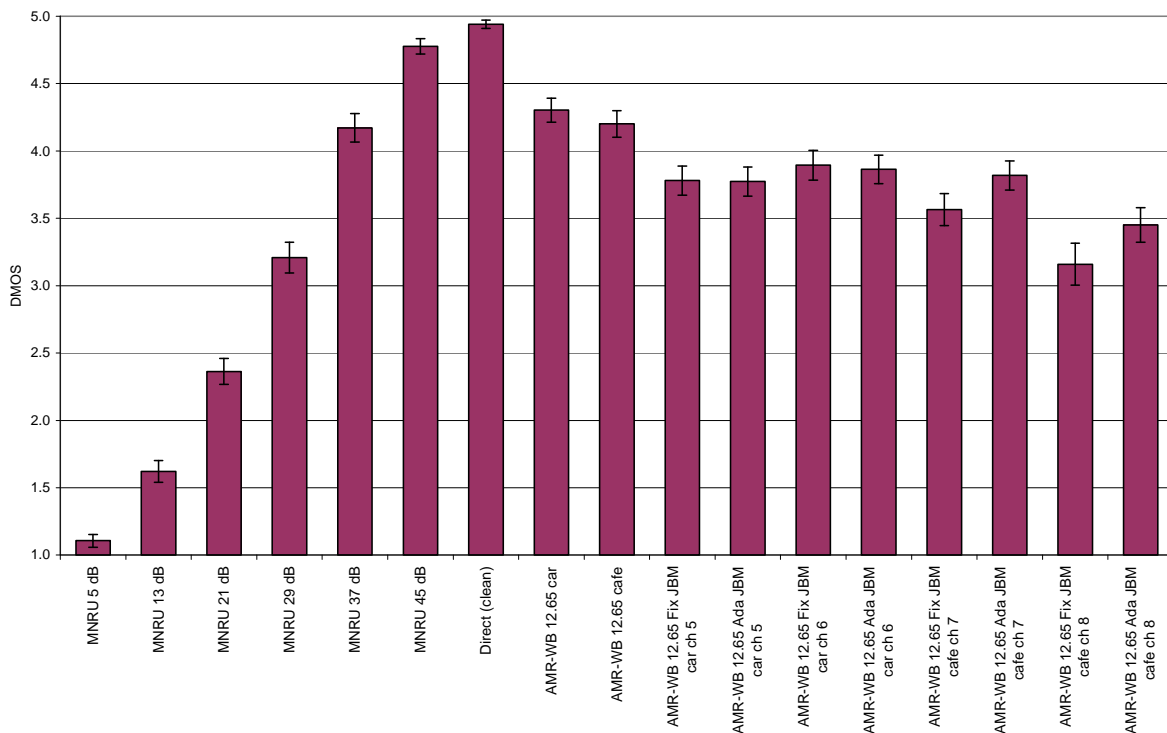

Figure 25: Experiment 4 (32 listeners, laboratory 1, Finnish)

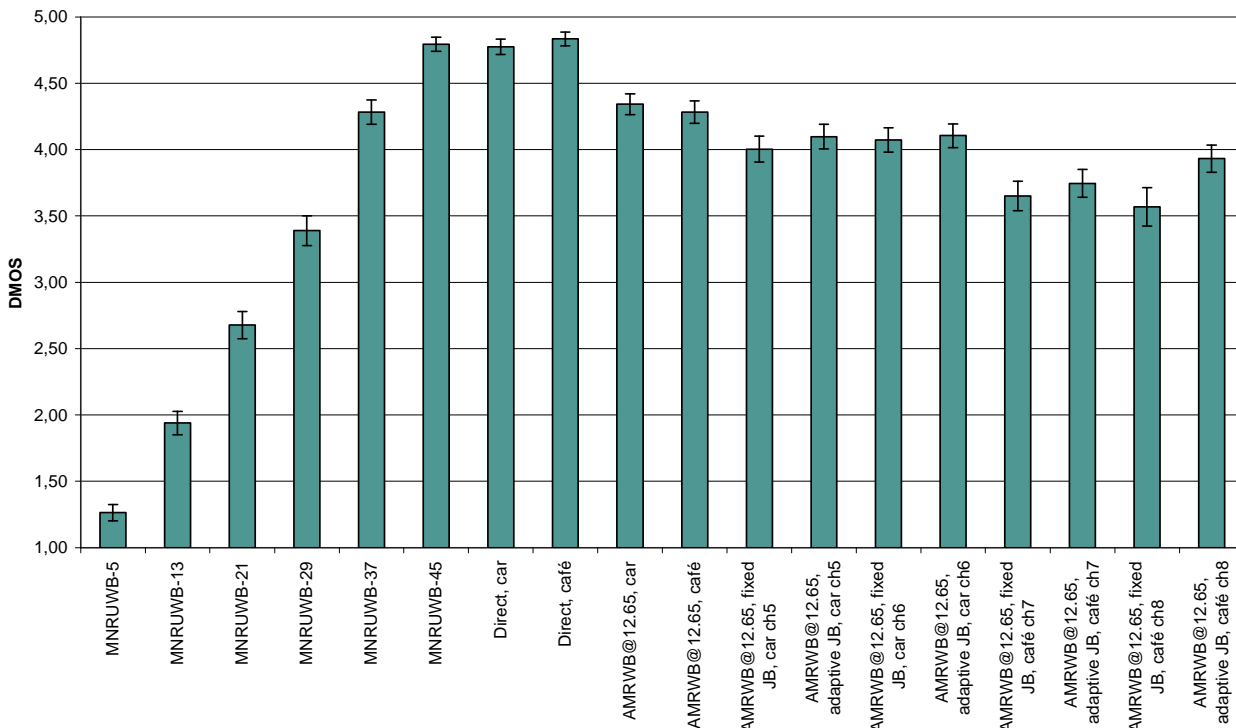

Figure 26: Experiment 4 (31 listeners, laboratory 2, Swedish)

8.A.7 Delay analysis

The delay analysis provided in Table 47 and Figures from 27 to 34 has only been done on channels 1 through 8 using AMR-NB with the adaptive JBM for the tests in laboratory 2 using the Swedish language. Including AMR-WB 12.65 in the analysis does not give any additional information since the patterns of voice activity is determined to be quite similar for both codecs. This is also true for including the Finnish language in the analysis. The voice activity for AMR-NB 5.9 and AMR-NB 12.2 is identical. The CDF curve is based on the JBM buffering time.

The average end-to-end delay figures in Table 47 indicate that the achieved delay performance is suitable for speech conversation. In addition, it can be noted that the error concealment operations caused by the JBM operation (i.e. frames dropped or inserted by the JBM e.g. due to late arrival or buffer under/overflow) are below 0.5% for all test cases restricting the media quality impact to be minor.

The adaptation principle of the tested JBM can be traced back when comparing average buffering times of all frame and speech frames. Since the adaptation is conducted mainly during inactive speech, i.e. during silence periods, the delay values are different. SID frames are forwarded for decoding typically immediately they arrive to the receiver, while the jitter buffer target delay is accumulated by delaying the playback of the first frame of speech burst.

Table 47: Delay analysis of adaptive JBM for AMR-NB 12.2 kbps operation

	Condition							
	Channel 1, clean	Channel 2, clean	Channel 3, clean	Channel 4, clean	Channel 5, car	Channel 6, café	Channel 7, car	Channel 8, café
Encoded frames	16000	16000	16000	16000	16000	16000	16000	16000
Encoded speech frames	8746	8746	8746	8746	8936	9583	8935	9583
Encoded SID frames	1029	1029	1029	1029	983	939	981	939
Encoded NO_DATA frames	6225	6225	6225	6225	6081	5478	6084	5478
Transmitted frames	9775	9775	9775	9775	9919	10522	9916	10522
Received frames	9635	9636	9621	9622	9820	10417	9820	10410
Received speech frames	8623	8621	8604	8619	8846	9484	8849	9479
Received SID frames	1012	1015	1017	1003	974	933	971	931
Lost frames	140	139	154	153	99	105	96	112
Late frames	6	2	39	26	23	13	40	17
Late speech frames	6	2	37	26	23	13	39	16
Late loss rate (speech frames)	0,07%	0,02%	0,43%	0,30%	0,26%	0,14%	0,44%	0,17%
Average buffering time (all frames) [msec]	57,7237	42,4383	71,2345	59,7803	56,294	39,0804	70,4495	56,7029
Average buffering time (speech frames) [msec]	62,1496	45,7399	77,0119	64,4522	60,5685	41,5635	76,0796	60,3656
Average end-to-end delay (all) [msec]	98,4819	74,6829	127,074	109,9885	104,3152	76,2146	125,1083	103,1506
Average end-to-end delay (speech) [msec]	103,0551	77,9534	132,6756	114,6473	108,6259	78,7723	130,4654	106,5322
Buffering time (fixed@startPos) [msec]	85,0551	57,9534	96,6756	66,6473	46,6259	46,7723	64,4654	68,5322

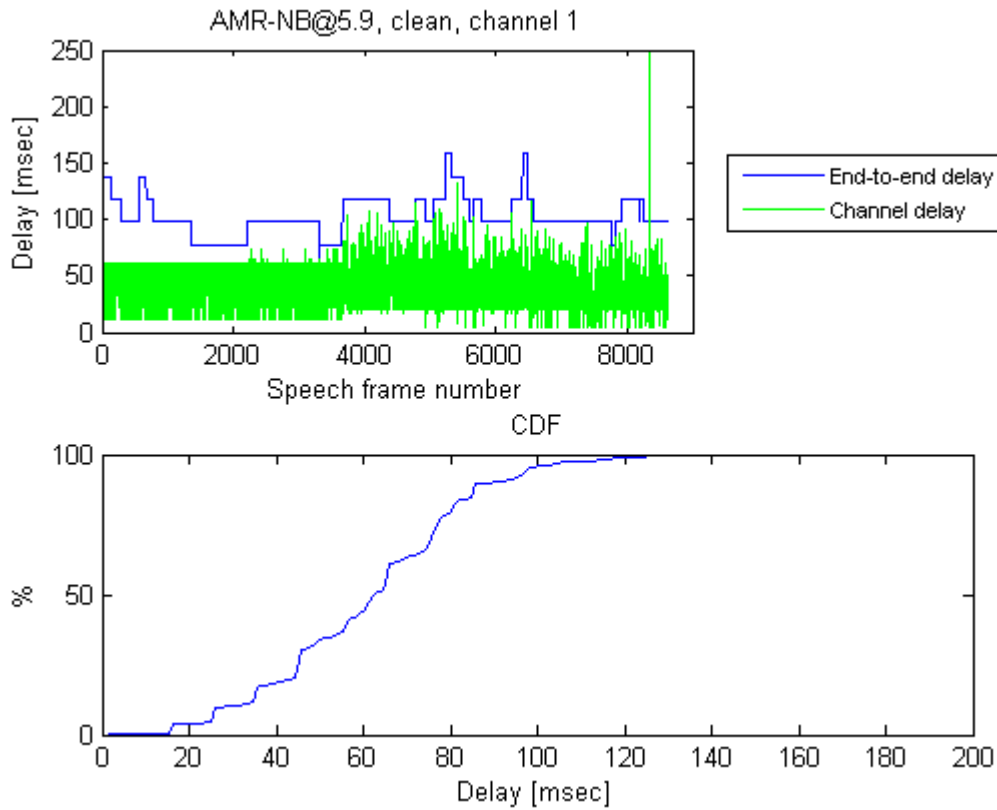

Figure 27: Performance, adaptive JBM channel 1, clean. The delay spike at the end of the channel profile was 340 msec. The CDF curve is based on the JBM buffering time.

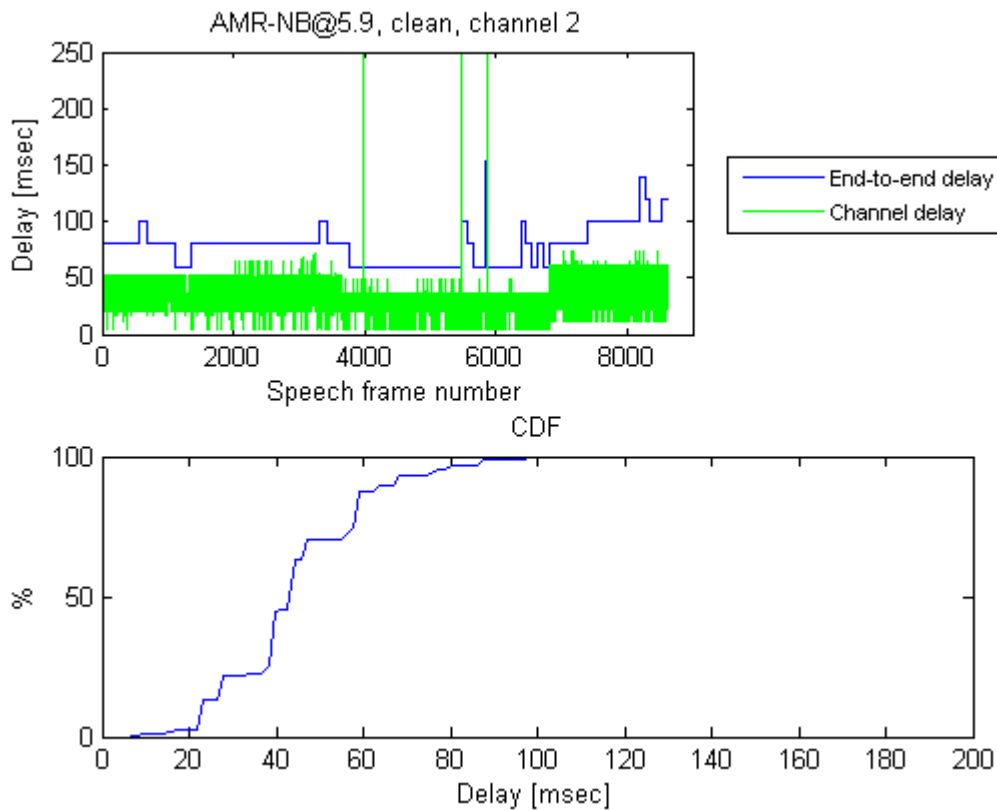

Figure 28: Performance, adaptive JBM channel 2, clean. The delay spikes of the channel profile were 310, 320 and 300 msec respectively. The CDF curve is based on the JBM buffering time.

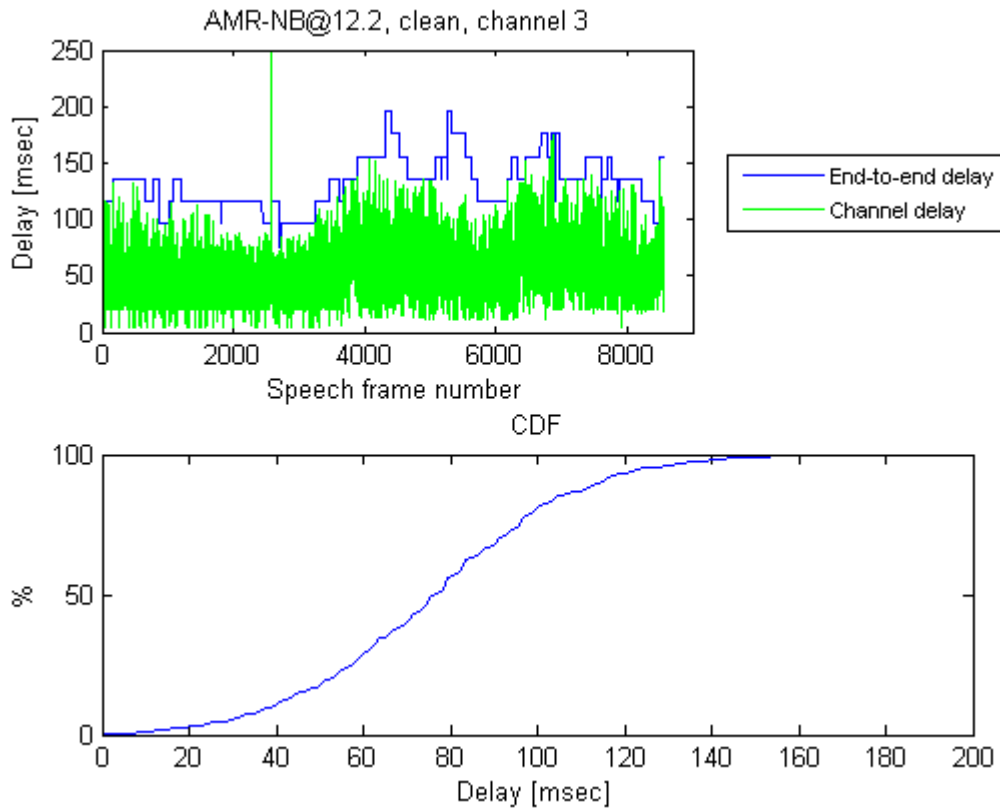

Figure 29: Performance, adaptive JBM channel 3, clean. The delay spike of the channel profile was 320 msec. The CDF curve is based on the JBM buffering time.

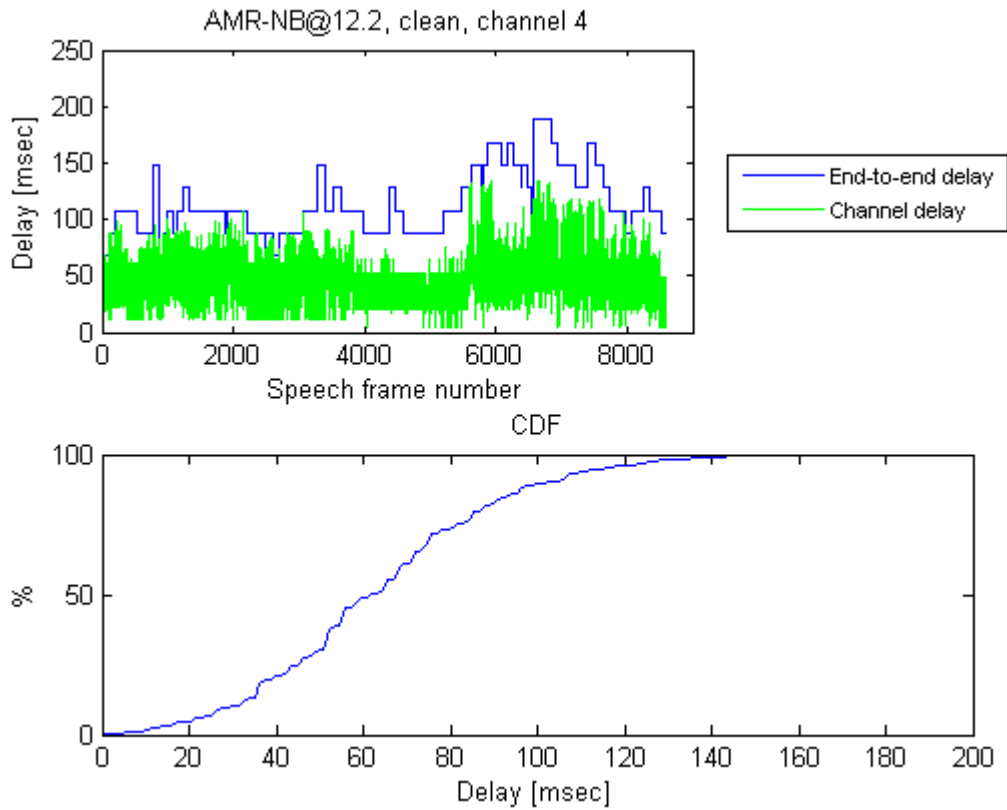

Figure 30: Performance, adaptive JBM channel 4, clean. The CDF curve is based on the JBM buffering time.

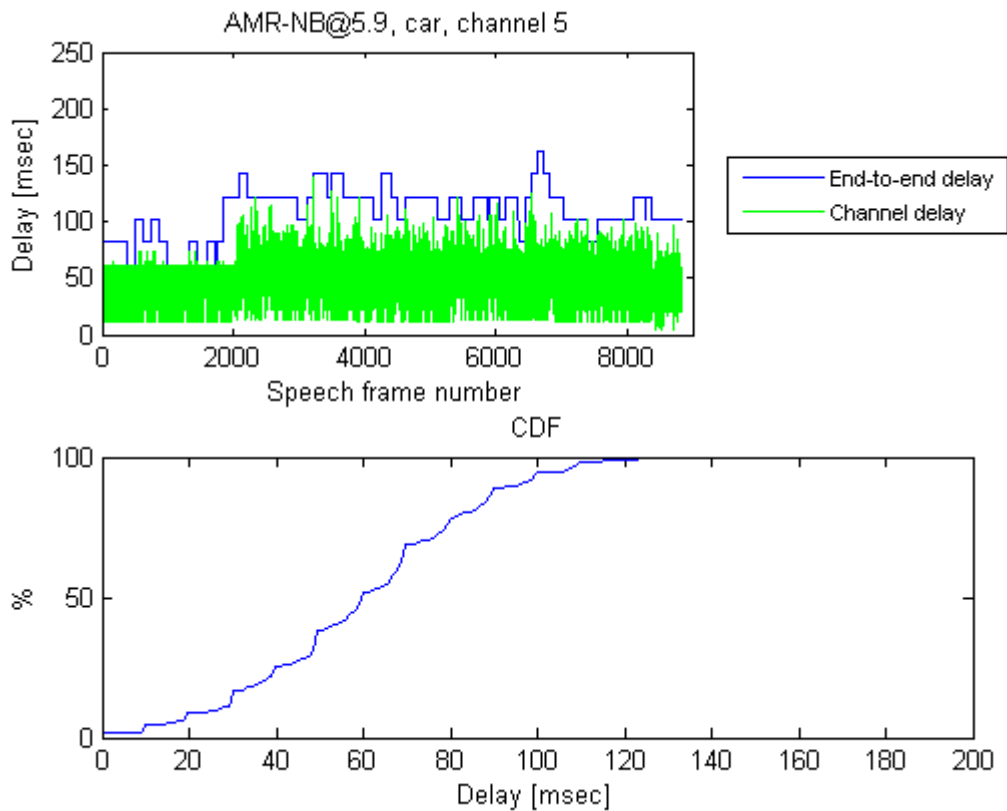

Figure 31: Performance, adaptive JBM channel 5, car. The CDF curve is based on the JBM buffering time.

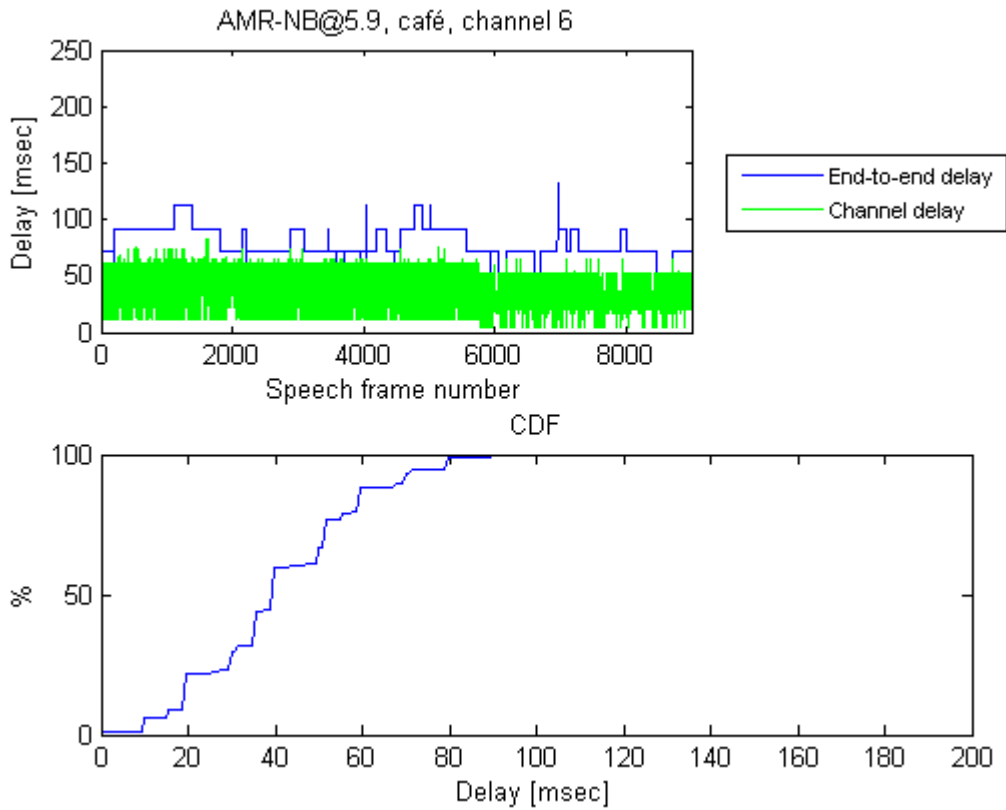

Figure 32: Performance, adaptive JBM channel 6, café. The CDF curve is based on the JBM buffering time.

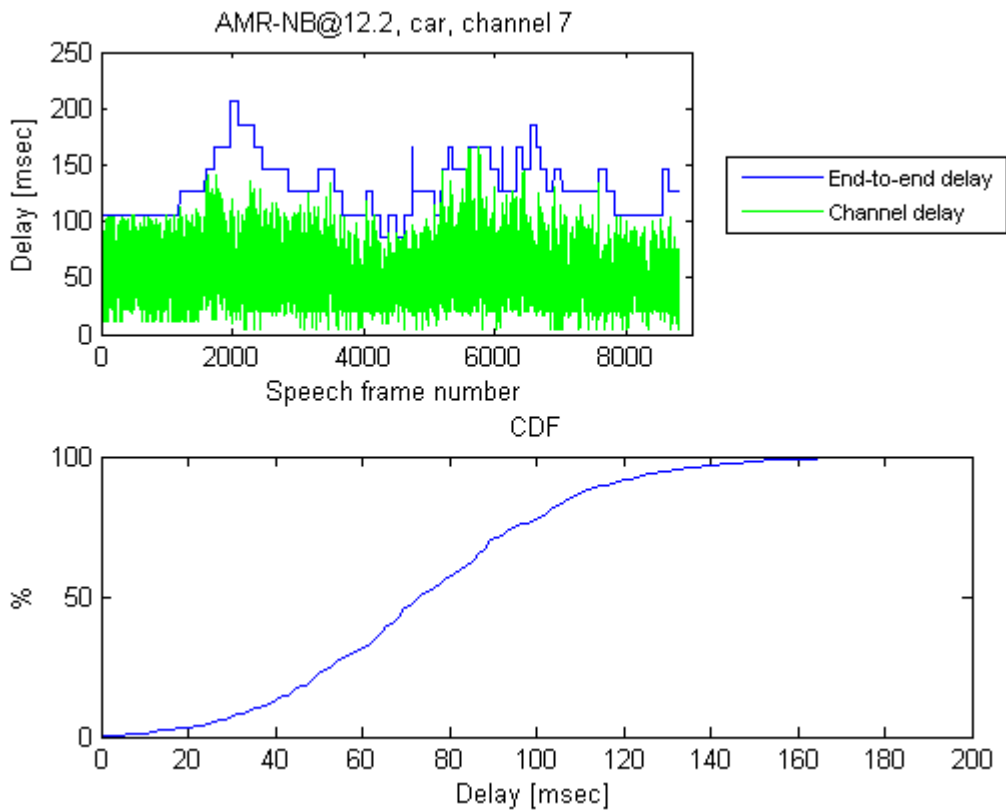

Figure 33: Performance, adaptive JBM channel 7, car. The CDF curve is based on the JBM buffering time.

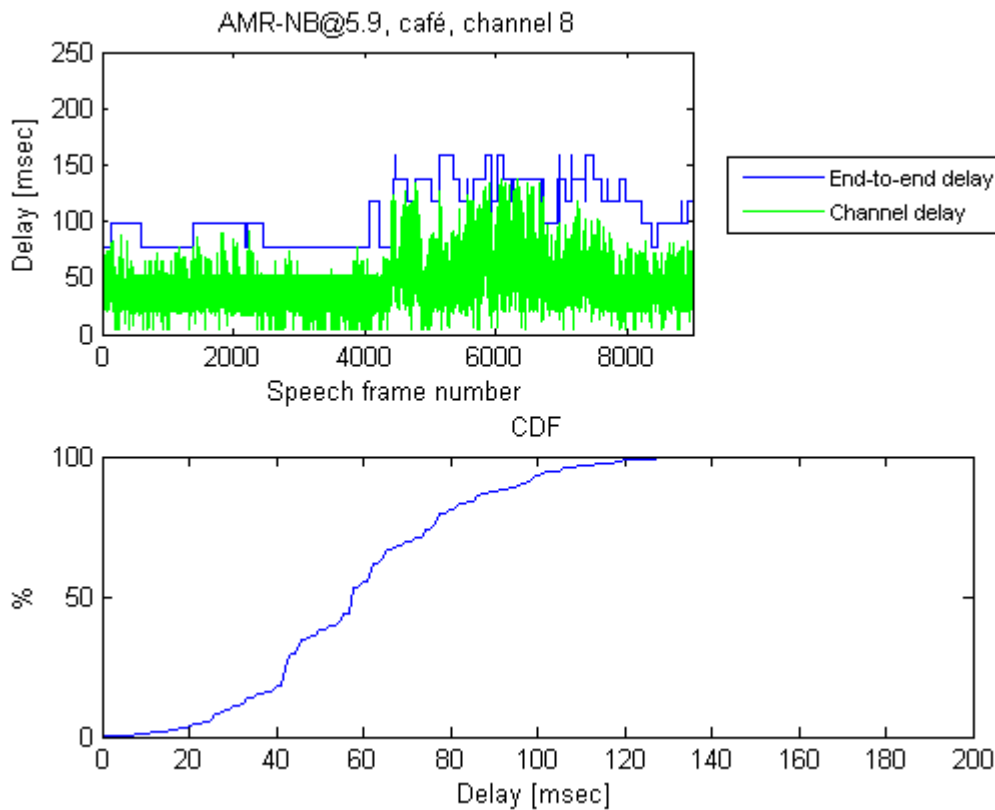

Figure 34: Performance, adaptive JBM channel 8, café. The CDF curve is based on the JBM buffering time.

8.A.8 Listening only test conclusions

The listening only test results for HSDPA/EUL radio channels indicate that an adaptive JBM conforming to the MTSI performance requirements is able to provide consistent voice quality over varying transmission conditions. The test also showed that the performance of the JBM directly impacts the voice quality.

Furthermore, the tested adaptive JBM provides equal or better voice quality than the reference non-causal fixed JBM in all test cases. In test conditions where the channel delay showed small variations the adaptive JBM provided performance equal to the fixed reference JBM, while in the test conditions where the channel behaviour introduced larger delay variations the adaptive JBM outperformed the fixed reference JBM. Thus, the results indicate that an adaptive JBM is needed to cope with the large variations in channel delay.

8.B Conversation Tests

8.B.1 Introduction

3GPP/SA4 developed a test plan [see ANNEX L] designed to evaluate the performance of AMR and AMR-WB for UMTS over HSDPA/EUL. Three test labs were contracted to conduct conversation tests according to the test plan and deliver raw voting data to the Global Analysis Lab (GAL) for processing and statistical analysis. This document reports the results for the three test labs and additional statistical analyses conducted by the GAL.

8.B.2 The Test Plan

The test plan described three conversation tests to be conducted in each of three test labs. The test labs were FTRD, testing in the French language, BIT, testing in the Chinese language, and Dynastat, testing in North American English. Each of the three conversation tests involved a different 3GPP standardized speech codec:

- Exp.1 - AMR operating at 5.9k bps

- Exp.2 - AMR operating at 12.2k bps

Exp.3 - AMR-WB operating at 12.65k bps The test plan specified that the experiments should be conducted according to specifications contained in the ITU-T Recommendation for Conversation Testing, P.805.

Alcatel-Lucent provided the network impairment simulation test-bed, which was described in the test plan. The test-bed was shipped to each test lab so that the same test conditions could be reproduced in each lab. Each conversation test involved the same 16 network test connections shown in Table 1.

Subjects were paired for the conversation task. Test conditions were designed such that each condition was evaluated by both members of the conversation pair. In each test condition, subjects were seated in one of four simulated noise environments as specified in Table 1: Hoth/Quiet (labeled **Q** in this document), Cafeteria/Babble (**B**), Car (**C**), and Street (**S**). In half of the test conditions both subjects in the pair were in the same noise environment (**QQ**, **BB**, **CC**, **SS**). In the other half they were in different noise environments (**QC**, **CQ**, **SB**, **BS**). The noise conditions were also represented in the network simulation as either High Mobility conditions (**HM** – Car and Street) or Low Mobility conditions (**LM** – Hoth/Quiet and Cafeteria/Babble). In half of the test connections the test-bed simulated High Traffic network connections (**HT**), in the other half it simulated Low Traffic (**LT**) network connections.

The test plan specified common testing parameters in order that the conversation test results would be comparable across test labs. Those parameters included the test-bed, the experimental design, test conditions, background noise environments, randomized test-condition presentation order, and number of subjects (32 subjects in 16 subject-pairs).

Table 8.B.1 –Test Conditions for the Conversation Tests

<i>Cond. #</i>	<i>Noise in Room A</i>	<i>Radio Network Conditions (RNC)</i>	<i>Noise in Room B</i>	<i>Description</i>
1	Hoth	A->B: [1] B->A: [1]	Hoth	Lm.LT.LM LM.LT.Lm
2	Car	A->B: [6] B->A: [6]	Car	Hm.LT.HM HM.LT.Hm
3	Car	A->B: [5] B->A: [2]	Hoth	Hm.LT.LM HM.LT.Lm
4	Hoth	A->B: [2] B->A: [5]	Car	Lm.LT.HM LM.LT.Hm
5	Cafeteria	A->B: [1] B->A: [1]	Cafeteria	Lm.LT.LM LM.LT.Lm
6	Cafeteria	A->B: [2] B->A: [5]	Street	Lm.LT.HM LM.LT.Hm
7	Street	A->B: [5] B->A: [2]	Cafeteria	Hm.LT.LM HM.LT.Lm
8	Street	A->B: [6] B->A: [6]	Street	Hm.LT.HM HM.LT.Hm
9	Hoth	A->B: [3] B->A: [3]	Hoth	Lm.HT.LM LM.HT.Lm
10	Car	A->B: [8] B->A: [8]	Car	Hm.HT.HM HM.HT.Hm
11	Car	A->B: [7] B->A: [4]	Hoth	Hm.HT.LM HM.HT.Lm
12	Hoth	A->B: [4] B->A: [7]	Car	Lm.HT.HM LM.HT.Hm
13	Cafeteria	A->B: [3] B->A: [3]	Cafeteria	Lm.HT.LM LM.HT.Lm
14	Cafeteria	A->B: [4] B->A: [7]	Street	Lm.HT.HM LM.HT.Hm
15	Street	A->B: [7] B->A: [4]	Cafeteria	Hm.HT.LM HM.HT.Lm
16	Street	A->B: [8] B->A: [8]	Street	Hm.HT.HM HM.HT.Hm

On each test trial, the subjects evaluated the test connection using five rating scales, where each rating scale involved five categories. In this report the results and analyses for the rating scales are labeled by the following conventions:

- Question 1 – **VQ** – Rate the **Voice Quality** of your partner.
- Question 2 – **UN** – Rate the difficulty of **Understanding** your partner.
- Question 3 – **LE** – Rate the **Level of Effort** required to communicate with your partner.
- Question 4¹ – **DD** – Did you **Detect Disturbances** in the conversation? If yes, how annoying were they.
- Question 5 – **OQ** – Rate the **Overall Quality** of the test connection.

8.B.3 Cross-check of Test Lab Results

The three test labs delivered their raw voting data to the GAL in the Excel spreadsheets provided by the GAL. Each of the test labs also provided test lab reports containing summary results for the conversation tests. Dynastat processed the raw voting data from the data delivery files and cross-checked the resulting scores against those contained in the test lab reports. In all cases the scores computed by Dynastat agreed with those reported by the test labs. The GAL therefore confirms the integrity of the raw data delivery for the three test labs.

8.B.4 Test Results

8.B.4.1 Mean Scores by Experiment and by Test Lab

The GAL was instructed by 3GPP/SA4 to treat the results of individual experiments from the test labs separately rather than making comparisons across experiments or across labs. This approach is justified by the experimental design of the conversation tests. Each experiment in each lab involved a different codec and each used an independent panel of test subjects. Comparisons of results across experiments within one lab are confounded by both codecs and subject panels. Comparisons across labs are further confounded by language and cultural differences in the subject panels. Finally, there are no common conditions across experiments and therefore no basis for transforming scores to a common origin and scale across experiments. The results and analyses contained in this report are limited to the results from a single experiment in a single Lab.

Figures 1-9 show the Mean scores for each of the five rating scales by Experiment and by Test Lab – Figs. 1-3 for Exp.1, Figs. 4-6 for Exp.2, and Figs. 7-9 for Exp.3.

¹ Question 4 contained two-parts. In the first part the subject answers whether he detects any disturbances - “yes” or “no.” If he answers “yes,” he then rates how annoying the disturbances were on a five-point scale. For practical purposes, a rating of 6 has been assigned to the responses of “no” disturbances detected. The ITU-T Recommendation for Conversational Testing, P.805, discusses Question 4 but does not address the procedure to be applied to “no” votes.

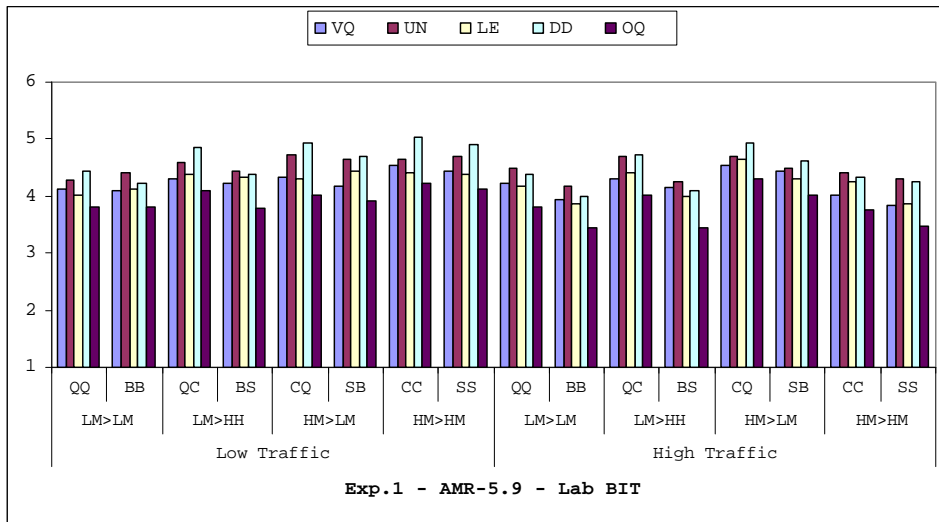

Fig. 8.B.1 – Mean Scores for Exp.1 - AMR-5.9 in Lab BIT

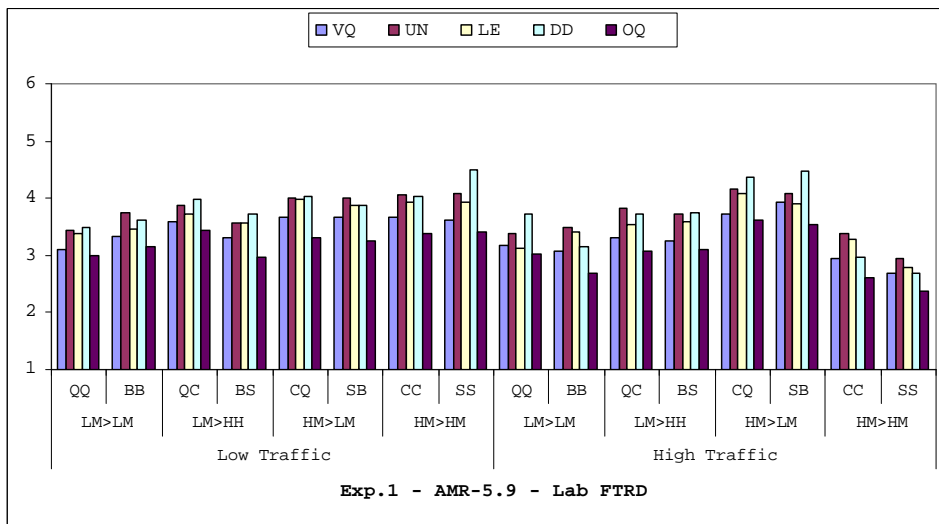

Fig. 8.B.2 – Mean Scores for Exp.1 - AMR-5.9 in Lab FTRD

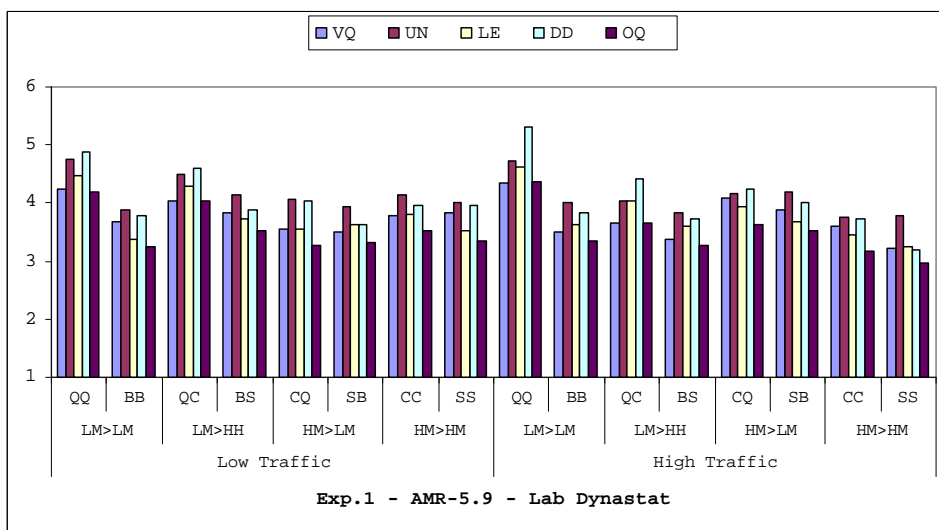

Fig. 8.B.3 – Mean Scores for Exp.1 - AMR-5.9 in Lab Dynastat

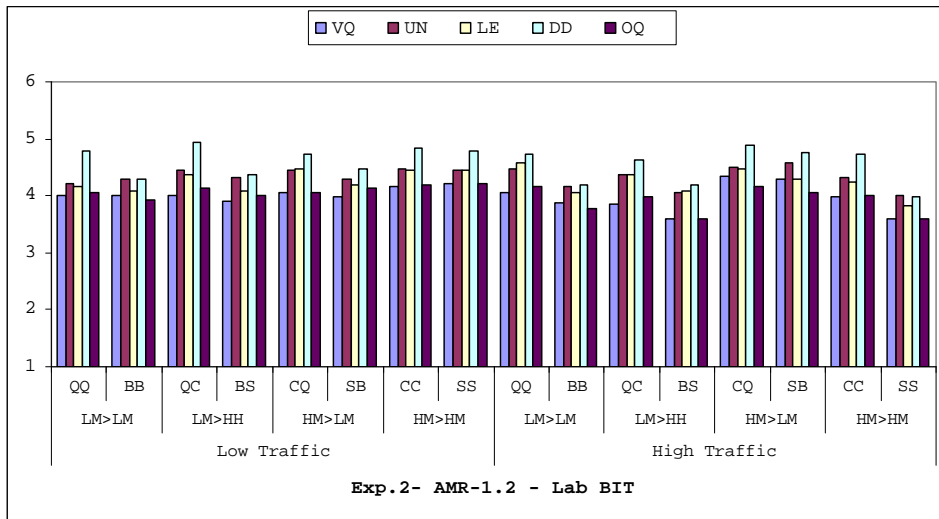

Fig. 8.B.4 – Mean Scores for Exp.2 - AMR-12.2 in Lab BIT

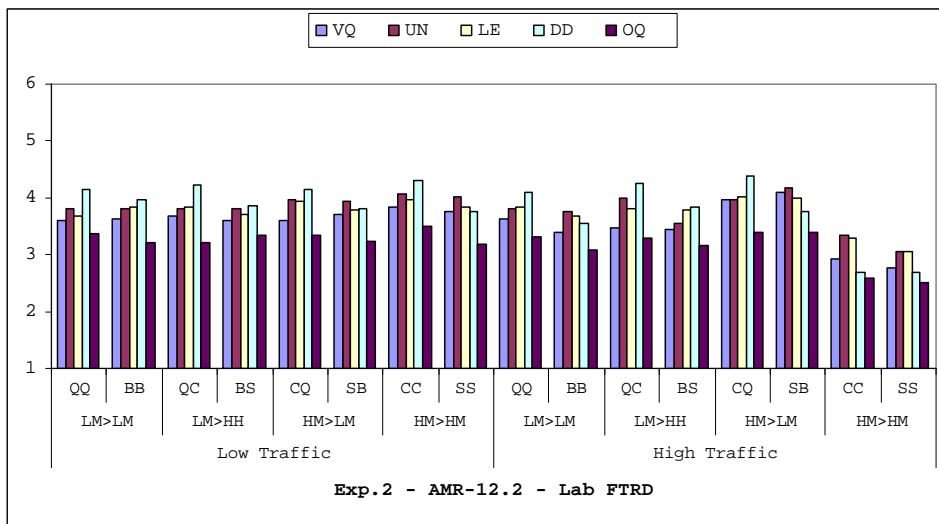

Fig. 8.B.5 – Mean Scores for Exp.2 - AMR-12.2 in Lab FTRD

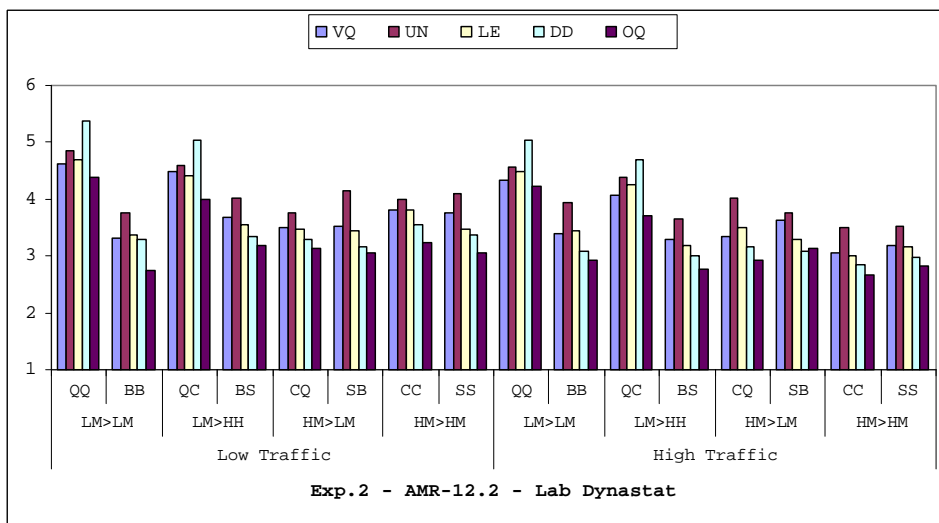

Fig. 8.B.6 – Mean Scores for Exp.2 - AMR-12.2 in Lab Dynastat

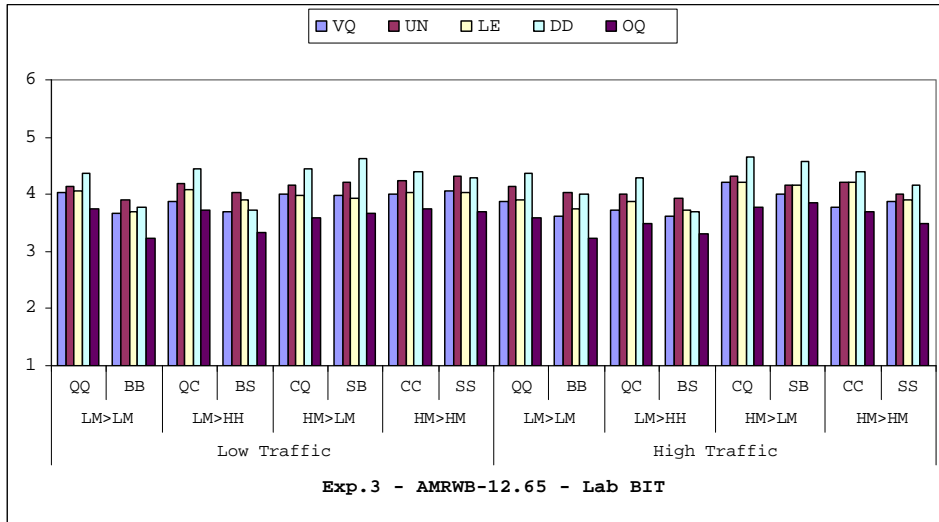

Fig. 8.B.7 – Mean Scores for Exp.3 - AMRWB-12.65 in Lab BIT

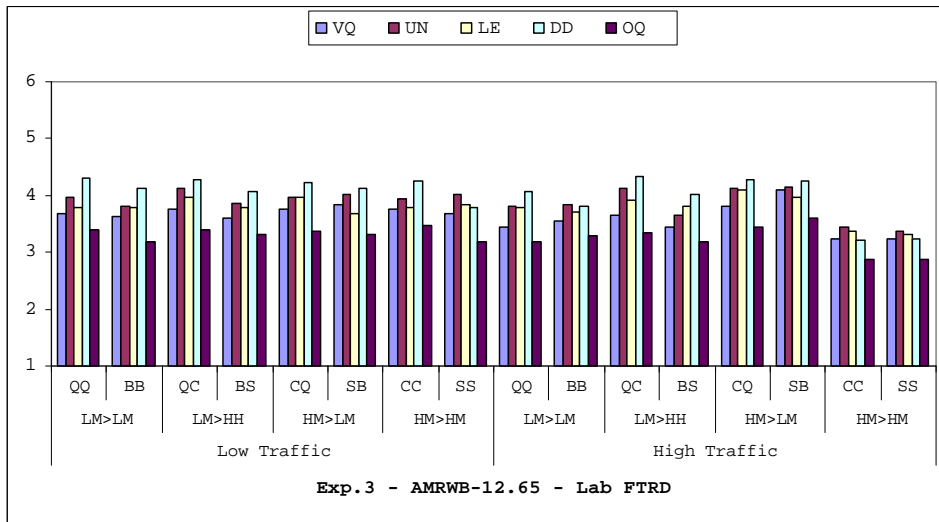

Fig. 8.B.8 – Mean Scores for Exp.3 - AMRWB-12.65 in Lab FTRD

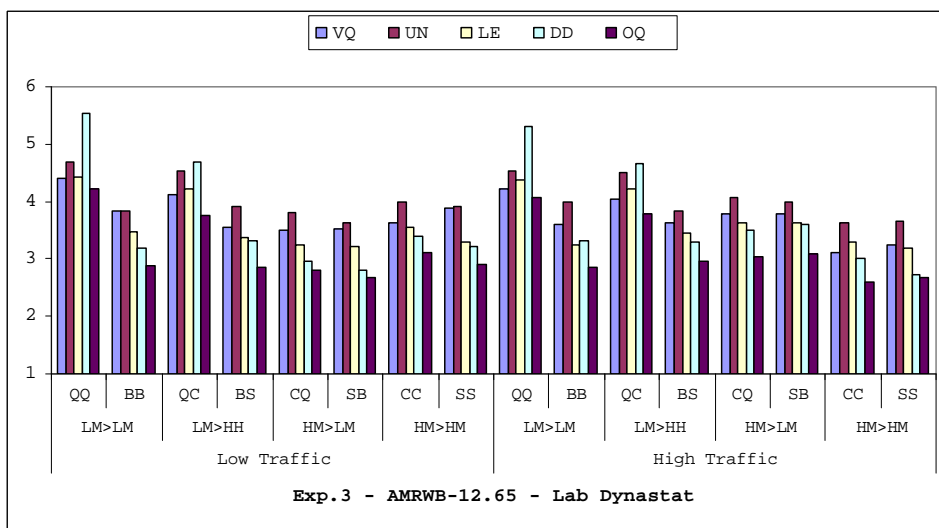

Fig. 8.B.9 – Mean Scores for Exp.3 - AMRWB-12.65 in Lab Dynastat

8.B.4.2 Subject Consistency Measures for Test Labs

In most subjective tests there are repeated measures, which may be used to evaluate the reliability of individual subject's performance in the subjective task relative to that of other subjects in the test panel. Furthermore, in those tests subjects hear and evaluate the same materials and there is a basis to compare and evaluate their responses across trials. For conversation tests, however, subjects don't have the same materials on which to base their responses (i.e., each conversation is unique) and there are no repeated measurers on which to evaluate reliability (i.e., there is only one trial per test condition). The only performance measure available for individual subjects within an experiment is the correlation of their responses across trials with the responses of the other subjects in the experiment. Table 2 shows the average correlation (across subjects and across rating scales) for each Test Lab and for each experiment within each lab. These values provide an indication of the consistency of the responses across subjects within an experiment. In general, the values are relatively low compared to values typically obtained for other subjective tests — for MOS tests conducted by Dynastat, those average correlations are typically around 0.90.

Table 8.B.2 – Consistency Measures by Lab and Experiment

Avg. Subj. R	BIT	FTRD	Dynastat
Exp. 1	0.32	0.38	0.44
Exp. 2	0.29	0.35	0.52
Exp. 3	0.25	0.28	0.47

Since the same 16 test conditions were tested in each of the three experiments, though with a different codec, the results across experiments can be expected to be positively correlated. Table 3 shows the intercorrelations across experiments for each of the five rating scales for each of the three Test Labs. The correlations are very high, especially for Labs Dynastat and FTRD, less so for Lab BIT. This finding was encouraging but somewhat unexpected considering the relatively narrow range of mean scores across test conditions, i.e., most mean scores were between 3.0 and 4.5.

Table 8.B.3 – Intercorrelations Across Experiments for the Five Rating Scales for Each Lab

Lab	Correlation	VQ	UN	LE	DD	OQ	Avg.
BIT	R(E1, E2)	0.76	0.75	0.70	0.77	0.85	0.77
	R(E1, E3)	0.71	0.64	0.45	0.71	0.66	0.63
	R(E2, E3)	0.61	0.62	0.57	0.69	0.69	0.64
FTRD	R(E1, E2)	0.90	0.85	0.80	0.69	0.79	0.81
	R(E1, E3)	0.89	0.92	0.92	0.95	0.90	0.92
	R(E2, E3)	0.90	0.79	0.75	0.68	0.78	0.78
Dynastat	R(E1, E2)	0.74	0.86	0.93	0.87	0.93	0.86
	R(E1, E3)	0.87	0.88	0.92	0.95	0.95	0.91
	R(E2, E3)	0.78	0.86	0.92	0.93	0.92	0.88

8.B.4.3 Multivariate Analysis of Variance (MANOVA)

The multiple rating scales used in conversation tests are designed to capture different aspects of the conversation task, e.g., voice quality, difficulty of understanding, level of effort, overall quality. In a previous conversation testing exercise conducted by 3GPP/SA4 [see clause 7] the rating scales were found to be highly intercorrelated and multivariate analyses (i.e., **Multivariate Analysis of Variance** or **MANOVA**) revealed that there was only one underlying variable that accounted for the significant variance in the five rating scales. The MANOVA procedure also provides coefficients for weighting the scores on the individual rating scales to produce a composite score corresponding to the underlying variable. The use of such composite scores makes it easier to compare test factors since the multiple criterion variables often give ambiguous or even conflicting results. Furthermore, the composite scores are more reliable than scores based on a single criterion variable. For the results reported here, the GAL conducted a MANOVA for each of the nine experiments involved in the conversation test, where the independent variable was *Conditions* (n=16) and the dependent variables were the five rating scales — VQ, UN, LE, DD, and OQ. The results of the MANOVA's showed that there was more never than one significant composite variable in any experiment. In five of the nine experiments (1F, 1D, 2F, 2D, 3D) there was a single significant underlying variable (criterion = $p < 0.05$). Furthermore, in one experiment (1B) the

composite variable was close to significant ($p=0.08$). In the three remaining experiments (2B, 3B, 3F) there was no significant composite variable ($p>0.05$). Nevertheless, in the interests of a parsimonious solution, the GAL computed a composite variable for each of the nine conversation tests based on results from the appropriate MANOVA. Using the precedent set in the previous 3GPP conversation tests, the GAL has labeled each composite variable as the measure of *Conversational Quality* for the appropriate experiment.

8.B.4.3.1 MANOVA Results and Statistics

The raw voting data from Exp.1, conducted at BIT, was subjected to MANOVA to determine whether the scores for the five rating scales could be represented by a smaller number of underlying variables. Table 4 shows the results of that MANOVA. The following description of Table 4 also applies to the MANOVA's for each of the other eight experiments.

Table 8.B.4 – Results of MANOVA for Exp.1 – AMR-5.9 – Lab BIT

Intercorrelations Among Rating Scales						MANOVA for Effects of Conditions x Rating Scales						
Exp. 1B	VQ	UN	LE	DD	OQ	Pillai Trace Statistic	Value	F-Ratio	df	Probability		
VQ	1.000	0.785	0.830	0.847	0.898	0.1810		1.2421	75,2480	0.0801		
UN	0.785	1.000	0.882	0.919	0.881	Test of residual roots						
LE	0.830	0.882	1.000	0.828	0.896	Root	ChiSq	df	Prob.	Dep. Var.	Canon. coef. For Root 1-5	
DD	0.847	0.919	0.828	1.000	0.933	1-5	93.49	75	0.0729	VQ	0.2606	
OQ	0.898	0.881	0.896	0.933	1.000	2-5	45.38	56	0.8441	UN	0.6287	
						3-5	25.96	39	0.9458	LE	0.2999	
						4-5	11.42	24	0.9857	DD	-0.0765	
						5-5	3.74	11	0.9770	OQ	-0.1127	

The first step in the MANOVA process is to examine the intercorrelations among the dependent variables for indications of underlying variables. The left-hand side of Table 4 shows the intercorrelation matrix of the five dependent variables across conditions for Exp.1 for Lab BIT. The table shows a high degree of intercorrelation, indicating the presence of a reduced set of underlying variables.

The right-hand side of Table 4 shows the results of the MANOVA for the effects of *Conditions* (independent variable) x *Rating Scales* (dependent variables). The top section of the table shows the statistical test for the significance of the combination of dependent variables. The Pillai Trace² and the associated F-statistic is not significant in this MANOVA, though it's probability ($p=0.0801$) is close to the criterion for significance, $p<0.05$. The bottom section of Table 4 shows the Chi-square tests of the MANOVA roots. It shows that only the first root (1-5) is close to significant, indicating that a single underlying variable accounts for the (almost) significant variation in the dependent variables. The canonical coefficients for this root are also shown in the table and are used to compute the composite dependent variable that corresponds to the underlying variable. The probability of the Chi-Square value for the initial root (Chi-square = 93.49, $df = 75$) is similar to that of the Pillai Trace (i.e., $p = 0.07$). The probability of the second root (2-5) is not even close to significance ($p=0.8441$). The same applies to the succeeding roots, 3-5, 4-5, and 5-5. The Canonical Coefficients for the first root are used to compute a weighted average of the five dependent variables producing the composite variable, labeled here as *Conversational Quality* for Exp.1-Lab BIT. The same process is applied to the data for each of the other eight experiments, producing a composite variable, or *Conversational Quality* measure, for each experiment. Tables 5-12 summarize the results of MANOVA for each of the other eight conversation tests, respectively.

Table 8.B.5 – Results of MANOVA for Exp.1 – AMR-5.9 – Lab FTRD

² For MANOVA, there is no single universally accepted procedure for hypothesis testing but rather a number of different methods. For the analyses that follow, we have chosen Pillai Trace and the associated F-statistic as the criterion for significance, primarily because of its robustness to violations of MANOVA assumptions.

Intercorrelations Among Rating Scales					
Exp.1F	VQ	UN	LE	DD	OQ
VQ	1.000	0.952	0.926	0.937	0.950
UN	0.952	1.000	0.972	0.906	0.925
LE	0.926	0.972	1.000	0.873	0.887
DD	0.937	0.906	0.873	1.000	0.961
OQ	0.950	0.925	0.887	0.961	1.000

MANOVA for Effects of Conditions x Rating Scales					
Pillai Trace	Value	F-Ratio	df	Probability	
Statistic	0.2062	1.4223	75,2480	0.0108	
Test of residual roots				Dep.Var.	Canon.coef. For Root 1-5
Root	ChiSq	df	Prob.		
1-5	108.85	75	0.0065	VQ	0.2565
2-5	34.51	56	0.9894	UN	0.3720
3-5	17.60	39	0.9987	LE	0.3534
4-5	9.79	24	0.9953	DD	-0.1706
5-5	3.33	11	0.9857	OQ	0.1887

Table 8.B.6 – Results of MANOVA for Exp.1 – AMR-5.9 – Lab Dynastat

Intercorrelations Among Rating Scales					
Exp.1D	VQ	UN	LE	DD	OQ
VQ	1.000	0.880	0.836	0.878	0.891
UN	0.880	1.000	0.934	0.911	0.962
LE	0.836	0.934	1.000	0.954	0.986
DD	0.878	0.911	0.954	1.000	0.962
OQ	0.891	0.962	0.986	0.962	1.000

MANOVA for Effects of Conditions x Rating Scales					
Pillai Trace	Value	F-Ratio	df	Probability	
Statistic	0.2857	2.0043	75,2480	0.0000	
Test of residual roots				Dep.Var.	Canon.coef. For Root 1-5
Root	ChiSq	df	Prob.		
1 - 5	153.76	75	0.0000	VQ	0.2305
2 - 5	52.33	56	0.6146	UN	0.5459
3 - 5	22.50	39	0.9841	LE	0.1564
4 - 5	7.60	24	0.9994	DD	-0.0410
5 - 5	1.55	11	0.9996	OQ	0.1082

Table 8.B.7 – Results of MANOVA for Exp.2 – AMR12.2 – Lab BIT

Intercorrelations Among Rating Scales					
Exp.2B	VQ	UN	LE	DD	OQ
VQ	1.000	0.885	0.713	0.785	0.860
UN	0.885	1.000	0.865	0.848	0.865
LE	0.713	0.865	1.000	0.852	0.799
DD	0.785	0.848	0.852	1.000	0.870
OQ	0.860	0.865	0.799	0.870	1.000

MANOVA for Effects of Conditions x Rating Scales					
Pillai Trace	Value	F-Ratio	df	Probability	
Statistic	0.1593	1.0883	75,2480	0.2847	
Test of residual roots				Dep.Var.	Canon.coef. For Root 1-5
Root	ChiSq	df	Prob.		
1 - 5	81.62	75	0.2811	VQ	0.2167
2 - 5	47.31	56	0.7894	UN	0.4179
3 - 5	24.77	39	0.9629	LE	0.4315
4 - 5	12.73	24	0.9703	DD	-0.0295
5 - 5	4.46	11	0.9545	OQ	-0.0367

Table 8.B.8 – Results of MANOVA for Exp.2 – AMR-12.2 – Lab FTRD

Intercorrelations Among Rating Scales					
Exp.2F	VQ	UN	LE	DD	OQ
VQ	1.000	0.922	0.937	0.790	0.907
UN	0.922	1.000	0.920	0.787	0.900
LE	0.937	0.920	1.000	0.885	0.931
DD	0.790	0.787	0.885	1.000	0.928
OQ	0.907	0.900	0.931	0.928	1.000

MANOVA for Effects of Conditions x Rating Scales					
Pillai Trace	Value	F-Ratio	df	Probability	
Statistic	0.1982	1.365	75,2480	0.0215	
Test of residual roots				Dep.Var.	Canon.coef. For Root 1-5
Root	ChiSq	df	Prob.		
1 - 5	103.28	75	0.0169	VQ	0.1152
2 - 5	44.40	56	0.8684	UN	0.3818
3 - 5	20.24	39	0.9943	LE	0.3861
4 - 5	9.44	24	0.9965	DD	-0.0531
5 - 5	3.23	11	0.9873	OQ	0.1960

Table 8.B.9 – Results of MANOVA for Exp.2 – AMR-12.2 – Lab Dynastat

Intercorrelations Among Rating Scales					
Exp.2D	VQ	UN	LE	DD	OQ
VQ	1.000	0.940	0.961	0.953	0.973
UN	0.940	1.000	0.949	0.917	0.927
LE	0.961	0.949	1.000	0.981	0.974
DD	0.953	0.917	0.981	1.000	0.972
OQ	0.973	0.927	0.974	0.972	1.000

MANOVA for Effects of Conditions x Rating Scales					
Pillai Trace	Value	F-Ratio	df	Probability	
Statistic	0.3892	2.7911	75,2480	0.0000	
Test of residual roots				Dep.Var.	Canon.coef. For Root 1-5
Root	ChiSq	df	Prob.		
1 - 5	220.80	75	0.0000	VQ	0.1193
2 - 5	53.12	56	0.5848	UN	0.5367
3 - 5	33.77	39	0.7071	LE	0.2168
4 - 5	15.71	24	0.8982	DD	-0.1346
5 - 5	6.98	11	0.8006	OQ	0.2618

Table 8.B.10 – Results of MANOVA for Exp.3 – AMRWB-12.65 – Lab BIT

Intercorrelations Among Rating Scales					
Exp. 3B	VQ	UN	LE	DD	OQ
VQ	1.000	0.785	0.830	0.847	0.898
UN	0.823	1.000	0.882	0.919	0.881
LE	0.737	0.882	1.000	0.828	0.896
DD	0.807	0.919	0.828	1.000	0.933
OQ	0.854	0.881	0.896	0.933	1.000

MANOVA for Effects of Conditions x Rating Scales					
Pillai Trace	Value	F-Ratio	df	Probability	
Statistic	0.1427	0.9713	75,2480	0.5488	
Test of residual roots				Dep.Var.	Canon.coef. For Root 1-5
Root	ChiSq	df	Prob.		
1 - 5	73.17	75	0.5384	VQ	0.2753
2 - 5	35.72	56	0.9841	UN	0.4856
3 - 5	21.09	39	0.9914	LE	0.2408
4 - 5	9.82	24	0.9952	DD	0.0904
5 - 5	3.87	11	0.9735	OQ	-0.0846

Table 8.B.11 – Results of MANOVA for Exp.3 – AMRWB-12.65 – Lab FTRD

Intercorrelations Among Rating Scales					
Exp. 3F	VQ	UN	LE	DD	OQ
VQ	1.000	0.952	0.926	0.937	0.950
UN	0.897	1.000	0.972	0.906	0.925
LE	0.761	0.972	1.000	0.873	0.887
DD	0.761	0.906	0.873	1.000	0.961
OQ	0.907	0.925	0.887	0.961	1.000

MANOVA for Effects of Conditions x Rating Scales					
Pillai Trace	Value	F-Ratio	df	Probability	
Statistic	0.1356	0.9219	75,2480	0.6672	
Test of residual roots				Dep.Var.	Canon.coef. For Root 1-5
Root	ChiSq	df	Prob.		
1 - 5	69.51	75	0.6572	VQ	-0.0259
2 - 5	33.34	56	0.9931	UN	0.4375
3 - 5	17.47	39	0.9989	LE	0.3891
4 - 5	9.64	24	0.9959	DD	-0.0634
5 - 5	3.31	11	0.9859	OQ	0.2730

Table 8.B.12 – Results of MANOVA for Exp.3 – AMRWB-12.65 – Lab Dynastat

Intercorrelations Among Rating Scales					
Exp. 3D	VQ	UN	LE	DD	OQ
VQ	1.000	0.880	0.836	0.878	0.891
UN	0.907	1.000	0.934	0.911	0.962
LE	0.873	0.934	1.000	0.954	0.986
DD	0.888	0.911	0.954	1.000	0.962
OQ	0.902	0.962	0.986	0.962	1.000

MANOVA for Effects of Conditions x Rating Scales					
Pillai Trace	Value	F-Ratio	df	Probability	
Statistic	0.4243	3.0662	75,2480	0.0000	
Test of residual roots				Dep.Var.	Canon.coef. For Root 1-5
Root	ChiSq	df	Prob.		
1 - 5	253.83	75	0.0000	VQ	0.1327
2 - 5	36.58	56	0.9793	UN	0.4614
3 - 5	18.58	39	0.9977	LE	0.0807
4 - 5	8.08	24	0.9990	DD	0.1201
5 - 5	3.26	11	0.9869	OQ	0.2052

8.B.4.3.2 Composite Scores – Conversational Quality

The canonical coefficients for the first root were used as weighting factors for the individual rating scales to compute a composite variable, labeled here as *Conversational Quality (CQ)*³ for each experiment. The CQ scores present a simplified method for evaluating the results for each experiment. The validity of the CQ measures is a function of the reliability of the MANOVA from which it was derived. More confidence can be afforded to CQ values from those experiments with a significant underlying variable (1B, 1F, 1D, 2F, 2D, 3D), less confidence to those experiments with no significant underlying variable (2B, 3B, 3F).

Table 13 shows Summary CQ results (Means and Standard Deviations) for Exp.1. Tables 14 and 15 show results for Exp.2 and Exp.3, respectively.

³ The term “Conversational Quality” was introduced in previous AMR and AMR-WB Conversation Tests [6] but it has not been validated in the ITU-T Recommendation for Conversational Testing, P.805. The Conversational Quality values reported in this document are specific to the particular lab and the experiment from which they are derived. Scores are not absolute and comparisons across experiments are not valid.

Table 8.B.13 – Conversational Quality Results for Exp.1 – AMR-5.9

CQ Cond.	Exp.1 - BIT		Exp.1 - FTRD		Exp.1 - Dynastat	
	Mean	SD	Mean	SD	Mean	SD
1	4.21	0.76	3.23	1.06	4.52	0.55
2	4.57	0.50	3.79	0.58	3.94	0.75
3	4.56	0.57	3.77	0.76	3.79	0.86
4	4.49	0.61	3.65	0.88	4.30	0.71
5	4.32	0.69	3.46	0.76	3.69	0.84
6	4.43	0.64	3.36	0.89	3.94	0.73
7	4.55	0.62	3.75	0.91	3.73	0.84
8	4.58	0.52	3.72	0.72	3.82	0.85
9	4.42	0.69	3.12	0.97	4.56	0.53
10	4.34	0.63	3.15	0.88	3.60	0.84
11	4.66	0.49	3.88	0.59	4.05	0.72
12	4.58	0.48	3.46	0.94	3.89	0.75
13	4.13	0.77	3.26	0.81	3.76	0.87
14	4.25	0.71	3.43	0.77	3.64	0.69
15	4.47	0.69	3.82	0.71	3.97	0.83
16	4.16	0.73	2.75	0.80	3.50	0.88

Table 8.B.14 – Conversational Quality Results for Exp.2 – AMR-12.2

CQ Cond.	Exp.2 - BIT		Exp.2 - FTRD		Exp.2 - Dynastat	
	Mean	SD	Mean	SD	Mean	SD
1	4.13	0.83	3.73	0.79	4.36	0.70
2	4.39	0.74	3.98	0.87	3.71	0.93
3	4.38	0.79	3.88	0.86	3.51	1.19
4	4.31	0.67	3.77	0.87	4.19	0.68
5	4.15	0.73	3.78	0.87	3.60	0.83
6	4.14	0.64	3.75	0.79	3.55	0.80
7	4.17	0.79	3.83	0.79	3.39	0.72
8	4.39	0.66	3.88	0.79	3.60	0.74
9	4.43	0.59	3.79	0.91	4.23	0.92
10	4.21	0.71	3.25	0.92	3.30	1.02
11	4.45	0.58	3.96	0.78	3.74	0.85
12	4.27	0.63	3.82	0.83	4.17	0.59
13	4.07	0.71	3.67	1.04	3.58	0.83
14	3.99	0.74	3.63	0.86	3.58	1.03
15	4.39	0.54	4.08	0.74	3.71	0.76
16	3.85	0.88	3.02	0.92	3.38	0.66

Table 8.B.15 – Conversational Quality Results for Exp.3 – AMRWB-12.65

CQ Cond.	Exp.3 - BIT		Exp.3 - FTRD		Exp.3 - Dynastat	
	Mean	SD	Mean	SD	Mean	SD
1	4.17	0.88	3.77	0.75	4.64	0.65
2	4.22	0.77	3.77	0.84	3.66	0.82
3	4.17	0.73	3.84	0.77	3.42	1.12
4	4.17	0.90	3.91	0.82	4.31	0.77
5	3.86	0.71	3.65	0.84	3.54	0.77
6	3.97	0.91	3.72	0.82	3.53	0.79
7	4.20	0.85	3.74	0.73	3.29	0.76
8	4.26	0.60	3.79	0.74	3.56	0.70
9	4.10	0.81	3.66	0.85	4.47	0.90
10	4.19	0.66	3.31	0.68	3.24	0.94
11	4.37	0.65	3.97	0.72	3.71	0.83
12	3.99	0.72	3.87	0.83	4.29	0.65
13	3.95	0.65	3.69	0.87	3.57	0.81
14	3.86	0.75	3.61	0.82	3.53	0.90
15	4.21	0.74	3.97	0.70	3.71	0.74
16	4.03	0.82	3.26	0.94	3.25	0.59

8.B.4.3.3 Conversational Quality by Experimental Factors

The conversation tests were designed primarily to evaluate two experimental factors, *Traffic* and *Mobility*, for each of three codecs. The *Traffic* effect had two levels – Low Traffic and High Traffic. The *Mobility* effect had four levels – LM \Rightarrow LM, LM \Rightarrow HM, HM \Rightarrow LM, and HM \Rightarrow HM. In addition, the *Mobility* factor had two test conditions (i.e., background noise conditions) representing each level of inter-connection.

The experimental design of the conversation tests does not permit a direct comparison of the effects of *Codecs*, since each codec was evaluated in a separate conversation test using independent test panels. The *Traffic* conditions were simulated by RNC settings in the test-bed. The *Mobility* conditions were simulated by a combination of test-bed RNC settings and background noise conditions in the test rooms. Each mobility connection, e.g., LM \Rightarrow HM, involved two different background noise conditions and therefore the effects of Mobility connection and background noise were confounded. This confounding means that the effects of Mobility and background noise cannot be separated. For this reason the results for the two background noise conditions were often inconsistent for each level of Mobility.

Figures 10-18 show the CQ results for each experiment involved in the conversations tests. Each figure has two parts — on the left are CQ scores for every test condition, on the right are average scores for the *Traffic* and *Mobility* factors. Each figure stands on its own – the scale and origin of the CQ scales apply only to the specific experiment. The caption in each figure indicates whether the CQ variable was significant in the MANOVA from which it was derived. Figures 10-12 show CQ scores for Exp.1 for Labs BIT, FTRD, and Dynastat, respectively. Similarly, Figs. 13-15 show CQ scores for Exp.2, and Figs. 16-18 for Exp.3.

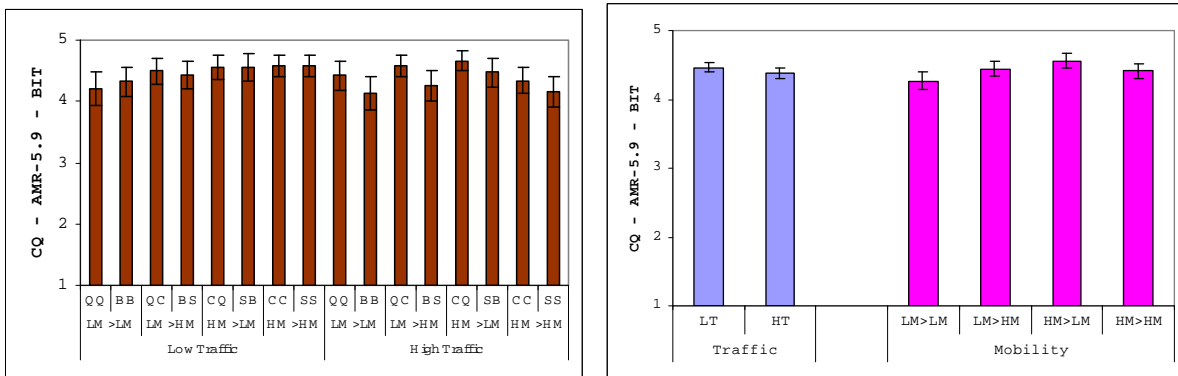

Fig.8.B.10 – Conversation Quality Scores for Exp.1-AMR-5.9 for Lab BIT (CQ was not significant, p=0.08)

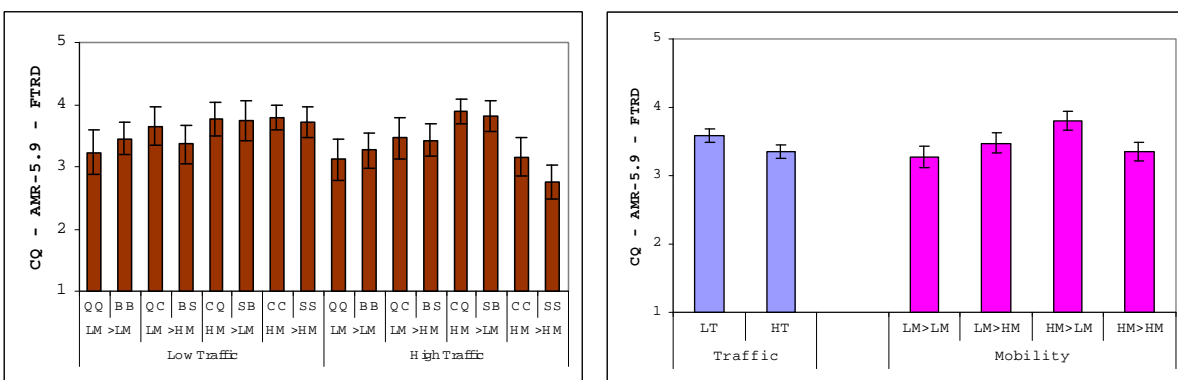

Fig. 8.B.11 – Conversation Quality Scores for Exp.1-AMR-5.9 for Lab FTRD (CQ was significant, p<0.05)

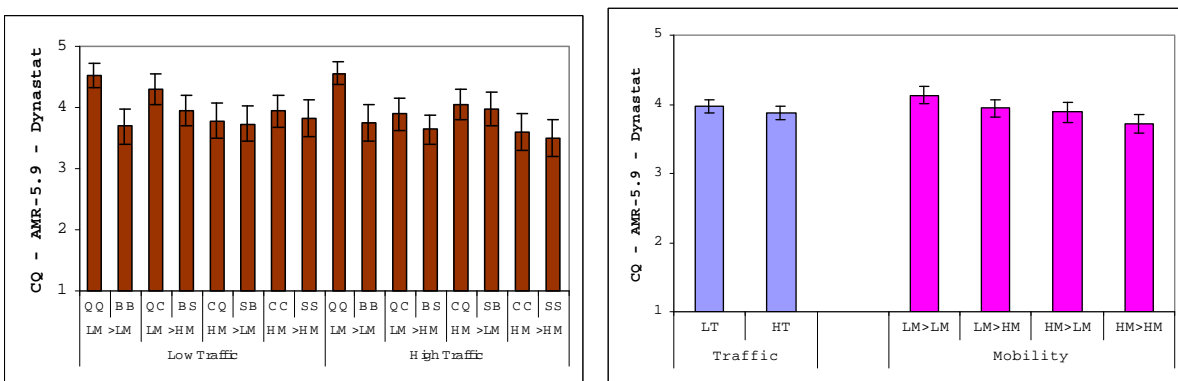

Fig. 8.B.12 – Conversation Quality Scores for Exp.1-AMR-5.9 for Lab Dynastat (CQ was significant, p<0.0001)

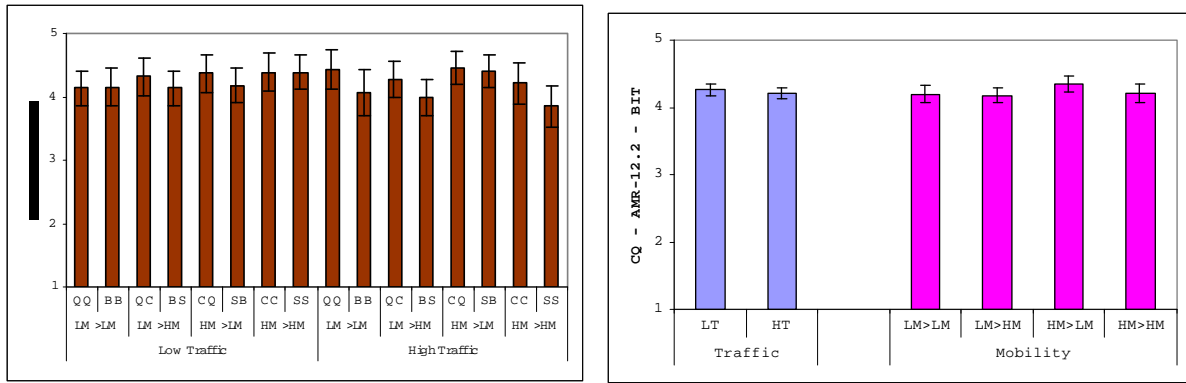

Fig. 8.B.13 – Conversation Quality Scores for Exp.2-AMR-12.2 for Lab BIT (CQ was not significant, p=0.28)

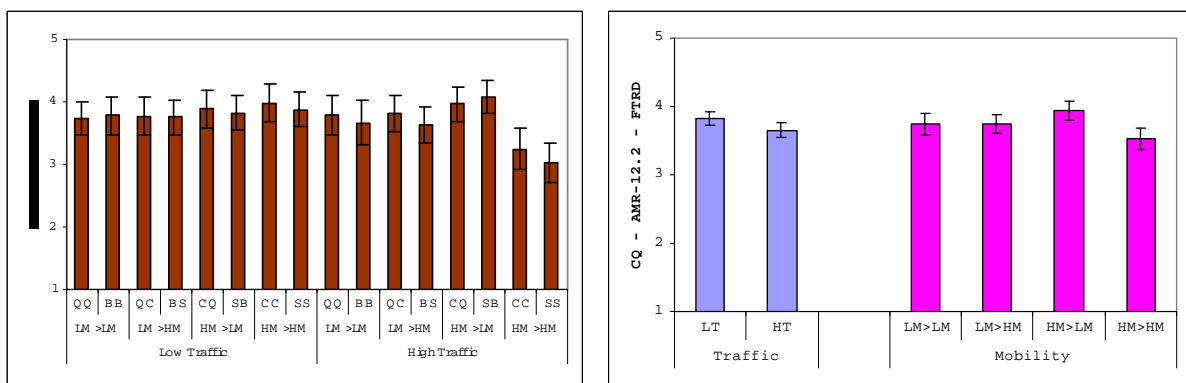

Fig.8.B.14 – Conversation Quality Scores for Exp.2-AMR-12.2 for Lab FTRD (CQ was significant, p<0.05)

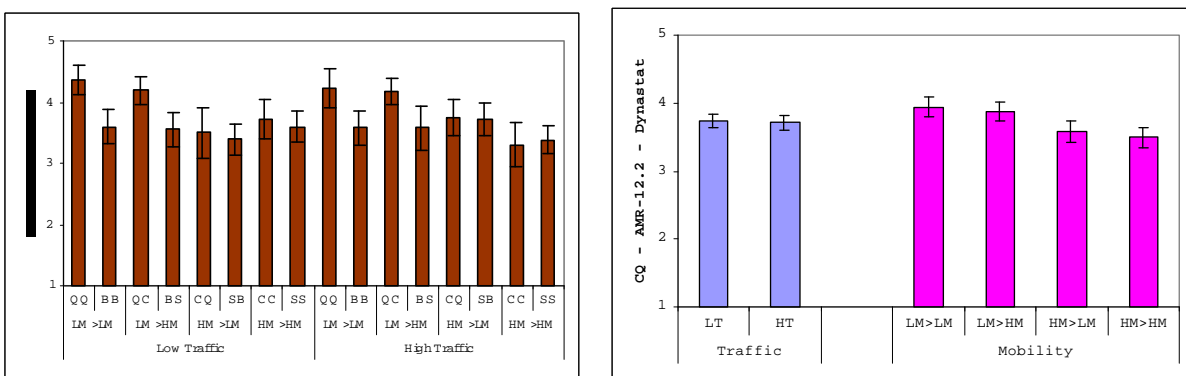

Fig. 8.B.15 – Conversation Quality Scores for Exp.2-AMR-12.2 for Lab Dynastat (CQ was significant, p<0.0001)

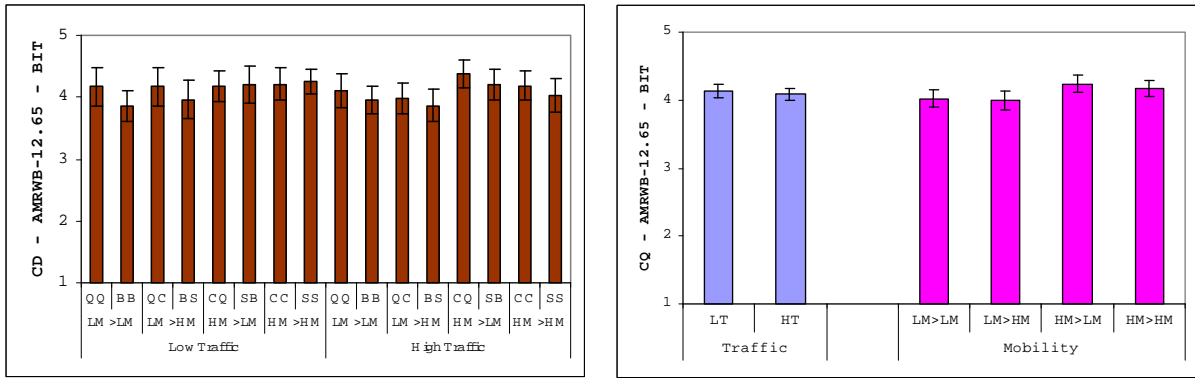

Fig. 8.B.16 – Conversation Quality Scores for Exp.3-AMRWB-12.65 for Lab BIT (CQ was not significant, p=0.55)

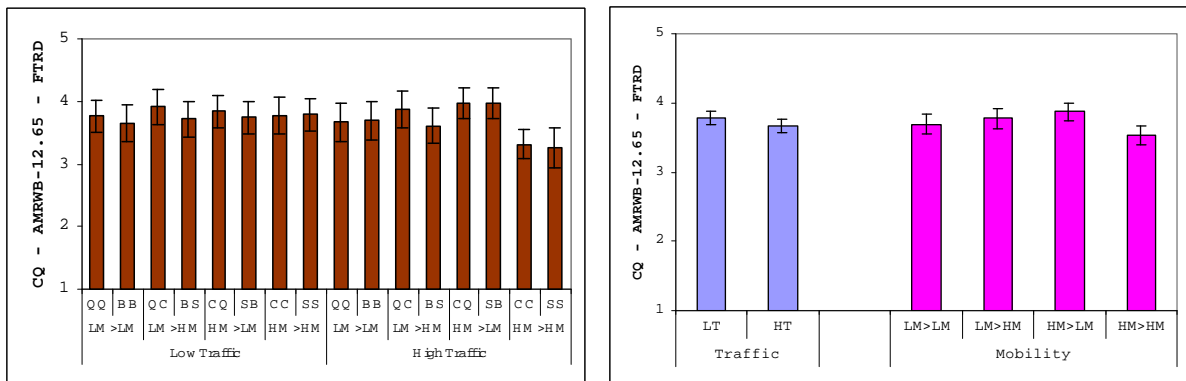

Fig. 8.B.17 – Conversation Quality Scores for Exp.3-AMRWB-12.65 for Lab FTRD (CQ was not significant, p=0.67)

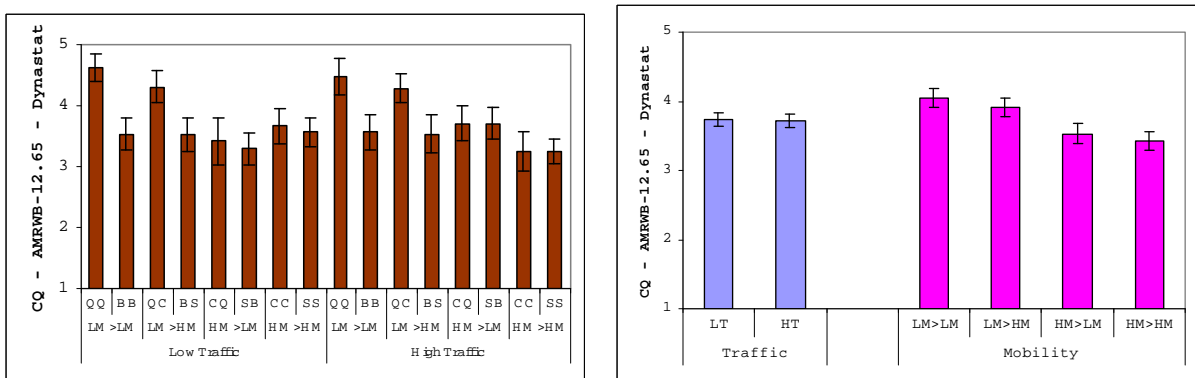

Fig. 8.B.18 – Conversation Quality Scores for Exp.3-AMRWB-12.65 for Lab Dynastat (CQ was significant, p<0.0001)

8.B.5 Conversation tests conclusions

For the *Traffic* factor, the Conversational Quality results are consistent and confirm expectations. For all three codecs and in all three test-labs, CQ is numerically higher in Low Traffic conditions than in High Traffic conditions. In general, the results of the Conversation Tests show that the effects of *Traffic* on the performance of AMR and AMR-WB for UMTS over HSDPA/EUL are relatively small.

For the *Mobility* factor, however, the results are not as consistent. This is not surprising, since Mobility conditions were confounded with background noise conditions.

It is important to note that the Conversational Quality scores computed in this exercise are specific to the particular lab and the experiment from which they are derived. Scores are not absolute and comparisons across experiments are not valid. Furthermore, the variables underlying the CQ scores were not significant in all experiments.

Overall, the performance of AMR and AMR-WB for UMTS over HSDPA/EUL is robust under conditions of Traffic, Mobility, and Background noise evaluated in the conversation tests.

9 Conclusions

9.1 Tests over DCH radio channels

The results from conversational tests on DCH channels confirm that the default speech codecs (AMR-NB and AMR-WB) operate well for packet switched conversational multimedia applications over various realistic operating conditions (i.e. packet loss, delay, background noise, radio conditions and ROHC).

The quality is somewhat reduced when packet losses occur and the end-to-end delay is increased, but the overall quality still remains acceptable even with 3% packet loss rate in the terrestrial IP network and up to a maximum of 1% BLER on each radio leg. The results also indicate that users have clear preference for AMR-WB speech over AMR-NB speech.

9.2 Tests over HSDPA/EUL radio channels; listening only tests

The listening only test results for HSDPA/EUL radio channels indicate that an adaptive JBM conforming to the MTSI performance requirements is able to provide consistent voice quality over varying transmission conditions. The test also shows that the performance of the JBM directly impacts the voice quality. Furthermore, the test results indicate that an adaptive JBM is needed to cope with the large variations in channel delay.

9.3 Tests over HSDPA/EUL radio channels; conversation tests

Overall, the performance of AMR and AMR-WB for UMTS over HSDPA/EUL is robust under conditions of Traffic, Mobility, and Background noise evaluated in the conversation tests.

9.4 General consideration

The performance results can be used as guidance for network planning regarding the QoS parameters for VoIP.

Annex A:

Conversation test composite dependent variable scores by condition and Lab

Set 1 - Narrowband/SYM Experimental Parameters							NB/S-CTQ Scores			
Cond	Rm-A	Rm-B	RC	PL	Mode	Del	Arcon	FT	NTT	Average
1	Quiet	Quiet	10^{-2}	0	6.7	300	3.80	3.73	3.79	3.77
2	Quiet	Quiet	10^{-2}	0	12.2	500	3.88	3.85	3.52	3.75
3	Quiet	Quiet	10^{-2}	0	12.2	300	4.05	3.73	3.91	3.89
4	Quiet	Quiet	10^{-2}	3	6.7	300	3.49	2.92	3.22	3.21
5	Quiet	Quiet	10^{-2}	3	12.2	500	3.68	2.99	3.28	3.32
6	Quiet	Quiet	10^{-2}	3	12.2	300	3.67	3.38	3.62	3.55
7	Quiet	Quiet	10^{-3}	0	6.7	300	4.09	4.22	3.96	4.09
8	Quiet	Quiet	10^{-3}	0	12.2	500	4.04	4.28	4.17	4.16
9	Quiet	Quiet	10^{-3}	0	12.2	300	4.31	4.66	3.94	4.30
10	Quiet	Quiet	10^{-3}	3	6.7	300	3.63	3.60	3.64	3.63
11	Quiet	Quiet	10^{-3}	3	12.2	500	3.83	3.82	3.75	3.80
12	Quiet	Quiet	10^{-3}	3	12.2	300	3.73	4.06	3.94	3.91
13	Quiet	Quiet	5×10^{-4}	0	6.7	300	4.20	4.45	4.07	4.24
14	Quiet	Quiet	5×10^{-4}	0	12.2	500	4.14	4.30	4.01	4.15
15	Quiet	Quiet	5×10^{-4}	0	12.2	300	4.26	4.37	4.38	4.34
16	Quiet	Quiet	5×10^{-4}	3	6.7	300	3.73	3.69	3.75	3.72
17	Quiet	Quiet	5×10^{-4}	3	12.2	500	3.93	3.98	3.71	3.87
18	Quiet	Quiet	5×10^{-4}	3	12.2	300	3.92	3.65	3.75	3.77

Set 2 - Narrowband/ASY Experimental Parameters							NB/A-CTQ Scores			
Cond	Rm-A	Rm-B	RC	PL	Mode	Del	Arcon	FT	NTT	Average
19	Car	Quiet	5×10^{-4}	3	12.2	300	3.44	2.93	3.43	3.27
20	Quiet	Car	5×10^{-4}	3	12.2	300	4.08	3.75	4.20	4.01
21	Cafeteria	Quiet	5×10^{-4}	0	6.7	300	3.84	3.58	3.86	3.76
22	Quiet	Cafeteria	5×10^{-4}	0	6.7	300	4.21	4.36	4.31	4.29
23	Street	Quiet	5×10^{-4}	0	12.2	500	3.77	3.58	4.01	3.79
24	Quiet	Street	5×10^{-4}	0	12.2	500	4.17	4.18	4.14	4.16

Set 3 - Wideband/SYM - Experimental Parameters							WB/S-CTQ Scores			
Cond	Rm-A	Rm-B	RC	PL	Mode	RoHC	Arcon	FT	NTT	Average
1	Quiet	Quiet	10 ⁻²	0	12.65	RoHC	4.76	4.68	4.73	4.72
2	Quiet	Quiet	10 ⁻²	0	12.65	-	4.55	5.01	4.90	4.82
3	Quiet	Quiet	10 ⁻²	0	15.85	RoHC	4.82	4.75	5.05	4.87
4	Quiet	Quiet	10 ⁻²	3	12.65	RoHC	4.53	4.35	4.44	4.44
5	Quiet	Quiet	10 ⁻²	3	12.65	-	4.42	4.21	4.52	4.38
6	Quiet	Quiet	10 ⁻²	3	15.85	RoHC	4.53	4.60	4.70	4.61
7	Quiet	Quiet	10 ⁻³	0	12.65	RoHC	4.90	4.87	5.05	4.94
8	Quiet	Quiet	10 ⁻³	0	12.65	-	4.68	4.92	5.10	4.90
9	Quiet	Quiet	10 ⁻³	0	15.85	RoHC	4.69	5.01	4.97	4.89
10	Quiet	Quiet	10 ⁻³	3	12.65	RoHC	4.64	4.69	4.88	4.74
11	Quiet	Quiet	10 ⁻³	3	12.65	-	4.77	4.72	4.72	4.74
12	Quiet	Quiet	10 ⁻³	3	15.85	RoHC	4.66	4.61	4.86	4.71
13	Quiet	Quiet	5 x 10 ⁻⁴	0	12.65	RoHC	4.74	4.88	5.09	4.91
14	Quiet	Quiet	5 x 10 ⁻⁴	0	12.65	-	4.80	5.07	5.01	4.96
15	Quiet	Quiet	5 x 10 ⁻⁴	0	15.85	RoHC	4.93	4.92	5.05	4.97
16	Quiet	Quiet	5 x 10 ⁻⁴	3	12.65	RoHC	4.55	4.64	4.84	4.67
17	Quiet	Quiet	5 x 10 ⁻⁴	3	12.65	-	4.73	4.70	4.75	4.72
18	Quiet	Quiet	5 x 10 ⁻⁴	3	15.85	RoHC	4.81	4.68	4.88	4.79

Set 4 - Wideband/ASY - Experimental Parameters							WB/A-CTQ Scores			
Cond	Rm-A	Rm-B	RC	PL	Mode	RoHC	Arcon	FT	NTT	Average
19	Car	Quiet	5 x 10 ⁻⁴	3	12.65	RoHC	3.69	3.62	3.17	3.49
20	Quiet	Car	5 x 10 ⁻⁴	3	12.65	RoHC	4.14	4.32	4.53	4.33
21	Cafeteria	Quiet	5 x 10 ⁻⁴	0	12.65	-	3.83	4.35	4.01	4.06
22	Quiet	Cafeteria	5 x 10 ⁻⁴	0	12.65	-	4.47	4.65	4.80	4.64
23	Street	Quiet	5 x 10 ⁻⁴	0	15.85	RoHC	3.71	3.87	4.32	3.97
24	Quiet	Street	5 x 10 ⁻⁴	0	15.85	RoHC	4.34	4.49	4.78	4.54

Set 5 - Phase II Experimental Parameters			Ph2-CTQ Scores		
Cond	PL	Codec, Mode	French	Arabic	Average
1	0	AMR-NB, 6.7kbit/s	4.22	3.94	4.08
2	0	AMR-NB, 12.2kbit/s	4.31	4.05	4.18
3	0	AMR-WB, 12.65kbit/s	4.33	4.30	4.32
4	0	AMR-WB, 15.85kbit/s	4.46	4.31	4.38
5	0	G. 723., 6.4 kbit/s	4.15	3.98	4.07
6	0	G.729, 8kbit/s	4.11	4.18	4.14
7	0	G.722, 64 kbit/s + plc	4.34	4.13	4.24
8	0	G.711 + plc	4.32	4.28	4.30
9	3	AMR-NB, 6.7kbit/s	3.79	3.58	3.68
10	3	AMR-NB, 12.2 kbit/s	4.03	3.88	3.95
11	3	AMR-WB, 12.65kbit/s	4.28	4.04	4.16
12	3	AMR-WB, 15.85kbit/s	4.14	3.99	4.07
13	3	G. 723.1, 6.4 kbit/s	3.87	3.51	3.69
14	3	G.729, 8kbit/s	3.99	3.82	3.90
15	3	G.722, 64 kbit/s + plc	4.33	4.30	4.32
16	3	G.711 + plc	4.34	4.33	4.34

Annex B: Instructions to subjects

In this experiment we are evaluating systems that might be used for telecommunication services.

You are going to have a conversation with another user. The test situation is simulating communications between two mobile phones. The most of the situations will correspond to silent environment conditions, but some other will simulate more specific situations, as in a car, or in a railway station or in an office environment, when other people are discussing in the background.

After the completion of each call conversation, you will have to give your opinions on the quality, by answering to the following questions that will be displayed on the screen of the black box in front of you. Your judgment will be stored. You have 8 seconds to answer to each question. After "pressing" the button on the screen, another question will be displayed. You continue the procedure for the 5 following questions.

Question 1: How do you judge the quality of the voice of your partner?

Excellent Good Fair Poor Bad

Question 2: Do you have difficulties to understand some words?

All the time Often Sometimes Rarely Never

Question 3: How did you judge the conversation when you interacted with your partner?

Excellent interactivity (similar to face- to-face situation)	Good interactivity (in few moments, you were talking simultaneously, and you had to interrupt yourself)	Fair interactivity (sometimes, you were talking simultaneously, and you had to interrupt yourself)	Poor interactivity (often, you were talking simultaneously, and you had to interrupt yourself)	Bad interactivity (it was impossible to have an interactive conversation)
---	--	---	--	---

Question 4: Did you perceive any impairment (noises, cuts,...)? In that case, was it:

No impairment Slight impairment,
but not disturbing Impairment
slightly disturbing Impairment
disturbing Very disturbing
Impairment

Question 5: How do you judge the global quality of the communication?

Excellent Good Fair Poor Bad

From then on you will have a break approximately every 30 minutes. The test will last a total of approximately 60 minutes.

Please do not discuss your opinions with other listeners participating in the experiment.

Annex C: Example Scenarios for the conversation test

The pretexts used for conversation test are those developed by the Ruhr University (Bochum, Germany) within the context of ITU-T SG12. These scenarios have been elaborated to allow a well-balanced conversation within both participants and lasting approximately 2'30 or 3', and to stimulate the discussion between persons that know each other to facilitate the naturalness of the conversation. They are derived from typical situations of every day life: railways inquiries, rent a car or an apartment, etc. Each condition should be given a different scenario.

Examples coming from ITU-T SG 12 COM12-35 "Development of scenarios for short conversation test", 1997

Scenario 1: Pizza service

Subject 1:

Your Name:	Clemence
Reason for the call	1 large Pizza
Condition which should be applied to the exchange of information	For 2 people, Vegetarian pizza preferred
Information you want to receive from your partner	Topping Price
Information that your partner requires	Delivery address : 41 industry street, Oxford Phone : 7 34 20
Question to which neither you nor your partner will have information.	How long will it take?
You should discuss and find a solution that is acceptable to both of you.	

Subject 2:

Your Name :	Pizzeria Roma			
Information from which you should select the details which your partner requires	Pizzas	1 person	2 persons	4 persons
	Toscana (ham, mushrooms, tomatoes, cheese)	3.2£	5.95£	10.5£
	Tonno (Tuna, onions, tomatoes, cheese)	3.95£	7.5£	13.95£
	Fabrizio (salami, ham, tomatoes, cheese)	4.2£	7.95£	14.95£
	Vegetarian (spinach, mushrooms, tomatoes, cheese)	4.5£	8.5£	15.95£
Information you want to receive from your partner	Name address telephone number			
Question to which neither you nor your partner will have information.				
You should discuss and find a solution that is acceptable to both of you.				

Scenario 2 : Information on flights

Subject 1:

Your Name:	Parker
Reason for the call	Intended journey: London Heathrow → Düsseldorf
Condition which should be applied to the exchange of information	On June 23rd, Morning flight, Direct flight preferred
Information you want to receive from your partner	Departure: Arrival Flight number
Information that your partner requires	Reservation: 1 seat, Economy class Address: 66 middle street, Sheffield Phone: 21 08 33
Question to which neither you nor your partner will have information.	From which airport is it easier to get into Cologne center : Düsseldorf or Cologne/Bonn
You should discuss and find a solution that is acceptable to both of you.	

Subject 2:

Your Name :	Heathrow flight information			
Information from which you should select the details which your partner requires	Flight schedule	Lufthansa	British Airways	Lufthansa
	Flight number	LH 2615	BA 381	LH 413
	London Heathrow departure	6:30	6:35	8:20
	Brussels arrival		7:35	
	Brussels departure		8:00	
	Düsseldorf arrival	7:35	9:05	9:25
Information you want to receive from your partner	Name address telephone number number of seats Class: Business or Economy			
Question to which neither you nor your partner will have information. You should discuss and find a solution that is acceptable to both of you.				

Annex D: Test Plan for the AMR Narrow-Band Packet Switched Conversation Test

Source: Siemens¹, France Telecom²
Title: Test Plan for the AMR Narrow-Band Packet switched Conversation Test
Document for: Approval
Agenda Item: 14.1

1. Introduction

This document contains the test plan of one conversation test for the Adaptive Multi-Rate Narrow-Band (AMR-NB) in Packet Switched networks.

All the laboratories participating to this conversation test phase will use the same test plan, just the language of the conversation would change.

Even if the test rooms or the test equipments are not exactly the same in all the laboratories, the calibration procedures and the tests equipment characteristics and performance (as defined in this document) will guarantee the similarity of the test conditions.

1 contact: ImreVarga

Imre.Varga @siemens.com

Tel: +49 89 722 47537

Siemens AG, ICM MP

Grillparzerstrasse 10a, 81675 Munich, Germany

2 contacts:

Catherine Quinquis catherine.quinquis@francetelecom.com Tel: +33 2 96 05 14 93 France Telecom T&I/R&D 2 avenue Pierre Marzin, 22397 Lannion, France	Jean-Yves Monfort Jeanyves.monfort@francetelecom.com Tel : +33296053171 France Telecom T&I/R&D 2 avenue Pierre Marzin, 22397 Lannion, France
--	--

Section 2 gives references, conventions and contacts, section 3 details the test methodology, including test arrangement and test procedure, and section 4 defines the financial considerations.

Annex A contains the instructions for the subjects participating to the conversation tests.

Annex B contains the description of results to be provided to the Analysis Laboratory (if any) by the testing laboratories.

Annex C contains the list of statistical comparisons to be performed.

Considerations about IPV6 versus IPV4 are given in section 3.2.

RoHC is not implemented in AMR-NB conversation test. The effect of RoHC should be extrapolated from the results observed in AMR-WB conversation test.

2. References, Conventions, and Contacts

2.1 Permanent Documents

ITU-T Rec.P.800	Methods for Subjective Determination of Transmission Quality	
ITU-T Rec. P.831	Subjective performance evaluation of network echo cancellers	This Recommendation defines conversation test procedures based on handset telephones, and gives inputs for the calibration.

2.2 Key Acronyms

AMR-NB	Adaptive Multi-Rate Narrowband Speech Codec
AMR-WB	Adaptive Multi-Rate Wide-band Speech Codec
MOS	Mean Opinion Score

2.3 Contact Names

The following persons should be contacted for questions related to the test plan.

Section	Contact Person/Email	Organisation	Address	Telephone/Fax
Experiments and results analysis	J-Y Monfort	France Telecom R&D	2, Avenue P. Marzin,	Tel : +33296053171
			22307 Lannion Cédex	Fax : +33296051316
			France	
AOB	Paolo Usai paolo.usai@etsi.fr	ETSI MCC	650 Route des Lucioles 06921 Sophia Antipolis Cedex France	Tel: 33 (0)4 92 94 42 36 Fax: 33 (0)4 93 65 28 17

2.4 Responsibilities

Each test laboratory has the responsibility to organize its conversation tests.

The list of Test laboratories participating to the conversation test phase.

Lab	Company	Language	Statistical analysis	Reporting
1	LAB1			
2	LAB2			

3. Test methodology

3.1 Introduction

The protocol described below evaluates the effect of degradation such as delay and dropped packets on the quality of the communications. It corresponds to the conversation-opinion tests recommended by the ITU-T P.800 [1]. First of all, conversation-opinion tests allow subjects passing the test to be in a more realistic situation, close to the actual service conditions experienced by telephone customers. In addition, conversation-opinion tests are suited to assess the effects of impairments that can cause difficulty while conversing (such as delay).

Subjects participate to the test by couple; they are seated in separate sound-proof rooms and are asked to hold a conversation through the transmission chain performed by means of UMTS simulators and communications are impaired by means of an IP impairments simulator part of the CN simulator and by the air interface simulator, as the figure below describes it.

The network configurations (including the terminal equipments) will be symmetrical (in the two transmission paths). The only dissymmetry will be due to presence of background noise in one of the test rooms.

3.2 Test arrangement

3.2.1 Description of the proposed testing system

This contribution describes a UMTS simulator for the characterization of the AMR speech codecs when the bitstream is transmitted over a PS network. The procedure to do the conversational listening test has been earlier described in [1].

Figure 1 describes the system that is going to be simulated:

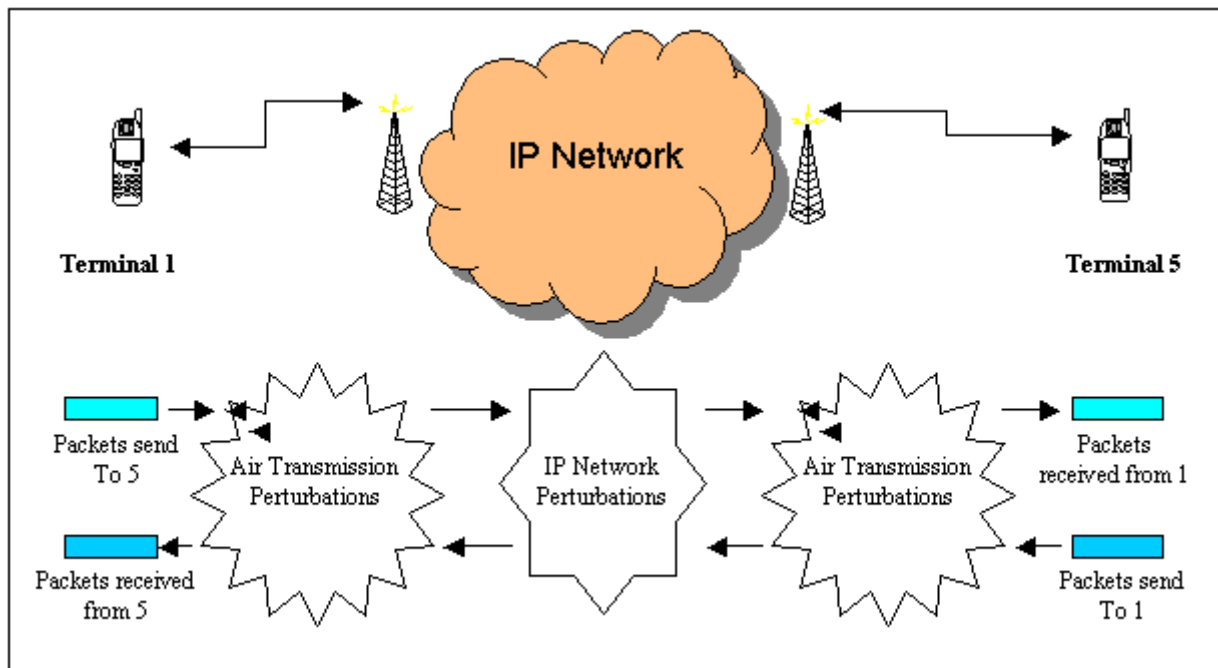

Figure 1: Packet switch audio communication simulator

This will be simulated using 5 PCs as shown in Figure 2.

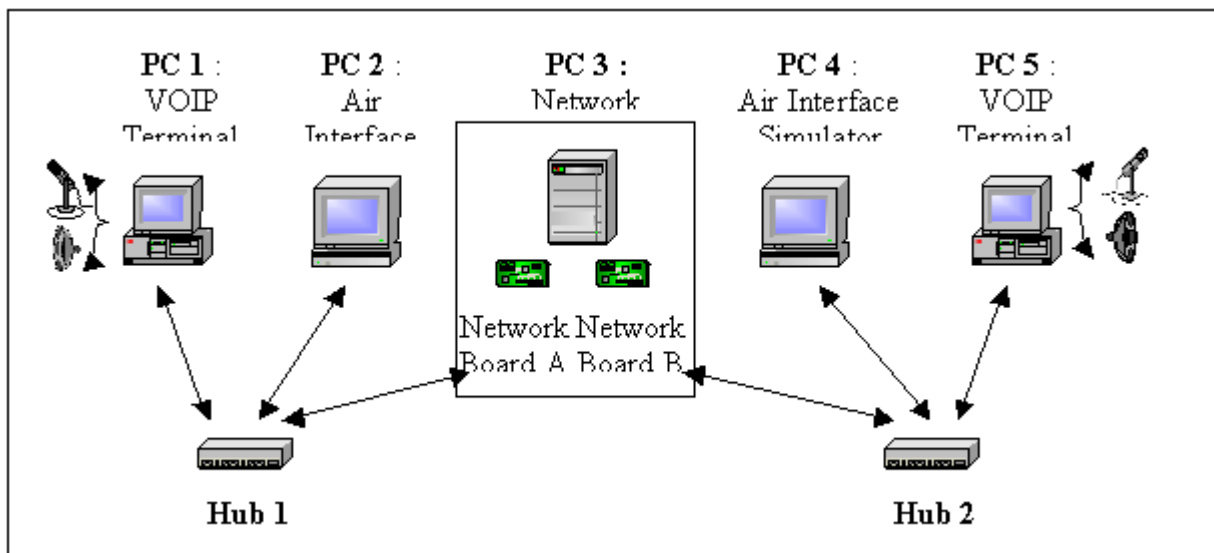

Figure 2: Simulation Platform

- PC 1 and PC 5: PCs under Windows OS with VOIP Terminal Simulator Software of France Telecom R&D.
- PC 2 and PC 4: PCs under Linux OS with Air Interface Simulator of Siemens AG.
- PC 3: PCs under WinNT OS with Network Simulator Software (NetDisturb).

Basic Principles:

The platform simulates a packet switch interactive communication between two users using PC1 and PC5 as their relatives VOIP terminals. PC1 sends AMR encoded packets that are encapsulated using IP/UDP/RTP headers to PC5. PC1 receives these IP/UDP/RTP audio packets from PC5.

In fact, the packets created in PC1 are sent to PC2. PC2 simulates the air interface Up Link transmission and then forwards the transmitted packets to PC4.

In the same way, PC4 simulates the air interface Down Link transmission and then forwards the packets to PC5. PC5 decodes and plays the speech back to the listener.

3.2.2 France Telecom Network simulator

The core network simulator, as implemented, works under IPv4.

However, as the core network simulator acts only on packets (loss, delay,...) the use of Ipv4 or Ipv6 is equivalent for this test conversation context. Considering the networks perturbations introduced by the simulator and the context of the interactive communications, the simulation using IPv4 perturbation network simulator is adapted to manage and simulate the behaviours of an IPv6 core network.

Figure 3 shows the possible parameters that can be modified.

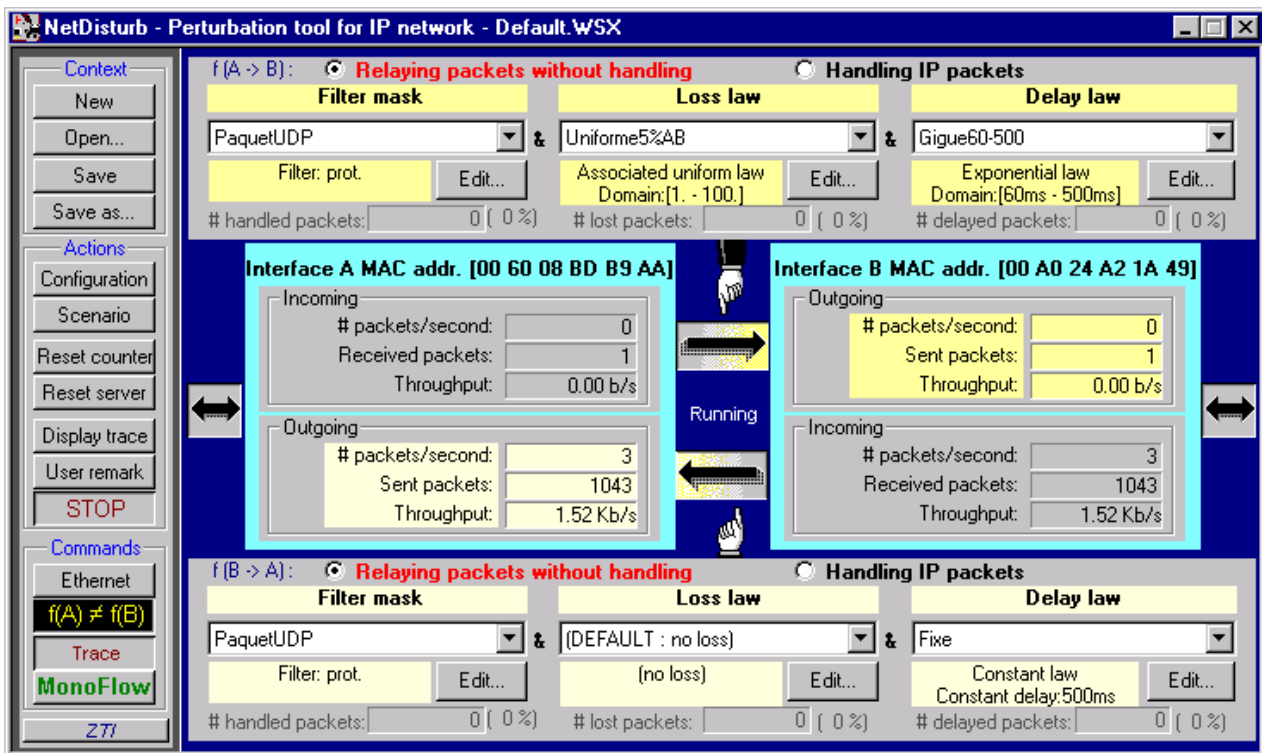

Figure 3: IP simulator interface

On both links, one can choose delay and loss laws. Both links can be treated separately or on the same way. For example, delay can be set to a fixed value but can also be set to another law such as exponential law.

3.2.3 UMTS simulator choices

The transmission of IP/UDP/RTP/AMR packets over the UMTS air interface is simulated using the RAB described in Section 3.2.3.1. The required functions of the RLC layer are implemented according to TS 25.322 and work in real-time. The underlying Physical Layer is simulated offline. Error patterns of block errors (i.e. discarded RLC PDUs) are inserted in the real-time simulation as described in Section 3.2.3.2. For more details on the parameter settings of the Physical Layer simulations see Section 3.2.3.3.

3.2.3.1 RAB and protocols

For our conversational tests, the AMR will encode speech at a maximum of 12.2 kbit/s. The bitstream will be encapsulated using IP/UDP/RTP protocols. The air interface simulator will receive IPv4 (or IPv6) packets from the CN simulator. The RTP packets will be extracted and before transmission over the air interface, IPv6 headers will be inserted. Finally real IPv6 packets are transmitted over the air interface simulator.

The payload Format should be the following:

- RTP Payload Format for AMR-NB (RFC 3267) will be used;
- Bandwidth efficient mode will be used;
- One speech frame shall be encapsulated in each RTP packet;
- Interleaving will not be used;

The payload header will then consist of the 4 bits of the CMR (Codec Mode Request). Then 6 bits is added for the ToC (Table of Content). For IPv4, this corresponds to a maximum of 72 bytes per frame that is to say 28.8 kbit/s, this goes up to 92 bytes (36.8 kbit/s) when using IPv6 protocol on the air interface.

RTCP packets will be sent. However, in the test conditions defined in the conversation test plans, RTCP is not mandatory, as it is not in a multicast environment (see IETF rfc 1889) we are not going to make use of the RTCP reports.

ROHC is an optional functionality in UMTS. In order to reduce the size of the tests and the number of condition ROHC algorithm will not be used for AMR-NB conversation test. This functionality will only be tested in the wideband condition. The Conversational / Speech / UL:42.8 DL:42.8 kbps / PS RAB RAB coming from TS 34.108 v4.7.0 will be used:

Here is the RAB description:

Higher layer	RAB/Signalling RB	RAB	
PDCP	PDCP header size, bit	8	
RLC	Logical channel type	DTCH	
	RLC mode	UM	
	Payload sizes, bit	920, 304, 96	
	Max data rate, bps	46000	
	UMD PDU header, bit	8	
MAC	MAC header, bit	0	
	MAC multiplexing	N/A	
Layer 1	TrCH type	DCH	
	TB sizes, bit	928, 312, 104	
	TFS	TF0, bits	0x928
		TF1, bits	1x104
		TF2, bits	1x312
		TF3, bits	1x928
	TTI, ms	20	
	Coding type	TC	
	CRC, bit	16	
	Max number of bits/TTI after channel coding	2844	
	Uplink: Max number of bits/radio frame before rate matching	1422	
RM attribute	180-220		

3.2.3.2 Description of the RLC implementation

The UMTS air interface simulator (PC 2 and 4) receives IP/UDP/RTP/AMR packets on a specified port of the network card (see Figure 4). The IP/UDP/RTP/AMR packets are given to the transmission buffer of the RLC layer, which works in UM. The RLC will segment or concatenate the IP bitstream in RLC PDUs, adding appropriate RLC headers (sequence number and length indicators). It is assumed that always Transport Format TF 3 is chosen on the physical layer, providing an RLC PDU length including header of 928 bits. In the regular case, one IP packet is placed into an RLC PDU that is filled up with padding bits. Due to delayed packets from the network simulator it may also occur that there are more than one IP packets in the RLC transmission buffer to transmit in the current TTI.

Each TTI of 20ms, an RLC PDU is formed. It is then given to the error insertion block that decides if the RLC PDU is transmitted successfully over the air interface or if it is discarded due to a block error after channel decoding. The physical layer will not be simulated in real time, but error pattern files will be provided. The error patterns of the air interface transmission will be simulated according to the settings given in Section 0. They consist of binary decisions for each transmitted RLC PDU, resulting in a certain BLER.

After the error pattern insertion, the RLC of the air interface receiver site receives RLC PDUs in the reception buffer. The sequence numbers of the RLC headers are checked to detect when RLC PDUs have been discarded due to block errors. A discarded RLC PDU will result in one or more lost IP packets, resulting in a certain packet loss rate of the IP packets and thereby in a certain FER of the AMR frames. The IP/UDP/RTP/AMR packets are reassembled and transmitted to the next PC. This PC is either the network simulator (PC 3) in case of uplink transmission, or it is one of the terminals (PC 1 or 5) in case of downlink transmission.

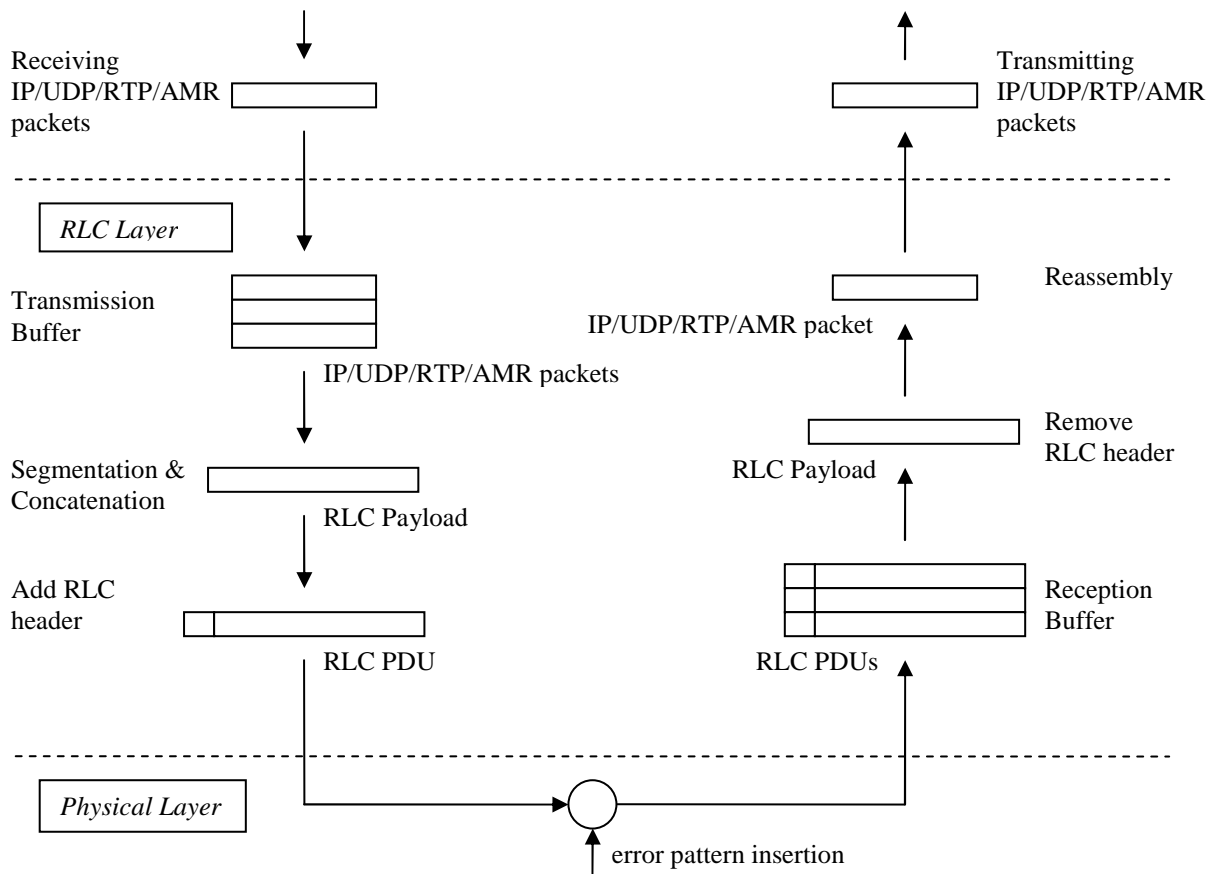

Figure 4: UMTS air interface simulation

3.2.3.3 Physical Layer Implementation

The parameters of the physical layer simulation were set according to the parameters for a DCH in multipath fading conditions given in TS 34.121 (downlink) and TS 25.141 (uplink). The TB size is 928 bits and the Turbo decoder uses the Log-MAP algorithm with 4 iterations. The rake receiver has 6 fingers at 60 possible positions.

The different channel conditions given in **Table 1**, **Table 2**, and **Table 3** were extracted from TR 101 112 (Selection procedures for the choice of radio transmission technologies of the UMTS) and also mentioned in the annex of the document S4-020680.

Tap	Channel A		Doppler Spectrum
	Rel. Delay (nsec)	Avg. Power (dB)	
1	0	0	FLAT
2	50	-3.0	FLAT
3	110	-10.0	FLAT
4	170	-18.0	FLAT
5	290	-26.0	FLAT
6	310	-32.0	FLAT

Table 1: Indoor Office Test Environment Tapped-Delay-Line Parameters

Tap	Channel A		Doppler Spectrum
	Rel. Delay (nsec)	Avg. Power (dB)	
1	0	0.0	CLASSIC
2	310	-1.0	CLASSIC
3	710	-9.0	CLASSIC
4	1090	-10.0	CLASSIC
5	1730	-15.0	CLASSIC
6	2510	-20.0	CLASSIC

Table 2: Vehicular Test Environment, High Antenna, Tapped-Delay-Line Parameters

Tap	Channel A		Doppler Spectrum
	Rel. Delay (nsec)	Avg. Power (dB)	
1	0	0	CLASSIC
2	110	-9.7	CLASSIC
3	190	-19.2	CLASSIC
4	410	-22.8	CLASSIC
5	-	-	CLASSIC
6	-	-	CLASSIC

Table 3: Outdoor to Indoor and Pedestrian Test Environment Tapped-Delay-Line Parameters

Table 4 (DL) and **Table 5** (UL) show approximate results of the air interface simulation for $\frac{DPCH - E_c}{I_{or}}$ and E_b/N_0 corresponding to the considered BLERs.

Channel	BLER			
	$5 \cdot 10^{-2}$	$1 \cdot 10^{-2}$	$1 \cdot 10^{-3}$	$5 \cdot 10^{-4}$
Indoor, 3 km/h ($\hat{I}_{or}/I_{oc} = 9$ dB)	-13.1 dB	-8.9 dB	-3.4 dB	-2.4 dB
Outdoor to Indoor, 3 km/h ($\hat{I}_{or}/I_{oc} = 9$ dB)	-13.2 dB	-9.7 dB	-5.9 dB	-5.2 dB
Vehicular, 50 km/h ($\hat{I}_{or}/I_{oc} = -3$ dB)	-9.35 dB	-8.2 dB	-6.9 dB	-6.55 dB
Vehicular, 120 km/h ($\hat{I}_{or}/I_{oc} = -3$ dB)	-9.7 dB	-8.95 dB	-7.95 dB	-7.55 dB

Table 4: Downlink performance - approximately $\frac{DPCH - E_c}{I_{or}}$ for the different channels and BLER

Channel	BLER			
	$5 \cdot 10^{-2}$	$1 \cdot 10^{-2}$	$1 \cdot 10^{-3}$	$5 \cdot 10^{-4}$
Indoor, 3 km/h	3.9 dB	6.4 dB	9.2 dB	9.8 dB
Outdoor to Indoor, 3 km/h	3.7 dB	6.1 dB	8.6 dB	9.2 dB
Vehicular, 50 km/h	-0.9 dB	-0.15 dB	0.55 dB	0.75 dB
Vehicular, 120 km/h	0.2 dB	0.6 dB	1.1 dB	1.3 dB

Table 5: Uplink performance - approximately E_b/N_0 for the different channels and BLER

3.2.4 Headsets and Sound Card

To avoid echo problems, it has been decided to use headsets, instead of handsets. The monaural headsets are connected to the sound cards of the PCs supporting the AMR simulators.

The sound level in the earphones can be adjusted, if needed, by the users. But, in practice, the original settings, defined during the preliminary tests, and producing a comfortable listening level, will not be modified. The microphones are protected by a foam ball in order to reduce the "pop" effect. It is also suggested to the user to avoid to place the acoustic opening of the microphone in front of the mouth.

3.2.5 Test environment

Each of the two subjects participating to the conversations is installed in a test room. They sit on an armchair, in front of a table. The test rooms are acoustically insulated. All the test equipments are installed in a third room, connected to the test rooms. When needed, the background noise is generated in the appropriate test room through a set of 4 loudspeakers. The background noise level is adjusted and controlled by a sound level meter. The measurement microphone, connected to the Sound level meter is located at the equivalent of the center of the subject's head. The noise level is A weighted.

3.2.6 Calibration and test conditions monitoring

Speech level

Before the beginning of a set of experiment, the end to end transmission level is checked subjectively, to ensure that there is no problem. If it is necessary to check the speech level following procedure will apply. An artificial mouth placed in front of the microphone of the Headset A, in the LRGP position -See ITU-T Rec. P.64-, generates in the artificial ear (according to ITU-T Rec. P57) coupled to the earphone of the Head set B the nominal level defined in section 4.3. If necessary, the level is adjusted with the receiving volume control of the headset. The similar calibration is done by inverting headsets A and B.

Delay

The overall delay (from the input of sound card A to the output of sound card B) will be evaluated for each test condition.

The hypothetical delay is calculated as shown :

On the air interface side, the simulator only receives packets on its network card, process them and transmits every 20 ms these packets to the following PC. Only processing delay and a possible delay due to a jitter can be added (a packet arrives just after the sending window of the air interface).

The hypothetical delay is calculated as shown :

On encoder side, delay have to take into account framing, look-ahead, processing and packetization: 45ms

Uplink delay between UE and Iu: 84.4 ms (see TR25.853)

Core network delay: a few ms

Routing through IP: depending on the number of routers.

Downlink delay between Iu and Ue: 71.8 ms (see TR25.853)

And delay on decoder side, taking into account jitter buffer, de-packetization and processing, 40 ms

The total delay to be considered is at least: 241.2 ms

3.3 Test Conditions

Based on circuit switched testing experiments, SA4 expects AMR 4.75 kb/s to provide insufficient quality for conversational applications. SA4 does not recommend testing AMR 4.75kb/s, this mode is considered as fall back solution in case of poor radio conditions.

Condition	Additional Background noise	Additional Background noise	Experimental actors		
	Room A	Room B	Radio conditions	IP conditions (Packet loss ratio)	Mode + delay
1	No	No	10^{-2}	0%	6,7kbit/s (delay 300 ms)
2	No	No	10^{-2}	0%	12.2 kbit/s (delay 500 ms)

Condition	Additional Background noise		Experimental actors		
	Room A	Room B	Radio conditions	IP conditions (Packet loss ratio)	Mode + delay
3	No	No	10^{-2}	0%	12,2 kbit/s (delay 300 ms)
4	No	No	10^{-2}	3%	6,7kbit/s (delay 300 ms)
5	No	No	10^{-2}	3%	12.2kbit/s(delay 500 ms)
6	No	No	10^{-2}	3%	12,2 kbit/s (delay 300 ms)
7	No	No	10^{-3}	0%	6,7kbit/s (delay 300 ms)
8	No	No	10^{-3}	0%	12.2kbit/s(delay 500 ms)
9	No	No	10^{-3}	0%	12,2 kbit/s (delay 300 ms)
10	No	No	10^{-3}	3%	6,7kbit/s (delay 300 ms)
11	No	No	10^{-3}	3%	12.2kbit/s(delay 500 ms)
12	No	No	10^{-3}	3%	12,2 kbit/s (delay 300 ms)
13	No	No	$5 \cdot 10^{-4}$	0%	6,7kbit/s (delay 300 ms)
14	No	No	$5 \cdot 10^{-4}$	0%	12.2kbit/s(delay 500 ms)
15	No	No	$5 \cdot 10^{-4}$	0%	12,2 kbit/s (delay 300 ms)
16	No	No	$5 \cdot 10^{-4}$	3%	6,7kbit/s (delay 300 ms)
17	No	No	$5 \cdot 10^{-4}$	3%	12.ékbit/s(delay 500 ms)
18	No	No	$5 \cdot 10^{-4}$	3%	12,2 kbit/s (delay 300 ms)
19	Car	No	$5 \cdot 10^{-4}$	3%	12,2 kbit/s (delay 300 ms)
20	No	Car	$5 \cdot 10^{-4}$	3%	12,2 kbit/s (delay 300 ms)
21	Cafeteria	No	$5 \cdot 10^{-4}$	0%	6,7 kbit/s (delay 300 ms)
22	No	Cafeteria	$5 \cdot 10^{-4}$	0%	6,7 kbit/s (delay 300 ms)
23	Street	No	$5 \cdot 10^{-4}$	0%	12.2kbit/s(delay 500 ms)
24	No	Street	$5 \cdot 10^{-4}$	0%	12.2kbit/s(delay 500 ms)

Noise types

Noise type	Level (dB Pa A)
Car	60
Street	55
Babble	50

Listening Level	1	79 dBSPL
Listeners	32	Naïve Listeners
Groups	16	2 subjects/group
Rating Scales	5	
Languages	1	See table
Listening System	1	Monaural headset (flat response in the audio bandwidth of interest: 50Hz-7kHz). The other ear is open.
Listening Environment		Room Noise: Hoth Spectrum at 30dBA (as defined by ITU-T, Recommendation P.800, Annex A, section A.1.1.2.2.1 Room Noise, with table A.1 and Figure A.1), except when background noise is needed (see table)

Annex A Example Instructions for the conversation test**Table :** Instructions to subjects.

INSTRUCTIONS TO SUBJECTS				
<p>In this experiment we are evaluating systems that might be used for telecommunication services. You are going to have a conversation with another user. The test situation is simulating communications between two mobile phones. The most of the situations will correspond to silent environment conditions, but some other will simulate more specific situations, as in a car, or in a railway station or in an office environment, when other people are discussing in the background.</p> <p>After the completion of each call conversation, you will have to give your opinions on the quality, by answering to the following questions that will be displayed on the screen of the black box in front of you. Your judgment will be stored. You have 8 seconds to answer to each question. After "pressing" the button on the screen, another question will be displayed. You continue the procedure for the 5 following questions.</p>				
Question 1: How do you judge the quality of the voice of your partner?				
Excellent	Good	Fair	Poor	Bad
Question 2: Do you have difficulties to understand some words?				
All the time	Often	Some time to time	Rarely	Never
Question 3: How did you judge the conversation when you interacted with your partner?				
Excellent interactivity (similar to face-to-face situation)	Good interactivity (in few moments, you were talking simultaneously, and you had to interrupt yourself)	Fair interactivity (sometimes, you were talking simultaneously, and you had to interrupt yourself)	Poor interactivity (often, you were talking simultaneously, and you had to interrupt yourself)	Bad interactivity (it was impossible to have an interactive conversation)
Question 4: Did you perceive any impairment (noises, cuts,...)? In that case, was it:				
No impairment	Slight impairment, but not disturbing	Impairment slightly disturbing	Impairment disturbing	Very disturbing Impairment
Question 5: How do you judge the global quality of the communication?				
Excellent	Good	Fair	Poor	Bad
<p>From then on you will have a break approximately every 30 minutes. The test will last a total of approximately 60 minutes.</p> <p>Please do not discuss your opinions with other listeners participating in the experiment.</p>				

Annex B: Example Scenarios for the conversation test

The pretexts used for conversation test are those developed by the Ruhr University (Bochum, Germany) within the context of ITU-T SG12 . These scenarios have been elaborated to allow a conversation well balanced within both participants and lasting approximately 2'30 or 3', and to stimulate the discussion between persons that know each other to facilitate the naturalness of the conversation. They are derived from typical situations of every day life: railways inquiries, rent a car or an apartment, etc. Each condition should be given a different scenario.

Examples coming from ITU-T SG 12 COM12-35 "Development of scenarios for short conversation test", 1997

- Scenario 1 : Pizza service

Subject 1:

Your Name :	Clemence
Reason for the call	1 large Pizza
Condition which should be applied to the exchange of information	For 2 people, Vegetarian pizza preferred
Information you want to receive from your partner	Topping Price
Information that your partner requires	Delivery address : 41 industry street,Oxford Phone : 7 34 20
Question to which neither you nor your partner will have information. You should discuss and find a solution that is acceptable to both of you.	How long will it take?

Subject 2:

Your Name :	Pizzeria Roma																							
Information from which you should select the details which your partner requires	<table border="1"> <thead> <tr> <th>Pizzas</th> <th>1 person</th> <th>2 persons</th> <th>4 persons</th> </tr> </thead> <tbody> <tr> <td>Toscana (ham, mushrooms, tomatoes,cheese)</td> <td>3.2£</td> <td>5.95£</td> <td>10.5£</td> </tr> <tr> <td>Tonno (Tuna, onions, tomatoes, cheese)</td> <td>3.95£</td> <td>7.5£</td> <td>13.95£</td> </tr> <tr> <td>Fabrizio (salami, ham, tomatoes, heese)</td> <td>4.2£</td> <td>7.95£</td> <td>14.95£</td> </tr> <tr> <td>Vegetaria (spinach, mushrooms, tomatoes,cheese)</td> <td>4.5£</td> <td>8.5£</td> <td>15.95£</td> </tr> </tbody> </table>				Pizzas	1 person	2 persons	4 persons	Toscana (ham, mushrooms, tomatoes,cheese)	3.2£	5.95£	10.5£	Tonno (Tuna, onions, tomatoes, cheese)	3.95£	7.5£	13.95£	Fabrizio (salami, ham, tomatoes, heese)	4.2£	7.95£	14.95£	Vegetaria (spinach, mushrooms, tomatoes,cheese)	4.5£	8.5£	15.95£
Pizzas	1 person	2 persons	4 persons																					
Toscana (ham, mushrooms, tomatoes,cheese)	3.2£	5.95£	10.5£																					
Tonno (Tuna, onions, tomatoes, cheese)	3.95£	7.5£	13.95£																					
Fabrizio (salami, ham, tomatoes, heese)	4.2£	7.95£	14.95£																					
Vegetaria (spinach, mushrooms, tomatoes,cheese)	4.5£	8.5£	15.95£																					
Information you want to receive from your partner	Name address telephone number																							
Question to which neither you nor your partner will have information. You should discuss and find a solution that is acceptable to both of you.																								

- Scenario 2 : Information on flights

Subject 1:

Your Name :	Parker
Reason for the call	Intended journey: London Heathrow → Düsseldorf
Condition which should be applied to the exchange of information	On June 23th, Morning flight, Direct flight preferred
Information you want to receive from your partner	Departure : Arrival Flight number
Information that your partner requires	Reservation : 1 seat, Economy class Address: 66 middle street, Sheffield Phone: 21 08 33
Question to which neither you nor your partner will have information. You should discuss and find a solution that is acceptable to both of you.	From which airport is it easier to get into Cologne center : Düsseldorf or Cologne/Bonn

Subject 2:

Your Name :	Heathrow flight information			
Information from which you should select the details which your partner requires	Flight schedule	Lufthansa	British Airways	Lufthansa
	Flight number	LH 2615	BA 381	LH 413
	London Heathrow departure	6:30	6:35	8:20
	Brussels arrival		7:35	
	Brussels departure		8:00	
	Düsseldorf arrival	7:35	9:05	9:25
Information you want to receive from your partner	Name address telephone number number of seats Class : Business or Economy			
Question to which neither you nor your partner will have information. You should discuss and find a solution that is acceptable to both of you.				

ITU-T SG 12 COM12-35 "Development of scenarios for short conversation test", 1997

Annex C: Results to be provided

For contractual purposes, the information which needs to be provided is defined here.

The information required from each test Laboratory is a table containing the following information for each of the conditions in the experiment:

The "Mean Opinion Score (MOS)" obtained for all the subjects.

When the conditions are symmetrical, the mean value is calculated from all the result for the two test rooms..

For the dissymmetric conditions, the mean is calculated on the two test conditions, each result cumulating the results obtained in each condition of background noise.

The Standard Deviation of the "MOS" obtained for all the subjects, for each test condition.

The specific statistical comparisons are specified in Annex C.

Annex D: Data analysis and presentation of results

D.1 Calculation of MOS and Standard Deviation

The (overall) MOS/DMOS for confounded subjects for condition C (Y_c) can then be obtained from:

$$Y_c = \frac{1}{T} \sum_{t=1}^T Y_{c,t}$$

The standard deviation (S) for condition C, denoted as S_c , can be calculated as:

$$S_c = \sqrt{\frac{1}{L \times T - 1} \sum_{t=1}^T \sum_{l=1}^L (X_{c,l,t} - Y_c)^2}$$

Finally, the confidence interval (CI) at the $(1-\alpha)$ level can be calculated for $N = L \times T$ as:

$$CI_c = (t_{1-\alpha, N-1}) \frac{S_c}{\sqrt{N}}$$

D.2 Presentation of Basic Statistical Results

The test results should be reported by the test Laboratory and the Global Analysis Laboratory as follows:

Calculate and tabulate "Mean Opinion Scores" for the (opinion scales, Standard Deviations and Confidence Intervals as shown in Table E.1.

Table C.1 - Layout for presentation of test results.

D.3 Thorough analysis

Two statistical analyses should be conducted on the data obtained with these subjective scales. The first analysis consists in a Multiple ANalysis OF VAriance (MANOVA), which globally indicates the possible effect of the experimental factors (*i.e.*, different conditions). Then, a specific ANOVA should be run on each dependent variable (the five scales) to test if there is an effect of a specific experimental factor for a given subjective variable. In other words, these statistical analyses indicate if the differences observed between the MOS obtained for the different conditions are significant, for one given dependant variable (ANOVA) or for the whole of dependant variables (MANOVA). Finally, Pearson's linear correlations should be computed between the results of all subjective variables, to see which are those preponderant or dependent on others.

Annex E: Test Plan for the AMR Wide-Band Packet Switched Conversation Test

Source:	Siemens¹, France Telecom²
Title:	Test Plan for the AMR Wide-Band Packet Switched Conversation Test
Document for:	Approval
Agenda Item:	14.1

1. Introduction

This document contains the test plan of a conversation test for the Adaptive Multi-Rate Wide-Band (AMR-WB) in Packet Switched network.

All the laboratories participating to this conversation test phase will use the same test plan just the language of the conversation would change.

Even if the test rooms or the test equipments are not exactly the same in all the laboratories, the calibration procedures and the tests equipment characteristics and performance (as defined in this document) will guarantee the similarity of the test conditions.

Section 2 gives references, conventions and contacts, section 3 details the test methodology, including test arrangement and test procedure, and section 4 defines the financial considerations.

1 contact: ImreVarga

Imre.Varga @siemens.com

Tel: +49 89 722 47537

Siemens AG, ICM MP

Grillparzerstrasse 10a, 81675 Munich, Germany

2 contacts:

Catherine Quinquis Catherine.quinquis@francetelecom.com Tel: +33 2 96 05 14 93 France Telecom T&I/R&D 2 avenue Pierre Marzin, 22397 Lannion, France	Jean-Yves Monfort Jeanyves.monfort@francetelecom.com Tel : +33296053171 France Telecom T&I/R&D 2 avenue Pierre Marzin, 22397 Lannion, France
--	--

Annex A contains the instructions for the subjects participating to the conversation tests.

Annex B contains the description of results to be provided to the Analysis Laboratory (if any) by the testing laboratories.

Annex C contains the list of statistical comparisons to be performed.

Considerations about IPV6 versus IPV4 are given in section 3.2.

RoHC is implemented for AMR-WB conversation test, but only for the AMR-WB mode at 12,65 kbit/s

2. References, Conventions, and Contacts

2.1 Permanent Documents

ITU-T Rec.P.800	Methods for Subjective Determination of Transmission Quality	
ITU-T Rec. P.831	Subjective performance evaluation of network echo cancellers	This Recommendation defines conversation test procedures based on handset telephones, and gives inputs for the calibration.

2.2 Key Acronyms

AMR-NB	Adaptive Multi-Rate Narrowband Speech Codec
AMR WB	Adaptive Multi-Rate Wide-band Speech Codec
MOS	Mean Opinion Score

2.3 Contact Names

The following persons should be contacted for questions related to the test plan.

Section	Contact Person/Email	Organisation	Address	Telephone/Fax
Experiments and results analysis	J-Y Monfort	France Telecom R&D	2, Avenue P. Marzin, 22307 Lannion Cédex France	Tel : +33296053171 Fax : +33296051316
AOB	Paolo Usai paolo.usai@etsi.fr	ETSI MCC	650 Route des Lucioles 06921 Sophia Antipolis Cedex France	Tel: 33 (0)4 92 94 42 36 Fax: 33 (0)4 93 65 28 17

2.4 Responsibilities

Each test laboratory has the responsibility to organize its conversation tests.

The list of Test laboratories participating to the conversation test phase.

Lab	Company	Language	Statistical analysis	Reporting
1	Lab1			
2	Lab2			

3. Test methodology

3.1 Introduction

The protocol described below evaluates the effect of degradation such as delay and dropped packets on the quality of the communications. It corresponds to the conversation-opinion tests recommended by the ITU-T P.800 [1]. First of all, conversation-opinion tests allow subjects passing the test to be in a more realistic situation, close to the actual service conditions experienced by telephone customers. In addition, conversation-opinion tests are suited to assess the effects of impairments that can cause difficulty while conversing (such as delay).

Subjects participate to the test by couple; they are seated in separate sound-proof rooms and are asked to hold a conversation through the transmission chain of the UMTS simulator. Communications are impaired by means of an IP impairments simulator simulator part of the CN simulator and by the air interface simulator, as the figure below describes it.

The network configurations (including the terminal equipments) will be symmetrical (in the two transmission paths). The only dissymmetry will be due to presence of background noise in one of the test rooms.

3.2 Test arrangement

3.2.1 Description of the proposed testing system

This contribution describes a UMTS simulator for the characterization of the AMR speech codecs when the bitstream is transmitted over a PS network. The procedure to do the conversational listening test has been earlier described in [1].

Figure 1 describes the system that is going to be simulated:

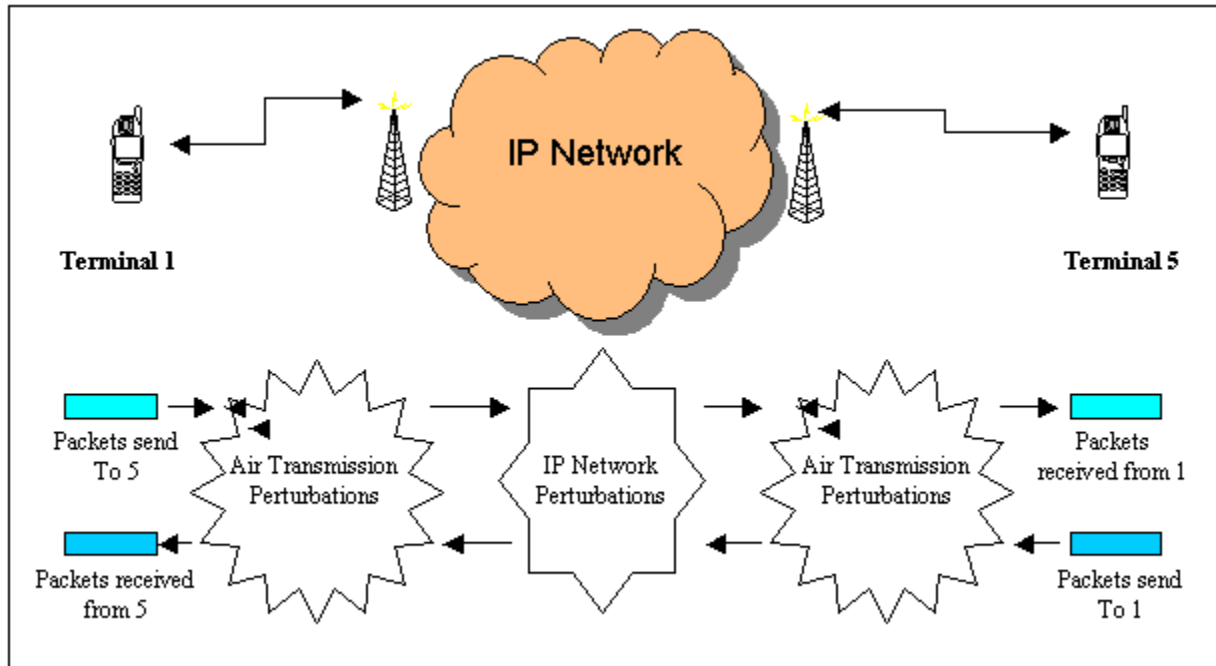

Figure 1: Packet switch audio communication simulator

This will be simulated using 5 PCs as shown in Figure 2.

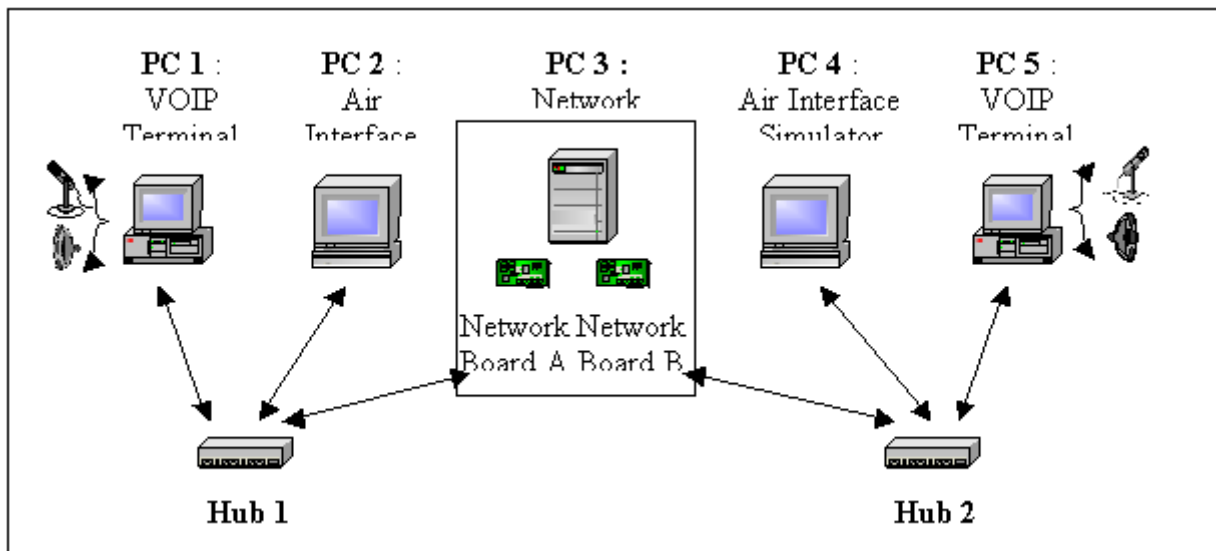

Figure 2: Simulation Platform

- PC 1 and PC 5: PCs under Windows OS with VOIP Terminal Simulator Software of France Telecom R&D.
- PC 2 and PC 4: PCs under Linux OS with Air Interface Simulator of Siemens AG.
- PC 3: PCs under WinNT OS with Network Simulator Software (NetDisturb).

Basic Principles :

The platform simulates a packet switch interactive communication between two users using PC1 and PC5 as their relatives VOIP terminals. PC1 sends AMR encoded packets that are encapsulated using IP/UDP/RTP headers to PC5. PC1 receives these IP/UDP/RTP audio packets from PC5.

In fact, the packets created in PC1 are sent to PC2. PC2 simulates the air interface Up Link transmission and then forwards the transmitted packets to PC4.

In the same way, PC4 simulates the air interface Down Link transmission and then forwards the packets to PC5. PC5 decodes and plays the speech back to the listener.

3.2.2 France Telecom Network simulator

The core network simulator, as implemented, works under IPv4.

However, as the core network simulator acts only on packets (loss, delay,...) the use of IPv4 or IPv6 is equivalent for this test conversation context. Considering the networks perturbations introduced by the simulator and the context of the interactive communications, the simulation using IPv4 perturbation network simulator is adapted to manage and simulate the behaviours of an IPv6 core network.

. Figure 3 shows the possible parameters that can be modified.

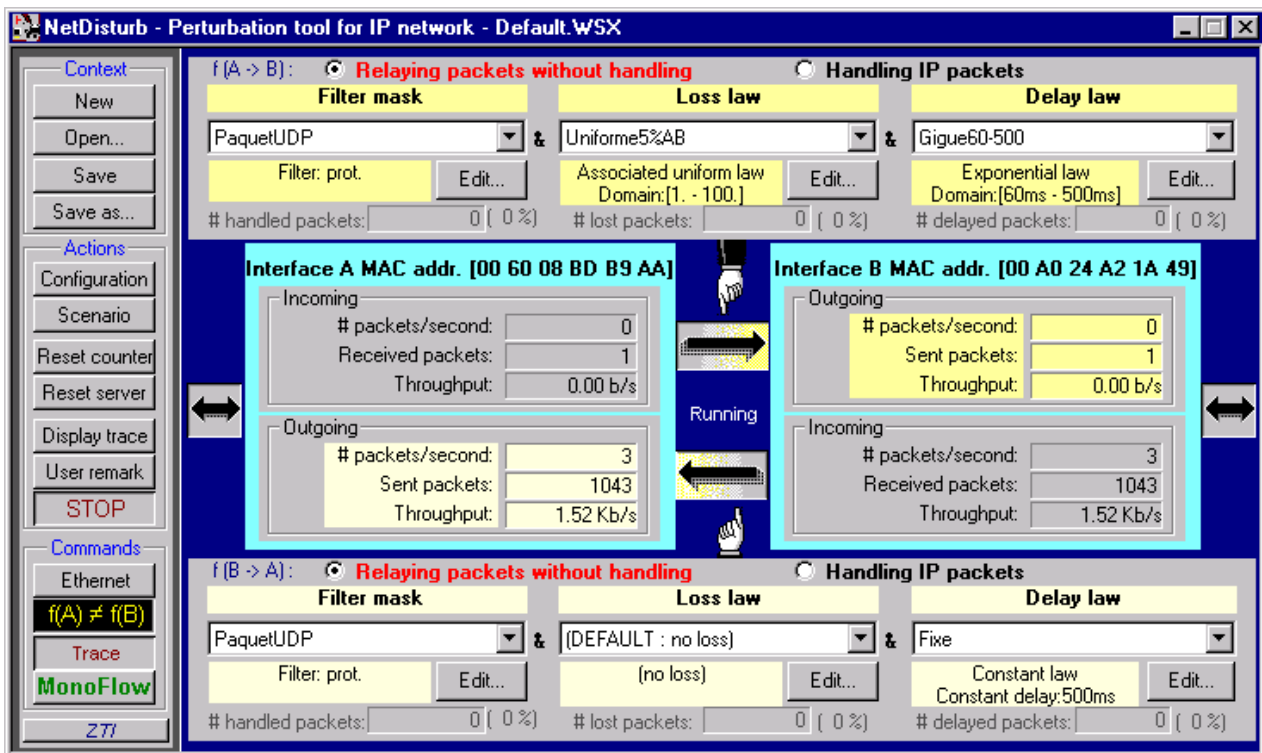

Figure 3: IP simulator interface

On both links, one can choose delay and loss laws. Both links can be treated separately or on the same way. For example, delay can be set to a fixed value but can also be set to another law such as exponential law.

3.2.3 UMTS simulator choices

The transmission of IP/UDP/RTP/AMR packets over the UMTS air interface is simulated using the RAB described in Section 3.2.3.1. The required functions of the RLC layer are implemented according to TS 25.322 and work in real-time. The underlying Physical Layer is simulated offline. Error patterns of block errors (i.e. discarded RLC PDUs) are inserted in the real-time simulation as described in Section 3.2.3.2. For more details on the parameter settings of the Physical Layer simulations see Section 3.2.3.3.

3.2.3.1 RAB and protocols

For our conversational tests, the AMR-WB will encode speech at a maximum of 15.85 kbit/s. The bitstream will be encapsulated using IP/UDP/RTP protocols. The air interface simulator will receive IPv4 packets from the IP network simulator. The RTP packets will be extracted and before transmission over the air interface, IPv6 headers will be inserted. Then a new IP/UDP/RTP packet will be transmitted through the air interface simulator.

The payload Format should be the following:

- RTP Payload Format for AMR-WB (RFC 3267) will be used;
- Bandwidth efficient mode will be used;
- One speech frame shall be encapsulated in each RTP packet;
- Interleaving will not be used;

The payload header will then consist of the 4 bits of the CMR (Codec Mode Request). Then 6 bits are added for the ToC (Table of Content). For IPv4 a maximum of 81 bytes (41 bytes for the AMR and its payload header plus the 40 bytes of the IP/UDP/RTP headers) per frame will be transmitted that is to say 32.4 kbit/s, this will go up to 101 bytes (40.4 kbit/s) when using IPv6 protocol on the air interface.

ROHC algorithm will be supported for AMR-WB conversation test, for the 12.65 kbit/s mode and the 15.85 mode. Header compression will be done on the IP/UDP/RTP headers. ROHC will start in the unidirectional mode and switch to bidirectional mode as soon as a packet has reached the decompressor and it has replied with a feedback packet indicating that a mode transition is desired.

The Conversational / Speech / UL:42.8 DL:42.8 kbps / PS RAB RAB coming from TS 34.108 v4.7.0 will be used:

Here is the RAB description:

Higher layer	RAB/Signalling RB	RAB	
PDCP	PDCP header size, bit	8	
RLC	Logical channel type	DTCH	
	RLC mode	UM	
	Payload sizes, bit	920, 304, 96	
	Max data rate, bps	46000	
	UMD PDU header, bit	8	
MAC	MAC header, bit	0	
	MAC multiplexing	N/A	
Layer 1	TrCH type	DCH	
	TB sizes, bit	928, 312, 104	
	TFS	TF0, bits	0x928
		TF1, bits	1x104
		TF2, bits	1x312
		TF3, bits	1x928
	TTI, ms	20	
	Coding type	TC	
	CRC, bit	16	
	Max number of bits/TTI after channel coding	2844	
Uplink: Max number of bits/radio frame before rate matching	1422		
RM attribute	180-220		

3.2.3.2 Description of the RLC implementation

The UMTS air interface simulator (PC 2 and 4) receives IP/UDP/RTP/AMR packets on a specified port of the network card (see Figure 4). The IP/UDP/RTP/AMR packets are given to the transmission buffer of the RLC layer, which works in UM. The RLC will segment or concatenate the IP bitstream in RLC PDUs, adding appropriate RLC headers (sequence number and length indicators). It is assumed that always Transport Format TF 3 is chosen on the physical layer, providing an RLC PDU length including header of 928 bits. In the regular case, one IP packet is placed into an RLC PDU that is filled up with padding bits. Due to delayed packets from the network simulator it may also occur that there are more than one IP packets in the RLC transmission buffer to transmit in the current TTI.

Each TTI of 20ms, an RLC PDU is formed. It is then given to the error insertion block that decides if the RLC PDU is transmitted successfully over the air interface or if it is discarded due to a block error after channel decoding. The physical layer will not be simulated in real time, but error pattern files will be provided. The error patterns of the air interface transmission will be simulated according to the settings given in Section 0. They consist of binary decisions for each transmitted RLC PDU, resulting in a certain BLER.

After the error pattern insertion, the RLC of the air interface receiver site receives RLC PDUs in the reception buffer. The sequence numbers of the RLC headers are checked to detect when RLC PDUs have been discarded due to block errors. A discarded RLC PDU will result in one or more lost IP packets, resulting in a certain packet loss rate of the IP packets and thereby in a certain FER of the AMR frames. The IP/UDP/RTP/AMR packets are reassembled and transmitted to the next PC. This PC is either the network simulator (PC 3) in case of uplink transmission, or it is one of the terminals (PC 1 or 5) in case of downlink transmission.

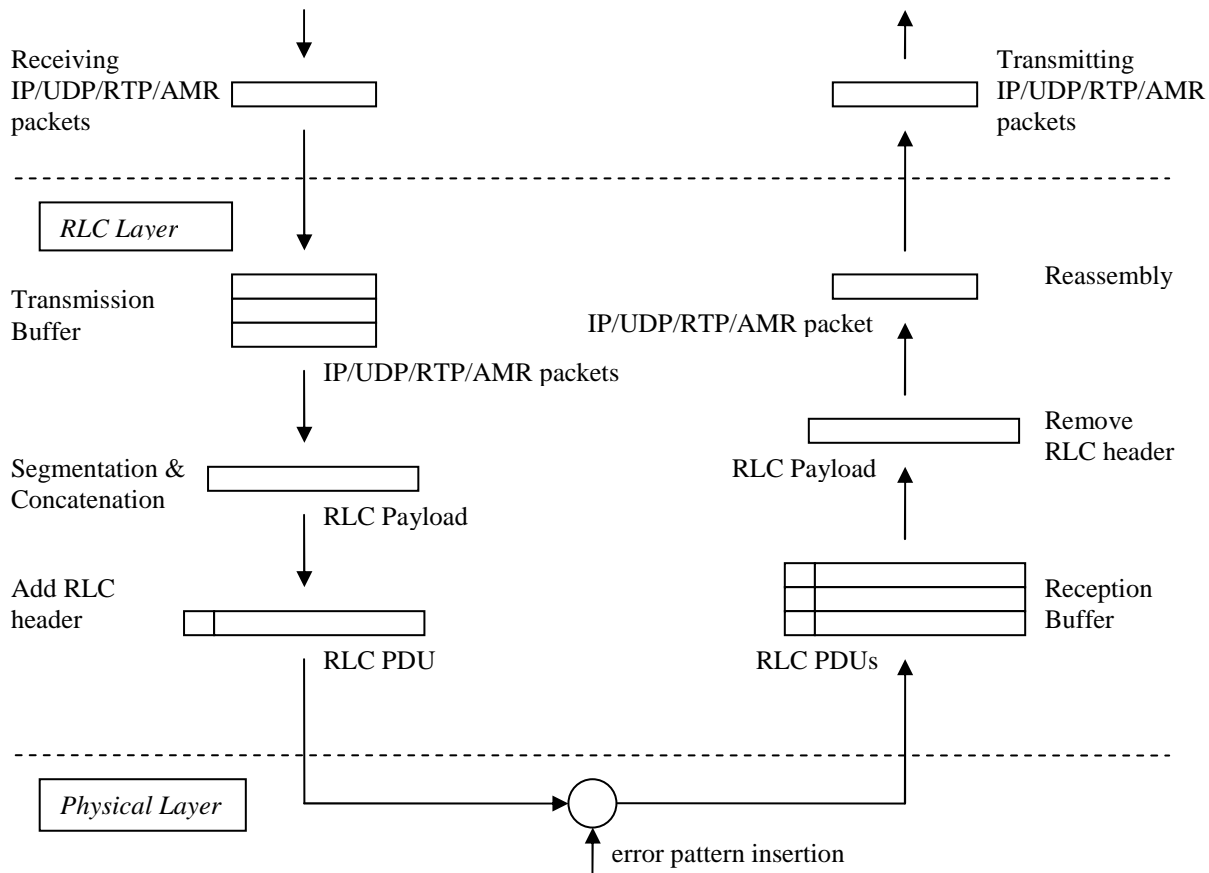

Figure 4: UMTS air interface simulation

3.2.3.3 Physical Layer Implementation

The parameters of the physical layer simulation were set according to the parameters for a DCH in multipath fading conditions given in TS 34.121 (downlink) and TS 25.141 (uplink). The TB size is 928 bits and the Turbo decoder uses the Log-MAP algorithm with 4 iterations. The rake receiver has 6 fingers at 60 possible positions.

The different channel conditions given in **Table 1**, **Table 2**, and **Table 3** were extracted from TR 101 112 (Selection procedures for the choice of radio transmission technologies of the UMTS) and also mentioned in the annex of the document S4-020680.

Tap	Channel A		Doppler Spectrum
	Rel. Delay (nsec)	Avg. Power (dB)	
1	0	0	FLAT
2	50	-3.0	FLAT
3	110	-10.0	FLAT
4	170	-18.0	FLAT
5	290	-26.0	FLAT
6	310	-32.0	FLAT

Table 1: Indoor Office Test Environment Tapped-Delay-Line Parameters

Tap	Channel A		Doppler Spectrum
	Rel. Delay (nsec)	Avg. Power (dB)	
1	0	0.0	CLASSIC
2	310	-1.0	CLASSIC
3	710	-9.0	CLASSIC
4	1090	-10.0	CLASSIC
5	1730	-15.0	CLASSIC
6	2510	-20.0	CLASSIC

Table 2: Vehicular Test Environment, High Antenna, Tapped-Delay-Line Parameters

Tap	Channel A		Doppler Spectrum
	Rel. Delay (nsec)	Avg. Power (dB)	
1	0	0	CLASSIC
2	110	-9.7	CLASSIC
3	190	-19.2	CLASSIC
4	410	-22.8	CLASSIC
5	-	-	CLASSIC
6	-	-	CLASSIC

Table 3: Outdoor to Indoor and Pedestrian Test Environment Tapped-Delay-Line Parameters

Table 4 (DL) and **Table 5** (UL) show approximate results of the air interface simulation for $\frac{DPCH - E_c}{I_{or}}$ and E_b/N_0 corresponding to the considered BLERs.

Channel	BLER			
	$5*10^{-2}$	$1*10^{-2}$	$1*10^{-3}$	$5*10^{-4}$
Indoor, 3 km/h ($\hat{I}_{or}/I_{oc} = 9$ dB)	-13.1 dB	-8.9 dB	-3.4 dB	-2.4 dB
Outdoor to Indoor, 3 km/h ($\hat{I}_{or}/I_{oc} = 9$ dB)	-13.2 dB	-9.7 dB	-5.9 dB	-5.2 dB
Vehicular, 50 km/h ($\hat{I}_{or}/I_{oc} = -3$ dB)	-9.35 dB	-8.2 dB	-6.9 dB	-6.55 dB
Vehicular, 120 km/h ($\hat{I}_{or}/I_{oc} = -3$ dB)	-9.7 dB	-8.95 dB	-7.95 dB	-7.55 dB

Table 4: Downlink performance - approximately $\frac{DPCH - E_c}{I_{or}}$ for the different channels and BLER

Channel	BLER			
	$5*10^{-2}$	$1*10^{-2}$	$1*10^{-3}$	$5*10^{-4}$
Indoor, 3 km/h	3.9 dB	6.4 dB	9.2 dB	9.8 dB
Outdoor to Indoor, 3 km/h	3.7 dB	6.1 dB	8.6 dB	9.2 dB
Vehicular, 50 km/h	-0.9 dB	-0.15 dB	0.55 dB	0.75 dB
Vehicular, 120 km/h	0.2 dB	0.6 dB	1.1 dB	1.3 dB

Table 5: Uplink performance - approximately E_b/N_0 for the different channels and BLER

3.2.4 Headsets and Sound Card

To avoid echo problems, it has been decided to use headsets, instead of handsets. The monaural headsets are connected to the sound cards of the PCs supporting the AMR simulators.

The sound level in the earphones can be adjusted, if needed, by the users. But, in practice, the original settings, defined during the preliminary tests, and producing a comfortable listening level, will not be modified. The microphones are protected by a foam ball in order to reduce the "pop" effect. It is also suggested to the user to avoid to place the acoustic opening of the microphone in front of the mouth.

3.2.5 Test environment

Each of the two subjects participating to the conversations is installed in a test room. They sit on an armchair, in front of a table. The test rooms are acoustically insulated. All the test equipments are installed in a third room, connected to the test rooms. When needed, the background noise is generated in the appropriate test room through a set of 4 loudspeakers. The background noise level is adjusted and controlled by a sound level meter. The measurement microphone, connected to the Sound level meter is located at the equivalent of the center of the subject's head. The noise level is A weighted.

3.2.6 Calibration and test conditions monitoring

Speech level

Before the beginning of a set of experiment, the end to end transmission level is checked subjectively, to ensure that there is no problem. If it is necessary to check the speech level following procedure will apply.

An artificial mouth placed in front of the microphone of the Headset A, in the LRGP position -See ITU-T Rec. P.64-, generates in the artificial ear (according to ITU-T Rec. P57) coupled to the earphone of the Headset B the nominal level defined in section 4.3. If necessary, the level is adjusted with the receiving volume control of the headset. The similar calibration is done by inverting headsets A and B.

Delay

The overall delay (from the input of sound card A to the output of sound card B) will be evaluated for each test condition.

The hypothetical delay is calculated as shown :

On the air interface side, the simulator only receives packets on its network card, process them and transmits every 20 ms these packets to the following PC. Only processing delay and a possible delay due to a jitter can be added (a packet arrives just after the sending window of the air interface).

The hypothetical delay is calculated as shown :

On encoder side, delay have to take into account framing, look-ahead, processing and packetization: 45ms

Uplink delay between UE and Iu: 84.4 ms (see TR25.853)

Core network delay: a few ms

Routing through IP: depending on the number of routers.

Downlink delay between Iu and Ue: 71.8 ms (see TR25.853)

And delay on decoder side, taking into account jitter buffer, de-packetization and processing, 40 ms

The total delay to be considered is at least: 241.2 ms.

Note : The actual delay will be measured on the test equipment.

3.3 Test Conditions

The 24 test conditions are :

Condition	Experimental actors		
	Radio conditions	IP conditions (Packet loss ratio)	Mode
1	10^{-2}	0%	12,65 kbit/s, RoHC
2	10^{-2}	0%	12,65 kbit/s
3	10^{-2}	0%	15,85 kbit/s, RoHC
4	10^{-2}	3%	12,65 kbit/s, RoHC
5	10^{-2}	3%	12,65 kbit/s
6	10^{-2}	3%	15,85 kbit/s, RoHC
7	10^{-3}	0%	12,65 kbit/s, RoHC
8	10^{-3}	0%	12,65 kbit/s
9	10^{-3}	0%	15,85 kbit/s, RoHC
10	10^{-3}	3%	12,65 kbit/s, RoHC
11	10^{-3}	3%	12,65 kbit/s
12	10^{-3}	3%	15,85 kbit/s, RoHC
13	$5 \cdot 10^{-4}$	0%	12,65 kbit/s, RoHC
14	$5 \cdot 10^{-4}$	0%	12,65 kbit/s
15	$5 \cdot 10^{-4}$	0%	15,85 kbit/s, RoHC
16	$5 \cdot 10^{-4}$	3%	12,65 kbit/s, RoHC
17	$5 \cdot 10^{-4}$	3%	12,65 kbit/s
18	$5 \cdot 10^{-4}$	3%	15,85 kbit/s, RoHC

Condition	Additional Background noise		Experimental actors		
	Room A	Room B	Radio conditions	IP conditions (Packet loss ratio)	Mode
19	Car	No	$5 \cdot 10^{-4}$	3%	12,65 kbit/s, RoHC

20	No	Car	$5 \cdot 10^{-4}$	3%	12,65 kbit/s, RoHC
21	Cafeteria	No	$5 \cdot 10^{-4}$	0%	12,65 kbit/s
22	No	Cafeteria	$5 \cdot 10^{-4}$	0%	12,65 kbit/s
23	Street	No	$5 \cdot 10^{-4}$	0%	15,85 kbit/s, RoHC
24	No	Street	$5 \cdot 10^{-4}$	0%	15,85 kbit/s, RoHC

Noise types

Noise type	Level (dB Pa A)
Car	60
Street	55
Bable	50

Listening Level	1	79 dBSPL
Listeners	32	Naïve Listeners
Groups	16	2 subjects/group
Rating Scales	5	
Languages	1	See table
Listening System	1	Monaural headset (flat response in the audio bandwidth of interest: 50Hz-7kHz). The other ear is open.
Listening Environment		Room Noise: Hoth Spectrum at 30dBA (as defined by ITU-T, Recommendation P.800, Annex A, section A.1.1.2.2.1 Room Noise, with table A.1 and Figure A.1),except when background noise is needed (see table)

Annex A Example Instructions for the conversation test

Table : Instructions to subjects.

<p>INSTRUCTIONS TO SUBJECTS</p> <p>In this experiment we are evaluating systems that might be used for telecommunication services. You are going to have a conversation with another user. The test situation is simulating communications between two mobile phones. The most of the situations will correspond to silent environment conditions, but some other will simulate more specific situations, as in a car, or in a railway station or in an office environment, when other people are discussing in the background.</p> <p>After the completion of each call conversation, you will have to give your opinions on the quality, by answering to the following questions that will be displayed on the screen of the black box in front of you. Your judgment will be stored. You have 8 seconds to answer to each question. After "pressing" the button on the screen, another question will be displayed. You continue the procedure for the 5 following questions.</p> <p>Question 1: How do you judge the quality of the voice of your partner?</p> <table border="1"> <tr> <td>Excellent</td> <td>Good</td> <td>Fair</td> <td>Poor</td> <td>Bad</td> </tr> </table> <p>Question 2: Do you have difficulties to understand some words?</p> <table border="1"> <tr> <td>All the time</td> <td>Often</td> <td>Some time to time</td> <td>Rarely</td> <td>Never</td> </tr> </table> <p>Question 3: How did you judge the conversation when you interacted with your partner?</p> <table border="1"> <tr> <td>Excellent interactivity (similar to face-to-face situation)</td> <td>Good interactivity (in few moments, you were talking simultaneously, and you had to interrupt yourself)</td> <td>Fair interactivity (sometimes, you were talking simultaneously, and you had to interrupt yourself)</td> <td>Poor interactivity (often, you were talking simultaneously, and you had to interrupt yourself)</td> <td>Bad interactivity (it was impossible to have an interactive conversation)</td> </tr> </table> <p>Question 4: Did you perceive any impairment (noises, cuts,...)? In that case, was it:</p> <table border="1"> <tr> <td>No impairment</td> <td>Slight impairment, but not disturbing</td> <td>Impairment slightly disturbing</td> <td>Impairment disturbing</td> <td>Very disturbing Impairment</td> </tr> </table> <p>Question 5: How do you judge the global quality of the communication?</p> <table border="1"> <tr> <td>Excellent</td> <td>Good</td> <td>Fair</td> <td>Poor</td> <td>Bad</td> </tr> </table> <p>From then on you will have a break approximately every 30 minutes. The test will last a total of approximately 60 minutes.</p> <p>Please do not discuss your opinions with other listeners participating in the experiment.</p>					Excellent	Good	Fair	Poor	Bad	All the time	Often	Some time to time	Rarely	Never	Excellent interactivity (similar to face-to-face situation)	Good interactivity (in few moments, you were talking simultaneously, and you had to interrupt yourself)	Fair interactivity (sometimes, you were talking simultaneously, and you had to interrupt yourself)	Poor interactivity (often, you were talking simultaneously, and you had to interrupt yourself)	Bad interactivity (it was impossible to have an interactive conversation)	No impairment	Slight impairment, but not disturbing	Impairment slightly disturbing	Impairment disturbing	Very disturbing Impairment	Excellent	Good	Fair	Poor	Bad
Excellent	Good	Fair	Poor	Bad																									
All the time	Often	Some time to time	Rarely	Never																									
Excellent interactivity (similar to face-to-face situation)	Good interactivity (in few moments, you were talking simultaneously, and you had to interrupt yourself)	Fair interactivity (sometimes, you were talking simultaneously, and you had to interrupt yourself)	Poor interactivity (often, you were talking simultaneously, and you had to interrupt yourself)	Bad interactivity (it was impossible to have an interactive conversation)																									
No impairment	Slight impairment, but not disturbing	Impairment slightly disturbing	Impairment disturbing	Very disturbing Impairment																									
Excellent	Good	Fair	Poor	Bad																									

Annex B: Example Scenarios for the conversation test

The pretexts used for conversation test are those developed by the Ruhr University (Bochum, Germany) within the context of ITU-T SG12 . These scenarios have been elaborated to allow a conversation well balanced within both participants and lasting approximately 2'30 or 3', and to stimulate the discussion between persons that know each other to facilitate the naturalness of the conversation. They are derived from typical situations of every day life: railways inquiries, rent a car or an apartment, etc. Each condition should be given a different scenario.

Examples coming from ITU-T SG 12 COM12-35 "Development of scenarios for short conversation test", 1997

- Scenario 1 : Pizza service

Subject 1:

Your Name :	Clemence
Reason for the call	1 large Pizza
Condition which should be applied to the exchange of information	For 2 people, Vegetarian pizza preferred
Information you want to receive from your partner	Topping Price
Information that your partner requires	Delivery address : 41 industry street,Oxford Phone : 7 34 20
Question to which neither you nor your partner will have information. You should discuss and find a solution that is acceptable to both of you.	How long will it take?

Subject 2:

Your Name :	Pizzeria Roma			
Information from which you should select the details which your partner requires	Pizzas	1 person	2 persons	4 persons
	Toscana (ham, mushrooms, tomatoes,cheese)	3.2£	5.95£	10.5£
	Tonno (Tuna, onions, tomatoes, cheese)	3.95£	7.5£	13.95£
	Fabrizio (salami, ham, tomatoes, heese)	4.2£	7.95£	14.95£
	Vegetaria (spinach, mushrooms, tomatoes,cheese)	4.5£	8.5£	15.95£
Information you want to receive from your partner	Name address telephone number			
Question to which neither you nor your partner will have information. You should discuss and find a solution that is acceptable to both of you.				

- Scenario 2 : Information on flights

Subject 1:

Your Name :	Parker
Reason for the call	Intended journey: London Heathrow → Düsseldorf
Condition which should be applied to the exchange of information	On June 23th, Morning flight, Direct flight preferred
Information you want to receive from your partner	Departure : Arrival Flight number
Information that your partner requires	Reservation : 1 seat, Economy class Address: 66 middle street, Sheffield Phone: 21 08 33
Question to which neither you nor your partner will have information. You should discuss and find a solution that is acceptable to both of you.	From which airport is it easier to get into Cologne center : Düsseldorf or Cologne/Bonn

Subject 2:

Your Name :	Heathrow flight information			
Information from which you should select the details which your partner requires	Flight schedule	Lufthansa	British Airways	Lufthansa
	Flight number	LH 2615	BA 381	LH 413
	London Heathrow departure	6:30	6:35	8:20
	Brussels arrival		7:35	
	Brussels departure		8:00	
	Düsseldorf arrival	7:35	9:05	9:25
Information you want to receive from your partner	Name address telephone number number of seats Class : Business or Economy			
Question to which neither you nor your partner will have information. You should discuss and find a solution that is acceptable to both of you.				

Annex C: Results to be provided

For contractual purposes, the information which needs to be provided is defined here.

The information required from each test Laboratory is a table containing the following information for each of the conditions in the experiment:

The "Mean Opinion Score (MOS)" obtained for all the subjects.

When the conditions are symmetrical, the mean value is calculated from all the result for the two test rooms..

For the dissymmetric conditions, the mean is calculated on the two test conditions, each result cumulating the results obtained in each condition of background noise.

The Standard Deviation of the "MOS" obtained for all the subjects, for each test condition.

The specific statistical comparisons are specified in Annex C.

Annex D: Data analysis and presentation of results

D.1 Calculation of MOS and Standard Deviation

The (overall) MOS/DMOS for confounded subjects for condition C (Y_c) can then be obtained from:

$$Y_c = \frac{1}{T} \sum_{t=1}^T Y_{c,t}$$

The standard deviation (S) for condition C, denoted as S_c , can be calculated as:

$$S_c = \sqrt{\frac{1}{L \times T - 1} \sum_{t=1}^T \sum_{l=1}^L (X_{c,l,t} - Y_c)^2}$$

Finally, the confidence interval (CI) at the $(1-\alpha)$ level can be calculated for $N = L \times T$ as:

$$CI_c = (t_{1-\alpha, N-1}) \frac{S_c}{\sqrt{N}}$$

D.2 Presentation of Basic Statistical Results

The test results should be reported by the test Laboratory and the Global Analysis Laboratory as follows:

Calculate and tabulate "Mean Opinion Scores" for the (opinion scales, Standard Deviations and Confidence Intervals as shown in Table E.1.

Table C.1 - Layout for presentation of test results.

D.3 Thorough analysis

Two statistical analyses should be conducted on the data obtained with these subjective scales. The first analysis consists in a Multiple ANalysis OF VAriance (MANOVA), which globally indicates the possible effect of the experimental factors (*i.e.*, different conditions). Then, a specific ANOVA should be run on each dependent variable (the five scales) to test if there is an effect of a specific experimental factor for a given subjective variable. In other words, these statistical analyses indicate if the differences observed between the MOS obtained for the different conditions are significant, for one given dependant variable (ANOVA) or for the whole of dependant variables (MANOVA). Finally, Pearson's linear correlations should be computed between the results of all subjective variables, to see which are those preponderant or dependent on others.

Annex F:

Test plan for Packet Switched Conversation Tests for Comparison of Quality Offered by Different Speech Coders

Source: France Telecom R&D

Title: Test plan for packet switched conversation test. Comparison of quality offered by different speech coders.

Document For: Discussion and Approval

Agenda Item:

Introduction

This document proposes a conversation test plan to compare the quality obtained with several different speech coders, over packet switched networks.

The different speech coders used in this test are

Adaptive Multi-Rate Narrow-Band (AMR-NB), in modes 6.7 kbit/s and 12.2 kbit/s,

Adaptive Multi-Rate Wide-Band (AMR-WB), in modes 12.65 kbit/s and 15.85 kbit/s,

ITU-T G.723.1, in mode 6.4 kbit/s,

ITU-T G.729, in mode 8 kbit/s,

ITU-T G.722, in mode 64 kbit/s, with packet loss concealment and,

ITU-T G.711, with packet loss concealment.

As there is no standardized packet loss concealment, plc for G.711 and G.722 are proprietary algorithms.

The simulated network will include two values of IP packet loss.

The test will be done in one test laboratory, only, but in two different languages.

This discussion gives references, conventions and contacts, section 3 details the test methodology, including test arrangement and test procedure,

Annex A contains the instructions for the subjects participating to the conversation tests.

Annex B contains the description of results to be provided to the Analysis Laboratory (if any) by the testing laboratories.

Annex C contains the list of statistical comparisons to be performed.

2. References, Conventions, and Contacts

2.1 Permanent Documents

ITU-T Rec.P.800	Methods for Subjective Determination of Transmission Quality
ITU-T Rec. P.831	Subjective performance evaluation of network echo cancellers
ITU-T Rec. G.711	Pulse code modulation (PCM) of voice frequencies
ITU-T Rec. G.729	Coding of speech at 8 kbit/s using conjugate-structure algebraic-code-excited linear-prediction (CS-ACELP)
ITU-T Rec. G.723.1	Speech coders : Dual rate speech coder for multimedia communications transmitting at 5.3 and 6.3 kbit/s
ITU-T Rec. G.722	7 kHz audio-coding within 64 kbit/s

2.2 Key Acronyms

AMR-NB Adaptive Multi-Rate Narrowband Speech Codec

AMR-WB Adaptive Multi-Rate Wide-band Speech Codec

MOS Mean Opinion Score

2.3 Contact Names

The following persons should be contacted for questions related to the test plan.

Section	Contact Person/Email	Organisation	Address	Telephone/Fax
Experiments and results analysis	L. Gros	France Telecom R&D	2, Avenue P. Marzin,	Tel : +3329605 0720
	Laetitia.gros@francetelecom.com		22307 Lannion Cédex	Fax : +33296051316
			France	
AOB	Paolo Usai paolo.usai@etsi.fr	ETSI MCC	650 Route des Lucioles 06921 Sophia Antipolis Cedex France	Tel: 33 (0)4 92 94 42 36 Fax: 33 (0)4 93 65 28 17

2.4 Responsibilities

Each test laboratory has the responsibility to organize its conversation tests.

The list of Test laboratories participating to the conversation test phase.

Lab	Company	Language
1	France Telecom R&D	French
	France Telecom R&D	Arabic

3. Test methodology

3.1 Introduction

The protocol described below evaluates the effect of degradation such as delay and dropped packets on the quality of the communications. It corresponds to the conversation-opinion tests recommended by the ITU-T P.800 [1]. First of all, conversation-opinion tests allow subjects passing the test to be in a more realistic situation, close to the actual service conditions experienced by telephone customers. In addition, conversation-opinion tests are suited to assess the effects of impairments that can cause difficulty while conversing (such as delay).

Subjects participate to the test by couple; they are seated in separate sound-proof rooms and are asked to hold a conversation through the transmission chain performed by means of networks simulators and communications are impaired by means of an IP impairments simulator part of the CN simulator, as the figure below describes it.

3.2 Test arrangement

3.2.1 Description of the proposed testing system

This contribution describes a networks simulator for the characterization of the different speech codecs when the bitstream is transmitted over a PS network. The procedure to do the conversational listening test has been earlier described in [1].

Figure 1 describes the system that is going to be simulated:

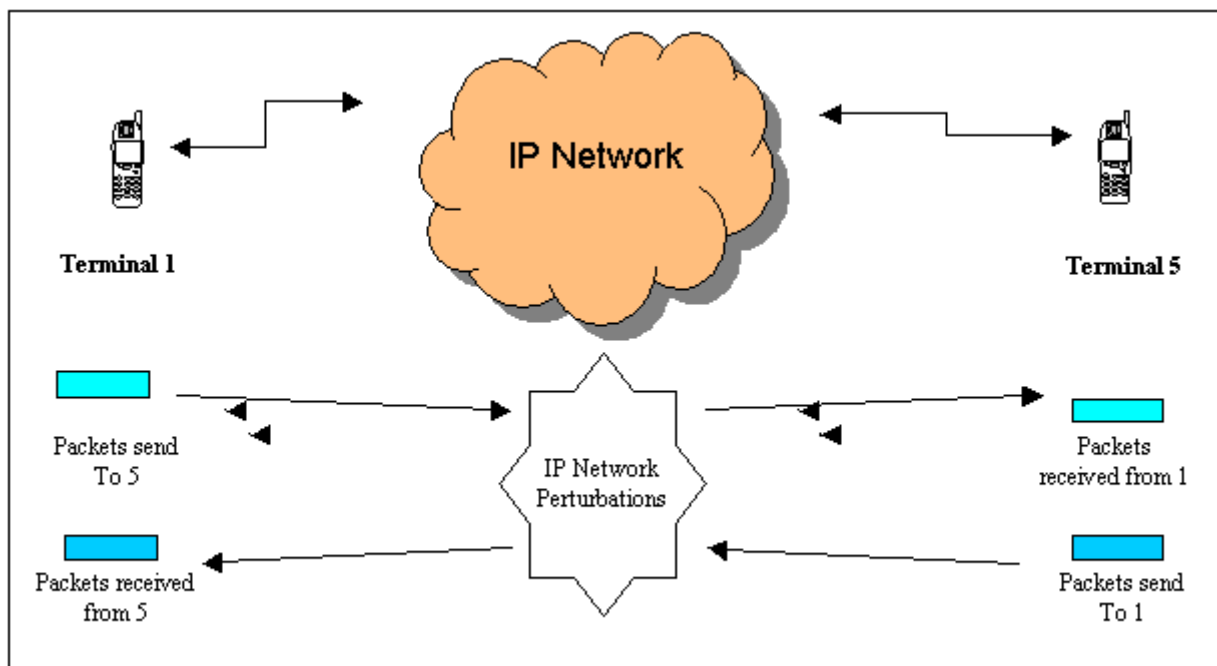

Figure 1: Packet switch audio communication simulator

This will be simulated using 5 PCs as shown in Figure 2.

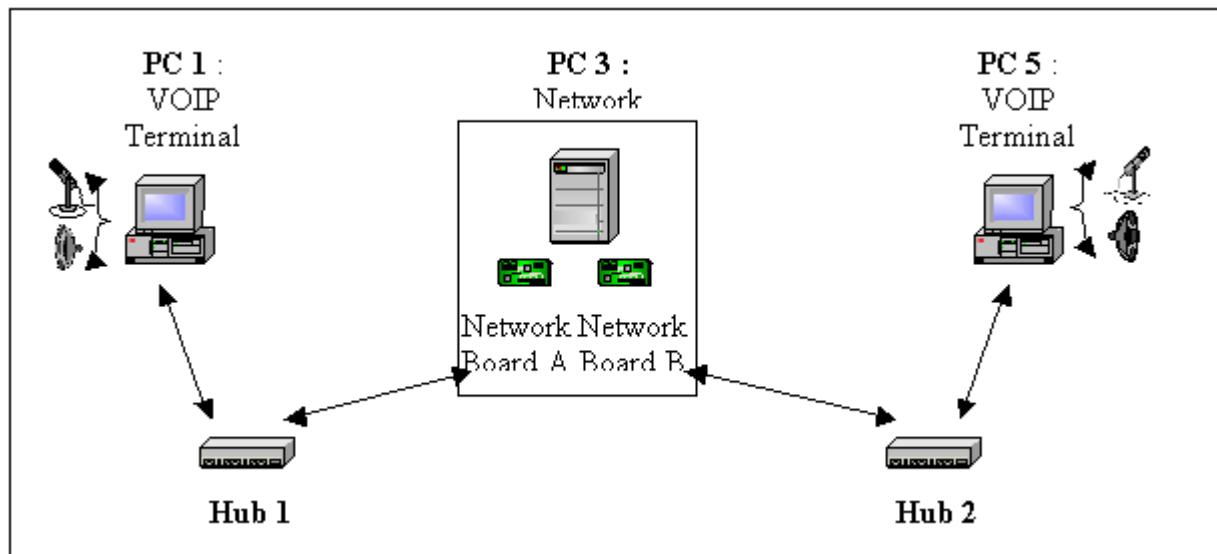

Figure 2: Simulation Platform

PC 1 and PC 5: PCs under Windows OS with VOIP Terminal Simulator Software of France Telecom R&D.

PC 3: PCs under WinNT OS with Network Simulator Software (NetDisturb).

Basic Principles:

The platform simulates a packet switch interactive communication between two users using PC1 and PC5 as their relatives VOIP terminals. PC1 sends encoded packets that are encapsulated using IP/UDP/RTP headers to PC5. PC1 receives these IP/UDP/RTP audio packets from PC5.

3.2.2 France Telecom Network simulator

The core network simulator, as implemented, works under IPv4.

Figure 3 shows the possible parameters that can be modified, but, in this test, only "loss Law" will have two values, all the others settings being fixed.

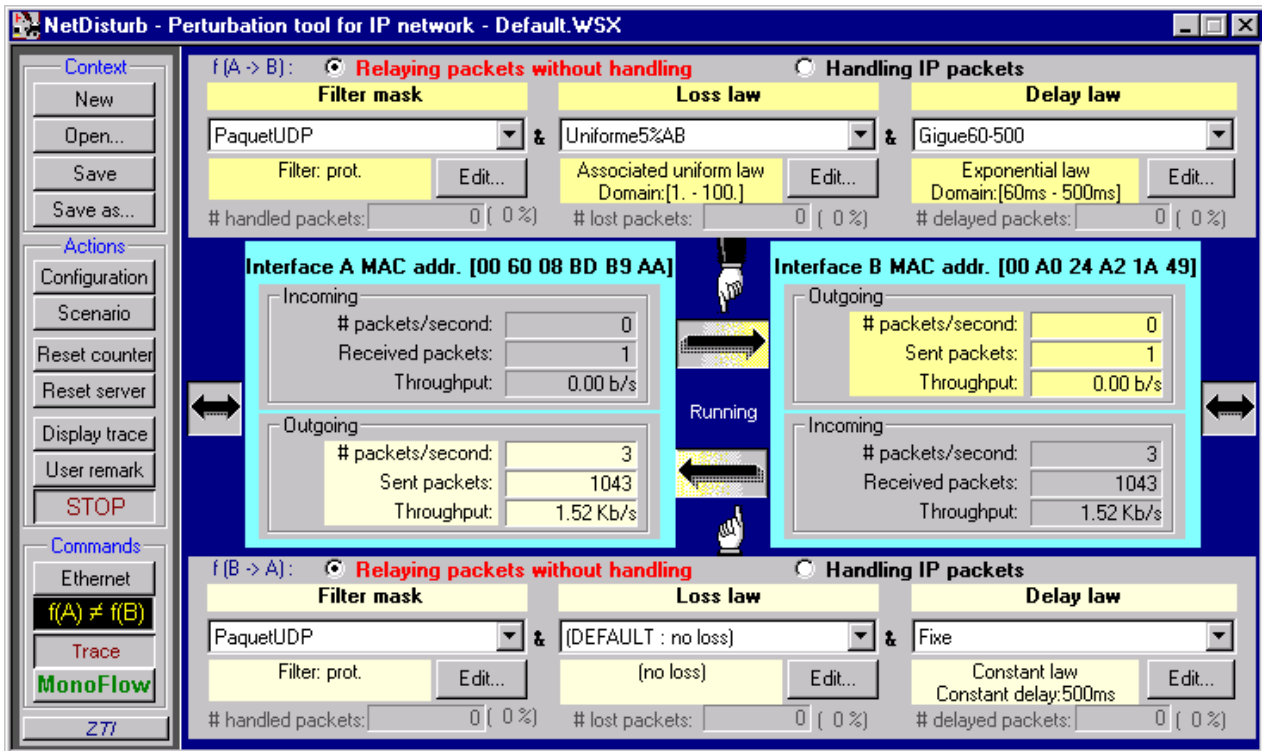

Figure 3: IP simulator interface

On both links, one can choose delay and loss laws. Both links can be treated separately or on the same way. For example, delay can be set to a fixed value but can also be set to another law such as exponential law.

3.2.3 Headsets and Sound Card

To avoid echo problems, it has been decided to use headsets, instead of handsets. The monaural headsets are connected to the sound cards of the PCs supporting the AMR simulators.

The sound level in the earphones can be adjusted, if needed, by the users. But, in practice, the original settings, defined during the preliminary tests, and producing a comfortable listening level, will not be modified. The microphones are protected by a foam ball in order to reduce the "pop" effect. It is also suggested to the user to avoid to place the acoustic opening of the microphone in front of the mouth.

3.2.4 Test environment

Each of the two subjects participating to the conversations is installed in a test room. They sit on an armchair, in front of a table. The test rooms are acoustically insulated. All the test equipments are installed in a third room, connected to the test rooms. The background noise level is checked by a sound level meter. The measurement microphone, connected to the Sound level meter is located at the equivalent of the center of the subject's head. The noise level is A weighted.

3.2.5 Calibration and test conditions monitoring

Speech level

Before the beginning of a set of experiment, the end to end transmission level is checked subjectively, to ensure that there is no problem. If it is necessary to check the speech level following procedure will apply. An artificial mouth placed in front of the microphone of the Headset A, in the LRGP position -See ITU-T Rec. P.64-, generates in the artificial ear (according to ITU-T Rec. P57) coupled to the earphone of the Head set B the nominal level defined in section 4.3. If necessary, the level is adjusted with the receiving volume control of the headset. The similar calibration is done by inverting headsets A and B.

Delay

The overall delay (from the input of sound card A to the output of sound card B) will be adjusted for each test condition taking into account the delay of the related codec in order to have a fixed delay around 250ms. This value of 250ms is close to the hypothetical delay computed for AMR and AMRWB through the UMTS network.

3.3 Test Conditions

Condition	Experimental actors	
	IP conditions (Packet loss ratio)	Mode
1	0%	AMR NB 6,7kbit/s
2	0%	AMR-NB 12,2 kbit/s
3	0%	AMR-WB 12,65 kbit/s
4	0%	AMR-WB 15,85 kbit/s
5	0%	G. 723.1 6,4 kbit/s
6	0%	G.729 8 kbit/s
7	0%	G.722 64 kbit/s + plc
8	0%	G.711 + plc
9	3%	AMR NB 6,7kbit/s
10	3%	AMR-NB 12,2 kbit/s (delay 300 ms)
11	3%	AMR-WB 12,65 kbit/s
12	3%	AMR-WB 15,85 kbit/s
13	3%	G. 723.1 6,4 kbit/s
14	3%	G.729 8 kbit/s
15	3%	G.722 64 kbit/s + plc
16	3%	G.711 + plc

Listening Level	1	79 dBSPL
Listeners	32	Naïve Listeners per language
Groups	16	2 subjects/group
Rating Scales	5	
Languages	1	See table
Listening System	1	Monaural headset (flat response in the audio bandwidth of interest: 50Hz-7kHz). The other ear is open.
Listening Environment		Room Noise: Hoth Spectrum at 30dBA (as defined by ITU-T, Recommendation P.800, Annex A, section A.1.1.2.2.1 Room Noise, with table A.1 and Figure A.1),

References

Tdoc S4-030564- Test Plan for the AMR Narrow-Band Packet switched Conversation test

Tdoc S4-030565- Test Plan for the AMR Wide-Band Packet switched Conversation test

END

Annex A Example Instructions for the conversation test

Table : Instructions to subjects.

<p>INSTRUCTIONS TO SUBJECTS</p> <p>In this experiment we are evaluating systems that might be used for telecommunication services. You are going to have a conversation with another user. The test situation is simulating communications between two mobile phones. All the situations will correspond to silent environment condition</p> <p>After the completion of each call conversation, you will have to give your opinions on the quality, by answering to the following questions that will be displayed on the screen of the black box in front of you. Your judgment will be stored. You have 8 seconds to answer to each question. After "pressing" the button on the screen, another question will be displayed. You continue the procedure for the 5 following questions.</p> <p>Question 1: How do you judge the quality of the voice of your partner?</p> <table border="1"> <tr> <td>Excellent</td> <td>Good</td> <td>Fair</td> <td>Poor</td> <td>Bad</td> </tr> </table> <p>Question 2: Do you have difficulties to understand some words?</p> <table border="1"> <tr> <td>All the time</td> <td>Often</td> <td>Some time to time</td> <td>Rarely</td> <td>Never</td> </tr> </table> <p>Question 3: How did you judge the conversation when you interacted with your partner?</p> <table border="1"> <tr> <td>Excellent interactivity (similar to face-to-face situation)</td> <td>Good interactivity (in few moments, you were talking simultaneously, and you had to interrupt yourself)</td> <td>Fair interactivity (sometimes, you were talking simultaneously, and you had to interrupt yourself)</td> <td>Poor interactivity (often, you were talking simultaneously, and you had to interrupt yourself)</td> <td>Bad interactivity (it was impossible to have an interactive conversation)</td> </tr> </table> <p>Question 4: Did you perceive any impairment (noises, cuts,...)? In that case, was it:</p> <table border="1"> <tr> <td>No impairment</td> <td>Slight impairment, but not disturbing</td> <td>Impairment slightly disturbing</td> <td>Impairment disturbing</td> <td>Very disturbing Impairment</td> </tr> </table> <p>Question 5: How do you judge the global quality of the communication?</p> <table border="1"> <tr> <td>Excellent</td> <td>Good</td> <td>Fair</td> <td>Poor</td> <td>Bad</td> </tr> </table> <p>From then on you will have a break approximately every 30 minutes. The test will last a total of approximately 60 minutes.</p> <p>Please do not discuss your opinions with other listeners participating in the experiment.</p>					Excellent	Good	Fair	Poor	Bad	All the time	Often	Some time to time	Rarely	Never	Excellent interactivity (similar to face-to-face situation)	Good interactivity (in few moments, you were talking simultaneously, and you had to interrupt yourself)	Fair interactivity (sometimes, you were talking simultaneously, and you had to interrupt yourself)	Poor interactivity (often, you were talking simultaneously, and you had to interrupt yourself)	Bad interactivity (it was impossible to have an interactive conversation)	No impairment	Slight impairment, but not disturbing	Impairment slightly disturbing	Impairment disturbing	Very disturbing Impairment	Excellent	Good	Fair	Poor	Bad
Excellent	Good	Fair	Poor	Bad																									
All the time	Often	Some time to time	Rarely	Never																									
Excellent interactivity (similar to face-to-face situation)	Good interactivity (in few moments, you were talking simultaneously, and you had to interrupt yourself)	Fair interactivity (sometimes, you were talking simultaneously, and you had to interrupt yourself)	Poor interactivity (often, you were talking simultaneously, and you had to interrupt yourself)	Bad interactivity (it was impossible to have an interactive conversation)																									
No impairment	Slight impairment, but not disturbing	Impairment slightly disturbing	Impairment disturbing	Very disturbing Impairment																									
Excellent	Good	Fair	Poor	Bad																									

Annex B: Example Scenarios for the conversation test

The pretexts used for conversation test are those developed by the Ruhr University (Bochum, Germany) within the context of ITU-T SG12 . These scenarios have been elaborated to allow a conversation well balanced within both participants and lasting approximately 2'30 or 3', and to stimulate the discussion between persons that know each other to facilitate the naturalness of the conversation. They are derived from typical situations of every day life: railways inquiries, rent a car or an apartment, etc. Each condition should be given a different scenario.

Examples coming from ITU-T SG 12 COM12-35 "Development of scenarios for short conversation test", 1997

- Scenario 1 : Pizza service

Subject 1:

Your Name :	Clemence
Reason for the call	1 large Pizza
Condition which should be applied to the exchange of information	For 2 people, Vegetarian pizza preferred
Information you want to receive from your partner	Topping Price
Information that your partner requires	Delivery address : 41 industry street,Oxford Phone : 7 34 20
Question to which neither you nor your partner will have information. You should discuss and find a solution that is acceptable to both of you.	How long will it take?

Subject 2:

Your Name :	Pizzeria Roma																							
Information from which you should select the details which your partner requires	<table border="1"> <thead> <tr> <th>Pizzas</th> <th>1 person</th> <th>2 persons</th> <th>4 persons</th> </tr> </thead> <tbody> <tr> <td>Toscana (ham, mushrooms, tomatoes,cheese)</td> <td>3.2£</td> <td>5.95£</td> <td>10.5£</td> </tr> <tr> <td>Tonno (Tuna, onions, tomatoes, cheese)</td> <td>3.95£</td> <td>7.5£</td> <td>13.95£</td> </tr> <tr> <td>Fabrizio (salami, ham, tomatoes, heese)</td> <td>4.2£</td> <td>7.95£</td> <td>14.95£</td> </tr> <tr> <td>Vegetaria (spinach, mushrooms, tomatoes,cheese)</td> <td>4.5£</td> <td>8.5£</td> <td>15.95£</td> </tr> </tbody> </table>				Pizzas	1 person	2 persons	4 persons	Toscana (ham, mushrooms, tomatoes,cheese)	3.2£	5.95£	10.5£	Tonno (Tuna, onions, tomatoes, cheese)	3.95£	7.5£	13.95£	Fabrizio (salami, ham, tomatoes, heese)	4.2£	7.95£	14.95£	Vegetaria (spinach, mushrooms, tomatoes,cheese)	4.5£	8.5£	15.95£
Pizzas	1 person	2 persons	4 persons																					
Toscana (ham, mushrooms, tomatoes,cheese)	3.2£	5.95£	10.5£																					
Tonno (Tuna, onions, tomatoes, cheese)	3.95£	7.5£	13.95£																					
Fabrizio (salami, ham, tomatoes, heese)	4.2£	7.95£	14.95£																					
Vegetaria (spinach, mushrooms, tomatoes,cheese)	4.5£	8.5£	15.95£																					
Information you want to receive from your partner	Name address telephone number																							
Question to which neither you nor your partner will have information. You should discuss and find a solution that is acceptable to both of you.																								

- Scenario 2 : Information on flights

Subject 1:

Your Name :	Parker
Reason for the call	Intended journey: London Heathrow → Düsseldorf
Condition which should be applied to the exchange of information	On June 23th, Morning flight, Direct flight preferred
Information you want to receive from your partner	Departure : Arrival Flight number
Information that your partner requires	Reservation : 1 seat, Economy class Address: 66 middle street, Sheffield Phone: 21 08 33
Question to which neither you nor your partner will have information. You should discuss and find a solution that is acceptable to both of you.	From which airport is it easier to get into Cologne center : Düsseldorf or Cologne/Bonn

Subject 2:

Your Name :	Heathrow flight information			
Information from which you should select the details which your partner requires	Flight schedule	Lufthansa	British Airways	Lufthansa
	Flight number	LH 2615	BA 381	LH 413
	London Heathrow departure	6:30	6:35	8:20
	Brussels arrival		7:35	
	Brussels departure		8:00	
	Düsseldorf arrival	7:35	9:05	9:25
Information you want to receive from your partner	Name address telephone number number of seats Class : Business or Economy			
Question to which neither you nor your partner will have information. You should discuss and find a solution that is acceptable to both of you.				

ITU-T SG 12 COM12-35 "Development of scenarios for short conversation test", 1997

Annex C: Results to be provided

For contractual purposes, the information which needs to be provided is defined here.

The information required from each test Laboratory is a table containing the following information for each of the conditions in the experiment:

The "Mean Opinion Score (MOS)" obtained for all the subjects.

When the conditions are symmetrical, the mean value is calculated from all the result for the two test rooms..

For the dissymmetric conditions, the mean is calculated on the two test conditions, each result cumulating the results obtained in each condition of background noise.

The Standard Deviation of the "MOS" obtained for all the subjects, for each test condition.

The specific statistical comparisons are specified in Annex C.

Annex D: Data analysis and presentation of results

D.1 Calculation of MOS and Standard Deviation

The (overall) MOS/DMOS for confounded subjects for condition C (Y_c) can then be obtained from:

$$Y_c = \frac{1}{T} \sum_{t=1}^T Y_{c,t}$$

The standard deviation (S) for condition C, denoted as S_c , can be calculated as:

$$S_c = \sqrt{\frac{1}{L \times T - 1} \sum_{t=1}^T \sum_{l=1}^L (X_{c,l,t} - Y_c)^2}$$

Finally, the confidence interval (CI) at the $(1-\alpha)$ level can be calculated for $N = L \times T$ as:

$$CI_c = (t_{1-\alpha, N-1}) \frac{S_c}{\sqrt{N}}$$

D.2 Presentation of Basic Statistical Results

The test results should be reported by the test Laboratory and the Global Analysis Laboratory as follows:

Calculate and tabulate "Mean Opinion Scores" for the (opinion scales, Standard Deviations and Confidence Intervals as shown in Table E.1.

Table C.1 - Layout for presentation of test results.

D.3 Thorough analysis

Two statistical analyses should be conducted on the data obtained with these subjective scales. The first analysis consists in a Multiple ANalysis OF VAriance (MANOVA), which globally indicates the possible effect of the experimental factors (*i.e.*, different conditions). Then, a specific ANOVA should be run on each dependent variable (the five scales) to test if there is an effect of a specific experimental factor for a given subjective variable. In other words, these statistical analyses indicate if the differences observed between the MOS obtained for the different conditions are significant, for one given dependant variable (ANOVA) or for the whole of dependant variables (MANOVA). Finally, Pearson's linear correlations should be computed between the results of all subjective variables, to see which are those preponderant or dependent on others.

Annex G:

Test Plan for Global Analysis of PSS Conversation Tests

Source:	Dynastat¹
Title:	Proposed Test Plan for Global Analysis of PSS Conversation Tests (R1)
Document for:	Discussion and Approval
Agenda Item:	7, 13.1

1. Introduction

This contribution presents a proposal for conducting a Global Analysis of the results derived from the 3GPP Conversation Tests for Packet Switched (PS) networks. Phase I of these tests are described in two test plans -- S4-030564 for conversation tests using the Adaptive Multi-Rate Narrow-Band (AMR-NB) codec, S4-030565 for conversation tests using the Adaptive Multi-Rate Wide-Band (AMR-WB) codec. The test plan for the Phase II tests are described in S4-030747 for conversation tests comparing various ITU-T standardized speech codecs. The Phase I test plans specify similar experimental designs involving 24 test conditions and 16 pairs of subjects. They also specify that three Listening Laboratories (LL) will conduct the tests in different languages: Arcon for North American English (NAE), NTT-AT for Japanese, and France Telecom for French. The Phase II test plan involves 16 conditions and a single Listening Lab (France Telecom) conducting the test in two languages (French and Arabic).

2. Phase I - AMR-NB Tests

Table 1 shows the 24 test conditions involved in the AMR-NB conversation tests.

Table 1. Test Conditions in the PS Conversation Tests for AMR-NB

Condition	Room A	Room B	Radio conditions	Packet loss (%)	Mode (kbps)	Delay (msec)
1	No	No	10^{-2}	0	6.7	300
2	No	No	10^{-2}	0	12.2	500
3	No	No	10^{-2}	0	12.2	300
4	No	No	10^{-2}	3	6.7	300
5	No	No	10^{-2}	3	12.2	500
6	No	No	10^{-2}	3	12.2	300
7	No	No	10^{-3}	0	6.7	300
8	No	No	10^{-3}	0	12.2	500
9	No	No	10^{-3}	0	12.2	300
10	No	No	10^{-3}	3	6.7	300
11	No	No	10^{-3}	3	12.2	500
12	No	No	10^{-3}	3	12.2	300
13	No	No	5×10^{-4}	0	6.7	300
14	No	No	5×10^{-4}	0	12.2	500
15	No	No	5×10^{-4}	0	12.2	300
16	No	No	5×10^{-4}	3	6.7	300
17	No	No	5×10^{-4}	3	12.2	500
18	No	No	5×10^{-4}	3	12.2	300
19	Car	No	5×10^{-4}	3	12.2	300
20	No	Car	5×10^{-4}	3	12.2	300
21	Cafeteria	No	5×10^{-4}	0	6.7	300
22	No	Cafeteria	5×10^{-4}	0	6.7	300
23	Street	No	5×10^{-4}	0	12.2	500
24	No	Street	5×10^{-4}	0	12.2	500

Test conditions 1-18 are symmetrical in that both subjects in a conversation-pair are listening in quiet (i.e., no noise) rooms. Conditions 19-24, on the other hand, are asymmetrical, one subject is listening in a quiet room, the other in a noisy room. Conditions 1-18 are categorized by four experimental factors:

- Delay – 300 msec and 500 msec
- AMR-NB mode (rate) – 6.7 kbps and 12.2 kbps
- Packet Loss – 0% and 3%
- Radio conditions – 10^{-2} , 10^{-3} , and 5×10^{-4}

These conditions can be assigned to two factorial designs for analysing the effects of three of these factors. Table 2 shows the conditions involved in the two three-factor analyses for the AMR-NB experiments. Using the 12 conditions shown in Table 2a, the effects of Rate, Radio Conditions, and Packet Loss can be evaluated (Delay held constant at 300 msec). Using the 12 conditions shown in Table 2b, the effects of Delay, Radio Conditions, and Packet Loss can be evaluated (Rate held constant at 12.2 kbps).

Table 2a AMR-NB: Factorial Design for the Effects of Rate, Radio Cond., and Packet Loss

No Noise - 300 msec delay			
6.7kbps / 0% PL		6.7kbps / 3% PL	
RC	Cond.#	RC	Cond.#
10^{-2}	1	10^{-2}	4
10^{-3}	7	10^{-3}	10
5×10^{-4}	13	5×10^{-4}	16
12.2kbps / 0% PL		12.2kbps / 3% PL	
RC	Cond.#	RC	Cond.#
10^{-2}	3	10^{-2}	6
10^{-3}	9	10^{-3}	12
5×10^{-4}	15	5×10^{-4}	18

Table 2b – AMR-NB: Factorial Design for the Effects of Delay, Radio Cond., and Packet Loss

No Noise - 12.2 kbps			
300 msec / 0% PL		300 msec / 3% PL	
RC	Cond.#	RC	Cond.#
10^{-2}	3	10^{-2}	6
10^{-3}	9	10^{-3}	12
5×10^{-4}	15	5×10^{-4}	18
500 msec / 0% PL		500 msec / 3% PL	
RC	Cond.#	RC	Cond.#
10^{-2}	2	10^{-2}	5
10^{-3}	8	10^{-3}	11
5×10^{-4}	14	5×10^{-4}	17

The three sets of paired conditions involving noise (i.e., conditions 19/20, 21/22, and 23/24) can be used to compare the effects of *sender in noise/receiver in quiet* with those for *sender in quiet/receiver in noise* for the three noise environments.

3. Phase I - AMR-WB Tests

Table 3 shows the test conditions involved in the AMR-WB conversation tests. As in the AMR-NB tests, conditions 1-18 are symmetrical and conditions 19-24 are asymmetrical. Conditions 1-18 are categorized by four experimental factors:

- RoHC – present and absent
- AMR-NB mode (rate) – 6.7 kbps and 12.2 kbps
- Packet Loss – 0% and 3%
- Radio conditions – 10^{-2} , 10^{-3} , and 5×10^{-4}

Table 3. Test Conditions in the PS Conversation Tests for AMR-WB

Condition	Room A Noise	Room B Noise	Radio conditions	Packet loss (%)	Mode (kbps)	RoHC
1	No	No	10^{-2}	0	12.65	RoHC
2	No	No	10^{-2}	0	12.65	
3	No	No	10^{-2}	0	15.85	RoHC
4	No	No	10^{-2}	3	12.65	RoHC
5	No	No	10^{-2}	3	12.65	
6	No	No	10^{-2}	3	15.85	RoHC
7	No	No	10^{-3}	0	12.65	RoHC
8	No	No	10^{-3}	0	12.65	
9	No	No	10^{-3}	0	15.85	RoHC
10	No	No	10^{-3}	3	12.65	RoHC
11	No	No	10^{-3}	3	12.65	
12	No	No	10^{-3}	3	15.85	RoHC
13	No	No	5×10^{-4}	0	12.65	RoHC
14	No	No	5×10^{-4}	0	12.65	
15	No	No	5×10^{-4}	0	15.85	RoHC
16	No	No	5×10^{-4}	3	12.65	RoHC
17	No	No	5×10^{-4}	3	12.65	
18	No	No	5×10^{-4}	3	15.85	RoHC
19	Car	No	5×10^{-4}	3	12.65	RoHC
20	No	Car	5×10^{-4}	3	12.65	RoHC
21	Cafeteria	No	5×10^{-4}	0	12.65	
22	No	Cafeteria	5×10^{-4}	0	12.65	
23	Street	No	5×10^{-4}	0	15.85	RoHC
24	No	Street	5×10^{-4}	0	15.85	RoHC

Consistent with the AMR-NB tests, conditions 1-18 can be assigned to two factorial designs for analysing the effects of three of these factors. Table 4 shows the conditions involved in the two three-factor analyses for the AMR-WB experiments. Using the 12 conditions shown in Table 4a, the effects of Rate, Radio Conditions, and Packet Loss can be evaluated (RoHC present in all conditions). Using the 12 conditions shown in Table 4b, the effects of RoHC, Radio Conditions, and Packet Loss can be evaluated (Rate held constant at 12.65 kbps).

Table 4a AMR-NB: Factorial Design for the Effects of Rate, Radio Cond., and Packet Loss

No Noise - RoHC			
12.65kbps / 0% PL		12.65 kbps / 3% PL	
RC	Cond.#	RC	Cond.#
10 ⁻²	1	10 ⁻²	4
10 ⁻³	7	10 ⁻³	10
5x10 ⁻⁴	13	5x10 ⁻⁴	16
15.85 kbps / 0% PL		15.85 kbps / 3% PL	
RC	Cond.#	RC	Cond.#
10 ⁻²	3	10 ⁻²	6
10 ⁻³	9	10 ⁻³	12
5x10 ⁻⁴	15	5x10 ⁻⁴	18

Table 4b – AMR-NB: Factorial Design for the Effects of RoHC, Radio Cond., and Packet Loss

No Noise - 12.65 kbps			
RoHC / 0% PL		RoHc / 3% PL	
RC	Cond.#	RC	Cond.#
10 ⁻²	3	10 ⁻²	6
10 ⁻³	9	10 ⁻³	12
5x10 ⁻⁴	15	5x10 ⁻⁴	18
No RoHC / 0% PL		No RoHC / 3% PL	
RC	Cond.#	RC	Cond.#
10 ⁻²	2	10 ⁻²	5
10 ⁻³	8	10 ⁻³	11
5x10 ⁻⁴	14	5x10 ⁻⁴	17

Again, consistent with the tests for AMR-NB, the three sets of paired conditions involving noise (i.e., conditions 19/20, 21/22, and 23/24) can be used to compare the effects of *sender in noise/receiver in quiet* with those for *sender in quiet/receiver in noise* for the three noise environments.

4. Phase II - ITU-T Codec Tests

Table 5 shows the test conditions involved in the conversation tests designed to compare the performance of standardized ITU-T codecs in packet switched networks. The test involves eight codecs and two levels of packet loss, 0% and 3%.

Condition	IP conditions (Packet loss)	Codec, Mode
1	0%	AMR-NB, 6.7kbit/s
2	0%	AMR-NB, 12.2kbit/s
3	0%	AMR-WB, 12.65kbit/s
4	0%	AMR-WB, 15.85kbit/s
5	0%	G. 723., 6.4 kbit/s
6	0%	G.729, 8kbit/s
7	0%	G.722, 64 kbit/s + plc
8	0%	G.711 + plc
9	3%	AMR-NB, 6.7kbit/s
10	3%	AMR-NB, 12.2 kbit/s
11	3%	AMR-WB, 12.65kbit/s
12	3%	AMR-WB, 15.85kbit/s
13	3%	G. 723.1, 6.4 kbit/s
14	3%	G.729, 8kbit/s
15	3%	G.722, 64 kbit/s + plc
16	3%	G.711 + plc

Table 5. Test Conditions in the PS Conversation Tests for ITU-T Codecs

5. Global Analyses

The purpose of the Global Analysis task is to bring together the results from the different Listening Labs/languages (Phase I - NAE, French, Japanese; Phase II – French, Arabic) and combine them, where appropriate, such that conclusions may be drawn about the performance of the AMR-NB and AMR-WB codecs in packet switched networks. This task is complicated by the fact that in the conversation tests multiple criterion measures are collected for each condition. In the tests involved here, listeners are required to rate each condition on five aspects of the communication situation:

- Quality of the voice of their partner
- Difficulty of understanding words
- Quality of interaction with their partner
- Degree of impairments
- Global communication quality

Each of these criteria is measured using ratings on five-category rating scales. Each criterion also represents a separate independent variable which must be evaluated in a Global Analysis. The appropriate analysis for this situation is a Multivariate Analysis of Variance (MANOVA). The first step in MANOVA involves an omnibus test for the combination of all independent variables. A number of statistical techniques may be employed in MANOVA to determine whether the independent variables are measuring different or the same underlying variable. Other techniques, discriminant analysis in particular, determine the contribution provided by each independent variable to a composite variable that maximally separates the data on the dependent variables. The omnibus MANOVA test is then followed by separate Analyses of Variance (ANOVA) for each independent variable. The F-ratios for the individual ANOVA's are adjusted (Bonferroni) to account for the fact that multiple tests are being performed. It is proposed here to perform MANOVA's and the associated univariate ANOVA's separately for each of the six experiments (AMR-NB and AMR-WB from each of the three listening labs). Examination of the results of these analyses will determine if there is a single composite independent variable for each experiment and whether these composites are similar across experiments and across listening labs. The results of these analyses will determine whether it is appropriate to combine the results across listening labs.

Pearson's correlation coefficients will be computed to identify and illustrate the inter-relationships among the dependent variables.

If the results can be legitimately combined across listening labs, a nested ANOVA for *Conditions* and *Listening Labs* will be conducted separately for each codec, AMR-NB and AMR-WB. Table 5 shows a generalized Source Table for the appropriate ANOVA with the effects of *Listening Labs* nested within the effects of *Subjects*.

One task of the Global Analysis exercise will be to provide an Excel spreadsheet to the individual Listening Labs for delivery of the raw ratings. The Global Analysis task will also include a comprehensive report containing the results of the various statistical analyses described above. Dynastat will present the final report at the February 2004 meeting of 3GPP-SA4.

Effect (Source of Variation)	F Ratio
Conditions	$MS_{\text{Cond}} / MS_{\text{Cond} \times \text{SwLL}}$
Subjects	---
Listening Labs (LL)	$MS_{\text{LL}} / MS_{\text{SwLL}}$
Subjects within LL (SwLL)	---
Conditions x Subjects	---
Conditions x LL	$MS_{\text{Cond} \times \text{LL}} / MS_{\text{Cond} \times \text{SwLL}}$
Conditions x SwLL	---
Total	---

Table 6. Generalized ANOVA Source Table for Combining Results across Listening Labs.

6. References

- S4-030564 Test Plan for the AMR Narrow-Band Packet Switched Conversation Test
- S4-030565 Test Plan for the AMR Wide-Band Packet Switched Conversation Test
- S4-030747 Test plan for Packet Switched Conversation Test. Comparison of quality offered by different speech coders.

Annex H:

Test Plan for Performance characterisation of VoIMS over HSDPA/EUL channels; listening only tests

H.1 Introduction

This annex describes subjective evaluation methods for characterising the overall performance of VoIMS over HSDPA/EUL radio channels. The main purpose is to evaluate and verify adequate subjective performance of the AMR and AMR-WB speech codecs defined in TS 26.114.

The VoIMS performance characterisation for HSDPA/EUL channels consists of subjective evaluation with listening-only and conversation test methodology. The former evaluates the basic subjective quality of the selected speech codecs when conducting buffer adaptation to the network delay variations. Listening-only tests are further completed with overall delay analysis. The latter is verifying the effect of overall delay variations in conversational situations.

Listening only tests will concentrate on the effect of channel error and channel jitter to speech quality instead of the impact of overall end-to-end delay in speech conversation. The end-to-end delay impact is considered in delay analysis conducted on the whole processed test material.

H.2 Listening only test conditions

Table H.1: Noise types for listening only test

Noise type	Level (dBSNR)
Clean	-
Car	15 dB
Cafeteria	20 dB

Table H.2: Test details for listening only

Listening Level	1	79 dBSPL
Reference Conditions (narrowband)	8	MNRU 5, 13, 21, 29, 37 dB, direct, clean 5.9 kbit/s, clean 12.2 kbit/s
Reference Conditions (wideband)	8	MNRU 5, 13, 21, 29, 37, 45 dB, direct, clean 12.65 kbit/s
Test Conditions	2	Fixed buffer (buffer size set to the average of adaptive JBM in the same network condition), adaptive JBM
Listeners	32	Naïve Listeners
Groups	4	8 subjects/group
Rating Scales	1	P.800.2 ACR (clean condition), DCR (background noise)
Languages	2	Finnish and Swedish
Listening System	1	Monaural headset audio bandwidth 3.4kHz (narrowband) 7.0 kHz (wideband). The other ear is open.
Listening Environment		Room Noise: Hoth Spectrum at 30dBA (as defined by ITU-T Recommendation P.800: Annex A, section A.1.1.2.2.1)
Number of Talkers	8	4 males, 4 females
Number of Samples/Talker	5	4 for the test, 1 for the preliminary items

Table H.3: Definition of Radio Network Conditions

Condition Name	Network Load: 40/45/60 per cell	Network Load: 80/100 per cell
DL: PedB3_km+PedA3_km	DL-LT	DL-HT
DL: VehA30km+Veh120km+PedB30km	DH-LT	DH-HT

UL: PedB3_km+PedA3_km	UL
UL: VehA30km+Veh120km+PedB30km	UH

Table H.4: Definition of Radio Network Channels conditions

Channel	Radio Network Condition
Ch1	DL-LT-UL
Ch2	DL-LT-UH
Ch3	DL-HT-UL
Ch4	DL-HT-UH
Ch5	DH-LT-UL
Ch6	DH-LT-UH
Ch7	DH-HT-UL
Ch8	DH-HT-UH

H.3 End-to-end delay analysis

An end-to-end delay analysis shall be evaluated in terms of characterizing the additional delay introduced by the tested jitter buffer. The analysis shall include a statistical representation of the buffering time for all channels as well as an analysis of the introduced error concealment operations from the jitter buffer, i.e so called late losses.

H.4 Listening only experiments

The goal of this test is to evaluate the impact of the HSDPA/EUL radio channel conditions on the speech quality especially when the channel is subject to packet losses and jitter. Subjective quality score and delay will be used as metrics to evaluate the results. The test will be designed based on P.800.Sec.6.2.

Table H.5: Test conditions for listening-only tests with AMR-NB

Cond.	Noise Type	Frame Loss Rate	Channel	AMR-Modes (fixed RTP delay)
1-1	Clean	0.01	Ch1	5.9kbit/s (150 ms)
1-2	Clean	0.01	Ch2	5.9kbit/s (150 ms)
1-3	Clean	0.01	Ch3	12.2kbit/s (150 ms)
1-4	Clean	0.01	Ch4	12.2kbit/s (150 ms)

Table H.6: Test conditions for listening-only tests with AMR-NB in background noise

Cond.	Noise Type	Frame Loss Rate	Channel	AMR-Modes (fixed RTP delay)
2-1	Car	0.01	Ch5	5.9kbit/s (150 ms)
2-2	Cafeteria	0.01	Ch6	5.9kbit/s (150 ms)
2-3	Car	0.01	Ch7	12.2kbit/s (150 ms)
2-4	Cafeteria	0.01	Ch8	12.2kbit/s (150 ms)

Table H.7: Test conditions for listening-only tests with AMR-WB

Cond.	Noise Type	Frame Loss Rate	Channel	AMR-WB (fixed RTP delay)
3-1	Clean	0.01	Ch1	12.65 kbit/s (150 ms)
3-2	Clean	0.01	Ch2	12.65 kbit/s (150 ms)

3-3	Clean	0.01	Ch3	12.65 kbit/s (150 ms)
3-4	Clean	0.01	Ch4	12.65 kbit/s (150 ms)

Table H.8: Test conditions for listening-only tests with AMR-WB in background noise

Cond.	Noise Type	Frame Loss Rate	Channel	AMR-WB (fixed RTP delay)
4-1	Car	0.01	Ch5	12.65 kbit/s (150 ms)
4-2	Car	0.01	Ch6	12.65 kbit/s (150 ms)
4-3	Cafeteria	0.01	Ch7	12.65 kbit/s (150 ms)
4-4	Cafeteria	0.01	Ch8	12.65 kbit/s (150 ms)

H.5 Test material processing

The term VoIP client is used to include speech encoder and RTP packetization on the sender side; a jitter buffer management (JBM) scheme and speech decoder on the receiver side. Figure 1 shows a test scenario.

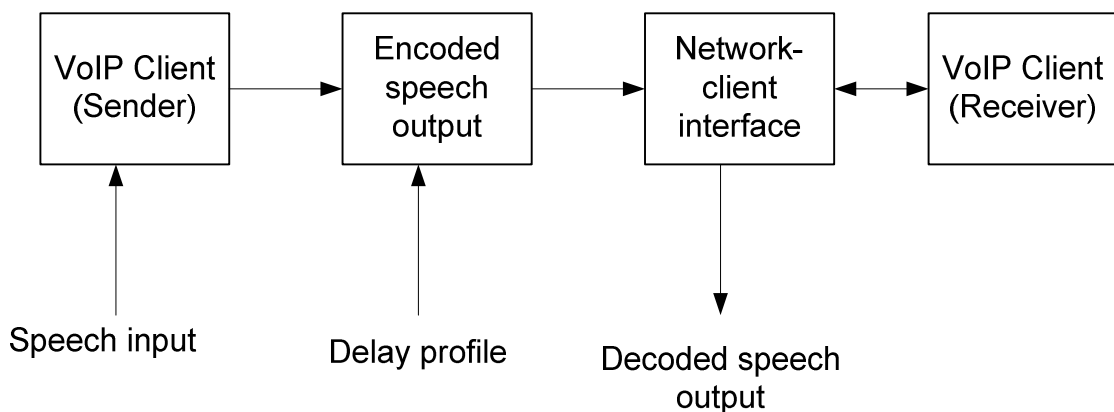

Figure H.1: Test setup for VoIP codecs for listening only test

The implementation of the system shown in Figure 1 has the following functional components:

- I VoIP Client/transmitter containing
 - a Pre-processing, including e.g. suitable pre-filtering and signal level control
 - b AMR/AMR-WB encoder
 - c RTP payload packetisation
- II Error insertion device (EID) applying error-delay patterns to the "transmitted" RTP stream
- III VoIP Client/receiver (and Network interface) containing
 - a RTP payload depacketisation
 - b Jitter buffer management (JBM)
 - c AMR/AMR-WB decoder
 - d Post-processing

For the listening-only test, the simulator can be implemented as an off-line tool. It includes Voice Encoding, RTP packetisation and error Insertion. Here, the error insertion device reads input RTP stream stored into a file, applies given error-delay pattern, and writes modified output RTP stream into a file. For this purpose the following storage protocol is introduced:

The raw-data speech (linear PCM masked to 14 bits at 8 kHz sampling rate for AMR-NB and at 16 kHz sampling rate for AMR-WB) is carried within VoIP client and receiver. The encoder output is then stored with the AMR-NB/AMR-WB file storage format according to media types audio/amr and audio/amr-wb, as specified in sections 5.1 and 5.3 of RFC 3267. The data exchanged between RTP packetization/depacketisation and error insertion device is a stream of encapsulated RTP packets in the RTPdump format shown in Table 9 and Table 10.

Table H.9: RTPdump file header elements.

Element	Size	Description
Start	32 bits ("struct timeval")	Start time (GMT) of the file
Source	32 bits ("long")	Source (IP) address
Port	16 bits ("short")	UDP port number
Padding	16 bits ("short")	Padding data to provide 32-bit alignment

Table H.10: RTPdump packet header elements.

Element	Size	Description
Length	16 bits ("short")	Length of the packet (in bytes), including this header
Plen	16 bits ("short")	Length of the RTP packet (RTP header + RTP payload)
Offset	32 bits ("long")	Milliseconds since the start of the file

Preparation of the evaluation speech material can be based on the following pseudo code:

```

Read in first speech packet
receivedPktTime = time of first received speech packet,
playoutTime = time of the first received speech packet.
lastReceivedPkt = 0
do {
    While (receivedPktTime <= playoutTime) {
        Deliver the received speech packet to the VoIP client
        Read in next speech packet
        Set receivedPktTime = time of next received speech packet
        If (no more packets) {
            lastReceivedPkt=1
            break;
        }
    }
    While (playoutTime < receivedPktTime) {
        Request speech samples from VoIP client
        VoIP client returns Tp sec of speech samples
        Write out Tp sec to file output
        Set playoutTime = playoutTime + Tp
    }
} While (VoIP client has PCM samples & lastReceivedPkt==1)

```

The VoIP client should, when requested speech samples, return short duration of PCM samples, e.g., 1ms. To ensure fair testing and verify the de-jitter and time warping aspects in a VoIP system, the network-decoder interface controls (i) the delivery of encoded speech packets to the speech decoder and (ii) controls the output of speech data from the speech decoder. However, to enable more realistic operation, the VoIP client is given the freedom of deciding how many speech samples it wants to output for each NCIM speech output request.

Annex I:

Illustrative scheme for jitter buffer management

This annex describes an illustrative example on jitter buffer management (JBM) solution. This illustrative example is described as pseudo code in Section I.1, and Section I.2 provides a performance analysis of one particular implementation according to the pseudo code.

I.1 Pseudo code

The pseudo code consists of two main parts:

- 1) Reception functionality, including the decapsulation of received RTP payload and storing the received speech frames into a buffer.
- 2) Decoding functionality, taking care of reading the frames from the buffer and providing a frame of decoded speech (or error concealment data) upon request.

To illustrate the relationship between these two functional parts in a simple way, the pseudo code is structured in a form of a simulation model in which a main loop handles the reception and decoding functionalities:

- The *main loop* models the time line – at each execution of this loop the simulated "wall clock time" is increased by one clock tick. Furthermore, the other two loops – reception loop and the decoding loop – are implemented inside the main loop.
- The *reception loop* is executed as many times as needed to process the new packets available at the packet input at/before current time.
- The *decoding loop* is executed as many times as needed to process all frames in the buffer scheduled for decoding at/before current time.

It is straightforward to implement the contents of the *reception loop* in function that is called each time a new RTP payload is received to provide the reception functionality. Similarly, the operations in the *decoding loop* can be implemented in a function that is called each time the audio device requests a new frame of speech to provide the decoding functionality.

Table I.1 describes the variables used in the pseudo code. Note that in addition to variables introduced in the table, the pseudo code also uses the constant `FRAME_DURATION` to indicate a frame duration as number of RTP clock ticks (`FRAME_DURATION = 160` for AMR, `FRAME_DURATION = 320` for AMR-WB). Furthermore, constants `THR1` and `THR2` are used to control the fine tuning of the onset frame buffering time.

Table I.1: Variables used in the pseudo code.

Variable	Purpose	Description / usage
current_time	Current simulation time as clock ticks at RTP time stamp clock rate	The current time is initialised to random value – indicated by "NOW" in the pseudo code. The value is increased by one at the each execution of the main loop to simulate the passing of time.
rx_time	Reception time of the current/next RTP packet (as clock ticks at RTP time stamp clock rate)	The reception time is initialised to the same value as current_time. The value is updated each time a new packet is available in the packet input.
dec_time	Decoding time of the next frame (as clock ticks at RTP time stamp clock rate)	The value is initialised by adding the value of desired buffering delay JBM_BUFFER_DELAY for the initial value of the current_time. This variable is updated after each decoded frame by increasing the value by number of RTP clock ticks corresponding to one frame (160 ticks for 8 kHz clock rate used for AMR, 320 ticks for 16 kHz clock rate used for AMR-WB).
rtptime	RTP timestamp of the current/next RTP packet (as clock ticks at RTP time stamp clock rate)	The value is updated each time a new input packet is captured
frame_ts	RTP timestamp of the current (received) frame (as clock ticks at RTP time stamp clock rate)	The frame timestamp value is set/updated when parsing a packet (containing several frames)
Next_ts	RTP timestamp of the frame to be decoded next (as clock ticks at RTP time stamp clock rate)	The variable is used both to request the next frame in decoding order from the buffer and to detect the frames that arrive late
end_of_input	Indication of input speech data status	A status variable that is initialised to value FALSE – the value is set to TRUE when the end of the input packet file is encountered.
buffer_occupancy	Buffer fill level in number of frames	A variable that is used to indicate buffering status – needed for detecting the end of the simulation and to detect buffer overflows.
loss_burst_len	Number of consecutive frames replaced by error concealment	The value of this variable is increased each time the decoder needs to invoke the error concealment operation. In case the value exceeds a predetermined threshold JBF_LOSS_PERIOD_THR, the re-synchronisation operation is initiated by setting resync_flag to value 1. In case of normal decoding the value of loss_burst_len is set to zero.
resync_flag	Flag to indicate that a re-synchronisation is needed.	See the description for the variable loss_burst_len above.
onset_flag	Indication that we are currently on the buffering time period before decoding the onset speech frame	The value of this variable is set to one in the reception loop when an onset frame (i.e. the first speech frame after a non-speech period) is received. The decoding loop sets this value to zero when a requested frame from a buffer has been found and decoded.
keep_frame_alignment	Indication whether the decoding time of a speech onset frame must be aligned with the current frame structure or not – i.e. whether the decoding must take place at time $T + n * 20$ ms, where T is the decoding time of the first frame of the session and n is an integer number.	Set to non-zero value to force keeping the original frame alignment at speech onsets, i.e. to force rounding the decoding time of the first frame of a talk spurt to occur at an integer multiple of 20 ms since the beginning of the session

```
/* INITIALISATION */
```

```
Read the first input frame, initialise variables based in received packet
```

```
/* NOTE that time is measured in speech samples at RTP clock rate – 8 kHz for AMR, 16 kHz for AMR-WB */
```

```
rx_time = current_time = NOW
next_ts = rtp_ts

/* Set the desired initial buffering delay */
dec_time = current_time + JBF_INITIAL_DELAY

end_of_input = FALSE
buffer_occupancy = 0
loss_burst_len = 0
resync_flag = 0
onset_flag = 0;

keep_frame_alingment = 1

/* MAIN LOOP */
WHILE end_of_input == FALSE OR buffer_occupancy > 0
{
  /* RECEPTION LOOP */
  WHILE end_of_input == FALSE AND rx_time <= current_time
  {
    /* Set RTP timestamp for the frame */
    frame_ts = rtp_ts

    /* Loop over all frames in the packet */
    WHILE more frames in this packet
    {
      /* Possible NO_DATA frames are discarded */
      IF frame_type != NO_DATA
      {
        IF speech onset detected
        {
          Find bt_min and bt_max, i.e. the minimum and maximum predicted
          buffering times over the period of JBF_HISTORY_LEN most recent frames

          /* Set new buffering time */
          buffer_delay = bt_max - bt_min

          /* Set this as the next frame to be decoded */
          next_ts = frame_ts

          /* Set decoding time */
          dec_time = current_time + buffer_delay

          /* Apply frame alignment if selected */
          IF keep_frame_alingment == 1
          {
            Move dec_time forward to the next frame boundary
          }

          /* Indicate for the decoder that we are buffering for speech onset */
          onset_flag = 1;
        }
      }
      /* Check if the decoder has set the re-synchronisation flag */
      ELSE IF resync_flag == 1
      {
        /* Continue decoding from the first frame arriving after a loss period
        */
        next_ts = frame_ts

        /* Clear the re-synchronisation flag */
        resync_flag = 0
      }
    }
  }
}
```

```

    }
    /* Check if received frame is late by less than one frame slot */
    ELSE IF frame_ts + FRAME_DURATION == next_ts AND TS >= next_ts NOT
    in the buffer
    {
        /* Re-schedule this frame to be the next frame to be decoded */
        next_ts = frame_ts
    }

    Compute predicted buffering time for the received frame and update
    buffering time history

    /* Check frame arrival time */
    IF frame_ts < next_ts
    {
        Discard the frame because it arrived late

        Update RX log: TIME = rx_time; RTP_TS = frame_ts; RX_STATUS = late_loss
    }
    ELSE
    {
        /* Check buffer occupancy */
        IF buffer_occupancy == MAX_BUFFER_OCCUPANCY
        {
            Discard the frame because the buffer is full

            Update RX log: TIME = rx_time; RTP_TS = frame_ts; RX_STATUS =
            overflow

        }
        ELSE
        {
            Store the frame into the buffer

            Update RX log: TIME = rx_time; RTP_TS = frame_ts; RX_STATUS = ok

            buffer_occupancy++
        }
    }
}

/* Update RTP timestamp for the next frame */
frame_ts += FRAME_DURATION

}

Read the next input packet

IF new packet available
{
    Update variables
    rx_time
    rtp_ts
}
ELSE
{
    end_of_input = TRUE
}

} /* end of RECEPTION LOOP */

```

```

/* DECODING LOOP */
WHILE dec_time <= current_time
{
  /* Fine tune onset buffering time */
  IF onset_flag == 1
  {
    first_ts = TS of the first frame in the buffer

    /* Early decoding of onset frame if buffer is filling too fast */
    IF buffer_occupancy * FRAME_DURATION - THR1 >= buffer_delay
    {
      next_ts = first_ts
    }
    /* Postpone decoding of onset frame if buffer is filling too slowly */
    ELSE IF buffer_occupancy * FRAME_DURATION + THR2 < buffer_delay AND
    next_ts == first_ts
    {
      next_ts -= FRAME_DURATION;
    }
  }
}

Request frame having the RTP timestamp value next_ts from the buffer

IF requested frame found
{
  Decode speech or generate comfort noise (SID or SID_FIRST frame) normally

  Update DEC log: TIME = dec_time; RX_TIME = rcv_time; RTP_TS = next_ts;
  DEC_STATUS = ok

  buffer_occupancy--

  /* Clear lost burst counter */
  loss_burst_len = 0

  /* Clear speech onset flag */
  onset_flag = 0
}
ELSE
{
  IF in speech state
  {
    /* Increase lost burst counter */
    loss_burst_len++

    /* Check the loss period length */
    IF loss_burst_len > JBF_LOSS_PERIOD_THR
    {
      Find the oldest frame in the buffer

      IF a frame having a time stamp value new_ts found
      {
        Decode the frame found in the buffer (i.e. reset the decoding to
        continue from the oldest frame found in the buffer)

        Update DEC log: TIME = dec_time; RX_TIME = rcv_time; RTP_TS =
        new_ts; DEC_STATUS = ok

        buffer_occupancy--

        /* Set the time stamp */

```

```

        next_ts = new_ts

        /* Clear lost burst counter */
        loss_burst_len = 0
    }
    ELSE
    {
        Invoke error concealment

        Update DEC log: TIME = dec_time; RX_TIME = N/A; RTP_TS = next_ts;
        DEC_STATUS = error_concealment

        /* Set the re-synchronisation flag to trigger the decoding to
        continue from the next arriving frame */
        resync_flag = 1
    }
}
ELSE
{
    Invoke error concealment

    Update DEC log: TIME = dec_time; RX_TIME = N/A; RTP_TS = next_ts;
    DEC_STATUS = error_concealment
}
}
ELSE
{
    /* DTX */
    Continue comfort noise generation

    Update DEC log: TIME = dec_time; RX_TIME = N/A; RTP_TS = next_ts;
    DEC_STATUS = comfort_noise
}
}

/* Update variables for decoding the next frame */
dec_time += FRAME_DURATION
next_ts += FRAME_DURATION
} /* end of DECODING LOOP */

/* CLOCK/TIMER UPDATE */
current_time++
}

```

1.2 Verification against the minimum performance requirements

This section provides a verification of an implementation of JBM according to the pseudo code in Section I.1 against the minimum performance requirements specified in Section 8.2.3 of TS 26.114 [19]. The verification was performed by using the implemented JBM algorithm with the AMR codec. On each channel the simulation was repeated 20 times, each time with different random starting point on the channel. The results provided in the following subsections indicate the observed worst-case results (i.e. measured delay CDF closest to the delay requirement CDF and the highest jitter loss rate).

The constants used in the pseudo code are set to the values given in Table I.2 for the verification.

Table I.2: Constant values in pseudo code used in performance analysis.

Constant	Value
JBF_INITIAL_DELAY	160 [ticks at 8 kHz clock rate]
JBF_HISTORY_LEN	100 [frames]
JBF_LOSS_PERIOD_THR	5 [frames]

I.2.1 Delay performance

Figures from I.1 to I.6 below show the delay performance of the implemented JBM and comparison against the minimum performance requirement specified in Section 8.2.2.2.2 of TS 26.114 [19]. The solid blue curve denotes the delay CDF for the implemented JBM, and the black dash-dotted curve indicates the delay requirement CDF.

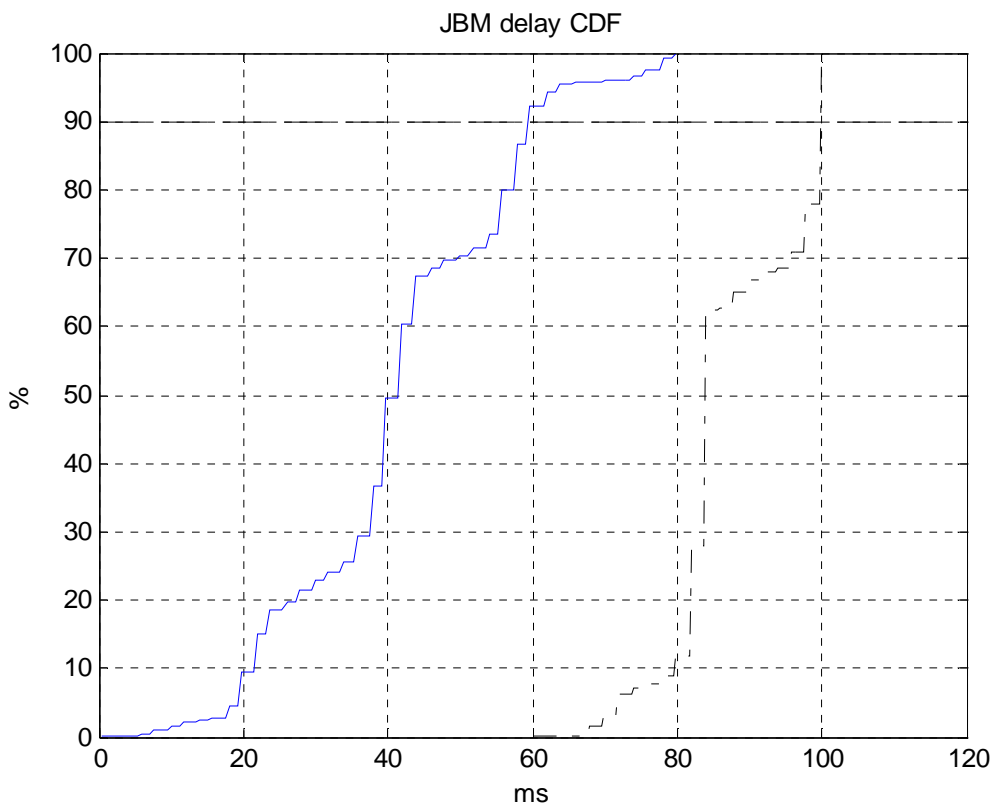

Figure I.1: Delay performance of the implemented JBM on channel 1.

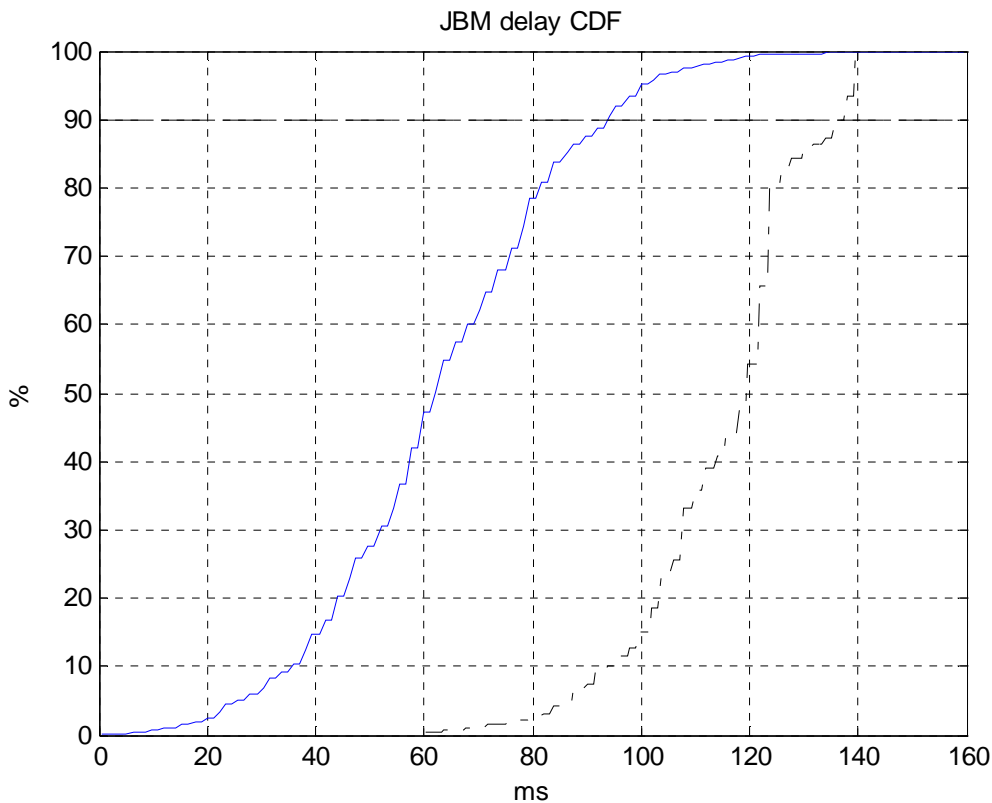

Figure I.2: Delay performance of the implemented JBM on channel 2.

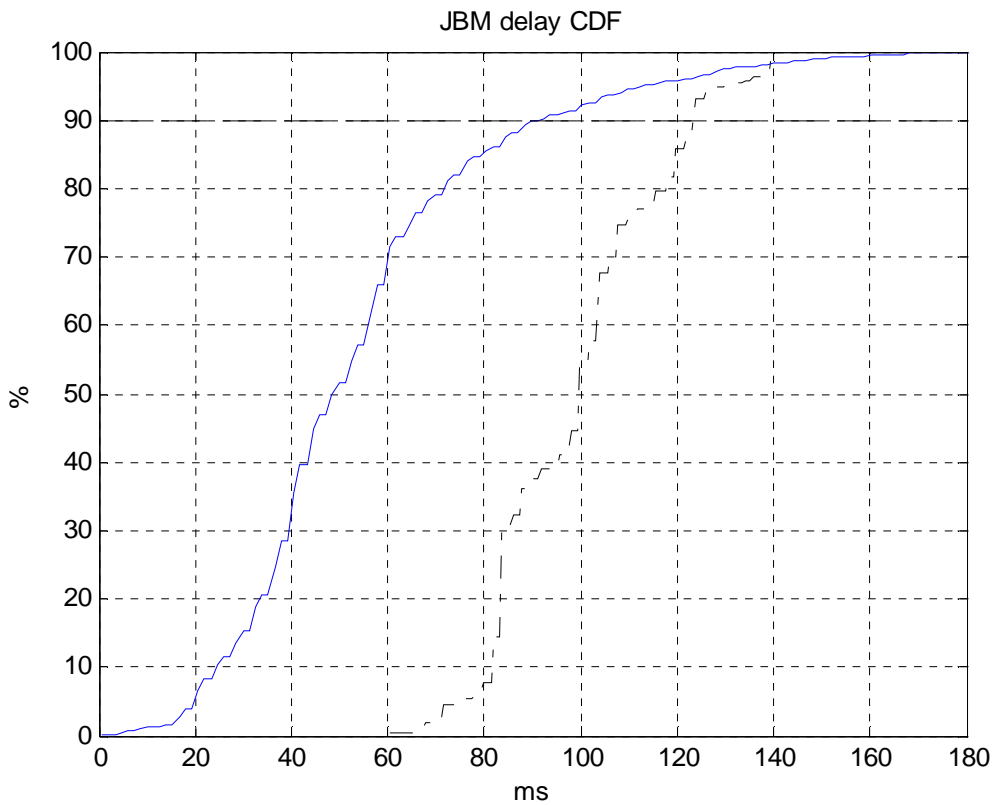

Figure I.3: Delay performance of the implemented JBM on channel 3.

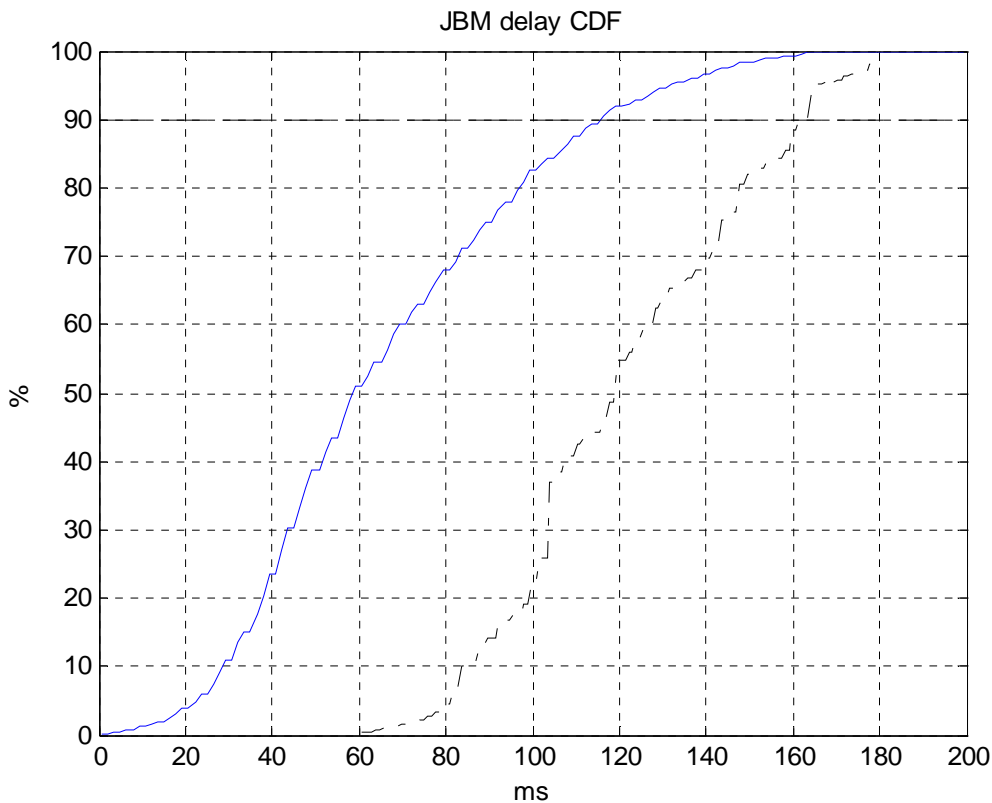

Figure I.4: Delay performance of the implemented JBM on channel 4.

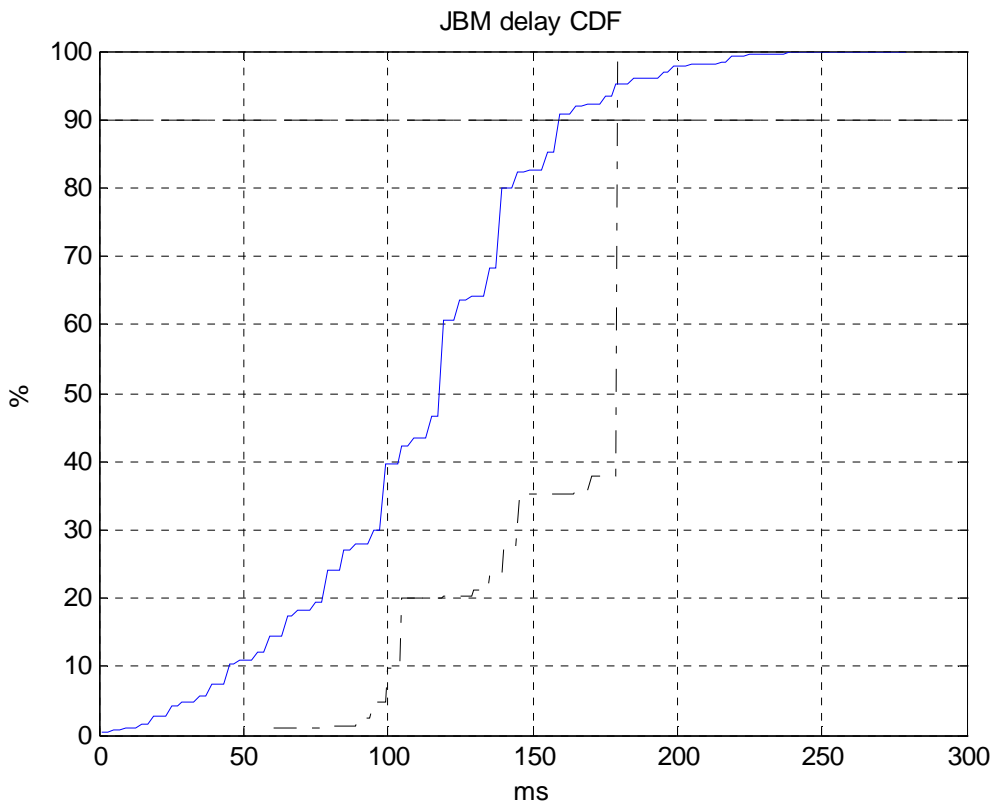

Figure I.5: Delay performance of the implemented JBM on channel 5.

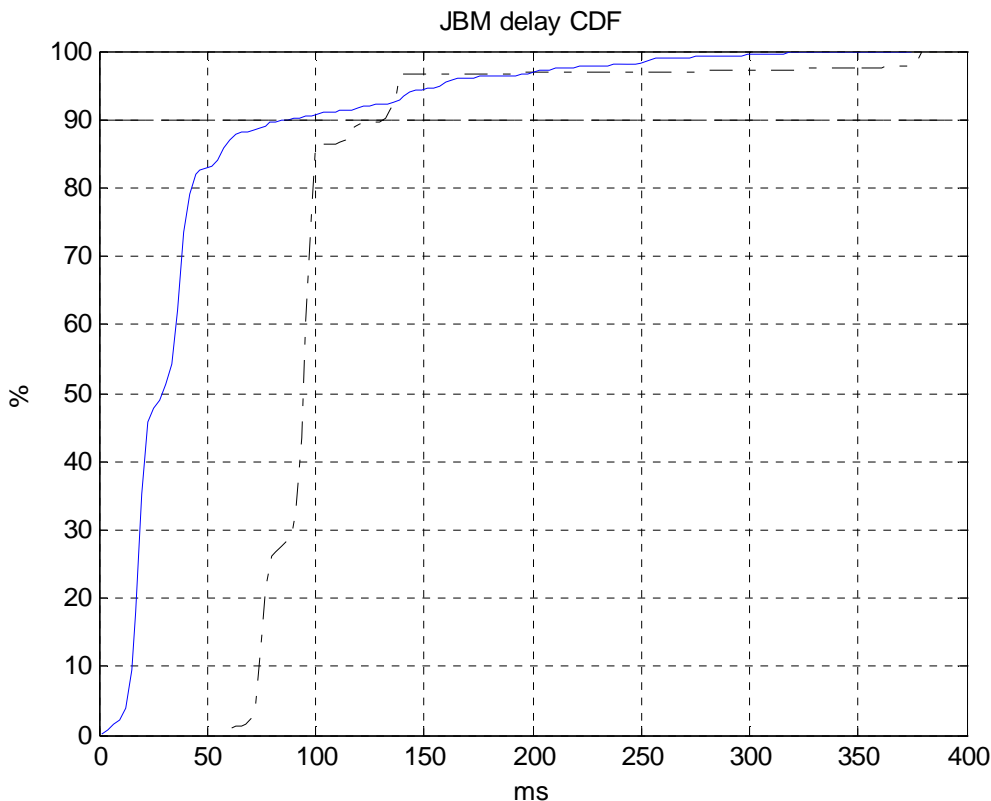

Figure I.6: Delay performance of the implemented JBM on channel 6.

1.2.2 JBM induced error concealment operations

Table I.3 summarizes the jitter loss rates of the implemented JBM for all test channels, computed as specified in TS 26.114 Section 8.2.3.2.3.

Table I.3: The jitter loss for the tested JBM on test channels.

Channel	1	2	3	4	5	6
JBM loss rate	0.07 %	0.40 %	0.15 %	0.72 %	0.95 %	0.57%

Annex J: Test processing for listening only tests

This section specifies the method for the processing of the speech material for the VoIMS over HSDPA/EUL listening only tests. The processing steps are illustrated by block diagrams for a clear understanding of the processing step. The processing of the speech material will be performed using the ITU-T's Software Tool Library Release 2000 (STL2000).

J.1 Speech preparation

The processing steps required for generation of the speech samples are described below.

J.2 Pre-processing

The first step is concatenation where all available speech samples are merged into one long speech file. This file is then pre-processed according to the figure below.

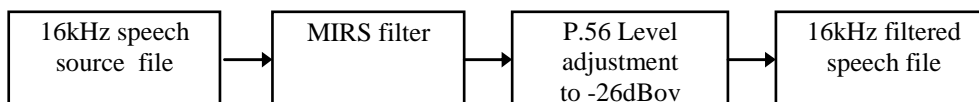

Figure J.1. Pre-processing of MIRS filtered speech file

STL2000 syntax

```

concat infile1 ... infileN outfile
filter -mod IRS16 infile outfile
sv56demo -lev -26 -sf 16000 infile outfile
  
```

J.3 Processing of speech/background noise signal

Noise files are filtered by the MIRS filter. The noise files are then converted to a near-field perception using the Δ SM filter.

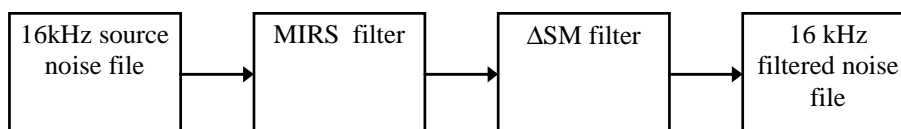

Figure J.2. Noise processing

STL2000 syntax

```

filter -mod IRS16 infile outfile
filter DSM infile outfile
  
```

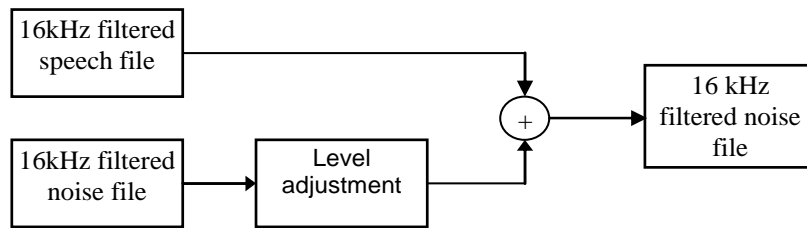

Figure J.3. Background noise mixing

STL2000 syntax

```
sv56demo -rms -lev -26 -sf 16000 infile noisefile
oper -gain dB 0 speechfile + AL noisefile 0 mixedfile
```

AL should be -15 for the car noise and -20 for the café noise.

J.4 Up and Down-Sampling, Rounding and Scaling

Up- and down-sampling is needed because the sample rate of the original speech files is 48 kHz, the processing is made with 8/16 kHz sampling and the listening was made with 16 kHz. The figure below describes the up- and down-sampling between 16 kHz and 8 kHz.

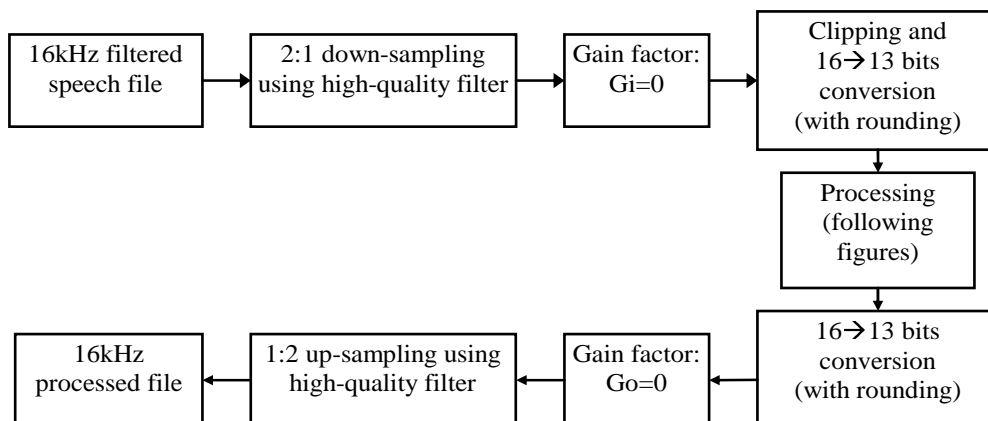

Figure J.4. Sample-rate conversion, rounding and scaling for narrow-band filtered conditions

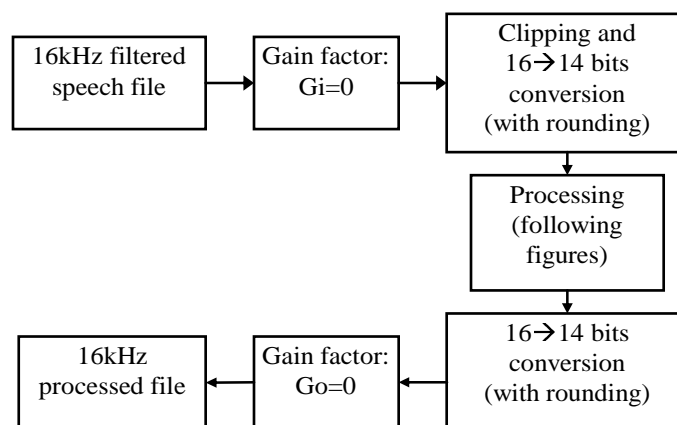

Figure J.5. Sample-rate conversion, rounding and scaling for wideband-band filtered conditions

STL2000 syntax (narrow-band)

```
filter -down HQ2 infile outfile
scaldemo -dB -gain 0 -bits 13 -round -nopremask -blk 160 infile outfile
```

(Processing ...)

```
scaldemo -dB -gain 0 -bits 13 -round -nopremask -blk 160 infile outfile
filter -up HQ2 infile outfile 160
```

STL2000 syntax (wide-band)

```
scaldemo -dB -gain 0 -bits 14 -round -nopremask -blk 320 infile outfile
```

(Processing ...)

```
scaldemo -dB -gain 0 -bits 14 -round -nopremask -blk 320 infile outfile
```

J.5 Processing for Direct Conditions

The processing for 'direct' conditions is very simple.

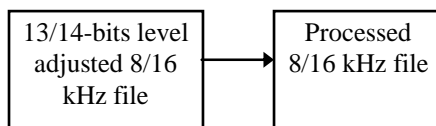

Figure J.6. Processing of speech for 'direct' conditions

13 bits 8 kHz for AMR-NB, 14 bits 16 kHz for AMR-WB

J.6 Processing for MNRU conditions

MNRU conditions are generated as shown in the figure below.

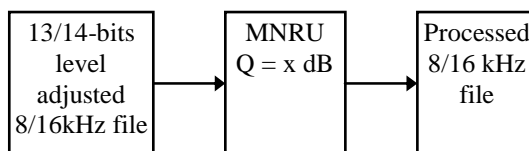

Figure J.7. Processing of narrow-/wideband MNRU conditions.

For AMR-NB the format of the infile is 13 bits 8 kHz and the MNRU levels are 5, 13, 21, 29, 37 dBq. For AMR-WB the format of the infile is 14 bits 16 kHz and the MNRU levels are 5, 13, 21, 29, 37, 45 dBq.

STL2000 syntax (narrow-band)

```
mnrudemo -Q x infile outfile 160 /* x = dBq level */
```

STL2000 syntax (wide-band)

```
mnrudemo -Q x infile outfile 320 /* x = dBq level */
```

J.7 Processing of voice over IMS over HSPA

The reference conditions with fixed JBM and the test conditions with adaptive JBM are processed as described below.

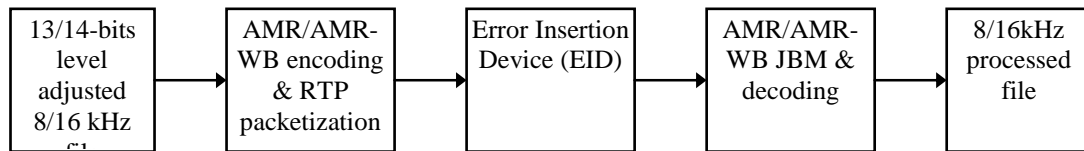

Figure J.8. Processing of voice over IMS over HSPA.

The output from the encoder/RTP packetization and the input to the JBM/decoder is in RTP-dump format.

The fixed JBM initial buffering delay is set in such a way that the resulting end-to-end delay (including channel delay and buffering delay) is similar to the average end-to-end delay of the adaptive JBM in the same test condition.

Command syntax for AMR/AMR-WB encoding & RTP packetization

```
amr_enc -dtx -fpp 1 -mode x -if infile -of outfile /* x = 2 for 5.9 kbit/s mode,
x = 7 for 12.2 kbit/s mode */
```

```
amrwb_enc -dtx -fpp 1 -mode 2 -if infile -of outfile /* x = 2 for 12.65 kbit/s
mode */
```

Command syntax for EID processing

```
EID_rtpdump -bs 24 -ps 128 -bl 20 -st x -df channelfile -if infile -of outfile
/* x = offset to the channel file */
```

Command syntax for adaptive JBM & AMR/AMR-WB decoding

```
amr_dec -bt 20 -bs 20 -if infile -of outfile
amrwb_dec -bt 20 -bs 20 -if infile -of outfile
```

Command syntax for fixed JBM & AMR/AMR-WB decoding

```
amr_dec_fixed -bt x -bs 20 -if infile -of outfile /* x = buffering time for the
1st received frame */
```

```
amrwb_dec_fixed -bt x -bs 20 -if infile -of outfile /* x = buffering time for
the 1st received frame */
```

J.8 Post-processing

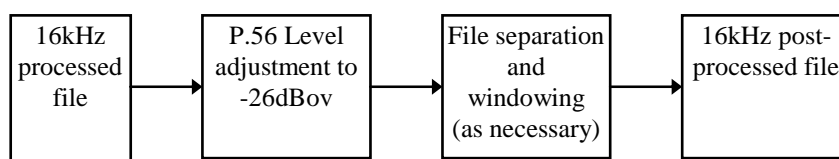

Figure J.8. Post processing.

A window of length 1600 samples was used in the file separation.

STL2000 syntax

```
sv56demo -lev -26 -sf 16000 infile outfile
astrip -wlen 1600 -blk 128000 -start no -n 1 infile outfile_no /* no = file
number i.e. 1 to 40 */
```

J.9 Test conditions

The test conditions are described below:

Table J.1. Test conditions

Cond.	Codec	JBM	Noise Type	Frame Loss Rate	Channel	AMR-Modes (fixed RTP delay)
1	Direct NB		Clean			
2	Direct WB		Clean			
3	NB		MNRU 5 dBq			
4	NB		MNRU 13 dBq			
5	NB		MNRU 21 dBq			
6	NB		MNRU 29 dBq			
7	NB		MNRU 37 dBq			
8	WB		MNRU 5 dBq			
9	WB		MNRU 13 dBq			
10	WB		MNRU 21 dBq			
11	WB		MNRU 29 dBq			
12	WB		MNRU 37 dBq			
13	WB		MNRU 45 dBq			
14	AMR-NB	Fixed	Clean		Error free	5.9 kbit/s (150 ms)
15	AMR-NB	Fixed	Clean		Error free	12.2 kbit/s (150 ms)
16	AMR-NB	Fixed	Car		Error free	5.9 kbit/s (150 ms)
17	AMR-NB	Fixed	Car		Error free	12.2 kbit/s (150 ms)
18	AMR-NB	Fixed	Cafeteria		Error free	5.9 kbit/s (150 ms)
19	AMR-NB	Fixed	Cafeteria		Error free	12.2 kbit/s (150 ms)
20	AMR-WB	Fixed	Clean		Error free	12.65 kbit/s (150 ms)
21	AMR-WB	Fixed	Car		Error free	12.65 kbit/s (150 ms)
22	AMR-WB	Fixed	Cafeteria		Error free	12.65 kbit/s (150 ms)
23	AMR-NB	Fixed	Clean	0.01	Ch1	5.9kbit/s (150 ms)
24	AMR-NB	Fixed	Clean	0.01	Ch2	5.9kbit/s (150 ms)
25	AMR-NB	Fixed	Clean	0.01	Ch3	12.2kbit/s (150 ms)
26	AMR-NB	Fixed	Clean	0.01	Ch4	12.2kbit/s (150 ms)
27	AMR-NB	Fixed	Car	0.01	Ch5	5.9kbit/s (150 ms)
28	AMR-NB	Fixed	Cafeteria	0.01	Ch6	5.9kbit/s (150 ms)
29	AMR-NB	Fixed	Car	0.01	Ch7	12.2kbit/s (150 ms)
30	AMR-NB	Fixed	Cafeteria	0.01	Ch8	12.2kbit/s (150 ms)
31	AMR-WB	Fixed	Clean	0.01	Ch1	12.65 kbit/s (150 ms)
32	AMR-WB	Fixed	Clean	0.01	Ch2	12.65 kbit/s (150 ms)
33	AMR-WB	Fixed	Clean	0.01	Ch3	12.65 kbit/s (150 ms)
34	AMR-WB	Fixed	Clean	0.01	Ch4	12.65 kbit/s (150 ms)
35	AMR-WB	Fixed	Car	0.01	Ch5	12.65 kbit/s (150 ms)
36	AMR-WB	Fixed	Car	0.01	Ch6	12.65 kbit/s (150 ms)
37	AMR-WB	Fixed	Cafeteria	0.01	Ch7	12.65 kbit/s (150 ms)
38	AMR-WB	Fixed	Cafeteria	0.01	Ch8	12.65 kbit/s (150 ms)
39	AMR-NB	Adaptive	Clean	0.01	Ch1	5.9kbit/s (150 ms)
40	AMR-NB	Adaptive	Clean	0.01	Ch2	5.9kbit/s (150 ms)
41	AMR-NB	Adaptive	Clean	0.01	Ch3	12.2kbit/s (150 ms)
42	AMR-NB	Adaptive	Clean	0.01	Ch4	12.2kbit/s (150 ms)
43	AMR-NB	Adaptive	Car	0.01	Ch5	5.9kbit/s (150 ms)
44	AMR-NB	Adaptive	Cafeteria	0.01	Ch6	5.9kbit/s (150 ms)
45	AMR-NB	Adaptive	Car	0.01	Ch7	12.2kbit/s (150 ms)
46	AMR-NB	Adaptive	Cafeteria	0.01	Ch8	12.2kbit/s (150 ms)
47	AMR-WB	Adaptive	Clean	0.01	Ch1	12.65 kbit/s (150 ms)
48	AMR-WB	Adaptive	Clean	0.01	Ch2	12.65 kbit/s (150 ms)
49	AMR-WB	Adaptive	Clean	0.01	Ch3	12.65 kbit/s (150 ms)
50	AMR-WB	Adaptive	Clean	0.01	Ch4	12.65 kbit/s (150 ms)
51	AMR-WB	Adaptive	Car	0.01	Ch5	12.65 kbit/s (150 ms)
52	AMR-WB	Adaptive	Car	0.01	Ch6	12.65 kbit/s (150 ms)
53	AMR-WB	Adaptive	Cafeteria	0.01	Ch7	12.65 kbit/s (150 ms)
54	AMR-WB	Adaptive	Cafeteria	0.01	Ch8	12.65 kbit/s (150 ms)
55	Direct NB		Car			
56	Direct NB		Cafeteria			
57	Direct WB		Car			

58	Direct WB		Cafeteria			
----	-----------	--	-----------	--	--	--

Annex K: Radio network simulation for HSDPA/EUL performance characterization

Two different radio network simulators were used to produce the radio network conditions used in the HSDPA/EUL performance characterization tests. Although both tests used the same RAB configurations, there were some subtle differences beyond the downlink schedulers and the lengths of the resulting channel profiles. The channel profiles used in the testing were constructed based on results from both simulations.

The system simulation was dynamic and included explicit modelling of fast fading, power control, CQI generation, scheduling of users, etc. Channels that connected different transmit/receive antenna pairs were generated at the UMTS slot rate (1500Hz). The instantaneous SINR seen at each receiver was computed at the slot rate. Virtual decoders mapped a sequence of slot rate SINRs to block error events at the TTI rate for each physical channel. The virtual decoders must generate the same statistical block error events as the true decoders operating on a bit by bit basis in a link level simulation for the same TTI rate for each physical channel under consideration.

Inner and outer loop power control loops were explicitly modelled for the associated DPCH. The OVFSF code and transmit power resources consumed by the associated DPCH and HS-SCCH channels were modelled dynamically. Errors made in HS-SCCH decoding were taken into account in determining whether the corresponding HS-DSCH transmission is decoded correctly.

The system simulation attempted to model sufficiently the MAC-d PDU flow and performance from the NodeB to the UE. Thus, the system simulation was considered an "over-the-air" model and did not capture impairments beyond the NodeB to UE subsystem

The RAB configuration can be found in 3GPP TS 25.993, sections 7.5.3 and 7.5.4. The respective simulator parameters are shown in the tables later in this section.

The results from each respective simulation were then assembled into channel profiles in the following way.

- The results from simulation 1 entailed 16 samples for down link and 16 samples for up link with paired channel conditions PedB_3km, PedB30km, VehA_30km and VehA_120km. The location of the reference user was fixed for all simulations.
- The results from simulation 2 entailed 22 samples, where 20 are for the down link and two for the up link, representing a paired channel PedB_3km. The difference between the 20 samples lied in the network load (number of users) and the location of the reference user (geometry).

Table K.1: File attributes of the available data

Attribute Name	Details	Number
Link Direction	Up-Link, Down-link	2
Network Load	40,45,60,80,100	5
Channel Model	PedA-3km, PedB-3km, PedB30km, VehA-30km, VehA- 120 km.	5

The definition of the conditions follows the conventions given below.

Table K.2: Definition of the radio network conditions

Radio Network Condition	Low Traffic Down Link	High Traffic Down Link	Uplink
Low Mobility Mobile	LM.LT	LM.HT	Lm
High Mobility Mobile	HM.LT	HM.HT	Hm

- Low Traffic (LT): 40, or 45, or 60 mobile users per cell
- High Traffic (HT): 80, or 100 mobile users per cell
- Low Mobility (LM, Lm): ITU –Channel-Model: PedB3_km or PedA3_km

- High Mobility (HM, Hm): ITU-Channel-Model: VehA30km or Veh120km or PedB30km

Table K.3: Simulation 1, radio network simulation parameters

Parameter	
UMTS BS Nominal TX Power [dBm]	43
P-CPICH Tx Power [dBm]	33
UMTS BS Overhead TX Power [dBm] including paging, sync and P/S-CCPCH	34
UMTS UE TX Power Class [dBm]	21
UMTS UE Noise Figure [dB]	10
BS Antenna Gain [dBi]	17.1
MS Antenna Gain [dBi]	0
Shadowing Standard Deviation [dB]	8
Path Loss Model: COST 231	$-136+35.22*\log_{10}(d)$, d in km
Shadow Site to site Correlation	50%
Other Losses [dB]	8
UMTS BS Antenna pattern beamwidth [degrees]	per TR 25.896 v6.0.0 A.3.1.1 65
Number of MS Antennas	2
Propagation Channel Mixture for loading users	25% AWGN 37% PedB 3 kph 13% PedB 30 kph 13% VehA 30 kph 12% VehA 120 kph
Number of loading users simulated	E-DCH: 40 UEs per cell HSDPA: 40/60/80/100 UEs per cell
Propagation Channel for the Reference UE	Case 1: PedB 3 kph Case 2: PedB 30 kph Case 3: VehA 30 kph Case 4: VehA 120 kph
Location for Reference UE	Case 1: One cell in active set, UE geometry = 3.3 dB Case 2: Soft handoff with 2 cells in active set, UE geometry = 3.0 dB, UE serving cell geometry = -0.7 dB
Ec/Io Admission Threshold	-18 dB
RSCP Admission Threshold	-115 dBm
Number of Node Bs	19 Node Bs/57 cells
Cell layout	3-Cell Clover-Leaf
Inter-site Distance [m]	2500
Frequency	1990 MHz

Table K.4 Simulation 1, traffic assumptions

Parameter	
User-Plane Traffic Model	100% VoIP
Vocoder Type	AMR 12.2
Vocoder Voice Model Loading Users	Markov Process with 50% activity (transition probability = 0.01)
Vocoder Voice Model Reference UE	100% activity
VoIP Packet Overheads	1 byte RLC UM header 4 bytes ROHC header
ROHC dynamics	Resynchronization ignored
RTCP	Not modeled
SIP	Not modeled
SID Frames	Not transmitted
RTP layer aggregation	None
MAC-d PDU Size	296 bits

Table K.5 Simulation 1, other simulation assumptions

Parameter	
UMTS Time Modelled [s]	60
Training Time [s]	5
UE Category	5
Receiver Type	Rake with Mobile Receive Diversity from 2 Antennas (2 Rx correlation = 0.5, mismatch 2 dB)
Downlink DCCH Traffic and Transport	DCCH mapped to HS-DSCH, F-DPCH used instead of assoc. DPCH. DCCH traffic modeled as 3.4kbps source with 5% activity factor.
Max. HSDPA Transmit Power (HS-SCCH + HS-PDSCH)	18 watt – power allocated for all common and dedicated channels
HS-SCCH Channel Model Number Errors Impact HS-DSCH Decoding Power Allocation	Depends on loading Yes Fixed Offset from F-DPCH
Downlink Over-the air Delay Budget [ms] (MAC-d to MAC-d)	90
Iub delay modelled	No
HSDPA Scheduler Implementation	Proprietary
Mobility Model	Static UE locations
E-DCH Scheduling	Non-scheduled transmission
E-DCH TTI length	Both 10ms TTI and 2ms TTI
E-DCH max number of HARQ transmissions	2 Tx for 10ms TTI 4 Tx for 2ms TTI
E-DCH QoS	Target 1% BLER post-HARQ
HS-DPCCH modeled for E-DCH simulation	Yes

Table K.6 Simulation 2, simulation assumptions**Parameters**

Multipath channel models	PA3 and PB3 Fader type: JTC.																					
User path loss and setup	PA3: Geometry from serving cell: 1.65 dB Soft-handover geometry: 5.8 dB Soft-handover legs: 2 PB3: Geometry from serving cell: 0.09 dB Soft-handover geometry: 5.22 dB Soft-handover legs: 2 Number of UE antennas: 1.																					
Node B resources	DL power reserved for common channels and DPCH for all users: 7.5 Watt (30%) 3 Watt for common channels + 1 Watt / ~100 users for DPCH Remaining power for all HS-SCCH and HS-PDSCH: 17.6 Watt OVSF codes reserved for common channels: <table border="1" data-bbox="592 607 1018 853"> <thead> <tr> <th>Channel</th> <th>SF</th> <th>Nb</th> </tr> </thead> <tbody> <tr> <td>CPICH</td> <td>256</td> <td>1</td> </tr> <tr> <td>P-CCPCH</td> <td>256</td> <td>1</td> </tr> <tr> <td>S-CCPCH</td> <td>256</td> <td>1</td> </tr> <tr> <td>E-AGCH</td> <td>256</td> <td>1</td> </tr> <tr> <td>AICH</td> <td>256</td> <td>1</td> </tr> <tr> <td>PICH</td> <td>256</td> <td>1</td> </tr> </tbody> </table> <p>OVSF code usage modeled for dedicated channels: F-DPCH + AICH Soft-handover overhead: 1.8 Up to 8 simultaneous HS-DSCH transmissions allowed.</p>	Channel	SF	Nb	CPICH	256	1	P-CCPCH	256	1	S-CCPCH	256	1	E-AGCH	256	1	AICH	256	1	PICH	256	1
Channel	SF	Nb																				
CPICH	256	1																				
P-CCPCH	256	1																				
S-CCPCH	256	1																				
E-AGCH	256	1																				
AICH	256	1																				
PICH	256	1																				
IMS VoIP packet format and overheads	AMR 12.2 kbps. VoIP packet with payload according to RFC3267. 24-bit ROHC overhead. 8-bit RLC overhead. No voice packet bundling.																					
VoIP traffic modelling	Voice users' frame boundaries are randomly time-staggered. SID transmitted every 160 ms of silence. Voice activity model for background users: ON and OFF periods of duration exponentially distributed, of average 3 seconds. 50% voice activity. Voice activity model for selected user : 100% voice activity																					
Signaling traffic	SRB, RTCP, and SIP not modeled.																					
HSDPA scheduling	VoIP traffic scheduler: Exponential scheduling rule with $a_i = 1$. SDU discarding in the MAC-HS modeled.																					
HSDPA feedback delays	CQI delay: 8 slots from time of measure to start of HS-PDSCH transmission. HARQ delay: minimum 15 slots from end of a transmission to start of a re-transmission.																					
HSDPA error modelling	HS-PDSCH: threshold-based decoder. HS-SCCH: threshold-based decoder. CQI: perfect estimation and with quantization errors. HS-DPCCH: HARQ feedback errors modelled with ACK false alarm probability of 10^{-3} and ACK mis-detection probability of 10^{-2} .																					
RAB for HSDPA	According to reference RAB configuration for VoIP over HSDPA in [5].																					
EUL format	2 ms TTI, 3 transmissions																					
EUL scheduling	Non-scheduled, autonomous transmissions. Delay from received packet re-ordering not modelled																					
EUL error modelling	No errors on E-HICH 4% independent errors on F-DPCH E-DPCCH power modelled, but assumed error-free HS-DPCCH not modelled																					
Simulation duration	3,000 warm-up slots 90,000 execution slots																					
RAB for EUL	According to reference RAB configuration for VoIP over EUL in [5].																					

Annex L: Test Plan for the AMR NB/WB Conversation Test in UMTS over HSDPA/EUL

L.1 Introduction

This document contains the test plan of a conversation test for the selected speech codecs of Adaptive Multi-Rate Narrow-Band (AMR-NB) and Adaptive Multi-Rate Wide-Band (AMR-WB) in Packet Switched networks with HSDPA/HSUPA radio interface, where HSUPA is also referred to as EUL, or EDCH within the terminology of 3GPP-TSG-RAN. All the laboratories participating in the conversation test will use the same test plan, while each laboratory uses a different test language. Even if the test rooms or the test equipments are not exactly the same in all the laboratories, the calibration procedures and the tests equipment characteristics will guarantee the similarity of the test conditions. The details of the test plan is given in the following in 3 sections:

- Section 2 gives the general information regarding the test.
- Section 3 details the test design and test methodology
- Section 4 provides procedure for the test arrangement and logistics

L.2 General Information

L.2.1 Permanent Documents

ITU-T Rec. P.800 Methods for Subjective Determination of Transmission Quality

ITU-T Rec. P.805 Conversational Tests

L.2.2 Key Acronyms

AMR-NB	Adaptive Multi-Rate Narrowband Speech Codec
AMR-WB	Adaptive Multi-Rate Wide-band Speech Codec
MOS	Mean Opinion Score
HSPA	High Speed Packet Access
HSDPA	High Speed Downlink Packet Access
HSUPA	High Speed Uplink Packet Access

L.2.3 Contacts

The following persons should be contacted for questions related to the test and test plan.

Responsibility	Contacts	Affiliation	Mail Address	Phone/Fax/Email
Coordination Test Bed	Jim McGowan	Alcatel-Lucent	67 Whippany Rd. Rm 2A-384, Whippany, NJ 07891, USA	Tel: +1 908 582 5667 Fax: +1-973-386-4555 mcgowan@lucent.com
3GPP-TSG-SA4-SQ-Chair	Paolo Usai	ETSI MCC	650 Route des Lucioles 06921 Sophia Antipolis Cedex France	Tel:+33 -4 92 94 42 36 Fax: + 33 4 93 38 52 06 paolo.usai@etsi.org
Background Noise Material	Alan Sharpley	Dynastat	6850 Austin Center Blvd., Ste.150 Austin, TX 78731	Tel.:+1-512-476-4797 Fax:+1-512-472-2883 asharpley@dynastat.com

L.2.4 Participants

Each test laboratory has the responsibility to organize its conversation tests. The list of the participating test laboratories is the following:

Lab	Company	Test Language	Contact
1	France Telecom	French	<p>Catherine Quinquis,</p> <p>France Telecom RD/TECH/SSTP Technopole Anticipa 2, Av P Marzin 22307 Lannion, Cédex, France</p> <p>Tel : +33-29605 1493</p> <p>Fax : +33-29605 3530</p> <p>catherine.quinquis@orange-ftgroup.com</p>
2	Dynastat	English	<p>Alan Sharpley,</p> <p>6850 Austin Center Blvd., Ste.150, Austin, TX 78731, US</p> <p>Tel.:+1-512-476-4797</p> <p>Fax:+1-512-472-2883</p> <p>asharpley@dynastat.com</p>
3	Beijing Institute of Technology	Chinese	<p>Prof. Xie Xiang,</p> <p>No.5 South Zhongguancun Street, Haidian District, Beijing 100081, China</p> <p>Phone: +86 10 68915838</p> <p>xiexiang@bit.edu.cn</p>

L.3 Test Methodology

L.3.1 Introduction

The method evaluates the effect of degradation on the quality of the communications through the conversation-opinion tests recommended by the ITU-T P.800. The conversation-opinion tests allow subjects in the test to be in a more realistic situation in terms of the actual service conditions experienced by telephone customers. In addition, the conversation-opinion tests are suited to assess the effects of impairments that can cause difficulty while conversing. Subjects participate

to the test in couple; they are seated in separate sound-proof rooms and are asked to hold a conversation through the transmission chain simulated by a computer that generates the impairment of the communication link considered typical for the packet switched network with HSDPA/HSUPA air-interface. The simulated network configurations (including the terminal equipments) will be symmetrical (in the two transmission paths as shown in Figure L.1, but the link conditions in each direction can be asymmetrical (to be elucidated later).

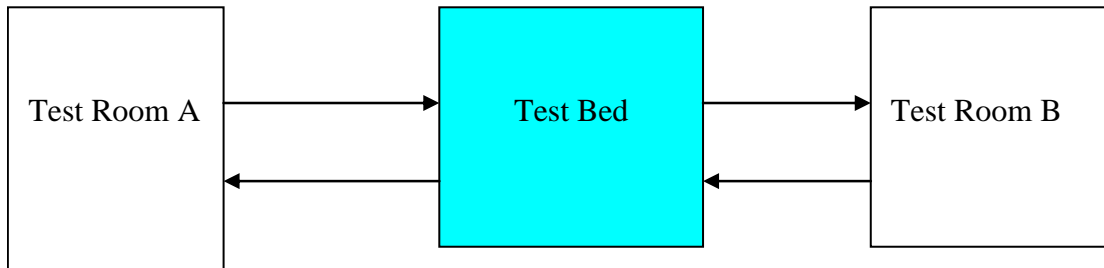

Figure L.1: Test Arrangement

L.3.2 Test Design

L.3.2.1 Description of the Test Bed

The test bed intends to provide an emulated transmission system that resembles the UMTS with HSDPA/HSUPA, as shown by Figure L.2. The real situation to be tested is a process in which a bit-stream is encoded by AMR packet-wise and transmitted through a HSUPA and HSDPA air-interfaces, so that it reaches the receiver, where it is decoded by AMR decoder packet-wise. The bit-stream encounters impairments while traversing through the system. The impairment is simulated by the simulator off-line and played into the test bed during the test.

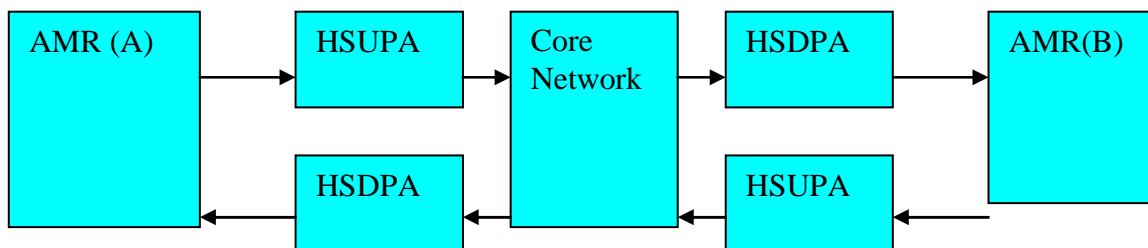

Figure L.2: UMTS system under test

Simulated transmission links are implemented in hardware through two computers, each being responsible for one direction, as shown in Figure L.3. The Internet Protocol is implemented in both computers. Each AMR frame generated by the AMR encoder is wrapped in a unique RTP packet every 20 ms. At the receiver the RTP packets are buffered and delayed according to the lower layer simulated receive time.

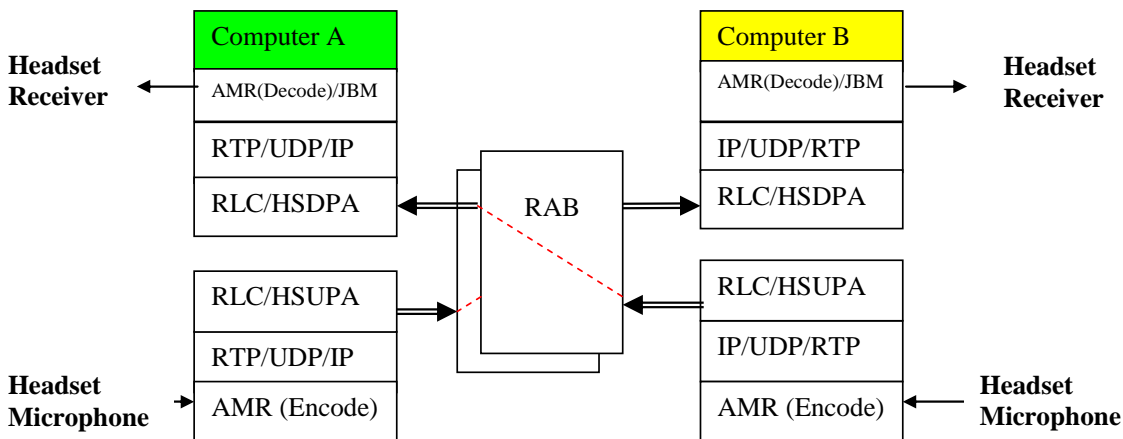

Figure L.3: Implementation of the Test Bed

The radio access bearer (RAB) represents the performance of the HSDPA/HSUPA of the physical layer. During the test, the test bed uses the delay-error profiles generated by the off-line simulation of the RAB. A software unit that inserts the off-line generated delays and errors into the RTP flows is implemented in each computer and allows selections of different network and channel conditions.

L.3.2.2 Transmission System

The transmission system is configured as a mobile-to-mobile connection within an IMS with HSDPA downlink and an HSUPA uplink. The protocol stack of the radio interface is shown in Figure L.4. The simulation of the performance of the radio interface simulator is based on a network layout of 19 cells and 57 sectors, while the output of the simulation is a sequence of RLC packet reception status. A RLC packet is transmitted from the mobile to the origination RNC, and from the destination RNC to the destination RNC via the core network, before reaching the receive mobile. The recorded traces include the delay and the error event of the received RLC packets.

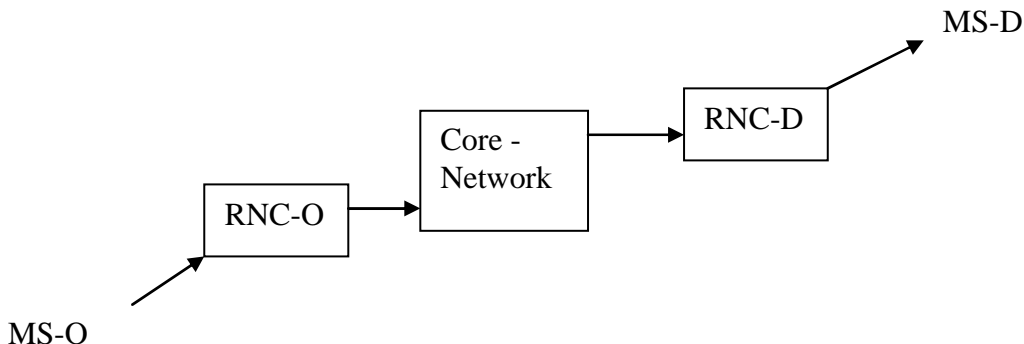

Figure L.4: Transmission path through a UMTS

The transmission of IP/UDP/RTP/AMR packets over the core network is not further simulated in details besides a static end-to-end delay.

L.3.2.3 Radio Access Bearers

The AMR-NB/AMR-WB will encode speech at a 5.9 kbps, 12.2 kbps, and 12.65 kbps, respectively. The bit-stream will be encapsulated using IP/UDP/RTP protocols and sent to the air-interface emulator located in the origination computer. The output of the air-interface is the payload of the IP packets, which are then sent through an RJ-45 port of the origination computer and received by the destination computer, where the RTP packets will be extracted and the AMR-NB/AMR-WB frames are buffered and decoded.

The RABs underlying the test are specified in TS 25.993 in the following sections:

"

7.5.3 - RB for Conversational / unknown UL: [max bitrate depending on UE category and TTI] on E-DCH DL: [max bitrate depending on UE category] on HS-DSCH / PS RAB
 + RB for interactive or background / UL : [max bitrate depending on UE category and TTI] on E-DCH DL : [max bitrate depending on UE category] on HS-DSCH / PS RAB
 + RB for interactive or background / UL : [max bitrate depending on UE category and TTI] on E-DCH DL : [max bitrate depending on UE category] on HS-DSCH / PS RAB
 + UL : [max bitrate depending on UE category and TTI] on E-DCH DL : [max bit rate depending on UE category] on HS-DSCH SRBs for DCCH"

7.5.4 RB for Conversational / Unknown UL: [max bitrate depending on UE category and TTI] on E-DCH DL: [max bitrate depending on UE category] on HS-DSCH / PS RAB
 + RB for interactive or background / UL : [max bitrate depending on UE category and TTI] on E-DCH DL : [max bitrate depending on UE category] on HS-DSCH / PS RAB
 + UL : [max bitrate depending on UE category and TTI] on E-DCH DL : [max bit rate depending on UE category] on HS-DSCH SRBs for DCCH"

"

L.3.2.4 Test environment

An external sound card will be used for each computer of the test bed. To avoid echo problems, headsets, instead of handsets will be used. The monaural supra-aural headsets, the other ear uncovered, are connected to the sound cards. But, in practice, the original settings, defined during the preliminary tests, and producing a comfortable listening level, will not be modified. A foam ball protects the microphones in order to reduce the "pop" effect. The user should avoid to place the acoustic opening of the microphone in front of the mouth

Each of the two subjects participating in the conversations is installed in a test room. They sit in an armchair in front of a table. The test rooms are acoustically insulated. All the test equipments are installed in a third room, connected to the test rooms. When needed, the background noise is generated in the appropriate test room through a set of 4 loudspeakers. The background noise level is adjusted and controlled by a sound level meter. The measurement microphone, connected to the sound level meter is located at the equivalent of the center of the subject's head. The noise level is A weighted.

Before the beginning of a set of experiments, the end-to-end transmission level is checked subjectively, to ensure that there is no problem. The speech level is checked by the following procedure: An artificial mouth placed in front of the microphone of the Headset A, in the LRGP position -See ITU-T Rec. P.64-, generates in the artificial ear (according to ITU-T Rec. P57) coupled to the earphone of the Head set B the nominal level defined in section 4.3. The level is adjusted according to the bandwidth to -15 dB Pa for NB and to -18 dB Pa for WB , when necessary, with the receiving volume control of the headset. Inverting headsets A and B does a similar calibration.

At each test laboratory the test bed must be calibrated, so that the given value of fixed delay for the speech transmission is the same for all labs.

L.3.3 Test Conditions

Three codec rates will be tested: AMR-NB 5.9 kbps and 12.2 kbps, as well as AMR-WB 12.65 kbps. Two different categories of test conditions are defined and their combination makes the actual test conditions.

Network Condition

Table L.1: Definition of the radio network conditions

Radio Network Condition	Low Traffic Down Link	High Traffic Down Link	Uplink
Low Mobility Mobile	LM.LT	LM.HT	Lm
High Mobility Mobile	HM.LT	HM.HT	Hm

In specifics:

- Low Traffic (LT): 40, or 45, or 60 mobile users per cell
- High Traffic (HT): 80, or 100 mobile users per cell
- Low Mobility (LM, Lm): ITU –Channel-Model: PedB3_km or PedA3_km
- High Mobility (HM, Hm): ITU-Channel-Model: VehA30km or Veh120km or PedB30km

The uplinks are simulated as dedicated channel, hence the traffic conditions apply only to the downlinks. From a mobile-to-mobile connection, the order of the uplink and downlink plays no role. Therefore, we have the following 8 possible construction of channel conditions:

Table L.2 Notation for the mobile-to-mobile radio network conditions

<i>Number</i>	<i>Notation</i>	<i>Meaning</i>
[1]	Lm.LT.LM	Lm + LT.LM
[2]	Lm.LT.HM	Lm+LT.HM
[3]	Lm.HT.LM	Lm+HT.LM
[4]	Lm.HT.HM	Lm+HT.HM
[5]	Hm.LT.LM	Hm+LT.LM
[6]	Hm.LT.HM	Hm+LT.HM
[7]	Hm.HT.LM	Hm+HT.LM
[8]	Hm.HT.HM	Hm+HT.HM

Acoustic Noise Condition

The condition refers the characteristic background noise of the subjects; four classes of noise will be deployed:

Noise type	Level (dB Pa)
Car	-30
Street	-35
Cafeteria	-35
Hoth	Spectrum at 30 dBA as defined by ITU-T, Recommendation P.800, Annex A, section A.1.1.2.2.1 Room Noise, with table A.1 and Figure

The production of background noise follows the guide lines of ETSI EG 202 396-1 (clause 6).

Combined Test Conditions

Each test condition is assigned a unique number defined as following:

x-y.z.c	x	y	Z	C
e.g. 1-1.3a	AMR-Mode	Network Load	Experiment	Swap subjects

Following conditions will be used for the tests:

AMR-Mode 5.9 kbps (x=1): 8 conditions (y=1), 8 conditions (y=2)

Cond. Label	Noise in Room A	Radio Network Condition	Noise in Room B	Description	Cond. Number
1-1.1	Hoth	A->B: [1] B->A: [1]	Hoth	Lm.LT.LM LM.LT.Lm	1
1-1.2	Car	A->B: [6] B->A: [6]	Car	Hm.LT.HM HM.LT.Hm	2
1-1.3a	Car	A->B: [5] B->A: [2]	Hoth	Hm.LT.LM HM.LT.Lm	3
1-1.3b	Hoth	A->B: [2] B->A: [5]	Car	Lm.LT.HM LM.LT.Hm	4
1-1.4	Cafeteria	A->B: [1] B->A: [1]	Cafeteria	Lm.LT.LM LM.LT.Lm	5
1-1.5a	Cafeteria	A->B: [2] B->A: [5]	Street	Lm.LT.HM LM.LT.Hm	6
1-1.5b	Street	A->B: [5] B->A: [2]	Cafeteria	Hm.LT.LM HM.LT.Hm	7
1-1.6	Street	A->B: [6] B->A: [6]	Street	Hm.LT.HM HM.LT.Hm	8
1-2.1	Hoth	A->B: [3] B->A: [3]	Hoth	Lm.HT.LM LM.HT.Lm	9
1-2.2	Car	A->B: [8] B->A: [8]	Car	Hm.HT.HM HM.HT.Hm	10
1-2.3a	Car	A->B: [7] B->A: [4]	Hoth	Hm.HT.LM HM.HT.Hm	11
1-2.3b	Hoth	A->B: [4] B->A: [7]	Car	Lm.HT.HM LM.HT.Hm	12
1-2.4	Cafeteria	A->B: [3] B->A: [3]	Cafeteria	Lm.HT.LM LM.HT.Lm	13
1-2.5a	Cafeteria	A->B: [4] B->A: [7]	Street	Lm.HT.HM LM.HT.Hm	14
1-2.5b	Street	A->B: [7] B->A: [4]	Cafeteria	Hm.HT.LM HM.HT.Lm	15
1-2.6	Street	A->B: [8]	Street	Hm.HT.HM	16

		B->A: [8]		HM.HT.Hm	
--	--	-----------	--	----------	--

AMR-Mode 12.2 kbps (x=2): 8 conditions (y=1), 8 conditions (y=2)

<i>Cond. Label</i>	<i>Noise in Room A</i>	<i>Radio Network Condition</i>	<i>Noise in Room B</i>	<i>Description</i>	<i>Cond. Number</i>
2-1.1	Hoth	A->B: [1] B->A: [1]	Hoth	Lm.LT.LM LM.LT.Lm	1
2-1.2	Car	A->B: [6] B->A: [6]	Car	Hm.LT.HM HM.LT.Hm	2
2-1.3a	Car	A->B: [5] B->A: [2]	Hoth	Hm.LT.LM HM.LT.Lm	3
2-1.3b	Hoth	A->B: [2] B->A: [5]	Car	Lm.LT.HM LM.LT.Hm	4
2-1.4	Cafeteria	A->B: [1] B->A: [1]	Cafeteria	Lm.LT.LM LM.LT.Lm	5
2-1.5a	Cafeteria	A->B: [2] B->A: [5]	Street	Lm.LT.HM LM.LT.Hm	6
2-1.5b	Street	A->B: [5] B->A: [2]	Cafeteria	Hm.LT.LM HM.LT.Hm	7
2-1.6	Street	A->B: [6] B->A: [6]	Street	Hm.LT.HM HM.LT.Hm	8
2-2.1	Hoth	A->B: [3] B->A: [3]	Hoth	Lm.HT.LM LM.HT.Lm	9
2-2.2	Car	A->B: [8] B->A: [8]	Car	Hm.HT.HM HM.HT.Hm	10
2-2.3a	Car	A->B: [7] B->A: [4]	Hoth	Hm.HT.LM HM.HT.Hm	11
2-2.3b	Hoth	A->B: [4] B->A: [7]	Car	Lm.HT.HM LM.HT.Hm	12
2-2.4	Cafeteria	A->B: [3] B->A: [3]	Cafeteria	Lm.HT.LM LM.HT.Lm	13
2-2.5a	Cafeteria	A->B: [4] B->A: [7]	Street	Lm.HT.HM LM.HT.Hm	14
2-2.5b	Street	A->B: [7] B->A: [4]	Cafeteria	Hm.HT.LM HM.HT.Lm	15
2-2.6	Street	A->B: [8] B->A: [8]	Street	Hm.HT.HM HM.HT.Hm	16

AMR-WB-Mode 12.65 kbps (x=3): 8 conditions (y=1), 8 conditions (y=2)

<i>Cond. Label</i>	<i>Noise in Room A</i>	<i>Radio Network Condition</i>	<i>Noise in Room B</i>	<i>Description</i>	<i>Cond. Number</i>
3-1.1	Hoth	A->B: [1]	Hoth	Lm.LT.LM	1

		B->A: [1]		LM.LT.Lm	
3-1.2	Car	A->B: [6] B->A: [6]	Car	Hm.LT.HM HM.LT.Hm	2
3-1.3a	Car	A->B: [5] B->A: [2]	Hoth	Hm.LT.LM HM.LT.Lm	3
3-1.3b	Hoth	A->B: [2] B->A: [5]	Car	Lm.LT.HM LM.LT.Hm	4
3-1.4	Cafeteria	A->B: [1] B->A: [1]	Cafeteria	Lm.LT.LM LM.LT.Lm	5
3-1.5a	Cafeteria	A->B: [2] B->A: [5]	Street	Lm.LT.HM LM.LT.Hm	6
3-1.5b	Street	A->B: [5] B->A: [2]	Cafeteria	Hm.LT.LM HM.LT.Hm	7
3-1.6	Street	A->B: [6] B->A: [6]	Street	Hm.LT.HM HM.LT.Hm	8
3-2.1	Hoth	A->B: [3] B->A: [3]	Hoth	Lm.HT.LM LM.HT.Lm	9
3-2.2	Car	A->B: [8] B->A: [8]	Car	Hm.HT.HM HM.HT.Hm	10
3-2.3a	Car	A->B: [7] B->A: [4]	Hoth	Hm.HT.LM HM.HT.Hm	11
3-2.3b	Hoth	A->B: [4] B->A: [7]	Car	Lm.HT.HM LM.HT.Hm	12
3-2.4	Cafeteria	A->B: [3] B->A: [3]	Cafeteria	Lm.HT.LM LM.HT.Lm	13
3-2.5a	Cafeteria	A->B: [4] B->A: [7]	Street	Lm.HT.HM LM.HT.Hm	14
3-2.5b	Street	A->B: [7] B->A: [4]	Cafeteria	Hm.HT.LM HM.HT.Lm	15
3-2.6	Street	A->B: [8] B->A: [8]	Street	Hm.HT.HM HM.HT.Hm	16

Preliminary training conditions are 1-1.1 and 1-1.2 (colored within red and blue, respectively, in the table)

Miscellaneous Conditions

Listening Level	1	79 dB SPL or 76 dB SPL (-15 dB Pa or -18 dB Pa)
Listeners/Speakers	32	Naïve Listeners/Native Speakers
Groups	16	2 subjects/group
Rating Scales	5	see section 4.2
Languages	3	French, English, Chinese
Listening System	2	Monaural headset (flat response in the audio bandwidth of interest: 50Hz-7kHz). The other ear is open.
Microphone	2	Frequency range: 100Hz-10kHz

L.4 Test Procedure

The procedure and logistic of the test across test laboratories are given in the following:

L.4.1 Time Projection

The following numbers characterizes the entire test:

#acoustic/radio conditions	8	2 subjects swapping
#network load conditions	2	Light, heavy
#codecs=#experiments per lab	3	5.9kbps, 12.2kbps, 12.65kbps
#languages	3	English, French, Chinese
#subjects per experiment	32	16 pairs

Each lab tests only one language. Each experiment covers 16 test conditions. Each group has to perform 16 conversations, each of ca. 3 minutes. A session consists of 4 consecutive conversations, corresponding to ca. 20 minutes test time. The subject panels for the three experiments shall be independent, i.e. no subject will participate in more than one experiment. The order of the presentation of test conditions are provided in Appendix 2.

The test time projection is the following:

- Practice and Training per group: 30 minutes
- Conversation plus setup and data collection: 5 minutes
- Break between sessions: 10 minutes
- Number of breaks per experiment: 3
- Work hours per day: 8 hours
- Work days per week: 5 days

This results in 3 groups per day, i.e. 6 working days per experiment, and 18 working days per laboratory, plus 1 day for system setup. In total, one month per laboratory is estimated as the minimum

The project plan can be envisioned as the following:

Test Month	Laboratories	Duration	Starting Date
Month 1	France Telecom	4 weeks	May 15, 2007
Month 2	BIT	4 weeks	June 19, 2007
Month 3	Dynastat	4 weeks	July 28, 2007
Month 4	Dynastat (GAL)	>1 week	August 28, 2007

The actual time will be adapted to the specific situation of the individual labs. The entire test is expected to take 3+ months.

L.4.2 Instructions to the Subjects

The following instruction shall be given to the subjects in each lab in the respective native language during the training phase prior to the tests.

"You are going to have a conversation with another user. The test situation is simulating communications between two mobile phones. The most of the situations will correspond to silent environment conditions, but some other will simulate more specific situations, as in a car, or in a railway station or in an office environment, when other people are discussing in the background.

After the completion of each call conversation, you will have to give your opinions on the quality, by answering to the following questions that will be displayed on the screen of the black box in front of you. Your judgment will be stored. You have 8 seconds to answer to each question. After "pressing" the button on the screen, another question will be displayed. You continue the procedure for the 5 following questions.

Question 1: How do you assess the sound quality of the other person's voice?

No distortion at all, natural	Minimal distortion	Moderate distortion	Considerable distortion	Severe distortion
-------------------------------	--------------------	---------------------	-------------------------	-------------------

Question 2: How well did you understand what the other person was telling you ?

No loss of understanding	Minimal loss of understanding	Moderate loss of understanding	Considerable loss of understanding	Severe loss of understanding
--------------------------	-------------------------------	--------------------------------	------------------------------------	------------------------------

Question 3: How would you assess your level of effort to converse back and forth during the conversation ?

No effort required	Minimal effort required	Moderate effort required	Considerable effort required	Severe effort required
--------------------	-------------------------	--------------------------	------------------------------	------------------------

Question 4: Did you detect (noises, cuts,)? Yes or no ? If yes, how annoying was it ?

No annoyance	Minimal annoyance	Moderate annoyance	Considerable annoyance	Severe annoyance
--------------	-------------------	--------------------	------------------------	------------------

Question 5: What is your opinion of the connection you have just been using ?

Excellent quality	Good quality	Fair quality	Poor quality	Bad quality
-------------------	--------------	--------------	--------------	-------------

From then on you will have a break approximately every 30 minutes. The test will last a total of approximately 60 minutes.

Please do not discuss your opinions with other listeners participating in the experiment."

L.4.3 Test Materials

The pretexts used for conversation test are those developed by ITU-T SG12. These scenarios have been elaborated to allow a conversation well balanced within both participants and lasting approximately 2'30 or 3', and to stimulate the discussion between persons that know each other to facilitate the naturalness of the conversation. They are derived from typical situations of every day life: railways inquiries, rent a car or an apartment, etc. Each condition should be given a different scenario. Each lab is responsible for developing the actual conversation materials to be used.

The examples are extracted from ITU-T rec. P.805 (2007) Appendices 4, 5 and 6.

Following the examples and the spirit given by this reference, the actual materials should be developed and adapted to the language being tested, the cultural specifics of the country of the lab and the local situations, depending on where the test lab is located.

L.4.4 Deliverables

The information required from each test laboratory is a table containing the "Opinion Score (OS)", in ASCII file or in spreadsheet, obtained from every subject for each conversation. No post processing is required from the labs. The original data are provided by each lab using a template that includes the following information:

Table L.3: Template for the raw data

Subject ID	Test Condition	Test Material	Rating	Conversation Partner ID	Time/Date	Comments

Raw data deliverable spreadsheet will be provided to the test labs by the Global Analysis Lab prior to the beginning of the tests.

L.4.5 Data Analysis

Two statistical analyses should be conducted on the data obtained with these subjective scales. The first analysis consists in a MANOVA, which globally indicates the possible effect of the experimental factors (*i.e.*, different conditions). Then, a specific ANOVA should be run on each dependent variable to test if there is an effect of a specific experimental factor for a given subjective variable. In other words, these statistical analyses indicate if the differences observed between the MOS obtained for the different conditions are significant, for any given dependant variable (ANOVA) or for the entirety of all the dependant variables (MANOVA). Finally, Pearson's linear correlations should be computed between the results of all subjective variables, to find out the specific dependent relations.

L.5 Working Document for the Performance Characterization of VoIMS over HSDPA/EDCH

L.5.1 Introduction

TR 26.935 provides information on the performance of default speech codec in packet switched conversational multimedia applications. The transmission of IP/UDP/RTP/AMR packets over the UMTS air interface (DCHs) was simulated using the Conversational / Speech / UL:46 kbit/s / PS RAB coming from TS 34.108 v. 4.7.0. During TSG SA#27 Tokyo [SP-050089], the new work item of "Performance Characterization of VoIMS over HSDPA/EUL" was approved. The goal of the work item is to test the codec performance when VoIP is supported by HS-DSCH in the DL and EDCH in the UL.

L.5.2 System Overview

The goal of the test system is to enable MOS tests of mobile-to-mobile conversational voice services in a representative UMTS system supporting VoIP over HSDPA/EDCH. The test system includes two independent links in opposite directions, used by the two parties of an active conversation, respectively. The two parties of the conversation are referred to as A and B, respectively. Thus, the entities of the test system occur always in pair, and the configuration of the link A-to-B and B-to-A are identical, reflecting the symmetry of the conversational connection.

The principle of the design of the test system is the balance of the fidelity to the reality and the feasibility of the implementation. The UMTS system and the IP network with the designated channel types and protocols will be simulated by means of digital computers. It is therefore important that a design of the test system allows for the verifications and repetitions, so that the correct implementation in software can be achieved with the highest probability. To this end, a modular design is taken.

Considering the fact that HARQ and ROHC introduce sources of delay jitters for the packets in both directions, it is necessary to implement them in two modules. Besides, the speech lab and the IP/Core network are both independent of RAN in nature, it is reasonable to divide the entire test system into 4 separate entities:

- RN simulator,
- IP/Core network simulator,
- VoIP simulator and
- Test Environment

This division results in 6 interfaces in each direction, as shown in Fig.1. On the high level, each entity has the following respective function:

- Radio Network (RN) Simulator: This simulates the performance of the protocol layers RLC/MAC/PHY for the downlink and the uplink, to produce statistics for the air interfaces on the RLC packet stream. It is noted that the RN simulator defined here is a sub-set of the RAN defined in the UMTS and it aims at capturing the RAN impacts that are essential to the VoIP performance characterisation.
- IP/Core Simulator: This simulates the routing through a loaded IPv6 network, to capture the impairments of packet loss and delay. For the purpose of testing the conversational services, only two entry/exit pairs for the IP core network are needed—one entry/exit for RN(A) and the other entry/exit for RN(B).
- VoIP Simulator: This simulates the VoIP specific functions between the sound cards and the RAN simulators, which comprises the speech encoder/decoder, AMR/RTP/UDP/IP/PDCP packetizing/depacketizing, robust header compression/decompression for both party A and party B of a conversation, etc. Physically, the two ends of the VoIP are located in the SRNC and belong to MAC-d entities of the two conversation parties, respectively.
- Speech Lab: This performs the MOS tests on the AMR/AMR-WB under the network conditions simulated by VoIP, RN and IP/Core. Each side of the conversation uses appropriate playback hardware. The requirement for the test material and the test subject can be taken from TR26.935.

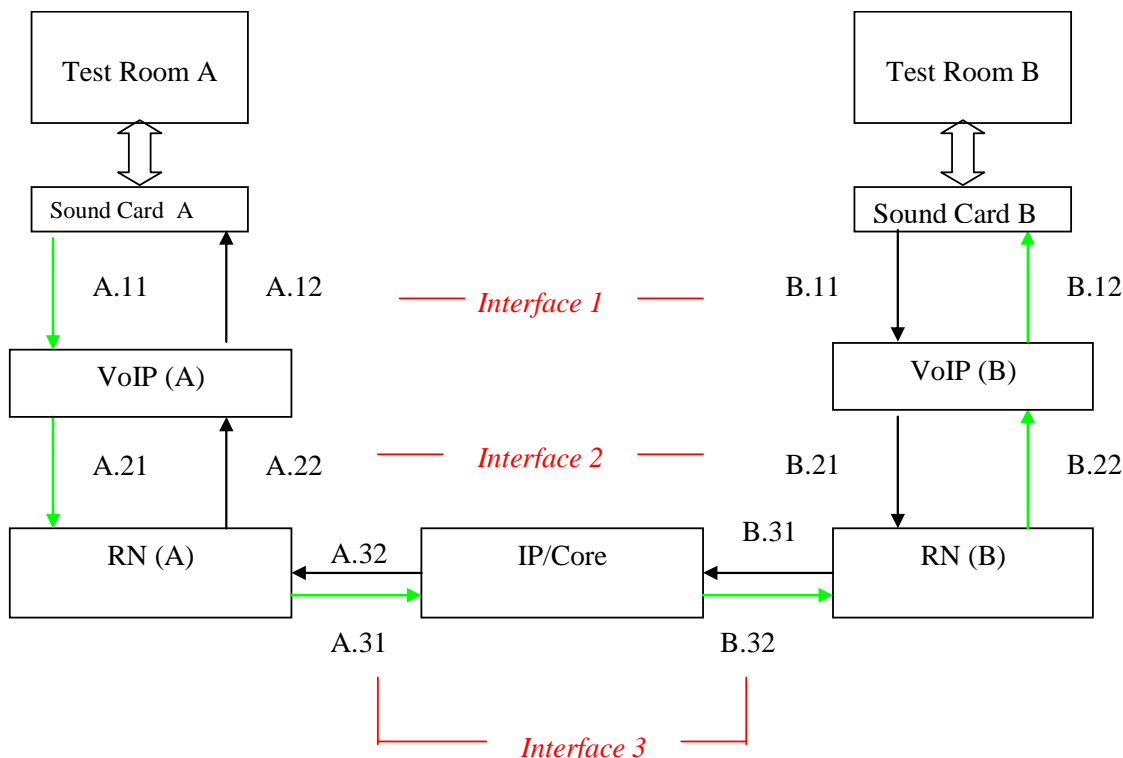

Figure L.5.1 Architecture of the Test System

The division of the test system into relatively independent entities serves to clarify the concepts involved. The modular structure allows for off-line simulation of each identified entity independently. However, the designated conversational test requires the availability of the simulated radio carrier in a real-time manner. The real-time simulation of the entire system is hardware limited due to the complexity of the RN simulator. Therefore a combination of the off-line simulation of the RN and the on-line simulation of the VoIP is considered. This is justified by the fact that a continuous stream of RLC PDUs can be produced by the RN simulator regardless of the payload.

L.5.3 Radio Access Bearers

The radio bearers used for the simulation of the lower layer delay and error performance are extracted from 25.993 in the following:

"

- 7.5.3 RB for Conversational / unknown UL: [max bitrate depending on UE category and TTI] on E-DCH DL: [max bitrate depending on UE category] on HS-DSCH / PS RAB
- + RB for interactive or background / UL : [max bitrate depending on UE category and TTI] on E-DCH DL : [max bitrate depending on UE category] on HS-DSCH / PS RAB
- + RB for interactive or background / UL : [max bitrate depending on UE category and TTI] on E-DCH DL : [max bitrate depending on UE category] on HS-DSCH / PS RAB
- + UL : [max bitrate depending on UE category and TTI] on E-DCH DL : [max bit rate depending on UE category] on HS-DSCH SRBs for DCCH

"

The minimum UE classes supporting this combination are : support of HS-PDSCH, DL on HS-PDSCH: category 11 and support of E-DPDCH, UL on E-DPDCH category 1.

This is supported in Release 6.

7.5.3.1 Uplink

	Radio Bearer on DPCH	Radio Bearer on E-DPCH	Signalling Radio Bearer on DPCH	Signalling Radio Bearer on E-DPCH
Transport Channel		7.5.3.1.1.1.1 for conversational RB, 6.10.2.4.6.1.1.1.1 of [1] for Interactive/Background RBs (MAC-e muxed)		7.5.1.1.1.1.1
TFCS				
Physical Channel	6.10.2.4.6.1.1.2.1 of [1] E-TFCI table index = 0; E-DCH minimum set E-TFCI = 29 (10 ms TTI, TB size 374 bits) or 32 (2 ms TTI, TB size 368 bits)			

Note: MAC-e multiplexing of scheduled and non-scheduled MAC-d flows is allowed.

7.5.3.1.1 Transport channel parameters

7.5.3.1.1.1 Transport channel parameters for E-DCH

7.5.3.1.1.1.1 MAC-d flow#1 parameters for conversational / Unknown UL: [max bit rate depending on UE category and TTI] on E-DCH / PS RAB

Higher layer	RAB/Signalling RB	RAB
PDCP	PDCP header size, bit	0
RLC	Logical channel type	DTCH
	RLC mode	UM
	Payload sizes, bit	88, 104, 136, 152, 168, 184, 200, 216, 280, 288, 304, 336 (alt 328)
	Max data rate, bps	Depends on UE category and TTI
	UMD PDU header, bit	8
MAC	MAC-e multiplexing	N/A
	MAC-d PDU size, bit	96, 112, 144, 160, 176, 192, 208, 224, 288, 296, 312, 344 (alt 336)
	Max MAC-e PDU content size, bit	(non-scheduled) (NOTE1)
	MAC-e/es header fixed part, bit	18
Layer 1	TrCH type	E-DCH
	TTI	10ms (alt. 2ms) (NOTE2)
	Coding type	TC
	CRC, bit	24

NOTE1: Max MAC-e PDU content sizes dependson non-scheduled grant given by SRNC

NOTE2: The support of 2ms TTI depends on the UE category.

7.5.3.2 Downlink

	Radio Bearer on DPCH	Radio Bearer on HS-PDSCH	Signalling Radio Bearer on DPCH	Signalling Radio Bearer on HS-PDSCH
Transport Channel		7.4.22.2.1.1.1 for Conversational RB 6.10.2.4.5.1.2.1.1.1 of [1] for Interactive/Background RBs		6.10.2.4.6.3.2.1.1.2 of [1]
TFCS				
Physical Channel	6.10.2.4.5.1.2.2.2 of [1] The physical channel configuration shall use F-DPCH.			

7.5.4

"

RB for Conversational / Unknown UL: [max bitrate depending on UE category and TTI] on E-DCH DL: [max bitrate depending on UE category] on HS-DSCH / PS RAB
+ RB for interactive or background / UL : [max bitrate depending on UE category and TTI] on E-DCH DL : [max bitrate depending on UE category] on HS-DSCH / PS RAB
+ UL : [max bitrate depending on UE category and TTI] on E-DCH DL : [max bit rate depending on UE category] on HS-DSCH SRBs for DCCH

"

The minimum UE classes supporting this combination are: support of HS-PDSCH, DL on HS-PDSCH: category 11 and support of E-DPDCH, UL on E-DPDCH category 1.

This is supported in Release 6.

7.5.4.1 Uplink

	Radio Bearer on DPCH	Radio Bearer on E-DPCH	Signalling Radio Bearer on DPCH	Signalling Radio Bearer on E-DPCH
Transport Channel		7.5.3.1.1.1.1 for Conversational RB 6.10.2.4.6.1.1.1.1 of [1] for Interactive/Background		7.5.1.1.1.1.1
TFCS				
Physical Channel	6.10.2.4.6.1.1.2.1 of [1] E-TFCI table index = 0; E-DCH minimum set E-TFCI = = 29 (10 ms TTI, TB size 374 bits) or 32 (2 ms TTI, TB size 368 bits)			

Note: MAC-e multiplexing of scheduled and non-scheduled MAC-d flows is allowed

7.5.4.2 Downlink

	Radio Bearer on DPCH	Radio Bearer on HS-PDSCH	Signalling Radio Bearer on DPCH	Signalling Radio Bearer on HS-PDSCH
Transport Channel		7.4.22.2.1.1.1 for Conversational RB 6.10.2.4.5.1.2.1.1.1 of [1] for Interactive/Background RB		6.10.2.4.6.3.2.1.1.2 of [1]
TFCS				
Physical Channel	6.10.2.4.5.1.2.2.2 of [1] The physical channel configuration shall use F-DPCH.			

L.5.4 Delay

The overall delay consists of the delay of the air interface as well as the networks. The predominant issue that distinguishes VoIP from voice service on circuit switched network is the variation of the delay with respect to a fixed delay value, which is referred to as jitter. In order to capture the impact of jitter on the performance of VoIP, a proper assumption about the overall delay budget is necessary.

The fixed delay component is estimated using the following example of delay budget for end-to-end VoIP calls in HSPA when the uplink uses 10 ms TTIs [19].

Table L.5.1. Example delay budget for VoIP in HSPA

Uplink (EUL 10 ms TTI)	Delay	Downlink (HSDPA)	Delay
AMR encoder	35 ms	AMR decoder	5 ms
UE L1/L2 processing	5 ms	UE L1/L2 processing	10 ms
TTI alignment	0 – 10 ms	-	-
Uu interleaving	10 ms	Uu interleaving	2 ms
UL re-TX	0 – 80 ms	DL Scheduling	5 – 100 ms
RNC/Iub/Node B	10 ms	RNC/Iub/Node B	10 ms
Iu + Gi	5 ms	Gi + Iu	5 ms
Sum min UL	65 ms	Sum min DL	37 ms
Sum max UL	155 ms	Sum max DL	132 ms

The different delay components are described below:

- The AMR encoder and decoder delay components includes: buffering time, due to the frame length (20 ms); look-ahead (5 ms); and processing time (10 ms and 5 ms for uplink and downlink respectively).
- The layer 1 and 2 processing time includes the following protocol layers: Packet Data Convergence Protocol (PDCP); Radio Link Control (RLC); Medium Access Control (MAC); and the Physical (PHY) layer.
- The TTI alignment delay component is needed in uplink since the packet may need to be buffered to align the transmission to the frame structure of the radio interface. Note that it is possible to adjust the speech encoder framing period to the air interface framing period to get 0 ms TTI alignment delay. Note also that EUL may use 2 ms TTIs, which would reduce this value to 0 – 2 ms. For downlink, the TTI alignment delay is included in the DL Scheduling delay and is therefore not specified as a separate delay component in this delay budget.
- The Uu interleaving consists of the actual transmission over the air interface, 10 ms and 2 ms for uplink and downlink respectively. The delay for the uplink can be reduced by using 2 ms TTIs.
- HARQ re-transmissions add only to the jitter but not to the fixed delay component. For uplink, since 10 ms TTIs are used in this example delay budget, the re-transmission time is estimated to 40 ms and that at most 2 re-transmissions are performed before the packet is dropped. Note that the allowed number of re-transmissions, and thus the delay jitter, will be different for different implementations.
- For downlink, the re-transmission time is included in the variable part of the DL Scheduling delay. In this case, it is assumed that the packet is dropped if it is delayed more than 100 ms in the scheduler. Note that this delay is the sum of scheduling delay and re-transmission delays. Note also that the scheduler is vendor specific and thus the delay, and especially the variable part, depends entirely on how different vendors choose to implement it.
- The RNC/Iub/Node B delay number describes the RAN delays, i.e. Node B and RNC processing times and transmission delays in-between these nodes.
- The Core Network delay is included in the Iu+Gi delay component.
- Delay for the backbone network is not included in this example.

In summary, the end-to-end packet delay, divided into two parts, is estimated as the following:

- A fixed part, which is identical to the minimum delay, i.e. 102 ms +30 ms, where the 30 ms accounts for the backbone core network delay.

- A variable part, which corresponds to the jitter, and is in the 0 – 185 ms range.

L.5.5 RN Simulator

High Speed Downlink Packet Access (HSDPA) is based on techniques such as adaptive modulation/coding and hybrid ARQ to achieve high throughput. The new channel HS-DSCH is terminated in the Node B and is applicable only to PS domain RABs. MAC-d is retained in the S-RNC, while a new entity, MAC-hs located in Node B, is introduced to host the functionalities of hybrid ARQ, rate selection, and HS-DSCH scheduling.

EDCH for the uplink has the same features of fast rate scheduling, hybrid ARQ, and adaptive coding in addition to DCH. It is managed by a new entity MAC-e and terminated in Node B, while another new entity MAC-es is introduced in S-RNC to manage the re-ordering of data from different MAC-d's. The relation is shown in Figure L.5.2.

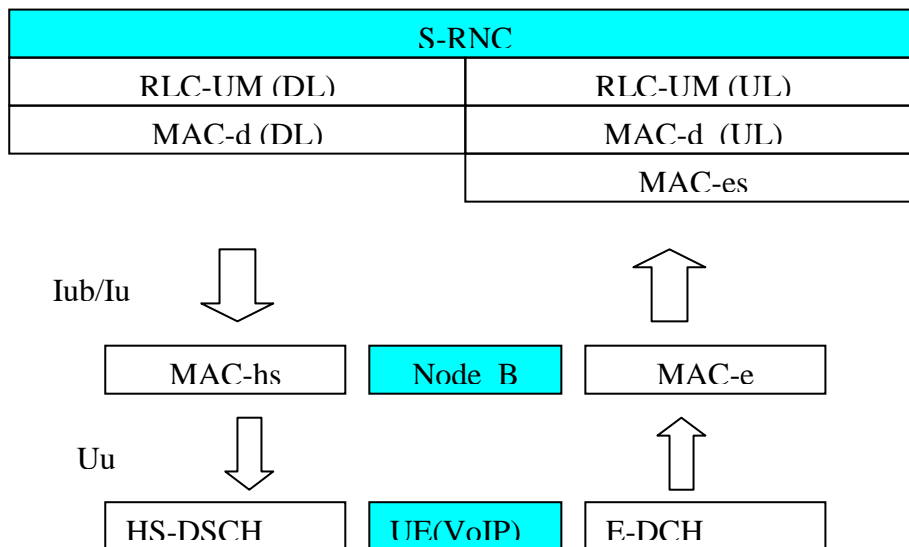

Figure L.5.2: MAC structure applicable to VoIMS via HSDPA/EDCH

The simulator will primarily simulate the functionalities of MAC-hs and MAC-e for the downlink and uplink, respectively. Scheduling for VoIP is crucial in the downlink over the shared HS-DSCH, however, VoIP can simply operate as a non-scheduled transmission (NST) in the uplink.

A simple implementation of RN simulator consists of the following components:

- 1) Radio Access Bearer: Mechanism of the protocols involved should be implemented as assumed by the given RAB. For the physical layer radio bearer the BLER of the physical channel corresponding to the given RB deployed at the given UE location with the given mobile speed will be measured for instantaneous E_c/N_t , and recorded for use by the system level simulation. The RAB's are chosen from section L.5.3 Radio Access Bearers.
- 2) Cellular Network: This consists of assumptions of the cell structure, channel models deployed, traffic load, antenna, locations of users, etc. Interactions between a reference user and the Node B is to be simulated here, for which the buffer configuration, the scheduler algorithm, the delay budget, number of users, etc. are needed. This simulator comprises the functions of Node_B and Iu interface, a part of the radio access network that is extensively simulated in 3GPP-RAN working groups. However, the simulation work done for the pure capacity has a different scope than here. The focus of the present work item is to test a single connection that is representative for the service provided by the network and the final test method is the listening test instead of statistical description. For this reason, the radio network simulator shall produce a sequence of coherent samples of error and delay events, which different objective of the simulator designed to evaluate the capacity or the channel quality based on statistic evaluation. The setup, the parameters and the working assumptions need to be designed specifically for this purpose. The expected main result of the simulation is a sequence of error and delay events with associated attributes necessary for the further processing. Details of the simulation assumptions can be found in Appendix A.

- 3) Packets stream: Payload traffic of the reference user will be mapped to the bearer by adding. RLC/MAC headers and extracted from the radio bearer by stripping the RLC/MAC header
- 4) The PDCP/IP/UDP/RTP/AMR packets at interfaces A11 and B11 are given to the transmission buffer of the RLC protocol working in UM. The RLC may segment the given bits to make RLC SDUs, and add RLC headers (sequence number and length indicators). By assumption, one IP packet is placed into an RLC PDU that is filled with padding bits.
- 5) To simplify the implementation and facilitate the typical continuous speech tests, the design of the simulation should target on steady state of the connection. This implies that we can disregard network re-synchronization (although the terminal may engage in packet resynchronization) and set-up during the simulation. Depending on the assumptions, issues of the packaging, the segmentation and re-assembly can also be ignored in case the AMR/AMR-WB frame fits into the RLC-SDU. The given time limit for the determination of the packet loss during the simulation comes from the delay budget planning, which simulates the implementation of the queuing buffers.

Payload exchanged at the interfaces are:

- A21, B21: PDCP packet with ROHC received in sequence
- A31, B31: IP packets delivered in sequence
- A32, B32: IP packets received in sequence
- A22, B22: PDCP packets with ROHC delivered in sequence

L.5.6 Core Network

The network introduces time delay for the transmission. Payload exchanged at the interfaces are:

- A31, B31: IP packets received in sequence
- A32, B32: IP packets delivered out of sequence

The IP packets are uniquely identified with a RLC PDU, when each AMR/AMR-WB speech frame is conveyed by a single RLC PDU. This assumption will simplify the implementation.

L.5.7 VoIP Client

The current section discusses the actions of PDCP/AMR or PDCP/AMR-WB. The PDCP entity is assumed to map to two RLC –UM entities, each used for one of the two directions of the conversation, as shown in Figure L.5.3. The payload exchanged at the interfaces are:

- A11, B11: speech frames received in order
- A21, B21: PDCP packets (RLC SDU) delivered in order
- A22, B22: PDCP packets (RLC SDU) received in order
- A12, B12: speech frames delivered in order within the given time limit
- For the conversational tests, AMR will encode the speech at the designated rate in accordance with 26.101, to make the RTP/UDP/IP/PDCH payload. Following TS 26.236, the RTP payload format should follow the bandwidth efficient mode defined in RFC-3267, and one speech frame shall be encapsulated in each RTP packet. Header compression according to RFC 3095 and TS 25.323 will be simulated as part of the PDCP protocol. For the VoIP test we are only interested in the normal operation of the PDCP, not the session set-up signalling .

Lossless RLC PDU size change. This is equal to assume that the RAB remains the same during the call. The assumption reduces the simulation complexity for the RN simulator.

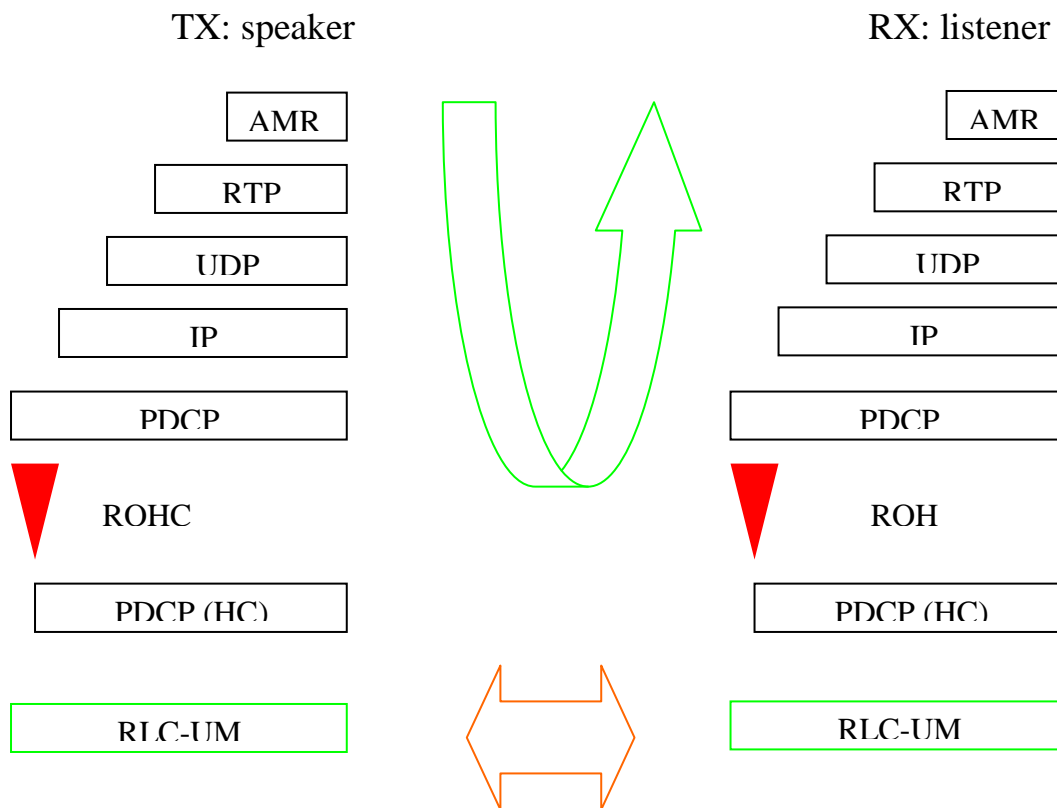

Figure L.5.3: Protocol stacks in VoIP entity

Consistently, only two PDU Formats will be considered:

- PDCP-No-Header PDU
- PDCP Data PDU

A decision is to be made in conjunction with other parameters in this context. The simulation of ROHC operation aims at the implementation of the state machine, Figure L.5.4.

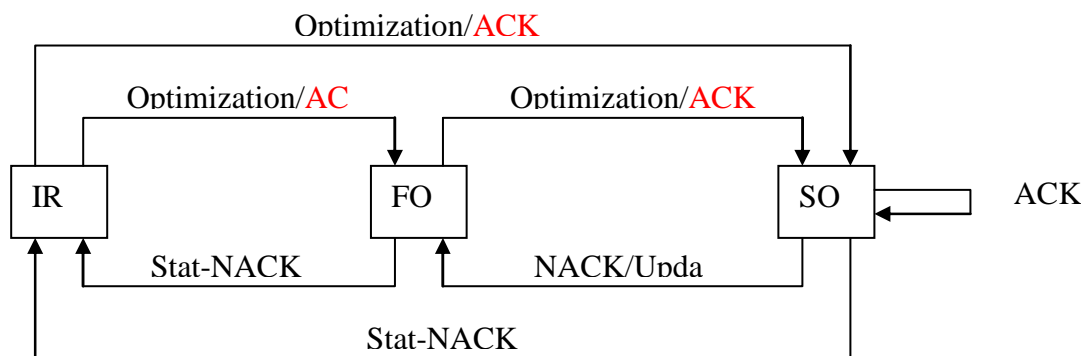

Figure L.5.4: State machine of the compressor operation.

Clearly, the transition depends on the lower layer quality. By QoS assured delivery, the compressor can be maintained in SO state during the call duration with the given probability. The simulation should assume steady state in SO. We also assume the operation mode of ROHC to be R (Reliable). That means it involves feedback. Assuming PDCP-No-Header PDU, the simulator delivers/receives to/from the RN simulator the RLC PDU, which consists of header and payload as following:

RLC SDU = ROHC feedback header + ROHC base header + ROHC extension header + UDP checksum + AMR payload

By assuming steady state of R mode operation, the header will only contain 1 byte R-0, 2 bytes ACK and a 2 byte UDP checksum. For the simulation of reference mobiles, there are two possibilities:

- Allow state transition between FO and SO. This would require simulation of coupled up-link and down-link.
- Disallow state transition between FO and SO. This is equivalent to assuming that the state transition is a rare event such that it does not occur during a typical call. Then, the feedback from the de-compressor would contain ACK only. Hence, the up link and the down link can be simulated independently.

To facilitate the simulation, the second option will be taken.

L.5.8 Interfaces

The physical composition of the test system is depicted in Fig.1. It shows that an end-to-end connection between A and B consists of the following chain of entities:

- Sound card (A)
- VoIP (A)
- RN(A) simulator
- IP/Core simulator
- RN(B) simulator
- VoIP (B)
- Sound card (B)

The figure, however, is not informative about the logical relation between the protocols that are spread in all entities. Figure L.5,5 visualizes the logical relations among the components. It helps to clarify the scope of each component simulators.

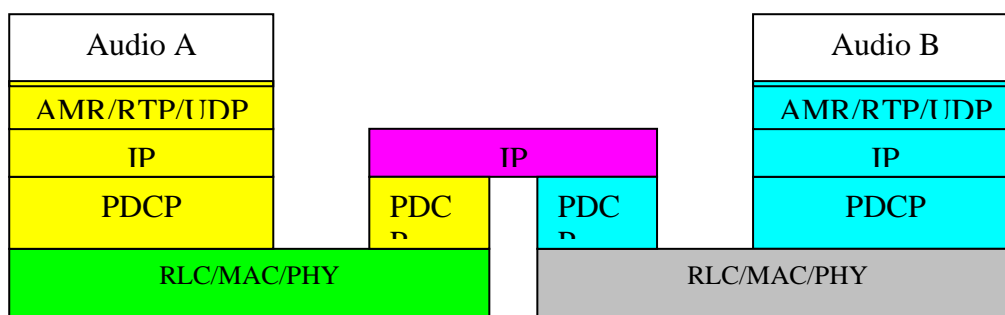
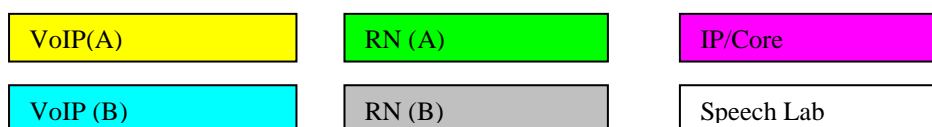

Figure L.5.5: Logical Relations between simulator entities and protocols. Color code:



For the convenience of verification, it is of great advantage to implement the system component-wise. Thus, the interfaces between the component simulators have to be specified. The physical interfaces are instances of 3 logical interfaces, respectively:

- **Interface 1** = {A11,A12,B11,B12}: the interface between sound card and VoIP
- **Interface 2** = {A21, A22, B21, B22}: the interface between VoIP and RN
- **Interface 3** = {A31, A32, B31, B32} : the interface between IP/Core and RN

The interfaces determine the information to be exchanged between the adjacent entities in the simulator and are specified in the following.

L.5.8.1 Interface 1

This interface exchanges information regarding operation of the protocol stacks AMR/RTP/UDP/IP/PDCP/RLC and the operation of rate selection. One of the issues is the coherence of the actions when off-line simulation method is used. Since each entity is simulated independent of others and the output files of the simulation are used in a later time, the consistency of the channel conditions and the selection made by AMR at a given moment cannot be warranted unless careful measure is taken.

One of the measures to maintain the coherence is to restrict the AMR/AMR-WB to a pre-selected single data rate for each test. This approach is justified by the fact that the enhanced uplink and downlink have already provided sufficient control and adaptation mechanism at the lower layers, so that the channel condition experienced by the interface 1 is sufficiently stable and would hardly require rate switching. The original concept of AMR is targeted at the balance between the individual voice quality and overall capacity. But when we fix the number of the supported users in our simulation in order to test the probe user's voice quality, the capacity-quality trade-off would not occur for the simulated cases. Hence, the testing of individual coder from the AMR/AMR-WB would be sufficiently informative about the VoIP performance for the give simulation set-up.

L.5.8.2 Interface 2

The output file of the RN simulator at this interface consists of 3 columns of the following entries for a stream of RLC PDUs:

Table L.5.2: Data format of interface 2

Sequence Number (int)	Loss Indicator (binary)	Accumulated Es/Nt after HARQ (dB)	Time Stamp (int)
0	1	..	0TTI
1	1	..	1TTI
2	0	..	2TTI
...

L.5.8.3 Interface 3

The transportation of the IP packet depends on the nodes traversed by the datagram within the IP/Core network. What really matters here is the delay and loss of a packet due to routing. This requires the IP/Core, based on a given topology [tbd] and traffic load [tbd], to generate a sequence of random events at A31 and B31, respectively, reflecting the relative delay and the loss of the packet fed into the network at A32 and B32, respectively. Alternatively, the delay and loss can be generated by an appropriate analytical model [tbd]. The file generated by the IP/Core at the interfaces A32 and B32 shall have the following format:

Table L.5.3: Data format of interface 3.

Sequence Number (int)	Loss Indicator (binary)	Time Stamp (int)
0	1	0TTI
1	1	1TTI
2	0	2TTI
...

L.5.9 Simulated HSPA Air-Interface

L.5.9.1 General Description

For the down link, the over-the-air delay of a speech frame is defined as the latency between the time a MAC-d PDU carrying a speech frame enters the MAC-hs priority queue in the Node-B and the time the MAC-d PDU is delivered (after reordering by the MAC-hs) to the UE. Similarly, for the up link, the over-the-air delay of a speech frame is defined as the latency between the time a MAC-d PDU carrying a speech frame enters the MAC-d of the Node-B.

The delay of the network is the time consumed by a packet, while staying within the network. Therefore, it is counted as the time difference between the entry and exit of the network.

The delay value for each connection is measured as the sum of the over-the-air delay for the up link and down link plus the network delay and the processing delay at both ends, when the value is within the delay budget.

A speech frame is declared to be lost if one of the following is true:

- The MAC-d PDU is discarded at the Node-B transmitter due to expiration of the MAC-hs discard timer
- The MAC-d PDU is transmitted but not successfully received post-HARQ
- The MAC-d PDU is successfully received after a specified delay bound

The MAC-hs discard timer and the MAC-hs T1 timer should be set appropriately for the given the over-the-air delay budget.

L.5.9.2 Error-Delay Profiles

In [2], we received samples coming from different simulation platforms

- Platform 1: Data contained in R1-061028.zip
- Platform 2: Data contained in R1-061070.zip

Although both are generated following the network layout and configuration of [3], there are subtle differences beyond the schedulers and the trace lengths.

The samples from the platform 1 entail 16 samples for down link and 16 samples for up link with paired channel conditions PedB_3km, PedB30km, VehA_30km and VehA_120km. The location of the reference user is fixed for all simulations.

The samples from the platform 2 entail 22 samples, where 20 are for the down link and two for the up link, representing a paired channel PedB_3km. The difference between the 20 samples lies in the network load (number of users) and the location of the reference user (geometry).

To capture the essential in regard of our subjective tests, the samples in the two groups have the following 4 attributes in common:

Table L.5.4: File attributes of the available data

Attribute Name	Details	Number
Link Direction	Up-Link, Down-link	2
Network Load	40,45,60,80,100	5
Channel Model	PedA-3km, PedB-3km, PedB30km, VehA-30km, VehA-120 km.	5

Table L.5.5: Number of files and length of traces, grouped according to the network load

Network Load	Number of Samples	Length without Repetition
40	4	4x60s
45	10	2x(215+155+95+55) ms
60	4	4x60s
80	4	4x60s
100	14	4x60s+2x(100+155+95+215+55)ms

The definition of the conditions follow the conventions given below:

Network Condition

Table L.5.6: Definition of the radio network conditions

Radio Network Condition	Low Traffic Down Link	High Traffic Down Link	Uplink
Low Mobility Mobile	LM.LT	LM.HT	Lm
High Mobility Mobile	HM.LT	HM.HT	Hm

In specifics:

- Low Traffic (LT): 40, or 45, or 60 mobile users per cell
- High Traffic (HT): 80, or 100 mobile users per cell
- Low Mobility (LM, Lm): ITU –Channel-Model: PedB3_km or PedA3_km
- High Mobility (HM, Hm): ITU-Channel-Model: VehA30km or Veh120km or PedB30km

The uplinks are simulated as dedicated channel, hence the traffic conditions apply only to the downlinks. From a mobile-to-mobile connection, the order of the uplink and downlink plays no role. Therefore, we have the following 8 possible construction of channel conditions:

Table L.5.7: Notation for the mobile-to-mobile radio network conditions

Number	Notation	Meaning
[1]	Lm.LT.LM	Lm + LT.LM
[2]	Lm.LT.HM	Lm+LT.HM
[3]	Lm.HT.LM	Lm+HT.LM
[4]	Lm.HT.HM	Lm+HT.HM
[5]	Hm.LT.LM	Hm+LT.LM
[6]	Hm.LT.HM	Hm+LT.HM
[7]	Hm.HT.LM	Hm+HT.LM
[8]	Hm.HT.HM	Hm+HT.HM

Combined Test Conditions

Each test condition is assigned a unique number defined as following:

x-y.z.c	X	Y	z	c
e.g. 1-1.3a	AMR-Mode	Network Load	Experiment	Swap subjects

The radio network conditions are identical for all the test cases with all three codecs under test. Hence only the table for codec AMR5.9 is shown as example in the following.

AMR-Mode 5.9 kbps (x=1): 8 conditions (y=1), 8 conditions (y=2)

<i>Cond.No</i>	<i>Noise in Room A</i>	<i>Radio Network Condition</i>	<i>Noise in Room B</i>	<i>Description</i>	<i>Comments</i>
1-1.1	Hoth	A->B: [1] B->A: [1]	Hoth	Lm.LT.LM LM.LT.Lm	sym
1-1.2	Car	A->B: [6] B->A: [6]	Car	Hm.LT.HM HM.LT.Hm	sym
1-1.3a	Car	A->B: [5] B->A: [2]	Hoth	Hm.LT.LM HM.LT.Lm	asym
1-1.3b	Hoth	A->B: [2] B->A: [5]	Car	Lm.LT.HM LM.LT.Hm	asym
1-1.4	Cafeteria	A->B: [1] B->A: [1]	Cafeteria	Lm.LT.LM LM.LT.Lm	sym
1-1.5a	Cafeteria	A->B: [2] B->A: [5]	Street	Lm.LT.HM LM.LT.Hm	asym
1-1.5b	Street	A->B: [5] B->A: [2]	Cafeteria	Hm.LT.LM HM.LT.Hm	asym
1-1.6	Street	A->B: [6] B->A: [6]	Street	Hm.LT.HM HM.LT.Hm	sym
1-2.1	Hoth	A->B: [3] B->A: [3]	Hoth	Lm.HT.LM LM.HT.Lm	sym
1-2.2	Car	A->B: [8] B->A: [8]	Car	Hm.HT.HM HM.HT.Hm	sym
1-2.3a	Car	A->B: [7] B->A: [4]	Hoth	Hm.HT.LM HM.HT.Hm	asym
1-2.3b	Hoth	A->B: [4] B->A: [7]	Car	Lm.HT.HM LM.HT.Hm	asym
1-2.4	Cafeteria	A->B: [3] B->A: [3]	Cafeteria	Lm.HT.LM LM.HT.Lm	sym
1-2.5a	Cafeteria	A->B: [4] B->A: [7]	Street	Lm.HT.HM LM.HT.Hm	asym
1-2.5b	Street	A->B: [7] B->A: [4]	Cafeteria	Hm.HT.LM HM.HT.Lm	asym
1-2.6	Street	A->B: [8] B->A: [8]	Street	Hm.HT.HM HM.HT.Hm	sym

For the designated tests comprise the following components:

- a VoIMS sender comprising of input capture (e.g. microphone), AMR encoder, RTP packetization and IP stack, operating in real time; and
- a VoIMS receiver comprising of IP stack, RTP de-packetization, AMR decoder with appropriate jitter handling and an output devise (e.g. headphone), operating in real tim
- error-delay profiles (including error mask and time of delivery in milliseconds) are generated using offline system simulations by RAN1. The data files, sorted according to the radio network conditions, are grouped into sets that represent the final test conditions. The data files belong to the same set are concatenated so that a longer trace is made. Up link and down link traces are combined, with addition of a fixed delay value, to simulate delay and error trace of the mobile-to-mobile connection, and
- use the above error-delay profiles to inject delays and packet losses in the VoIMS traffic in an error insertion devise running in real time.

Design and arrangement of the tests are detailed in the test plan.

L.5.A.1 Network Parameters

Parameter	
UMTS BS Nominal TX Power [dBm]	43
P-CPICH Tx Power [dBm]	33
UMTS BS Overhead TX Power [dBm] including paging, sync and P/S-CCPCH	34
UMTS UE TX Power Class [dBm]	21
UMTS UE Noise Figure [dB]	10
BS Antenna Gain [dBi]	17.1
MS Antenna Gain [dBi]	0
Shadowing Standard Deviation [dB]	8
Path Loss Model: COST 231	$-136+35.22*\log_{10}(d)$, d in km
Shadow Site to site Correlation	50%
Other Losses [dB]	8
UMTS BS Antenna pattern beamwidth [degrees]	per TR 25.896 v6.0.0 A.3.1.1 65
Propagation Channel Mixture for loading users	25% AWGN 37% PedA 3 kph 13% PedA 30 kph 13% VehA 30 kph 12% VehA 120 kph
Propagation Channel for the Reference UE	Case 1: PedA 3 kph Case 2: VehA 30 kph Case 3: VehA 120 kph
Ec/Io Admission Threshold	-18 dB
RSCP Admission Threshold	-115 dBm
Number of Node Bs	19 Node Bs/57 cells
Locations of the Reference UE	Geometrical centre of each sector cell
Cell layout	3-Cell Clover-Leaf
Inter-site Distance [m]	2500
Frequency	1990 MHz

L.5.A.2 Traffic Assumptions (example: AMR 7.95)

Parameter	
User-Plane Traffic Model Vocoder Type Vocoder Voice Model	100% VoIP AMR 7.95 Markov Process with 50% activity (transition probability = 0.01)
Overhead : RTP payload (AMR bandwidth efficient mode)	4 bits CMR 6 bits TOC per aggregated speech frame 7 bits padding for octet alignment (assuming no aggregation)
Overhead: RTP/UDP/IPv6 uncompressed header	60 bytes
Overhead: RLC-UM	2 bytes
ROHC	1 byte R-0, 2 bytes UDP checksum (will be zero bytes with UDP-Lite)
ROHC	Resynchronization ignored
RTCP	Not modeled
SIP	Not modeled
SID Frames	Not transmitted
Effective Data Rate with no RTP layer aggregation	10.8 kbps
MAC-d PDU Size ¹	216 bits (one speech frame per MAC-d PDU)

L.5.A.3 Other Assumptions

Parameter	
UMTS Time Modelled [s]	180
Number of Simulation Runs	9
UE Category	5
Receiver Type	Rake ² with Mobile Receive Diversity from 2 Antennas (2 Rx correlation = 0.5, mismatch 2 dB)
Associated DPCH Data Rate	3.4 kbps, SF 256
Associated DPCH Activity Factor	5%
HS-SCCH Channel Model Number Errors Impact HS-DSCH Decoding Power Allocation	Depends on loading Yes Fixed Offset
HSDPA Scheduler Implementation	
Mobility Model	Static location for UE
Downlink Over-the air Delay Budget [ms]	90
E-DCH Scheduling	Non-scheduled transmission
E-DCH TTI length	Both 10ms and 2ms TTI
E-DCH max number of HARQ transmissions	2 Tx for 10ms TTI 6 Tx for 2ms TTI

L.5.A.4 Simulation Methodology

The system simulation is dynamic and includes explicit modelling of fast fading, power control, CQI generation, scheduling of users, etc. Channels that connect different transmit/receive antenna pairs are generated at the UMTS slot rate (1500Hz). The instantaneous SINR seen at each receiver is computed at the slot rate. Virtual decoders map a sequence of slot rate SINRs to block error events at the TTI rate for each physical channel. The virtual decoders must generate the same statistical block error events as the true decoders operating on a bit by bit basis in a link level simulation for the same TTI rate for each physical channel under consideration.

Inner and outer loop power control loops are explicitly modelled for the associated DPCH. The OVSF code and transmit power resources consumed by the associated DPCH and HS-SCCH channels are modelled dynamically. Errors made in HS-SCCH decoding are taken into account in determining whether the corresponding HS-DSCH transmission is decoded correctly.

The system simulation attempts to model sufficiently the MAC-d PDU flow and performance from the NodeB to the UE. Thus, the system simulation is considered an "over-the-air" model and does not capture impairments beyond the NodeB to UE subsystem

Bibliography

- [1] 3GPP TS 25.322 "RLC Protocol"
- [2] 3GPP TS 34.108 "Common test environments for User Equipment (UE) conformance testing"
- [3] 3GPP TR 25.931 "UTRAN functions, examples on signaling procedures"
- [4] 3GPP TS 26.236 "Performance characterization of the Enhanced aacPlus and Extended Adaptive Multi-Rate - Wideband (AMR-WB+) audio codecs"
- [5] 3GPP TS 25.323 "Packet Data Convergence Protocol"
- [6] 3GPP TS 25.331 "Radio Resource Control Protocol"
- [7] 3GPP TR 25.933 "IP transport in UTRAN"
- [8] 3GPP TR 25.896 "Feasibility Study for the Enhanced Uplink for UTRA FDD"
- [9] IETF RFC 3095
- [10] IETF RFC 3267
- [11] 3GPP TR 25.932 "Delay budget within the access stratum"
- [12] 3GPP TS 22.105 v3.6.0 "Service and Capability"

Annex M: Change history

Change history							
Date	TSG #	TSG Doc.	CR	Rev	Subject/Comment	Old	New
2004-06	SP-24	SP-040342			Version 6.0.0 approved at 3GPP TSG SA#24	2.0.0	6.0.0
2007-06	SP-36				Version for Release 7	6.0.0	7.0.0
2007-09	SP-37	SP-070633	0001	2	Characterisation of VoIMS over HSDPA/EUL	7.0.0	7.1.0
2007-12	SP-38	SP-070765	0002	2	Corrections to Characterization of VoIMS over HSDPA/EUL	7.1.0	7.2.0
2007-12	SP-38	SP-070765	0003		Characterization of VoIMS over HSDPA/EUL – Conversation Tests	7.1.0	7.2.0
2008-12	SP-42				Version for Release 8	7.2.0	8.0.0
2009-12	SP-46				Version for Release 9	8.0.0	9.0.0
2011-03	SP-51				Version for Release 10	9.0.0	10.0.0
2012-09	SP-57				Version for Release 11	10.0.0	11.0.0
2014-09	SP-65				Version for Release 12	11.0.0	12.0.0
2015-12	SP-70				Version for Release 13	12.0.0	13.0.0

Change history							
Date	Meeting	TDoc	CR	Rev	Cat	Subject/Comment	New version
2017-03	75					Version for Release 14	14.0.0
2018-06	80					Version for Release 15	15.0.0
2020-07	-	-	-	-	-	Update to Rel-16 version (MCC)	16.0.0
2022-04	-	-	-	-	-	Update to Rel-17 version (MCC)	17.0.0
2024-03	-	-	-	-	-	Update to Rel-18 version (MCC)	18.0.0

History

Document history		
V18.0.0	May 2024	Publication