

ETSI TR 133 928 V18.4.0 (2024-07)



5G;
ADMF logic for provisioning Lawful Interception (LI)
(3GPP TR 33.928 version 18.4.0 Release 18)



Reference

RTR/TSGS-0333928vi40

Keywords

5G

ETSI

650 Route des Lucioles
F-06921 Sophia Antipolis Cedex - FRANCE

Tel.: +33 4 92 94 42 00 Fax: +33 4 93 65 47 16

Siret N° 348 623 562 00017 - APE 7112B
Association à but non lucratif enregistrée à la
Sous-Préfecture de Grasse (06) N° w061004871

Important notice

The present document can be downloaded from the
ETSI [Search & Browse Standards application](#).

The present document may be made available in electronic versions and/or in print. The content of any electronic and/or print versions of the present document shall not be modified without the prior written authorization of ETSI. In case of any existing or perceived difference in contents between such versions and/or in print, the prevailing version of an ETSI deliverable is the one made publicly available in PDF format on [ETSI deliver](#).

Users should be aware that the present document may be revised or have its status changed,
this information is available in the [Milestones listing](#).

If you find errors in the present document, please send your comments to
the relevant service listed under [Committee Support Staff](#).

If you find a security vulnerability in the present document, please report it through our
[Coordinated Vulnerability Disclosure \(CVD\)](#) program.

Notice of disclaimer & limitation of liability

The information provided in the present deliverable is directed solely to professionals who have the appropriate degree of experience to understand and interpret its content in accordance with generally accepted engineering or other professional standard and applicable regulations.

No recommendation as to products and services or vendors is made or should be implied.

No representation or warranty is made that this deliverable is technically accurate or sufficient or conforms to any law and/or governmental rule and/or regulation and further, no representation or warranty is made of merchantability or fitness for any particular purpose or against infringement of intellectual property rights.

In no event shall ETSI be held liable for loss of profits or any other incidental or consequential damages.

Any software contained in this deliverable is provided "AS IS" with no warranties, express or implied, including but not limited to, the warranties of merchantability, fitness for a particular purpose and non-infringement of intellectual property rights and ETSI shall not be held liable in any event for any damages whatsoever (including, without limitation, damages for loss of profits, business interruption, loss of information, or any other pecuniary loss) arising out of or related to the use of or inability to use the software.

Copyright Notification

No part may be reproduced or utilized in any form or by any means, electronic or mechanical, including photocopying and microfilm except as authorized by written permission of ETSI.

The content of the PDF version shall not be modified without the written authorization of ETSI.

The copyright and the foregoing restriction extend to reproduction in all media.

© ETSI 2024.
All rights reserved.

Intellectual Property Rights

Essential patents

IPRs essential or potentially essential to normative deliverables may have been declared to ETSI. The declarations pertaining to these essential IPRs, if any, are publicly available for **ETSI members and non-members**, and can be found in ETSI SR 000 314: "*Intellectual Property Rights (IPRs); Essential, or potentially Essential, IPRs notified to ETSI in respect of ETSI standards*", which is available from the ETSI Secretariat. Latest updates are available on the ETSI Web server (<https://ipr.etsi.org/>).

Pursuant to the ETSI Directives including the ETSI IPR Policy, no investigation regarding the essentiality of IPRs, including IPR searches, has been carried out by ETSI. No guarantee can be given as to the existence of other IPRs not referenced in ETSI SR 000 314 (or the updates on the ETSI Web server) which are, or may be, or may become, essential to the present document.

Trademarks

The present document may include trademarks and/or tradenames which are asserted and/or registered by their owners. ETSI claims no ownership of these except for any which are indicated as being the property of ETSI, and conveys no right to use or reproduce any trademark and/or tradename. Mention of those trademarks in the present document does not constitute an endorsement by ETSI of products, services or organizations associated with those trademarks.

DECT™, **PLUGTESTS™**, **UMTS™** and the ETSI logo are trademarks of ETSI registered for the benefit of its Members. **3GPP™** and **LTE™** are trademarks of ETSI registered for the benefit of its Members and of the 3GPP Organizational Partners. **oneM2M™** logo is a trademark of ETSI registered for the benefit of its Members and of the oneM2M Partners. **GSM®** and the GSM logo are trademarks registered and owned by the GSM Association.

Legal Notice

This Technical Report (TR) has been produced by ETSI 3rd Generation Partnership Project (3GPP).

The present document may refer to technical specifications or reports using their 3GPP identities. These shall be interpreted as being references to the corresponding ETSI deliverables.

The cross reference between 3GPP and ETSI identities can be found under <https://webapp.etsi.org/key/queryform.asp>.

Modal verbs terminology

In the present document "**should**", "**should not**", "**may**", "**need not**", "**will**", "**will not**", "**can**" and "**cannot**" are to be interpreted as described in clause 3.2 of the [ETSI Drafting Rules](#) (Verbal forms for the expression of provisions).

"**must**" and "**must not**" are **NOT** allowed in ETSI deliverables except when used in direct citation.

Contents

Intellectual Property Rights	2
Legal Notice	2
Modal verbs terminology.....	2
Foreword.....	5
Introduction	5
1 Scope	6
2 References	6
3 Definitions of terms, symbols and abbreviations	6
3.1 Terms.....	6
3.2 Symbols.....	6
3.3 Abbreviations	6
4 ADMF and provisioning	7
4.1 Overview	7
4.2 General	7
4.3 Destination end points.....	9
5 LIPF logic.....	10
5.1 Background	10
5.2 Governing scenarios	11
5.3 Top-level LIPF provisioning logic	11
5.3.1 LIPF logic for initial configuration.....	11
5.3.2 LI provisioning logic in LIPF	11
5.3.3 Service-based LI provisioning logic in LIPF.....	12
5.3.4 Location Acquisition.....	12
5.4 Data	13
5.4.1 Scope of interception	13
5.4.2 Top-level view	14
5.4.3 5GC.....	14
5.4.3.1 The flow-chart.....	14
5.4.3.2.1 PDHR	17
5.4.3.2.2 LALS triggering	17
5.4.3.2.3 UDM.....	17
5.4.3.2.4 Summary	17
5.4.3.3 LI provisioning for additional data services in 5GC	18
5.4.3.3.1 LI provisioning for AKMA	18
5.4.3.3.2 LI provisioning for NEF based services	18
5.4.3.3.2.1 Scope of interception	18
5.4.3.3.2.2 The flow-chart.....	19
5.4.3.3.2.3 Interception	19
5.4.3.3.3 LI provisioning for Edge Computing Service.....	20
5.4.3.3.4 LI provisioning for 5G Media Streaming	21
5.4.4 EPC.....	22
5.4.4.1 The flow-chart.....	22
5.4.4.2 Interception	25
5.4.4.2.1 PDHR	25
5.4.4.2.2 LALS triggering	25
5.4.4.2.3 SGW/PGW deployment options.....	25
5.4.4.2.4 HSS.....	26
5.4.4.2.5 Summary	26
5.4.4.3 LI provisioning for additional data services in EPC	27
5.4.4.3.1 LI provisioning for SCEF/IWK-SCEF based services	27
5.4.4.3.1.1 Scope of interception	27
5.4.4.3.1.2 The flow-chart.....	28

5.4.4.3.1.3	Interception	28
5.5	Voice	29
5.5.1	Scope of interception	29
5.5.2	Initial configuration for N9HR/S8HR	29
5.5.2.1	General	29
5.5.2.2	Common to all HPLMNs	30
5.5.2.3	Separate configuration for an HPLMN	30
5.5.3	Top level LIPF logic for service type voice	31
5.5.4	LIPF logic for targets that are not non-local ID	32
5.5.4.1	The flowchart	32
5.5.4.2	Interception	38
5.5.4.2.1	IMS deployment	38
5.5.4.2.2	LALS triggering	38
5.5.4.2.3	Summary	38
5.5.4.2.4	STIR/SHAKEN	40
5.5.5	LIPF logic for targets that are non-local ID	42
5.5.5.1	The flowchart	42
5.5.5.2	Interception	46
5.5.5.2.1	IMS deployment	46
5.5.5.2.2	Summary	47
5.5.5.2.3	STIR/SHAKEN	48
5.6	Messaging	48
5.6.1	Scope of interception	48
5.6.2	LIPF logic for service type messaging	49
5.6.2.1	Flowcharts	49
5.6.2.2	Interception	53
5.6.2.2.1	IMS deployment	53
5.6.2.2.2	LALS triggering	53
5.6.2.2.3	Summary	53
5.7	PTC	54
5.7.1	Scope of interception	54
5.7.2	LIPF logic for service type of PTC	55
5.8	LALS	56
5.8.1	Scope of interception	56
5.8.2	LIPF logic for service type of LALS	56
5.9	Void	56
5.10	RCS	56
5.10.1	Scope of interception	56
5.10.2	LIPF logic for service type of RCS	57
5.10.3	Interception	60
5.10.3.1	Deployment	60
5.10.3.2	Summary	60
Annex C (informative):	Bibliography	62
Annex Z (informative):	Change history	63
History		64

Foreword

This Technical Report has been produced by the 3rd Generation Partnership Project (3GPP).

Introduction

The LI technical specifications (TS 33.126 [2], TS 33.127 [3], TS 33.128 [4]) contain the normative part of the LI requirements and the technical report TR 33.929 [5] contains additional information as an implementation guidance for LI. The ADMF that receives the warrant information from the Law Enforcement Agencies has the task of provisioning the LI functions present in various Network Functions (NFs) of the serving CSP network. Upon provisioning, the LI is activated in those NFs, and accordingly, the LI functions within those NFs monitor the target's communications and provide the LI as required by the warrant.

The scope of the NFs that provide the LI functions within the CSP network is determined based on various factors such as LI service type, CSP deployment choice, scope of LI as authorized in the warrant. The present document provides the logic used within the ADMF in provisioning the LI functions considering those points.

1 Scope

The present document provides ADMF provisioning logic for LI in association with the LI functions defined in TS 33.126 [2], TS 33.127 [3] and TS 33.128 [4].

2 References

The following documents contain provisions which, through reference in this text, constitute provisions of the present document.

- References are either specific (identified by date of publication, edition number, version number, etc.) or non-specific.
- For a specific reference, subsequent revisions do not apply.
- For a non-specific reference, the latest version applies. In the case of a reference to a 3GPP document (including a GSM document), a non-specific reference implicitly refers to the latest version of that document *in the same Release as the present document*.

- [1] 3GPP TR 21.905: "Vocabulary for 3GPP Specifications".
- [2] 3GPP TS 33.126: "Lawful Interception Requirements".
- [3] 3GPP TS 33.127: "Lawful Interception (LI) Architecture and Functions".
- [4] 3GPP TS 33.128: "Lawful Interception (LI) Protocol and Procedures".
- [5] 3GPP TR 33.929: "Lawful Interception (LI) Implementation Guidance".
- [6] ETSI TS 103 221-1: "Lawful Interception (LI); Internal Network Interfaces; Part 1: X1".

3 Definitions of terms, symbols and abbreviations

3.1 Terms

For the purposes of the present document, the terms given in TR 21.905 [1] and the following apply. A term defined in the present document takes precedence over the definition of the same term, if any, in TR 21.905 [1].

3.2 Symbols

For the purposes of the present document, the following symbols apply:

None.

3.3 Abbreviations

For the purposes of the present document, the abbreviations given in TR 21.905 [1] and the following apply. An abbreviation defined in the present document takes precedence over the definition of the same abbreviation, if any, in TR 21.905 [1].

4 ADMF and provisioning

4.1 Overview

According to the LI model defined in ETSI TS 103 221-1 [6], the ADMF as an administration function establishes and manages the Lawful Interception (LI). In doing so, the ADMF performs the target provisioning at various Network Elements (NEs) using the X1 protocol as defined in ETSI TS 103 221-1 [6].

Within the LI architecture model defined in TS 33.127 [3] and TS 33.128 [4], the ADMF has two sub-functions referred to as Lawful Interception Control Function (LICF) and Lawful Interception Provisioning Function (LIPF). The LICF receives the warrant information from the LEA over LI_HI1 interface. The LIPF performs the provisioning of all LI functions within various NFs of CSP network including the MDF2 and MDF3. See figure 4.1-1 below for an overview.

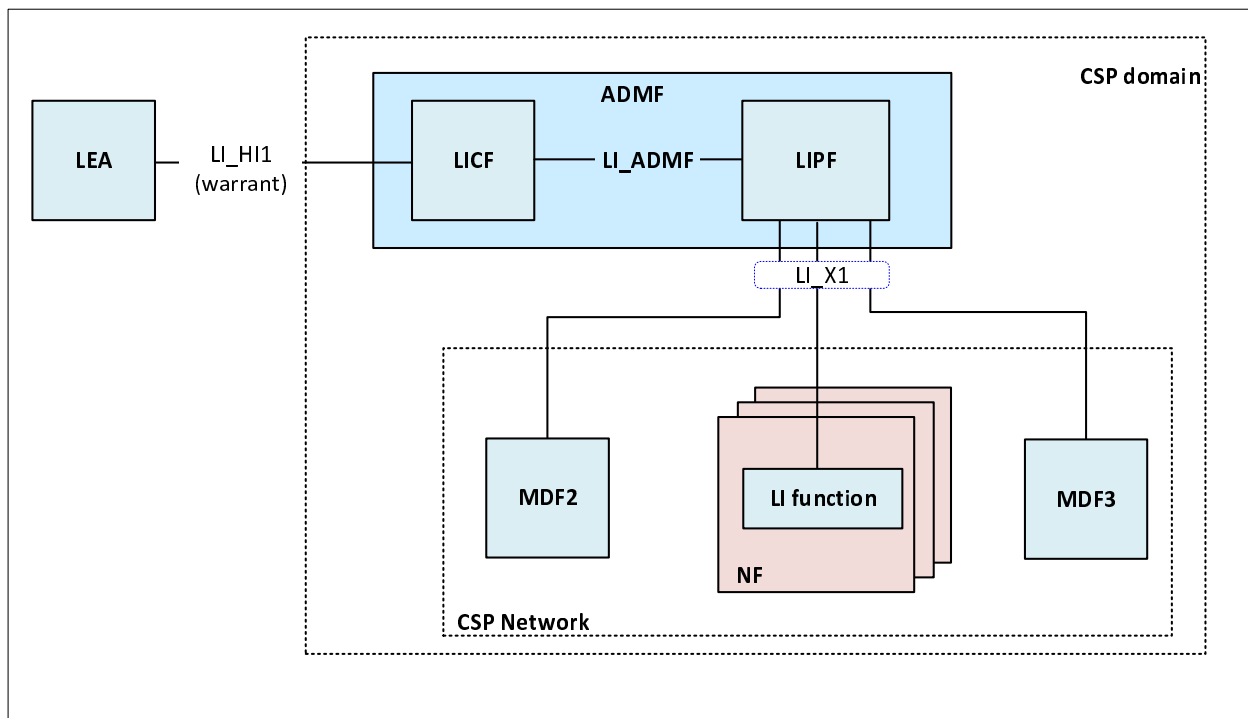

Figure 4.1-1: LIPF in ADMF provisioning of NEs

With respect to the LI model of ETSI 103 221-1 [6], the LIPF plays the role of ADMF (as defined in ETSI 103 221-1 [6]), and the LI functions (within the NFs) MDF2, and MDF3 play the role of NE (as defined in ETSI 103 221-1 [6]).

The present document focuses on LIPF provisioning logic of LI functions, MDF2, MDF3 over the LI_X1. Henceforth, the term LIPF logic is used in the present document. See clause 5 for details of LIPF logic.

4.2 General

A separate box is used to represent each of the NF in which an LI function is provisioned by the LIPF. In the illustration shown below in figure 4.2-1, P-CSCF and MGCF are two NFs and are represented by two separate boxes.



Figure 4.2-1: Separate box for each NF that has the LI function

The LI function present within a NF and provisioned by the LIPF is represented within the parenthesis. In the illustration shown in figure 4.2-2, the IRI-POI in P-CSCF and IRI-POI in MGCF are provisioned by the LIPF.

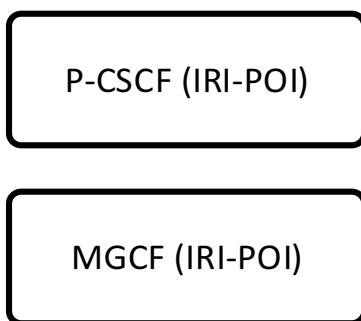

Figure 4.2-2: LI function as applicable to the NF

The possible target identities that are applicable to the LI function present in a NF are represented within another parenthesis that begin with "Target Id:". In the illustration shown in figure 4.2-3, the possible target identities for an IRI-POI in P-CSCF and IRI-POI in MGCF are PEI (IMEI only), IMEI, IMPU and IMPI.

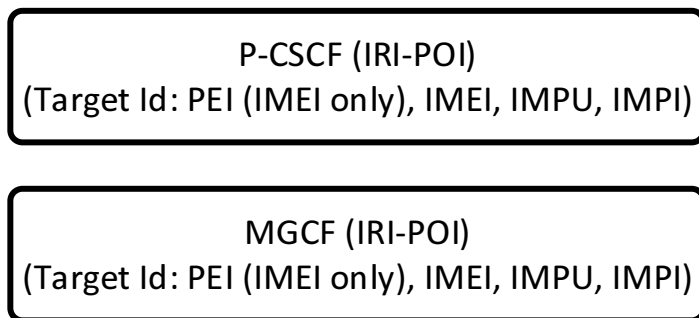

Figure 4.2-3: Possible target identifiers are in parentheses

Some of the flow-charts have a callout description shown next to the provisioned box. The text within the callout description provides a hint on the conditions that would enable the LI function to provide the interception. When such a condition for the interception is obvious, no such call-out description is provided. In the illustration shown in figure 4.2-4, no callout description is given for the IRI-POI of P-CSCF implying no further clarity is needed. The callout description for the IRI-POI in MGCF is to hint that the IRI-POI in an MGCF is used only when an IMS session is redirected to a CS domain (see TR 33.929 [5]).

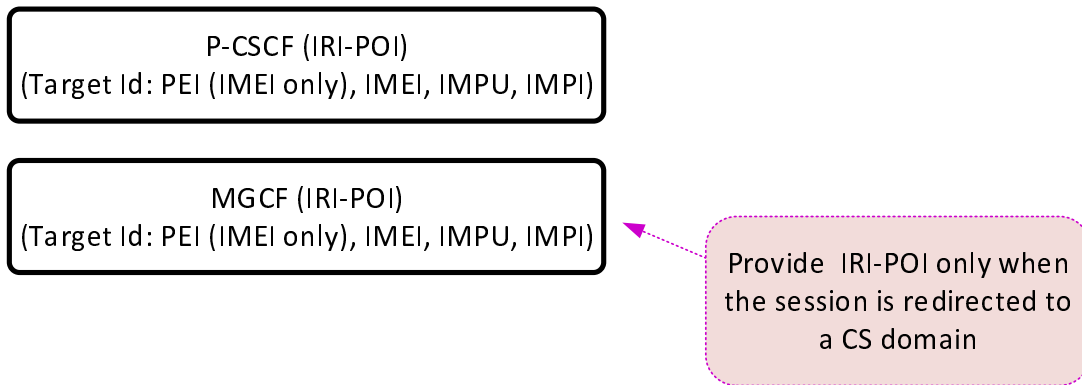

Figure 4.2-4: Call out next to the NF describe the conditionality of interception

The conditions given inside the call-out description are outside the scope of LIPF logic. However, the LIPF logic is aware of the condition in an overall scheme of things.

Most of the flow-charts have follow up tables that identify the scope of NF domain in providing the LI functions.

In the illustration shown in table 4.2-1:

- P-CSCF has CC-TF in a non-roaming case, has IRI-POI (for non-emergency services only) and CC-TF in VPLMN with LBO and CC-TF (for emergency services only) in VPLMN with HR (home-routed).
- MGCF has CC-TF in a non-roaming case, CC-TF in HPLMN with roaming (both LBO and HR) when an incoming session is redirected over a CS domain.
- IMS-AGW has CC-POI when P-CSCF has the CC-TF and IM-MGW has the CC-POI whenever the MGCF has the CC-TF.

Note that for each clause the relevant table is to be used as an aid to understand the LIPF logic and it is outside the scope of LIPF logic. However, the LIPF logic is aware of the condition in an overall scheme of things.

Table 4.2-1: Scope of NF domain that provide the LI functions

NFs with LI function	Non-roaming	Roaming with LBO		Roaming with HR	
		VPLMN	HPLMN	VPLMN	HPLMN
P-CSCF	n/a	IRI-POI (NOTE 1)	n/a	n/a	n/a
P-CSCF	CC-TF	CC-TF	n/a	CC-TF (NOTE 2)	n/a
IMS-AGW	CC-POI	CC-POI	n/a	CC-POI (NOTE 2)	n/a
MGCF (NOTE 3)	CC-TF	n/a	CC-TF	n/a	CC-TF
IM-MGW (NOTE 3)	CC-POI	n/a	CC-POI	n/a	CC-POI

NOTE 1: For non-emergency sessions only.

NOTE 2: For emergency sessions only.

NOTE 3: Only when an incoming session to a target is redirected over a CS domain.

4.3 Destination end points

As a part of the LI provisioning task, the LIPF first provisions the LI functions with the destination end points for the delivery of the appropriate intercepted data on the LI interfaces that those LI functions support.

Table 4.3-1 provides the destination end points for each of the LI interfaces defined in TS 33.127 [3] and TS 33.128 [4].

Table 4.3-1: Destination end points

LI interface	Destination end point	Source LI function
LI_HI2	LEMF	MDF2
LI_HI3	LEMF	MDF3
LI_HI4	LEMF	MDF2, MDF3
LI_X2	MDF2	IRI-POI, LI_LCS Client, LMISF-IRI
LI_X2_LA	MDF2	LARF
LI_X3	MDF3	CC-POI, CC-PAG
LI_X2_LITE	LMISF-IRI	BBIFF-C, BBIFF
LI_X3_LITE_S	LMISF-IRI	BBIFF-U, BBIFF
LI_X3A	CC-PAG	CC-POI

NOTE: The present document is on the provisioning of various LI functions (i.e. on LI_X1 interface) and as such delivery end point is not applicable to LI_X1 or the triggering interfaces (i.e. LI_T2, LI_T3).

If the same destination end point is used for one or more intercepts, then the provisioning of that destination end point at an LI function is done only once. If the same destination end point is used on multiple interfaces at an LI function, then the provisioning of that destination end point at that LI function is done only once (e.g. the same LEMF as the destination end from MDF2 for LI_HI2 and LI_HI4).

The present document assumes that the required provisioning is done as per the above table prior to any provisioning and these aspects are not shown in the illustrative LIPF logic diagrams.

5 LIPF logic

5.1 Background

According to TS 33.126 [2] clause 6.4, the CSP is expected to only deliver Interception Product relating to specific CSP services. In other words, the CSP is expected to perform the interception only for the services required by the warrant. The interception may be performed for more than one service when required by the warrant.

NOTE: The term "interception" used in the present document refers to the step that involves actual capturing and then delivery of the Intercept Product to the LEMF.

This clause considers the following possibilities in the analysis:

- The intended target may have subscribed to only a specific service and in this case, by default, the interception would apply only to such service when specified in the warrant. The CSP network would provide the interception as and when the service is accessed by the target.
- The intended target may have subscribed to multiple services and in this case, the interception would have to be done based on the service type(s) specified in the warrant as and when CSP network detects that such services are accessed by the target.
- A NF may be involved in providing only a particular service and in this case, by default, the interception performed by the POI present in that NF would apply to such service when specified in the warrant.
- A NF may be involved in providing multiple services and in this case, the interception performed by the POI present in that NF would have to be based on the service type applicable to the warrant.
- There may be multiple warrants with differing service types active on a target, in this case, all applicable services would have to be intercepted at the POIs, and the MDFs would have to then deliver Interception Product based on the service type (s) applicable to the warrant.

In supporting the above scenarios, as per clause 4.4 of TS 33.128 [4], the LIPF will have to provision the POIs, TFs and the MDF2/MDF3 according to the CSP service type(s) applicable to a warrant.

To cover all the scenarios mentioned above, the service type may have to be part of LI provisioning data sent to the MDFs. Whether a service type will have to be provisioned to the POIs and TFs as an indication will depend on the services provided by the NFs that have such POIs and TFs.

In addition to the CSP service type, a few other factors present in the warrant may influence the LIPF logic in provisioning the POIs, TFs and MDF2/MDF3. Few examples are:

- Delivery type.
- LALS triggering.
- CSP deployment options.
- The target type (local Vs non-local ID).

For the target non-local ID, Voice, RCS and Messaging type of services are supported in the present document. In this case, the other party communicating with the target non-local ID happens to access the service provided by the CSP.

This clause illustrates the LIPF logic through a series of flow-charts in provisioning the POIs and the TFs. The provisioning aspect of MDF2/MDF3 are not shown unless such details provide additional clarity. For a given warrant, the provisioning of MDF2 and MDF3 are done before the provisioning of LI functions (e.g. POIs).

5.2 Governing scenarios

With respect to the interception performed within the CSP network, there are five scenarios:

1. The target (or party communicating with a target non-local ID) is non-roaming.
2. The target (or party communicating with a target non-local ID) is outbound roaming with HR.
3. The target (or party communicating with a target non-local ID) is outbound roaming with LBO.
4. The target (or party communicating with a target non-local ID) is inbound roaming with HR.
5. The target (or party communicating with a target non-local ID) is inbound roaming with LBO.

Scenario 4 is also referred to as N9HR or S8HR, depending on whether the packet core is 5GC or EPC. As indicated clause 5.1, a target can be a non-local ID only when the service type is Voice or Messaging.

The same NF that provides an LI function may be present in one or more of the above scenarios. The LIPF logic, even though may not be aware of the roaming nature of a target, will have to accommodate the above five scenarios while provisioning the LI functions.

5.3 Top-level LIPF provisioning logic

5.3.1 LIPF logic for initial configuration

The provisioning for Identity Association Caching is considered as a part of initial configuration. Likewise, part of the S8HR/N9HR LI also requires some initial configuration (see clause 5.5.2).

The details of initial configuration for N9HR/S8HR are illustrated in figure 5.5.2-1 (clause 5.5.2). The initial configuration of Identity Association Caching is required if and only if the CSP has deployed the Identity Association Caching service. Likewise, the initial configuration for N9HR/S8HR is required if and only if the interception of voice calls for inbound roaming targets is required in a home-routed roaming scenario.

5.3.2 LI provisioning logic in LIPF

When Location Acquisition service is deployed in the CSP network, a warrant may be received to authorize Location Acquisition service for the targeted user. This may be a standalone warrant of its own or may be tagged along with the warrant issued to perform the service-based interception.

The details of LI provisioning logic for Location Acquisition are illustrated in clause 5.9. The details of service-based LI provisioning logic in LIPF are illustrated in clause 5.3.3.

5.3.3 Service-based LI provisioning logic in LIPF

The flow-chart in figure 5.3-1 shows a top-level logic within the LIPF to branch off into separate processes according to the service type defined in the present document.

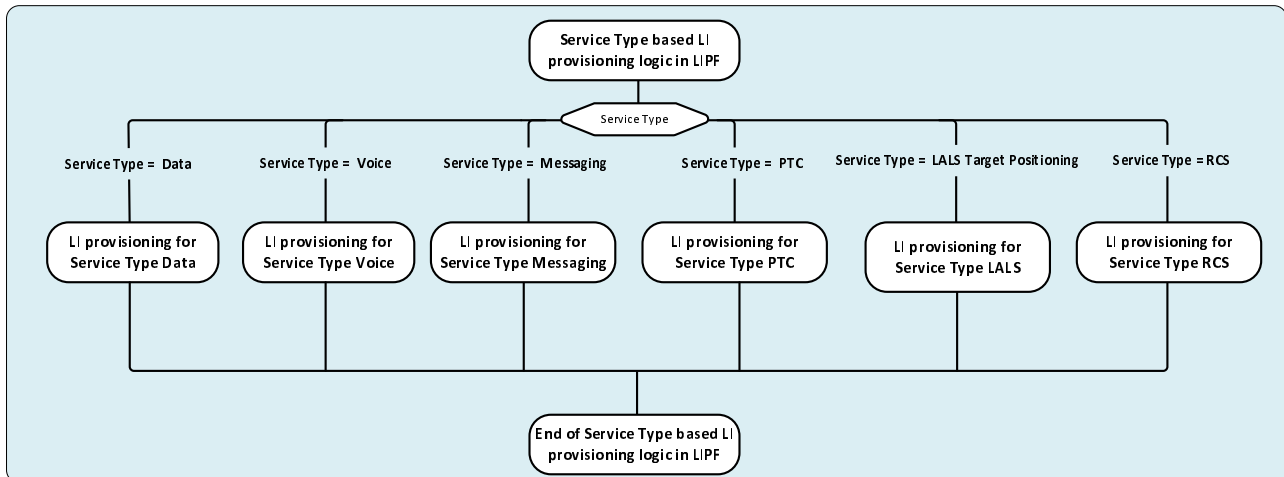

Figure 5.3.3-1: Top-level view of LIPF logic in handling the service type

Based on the LI functionality defined in the present document:

- For the service type of Data, it is assumed that the NFs in the packet core network are involved and hence, provide the IRI and CC interception.
- For the service type of Voice, it is assumed that the NFs in the IMS domain are involved and hence, provide the IRI and CC interception.
- For the service type of Messaging (that includes SMS and MMS), the NFs in the packet core network, IMS or MMS Proxy Relay are involved and hence, provide the IRI and CC interception. The interception of SMS has only the IRIs. For, the service type of Messaging, the LI provisioning for the service type RCS is also done (see below) if supported and applicable to the target.
- For the service type of PTC, the PTC Server is involved and hence, provides the IRI and CC interception.
- For the service type of LALS, the LI-LCS Client provides the IRI interception, and the CC interception does not apply to LALS.

For the service type RCS, the RCS Server, the HTTP Content Server, the File Transfer Localization Function are involved and hence, provide the IRI and CC interception.

When the service type "Messaging" is explicitly specified in a warrant, the provisioning for the service type RCS is also performed by the LIPF, if the latter is supported and applicable to the target. If the warrant explicitly includes both "Messaging" and "RCS" as the service types, the LI provisioning for the service type RCS is done only once.

The UDM and HSS are also the NFs that have the IRI-POI and the provisioning of IRI-POI in UDM and HSS is independent of the service type indicated in the warrant as long as the target is not indicated as a non-local ID. The provisioning of IRI-POI in the UDM and HSS for a target identifier is done only once.

When multiple service types are applicable for a target identifier, the LIPF may provision the LI function in a NF only once including all the applicable service types. Alternatively, the LIPF may determine the services that need to be intercepted at the LI function present in a NF and then provision that LI function for all services together.

5.3.4 Location Acquisition

Figure 5.3.4-1 shows the LIPF logic in provisioning the LI functions for Location Acquisition.

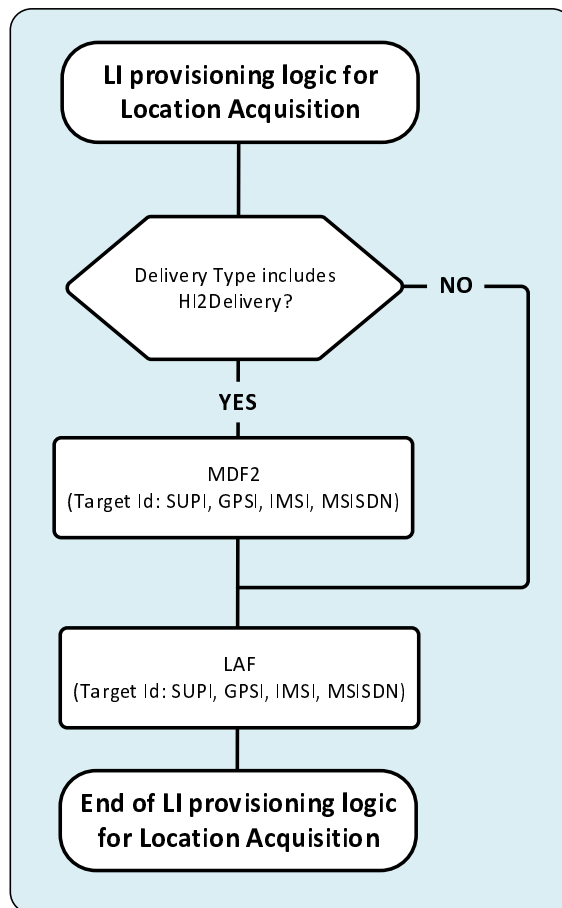

Figure 5.3.4-1: LIPF logic for Location Acquisition

The LAF is a Location Acquisition specific LI function present in the ADMF. Therefore, the provisioning of LAF is treated as internal to the ADMF. The provisioning of MDF2 is required if and only if the delivery method for Location Acquisition includes IRI-based reporting which is indicated with the Delivery Type of HI2Delivery.

The target identity SUPI collectively represents the SUPIIMSI and SUPINAI. The target identity GPSI collectively represents the GPSIMSISDN and GPSINAI.

5.4 Data

5.4.1 Scope of interception

For the service type of Data, the NFs present in the packet core network provide the LI functions. This clause illustrates the LIPF logic for 5GC and EPC as the two packet core networks.

The interception of service type of Data includes:

- Delivery of IRI, or CC based on the delivery type indicated in the warrant.
- When required, the delivery of packet data header reporting.
- When required, the delivery of LALS reports based on the LALS triggering.

The CSP may have differing implementation options for the packet data header reporting and LALS triggering.

In the case of EPC, the CSP may also have differing deployment options in choosing the NFs (SGW-based Vs PGW-based) that provide the interception.

5.4.2 Top-level view

When the target identifier is one or more of IMSI, IMEI, MSISDN, the LI functions in EPC are provisioned. When the target identifier is one or more variants of SUPI, PEI, GPSI, the LI functions in 5GC are provisioned.

Figure 5.4.2-1 provides the top-level view of LIPF logic for the service type of Data.

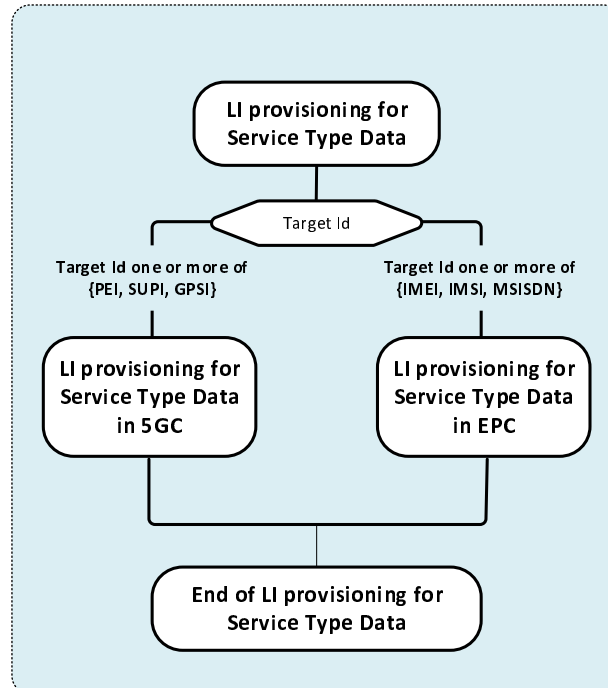

Figure 5.4.2-1: Top-level view of LIPF logic for the service type Data

Within figure 5.4.2-1, PEI collectively represents PEIIMEI and PEIIMEISV. Likewise, SUPI represents SUPIIMSI and SUPINAI whereas GPSI represents GPSIMISDN and GPSINAI.

5.4.3 5GC

5.4.3.1 The flow-chart

Figure 5.4.3.1-1 shows the LIPF logic in provisioning the LI functions for the 5GC for the service type of Data.

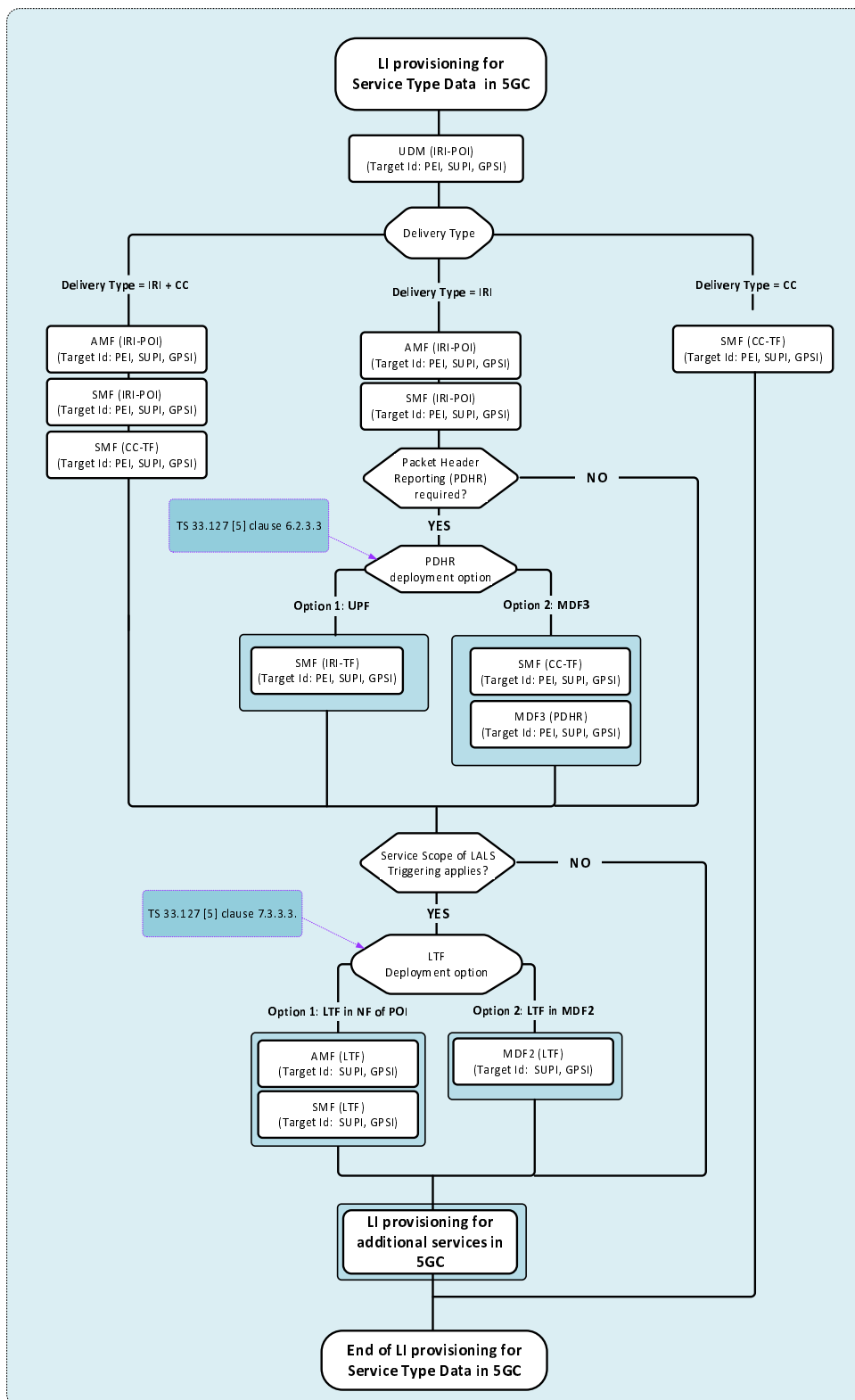

Figure 5.4.3.1-1: LIPF logic for the service type Data in 5GC

For the delivery type of IRI + CC, the IRI-POIs and the CC-TFs are provisioned. For the delivery type of IRI, the IRI-POIs and the IRI-TFs are provisioned. For the delivery type of CC, the CC-TFs are provisioned.

Figure 5.4.3.1-2 shows the LIPF logic in provisioning the LI functions for additional data services in 5GC.

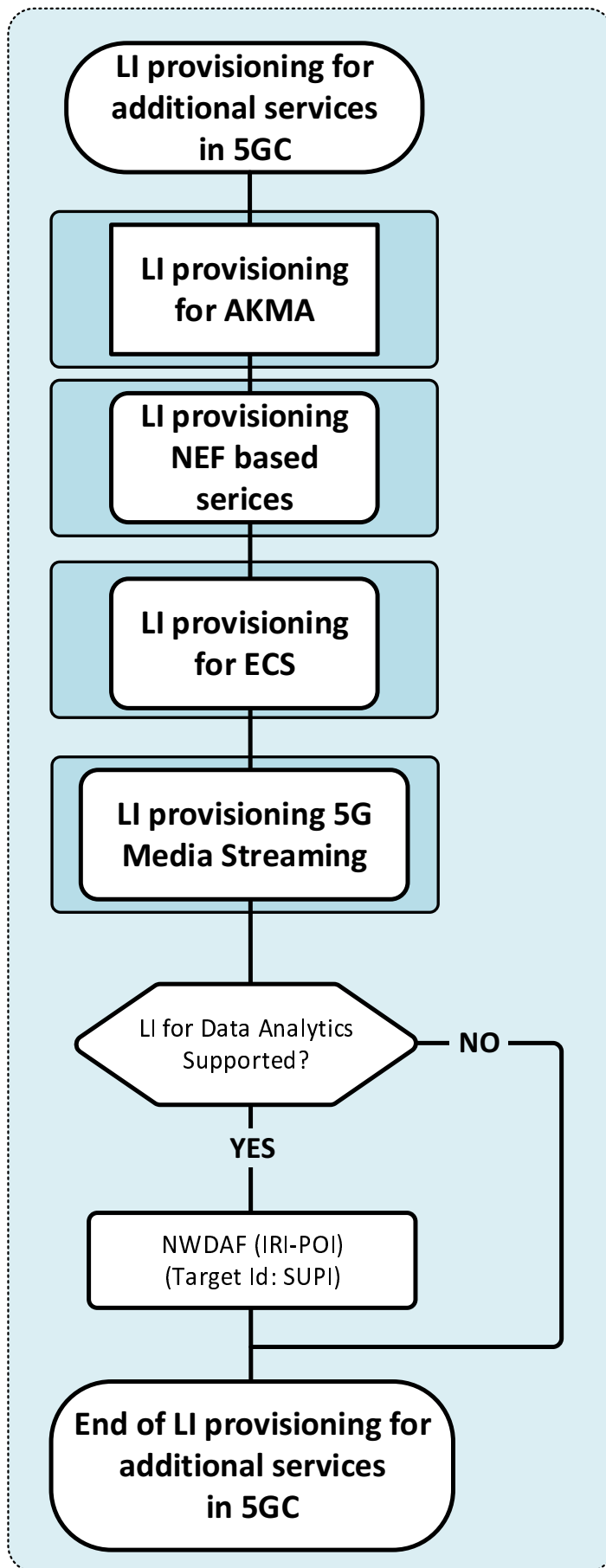

Figure 5.4.3.1-2: LIPF logic for the additional data services in 5GC

The details of LI provisioning for AKMA, NEF based services, ECS and 5G Media Streaming are illustrated in clause 5.4.3.3.

NOTE: Even though the figure 5.4.3.1-2 shows that LI provisioning for AKMA is part of LI provisioning for the service type Data, AKMA may have to be intercepted independently in order to support other services.5.4.3.2 Interception

5.4.3.2.1 PDHR

There are two deployment options for the packet data header reporting. It is expected that the CSP implements one of the two deployment options.

In PDHR option 1, the IRI-POI in the UPF (based on a trigger from IRI-TF present in the SMF) generates the xIRI. Accordingly, the IRI-TFs in SMFs are provisioned.

In PDHR option 2, the CC-POI present in the UPF (based on a trigger from CC-TF present in the SMF) delivers the UP packets as xCC to the MDF3, which in turn, forwards the same to the MDF2 and MDF2 would then generate the IRI messages from the received xCC. Accordingly, the CC-TFs in SMFs, and the PDHR handling function in MDF3 are provisioned.

5.4.3.2.2 LALS triggering

There are two deployment options for LALS triggering. It is expected that the CSP implements one of the two deployment options.

In LALS triggering option 1, the LTF present in the host NF that has the associated IRI-POI triggers the LI-LCS Client. Accordingly, the LTFs in AMFs and SMFs are provisioned.

In LALS triggering option 2, the LTF present in the MDF2 triggers the LI-LCS Client. Accordingly, the LTF in MDF2 is provisioned.

5.4.3.2.3 UDM

The UDM is expected to provide the IRI-POI functions in the HPLMN only.

5.4.3.2.4 Summary

Table 5.4.3.2.4-1 provides the scope of NF domain that provides the IRI-POI/CC-TF/CC-POI functions for the service type of Data in the 5GC for various scenarios.

Table 5.4.3.2.4-1: Scope of NF domain in 5GC providing the LI functions

NFs with LI function			Non-roaming	Roaming with LBO		Roaming with HR	
				VPLMN	HPLMN	VPLMN	HPLMN
UDM			IRI-POI	n/a	IRI-POI	n/a	IRI-POI
AMF			IRI-POI	IRI-POI	n/a	IRI-POI	n/a
SMF			IRI-POI	IRI-POI	n/a	IRI-POI	IRI-POI
SMF			CC-TF	CC-TF	n/a	CC-TF	CC-TF
UPF			CC-POI	CC-POI	n/a	CC-POI	CC-POI
PDHR	Option 1	SMF	IRI-TF	IRI-TF	n/a	IRI-TF	IRI-TF
		UPF	IRI-POI	IRI-POI	n/a	IRI-POI	IRI-POI
	Option 2	SMF	CC-TF	CC-TF	n/a	CC-TF	CC-TF
		UPF	CC-POI	CC-POI	n/a	CC-POI	CC-POI
		MDF3	PDHR	PDHR	n/a	PDHR	PDHR
LALS triggering	Option 1	AMF	LTF	LTF	n/a	LTF	n/a
		SMF	LTF	LTF	n/a	LTF	LTF
	Option 2	MDF2	LTF	LTF	n/a	LTF	LTF

NOTE 1: The use of "n/a" in the above table implies that the LI function is not applicable to the NF for the indicated scenario.

NOTE 2: The LIPF is not aware of the above role played by the host NFs in providing the LI functions.

NOTE 3: MDF2, MDF3 and LI-LCS Client which are also involved in providing the LI functions are not shown in the tables above.

5.4.3.3 LI provisioning for additional data services in 5GC

5.4.3.3.1 LI provisioning for AKMA

LI provisioning for AKMA is required when there is a need to provide the interception of encryption services between the target UE and the application function that makes use of AKMA-provided cryptographic keys (see TS 33.128 [4]).

Figure 5.4.3.3.1-1 shows the LIPF logic for provisioning the LI functions in AAnF for AKMA.

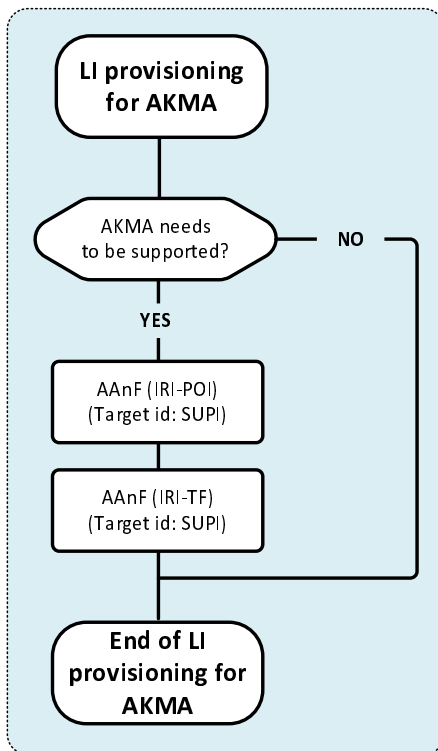

Figure 5.4.3.3.1-1: LI provisioning for AKMA

Within the figure, SUPI collectively represents SUPIIMSI and SUPINAI. AKMA stands for Authentication and Key Management for Applications. AAnF is the AKMA Anchor Function. AF is the Application Function.

The table 5.4.3.3.1-1 provides the scope of NF domain providing the LI functions for AKMA.

Table 5.4.3.3.1-1: Scope of NF domain providing the LI functions for AKMA

NFs with the LI function	LI function
AAnF	IRI-POI
AAnF	IRI-TF
AF	IRI-POI

NOTE: MDF2 which is also involved in providing the LI function is not shown in the tables above.

5.4.3.3.2 LI provisioning for NEF based services

5.4.3.3.2.1 Scope of interception

This clause references to the LI functions provided in the NEF. The following is a list of 5GC services to which the LI functions are provided in the NEF:

- NIDD using NEF.

- Device triggering.
- MSISDN-less SMS.
- Parameter provisioning.
- AF session with QoS.

The details of the above are described in TS 33.128 [4].

5.4.3.3.2.2 The flow-chart

Figure 5.4.3.3.2.2-1 shows the LIPF logic for provisioning the LI functions in NEF.

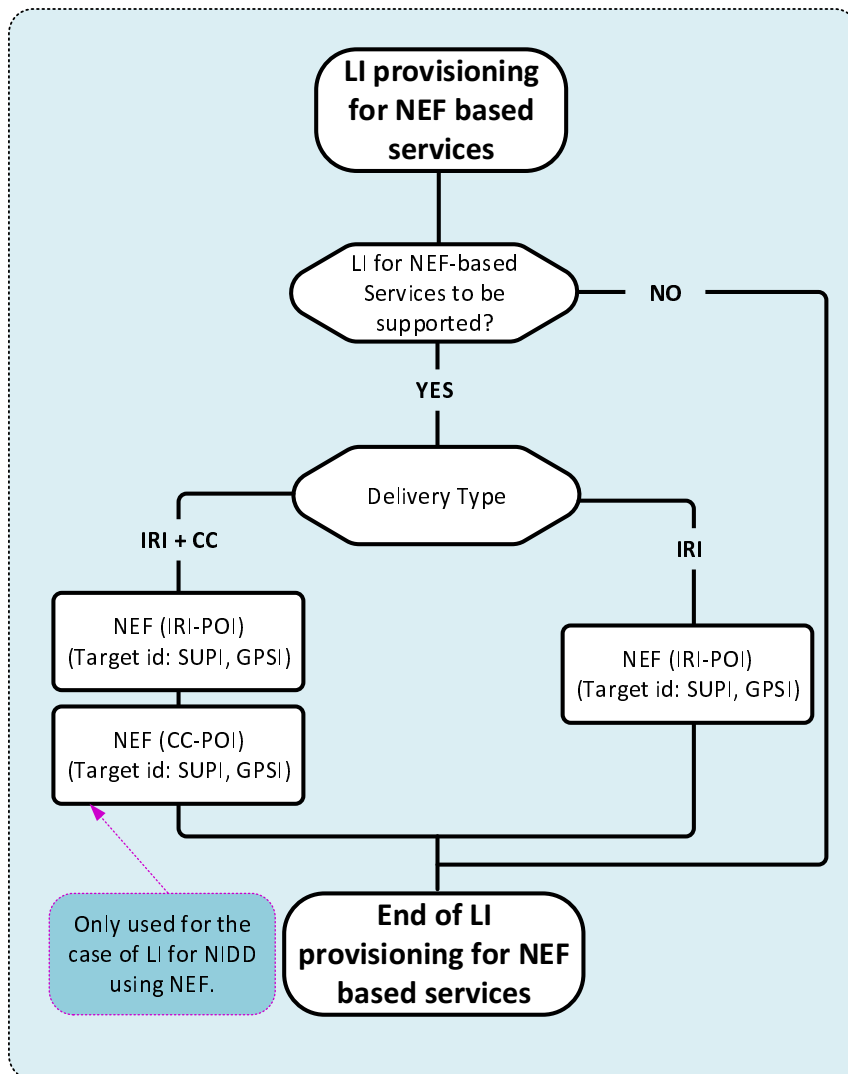

Figure 5.4.3.3.2.2-1: LI for NEF based services.

For all except the parameter provisioning, GPSI and SUPI are used as the target identifiers. For parameter provisioning, only the GPSI is used as a target identifier.

GPSI collectively represents GPSIMSIDN and GPSINAI. SUPI collectively represents SUPIIMSI and SUPINAI.

5.4.3.3.2.3 Interception

The CC-POI in NEF is used only for the NIDD using the NEF.

The table 5.4.3.3.2.3-1 provides the scope of LI functions provided in NEF.

Table 5.4.3.3.2.3-1: Scope of LI functions in NEF

NEF-based services	NEF LI functions	
NIDD using NEF	IRI-POI	CC-POI
Device triggering	IRI-POI	n/a
MSISDN-less SMS	IRI-POI	n/a
Parameter provisioning	IRI-POI	n/a
AF session with QoS	IRI-POI	n/a

NOTE 1: The use of "n/a" in the above table implies that the LI function is not applicable to the NEF for the indicated scenario.

NOTE 2: The LIPF is not aware of the above role played by the NEF in providing the LI functions.

NOTE 3: MDF2 and MDF3 which are also involved in providing the LI functions are not shown in the tables above.

5.4.3.3.3 LI provisioning for Edge Computing Service

The Edge Computing Service (ECS) may be provided by the CSP or a third party service provider. Either way, the service provider that provides the ECS will have to provide the LI functions. EES present in the ECS provider's network provides the LI functions. When CSP provides the ECS, the LI applies only when target is non-roaming or inbound roaming. The details of this are described in TS 33.128 [4].

Figure 5.4.3.3.3-1 shows the LIPF logic for provisioning the LI functions in EES for ECS.

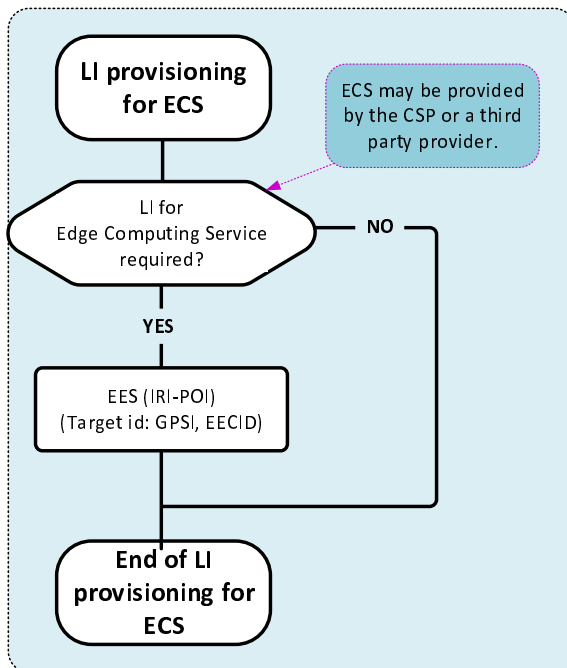

Figure 5.4.3.3.3-1: LI provisioning for ECS

Within figure 5.4.3.3.3-1, GPSI collectively represents GPSIMSIDN and GPSINAI. The EECID (EEC Identifier) is ECS specific.

The table 5.4.3.3.3-1 provides the scope of NF domain providing the LI functions for ECS.

Table 5.4.3.3-1: Scope of NF domain providing the LI functions for ECS

NF with the LI function	CSP provides ECS			ECS is provided by third party provider			ECS provider
	Roaming			CSP			
	Not	Outbound	Inbound	Not	Outbound	Inbound	
EES	IRI-POI	n/a	IRI-POI	n/a	n/a	n/a	IRI-POI

NOTE 1: The use of "n/a" in the above table implies that the LI function is not applicable to the EES for the indicated scenario.

NOTE 2: The LIPF is not aware of the roaming situations of the target.

NOTE 3: MDF2 which is also involved in providing the LI function is not shown in the tables above.

5.4.3.3.4 LI provisioning for 5G Media Streaming

The AF that handles the 5G Media Streaming (5G MS) provides the LI for 5G MS. The LI applies when a target is non-roaming or inbound roaming in the CSP network. The details of LI for 5G MS are described in TS 33.128 [4].

Figure 5.4.3.3.4-1 shows the LIPF logic for provisioning the LI functions in 5G MS AF.

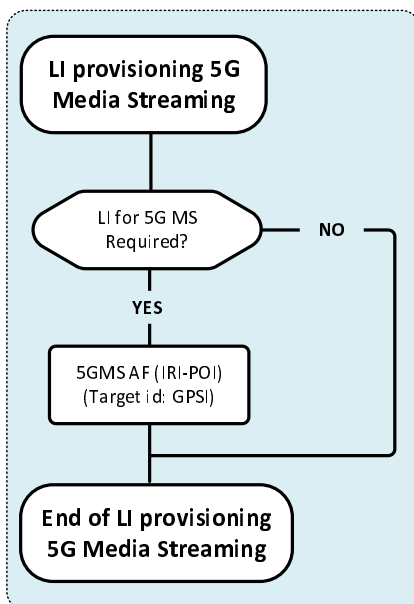

Figure 5.4.3.3.4-1: LI provisioning for 5G MS

Within the figure, GPSI collectively represents GPSIMSISDN and GPSINAI.

The table 5.4.3.3.4-1 provides the scope of NF domain providing the LI functions for 5G MS.

Table 5.4.3.3.4-1: Scope of NF domain providing the LI functions for 5G MS

NF with the LI function	Not-roaming	Roaming	
		VPLMN	HPLMN
5G MS AF	IRI-POI	IRI-POI	n/a

NOTE 1: The use of "n/a" in the above table implies that the LI function is not applicable to the 5G MS AF for the indicated scenario.

NOTE-2: The LIPF is not aware of the roaming situation of the target.

NOTE 3: MDF2 which is also involved in providing the LI function is not shown in the tables above.

5.4.4 EPC

5.4.4.1 The flow-chart

Figure 5.4.4.1-1 shows the LIPF logic in determining the host NFs in EPC that have the LI functions for the service type of Data.

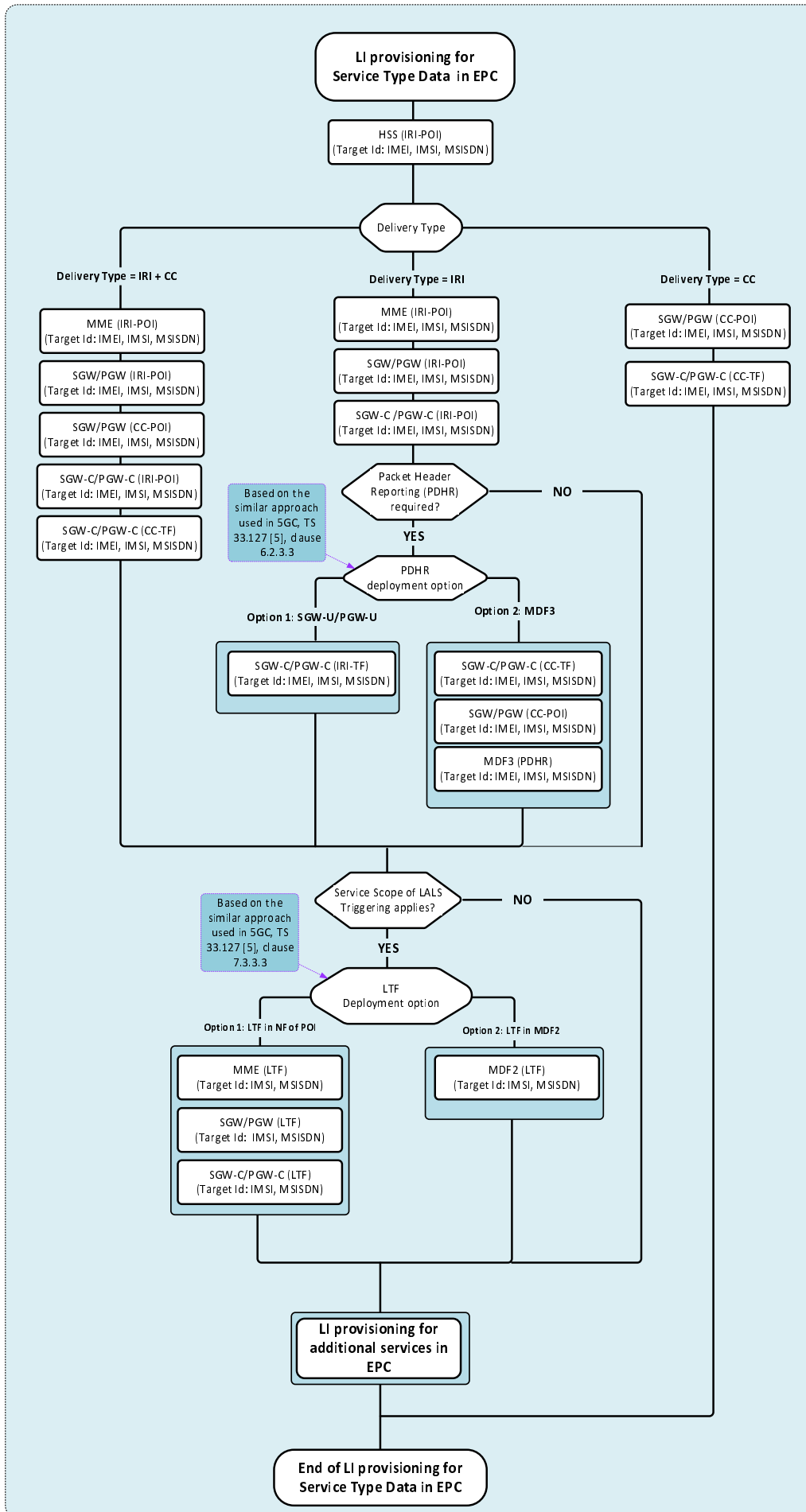

Figure 5.4.4.1-1: LIPF logic for the service type Data in EPC

For the delivery type of IRI + CC, the IRI-POIs, the CC-TFs and the CC-POIs (when EPC is deployed without CUPS) are provisioned. For the delivery type of IRI, the IRI-POIs and the IRI-TFs (when EPC is deployed with CUPS) are provisioned. For the delivery type of CC, the CC-TFs and the CC-POIs (when EPC is deployed without CUPS) are provisioned.

For the LI within the EPC, the CSP may deploy either an SGW-based interception or a PGW-based interception. The LIPF logic in supporting the two deployment options is illustrated in figure 5.4.4.1-2.

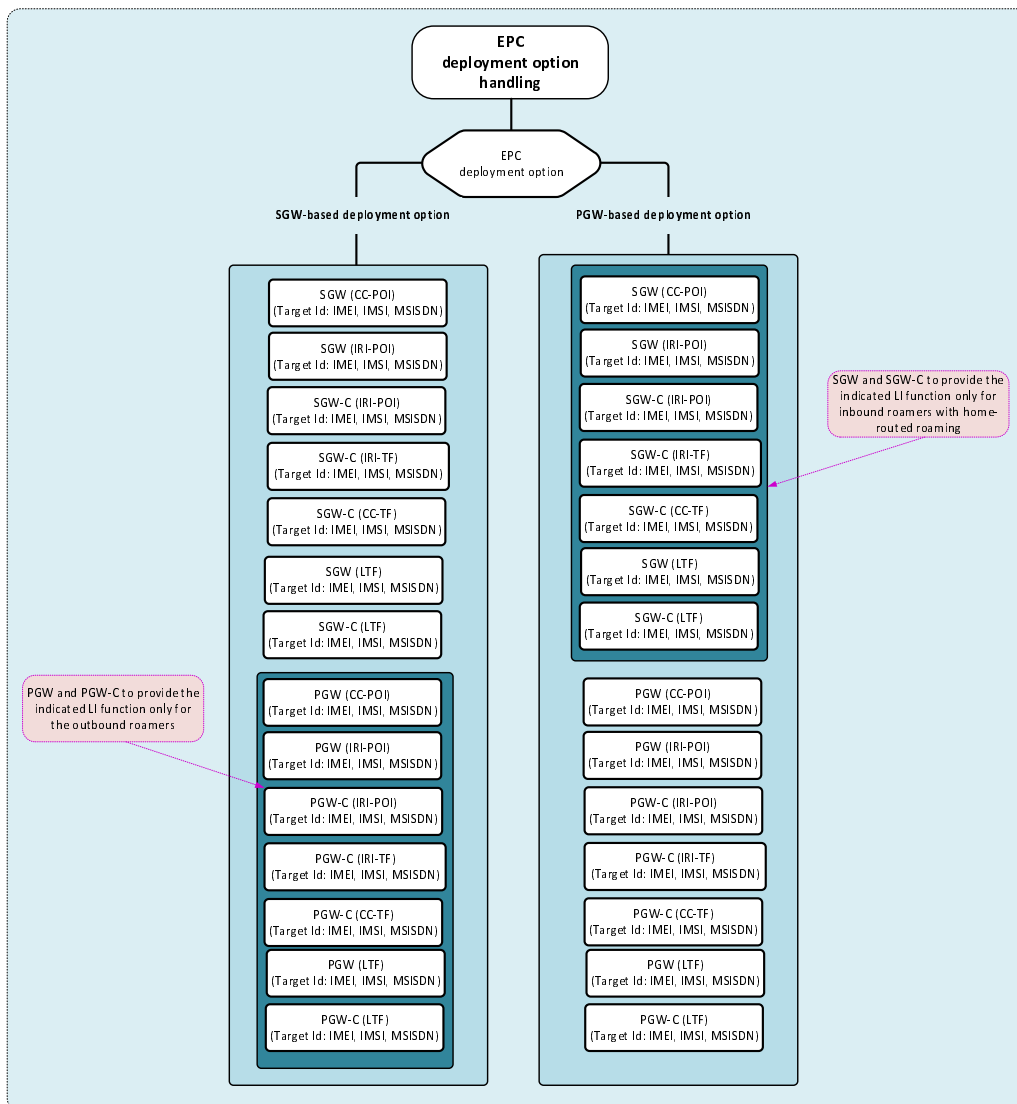

Figure 5.4.4.1-2: Two deployment options in EPC

The LIPF includes a parameter while provisioning the SGW/SGW-C and PGW/PGW-C.

To PGW/PGW-C, with the SGW based deployment option:

- Provide LI functions only for the targets that are outbound roaming with HR.

SGW/SGW-C, with the PGW based deployment option:

- Provide LI functions only for the targets that are inbound roaming with HR.

The above parameter is needed to avoid both SGW/SGW-C and PGW/PGW-C end up performing the interceptions for the same packet data session.

Figure 5.4.4.1-3 shows the LIPF logic in provisioning the LI functions for additional data services in EPC.

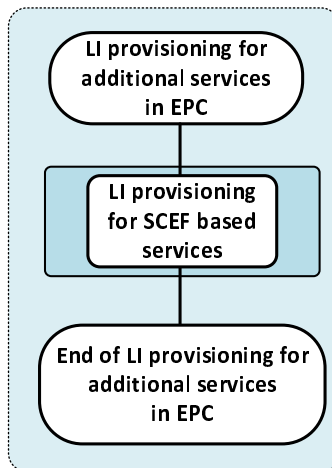

Figure 5.4.4.1-3: LIPF logic for the additional data services in EPC

The details of LI provisioning for SCEF based services are illustrated in clause 5.4.4.3.

5.4.4.2 Interception

5.4.4.2.1 PDHR

There are two deployment options for the packet data header reporting. It is expected that the CSP implements one of the two deployment options.

In PDHR option 1, the IRI-POI present in the SGW-U/PGW-U (based on a trigger from IRI-TF present in the SGW-C/PGW-C) or the IRI-POI present in the SGW/PGW generates the xIRI. Accordingly, the IRI-TFs in SGW-C/PGW-C and IRI-POI in SGW/PGW are provisioned.

In PDHR option-2, the CC-POI present in the SGW-U/PGW-U (based on a trigger from CC-TF present in the SGW-C/PGW-C) or the CC-POI present in the SGW/PGW delivers the UP packets as xCC to the MDF3, which in turn, forward the same to the MDF2, and MDF2 then would generate the IRI messages from the received xCC. Accordingly, the CC-TF in SGW-C/PGW-C, CC-POI in SGW/PGW and the PDHR handling function in MDF3 are provisioned.

5.4.4.2.2 LALS triggering

There are two deployment options for LALS triggering. It is expected that the CSP implements one of the two deployment options.

In LALS triggering option 1, the LTF present in the host NF that has the associated IRI-POI triggers the LI-LCS client. Accordingly, the LTFs in MME, SGW, PGW, SGW-C and PGW-C (when EPC is deployed with CUPS) are provisioned.

In LALS triggering option 2, the LTF present in the MDF2 triggers the LI-LCS Client. Accordingly, the LTF in MDF2 is provisioned.

5.4.4.2.3 SGW/PGW deployment options

For the IRI/CC generation, two deployment options are considered:

- SGW-based.
- PGW-based.

The CSP expected to implement one of the two options.

When SGW/SGW-C is provisioned, if the deployment option is PGW-based approach, then the SGW/SGW-C does not perform an interception unless the target is inbound roaming with HR. Similarly, when the PGW/PGW-C is

provisioned, if the deployment option is SGW-based approach, then the PGW/PGW does not perform the interception unless the target is outbound roaming with HR.

5.4.4.2.4 HSS

The HSS is expected to provide the IRI-POI functions in the HPLMN only.

5.4.4.2.5 Summary

Table 5.4.4.2.5-1 provides the scope of NF domain that provides the IRI-POI/CC-TF/CC-POI functions for the service type of Data in the EPC for an SGW-based deployment option.

Table 5.4.4.2.5-1: Scope of NF domain in EPC providing the LI functions (SGW-based deployment) NFs with LI function

		Non-roaming	Roaming with LBO		Roaming with HR		
			VPLMN	HPLMN	VPLMN	HPLMN	
HSS		IRI-POI	n/a	IRI-POI	n/a	IRI-POI	
MME		IRI-POI	IRI-POI	n/a	IRI-POI	n/a	
SGW		IRI-POI	IRI-POI	n/a	IRI-POI	n/a	
SGW		CC-POI	CC-POI	n/a	CC-POI	n/a	
PGW		n/a	n/a	n/a	n/a	IRI-POI	
PGW		n/a	n/a	n/a	n/a	CC-POI	
SGW-C		IRI-POI	IRI-POI	n/a	IRI-POI	n/a	
SGW-C		CC-TF	CC-TF	n/a	CC-TF	n/a	
SGW-U		CC-POI	CC-POI	n/a	CC-POI	n/a	
PGW-C		n/a	n/a	n/a	n/a	IRI-POI	
PGW-C		n/a	n/a	n/a	n/a	CC-TF	
PGW-U		n/a	n/a	n/a	n/a	CC-POI	
PDHR	Option 1	SGW	IRI-POI	IRI-POI	n/a	IRI-POI	n/a
		SGW-C	IRI-TF	IRI-TF	n/a	IRI-TF	n/a
		SGW-U	IRI-POI	IRI-POI	n/a	IRI-POI	n/a
		PGW	n/a	n/a	n/a	n/a	IRI-POI
		PGW-C	n/a	n/a	n/a	n/a	IRI-TF
		PGW-U	n/a	n/a	n/a	n/a	IRI-POI
	Option 2	SGW	CC-POI	CC-POI	n/a	CC-POI	n/a
		SGW-C	CC-TF	CC-TF	n/a	CC-TF	n/a
		SGW-U	CC-POI	CC-POI	n/a	CC-POI	n/a
		PGW	n/a	n/a	n/a	n/a	CC-POI
		PGW-C	n/a	n/a	n/a	n/a	CC-TF
		PGW-U	n/a	n/a	n/a	n/a	CC-POI
LALS triggering	Option 1	MDF3	PDHR	PDHR	n/a	PDHR	PDHR
		SGW	LTF	LTF	n/a	LTF	n/a
		SGW-C	LTF	LTF	n/a	LTF	n/a
		PGW	n/a	n/a	n/a	n/a	LTF
	Option 2	PGW-C	n/a	n/a	n/a	n/a	LTF
		MDF2	LTF	LTF	n/a	LTF	LTF

Table 5.4.4.2.5-2 provides the scope of NF domain that provides the IRI-POI/CC-TF/CC-POI functions for the service type of Data in the EPC for a PGW-based deployment option.

Table 5.4.4.2.5-2: Scope of NF domain in EPC providing the LI functions (PGW-based deployment)

NFs with LI function		Non-roaming	Roaming with LBO		Roaming with HR		
			VPLMN	HPLMN	VPLMN	HPLMN	
HSS		IRI-POI	n/a	IRI-POI	n/a	IRI-POI	
MME		IRI-POI	IRI-POI	n/a	IRI-POI	n/a	
SGW		n/a	n/a	n/a	IRI-POI	n/a	
SGW		n/a	n/a	n/a	CC-POI	n/a	
PGW		IRI-POI	IRI-POI	n/a	n/a	IRI-POI	
PGW		CC-POI	CC-POI	n/a	n/a	CC-POI	
SGW-C		n/a	n/a	n/a	IRI-POI	n/a	
SGW-C		n/a	n/a	n/a	CC-TF	n/a	
SGW-U		n/a	n/a	n/a	CC-POI	n/a	
PGW-C		IRI-POI	IRI-POI	n/a	n/a	IRI-POI	
PGW-C		CC-TF	CC-TF	n/a	n/a	CC-TF	
PGW-U		CC-POI	CC-POI	n/a	n/a	CC-POI	
PDHR	Option 1	SGW	n/a	n/a	n/a	IRI-POI	n/a
		SGW-C	n/a	n/a	n/a	IRI-TF	n/a
		SGW-U	n/a	n/a	n/a	IRI-POI	n/a
		PGW	IRI-POI	IRI-POI	n/a	n/a	IRI-POI
		PGW-C	IRI-TF	IRI-TF	n/a	n/a	IRI-TF
		PGW-U	IRI-POI	IRI-POI	n/a	n/a	IRI-POI
	Option 2	SGW	n/a	n/a	n/a	CC-POI	n/a
		SGW-C	n/a	n/a	n/a	CC-TF	n/a
		SGW-U	n/a	n/a	n/a	CC-POI	n/a
		PGW	CC-POI	CC-POI	n/a	n/a	CC-POI
		PGW-C	CC-TF	CC-TF	n/a	n/a	CC-TF
		PGW-U	CC-POI	CC-POI	n/a	n/a	CC-POI
LALS triggering	Option 1	MDF3	PDHR	PDHR	n/a	PDHR	PDHR
		SGW	n/a	n/a	n/a	LTF	n/a
		SGW-C	n/a	n/a	n/a	LTF	n/a
		PGW	LTF	LTF	n/a	n/a	LTF
	Option 2	PGW-C	LTF	LTF	n/a	n/a	LTF
		MDF2	LTF	LTF	n/a	LTF	LTF

NOTE 1: The use of "n/a" in the above table implies that the LI function is not applicable to the NF for the indicated scenario.

NOTE 2: The LIPF is not aware of the above role played by the host NFs in providing the LI functions.

NOTE 3: MDF2, MDF3 and LI-LCS Client which are also involved in providing the LI functions are not shown in the tables above.

5.4.4.3 LI provisioning for additional data services in EPC

5.4.4.3.1 LI provisioning for SCEF/IWK-SCEF based services

5.4.4.3.1.1 Scope of interception

This clause references to the LI functions provided in the SCEF and IWK-SCEF. NIDD happens to be one of those services. The following is a list of EPC services to which the LI functions are provided in the SCEF and IWK-SCEF:

- NIDD using SCEF.
- Device triggering.
- MSISDN-less SMS.
- Parameter provisioning.
- AS session with QoS.

The details of the above are described in TS 33.128 [4].

5.4.4.3.1.2 The flow-chart

Figure 5.4.4.3.1.2-1 shows the LIPF logic for provisioning the LI functions in SCEF/IWK-SCEF.

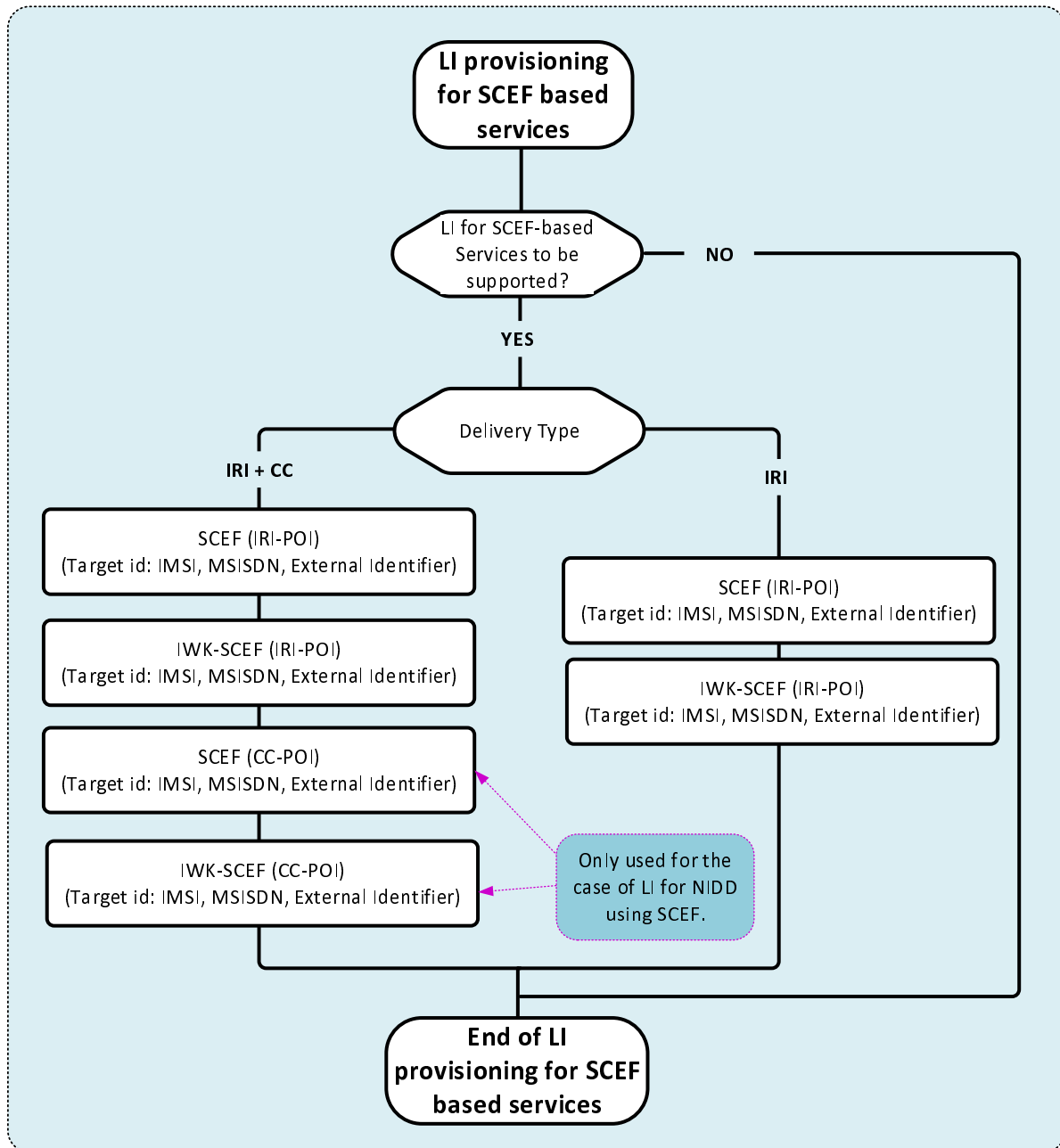

Figure 5.4.4.3.1.2-1: LIPF logic for provisioning the LI functions in SCEF/IWK-SCEF

For all except the parameter provisioning, MSISDN, IMSI and External Identifier are used as the target identifiers. For parameter provisioning, only the MSISDN and the External Identifier are used as a target identifier.

5.4.4.3.1.3 Interception

The LI functions in the SCEF are provided in a non-roaming case and in the HPLMN for a roaming case. The LI functions in the IWK-SCEF are provided in the VPLMN for a roaming case.

The CC-POI in SCEF and IWK-SCEF is used only for the NIDD using the SCEF.

The table 5.4.4.3.1.3-1 provides the scope of LI functions provided in SCEF and IWK-SCEF.

Table 5.4.4.3.1.3-1: Scope of LI functions in SCEF

SCEF based services	NFs with LI functions					
	Non-roaming		Roaming			
	SCEF	IWK-SCEF	VPLMN		HPLMN	
			SCEF	IWK-SCEF	SCEF	IWK-SCEF
NIDD using SCEF	IR-POI	n/a	n/a	IRI-POI	IRI-POI	n/a
	CC-POI	n/a	n/a	CC-POI	CC-POI	n/a
Device triggering	IR-POI	n/a	n/a	IRI-POI	IRI-POI	n/a
MSISDN-less SMS	IR-POI	n/a	n/a	IRI-POI	IRI-POI	n/a
Parameter provisioning	IR-POI	n/a	n/a	IRI-POI	IRI-POI	n/a
AS session with QoS	IR-POI	n/a	n/a	IRI-POI	IRI-POI	n/a

NOTE 1: The use of "n/a" in the above table implies that the LI function is not applicable to the NFs for the indicated scenario.

NOTE 2: The LIPF is not aware of the above role played by the SCEF or IWK-SCEF in providing the LI functions and not the roaming situations of the target.

NOTE 3: MDF2 and MDF3 which are also involved in providing the LI functions are not shown in the tables above.

5.5 Voice

5.5.1 Scope of interception

For the service type of Voice, the NFs present in IMS domain provide the LI functions except for the case of inbound roaming targets with home routed roaming architecture.

A target can be a subscriber of the CSP, an inbound roamer or a non-local ID. In the case where a target is a non-local ID, the party communicating with the target can be non-roaming, inbound roamer or outbound roamer. When a target is non-local ID, provisioning of HSS and LTF are not applicable.

The interception of service type of Voice includes:

- Delivery of IRI, or CC based on the delivery type indicated in the warrant.
- When required, the delivery of LALS reports based on the LALS triggering.
- Whether a target is non-local ID.
- IMS services such as redirection, conferencing, application of media such as music or announcements.

The CSP may have differing implementation options for the interception of IRI and CC, for local as well as non-local ID targets. The CSP may also have differing implementation options for LALS triggering.

The CSP may have either an LBO based roaming architecture or a home-routed based roaming architecture.

5.5.2 Initial configuration for N9HR/S8HR

5.5.2.1 General

To support the N9HR/S8HR (i.e. scenario 4 listed in clause 5.2), the LIPF will have to configure the BBIFF/BBIFF-C present in the packet core network. This is also known as the initial configuration for N9HR/S8HR LI.

Two methods of initial configuration are supported:

- Common to all HPLMNs.
- Separate configuration for an HPLMN.

When separate configuration is not done for an HPLMN, the N9HR/S8HR LI for the inbound roamers from that HPLMN uses the method of initial configuration common to all HPLMNs.

5.5.2.2 Common to all HPLMNs

This applies to all inbound roaming users using the IMS service.

Figure 5.5.2.2-1 provides the LIPF logic for N9HR/S8HR that is applicable to all inbound roaming users using IMS services.

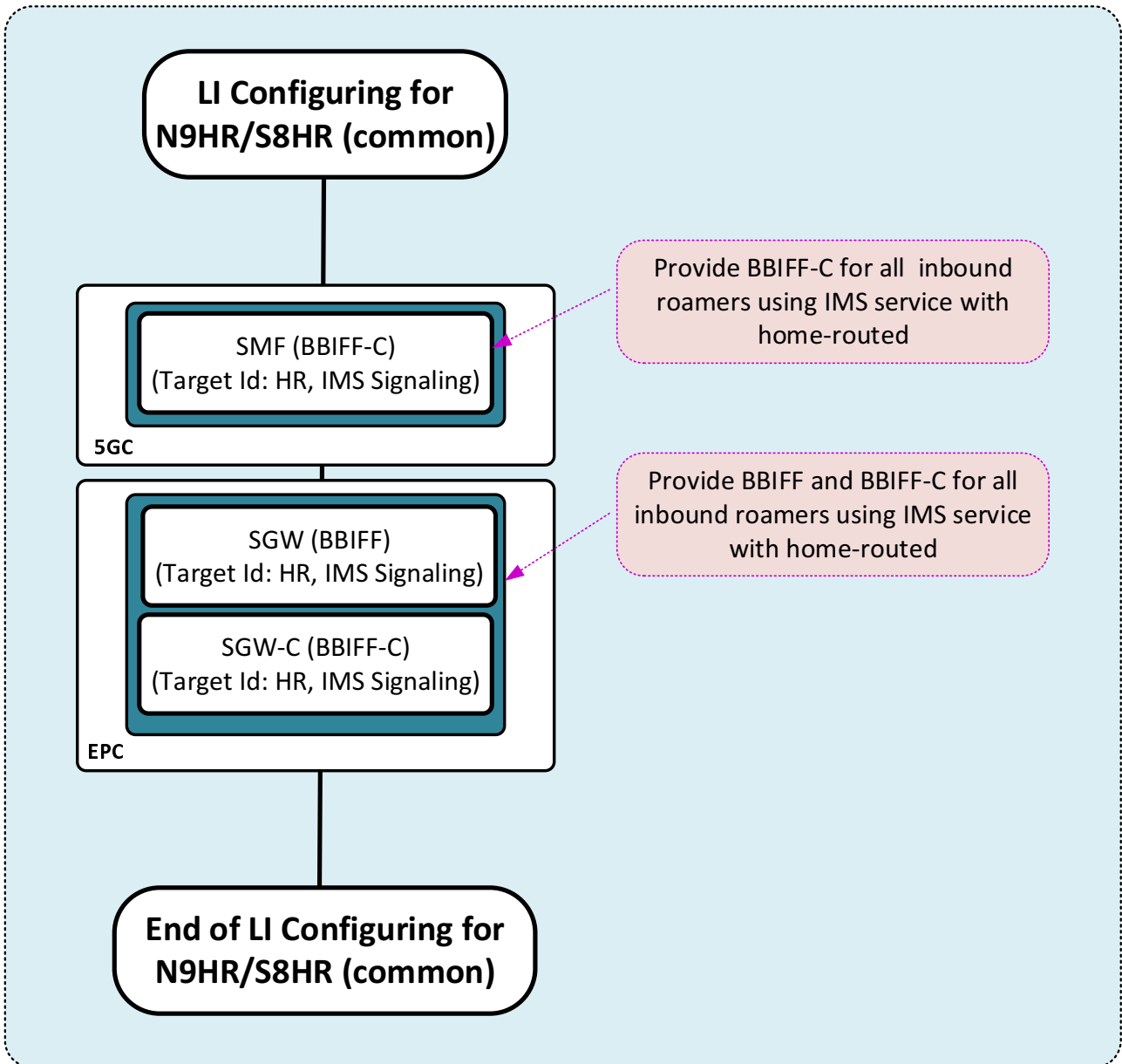

Figure 5.5.2.2-1: LIPF logic for initial configuration for N9HR/S8HR (Common)

When the packet core network is 5GC, the BBIFF-C function is provided by the SMF and when the packet core network is EPC, the BBIFF-C/BBIFF function is provided by the SGW-C/SGW.

5.5.2.3 Separate configuration for an HPLMN

This applies to inbound roaming users using the IMS service for the HPLMN identified via the DNN or APN.

Figure 5.5.2.3-1 provides the LIPF logic for N9HR/S8HR that is applicable to all inbound roaming users using IMS services.

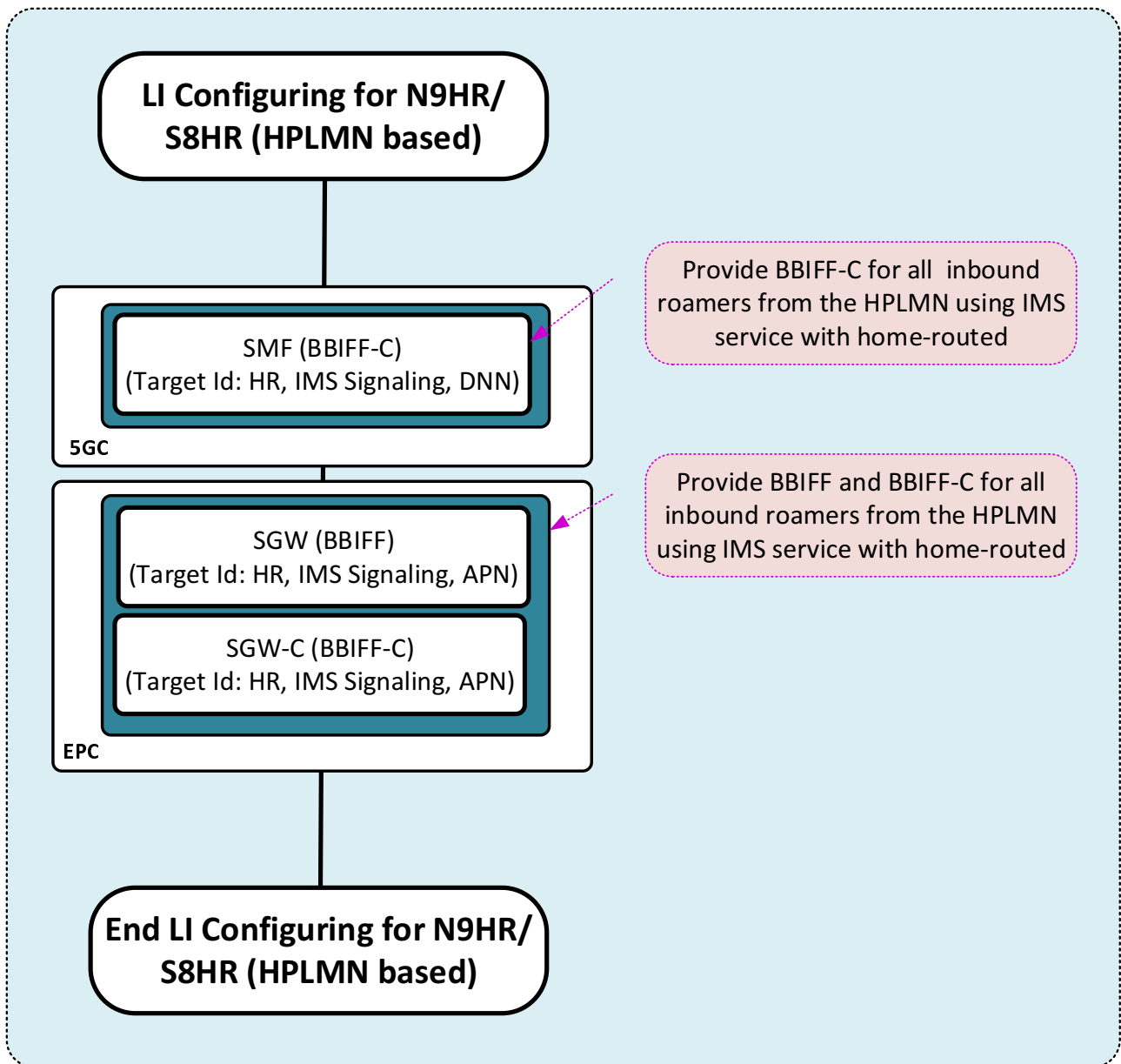

Figure 5.5.2.3-1: LIPF logic for initial configuration for N9HR/S8HR (HPLMN based)

When the packet core network is 5GC, the BBIFF-C function is provided by the SMF and when the packet core network is EPC, the BBIFF-C/BBIFF function is provided by the SGW-C/SGW.

With the separate configuration for each HPLMN (aka HPLMN-based initial configuration), the LMISF-IRI that would receive the signalling/user plane packets from the BBIFF/BBIFF-C/BBIFF-U is also configured for the HPLMN.

5.5.3 Top level LIPF logic for service type voice

When a target ID is an IMPU, the warrant may specify whether a target is non-local ID. The host NFs that provide the LI functions when the target is non-local ID can be different from the host NFs that provide the LI functions when the target is not a non-local ID. The provisioning of IRI-POI in HSS and provisioning of LTF in support of LALS triggering applies only when the target is not a non-local ID.

Figure 5.5.3-1 provides the top-level view of LIPF logic for the service type of Voice.

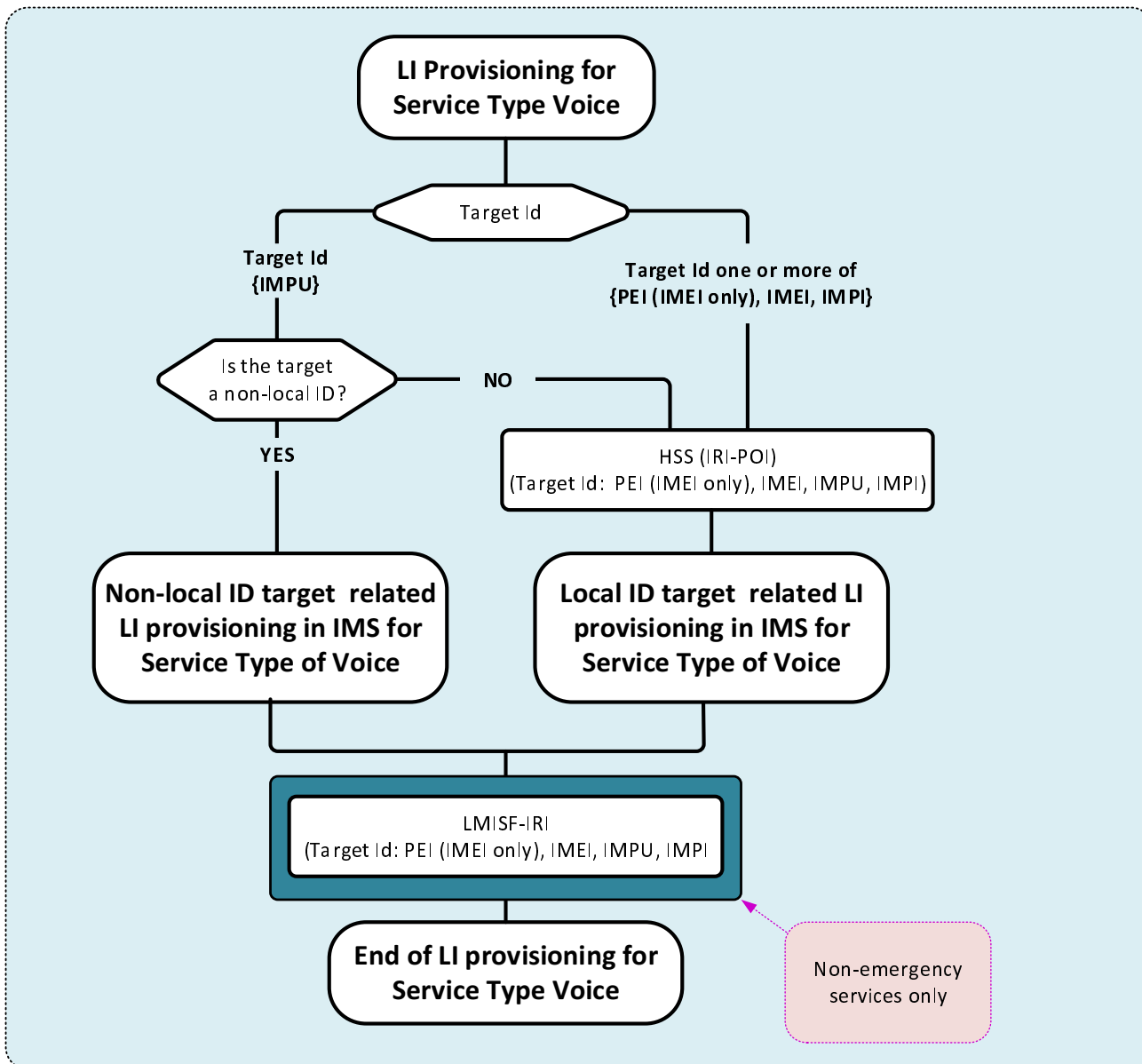

Figure 5.5.3-1: Top level view of LIPF logic for service type of Voice

Within figure 5.5.3-1, PEI (IMEI only) represents PEIIMEI. The target identity in the IMPU format may contain a value derived from a SUPI or an IMSI. The target identity in the IMPU format containing a SIP URI or TEL URI may contain a value derived from a GPSI, MSISDN, an E.164 number, or IMSI. Only IMPU is used for target non-local ID.

The LMISF-IRI is provisioned to support the interception of inbound roaming target (or party communicating with a target non-local ID target is inbound roaming) with HR that uses IMS services. The LMISF-IRI is expected to provide the LI functions only for non-emergency services.

5.5.4 LIPF logic for targets that are not non-local ID

5.5.4.1 The flowchart

Figures 5.5.4.1-1, 5.5.4.1-2, 5.5.4.1-3 and 5.5.4.1-4 show the LIPF logic for the service type of Voice when the target is not a non-local ID.

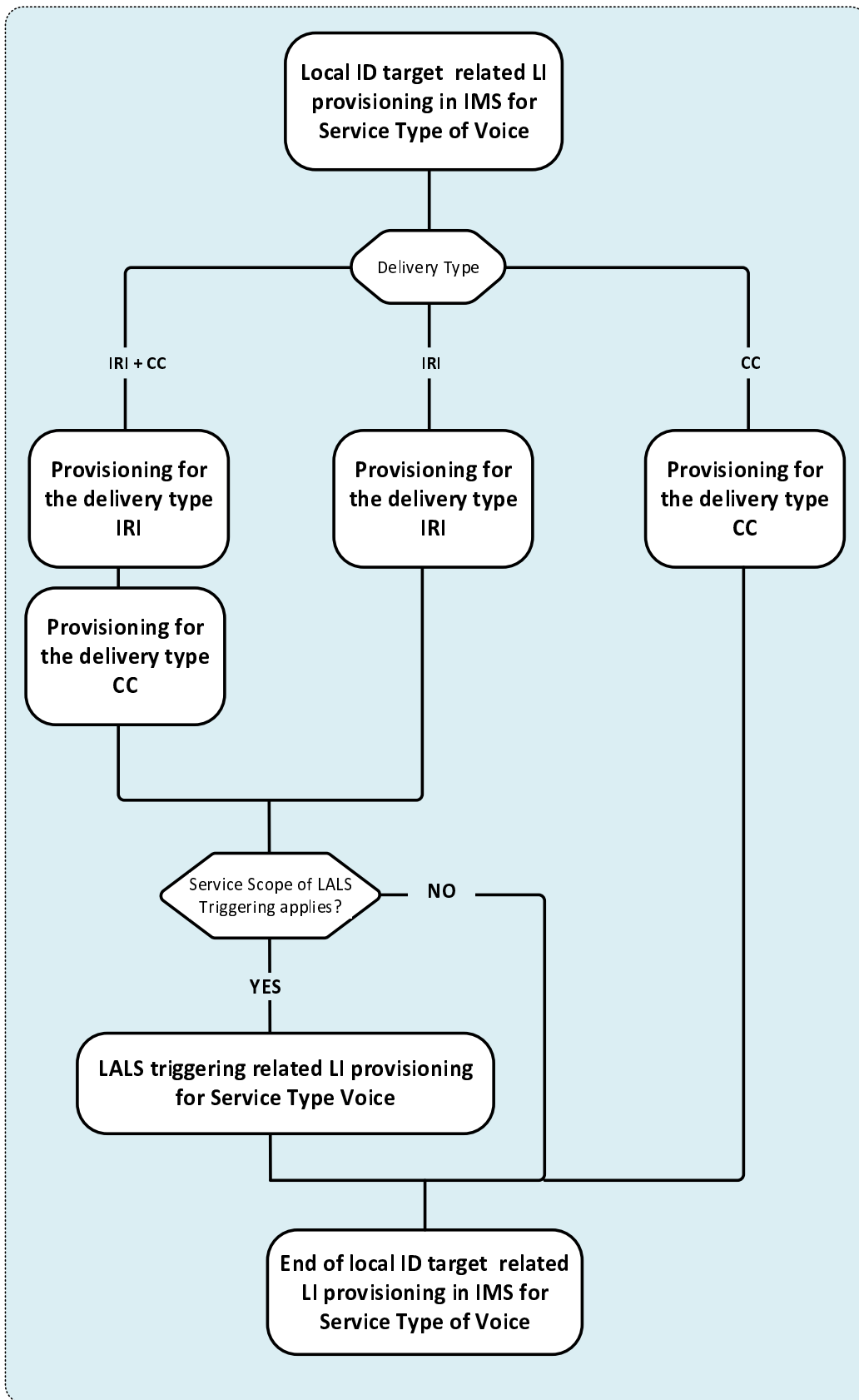

Figure 5.5.4.1-1: Top level LIPF logic for service type of Voice when target is not a non-local ID

For the delivery type of IRI + CC, the IRI-POIs and the CC-TFs are provisioned. For the delivery type of IRI, the IRI-POIs are provisioned. For the delivery type of CC, the CC-TFs are provisioned.

Figure 5.5.4.1-2 shows the LIPF logic for the provisioning of IRI-POIs and figure 5.5.4.1-3 shows the LIPF logic for the provisioning of CC-TFs.

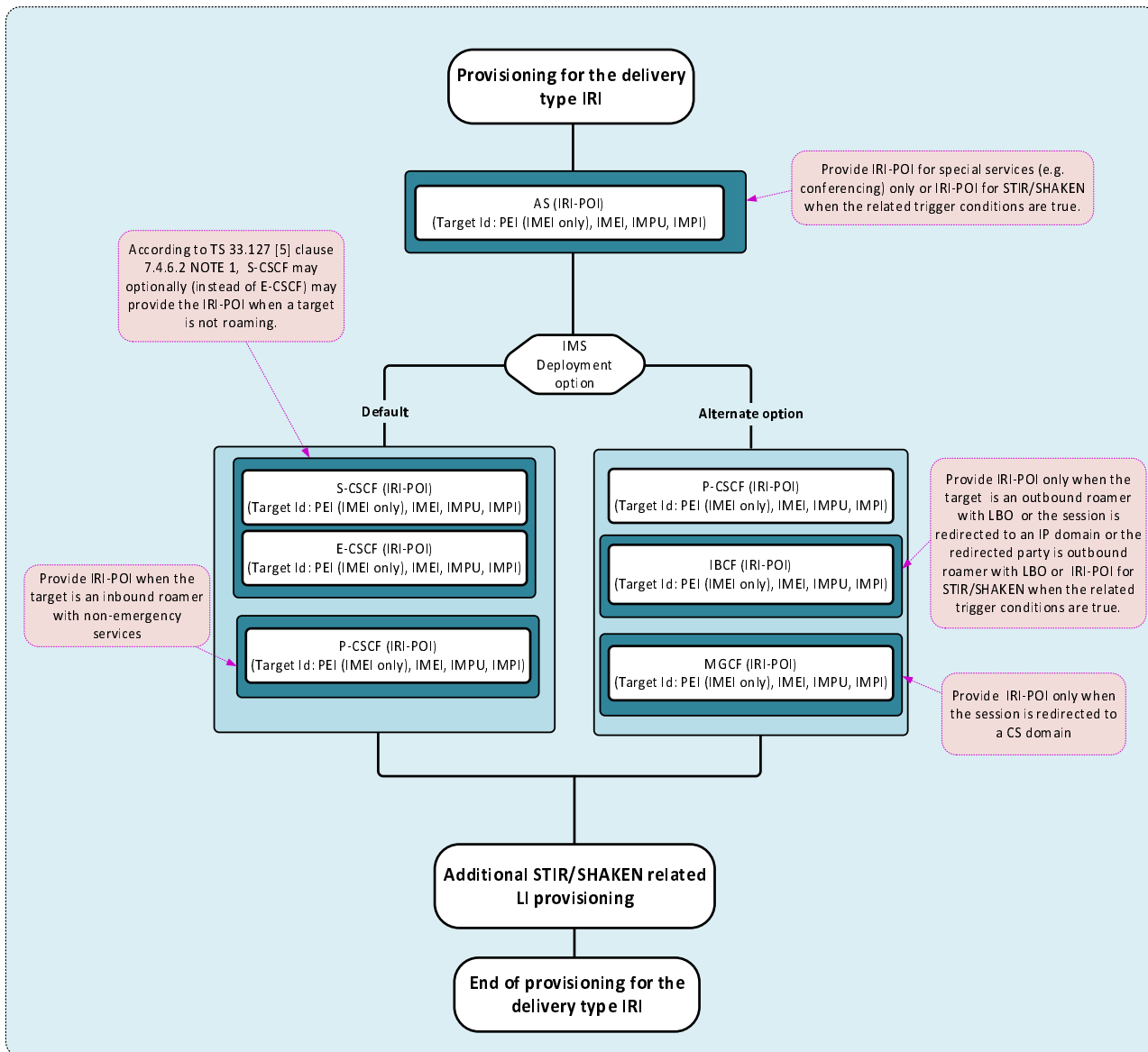

Figure 5.5.4.1-2: LIPF logic for delivery type of IRI for service type of Voice when target is not a non-local ID

The S-CSCF, E-CSCF, P-CSCF, IBCF, MGCF and AS (in figure 5.5.4.1-2) provide IRI-POI functions under certain conditions as noted within the illustration. To prevent those IRI-POIs from providing the LI functions when not supposed to, the LIPF may have to include a parameter during the provisioning. If STIR/SHAKEN is required to be intercepted in the network, then the provisioning of IRI-POIs in IBCF and AS include the parameter ReportDiversionPASSporTInfo if the target identity is IMPU. Additional STIR/SHAKEN related provisioning is illustrated in figure 5.5.4.1-5.

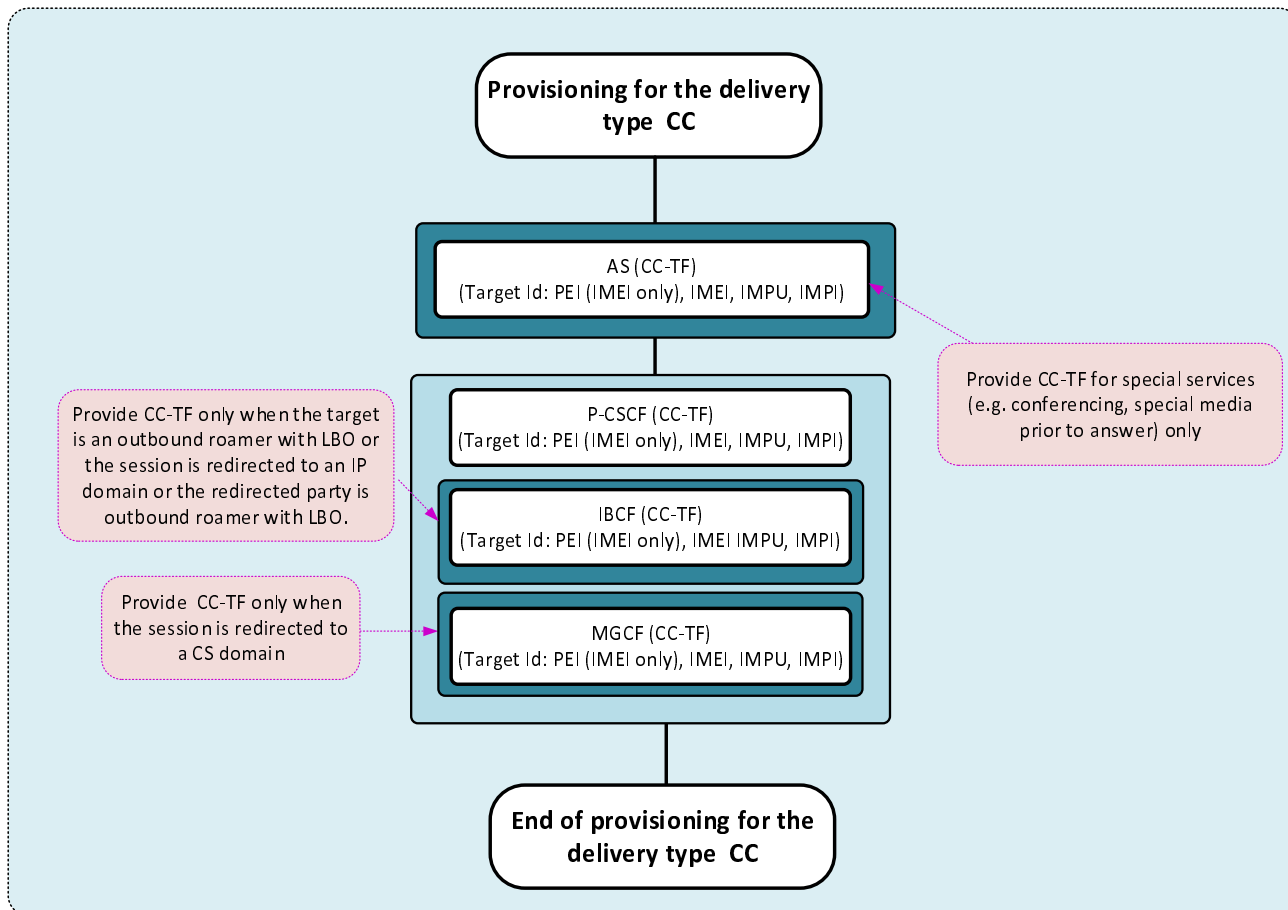

Figure 5.5.4.1-3: LIPF logic for delivery type of CC for service type of Voice when target is not a non-local ID

The IBCF, MGCF and AS (in figure 5.5.4.1-3) provide CC-TF functions under certain conditions as noted within the illustration. To prevent those CC-TFs from triggering the CC-POIs when not supposed to, the LIPF may have to include a parameter during the provisioning.

Figure 5.5.4.1-4 illustrates the LIPF logic for LALS triggering.

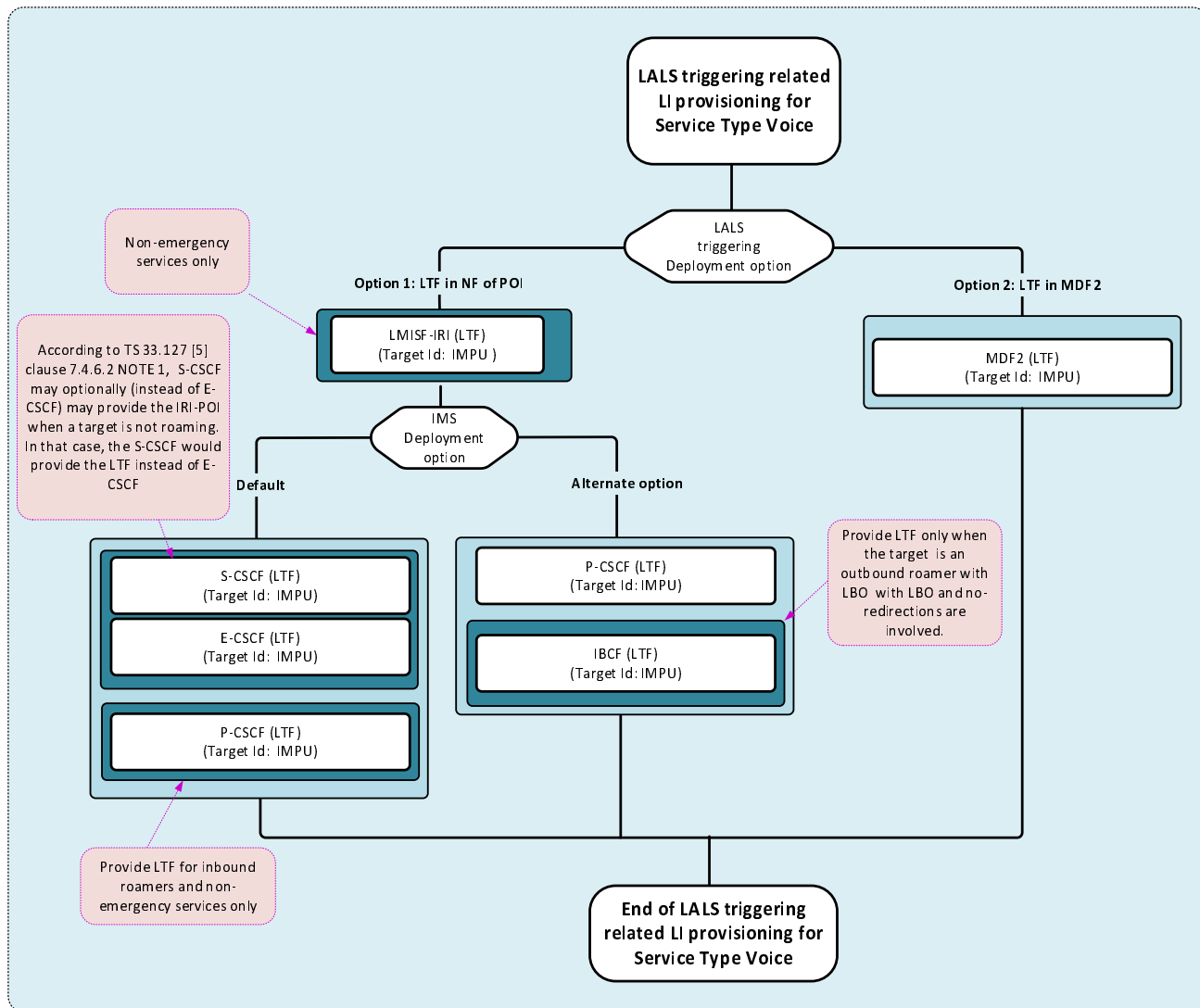
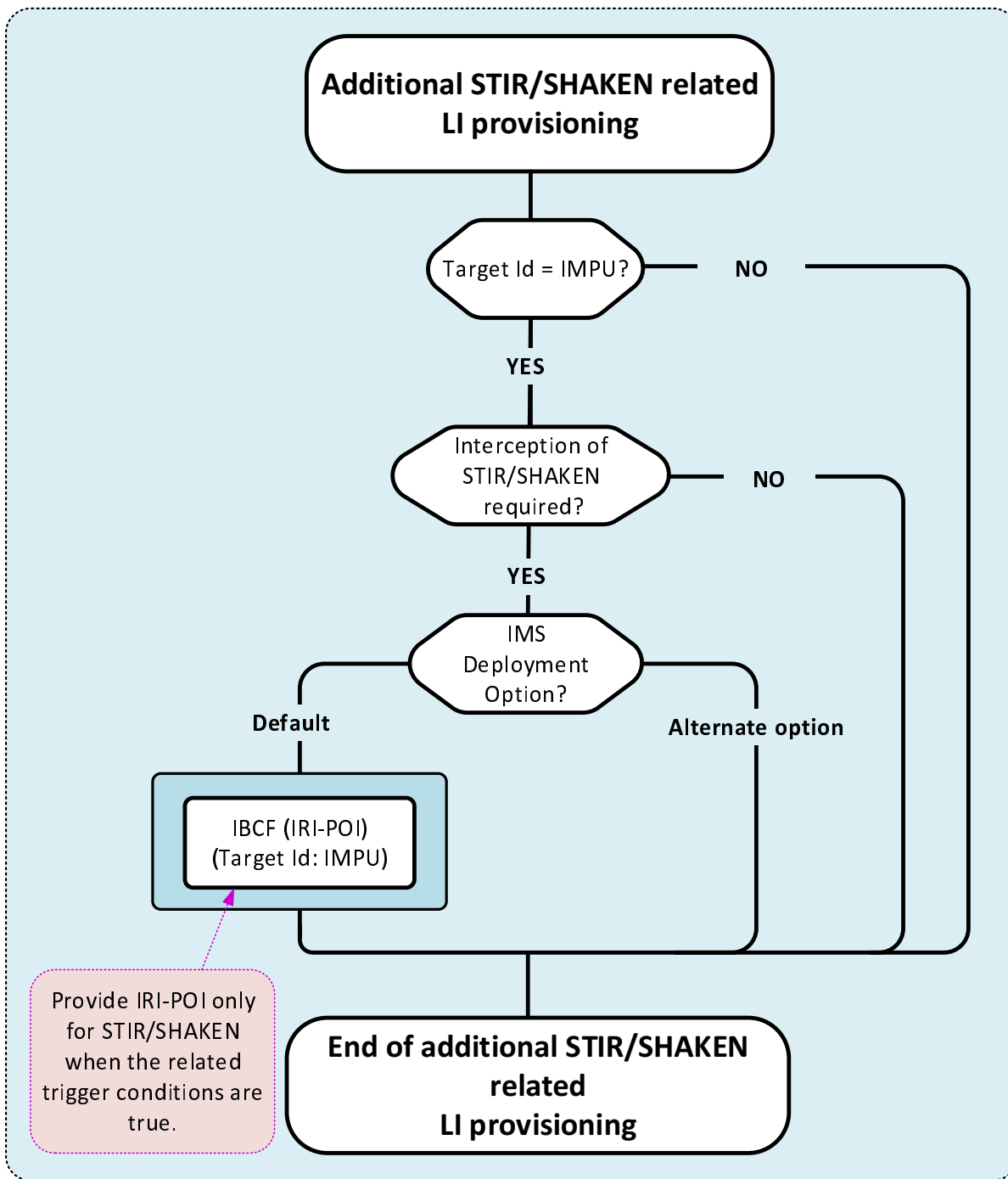

Figure 5.5.4.1-4: LIPF logic for LALS triggering for the service type of Voice

In LALS triggering option 1, the host NF that provides the LTF is same as the NF that provides the IRI-POI functions. And therefore, the host NFs that provide the LTF can be different based on the IMS deployment options.

The P-CSCF, IBCF and LMISF-IRI (in figure 5.5.4.1-4) provide LTF under certain conditions as noted within the illustration. Under special scenario, the S-CSCF may provide the IRI-POI for emergency services (instead of E-CSCF) as specified in TS 33.127 [3]. To prevent those LTFs from providing the LI functions when not supposed to, the LIPF may have to include a parameter during the provisioning.

Figure 5.5.4.1-5 illustrates the LIPF logic for additional STIR/SHAKEN related provisioning.



Figure

5.5.4.1-5: LIPF logic for additional STIR/SHAKEN related provisioning

For STIR/SHAKEN related reporting, IBCF, AS, P-CSCF (VPLMN with LBO), LMISF-IRI (VPLMN with HR) provide the IRI-POI functions. The LIPF logic shown in figure 5.5.4.1-5 is additional logic required to support the LI for STIR/SHAKEN.

As illustrated in figure 5.5.4.1-2, the IRI-POIs in P-CSCF, LMISF-IRI and AS are provisioned as part IMS-based voice LI. Likewise, the IRI-POI in IBCF is also provisioned for IMS-based voice LI when the alternate option is used.

When the STIR/SHAKEN is required to be intercepted in the network, the IRI-POIs in IBCF and AS are to be provisioned with ReportDiversionPASSporTInfo value when the target identity is IMPU.

5.5.4.2 Interception

5.5.4.2.1 IMS deployment

There are two deployment options for IMS for intercepting the service type of Voice (TS 33.127 [3]):

- Default.
- Alternate option.

It is expected that the CSP implements one of the two deployment options.

The conditions under which IRI-POI or CC-TF functions have to be provisioned are illustrated within the drawing and are further clarified in table 5.5.4.2.3-1 and 5.5.4.2.3-2.

5.5.4.2.2 LALS triggering

There are two deployment options for LALS triggering. It is expected that the CSP implements one of the two deployment options.

In LALS triggering option 1, the LTF present in the host NF that has the associated IRI-POI triggers the LI-LCS Client. In LALS triggering option 2, the LTF presents in the MDF2 triggers the LI-LCS Client.

5.5.4.2.3 Summary

Table 5.5.4.2.3-1 provides the scope of NF domain that provides the IRI-POI/CC-TF/CC-POI functions for the service type of Voice with the IMS deployment option Default.

Table 5.5.4.2.3-1: Scope of NF domain in IMS providing the LI functions with Default option

NFs with LI function		Non-roaming	Roaming with LBO		Roaming with HR		
			VPLMN	HPLMN	VPLMN	HPLMN	
HSS		IRI-POI	n/a	IRI-POI	n/a	IRI-POI	
AS (NOTE 6, NOTE 12)		IRI-POI	n/a	IRI-POI	n/a	IRI-POI	
AS (NOTE 7)		CC-TF	n/a	CC-TF	n/a	CC-TF	
MRFP (NOTE 7)		CC-POI	n/a	CC-POI	n/a	CC-POI	
S-CSCF (NOTE 8)		IRI-POI	n/a	IRI-POI	n/a	IRI-POI	
E-CSCF (NOTE 8)		IRI-POI	IRI-POI	n/a	IRI-POI	n/a	
P-CSCF		n/a	IRI-POI (NOTE 1)	n/a	n/a	n/a	
P-CSCF		CC-TF	CC-TF	n/a	CC-TF (NOTE 2)	n/a	
IMS-AGW		CC-POI	CC-POI	n/a	CC-POI (NOTE 2)	n/a	
MGCF (NOTE 3)		CC-TF	n/a	CC-TF	n/a	CC-TF	
IM-MGW (NOTE 3)		CC-POI	n/a	CC-POI	n/a	CC-POI	
IBCF (NOTE 14)		IRI-POI	IRI-POI	IRI-POI	IRI-POI	IRI-POI	
IBCF (NOTE 4)		CC-TF	n/a	CC-TF	n/a	CC-TF	
TrGW (NOTE 4)		CC-POI	n/a	CC-POI	n/a	CC-POI	
LMISF-IRI (NOTE 1)		n/a	n/a	n/a	IRI-POI	n/a	
LMISF-CC (NOTE 1)		n/a	n/a	n/a	CC-POI	n/a	
LALS triggering	Option 1	S-CSCF	LTF	n/a	LTF	n/a	LTF
		E-CSCF	LTF	LTF	n/a	LTF	n/a
		P-CSCF	n/a	LTF (NOTE 1)	n/a	n/a	n/a
		LMISF-IRI	n/a	n/a	n/a	LTF (NOTE 1)	n/a
	Option 2	MDF2	LTF	LTF	LTF	LTF	LTF

Table 5.5.4.2.3-2 provides the scope of NF domain that provides the IRI-POI/CC-TF/CC-POI functions for the service type of Voice with the IMS deployment option Alternate option.

Table 5.5.4.2.3-2: Scope of NF domain in IMS providing the LI functions with Alternate option

NFs with LI function		Non-roaming	Roaming with LBO		Roaming with HR		
			VPLMN	HPLMN	VPLMN	HPLMN	
HSS		IRI-POI	n/a	IRI-POI	n/a	IRI-POI	
AS (NOTE 6, NOTE 12)		IRI-POI	n/a	IRI-POI	n/a	IRI-POI	
AS (NOTE 7)		CC-TF	n/a	CC-TF	n/a	CC-TF	
MRFP (NOTE 7)		CC-POI	n/a	CC-POI	n/a	CC-POI	
P-CSCF		IRI-POI	IRI-POI	n/a	IRI-POI (NOTE 2)	IRI-POI	
P-CSCF		CC-TF	CC-TF	n/a	CC-TF (NOTE 2)	CC-TF	
IMS-AGW		CC-POI	CC-POI	n/a	CC-POI (NOTE 2)	CC-POI	
MGCF (NOTE 3)		IRI-POI	n/a	IRI-POI	n/a	IRI-POI	
MGCF (NOTE 3)		CC-TF	n/a	CC-TF	n/a	CC-TF	
IM-MGW (NOTE 3)		CC-POI	n/a	CC-POI	n/a	CC-POI	
IBCF		IRI-POI (NOTE 13)	IRI-POI (NOTE 2, 14)	IRI-POI (NOTE 13)	IRI-POI (NOTE 2, 14)	IRI-POI (NOTE 13)	
IBCF (NOTE 4)		CC-TF	n/a	CC-TF	n/a	CC-TF	
TrGW (NOTE4)		CC-POI	n/a	CC-POI	n/a	CC-POI	
LMISF-IRI (NOTE 1)		n/a	n/a	n/a	IRI-POI	n/a	
LMISF-CC (NOTE 1)		n/a	n/a	n/a	CC-POI	n/a	
LALS Triggering	Option 1	P-CSCF	LTF	LTF	n/a	LTF (NOTE 2)	LTF
		IBCF	n/a	n/a	LTF (NOTE 5)	n/a	n/a
		LMISF-IRI	n/a	n/a	n/a	LTF (NOTE 1)	n/a
	Option 2	MDF2	LTF	LTF	LTF	LTF	LTF

NOTE 1: For non-emergency sessions only.

NOTE 2: For emergency sessions only.

NOTE 3: Only when an incoming session to a target is redirected over a CS domain.

NOTE 4: Only when target is outbound roaming or when an incoming session to a target is redirected over an IP domain, or to an outbound roaming party with LBO.

NOTE 5: Only when the target is outbound roaming without a redirection.

NOTE 6: When the interception of conferencing services is required.

NOTE 7: When the content interception of conferencing, or application of music/ is required.

NOTE 8: For IMS emergency sessions in fixed networks when the S-CSCF is on the signalling path, S-CSCF may optionally (instead of E-CSCF) provide the IRI-POI functions with the default option.

NOTE 9: The use of "n/a" in the above table implies that the LI function is not applicable to the NF for the indicated scenario.

NOTE 10: The LIPF is not aware of the above role played by the host NFs in providing the LI functions.

NOTE 11: MDF2, MDF3 and LI-LCS Client which are also involved in providing the LI functions are not shown in the tables above.

NOTE 12: When the interception of STIR/SHAKEN is required.

NOTE 13: Only when target is outbound roaming or when an incoming session to a target is redirected over an IP domain, or to an outbound roaming party with LBO, or when the interception of STIR/SHAKEN is required.

NOTE 14: Only when the interception of STIR/SHAKEN is required.

5.5.4.2.4 STIR/SHAKEN

Since the IRI-POI in AS, in support of LI for special services such as conferencing, is always provisioned, the LIPF logic has to ensure that when the STIR/SHAKEN is required to be intercepted and the target Id is IMPU, the ReportDiversionPASSporTInfo is included as part of that provisioning.

Likewise, the IRI-POI in IBCF is also provisioned except for the case when the default option for IMS LI is deployed. The diagram shown in figure 5.5.4.1-5 illustrates that when STIR/SHAKEN is required to be intercepted and the target Id is IMPU, the IRI-POI in IBCF is provisioned even with the default option of IMS LI with ReportDiversionPASSporTInfo is included.

In general, when the STIR/SHAKEN is required to be intercepted in the network, and the target Id is IMPU, the IRI-POIs in AS and the IBCF are provisioned with ReportDiversionPASSporTInfo parameter included.

The diagram shown in figure 5.5.4.2.4-1 below illustrates the LI provisioning just from STIR/SHAKEN perspective. However, from an overall provisioning perspective, it is embedded within the LIPF logic of IMS LI provisioning as illustrated in clause 5.5.4.1.

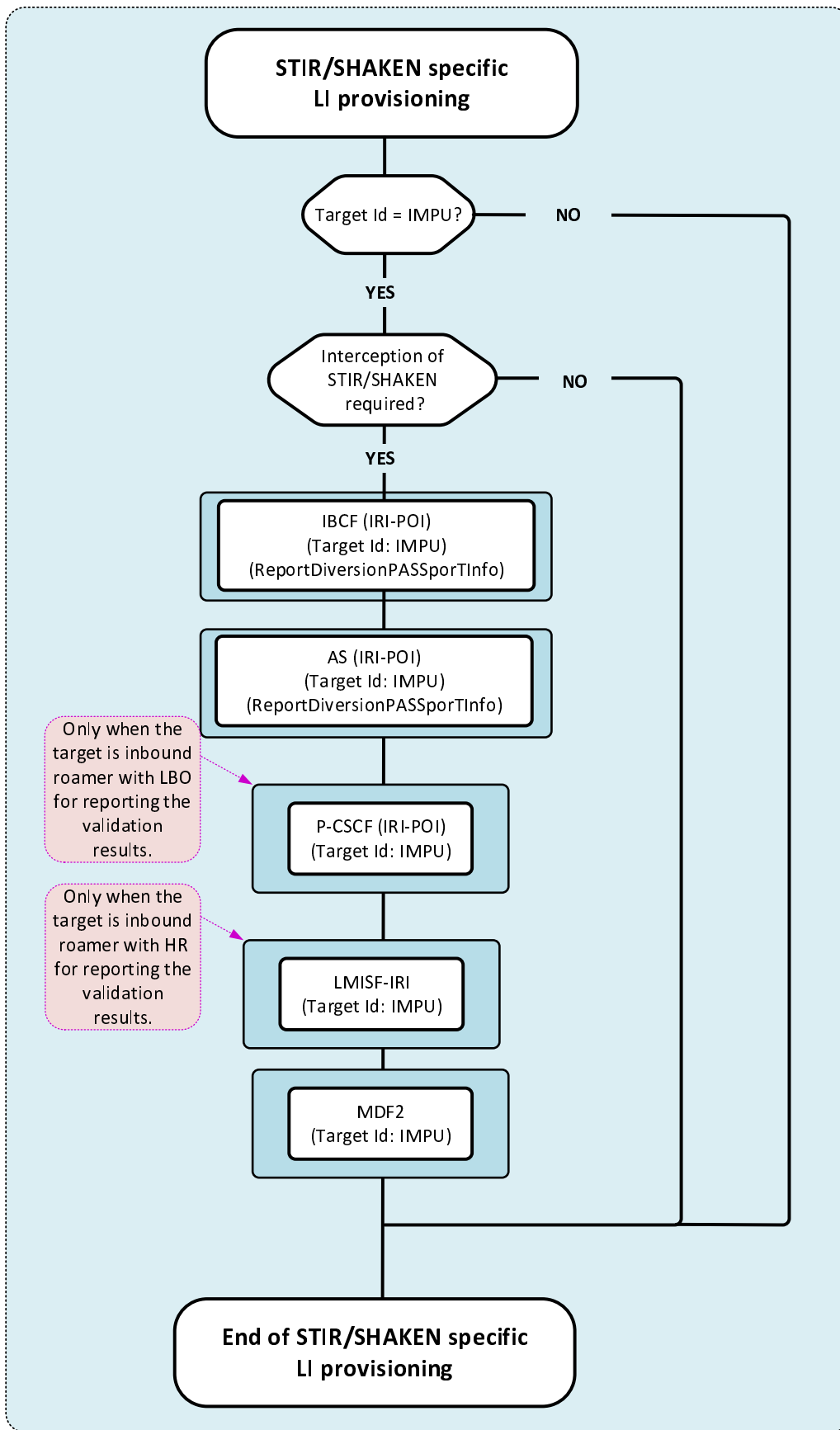

Figure 5.5.4.2.4-1: Localized LI provisioning view from STIR/SHAKEN perspective

The inclusion of ReportDiversionPASSporTInfo for provisioning of IRI-POI in P-CSCF and LMISF-IRI is not required.

Table 5.5.4.2.4-1 shows the NFs that will have to provide the STIR/SHAKEN LI (signing) for various scenarios and table 5.5.4.2.4-2 shows the NFs that will have to provide the STIR/SHAKEN LI (verification) for various scenarios.

The signing for STIR/SHAKEN happens in the HPLMN except for the emergency sessions it can also happen in the VPLMN. In these tables the indicated scenarios are from the perspective of target.

Table 5.5.4.2.4-1: Scope of NF domain in IMS providing the LI functions for STIR/SHAKEN (signing)

Scenario	HPLMN		VPLMN
	CSP choice AS	CSP choice is IBCF	
Emergency call	IBCF	IBCF	IBCF
RCD present	AS	AS	n/a
Intra-CSP session signing/verification required	AS	AS	n/a
Intra-CSP session signing/verification not required	Intra-CSP session	n/a	n/a
	Inter-CSP session	AS	IBCF

Table 5.5.4.2.4-2: Scope of NF domain in IMS providing the LI functions for STIR/SHAKEN (verification)

Scenario	HPLMN		VPLMN
	CSP choice AS	CSP choice is IBCF	
Emergency callback	AS	IBCF	See NOTE 1
Inbound roaming with LBO	n/a	n/a	P-CSCF
Inbound roaming with Home-Routed	n/a	n/a	LMISF-IRI
Intra-CSP session signing/verification required	AS	AS	See NOTE 1
Intra-CSP session signing/verification not required	Intra-CSP session	AS (see NOTE 2)	See NOTE 1
	Inter-CSP session	AS	IBCF (see NOTE 3)

NOTE 1: Same as in the row for inbound roaming (LBO) and inbound roaming (HR).

NOTE 2: This is the case where the redirection happens with the outgoing SIP INVITE containing the validation result and the REQUEST URI is a target identity (see TS 33.128 [4], clause 7.11.2.3). The AS may or may not interact with the Verification AS.

NOTE 3: The IRI-POI is in IBCF. The IRI-POI can be in AS for the special redirection case depicted in NOTE 2 (see TS 33.128 [4], clause 7.11.2.3).

The indicated CSP choice is applicable when the signing/verification of only inter-CSP session is required. The CSP choice for signing and verification need not be the same.

5.5.5 LIPF logic for targets that are non-local ID

5.5.5.1 The flowchart

Figures 5.5.5.1-1, 5.5.5.1-2 and 5.5.5.1-3 show the LIPF logic for the service type of Voice when the target is a non-local ID.

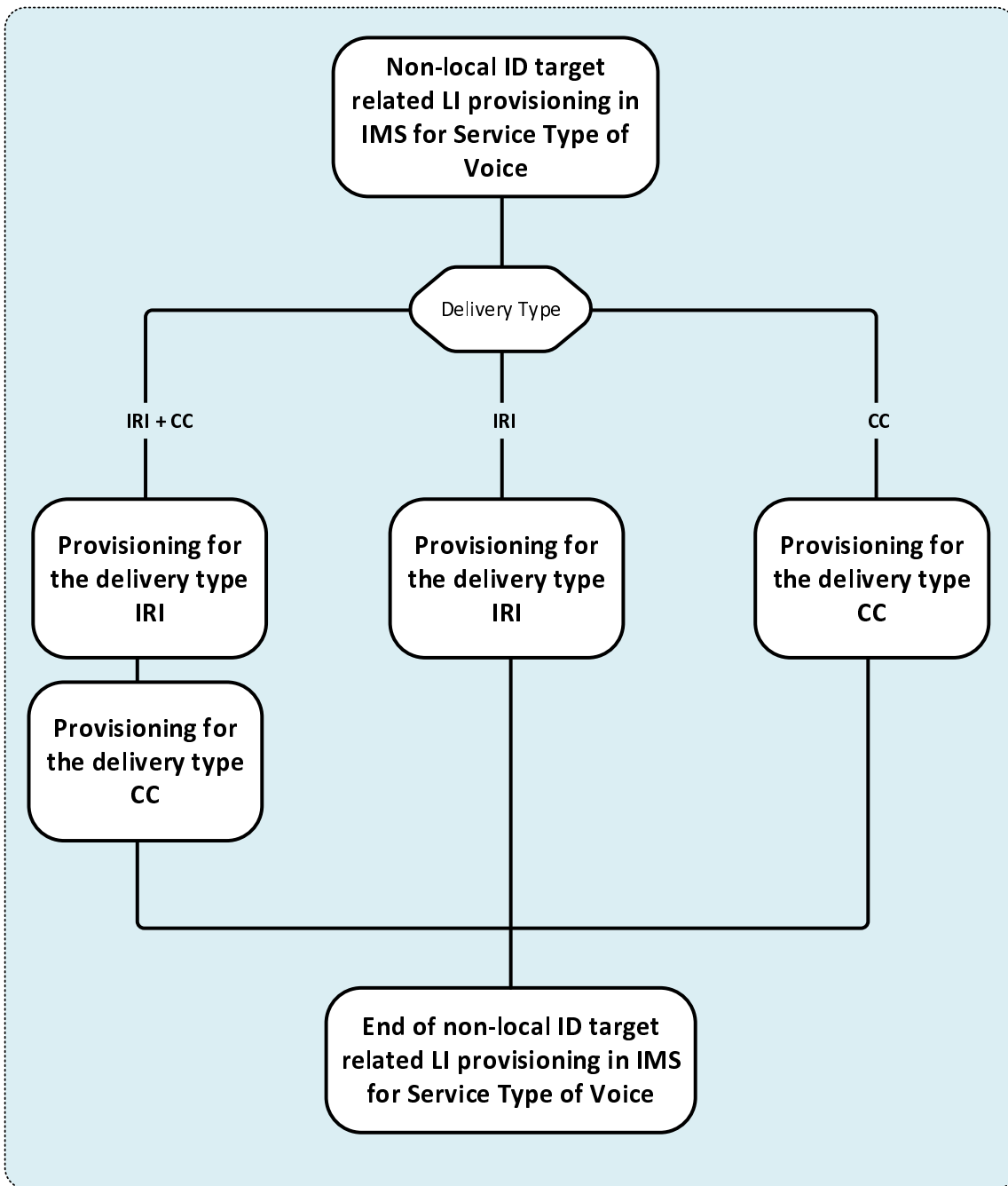

Figure 5.5.5.1-1: LIPF logic for service type of Voice when target is a non-local ID

For the delivery type of IRI + CC, the IRI-POIs and the CC-TFs are provisioned. For the delivery type of IRI, the IRI-POIs are provisioned. For the delivery type of CC, the CC-TFs are provisioned.

Figure 5.5.5.1-2 shows the LIPF logic for the provisioning of IRI-POIs and figure 5.5.5.1-3 shows the LIPF logic for the provisioning of CC-TFs.

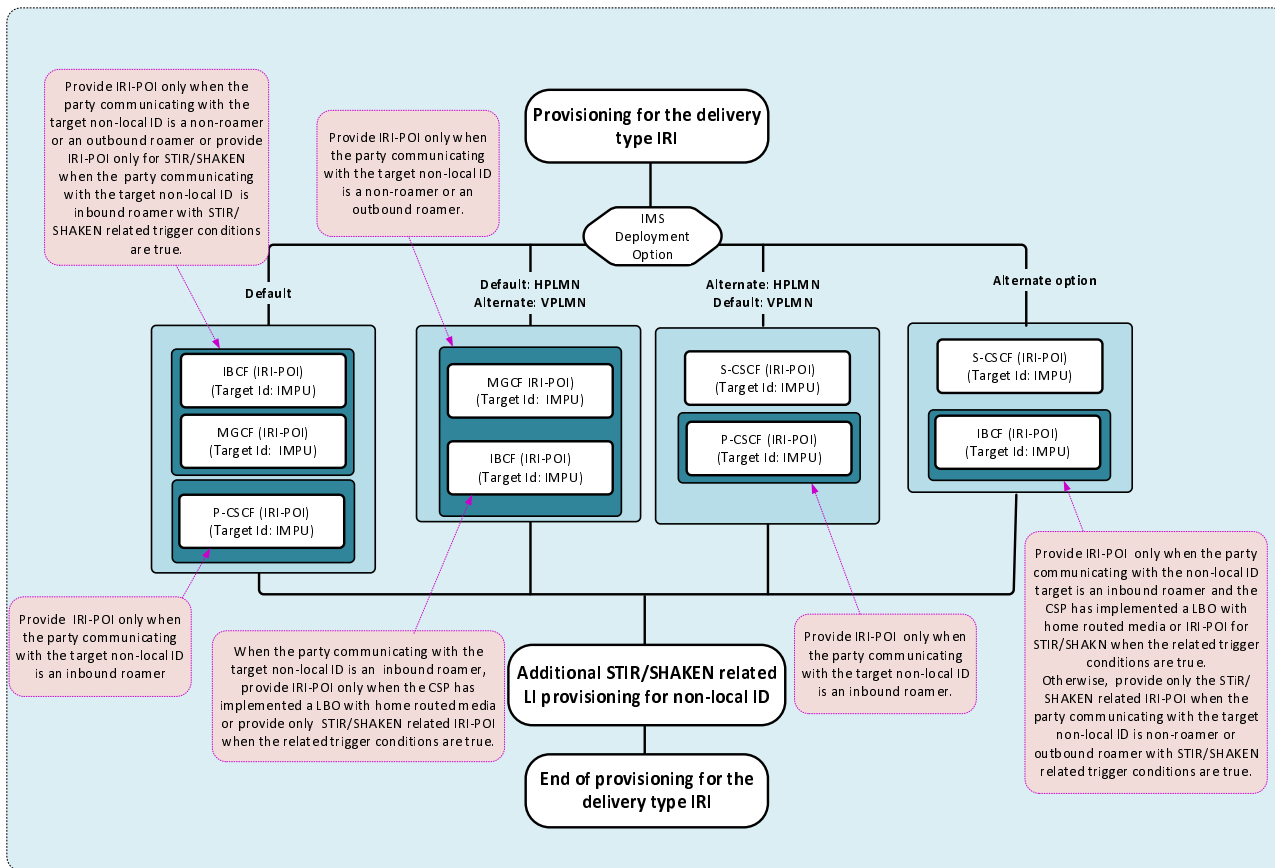

Figure 5.5.5.1-2: LIPF logic for delivery type of IRI for service type of Voice when target is a non-local ID

The P-CSCF, IBCF and MGCF (in figure 5.5.5.1-2) provide IRI-POI functions under certain conditions as noted within the illustration. To prevent those IRI-POIs from providing the LI functions when not supposed to, the LIPF may have to include a parameter during the provisioning.

If STIR/SHAKEN is required to be intercepted in the network, the provisioning of IRI-POI in IBCF include the parameter ReportDiversionPASSporTInfo. Additional STIR/SHAKEN related provisioning for target non-local ID is illustrated in figure 5.5.5.1-4.

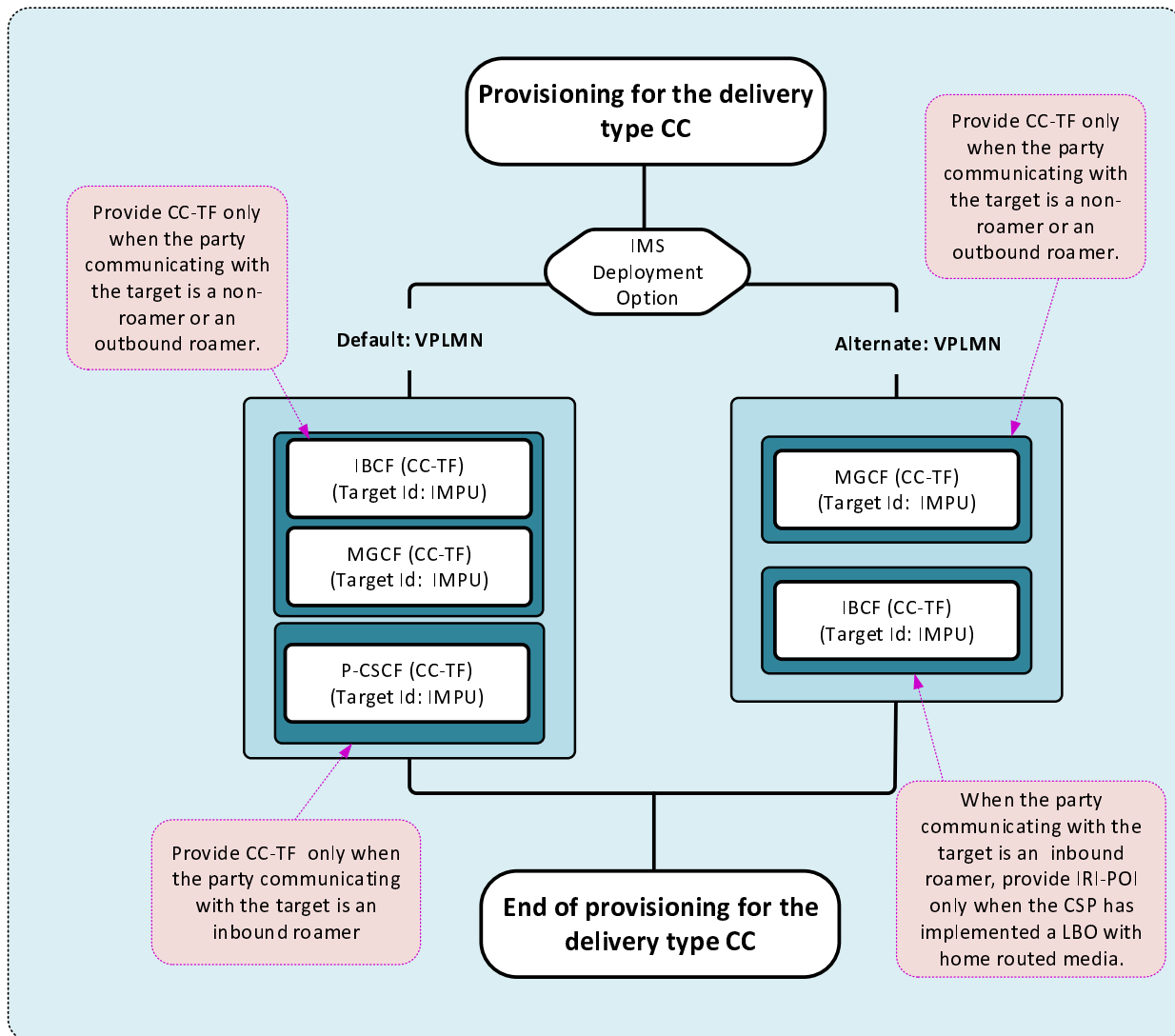

Figure 5.5.5.1-3: LIPF logic for delivery type of CC for service type of Voice when target is a non-local ID

The P-CSCF, IBCF and MGCF (in figure 5.5.5.1-3) provide CC-TF functions under certain conditions as noted within the illustration. To prevent those CC-TFs from triggering the CC-POI when not supposed to, the LIPF may have to include a parameter during the provisioning.

Figure 5.5.5.1-4 illustrates the LIPF logic for additional STIR/SHAKEN related provisioning for target non-local ID.

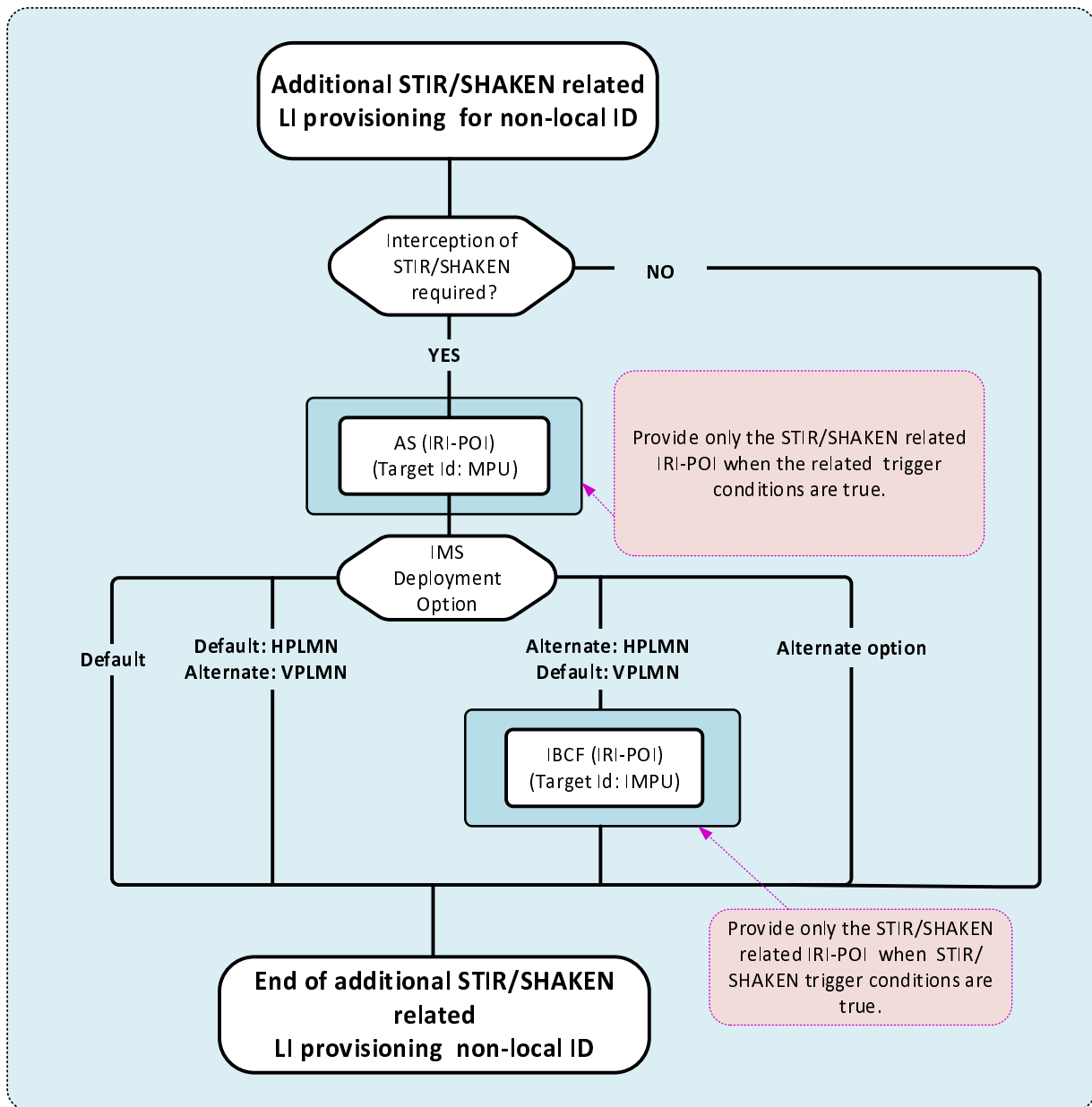

Figure 5.5.5.1-4: LIPF logic for additional STIR/SHAKEN related provisioning for target non-local ID

For STIR/SHAKEN related reporting IBCF, AS, P-CSCF (VPLMN with LBO), LMISF-IRI-POI (VPLMN with HR) provide the IRI-POI functions. The LIPF logic shown in figure 5.5.5.1-4 is additional logic required to support the STIR/SHAKEN when the target is non-local ID.

As illustrated in figure 5.5.5.1-2, the IRI-POIs in P-CSCF, LMISF-IRI are provisioned as part IMS-based voice LI. Likewise, the IRI-POI in IBCF is also provisioned for IMS-based voice LI when default option is used in HPLMN, or when alternate options are used in both HPLMN and VPLMN.

When the interception of STIR/SHAKEN is required in the network, the IRI-POIs in IBCF and AS are to be provisioned with ReportDiversionPASSporTInfo value.

5.5.5.2 Interception

5.5.5.2.1 IMS deployment

There are two deployment options for IMS for intercepting the service type of Voice (TS 33.127 [3]):

- Default.

- Alternate option.

It is expected that the CSP implements one of the two deployment options.

The conditions under which IRI-POI or CC-TF functions have to be provided are illustrated within the drawing and are further clarified in tables 5.5.5.2.2-1 and 5.5.5.2.2-2. The LIPF may have to indicate to the IRI-POI and CC-TF the condition in which they have to provide the respective functions.

5.5.5.2.2 Summary

Table 5.5.5.2.2-1 provides the scope of NF domain that provides the IRI-POI/CC-TF/CC-POI functions for the service type of Voice with the IMS deployment option Default in HPLMN.

Table 5.5.5.2.2-1: Scope of NF domain in IMS providing the LI functions with Default in HPLMN

NF with LI function	Non-roaming	Roaming with LBO			Roaming with HR	
		VPLMN		HPLMN	VPLMN	HPLMN
		Default	Alternate			
P-CSCF	n/a	IRI-POI	n/a	n/a	n/a	n/a
P-CSCF	n/a	CC-TF	n/a	n/a	n/a	n/a
IMS-AGW	n/a	CC-POI	n/a	n/a	n/a	n/a
AS (NOTE 5)	IRI-POI	n/a	n/a	IRI-POI	n/a	IRI-POI
MGCF	IRI-POI	n/a	n/a	IRI-POI	n/a	IRI-POI
MGCF	CC-TF	n/a	n/a	CC-TF	n/a	CC-TF
IM-MGW	CC-POI	n/a	n/a	CC-POI	n/a	CC-POI
IBCF	IRI-POI	IRI-POI (NOTE 5)	IRI-POI	IRI-POI	IRI-POI (NOTE5)	IRI-POI
IBCF	CC-TF	n/a	CC-TF	CC-TF	n/a	CC-TF
TrGW	CC-POI	n/a	CC-POI	CC-POI	n/a	CC-POI
LMISF-IRI	n/a	n/a	n/a	n/a	IRI-POI	n/a
LMISF-CC	n/a	n/a	n/a	n/a	CC-POI	n/a

Table 5.5.5.2.2-2 provides the scope of NF domain that provides the IRI-POI/CC-TF/CC-POI functions for the service type of Voice with the IMS deployment option Alternate option in HPLMN.

Table 5.5.5.2.2-2: Scope of NF domain in IMS providing the LI functions with Alternate option in HPLMN

NF with LI function	Non-roaming	Roaming with LBO			Roaming with HR	
		VPLMN		HPLMN	VPLMN	HPLMN
		Default	Alternate			
P-CSCF	n/a	IRI-POI	n/a	n/a	n/a	n/a
P-CSCF	n/a	CC-TF	n/a	n/a	n/a	n/a
IMS-AGW	n/a	CC-POI	n/a	n/a	n/a	n/a
AS (NOTE 5)	IRI-POI	n/a	n/a	IRI-POI	n/a	IRI-POI
S-CSCF	IRI-POI	n/a	n/a	IRI-POI	n/a	IRI-POI
MGCF	CC-TF	n/a	n/a	CC-TF	n/a	CC-TF
IM-MGW	CC-POI	n/a	n/a	CC-POI	n/a	CC-POI
IBCF (NOTE 5)	IRI-POI	IRI-POI	IRI-POI	IRI-POI	IRI-POI	I-IRI-POI
IBCF	CC-TF	n/a	CC-TF	CC-TF	n/a	CC-TF
TrGW	CC-POI	n/a	CC-POI	CC-POI	n/a	CC-POI
LMISF-IRI	n/a	n/a	n/a	n/a	IRI-POI	n/a
LMISF-CC	n/a	n/a	n/a	n/a	CC-POI	n/a

NOTE 1: In tables 5.5.5.2.2-1 and 5.5.5.2.2-2, the use of the phrase non-roaming/roaming applies to the party communicating with the target non-local ID.

NOTE 2: The use of "n/a" in the above table implies that the LI function is not applicable to the NF for the indicated scenario.

NOTE 3: The LIPF is not aware of the above role played by the host NFs in providing the LI functions.

NOTE 4: MDF2, MDF3 and LI-LCS Client which are also involved in providing the LI functions are not shown in the tables above.

NOTE 5: Only when the interception of STIR/SHAKEN is required.

5.5.5.2.3 STIR/SHAKEN

When the target is non-local ID, the IRI-POI in AS is not provisioned for IMS-LI. The IRI-POI in IBCF is provisioned except for the case where the alternate option is deployed in the HPLMN for IMS LI (target non-local ID) and default option is used for IMS-LI in the VPLMN (target non-local ID).

The diagram shown in figure 5.5.4.2.4-4 illustrates that when the interception of STIR/SHAKEN is required in the network, and the target Id is IMPU, and the target is non-local ID, the IBCF is provisioned even when the alternate option for IMS LI is used in the HPLMN and default option is used for IMS LI in the VPLMN.

The diagram shown in figure 5.5.4.1-5 (clause 5.5.4.1) illustrates the LI provisioning just from STIR/SHAKEN perspective. However, from an overall provisioning perspective for target non-local ID, it is embedded within the LIPF logic of IMS LI provisioning as illustrated in clause 5.5.5.1.

Table 5.5.5.2.3-1 shows the NFs that will have to provide the STIR/SHAKEN LI (signing) for various scenarios and table 5.5.5.2.3-2 shows the NFs that will have to provide the STIR/SHAKEN LI (verification) for various scenarios.

The signing for STIR/SHAKEN happens in the HPLMN. In these tables the indicated scenarios are from the perspective of the party communicating with the target non-local ID.

Table 5.5.5.2.3-1: Scope of NF domain in IMS providing the LI functions for STIR/SHAKEN (signing)

Scenario		CSP choice AS	CSP choice is IBCF
RCD present		AS	AS
Intra-CSP session		n/a	n/a
Inter-CSP session	Intra-CSP session signing/verification is required	AS	AS
	Intra-CSP session signing/verification not required	AS	IBCF

Table 5.5.5.2.3-2: Scope of NF domain in IMS providing the LI functions for STIR/SHAKEN (verification)

Scenario		HPLMN		VPLMN	
		CSP choice AS	CSP choice is IBCF	Default	Alternate
Inbound roaming with LBO		n/a	n/a	P-CSCF	IBCF
Inbound roaming with Home-Routed		n/a	n/a	LMISF-IRI	LMISF-IRI
Intra-CSP session		n/a	n/a	n/a	n/a
Inter-CSP session	Intra-CSP session signing/verification is required	AS	AS	See NOTE	See NOTE
	Intra-CSP session signing/verification not required	AS	IBCF	See NOTE	See NOTE

NOTE: Same as in the rows for inbound roaming (LBO) and inbound roaming (HR).

The indicated CSP choice is applicable when the signing/verification of only inter-CSP session is required. The CSP choice for signing and verification need not be the same.

5.6 Messaging

5.6.1 Scope of interception

The illustrations shown in this clause for the service type Messaging includes:

- MMS.

- SMS.

The interception for the MMS is done by the IRI-POI and CC-POI present in the MMS Proxy Relay. The interception for the SMS is done by the IRI-POI present in the SMSF and the MME (when MME provides the SMS service) and the IMS domain for SMS over IMS.

A target can be a subscriber of the CSP, an inbound roamer or a non-local ID. In the case where a target is a non-local ID, the party communicating with the target can be non-roaming, inbound roamer or outbound roamer. When a target is non-local ID, provisioning of HSS and LTF are not applicable.

For N9HR/S8HR, the LI functions for the inbound roamers are provided in the LMISF-IRI. To support the interception in LMISF-IRI, the initial configuration for N9HR/S8HR will have to be done as illustrated in clause 5.5.2.

The interception of service type of Messaging includes:

- Delivery of IRI or CC based on the delivery type indicated in the warrant (the delivery of CC is applicable to MMS only).
- Whether a target is non-local ID.
- When required, the delivery of LALS reports based on the LALS triggering (applicable to SMS only).

In view of SMS over IMS, the CSP may have either an LBO based roaming architecture or a home-routed based roaming architecture. The CSP may have differing implementation options for LALS triggering.

Table 5.6.1-1 shows the target identities that are applicable to different type of SMS and MMS use.

Table 5.6.1-1: Target IDs as applicable to the interception of service type Messaging

SMS method	GPSI	SUPI	PEI	MSISDN	IMSI	IMEI	IMPU	IMPI	Email Address
MMS	YES	n/a	n/a	YES	n/a	n/a	n/a	n/a	n/a
MMS (target non-local ID)	YES	n/a	n/a	YES	n/a	n/a	n/a	n/a	YES
SMS over IMS (local)	YES (NOTE)	As IMPI	As IMEI	YES (NOTE)	As IMPI	YES	YES	YES	n/a
SMS over IMS (non-local ID)	YES	n/a	n/a	YES	n/a	n/a	YES	n/a	n/a
SMS over 5GS	YES	YES	YES	As GPSI	As SUPI	As PEI	n/a	n/a	n/a
SMS over 5GS (target non-local ID)	YES	n/a	n/a	As GPSI	n/a	n/a	n/a	n/a	n/a
SMS over EPS	n/a	n/a	n/a	YES	YES	YES	n/a	n/a	n/a
SMS over EPS (target non-local ID)	n/a	n/a	n/a	YES	n/a	n/a	n/a	n/a	n/a

The target identity PEI collectively represents PEIIMEI and PEIIMEISV. Likewise, SUPI represents SUPIIMSI and SUPINAI whereas GPSI represents GPSIMISDN and GPSINAI. The target identity in the IMPI format may contain a value derived from a SUPI or an IMSI. The target identity in the IMPU format containing a SIP URI or TEL URI may contain a value derived from a GPSI, MSISDN, an E.164 number, or IMSI.

NOTE: The GPSI and MSISDN may also be the target IDs as an IMPU.

A part of LIPF logic is based on the target identity applicability shown in table 5.6.1-1.

5.6.2 LIPF logic for service type messaging

5.6.2.1 Flowcharts

Figure 5.6.2.1-1 provides the top-level view of LIPF logic for the service type of Messaging.

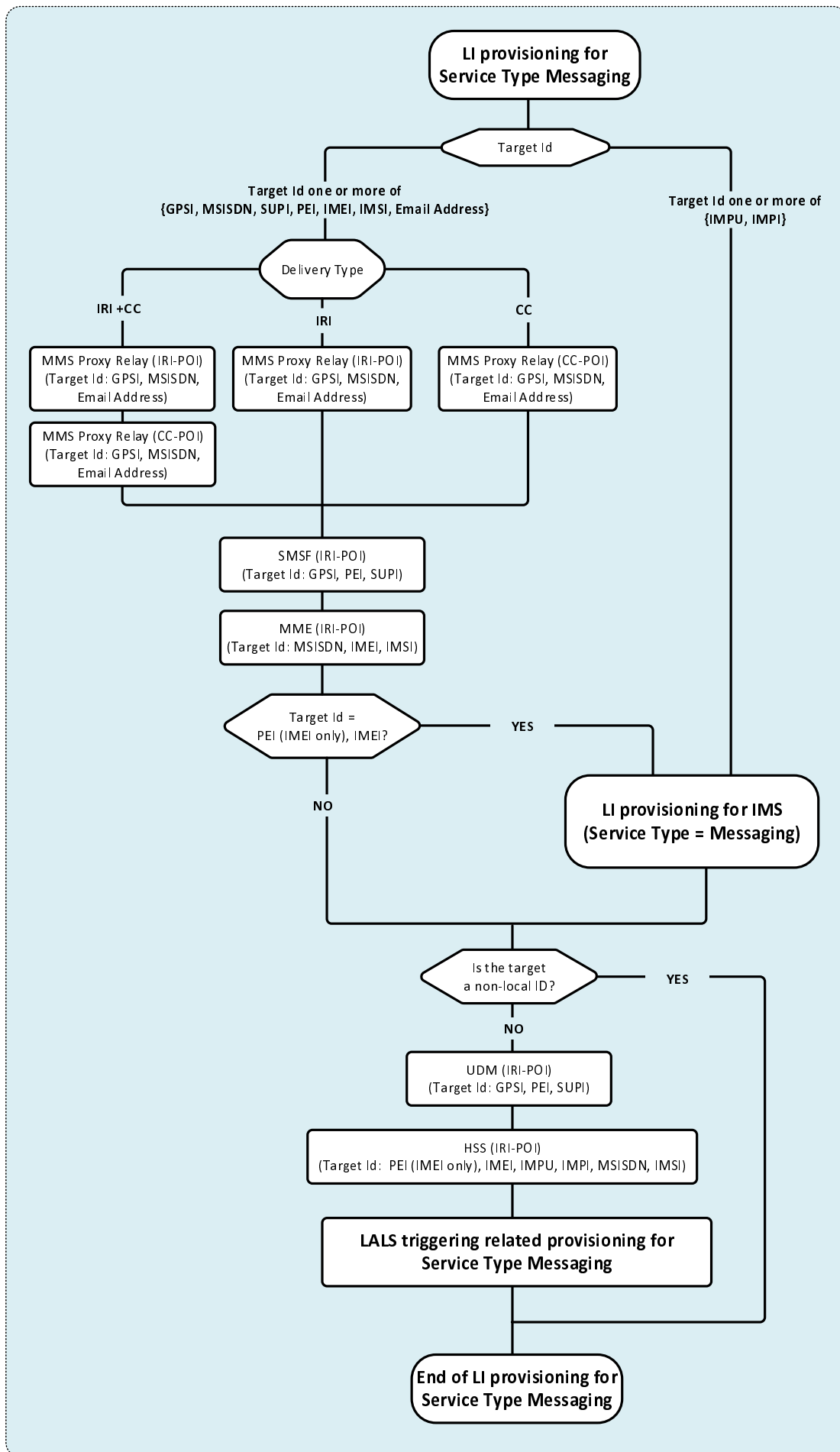

Figure 5.6.2.1-1: Top-level view of LIPF logic for service type of Messaging

The IRI-POI in HSS, UDM and LMISF-IRI are provisioned only when a target is not a non-local ID. The Email Address as a target identity is applicable only for target non-local ID. Any communication from a local target that uses the Email Address does not go through the local MMS Proxy Relay.

Figure 5.6.2.1-2 shows the LIPF logic for service type Messaging with SMS over IMS.

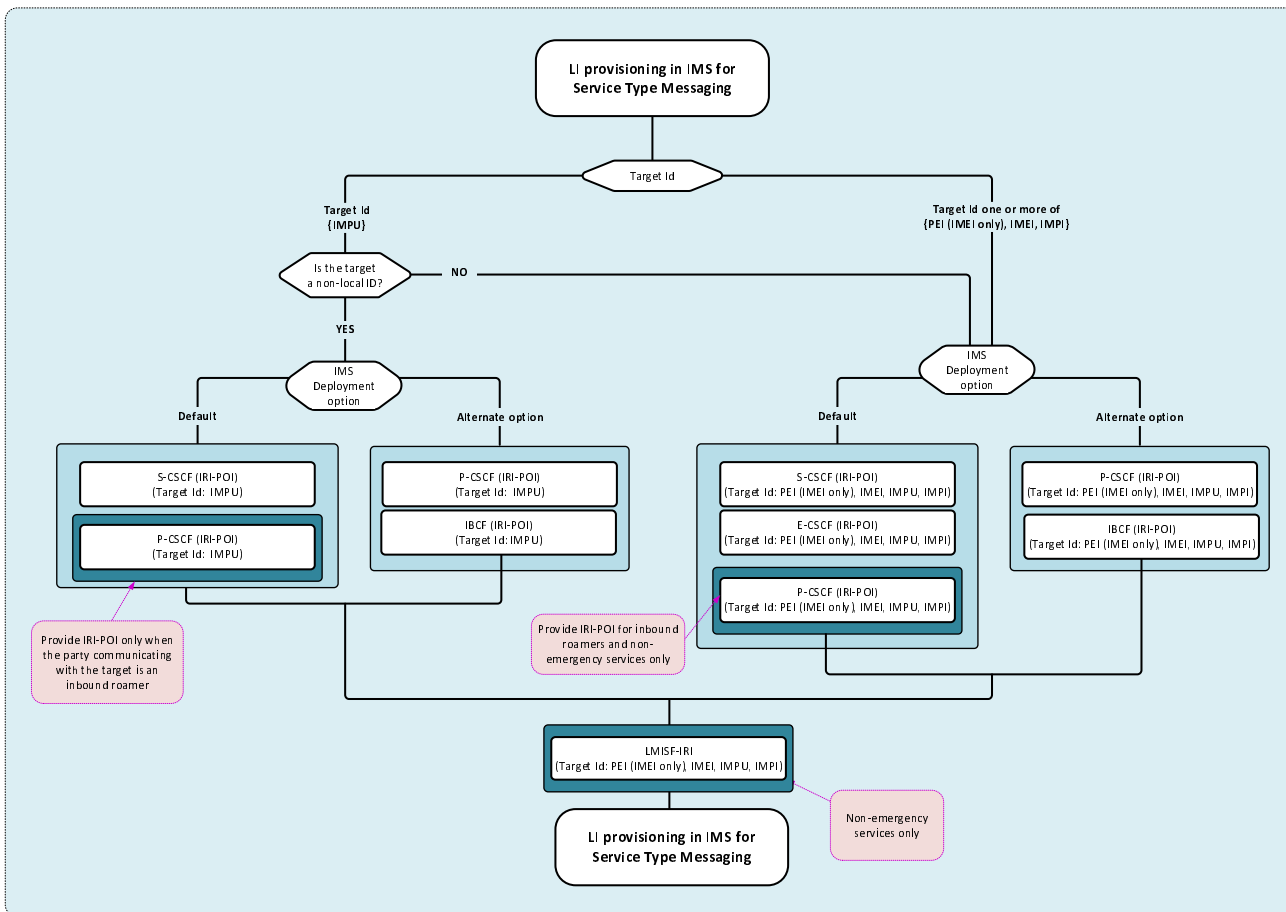

Figure 5.6.2.1-2: LIPF logic for service type of Messaging for SMS over IMS

The P-CSCF (in figure 5.6.2.1-2) provides IRI-POI functions under certain conditions as noted within the illustration. To prevent the IRI-POI in P-CSCF from providing the LI functions when not supposed to, the LIPF may have to include a parameter during the provisioning.

Figure 5.6.2.1-3 shows the LIPF logic for LALS triggering with service type of Messaging.

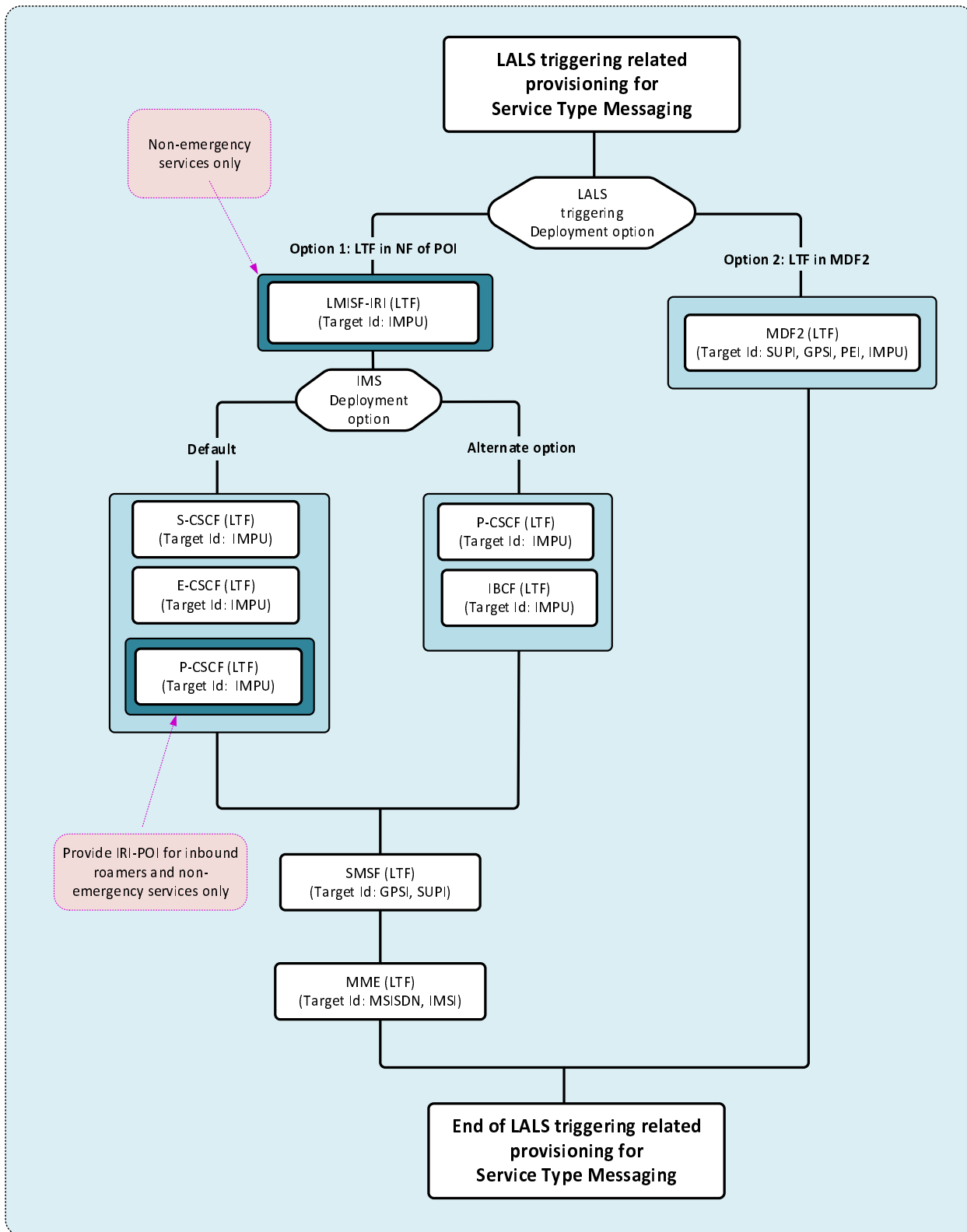

Figure 5.6.2.1-3: LIPF logic for LALS triggering for the service type of Messaging

The P-CSCF (in figure 5.6.2.1-3) provides LTF functions under certain conditions as noted within the illustration. To prevent LTF in P-CSCF from providing the LI functions when not supposed to, the LIPF may have to include a parameter during the provisioning.

5.6.2.2 Interception

5.6.2.2.1 IMS deployment

There are two deployment options for IMS for intercepting the service type of Messaging for SMS over IMS:

- Default.
- Alternate option.

It is expected that the CSP implements one of the two deployment options.

The conditions under which IRI-POI functions have to be provisioned are illustrated within the drawing and are further clarified in tables from 5.6.2.2.3-2 to 5.6.2.2.3-5.

5.6.2.2.2 LALS triggering

There are two deployment options for LALS triggering. It is expected that the CSP implements one of the two deployment options.

In LALS triggering option 1, the LTF present in the host NF that has the associated IRI-POI triggers the LI-LCS Client. In LALS triggering option 2, the LTF presents in the MDF2 triggers the LI-LCS Client.

5.6.2.2.3 Summary

Table 5.6.2.2.3-1 provides the scope of NF domain that provides the IRI-POI/CC-POI/LTF functions for the service type of Messaging.

Table 5.6.2.2.3-1: Scope of NF domain providing the LI functions for service type Messaging

NFs with LI function			Non-roaming	Roaming with LBO		Roaming with HR	
				VPLMN	HPLMN	VPLMN	HPLMN
MMS Proxy Relay			IRI-POI	n/a	IRI-POI	n/a	IRI-POI
MMS Proxy Relay			CC-POI	n/a	CC-POI	n/a	CC-POI
SMSF			IRI-POI	IRI-POI	n/a	IRI-POI	n/a
MME (with SMS service)			IRI-POI	IRI-POI	n/a	IRI-POI	n/a
IMS NFs			See tables 5.6.2.2.3-2 to 5.6.2.2.3-5.				
LALS triggering	Option 1	SMSF	LTF	LTF	n/a	LTF	n/a
		MME	LTF	LTF	n/a	LTF	n/a
		IMS NFs	See tables 5.6.2.2.3-2 and 5.6.2.2.3-3				
	Option 2	MDF2	LTF	LTF	LTF	LTF	LTF

Table 5.6.2.2.3-2 provides the scope of NF domain in the IMS that provides the IRI-POI/LTF for SMS over IMS when the target is not a non-local ID with default IMS deployment option.

Table 5.6.2.2.3-2: Scope of NF domain in IMS providing the LI functions for SMS over IMS (local ID) with Default

NFs with LI function			Non-roaming	Roaming with LBO		Roaming with HR	
				VPLMN	HPLMN	VPLMN	HPLMN
P-CSCF			n/a	IRI-POI (NOTE 1)	n/a	n/a	n/a
E-CSCF			IRI-POI	IRI-POI	n/a	IRI-POI	n/a
S-CSCF			IRI-POI	n/a	IRI-POI	n/a	IRI-POI
LMISF-IRI			n/a	n/a	n/a	IRI-POI (NOTE 1)	n/a
LALS triggering	Option 1	P-CSCF	n/a	LTF (NOTE 1)	n/a	n/a	n/a
		E-CSCF	n/a	LTF	n/a	LTF	n/a
		S-CSCF	LTF	n/a	LTF	n/a	LTF
		LMISF-IRI	n/a	n/a	n/a	LTF (NOTE1)	n/a
	Option 2	MDF2	LTF	LTF	LTF	LTF	LTF

Table 5.6.2.2.3-3 provides the scope of NF domain in the IMS that provides the IRI-POI/LTF for SMS over IMS when the target is not a non-local ID with Alternate IMS deployment option.

Table 5.6.2.2.3-3: Scope of NF domain in IMS providing the LI functions for SMS over IMS (local ID) with Alternate option

NFs with LI function		Non-roaming	Roaming with LBO		Roaming with HR		
			VPLMN	HPLMN	VPLMN	HPLMN	
P-CSCF		IRI-POI	IRI-POI	n/a	IRI-POI (NOTE 2)	IRI-POI	
IBCF		n/a	n/a	IRI-POI	n/a	n/a	
LMISF-IRI		n/a	n/a	n/a	IRI-POI (NOTE 1)	n/a	
LALS triggering	Option 1	P-CSCF	LTF	LTF	n/a	LTF (NOTE 2)	n/a
		IBCF	n/a	n/a	LTF	n/a	n/a
		LMISF-IRI	n/a	n/a	n/a	LTF (NOTE 1)	n/a
	Option 2	MDF2	LTF	LTF	LTF	LTF	

Table 5.6.2.2.3-4 provides the scope of NF domain in the IMS that provides the IRI-POI/LTF for SMS over IMS when the target is a non-local ID with default IMS deployment option.

Table 5.6.2.2.3-4: Scope of NF domain in IMS providing the LI functions for SMS over IMS (non-local ID) with Default

NFs with LI function		Non-roaming	Roaming with LBO		Roaming with HR	
			VPLMN	HPLMN	VPLMN	HPLMN
P-CSCF		n/a	IRI-POI	n/a	n/a	n/a
S-CSCF		IRI-POI	n/a	IRI-POI	n/a	IRI-POI
LMISF-IRI		n/a	n/a	n/a	IRI-POI	n/a

Table 5.6.2.2.3-5 provides the scope of NF domain in the IMS that provides the IRI-POI/LTF for SMS over IMS when the target is a non-local ID with Alternate IMS deployment option.

Table 5.6.2.2.3-5: Scope of NF domain in IMS providing the LI functions for SMS over IMS (non-local ID) with Alternate option

NFs with LI function		Non-roaming	Roaming with LBO		Roaming with HR	
			VPLMN	HPLMN	VPLMN	HPLMN
P-CSCF		IRI-POI	IRI-POI	n/a	n/a	IRI-POI
IBCF		n/a	n/a	IRI-POI	n/a	n/a
LMISF-IRI		n/a	n/a	n/a	IRI-POI	n/a

NOTE 1: Only for SMS over IMS not involving the emergency centre.

NOTE 2: Only for SMS over IMS to emergency centres.

NOTE 3: The use of "n/a" in the above table implies that the LI function is not applicable to the NF for the indicated scenario.

NOTE 4: The LIPF is not aware of the above role played by the host NFs in providing the LI functions

NOTE 5: MDF2, MDF3 and LI-LCS Client which are also involved in providing the LI functions are not shown in the tables above.

5.7 PTC

5.7.1 Scope of interception

The illustrations shown in this clause are for the service type PTC.

The interception of service type of PTC is done by the IRI-POI and CC-POI present in the PTC server and includes delivery of IRI or CC based on the delivery type indicated in the warrant.

The following target identifiers are applicable to the service type of PTC for provisioning the IRI-POI/CC-POI at the PTC Server:

- IMPU.
- IMPI.
- MCPTT ID.
- Instant ID URN.
- Chat group ID.

The following target identifiers are applicable to the service type of PTC for provisioning the IRI-POI at the HSS:

- IMPU.
- IMPI.

The target identity in the IMPU format may contain a SIP URI, TEL URI.

5.7.2 LIPF logic for service type of PTC

Figure 5.7.2-1 illustrates the LIPF logic for the provisioning of IRI-POI/CC-POI in the PTC server.

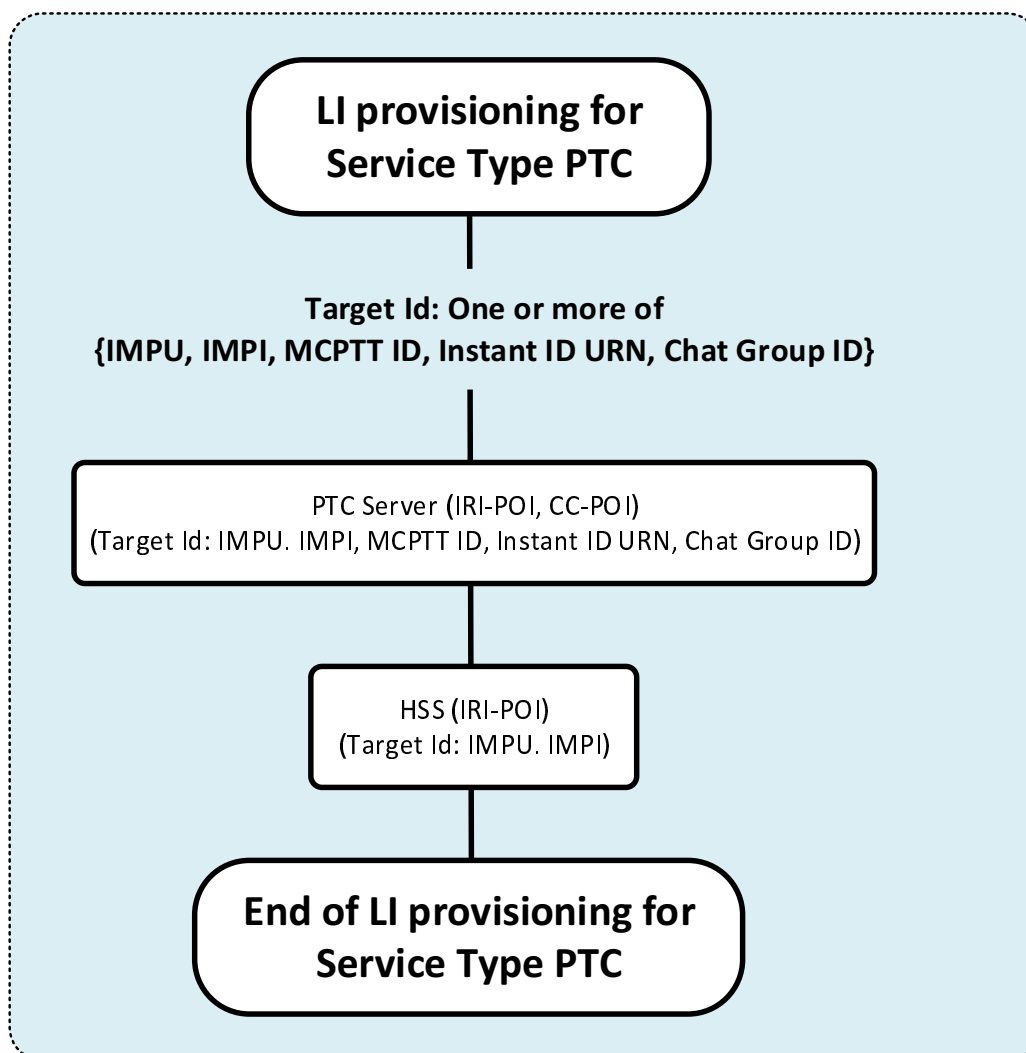

Figure 5.7.2-1: LIPF logic for provisioning the IRI-POI/CC-POI in PTC Server for the service type of PTC

When the Chat Group ID is used as the target ID, the PTC server happens to intercept when the indicated chat group ID is used for a PTC chat session.

5.8 LALS

5.8.1 Scope of interception

The illustrations shown in this clause are for the service type LALS.

The interception of service type of LALS includes the delivery of target's location information either immediate (at the time of provisioning) or periodic by the LI-LCS Client.

5.8.2 LIPF logic for service type of LALS

Figure 5.8.2-1 illustrates the LIPF logic for the provisioning of LI-LCS Client.

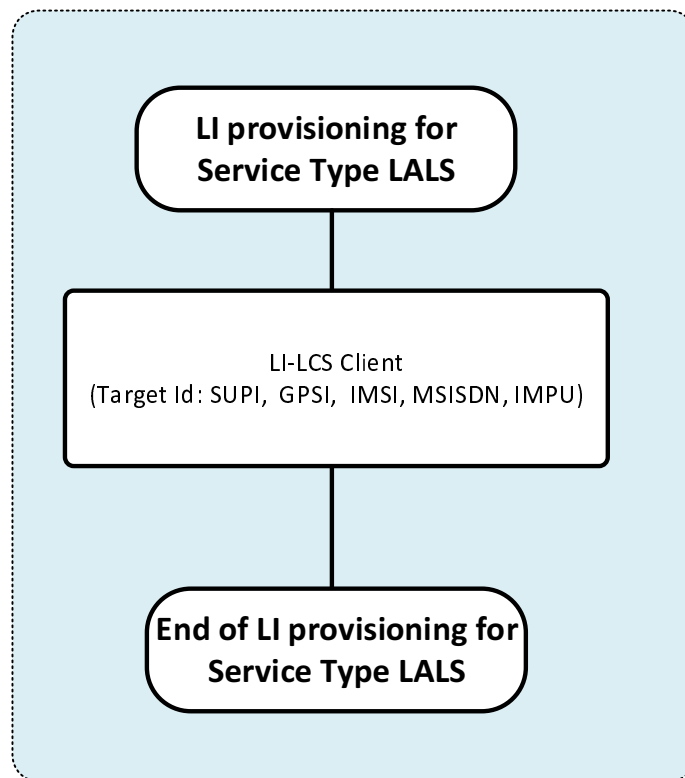

Figure 5.8.2-1: LIPF logic the provisioning of LI-LCS Client for the service type of LALS

5.9 Void

5.10 RCS

5.10.1 Scope of interception

The illustrations shown in this clause are for the service type RCS. The RCS services may be provided by the CSP or by a third party service provider. In the latter case, the provisioning logic defined below applies to the RCS service provider. The S-CSCF in the CSP domain if involved may still need to report the RCS registration related events.

A target can be a subscriber of the RCS service provider or a non-local ID. In the case where a target is a non-local ID, the party communicating with the target is a subscriber of RCS service provider.

The interception of service type of RCS is done by the IRI-POI and CC-POI present in the RCS server, the IRI-POI and CC-POI present in the HTTP Content Server and File Transfer Localization Function and the IRI-POI present in the S-CSCF (always CSP).

For the cases where the file transfer related events cannot be associated to a provisioned target identity in the HTTP Content Server and the File Transfer Localization Function, the TFs (IRI-TF and CC-TF) present in the RCS Server trigger the POIs (i.e. the triggered IRI-POI and the triggered CC-POI) in the HTTP Content Server and File Transfer Localization Function.

For one file transfer related event, either the triggered IRI-POI or non-triggered IRI-POI in the HTTP Content Server and the File Transfer Localization Function generate the xIRIs. Likewise, to deliver the content of the file, either the triggered CC-POI or non-triggered CC-POI in the HTTP Content Server and the File Transfer Localization Function generate the xCC.

If the File Transfer Localization Function is not deployed by the RCS Service Provider, the reporting what would have been done by the LI function in the File Transfer Localization Function cannot be done.

The IRI-POI present in the S-CSCF reports just the RCS Registration related xIRI when the same cannot be reported by the IRI-POI present in the RCS Server (i.e. the case where IMS and RCS services are provided by different service providers).

5.10.2 LIPF logic for service type of RCS

Figure 5.10.2-1 illustrates the LIPF logic for the service type RCS.

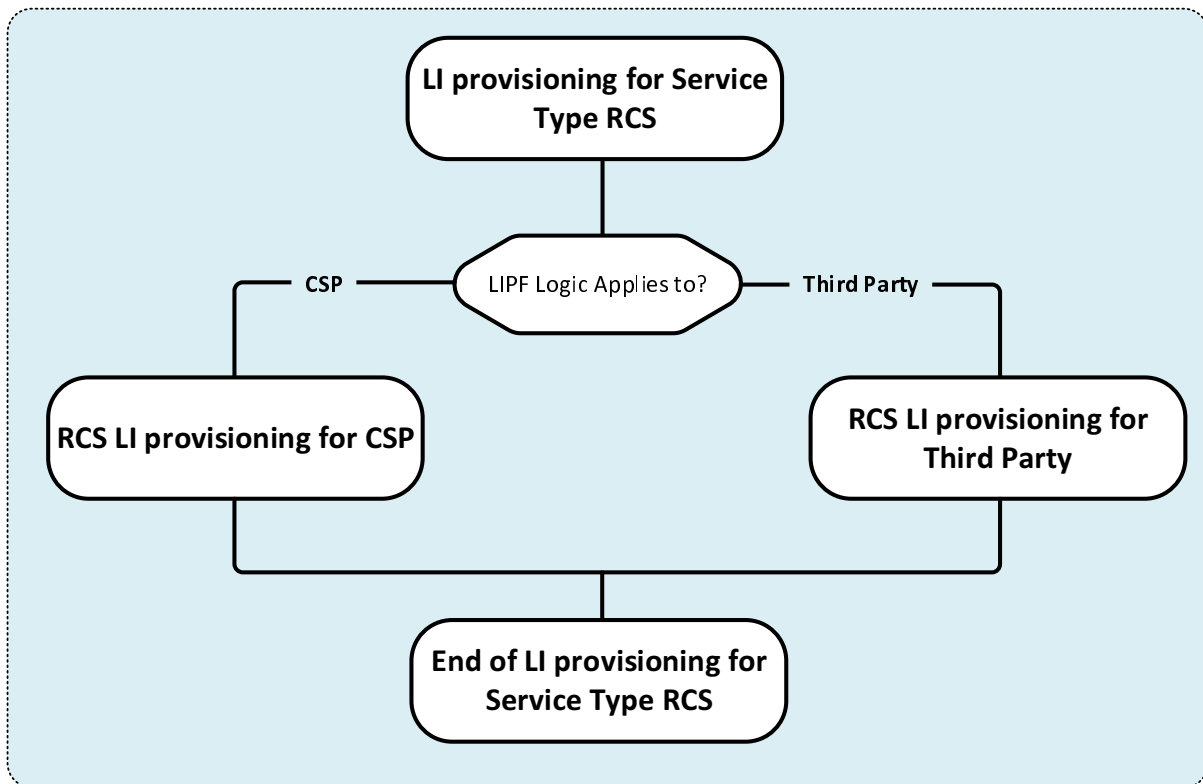

Figure 5.10.2-1: LIPF logic for provisioning for the service type RCS

Figure 5.10.2-2 illustrates the RCS LI provisioning logic as applicable to CSP, and figure 5.10.2-3 illustrates the RCS-LI provisioning logic as applicable to the third party service provider.

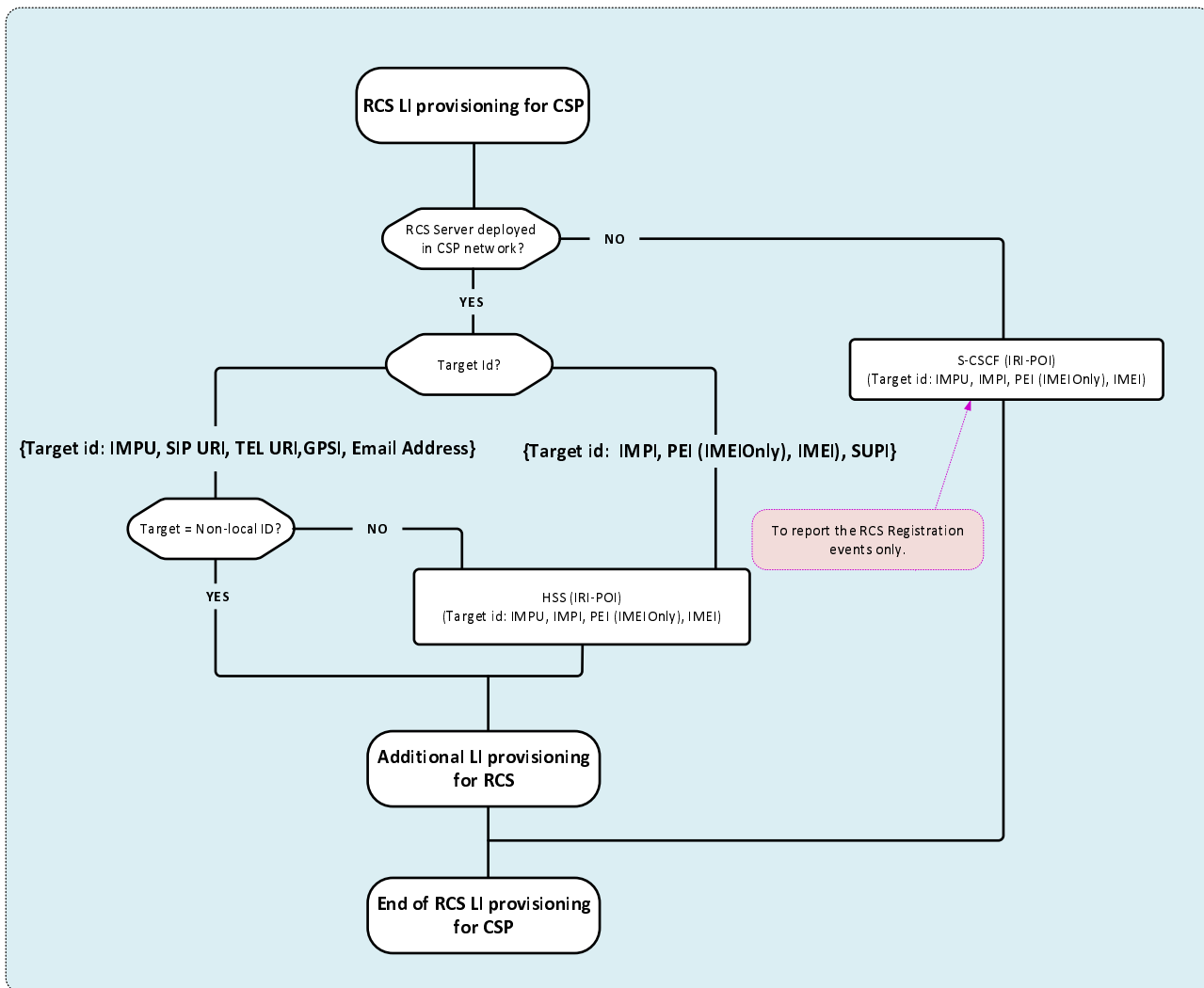

Figure 5.10.2-2: RCS LI provisioning as applicable to a CSP

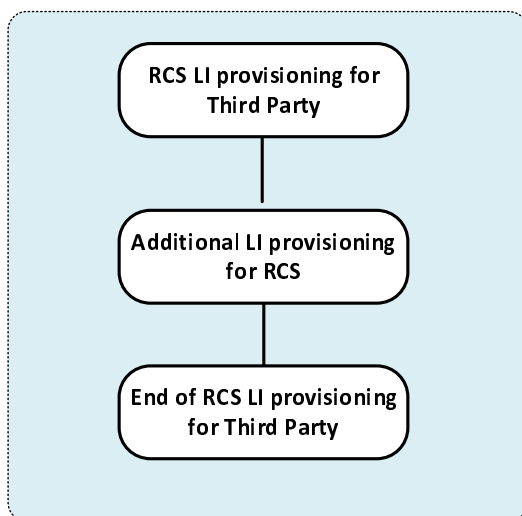

Figure 5.10.2-3: RCS LI provisioning as applicable to third party service provider

As shown in figure 5.10.2-2, the provisioning of IRI-POI in HSS is not applicable for target non-local ID. Also, provisioning of IRI-POI in the HSS is not applicable for the RCS provider when different from a CSP. The provisioning of an IRI-POI in the S-CSCF is not required if the RCS server is deployed in CSP network.

Figure 5.10.2-4 illustrates the LIPF logic for additional LI provisioning for RCS.

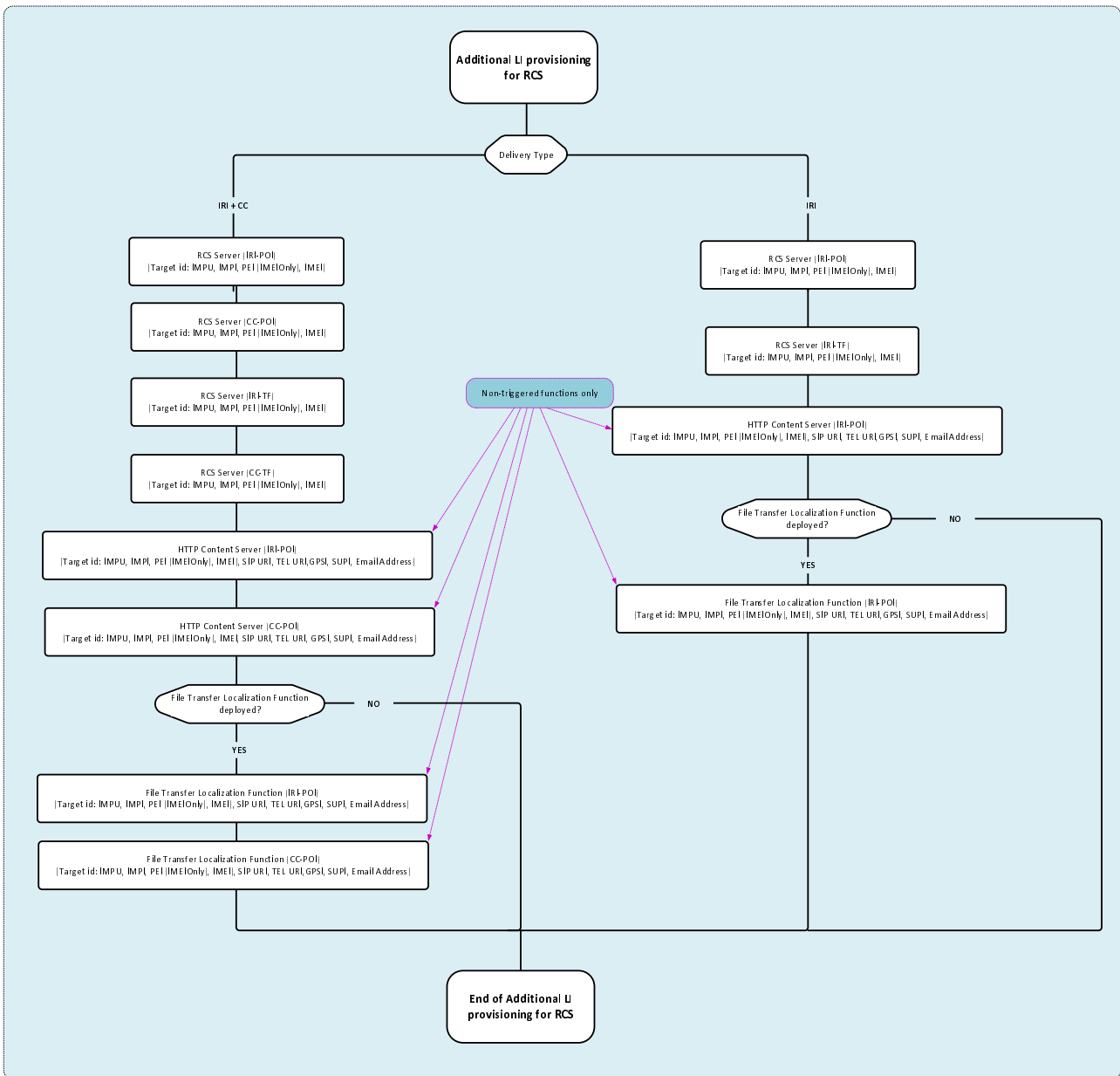

Figure 5.10.2-4: Additional LIPF logic for provisioning for the service type RCS

The provisioning of IRI-POI, CC-POI in HTTP Content Server and File Transfer Localization Function is only for the POIs triggered from the IRI-TF, CC-TF present in the RCS Server.

The following target identifiers are applicable to the service type of RCS for provisioning the IRI-POI/CC-POI at the RCS Server:

- IMPU.
- IMPI.
- PEI (IMEI only).
- IMEI.

The target identity in the IMPU format may contain a SIP URI, TEL URI.

The following target identifiers are applicable to the service type of RCS for provisioning the IRI-POI/CC-POI at the HTTP Content Server and File Transfer Localization Function:

- SIP URI.
- TEL URI.
- GPSI.
- SUPI.
- IMSI.
- MSISDN.
- Email Address.

The target identity in the GPSI format may contain a GPSIIMSI or GPSINAI. The target identity in the SUPI format may contain SUPIIMSI or SUPINAI.

5.10.3 Interception

5.10.3.1 Deployment

The CSP may or may not deploy a File Transfer Localization Function.

If the File Transfer Localization Function is not deployed, then reporting of xIRIs and xCC that were supposed to be reported from IRI-POI and CC-POI in the File Transfer Localization Function is not possible. This limitation happens when a target or party communicating with the target non-local ID downloads a file from the HTTP Content Server.

The RCS Server and the IMS may be managed by different service providers. When the RCS Server is deployed and managed by a different provider, the IRI-POI in the S-CSCF present of the IMS provider network is able to report RCS registration related xIRIs.

5.10.3.2 Summary

Table 5.10.3.2-1 provides the scope of NF domain that provides the IRI-POI/IRI-TF/CC-TF/CC-POI functions for the service type of RCS.

Table 5.10.3.2-1: Scope of NF providing the LI functions for RCS

NF with the LI function	CSP provides IMS and RCS			IMS provider is different from RCS provider			RCS provider
	Roaming			IMS provider			
	Not	Outbound	Inbound	Not	Outbound	Inbound	
HSS (target local)	IRI-POI	IRI-POI	n/a	IRI-POI	IRI-POI	n/a	n/a
HSS (target non-local)	n/a	n/a	n/a	n/a	n/a	n/a	n/a
S-CSCF	n/a	n/a	n/a	IRI-POI	IRI-POI	n/a	n/a
RCS Server	IRI-POI	IRI-POI	n/a	n/a	n/a	n/a	IRI-POI
RCS Server	CC-POI	CC-POI	n/a	n/a	n/a	n/a	CC-POI
RCS Server	IRI-TF	IRI-TF	n/a	n/a	n/a	n/a	IRI-TF
RCS Server	CC-TF	CC-TF	n/a	n/a	n/a	n/a	CC-TF
HTTP Content Server	IRI-POI	IRI-POI	n/a	n/a	n/a	n/a	IRI-POI
HTTP Content Server	CC-POI	CC-POI	n/a	n/a	n/a	n/a	CC-POI
File Transfer Localization Function	IRI-POI	IRI-POI	n/a	n/a	n/a	n/a	IRI-POI
File Transfer Localization Function	CC-POI	CC-POI	n/a	n/a	n/a	n/a	CC-POI

NOTE 1: The use of "n/a" in the above table implies that the LI function is not applicable to the NF for the indicated scenario.

NOTE 2: The LIPF is not aware of the above role played by the NFs in providing the LI functions nor the roaming situations of the target or the party communicating with the target non-local ID.

NOTE 3: The LIPF is aware of whether RCS services are provided by CSP (that provides the IMS services) or in third party service provider.

NOTE 4: MDF2 and MDF3 which are also involved in providing the LI functions are not shown in the tables above.

Annex C (informative): Bibliography

Annex Z (informative): Change history

Change history							
Date	Meeting	TDoc	CR	Rev	Cat	Subject/Comment	New version
2023-04	SA3LI#89	S3i230321				Initial Version	0.0.1
2023-04	SA3LI#89	S3i230325				Agreed for Change Control	2.0.0
2023-05	SA#100	SP-230439				Submitted to SA#100 Plenary with minor editorial update	2.0.1
2023-06	-	-				Published following SA#100 Plenary approval	18.0.0
2023-09	SA#101	SP-230827	0002	1	B	More on LIPF logic diagrams: Updates to the top-level and introduction clauses	18.1.0
2023-09	SA#101	SP-230827	0003	1	B	More on LIPF logic diagrams: Top-level views	18.1.0
2023-09	SA#101	SP-230827	0004	1	B	More on LIPF logic diagrams: Logic for Location Acquisition	18.1.0
2023-09	SA#101	SP-230827	0005	1	B	More on LIPF logic diagrams: Detailed logic for the service type of RCS	18.1.0
2023-09	SA#101	SP-230827	0006	1	B	More on LIPF logic diagrams: Logic of LI provisioning for additional services with Data	18.1.0
2023-09	SA#101	SP-230827	0007	1	B	More on LIPF logic diagrams: Logic of LI provisioning for AKMA	18.1.0
2023-09	SA#101	SP-230827	0008	1	B	More on LIPF logic diagrams: Logic of LI provisioning for NIDD	18.1.0
2023-09	SA#101	SP-230827	0009	1	B	More on LIPF logic diagrams: Logic of LI provisioning for ECS	18.1.0
2023-09	SA#101	SP-230827	0010	1	B	More on LIPF logic diagrams: Logic of LI provisioning for 5G MS	18.1.0
2023-12	SA#102	SP-231603	0011	-	F	Moving the Location Acquisition related text from clause 5.9 to 5.3.4	18.2.0
2023-12	SA#102	SP-231603	0012	-	F	New clause on destination end point and provisioning of MDFs	18.2.0
2024-03	SA#103	SP-240139	0013	1	B	LIPF Logic for NWDAF provisioning	18.3.0
2024-06	SA#104	SP-240566	0014	1	F	Supporting of Email Address as a target non-local ID for MMS	18.4.0
2024-06	SA#104	SP-240566	0015	-	F	Supporting HPLMN-based initial configuration for HR LI	18.4.0

History

Document history		
V18.3.0	May 2024	Publication
V18.4.0	July 2024	Publication